

**MEGA  
BLOKS**

# PROBUILDER<sup>®</sup>

9735



## FDNY<sup>™</sup> FIRETRUCK



A portion of the proceeds from the sale of this FIRE ZONE product benefits the FDNY Fire Safety Education Fund.

Una parte de los beneficios derivados de la venta del producto FIRE ZONE serán destinados a la FDNY Fire Safety Education Fund.

Une partie des recettes de la vente de ce produit FIRE ZONE sera versée au FDNY Fire Safety Education Fund.

Instruction Book  
Manual de instrucciones  
Livret d'instructions

1

Ages / Años / Âges

Pieces / Piezas / Pièces

































































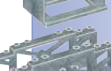























































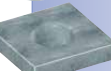





























7+

1120

The FDNY<sup>™</sup> name and logos are the exclusive property of the Fire Department of the City of New York being used under license and may not be reproduced or copied without its express written permission. 2002 FDNY Fire Safety Education Fund, Inc. All Rights Reserved.

El nombre FDNY<sup>™</sup> y los logotipos son propiedad exclusiva del Departamento de Bomberos de la ciudad de Nueva York; están bajo licencia y no pueden ser reproducidos o copiados sin previa autorización expresa por escrito. 2002 FDNY Fire Safety Education Fund, Inc. Todos los derechos reservados.

Le nom et les logos FDNY<sup>™</sup>, utilisés sous licence, sont la propriété exclusive du Service d'incendie de la ville de New York et ne peuvent être reproduits ou copiés sans leur autorisation écrite expresse. 2002 FDNY Fire Safety Education Fund, Inc. Tous droits réservés.

	<b>8x</b>	M1113F		<b>2x</b>	M02250F		<b>7x</b>	M1389F		<b>2x</b>	M1322F		<b>1x</b>	M09013F		<b>3x</b>	M09023F		<b>16x</b>	M1172F		<b>6x</b>	AS0973516
	<b>2x</b>	M1113X		<b>2x</b>	M02250W		<b>7x</b>	M1390F		<b>2x</b>	M1322A		<b>41x</b>	M09013A		<b>9x</b>	M09023A		<b>5x</b>	M1172E		<b>1x</b>	AM02267N
	<b>14x</b>	M1113ZD		<b>6x</b>	M02250N		<b>2x</b>	M1148F		<b>3x</b>	M1322E		<b>9x</b>	M09013E		<b>3x</b>	M09023N		<b>4x</b>	M1172N		<b>1x</b>	AM02200N
	<b>6x</b>	M1113E		<b>40x</b>	M09393F		<b>2x</b>	M11161F		<b>2x</b>	M1417N		<b>11x</b>	M09013N		<b>47x</b>	M09033F		<b>8x</b>	AM02237F		<b>1x</b>	AM02200N
	<b>10x</b>	AM1113JX		<b>40x</b>	M09393A		<b>2x</b>	M11162F		<b>2x</b>	M1323F		<b>15x</b>	M1419N		<b>46x</b>	M09033A		<b>2x</b>	AM02237A		<b>2x</b>	AM02193N
	<b>4x</b>	M1312F		<b>2x</b>	M09393X		<b>6x</b>	M11101F		<b>4x</b>	AM02206A		<b>4x</b>	M1087F		<b>25x</b>	M09033N		<b>2x</b>	AM02237E		<b>6x</b>	AM02209N
	<b>2x</b>	AM1312JX		<b>10x</b>	M09393E		<b>20x</b>	M0948F		<b>7x</b>	M10273F		<b>16x</b>	M1087A		<b>1x</b>	AM01555F		<b>2x</b>	AM02237E		<b>4x</b>	AM02199N
	<b>8x</b>	M1124F		<b>6x</b>	M09393W		<b>12x</b>	M0948A		<b>4x</b>	M1154F		<b>7x</b>	M1087N		<b>16x</b>	M1480F		<b>8x</b>	AM02237N		<b>4x</b>	AM02199N
	<b>16x</b>	M1225N		<b>5x</b>	AM09393JX		<b>2x</b>	M0948X		<b>8x</b>	M1154A		<b>8x</b>	M1313F		<b>13x</b>	M1480A		<b>1x</b>	AM02237N		<b>4x</b>	AM02199N
	<b>2x</b>	M0910X		<b>18x</b>	M09393N		<b>5x</b>	M0948N		<b>6x</b>	AM02212A		<b>6x</b>	M1313A		<b>2x</b>	M1480E		<b>2x</b>	AM02237E		<b>4x</b>	AM02198N
	<b>22x</b>	M0910F		<b>20x</b>	M1314F		<b>1x</b>	AM01495F		<b>4x</b>	M1139E		<b>1x</b>	M1313E		<b>18x</b>	M1480N		<b>1x</b>	AM02237E		<b>1x</b>	AM02211N
	<b>8x</b>	M0910A		<b>7x</b>	M1314A		<b>2x</b>	M1146N		<b>2x</b>	AM02196JX		<b>2x</b>	M1313N		<b>2x</b>	AM02190A		<b>2x</b>	AM02237E		<b>1x</b>	AM02211N
	<b>2x</b>	M1086F		<b>6x</b>	M1314E		<b>4x</b>	M1142N		<b>1x</b>	AM02187JX		<b>6x</b>	M10233F		<b>2x</b>	AM02189A		<b>2x</b>	AM02237E		<b>1x</b>	AM02211N
	<b>5x</b>	M1086A		<b>9x</b>	M1314N		<b>2x</b>	M1141N		<b>2x</b>	AM02195JX		<b>27x</b>	M10233A		<b>6x</b>	AM02210A		<b>2x</b>	AM02237E		<b>1x</b>	AM02211N
	<b>4x</b>	M1086E		<b>21x</b>	M09593F		<b>22x</b>	M09493F		<b>18x</b>	M09493A		<b>5x</b>	M10233E		<b>6x</b>	AM02210A		<b>8x</b>	AM02237E		<b>1x</b>	AM02211N
	<b>6x</b>	M1086N		<b>29x</b>	M09593A		<b>18x</b>	M09493A		<b>41x</b>	M09493N		<b>4x</b>	M10233N		<b>2x</b>	AM02194A		<b>1x</b>	AM02237E		<b>1x</b>	AM02211N
	<b>3x</b>	AM01684JX		<b>21x</b>	M09593E		<b>18x</b>	M09493A		<b>2x</b>	AM02213JX		<b>2x</b>	AM02204N		<b>2x</b>	AM02194A		<b>1x</b>	AM02237E		<b>1x</b>	AM02211N
	<b>1x</b>	AM02184JX		<b>63x</b>	M09593N		<b>4x</b>	M09493N		<b>1x</b>	AM02185JX		<b>1x</b>	AM02204N		<b>2x</b>	AM02194A		<b>1x</b>	AM02237E		<b>1x</b>	AM02211N
	<b>4x</b>	AM02191JX		<b>3x</b>	AM01797N		<b>4x</b>	AM01531N		<b>8x</b>	AM02205JX		<b>2x</b>	AM02203N		<b>2x</b>	AM02194A		<b>1x</b>	AM02237E		<b>1x</b>	AS0973513 AS0973514





Active step / Étape active / Etapa activa / Azione attiva  
 Aktivt skede / Actieve stap / アクティブなステップ / 積極步驟  
 Previous step / Étape précédente / Etapa precedente  
 Azione precedente / Föregående skedet / Vorige stap  
 前のステップ / 上一步驟

Color chart.

Charte de couleurs.

Cuadro cromático.

Quadro cromatico.

Färgtabell.

Kleurenkaart.

カラーチャート

色彩表

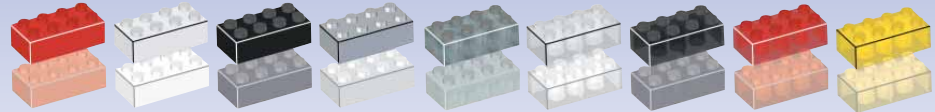

Adult assistance is required. / L'aide d'un adulte est requise. / Necesita ayuda de un adulto. / È necessario l'aiuto di un adulto. /  
 Hjälp av en vuxen är nödvändigt. / Hulp van een volwassene is gewenst. / 大人の方が手伝ってあげる必要があります。 / 需要成年人協助

**⚠ WARNING:**  
 Choking hazard - Small parts.  
 Not for children under 3 years.

**⚠ AVERTISSEMENT:**  
 Risque de suffocation. Ne convient pas à un enfant  
 de moins de 3 ans - contient de petits éléments.

**⚠ ADVERTENCIA:**  
 Peligro de asfixia. No recomendado para niños  
 menores de 3 años - contiene piezas pequeñas.

**⚠ AVVERTENZA:**  
 Rischio di soffocamento. Non adatta ad un bambino  
 di età minore ai 36 mesi. Contiene parti piccole - non  
 ingerire.

**⚠ VARNING:**  
 Risk for kvävning. Ikke egnet til barn under  
 3 år - inneholder smådelar.

**⚠ WAARSCHUWING:**  
 Stikgevaar. Niet geschikt voor kinderen onder  
 3 jaar - i.v.m. kleine onderdelen.

**⚠ 注意:**  
 飲み込むと危険です。  
 小さいパーツがあるので、  
 3才以下の幼児には  
 与えないでください。  
 ⚠ 不适于三岁以下儿童。

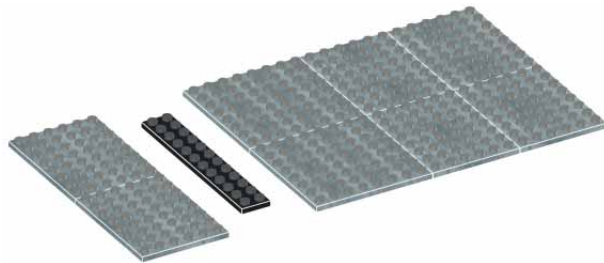
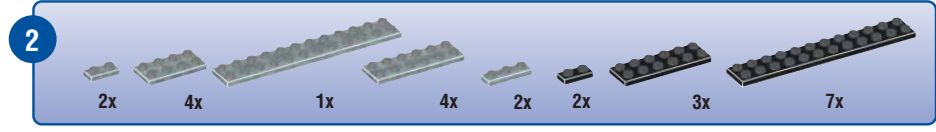
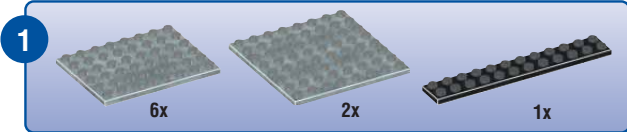



Active step / Étape active / Etapa activa / Azione attiva  
 Aktivt skede / Active step / アクティブなステップ / 積極步驟  
 Previous step / Étape précédente / Etapa precedente  
 Azione precedente / Föregående skedet / Vorige stap  
 前のステップ / 上一步驟

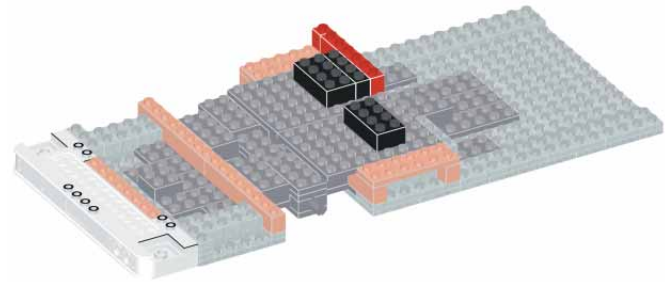
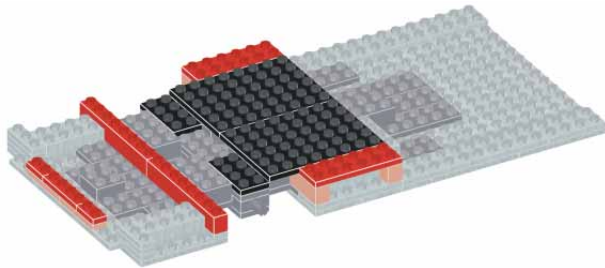
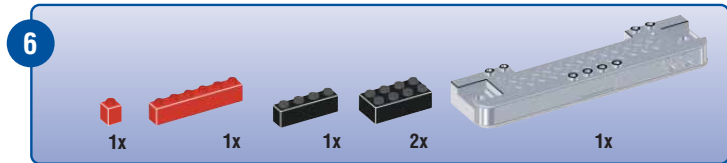
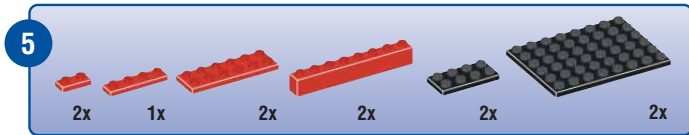
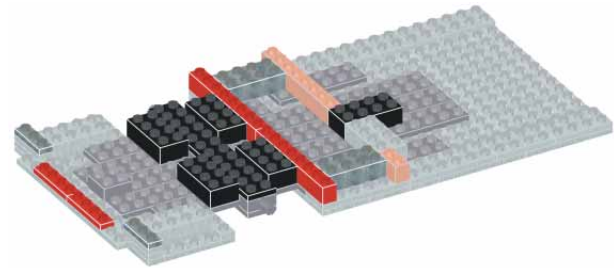
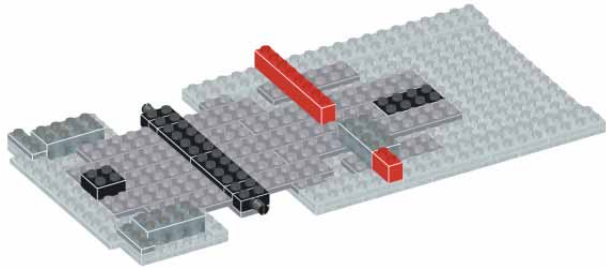
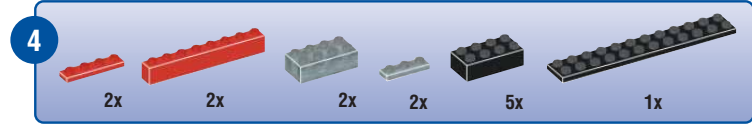
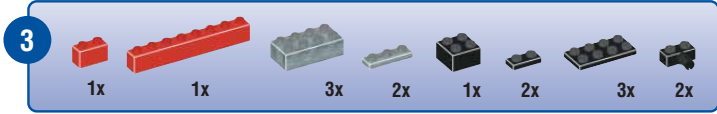
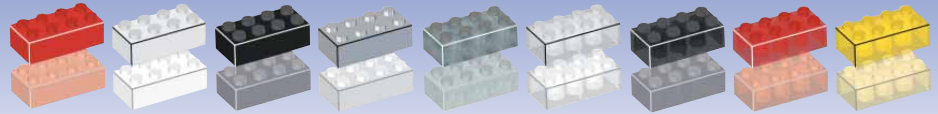

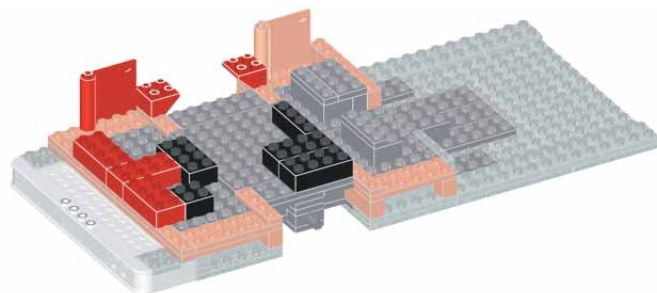
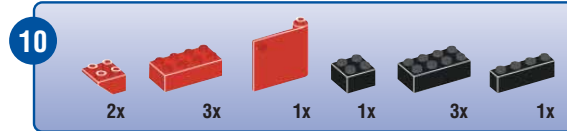
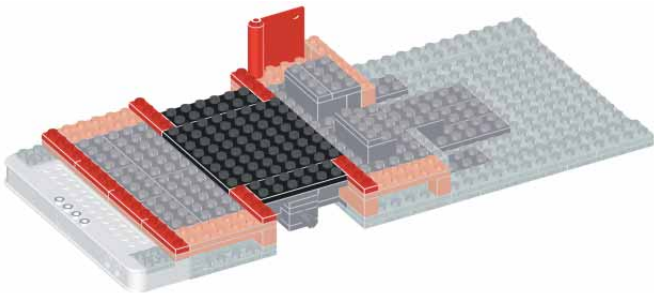
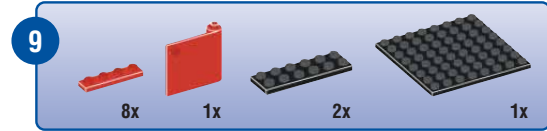
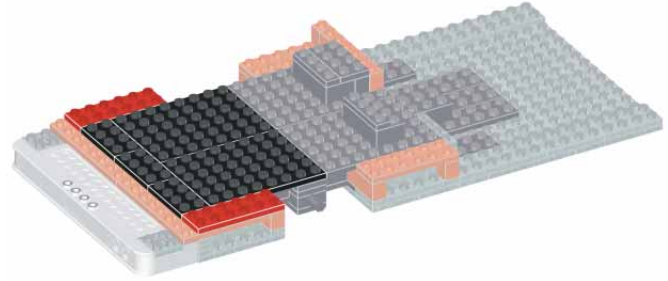
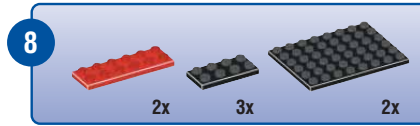
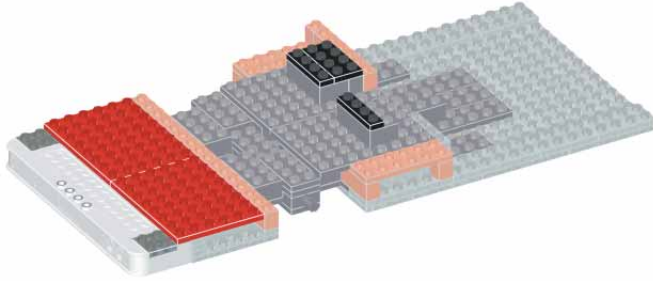
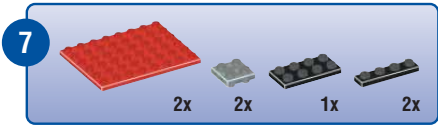



Active step / Étape active / Etapa activa / Azione attiva  
 Aktivt skede / Actieve stap / アクティブなステップ / 積極步驟  
 Previous step / Étape précédente / Etapa precedente  
 Azione precedente / Föregående skedet / Vorige stap  
 前のステップ / 上一步驟

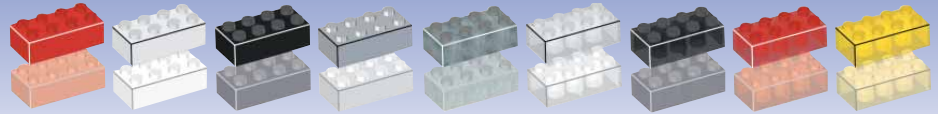

11

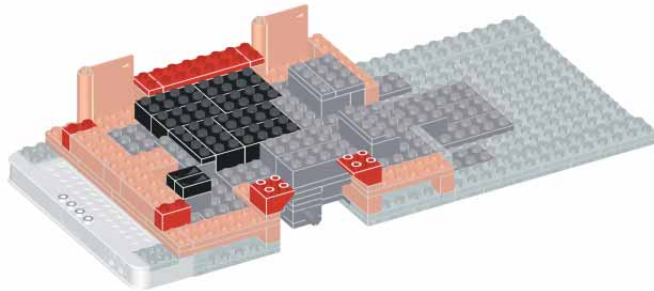
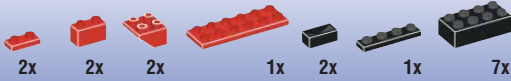

12

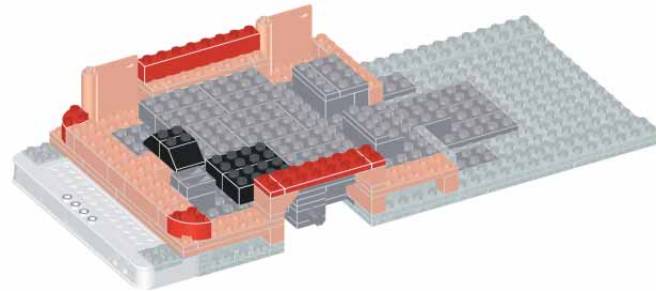
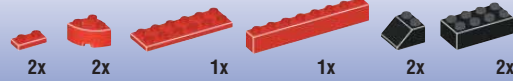

13

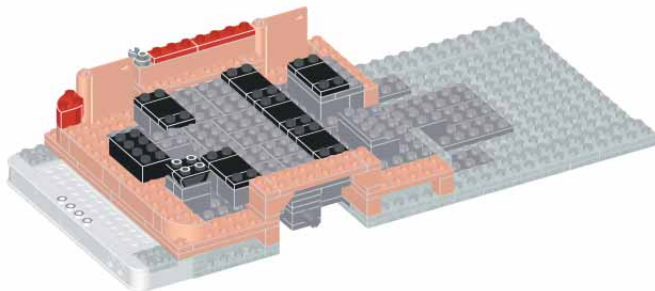

14

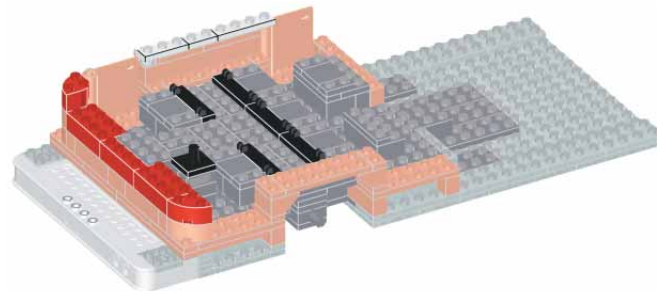
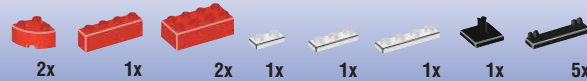



15

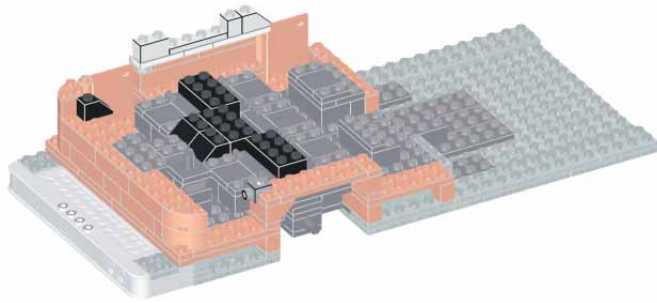

16

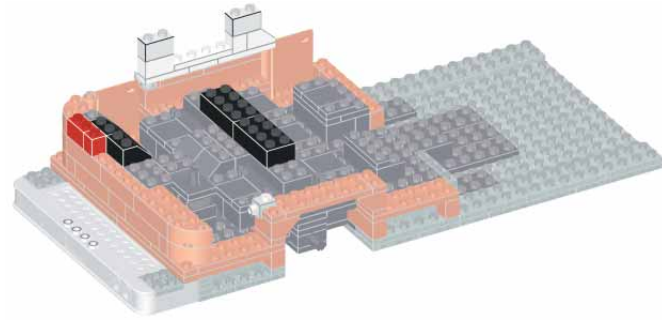

17

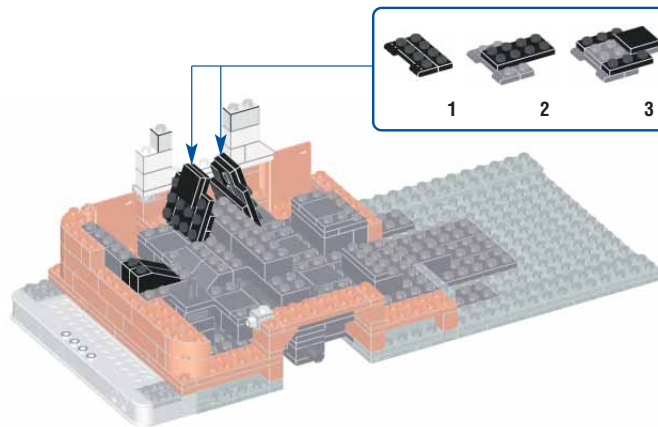

18

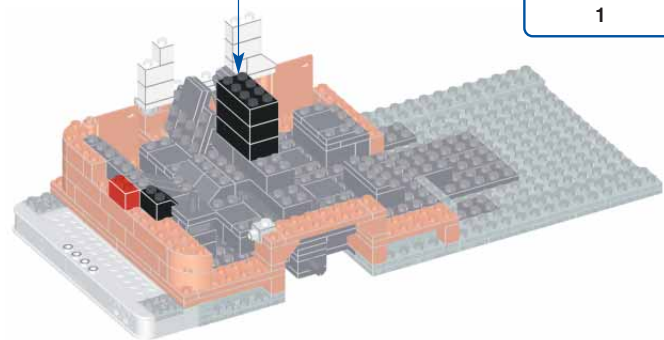
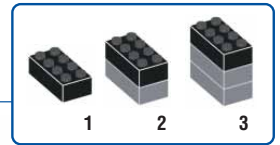



Active step / Étape active / Etapa activa / Azione attiva  
 Aktivt skede / Actieve stap / アクティブなステップ / 積極步驟  
 Previous step / Étape précédente / Etapa precedente  
 Azione precedente / Föregående skedet / Vorige stap  
 前のステップ / 上一步驟

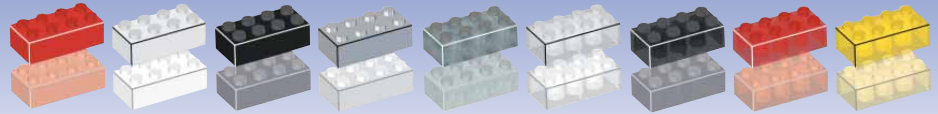

19

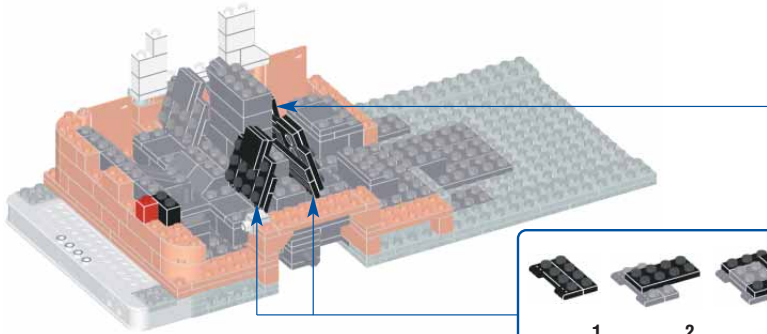

20

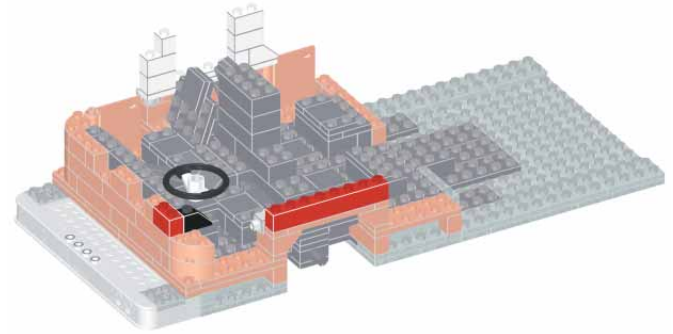
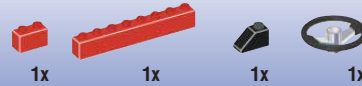

21

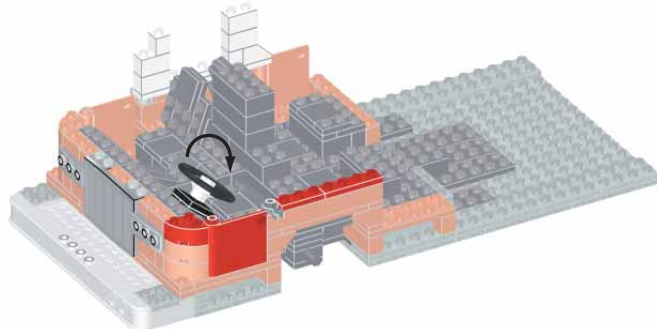
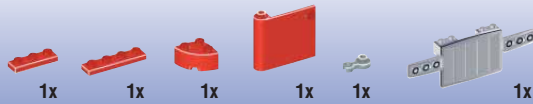

22

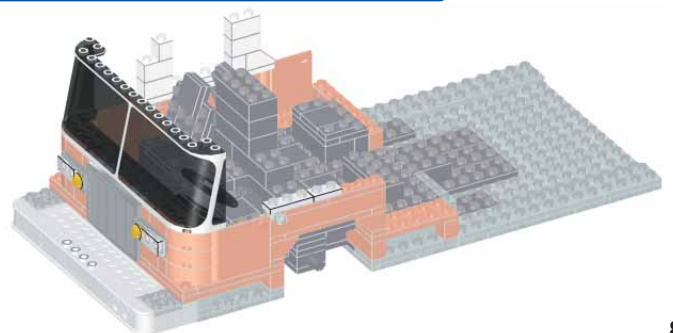
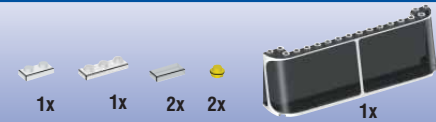



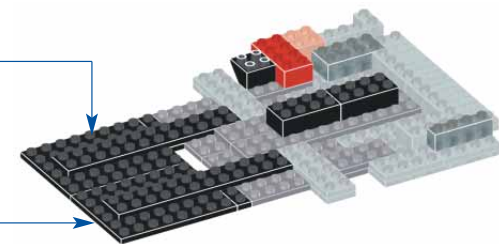
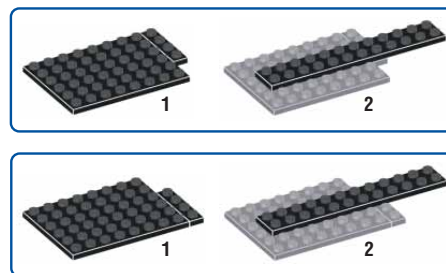
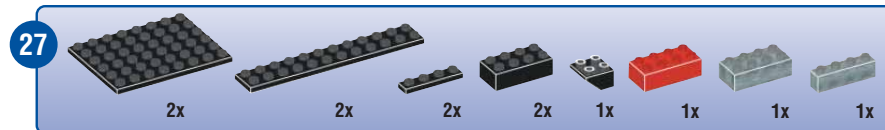
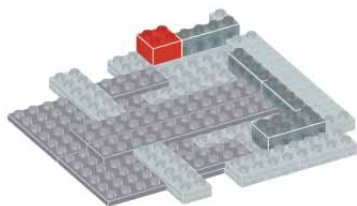
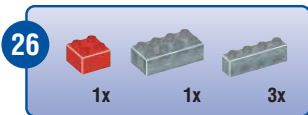
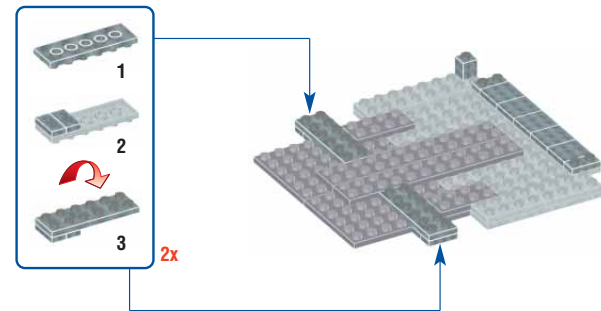
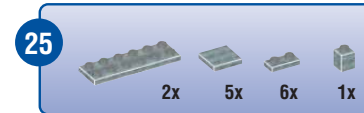
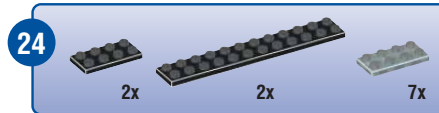
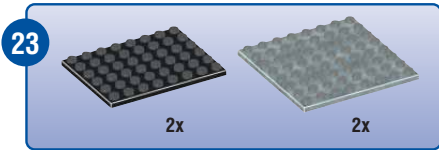



Active step / Étape active / Etapa activa / Azione attiva  
 Aktivt skede / Aktieve stap / アクティブなステップ / 積極步驟  
 Previous step / Étape précédente / Etapa precedente  
 Azione precedente / Föregående skedet / Vorige stap  
 前のステップ / 上一步驟

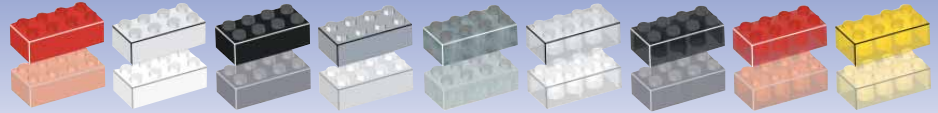

28

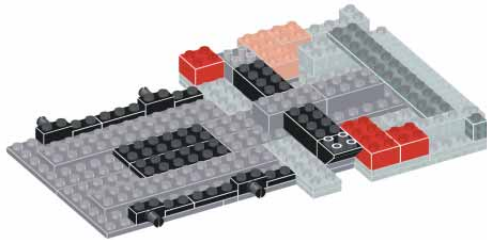
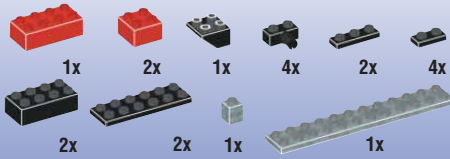

29

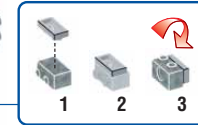
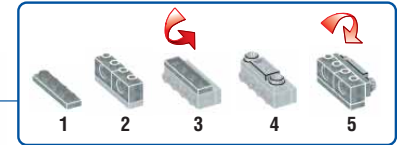
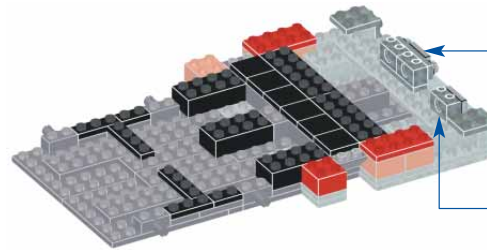

30

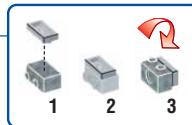
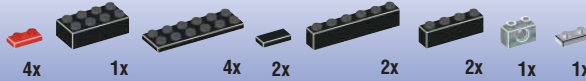

31

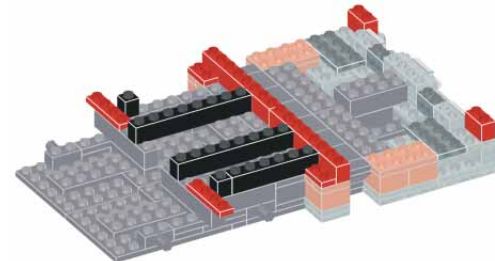
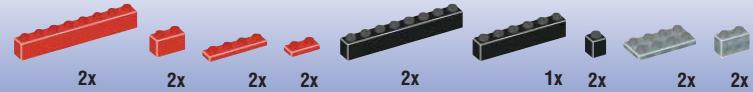

32

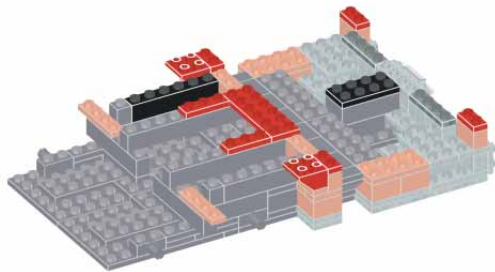

33

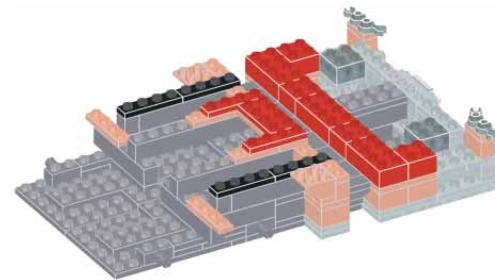
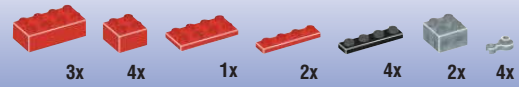

34

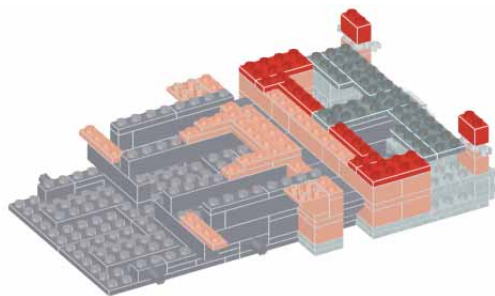

35

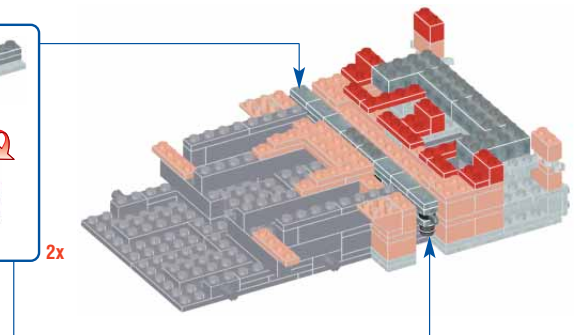
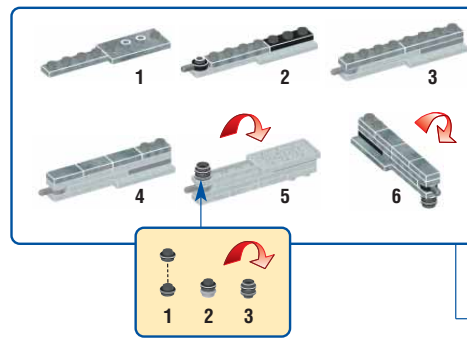
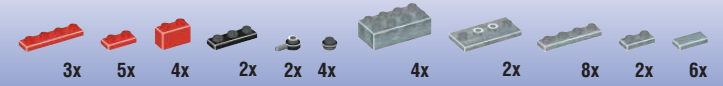





Active step / Étape active / Etapa activa / Azione attiva  
 Aktivt skede / Actieve stap / アクティブなステップ / 積極步驟  
 Previous step / Étape précédente / Etapa precedente  
 Azione precedente / Föregående skedet / Vorige stap  
 前のステップ / 上一步驟



36

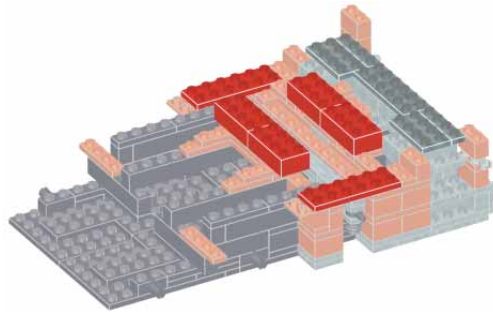
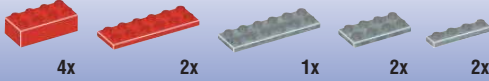

37

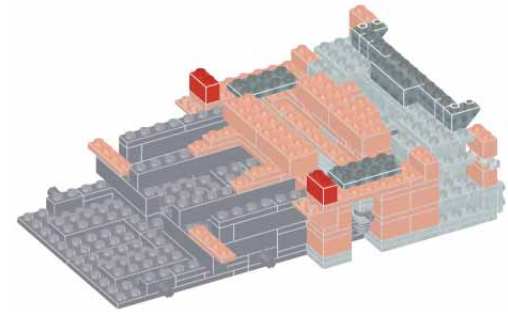
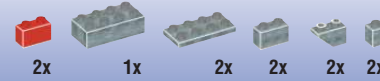

38

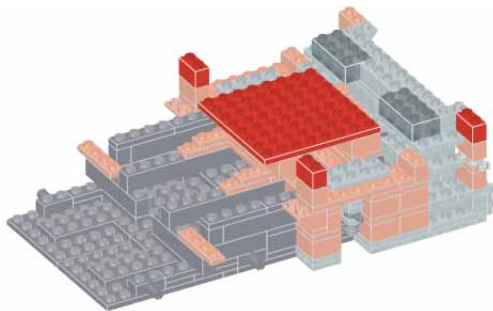
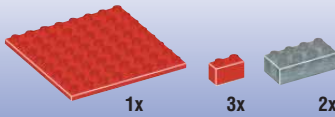

39

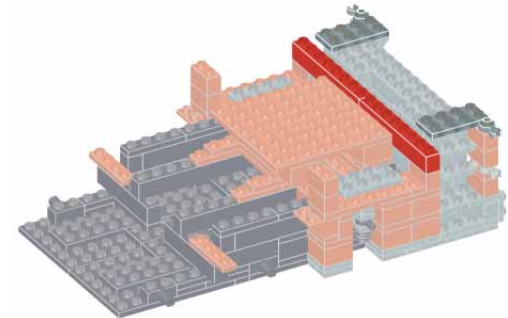
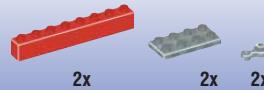

40

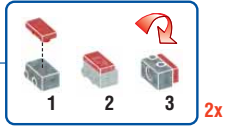
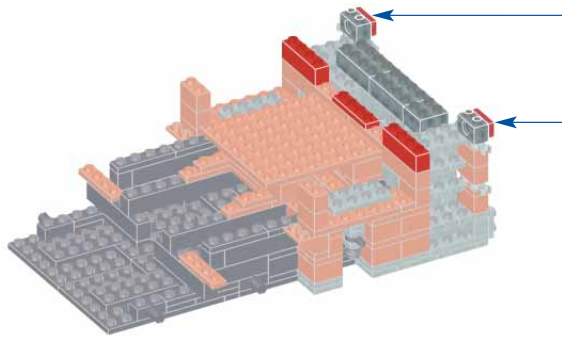

41

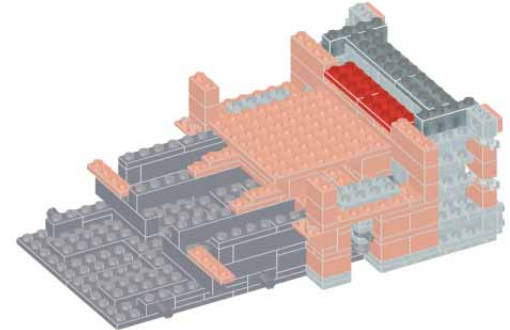
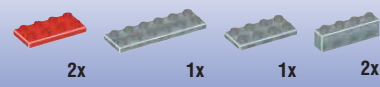

42

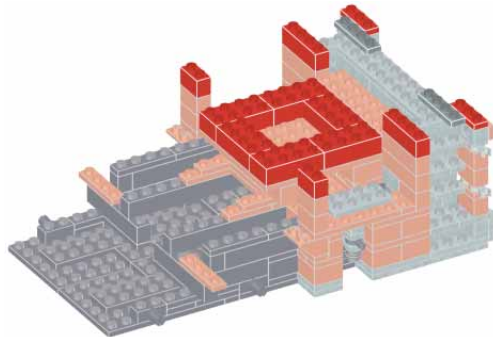

43

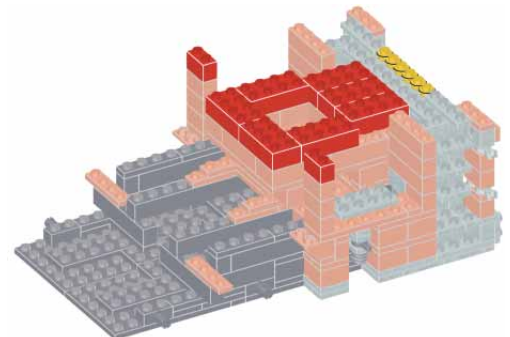
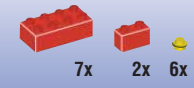



Active step / Étape active / Etapa activa / Azione attiva  
 Aktivt skede / Actieve stap / アクティブなステップ / 積極步驟  
 Previous step / Étape précédente / Etapa precedente  
 Azione precedente / Föregående skedet / Vorige stap  
 前のステップ / 上一步驟

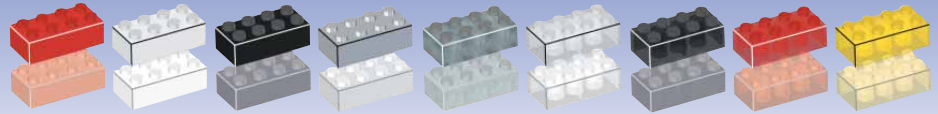

44

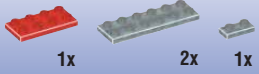

1x 2x 1x

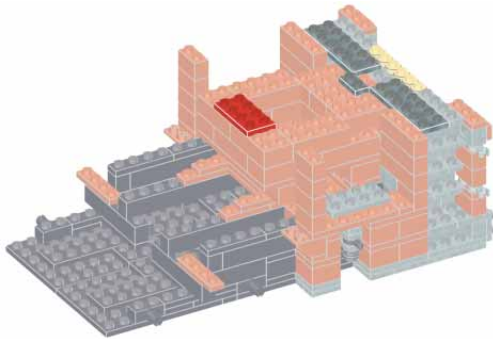

45



2x 2x 2x 2x

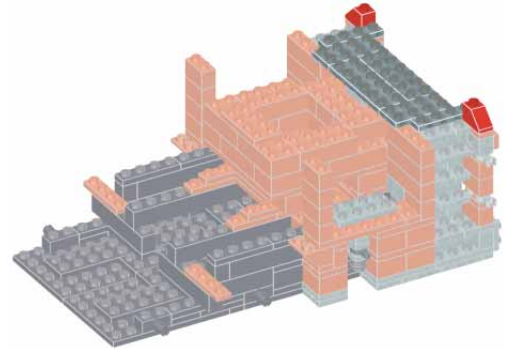

46

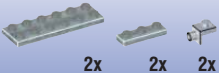

2x 2x 2x

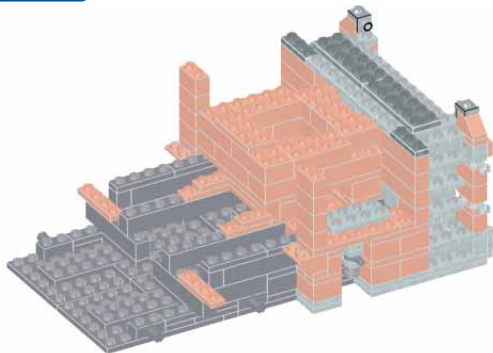

47



2x 2x 2x

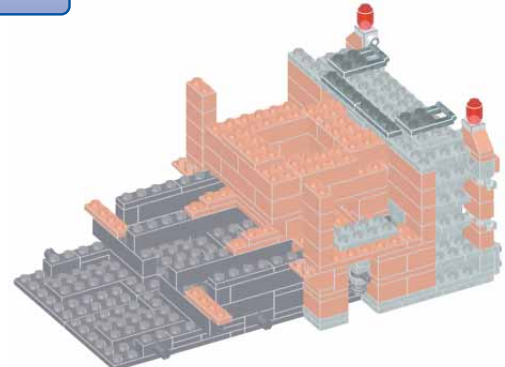



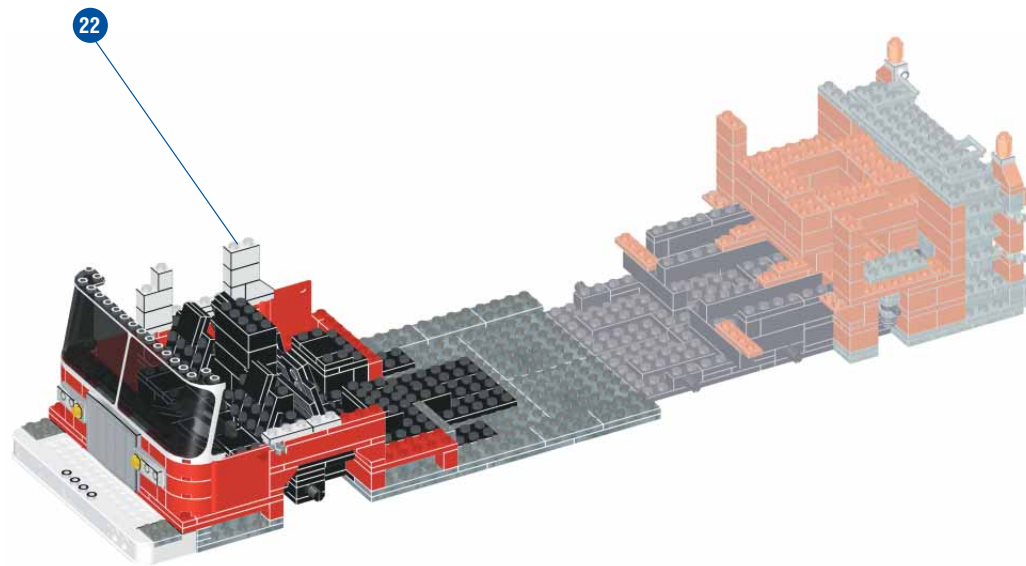



Active step / Étape active / Etapa activa / Azione attiva  
Aktivt skede / Actieve stap / アクティブなステップ / 積極步驟  
Previous step / Étape précédente / Etapa precedente  
Azione precedente / Föregående skedet / Vorige stap  
前のステップ / 上一步驟

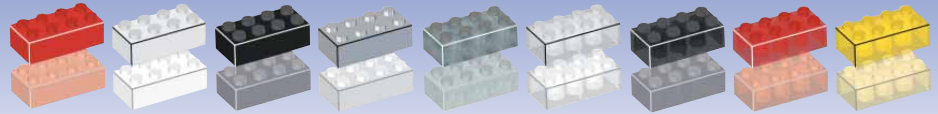

49

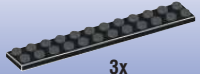

3x

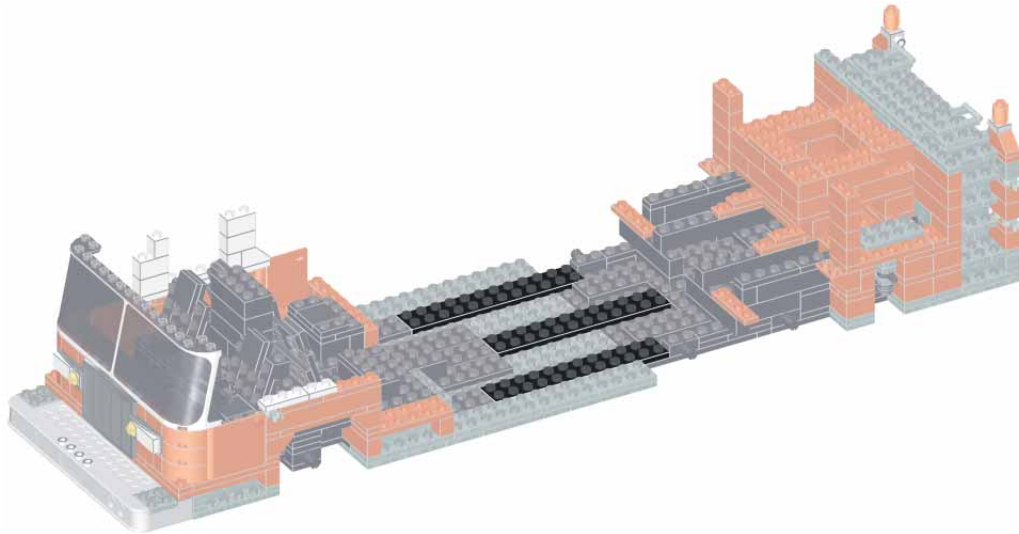

50

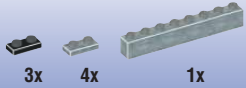

3x 4x 1x

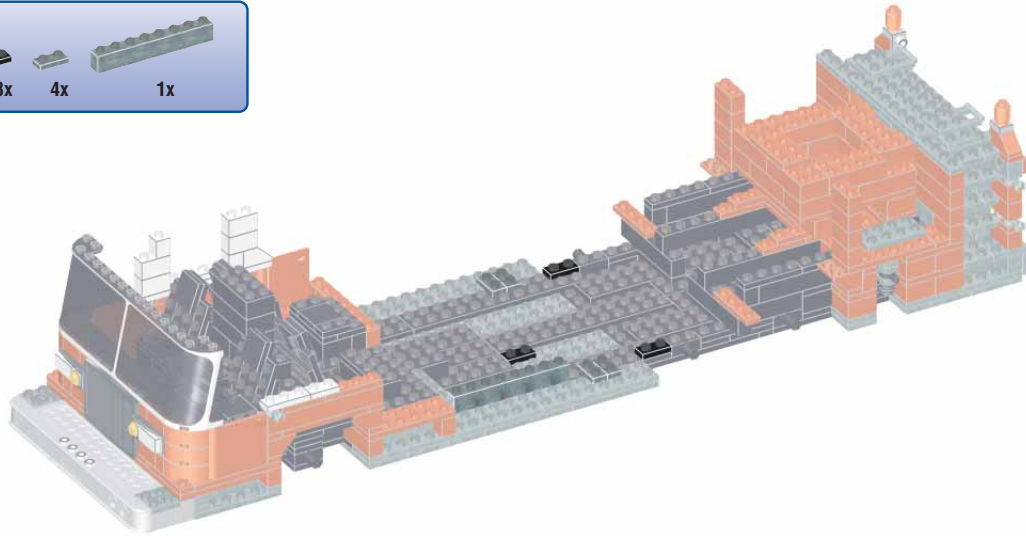

51

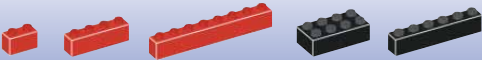

1x 1x 4x 2x 2x

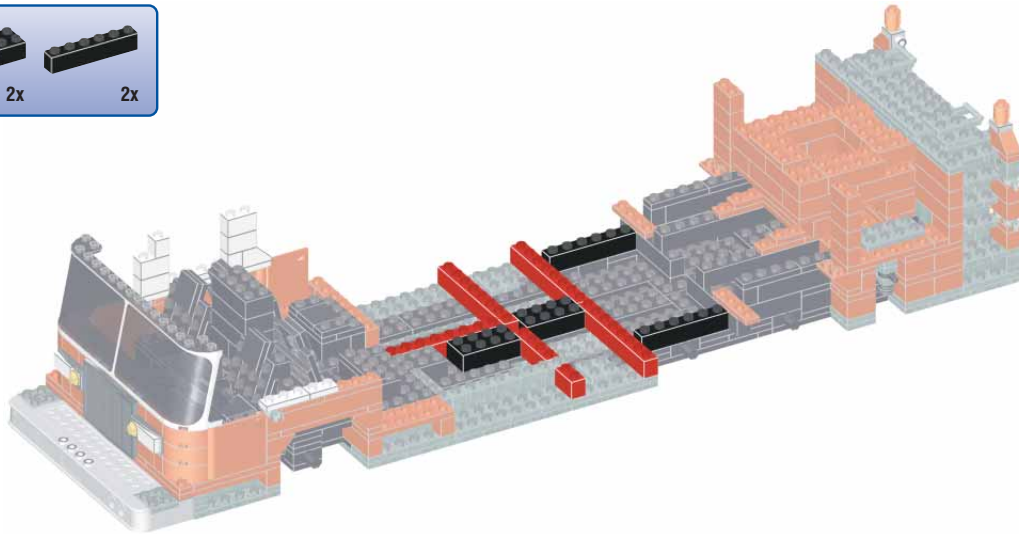







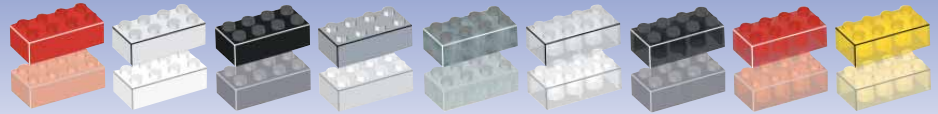

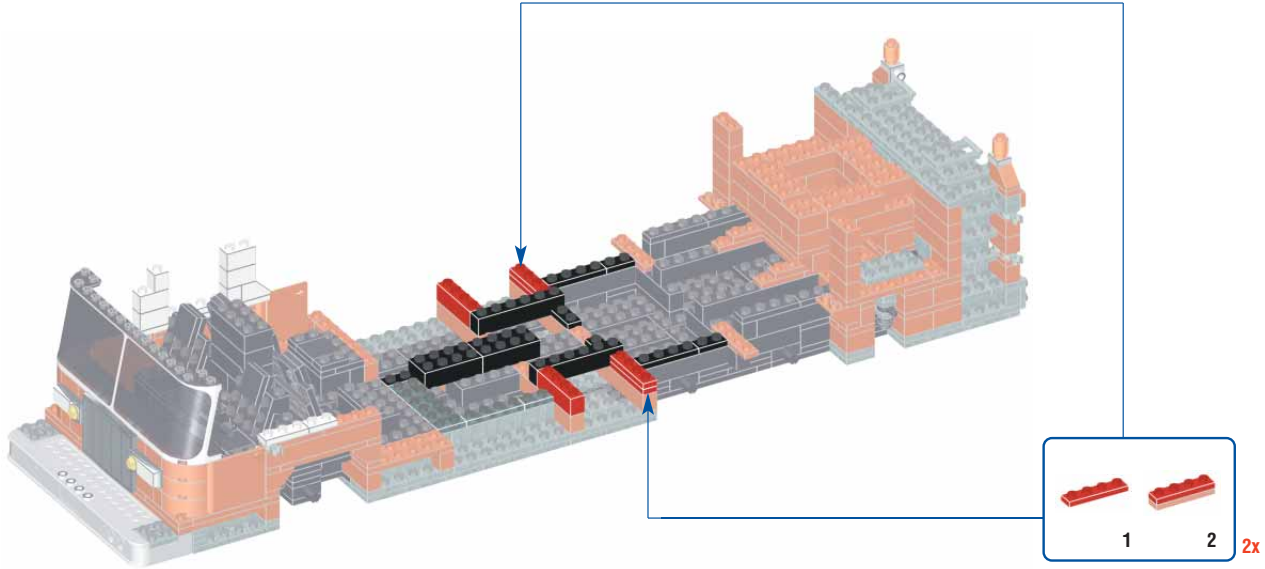
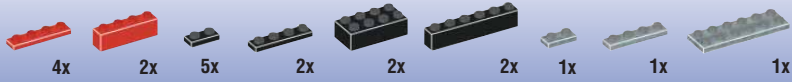

Active step / Étape active / Etapa activa / Azione attiva  
 Aktivt skede / Actieve stap / アクティブなステップ / 積極步驟  
 Previous step / Étape précédente / Etapa precedente  
 Azione precedente / Föregående skedet / Vorige stap  
 前のステップ / 上一步驟



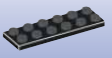
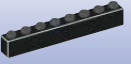

52





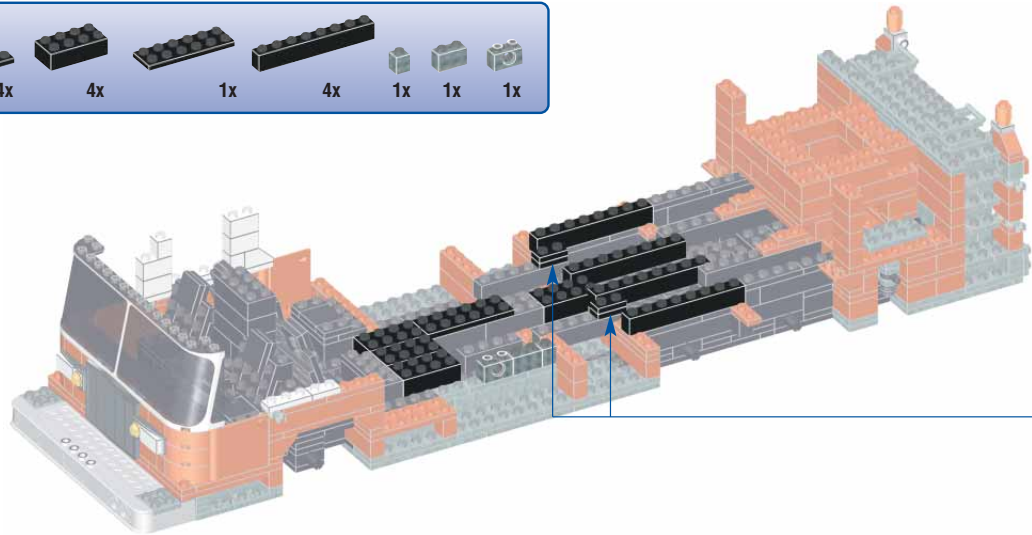





53

-  4x
-  4x
-  1x
-  4x
-  1x
-  1x
-  1x



-  1
  -  2
- 2x

54

-  4x
-  2x
-  2x
-  3x
-  1x
-  1x
-  3x
-  1x
-  2x

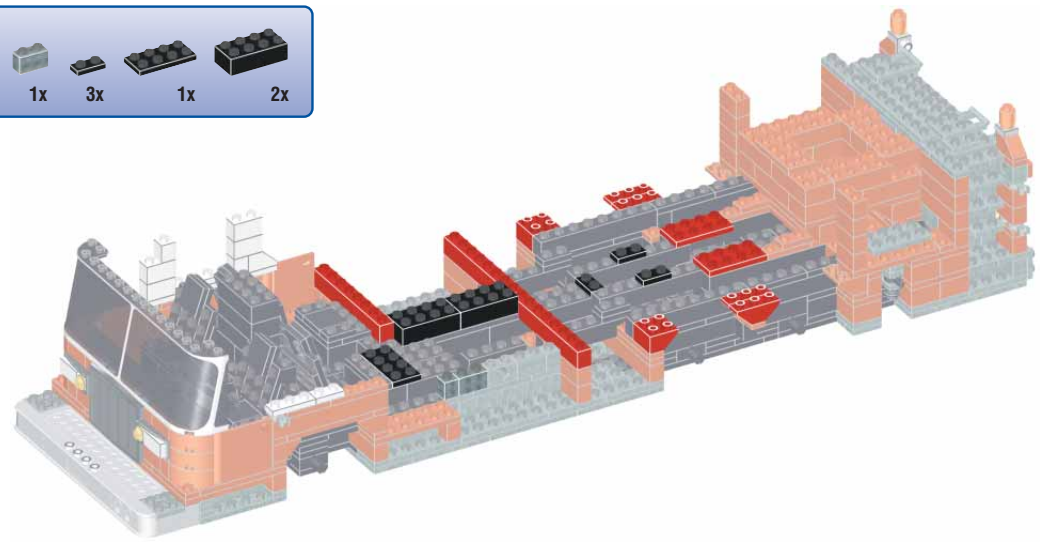



Active step / Étape active / Etapa activa / Azione attiva  
 Aktivt skede / Active step / アクティブなステップ / 積極步驟  
 Previous step / Étape précédente / Etapa precedente  
 Azione precedente / Föregående skedet / Vorige stap  
 前のステップ / 上一步驟

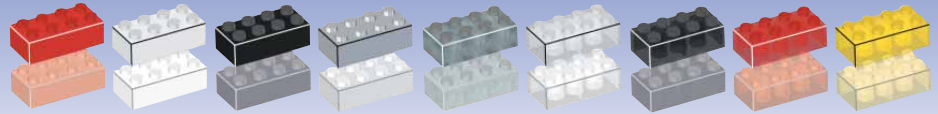

55

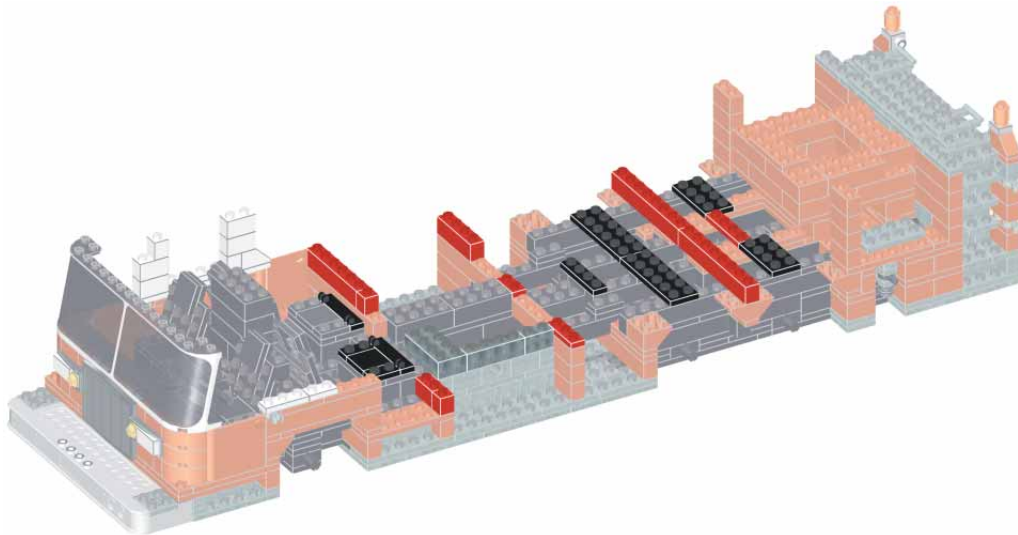

56

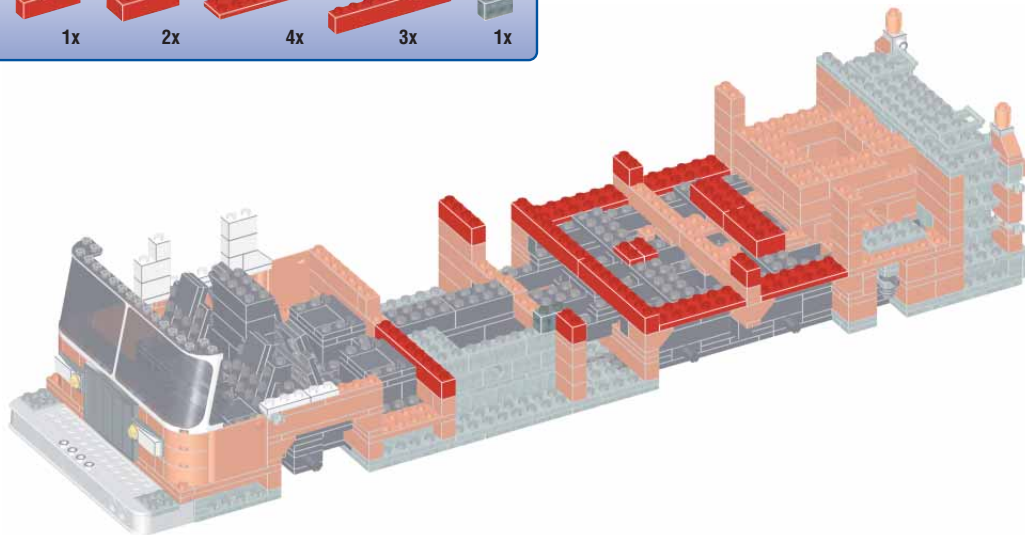
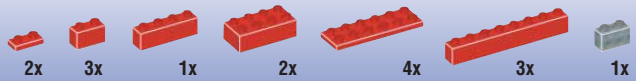

57

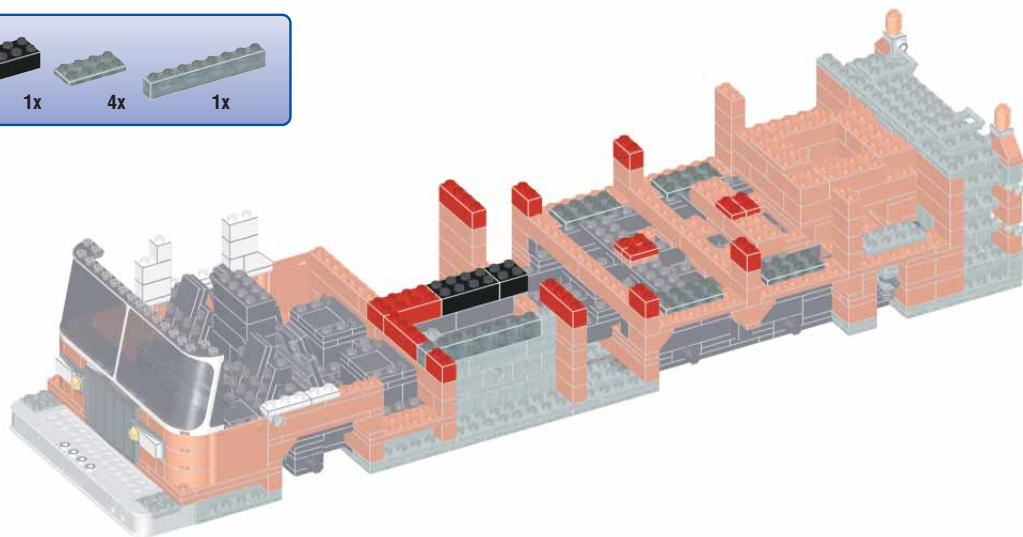







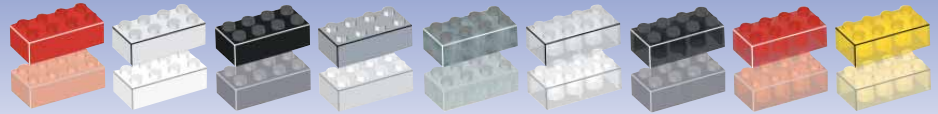



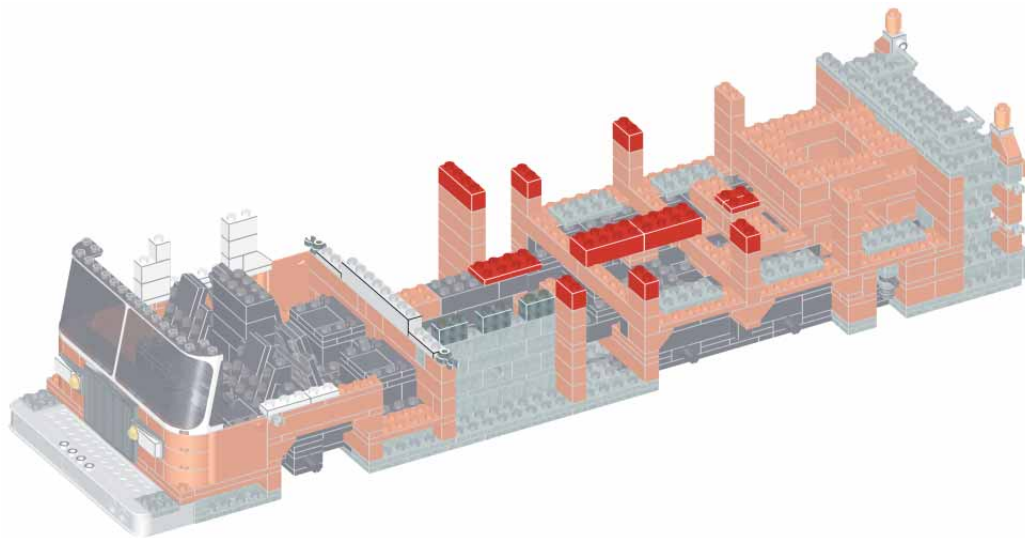
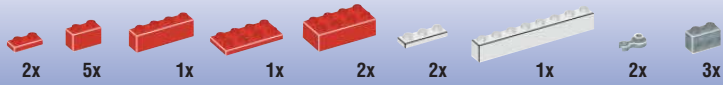

Active step / Étape active / Etapa activa / Azione attiva  
 Aktivt skede / Aktieve stap / アクティブなステップ / 積極步驟  
 Previous step / Étape précédente / Etapa precedente  
 Azione precedente / Föregående skedet / Vorige stap  
 前のステップ / 上一步驟





58



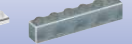

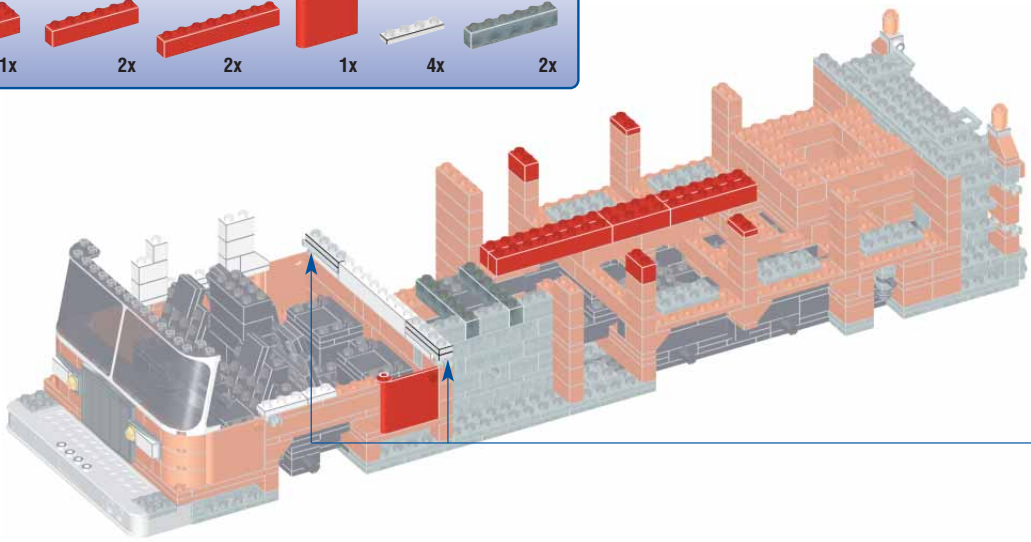



59

-   
2x
-   
2x
-   
1x
-   
2x
-   
2x
-   
1x
-   
4x
-   
2x





-   
1
  -   
2
- 2x

60

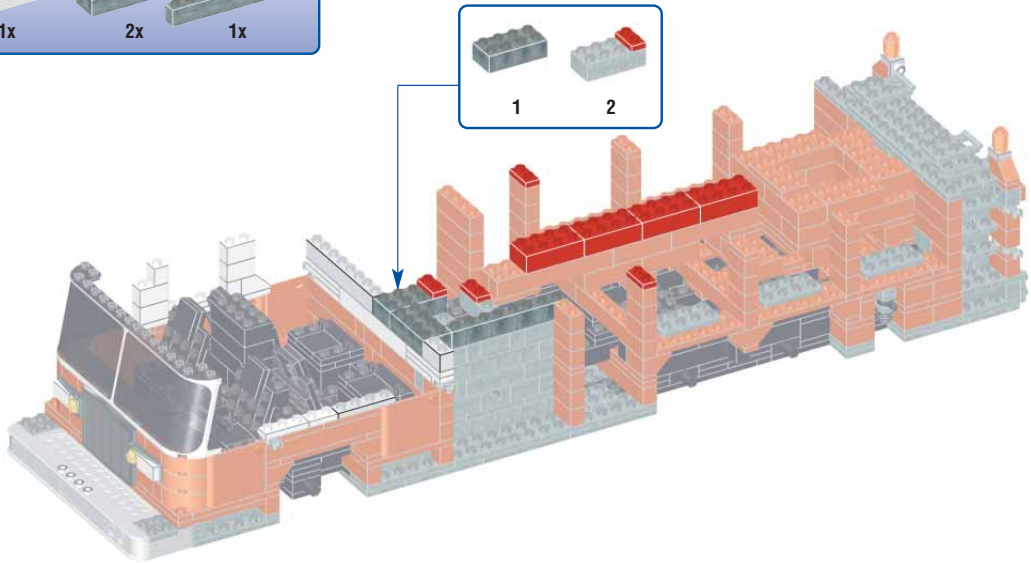
-   
4x
-   
4x
-   
1x
-   
1x
-   
1x
-   
2x
-   
1x



-   
1
-   
2



Active step / Étape active / Etapa activa / Azione attiva  
 Aktivt skede / Actieve stap / アクティブなステップ / 積極步驟  
 Previous step / Étape précédente / Etapa precedente  
 Azione precedente / Föregående skedet / Vorige stap  
 前のステップ / 上一步驟

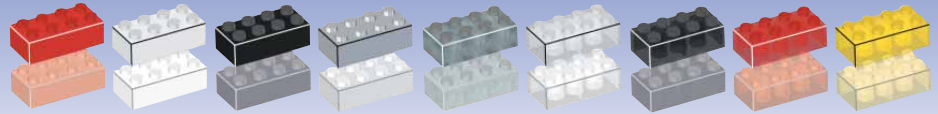

61

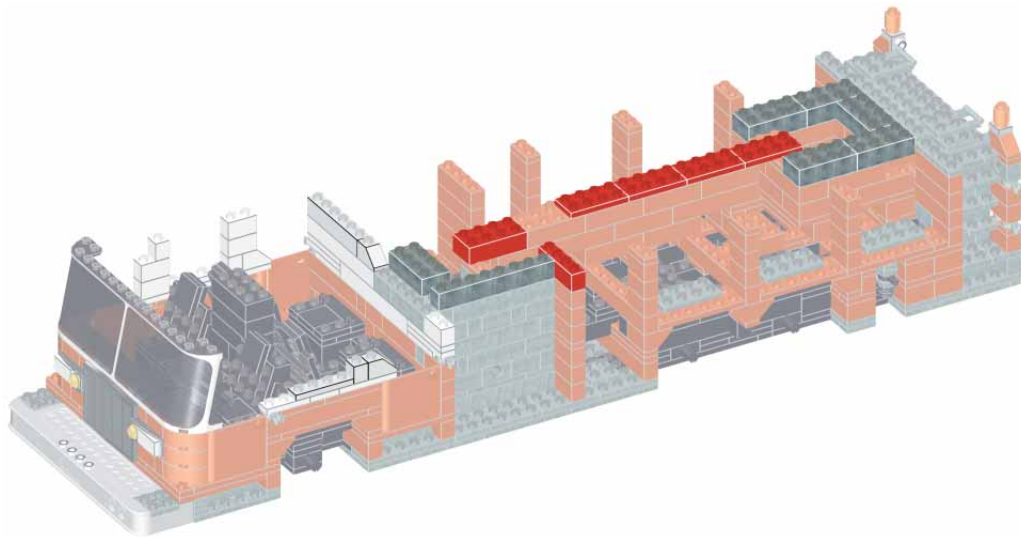
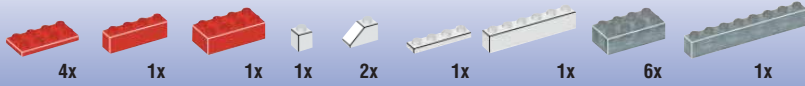

**MEGA  
BLOKS**

# PROBUILDER<sup>®</sup>

9735



## FDNY<sup>™</sup> FIRETRUCK



A portion of the proceeds from the sale of this FIRE ZONE product benefits the FDNY Fire Safety Education Fund.

Una parte de los beneficios derivados de la venta del producto FIRE ZONE serán destinados a la FDNY Fire Safety Education Fund.

Une partie des recettes de la vente de ce produit FIRE ZONE sera versée au FDNY Fire Safety Education Fund.

Instruction Book  
Manual de instrucciones  
Livret d'instructions

2

Ages / Años / Âges

Pieces / Piezas / Pièces

7+

1120

The FDNY<sup>™</sup> name and logos are the exclusive property of the Fire Department of the City of New York being used under license and may not be reproduced or copied without its express written permission. 2002 FDNY Fire Safety Education Fund, Inc. All Rights Reserved.

El nombre FDNY<sup>™</sup> y los logotipos son propiedad exclusiva del Departamento de Bomberos de la ciudad de Nueva York; están bajo licencia y no pueden ser reproducidos o copiados sin previa autorización expresa por escrito. 2002 FDNY Fire Safety Education Fund, Inc. Todos los derechos reservados.

Le nom et les logos FDNY<sup>™</sup>, utilisés sous licence, sont la propriété exclusive du Service d'incendie de la ville de New York et ne peuvent être reproduits ou copiés sans leur autorisation écrite expresse. 2002 FDNY Fire Safety Education Fund, Inc. Tous droits réservés.





Active step / Étape active / Etapa activa / Azione attiva  
 Aktivt skede / Actieve stap / アクティブなステップ / 積極步骤  
 Previous step / Étape précédente / Etapa precedente  
 Azione precedente / Föregående skedet / Vorige stap  
 前のステップ / 上一步骤

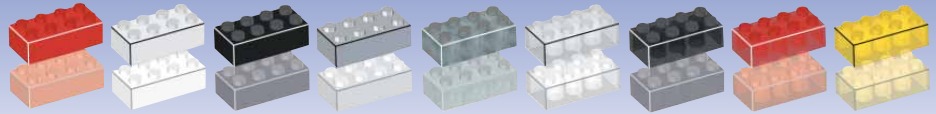

62

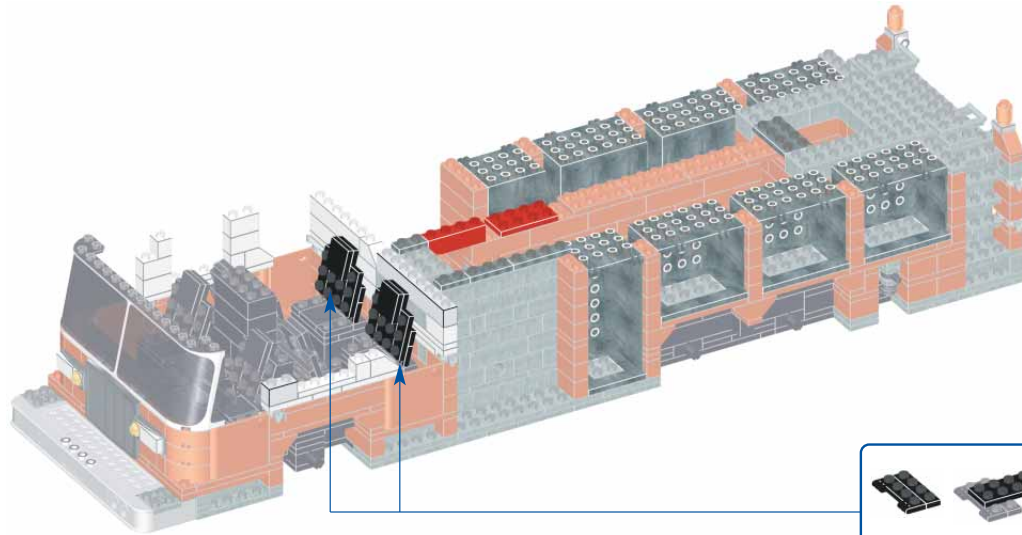
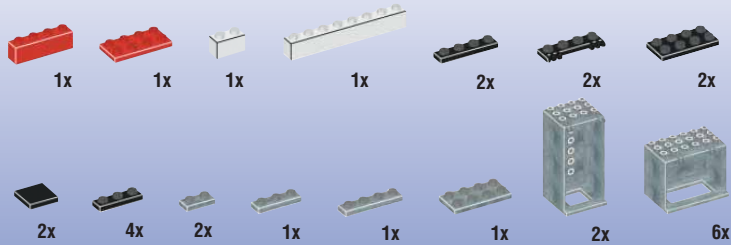

63

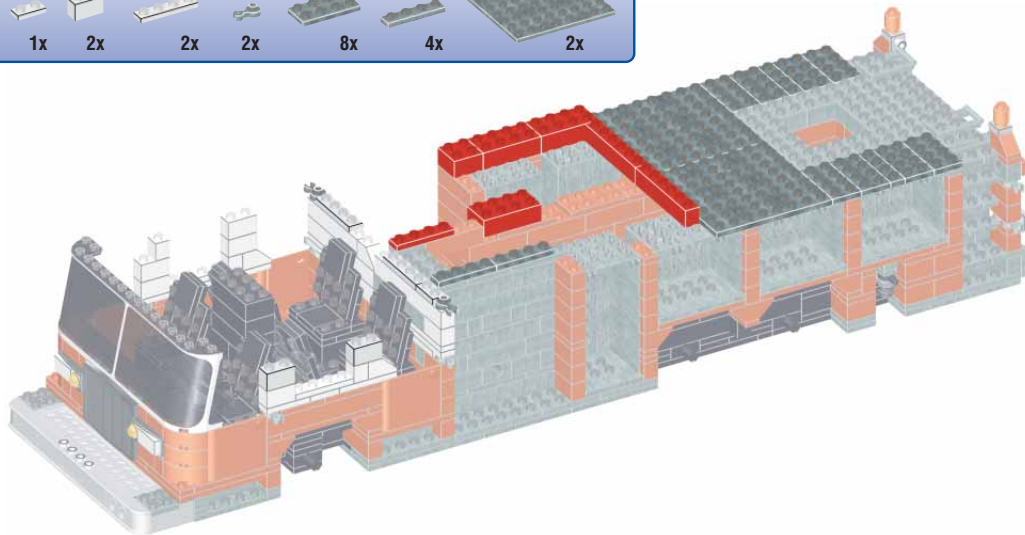

64

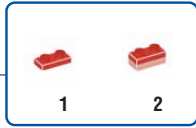
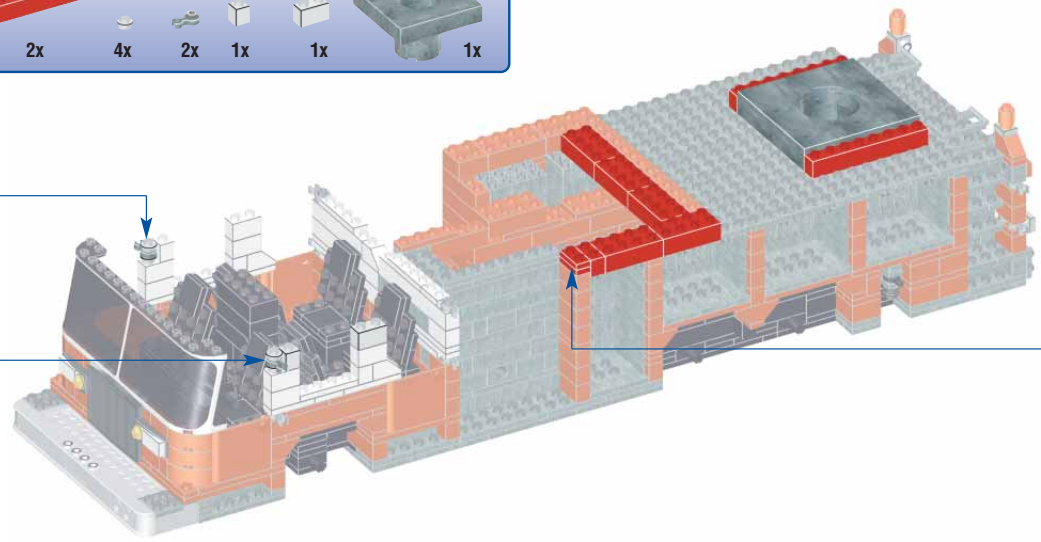



Active step / Étape active / Etapa activa / Azione attiva  
 Aktivt skede / Actieve stap / アクティブなステップ / 積極步驟  
 Previous step / Étape précédente / Etapa precedente  
 Azione precedente / Föregående skedet / Vorige stap  
 前のステップ / 上一步驟

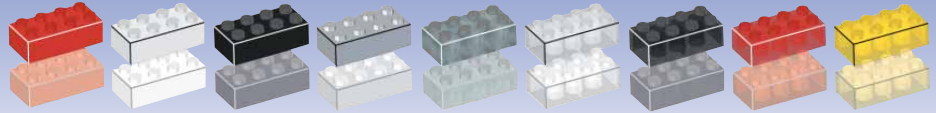

65

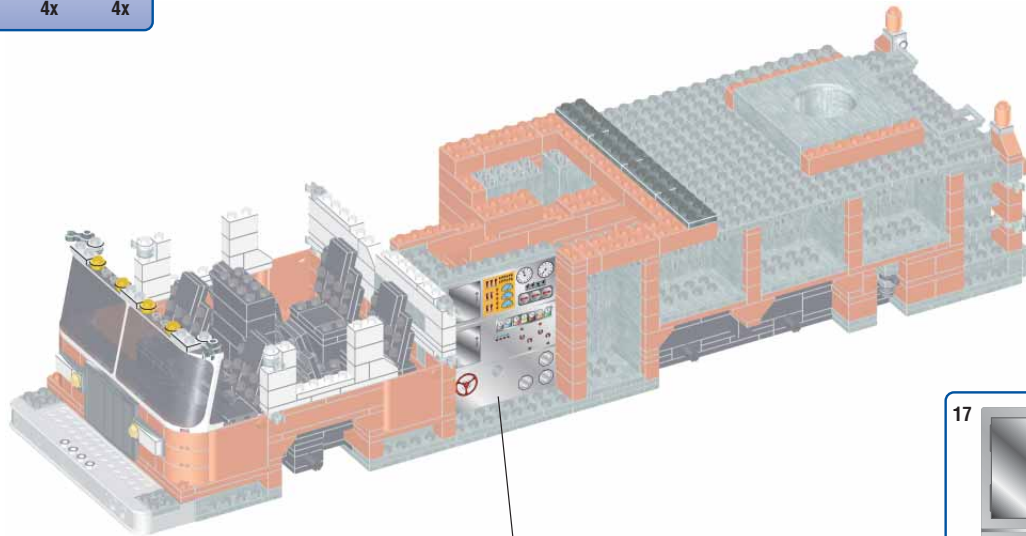

17

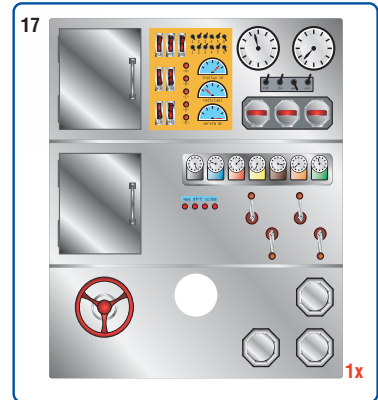

1x

66

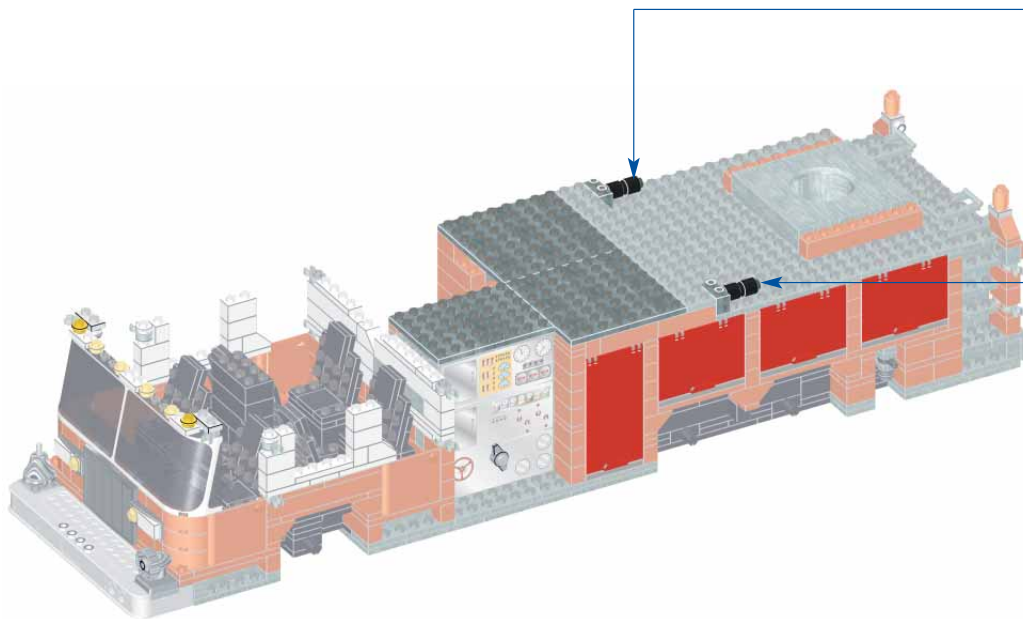
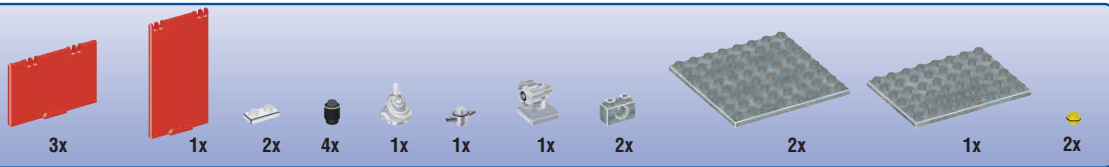





Active step / Étape active / Etapa activa / Azione attiva  
 Aktivt skede / Aktieve stap / アクティブなステップ / 積極步驟  
 Previous step / Étape précédente / Etapa precedente  
 Azione precedente / Föregående skedet / Vorige stap  
 前のステップ / 上一步驟

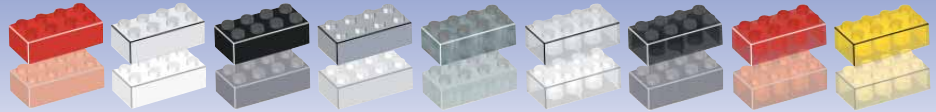

67



2x

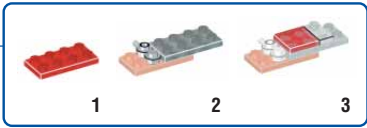
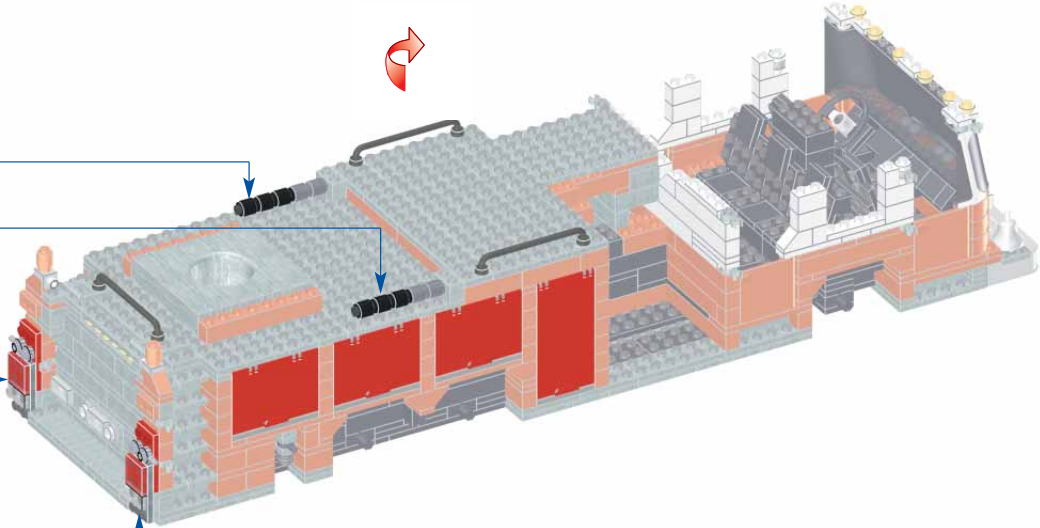

68

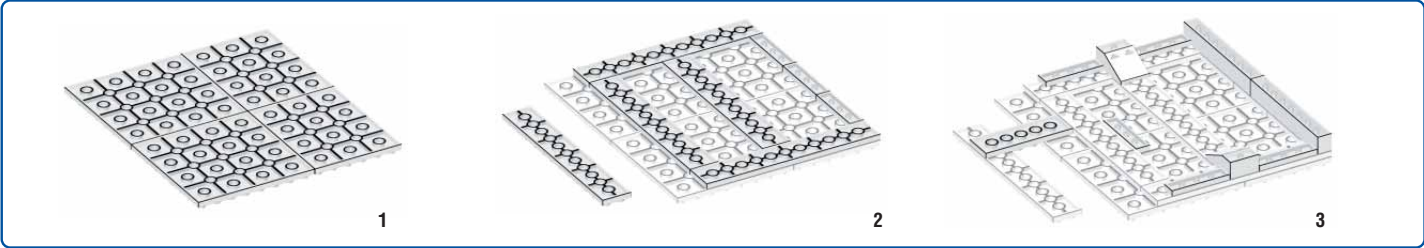
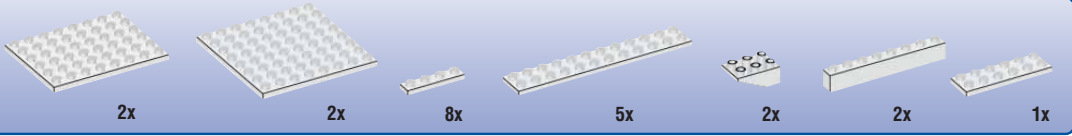

69

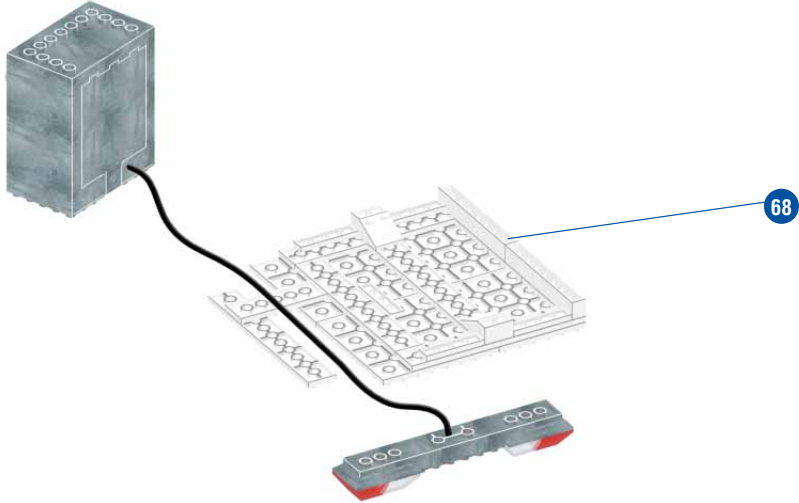
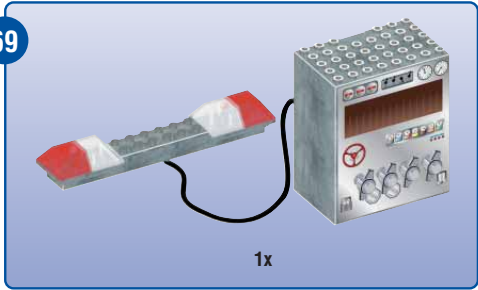



Active step / Étape active / Etapa activa / Azione attiva  
 Aktivt skede / Actieve stap / アクティブなステップ / 積極步驟  
 Previous step / Étape précédente / Etapa precedente  
 Azione precedente / Föregående skedet / Vorige stap  
 前のステップ / 上一步驟

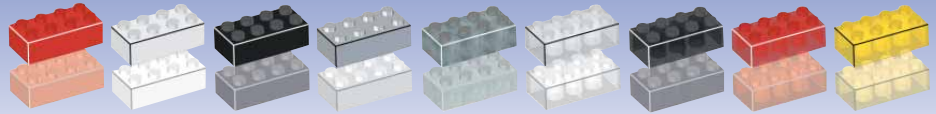

70



1x

1x

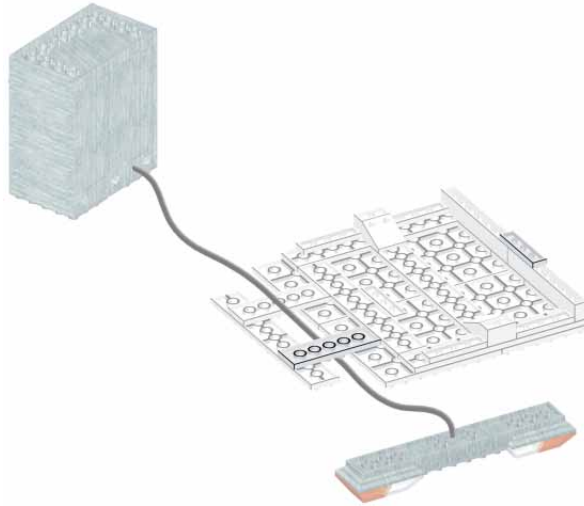

71



2x

2x

2x

1x

2x

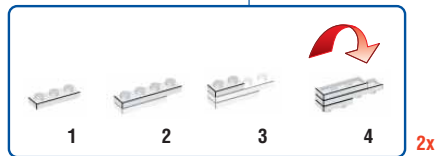

2x

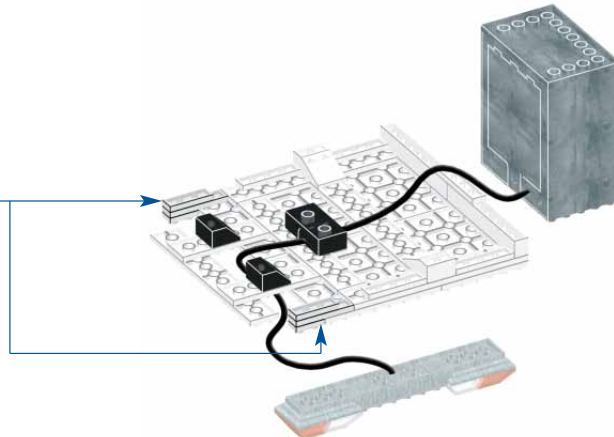

72



2x

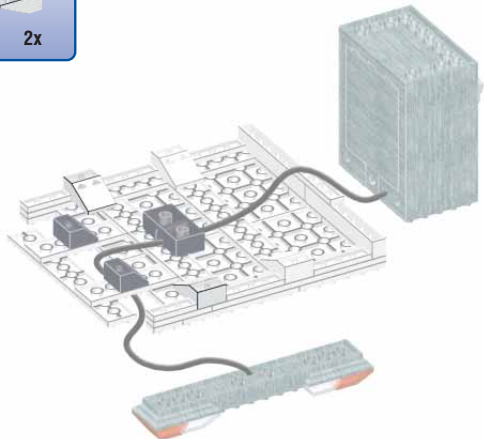

73

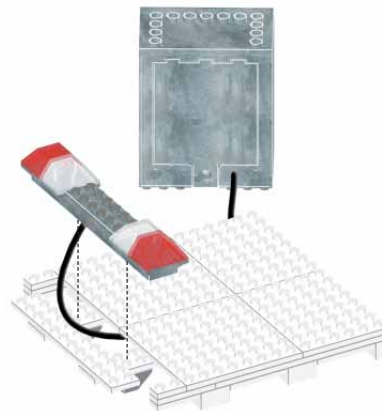

74



2x

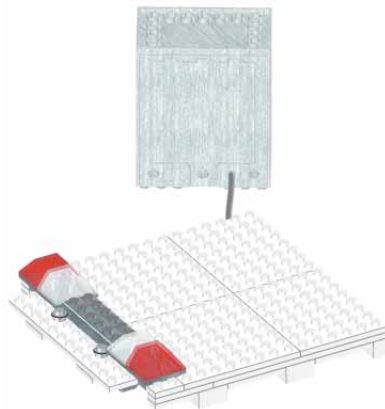





Active step / Étape active / Etapa activa / Azione attiva  
 Aktivt skede / Actieve stap / アクティブなステップ / 積極步骤  
 Previous step / Étape précédente / Etapa precedente  
 Azione precedente / Föregående skedet / Vorige stap  
 前のステップ / 上一步骤

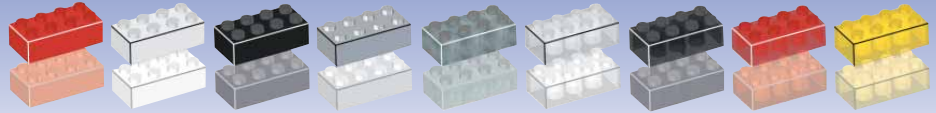

75  
 6x



2x

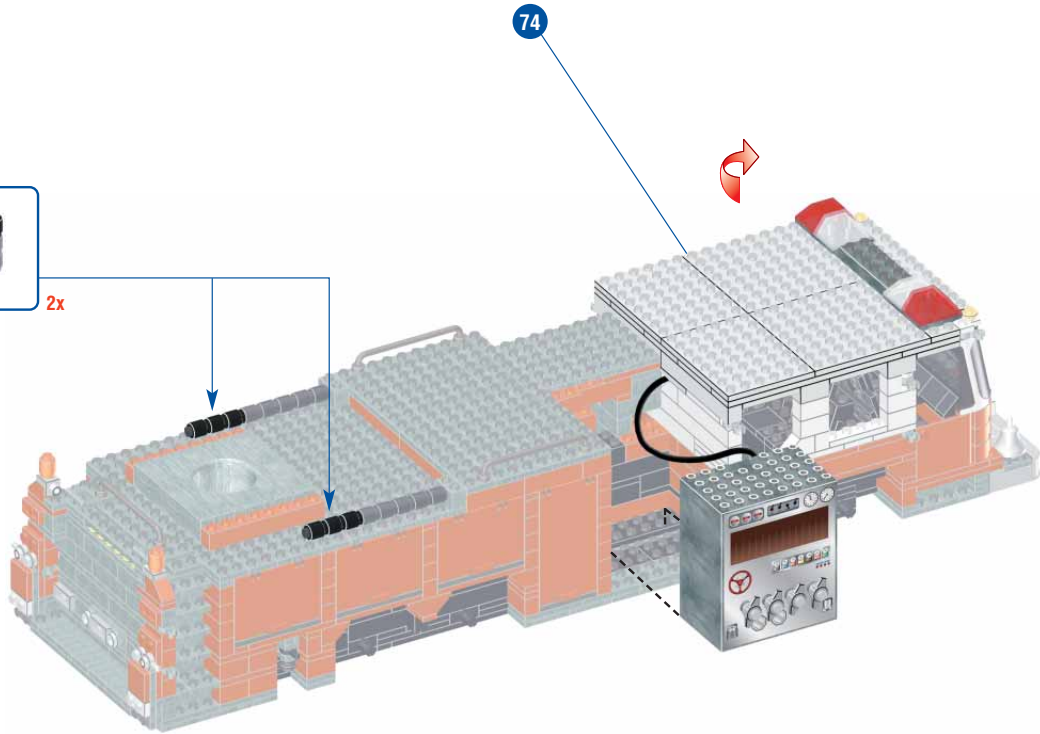

76



6x



3x



1

2

3

2x

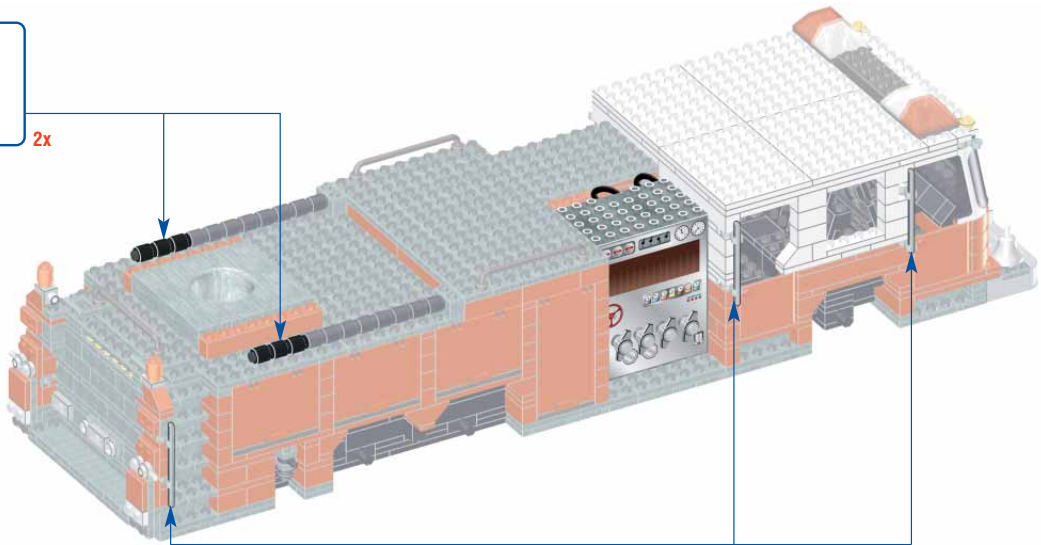

3x



Active step / Étape active / Etapa activa / Azione attiva  
 Aktivt skede / Actieve stap / アクティブなステップ / 積極步骤  
 Previous step / Étape précédente / Etapa precedente  
 Azione precedente / Föregående skedet / Vorige stap  
 前のステップ / 上一步骤

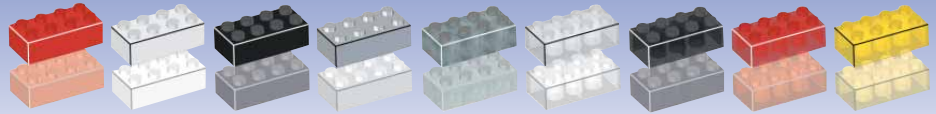

77

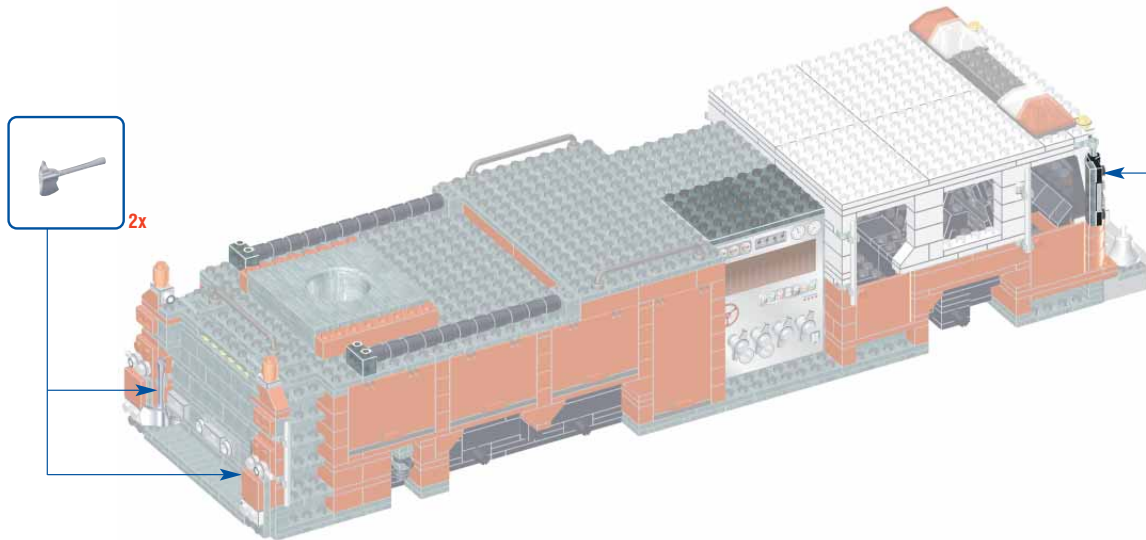
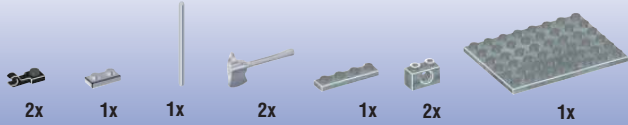

78

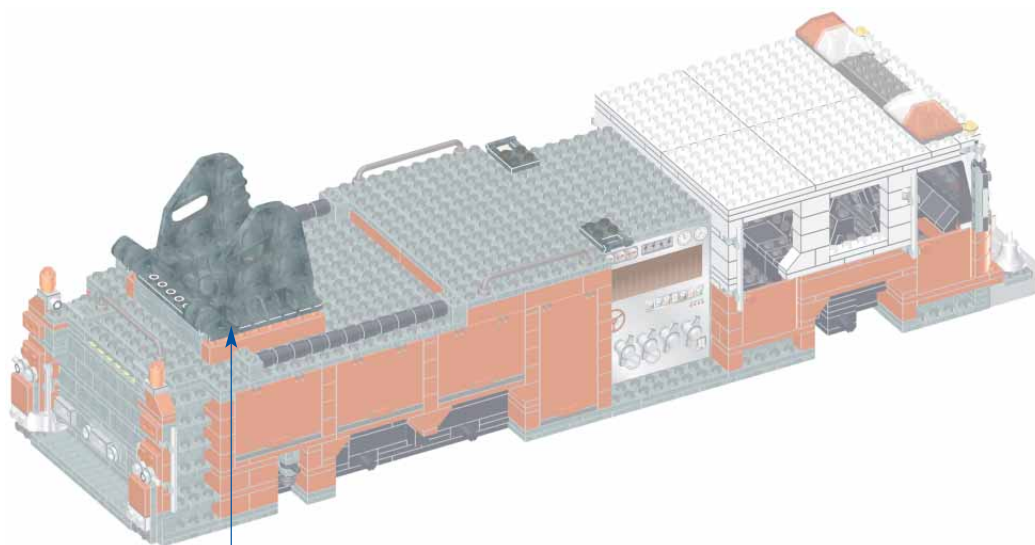
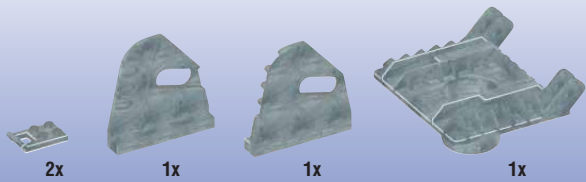





Active step / Étape active / Etapa activa / Azione attiva  
Aktivt skede / Actieve stap / アクティブなステップ / 積極步骤  
Previous step / Étape précédente / Etapa precedente  
Azione precedente / Föregående skedet / Vorige stap  
前のステップ / 上一步骤

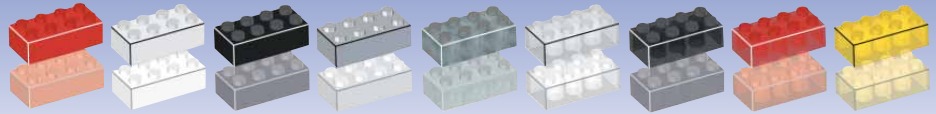

79

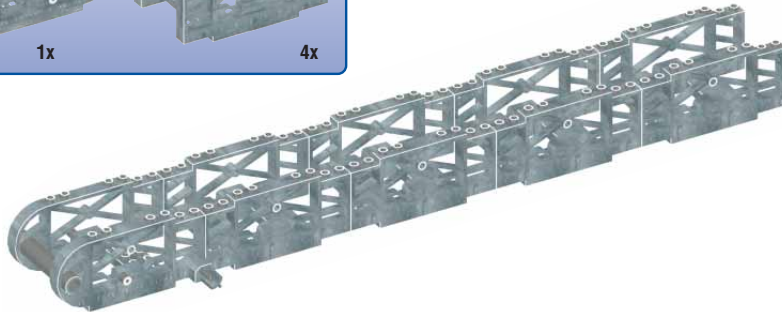
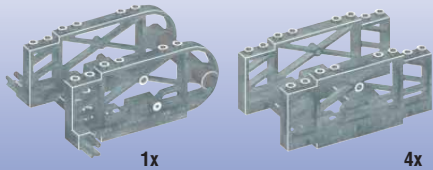

80



8x

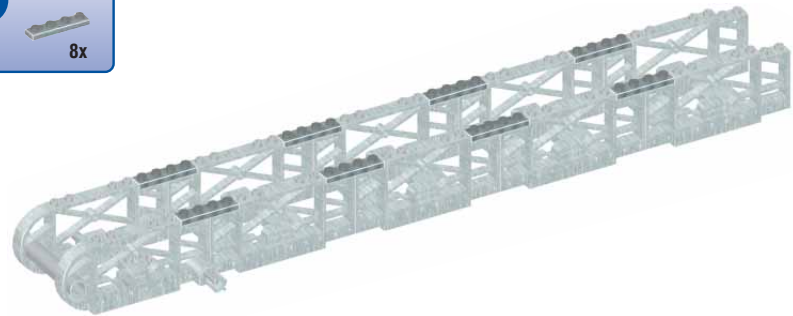

81

8x

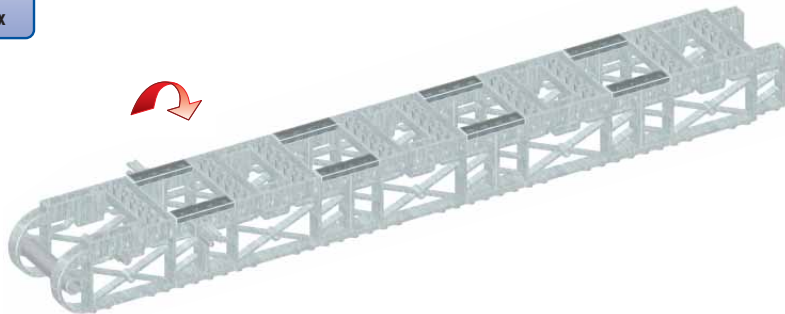

82

12x 4x 2x

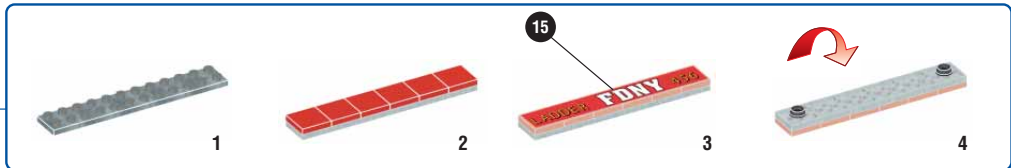
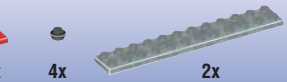

2x

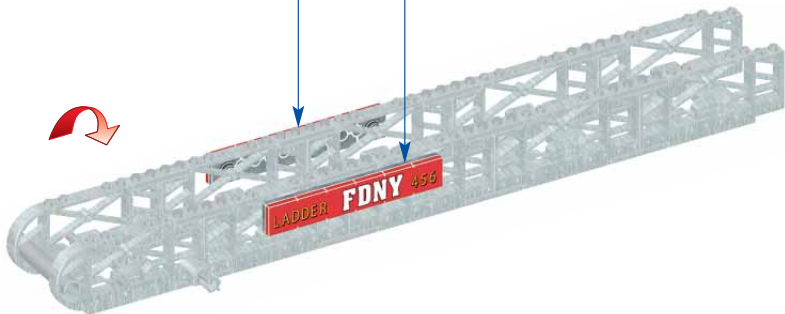

15

**LADDER FDNY 456**

2x



Active step / Étape active / Etapa activa / Azione attiva  
 Aktivt skede / Actieve stap / アクティブなステップ / 積極步驟  
 Previous step / Étape précédente / Etapa precedente  
 Azione precedente / Føregående skedet / Vorige stap  
 前のステップ / 上一步驟

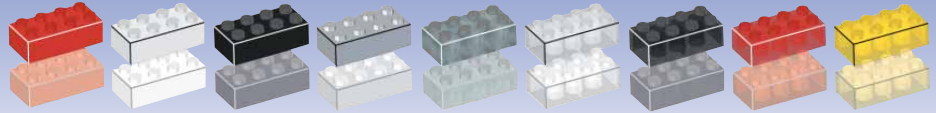

83



82



4x

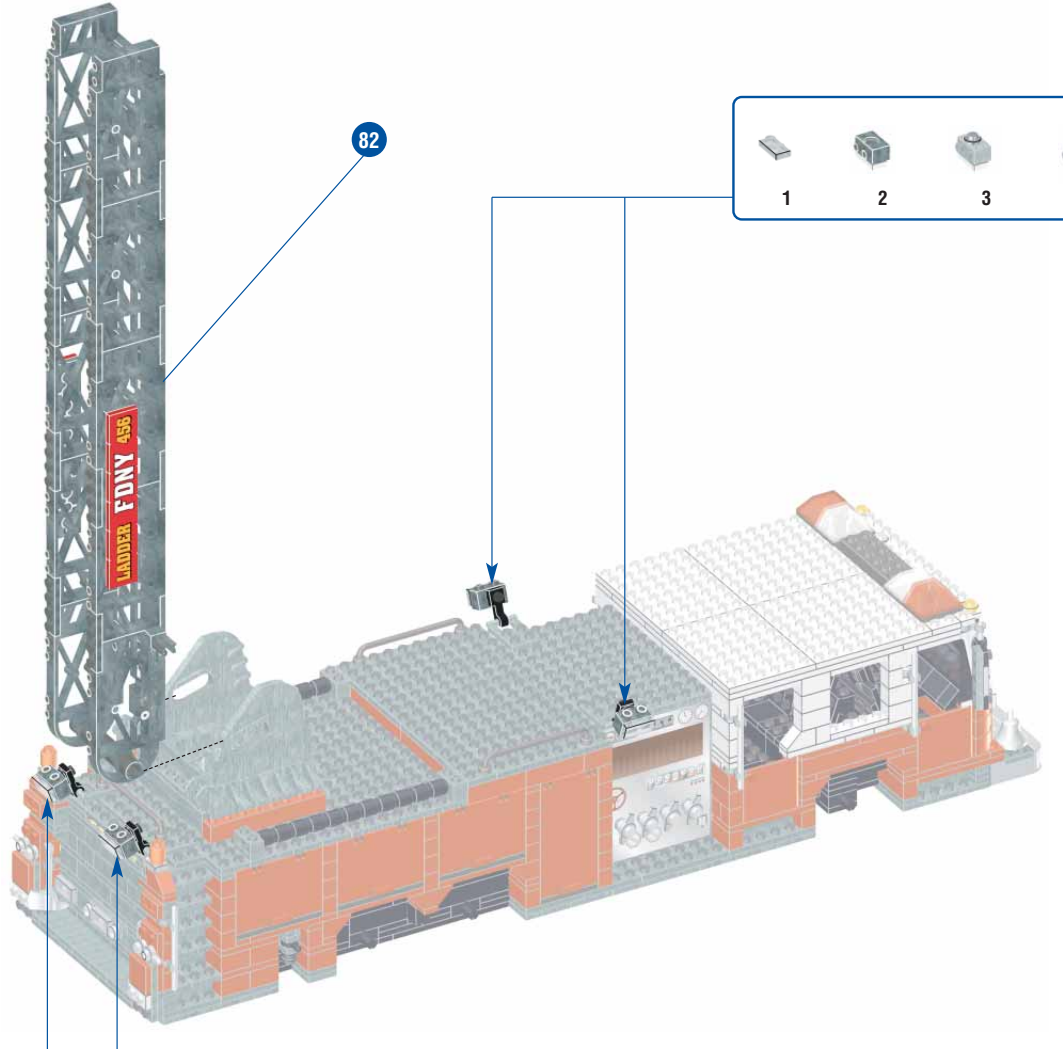

84

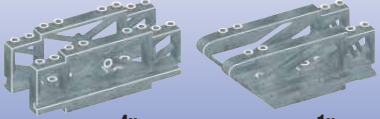

4x

1x



85



8x



86



8x

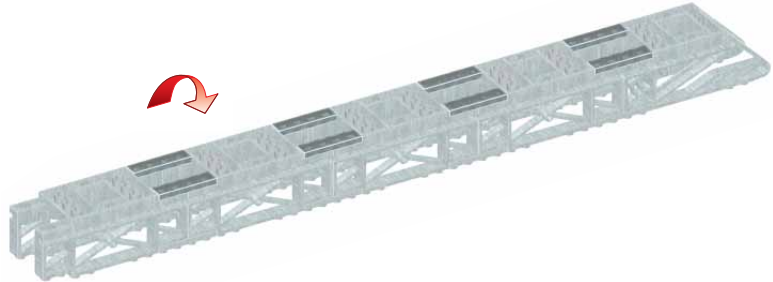

87







Active step / Étape active / Etapa activa / Azione attiva  
 Aktivt skede / Actieve stap / アクティブなステップ / 積極ステップ  
 Previous step / Étape précédente / Etapa precedente  
 Azione precedente / Føregående skedet / Vorige stap  
 前のステップ / 上一ステップ

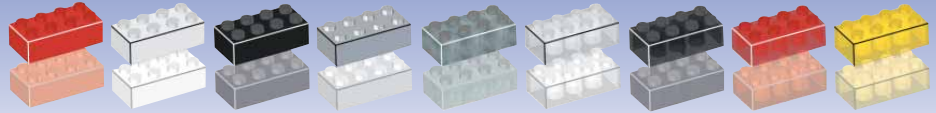

88

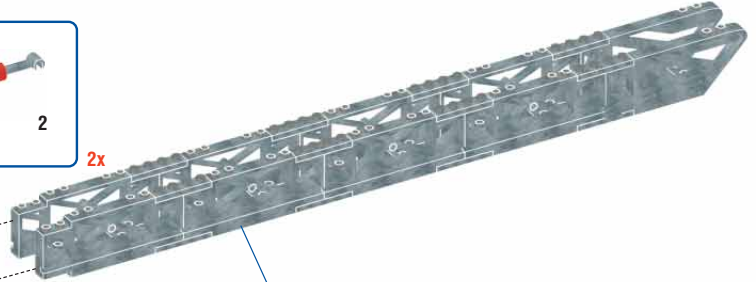
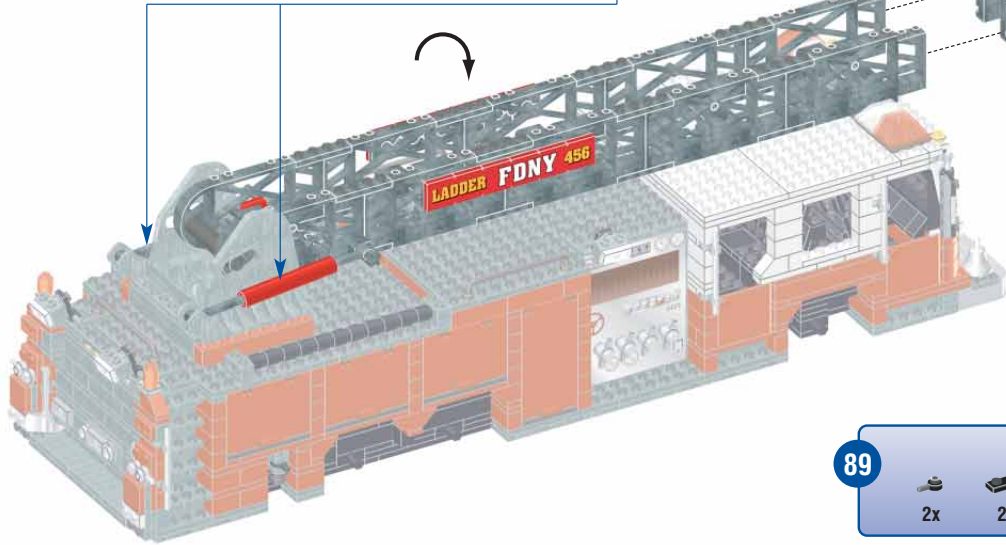

87

89



90



4x



2x



1x



1x

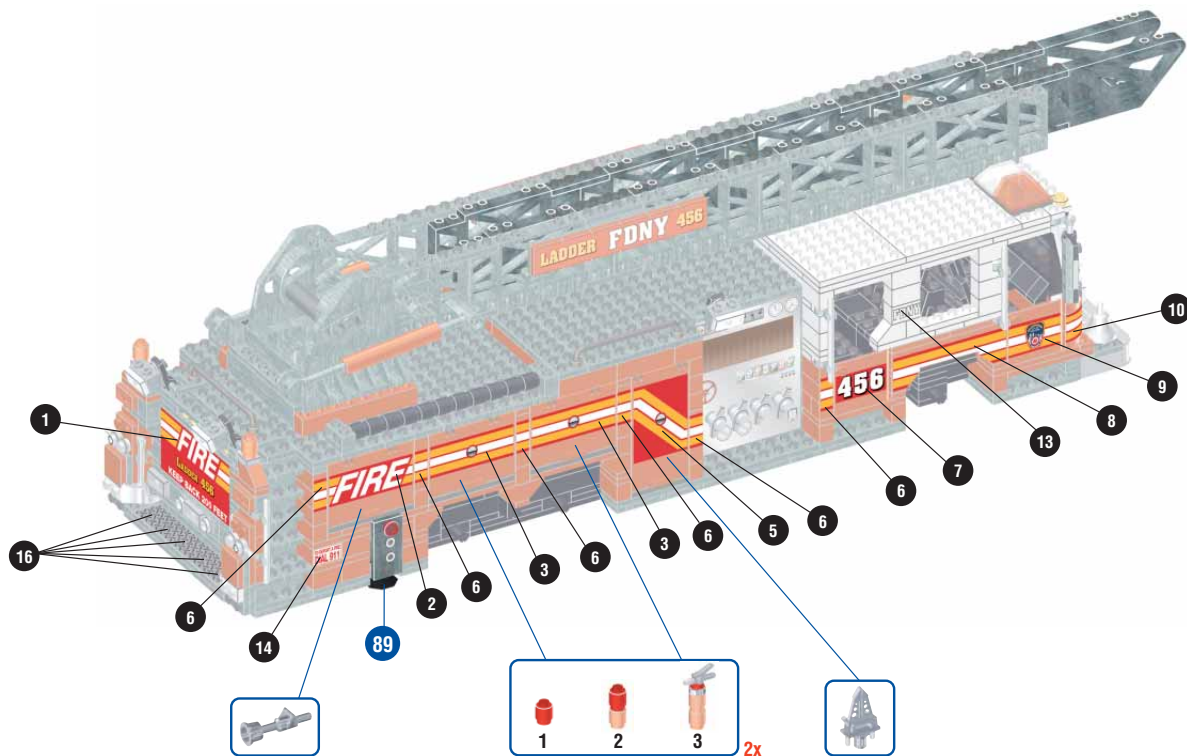
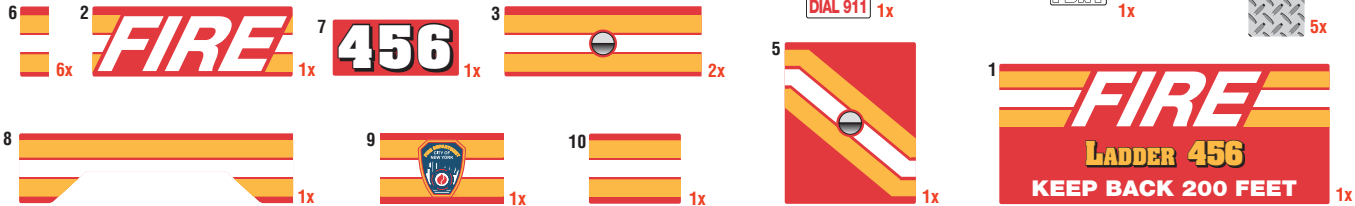



Active step / Étape active / Etapa activa / Azione attiva  
 Aktivt skede / Actieve stap / アクティブなステップ / 積極步驟  
 Previous step / Étape précédente / Etapa precedente  
 Azione precedente / Føregående skedet / Vorige stap  
 前のステップ / 上一步驟

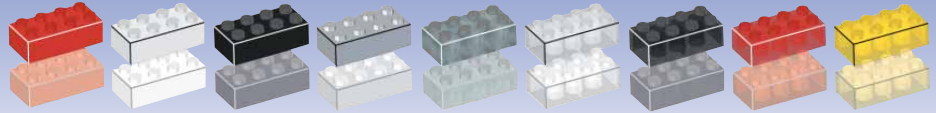

91

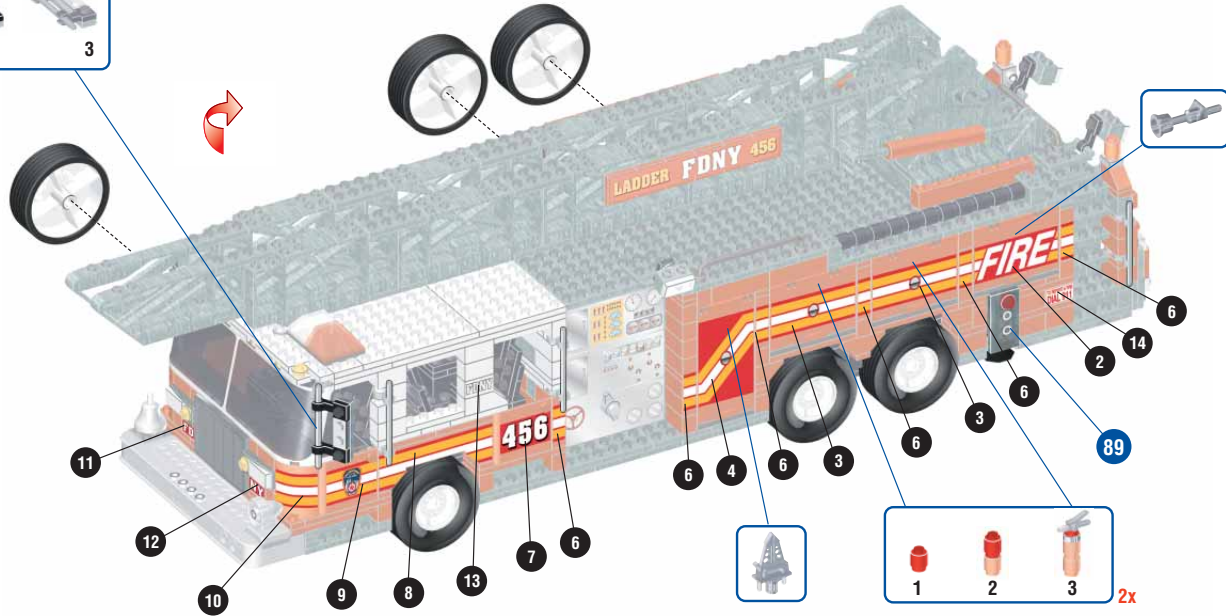
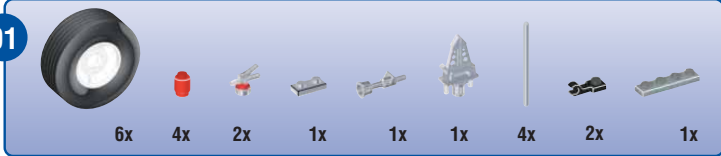





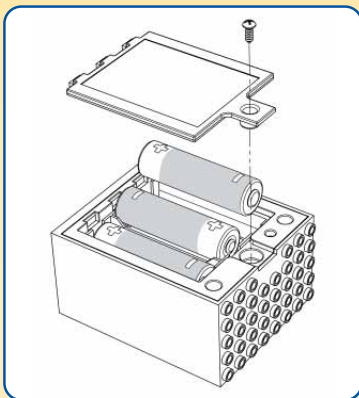

- Batteries included with this toy are for demonstration "TRY ME" purpose only. In order to get the best performance from this toy, we recommend that 3 fresh "AA" alkaline batteries be inserted prior to use.
- Las pilas incluidas con este juguete permiten activar el modo de demostración únicamente. A fin de lograr un funcionamiento óptimo, cámbielas por 3 pilas AA alcalinas nuevas antes de utilizar el juguete.
- Les piles incluses avec ce jouet ne servent que pour actionner le mode de démonstration. Afin de maximiser le rendement de ce jouet, nous recommandons d'installer 3 piles AA alcalines neuves avant de l'utiliser.
- Requires (3) 1.5V (AA, R-6, SUM-3) Batteries. 4.5V --- .15A. Non rechargeable batteries included.
- Requiere (3) pilas de 1,5V (AA, R-6, SUM-3). 4.5V --- 0,15A. Incluye pilas no recargables.
- Fonctionne à l'aide de (3) piles 1,5V (AA, R-6, SUM-3). 4.5V --- 0,15A. Piles fournies non rechargeables.

#### **BATTERY INSTALLATION**

- Use a phillips (star-nose) screwdriver to unscrew the door of the battery compartment.
- Lift and remove the compartment door.
- Insert 3 AA-1.5V alkaline batteries according to the correct polarity shown.
- Replace the door and screw, being sure that it is not screwed in too tightly.

#### **INSTALACIÓN DE LAS PILAS**

- Utilice un destornillador en cruz (o con punta de estrella) para abrir la tapa del compartimiento de las pilas.
- Levante y retire la tapa del compartimiento de las pilas.
- Coloque 3 pilas alcalinas AA 1,5V respetando la polaridad indicada.
- Cierre la tapa y ajuste el tornillo, sin apretar demasiado.

#### **MISE EN PLACE DES PILES**

- Avec un tournevis cruciforme, dévisser la porte du compartiment à piles. Soulever et ouvrir la porte du compartiment.
- Mettre en place les 3 piles alcalines AA 1,5V suivant la polarité indiquée dans le compartiment.
- Remettre la porte en place et resserrer la vis. Ne pas trop serrer.

PROBLEMS? PLEASE DO NOT TAKE THIS TOY BACK TO THE STORE. / ¿TIENE PROBLEMAS? NO DEVUELVA EL JUGUETE AL COMERCIO DONDE LO ADQUIRIÓ. / VOUS AVEZ DES PROBLÈMES? ON VOUS PRIERAIT DE NE PAS RETOURNER VOTRE JOUET AU MAGASIN.

CONTACT US /  
COMUNÍQUESE CON NOSOTROS /  
CONTACTEZ-NOUS :

1-800-465-MEGA  
INFO@MEGABLOKS.COM

#### **CAUTION: TO AVOID BATTERY LEAKAGE**

1. Be sure to install the batteries correctly (see diagram) and always follow the toy and battery manufacturer's instructions.
2. Do not mix used and new batteries together. Do not mix alkaline, standard (carbon zinc), or rechargeable (nickel cadmium) batteries. Only batteries of the same type are to be used.
3. Always remove exhausted or dead batteries from the product and always remove batteries before extended storage.
4. Rechargeable batteries must be removed from the toy prior to re-charging. Rechargeable batteries are only to be charged under adult supervision.
5. Non rechargeable batteries are not to be recharged.
6. The supply terminal is not to be short circuited.
7. Batteries are to be inserted according to the correct polarity, (see diagram)
8. How to remove and insert replaceable batteries. (see diagram)
9. Only batteries of the recommended type or of a similar type are to be used.

#### **ADVERTENCIA: PARA EVITAR QUE LAS PILAS SE SULFATEN:**

1. Asegúrese de colocar las pilas correctamente (ver diagrama) y de seguir las instrucciones de los fabricantes del juguete y de las pilas.
2. No mezclar pilas nuevas con pilas usadas ni tampoco acumuladores (níquel cadmio) o pilas de tipos diferentes (alcalina, carbón cinc).
3. Retire siempre las pilas acabadas o gastadas del juguete, especialmente si piensa guardarlo por tiempo prolongado.
4. Un adulto debe retirar las pilas del juguete antes de recargar las pilas recargables (siempre que las pueda retirar).
5. No recargue pilas que no sean recargables.
6. No origine cortocircuitos en los bornes del compartimiento de las pilas.
7. Coloque las pilas respetando la polaridad correcta. (ver diagrama)
8. Cómo sacar e introducir las pilas reemplazables. (ver diagrama)
9. Solamente deben utilizarse las pilas o acumuladores del tipo recomendado o de tipo similar.

#### **AVERTISSEMENT: POUR ÉVITER LA FUITE DES PILES:**

1. S'assurer d'installer les piles ou accumulateurs correctement (voir le diagramme) en suivant toujours les instructions du fabricant du jouet et des piles.
2. Différents types de piles ou accumulateurs ou des piles ou accumulateurs neufs et usagés ne doivent pas être mélangés. Différents types de piles (alcaline, carbone zinc) ou accumulateurs (nickel cadmium) ne doivent pas être mélangés.
3. Les piles et accumulateurs usagés doivent être enlevés du jouet, avant le rangement pour une longue période.
4. Les accumulateurs doivent être enlevés du jouet avant d'être chargés. Les accumulateurs ne doivent être chargés que sous la surveillance d'un adulte.
5. Ne jamais recharger des piles (non-rechargeables).
6. Les bornes d'une pile ou d'un accumulateur ne doivent pas être mises en court-circuit.
7. Les piles et accumulateurs doivent être mis en place en respectant la polarité. (voir le diagramme)
8. Comment enlever ou mettre en place les piles ou accumulateurs remplaçables. (voir le diagramme)
9. Seuls des piles ou accumulateurs du type recommandé ou d'un type similaire doivent être utilisés.

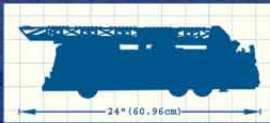

Become part of our Fire Safety Team. Keeping you and your family fire safe at home, at work or at school takes planning, preparation and teamwork. Fire prevention starts with you.

**INSTALL SMOKE ALARMS**

Test them often to make sure they work. Replace the batteries at least twice a year when you change your clock for daylight savings.

**HAVE A HOME FIRE ESCAPE PLAN**

Develop a home escape plan with your family in case of fire. Practice it. Have a pre-arranged meeting place somewhere outside.

**HOME SAFETY INSPECTION**

Conduct a safety inspection of potential fire hazards in the home. Eliminate them. Make every room fire safe.

When in New York City, please visit the FIRE ZONE Learning Center and Store, 34 W. 51st Street in Rockefeller Center. [www.fdnfirezone.org](http://www.fdnfirezone.org)

Entra a formar parte de nuestro equipo para la prevención de incendios. Mantener a toda tu familia y a ti mismo fuera del peligro de incendio en la casa, en el trabajo o en la escuela, requiere planificación, preparación y un trabajo de equipo. La prevención contra los incendios empieza contigo.

**INSTALA DETECTORES DE HUMO**

Compruébalos a menudo para asegurarte de que funcionan. Cambia las baterías al menos dos veces al año, cuando ajustes tu reloj al cambio horario.

**TEN PREPARADO UN PLAN DE EVACUACIÓN CONTRA INCENDIOS PARA LA VIVIENDA**

Con tu familia, desarrolla un plan de evacuación de la vivienda para casos de incendio. Ten predeterminado un lugar de encuentro fuera de la casa.

**INSPECCIÓN DE LA SEGURIDAD DE LA VIVIENDA**

Realiza un inspección minuciosa de los posibles peligros de incendio en la vivienda y elimínalos. Garantiza la seguridad contra incendios en cada habitación.

Cuando vengas a la ciudad de Nueva York, no olvides visitar la Tienda y el Centro de Aprendizaje FIRE ZONE, en la calle 51, 34 O, en el Rockefeller Center. [www.fdnfirezone.org](http://www.fdnfirezone.org)

Devenez membre de notre équipe de sécurité-incendie. La protection de votre famille contre les incendies à la maison, au travail ou à l'école exige de la planification, de la préparation et un travail d'équipe. La prévention des incendies commence avec vous.

**INSTALLATION DES DÉTECTEURS DE FUMÉE**

Vérifiez-les souvent afin de vous assurer qu'ils fonctionnent. Remplacez les piles au moins deux fois par année au moment de changer l'heure à l'automne et au printemps.

**PLAN D'ÉVACUATION DE LA MAISON**

Élaborez un plan d'évacuation de la maison avec votre famille en cas d'incendie. Mettez-le en pratique. Choisissez un endroit où vous pourriez vous rejoindre à l'extérieur.

**INSPECTION DE SÉCURITÉ À LA MAISON**

Procédez à une inspection de sécurité des risques éventuels d'incendie à la maison. Éliminez-les. Protégez chaque pièce contre le feu.

Lorsque vous serez à New York, veuillez visiter le magasin et le centre d'apprentissage FIRE ZONE situé au 34 W. 51st Street au Rockefeller Center. [www.fdnfirezone.org](http://www.fdnfirezone.org)