

Thank you for purchasing **UNSC ROCKETHOG VS ANTI AIRCRAFT GUN** an authentic licensed product by MEGA Bloks based on the legendary Halo universe. The collectible construction toy line features the heroic UNSC and enemy Covenant vehicles, characters and weapons. Choose an alliance, build the battle and emerge victorious!

Gracias por comprar **ATRAPA-COHETES DE LA UNSC VS CAÑÓN ANTIAÉREO** un producto auténtico con licencia de MEGA Bloks según el legendario Halo universe. La línea de juguetes de construcción coleccionable ofrece vehículos, personajes y armas heroicos de UNSC y enemigos de Covenants. ¡Elije una alianza, elabora la batalla y sal victorioso!

Nous vous remercions d'avoir acheté **ROCKETHOG DE L'UNSC VS. CANON ANTIAÉRIEN**, un produit certifié authentique par MEGA Bloks basé sur l'univers légendaire de Halo. La gamme d'articles de construction de collection met en vedette les membres héroïques du CSNU ainsi que les véhicules, personnages et armes de l'ennemi Covenant. Choisissez votre alliance, créez le combat et remportez la victoire.

Vielen Dank für den Kauf von **UNSC-ROCKETHOG GEGEN FLUGABWEHRKANONE**. Hierbei handelt es sich um ein authentisches Lizenzprodukt von MEGA Bloks, das auf dem legendären Halo-Universum beruht. Die Spielzeug-Baureihe zum Sammeln besteht aus heldenhaften UNSC- und feindlichen Allianz-Fahrzeugen, Figuren und Waffen. Entscheide Dich, auf welcher Seite du kämpfen willst, baue das Schlachtfeld auf und gehe aus der Schlacht als Sieger hervor!

Hartelijk dank voor het aanschaffen van de of het authentiek gelicentieerde **UNSC RAKETZWIJN VS ANTI VLIEGTUIG GEWEER** van MEGA Bloks dat op de legendarische Halo wereld gebaseerd is. De lijn waardevolle bouwpakketten bevat modellen van de heldhaftige Covenant voertuigen, personages en vuurwapens van de UNSC en de vijand. Kies je bondgenoten, vervaardig je slagveld en win het gevecht!

La ringraziamo per avere acquistato **UNSC ROCKETHOG VS CANNONE ANTIAEREO** un prodotto autentico con licenza della MEGA Bloks basato sul leggendario universo Halo. La linea di giocattoli da collezione costruibili presenta i veicoli dell'eroica UNSC della nemica Alleanza, con i personaggi e le armi. Scegli un alleato, costruisci la battaglia e vieni fuori vincitore!

Obrigado por adquirir **ROCKETHOG UNSC VS ARMA ANTIAÉREA**, um produto autêntico licenciado pela MEGA Bloks baseado no lendário universo de Halo. A linha de brinquedos de construção colecionáveis conta com veículos dos heróis da UNSC e do inimigo Covenant, bem como personagens e armas. Escolha uma aliança, construa a batalha e saia vitorioso!

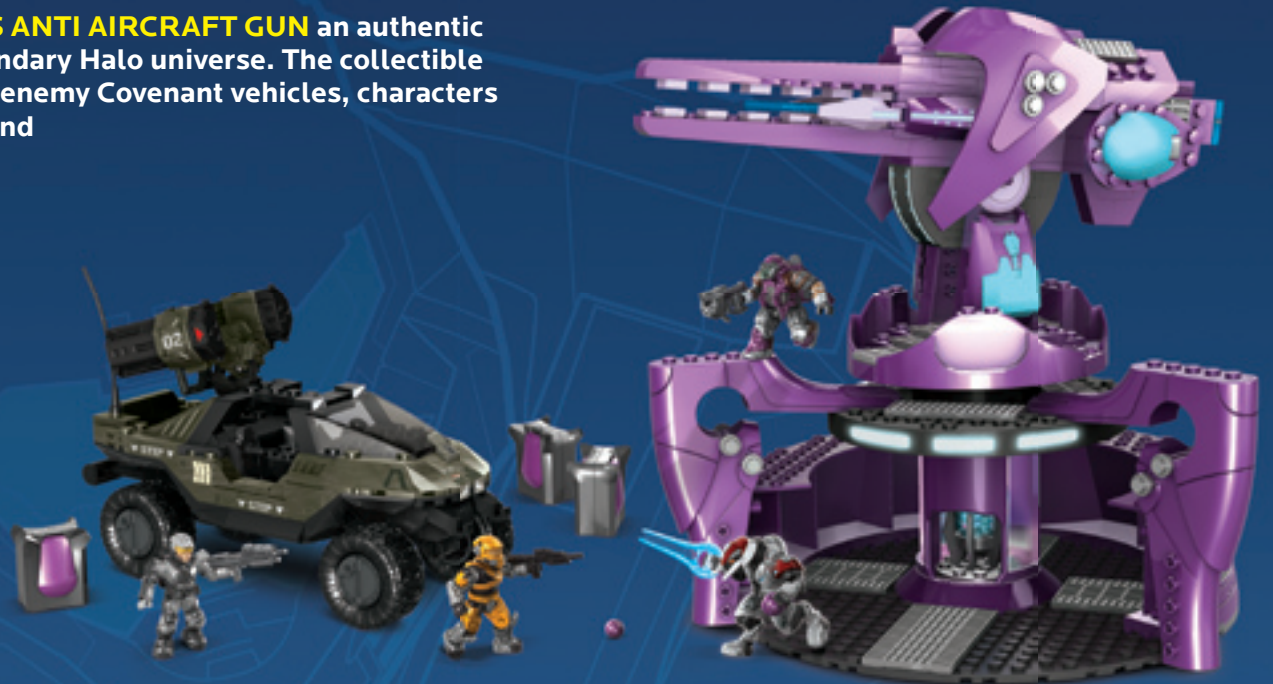



HALO
THE AUTHENTIC COLLECTOR'S SERIES

Register for the Halo Bloks Brigade!
Apuntate a la brigada Halo Bloks!
Enrolez-vous dans la Brigade Halo Bloks!
Registriere dich für die Halo-Bloks Brigade! • Schrijf je in voor de Halo Bloks Brigade!
Effetua la registrazione per la Brigata dei Blok Halo! • Regista-te para a Brigada Halo Bloks!

halo.megabloks.com
www.facebook.com/halomegabloks
twitter.com/megabrands



1X 
AMI8240APD

12X 
M1113HJ

2X 
MA11135X

18X 
MA1113AGV

6X 
AM07223BX

10X 
MA03328F

2X 
MA03328BYE

2X 
M03328X

2X 
MA03328APD

6X 
AM03328BX

6X 
MA044285X

4X 
MA15258APD

14X 
AM17003F

8X 
AM170035X

2X 
AM17506F

4X 
AM17115ACX

4X 
AM01793F

2X 
M022502HJ

2X 
MA022501APD

87X 
MA09198AGV

6X 
MA09393F

7X 
MA09393MM

3X 
MA093935X

2X 
MA09393APD

2X 
MA075905X

1X 
MA07590APD

1X 
AM18221F

2X 
AM169545X

1X 
AM182695X

2X 
AM18232APD

2X 
AM182325X

4X 
MA1417F

1X 
AM18234APD

1X 
AM18235APD

1X 
AM15480F

1X 
AM15481F

4X 
AM09835F

1X 
MA03019F

2X 
MA090135X

1X 
AM186015X

4X 
AM02799MM

4X 
AM027995X

2X 
AM091065X

1X 
AM09106F

2X 
AM17522F

2X 
AM084805X

4X 
AM042185X

2X 
AM187155X

2X 
AM098935X

2X 
MA15484F

4X 
AM04322MM

4X 
AM18223F

1X 
AM18250F

2X 
MA0948F

3X 
MA03773F

3X 
MA03773MM

12X 
MA037735X

6X 
MA03773APD

2X 
MA09023BYE

2X 
MA090235X

2X 
AM166815X

4X 
MA11415X

1X 
MA038735X

4X 
MA11395X

1X 
AM18265MM

1X 
AM18784MM

1X 
AM18231APD

1X 
MA1323APD

2X 
AM18557ACX

2X 
AM17869BX

1X 
MA1087BYE

1X 
AM17503F

1X 
MA1087F

4X 
MA09033BYE

1X 
MA09033MM

3X 
MA090335X

1X 
AM09487APD

1X 
AM09488APD

1X 
AM09838F

1X 
AM098385X

3X 
MA095935X

6X 
MA09593APD

4X 
MA09593F

3X 
MA09593MM

1X 
MA09493BYE

5X 
MA09493F

9X 
MA094935X

4X 
MA09493MM

2X 
MA09493APD

2X 
AM015315X





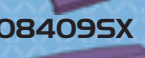

2X 
MA13675X

2X 
AM084095X











2X 
AM084165X

- IX**  AMI8220F
- 2X**  AMI8246F
- IX**  AMI7019F
- IX**  AMI8229APD
- 2X**  AMI8224F
- 2X**  AMI8225F
- IX**  AMI8233F
- 2X**  AMI8245F
- IX**  AS969231I
- 4X**  AMI8251F
- IX**  AMI8227APD
- IX**  AMI8226APD

- 2X**  AMI8241F
- 4X**  AMI8248MM
- 2X**  AMI7155BX
- IX**  AMI8228APD
- 2X**  AMI6964F
- IX**  AMO9487BX
- IX**  AMO9488BX
- 2X**  AMI7240MM
- 4X**  AMI8249F
- IX**  AMI8244APD

- 2X**  AS9692308
- 2X**  AS9692307
- 2X**  AMI8712MM
- 2X**  AS9692316
- 2X**  AS9692317
- IX**  AMI8236AMD
- IX**  AMI8243APD

- IX**  AMI8238APD
- IX**  AMI8239APD
- IX**  AMI5512MM
- IX**  AMI7054F
- 2X**  AMI87965X
- IX**  AMI7148F
- 2X**  MAO7475APD
- 4X**  MAO9292F
- 2X**  MAO9292APD

- IX**  AMI8219F
- IX**  AMI6331F
- 4X**  MAI480SX
- 2X**  MAI480F
- IX**  MAO84835X
- IX**  MAO8483SX
- IX**  MAO8483F
- IX**  MAO9923F
- IX**  MAI1725X
- 2X**  AMI8668F
- IX**  AMI87935X
- IX** AMI87925X



IX
AMI8237F



IX
AMI8218F



IX
AMI8259HJ



IX
AM022375X



IX
AMI8217F



IX
AMI8782MM



3X
AMI87855X



3X
AMI87865X



2X
AMI87975X



3X
AMI87885X



IX
AMI87835X



3X
AMI87875X



IX
AMI87985X



IX
AMI87995X



IX
A59692312



IX
AMI71965X

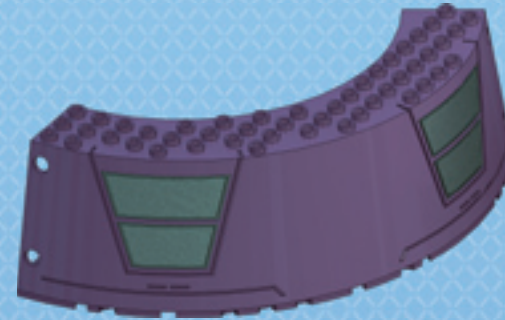

IX
A59692313



4X
AMI8780MM

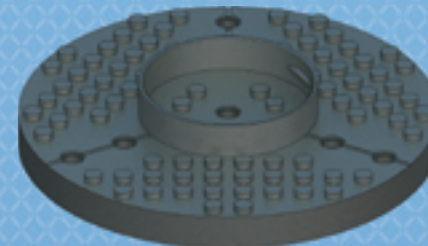

IX
AMI8781MM

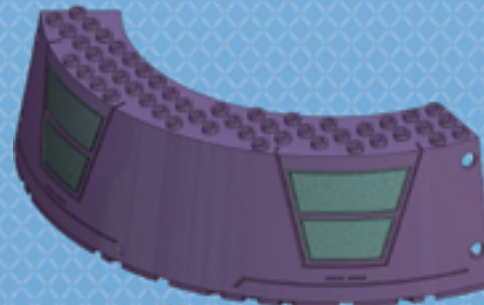

IX
A59692314



IX
AMI8222F



IX
AM03103HJ



IX
AM09893HJ



IX
AMI6701F



5X
AMI78705X



4X
AMI69815X



IX
A59692305



6X
AMI82135X



6X
A59694107

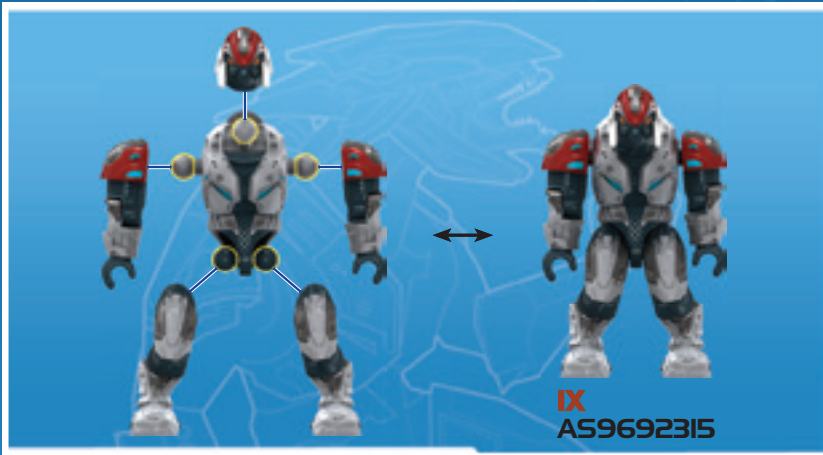

IX
AS9692315



IX
AS9692304

IX
AS9692302

IX
AMI8802MM

IX
AMI8539MM



IX
AS9692301

IX
AS9682308

IX
AMI7622F

IX
L969231

- EN** Please read these instructions carefully before first use and keep them for future reference.
- ES** Leer estas instrucciones cuidadosamente antes de la primera utilización y guardarlas para referencia futura.
- FR** Il est recommandé de lire attentivement ce feuillet avant la première utilisation et de le conserver pour référence future.
- DE** Die Gebrauchsanleitung bitte durchlesen und aufbewahren.
- NL** Wij raden u aan deze handleiding zorgvuldig te lezen en te bewaren voor eventuele raadpleging op een later tijdstip.
- DA** Vær venlig at læse disse instruktioner omhyggeligt inden ibrugtagten og opbevar dem til fremtidigt brug.
- EL** Διαβάστε αυτές τις οδηγίες προσεκτικά πριν χρησιμοποιήσετε το προϊόν για πρώτη φορά και φυλάξτε τις για μελλοντική αναφορά.
- FI** Lue nämä ohjeet huolellisesti ennen ensimmäistä käyttöä ja säilytä ne myöhempää tarvetta varten.
- IT** Leggere le istruzioni prima di cominciare ad usare il gioco e conservarle per reference futura.
- NO** Les disse instruksjonene nøye før første gangs bruk, og ta vare på dem for fremtidige oppslag.
- PT** Leia as instruções antes do primeiro uso e guarde-as para futura referência.
- SV** Läs noggrant igenom dessa instruktioner innan du använder produkten för första gången och spara dem för ev. framtida frågor.
- JA** 初めてご使用になる前に、この説明書をよくお読みください。また、本書は将来いつでも参照できるように保管してください。
- ZH** 请在初次使用前仔细阅读这些指示，并保留它们以便未来参考。
- AR** يرجى قراءة هذه التعليمات بدقة قبل البدء بالاستعمال والاحتفاظ بها كمرجع للمستقبل

- EN** ⚠ **WARNING :**
CHOKING HAZARD. - Small parts.
Toy contains a small ball.
Not for children under 3 years.
- ES** ⚠ **ADVERTENCIA :**
PELIGRO DE ASFIXIA. - Contiene piezas pequeñas.
El juguete contiene una bola pequeña.
No recomendado para niños menores de 3 años.
- FR** ⚠ **AVERTISSEMENT :**
RISQUE DE SUFFOCATION. - Présence de petits éléments.
Le jouet contient une petite balle.
Ne convient pas aux enfants de moins de 3 ans.
- DE** ⚠ **WARNUNG :**
ERSTICKUNGSGEFAHR. - Enthält kleine Teile.
Ein kleiner Ball ist im Spielzeug inbegriffen.
Nicht für Kinder unter 3 Jahren geeignet.
- NL** ⚠ **WAARSCHUWING :**
VERSTIKKINGSGEVAAR. - Bevat kleine onderdelen.
Speelgoed bevat een klein balletje.
Niet geschikt voor kinderen onder de 3 jaar.
- DA** ⚠ **ADVARSEL :**
KVÆLNINGSFARE. - Indeholder smådele.
Legetøjet indeholder en lille bold.
Ikke til børn under 3 år.
- EL** ⚠ **ΠΡΟΕΙΔΟΠΟΙΗΣΗ :**
ΚΙΝΔΥΝΟΣ ΠΝΙΞΙΜΑΤΟΣ. - Περιέχει μικρά αντικείμενα.
Το παιχνίδι περιέχει ένα μπαλάκι.
Όχι για παιδιά κάτω των 3 ετών.
- FI** ⚠ **VAROITUS :**
TUKEHTUMISVAARA. - Sisältää pieniä osia.
Lelun sisältyy pieni pallo.
Ei alle 3-vuotiaille lapsille.
- IT** ⚠ **ATTENZIONE :**
PERICOLO DI SOFFOCAMENTO. - Contiene piccole parti.
Il giocattolo comprende una pallina.
Non indicato per bambini sotto i 3 anni.
- NO** ⚠ **ADVARSEL :**
KVÆLNINGSFARE. - Inneholder små deler.
Leketøyet inneholder en liten ball.
Kun for barn over 3 år.
- PT** ⚠ **ATENÇÃO :**
PERIGO DE ASFIXIA. - Contém peças pequenas.
O brinquedo contém uma pequena bola.
Não é concebido para crianças de menos de 3 anos.
- SV** ⚠ **VARNING :**
KVÄVNINGSRISK. - Innehåller små delar.
Leksaken innehåller en liten boll.
Inte för barn under 3 år.
- JA** ⚠ **警告 :**
窒息の危険性 - 小さな部品が含まれています
小さな玉が含まれています。
3歳以下の子供には与えないで下さい。
- ZH** ⚠ **警告 :**
有窒息危险 - 包含有小部件
此玩具含有一个球。
不适合3岁以下的小孩玩。
- AR** ⚠ **تحذير :**
خطر اختناق - قطع صغيرة.
تحتوي اللعبة على كرة صغيرة.
غير صالحة للأطفال أقل من 3 سنوات.



© 2011 MICROSOFT CORPORATION. ALL RIGHTS RESERVED. MICROSOFT, 343 INDUSTRIES, THE 343 INDUSTRIES LOGO, HALO, THE HALO LOGO, XBOX, XBOX 360, AND THE XBOX LOGOS, ARE TRADEMARKS OF THE MICROSOFT GROUP OF COMPANIES.

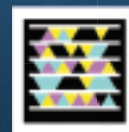

Get the free mobile app for your phone
<http://gettag.mobi>



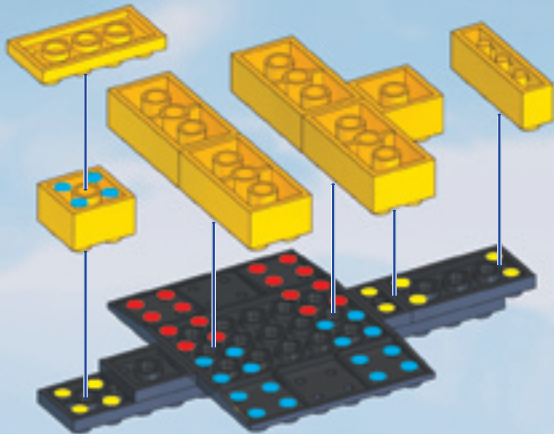
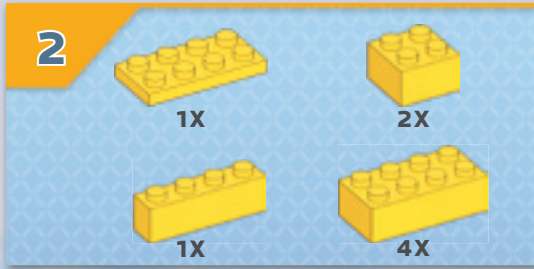
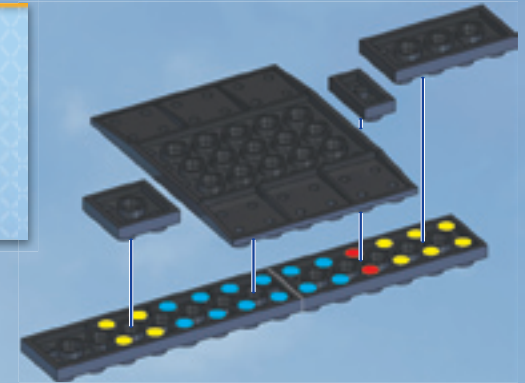
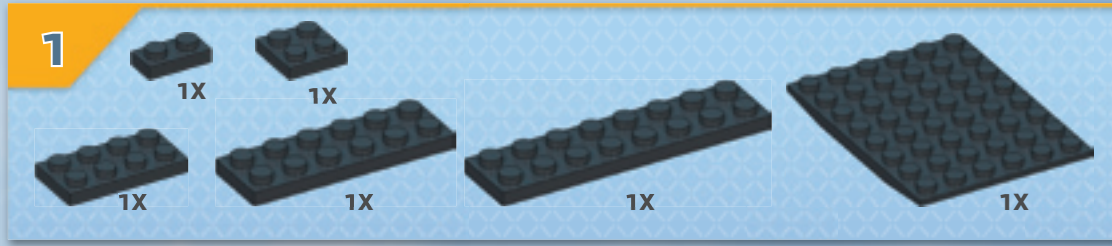

Place temporary pieces.
 Colocar las piezas provisionales.
 Installer les pièces temporaires.
 Provisorische Teile einsetzen.
 Instaleer de tijdelijke onderdelen.
 Piazzare i pezzi temporanei.
 Colocar peças temporárias.

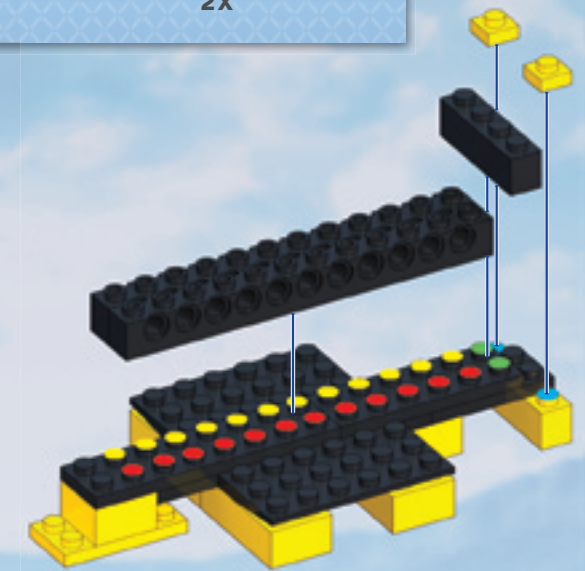
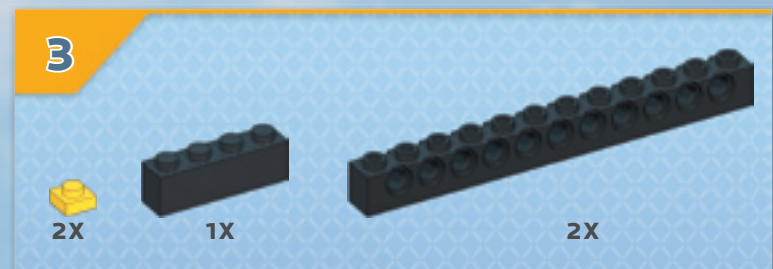

4

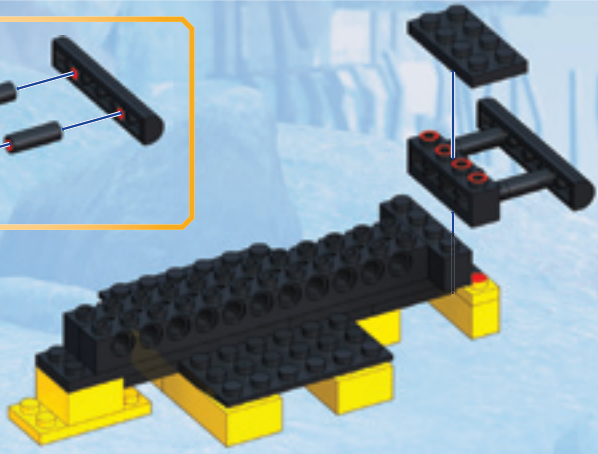
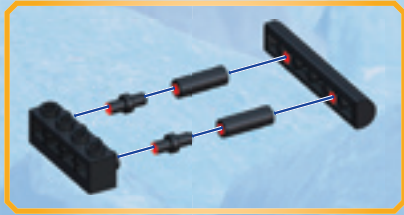

5

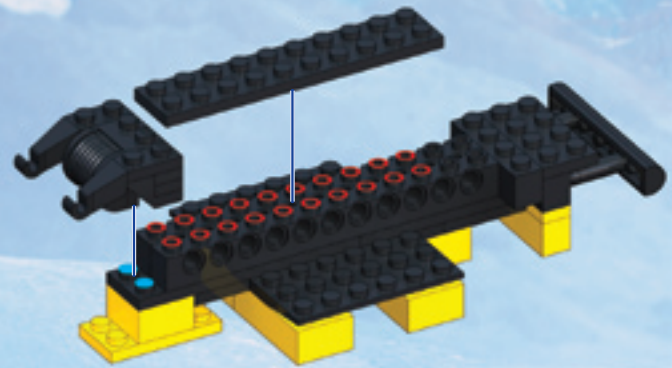

6

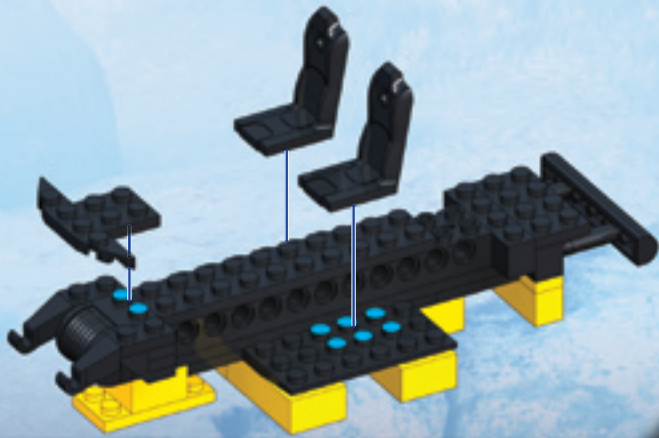
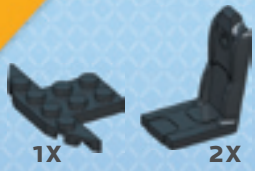

7

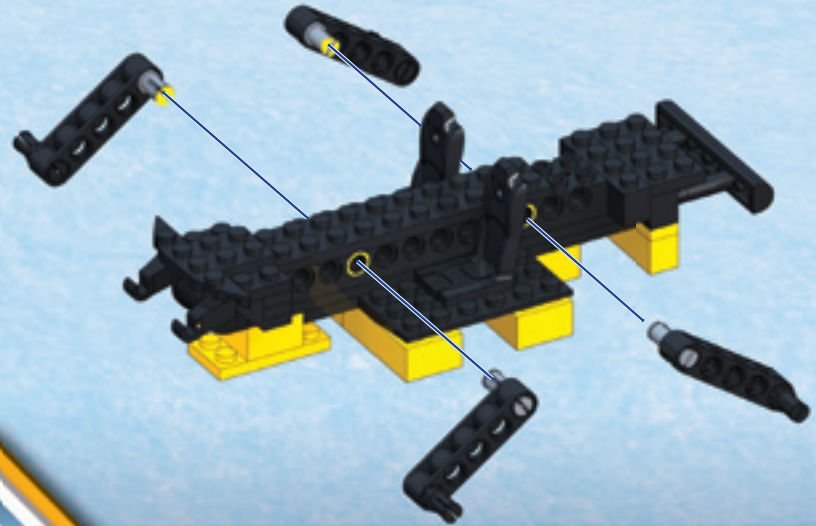

8

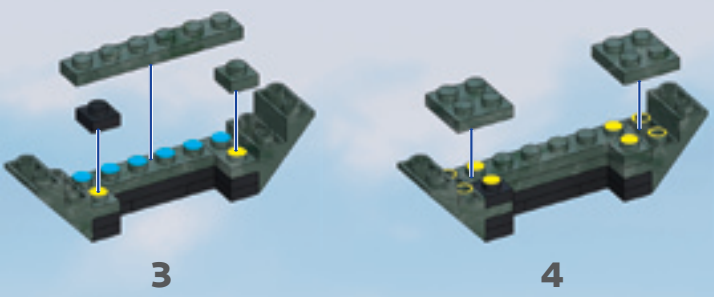
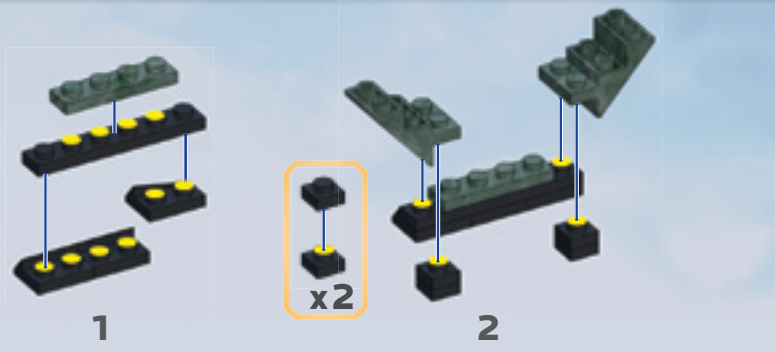

9

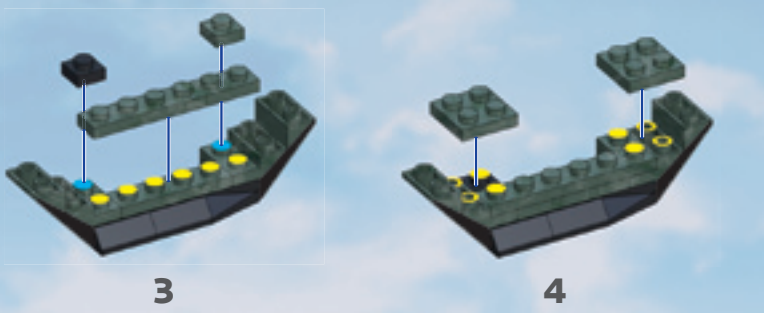
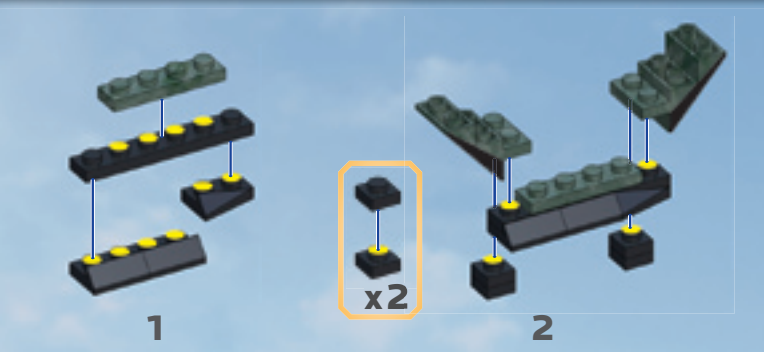

10

8

9

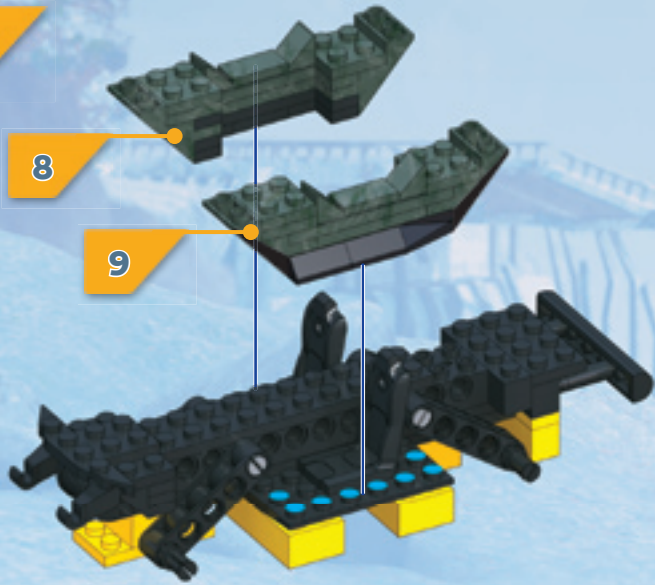

11

1X

1X

2X

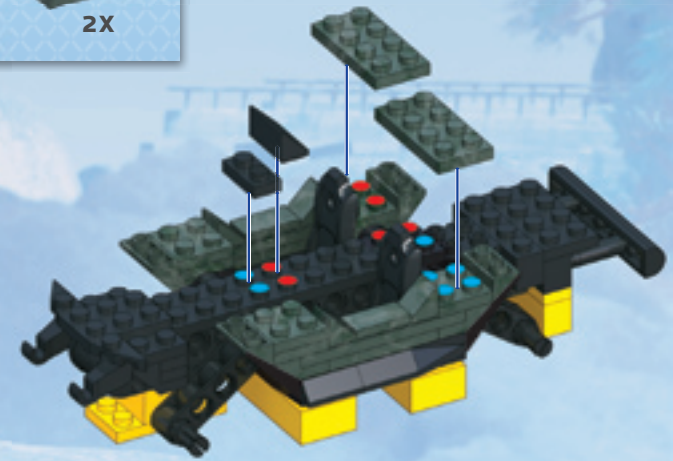

12

2X

2X

2X

1X

1X

2X

1X

1X

1X

1X

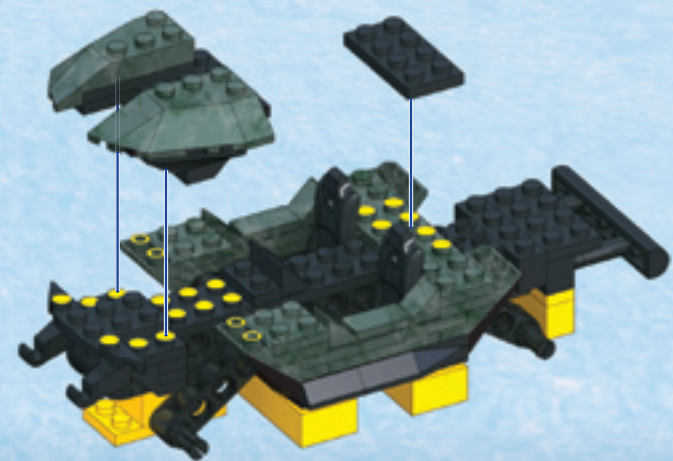
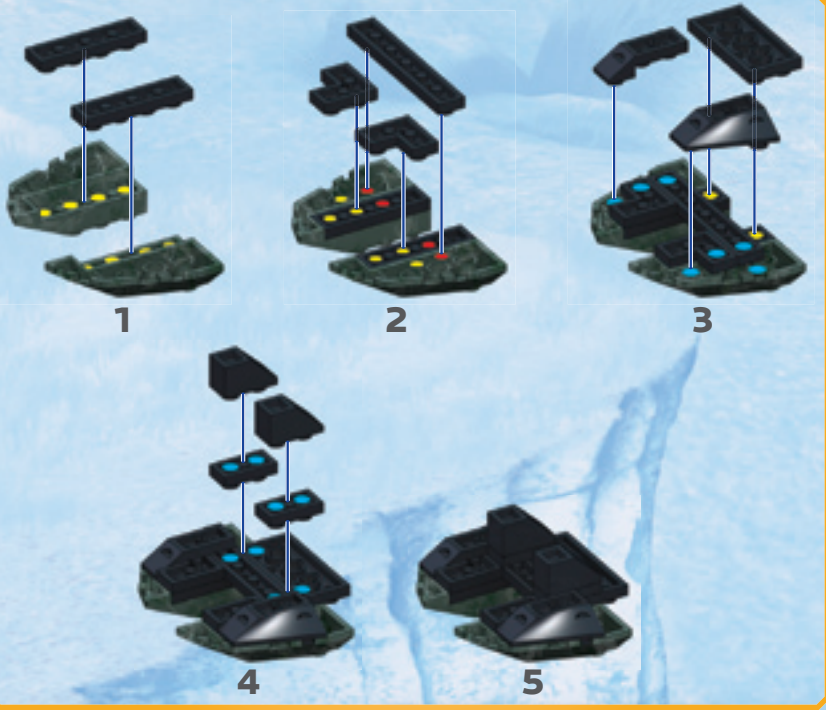

13

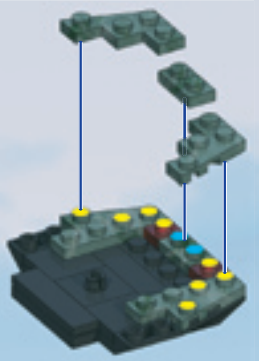
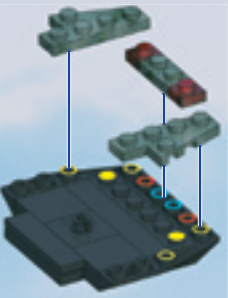
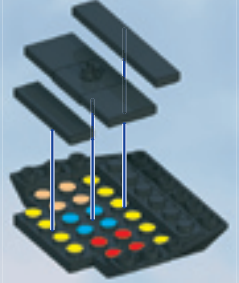
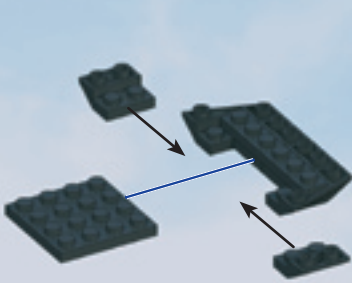

14

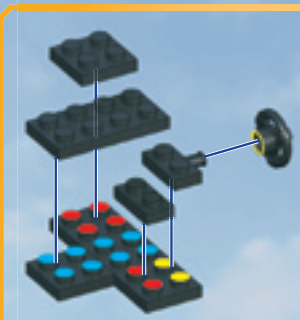

15

- 1X
- 1X
- 2X
- 2X



16

- 1X
- 1X
- 2X



17

- 1X
- 1X
- 1X



18

- 1X
- 1X
- 1X
- 1X



19

1X 1X

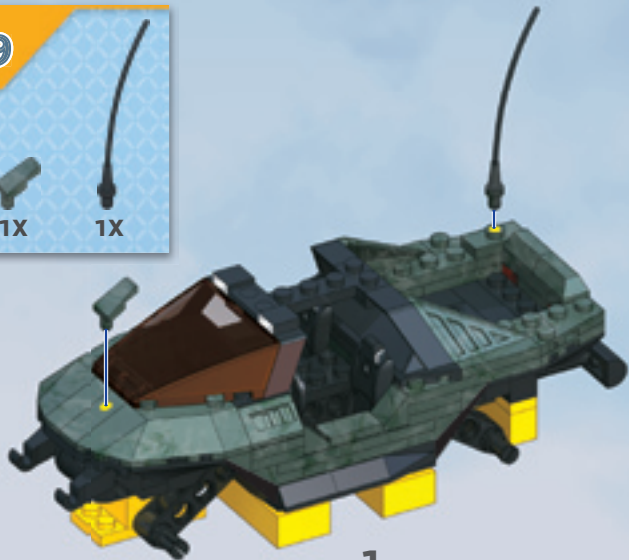

1



2



20

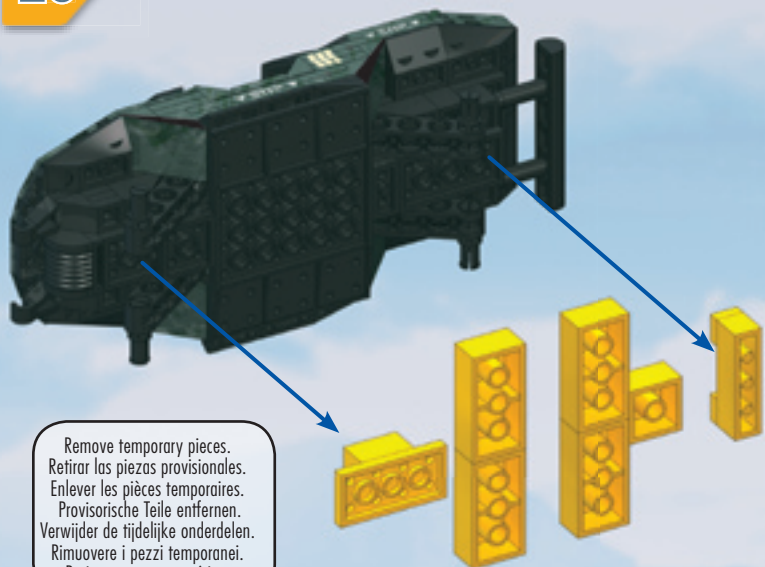

Remove temporary pieces.
 Retirar las piezas provisionales.
 Enlever les pièces temporaires.
 Provisorische Teile entfernen.
 Verwijder de tijdelijke onderdelen.
 Rimuovere i pezzi temporanei.
 Retirar peças temporárias.

21

4X 4X

x4



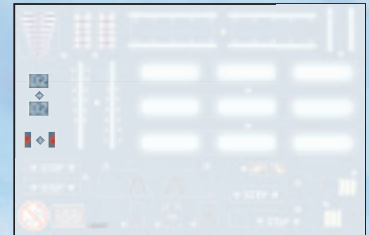
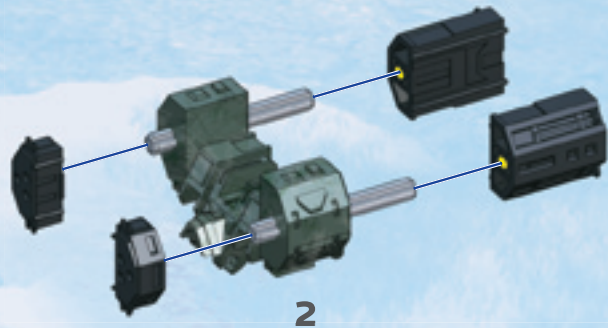
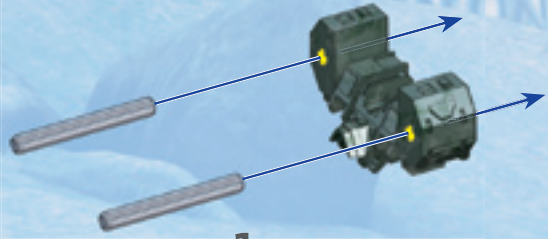
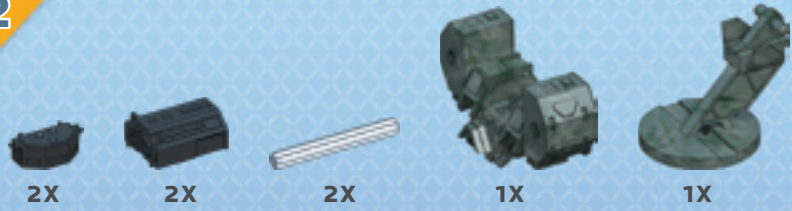

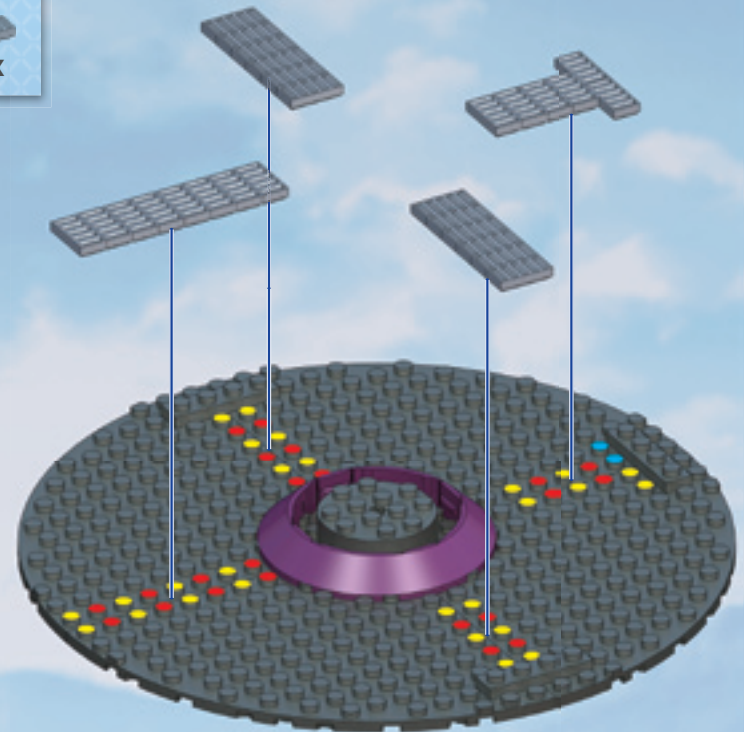
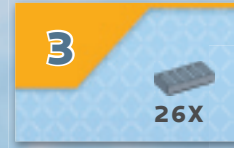
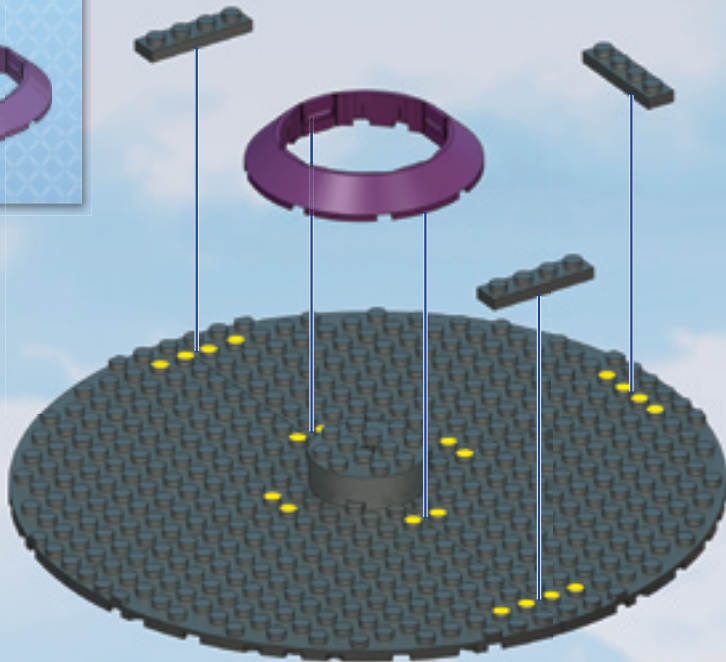
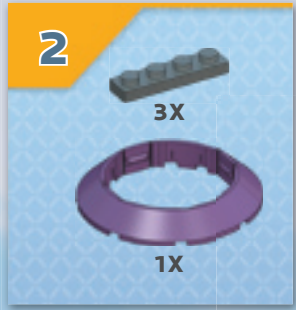
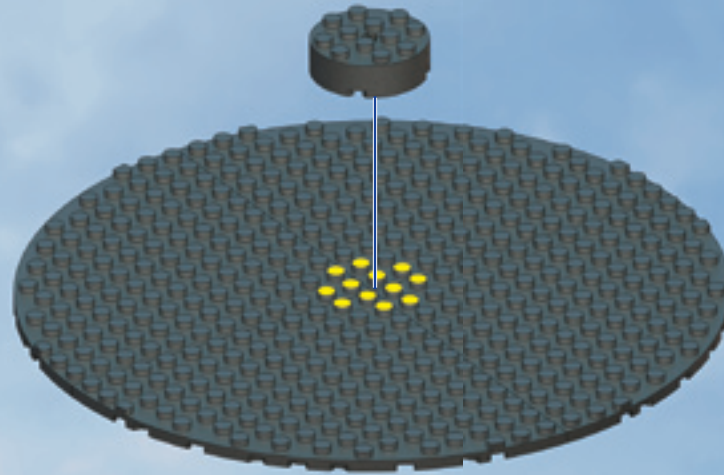
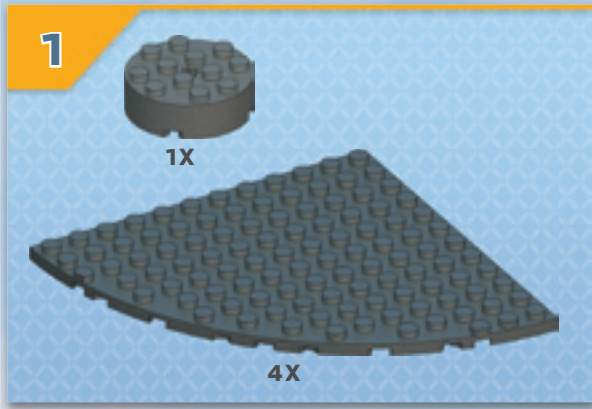

4

24X

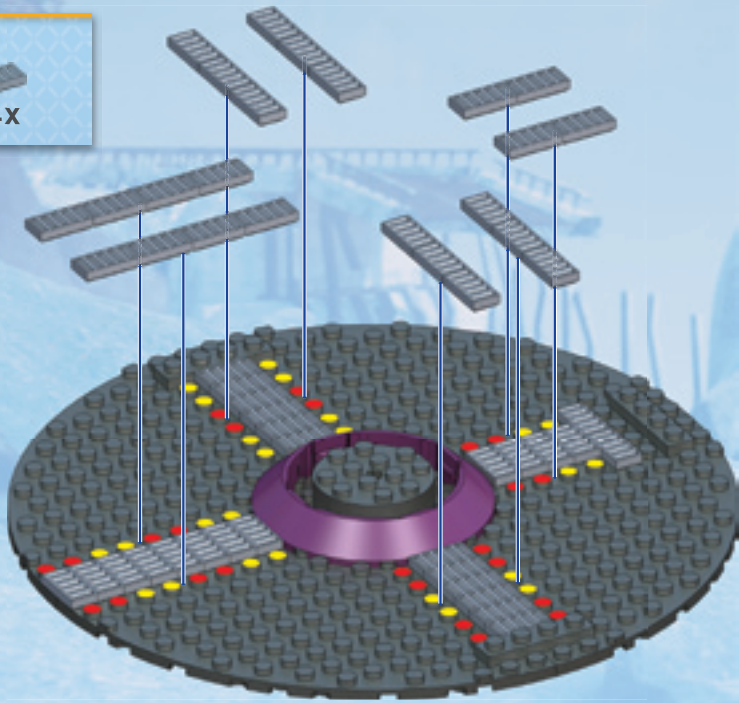

5

12X

1X

1X

1X

1X

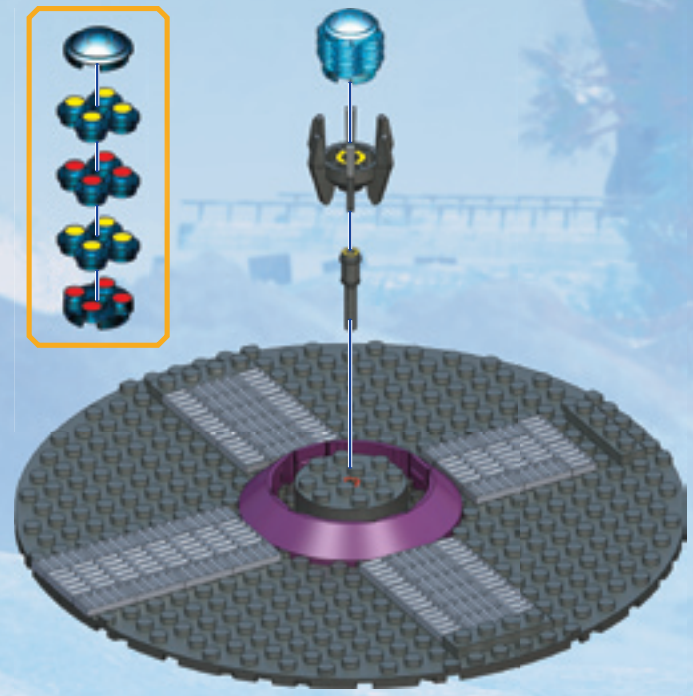

6

1X

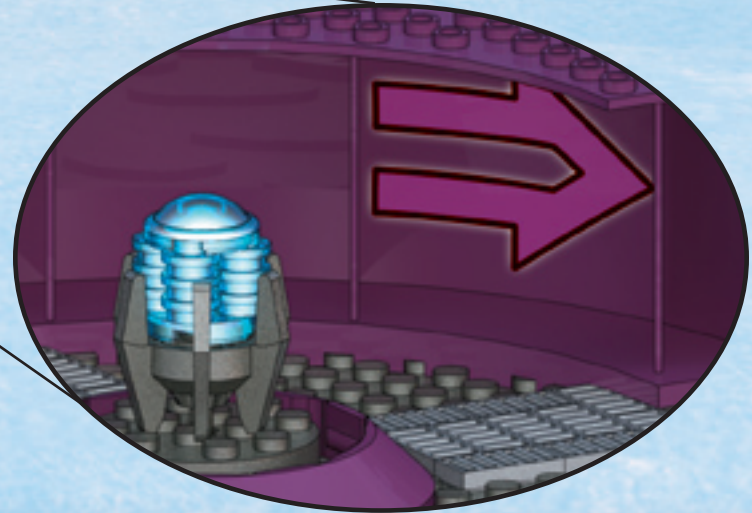
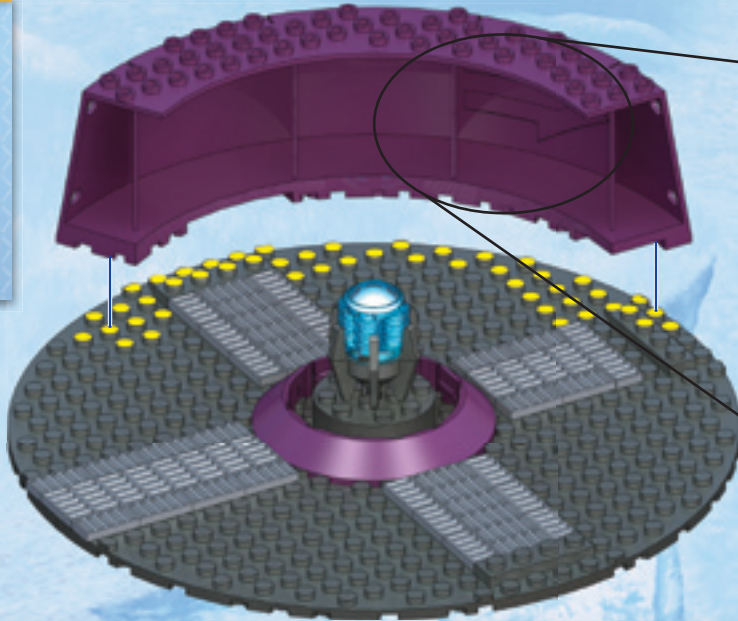
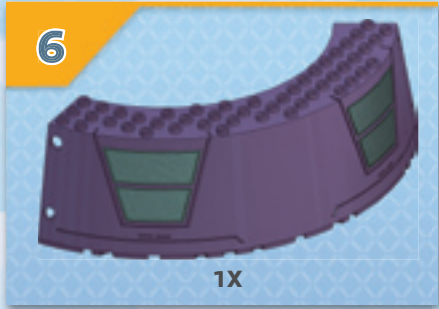

7



1X

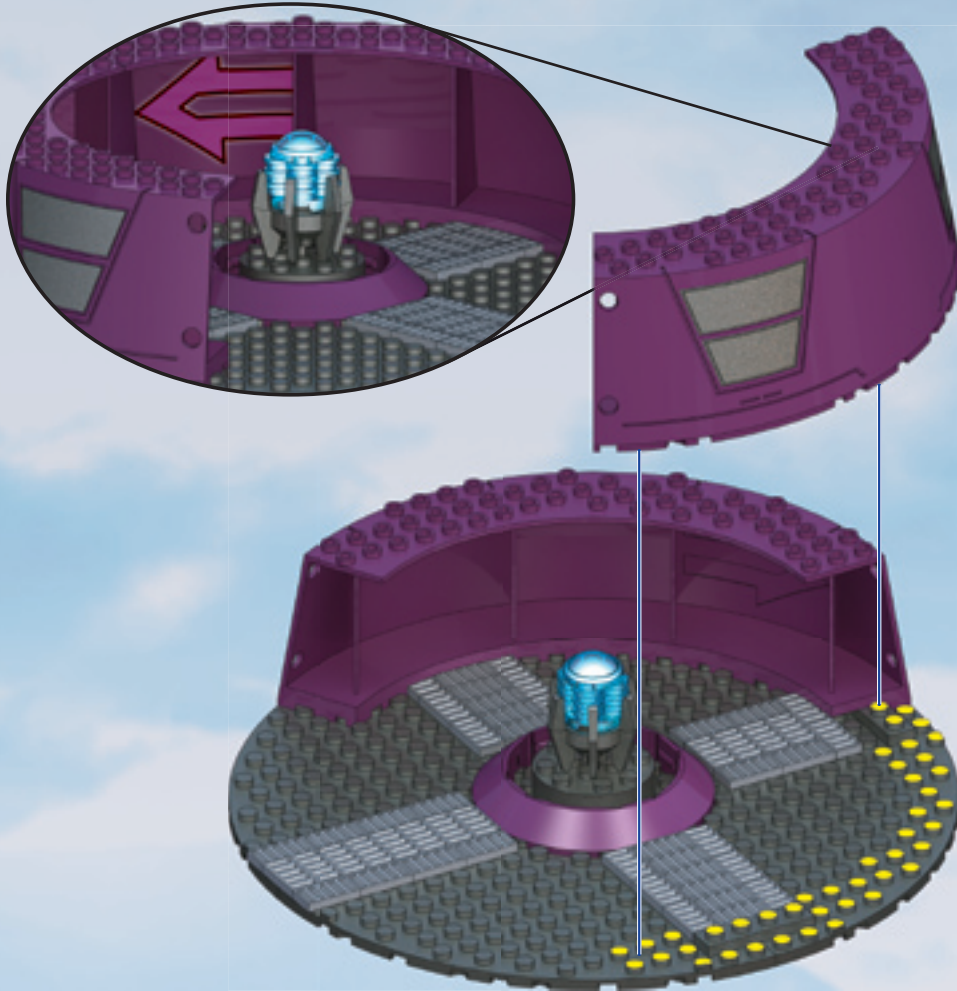

8



2X

1X

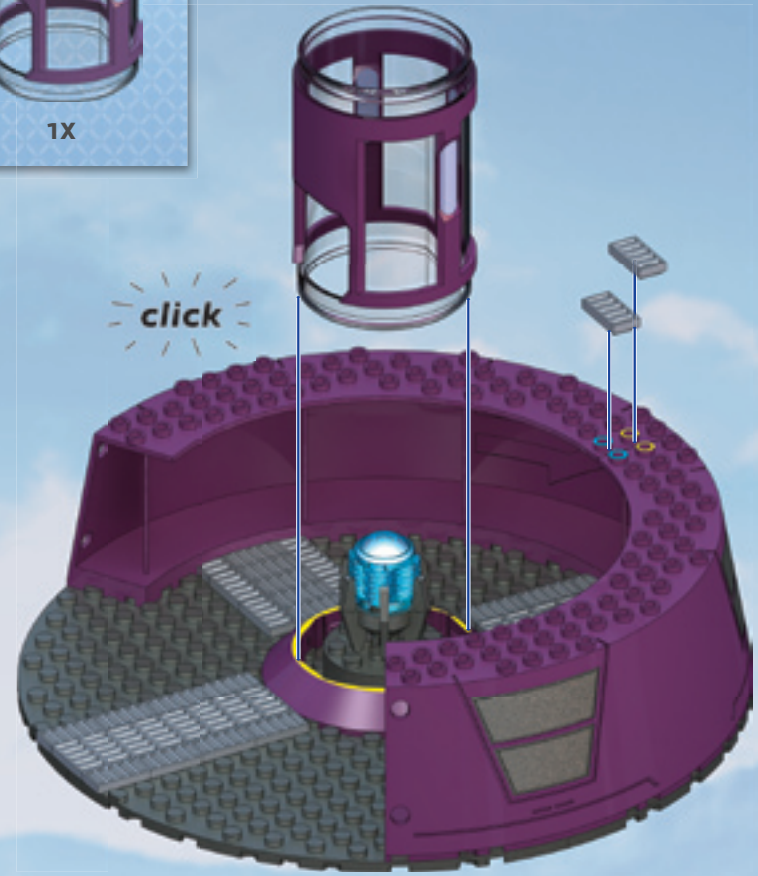

9

12X
3X



x3

10

15X 1X 1X 1X

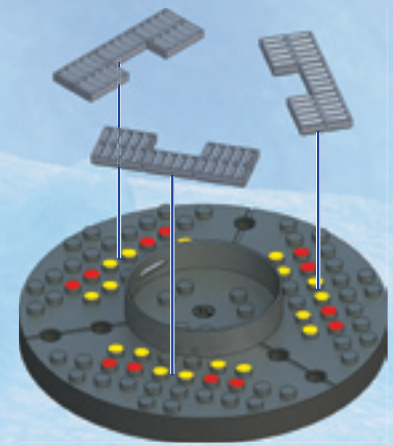

1

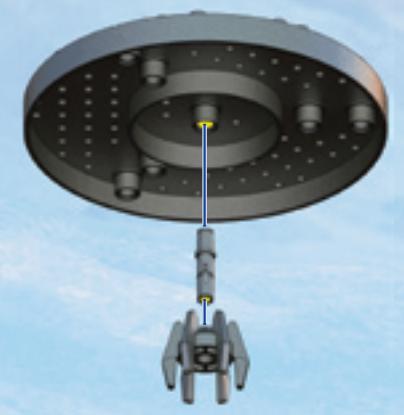

2

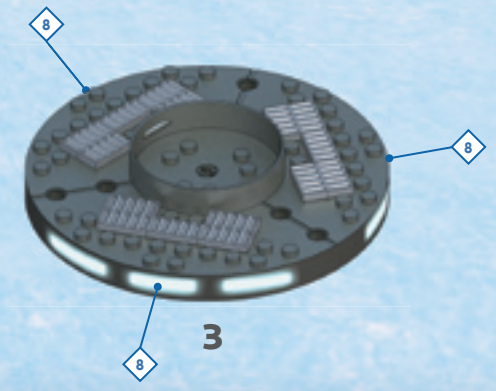

3

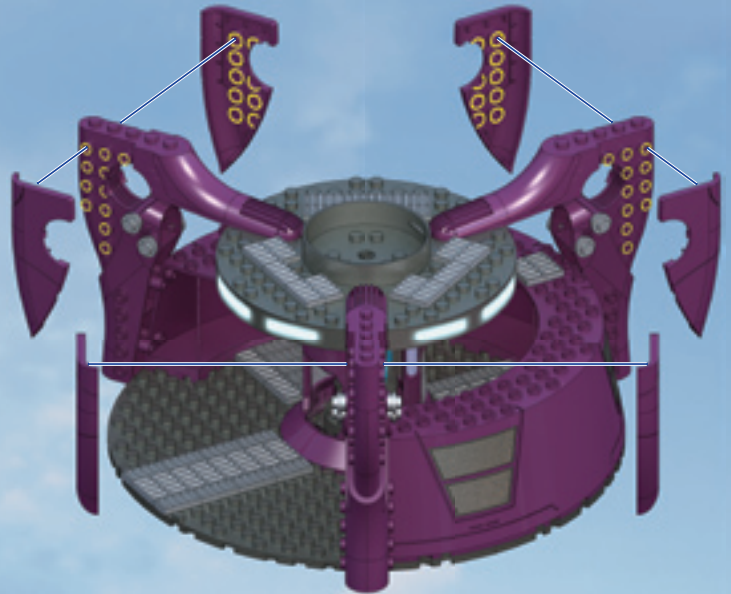
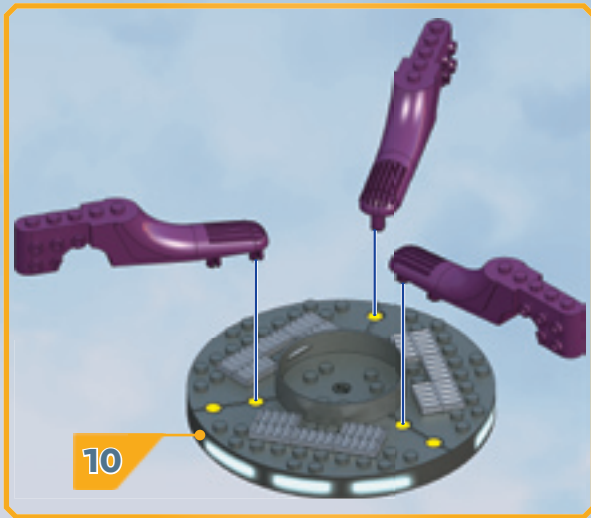

1

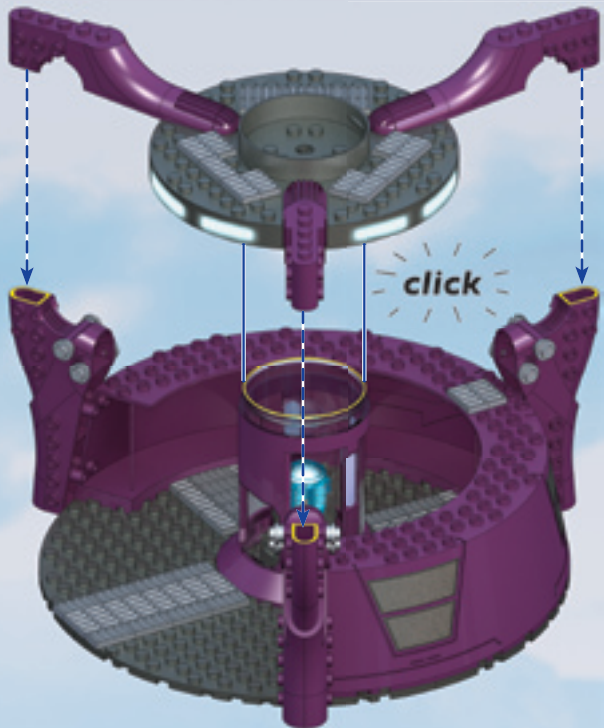

2

13

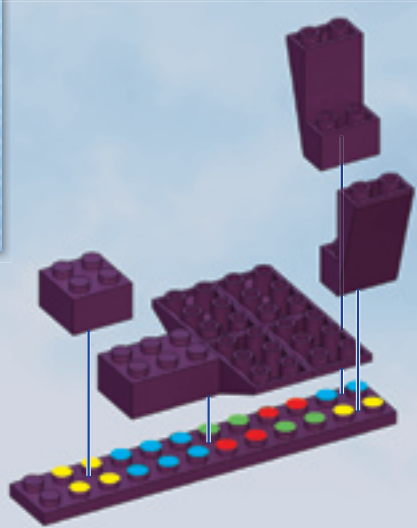

14

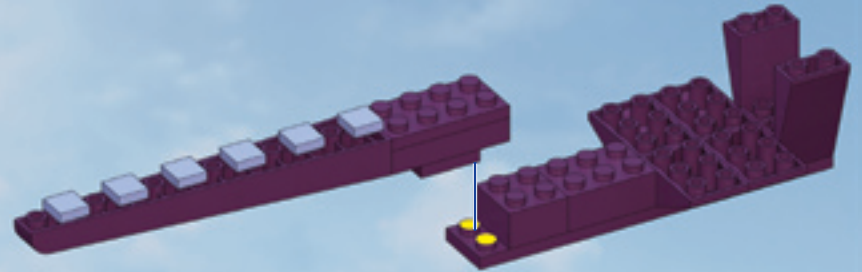
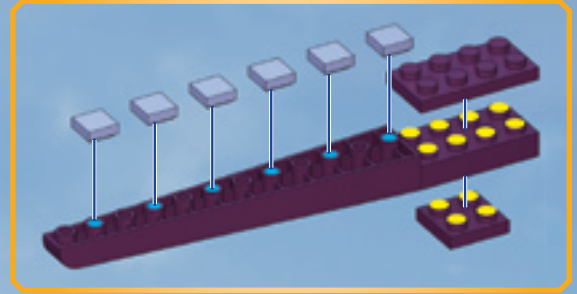
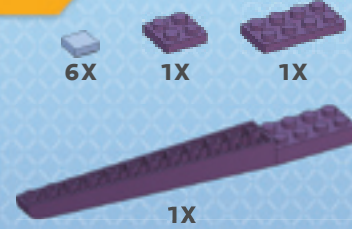

15

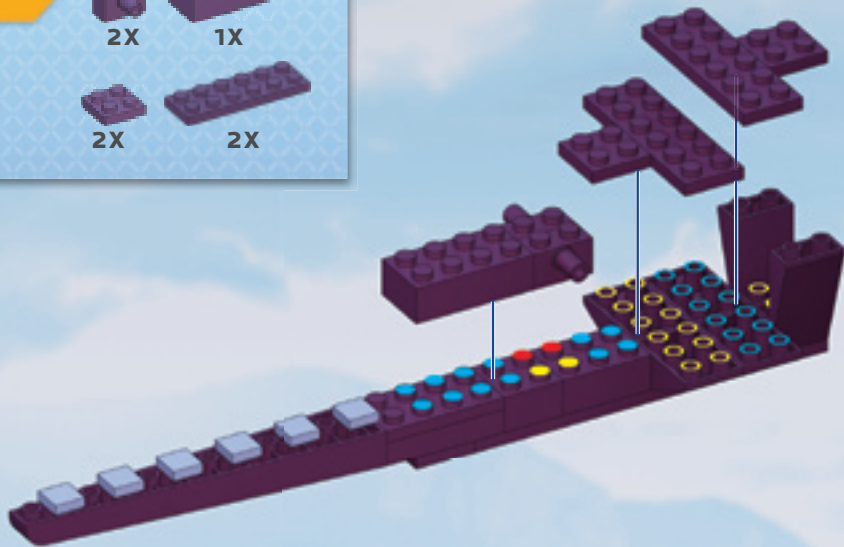

16

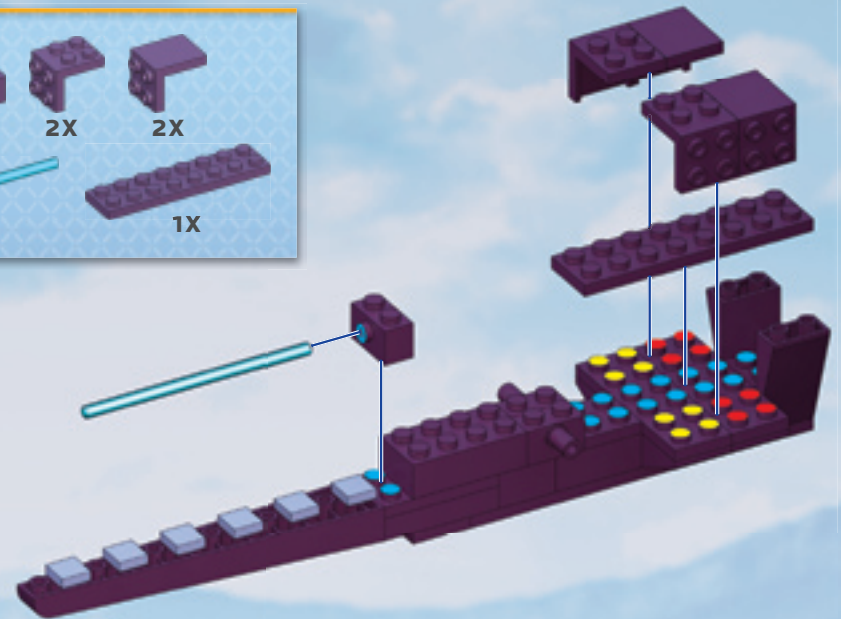
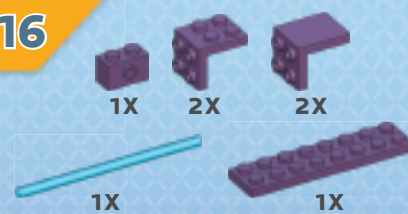

17

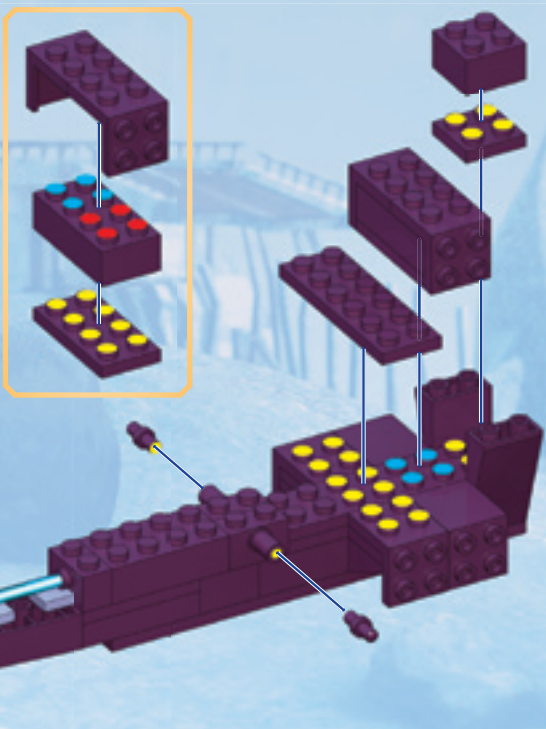
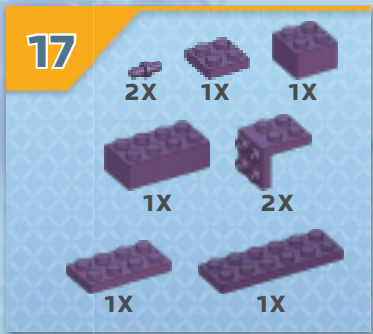

18

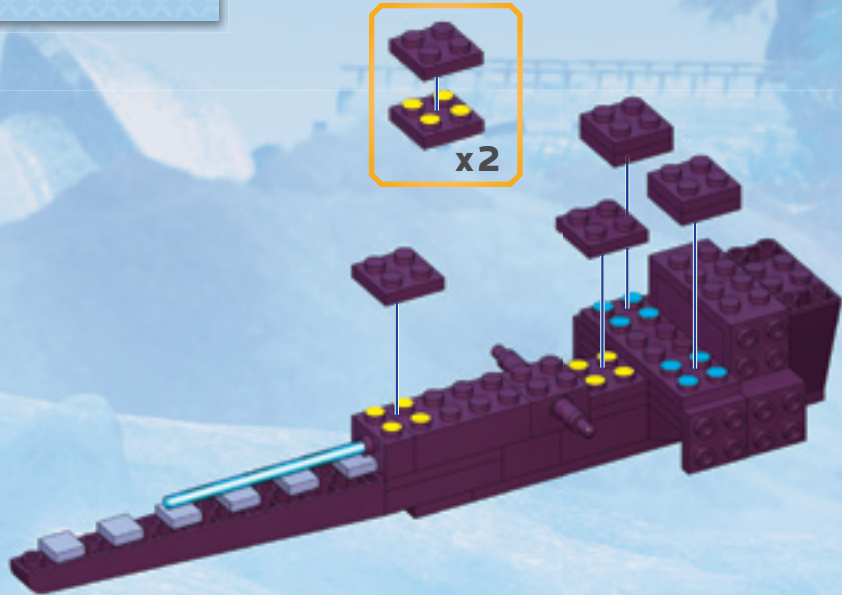
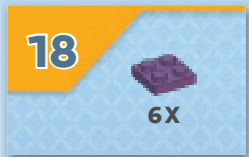

19

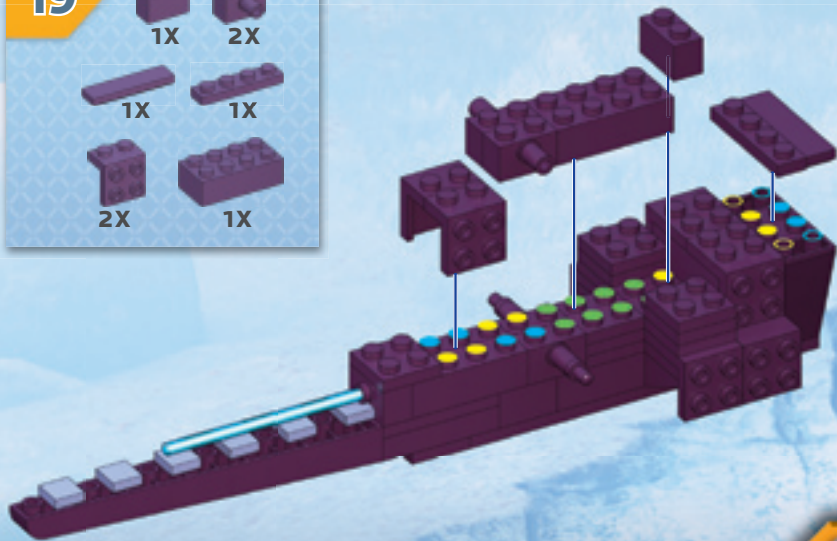
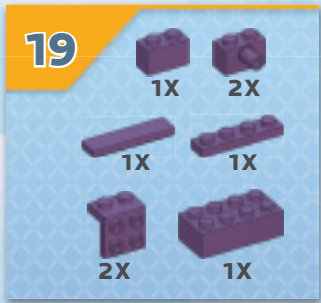

20

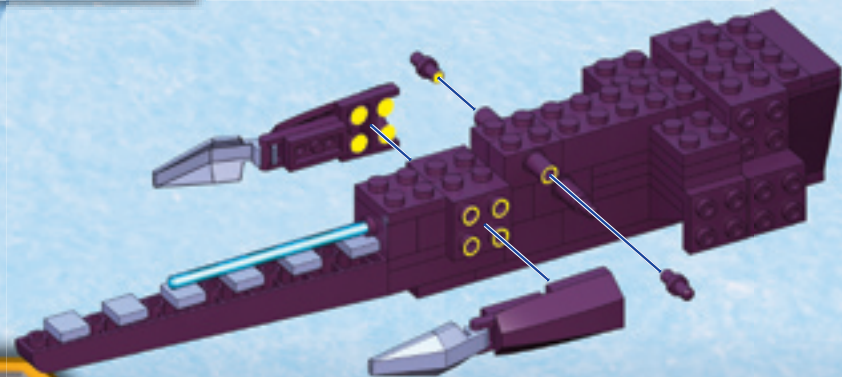
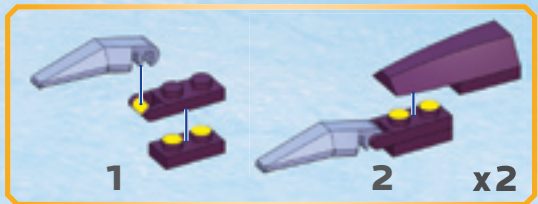
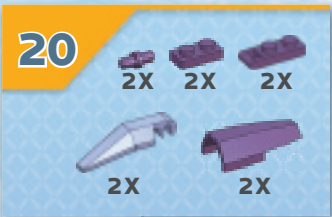

21

- 6X [1x1 grey brick]
- 1X [1x2 dark red brick]
- 1X [1x4 dark red brick]
- 1X [1x6 dark red brick]
- 1X [1x12 dark red brick]

1

2

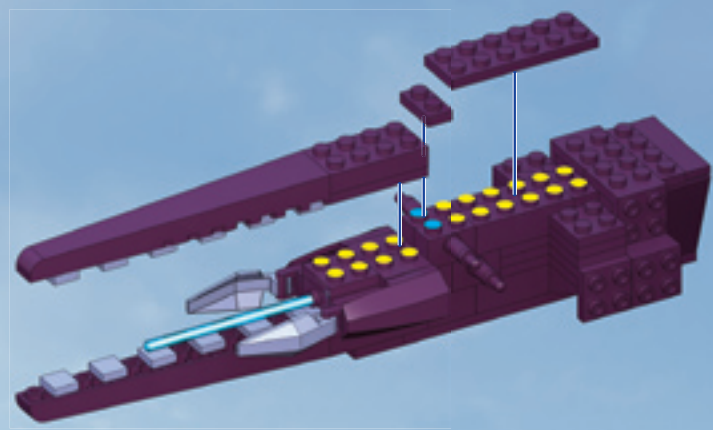

22

- 2X [1x2 dark red brick]
- 2X [1x4 dark red brick]
- 1X [1x4 grey brick]
- 1X [1x6 grey brick]

23

- 6X [1x1 grey brick]
- 2X [1x2 teal brick]
- 4X [1x2 dark red brick]
- 2X [1x4 dark red brick]
- 2X [1x6 dark red brick]
- 4X [1x4 dark red brick]

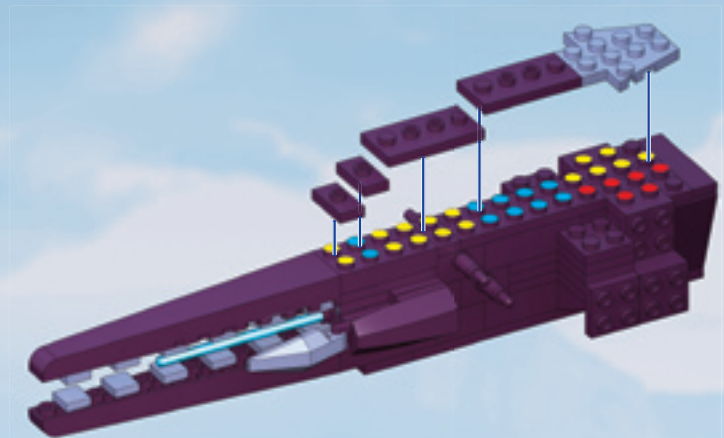

1

2

x2

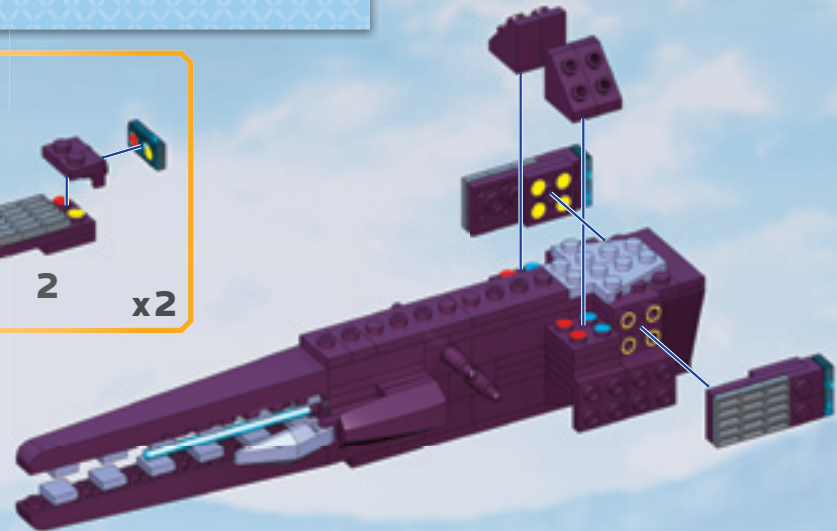

24

- 4X
- 1X
- 2X
- 2X



25

- 4X
- 2X
- 2X

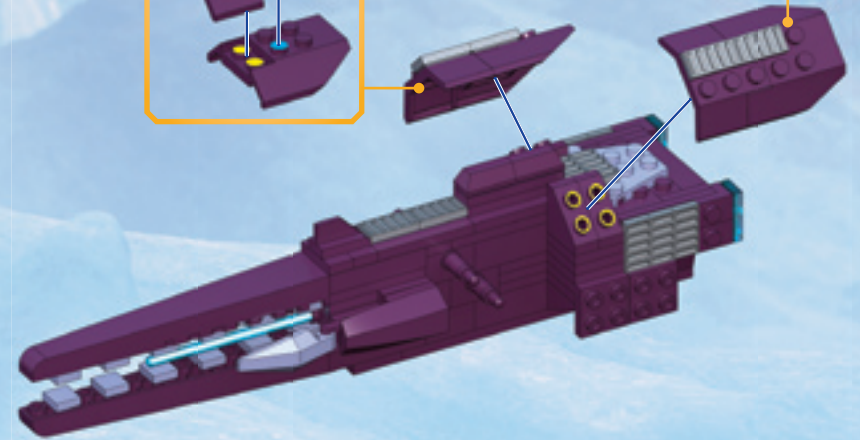

26

- 2X
- 2X
- 2X
- 2X
- 2X

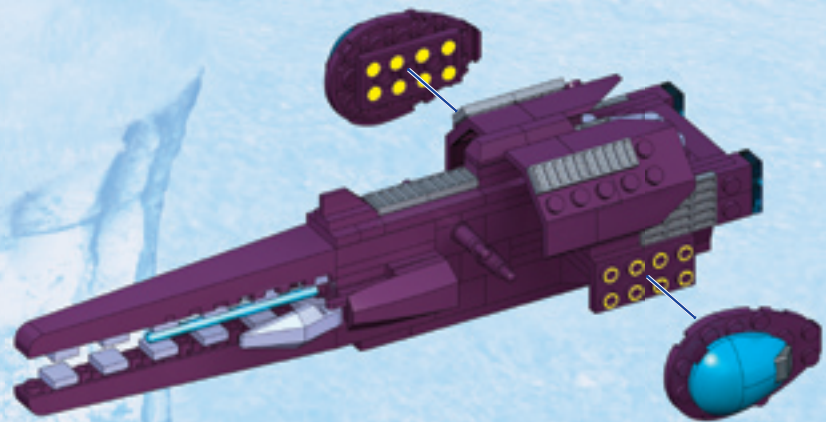
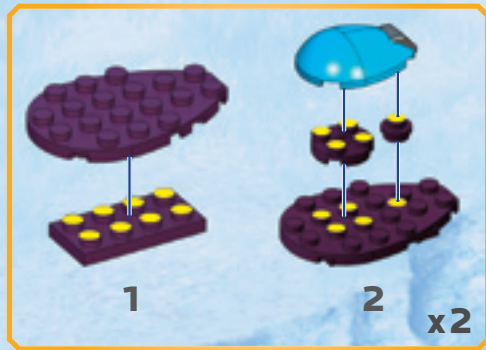

27

6X	2X	4X	2X
3X	1X	4X	2X
2X	1X	2X	
1X	1X		

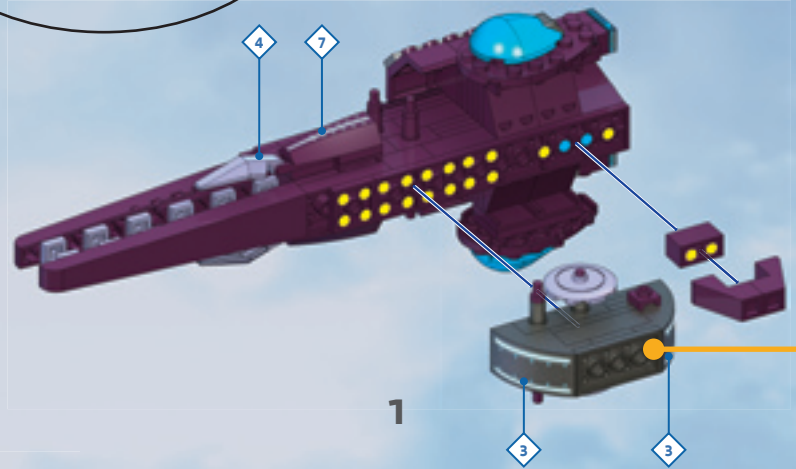
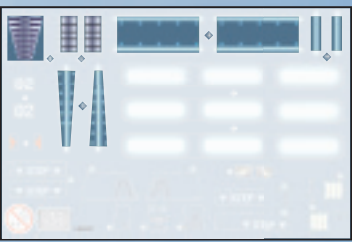
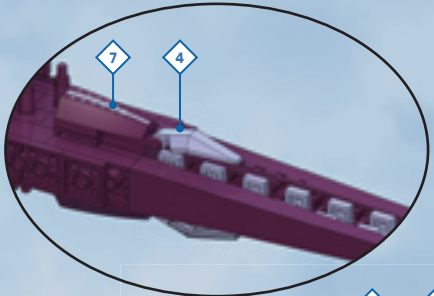

1

2

3

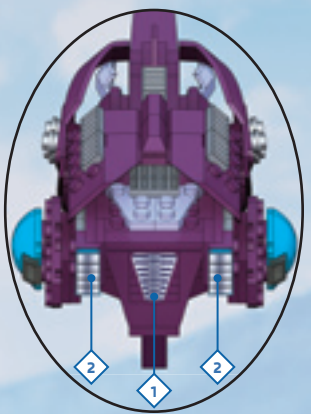
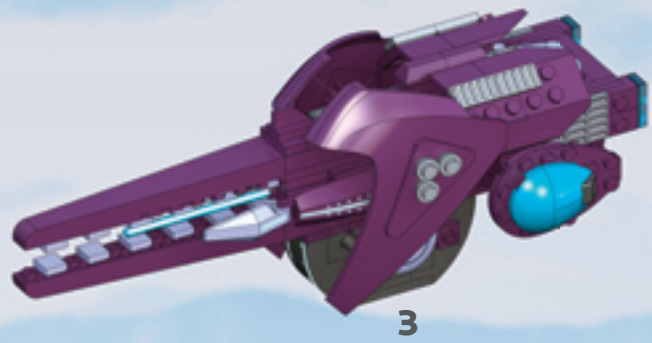
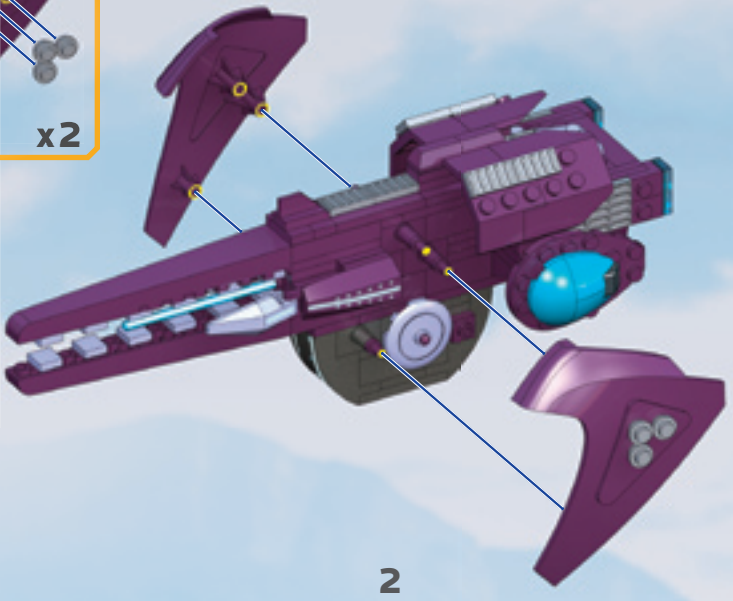
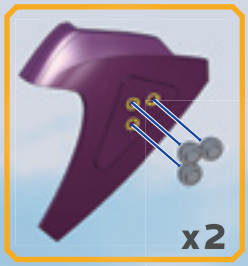

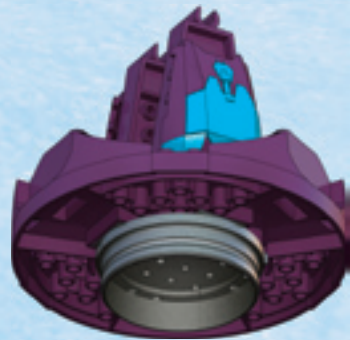
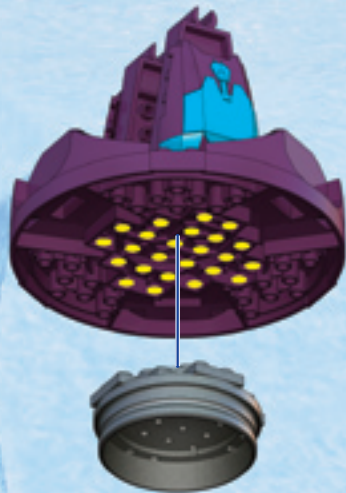
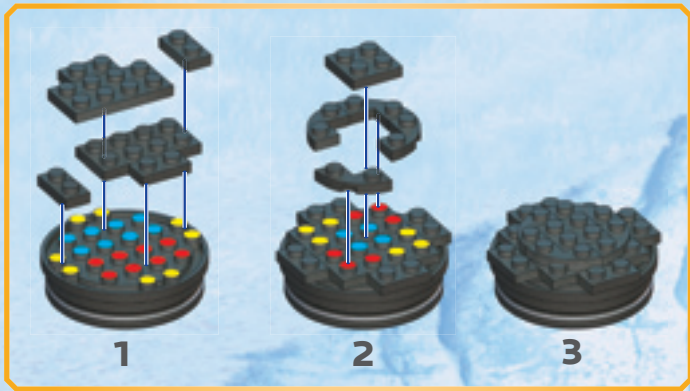
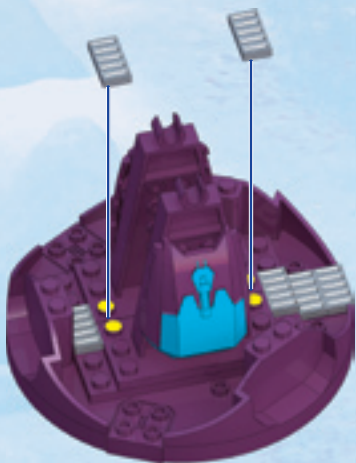
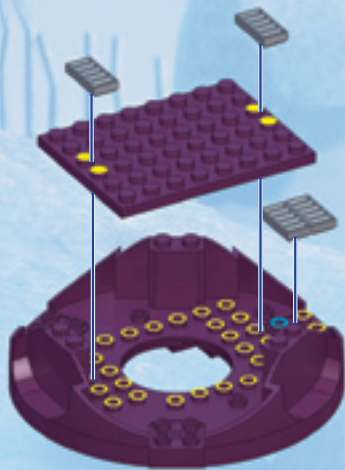

29

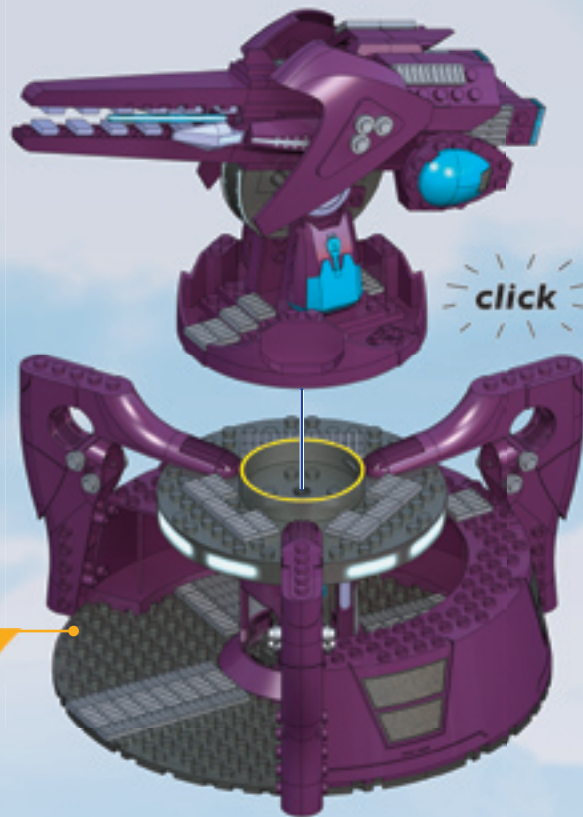

UNSC Rockethog vs Anti Aircraft Gun
Atrapa-Cohetes de la UNSC vs Cañón Antiaéreo
Rockethog de l'UNSC vs. Canon antiaérien
UNSC-Rockethog gegen Flugabwehrkanone
UNSC Raketzwijn vs Anti Vliegtuig Geweer
UNSC Rockethog vs Cannone antiaereo
Rockethog UNSC vs Arma Antiaérea



HALO

THE AUTHENTIC COLLECTOR'S SERIES
 LA AUTÉNTICA SERIE PARA COLECCIONISTAS
 SÉRIE AUTHENTIQUE POUR COLLECTIONNEUR
 DE AUTHENTISCHE SAMMEL-SERIE - DE AUTHENTISCHE VERZAMELINGSREKIE
 L'AUTENTICA SERIE PER COLLEZIONISTI - A SERIE DO VERBADEKOR COLECCIONADORA

UNSC ROCKETHOG vs ANTI AIRCRAFT GUN

Atrapa-Cohetes de la UNSC vs
 Cañón Antiaéreo
 Rockethog du CSNU vs.
 Canon antiaérien
 UNSC-Rockethog gegen
 Flugabwehrkanone
 UNSC Raketwijn vs Anti
 Vliegtuig Geweer
 UNSC Rockethog vs Cannone
 antiaereo
 Rockethog UNSC vs Arma
 Antiaérea

MEGABLOKS CAMO EFFECT



Espartano Hazop de UNSC
 Hazop Spartan de UNSC
 UNSC Hazop Spartan / UNSC Hazop
 Spartan / Hazop Spartan/UNSC
 Spartan Hazop de UNSC

UNSC HAZOP SPARTAN



Marines UNSC
 Marines de UNSC
 UNSC Marines / UNSC mariners
 Marines degli UNSC
 Soldados da UNSC

UNSC MARINES



Ascetic de la Elite del Pacto
 Elite Ascétique Covenant
 Covenant Ascetic Elite / Covenant
 Ascetische Elite / Elite ascetica
 Covenant / Elite Ascetica/Covenant

COVENANT ASCETIC ELITE



Pacote de Salto Bruto / Dispositivo de
 salt Bruto / Sprungpack (Riding)
 Brut Springpack / Pacchetto salto
 bruto / Dispositivo de salto Bruto

JUMP PACK BRUTE

UNSC INTEL

Collect them all! - ¡Colecciónalos todos! - Collectionne-les tous!
 Mei sie die alle! - Verzamel ze allemaal! - Collezionali tutti! - Colecciónalos todos ellos!

