

**Xtreme**  
SPORTS™



96514 Flair Pipe™

**MEGA**  
**BLOKS**

- 1x AM01113RF
- 1x AM09393BDG
- 2x AM09593BTN
- 8x AM09593BDG
- 8x M0948BDG
- 2x M1146RL
- 8x M1146BDG
- 4x AM03329BDG
- 2x AM01087BDG
- 3x AM01313BLG
- 4x AM01313BDG

- 2x AM094493BTN
- 4x AM094493BDG
- 6x AM09033BLG
- 1x AM03058BDG
- 2x AM03058BTN
- 3x AM03058BLG
- 3x AM09269ACX
- 1x AM01480BDG
- 1x AM08483RL

- 1x AM09197BLG
- 2x AM06618ACX
- 1x AM0239ITS
- 2x AM15299BDG
- 1x AM01797ACX

- 1x M1115RF
- 6x AM03862BLG
- 2x AM03862BDG
- 1x AM01530BDG
- 2x AM01462RF

- 1x AM15027ACX
- 1x AM15299BLG
- 2x AS965131
- 1x AM16203RF





2x  
AS965141I



2x  
AS965149



1x  
AMI6199ACX



1x  
AS965143



3x  
AM09205RL



1x  
AS965144



2x  
AMI6201ACX



4x  
AMI6202F



1x  
AS965141



1x  
AS965142

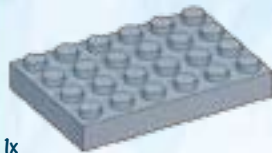

1x  
AM03015ACX



1x  
AS965136



1x  
AS965145

Choose best place for stickers! | ¡Elige el mejor lugar para las pegatinas! | Choisissez le meilleur endroit pour les autocollants! | Klebe die Aufkleber auf eine beliebige Stelle! | Kies de beste plaats voor de plakplaatjes! | Autoadesivi da mettere dove vuoi tu! | Escolhe o melhor lugar para os autocolantes!



1x  
AL965141



**EN** Please read these instructions carefully before first use and keep them for future reference. / **ES** Leer estas instrucciones cuidadosamente antes de la primera utilización y guardarlas para referencia futura. / **FR** Il est recommandé de lire attentivement ce feuillet avant la première utilisation et de le conserver pour référence future. / **DE** Die Gebrauchsanleitung bitte durchlesen und aufbewahren. / **NL** Wij raden u aan deze handleiding zorgvuldig te lezen en te bewaren voor eventuele raadpleging op een later tijdstip. / **IT** Leggere le istruzioni prima di cominciare ad usare il gioco e conservarle per referenze future. / **PT** Leia as instruções antes do primeiro uso e guarde-as para futura referência.

**EN** ⚠ **WARNING :**  
CHOKING HAZARD. - Small parts.  
Not for children under 3 years.

**ES** ⚠ **ADVERTENCIA :**  
PELIGRO DE ASFIXIA. - Contiene piezas pequeñas.  
No recomendado para niños menores de 3 años.

**FR** ⚠ **AVERTISSEMENT :**  
RISQUE DE SUFFOCATION. - Présence de petits éléments.  
Ne convient pas aux enfants de moins de 3 ans.

**DE** ⚠ **WARNUNG :**  
ERSTICKUNGSGEFAHR. - Enthält kleine Teile.  
Nicht für Kinder unter 3 Jahren geeignet.

**NL** ⚠ **WAARSCHUWING :**  
VERSTIKKINGSGEVAAR. - Bevat kleine onderdelen.  
Niet geschikt voor kinderen onder de 3 jaar.

**DA** ⚠ **ADVARSEL :**  
KVÆLNINGSFARE. - Indeholder smådele.  
Ikke til børn under 3 år.

**EL** ⚠ **ΠΡΟΕΙΔΟΠΟΙΗΣΗ :**  
ΚΙΝΔΥΝΟΣ ΠΝΙΞΙΜΑΤΟΣ. - Περιέχει μικρά αντικείμενα  
Όχι για παιδιά κάτω των 3 ετών.

**FI** ⚠ **VAROITUS :**  
TUKEHTUMISVAARA. - Sisältää pieniä osia.  
Ei alle 3-vuotiaille lapsille.

**IT** ⚠ **ATTENZIONE :**  
PERICOLO DI SOFFOCAMENTO. - Contiene piccole parti.  
Non indicato per bambini sotto i 3 anni.

**NO** ⚠ **ADVARSEL :**  
KVÆLNINGSFARE. - Inneholder små deler.  
Kun for barn over 3 år.

**PT** ⚠ **ATENÇÃO :**  
PERIGO DE ASFIXIA. - Contém peças pequenas.  
Não é concebido para crianças de menos de 3 anos.

**SV** ⚠ **VARNING :**  
KVÄVNINGSRISK. - Innehåller små delar.  
Inte för barn under 3 år.

**JA** ⚠ **警告 :**  
窒息の危険性 - 小さな部品が含まれています  
3歳以下の子供には与えないで下さい。

**ZH** ⚠ **警告 :**  
有窒息危險 - 包含有小部件  
不适合3岁以下的小孩玩。

**AR** ⚠ **تحذير :**  
خطر اختناق - قطع صغيرة.  
غير صالحة للأطفال أقل من 3 سنوات.

Patent pending.  
Patente en trámite.  
Brevet en instance.  
Patent angemeldet.  
Patent aangevraagd.  
Brevetto in corso.  
Patente pendente.





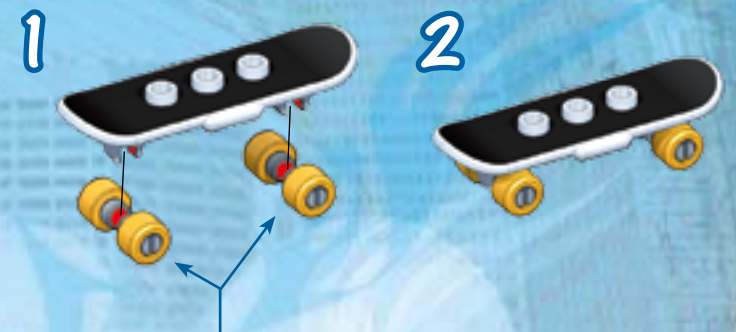



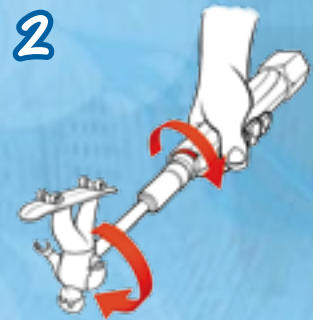
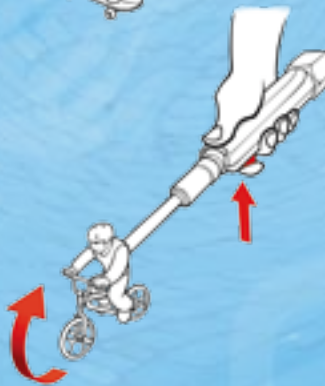
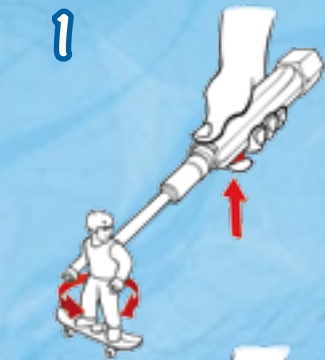
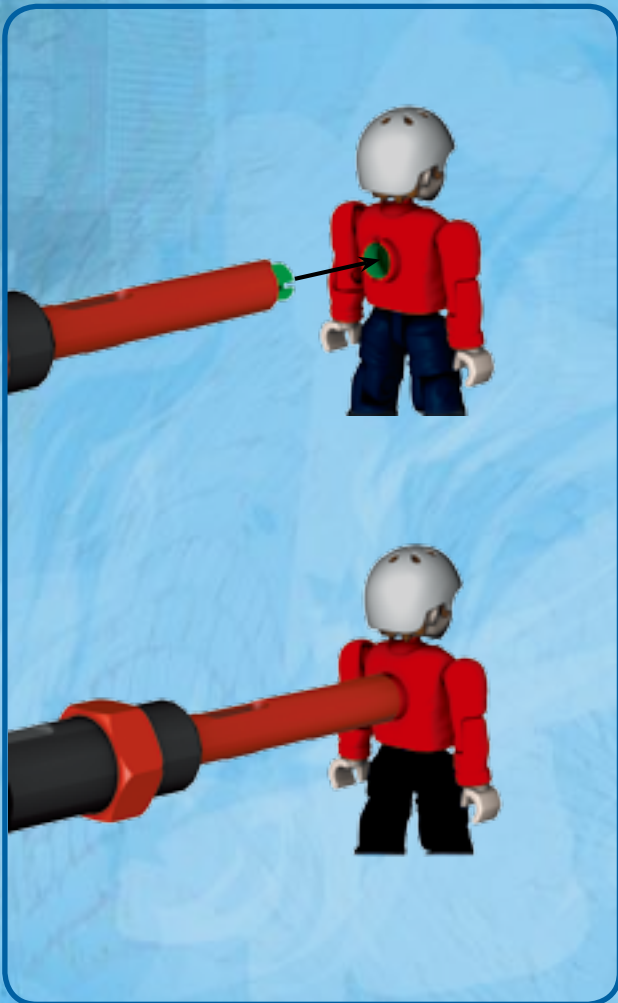







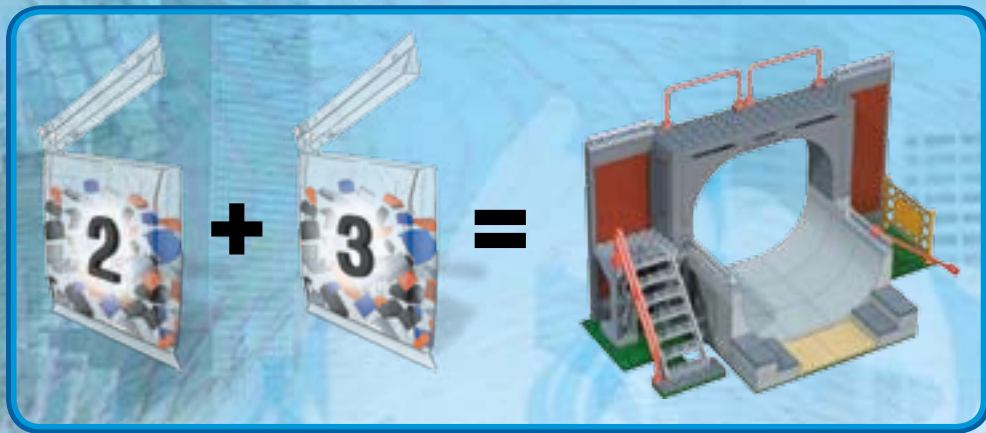

1

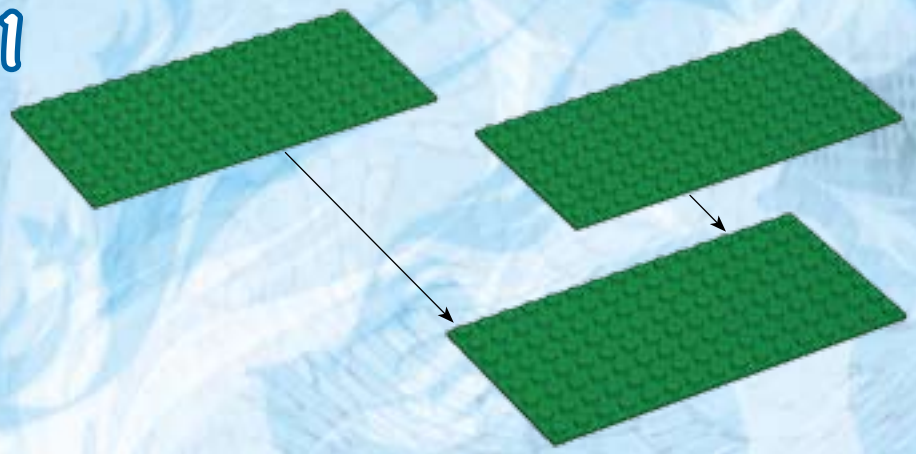

2

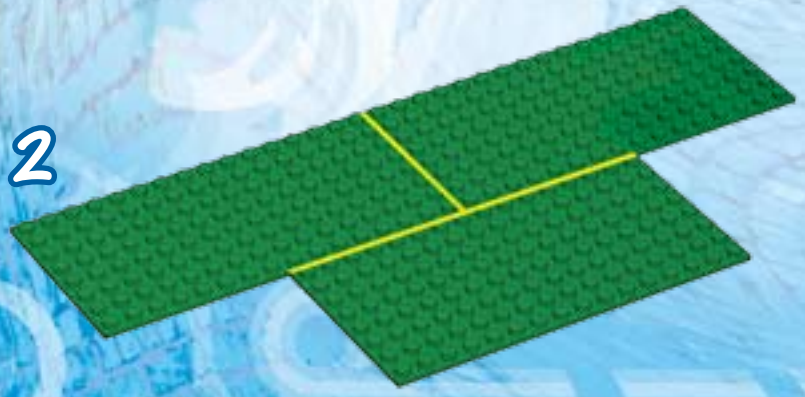

2



2x



2x



2x



2x

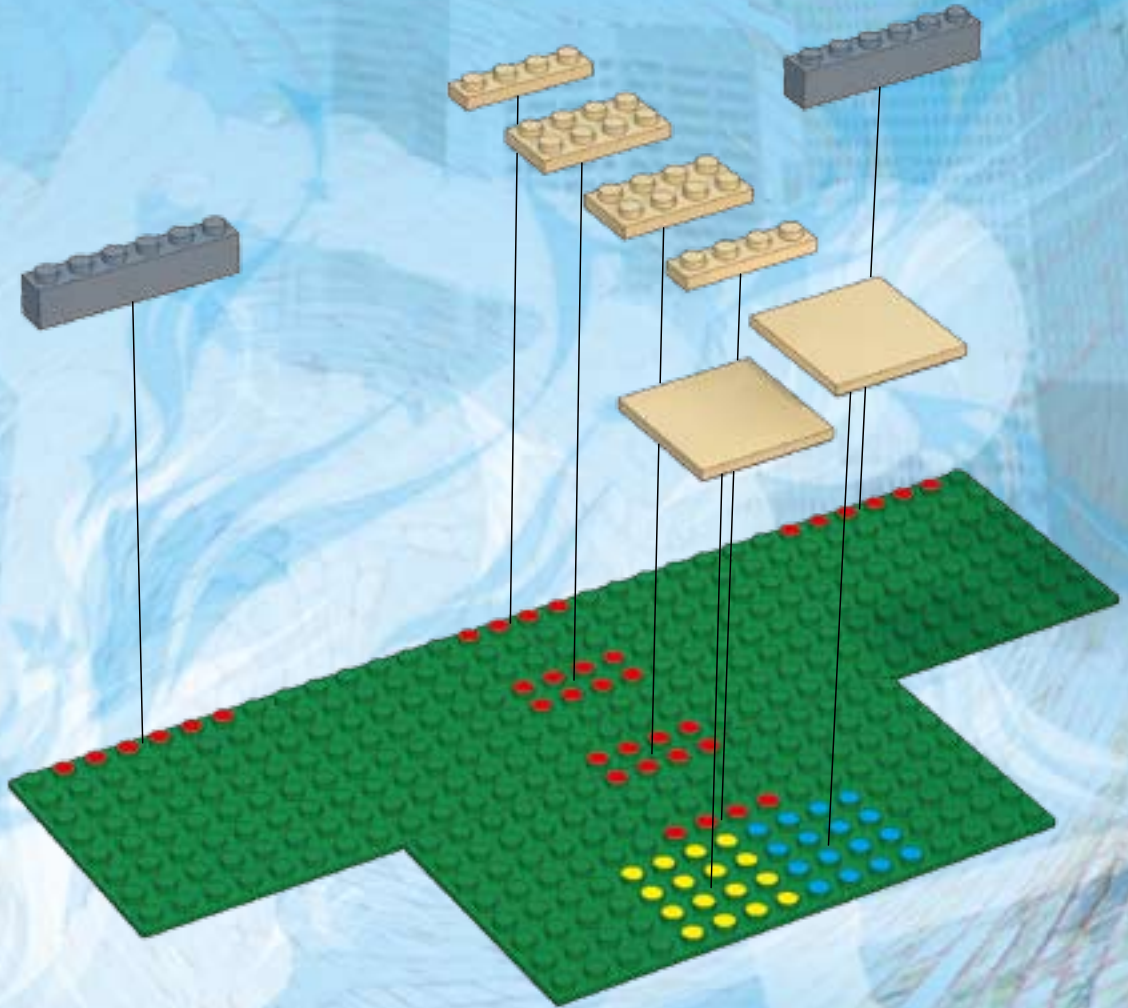



1

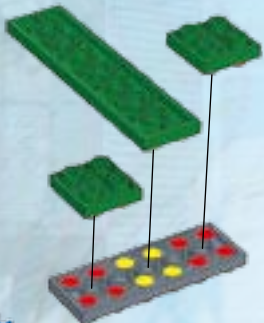

2

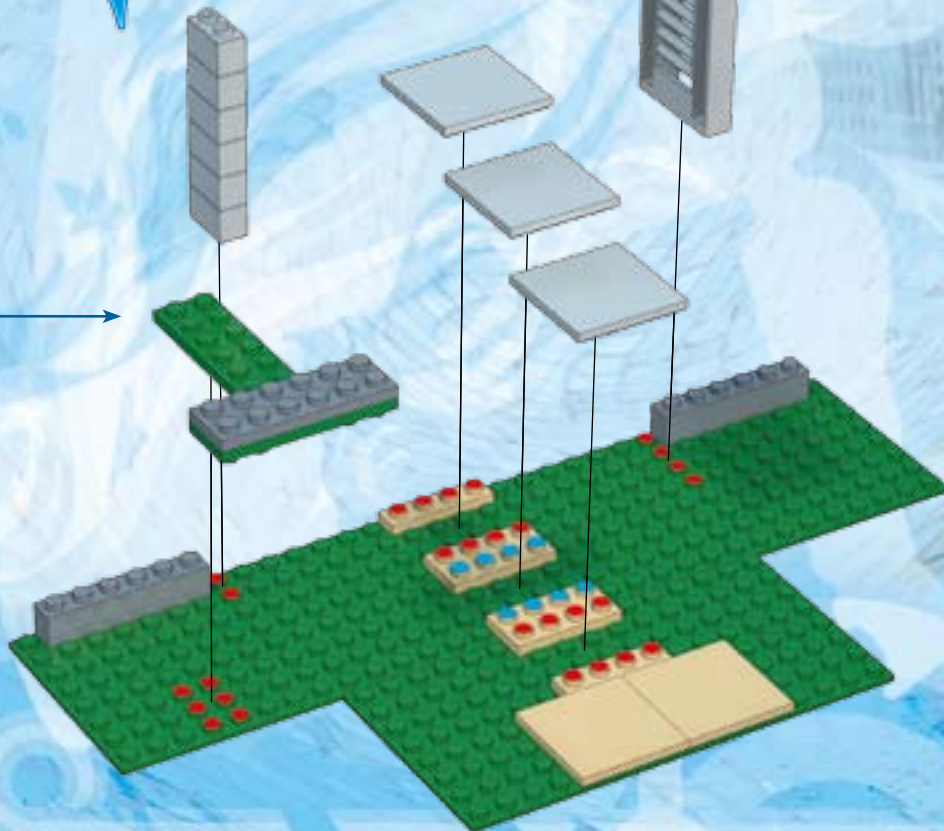

3

- 2x
- 1x
- 1x
- 3x
- 1x
- 1x





5

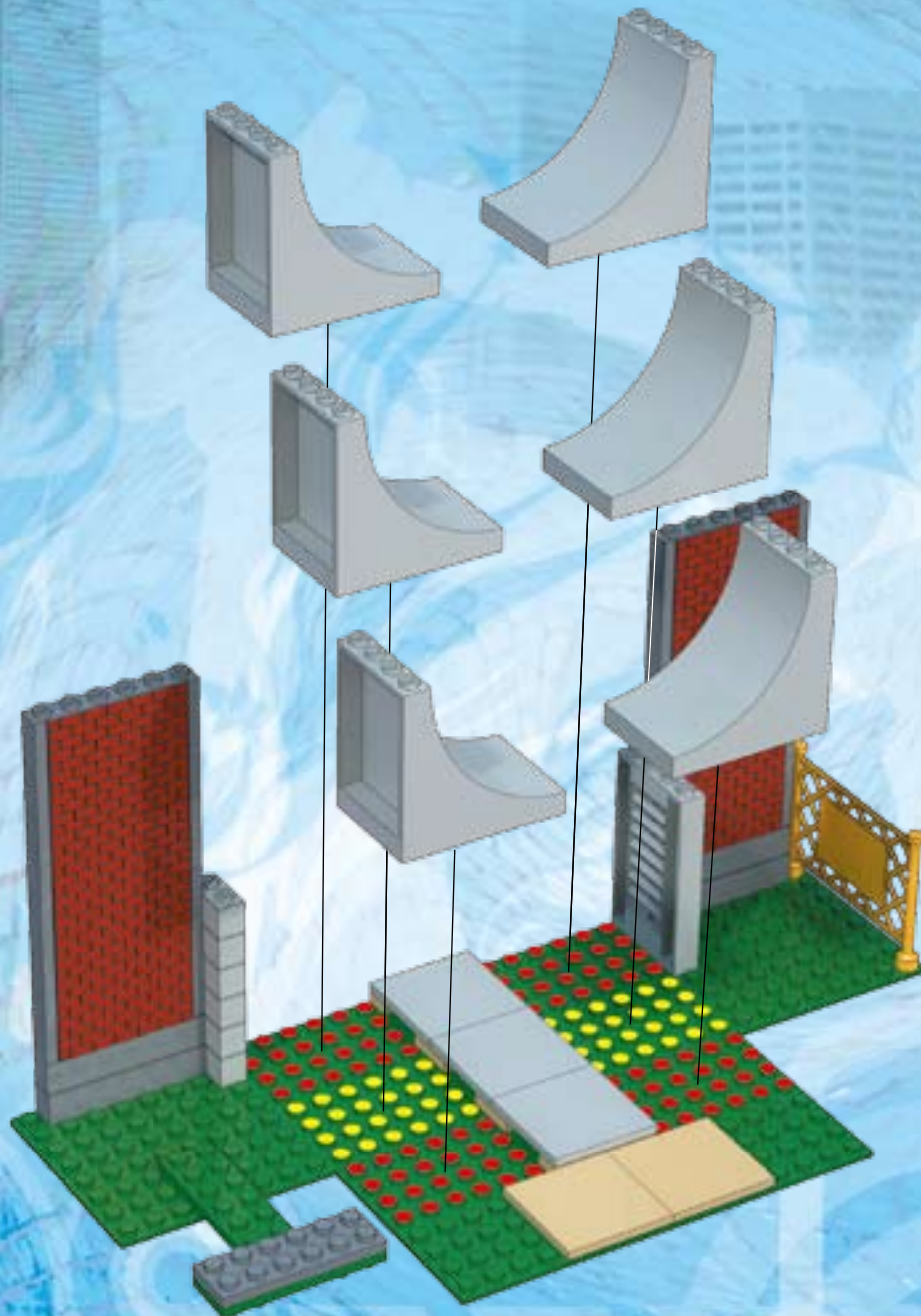

6x

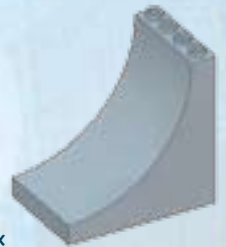

6



4x



3x



1x



2x

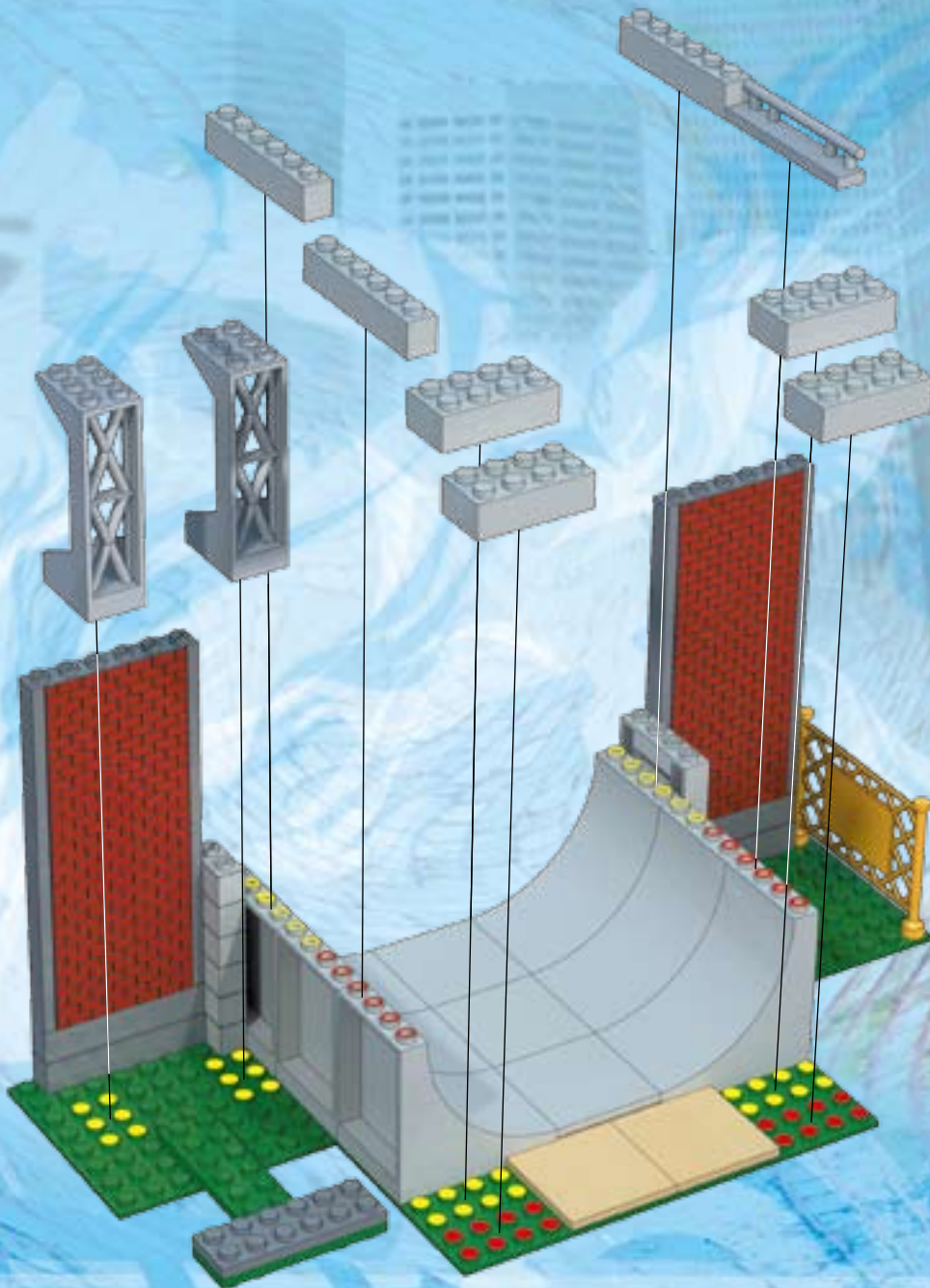



1



2

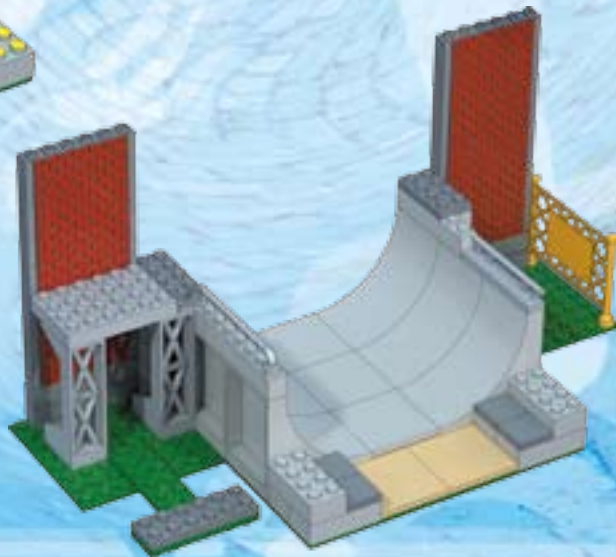

7

4x



2x



2x



1x



1x



8

8x

4x

2x

1x

1

2



9

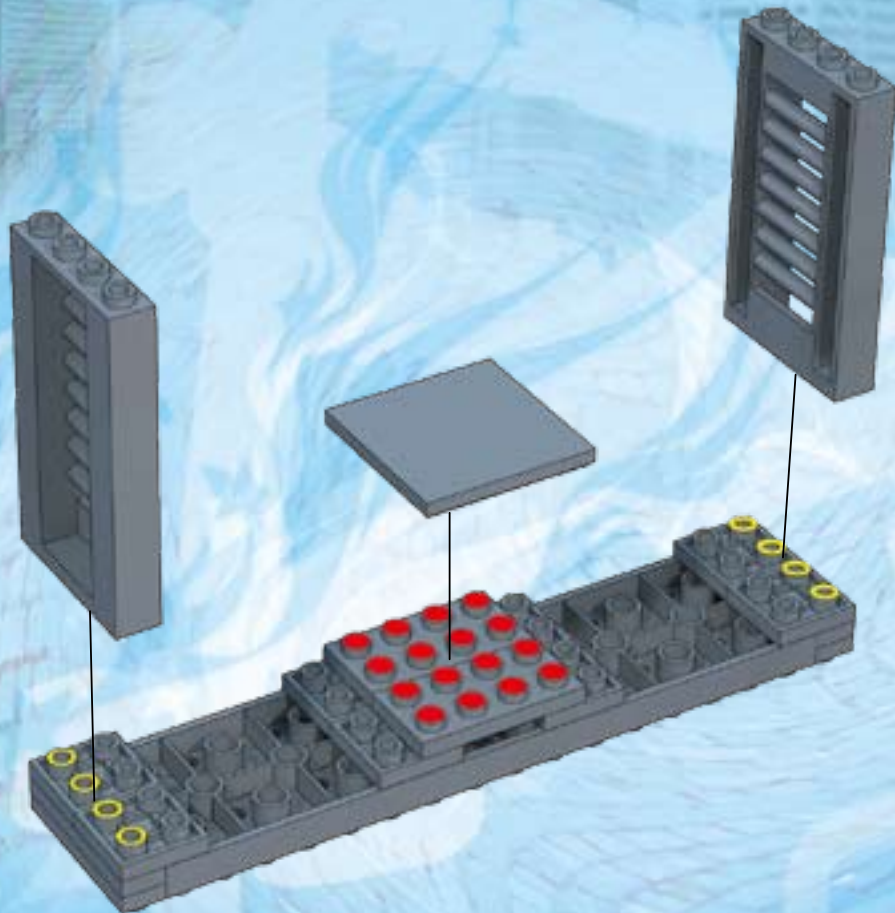

1x



2x



10



2x



2x



2x

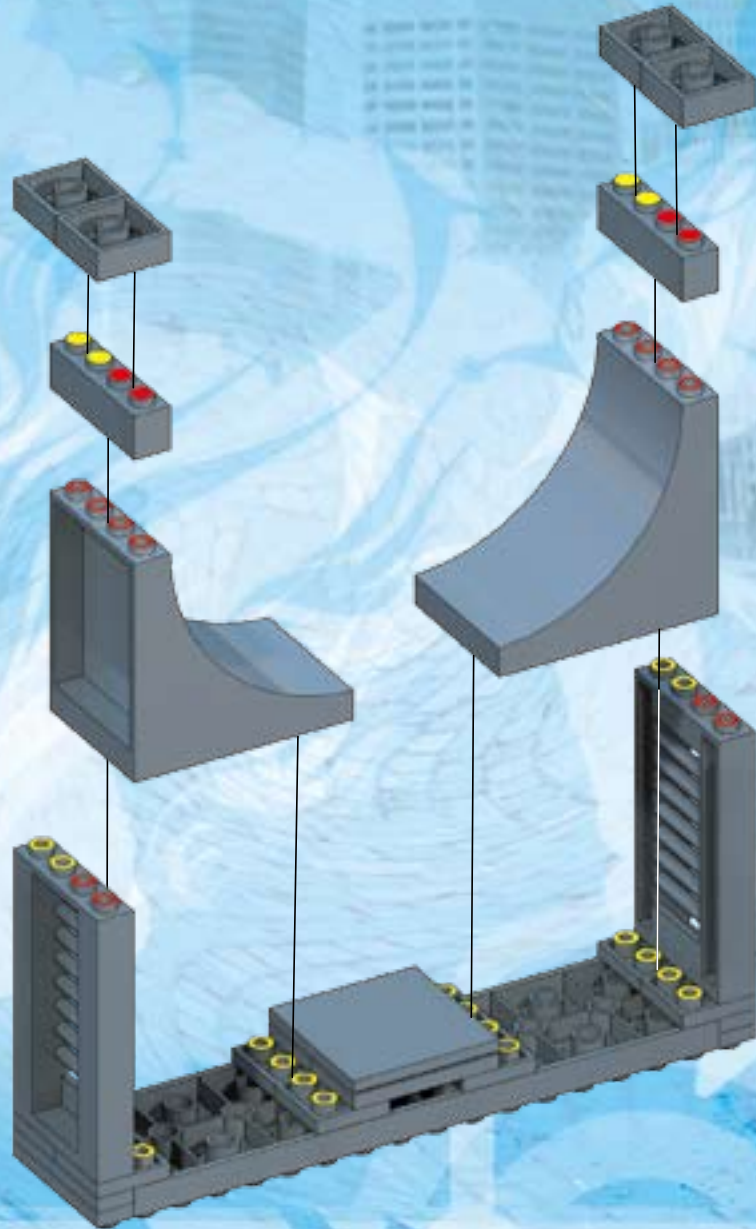



1

10

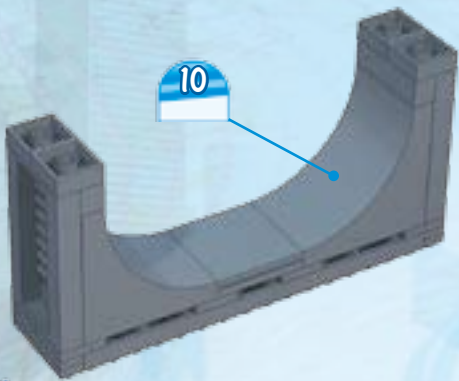

2

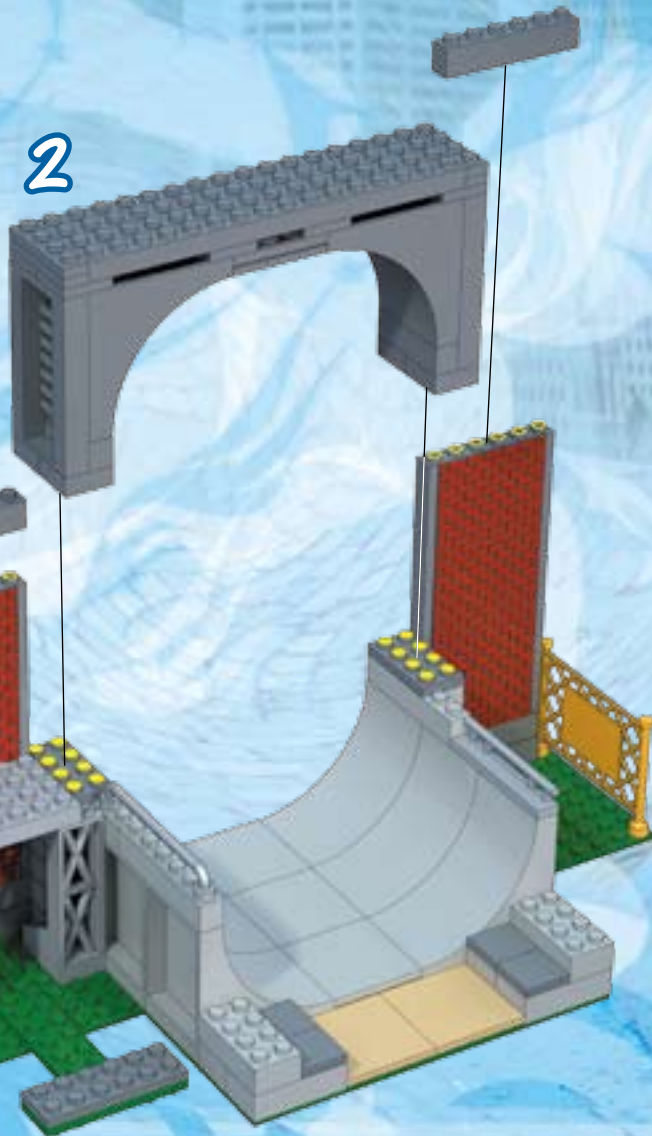

7

11

2x



12

1x

4x

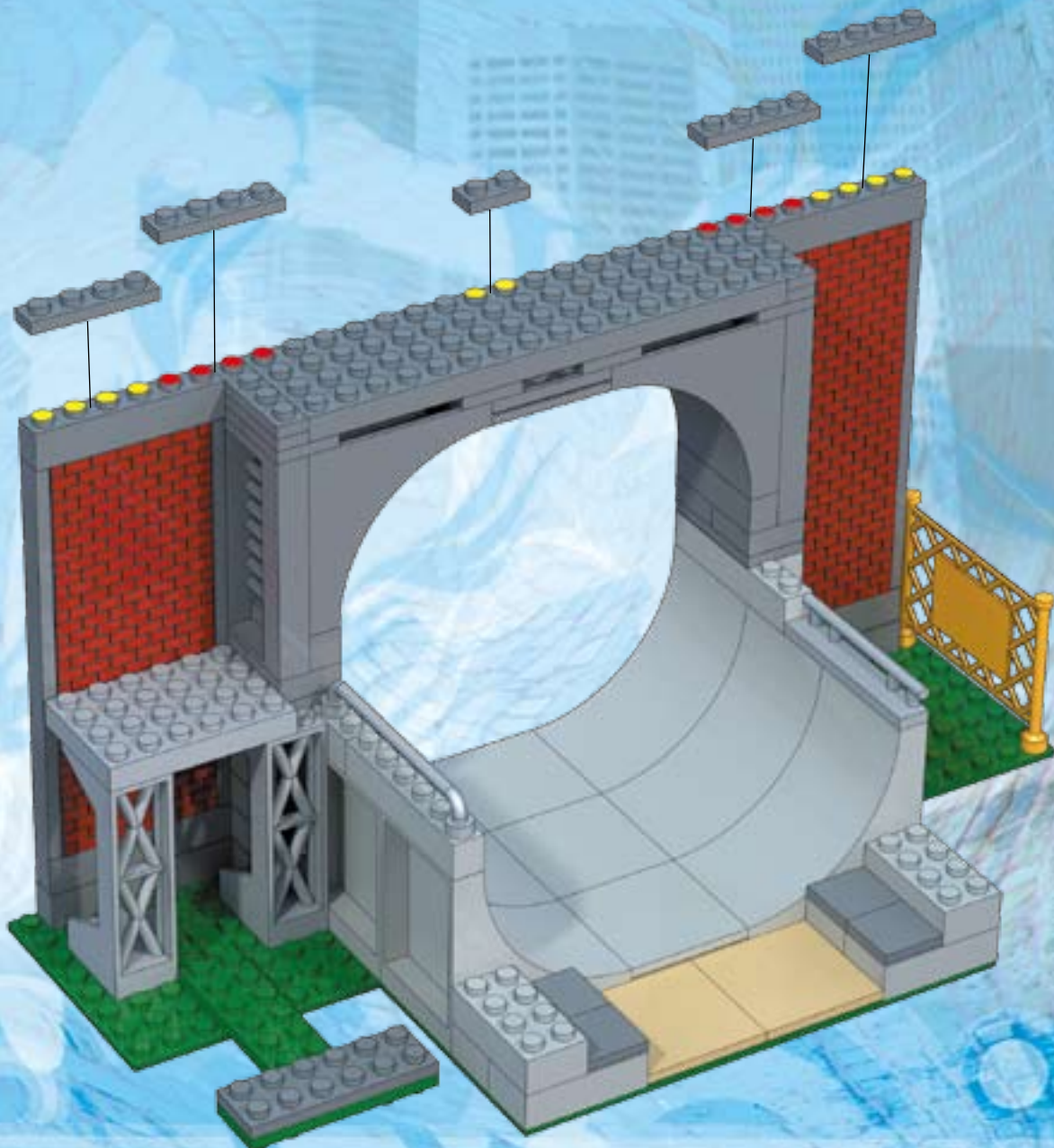

18



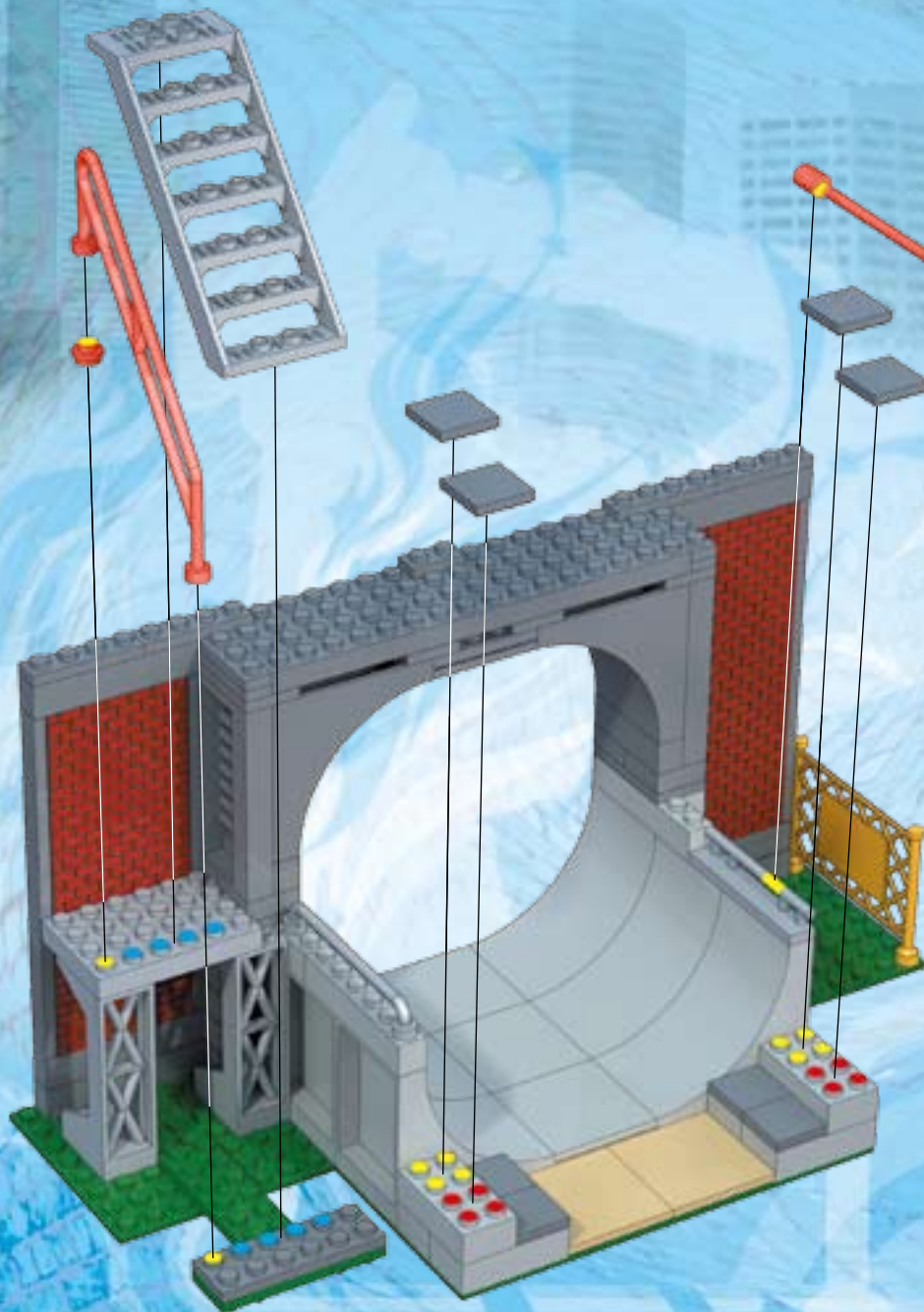

- 1x 
- 4x 
- 1x 
- 1x 
- 1x 

14



2x

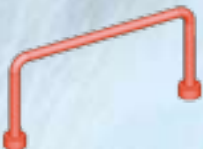

2x

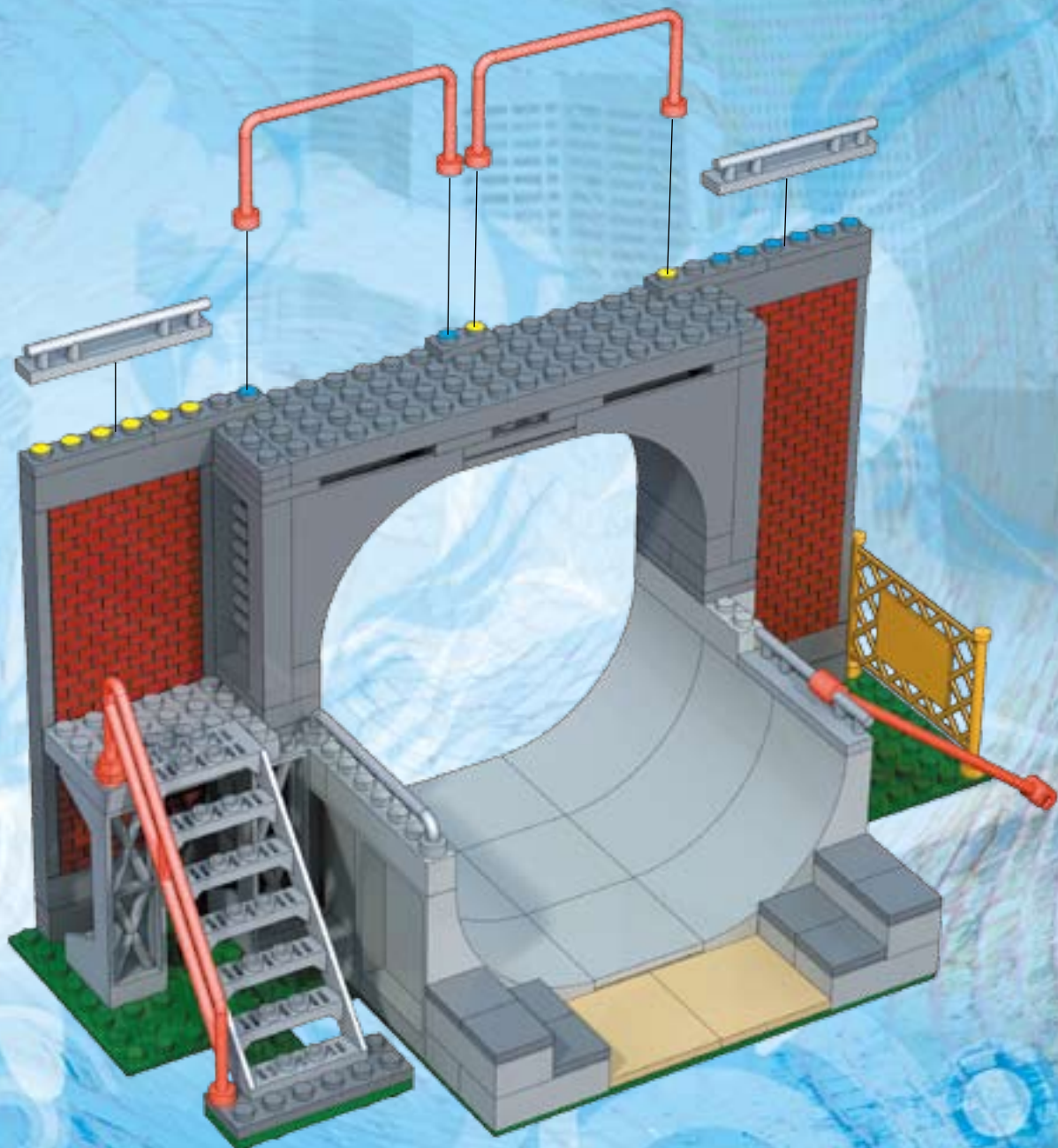

20



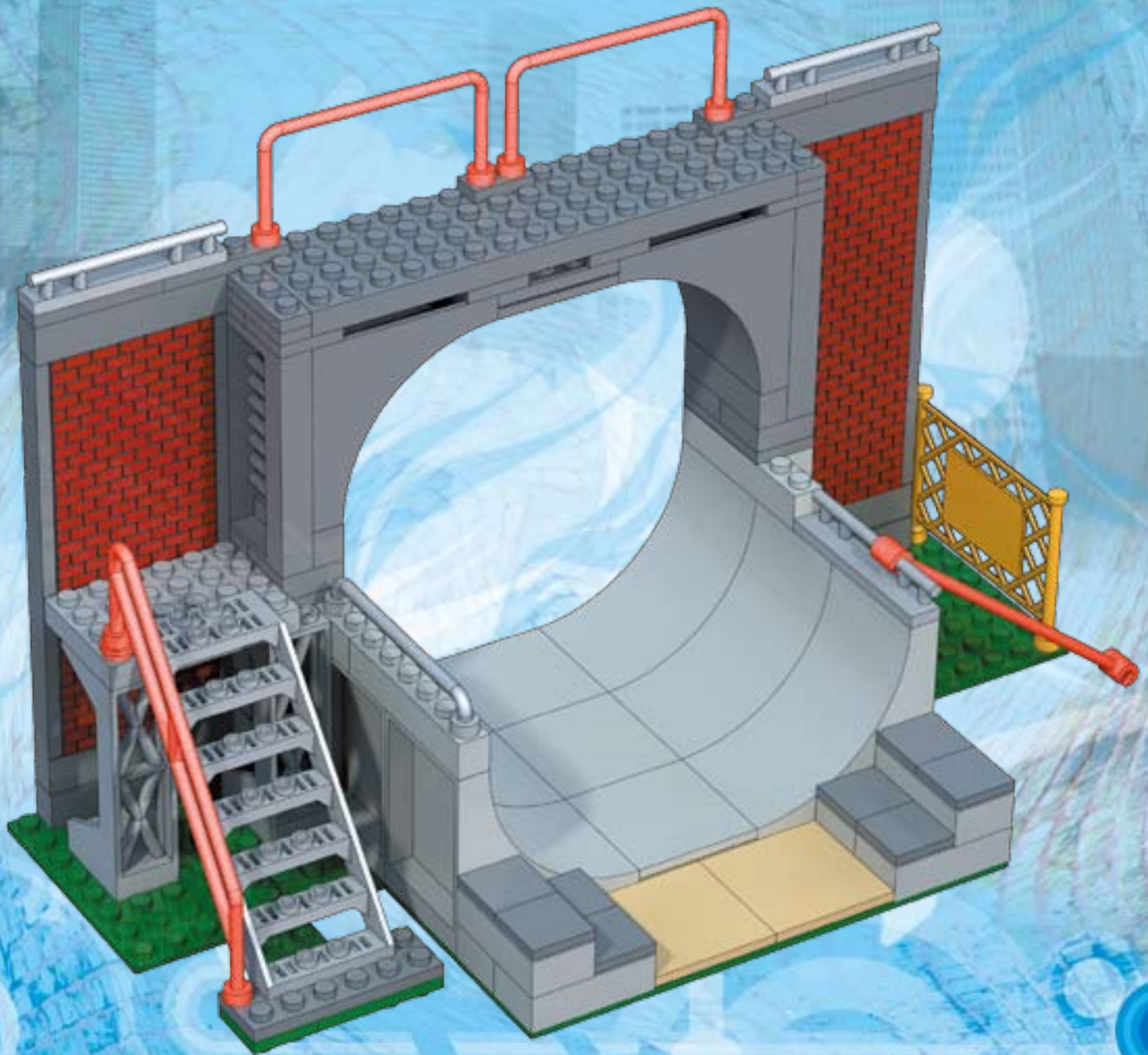

# Xtreme SPORTS™



**Tada Kai**  
Tokyo, Japan



**Manuel Gonzales**  
Barcelona, Spain





Collect them all!  
 ¡Coleccionalos todos!  
 Collectionne-les tous!  
 Sammle alle!  
 Verzamel ze allemaal!  
 Collezionali tutti!  
 Coleccione todo!



**Kale Buxton**  
 Warrnambool, Australia  
 96501 RAIL GRIND™



**Ray Twist**  
 Southampton, England  
 96502 PICK TRICK™



**Marlon Taye**  
 New York, USA  
 96503 STAIR SHRED™



**Liam Widmark**  
 Springbok, South Africa  
 96504 GRIZ-AIR™



**Craig Johnson**  
 Sarnia, Canada  
 96507 BIG AIR BANZAI™



**Cedric Rufus**  
 La Rochelle, France  
 96506 50-50 DECKSLIDE™



**Flavor Van Taak**  
 Springbok, South Africa  
 96513 VERT MADNESS™



**Billy Boyd**  
 Santa Cruz, USA  
 96513 VERT MADNESS™

[www.megabloks.com/xtreme](http://www.megabloks.com/xtreme)



# Xtreme Sports™



Collect them all / Réunissez-les tous / Collectaone-les tous / Acquisti supplementari necessari per collezionare tutti gli elementi illustrati / Para coleccionar todos los elementos mostrados se precisa realizar unas compras adicionales. / Um alle dargestellten Elemente zu sammeln sind zusätzliche Käufe erforderlich. / Verdere aankopen zijn nodig om alle afgebeelde artikelen te verzamelen. / Additional purchases required to collect all elements shown. / Para coleccionar todos los elementos mostrados se precisa realizar unas compras adicionales. / Um alle dargestellten Elemente zu sammeln sind zusätzliche Käufe erforderlich. / Verdere aankopen zijn nodig om alle afgebeelde artikelen te verzamelen. / Acquisti supplementari necessari per collezionare tutti gli elementi illustrati.

96513  
Vert Madness™



96507  
Big Air Banzai™



96506  
50-50 Deckslope™



96503  
Stair Shred™



96501  
Rail Grind™



96502  
Pick-Trick™



96504  
Griz-Air™



© 2008, MEGA Brands Inc.  
 MEGA Brands Inc. and the MEGA Brands Inc. logo are registered trademarks of MEGA Brands Inc.  
 MEGA Brands Inc. y el logotipo MEGA Brands Inc. son marcas registradas de MEGA Brands Inc.  
 MEGA Brands Inc. et le logo de MEGA Brands Inc. sont des marques de commerce déposées de MEGA Brands Inc.  
 MEGA Brands Inc. und das MEGA Brands Inc.-Logo sind eingetragene Warenzeichen von MEGA Brands Inc.  
 MEGA Brands Inc. en het MEGA Brands Inc. logo zijn gedeponeerde handelsmerken van MEGA Brands Inc.  
 MEGA Brands Inc. ed il logo di MEGA Brands Inc. sono marchi di fabbrica di MEGA Brands Inc.  
 MEGA Brands Inc. e o logo MEGA Brands Inc. são marcas registradas de MEGA Brands Inc.

