

MEGA
BLOKS

WARRIORS

FUTURE FORCE™

9528

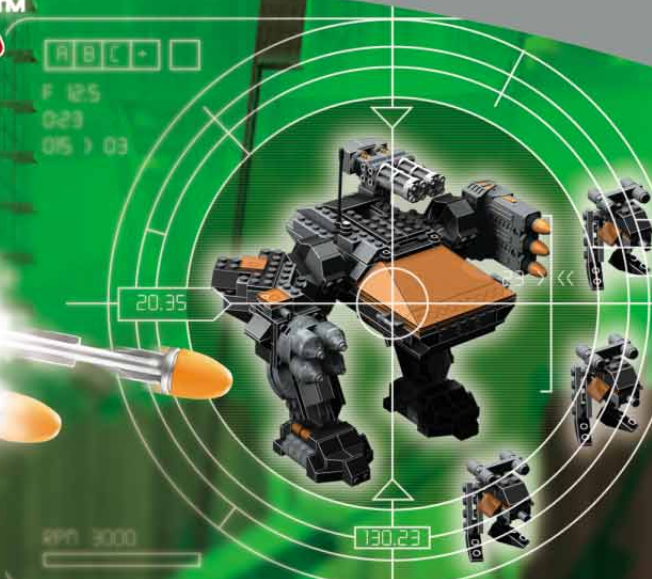

U-240
Assault™
+ 3 recon drones



Ages / Años / Âges

Pieces / Piezas / Pièces

7+

412

⚠ WARNING:
CHOKING HAZARD - Small Parts.
Not for children under 3 years

¡Los misiles se disparan de verdad!

Tirez réellement les missiles!

Missiles really fire!



Color chart.

Charte de couleurs.

Cuadro cromático.

Quadro cromatico.

Färgtabell.

Kleurenkaart.

カラーチャート

色彩表

Active step / Étape active / Etapa activa / Azione attiva
 Aktivt skede / Actieve stap / アクティブなステップ / 積極步骤
 Previous step / Étape précédente / Etapa precedente
 Azione precedente / Föregående skedet / Vorige stap
 前のステップ / 上一步骤

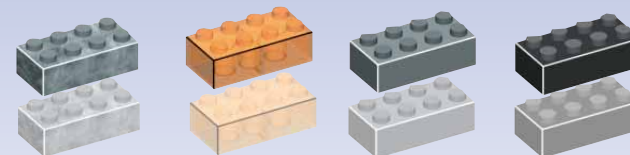

Adult assistance is required. / L'aide d'un adulte est requise. / Necesita ayuda de un adulto. / È necessario l'aiuto di un adulto. /
 Hjälp av en vuxen är nödvändigt. / Hulp van een volwassene is gewenst. / 大人の方が手伝ってあげる必要があります。 / 需要成年人協助

WARNING:
 Choking hazard - Small parts.
 Not for children under 3 years.

AVERTISSEMENT:
 Risque de suffocation. Ne convient pas à un enfant
 de moins de 3 ans - contient de petits éléments.

ADVERTENCIA:
 Peligro de asfixia. No recomendado para niños
 menores de 3 años - contiene piezas pequeñas.

AVVERTENZA:
 Rischio di soffocamento. Non adatta ad un bambino
 di età minore ai 36 mesi. Contiene parti piccole - non
 ingerire.

WARNING:
 Risk for kvävning. Ikke egnet til barn under
 3 år - inneholder smådeler.

WAARSCHUWING:
 Stikgevaar. Niet geschikt voor kinderen onder
 3 jaar - i.v.m. kleine onderdelen.

注意:
 飲み込むと危険です。
 小さいパーツがあるので、
 3才以下の幼児には
 与えないでください。
 ⚠️ 不适宜三岁以下儿童。



1

1x

2

2x 1x 1x

3

6x 1x 1x

4

4x

5

2x

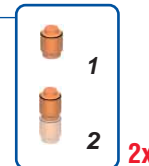
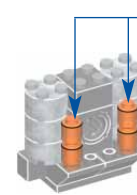
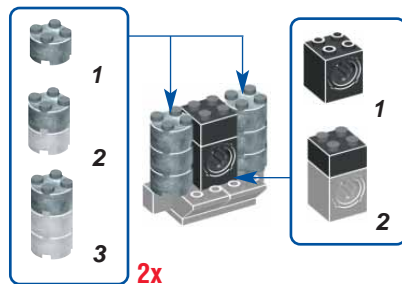

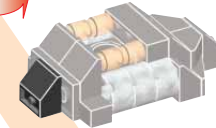
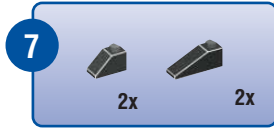

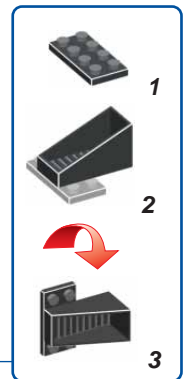
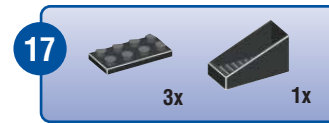
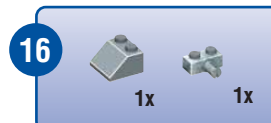
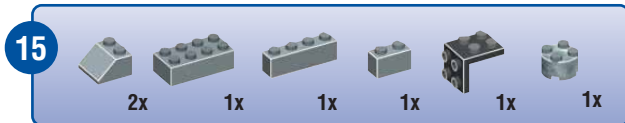
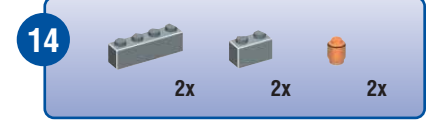
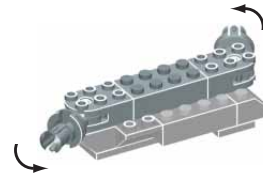
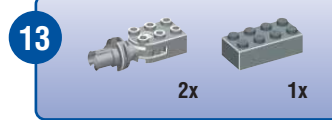
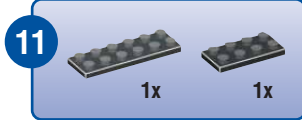
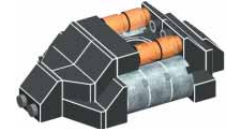

10

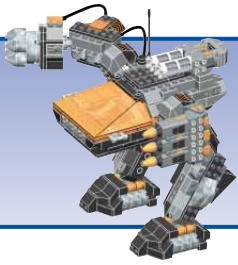



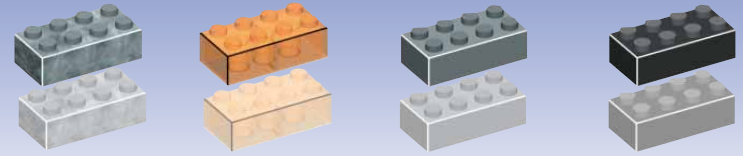





Active step / Étape active / Etapa activa / Azione attiva
 Aktivt skede / Aktieve stap / アクティブなステップ / 積極步驟
 Previous step / Étape précédente / Etapa precedente
 Azione precedente / Föregående skedet / Vorige stap
 前のステップ / 上一步驟







18  1x



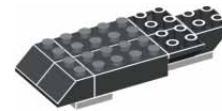

19  1x  1x

20  2x  2x  3x



21  2x  1x





22  2x  2x  2x

23  1x  1x  1x  1x

24  1x  2x  1x  1x

25  3x  1x

25  1  2  3

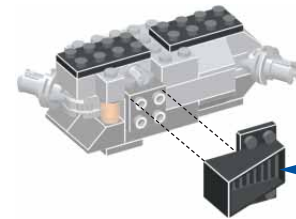
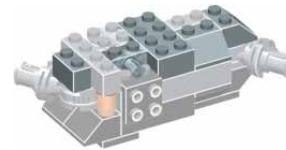

26



1x

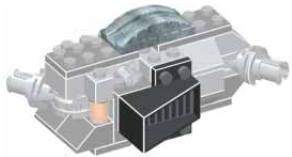

27



1x



28



1x



1x



1x



29



2x



1x



1x



30



2x



1x

31



1x



2x



1x



1x



32



3x



1x



33



1x



2x



1x



34



2x



1



1x



35



1x



36



1x



37



1x



1x



1x



38



2x



1x



1x



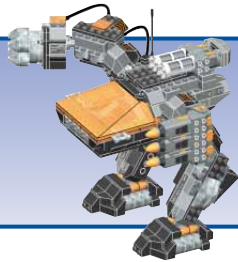

Active step / Étape active / Etapa activa / Azione attiva
 Aktivt skede / Actieve stap / アクティブなステップ / 積極步驟
 Previous step / Étape précédente / Etapa precedente
 Azione precedente / Föregående skedet / Vorige stap
 前のステップ / 上一步驟

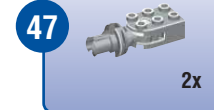
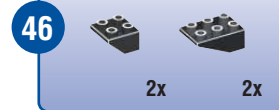
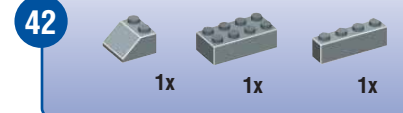
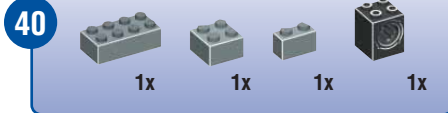
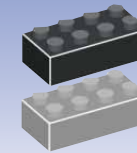
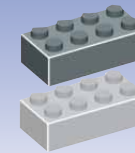
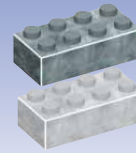

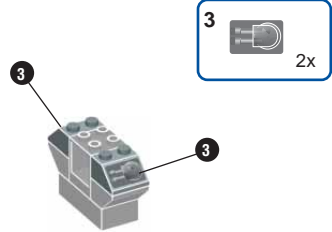
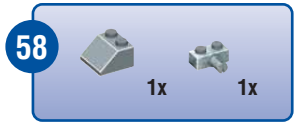
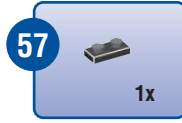
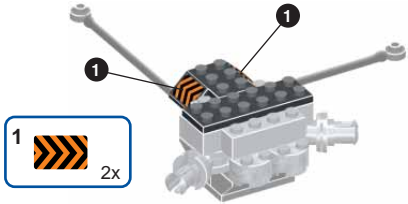
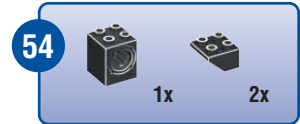
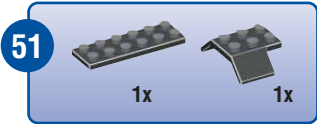
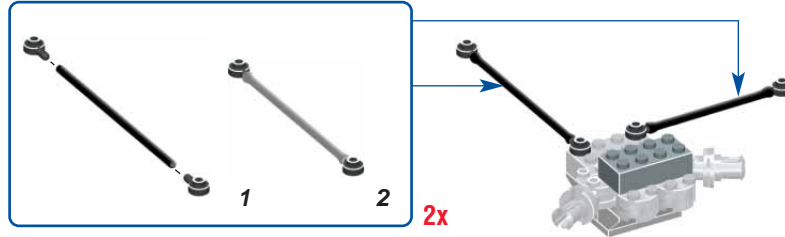
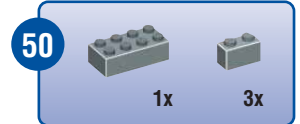
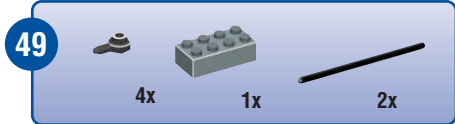
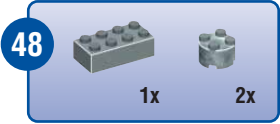

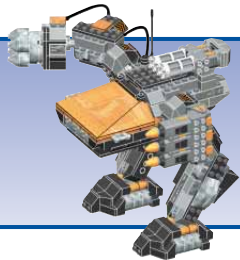

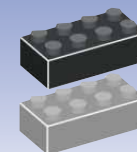
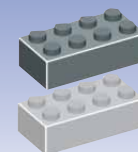
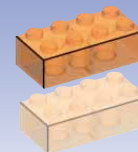

Active step / Étape active / Etapa activa / Azione attiva
 Aktivt skede / Actieve stap / アクティブなステップ / 積極步驟
 Previous step / Étape précédente / Etapa precedente
 Azione precedente / Föregående skedet / Vorige stap
 前のステップ / 上一步驟



59  1x



60  2x

61  1x

62  1x

63  4x  4x

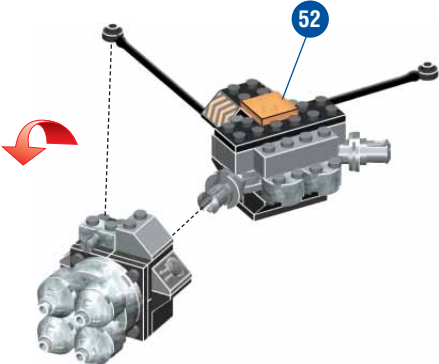

 1
 2 4x

64 

65 

66  1x

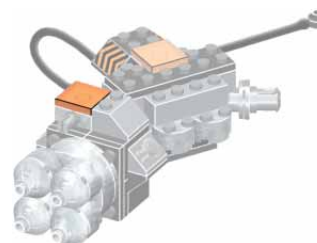

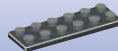
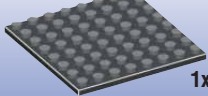
67  2x  1x

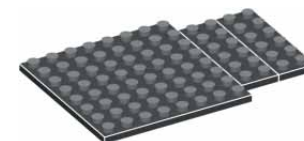

68

2x 4x 3x 1x

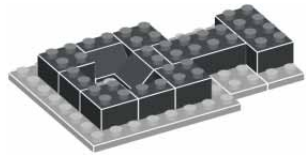

69

2x 2x 10x

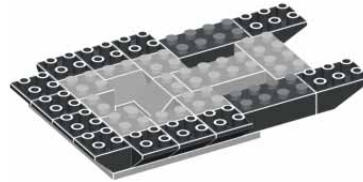

70

6x 1x 4x 2x

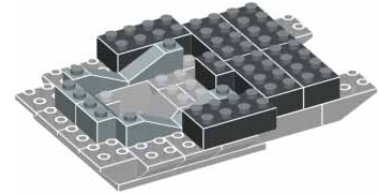

71

2x 2x 2x 2x 3x 2x

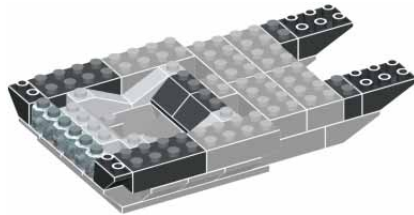

72

9x 5x 2x 2x

4

1x

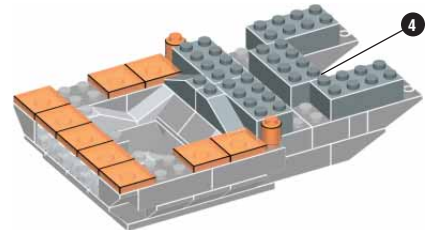

73

2x 2x 2x 2x 1x 2x 2x 2x

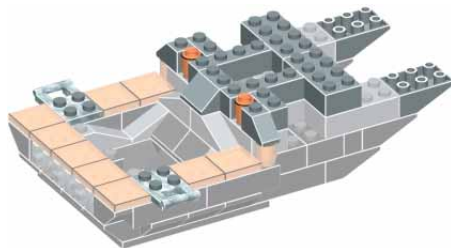

74

2x 1x 2x 2x

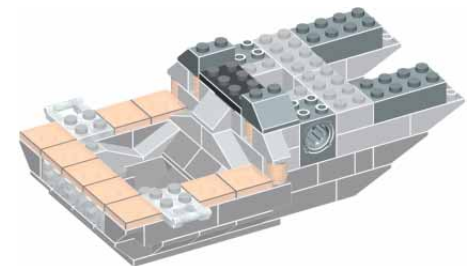

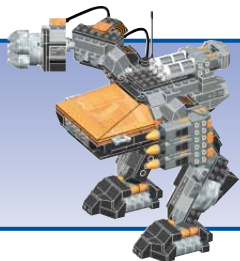

Active step / Étape active / Etapa activa / Azione attiva
 Aktivt skede / Actieve stap / アクティブなステップ / 積極步驟

Previous step / Étape précédente / Etapa precedente
 Azione precedente / Föregående skedet / Vorige stap
 前のステップ / 上一步驟

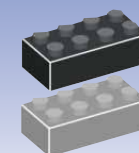
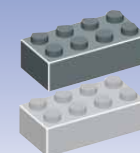

75

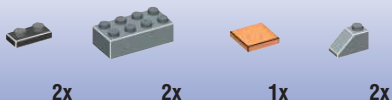

76

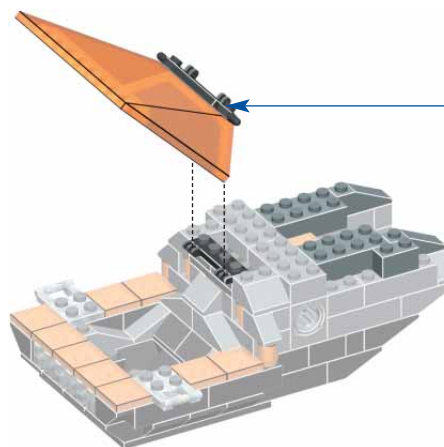
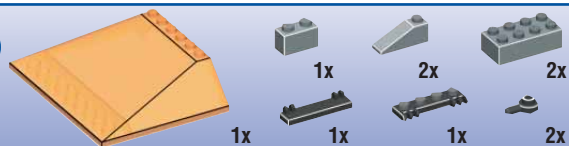

77

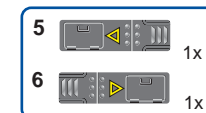
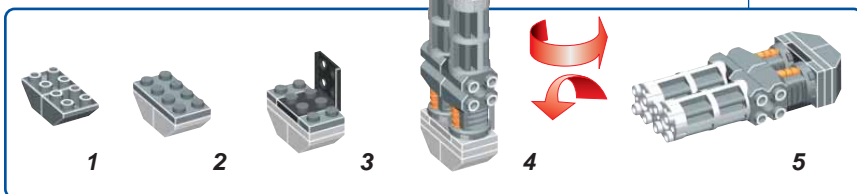
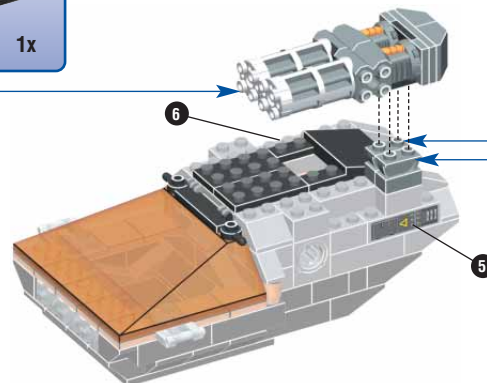

78

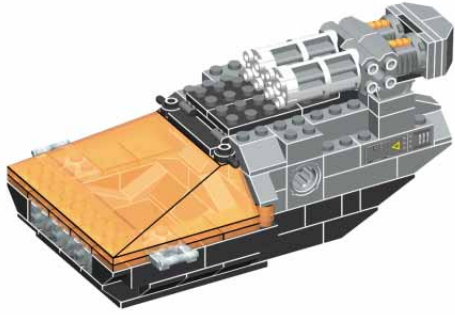

79

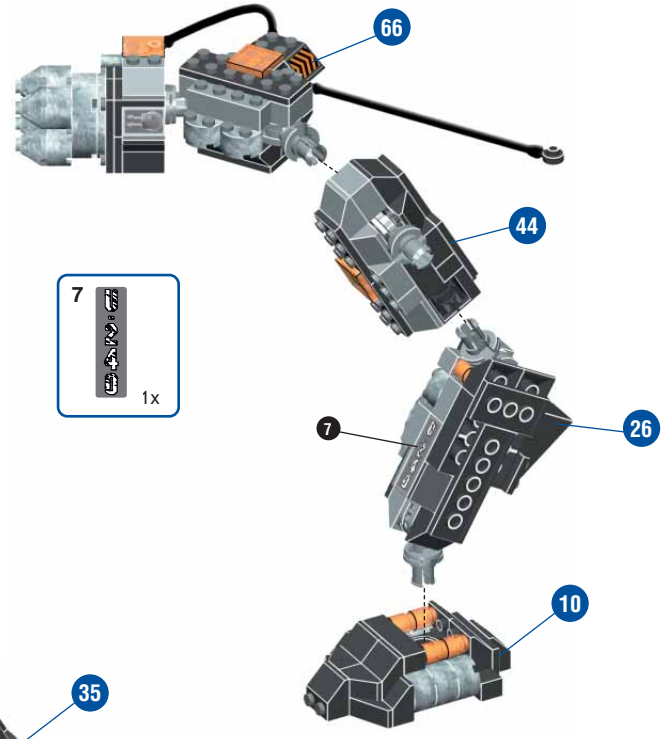

80



81

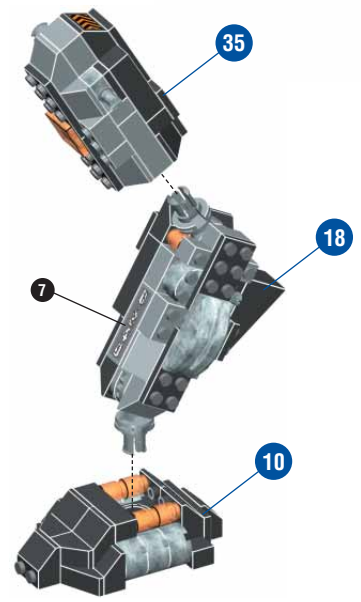

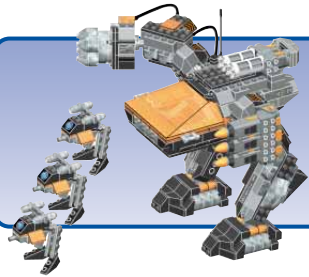

Active step / Étape active / Etapa activa / Azione attiva
 Aktivt skede / Actieve stap / アクティブなステップ / 積極步驟

Previous step / Étape précédente / Etapa precedente
 Azione precedente / Föregående skedet / Vorige stap
 前のステップ / 上一步驟

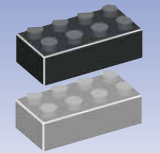
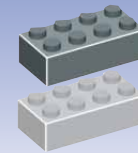
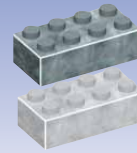

82



83

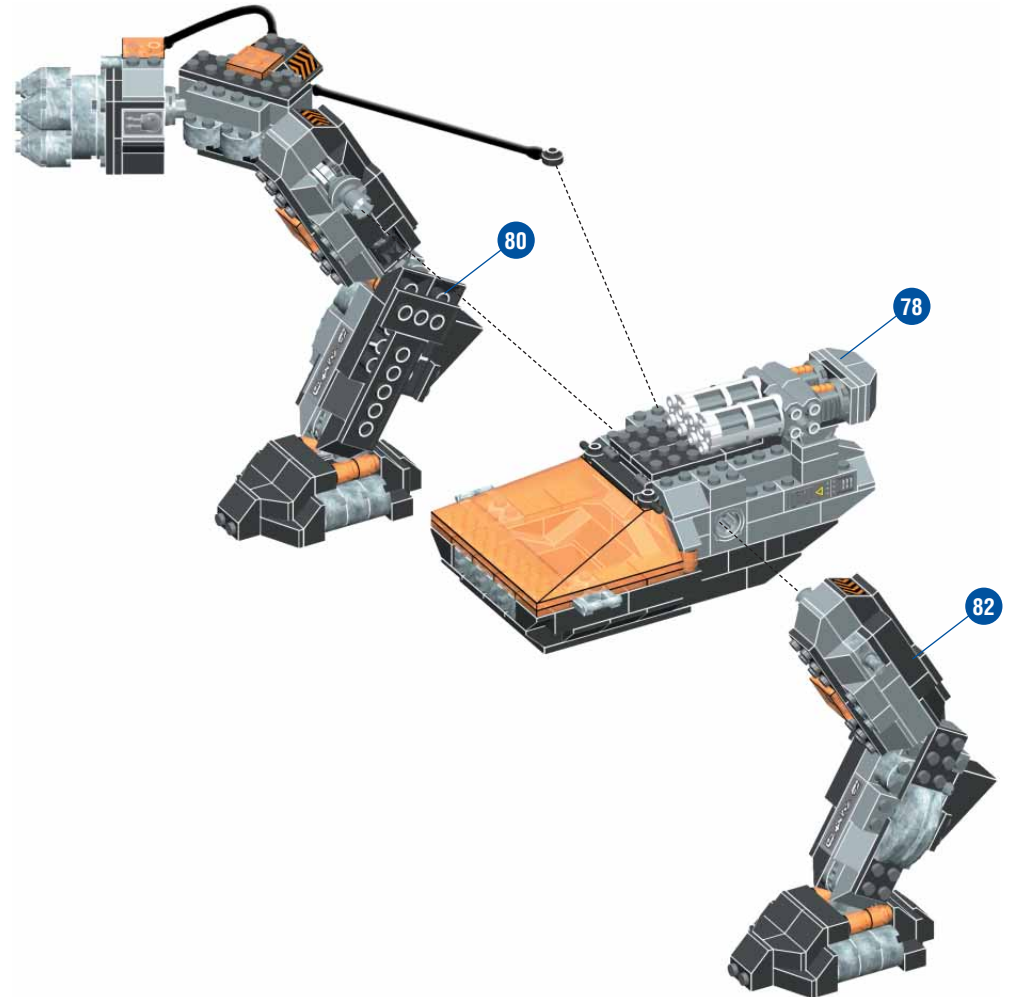

84

1x 3x 1x 1x

85

3x 3x 3x 3x 6x
12x 3x 12x 15x 6x

1 2 3
4 5 6

2  3x

1
2
3

1 2 3

1 2

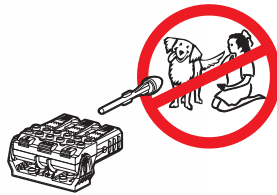

86

3x

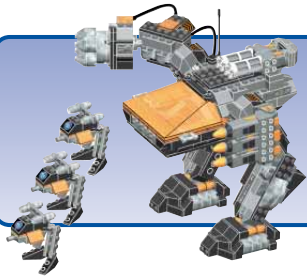

Active step / Étape active / Etapa activa / Azione attiva
Aktivt skede / Actieve stap / アクティブなステップ / 積極步驟
Previous step / Étape précédente / Etapa precedente
Azione precedente / Föregående skedet / Vorige stap
前のステップ / 上一步驟

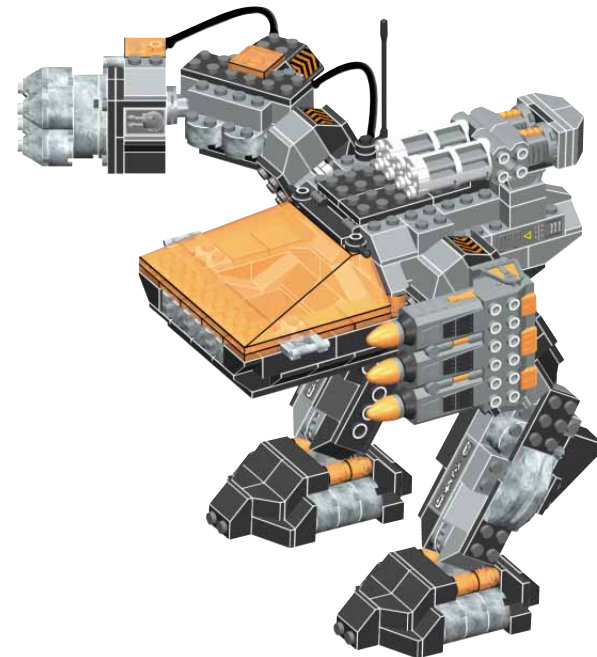
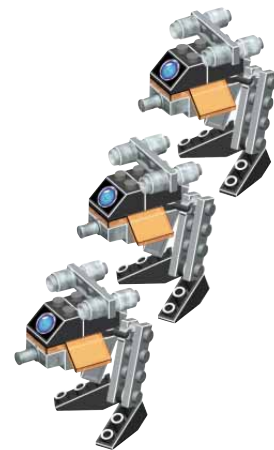
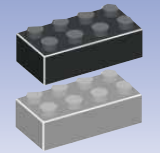
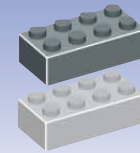
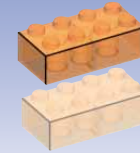
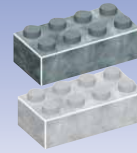

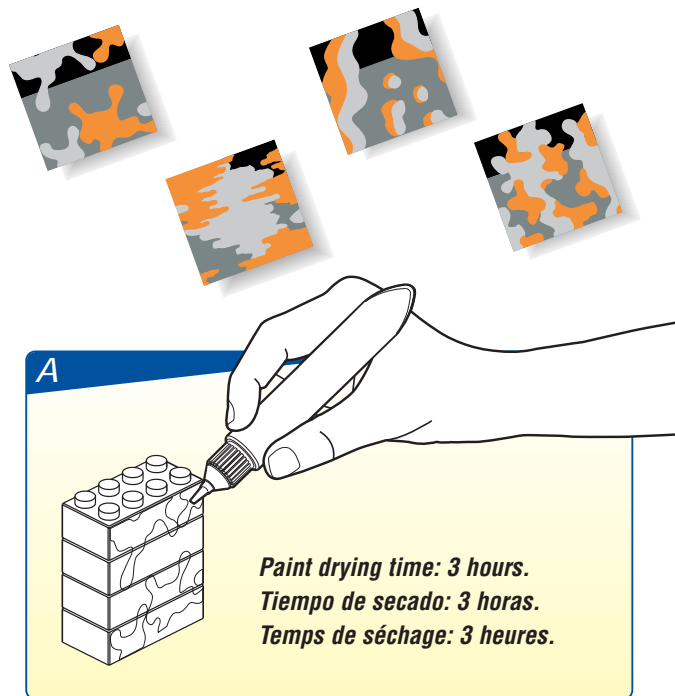

A

Paint drying time: 3 hours.
Tiempo de secado: 3 horas.
Temps de séchage: 3 heures.

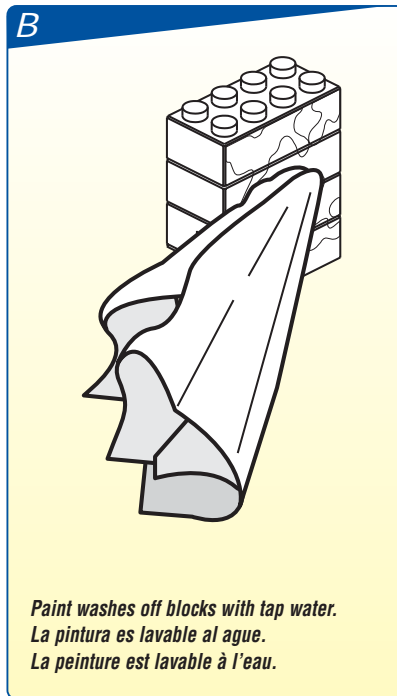

Paint washes off blocks with tap water.
La pintura es lavable al agua.
La peinture est lavable à l'eau.

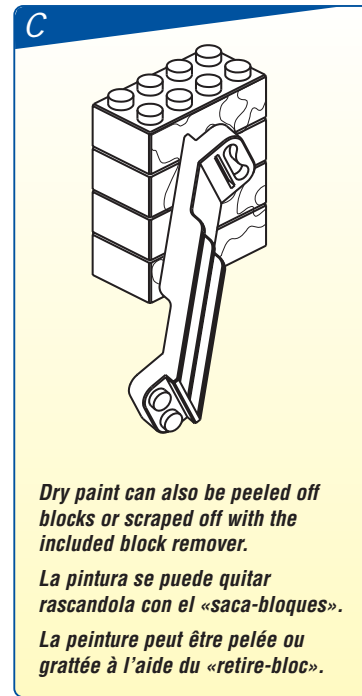

Dry paint can also be peeled off blocks or scraped off with the included block remover.
La pintura se puede quitar rascandola con el «saca-bloques».
La peinture peut être pelée ou grattée à l'aide du «retire-bloc».

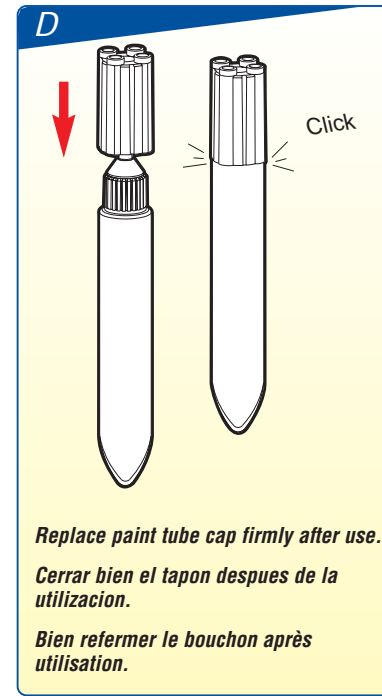

Replace paint tube cap firmly after use.
Cerrar bien el tapon despues de la utilizacion.
Bien refermer le bouchon après utilisation.



E

Use the block remover for disassembling.
Utilizar el saca-bloques para facilitar el desmontaje.
Utiliser le «retire-bloc» pour faciliter le désassemblage.



F

CAUTION ATENCION ATTENTION
Paint may stain fabric and clothing.
La pintura puede manchar los tejidos y la ropa.
La peinture peut tacher les tissus et les vêtements.



G

To avoid injury, never launch projectiles in the direction of people or animals.
No tirar o apuntar nunca en direccion o cerca de personas o animales.
Ne jamais viser ou tirer les projectiles en direction ou près de gens ou d'animaux.

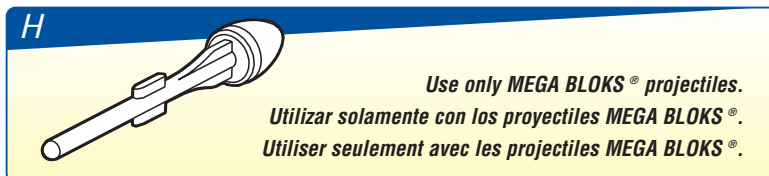

H

Use only MEGA BLOKS® projectiles.
Utilizar solamente con los proyectiles MEGA BLOKS®.
Utiliser seulement avec les projectiles MEGA BLOKS®.

**MEGA
BLOKS**

WARRIORS

FUTURE FORCE™

9528

U-240
Assault™
+ 3 recon drones
9528

J-227
Quadwalker™
+ 3 recon drones
9527

U-122
Striker™
9521

D-105
Sandstorm™
9519

Collect them all

Colecciónalos todos

Collectionne-les tous

Ritvik

© 2001, RITVIK HOLDINGS INC.
PRINTED IN CANADA D095281