

**MEGA
BLOKS**



**BLOK
TOWN**

Farm • Granja • Ferme
Bauernhof • Boerderij • Fattoria • Quinta

7133

2x
AM61231CJ

4x
AM60567EL

2x
AM05337HP

2x
AM05337QS

1x
AM05337GG

2x
AM61229ACF

8x
AM60214A

2x
AM05832A



1x
AS0713304



1x
AS0713308



2x
AS0713307



2x
AM05847SV



1x
AS0713306



1x
AS0713305

1x
AM61071TS

3x
AM60307KP

2x
AM60140A

4x
AM60141DZ

5x
AM05519KP

2x
AM05723HV

2x
AM05682MY



1x
AM61525TS

4x
AM61523F



1x
AS0713301

2x
AM61524F

2x
AM05682A

1x
AM05599MY

1x
AM05838MY

1x
AM05818ACF



1x
AM05831QS



1x
AM05831HV



1x
AS0713303



1x
AS0713302

BLOK TOWN



- EN** Please read these instructions carefully before first use and keep them for future reference.
- ES** Leer estas instrucciones cuidadosamente antes de la primera utilización y guardarlas para referencia futura.
- FR** Il est recommandé de lire attentivement ce feuillet avant la première utilisation et de le conserver pour référence future.
- DE** Die Gebrauchsanleitung bitte durchlesen und aufbewahren.
- NL** Wij raden u aan deze handleiding zorgvuldig te lezen en te bewaren voor eventuele raadpleging op een later tijdstip.
- DA** Vær venlig at læse disse instruktioner omhyggeligt inden ibrugtagten og opbevar dem til fremtidigt brug.
- EL** Διαβάστε αυτές τις οδηγίες προσεκτικά πριν χρησιμοποιήσετε το προϊόν για πρώτη φορά και φυλάξτε τις για μελλοντική αναφορά.
- FI** Lue nämä ohjeet huolellisesti ennen ensimmäistä käyttöä ja säilytä ne myöhempää tarvetta varten.
- IT** Leggere le istruzioni prima di cominciare ad usare il gioco e conservarle per referenze future.
- NO** Les disse instruksjonene nøye før første gangs bruk, og ta vare på dem for fremtidige oppslag.
- PT** Leia as instruções antes do primeiro uso e guarde-as para futura referência.
- SV** Läs noggrant igenom dessa instruktioner innan du använder produkten för första gången och spara dem för ev. framtida frågor.
- JA** 初めてご使用になる前に、この説明書をよくお読みください。また、本書は将来いつでも参照できるように保管してください。
- ZH** 请在初次使用前仔细阅读这些指示，并保留它们以便未来参考。
- AR** يرجى قراءة هذه التعليمات بدقة قبل البدء بالاستعمال والاحتفاظ بها كمرجع للمستقبل

- EN** ⚠️ **WARNING :**
CHOKING HAZARD. - Small parts.
Not for children under 3 years.
- ES** ⚠️ **ADVERTENCIA :**
PELIGRO DE ASFIXIA. - Contiene piezas pequeñas.
No recomendado para niños menores de 3 años.
- FR** ⚠️ **AVERTISSEMENT :**
RISQUE DE SUFFOCATION. - Présence de petits éléments.
Ne convient pas aux enfants de moins de 3 ans.
- DE** ⚠️ **WARNUNG :**
ERSTICKUNGSGEFAHR. - Enthält kleine Teile.
Nicht für Kinder unter 3 Jahren geeignet.
- NL** ⚠️ **WAARSCHUWING :**
VERSTIKKINGSGEVAAR. - Bevat kleine onderdelen.
Niet geschikt voor kinderen onder de 3 jaar.
- DA** ⚠️ **ADVARSEL :**
KVÆLNINGSFARE. - Indeholder smådele.
Ikke til børn under 3 år.
- EL** ⚠️ **ΠΡΟΕΙΔΟΠΟΙΗΣΗ :**
ΚΙΝΔΥΝΟΣ ΠΝΙΞΙΜΑΤΟΣ. - Περιέχει μικρά αντικείμενα
Όχι για παιδιά κάτω των 3 ετών.
- FI** ⚠️ **VAROITUS :**
TUKENTUMISVAARA. - Sisältää pieniä osia.
Ei alle 3-vuotiaalle lapsille.
- IT** ⚠️ **ATTENZIONE :**
PERICOLO DI SOFFOCAMENTO. - Contiene piccole parti.
Non indicato per bambini sotto i 3 anni.
- NO** ⚠️ **ADVARSEL :**
KVELNINGSFARE. - Inneholder små deler.
Kun for barn over 3 år.
- PT** ⚠️ **ATENÇÃO :**
PERIGO DE ASFIXIA. - Contém peças pequenas.
Não é concebido para crianças de menos de 3 anos.
- SV** ⚠️ **WARNING :**
KVÄVNINGSRISK. - Innehåller små delar.
Inte för barn under 3 år.
- JA** ⚠️ **警告 :**
窒息の危険性 - 小さな部品が含まれています
3歳以下の子供には与えないで下さい。
- ZH** ⚠️ **警告 :**
有窒息危险。 - 包含有小部件
不适合3岁以下的小孩玩。
- AR** ⚠️ **تحذير :**
خطر اختناق - قطع صغيرة.
غير صالحة للأطفال أقل من 3 سنوات.

1

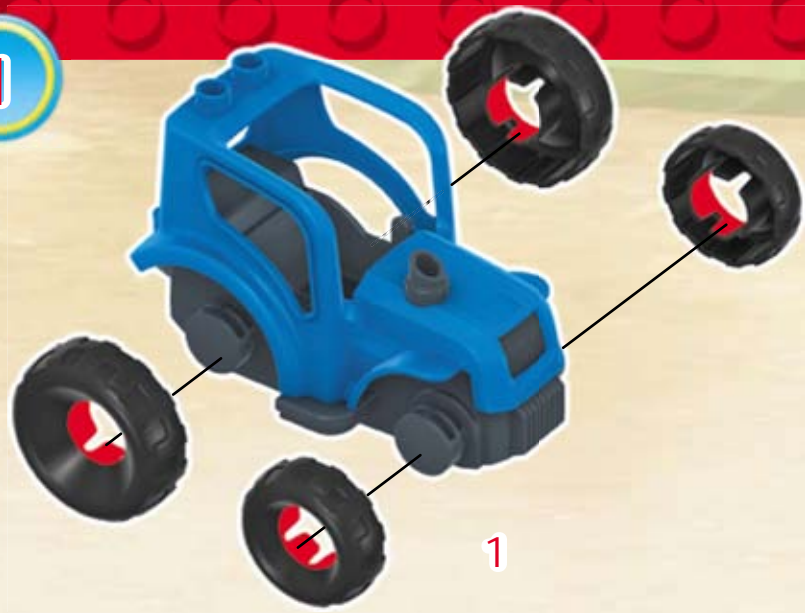

1



2

2

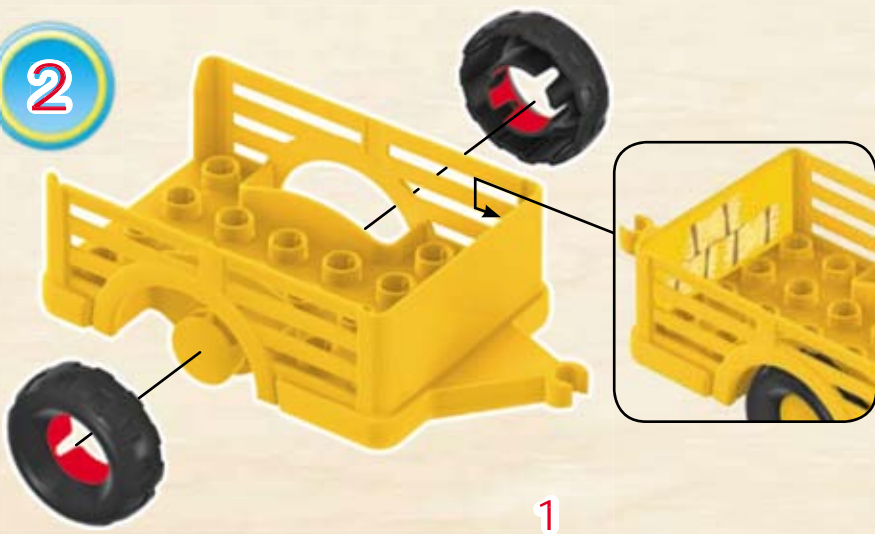

1



2



Adult assembly required before giving this toy to children. Care should be taken in the unpacking and assembly of this toy. / Este juguete debe ser montado por un adulto antes de entregarlo al niño. Desembalar y montar este juguete con mucho cuidado. / Un adulte devrait monter ce jouet avant de le remettre aux enfants. Veuillez porter une attention particulière lors du déballage et du montage de ce jouet. / Ein Erwachsener muss dieses Spielzeug zuerst zusammenbauen. Sehr vorsichtig auspacken und zusammenbauen. / Dit speelgoed moet door volwassenen in elkaar gezet worden alvorens het aan kinderen te geven. Uitpakken en in elkaar zetten moet met zorg geschieden. / Il montaggio deve essere eseguito da un adulto prima di dare questo giocattolo ad un bambino. Prestare attenzione mentre si toglie dall'imballaggio e durante il montaggio di questo giocattolo. / A montagem deveser feita por um adulto antes de dar este brinquedo a crianças. Deverá ser desembalado e montado com cuidado.

3



1

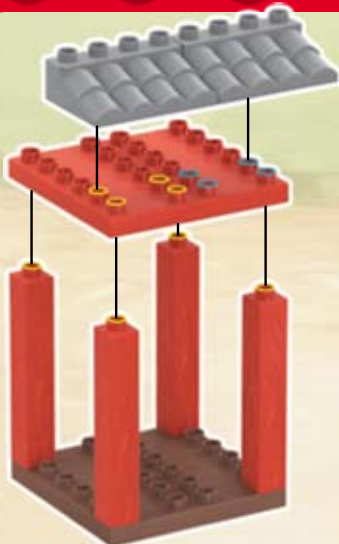

2



3

4



1

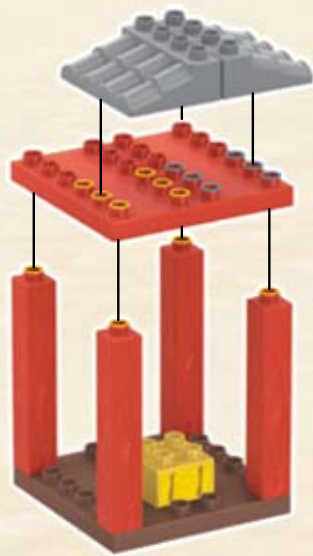
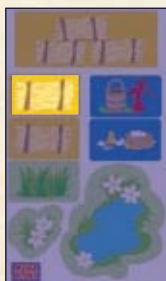

2



3

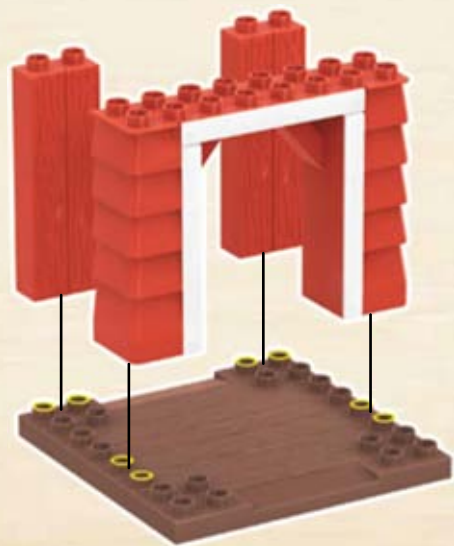
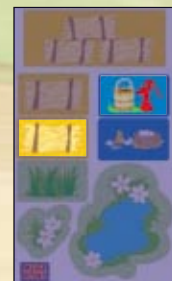
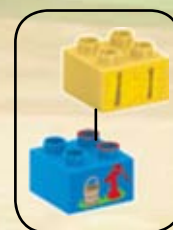

1

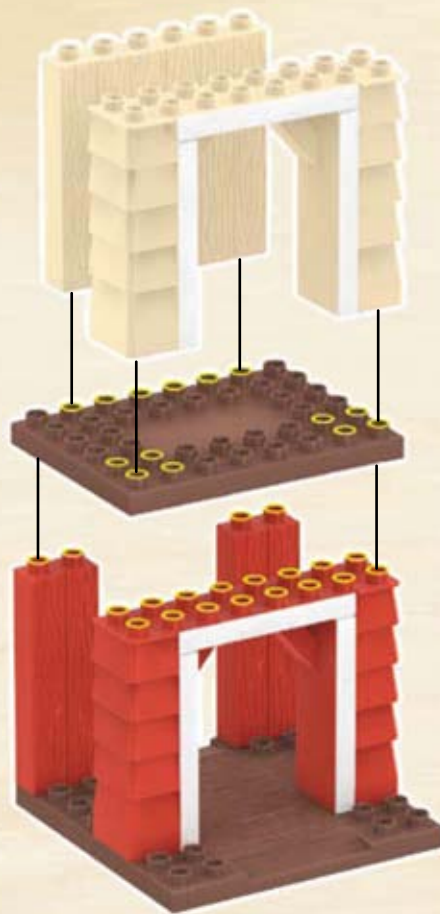

2

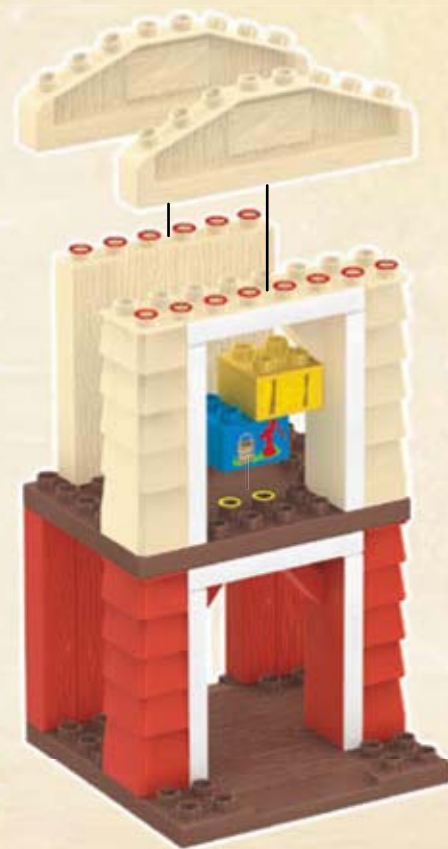

3



4



5



6

6

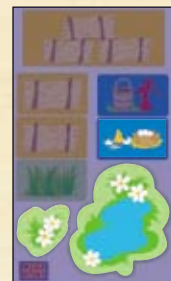
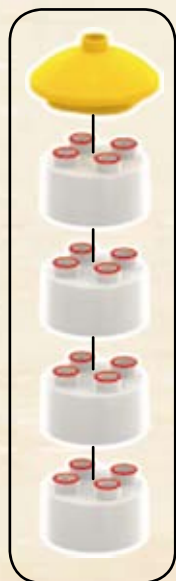

7



1

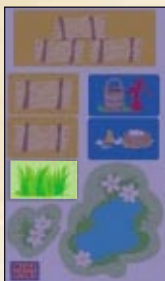

2

8

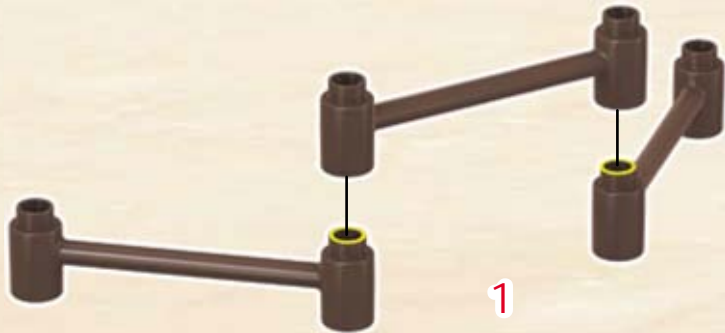

1



2

BLOK TOWN



AL071331



Build & Rebuild!
! Construye y vuelve a construir !
Construis et reconstruis!
Bau und Neubau!
Bouwen en herbouw!
Costruisci e ricostruisci!
Construir e Re construir!



**MEGA
BLOKS**

**BLOK
TOWN**



Stickers Included!
¡Calcomanías incluidas!
Autocollants inclus!
Mit Aufklebern!
Stickers inbegrepen!
Adesevi incluse!
Autocolantii incluse!



Build & Rebuild!
¡Construye y vuelve a construir!
Construis et reconstruis!
Bau und Neubauf! • Bouwen en herbouwf!
Costruisci e ricostruisci! • Construir e Re construir!



Collect them all!
¡Colecciónalos todos!
Collectionne-les tous!
Hol sie dir alle! • Verzamelf ze allemaal!
Colectionalii tutti! • Colectione todos eles!

MEGA

© 2011, MEGA Brands Inc.
® and ™ denote trademarks of
MEGA Brands Inc.
Printed in China AD071331