

**MEGA
BLOKS**

STRUXX

SKINZZ

6019
Skinzz™



**STRETCH YOUR
SKINZZ™**

6019 | Skinzz™

**MEGA
BLOKS**

10x
AMI5698GT



12x
AMI5605KM



17x
AS060191



3x
AMI5615GT



18x
AMI5603KM



3x
AS060196



2x
AS0601915



2x
AS060192



7x
AMI5604KM



1x
AS0601914



75



2x
AMI5631GT



135



9x
AMI5633GT



4x
AMI5619GT



2x
AMI5606GT



2x
AMI5664AGV



5x
AMI5611AGV



1x
AMI5699KM



6x
AMI5607AGV



3x
AS060193



1x
AMI6248MX



1x
AS060199

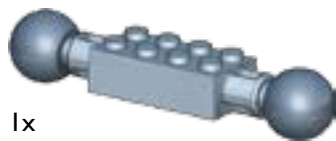

4



6



8



10



12



14



18



Building Tips / Consejos para construir / Conseils pour la construction / Bau-Tipps / Consigli per la costruzione / Bouwtips / Dicas de construção



2x
AS060191



2x
AS060193



3x
AS060192

EN Please read these instructions carefully before first use and keep them for future reference. / **ES** Leer estas instrucciones cuidadosamente antes de la primera utilización y guardarlas para referencia futura. / **FR** Il est recommandé de lire attentivement ce feuillet avant la première utilisation et de le conserver pour référence future. / **DE** Die Gebrauchsanleitung bitte durchlesen und aufbewahren. / **NL** Wij raden u aan deze handleiding zorgvuldig te lezen en te bewaren voor eventuele raadpleging op een later tijdstip. / **IT** Leggere le istruzioni prima di cominciare ad usare il gioco e conservarle per referenze future. / **PT** Leia as instruções antes do primeiro uso e guarde-as para futura referência.

EN ⚠ **WARNING :**
CHOKING HAZARD. - Small parts.
Toy contains a small ball.
Not for children under 3 years.

ES ⚠ **ADVERTENCIA :**
PELIGRO DE ASFIXIA. - Contiene piezas pequeñas.
El juguete contiene una bola pequeña.
No recomendado para niños menores de 3 años.

FR ⚠ **AVERTISSEMENT :**
RISQUE DE SUFFOCATION. - Présence de petits éléments.
Le jouet contient une petite balle.
Ne convient pas aux enfants de moins de 3 ans.

DE ⚠ **WARNUNG :**
ERSTICKUNGSGEFAHR. - Enthält kleine Teile.
Ein kleiner Ball ist im Spielzeug inbegriffen.
Nicht für Kinder unter 3 Jahren geeignet.

NL ⚠ **WAARSCHUWING :**
VERSTIKKINGSGEVAAR. - Bevat kleine onderdelen.
Speelgoed bevat een klein balletje.
Niet geschikt voor kinderen onder de 3 jaar.

DA ⚠ **ADVARSEL :**
KVÆLNINGSFARE. - Indeholder smådele.
Legetøjet indeholder en lille bold.
Ikke til børn under 3 år.

EN Latex free toy.
ES Juguete sin látex.
FR Jouet sans latex.
DE Latexfreies Spielzeug.
NL Speelgoed vrij van latex.
DA Dette legetøj indeholder ikke latexgummi.
EL Παιχνίδι χωρίς λάτεξ
FI Lelu ei sisällä lateksia.
IT Non contiene latex.
NO Leksak fri leketøy.
PT Brinquedo sem conteúdo de latex.
SV Leksak utan latex.
JA この玩具にはラテックスは使用されていません。
ZH 無乳膠玩具。
AR لعبة خالية من مادة اللاتكس

EL ⚠ **ΠΡΟΕΙΔΟΠΟΙΗΣΗ :**
ΚΙΝΔΥΝΟΣ ΠΝΕΙΜΑΤΟΣ. - Περιέχει μικρά αντικείμενα
Το παιχνίδι περιέχει ένα μπαλάκι.
Όχι για παιδιά κάτω των 3 ετών.

FI ⚠ **VAROITUS :**
TUKEHTUMISVAARA. - Sisältää pieniä osia.
Leluun sisältyy pieni pallo.
Ei alle 3-vuotiaalle lapsille.

IT ⚠ **ATTENZIONE :**
PERICOLO DI SOFFOCAMENTO. - Contiene piccole parti.
Il giocattolo comprende una pallina.
Non indicato per bambini sotto i 3 anni.

NO ⚠ **ADVARSEL :**
KVÆLNINGSFARE. - Inneholder små deler.
Leketøy inneholder en liten ball.
Kun for barn over 3 år.

PT ⚠ **ATENÇÃO :**
PERIGO DE ASFIXIA. - Contém peças pequenas.
O brinquedo contém uma pequena bola.
Não é concebido para crianças de menos de 3 anos.

SV ⚠ **WARNING :**
KVÄVNINGSRISK. - Innehåller små delar.
Leksaken innehåller en liten boll.
Inte för barn under 3 år.

JA ⚠ **警告 :**
窒息の危険性 - 小さな部品が含まれています
小さな玉が含まれています。
3歳以下の子供には与えないで下さい。

ZH ⚠ **警告 :**
有窒息危险 - 包含有小部件
此玩具含有一个小球。
不适合3岁以下的幼儿玩。

AR ⚠ **تحذير :**
خطر اختناق - قطع صغيرة
تحتوي اللعبة على كرة صغيرة.
غير صالحة للأطفال أقل من 3 سنوات.

Sort and organize your parts / Ordena y organiza las piezas / Trie les pièces et range-les par catégories / Sortiere die einzelnen Teile / Sorteert in orden de onderdelen / Seleziona e ordina i pezzi / Organiza as tuas peças



Patent pending.
Patente en trámite.
Brevet en instance.
Patent angemeldet.
Patent aangevraagd.
Brevet in corso.
Patente pendente.



How to assemble / Instrucciones de montaje / Méthodes d'assemblage / So werden die Teile zusammengefügt /
In elkaar zetten / Assemblaggio / Como montar

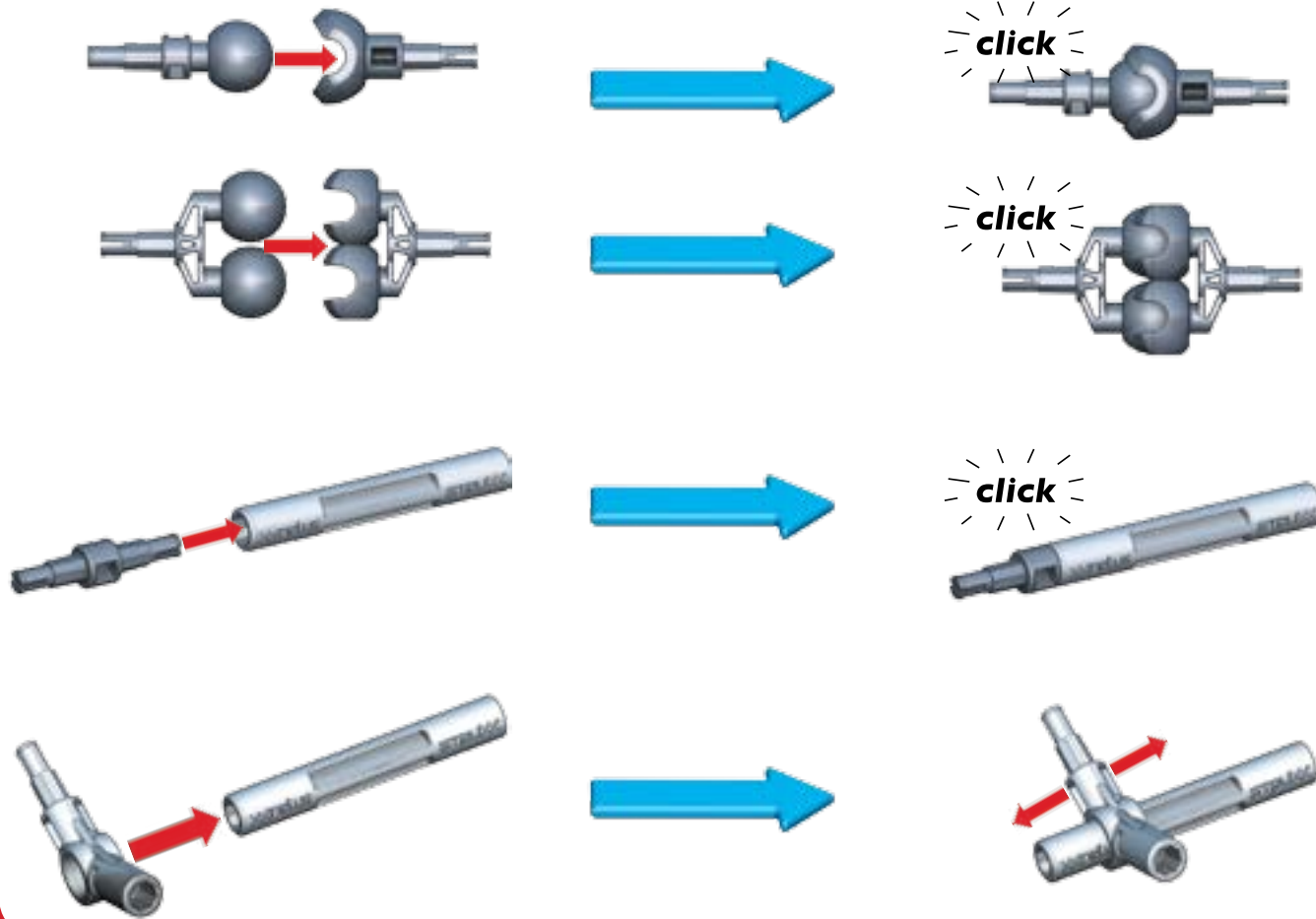

Pay special attention to the different angles of parts / Presta especial atención a los distintos ángulos de las piezas / Fait particulièrement attention
aux différents angles des pièces / Achte besonders auf die unterschiedlichen Winkel der Teile / Let goed op, want de onderdelen hebben verschil-
lende hoeken / Presta attenzione particolare alle diverse angolature dei pezzi / Presta atenção aos diferentes ângulos das peças

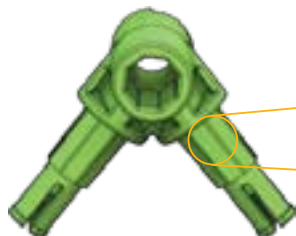

75°



105°

Pay special attention when connecting these parts / Presta especial atención a la hora de conectar las piezas / Assemble ces pièces avec soin dans la position adéquate / Achte darauf, dass du die richtigen Teile miteinander verbindest / Let goed op als je deze onderdelen aan elkaar bevestigt / Presta attenzione particolare quando connetti i seguenti pezzi / Presta especial atenção ao encaixares estas peças



AMI5611AGV



AMI5633GT



AMI5664AGV



AMI5632GT

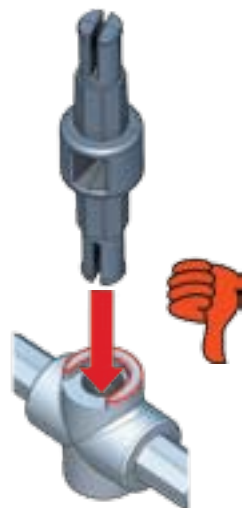

There exists multiple fit positions between parts / Existen multitud de posibilidades para hacer encajar las piezas / Pour chaque pièces, il existe de multiples positions d'assemblages / Es gibt verschiedene Möglichkeiten, die Teile zusammenzufügen / De onderdelen kunnen in verschillende posities worden bevestigd / Esistono diverse possibilità di incastro tra i pezzi / As peças podem ser montadas em posições diferentes

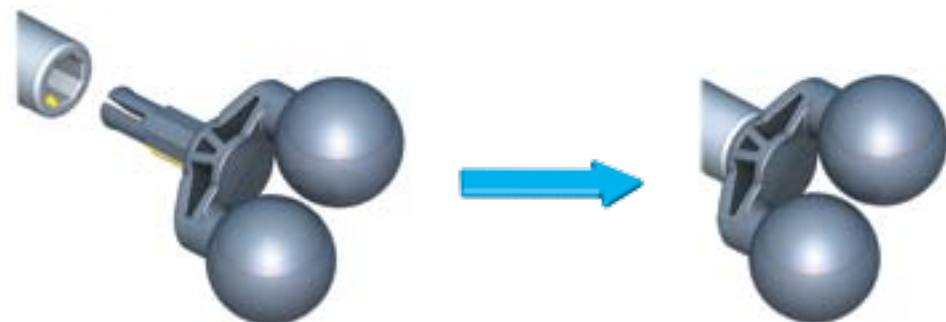
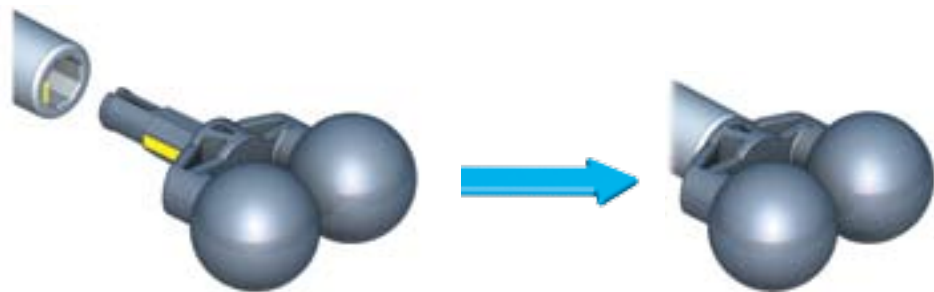
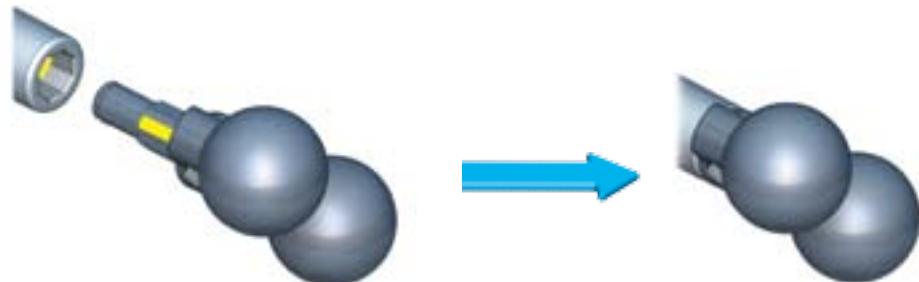
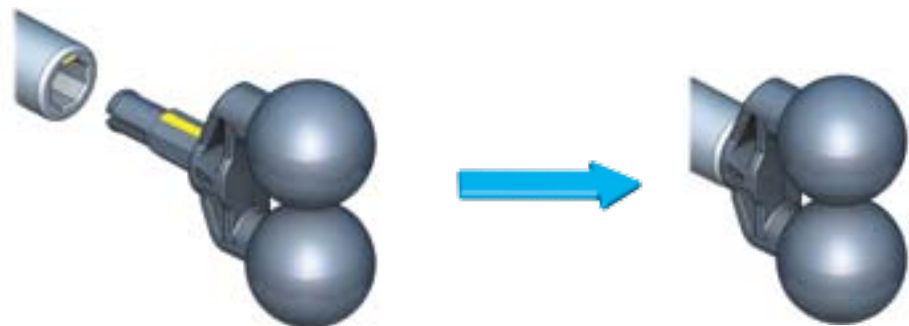

How to disassemble / Instrucciones para desmontar / Méthodes de désassemblage / So werden die Teile auseinandergebaut / Uit elkaar halen / Disassemblaggio / Como desmontar

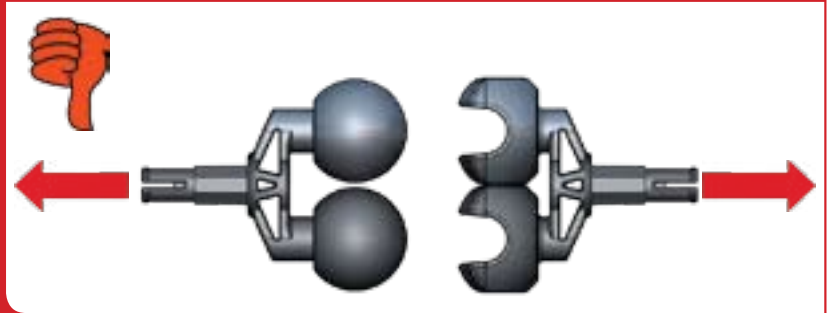
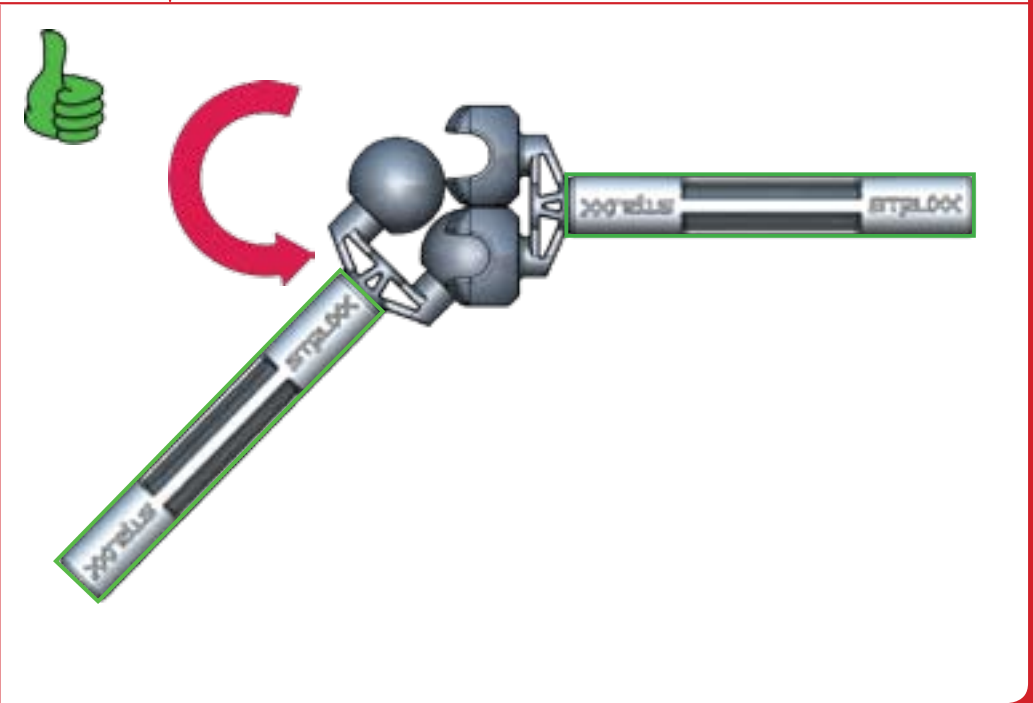
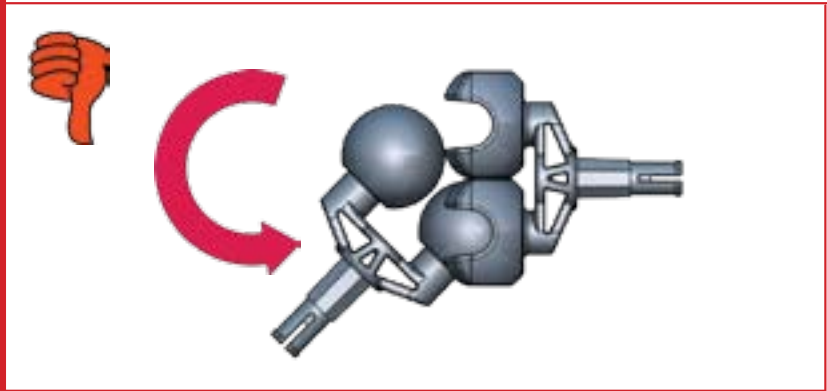
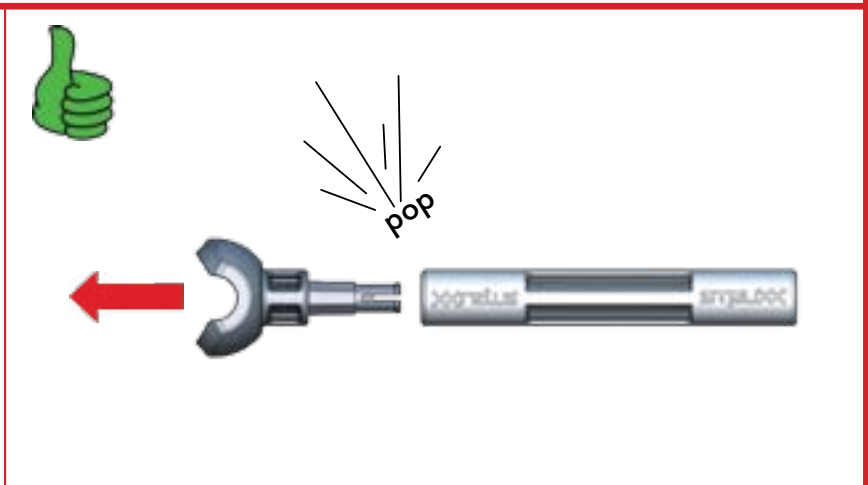
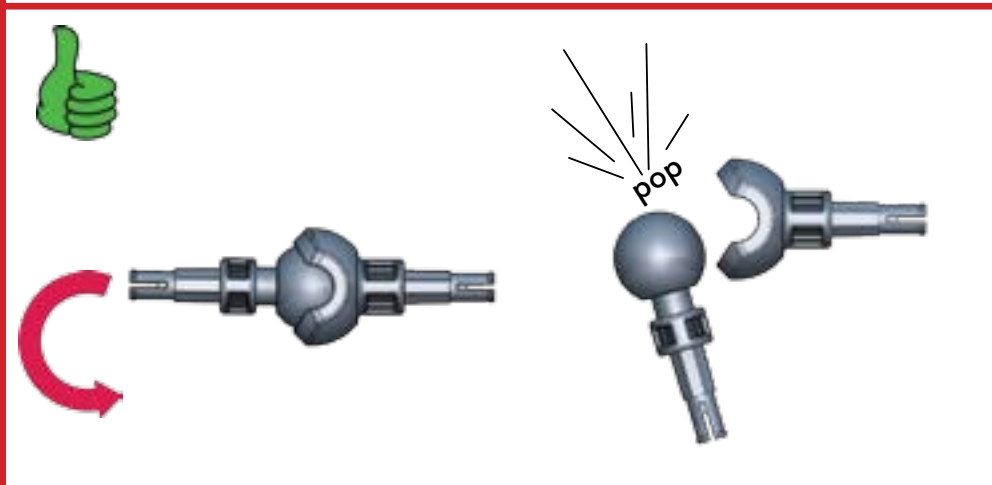

How to disassemble / Instrucciones para desmontar / Méthodes de désassemblage / So werden die Teile auseinandergelöst /
Uit elkaar halen / Disassemblaggio / Como desmontar

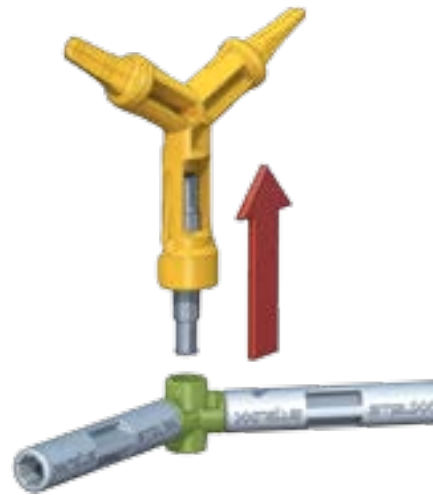
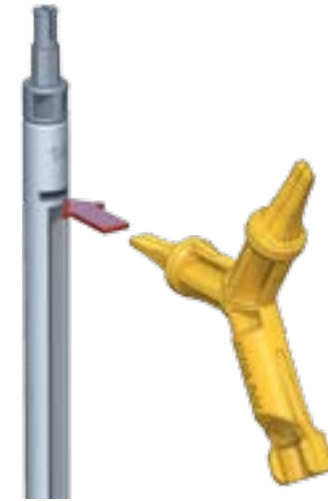
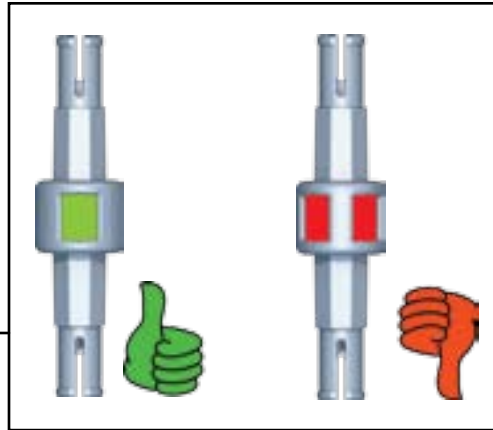
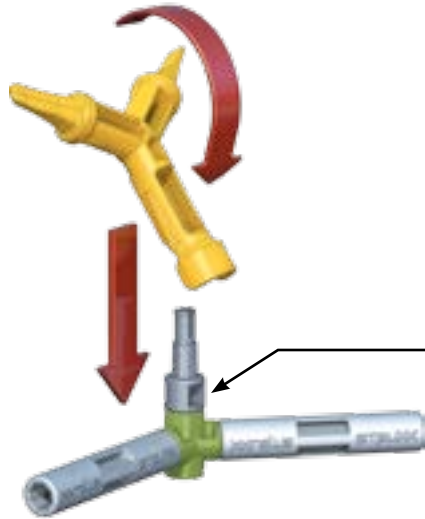

**Build / Construir / Construire / Bauen /
Bouw / Costruisci / Construir**

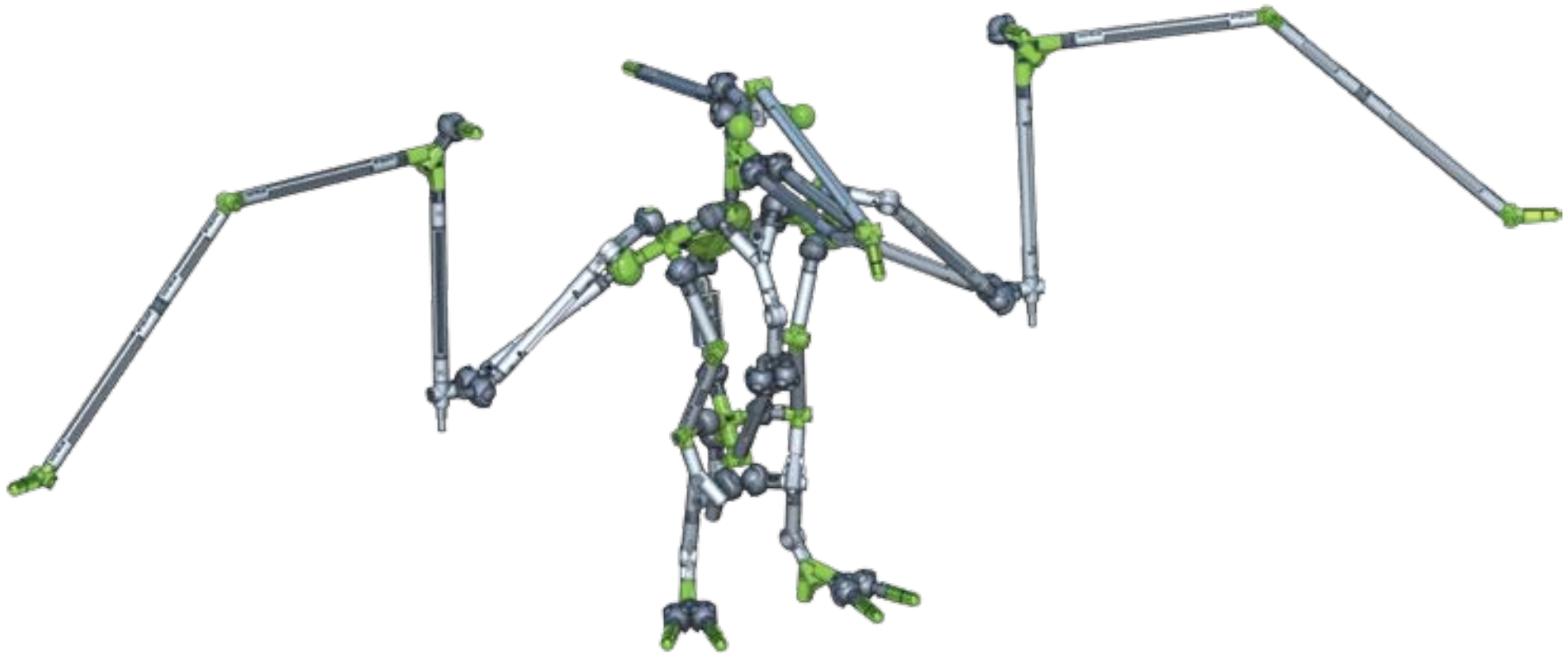

1

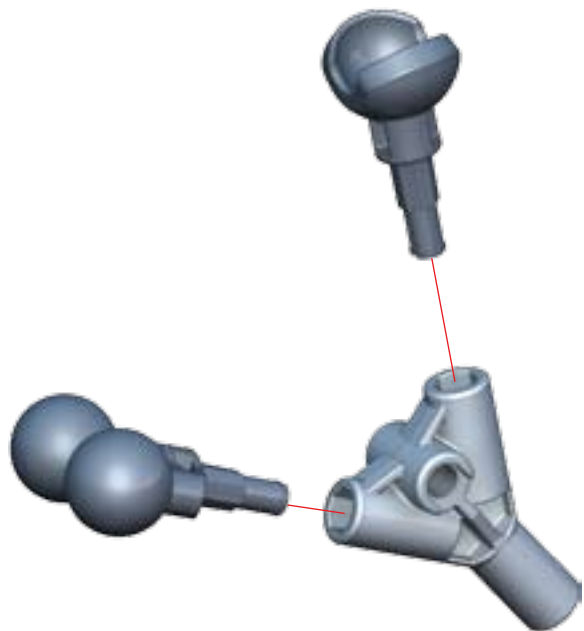

2

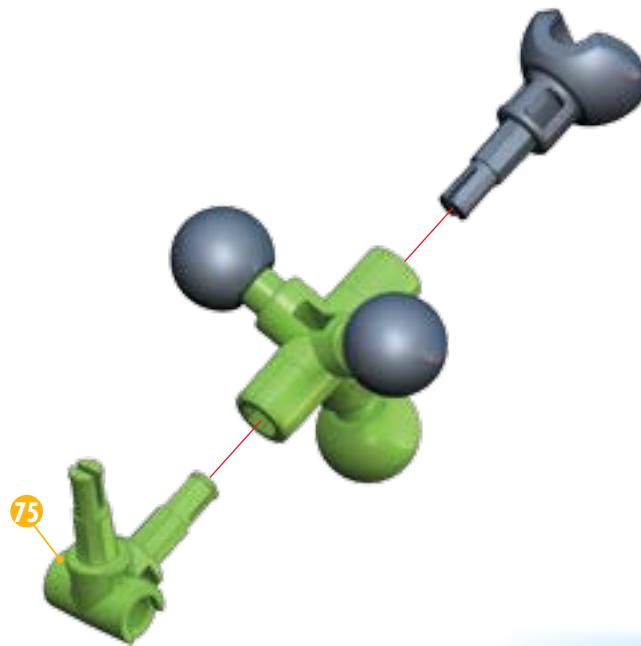

3

- 4 1x
- 6 1x
- 135 2x
- 3x
- 1x

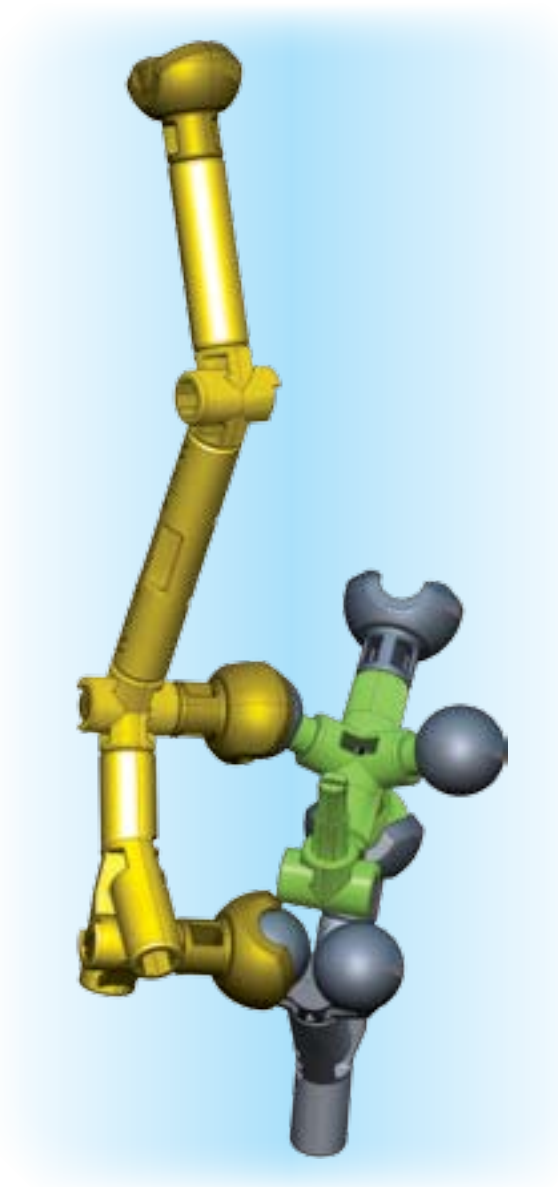
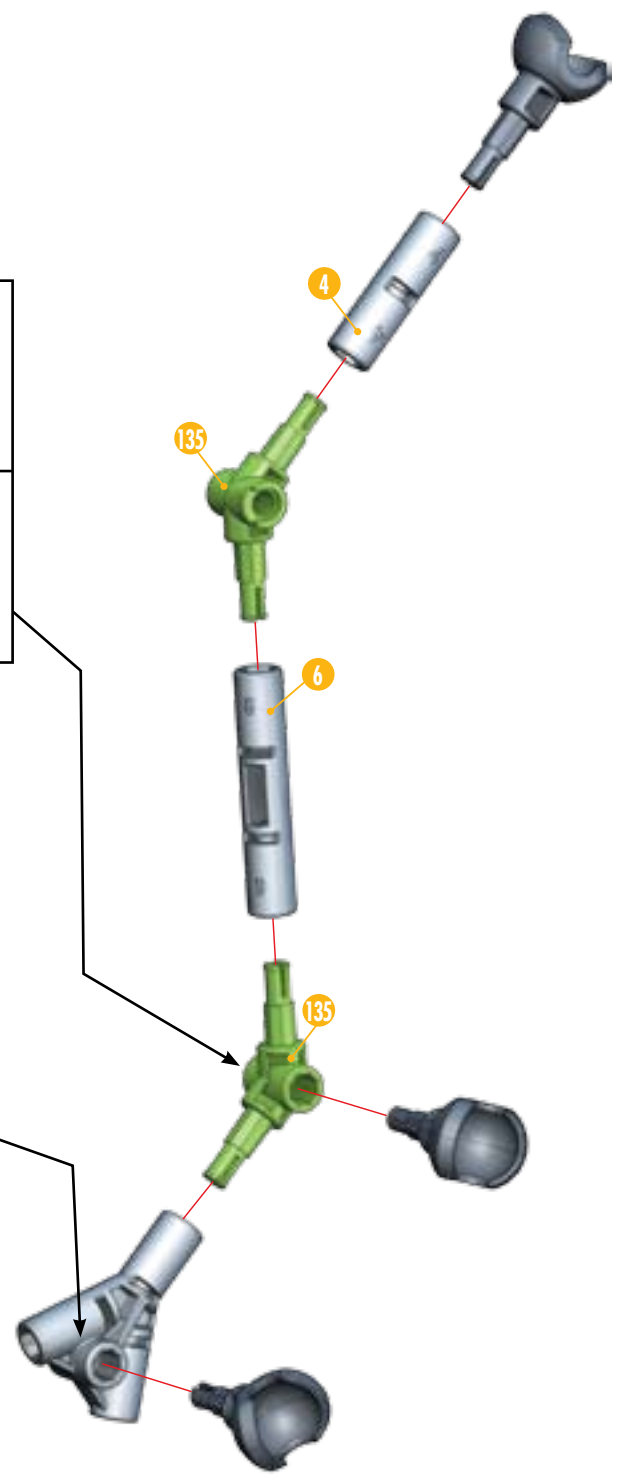
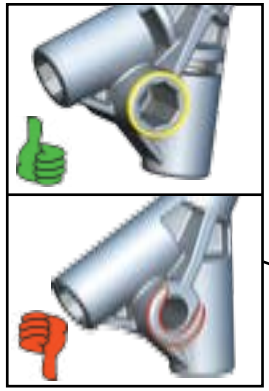
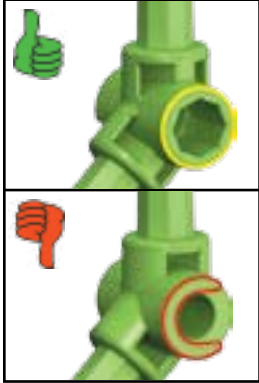

4

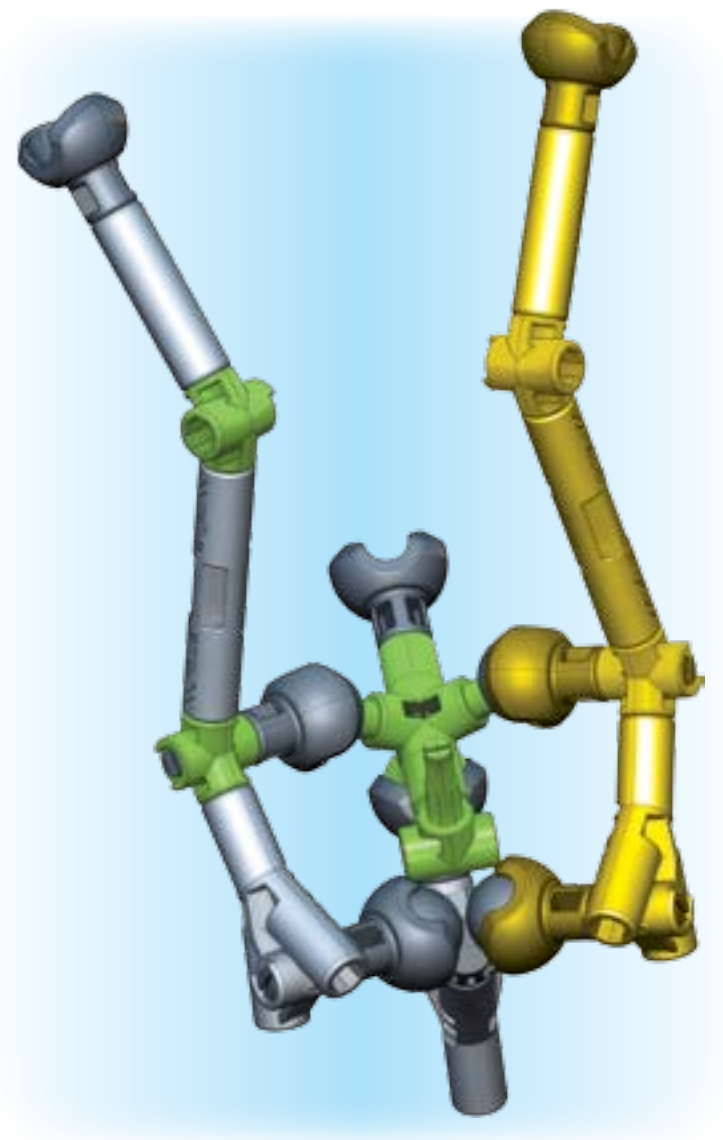
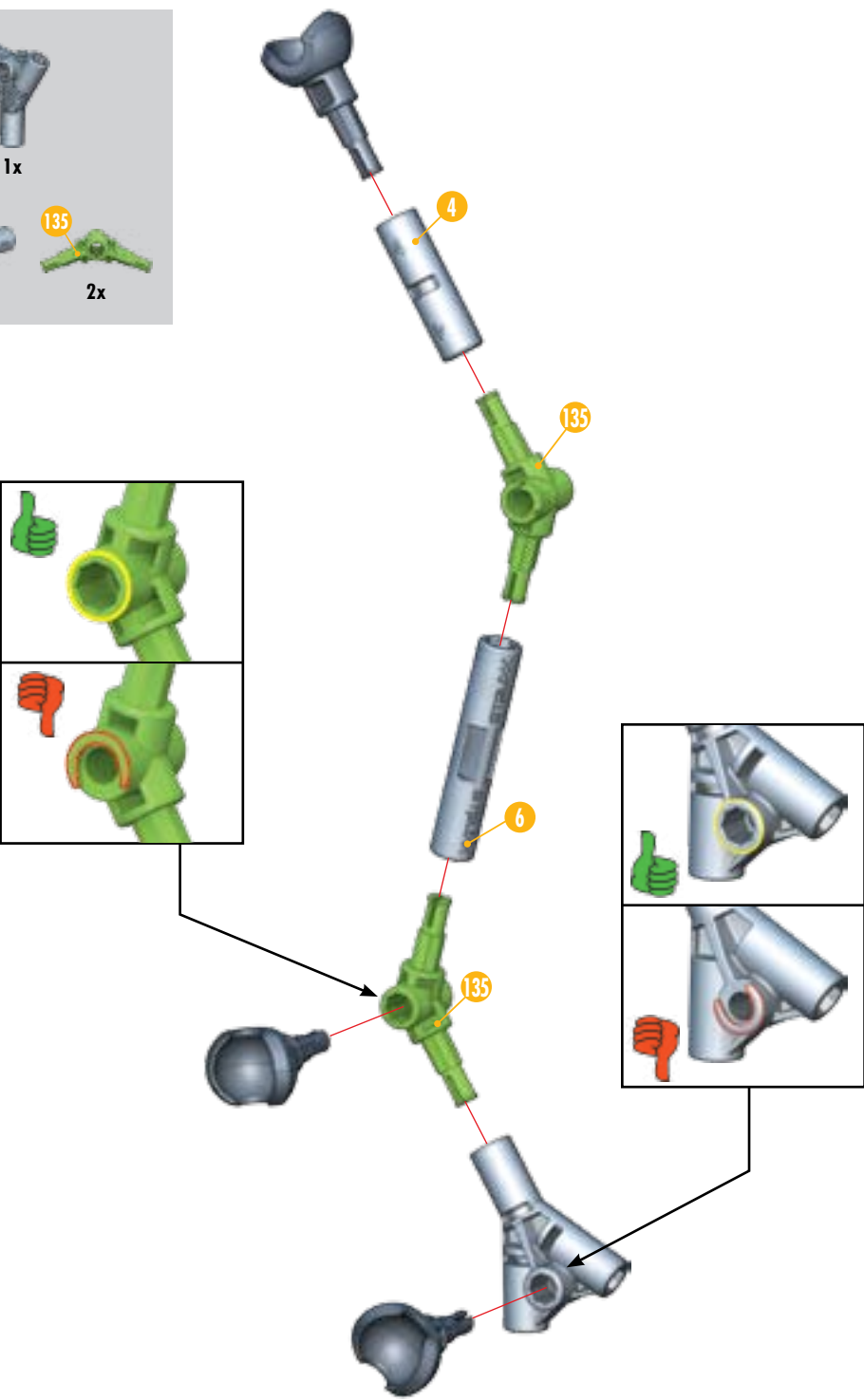

5

- 4x [Small green cylindrical pin]
- 2x [Green T-shaped connector]
- 4x [Grey ball joint]
- 2x [Grey axle with ball joint]
- 2x [Grey multi-ported hub]
- 2x [Grey axle with ball joint]

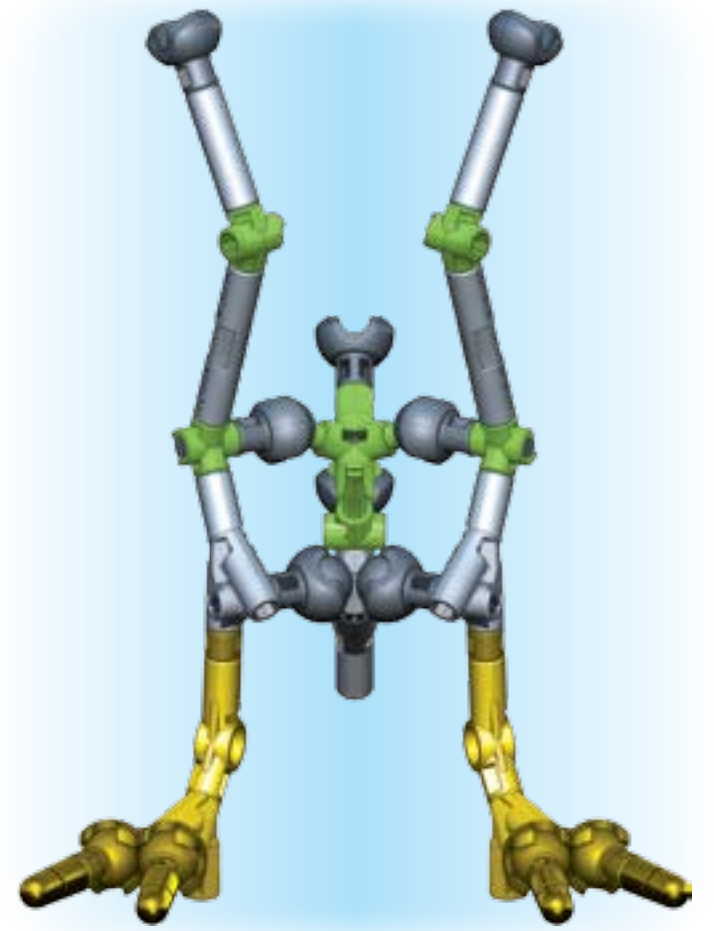
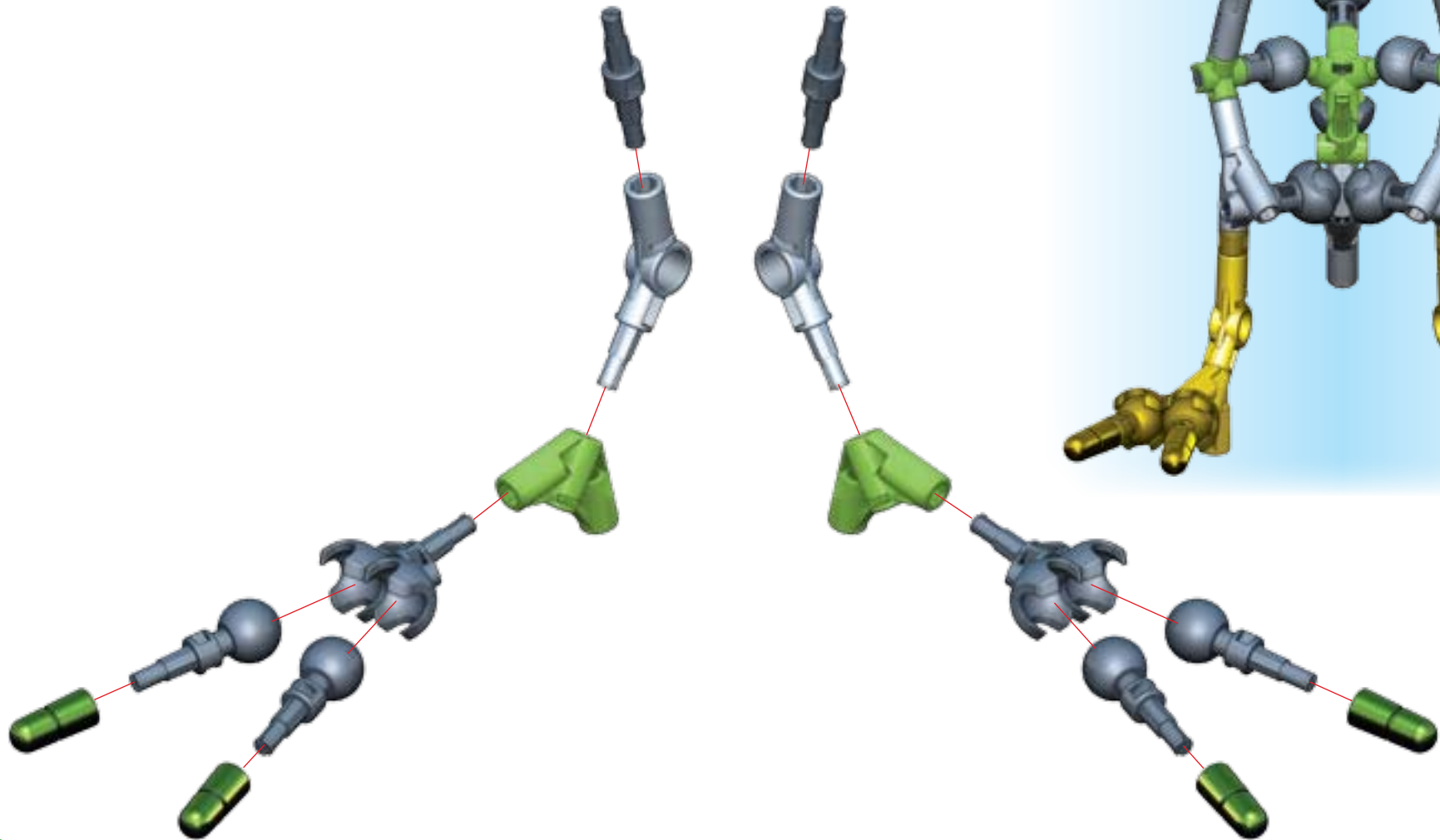

6

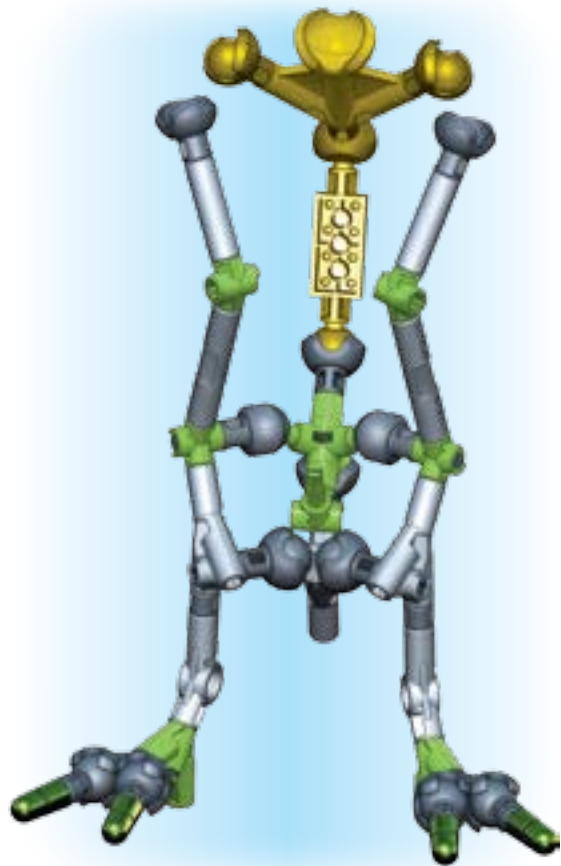

7

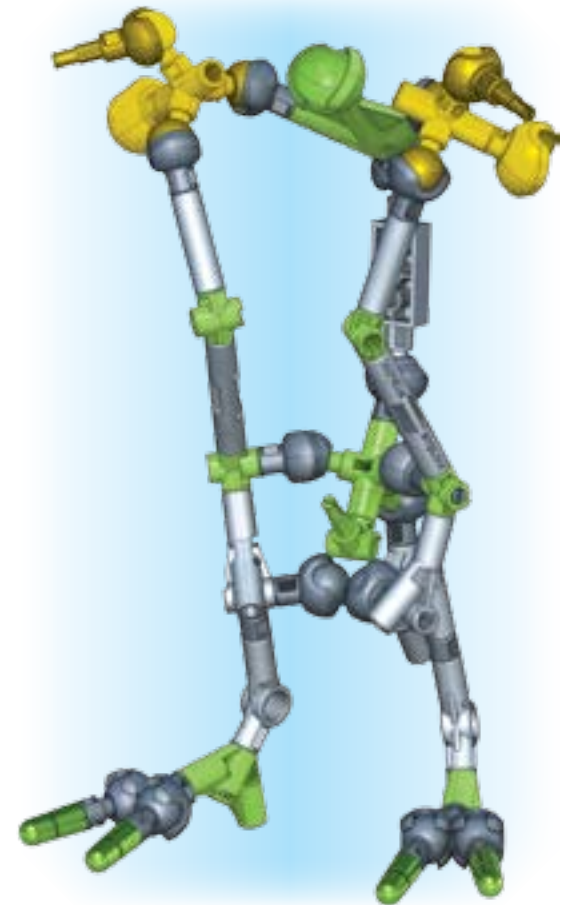

8

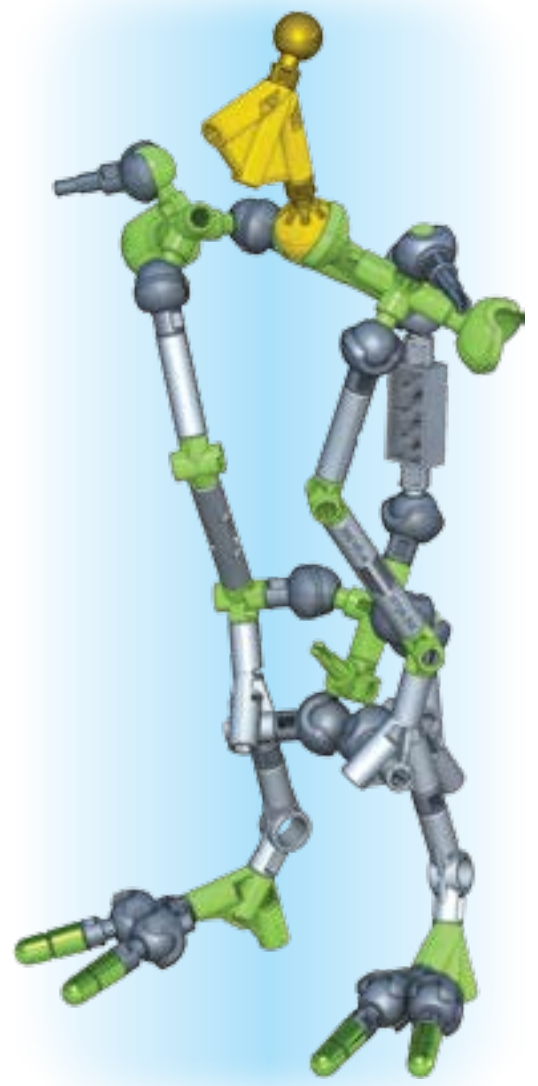
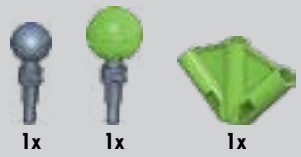

9

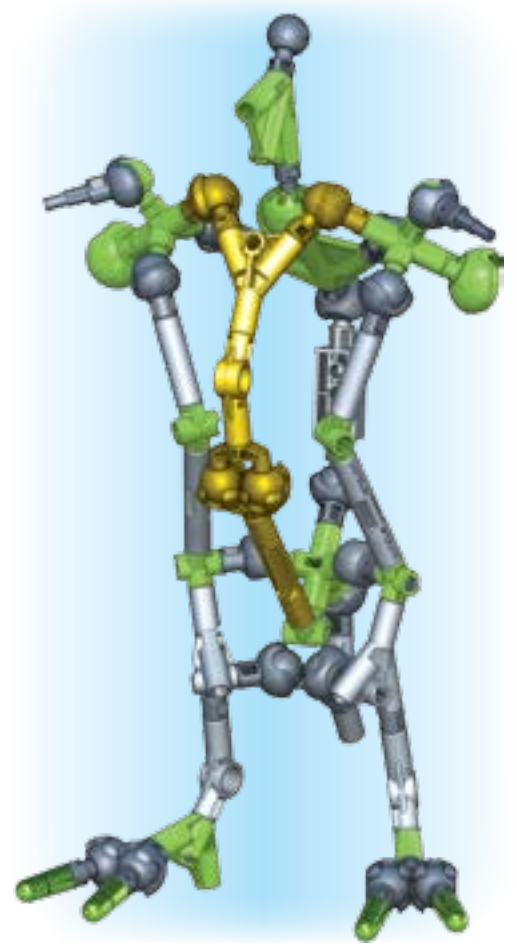
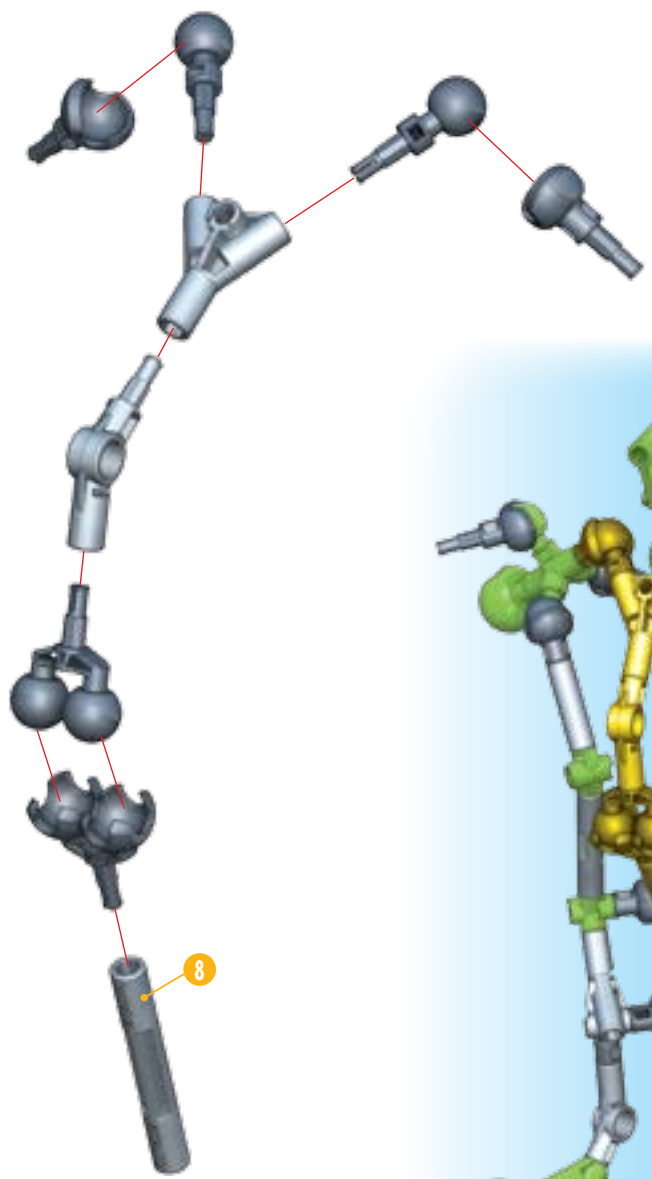

10

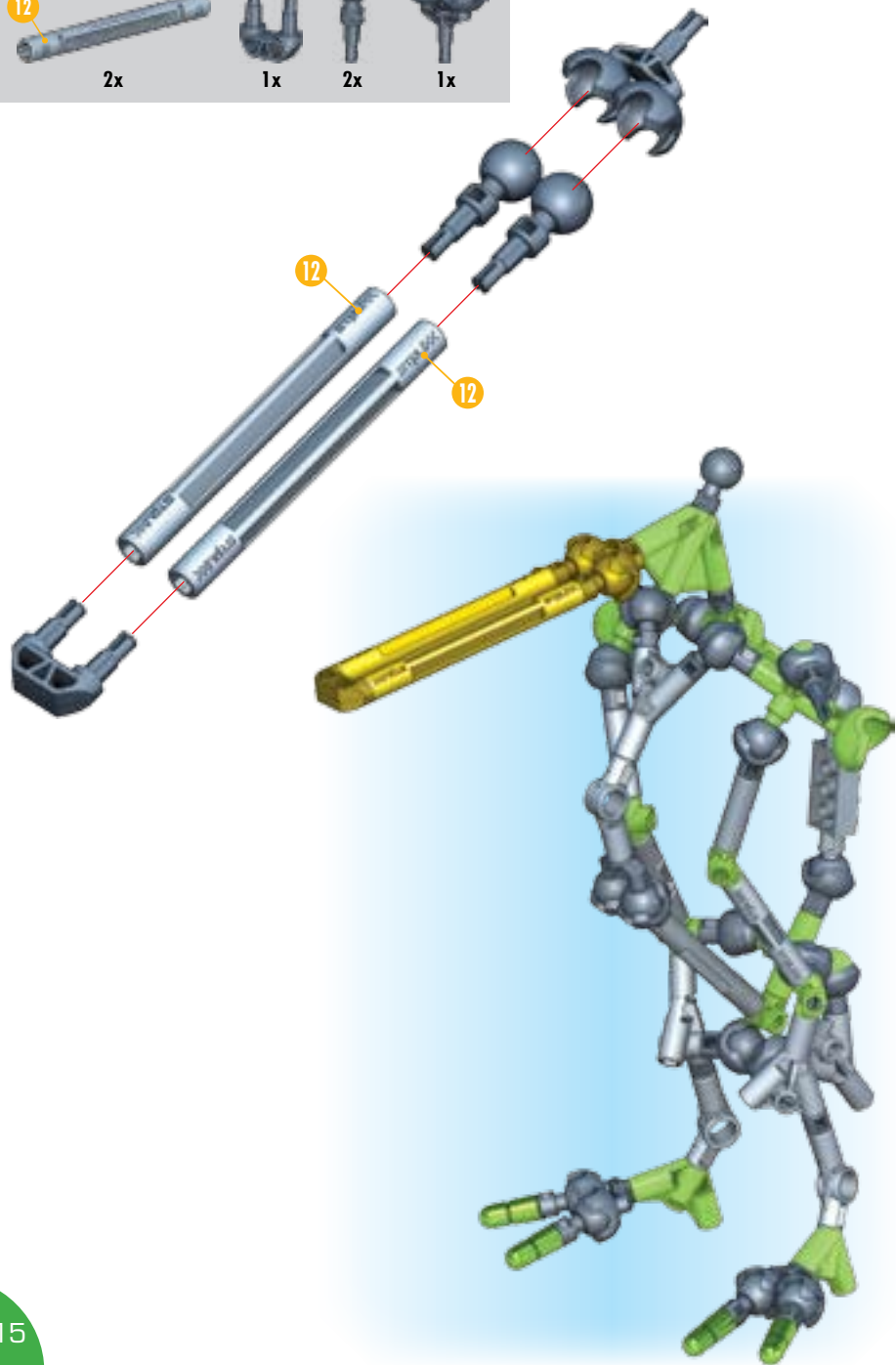

11

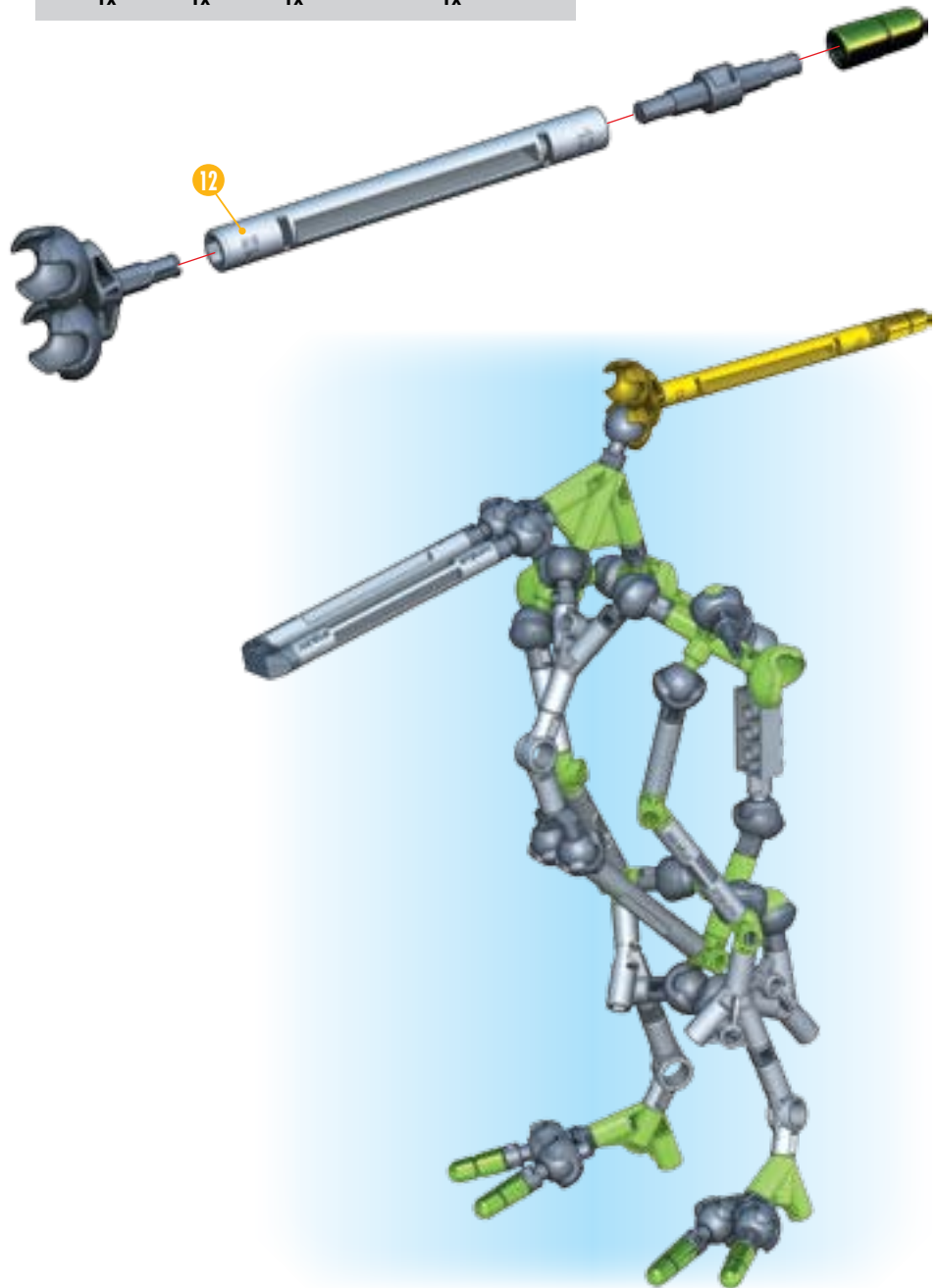

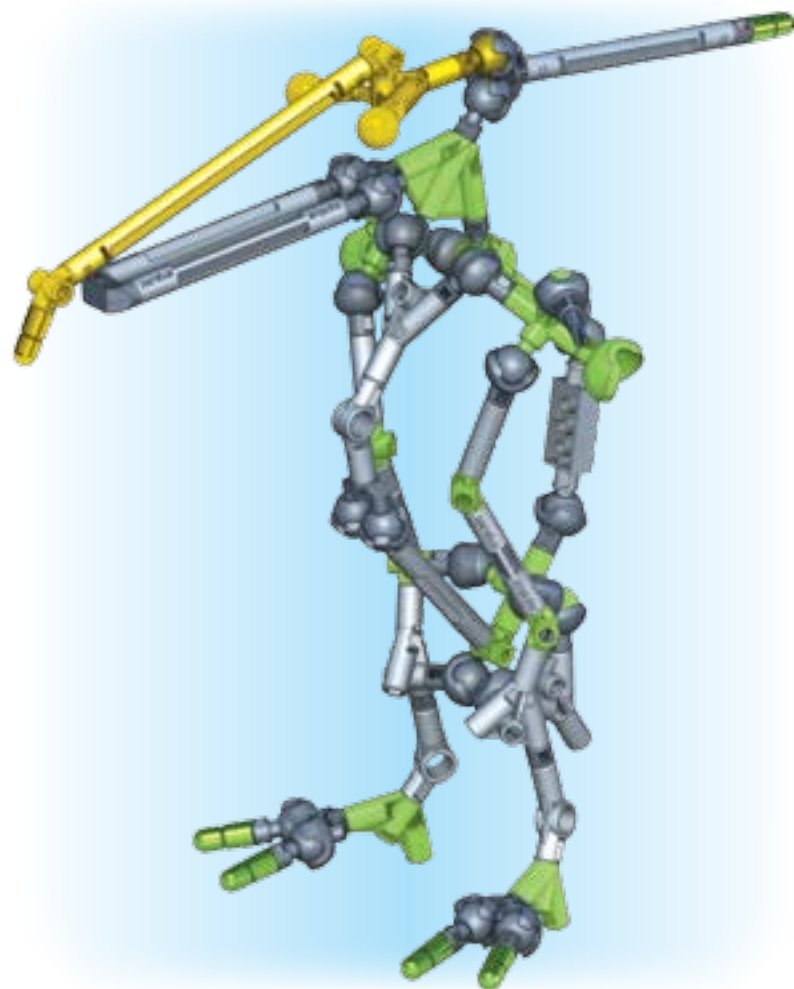
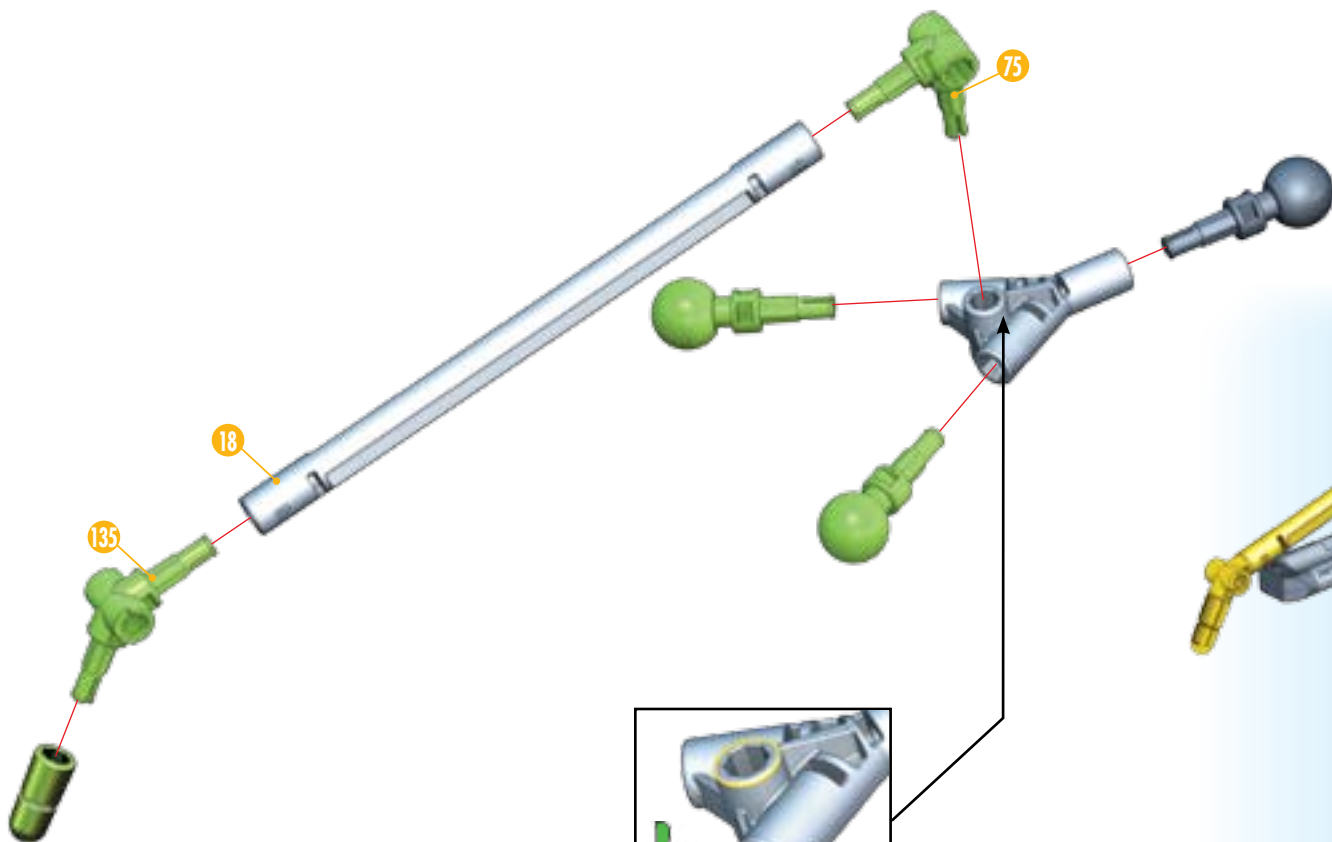

13

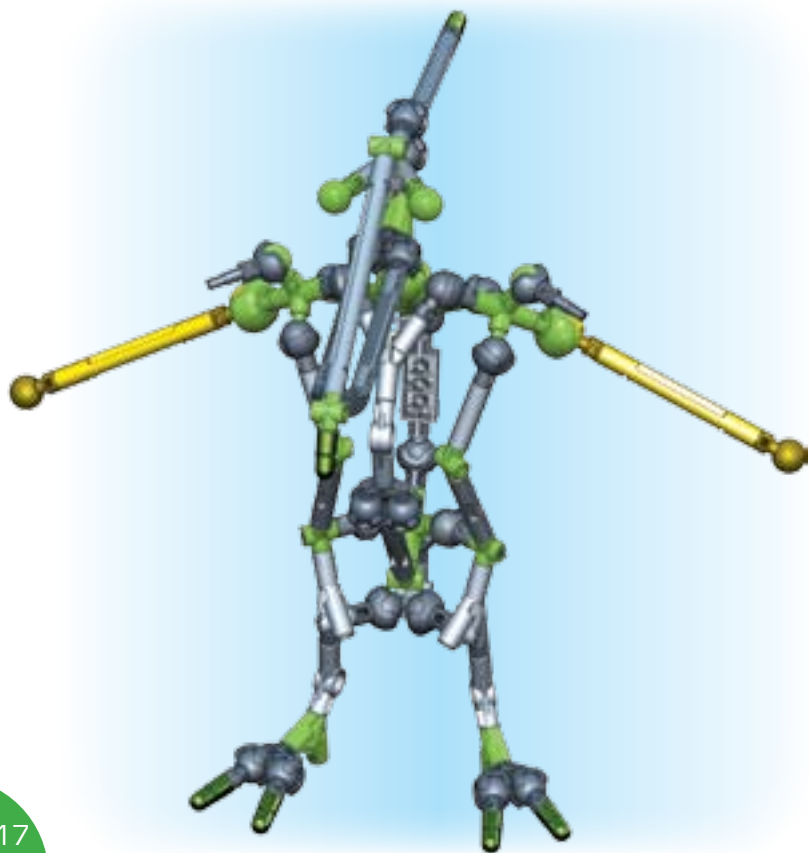
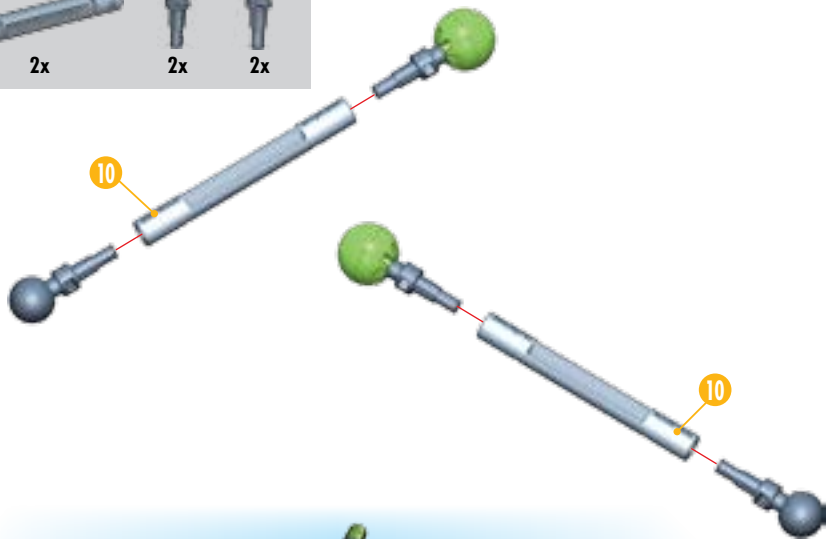
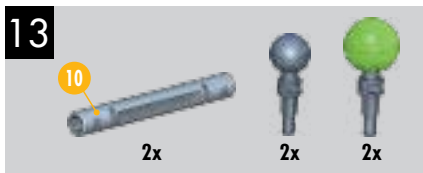

14

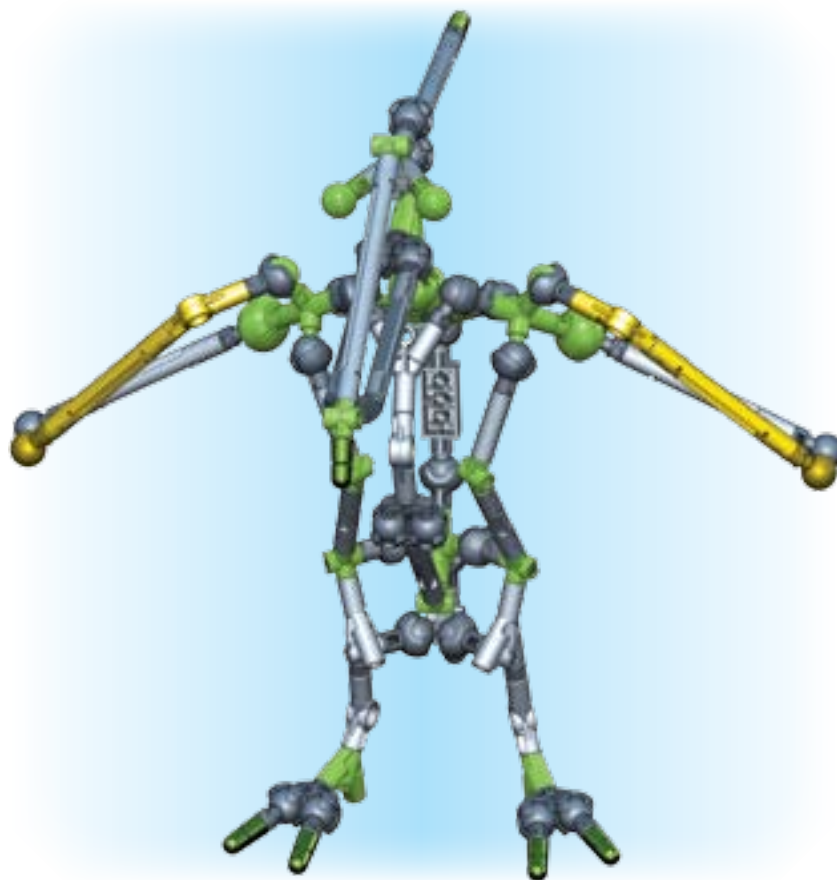
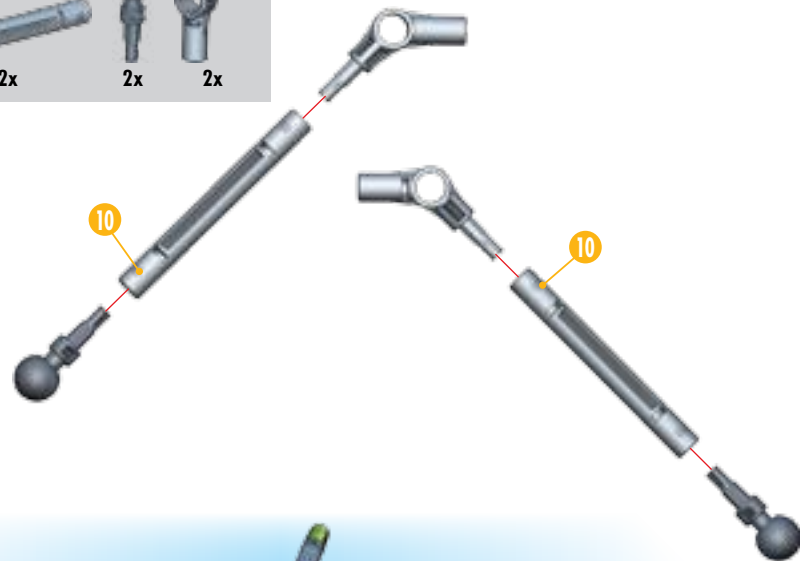
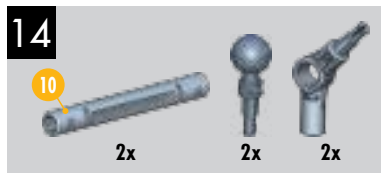

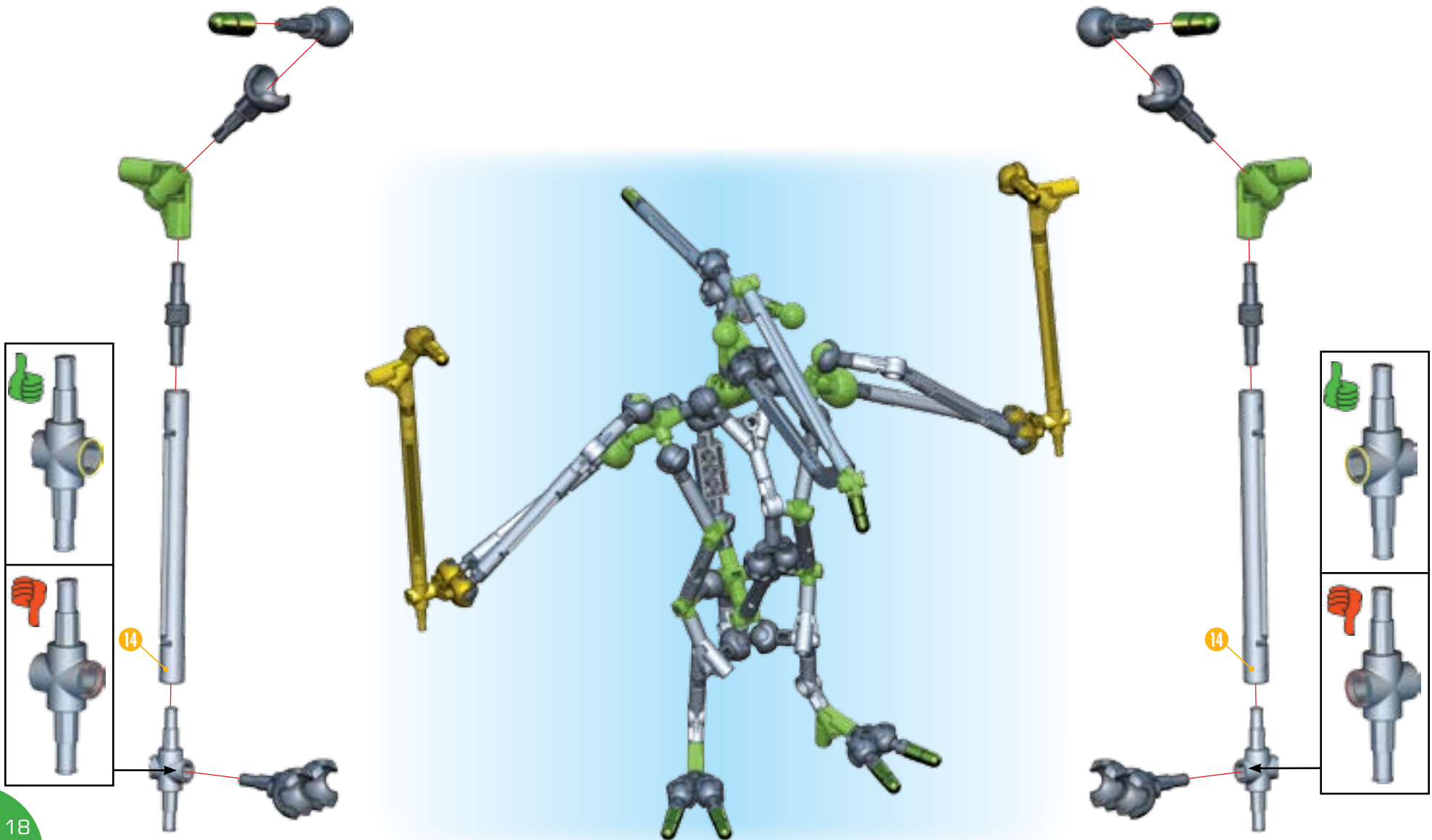

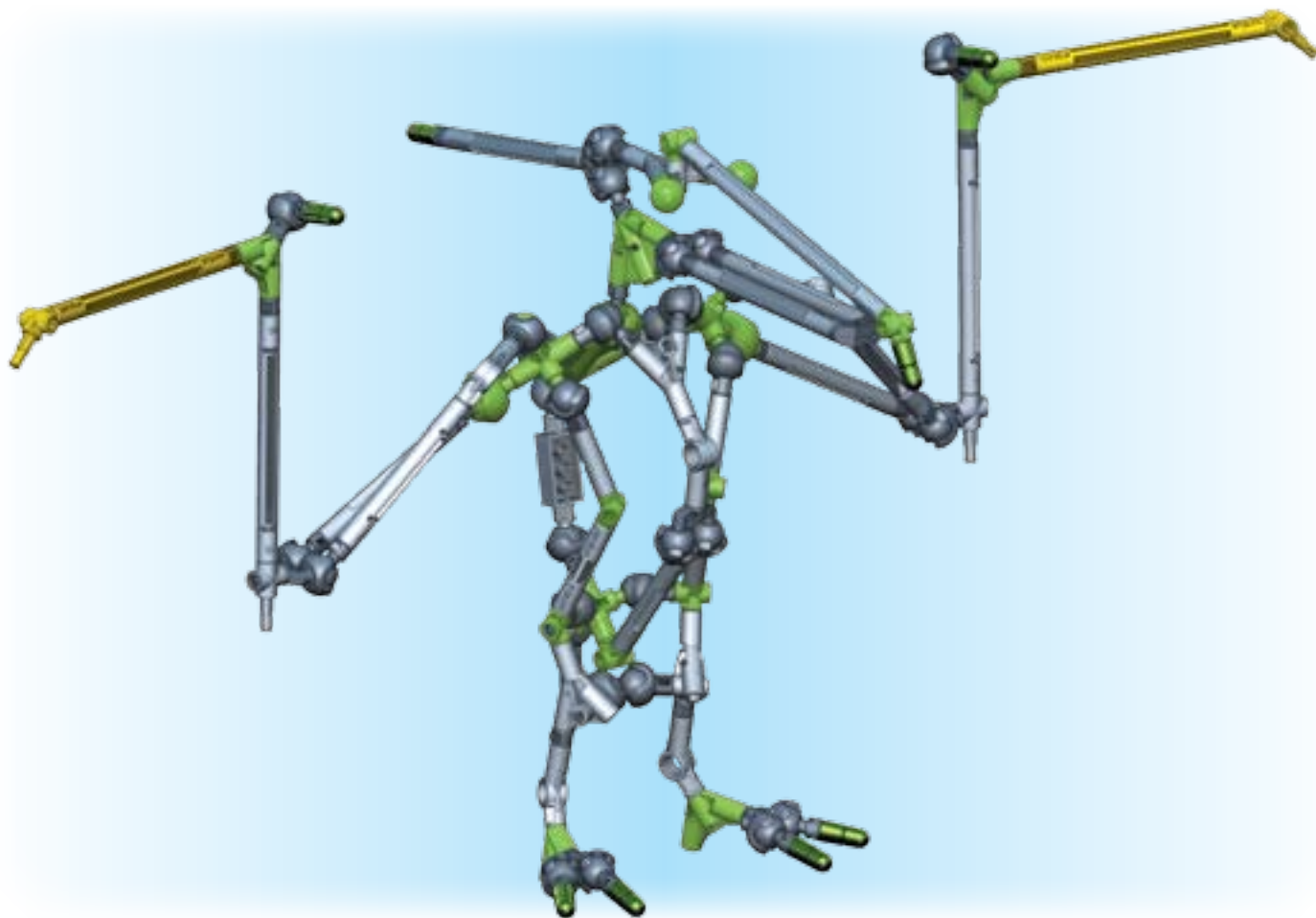
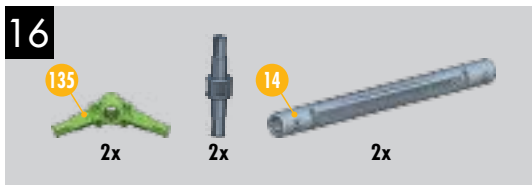

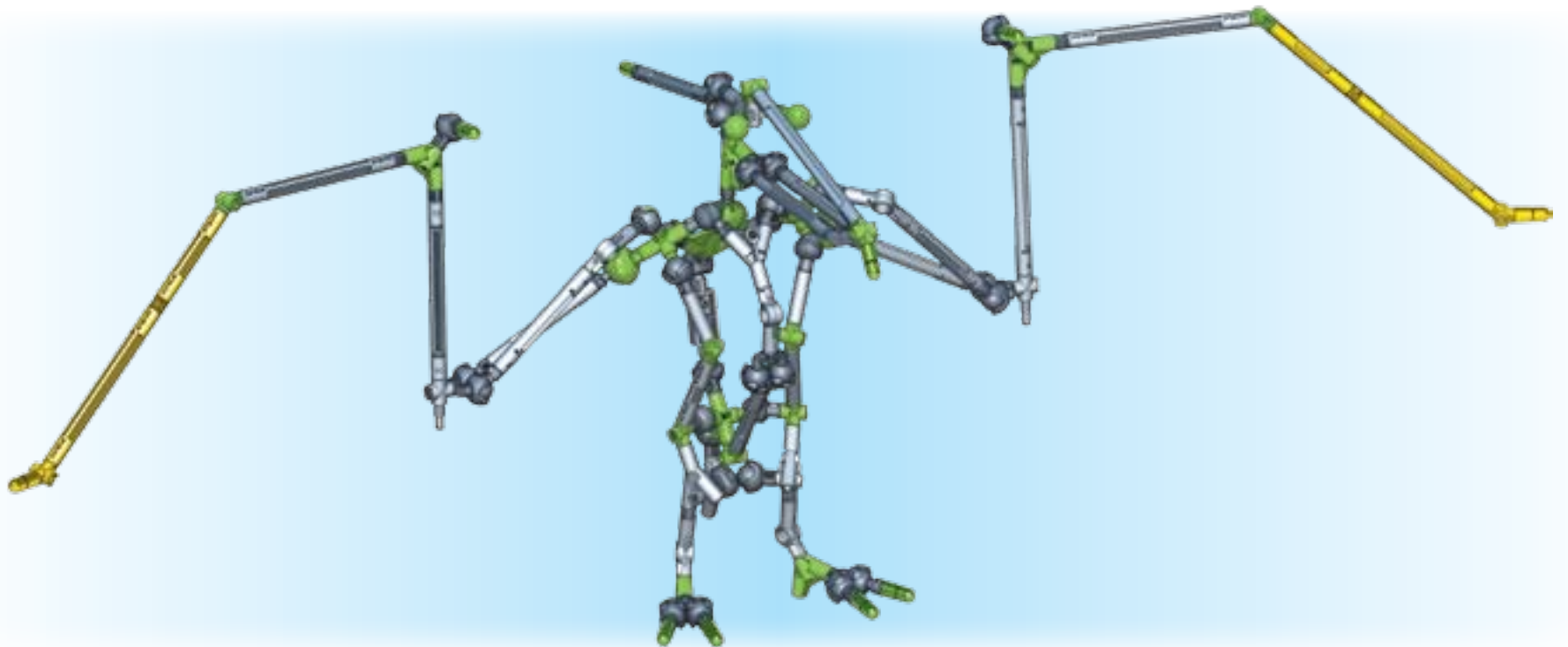
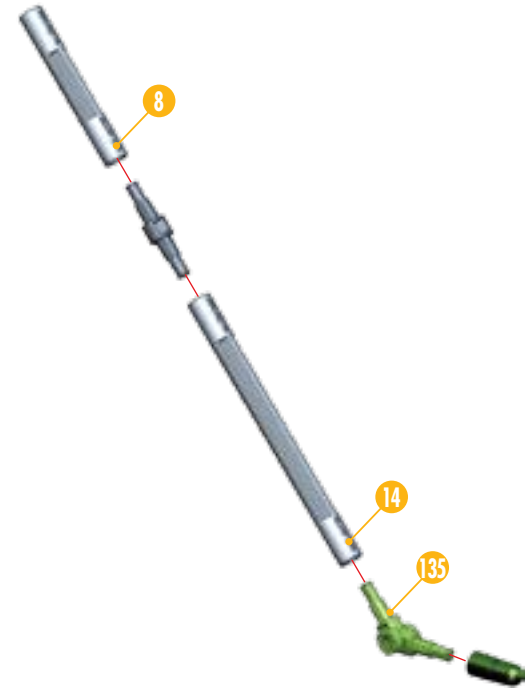
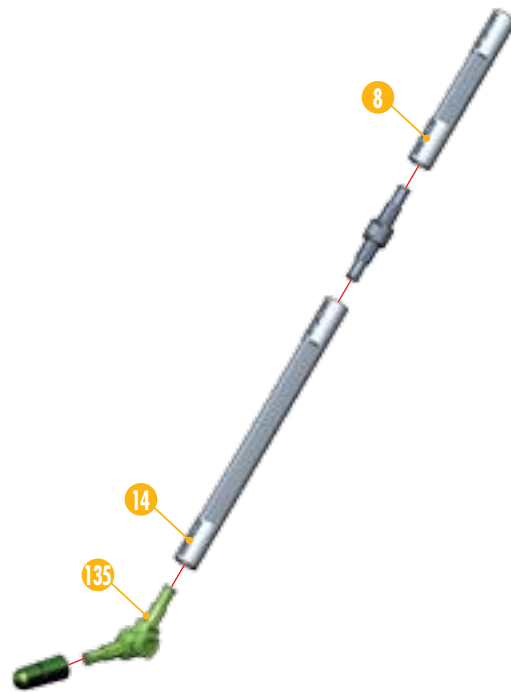
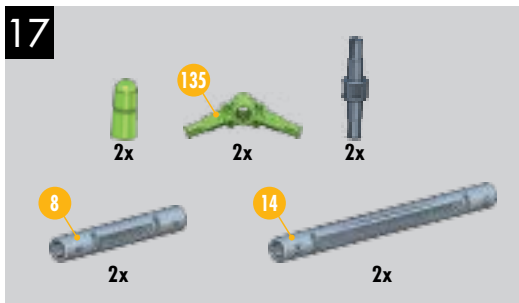

Build / Construir / Construire / Bauen / Bouw / Costruisci / Construir

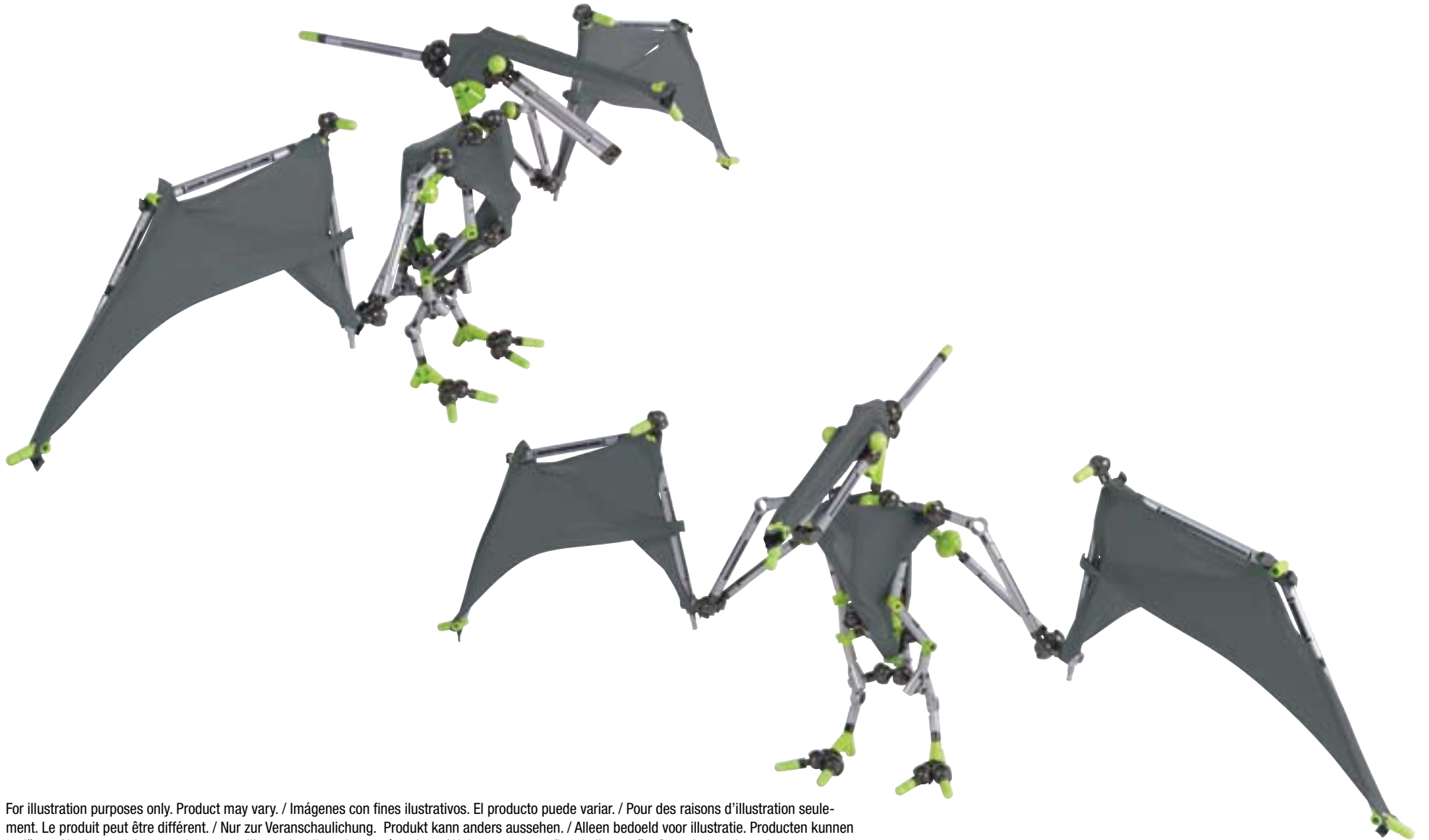

For illustration purposes only. Product may vary. / Imágenes con fines ilustrativos. El producto puede variar. / Pour des raisons d'illustration seulement. Le produit peut être différent. / Nur zur Veranschaulichung. Produkt kann anders aussehen. / Alleen bedoeld voor illustratie. Producten kunnen variëren. / Le immagini sono solo a scopo illustrativo. Il prodotto può variare. / Unicamente para fins de ilustração. O produto pode variar.

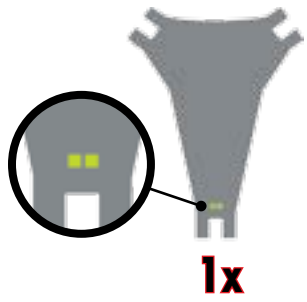

1x



Back / Reverso / Arrière / Rückseite
Achterzijde / Dietro / Trás



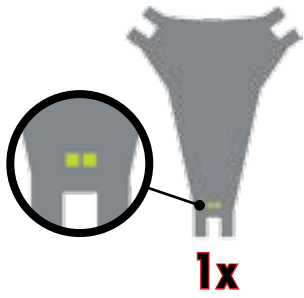

1x

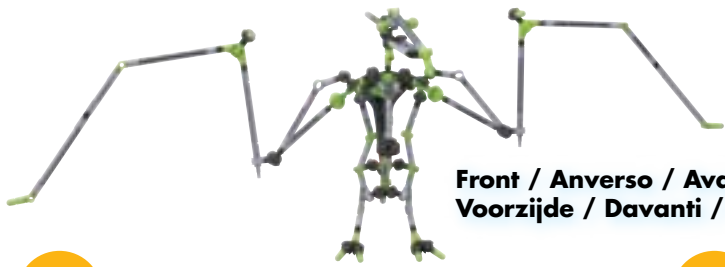
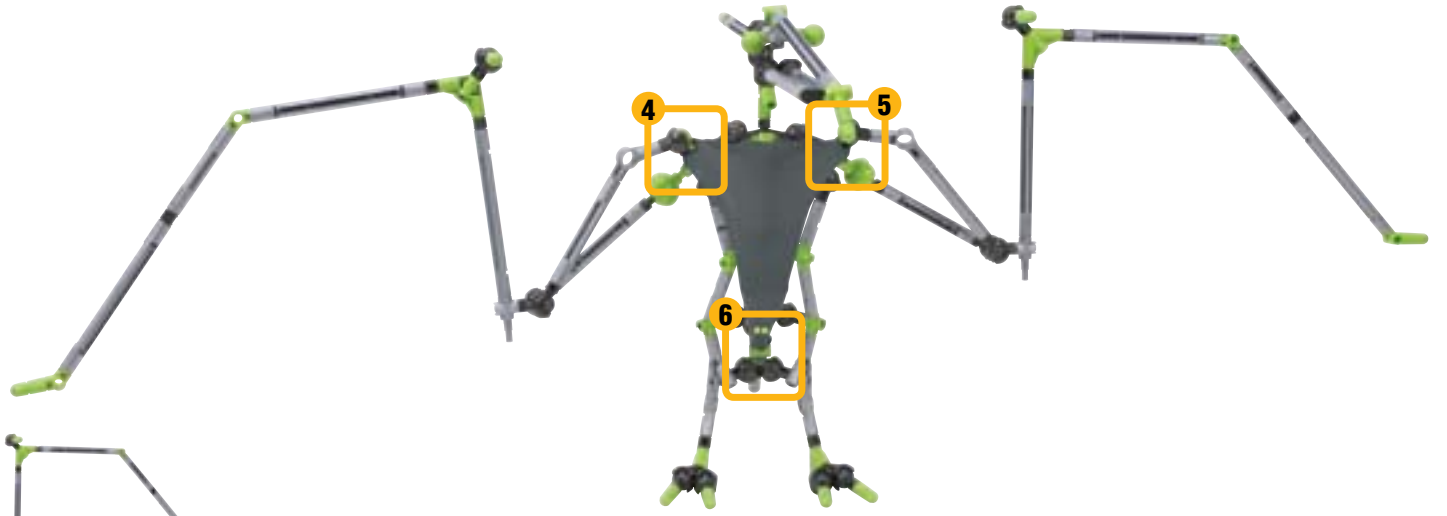

Front / Anverso / Avant / Vorderseite /
Voorzijde / Davanti / Frente

4



5



6



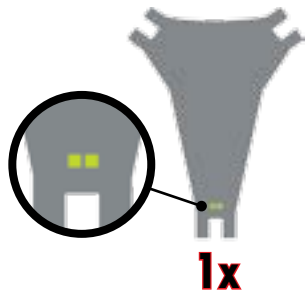

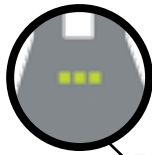

2x

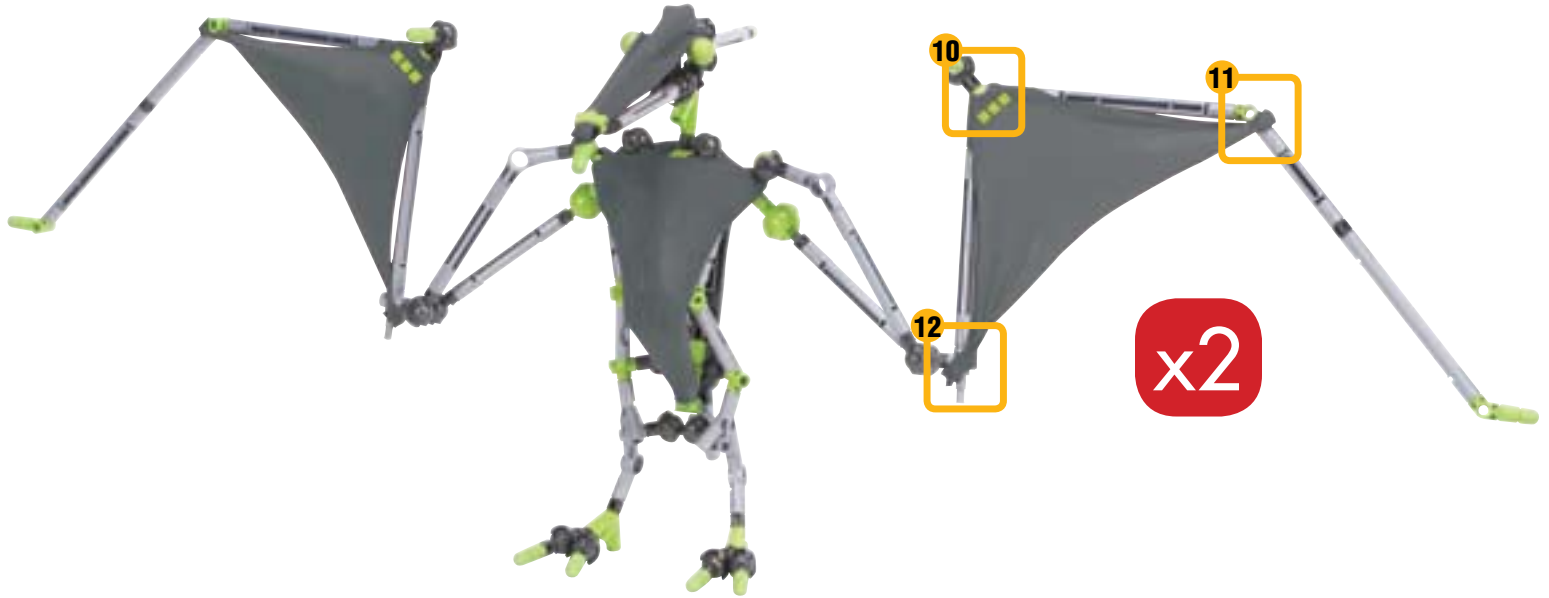

x2

10



11



12



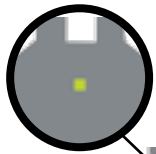

2x

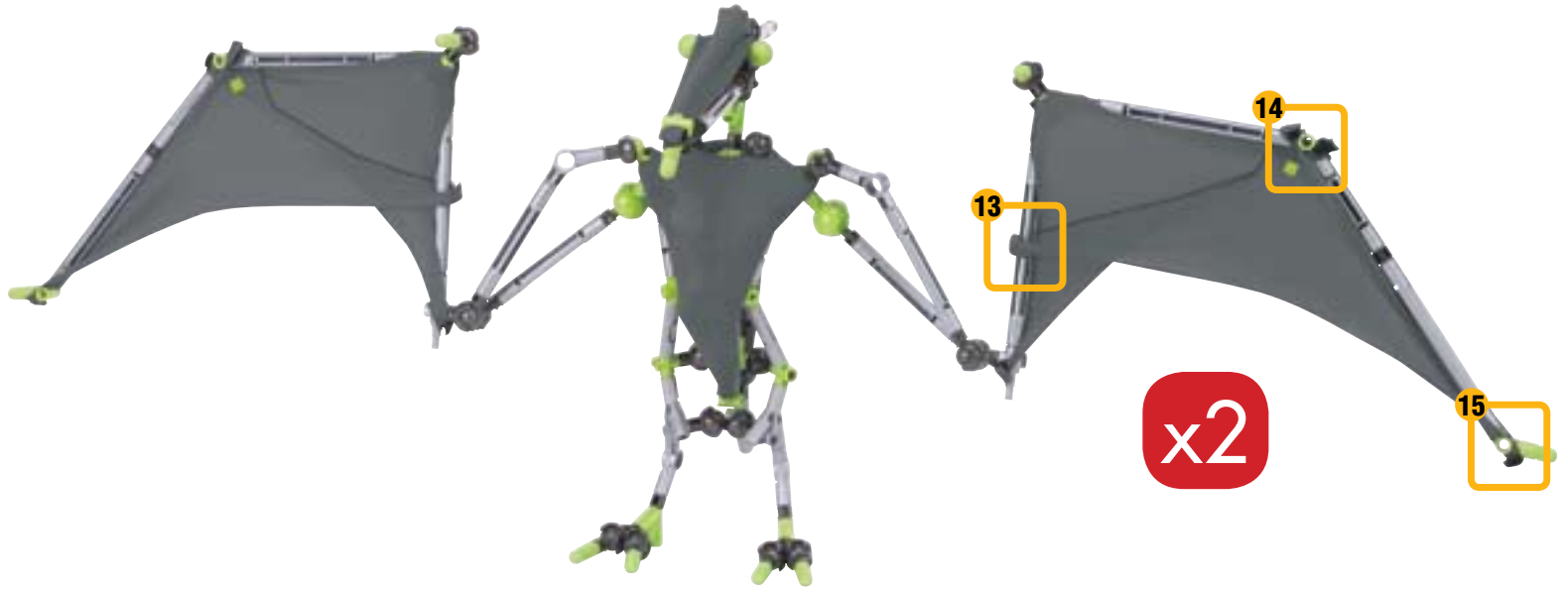

x2

13



14

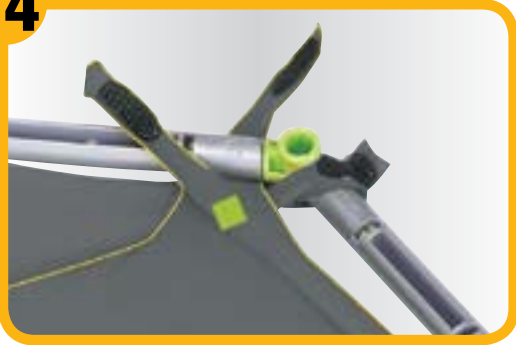

15

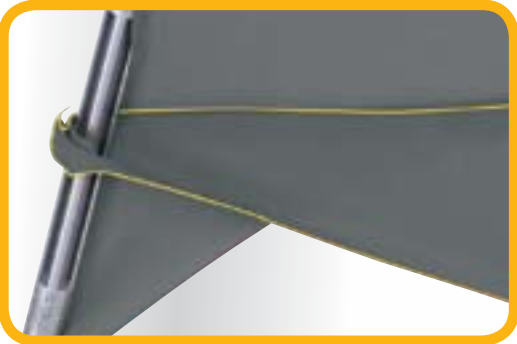

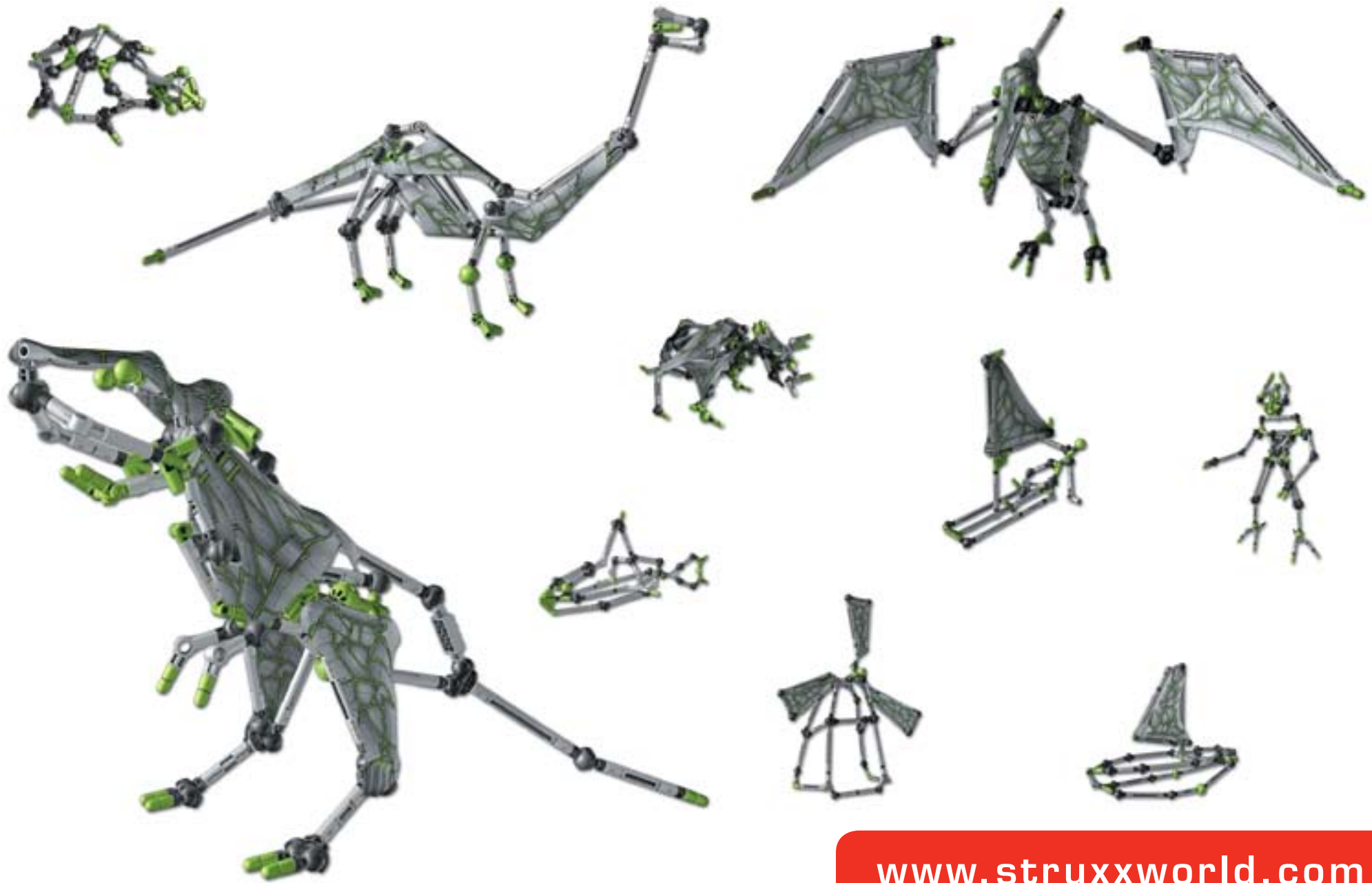

www.struxxworld.com

**BUILDING IDEAS / IDEAS DE CONSTRUCCIÓN / IDÉES DE CONSTRUCTION / BAUVORSCHLÄGE /
BOUW SUGGESTIES / IDEE DI COSTRUZIONE / IDEIAS DE CONSTRUÇÃO**

STRUXX

SKINZZ

6019

Also available / Tambien disponible / Également disponible / Ebenfalls erhältlich /
Eveneens beschikbaar / Anche disponibile / Tambem disponível



6015
Basixx 20x™



6016
Basixx
Tube Trixx™

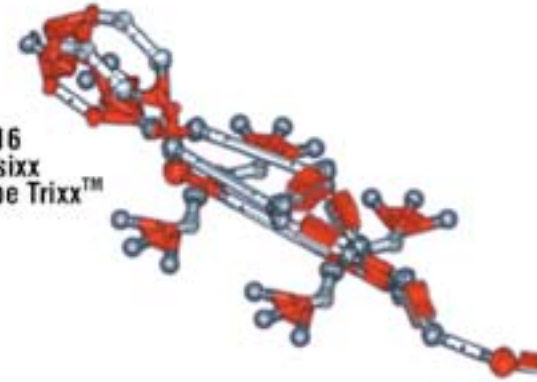

6000
Basixx 40x™



6001
Robotrixx™

© 2008, MEGA Brands Inc.
© and ™ denote trademarks of MEGA Brands Inc.
© y ™ designan la marca registrada y la marca comercial de MEGA Brands Inc.
© et ™ désignent des marques de commerce de MEGA Brands Inc.
© und ™ sind Markenzeichen der Firma MEGA Brands Inc.
© en ™ duiden op handelsmerken van MEGA Brands Inc.
© e ™ indicano dei marchi depositati di MEGA Brands Inc.
© e ™ denotam marcas registradas de MEGA Brands Inc.



**MEGA
BLOKS**

STRUXX

SKINZZ™



6019 T-Rex Skinzz™

**MEGA
BLOKS**

10x
AMI5698GT



12x
AMI5605KM



17x
AS060191



3x
AMI5615GT



18x
AMI5603KM



3x
AS060196



2x
AS0601915



2x
AS060192



7x
AMI5604KM



1x
AS0601914



75



2x
AMI5631GT

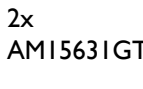

135



9x
AMI5633GT

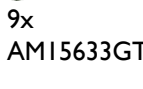

4x
AMI5619GT



2x
AMI5606GT



2x
AMI5664AGV



5x
AMI5611AGV



1x
AMI5699KM



6x
AMI5607AGV



3x
AS060193



1x
AMI6248MX



1x
AS060199

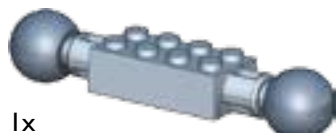

4



5x
AMI5646AGV



6

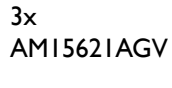

8



4x
AMI5622AGV



10



12



3x
AMI5624AGV



14



6x
AMI5625AGV



18



1x
AMI5626AGV

Building Tips / Consejos para construir / Conseils pour la construction / Bau-Tipps / Consigli per la costruzione / Bouwtips / Dicas de construção



2x
AX060191



2x
AX060193



3x
AX060192

EN Please read these instructions carefully before first use and keep them for future reference. / **ES** Leer estas instrucciones cuidadosamente antes de la primera utilización y guardarlas para referencia futura. / **FR** Il est recommandé de lire attentivement ce feuillet avant la première utilisation et de le conserver pour référence future. / **DE** Die Gebrauchsanleitung bitte durchlesen und aufbewahren. / **NL** Wij raden u aan deze handleiding zorgvuldig te lezen en te bewaren voor eventuele raadpleging op een later tijdstip. / **IT** Leggere le istruzioni prima di cominciare ad usare il gioco e conservarle per referenze future. / **PT** Leia as instruções antes do primeiro uso e guarde-as para futura referência.

EN ⚠ **WARNING :**
CHOKING HAZARD. - Small parts.
Toy contains a small ball.
Not for children under 3 years.

ES ⚠ **ADVERTENCIA :**
PELIGRO DE ASFIXIA. - Contiene piezas pequeñas.
El juguete contiene una bola pequeña.
No recomendado para niños menores de 3 años.

FR ⚠ **AVERTISSEMENT :**
RISQUE DE SUFFOCATION. - Présence de petits éléments.
Le jouet contient une petite balle.
Ne convient pas aux enfants de moins de 3 ans.

DE ⚠ **WARNUNG :**
ERSTICKUNGSGEFAHR. - Enthält kleine Teile.
Ein kleiner Ball ist im Spielzeug inbegriffen.
Nicht für Kinder unter 3 Jahren geeignet.

NL ⚠ **WAARSCHUWING :**
VERSTIKKINGSGEVAAR. - Bevat kleine onderdelen.
Speelgoed bevat een klein balletje.
Niet geschikt voor kinderen onder de 3 jaar.

DA ⚠ **ADVARSEL :**
KVÆLNINGSFARE. - Indeholder smådele.
Legetøjet indeholder en lille bold.
Ikke til børn under 3 år.

EN Latex free toy.
ES Juguete sin látex.
FR Jouet sans latex.
DE Latexfreies Spielzeug.
NL Speelgoed vrij van latex.
DA Dette legetøj indeholder ikke latexgummi.
EL Παιχνίδι χωρίς λάτεξ
FI Lelu ei sisällä lateksia.
IT Non contiene latex.
NO Leksak fri leketøy.
PT Brinquedo sem conteúdo de latex.
SV Leksak utan latex.
JA この玩具にはラテックスは使用されていません。
ZH 無乳膠玩具。
AR لعبة خالية من مادة اللاتكس

EL ⚠ **ΠΡΟΕΙΔΟΠΟΙΗΣΗ :**
ΚΙΝΔΥΝΟΣ ΠΝΕΙΜΑΤΟΣ. - Περιέχει μικρά αντικείμενα
Το παιχνίδι περιέχει ένα μπαλάκι.
Όχι για παιδιά κάτω των 3 ετών.

FI ⚠ **VAROITUS :**
TUKEHTUMISVAARA. - Sisältää pieniä osia.
Leluun sisältyy pieni pallo.
Ei alle 3-vuotiaalle lapsille.

IT ⚠ **ATTENZIONE :**
PERICOLO DI SOFFOCAMENTO.
- Contiene piccole parti.
Il giocattolo comprende una pallina.
Non indicato per bambini sotto i 3 anni.

NO ⚠ **ADVARSEL :**
KVÆLNINGSFARE. - Inneholder små deler.
Leketøy inneholder en liten ball.
Kun for barn over 3 år.

PT ⚠ **ATENÇÃO :**
PERIGO DE ASFIXIA. - Contém peças pequenas.
O brinquedo contém uma pequena bola.
Não é concebido para crianças de menos de 3 anos.

SV ⚠ **WARNING :**
KVÄVNINGSRISK. - Innehåller små delar.
Leksaken innehåller en liten boll.
Inte för barn under 3 år.

JA ⚠ **警告 :**
窒息の危険性 - 小さな部品が含まれています
小さな玉が含まれています。
3歳以下の子供には与えないで下さい。

ZH ⚠ **警告 :**
有窒息危險 - 包含有小部件
此玩具含有一個小球。
不适合3岁以下的小孩玩。

AR ⚠ **تحذير :**
خطر اختناق - قطع صغيرة
تحتوي اللعبة على كرة صغيرة.
غير صالحة للأطفال أقل من 3 سنوات.

Sort and organize your parts / Ordena y organiza las piezas / Trie les pièces et range-les par catégories / Sortiere die einzelnen Teile / Sorteer en orden de onderdelen / Seleziona e ordina i pezzi / Organiza as tuas peças



Patent pending.
Patente en trámite.
Brevet en instance.
Patent angemeldet.
Patent aangevraagd.
Brevet in corso.
Patente pendente.



How to assemble / Instrucciones de montaje / Méthodes d'assemblage / So werden die Teile zusammengefügt /
In elkaar zetten / Assemblaggio / Como montar

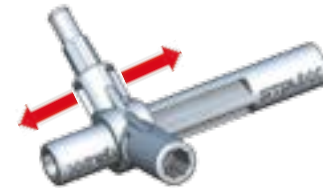
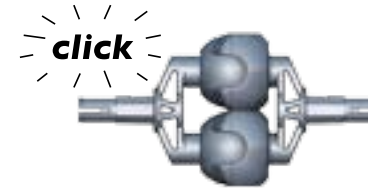
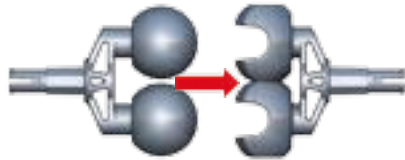
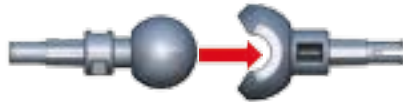

Pay special attention to the different angles of parts / Presta especial atención a los distintos ángulos de las piezas / Fait particulièrement attention
aux différents angles des pièces / Achte besonders auf die unterschiedlichen Winkel der Teile / Let goed op, want de onderdelen hebben verschil-
lende hoeken / Presta attenzione particolare alle diverse angolature dei pezzi / Presta atenção aos diferentes ângulos das peças

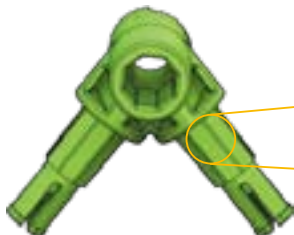

75°



105°

Pay special attention when connecting these parts / Presta especial atención a la hora de conectar las piezas / Assemble ces pièces avec soin dans la position adéquate / Achte darauf, dass du die richtigen Teile miteinander verbindest / Let goed op als je deze onderdelen aan elkaar bevestigt / Presta attenzione particolare quando connetti i seguenti pezzi / Presta especial atenção ao encaixares estas peças



AMI5611AGV



AMI5633GT



AMI5664AGV



AMI5632GT

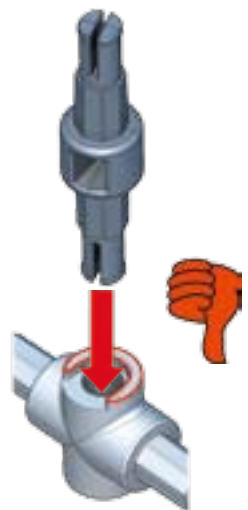

There exists multiple fit positions between parts / Existen multitud de posibilidades para hacer encajar las piezas / Pour chaque pièces, il existe de multiples positions d'assemblages / Es gibt verschiedene Möglichkeiten, die Teile zusammenzufügen / De onderdelen kunnen in verschillende posities worden bevestigd / Esistono diverse possibilità di incastro tra i pezzi / As peças podem ser montadas em posições diferentes

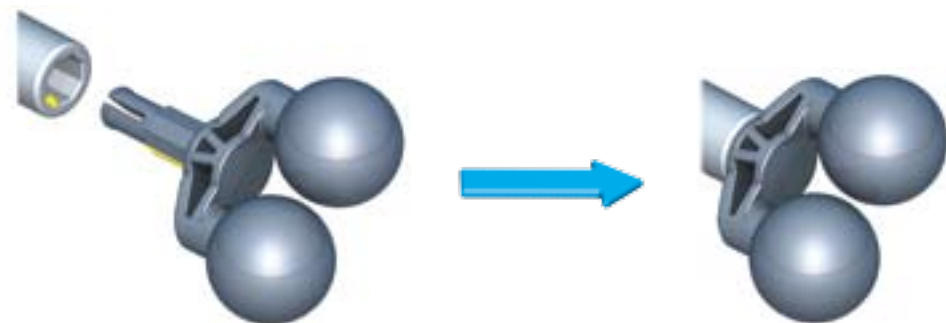
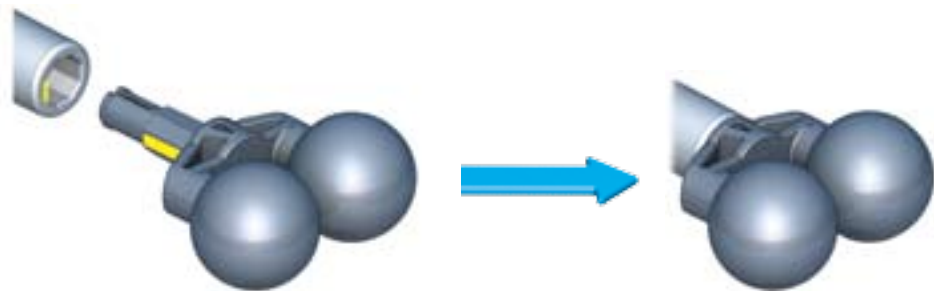
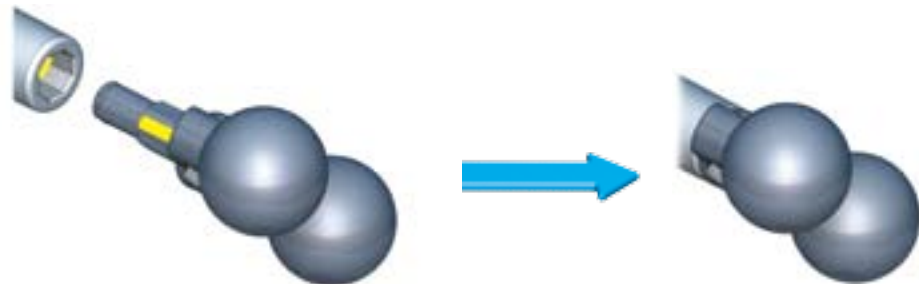
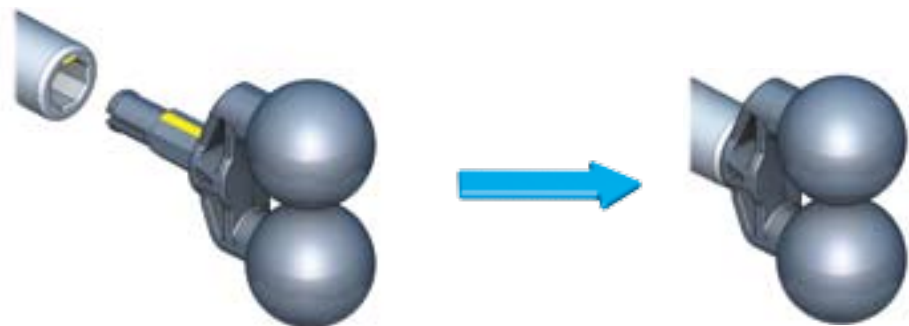

How to disassemble / Instrucciones para desmontar / Méthodes de désassemblage / So werden die Teile auseinandergebaut / Uit elkaar halen / Disassemblaggio / Como desmontar

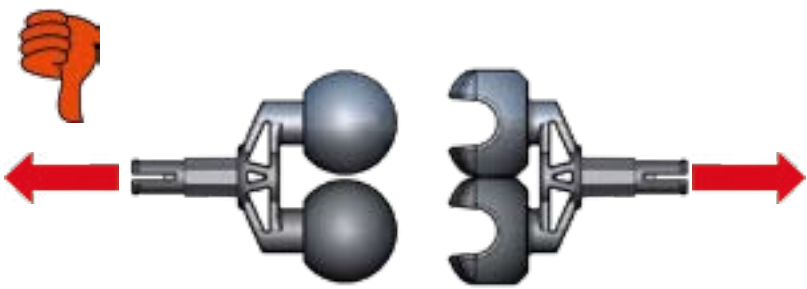
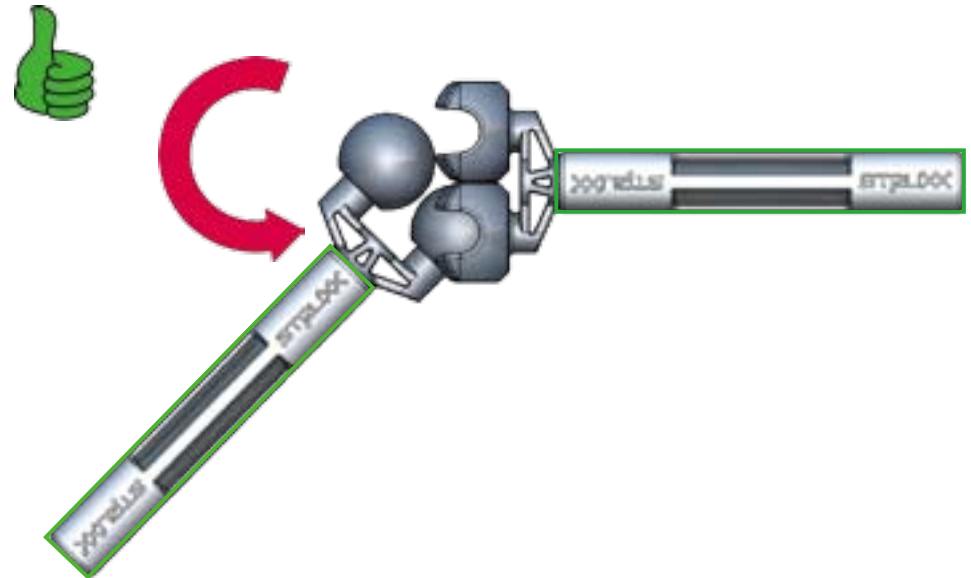
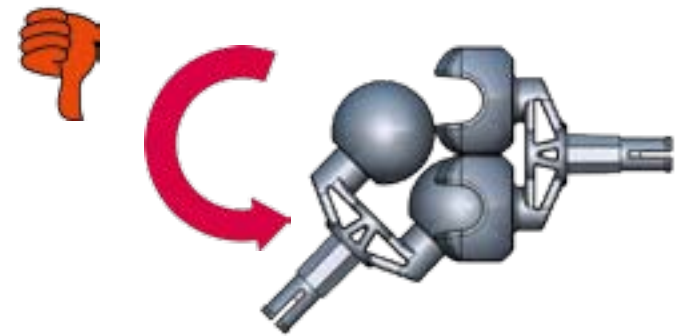
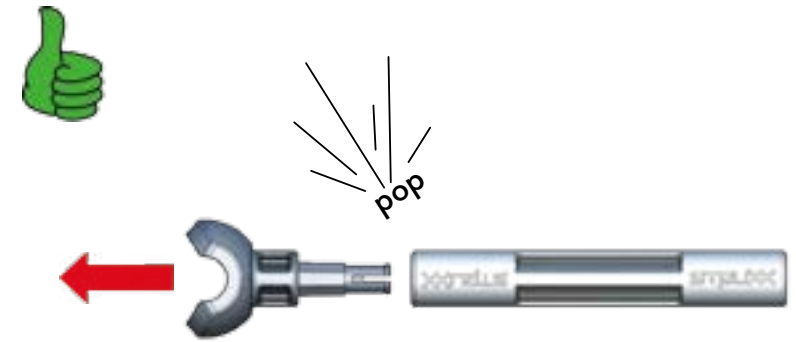
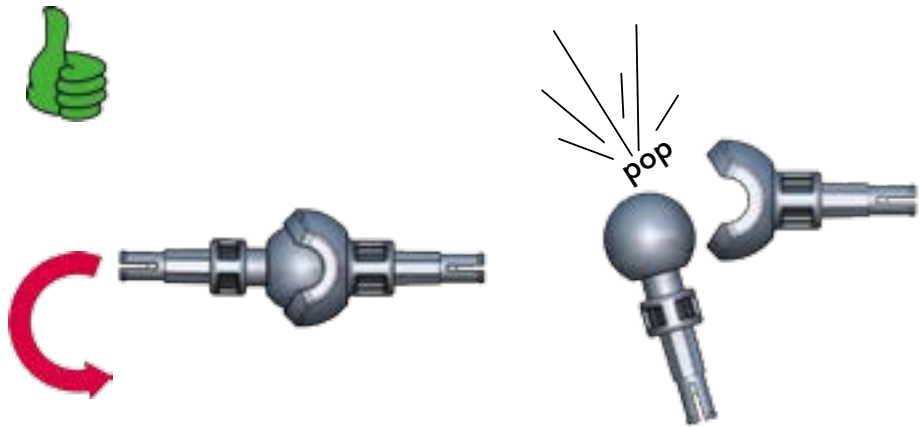

How to disassemble / Instrucciones para desmontar / Méthodes de désassemblage / So werden die Teile auseinandergelöst /
Uit elkaar halen / Disassemblaggio / Como desmontar

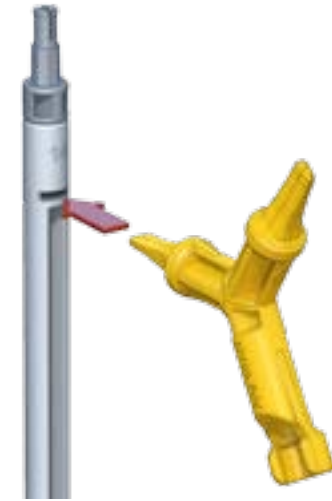
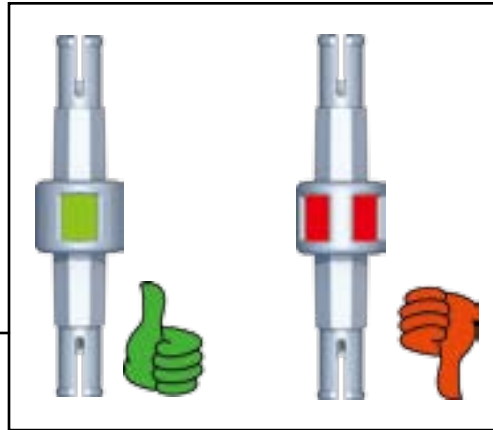
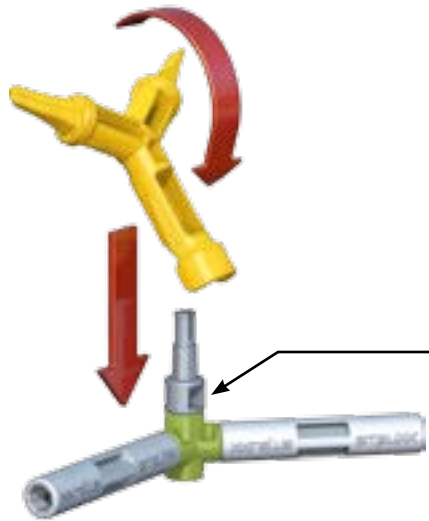

**Build / Construir / Construire / Bauen /
Bouw / Costruisci / Construir**

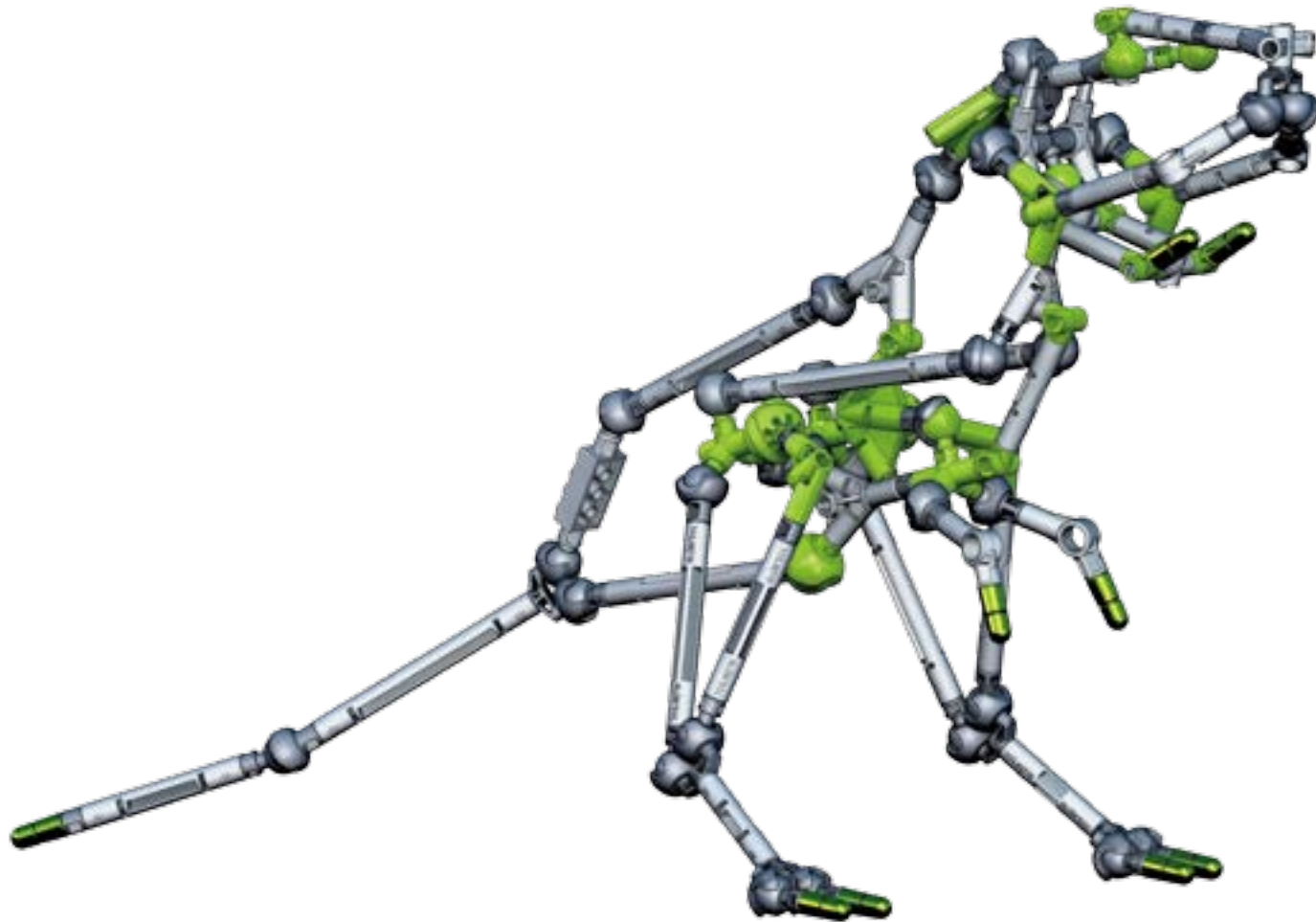

1

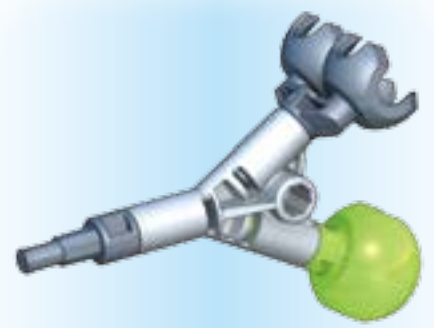
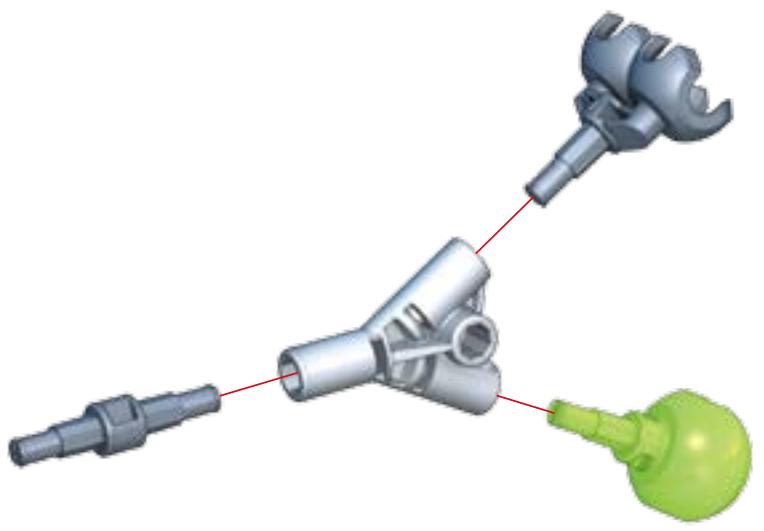

2

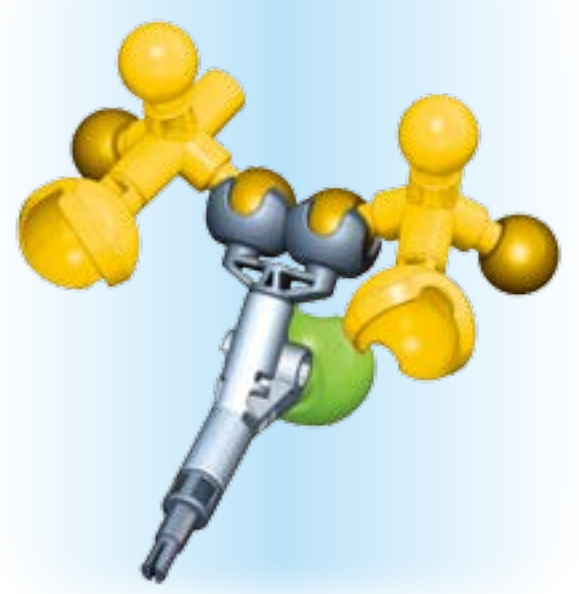
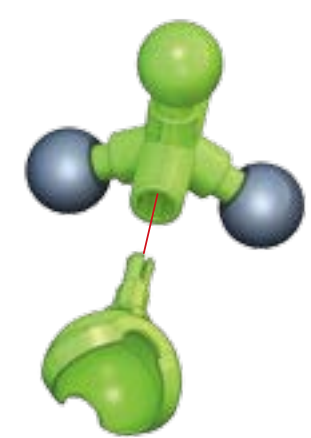
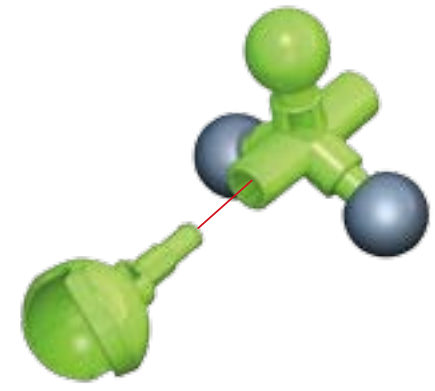

3

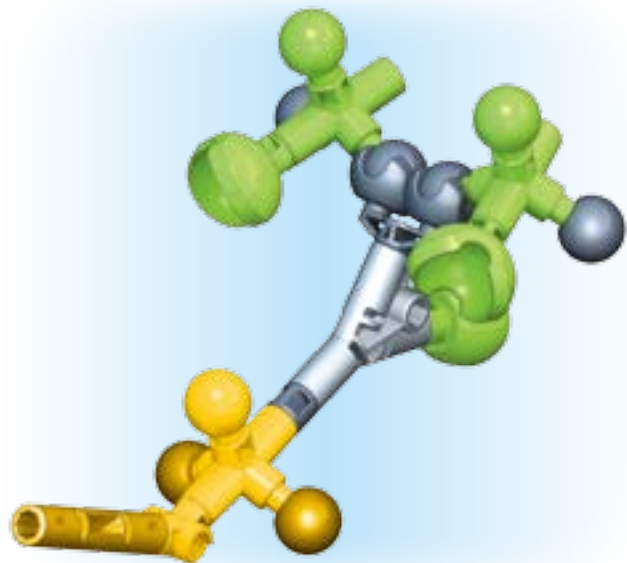
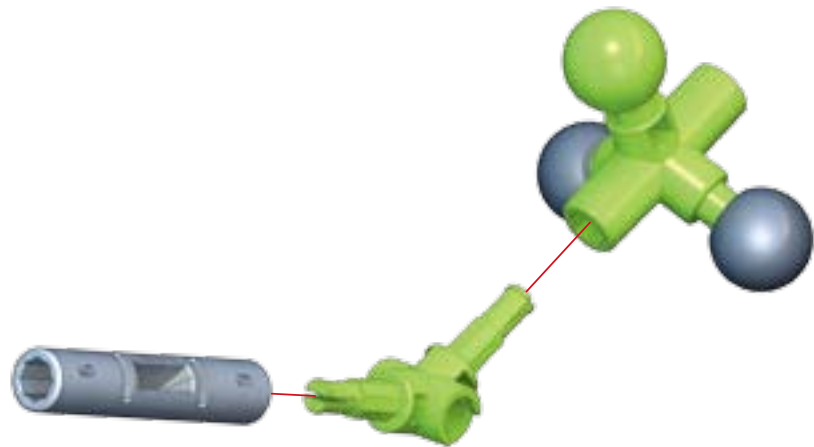

4

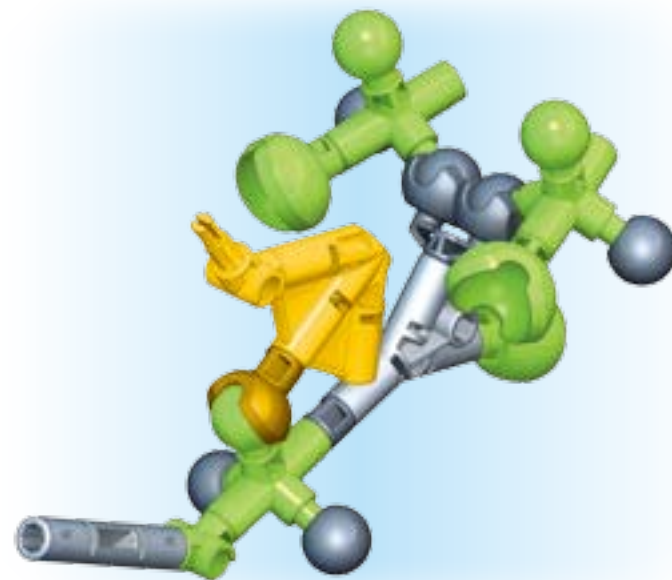
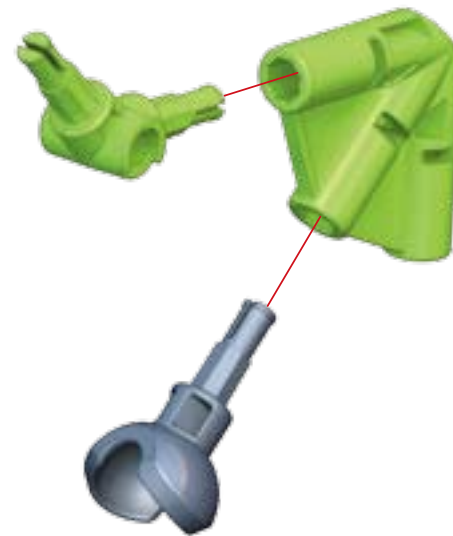

5

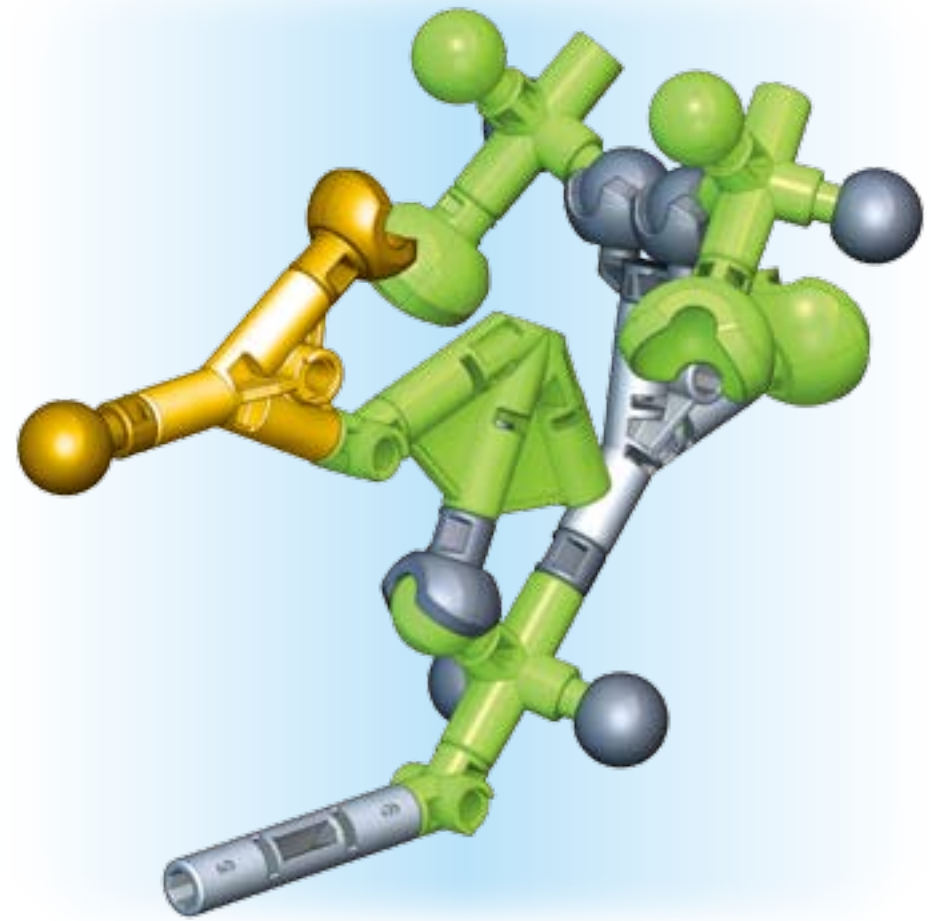
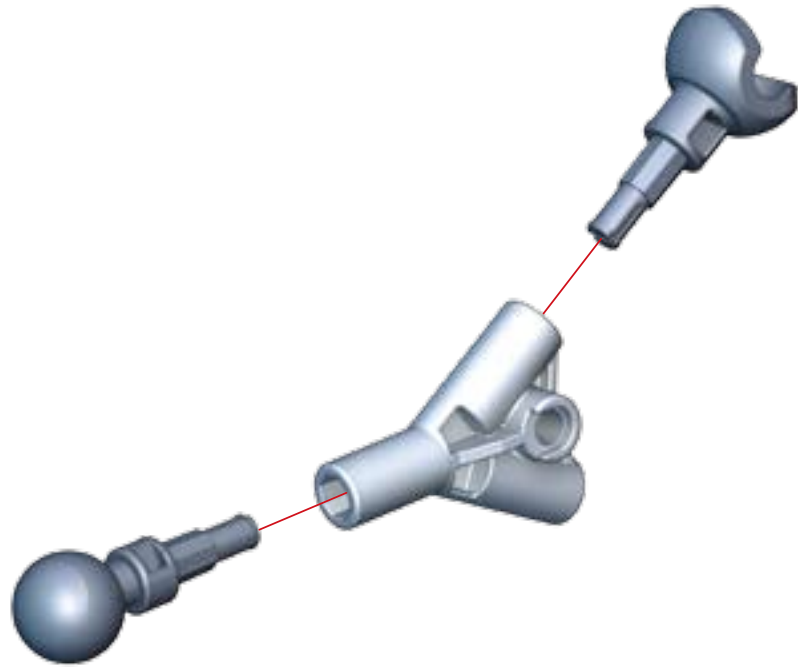

6

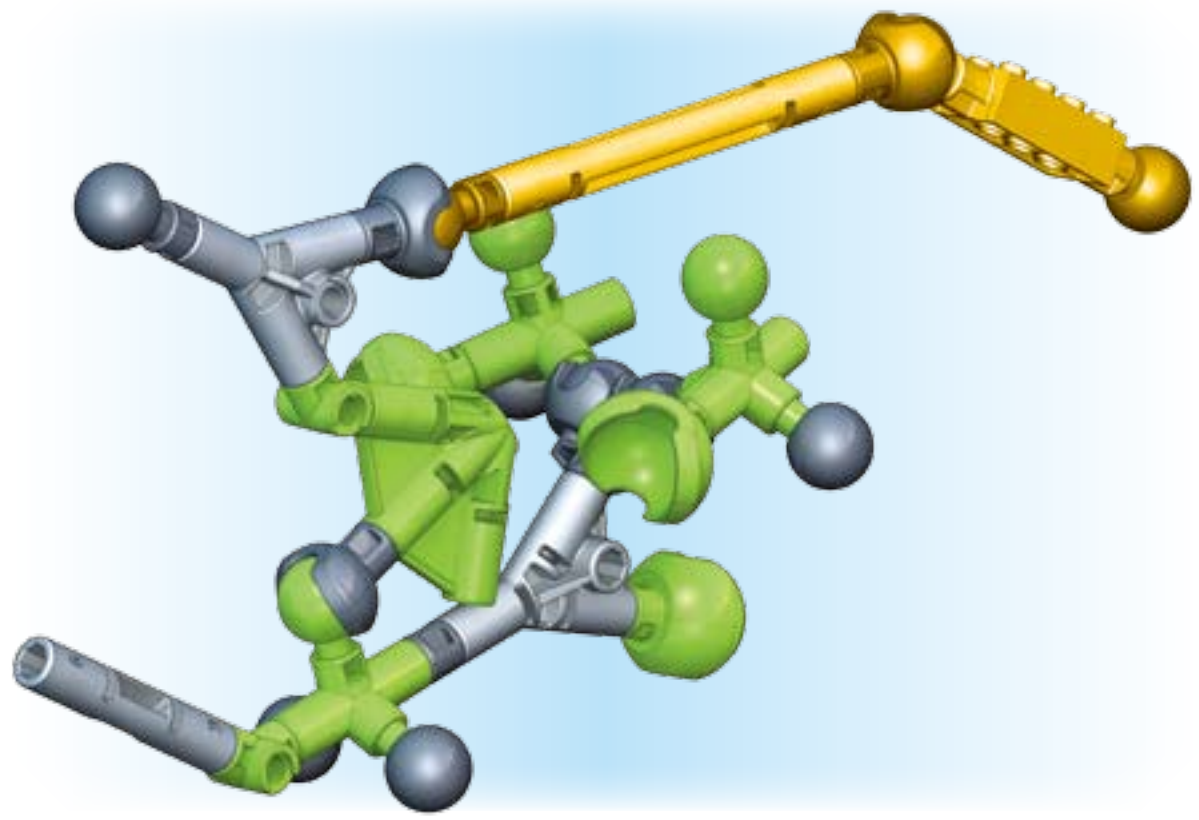

7

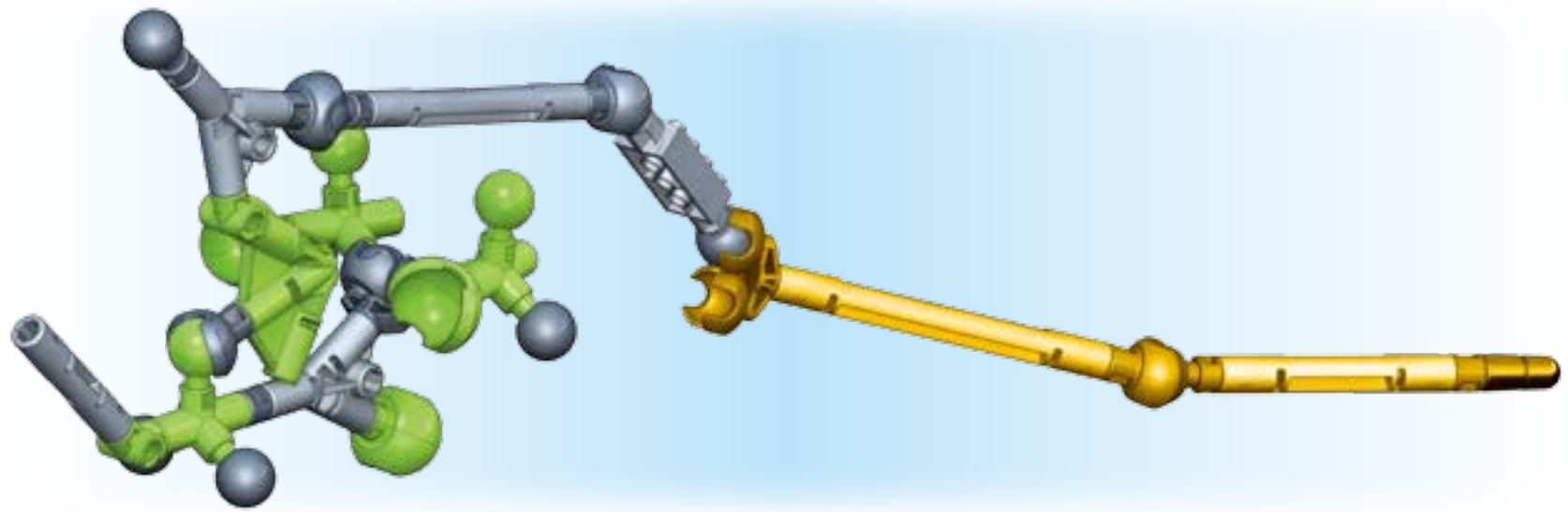
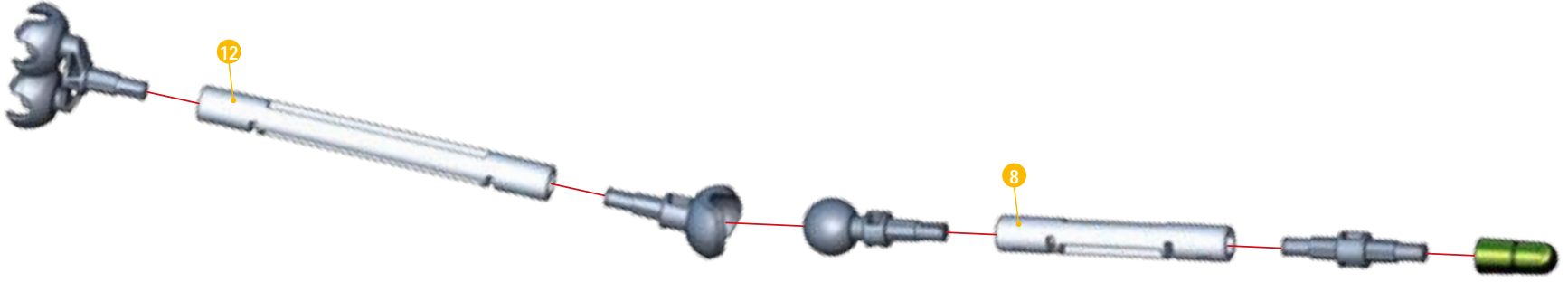

8

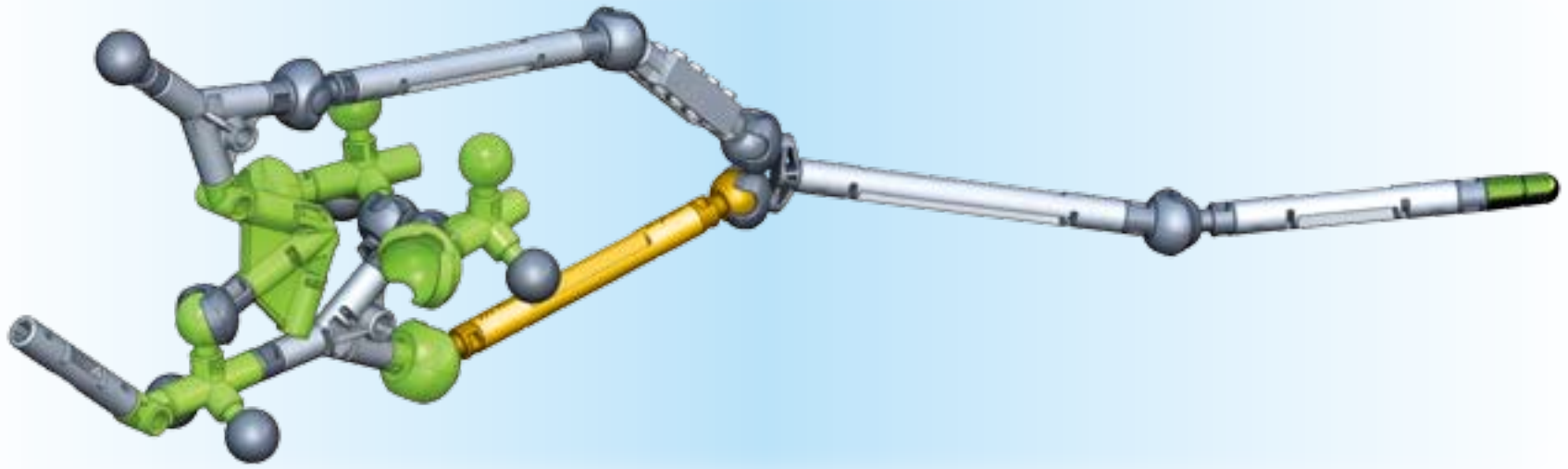
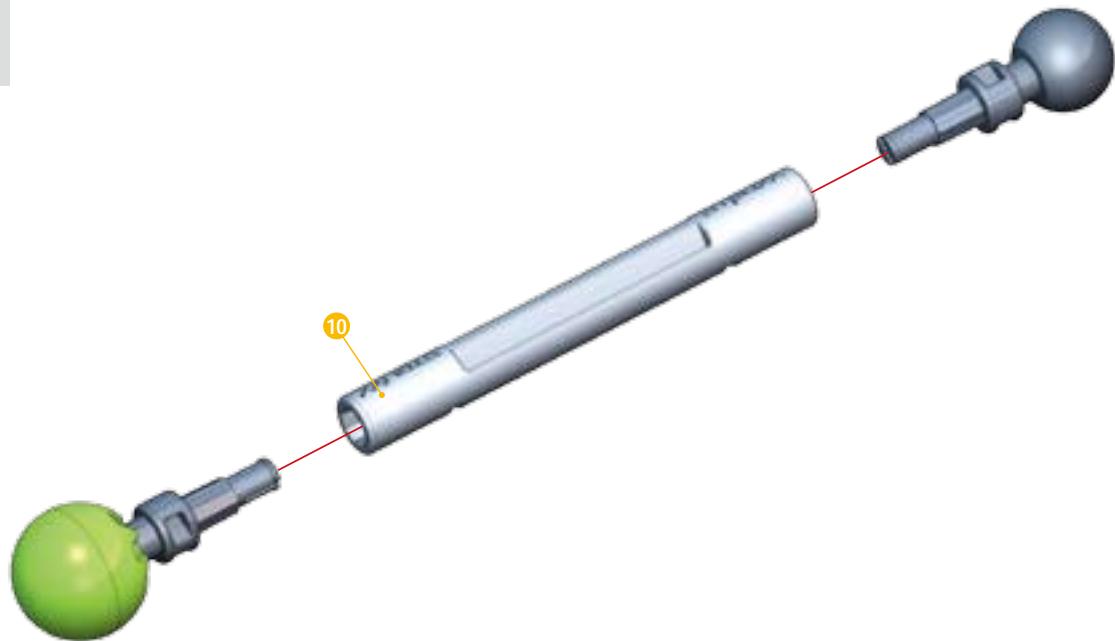
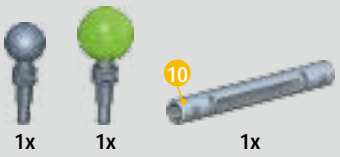

9



10

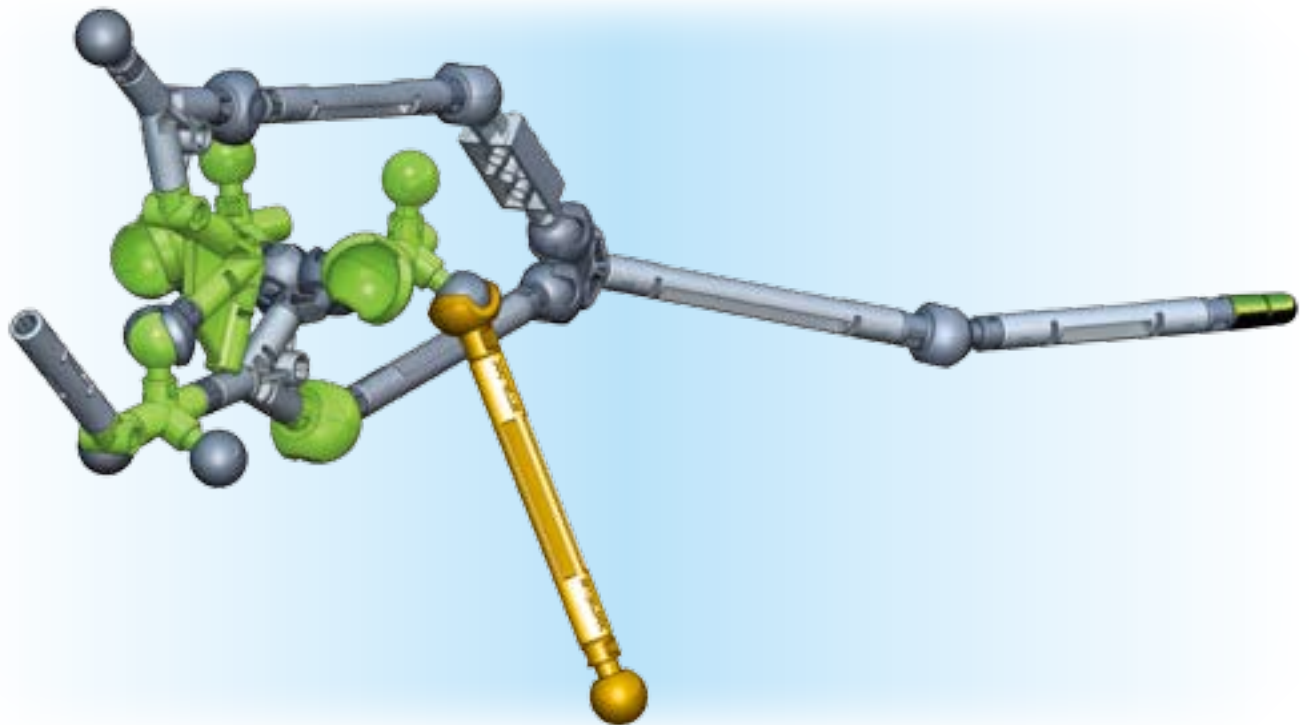
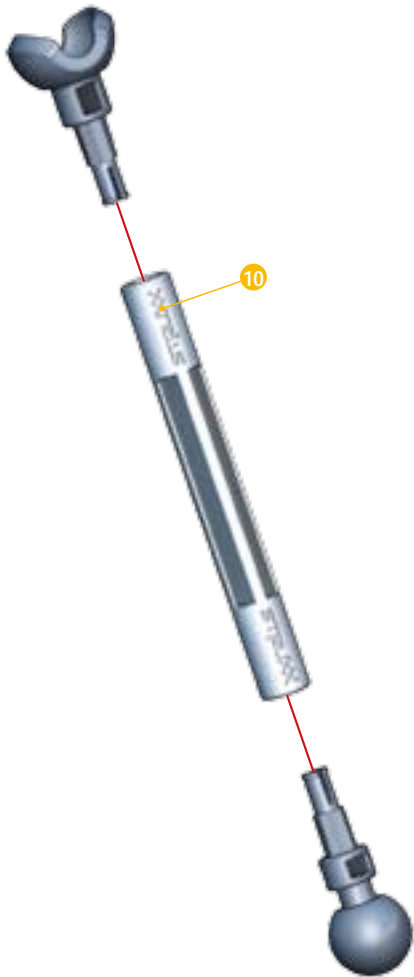

10

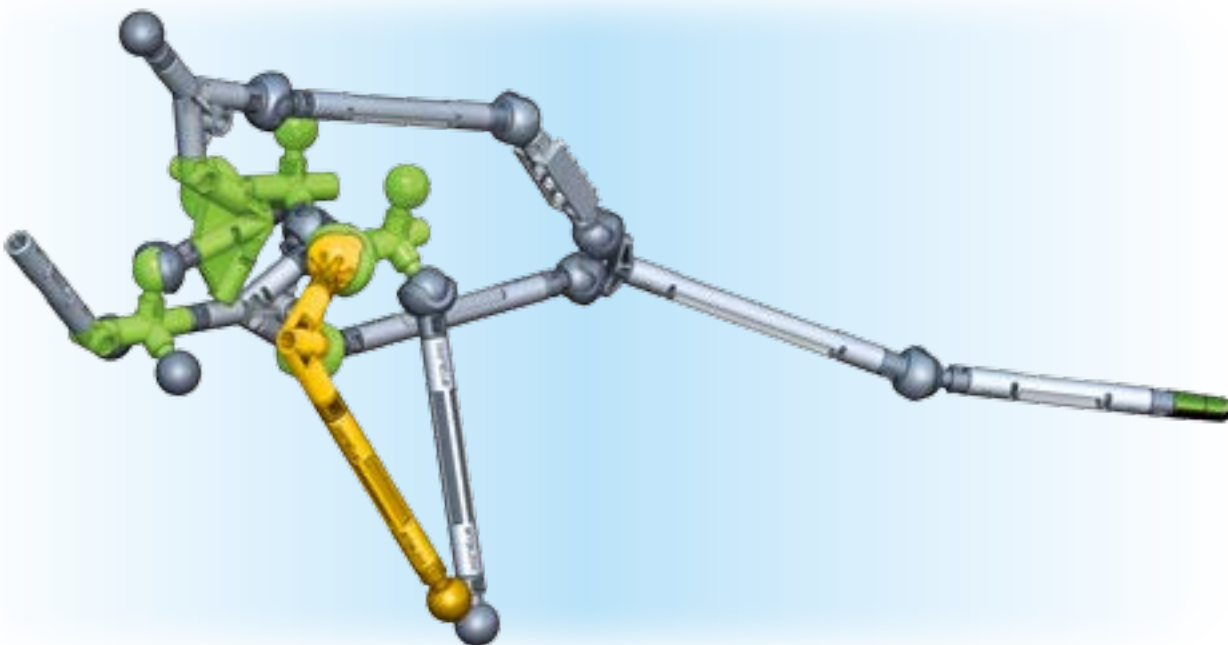
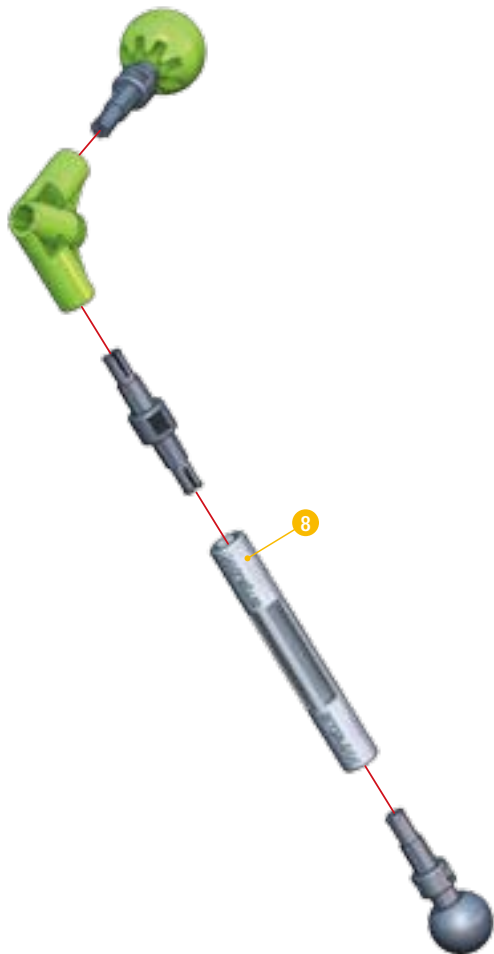

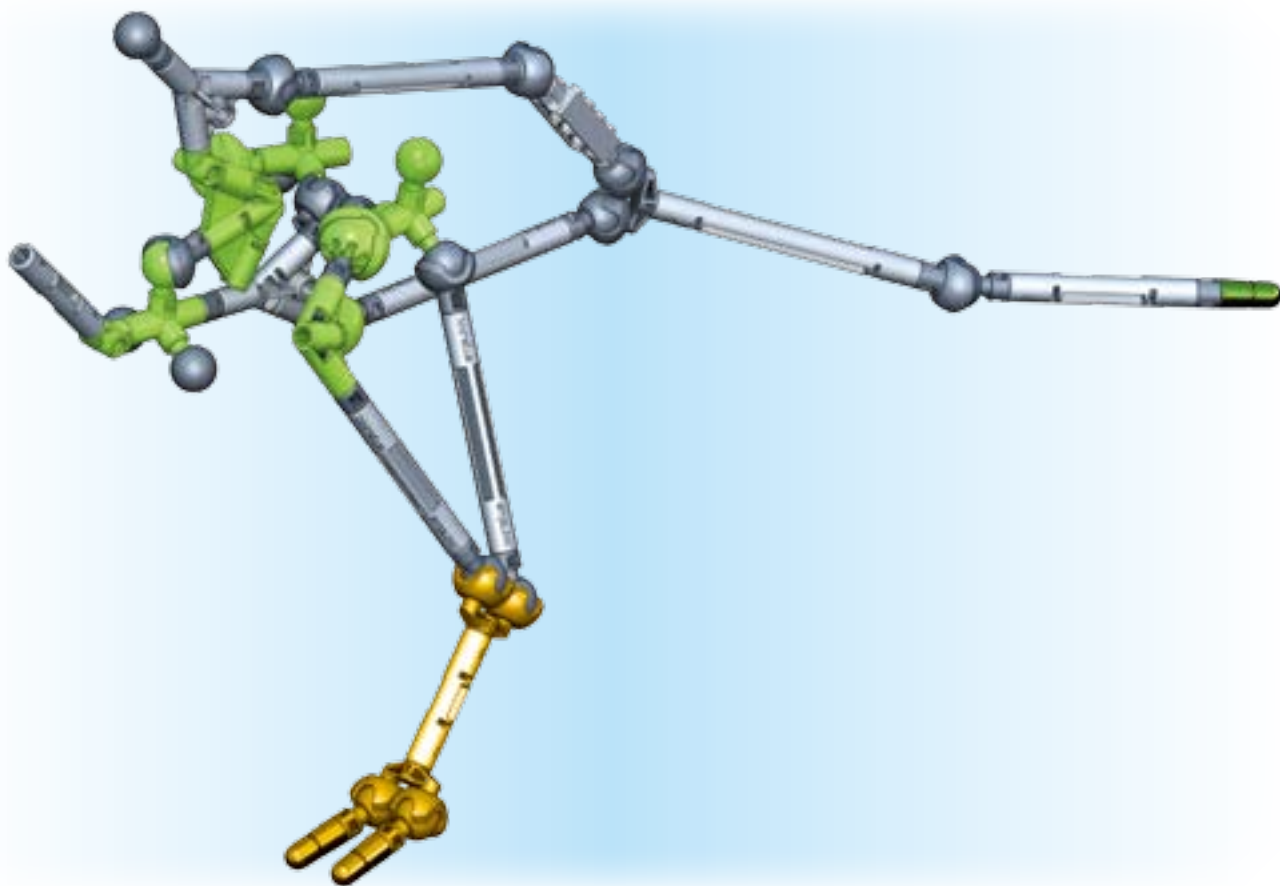
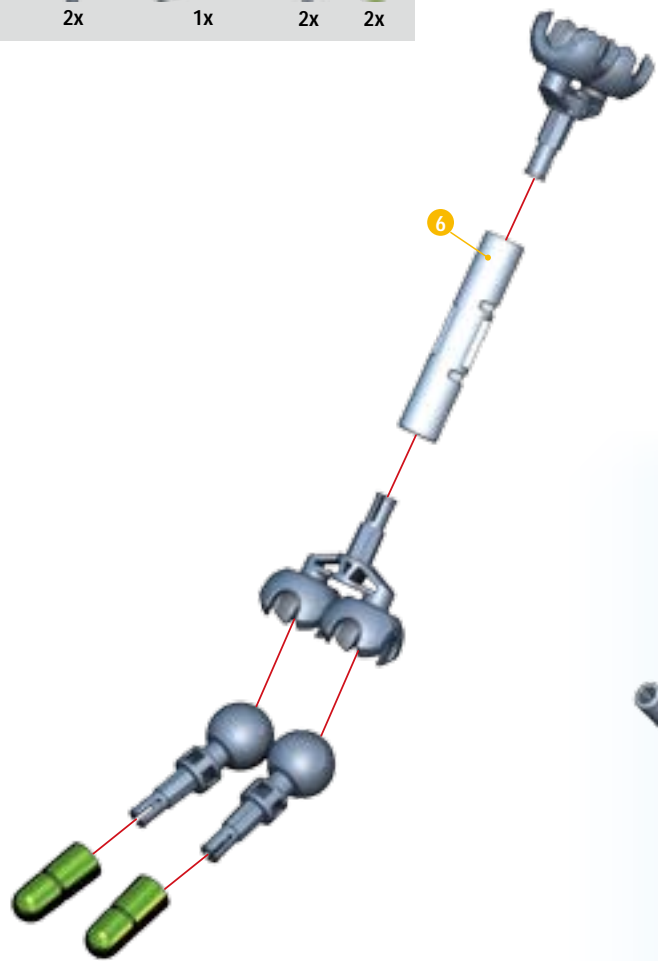
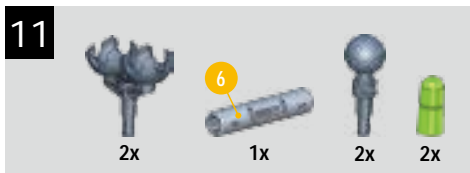

12

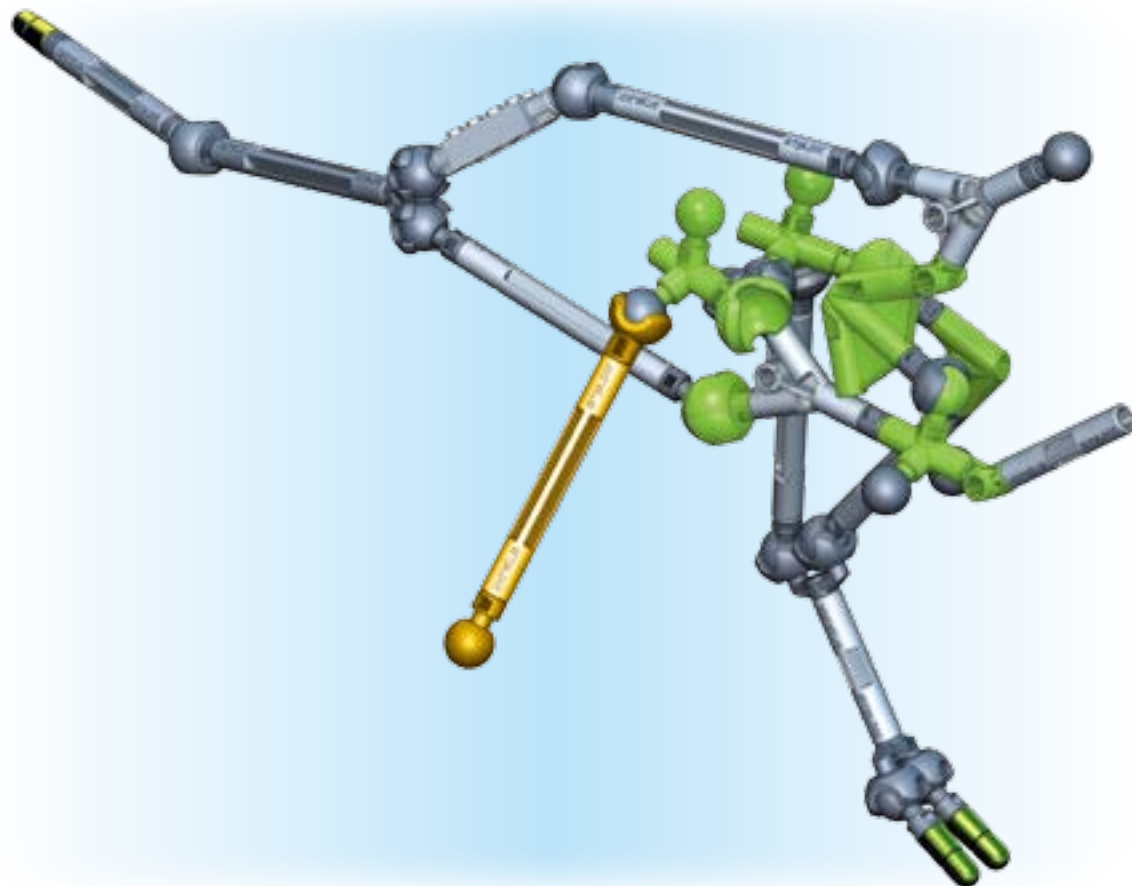
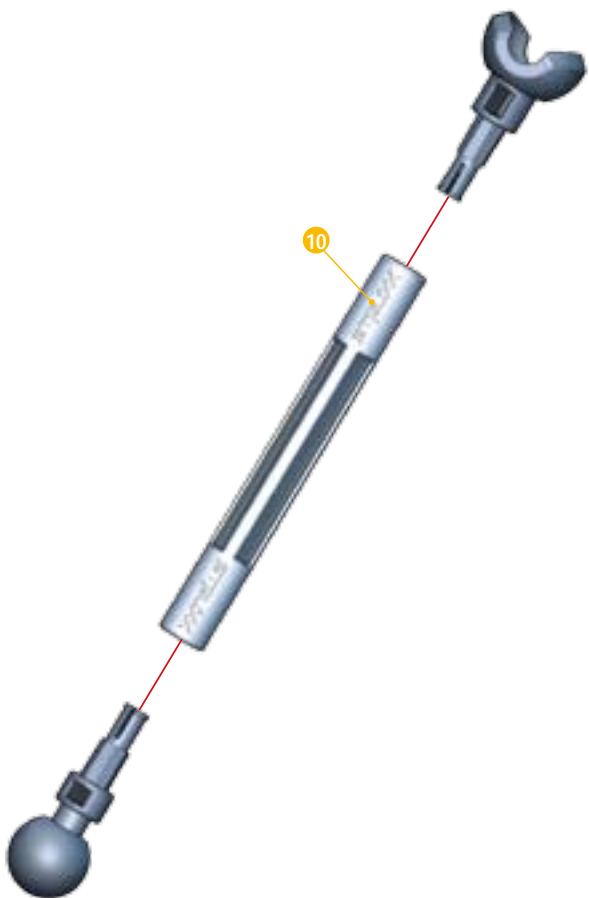
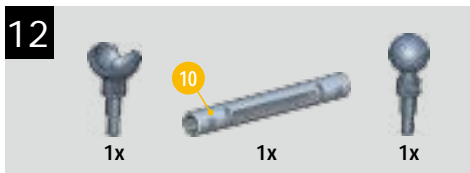

13

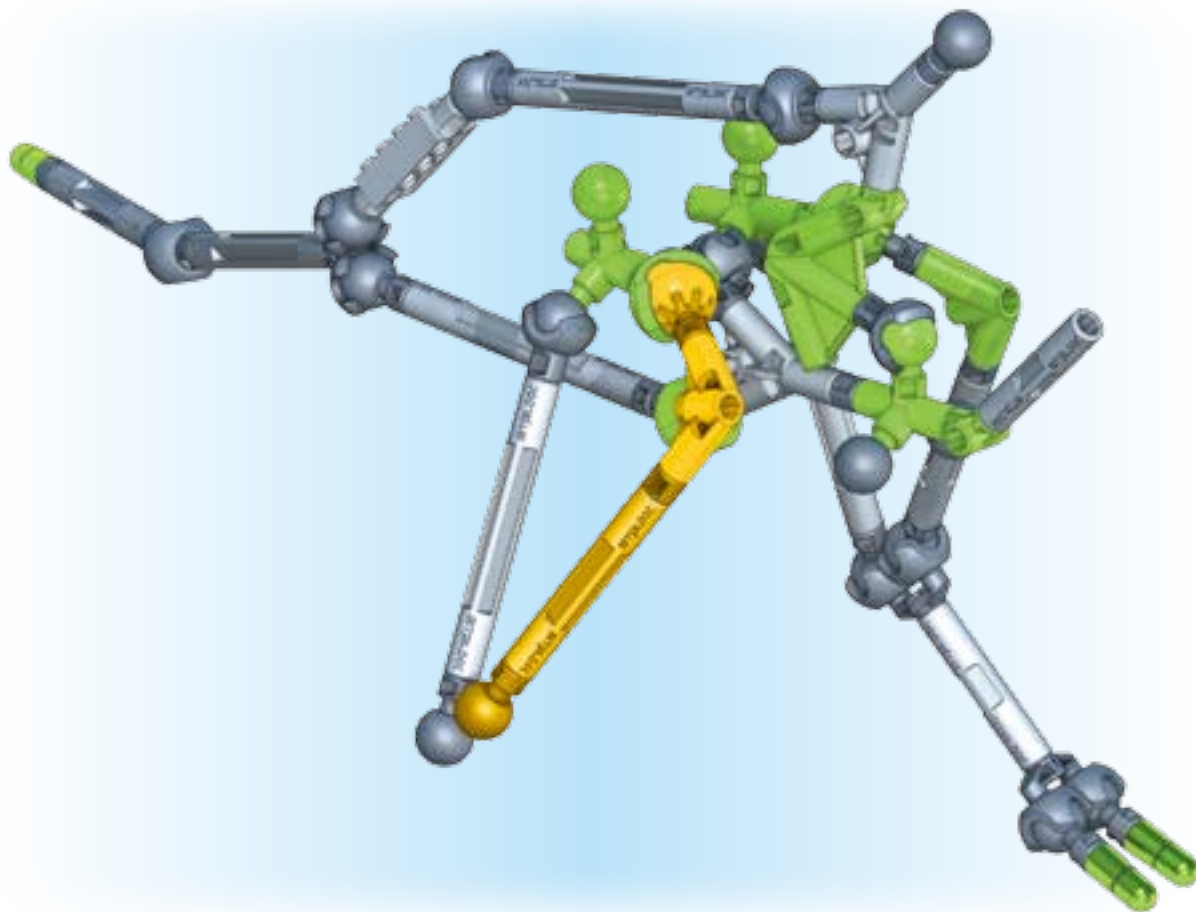

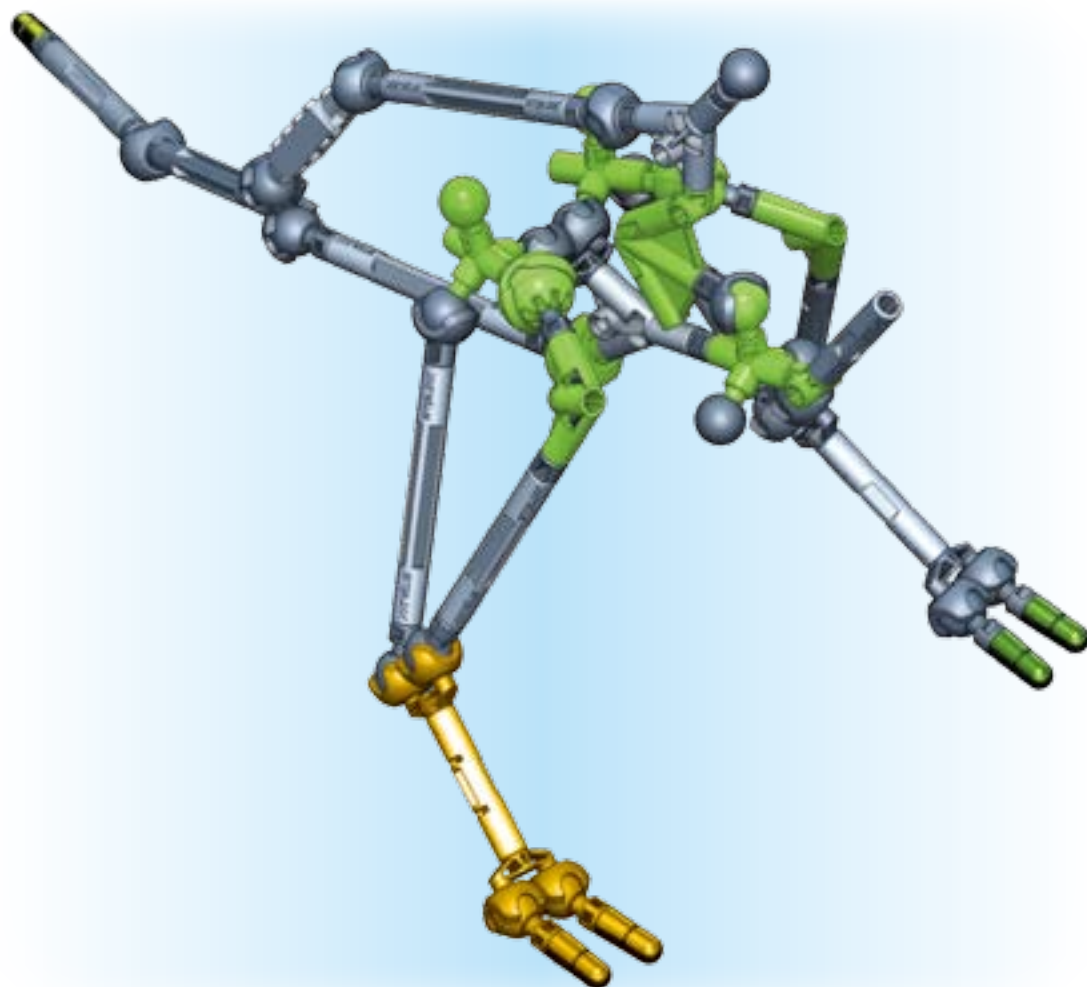
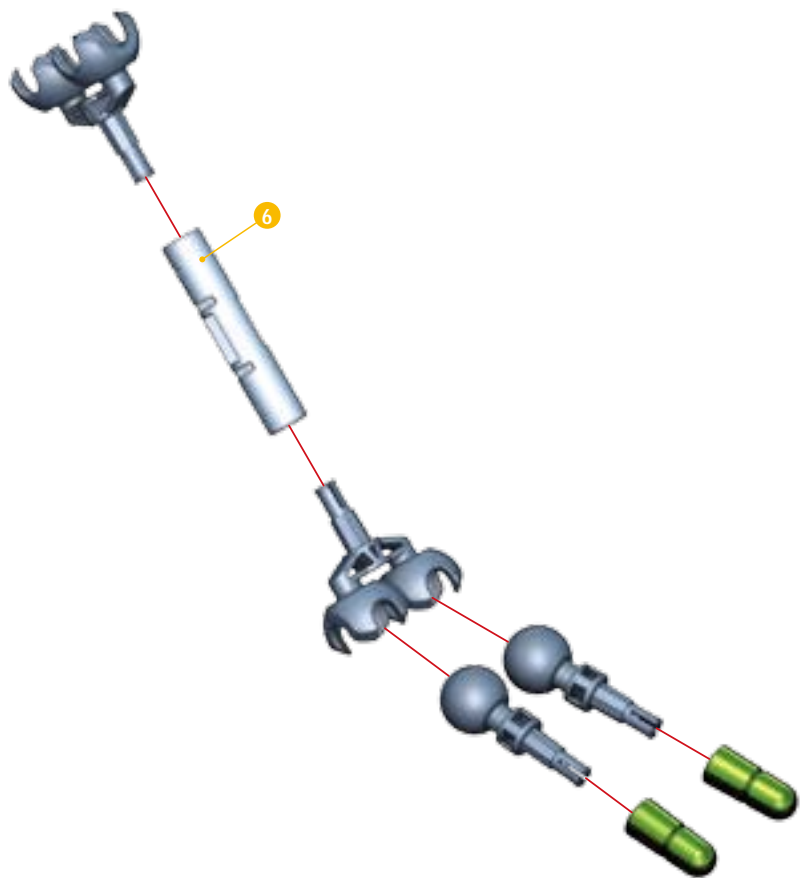
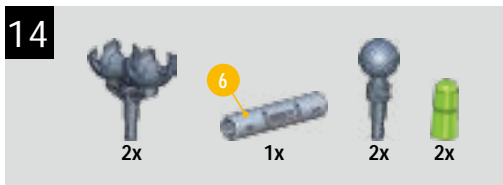

15

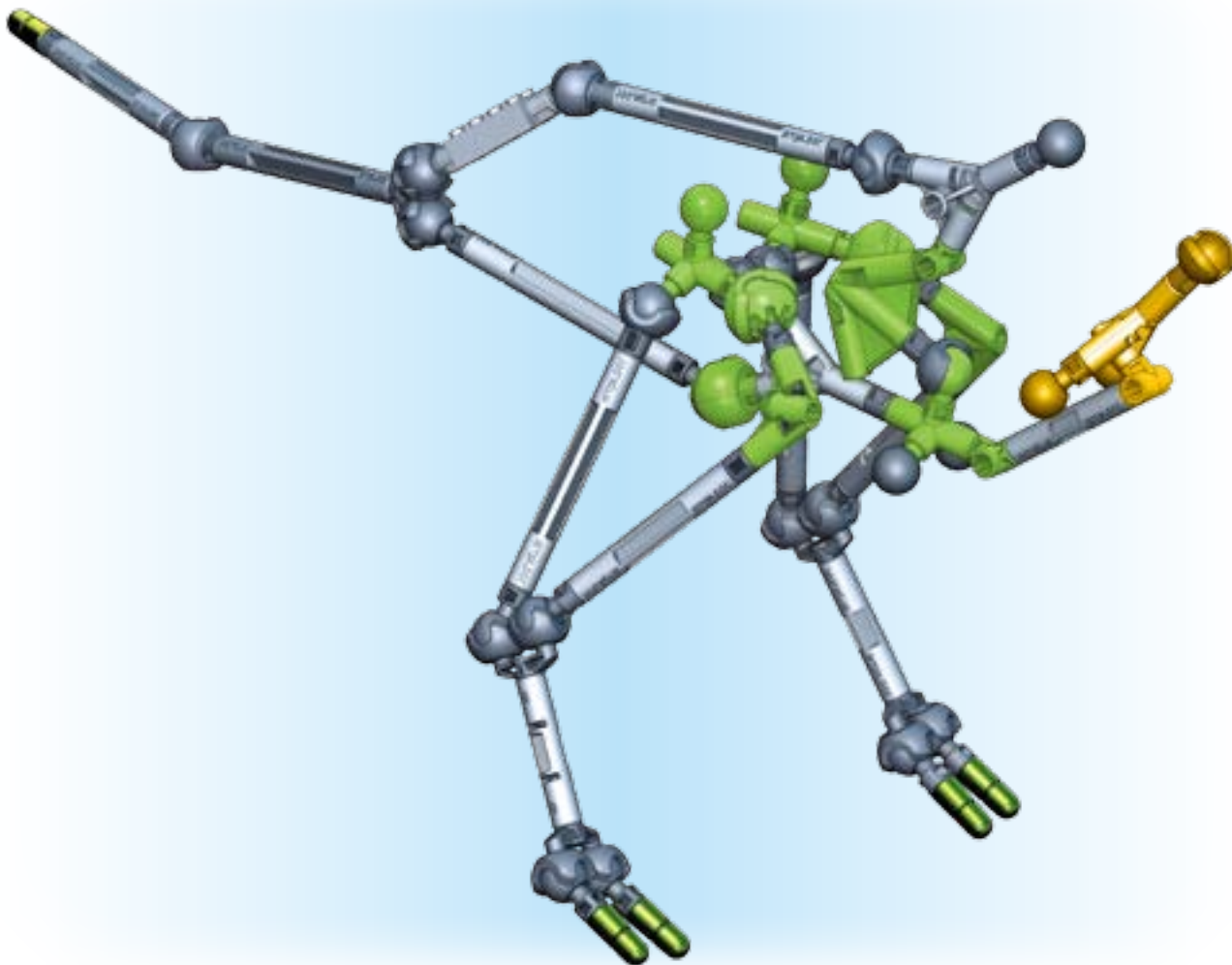
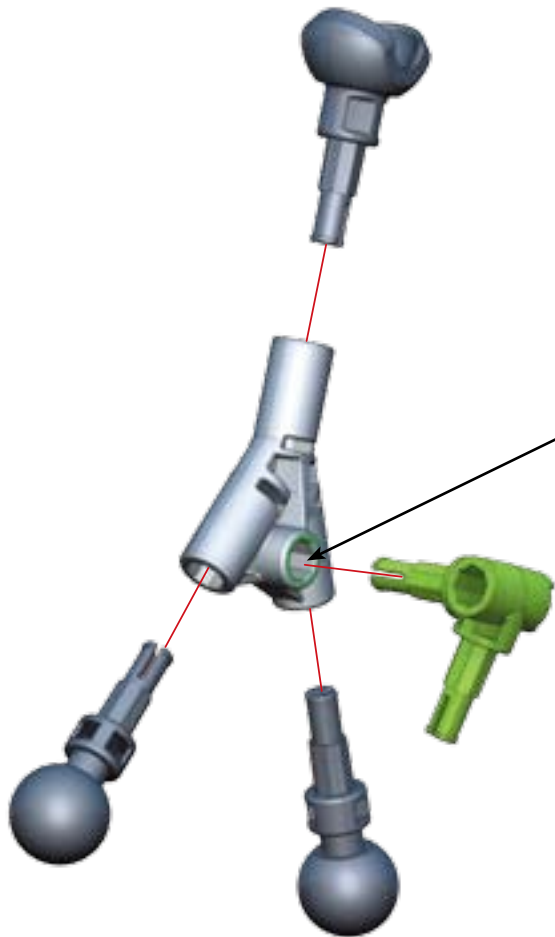

16

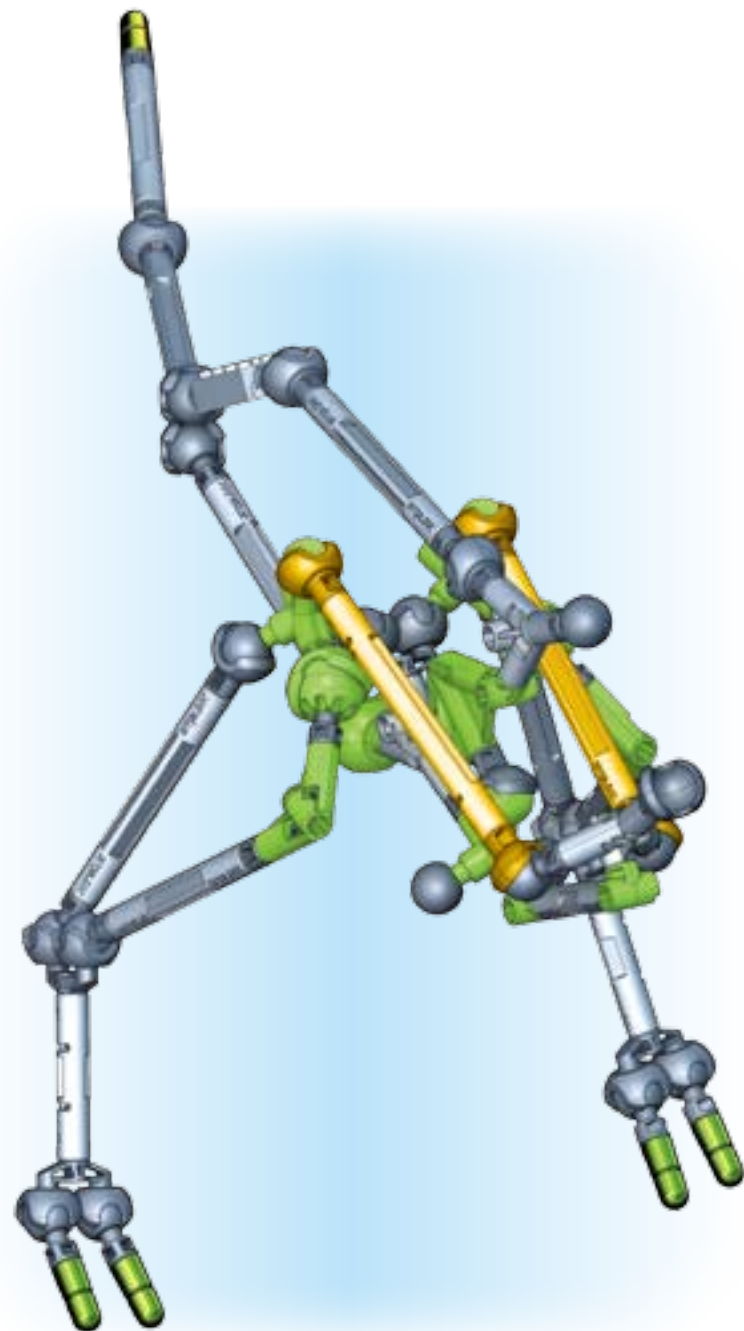
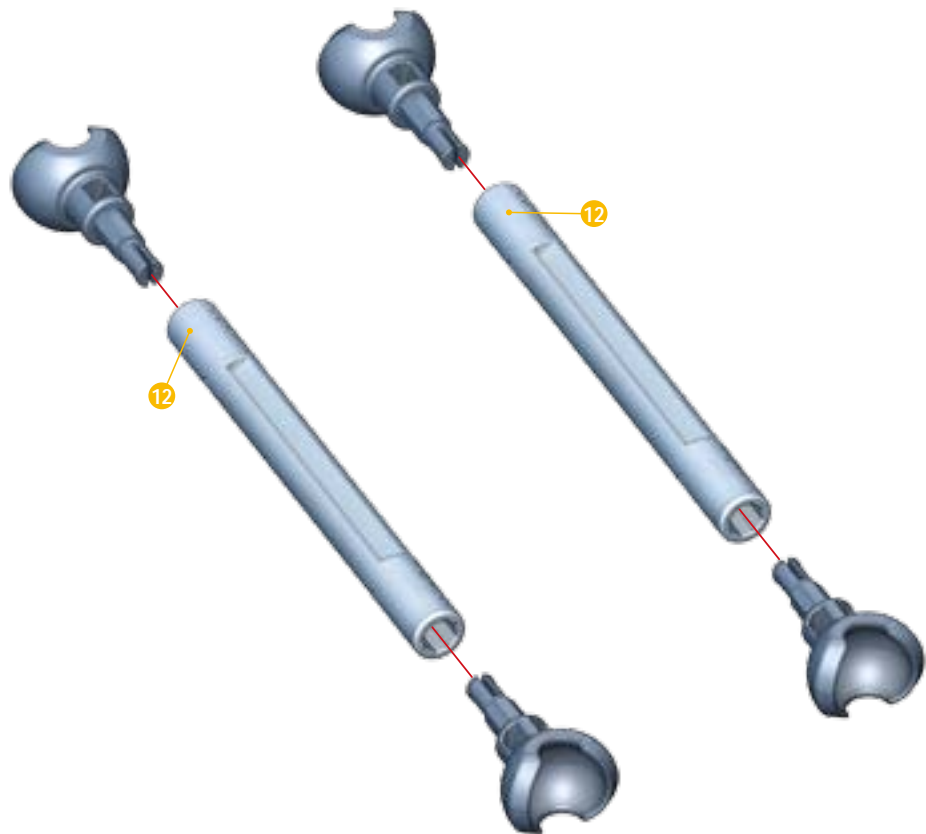
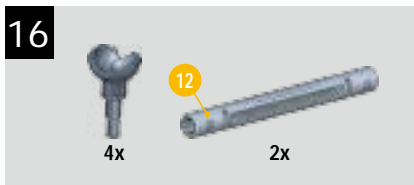

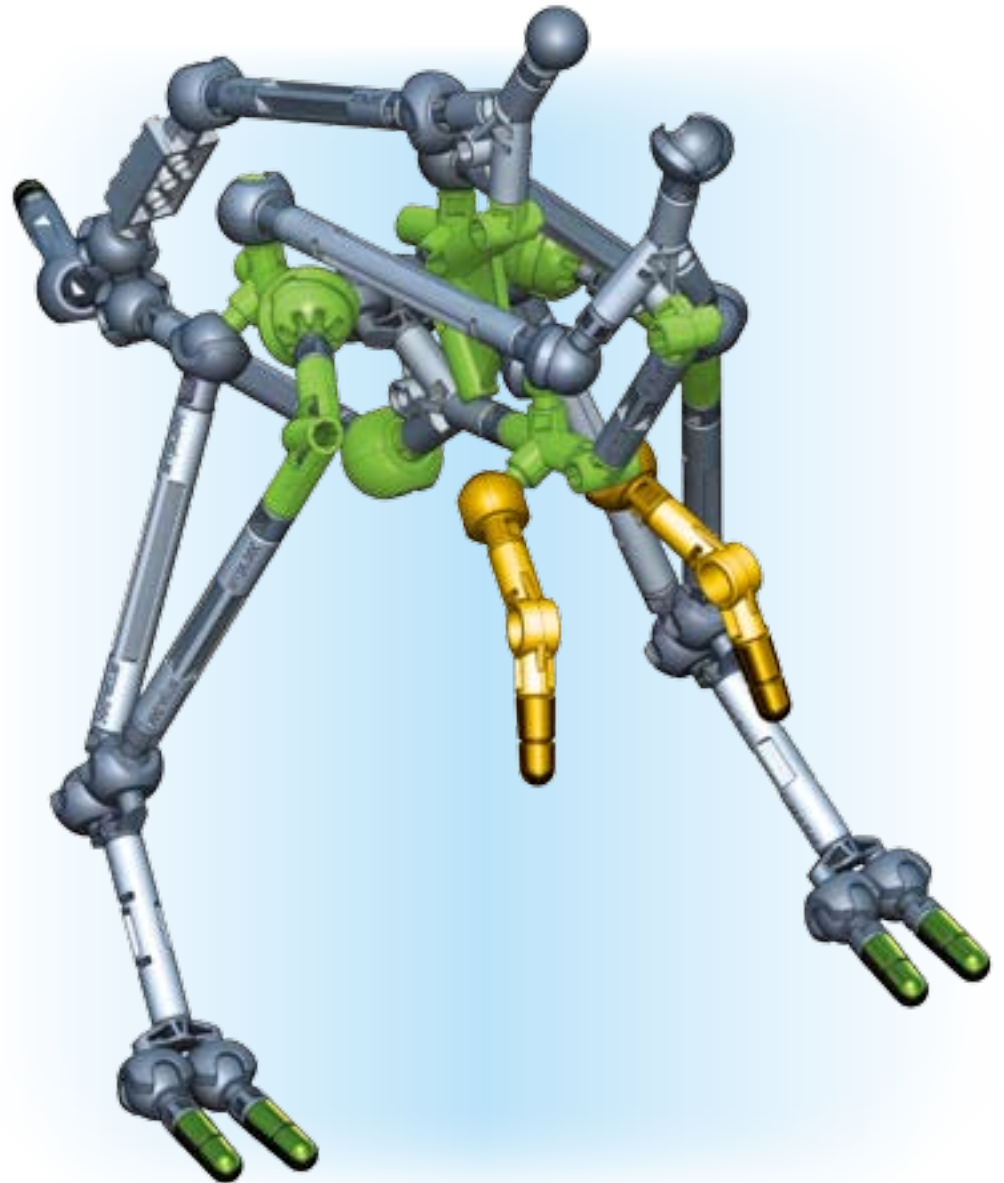
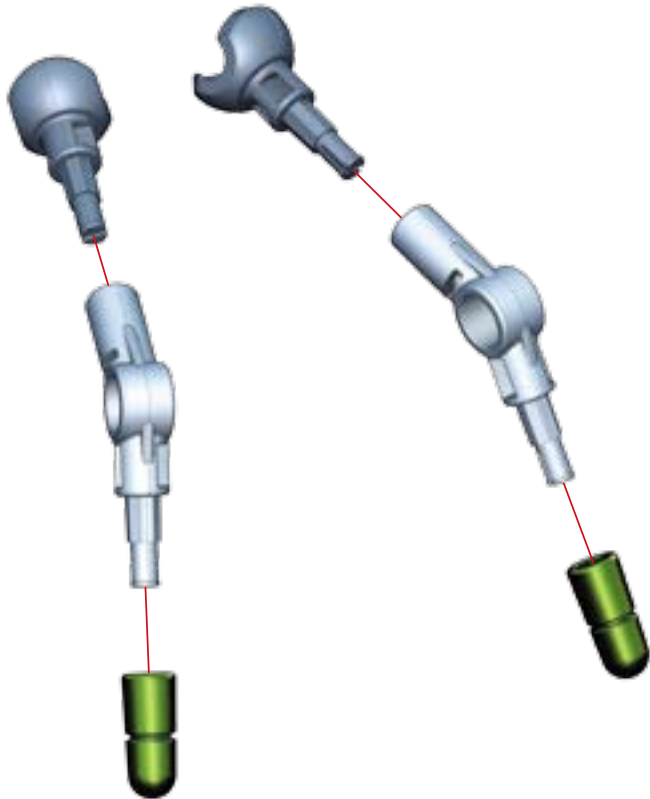



1x



1x



1x

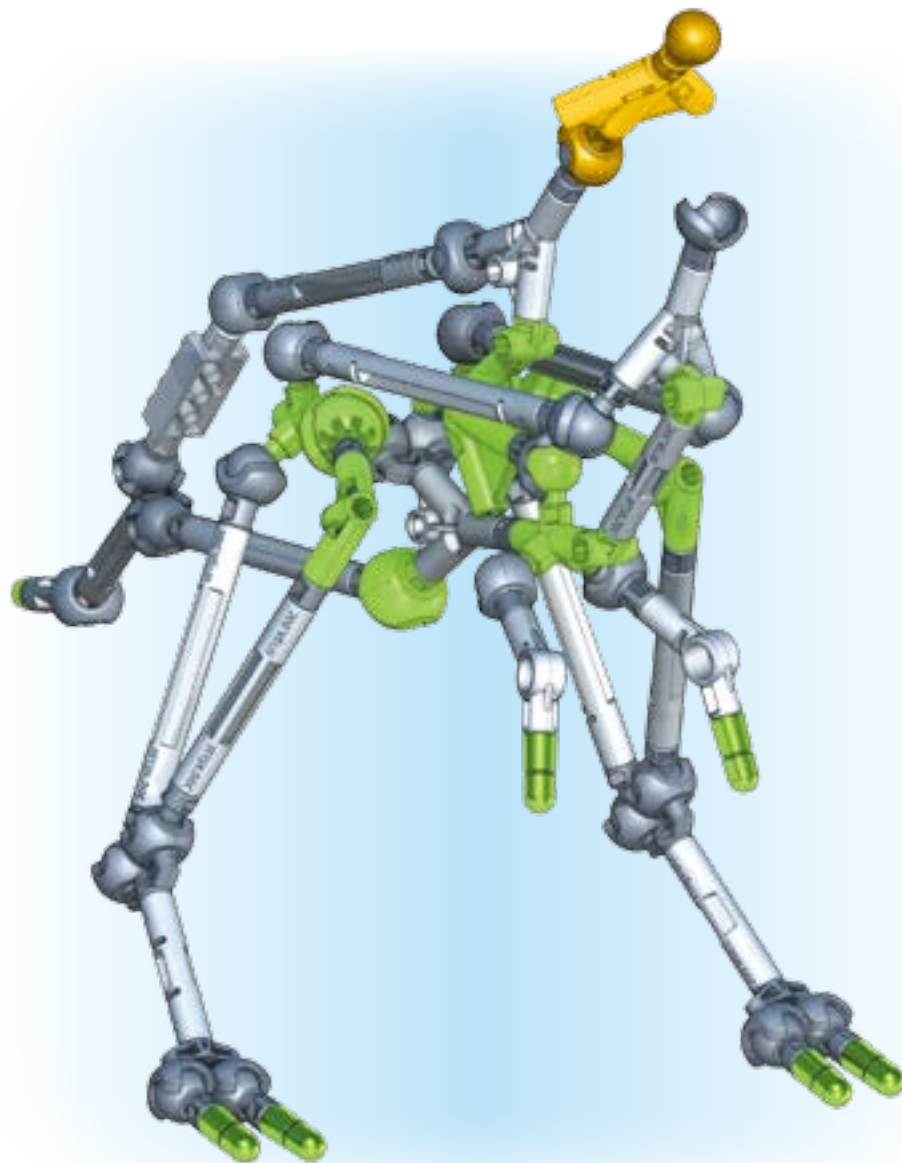

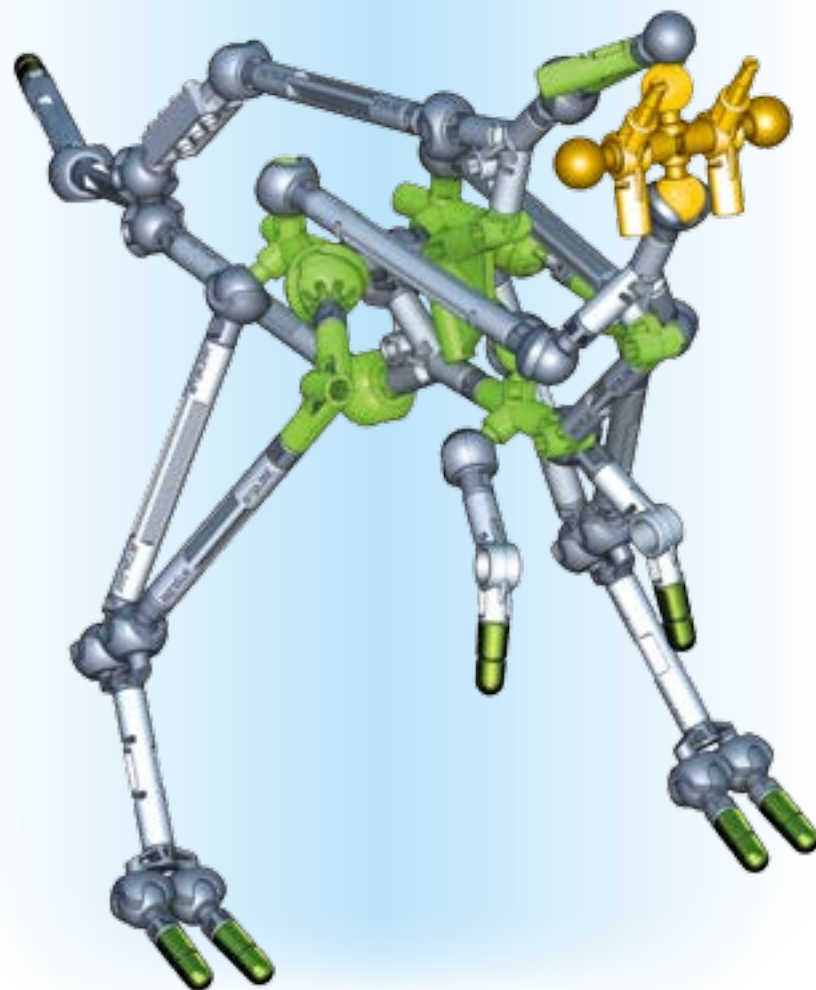
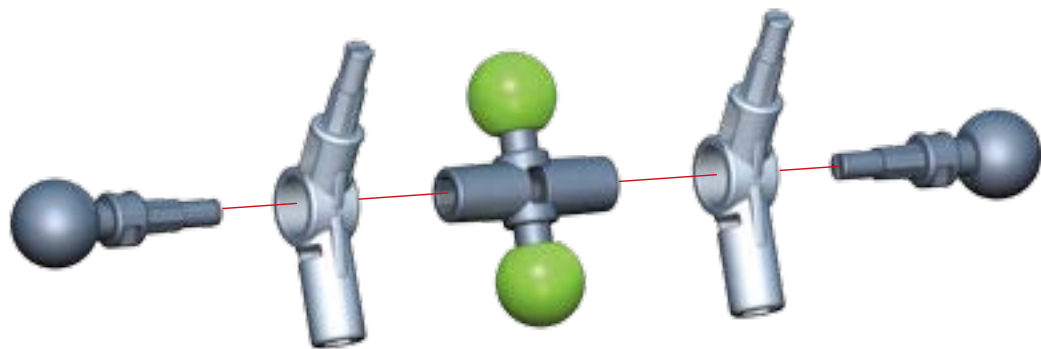

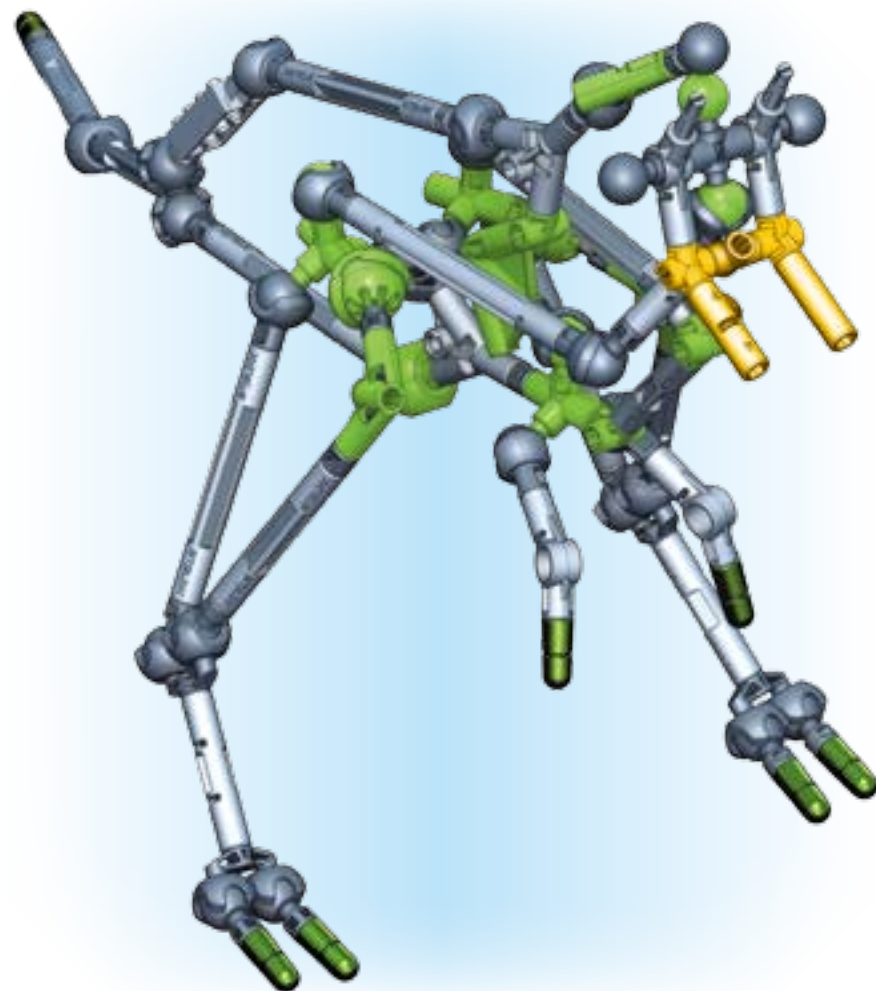
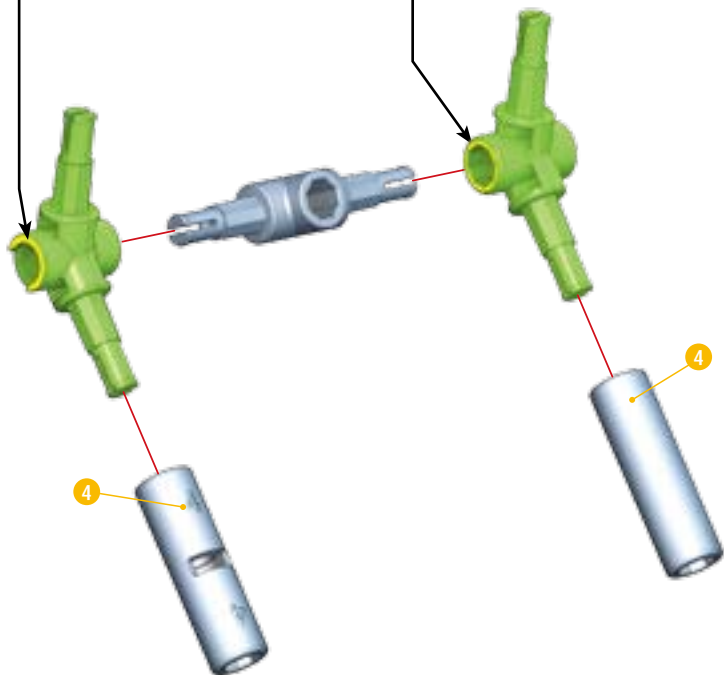
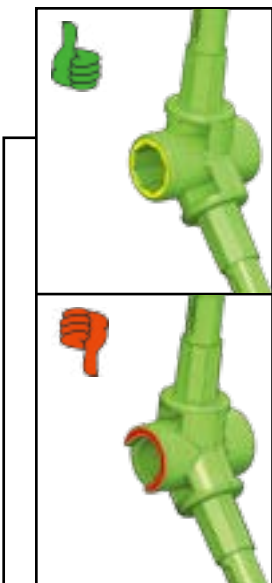
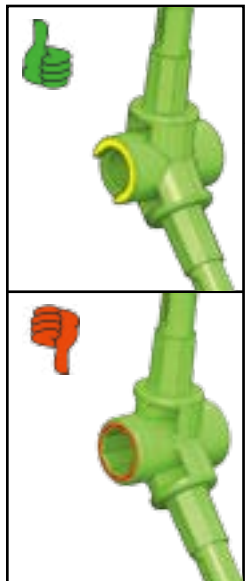
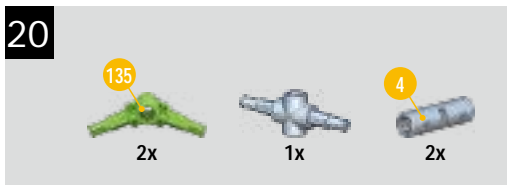

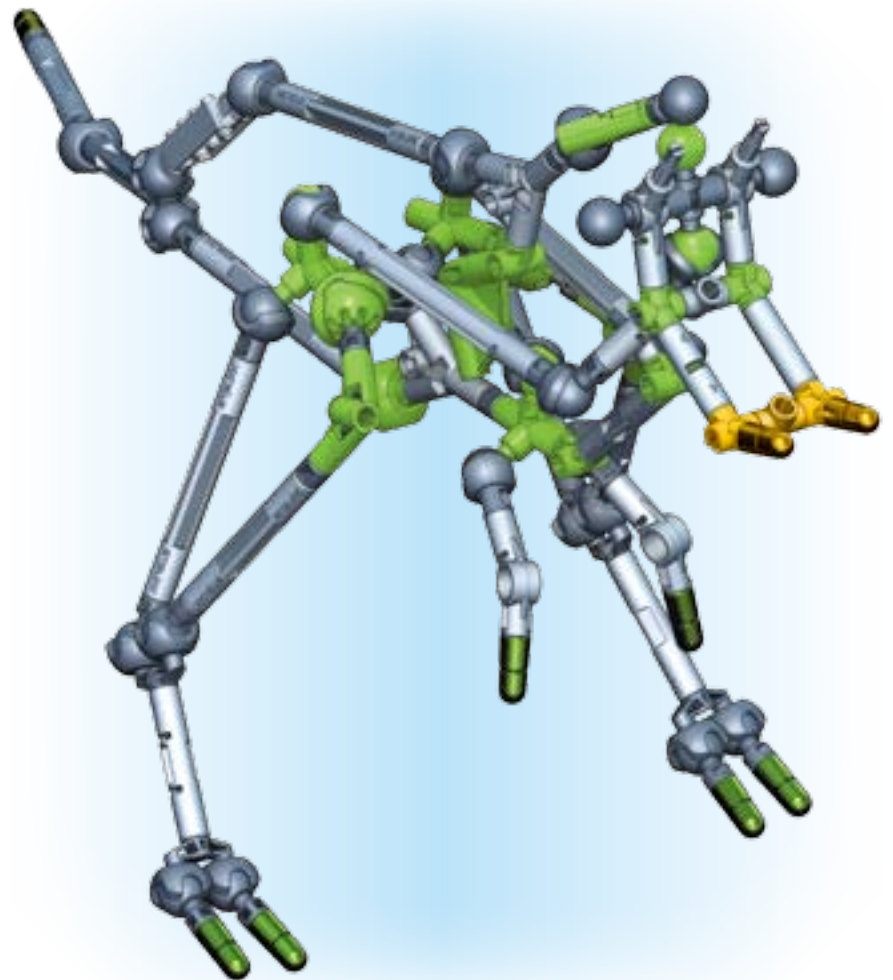
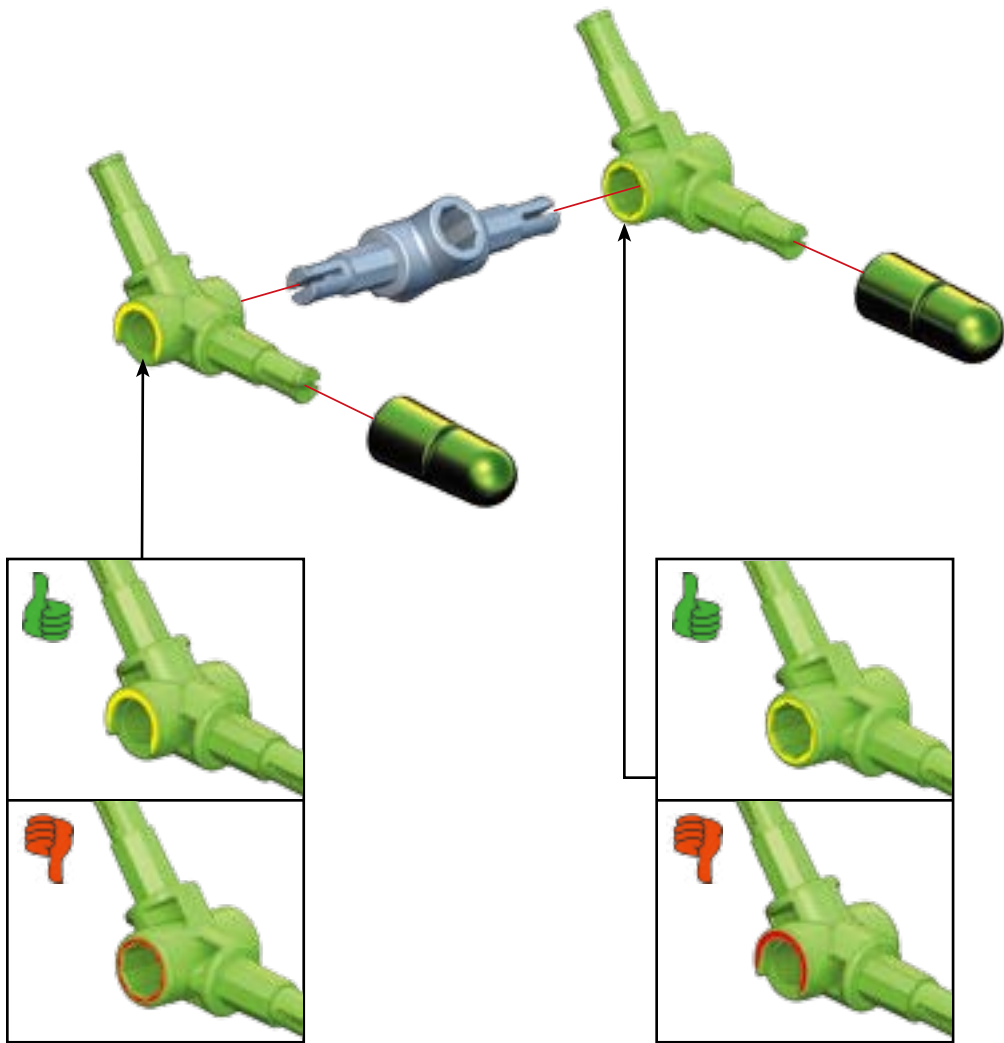

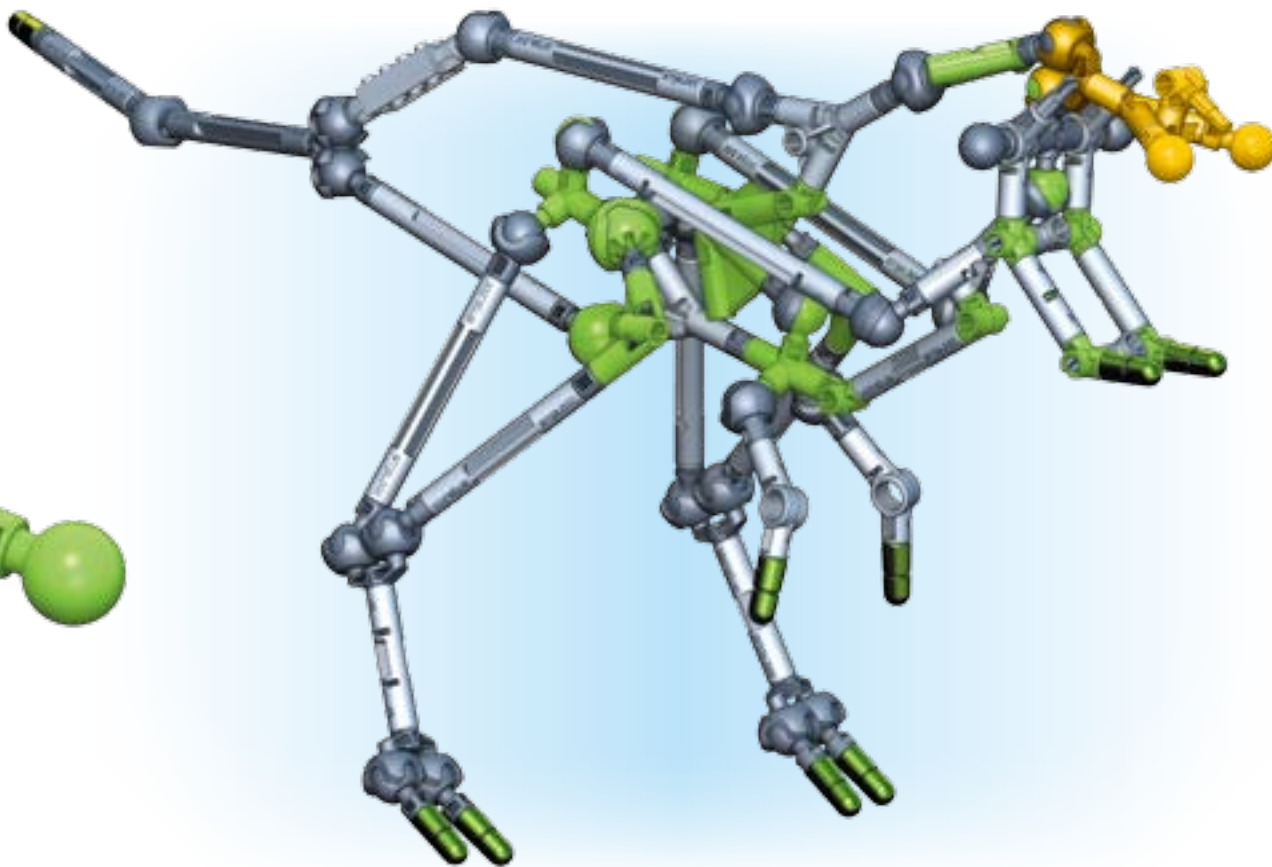
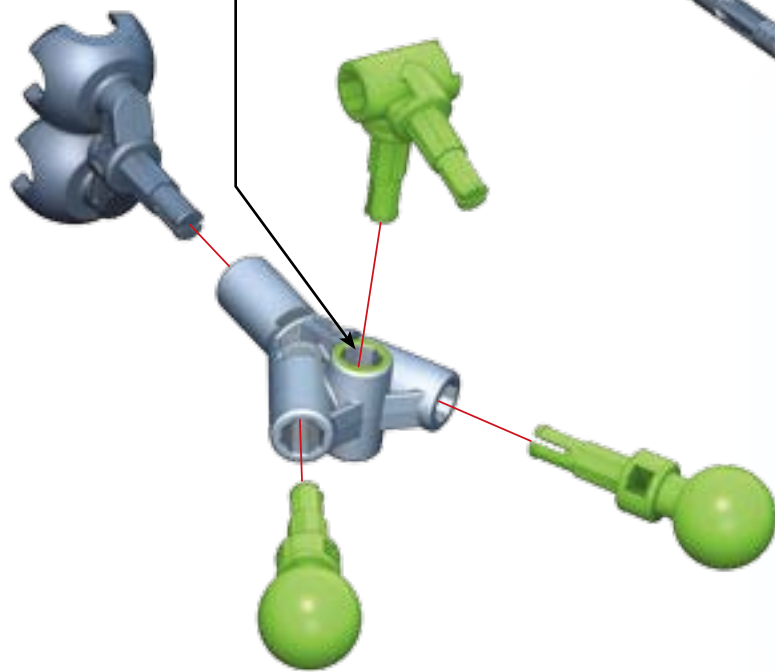

- 4 1x
- 1x
- 1x
- 1x

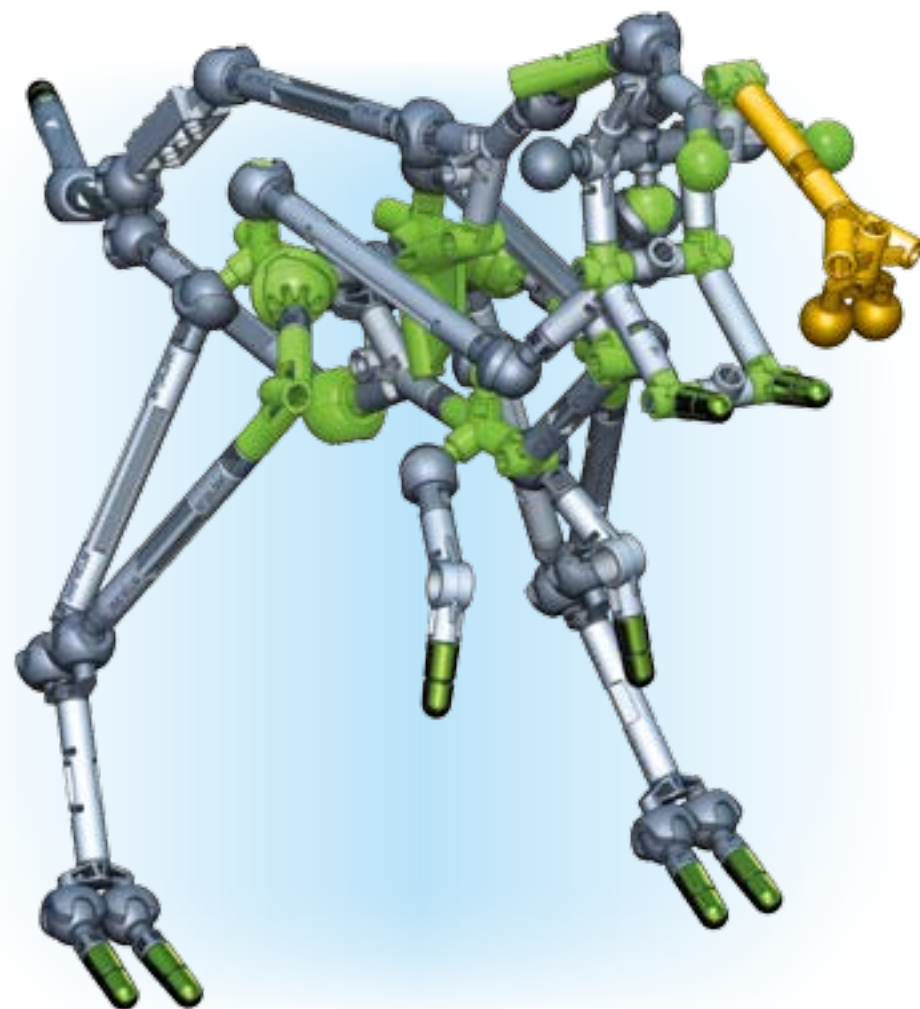
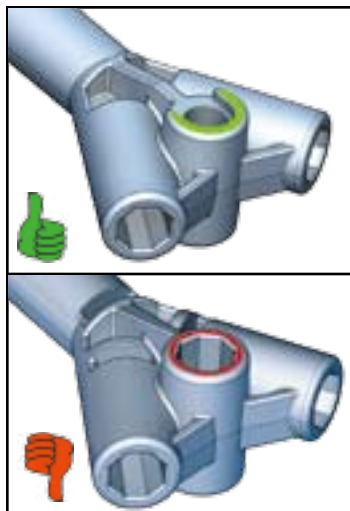
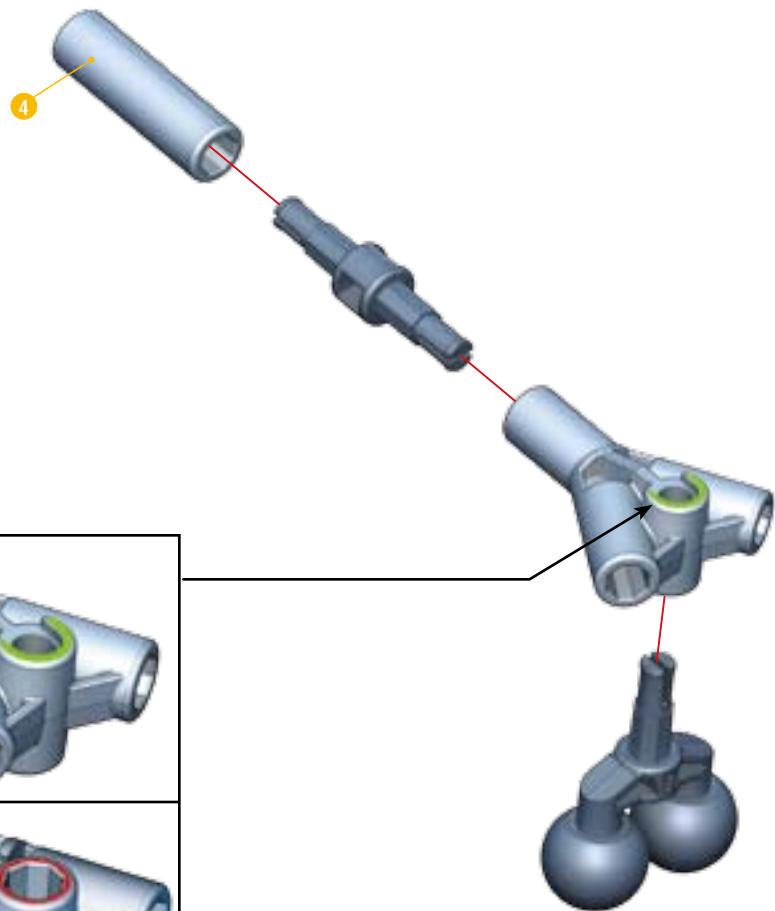

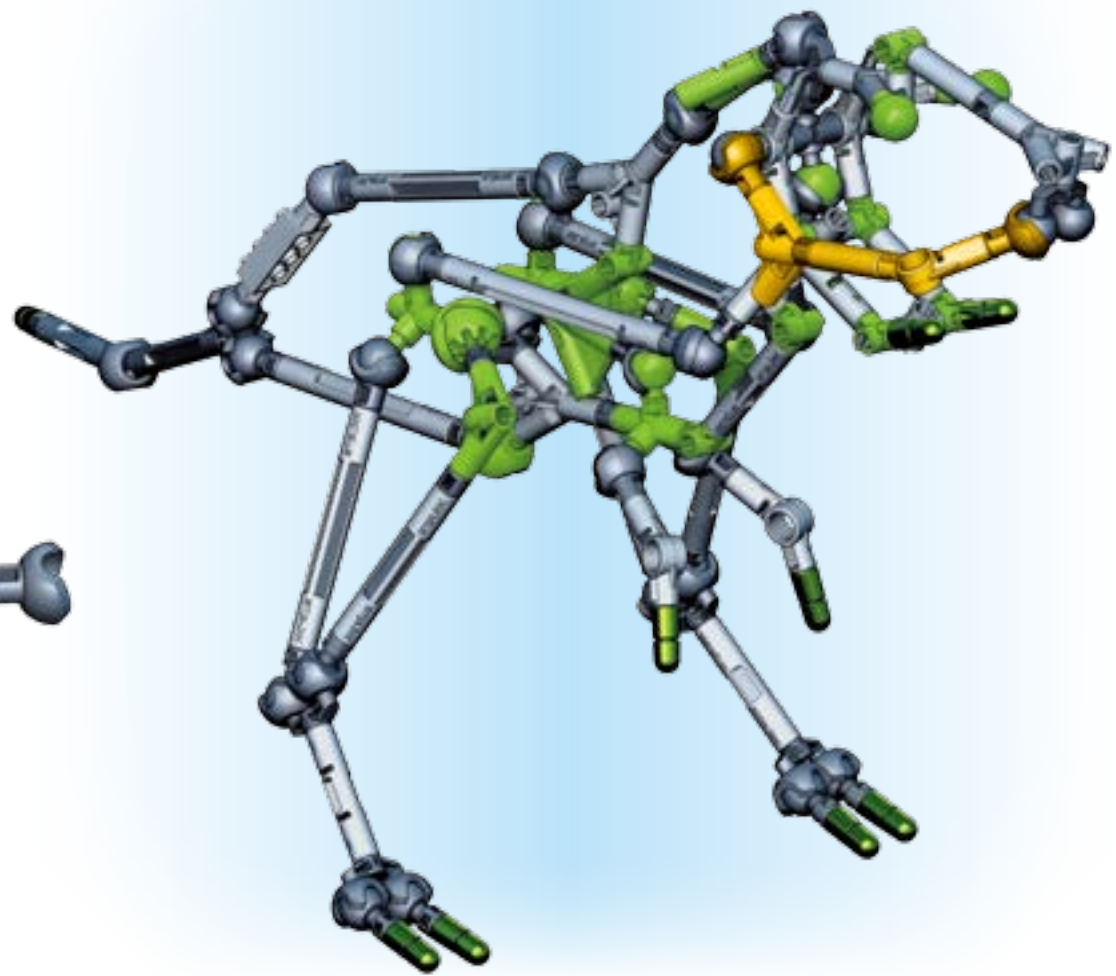
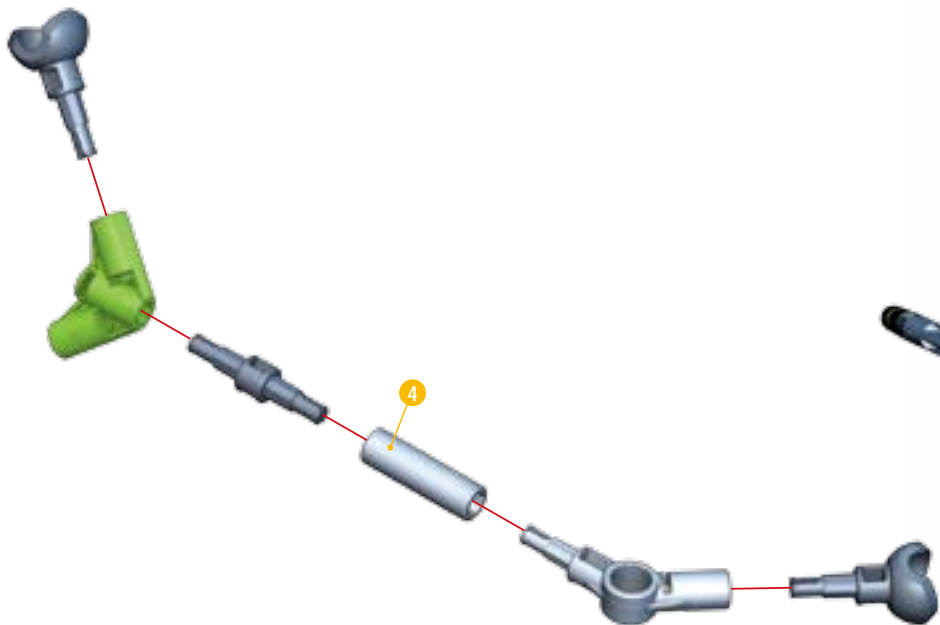

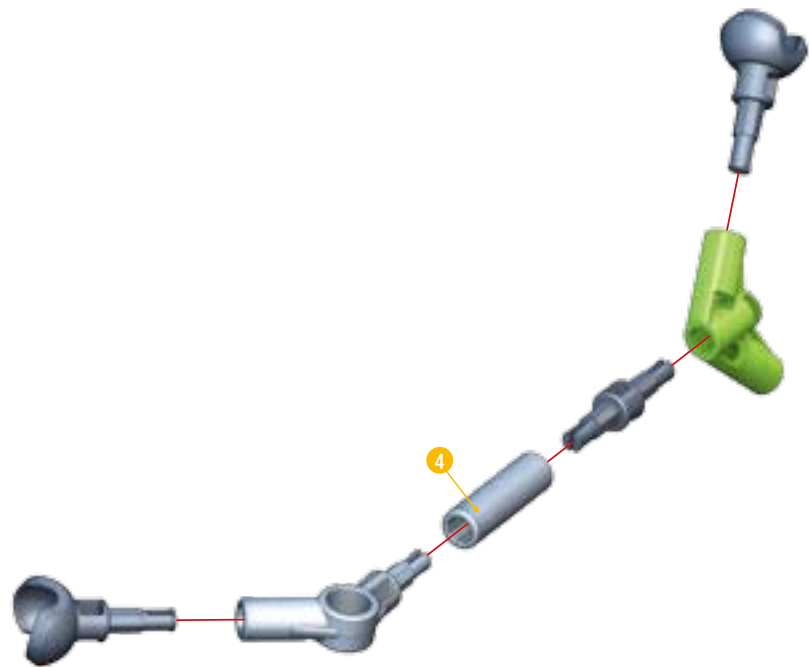
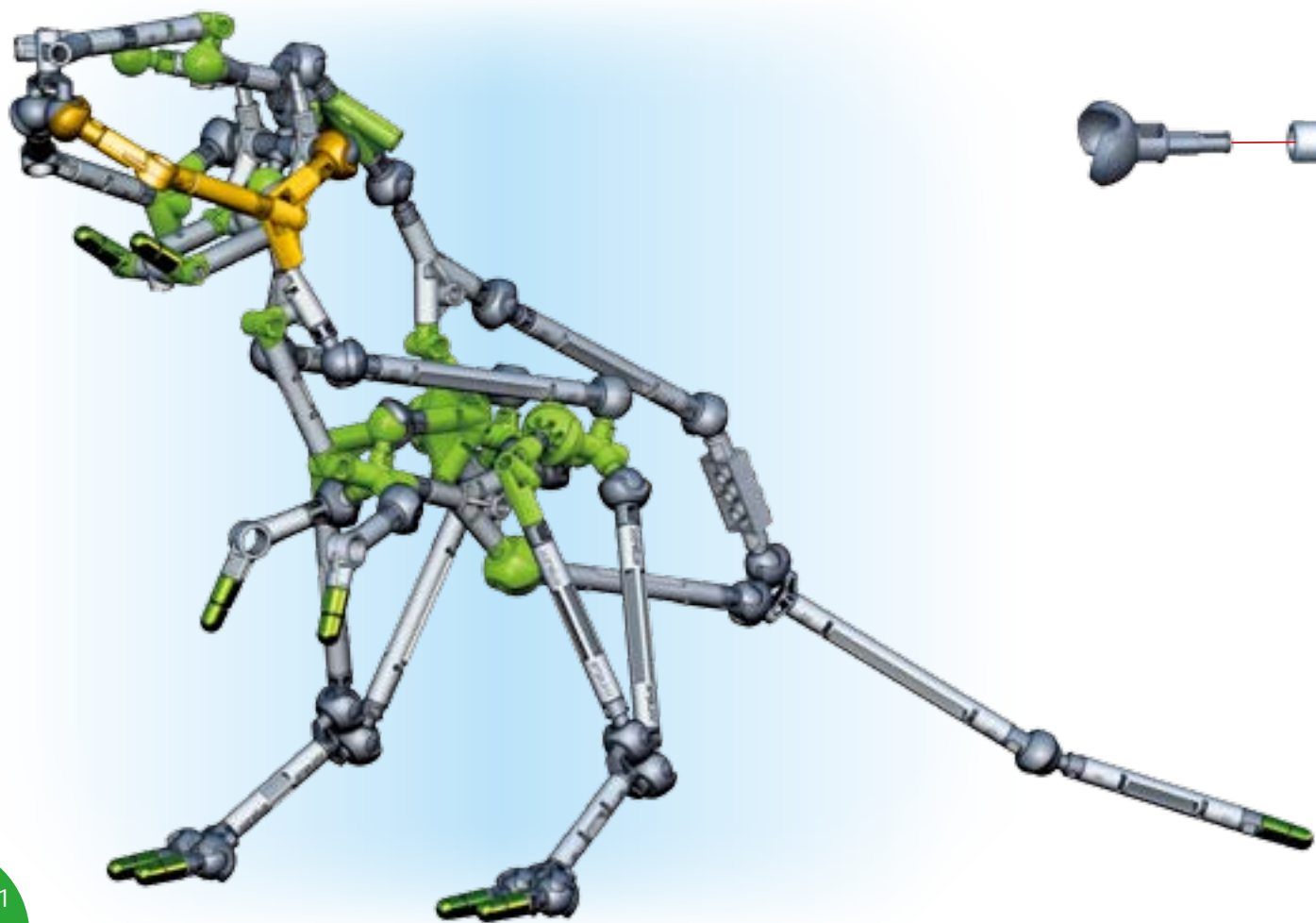

Build / Construir / Construire / Bauen / Bouw / Costruisci / Construir



For illustration purposes only. Product may vary. / Imágenes con fines ilustrativos. El producto puede variar. / Pour des raisons d'illustration seulement. Le produit peut être différent. / Nur zur Veranschaulichung. Produkt kann anders aussehen. / Alleen bedoeld voor illustratie. Producten kunnen variëren. / Le immagini sono solo a scopo illustrativo. Il prodotto può variare. / Unicamente para fins de ilustração. O produto pode variar.

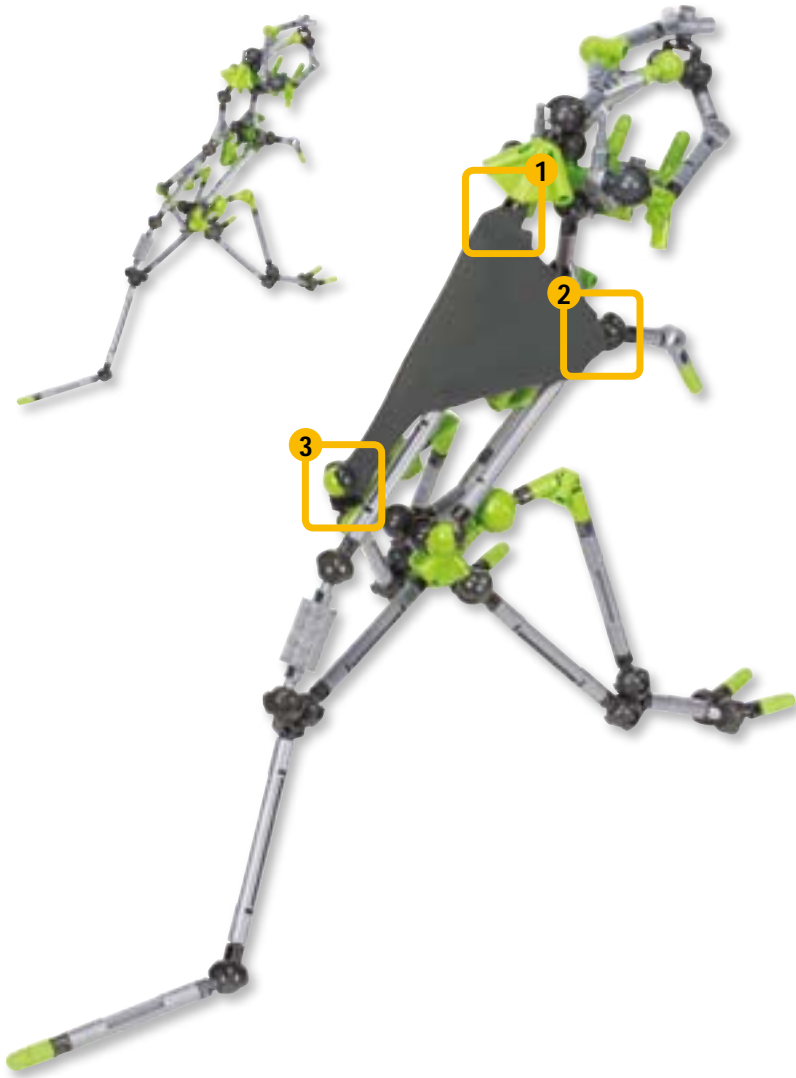
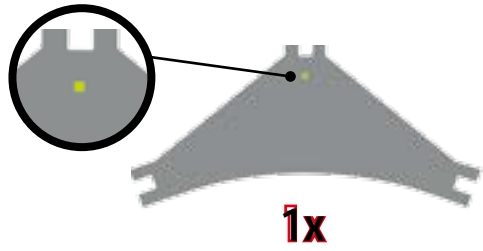

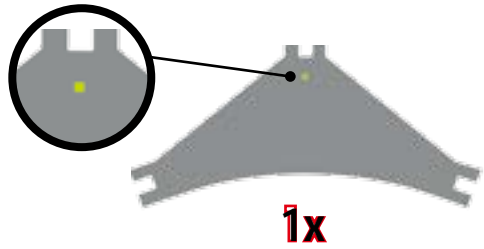

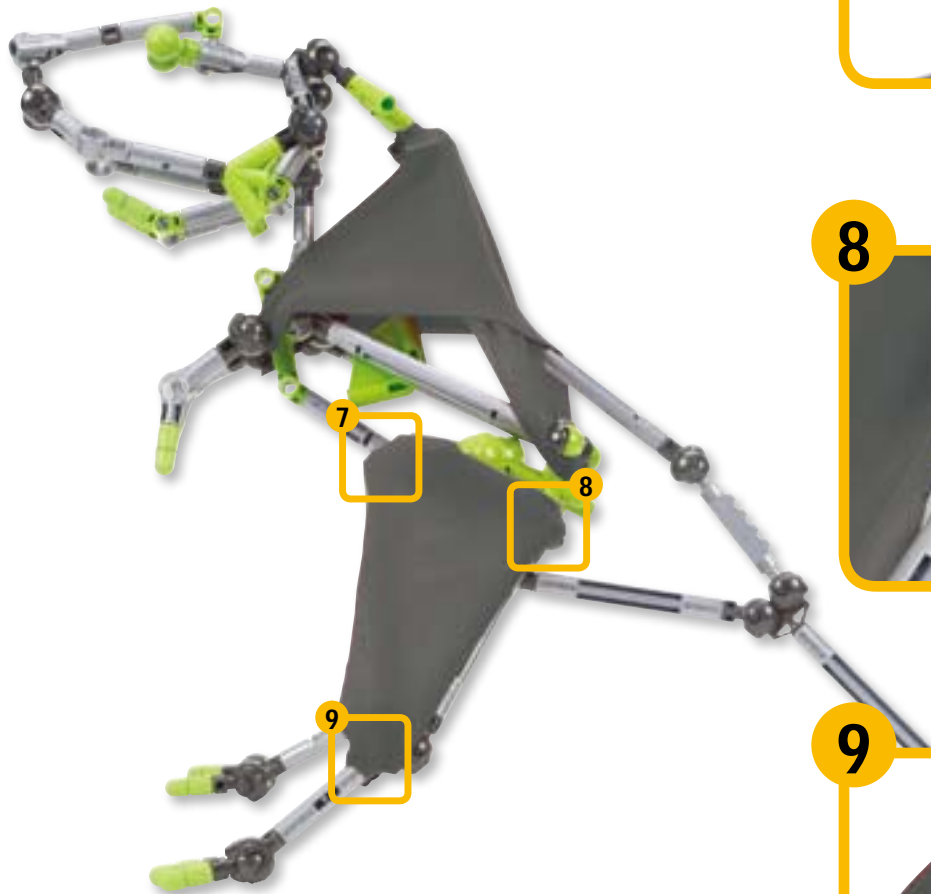
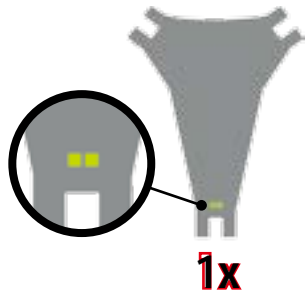

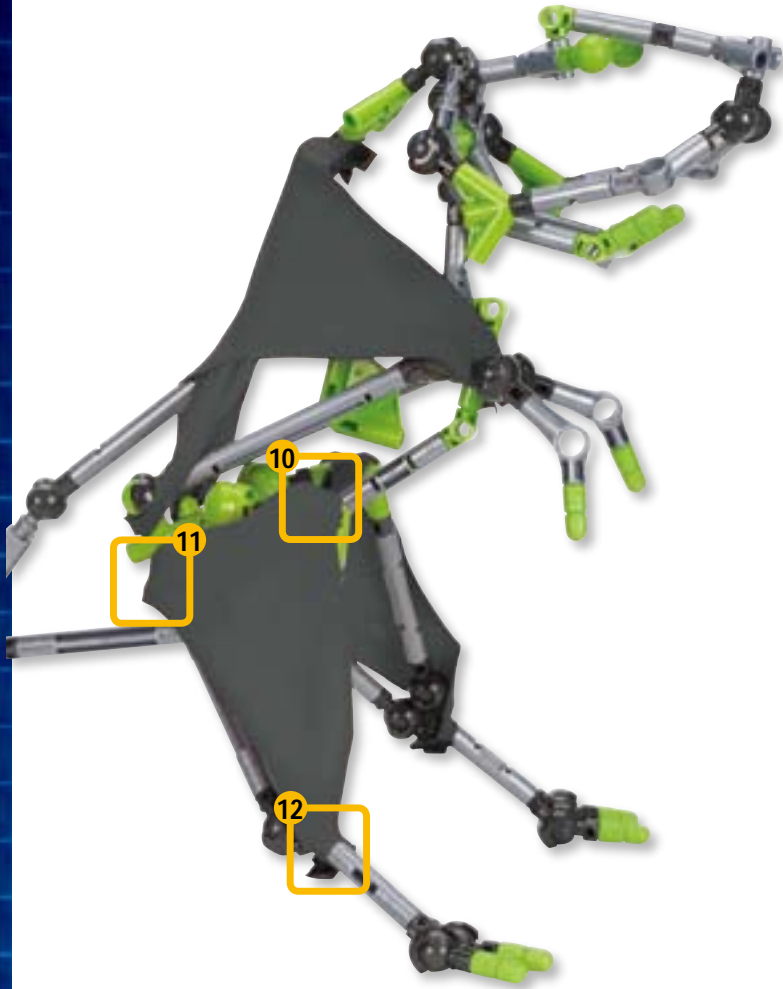
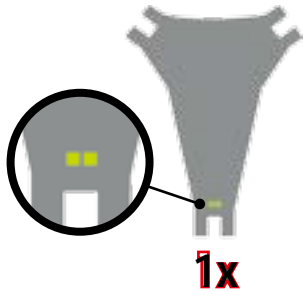

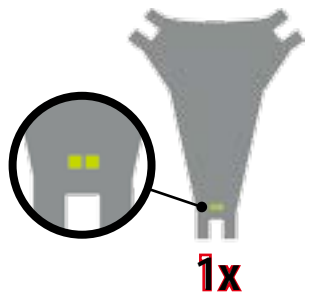

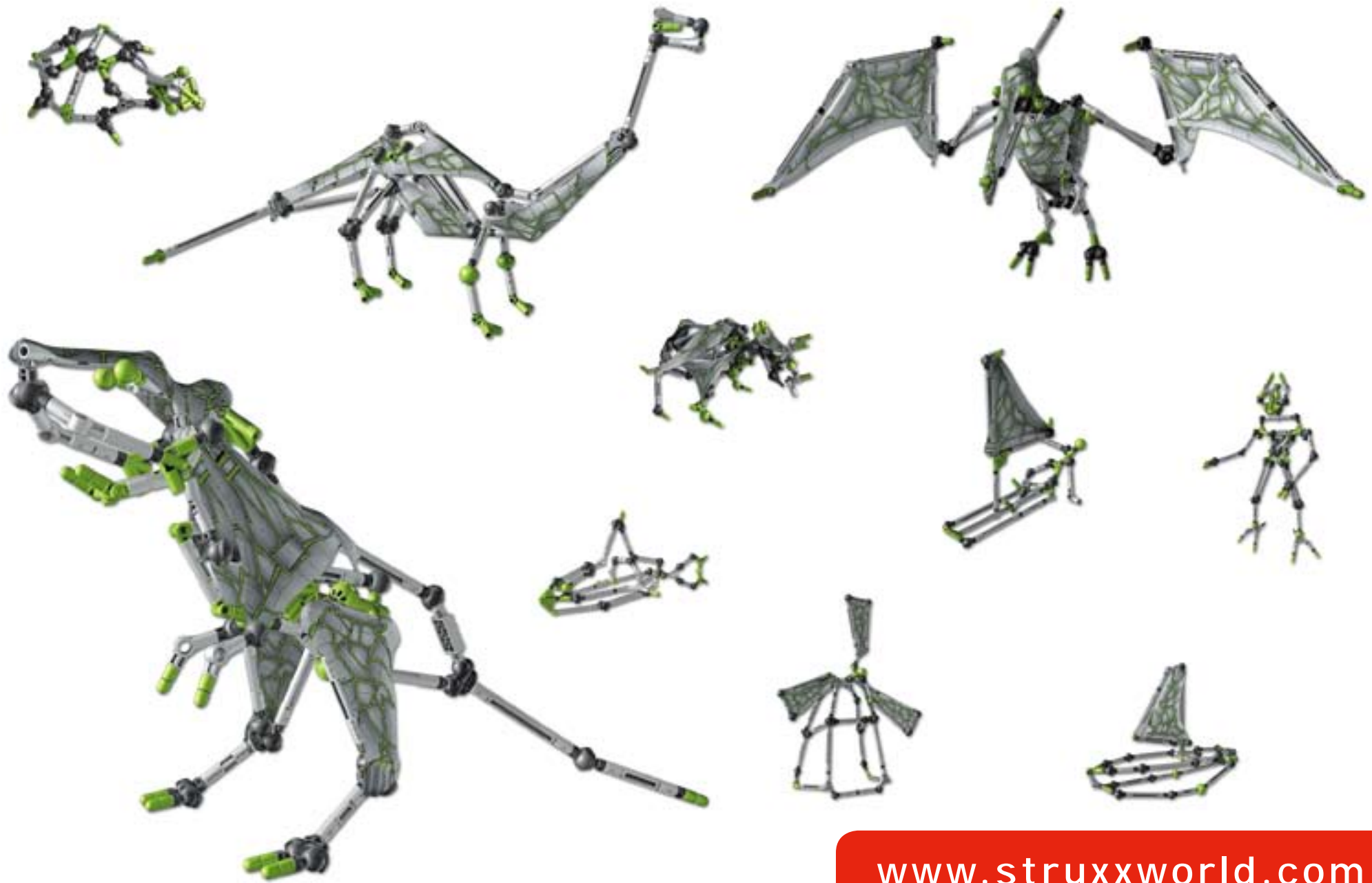

www.struxxworld.com

**BUILDING IDEAS / IDEAS DE CONSTRUCCIÓN / IDÉES DE CONSTRUCTION / BAUVORSCHLÄGE /
BOUW SUGGESTIES / IDEE DI COSTRUZIONE / IDEIAS DE CONSTRUÇÃO**

STRUXX

SKINZZ™

6019

Also available / Tambien disponible / Également disponible / Ebenfalls erhältlich /
Eveneens beschikbaar / Anche disponibile / Tambem disponível



6000
Basixx 40x™



6015
Basixx 20x™



6001
Robotrixx™

6016
Basixx
Tube Trixx™

© 2009, MEGA Brands Inc.
© and ™ denote trademarks of MEGA Brands Inc.
© y ™ designan la marca registrada y la marca comercial de MEGA Brands Inc.
© et ™ designent des marques de commerce de MEGA Brands Inc.
© und ™ sind Markenzeichen der Firma MEGA Brands Inc.
© en ™ duiden op handelsmerken van MEGA Brands Inc.
© e ™ indicano dei marchi depositati di MEGA Brands Inc.
© e ™ denotam marcas registradas de MEGA Brands Inc.

