

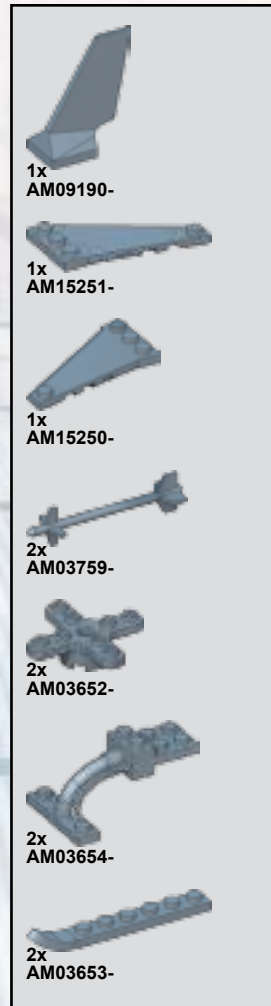

6+ | 122  | 2067 | Black Costume Spider-Man™

**MEGA
BLOKS**

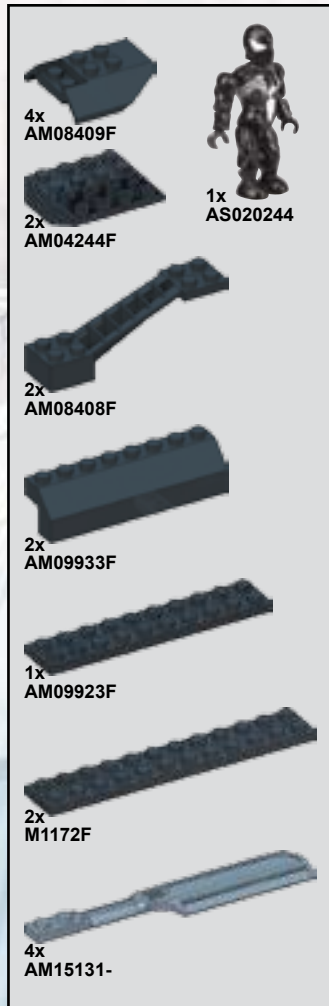

LIFETIME GUARANTEE / GARANTIZADO DE POR VIDA / GARANTIE À VIE / LEBENSLANGE GARANTIE / LEVENSLANGE GARANTIE / GARANZIA A VITA / TEM GARANTIA VITAÍCIA

COMMENTS, QUESTIONS ? / ¿ COMENTARIOS, PREGUNTAS ? / COMMENTAIRES, QUESTIONS ? / KOMMENTARE, FRAGEN ? / COMMENTAAR, VRAGEN ? / COMMENTI?, DOMANDE? / PERGUNTAS?, COMENTÁRIOS?

1-800-465-MEGA

U.S. & Canada only / Solamente en EEUU y Canadá / É.U. et Canada seulement / Nur für U.S und Kanada / Uitsluitend in de V.S. en Canada / USA e Canada solamente / Somente EE.UU. e Canadá

www.megabrand.com

MARVEL

MARVEL, Black Costume Spider-Man: TM & © 2008 Marvel Characters, Inc. All rights reserved. www.marvel.com. Licensed by Marvel Characters, Inc.

⚠ Please read these instructions carefully before first use and keep them for future reference. / ⚠ Leer estas instrucciones cuidadosamente antes de la primera utilización y guardarlas para referencia futura. / ⚠ Il est recommandé de lire attentivement ce feuillet avant la première utilisation et de le conserver pour référence future. / ⚠ Die Gebrauchsanleitung bitte durchlesen und aufbewahren. / ⚠ Wij raden u aan deze handleiding zorgvuldig te lezen en te bewaren voor eventuele raadpleging op een later tijdstip. / ⚠ Leggere le istruzioni prima di cominciare ad usare il gioco e conservarle per referenze future. / ⚠ Leia as instruções antes do primeiro uso e guarde-as para futura referência.

⚠ **WARNING :**
CHOKING HAZARD. - Small parts.
Not for children under 3 years.

⚠ **ADVERTENCIA :**
PELIGRO DE ASFIXIA. - Contiene piezas pequeñas.
No recomendado para niños menores de 3 años.

⚠ **AVERTISSEMENT :**
RISQUE DE SUFFOCATION. - Présence de petits éléments.
Ne convient pas aux enfants de moins de 3 ans.

⚠ **WARNUNG :**
ERSTICKUNGSGEFAHR. - Enthält kleine Teile.
Nicht für Kinder unter 3 Jahren geeignet.

⚠ **WAARSCHUWING :**
VERSTIKKINGSGEVAAR. - Bevat kleine onderdelen.
Niet geschikt voor kinderen onder de 3 jaar.

⚠ **ADVARSEL :**
KVÆLNINGSFARE. - Inneholder smådele.
Ikke til børn under 3 år.

⚠ **ΠΡΟΕΙΔΟΠΟΙΗΣΗ :**
ΚΙΝΔΥΝΟΣ ΠΝΙΞΙΜΑΤΟΣ. - Περιέχει μικρά αντικείμενα.
Όχι για παιδιά κάτω των 3 ετών.

⚠ **VAROITUS :**
TUKEHTUMISVAARA. - Sisältää pieniä osia.
Ei alle 3-vuotiaalle lapsille.

⚠ **ATTENZIONE :**
PERICOLO DI SOFFOCAMENTO. - Contiene piccole parti.
Non indicato per bambini sotto i 3 anni.

⚠ **ADVARSEL :**
KVELNINGSFARE. - Inneholder små deler.
Kun for barn over 3 år.

⚠ **ATENÇÃO :**
PERIGO DE ASFIXIA. - Contém peças pequenas.
Não é concebido para crianças de menos de 3 anos.

⚠ **VARNING :**
KVÄVNINGSRISK. - Innehåller små delar.
Inte för barn under 3 år.

⚠ **警告 :**
窒息の危険性。小さな部品が含まれています。
3歳以下の子供には与えないで下さい。

⚠ **警告 :**
有窒息危險。- 包含有小部件。
不适合3岁以下的的小孩。

⚠ **تحذير :**
خطر الاختناق. قطع صغيرة.
غير صالحة للأطفال أقل من 3 سنوات.

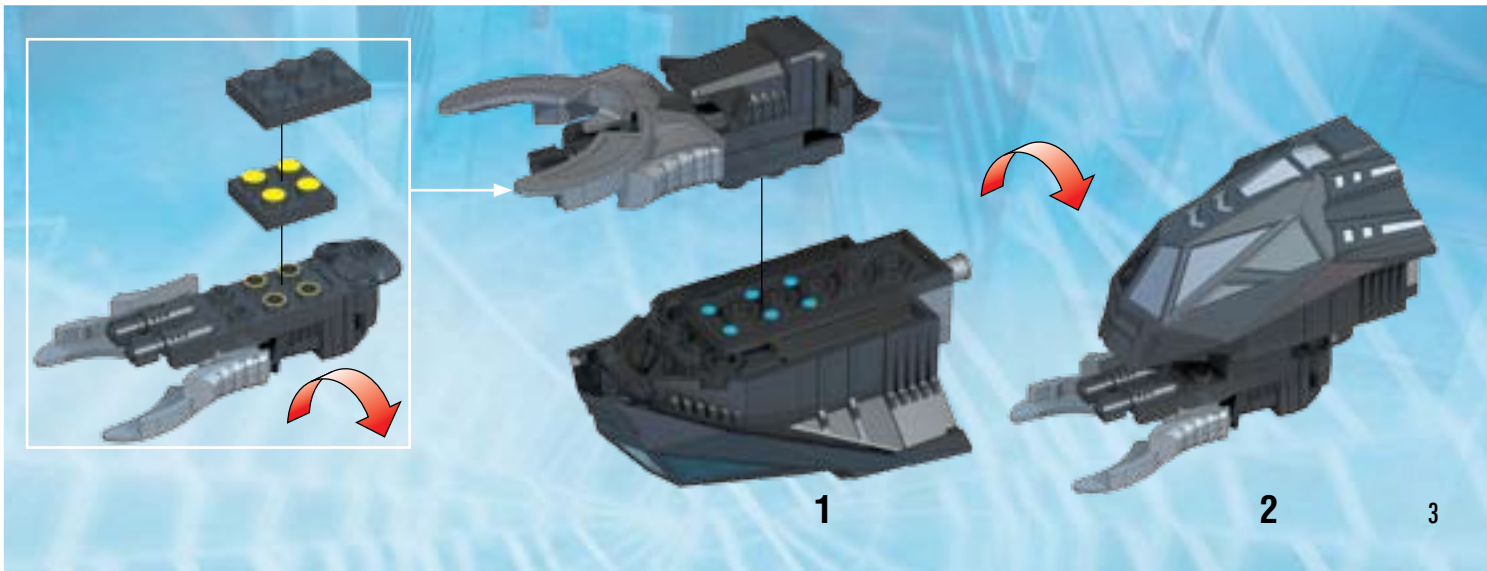
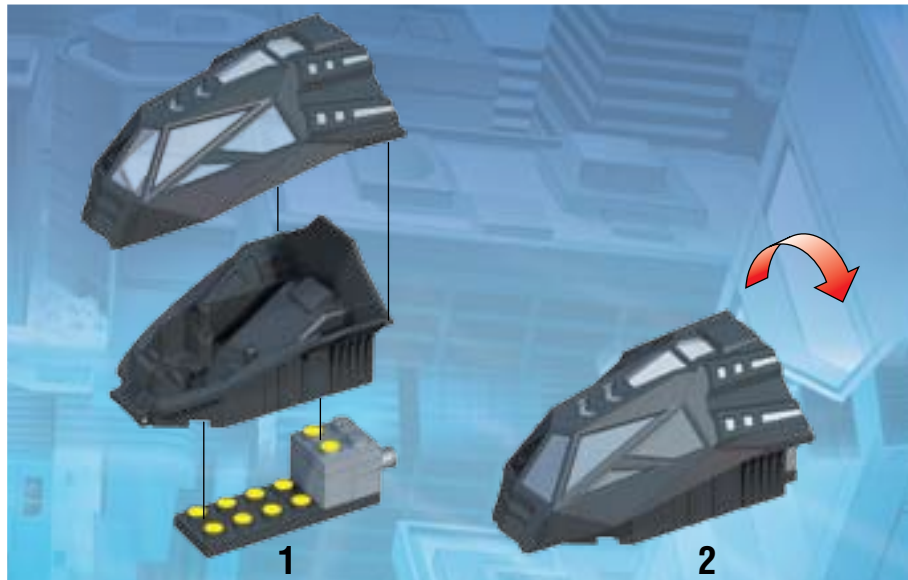
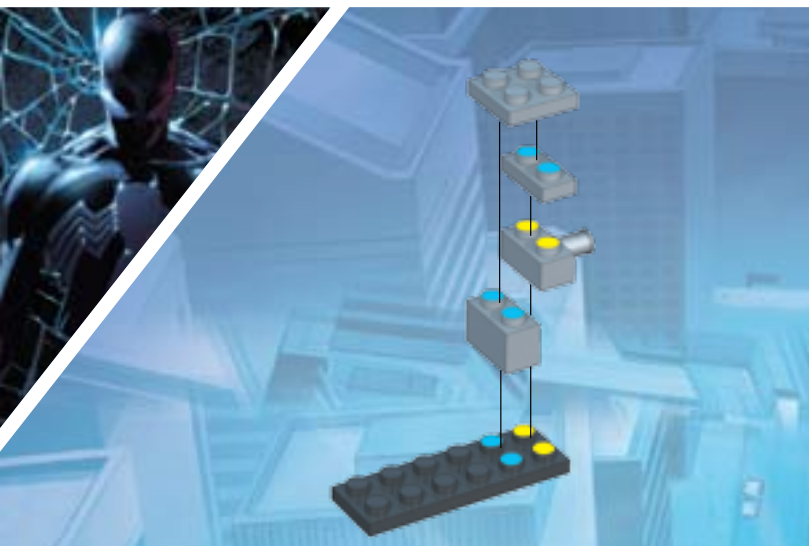
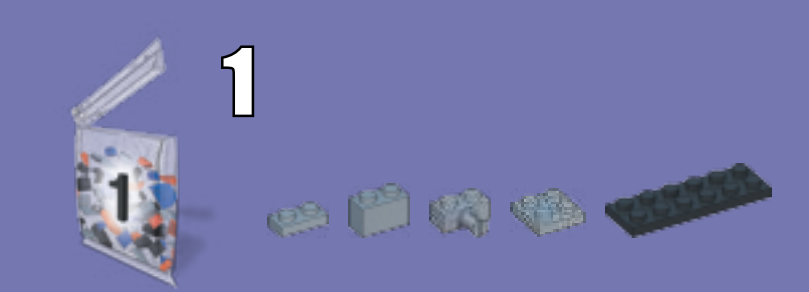



5

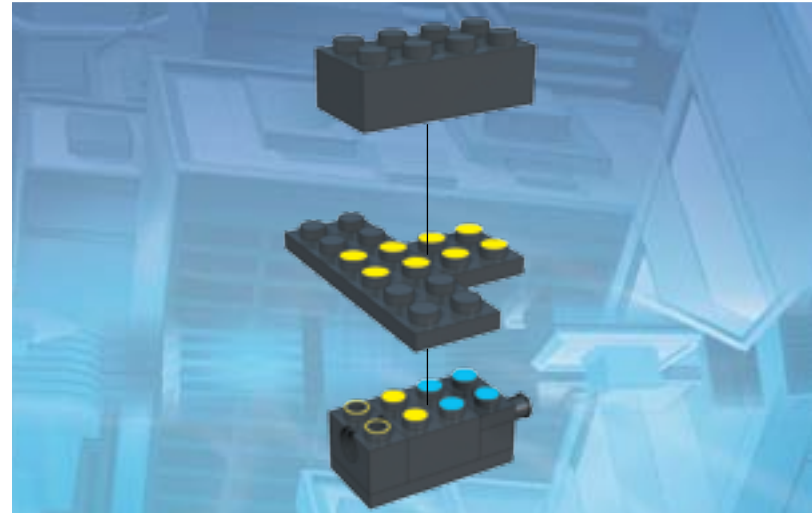
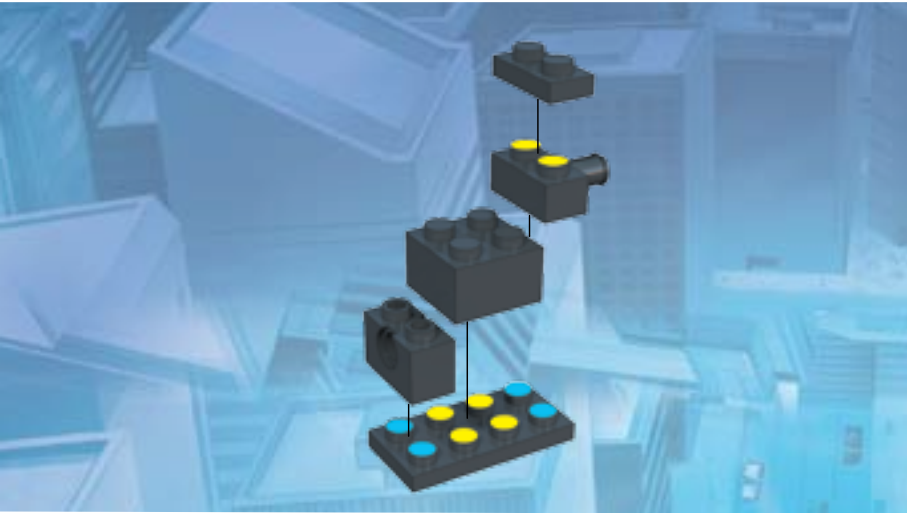

6

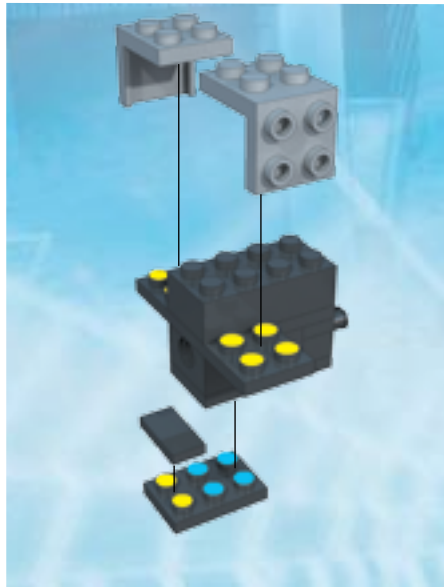

7



8

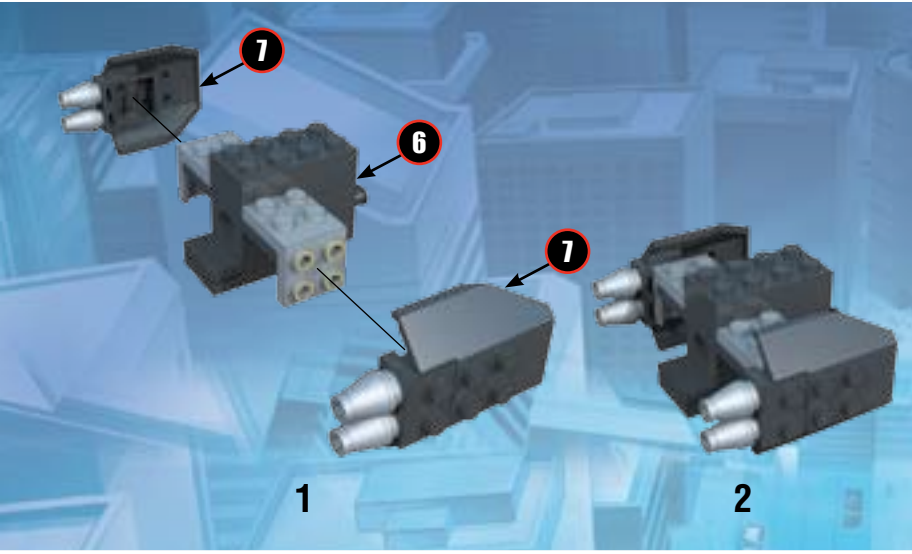

9

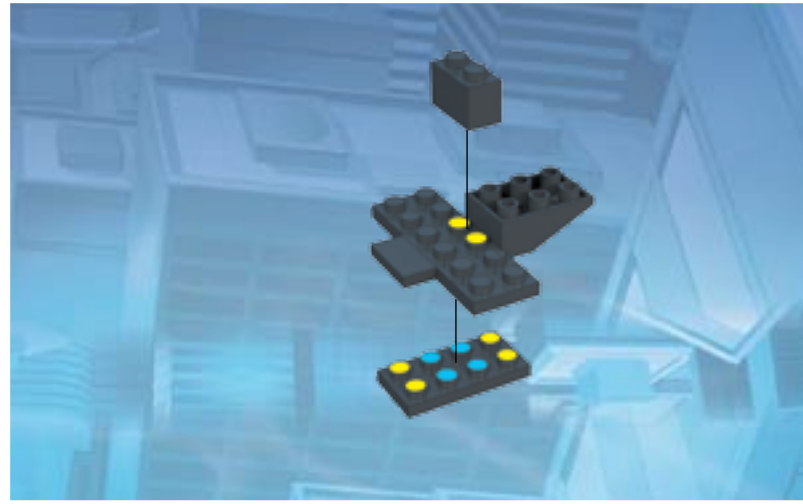
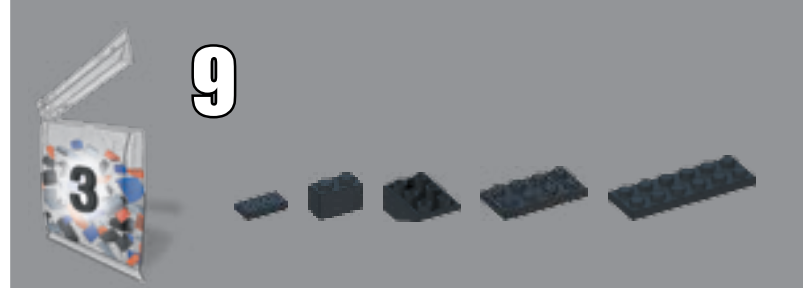

10

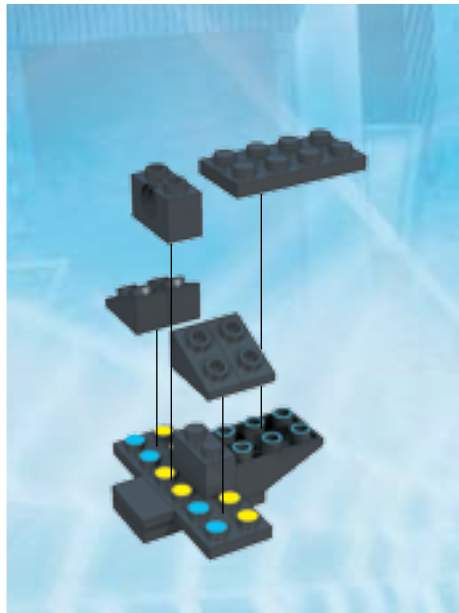
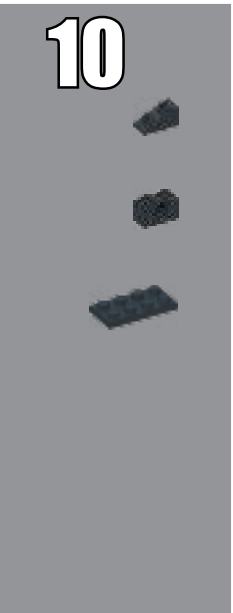

11

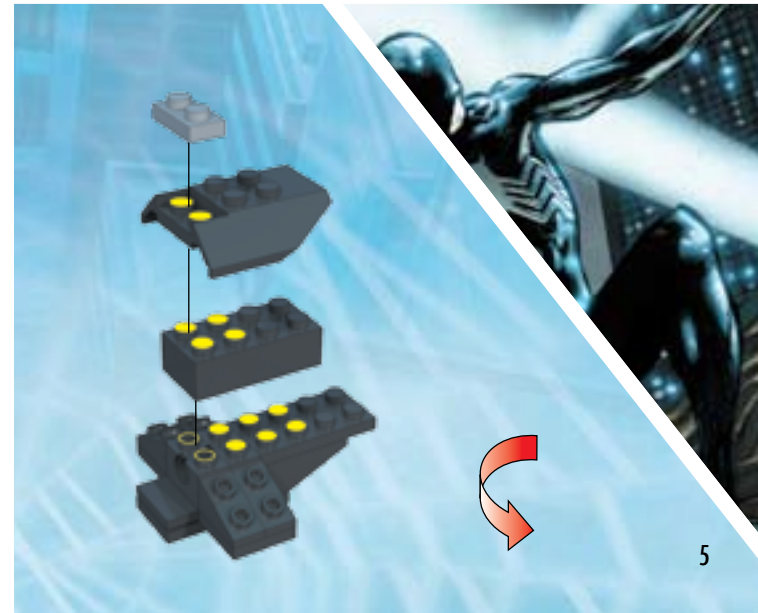
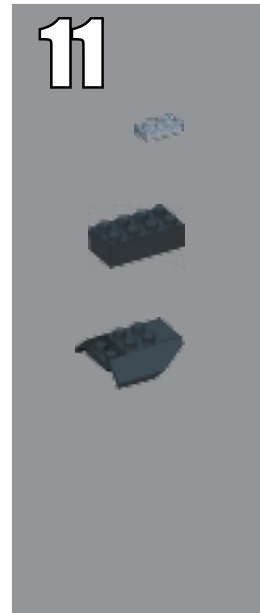

12

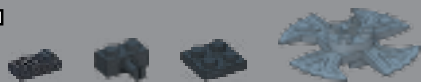

13



14

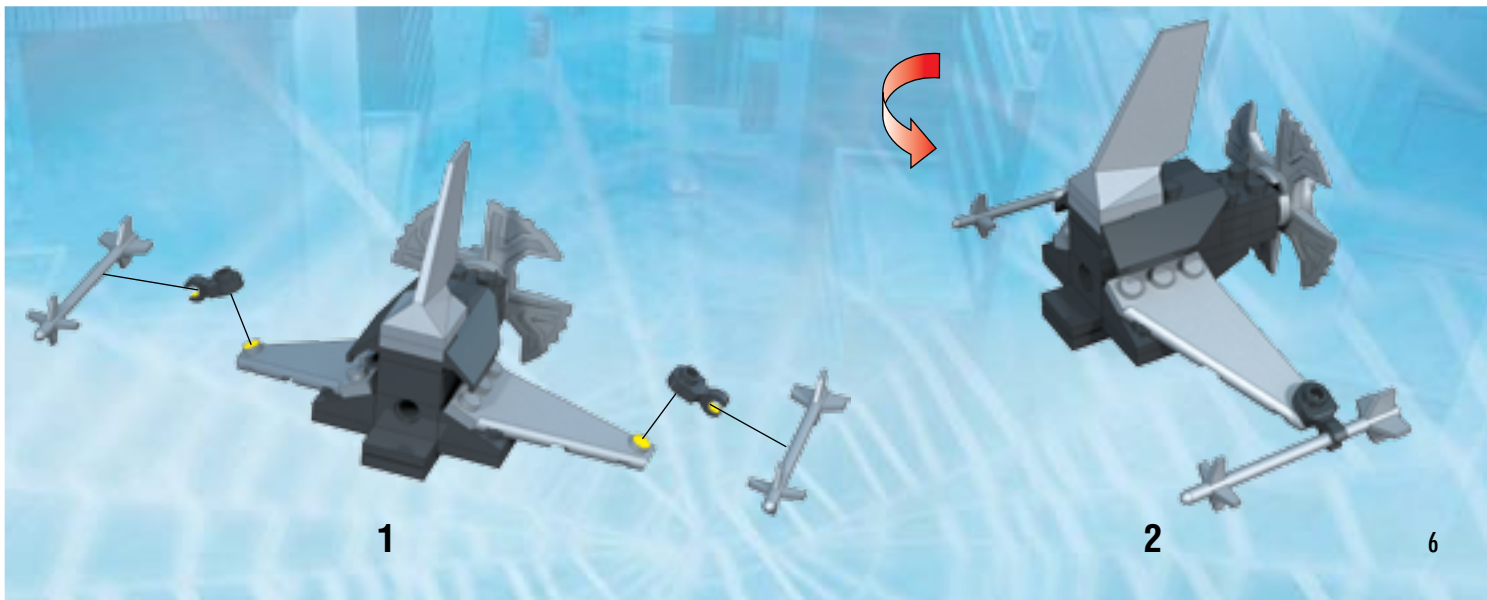

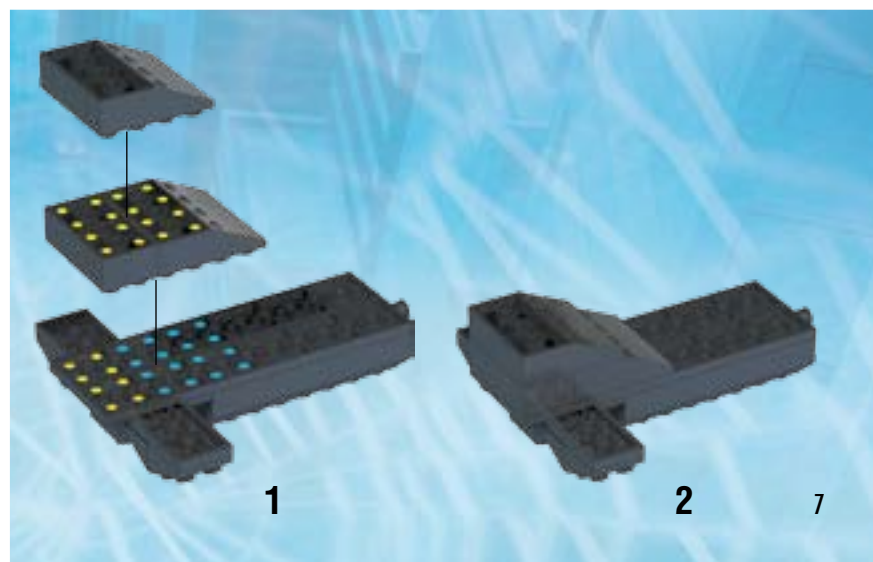
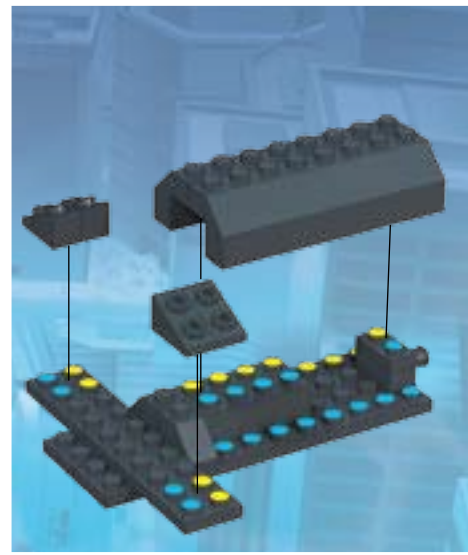
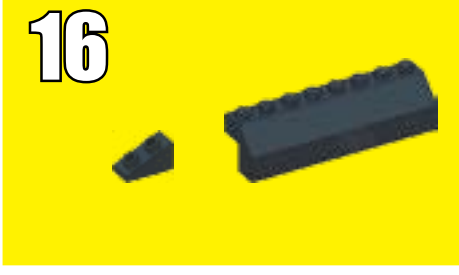

23

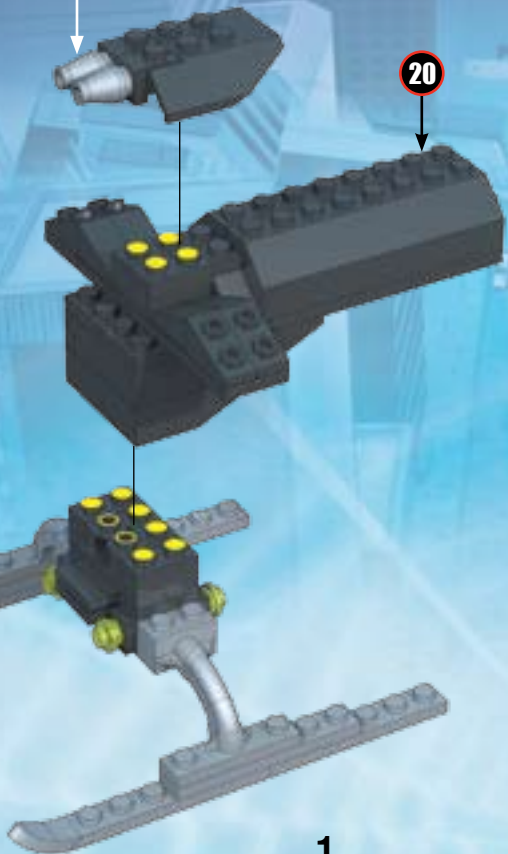
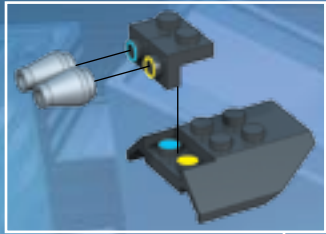

24

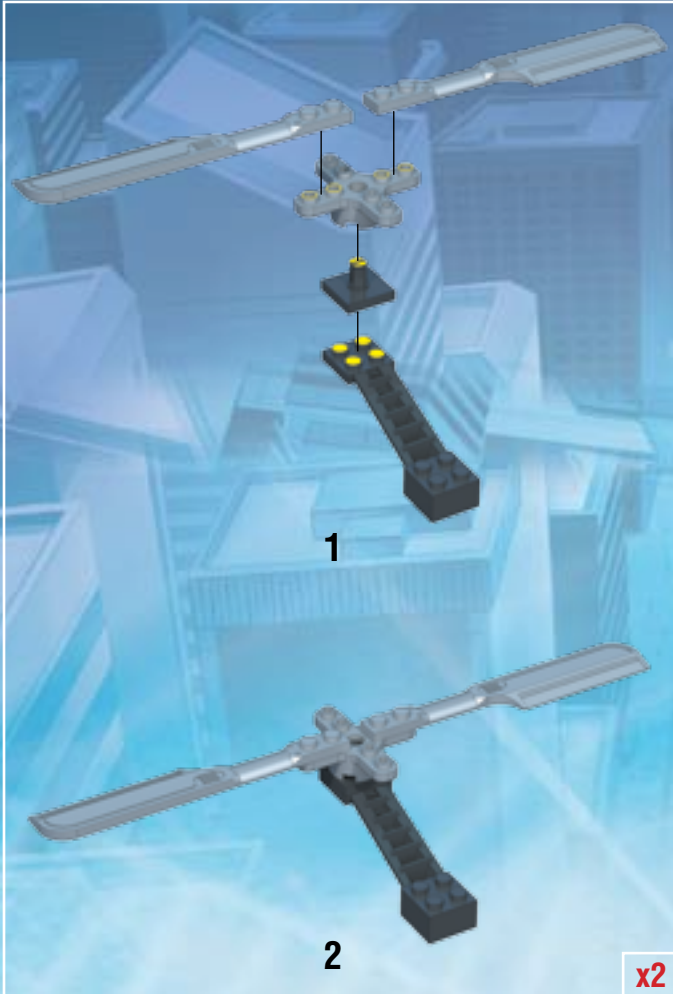



EN CAUTION! Do not aim at eyes or face.

ES ¡ADVERTENCIA! NO dirigir nunca los proyectiles hacia los ojos o la cara.

FR ATTENTION! Ne pas viser les yeux ou le visage.

DE VORSICHT! Nicht auf das Gesicht oder die Augen richten.

NL LET OP: Niet op ogen of gezicht richten.

DA ADVARSEL! Peg ikke i retning af øjne eller ansigt.

EL ΠΡΟΣΟΧΗ! Να μην σκοπεύετε προς τα μάτια ή το πρόσωπο.

FI VARO! Älä tähtää silmiin tai kasvoihin.

IT Attenzione! Non puntare verso gli occhi o il viso.

NO FORSIKTIG! Sikt ikke mot øyne eller ansikt.

PT ATENÇÃO: Não apontar para os olhos ou o rosto.

SV VAR FÖRSIKTIG! Rikta inte med ögon eller ansikte.

JA 注意! 目や顔に使用しないで下さい。

ZH 警告! 不要对准眼睛或脸。

AR تنبيه! لا توجه للعينين أو الوجه

Use only the projectile included with this toy.
Utilizar solamente el proyectil incluido con el juguete.
Utiliser seulement le projectile fourni avec le jouet.
Nur das mit dem Spielzeug mitgelieferte Projektil verwenden.
Alleen het met het speelgoed bijgeleverde projectiel gebruiken.
Utilizzare soltanto il proiettile fornito con questo giocattolo.
Usar somente o projétil incluído com este brinquedo.
استخدم فقط القذيفة المرافقة لهذه اللعبة



Multiple transformations! // ¡Diversas transformaciones! // Plusieurs transformations possibles! // Mehrfache Umwandlungen möglich! // Meerdere transformaties mogelijk! // Trasformazioni multiple! // Múltiplas transformações!

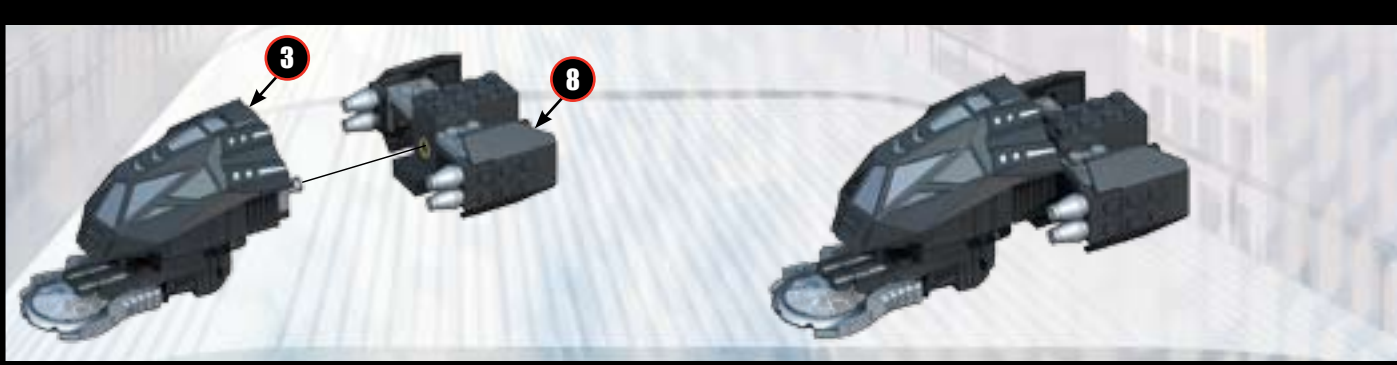

Multiple transformations! // ¡Diversas transformaciones! // Plusieurs transformations possibles! // Mehrfache Umwandlungen möglich! // Meerdere transformaties mogelijk! // Trasformazioni multiple! // Múltiplas transformações!

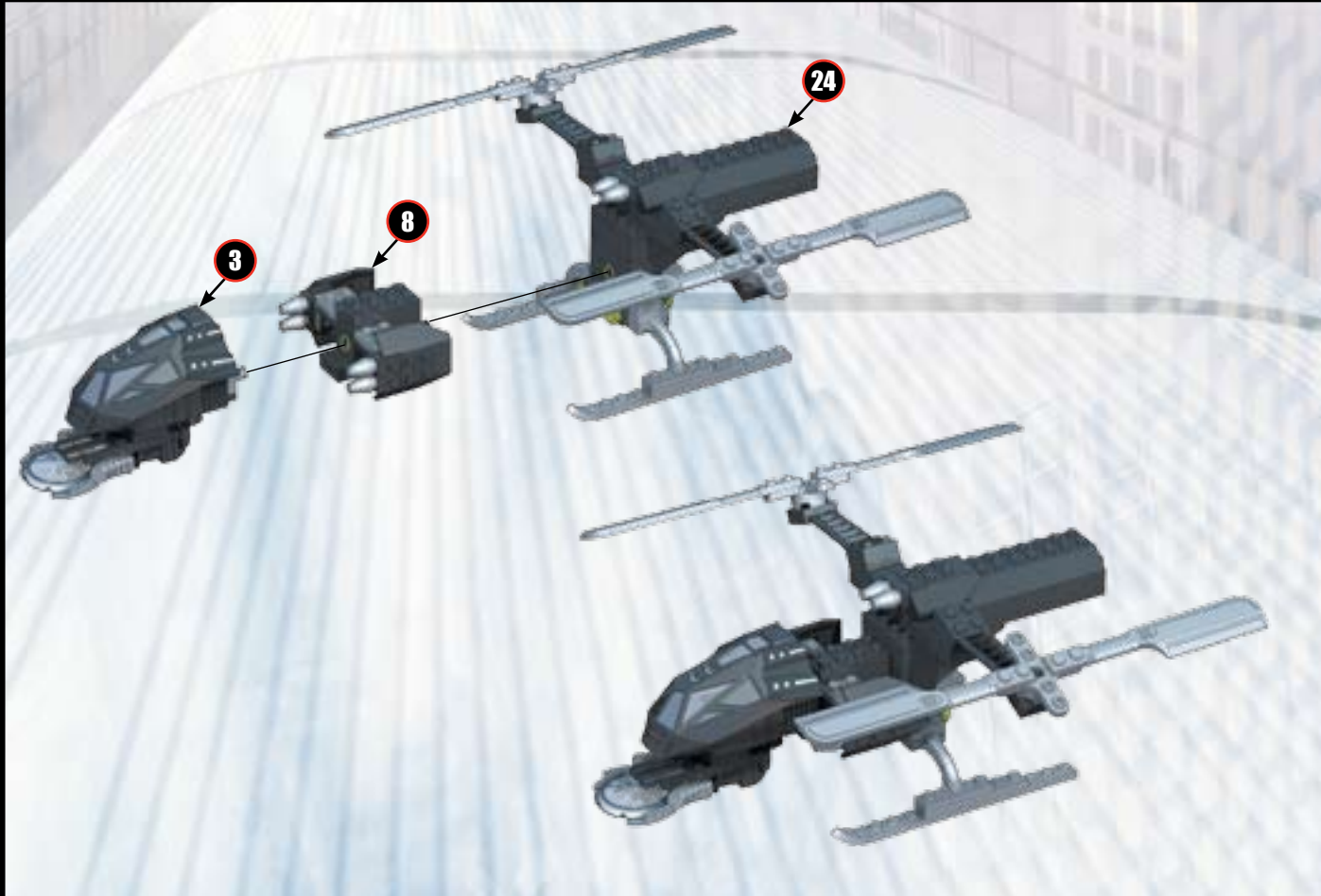

Collect & Combine! / ¡Colecciona piezas y combínalas como prefieras! / Collectionne et assemble! / Sammeln und kombinieren / Verzamel en combineer! / Raccogli e combina! / Colecciona e combina!



**2029
+
2067**



**2066
+
2029**



**2066
+
2067**



**2066
+
2067**



**2043
+
2066
+
2067**



**2066
+
2067
+
2029**



**2066
+
2029**



**2066
+
2067**

Additional purchases required to collect all elements shown. / Para coleccionar todos los elementos mostrados se precisa realizar compras adicionales. / Des achats additionnels sont nécessaires afin d'obtenir tous les articles de la collection illustrés. / Um alle dargestellten Elemente zu sammeln sind zusätzliche Käufe erforderlich / Verdere aankopen zijn nodig om alle afgebeelde artikelen te verzamelen. / Acquisti supplementari necessari per collezionare tutti gli elementi illustrati / Compras adicionais são necessárias para coleccionar todos os elementos exibidos.

**MEGA
BLOKS**

**THE AMAZING
SPIDER-MAN**

2067



Also available
También disponible
Egalement disponible
Ebenfalls erhältlich
Ook beschikbaar
Anche disponibile
Também disponível

2066 Spider-Man Motorcycle

2033 Hulk's Cave

2068 Amazing Spider-Man Power Cell

2062 Max Upp's Stickerbook

2063 Max Upp's Stickerbook

2064 Max Upp's Stickerbook

Spider-Man Stickerbook

©2008, MEGA Brands International. © & ™ MEGA Brands Inc. & MEGA Brands International. This toy conforms to: Voluntary Product Standard F963-07 U.S., Canadian Hazardous Products Act, CEN Standards E.N. 71. Products and colors may vary. Este juguete es de conformidad con: Voluntary Product Standard F963-07 U.S., Canadian Hazardous Products Act, CEN Standards E.N. 71. Las piezas y los colores pueden variar. Ce jouet est conforme aux: Voluntary Product Standard F963-07 U.S., Canadian Hazardous Products Act, CEN Standards E.N. 71. Les items et les couleurs peuvent varier. Dieses Spielzeug stimmt mit: Voluntary Product Standard F963-07 U.S., Canadian Hazardous Products Act, CEN Standards E.N. 71 überein. Produkte und Farben können unterschiedlich sein. Dit speelgoed voldoet aan: Voluntary Product Standard F963-07 U.S., Canadian Hazardous Products Act, CEN Standards E.N. 71. In producten en kleuren kan variatie optreden. Questo giocattolo è conforme a: Voluntary Product Standard F963-07 U.S., Canadian Hazardous Products Act, CEN Standards E.N. 71. Prodotti e colori possono variare. Este brinquedo conforma-se ao Produto Padrão Voluntário F963-07 EE.UU., Decreto Canadense de Produtos Perigosos, Padrões CEN, E.N. 71. Produtos e cores podem variar. Printed in China AD020671

