



# STAR WAR



9526



1

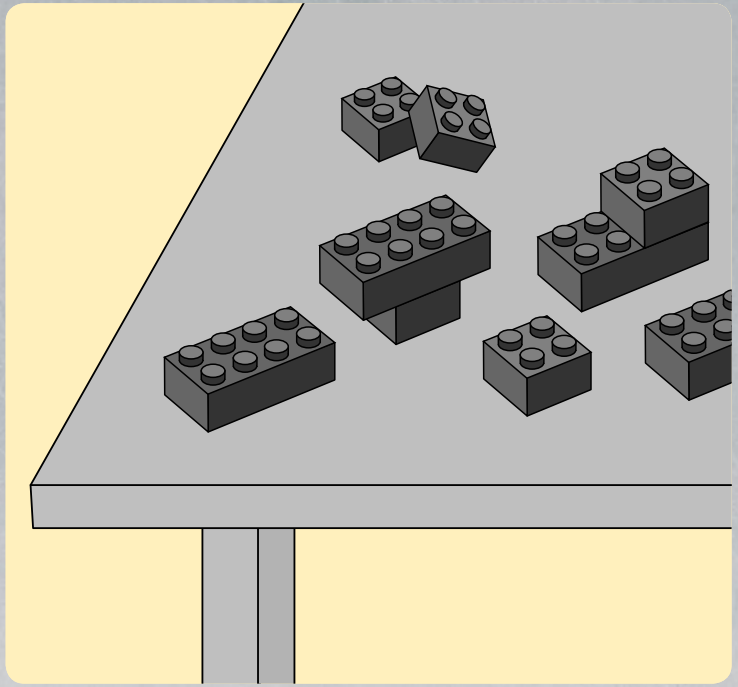
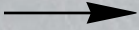
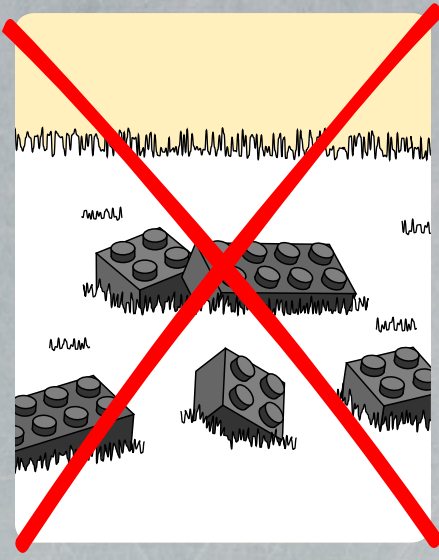

2

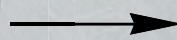

<http://lego.com/brickseparator>



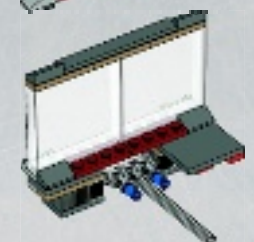
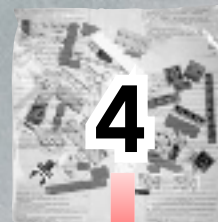
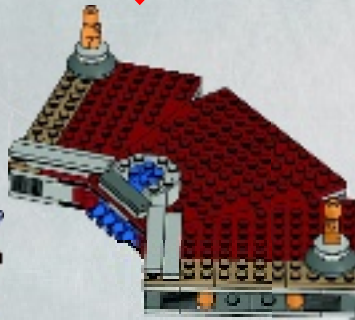
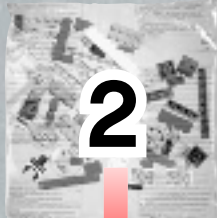
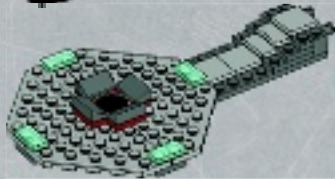

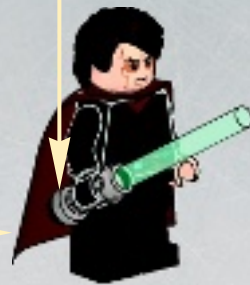
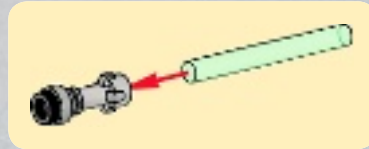





1

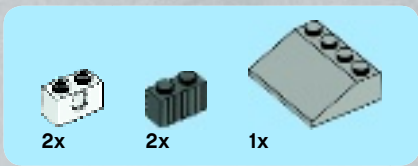
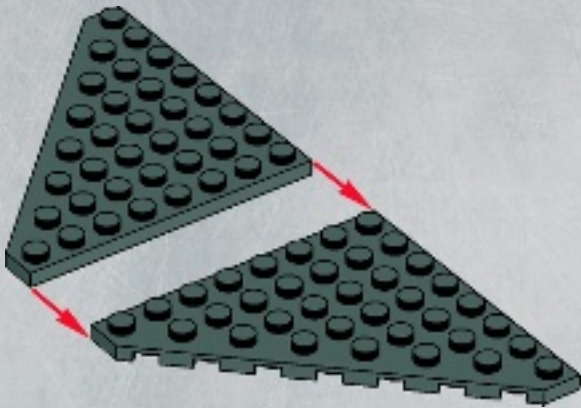

2

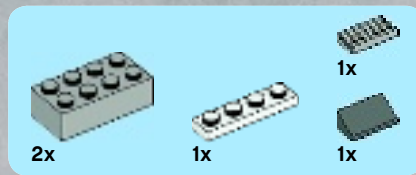
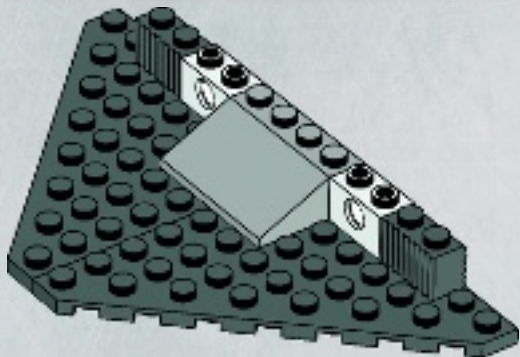

3

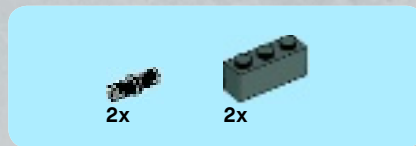
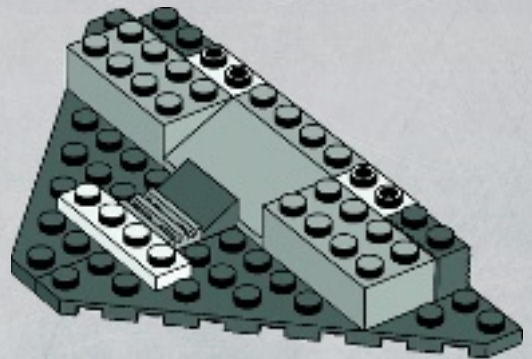

4

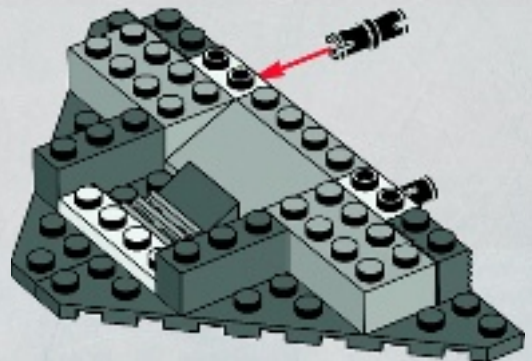

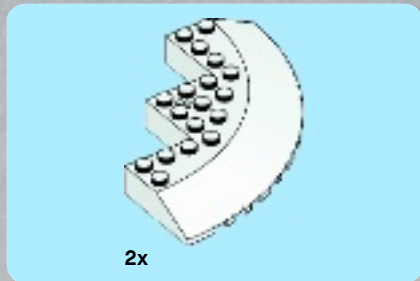

5

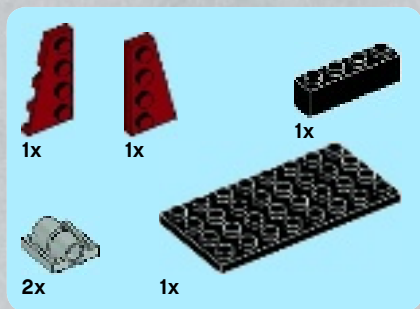
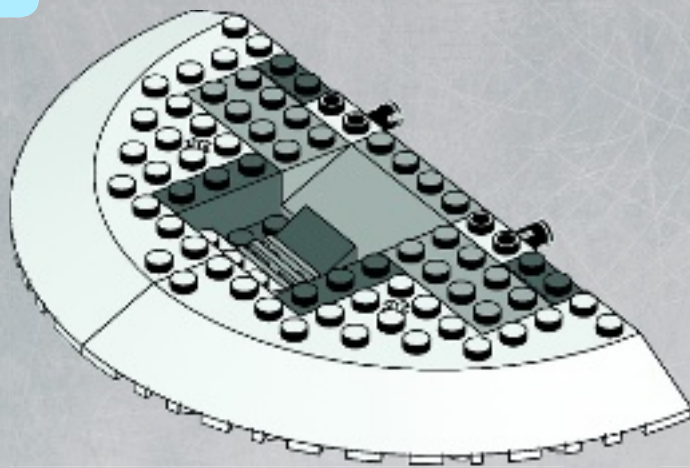

6

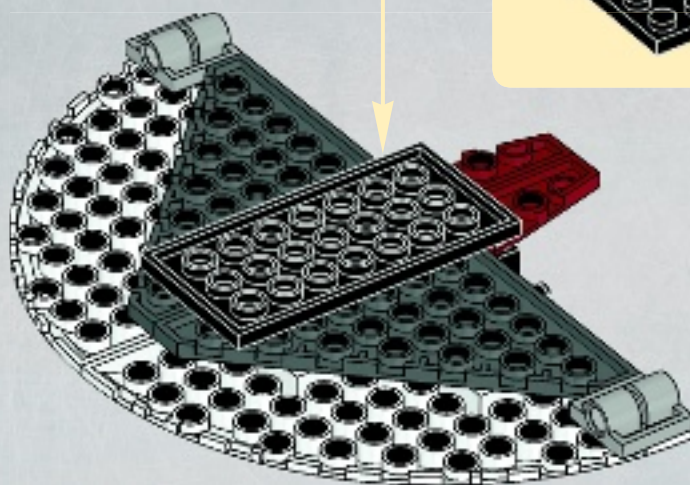
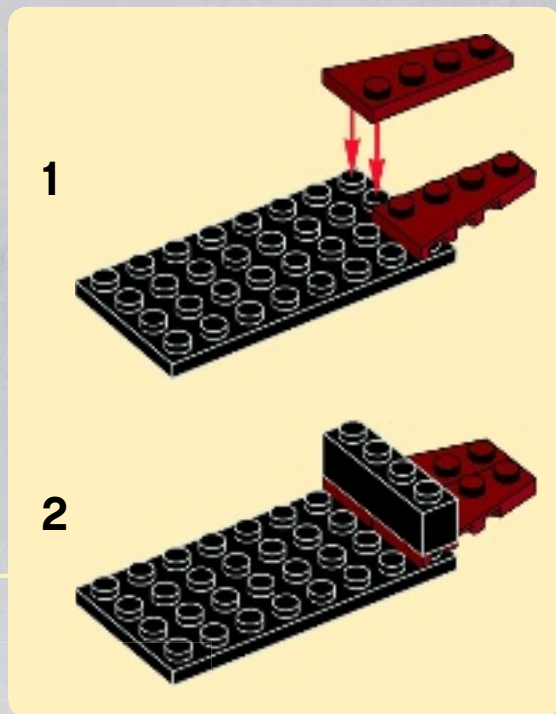



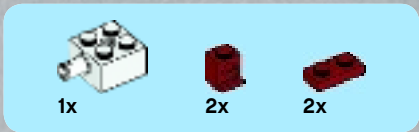

7

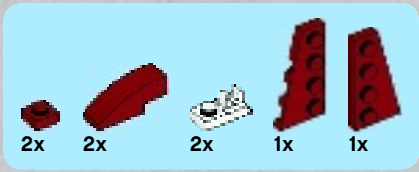
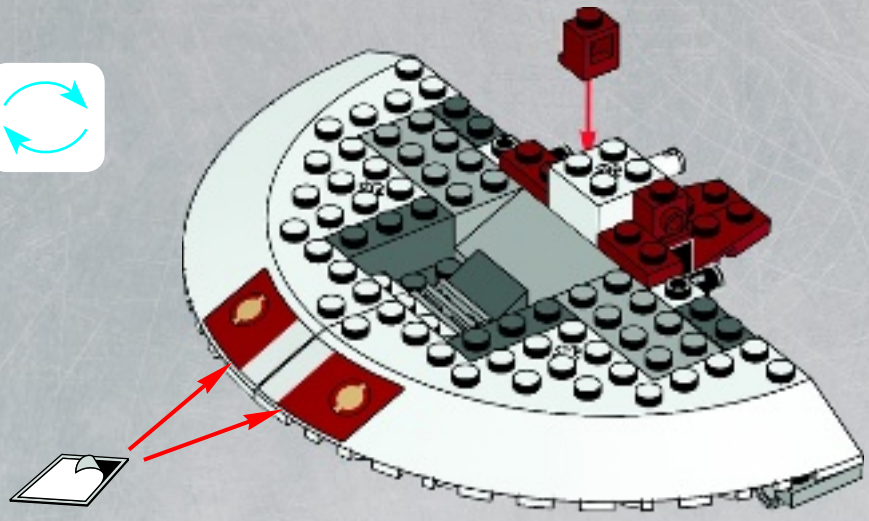

8

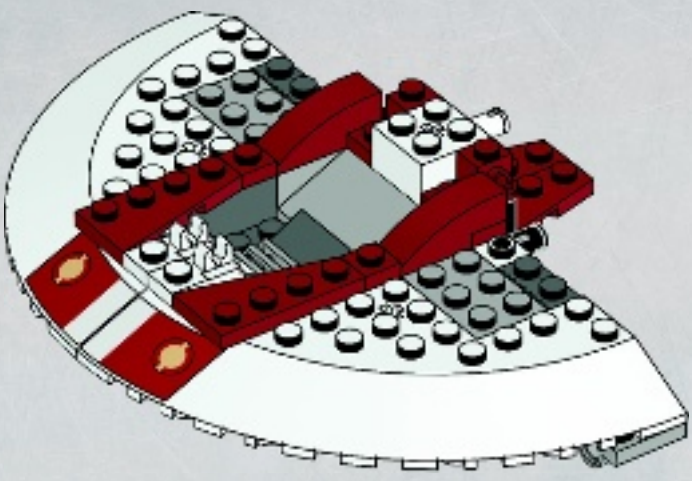



2x



2x

# 9

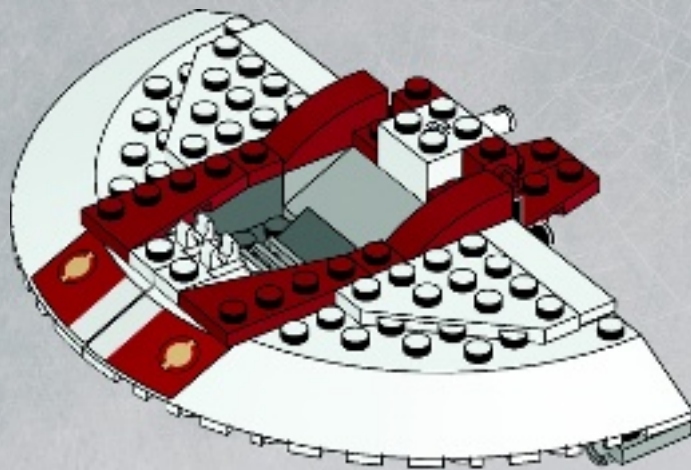

1x



1x



2x

# 10

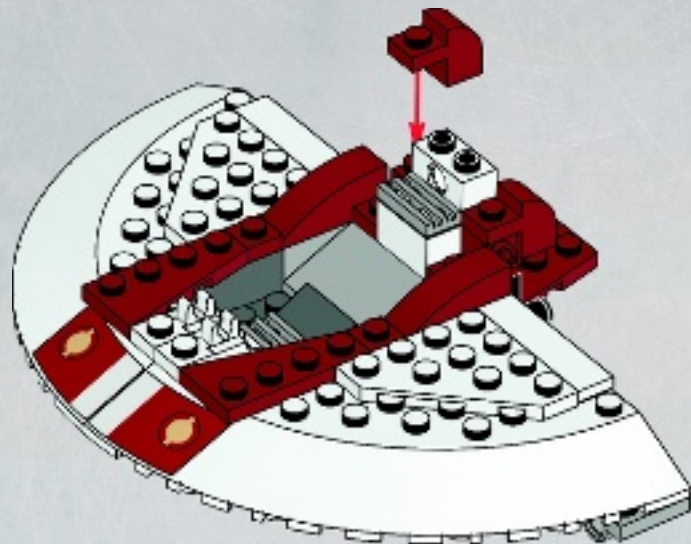





1x



2x

# 11

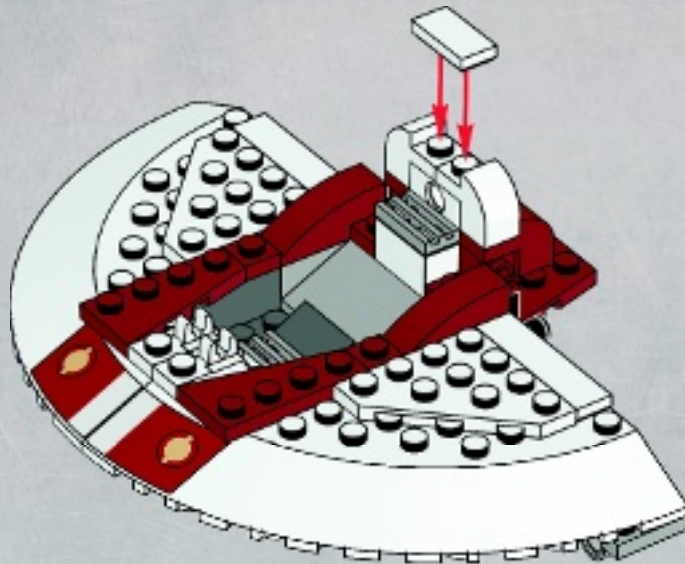



# 12

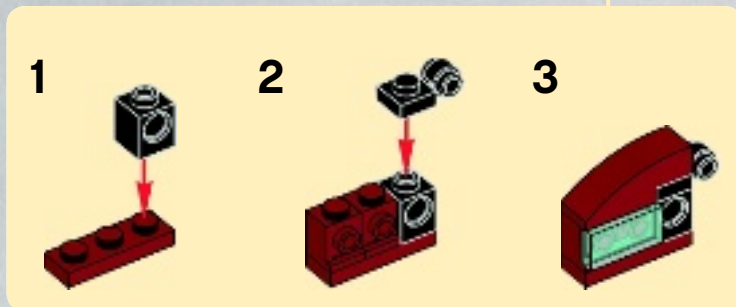
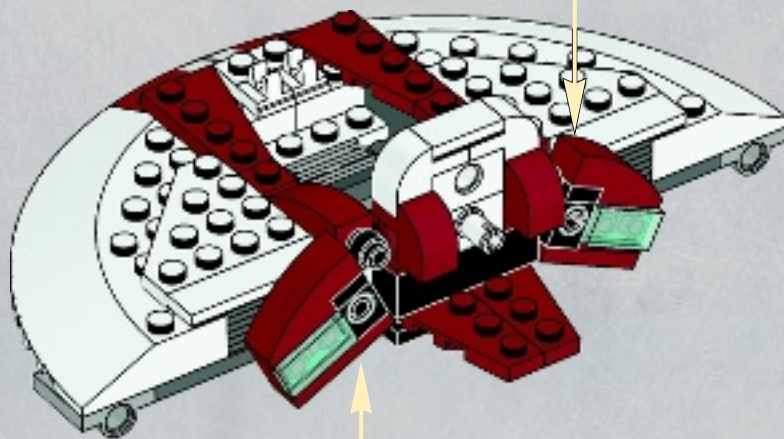



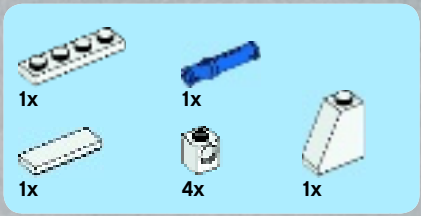

13

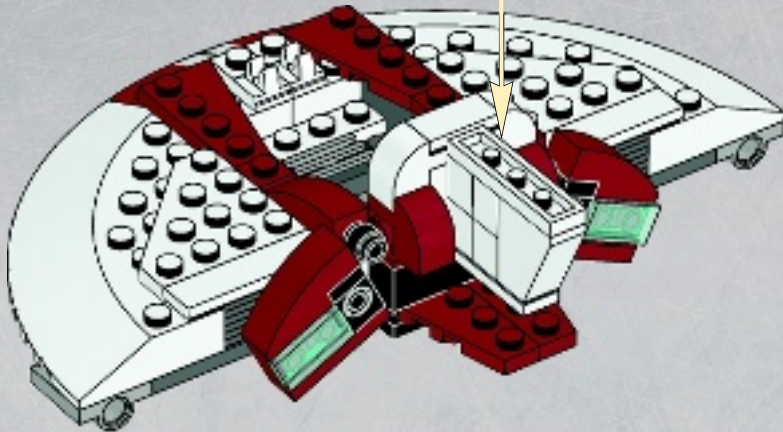
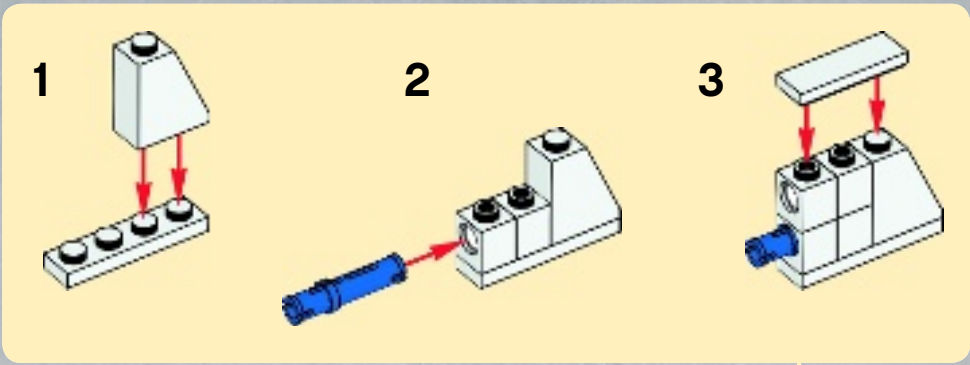

14

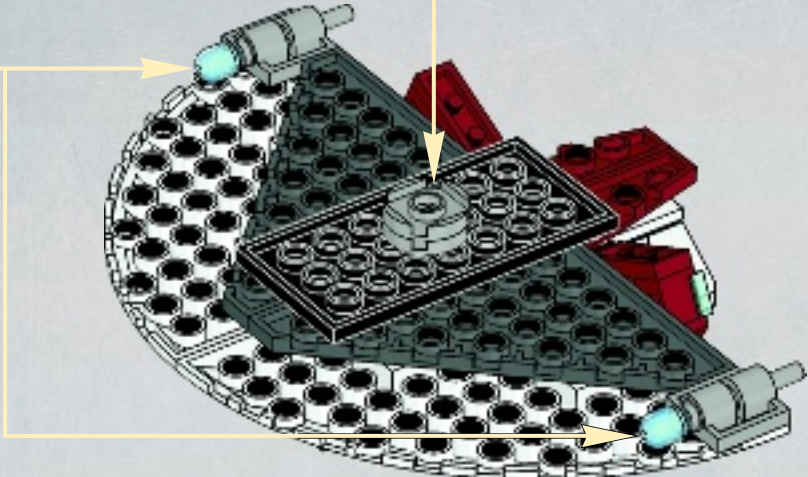
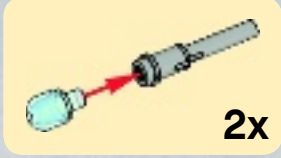
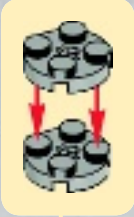

# 15

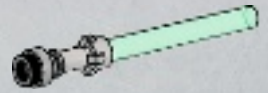

1x

# 16

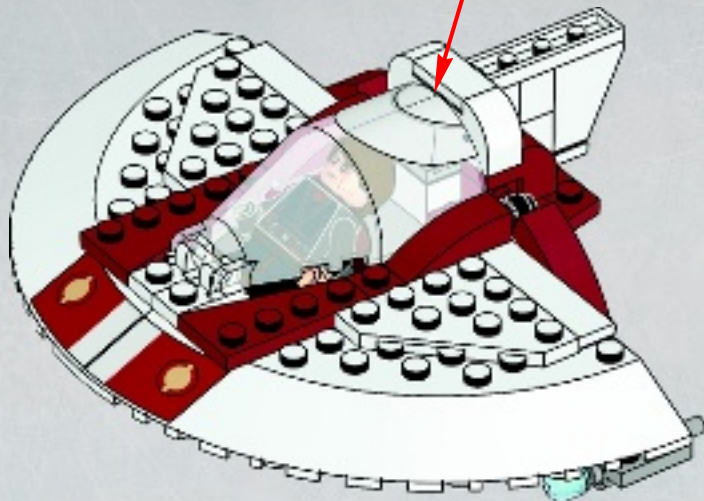



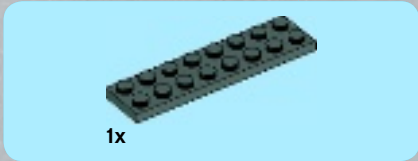
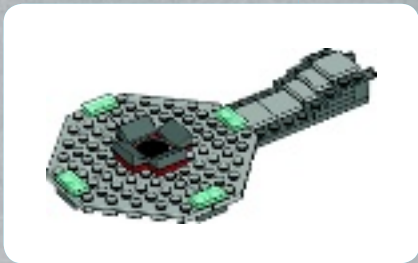

1x

1

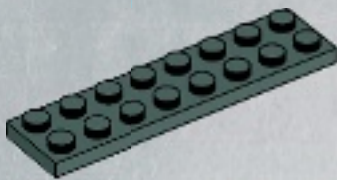

2x

2

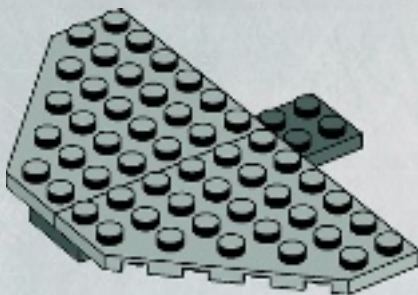

2x

3

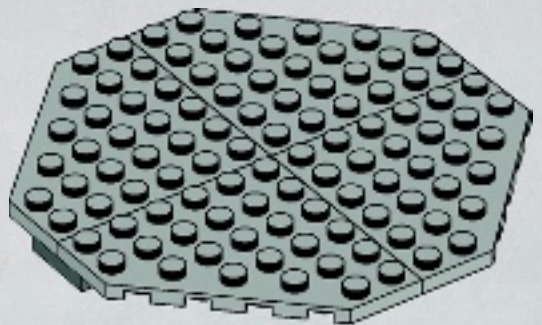

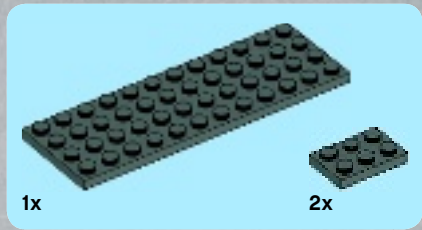

4

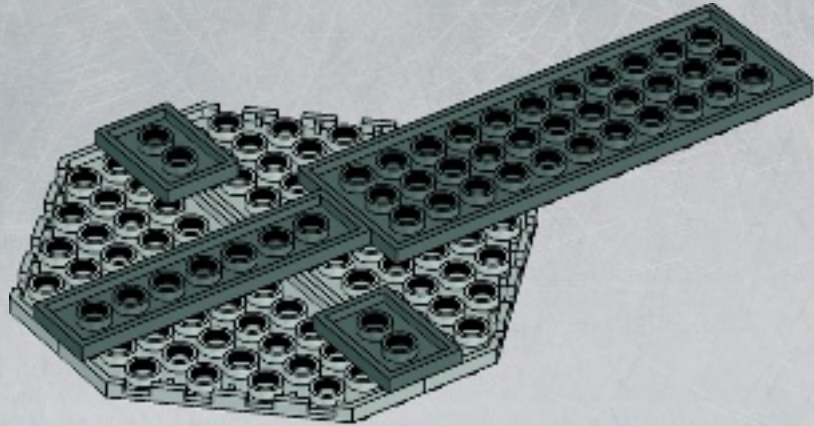

5

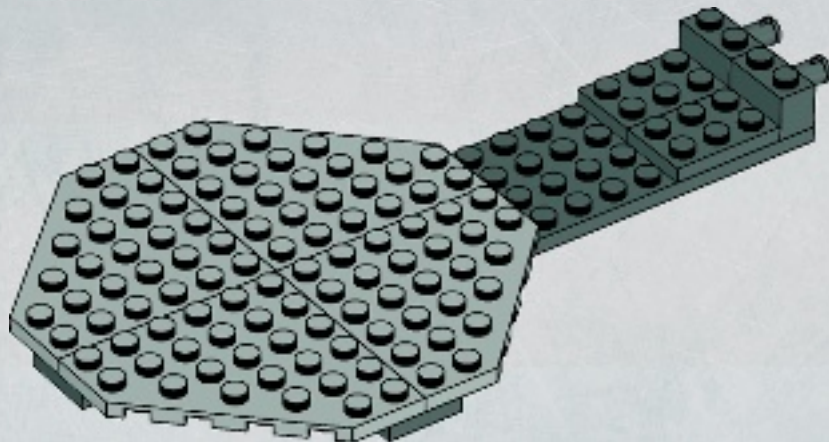





1x



1x

# 6

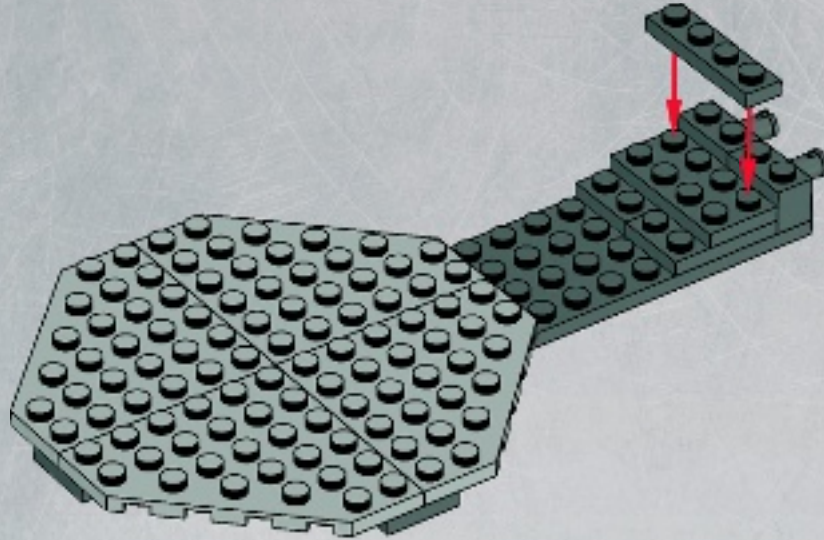

1x



3x



2x

# 7

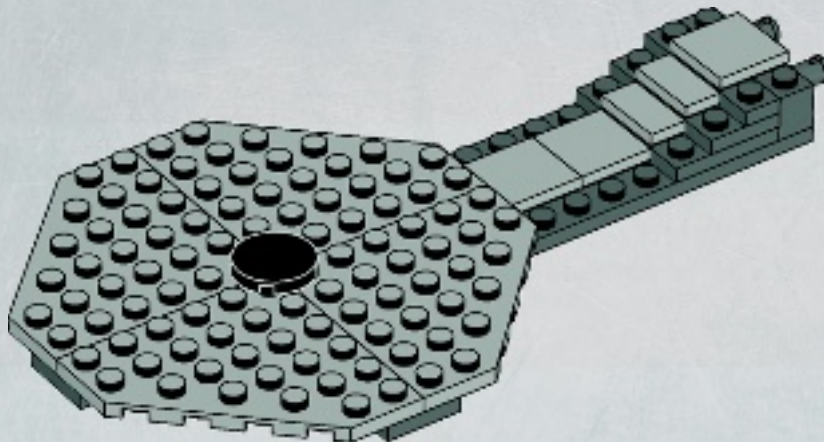



4x



4x

8

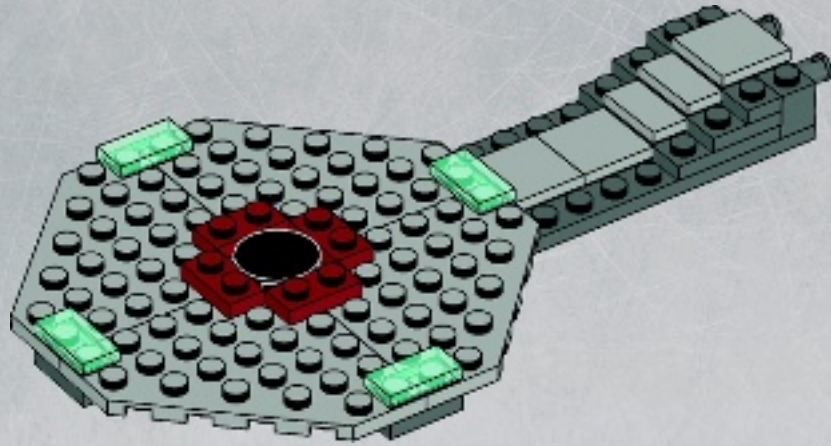

4x

9

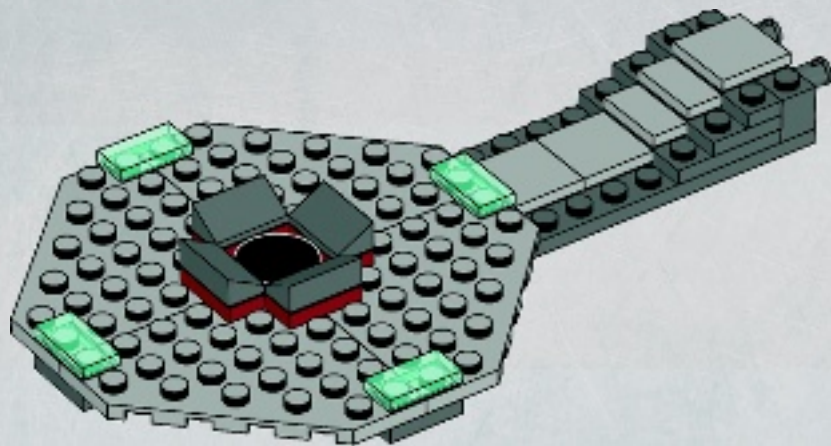





10

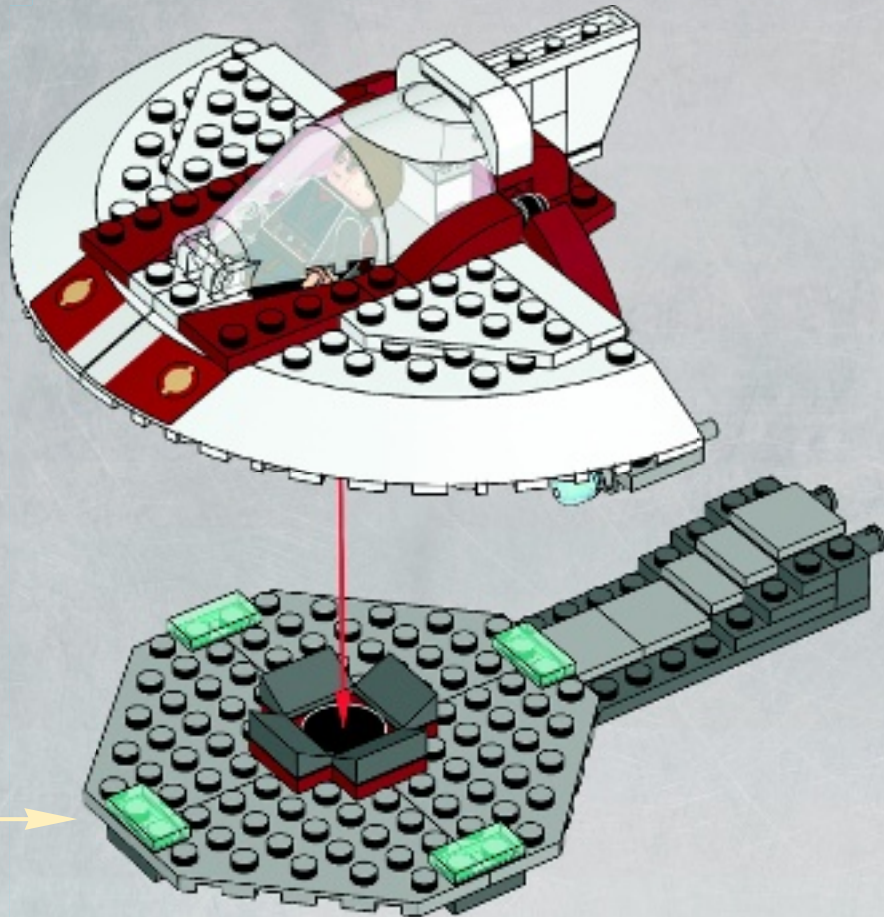

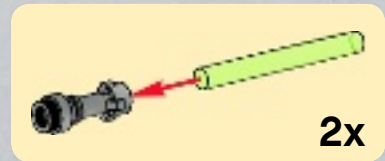
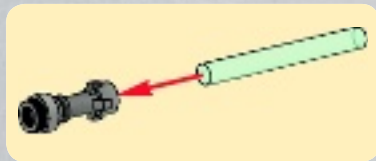
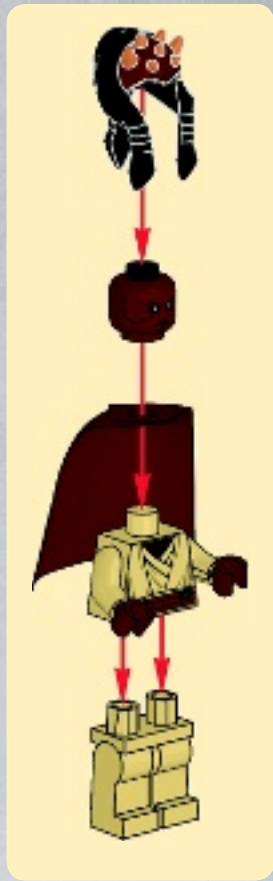



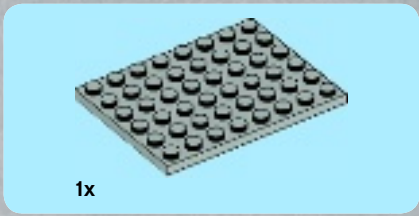

1

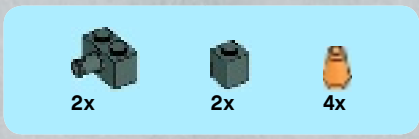
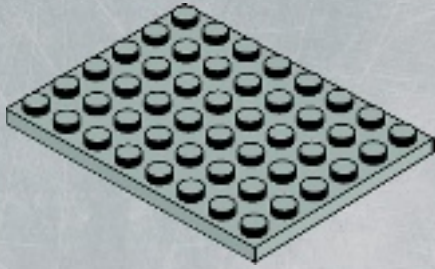

2



3

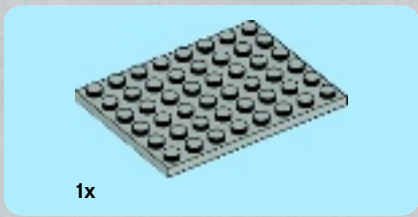

4

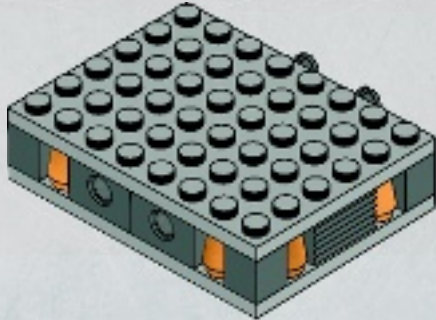

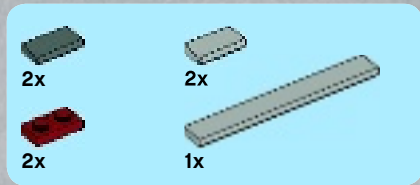

5

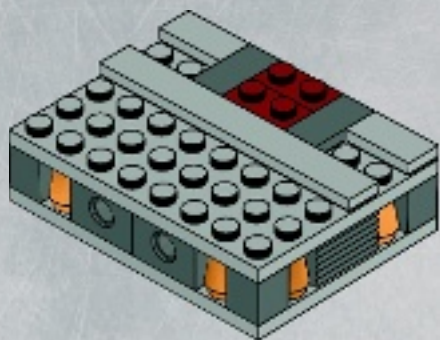

6

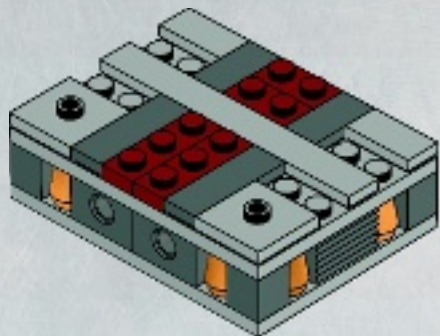

7

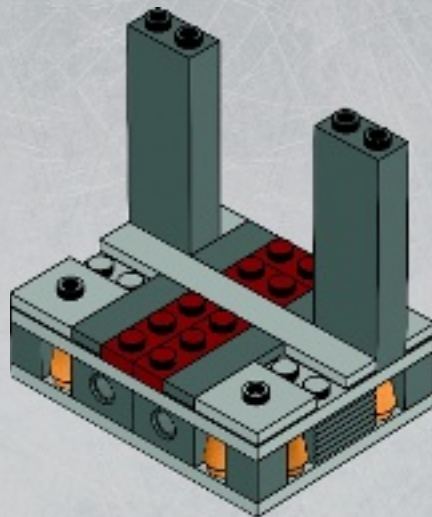





4x



6x

# 8

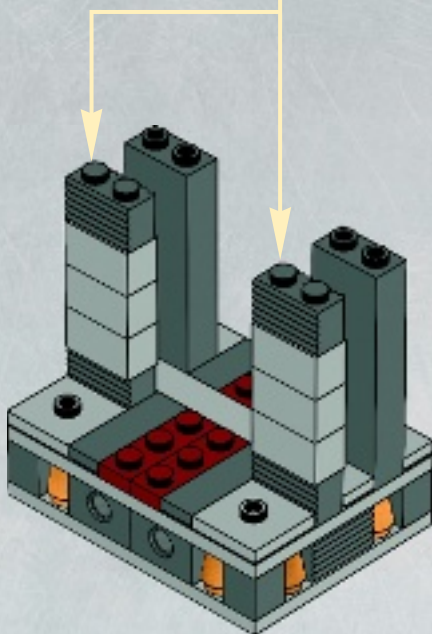
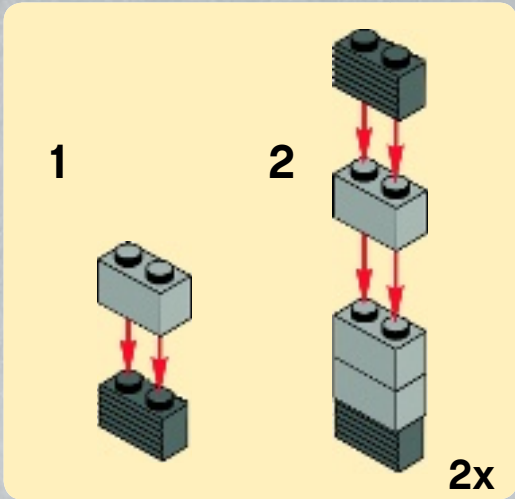

2x



2x

# 9

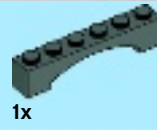
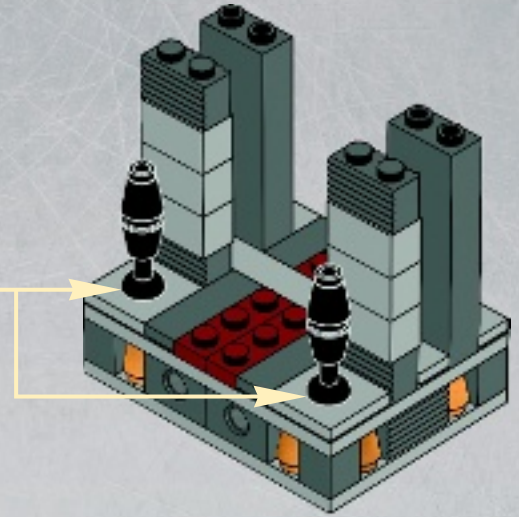
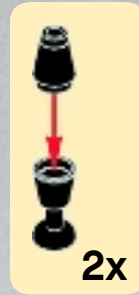

1x



4x



4x



# 10

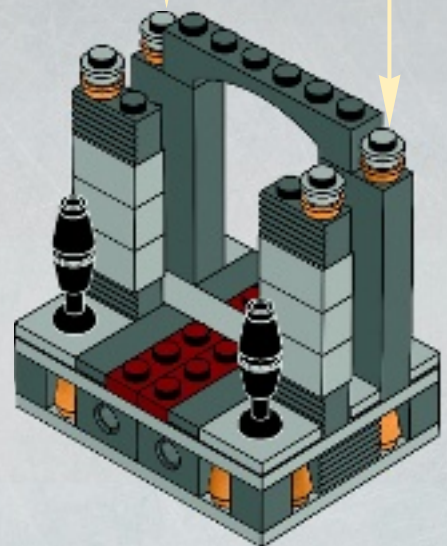

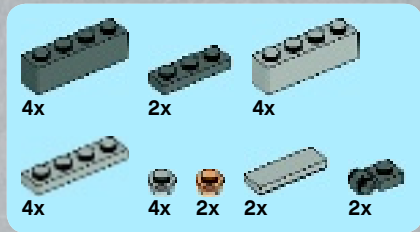

# 11

1

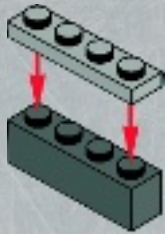

2

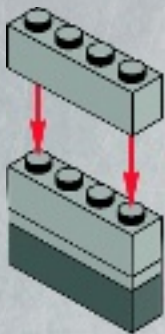

3

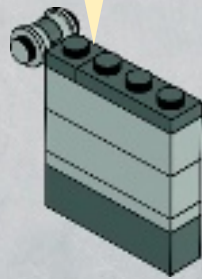

4

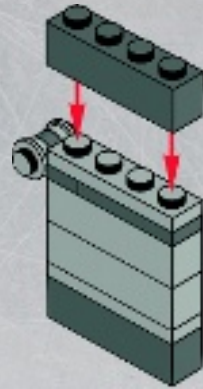

5



2x

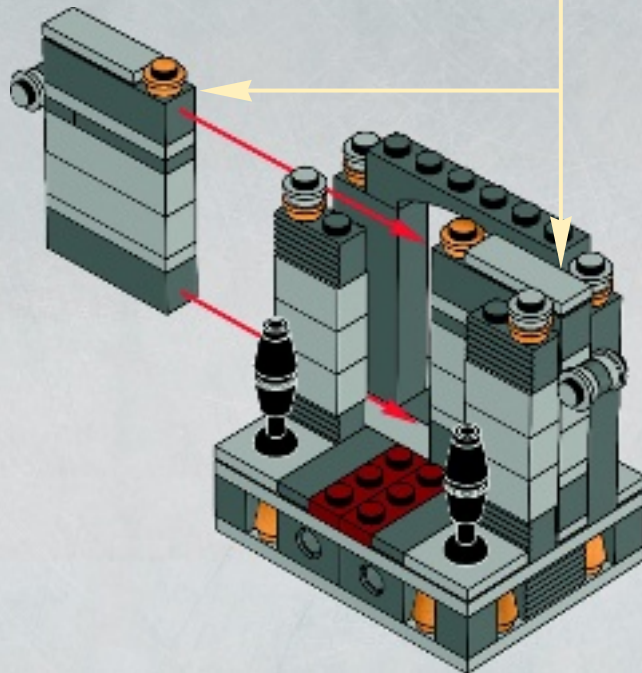





2x



1x

# 12

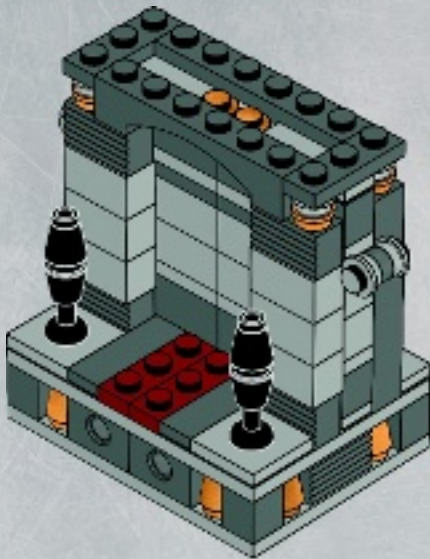

2x

# 13

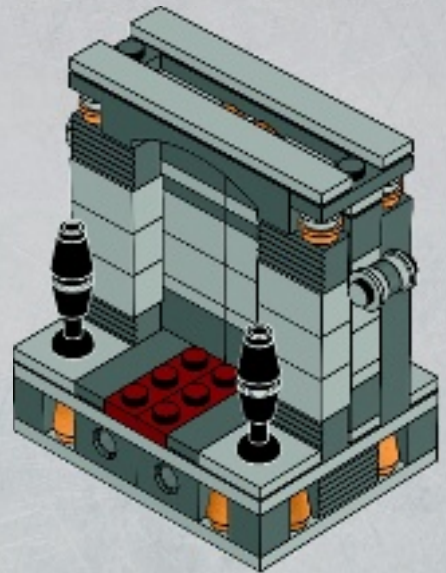

14

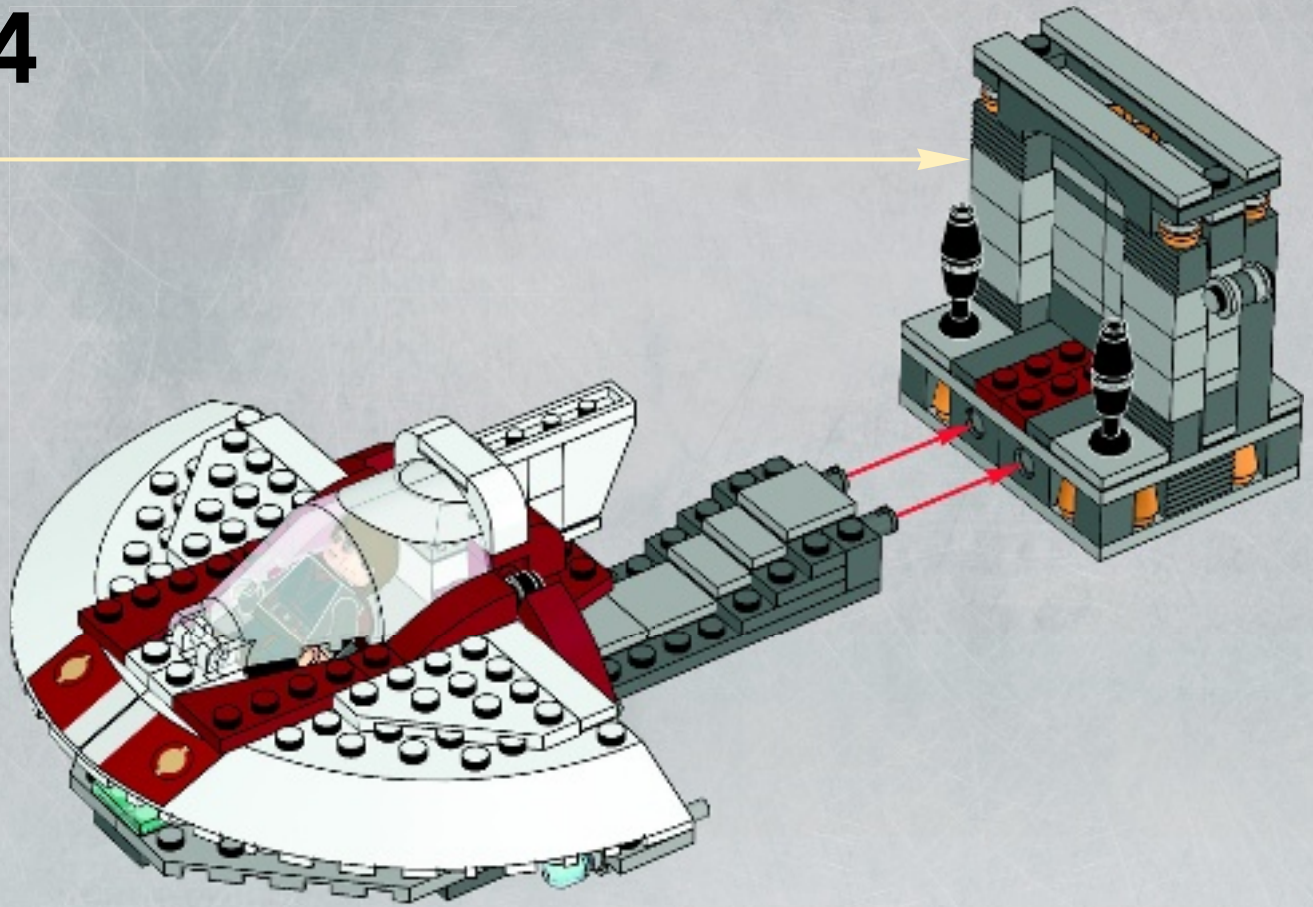





3

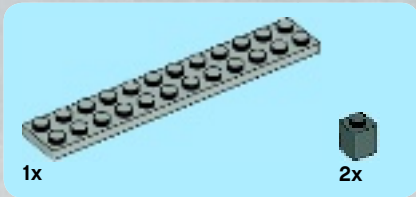
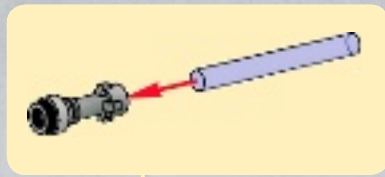
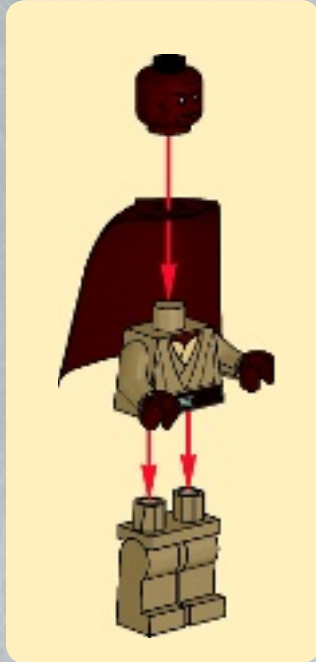
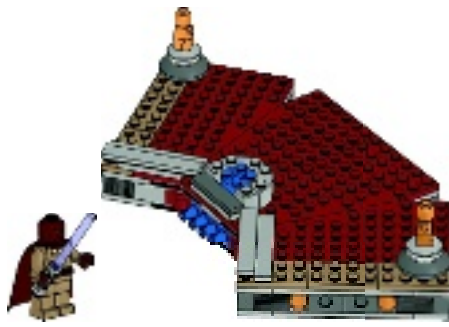

1x

2x

1

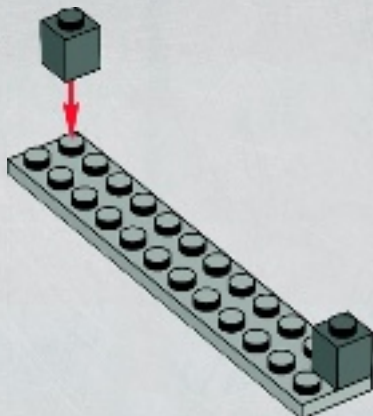

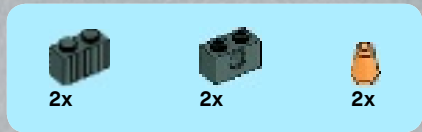

2

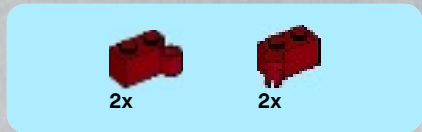
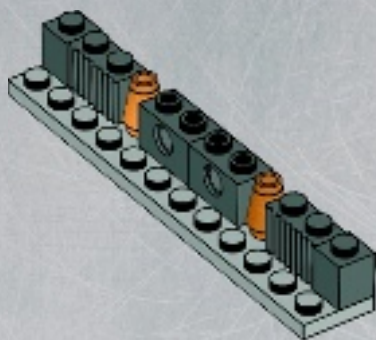

3

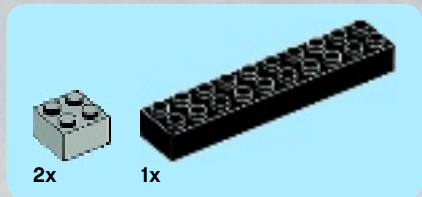
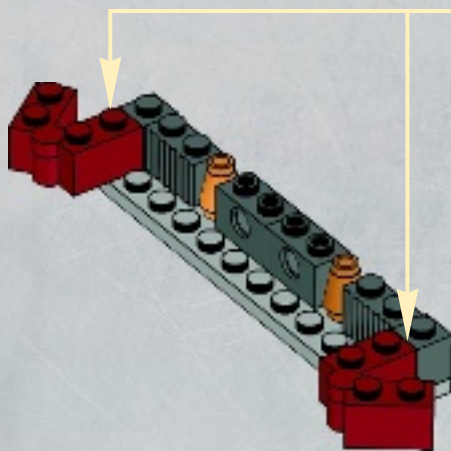
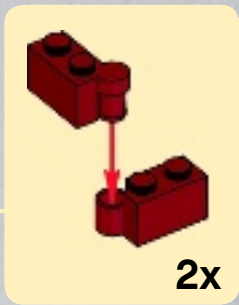

4

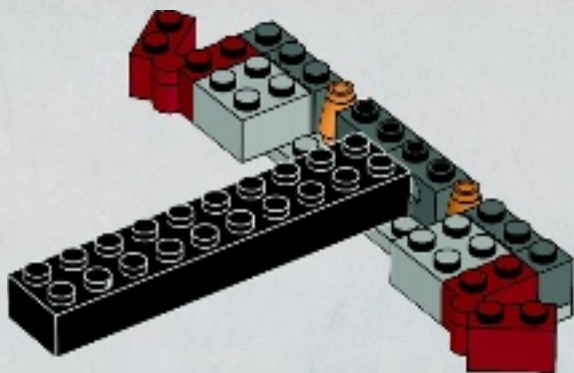



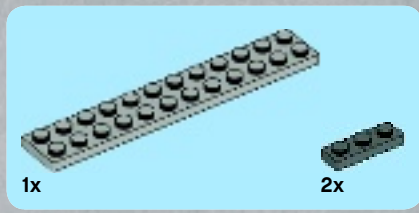

5

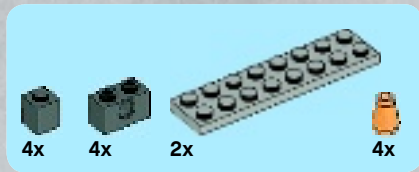
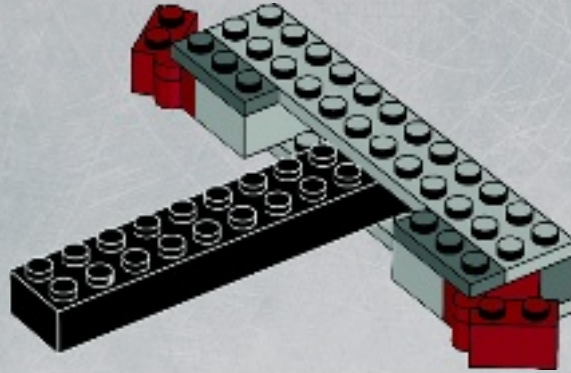

6

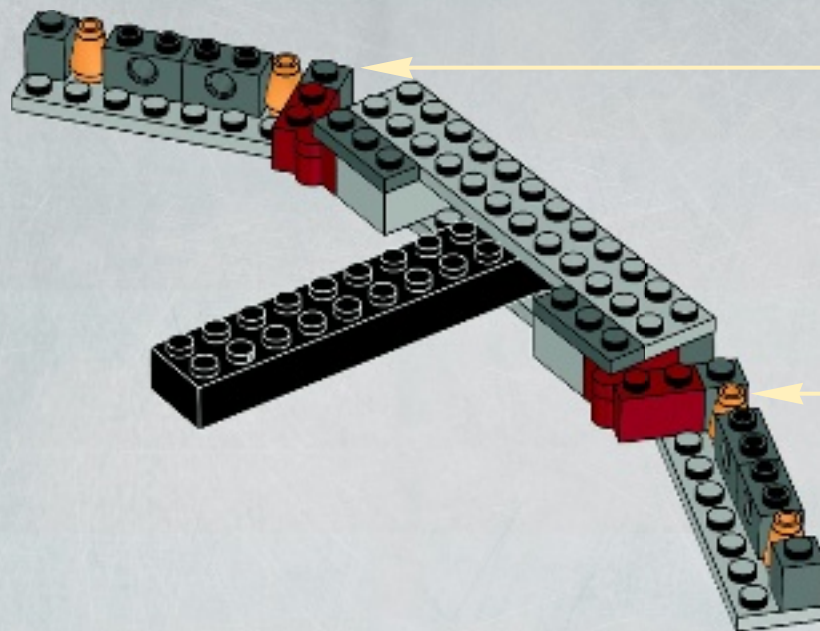
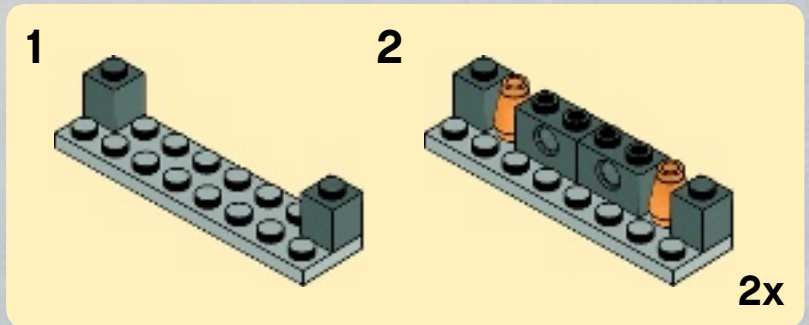

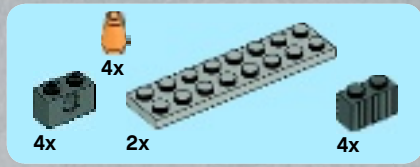

7

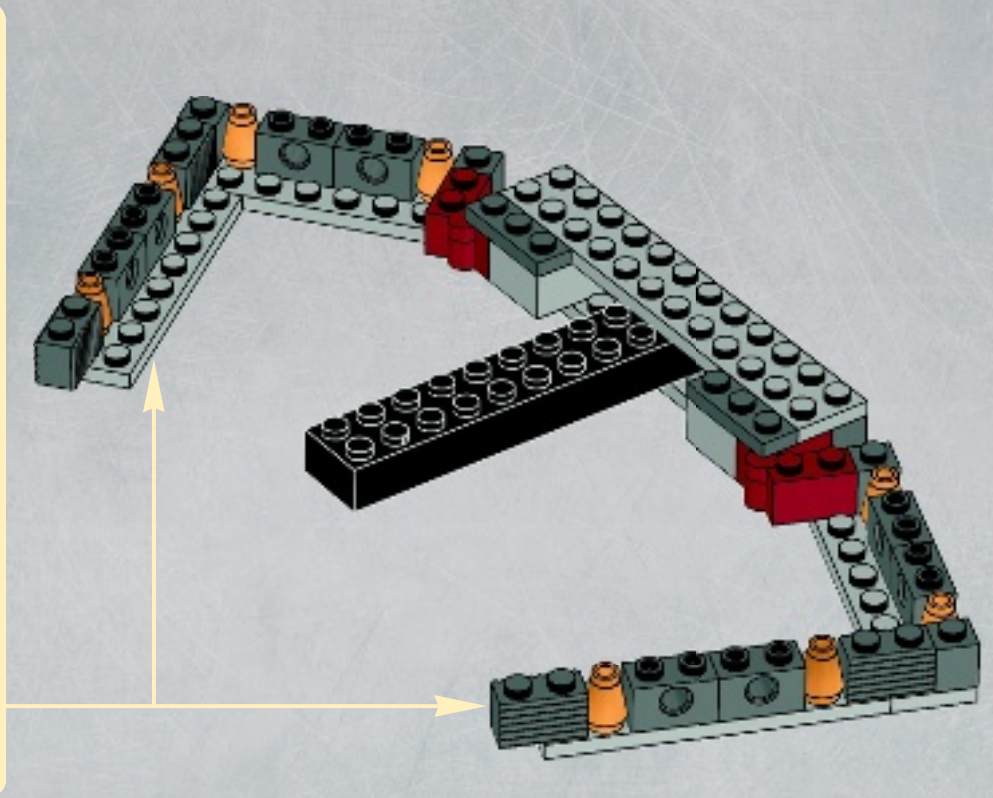
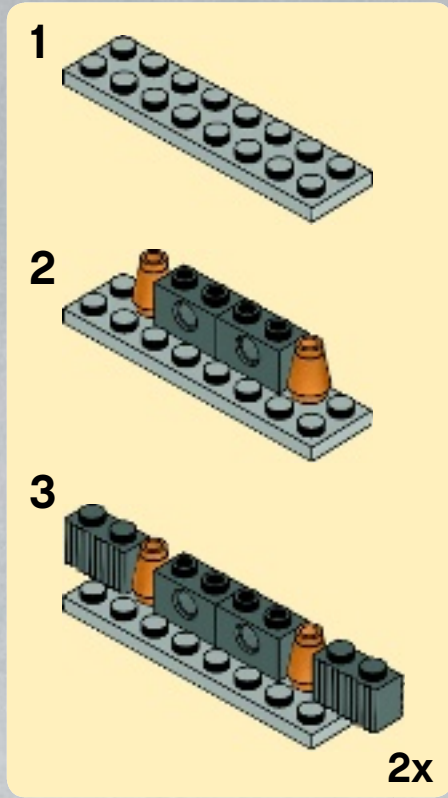

8

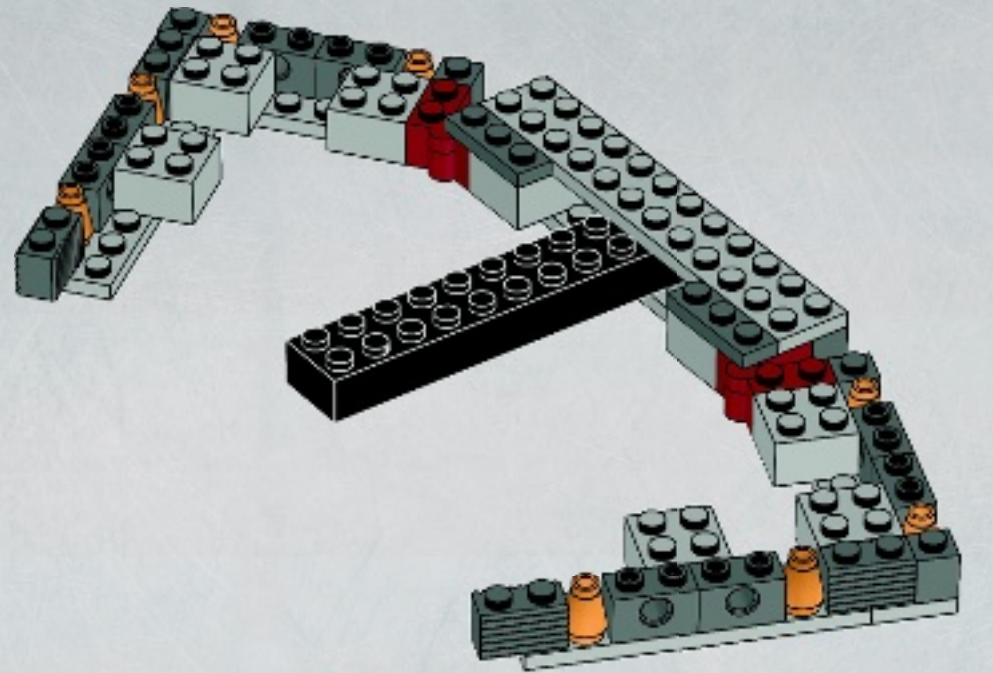



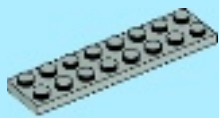

4x

# 9

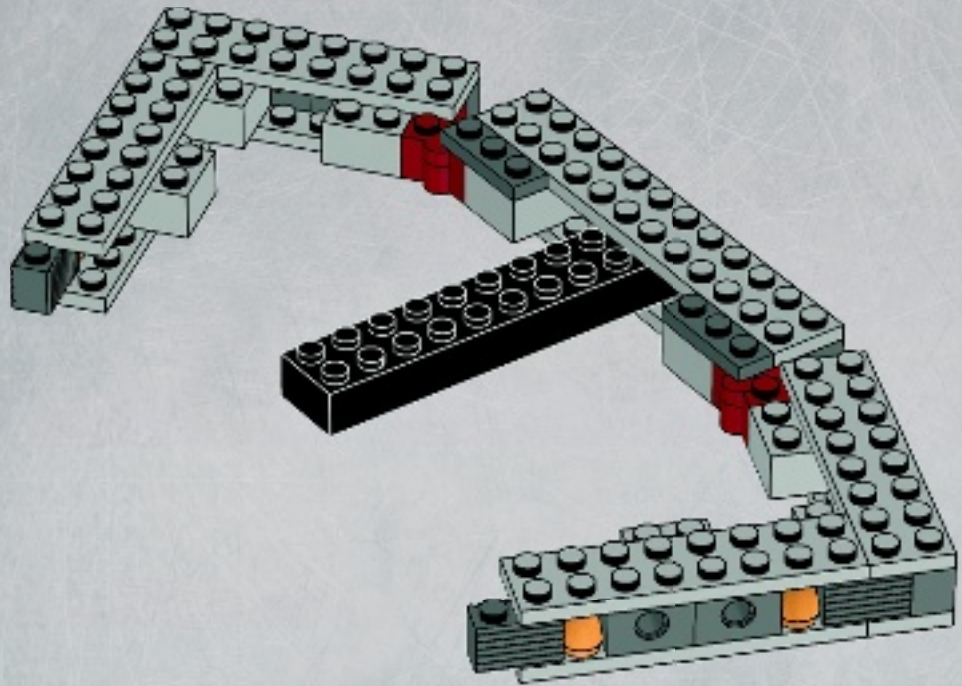

4x



2x

# 10

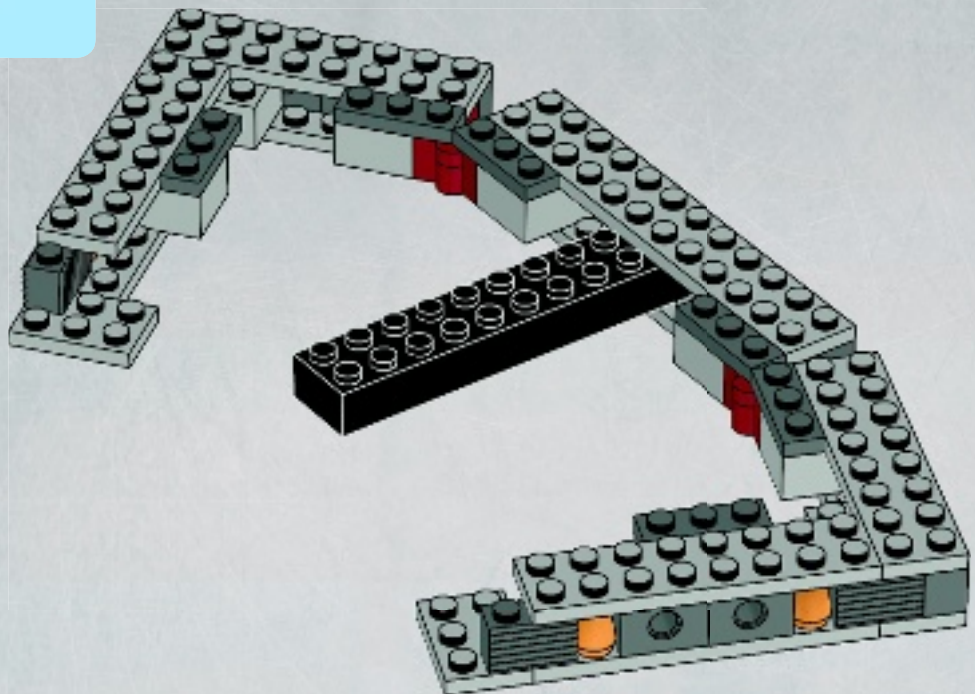

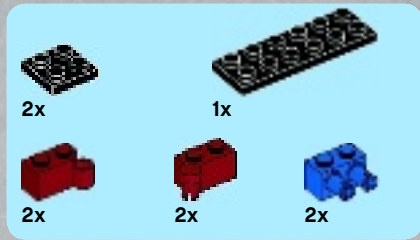

# 11

1



2

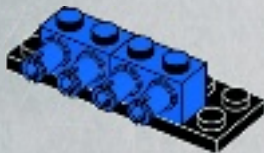

3



4

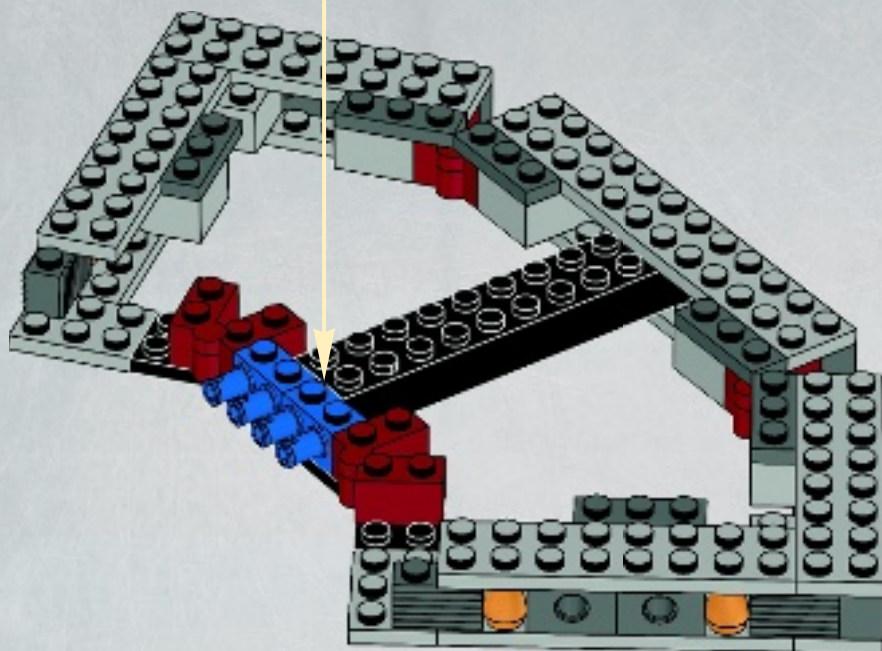
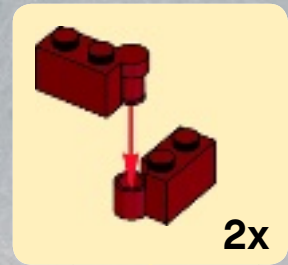
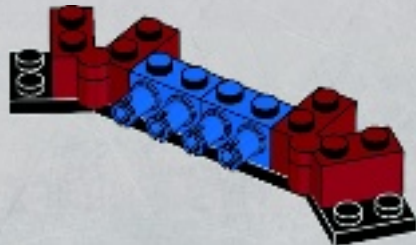





2x



2x

# 12

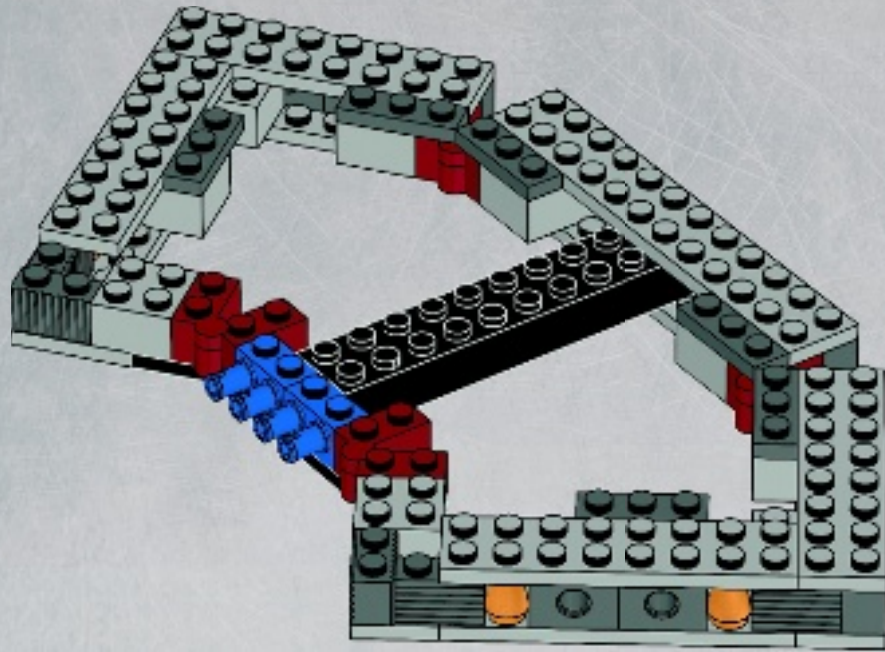

1x



4x



2x

# 13

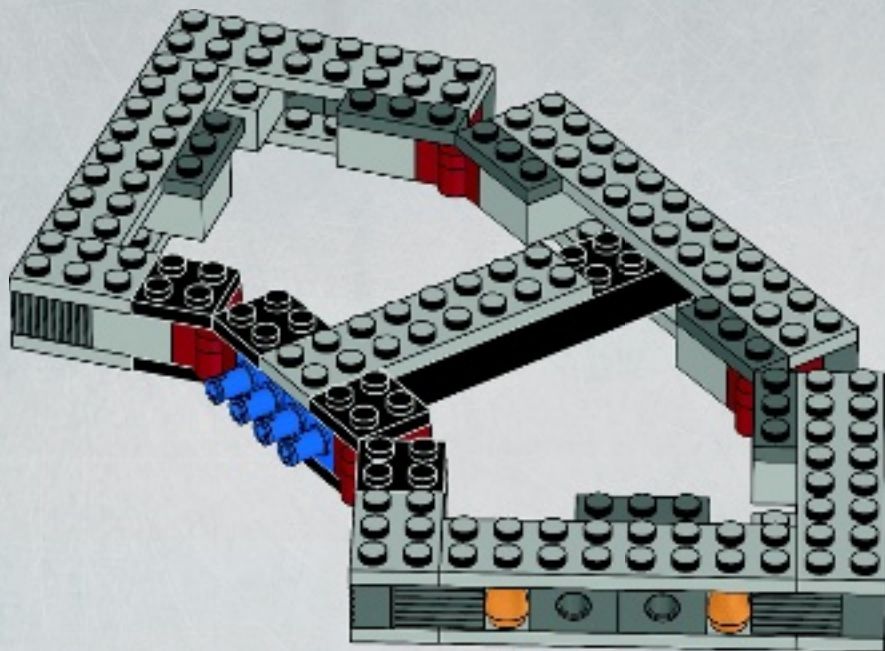

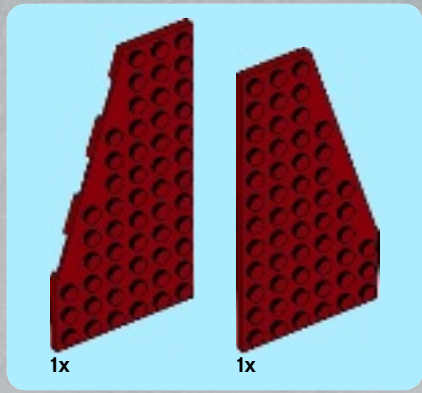

14

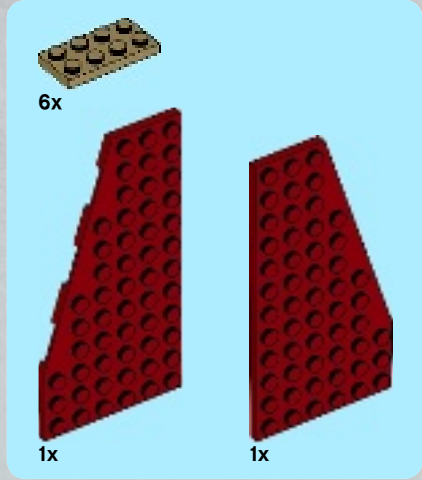
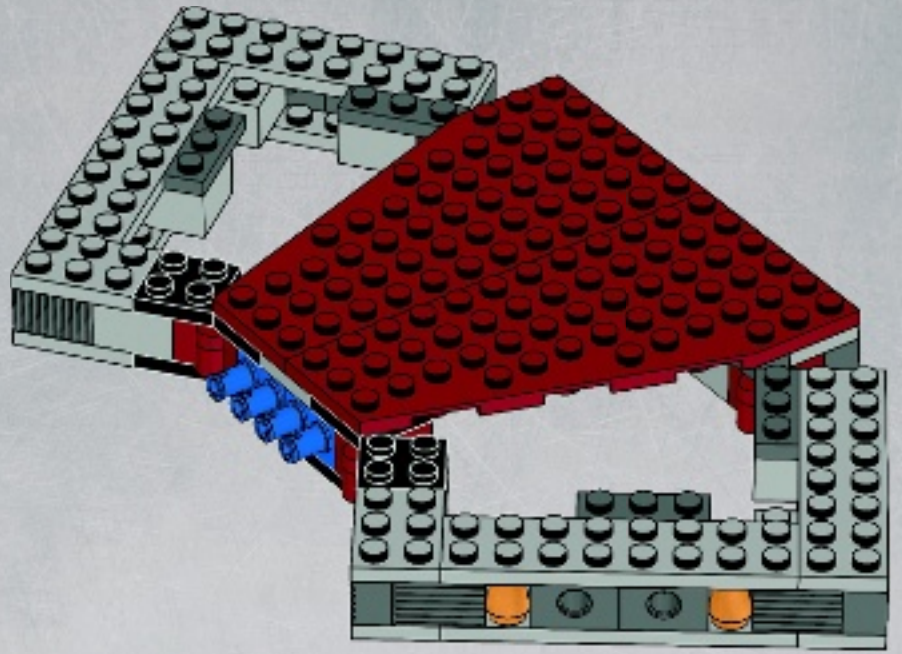

15

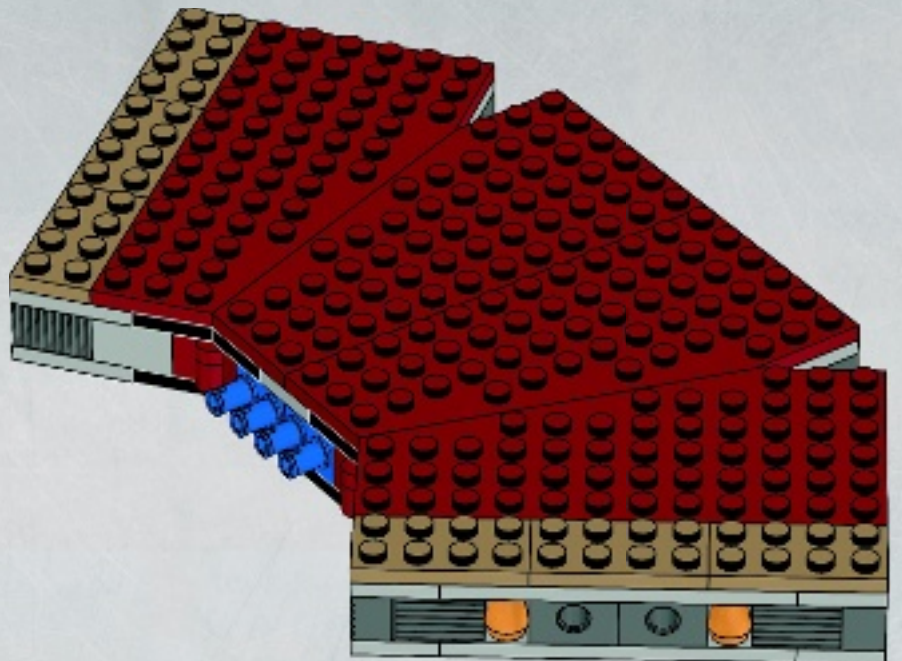



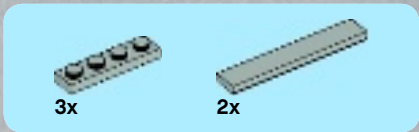

# 16

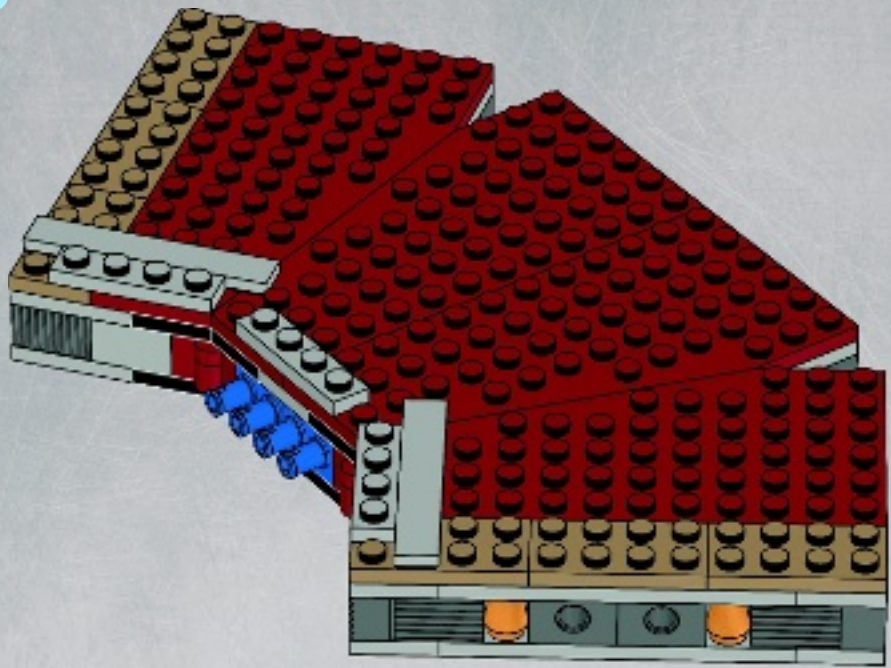

# 17

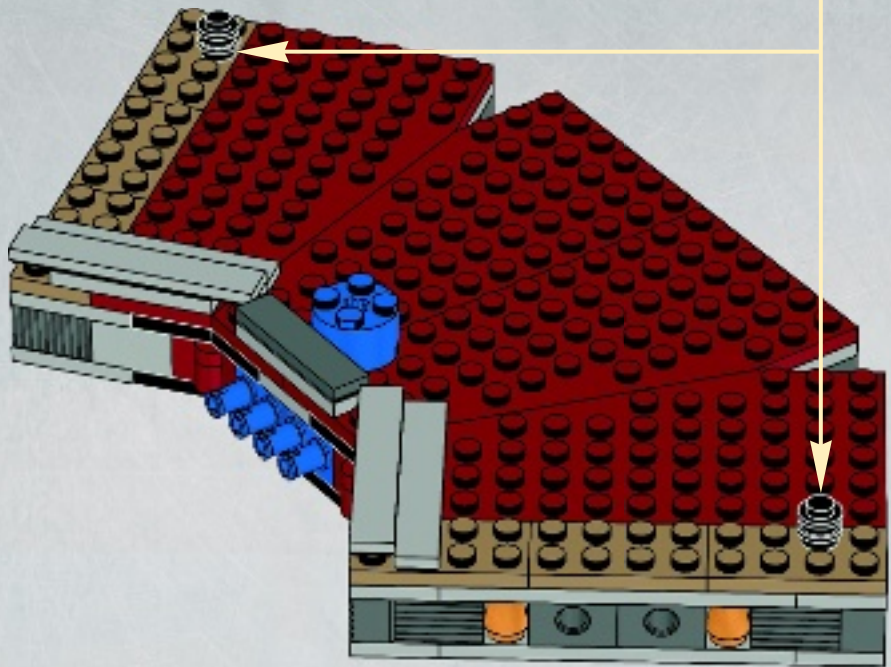
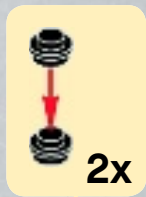





2x



2x

# 18

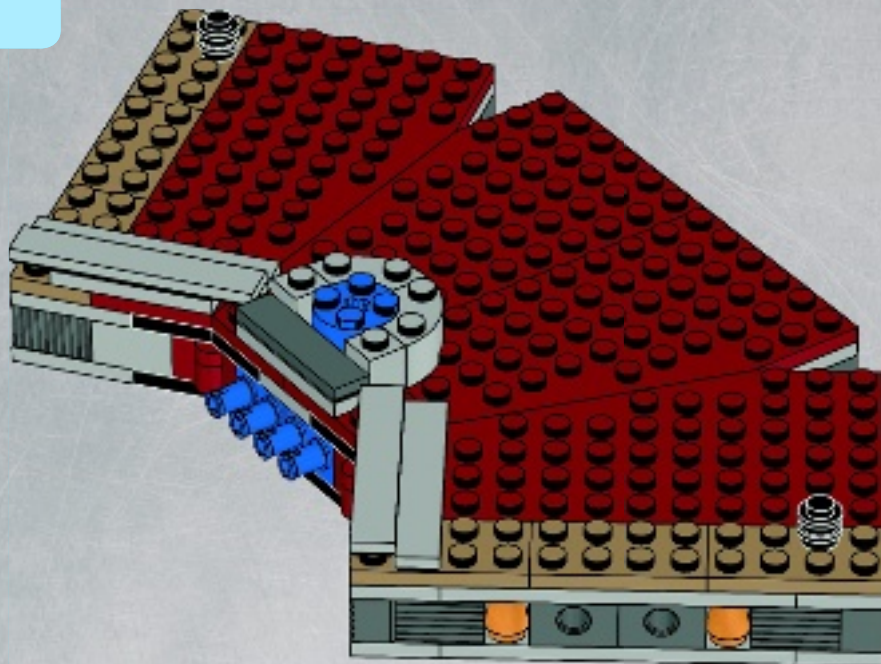

2x



2x



2x



2x

# 19

1



2



2x

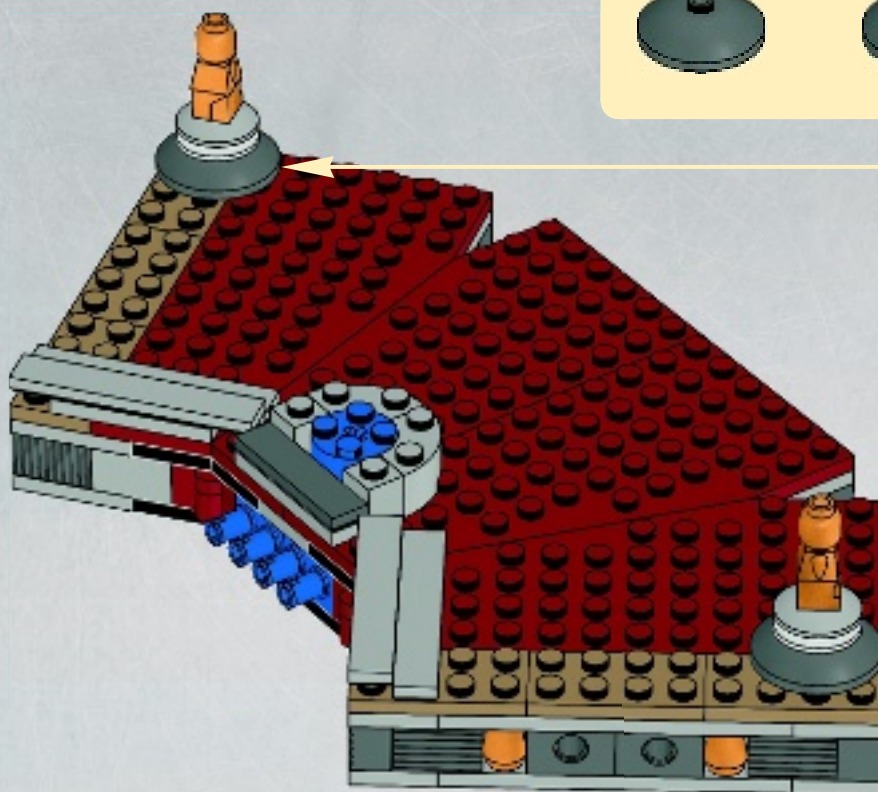



20

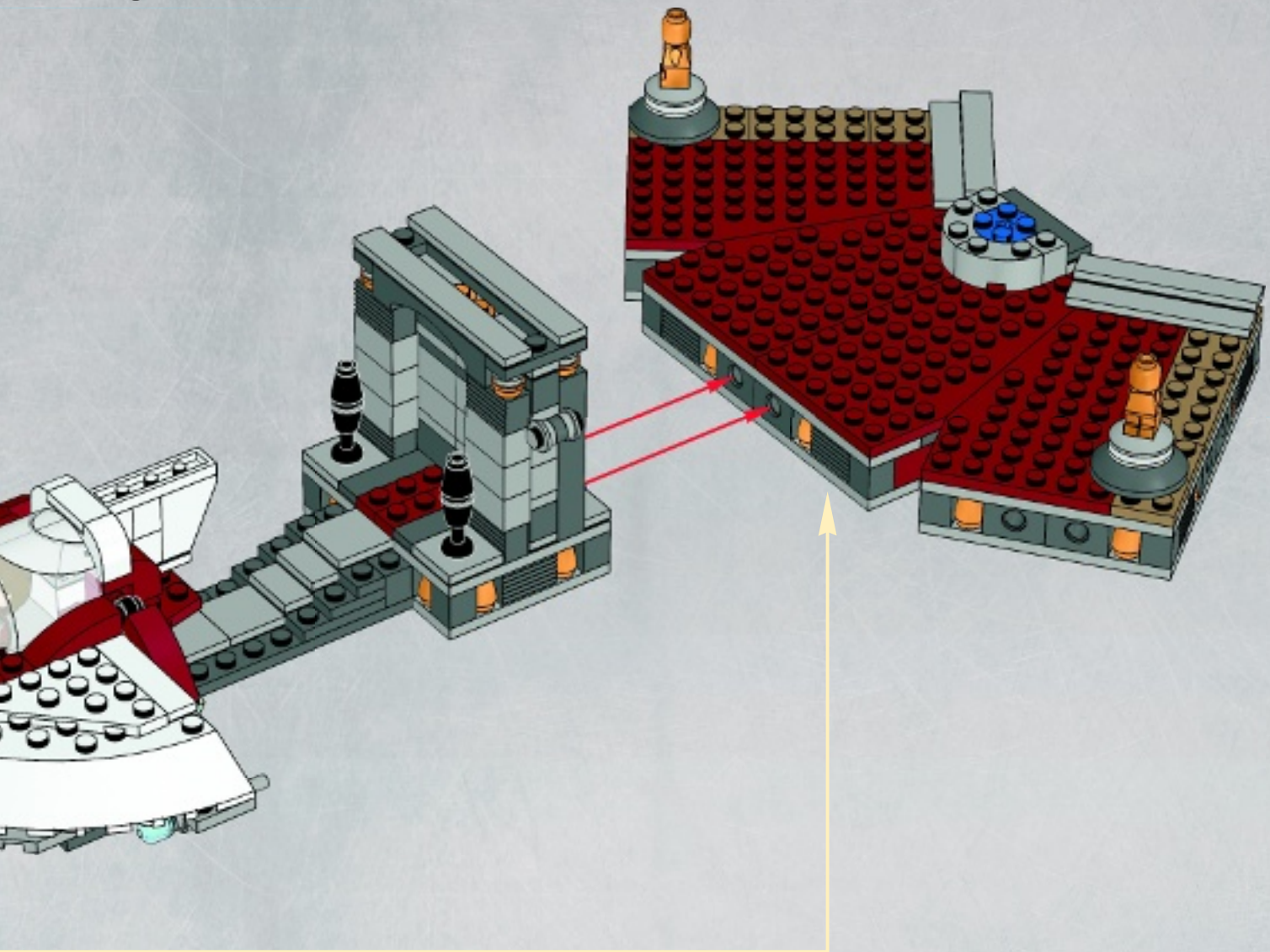



1

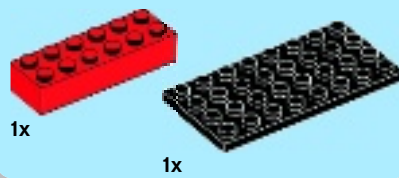
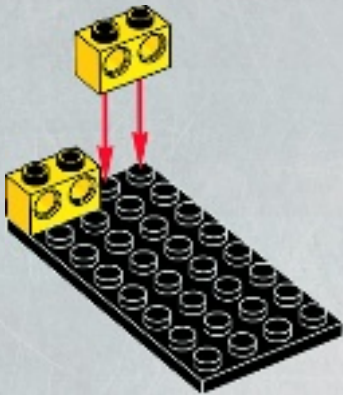

2

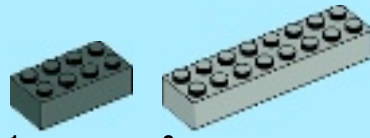
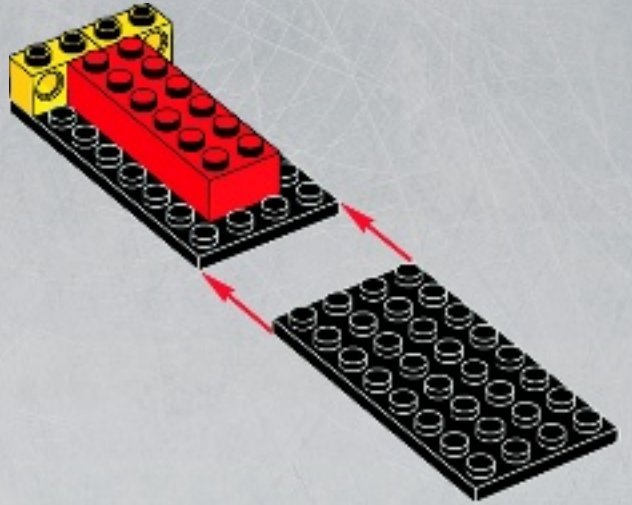

3

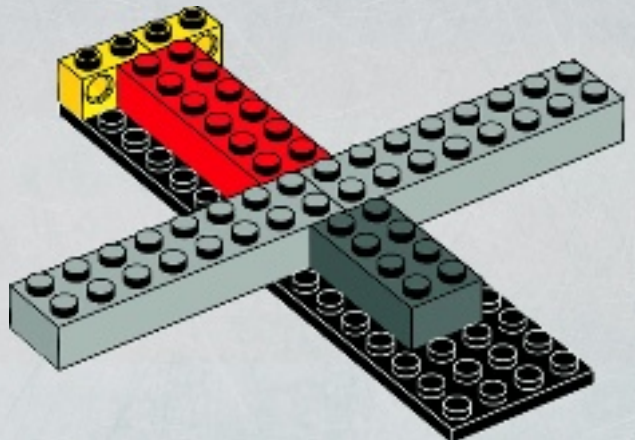



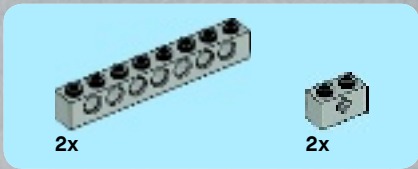

4

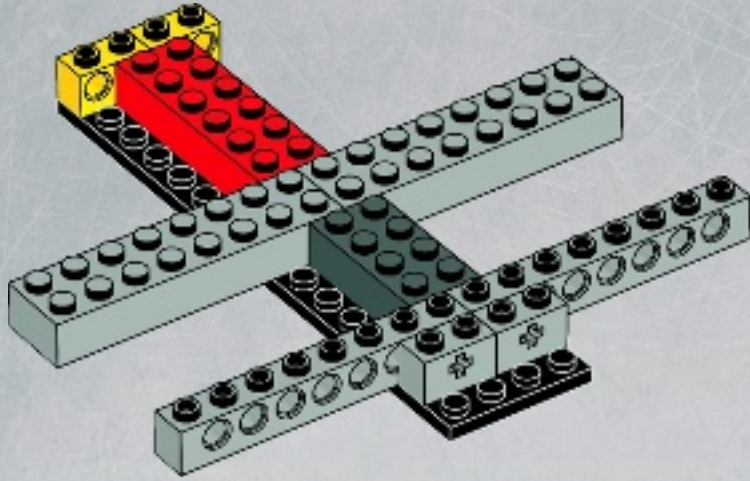

5

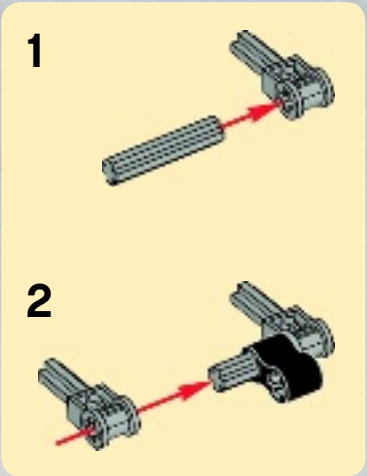
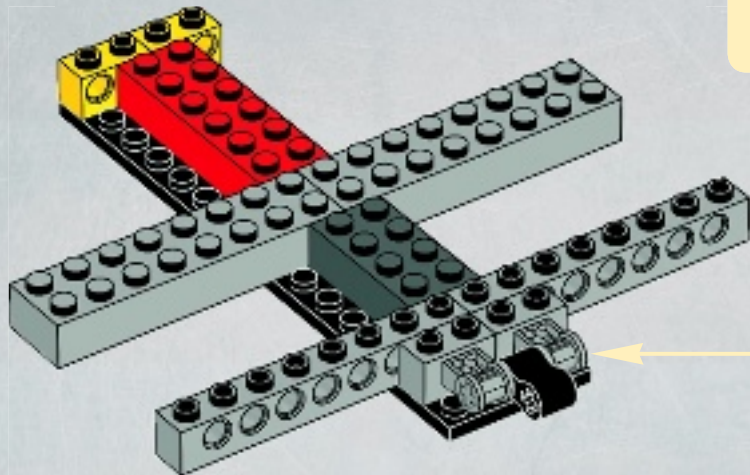



6

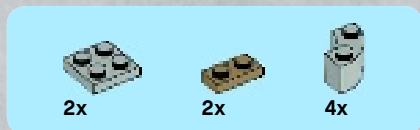
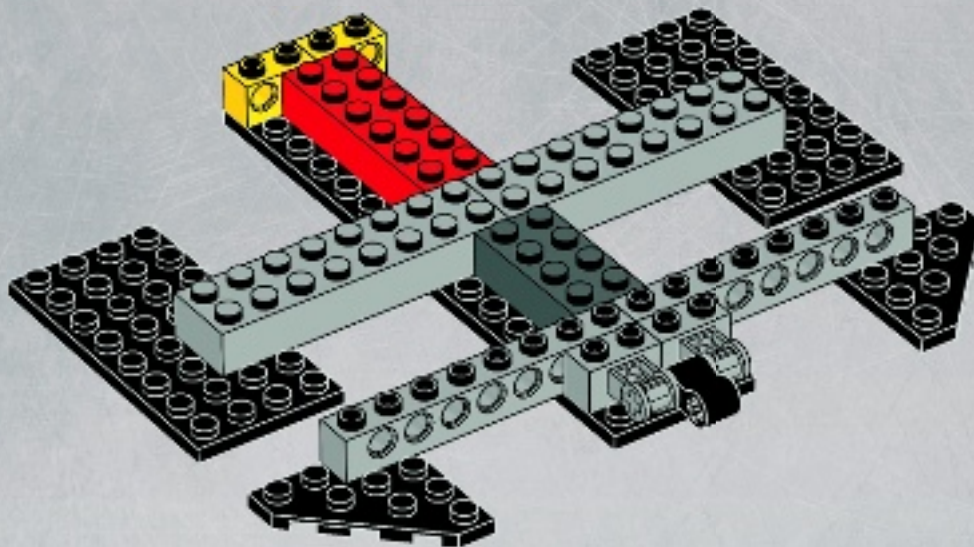

7

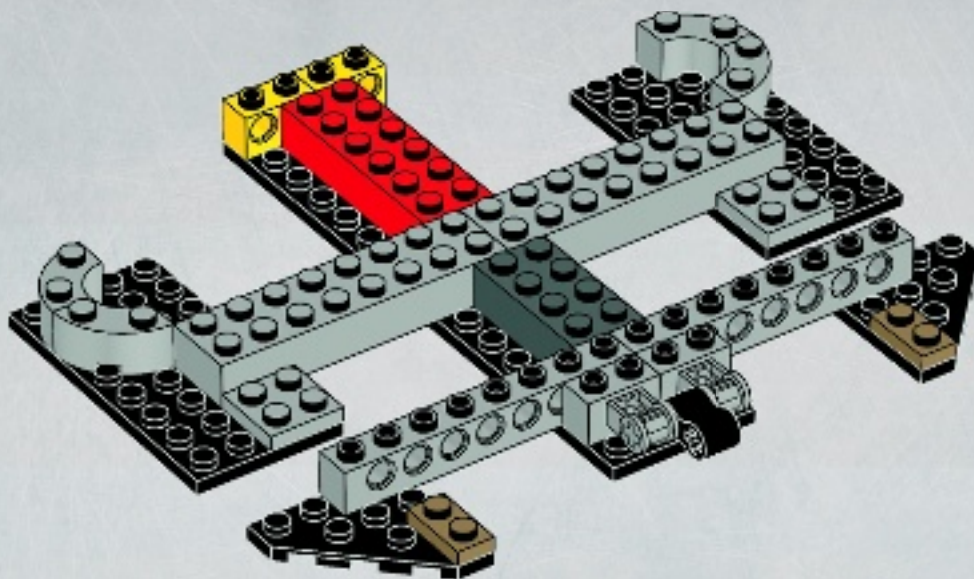





2x



4x

# 8

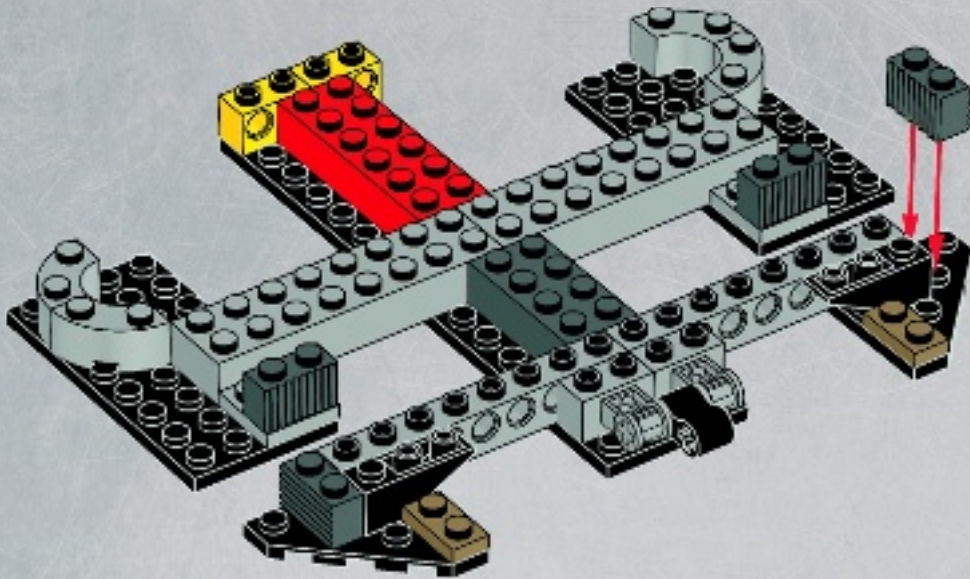

6x



6x

# 9



6x

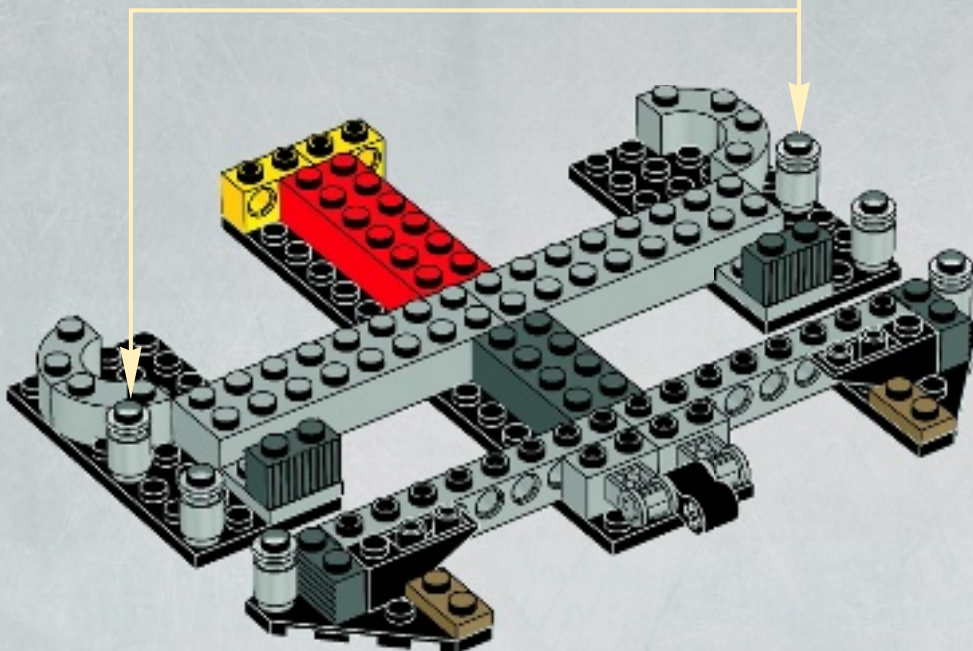



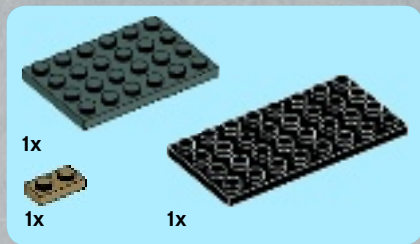

# 10

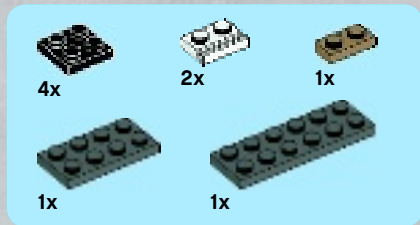
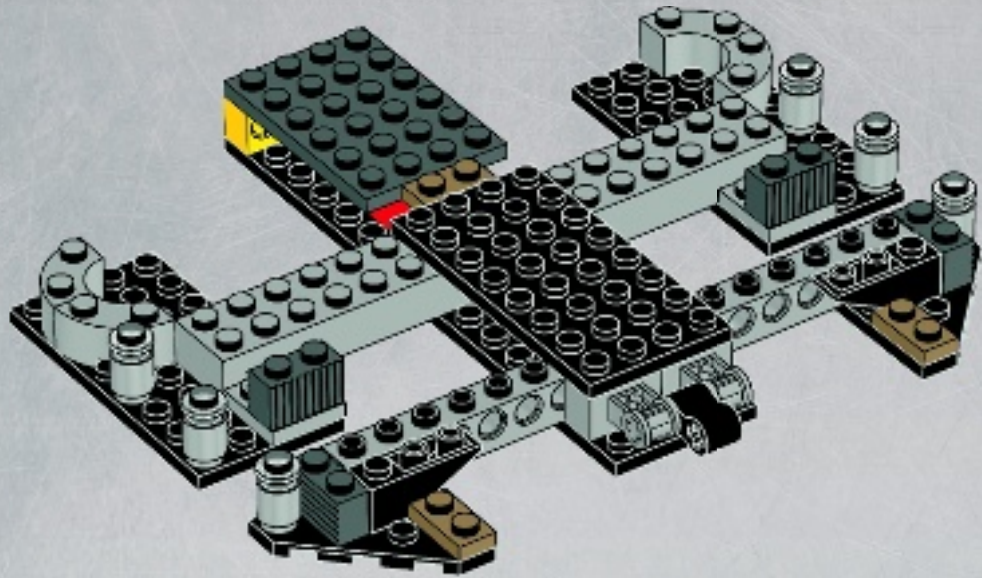

# 11

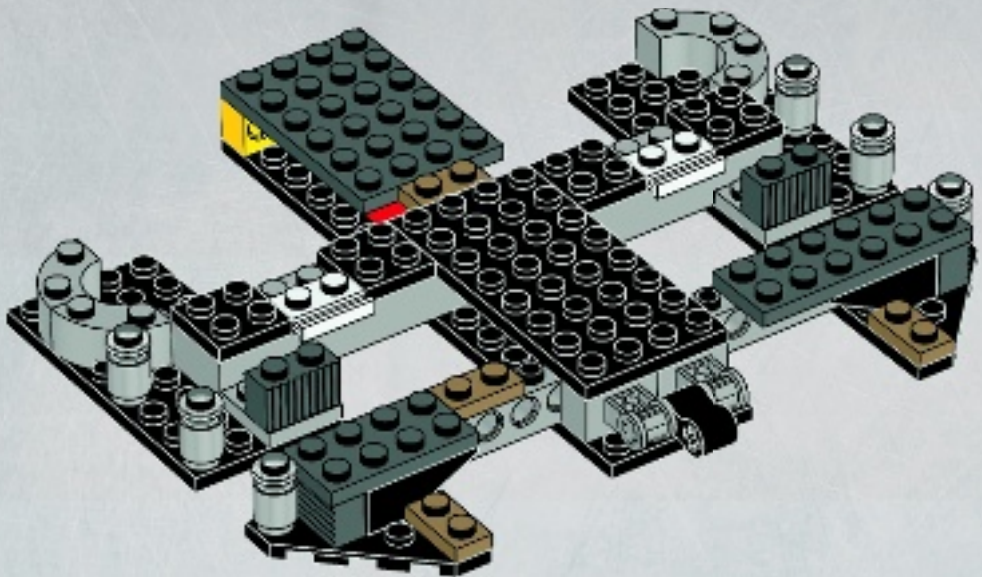



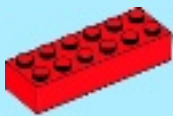

3x



1x

12

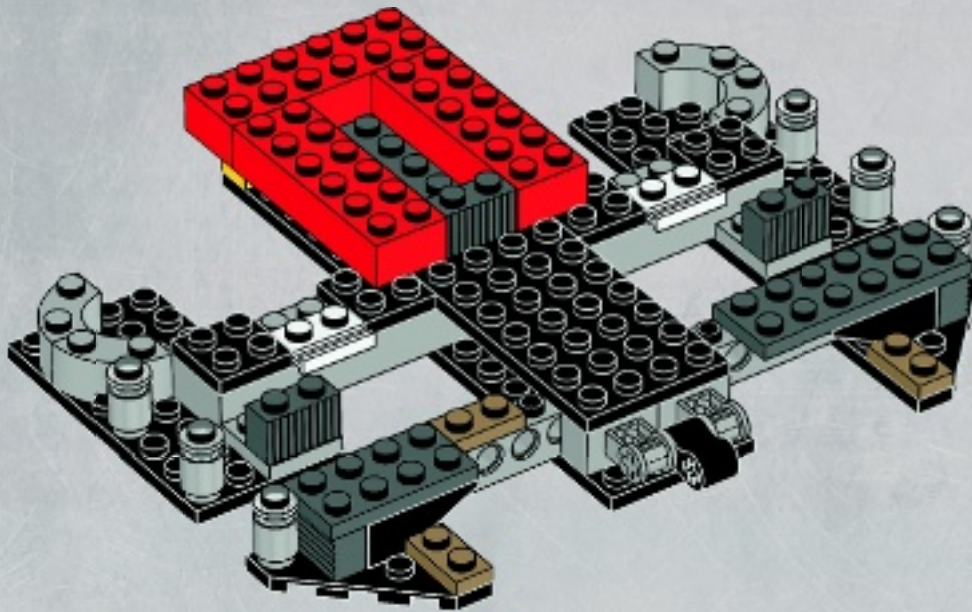



6x



4x

# 13

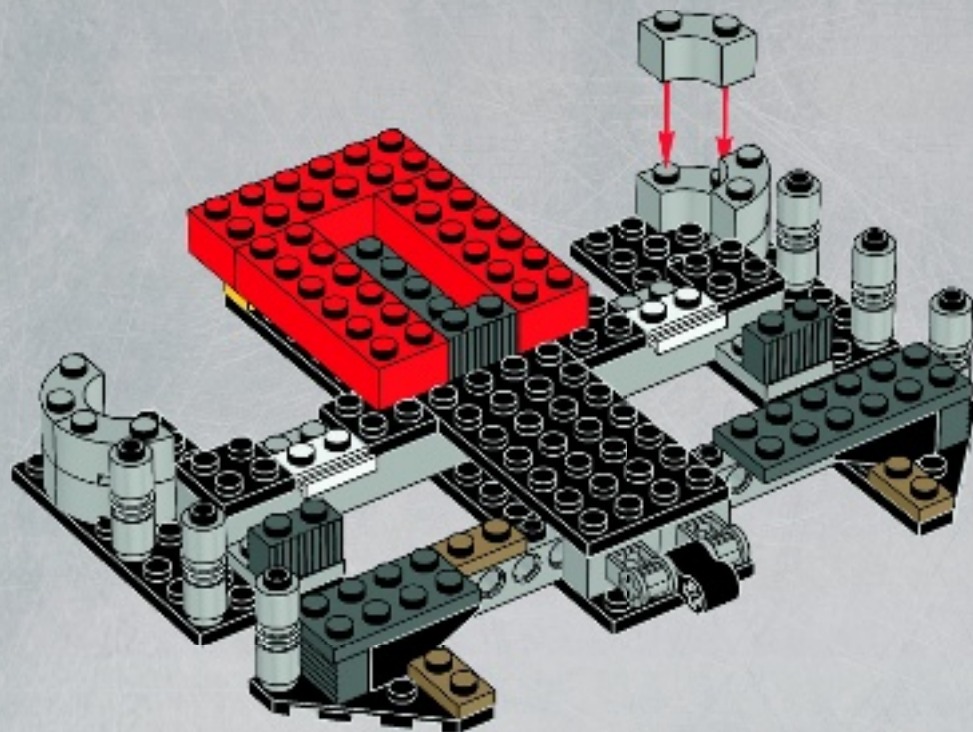

2x

# 14

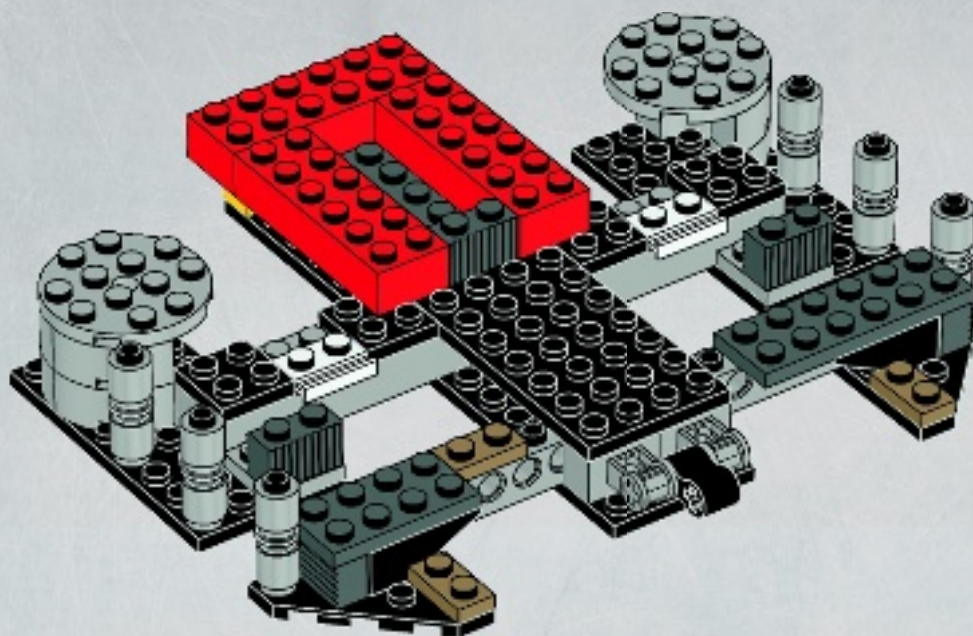



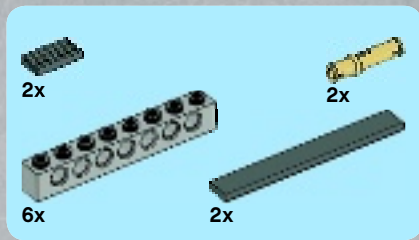

15

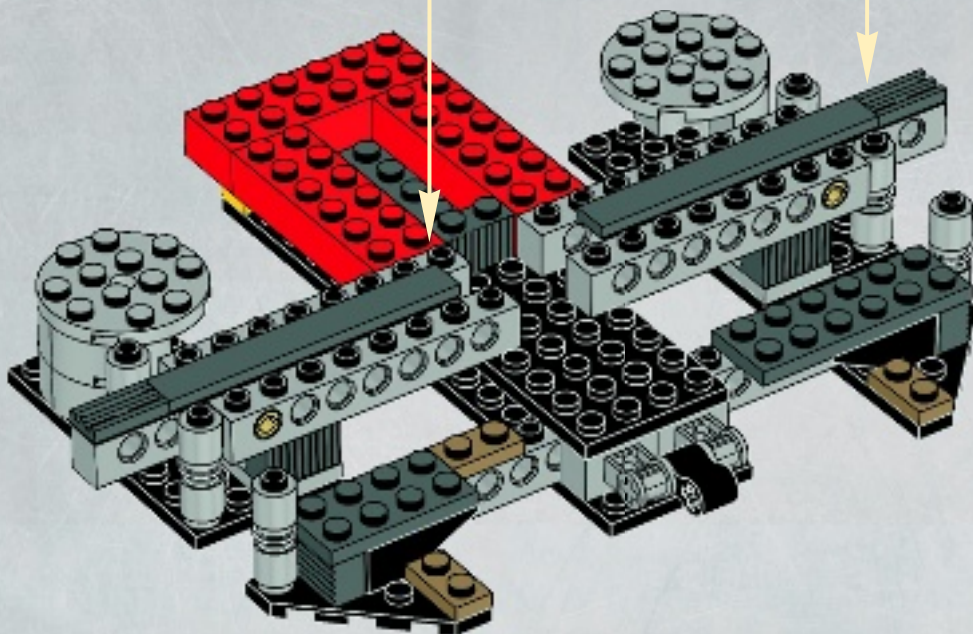
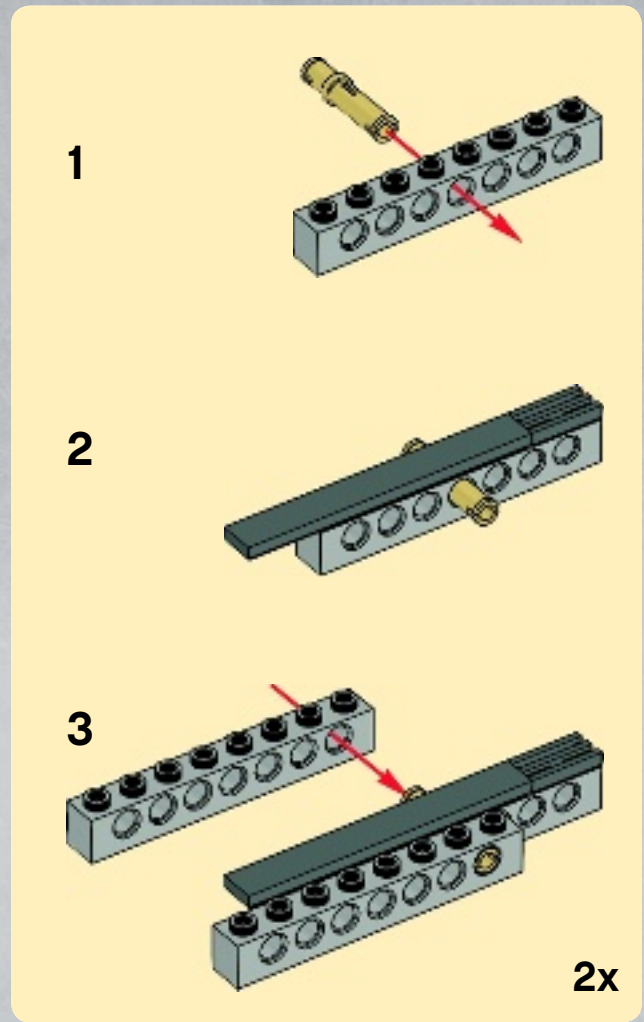

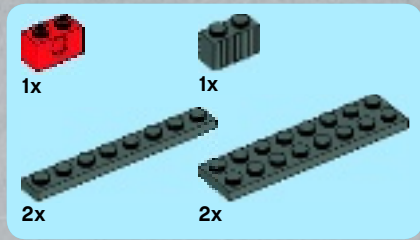

16

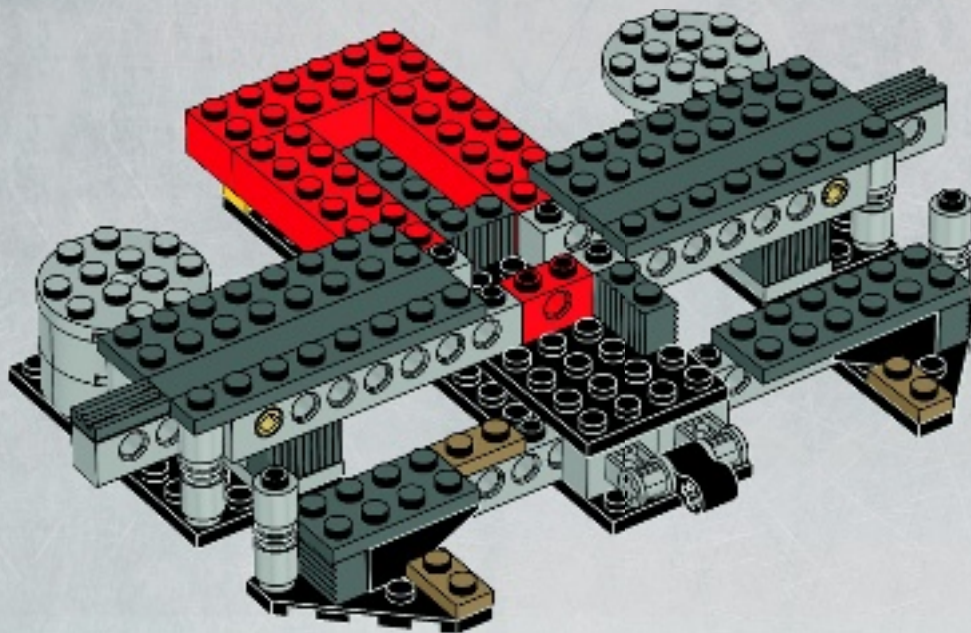





1x



2x



1x



1x

# 17



1

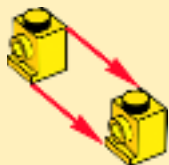

2

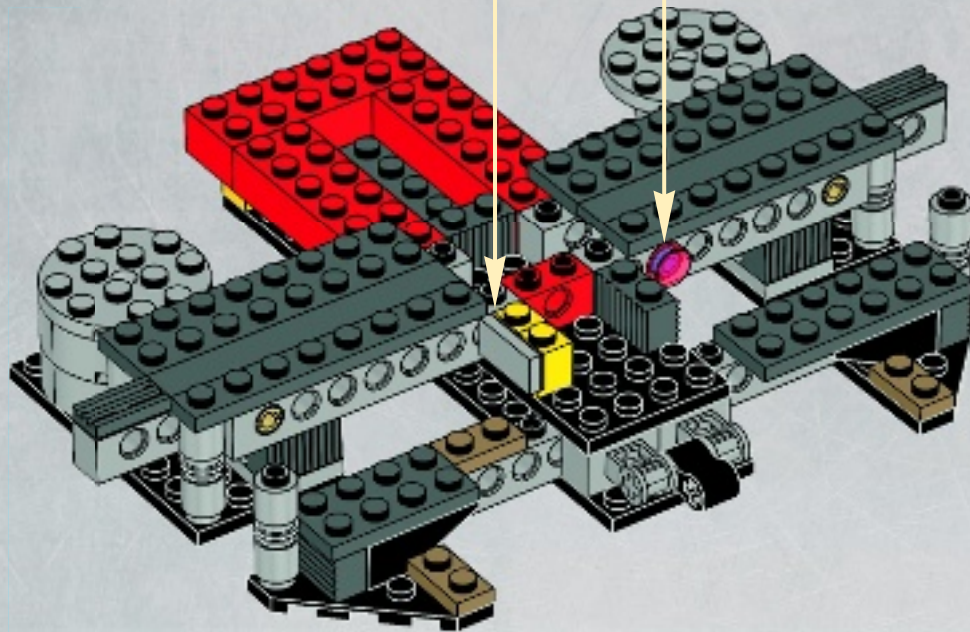

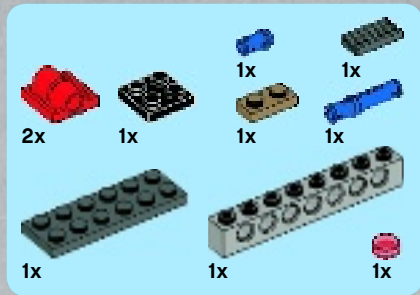

# 18

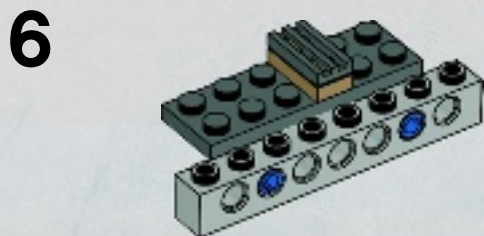
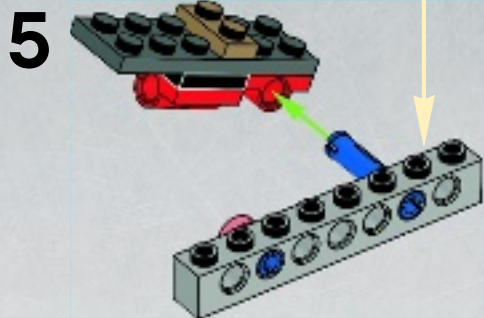
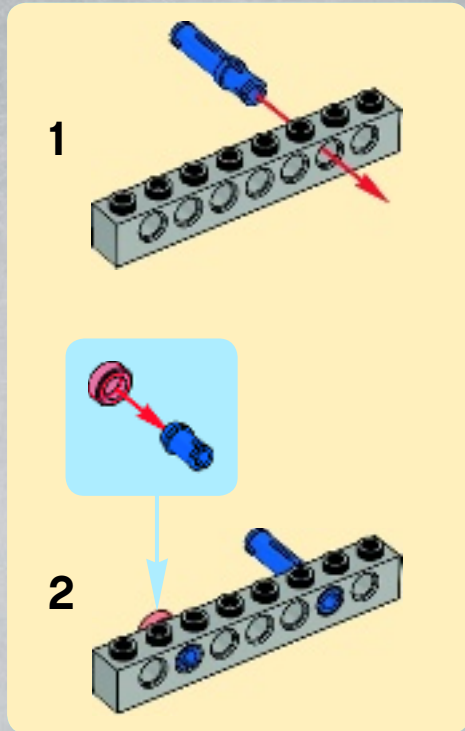
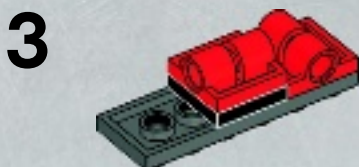
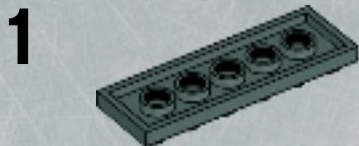



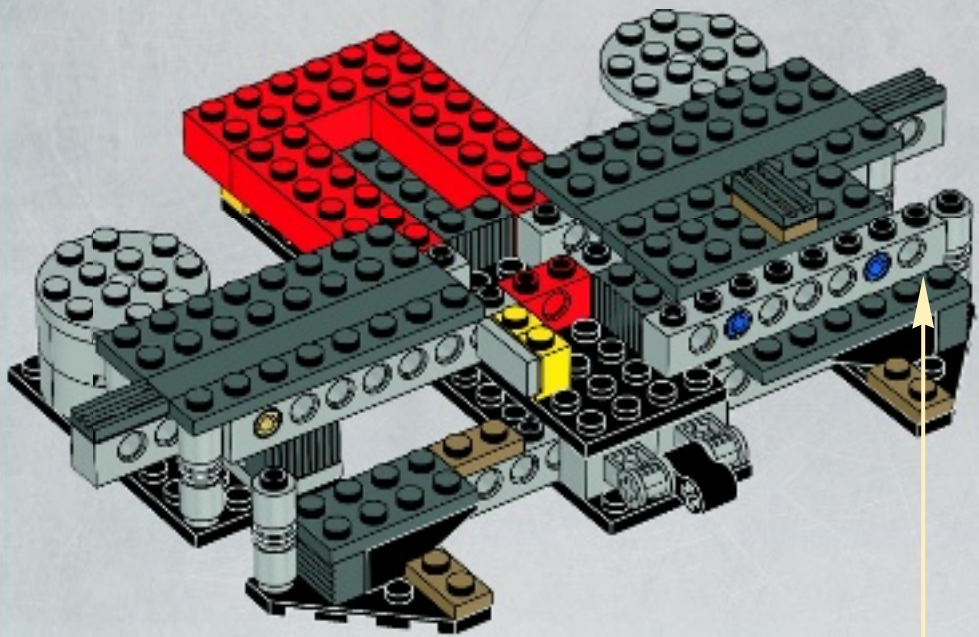

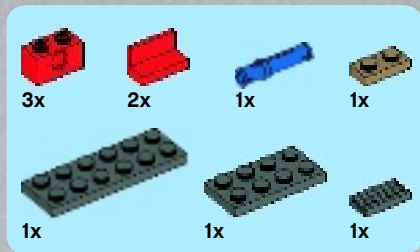

# 19

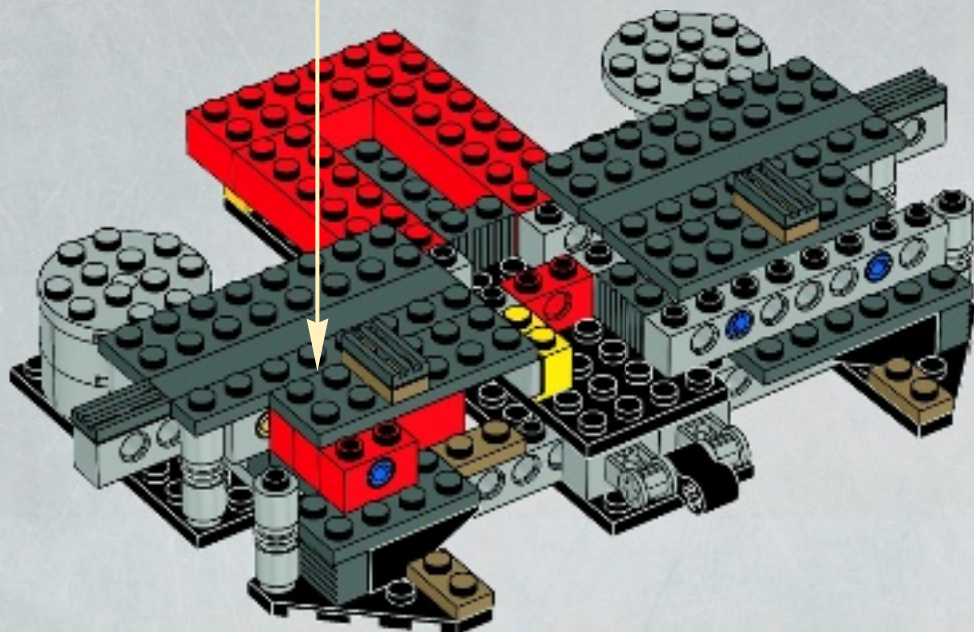
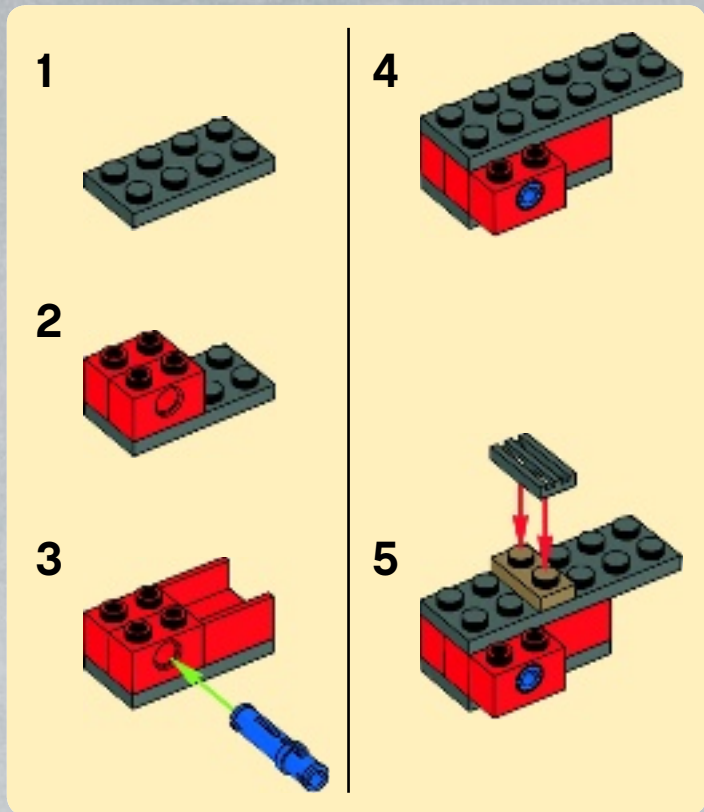



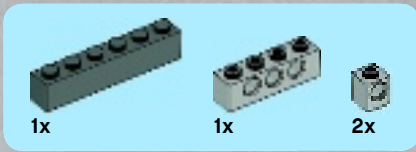

# 20

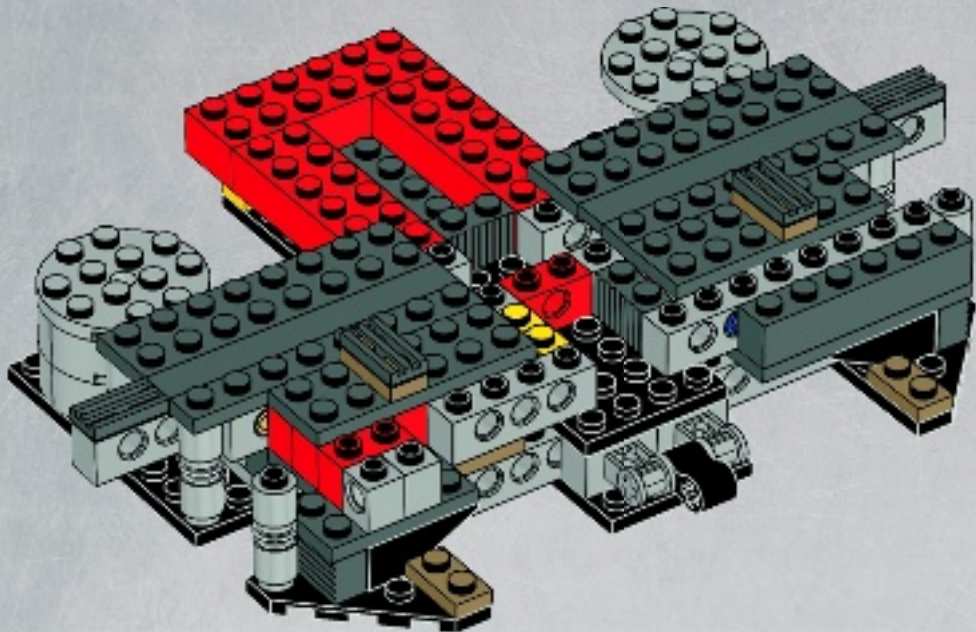

# 21

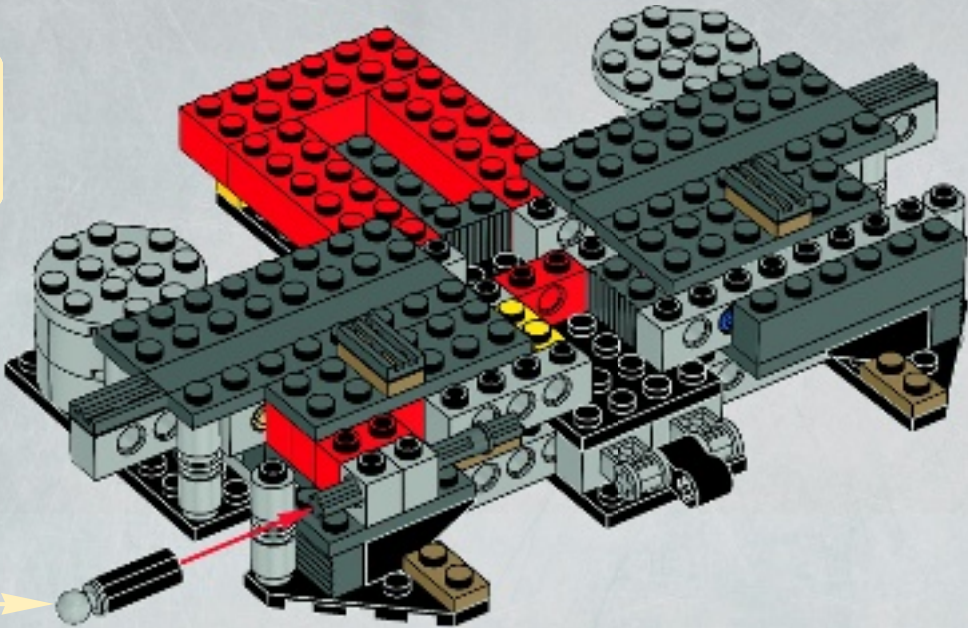
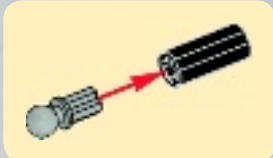





22

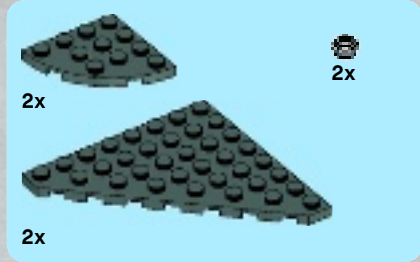
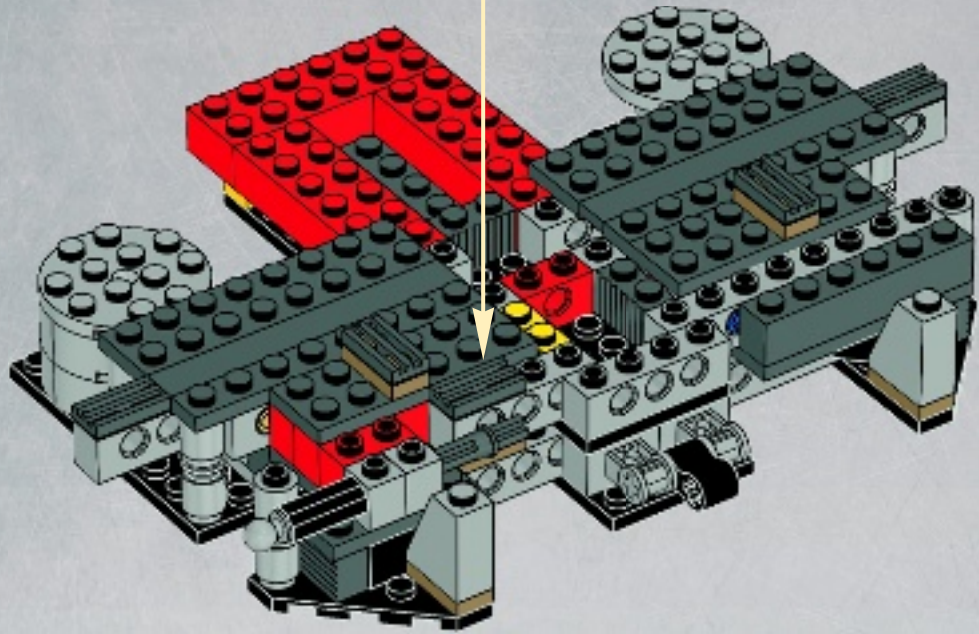

23

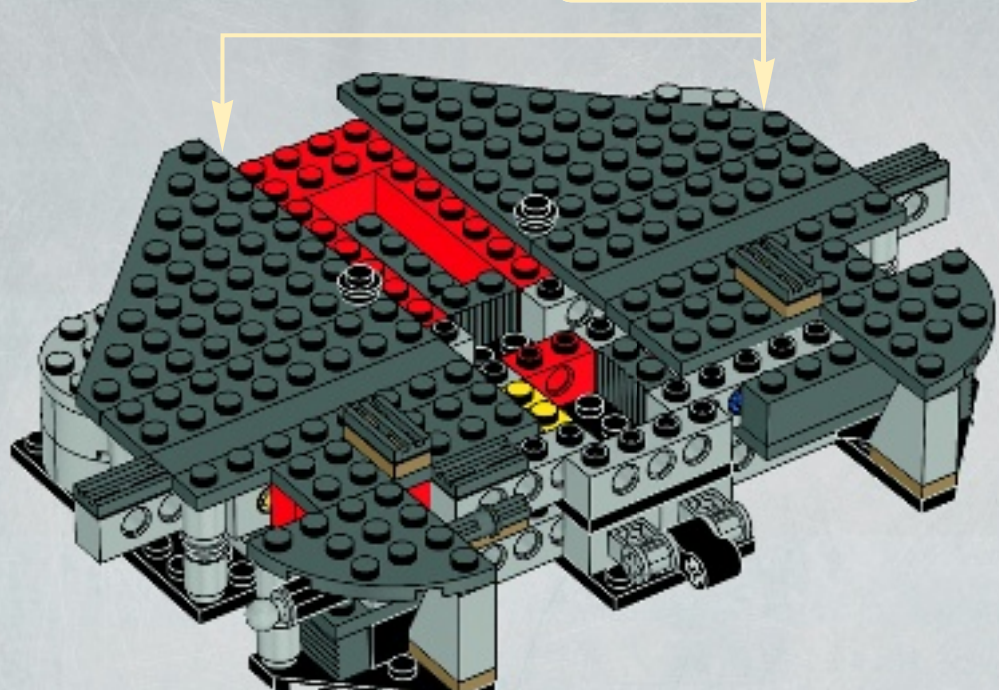
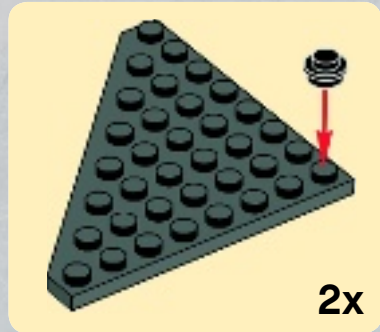





2x



8x

# 24

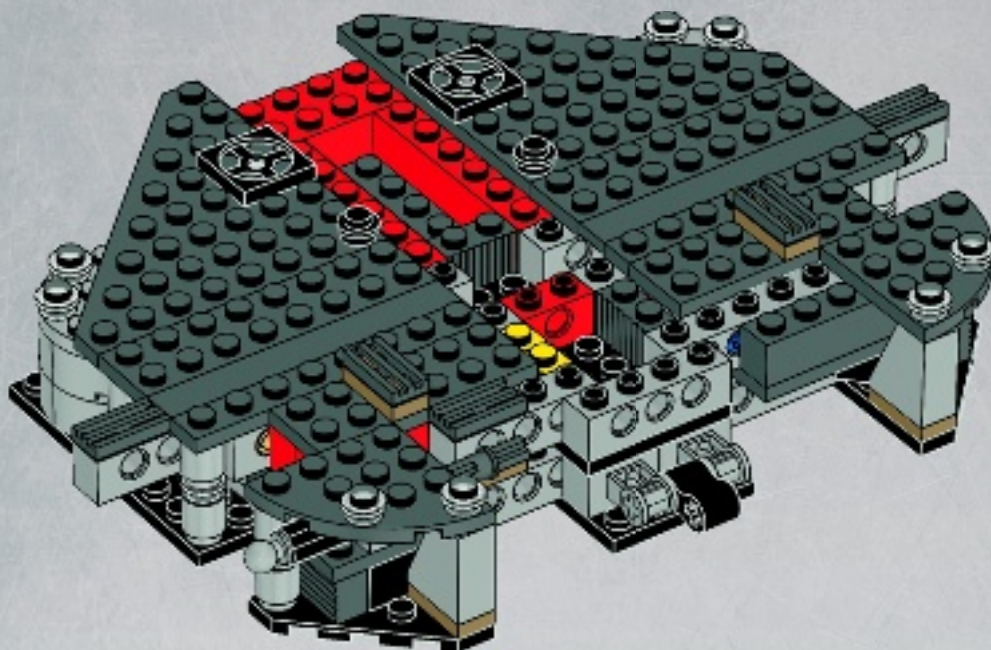

1x



1x



1x



2x

# 25

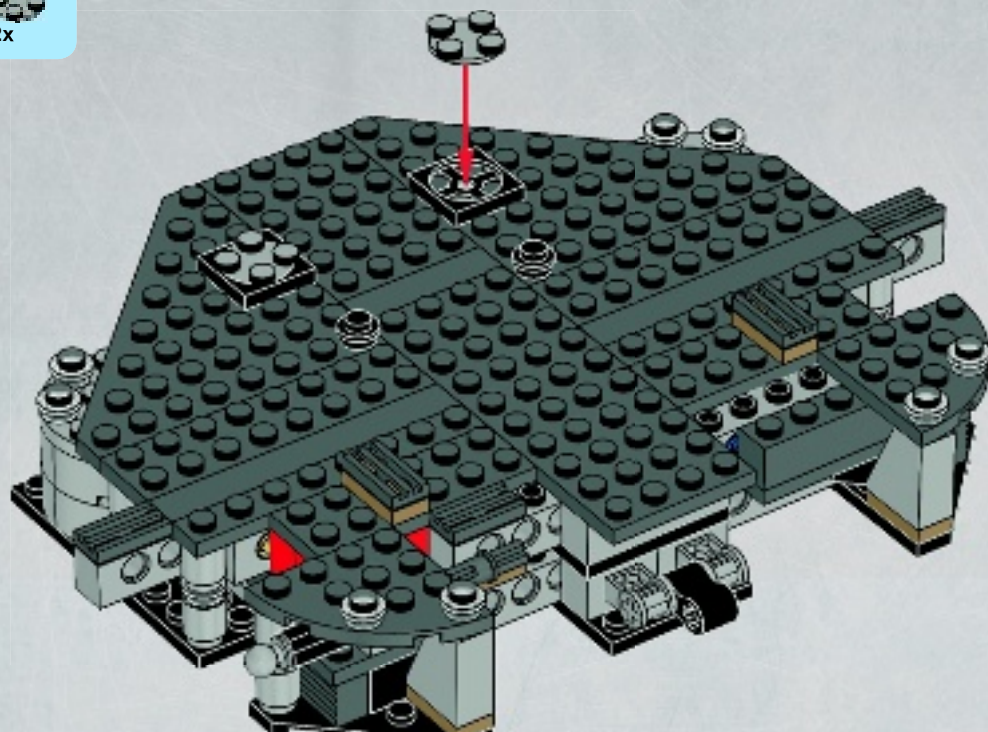







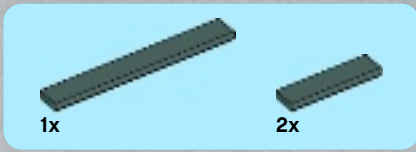

27

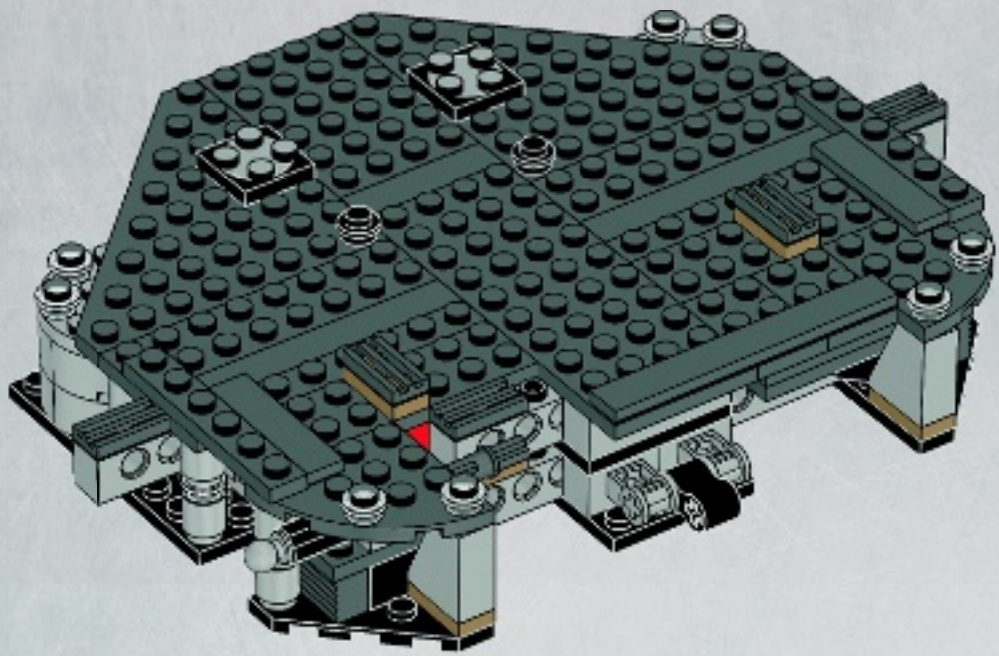



2x

28

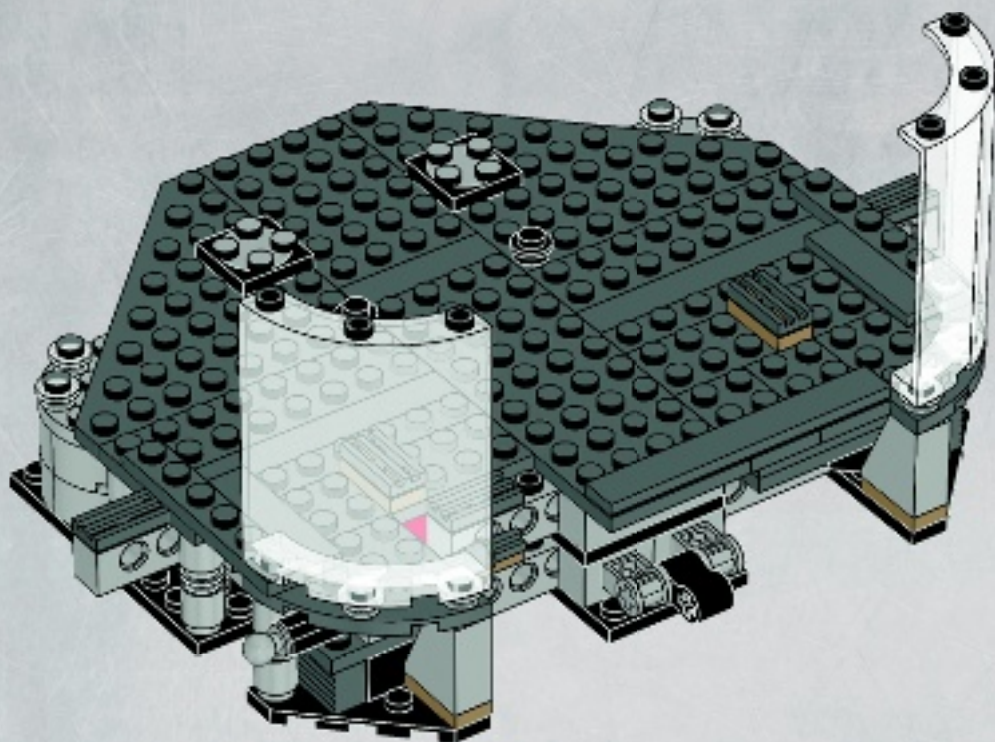



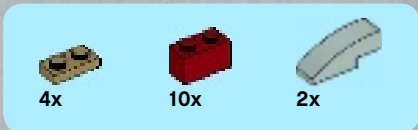

# 29

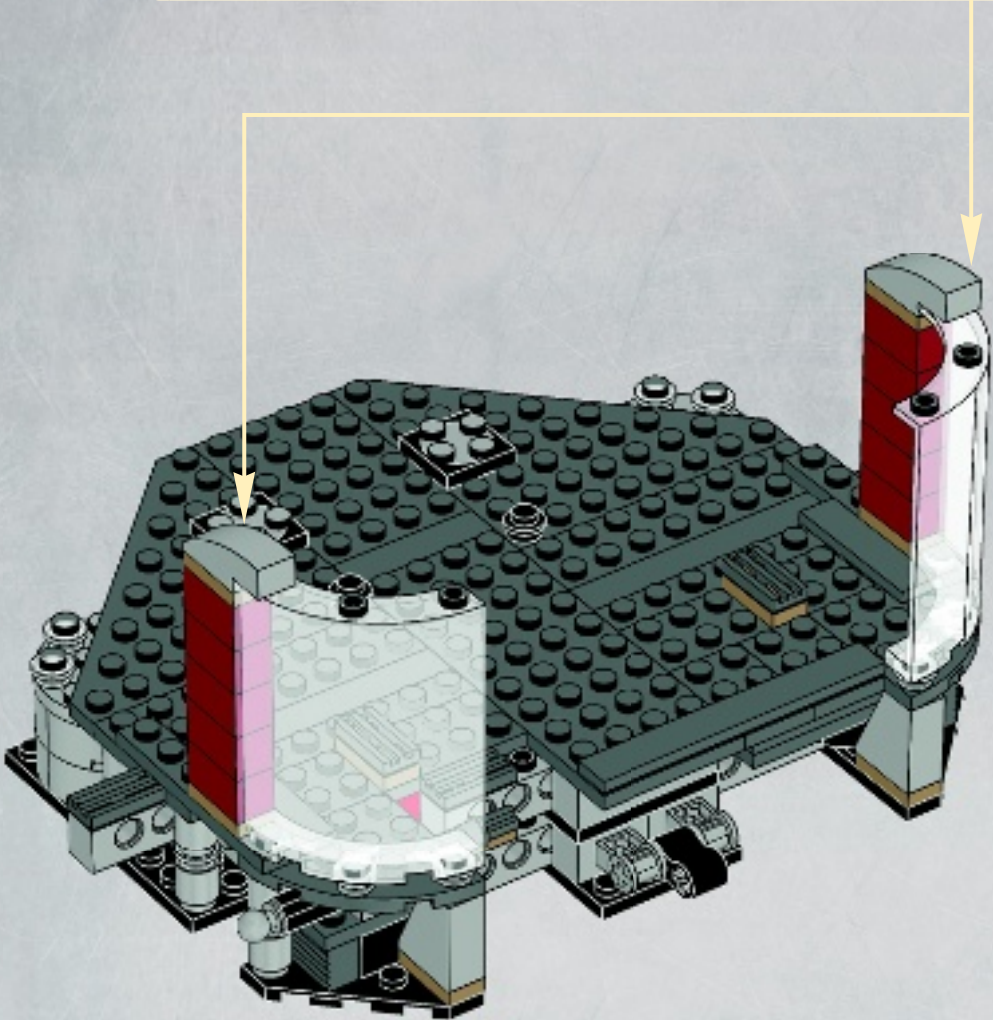
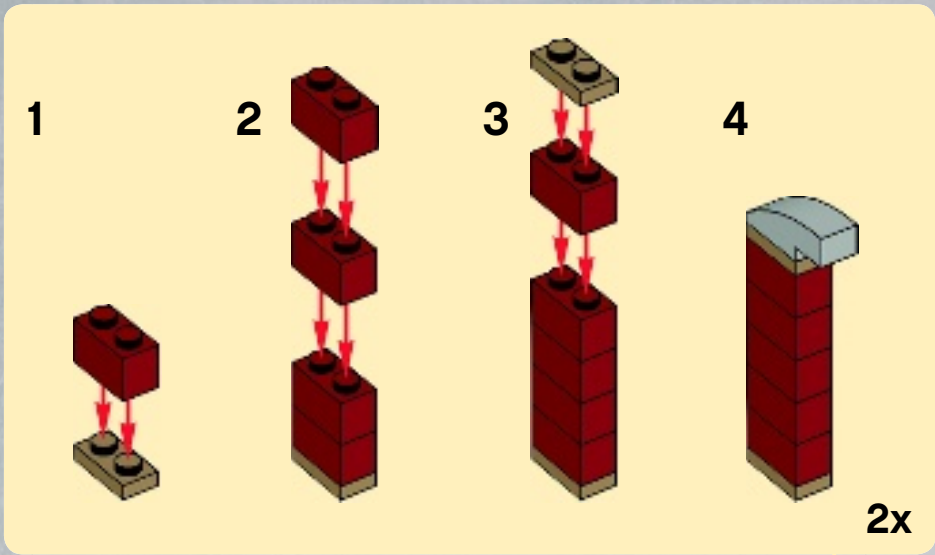

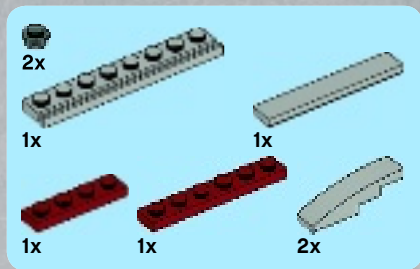

# 30

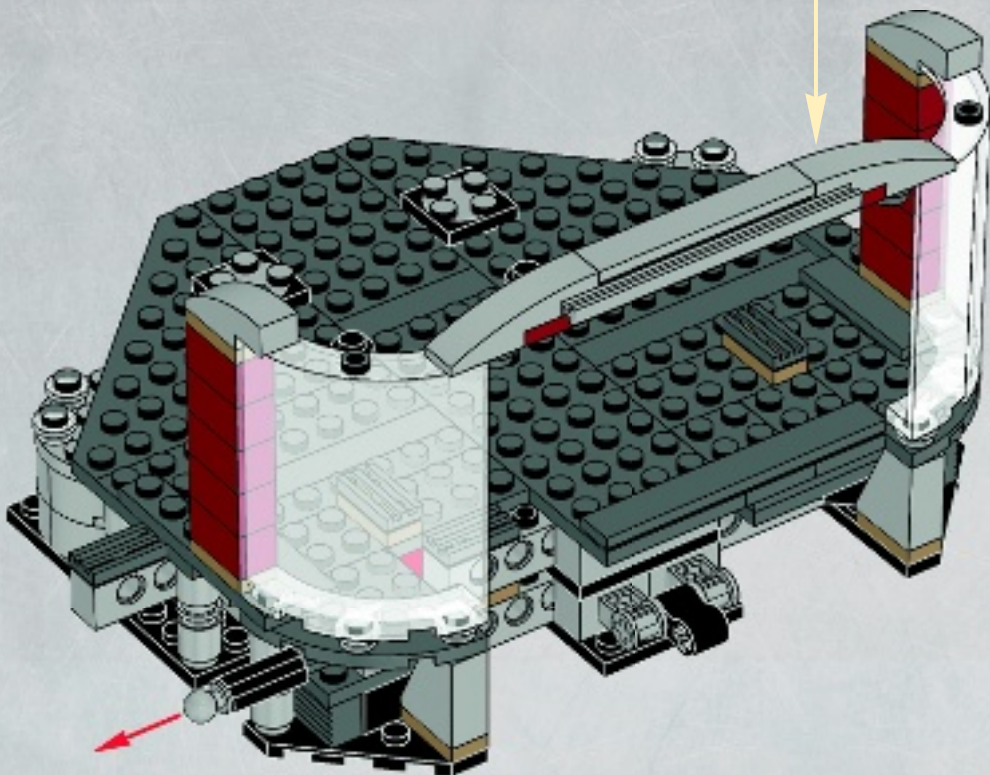
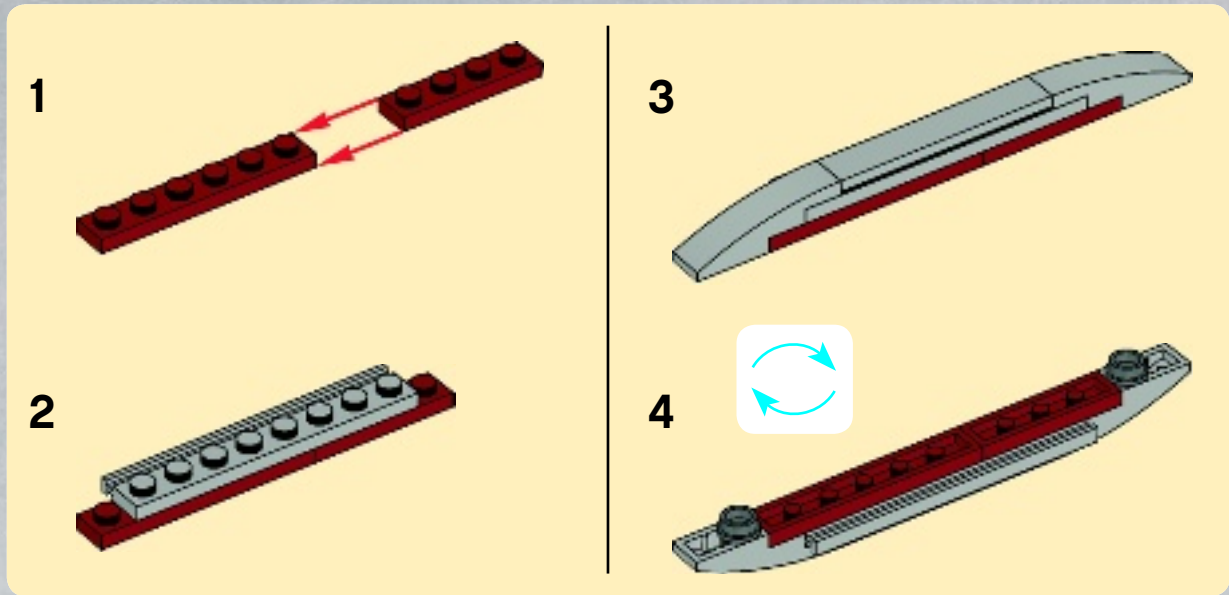





1x

1



1x

1x

2

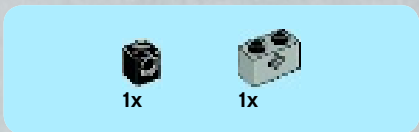

1x

1x

3



1x

4

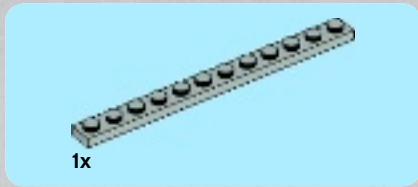

1x

5

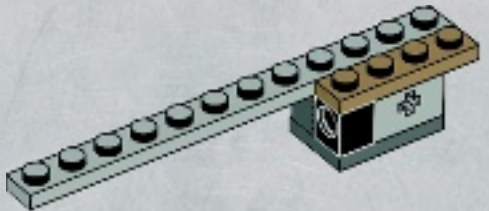

1x

1x

6

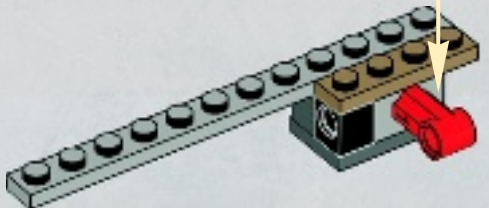
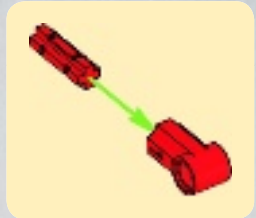

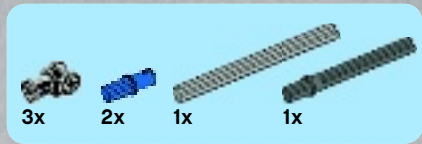

7

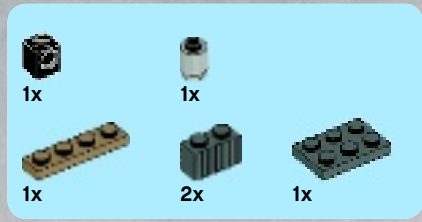
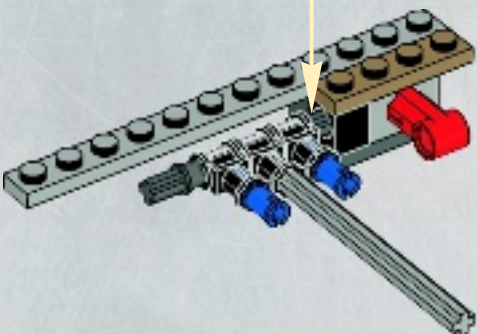
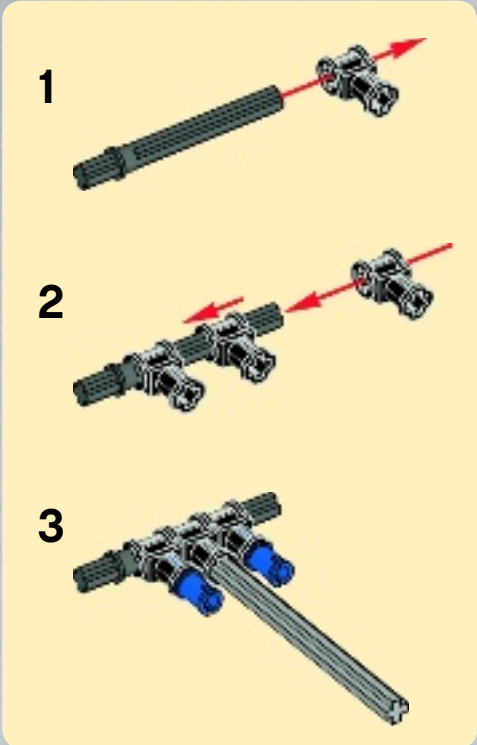

8

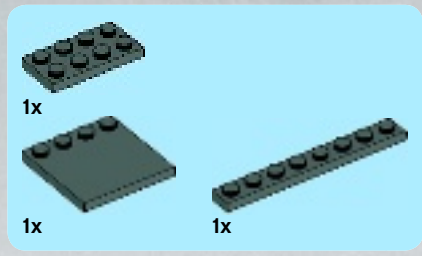
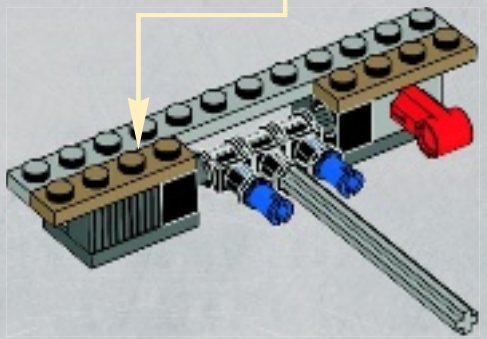
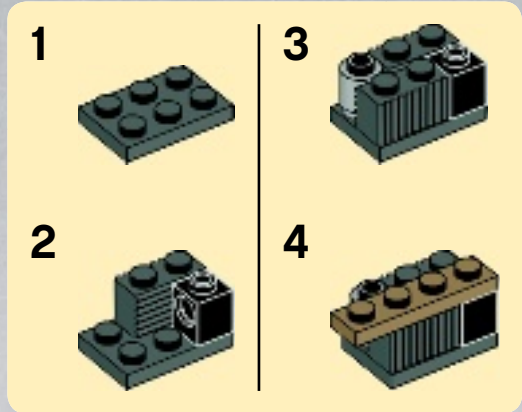

9

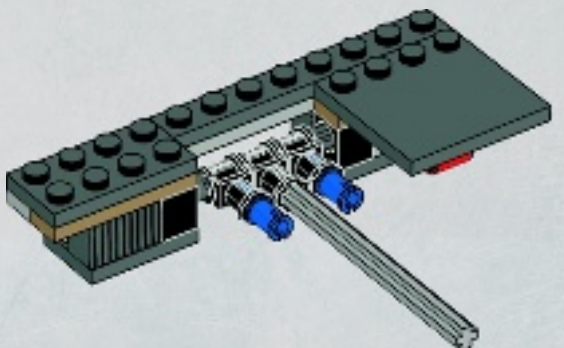



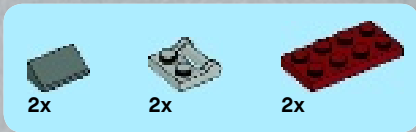

10

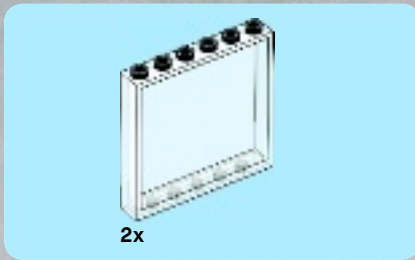
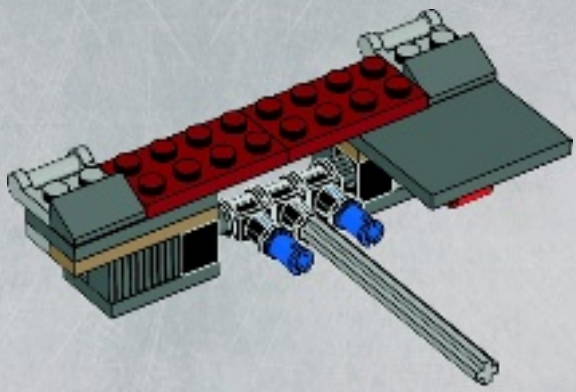

12

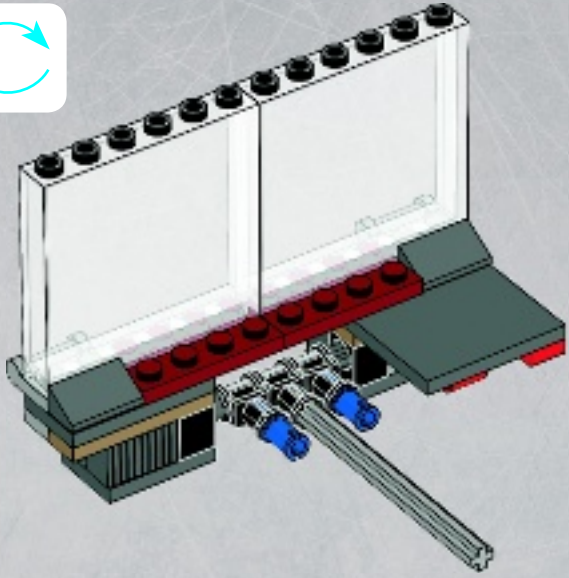

11

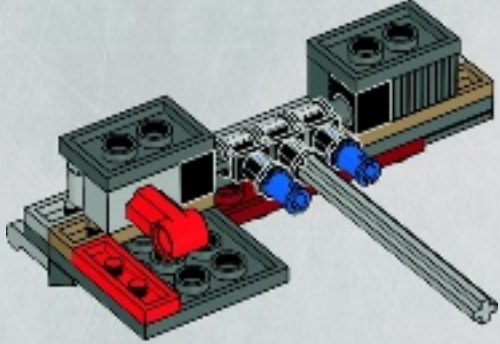

13

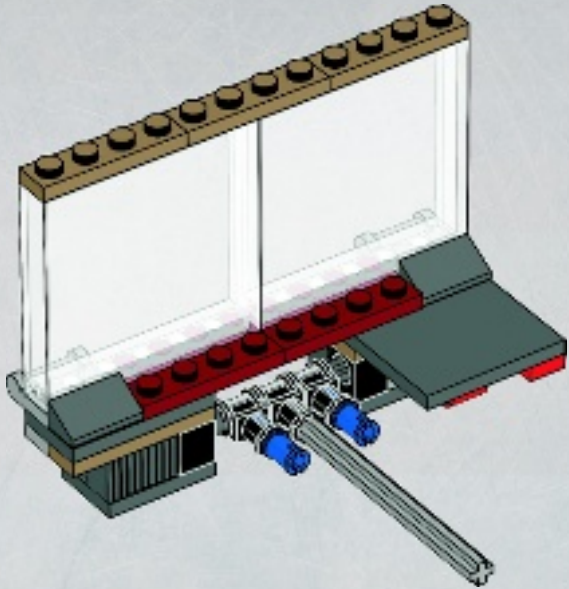

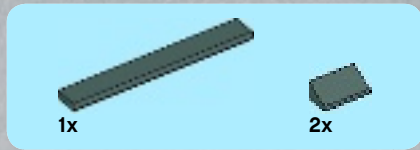

14

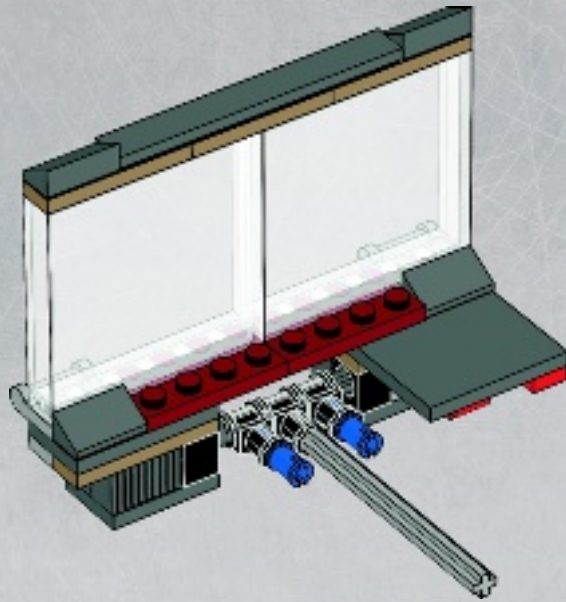

31

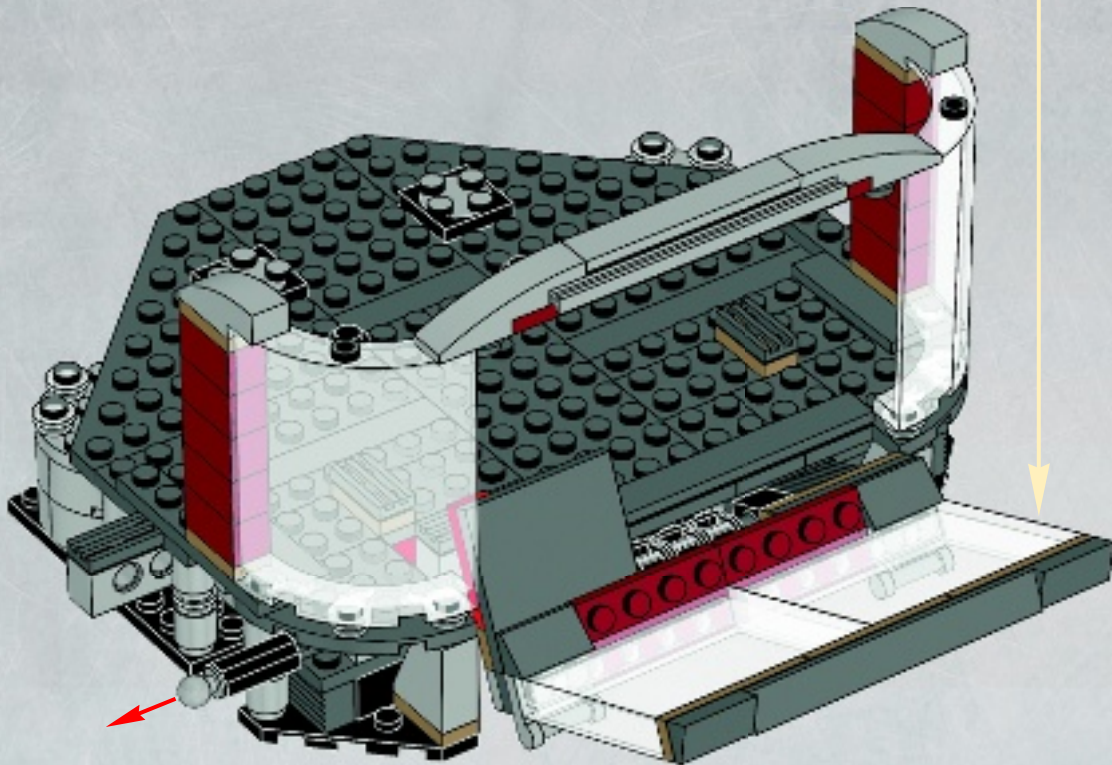



32

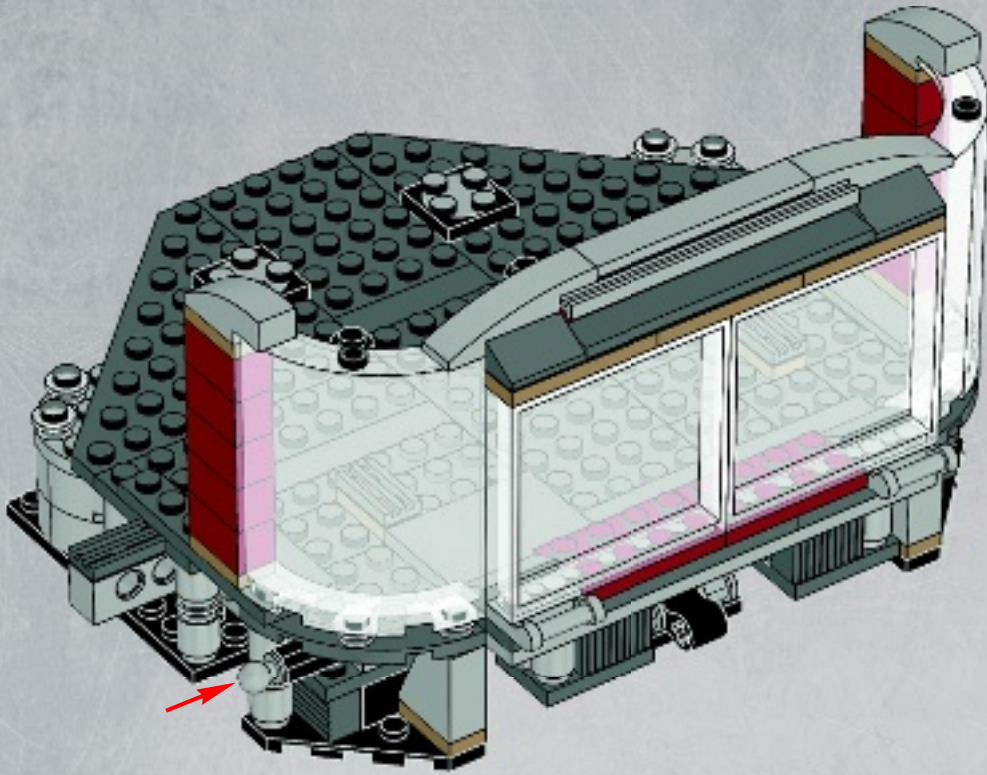

33

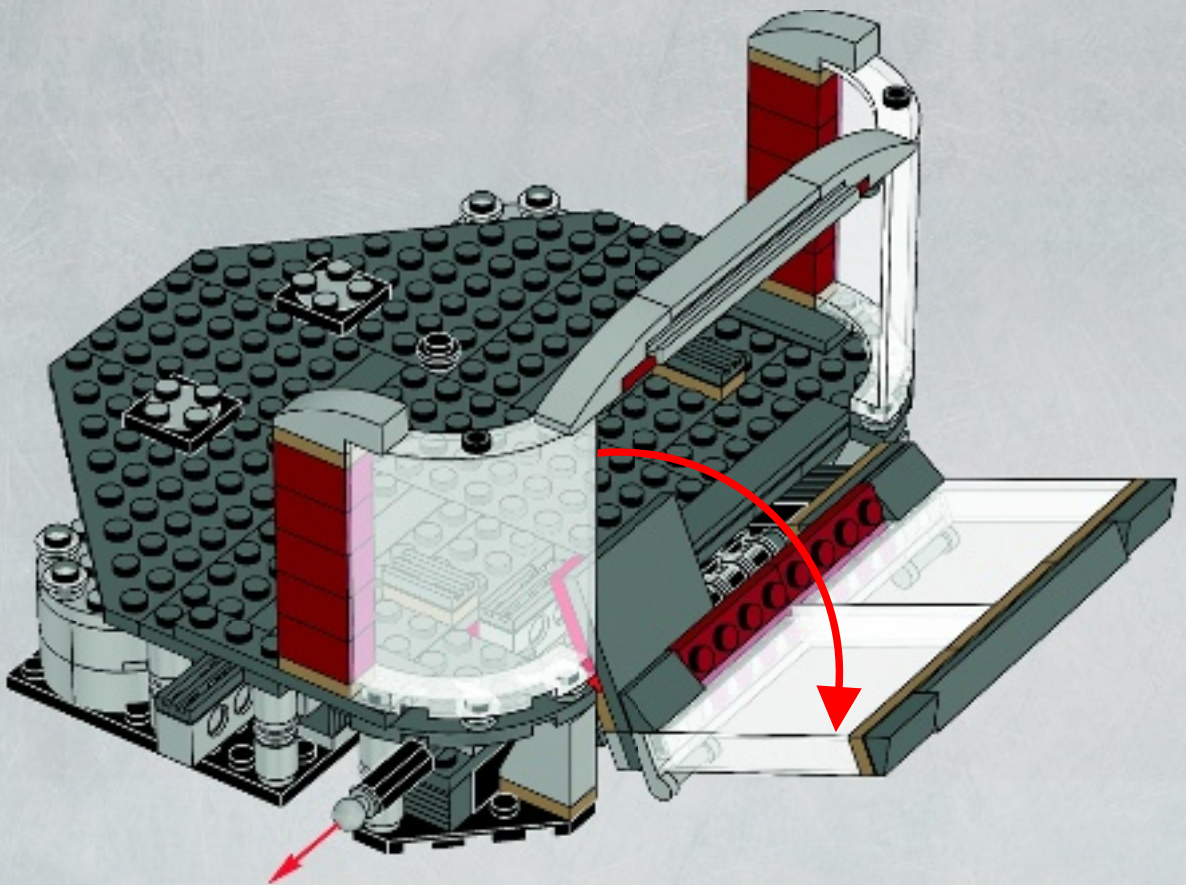



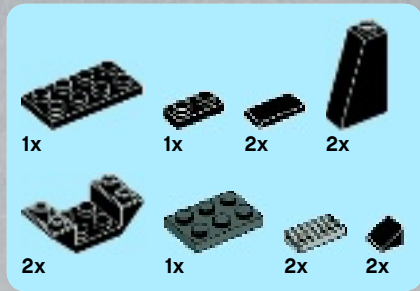

# 34

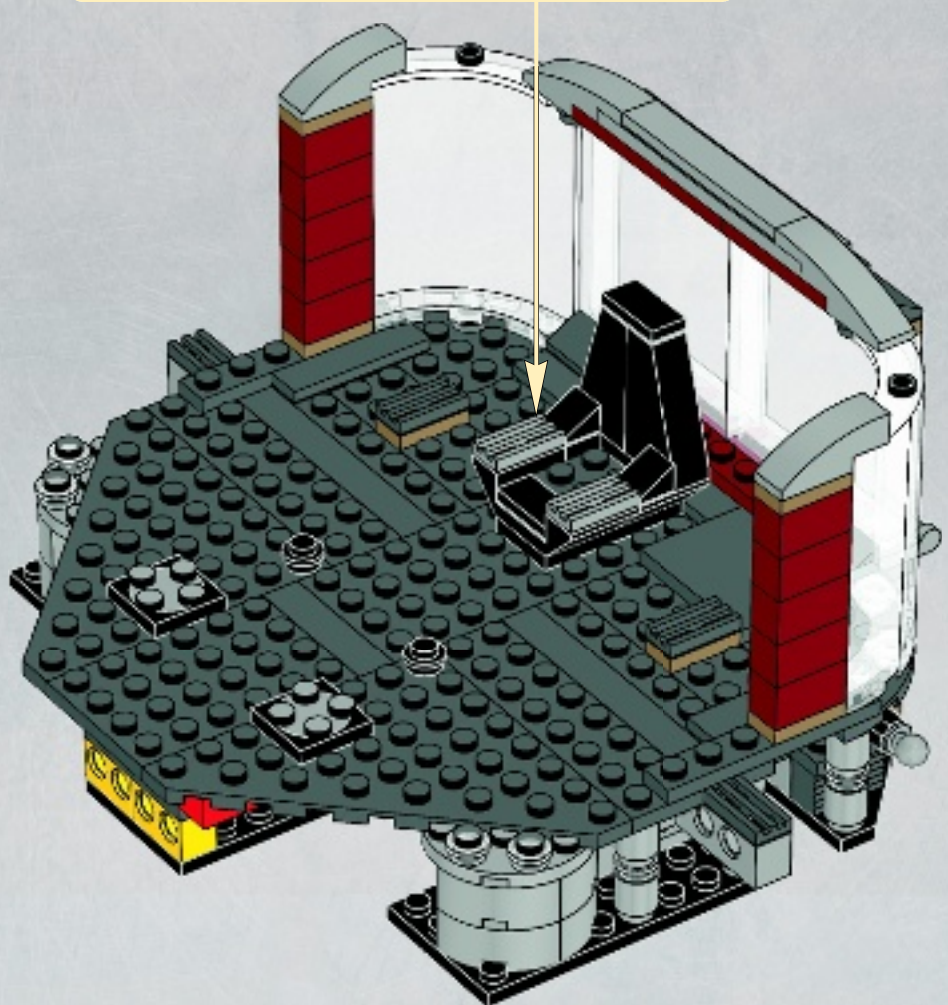
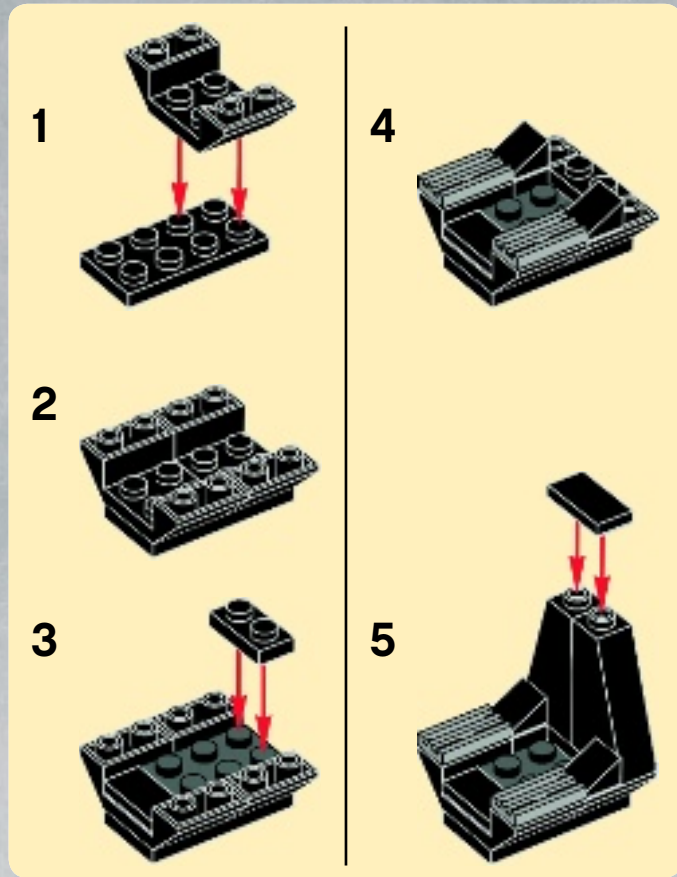



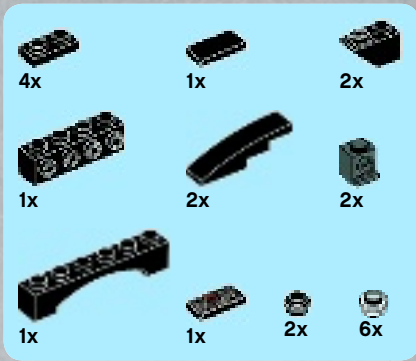

# 35

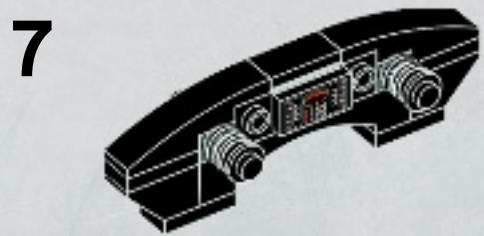
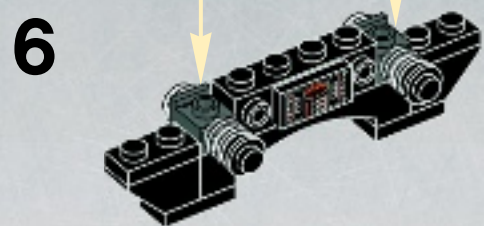
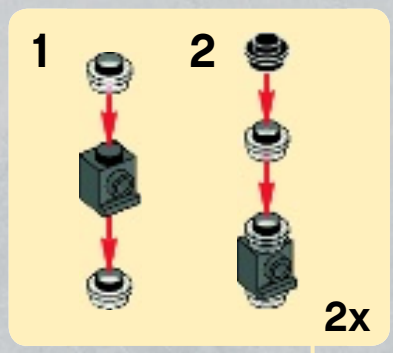
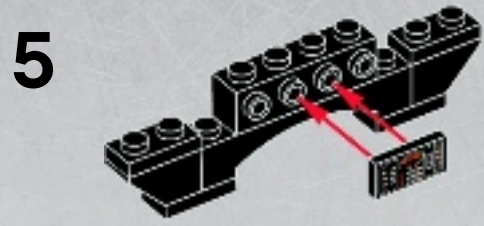
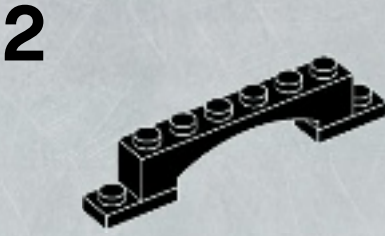

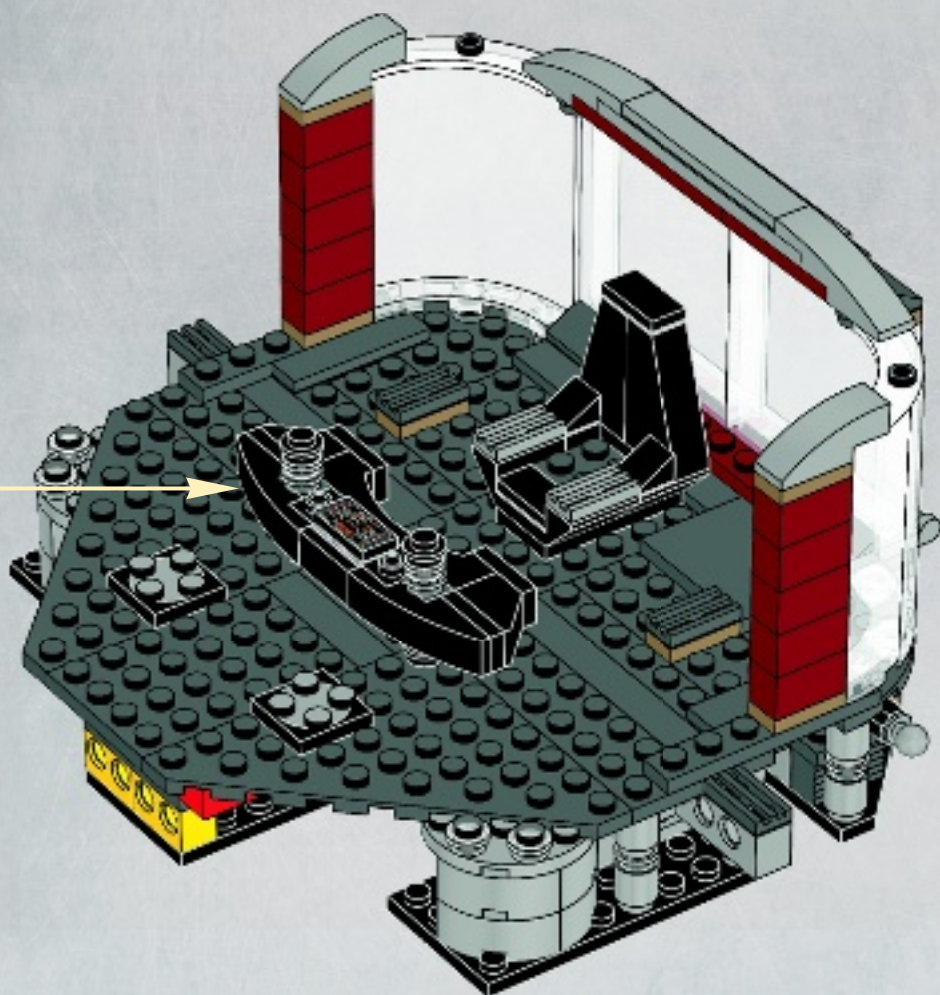



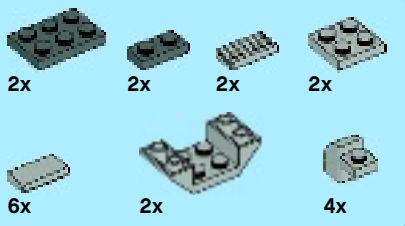

# 36



**1**

**2**

**3**

**4**

**5**

**2x**

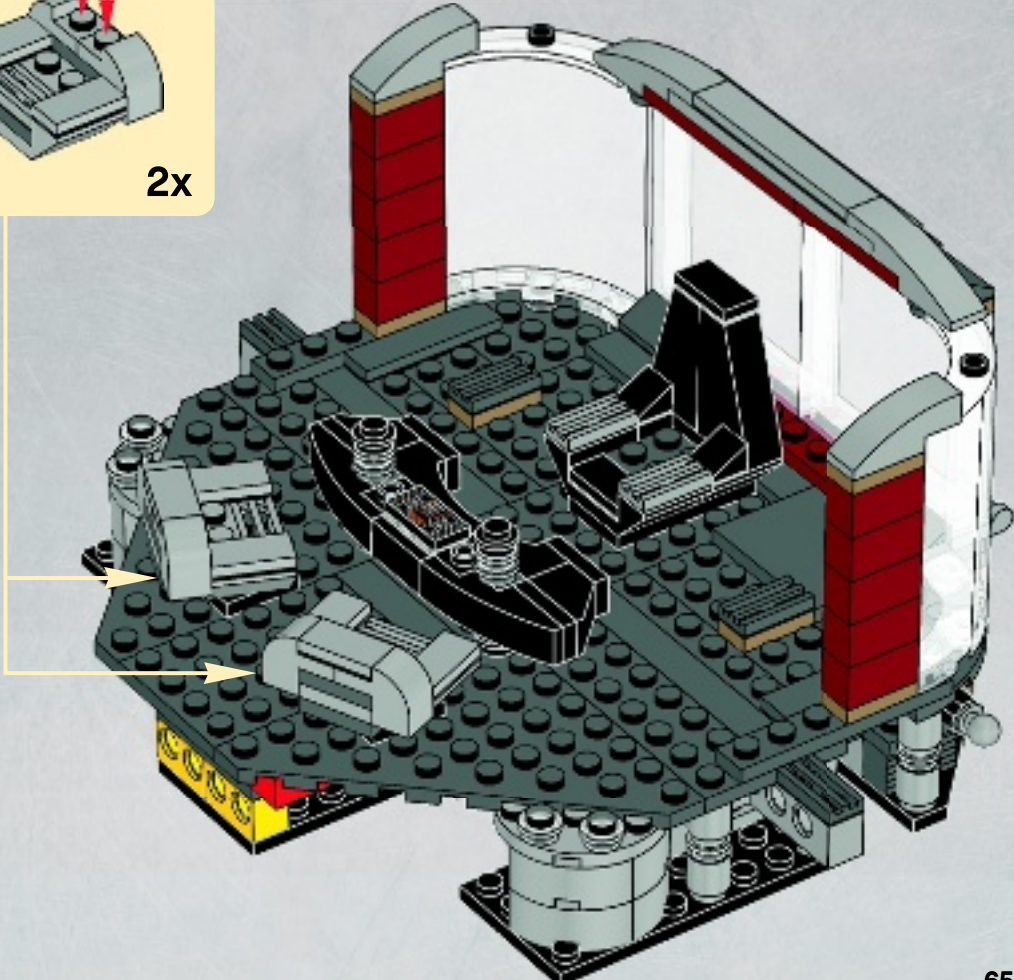

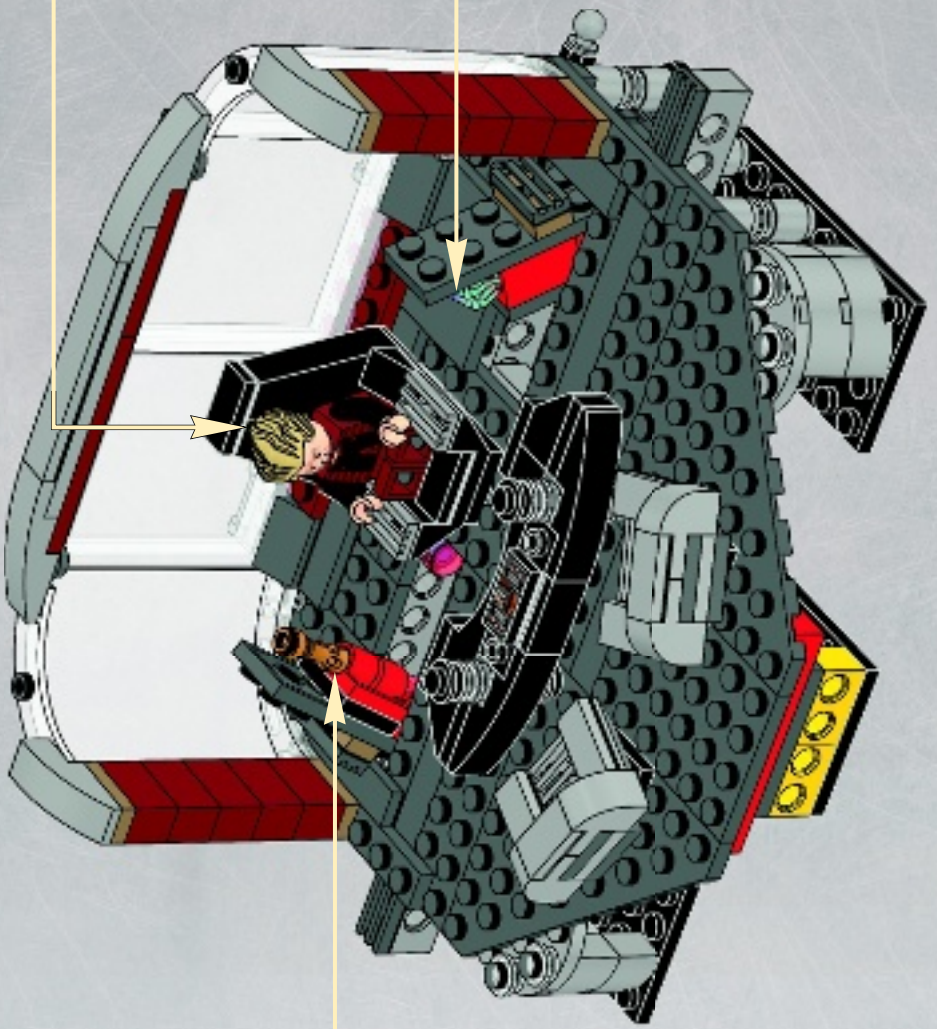
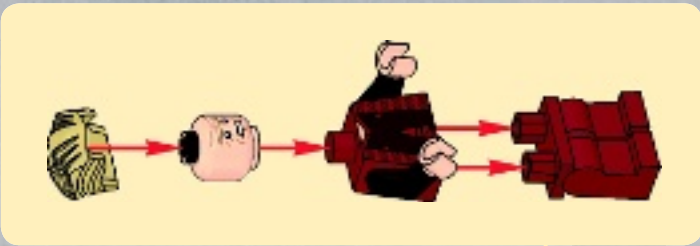

# 37





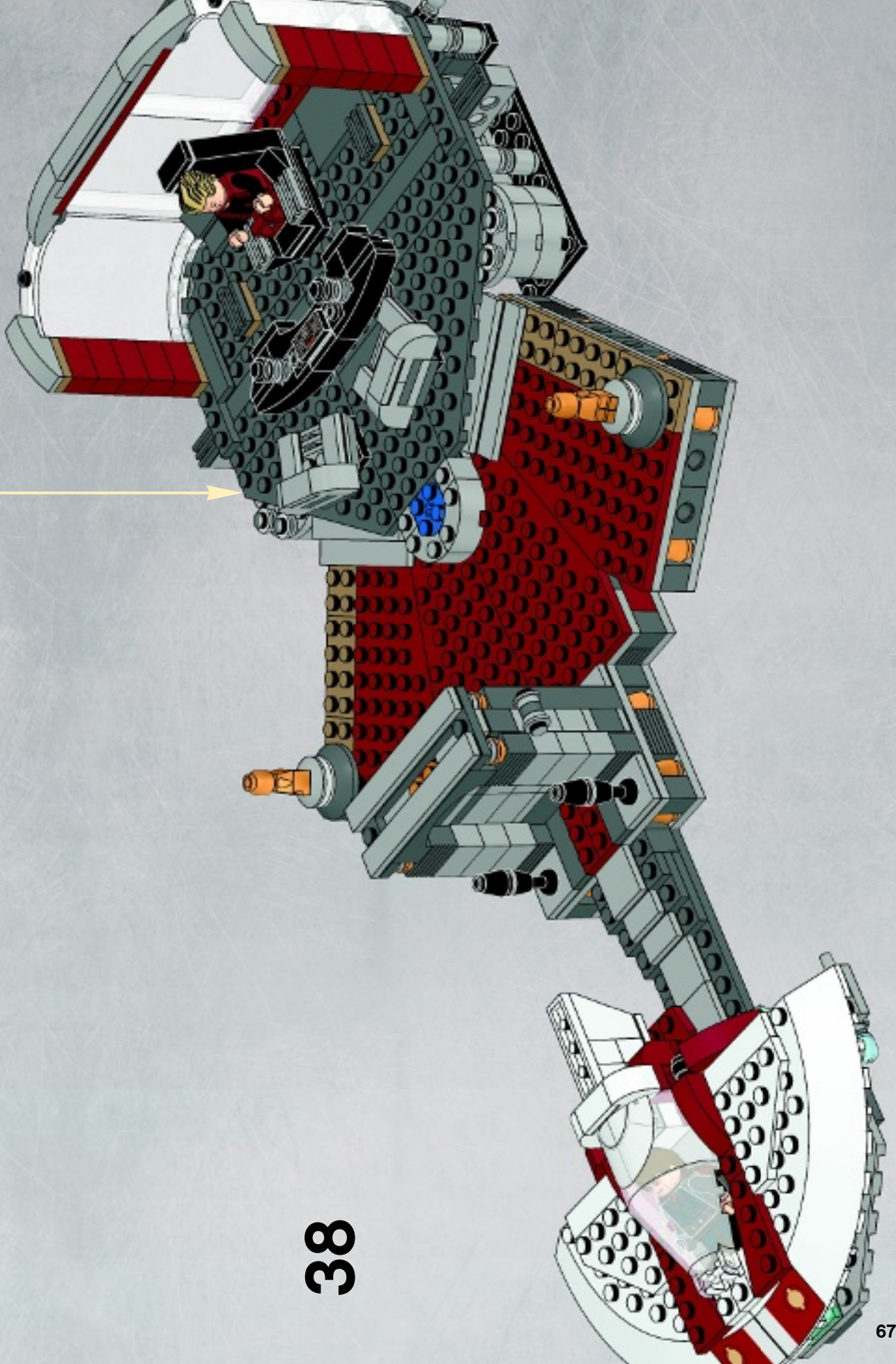

38



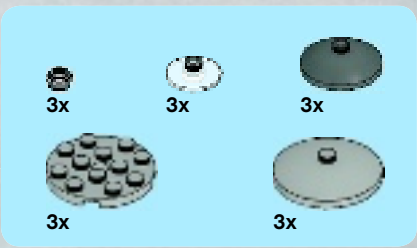

# 39

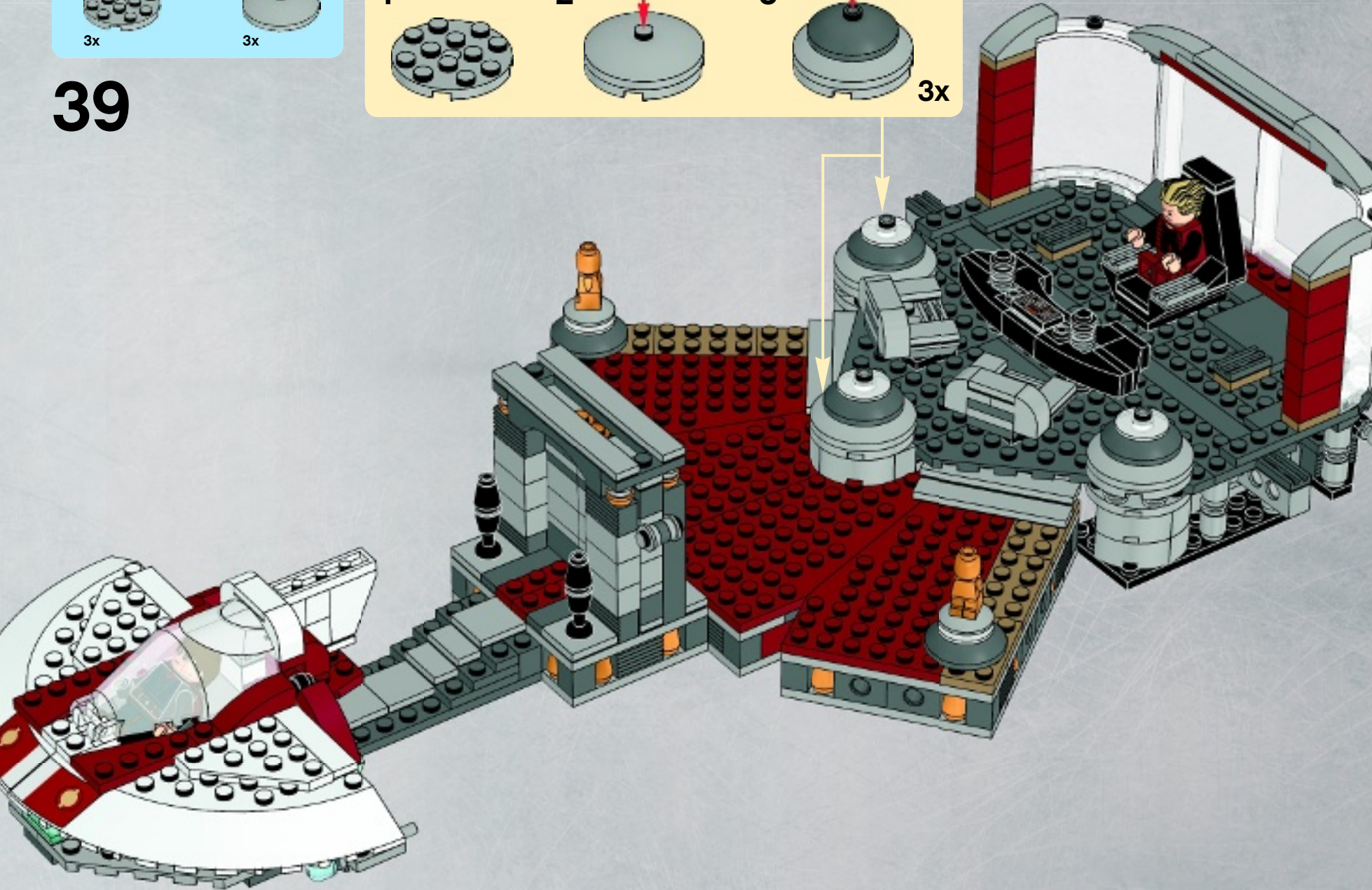
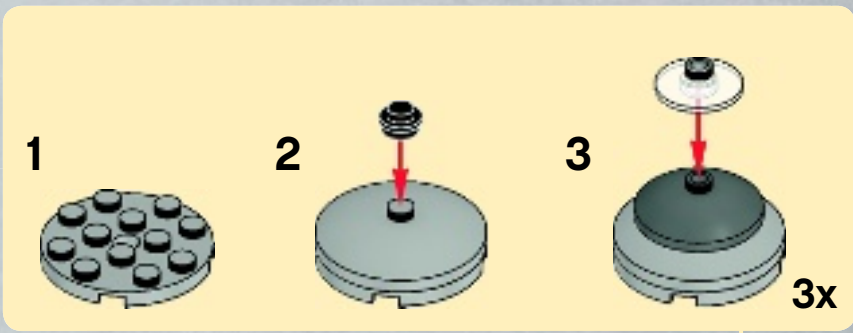



40

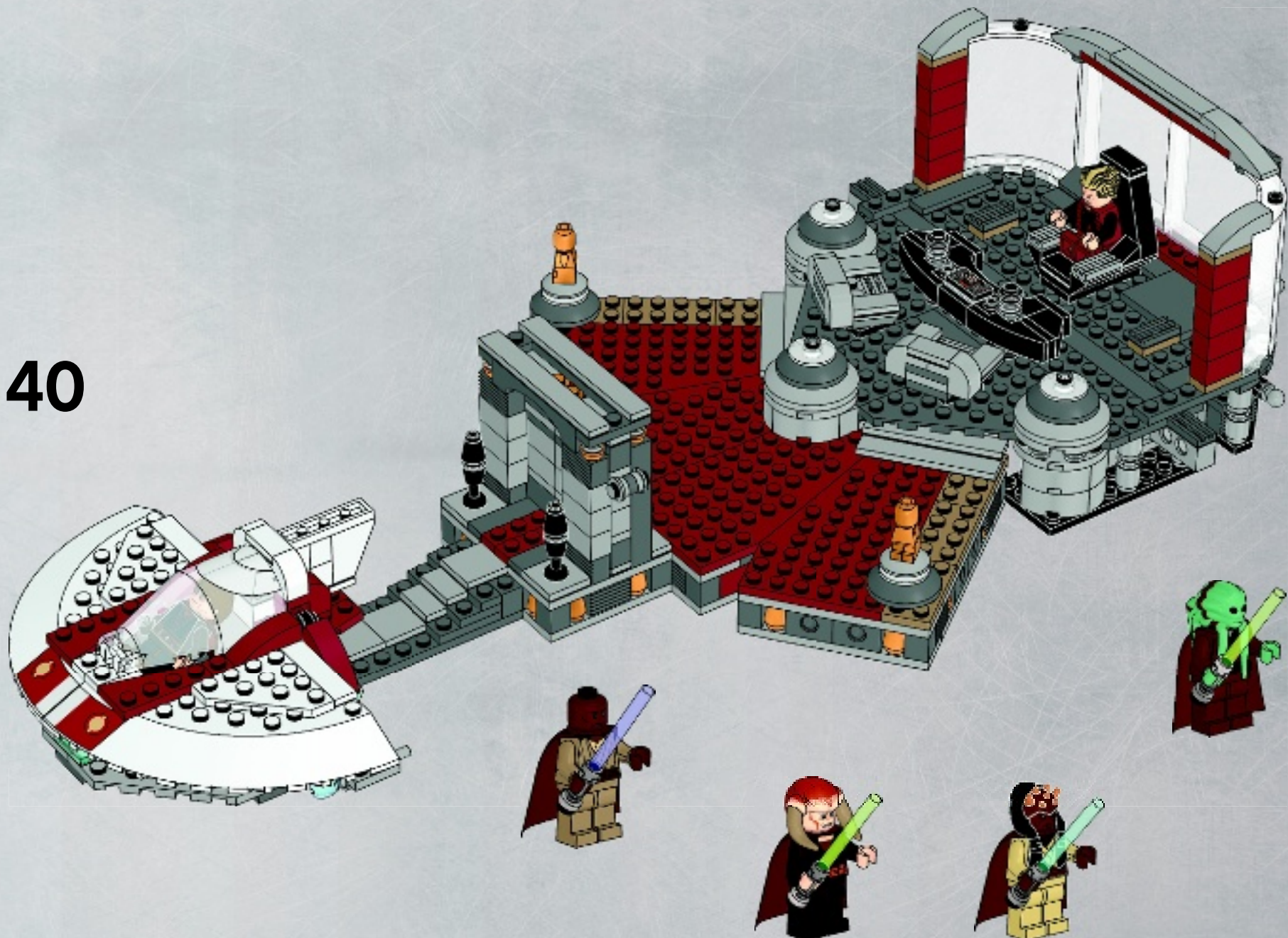





1x 4143137  
 2x 6010451  
 4x 654101  
 3x 370001  
 1x 4515370  
 2x 609101  
 2x 371001  
 1x 306901  
 2x 4598527  
 2x 4249563  
 1x 4558168  
 2x 243101  
 2x 4160215  
 1x 4107623  
 1x 6009852  
 1x 4549391  
 2x 4514554  
 4x 4181138

4x 370021  
 1x 362321  
 2x 281721  
 2x 486521  
 1x 4254606  
 1x 4142865  
 2x 4522302  
 1x 614323  
 2x 4143005  
 2x 4206482  
 3x 4514553  
 2x 407024  
 2x 4201615  
 1x 301026  
 1x 4617860  
 1x 4162443  
 2x 4529236  
 4x 654126  
 2x 4504382  
 2x 366526  
 2x 428726

2x 446026  
 1x 4620763  
 1x 6021512  
 5x 302326  
 11x 302226  
 1x 302026  
 1x 379526  
 6x 303526  
 1x 415026  
 2x 4632571  
 3x 306926  
 2x 4656346  
 11x 614126  
 2x 4160025  
 1x 4651406  
 2x 4223189  
 2x 368026  
 2x 4121715  
 3x 4107081  
 1x 4198367  
 1x 4512363

2x 4188534  
 2x 4522034  
 20x 3005740  
 5x 4187750  
 2x 4504229  
 2x 4599452  
 1x 4597712  
 2x 4646864  
 1x 4124108  
 6x 4667222  
 2x 4124073  
 2x 6006124  
 2x 4514700  
 10x 4528604  
 5x 4626904  
 6x 4267874  
 1x 4524098  
 1x 4544211

1x 6019847  
 1x 4654448  
 6x 4539092  
 2x 4539082  
 4x 4541546  
 2x 4539114  
 8x 4539097  
 4x 4539076  
 1x 4539061  
 2x 4539071  
 1x 4539062  
 2x 6008593  
 2x 6008595  
 2x 4541072  
 2x 4541073

10x 4539102  
 1x 4541496  
 1x 6009876  
 4x 6011462  
 4x 4568761  
 1x 4221886  
 1x 4569574  
 1x 4580482  
 1x 6009725  
 5x 4227505  
 2x 4211389  
 6x 4211388  
 10x 4211387  
 4x 4211394  
 2x 4211385  
 2x 4211391  
 3x 4233493  
 14x 4211412  
 10x 4567448



2x 4211535  
 2x 4211441  
 9x 4211442  
 2x 4515374  
 2x 4211517  
 1x 4211420  
 4x 4211519  
 2x 4251163  
 2x 4532593  
 2x 4565393  
 4x 4211397  
 4x 4211396  
 7x 4211445  
 9x 4211406  
 2x 4211408  
 1x 4514846  
 2x 4211360

6x 4211350  
 3x 4211413  
 2x 4558169  
 5x 4211549  
 3x 4211481  
 1x 4211498  
 8x 4211525  
 2x 4211475  
 2x 4211512  
 5x 4515351  
 3x 4211664  
 4x 4211520  
 2x 4540203  
 2x 4520320  
 1x 4211375  
 1x 4211815  
 2x 4211536  
 1x 4211805  
 11x 4211414  
 2x 4244627  
 2x 4211376

18x 4529247  
 6x 4523159  
 2x 4558457  
 1x 6003147  
 5x 4548731  
 1x 4529672  
 1x 4656389  
 1x 6023597  
 1x 4659732  
 2x 4620760  
 2x 4211063  
 10x 4211133  
 11x 4211043  
 1x 4211001  
 4x 4211065  
 2x 4211056  
 1x 4509911  
 3x 4211002  
 3x 4210998

2x 4211115  
 3x 4210997  
 1x 4211122  
 1x 4210706  
 2x 4632574  
 5x 4210631  
 2x 4211052  
 2x 4568734  
 4x 4211053  
 4x 4211008  
 2x 4210633  
 5x 4210865  
 2x 4222042  
 4x 4547222  
 2x 4508553  
 1x 4211085  
 1x 4211100

2x 4211044  
 25x 4210636  
 4x 4211087  
 10x 4211098  
 2x 4211075  
 2x 4211104  
 4x 4211103  
 12x 4211111  
 9x 4567887  
 2x 4626400  
 1x 4544069  
 1x 6009868  
 1x 6009861  
 1x 6009055  
 1x 6019634



**Customer Service**  
**Kundenservice**  
**Service Consommateurs**  
**Servicio Al Consumidor**

[www.lego.com/service](http://www.lego.com/service) or dial

 : 00800 5346 5555  
 : 1-800-422-5346





9488



9489



9490



9491



9492



9493





9496



9496



9496



9496



9497



9497



9497



9498



9498



9498



9499



9499



9499



9499



9500



9500



9500



9515



9515



9515



9515



9515



9515



9516



9516



9516



9516



9516



9516



9516



9516



9516



9516



# ACE ASSAULT II

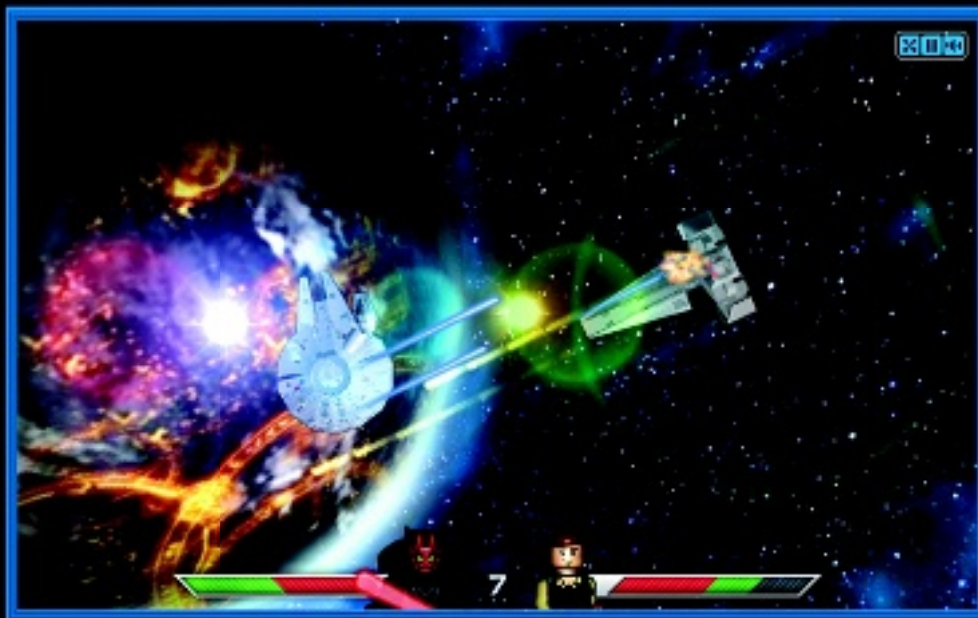

0704



starwars.LEGO.com









# WIN!

Go to [www.LEGOsurvey.com/product](http://www.LEGOsurvey.com/product) to fill out a survey for a chance to win a cool LEGO® Product.

No purchase necessary.

Open to all residents where not prohibited.



[www.LEGO.com](http://www.LEGO.com)



## [www.LEGOsurvey.com/product](http://www.LEGOsurvey.com/product)

### GEWINNE!

Nimm an der Umfrage auf [www.LEGOsurvey.com/product](http://www.LEGOsurvey.com/product) teil und hab die Chance ein cooles LEGO® Produkt zu gewinnen!

Die Teilnahme am Gewinnspiel führt zu keinerlei Kaufverpflichtungen. Teilnahme in allen nicht ausgeschlossenen Ländern möglich.

### WIN!

Ga naar [www.LEGOsurvey.com/product](http://www.LEGOsurvey.com/product), vul een enquêteformulier in en maak kans op een cool LEGO® product.

Geen aankoopverplichting. Iedereen mag deelnemen, uitgezonderd ingezetenden van landen waar een enquêteverbod geldt.

### GAGNE!

Visite [www.LEGOsurvey.com/product](http://www.LEGOsurvey.com/product) pour répondre à un questionnaire et avoir une chance de gagner un produit LEGO® très cool!

Aucune obligation d'achat. Ouvert à tous les résidents des pays autorisés.

### 当てよう!

[www.LEGOsurvey.com/product](http://www.LEGOsurvey.com/product) にアクセスして、アンケートにご記入ください。当選者にはレゴ製品を差し上げます。

お買い上げの必要はありません。禁止されていない限り、すべての皆様にご利用いただけます。