



# STAR WARS



9516



1

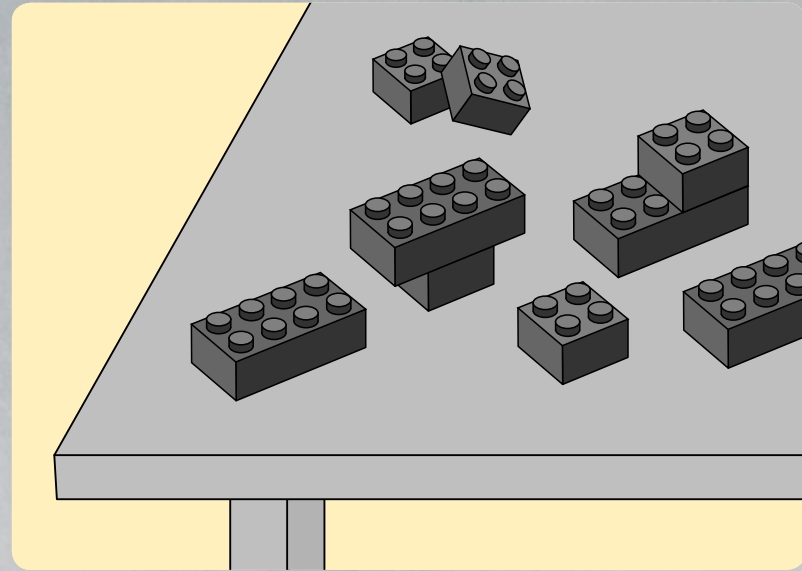
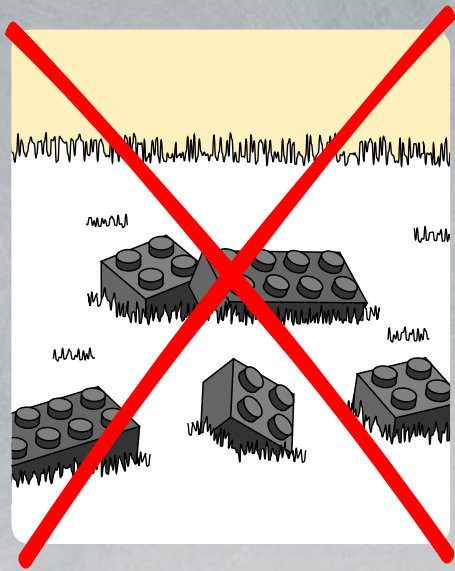

2

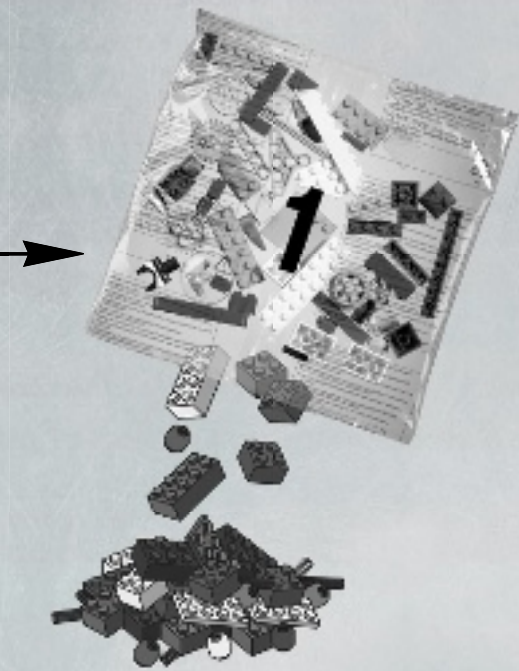

<http://lego.com/brickseparator>

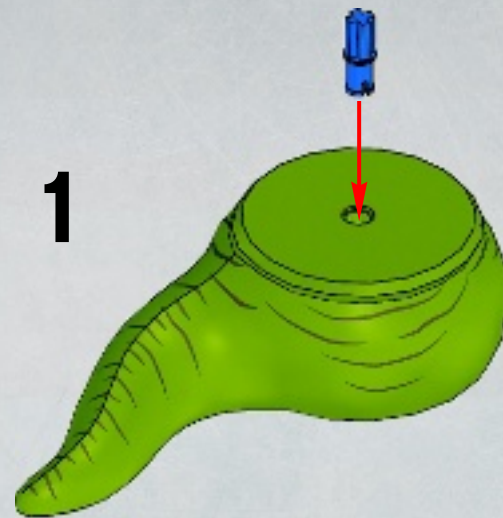
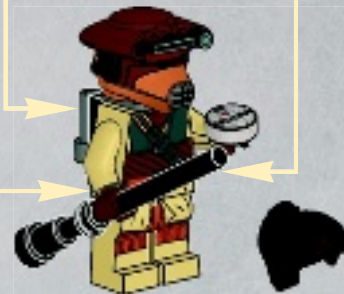
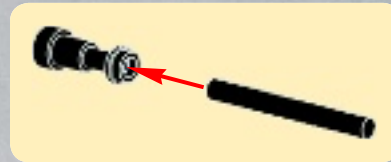
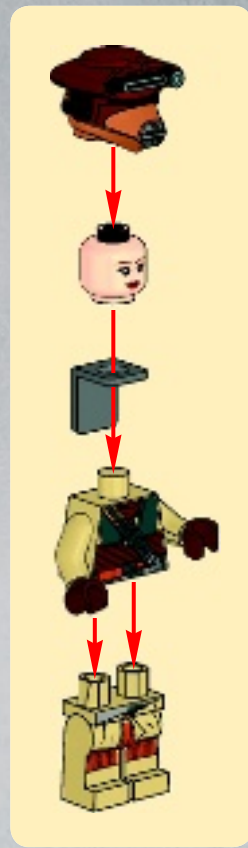



1x

1



4x

2



1x

3

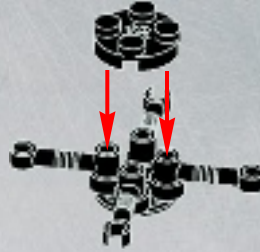

1x



1x

4

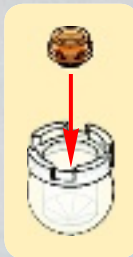

4x

5



6



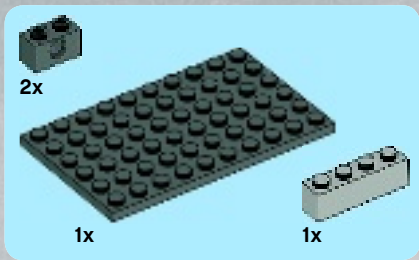
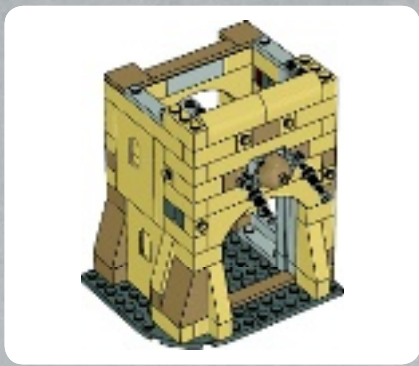

1

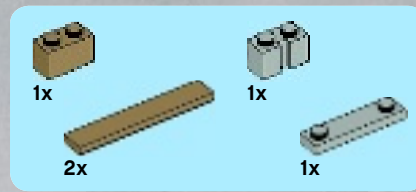
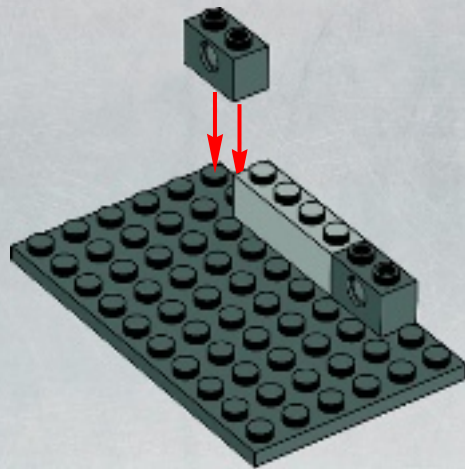

2

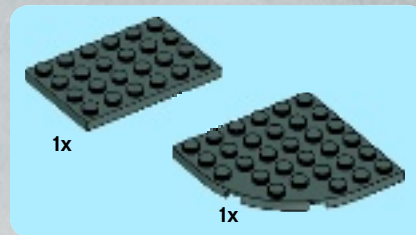
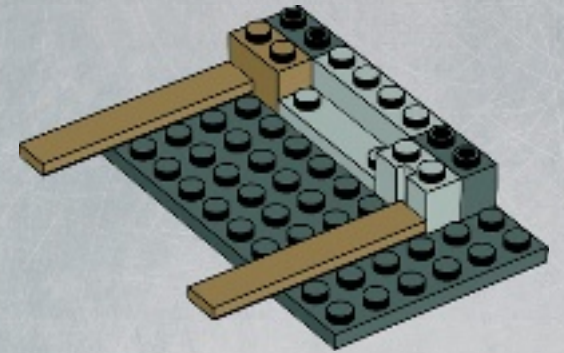

3

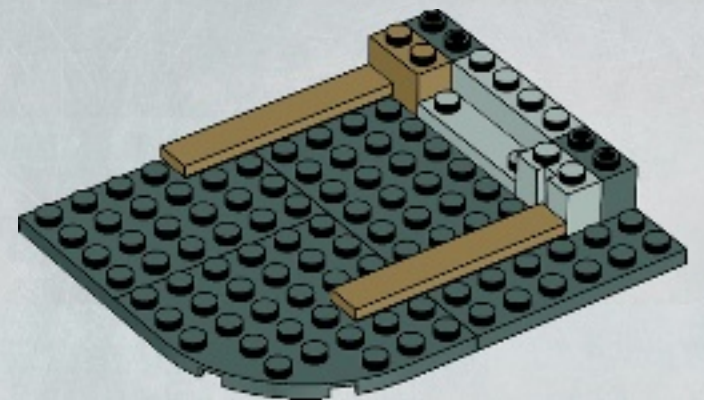

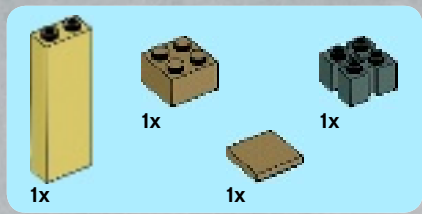

4

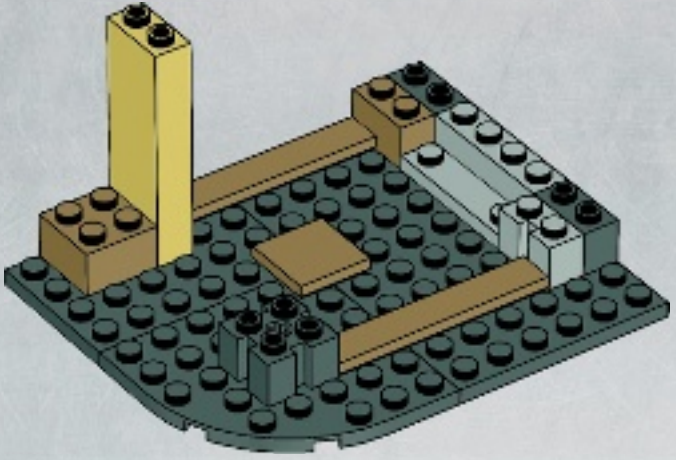

5

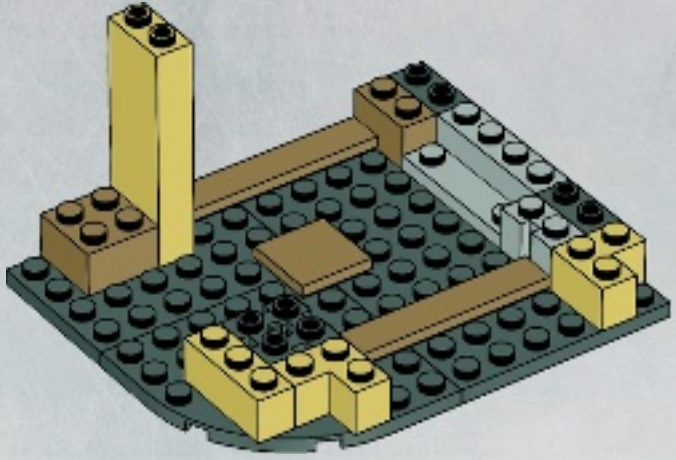



6

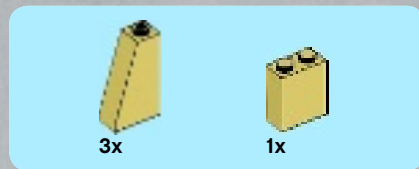
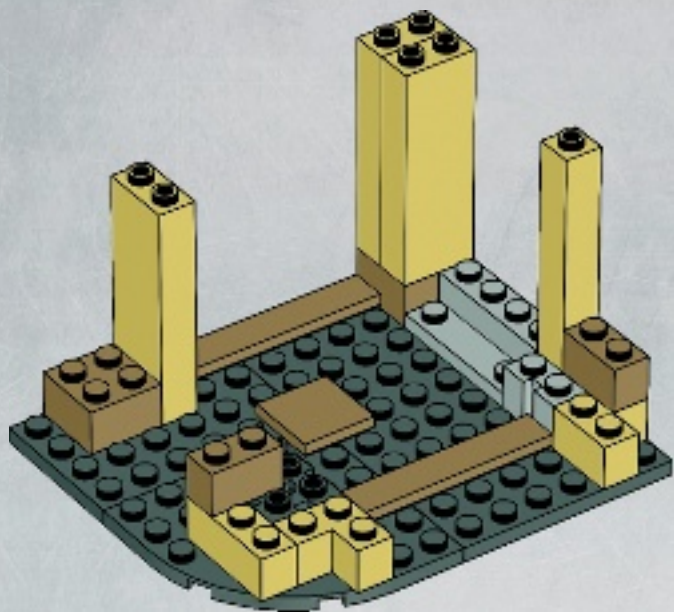

7

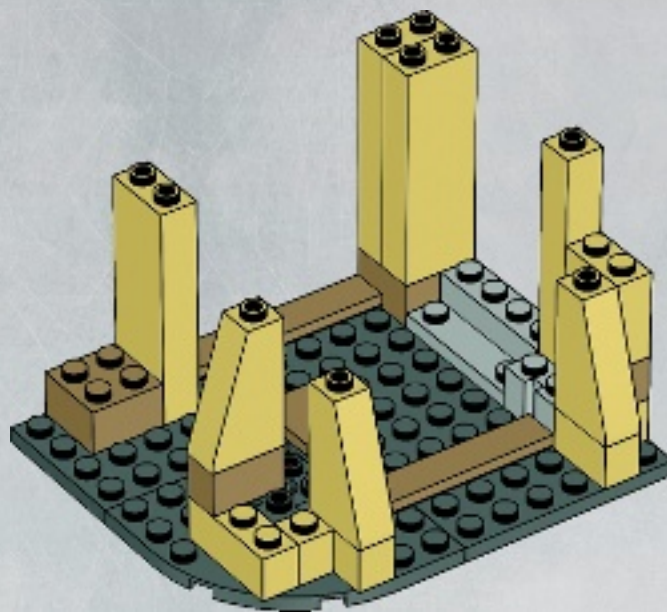

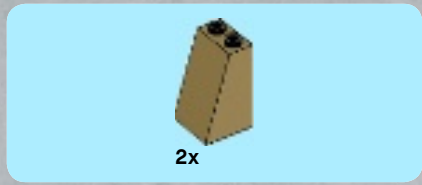

8

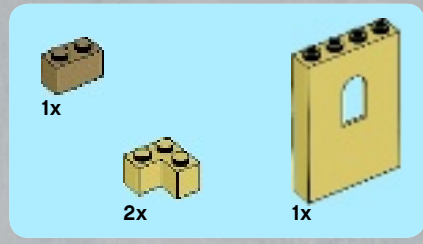
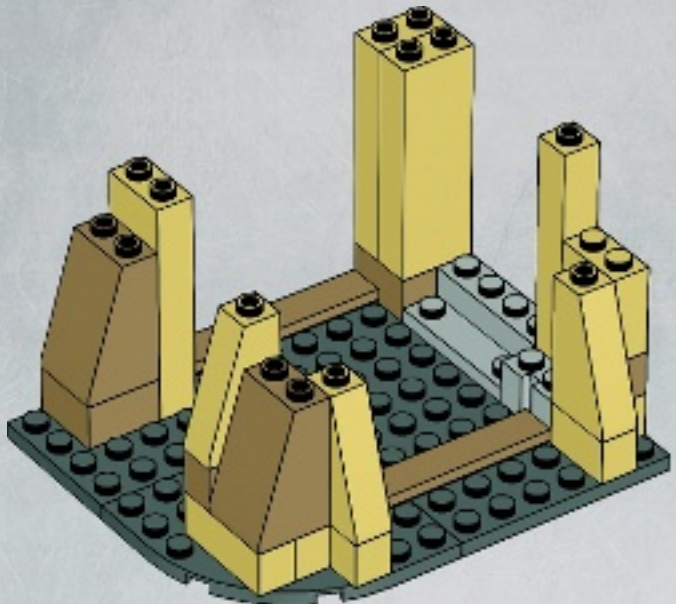

9

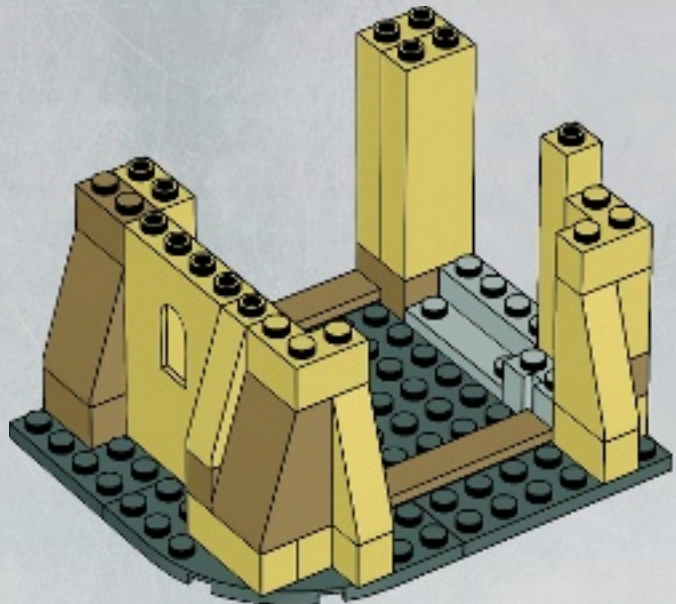



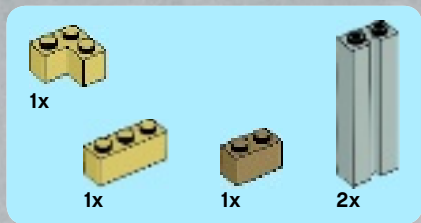

10

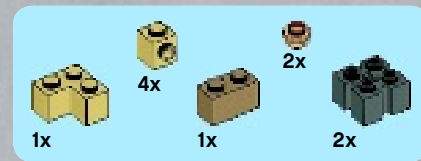
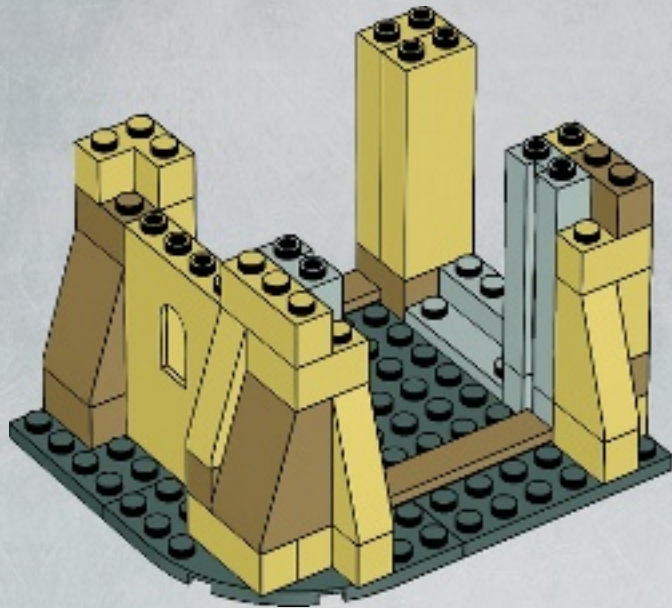

11

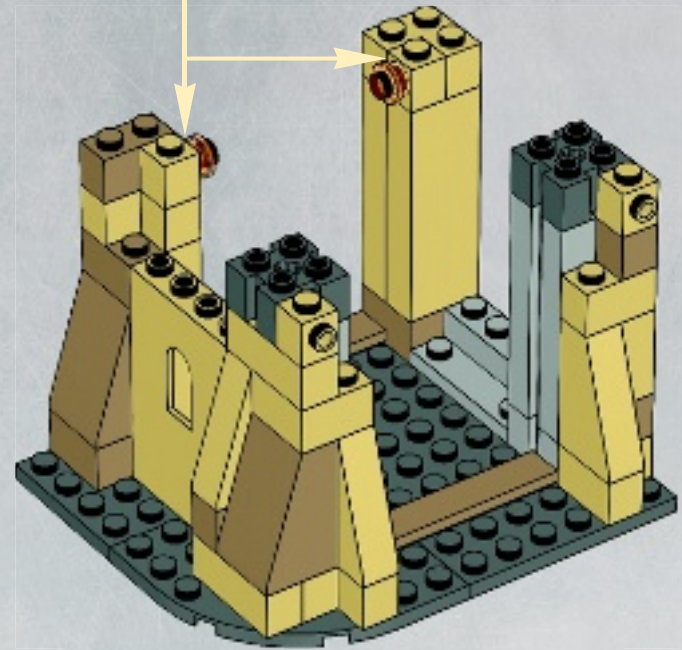
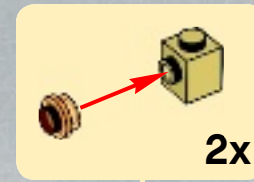

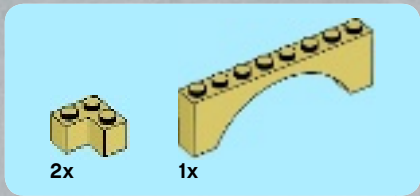

# 12

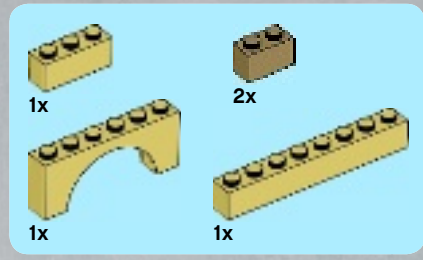
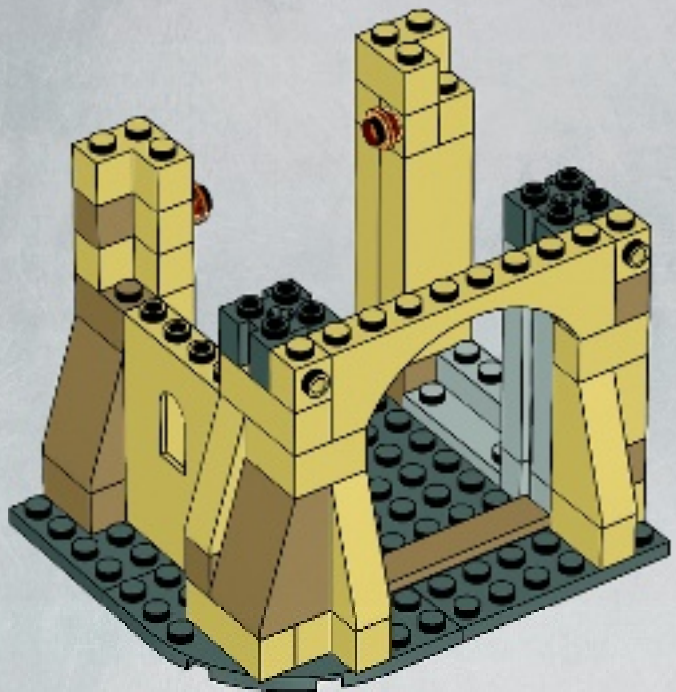

# 13

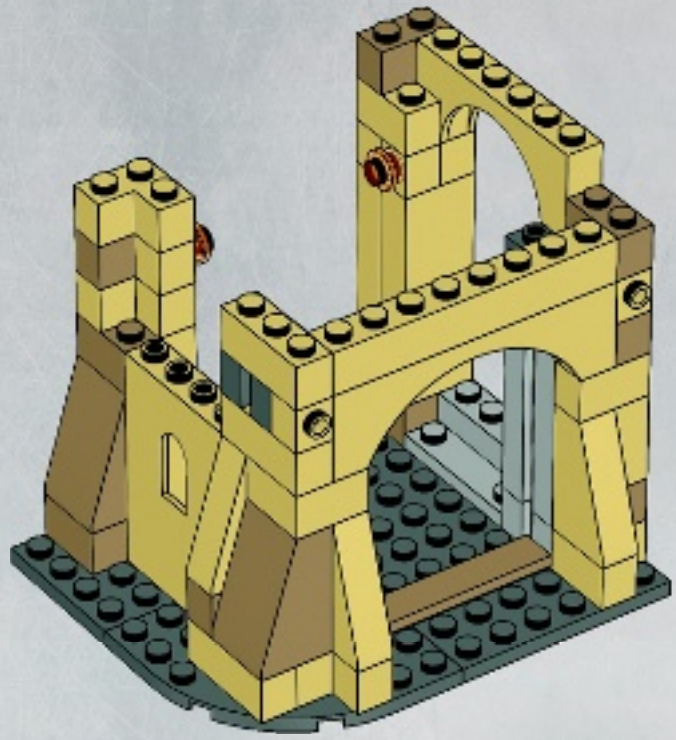



14

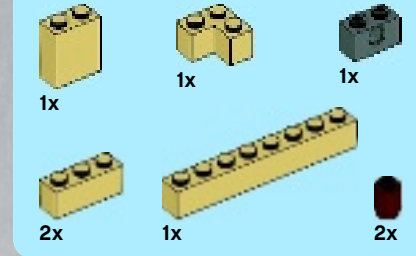
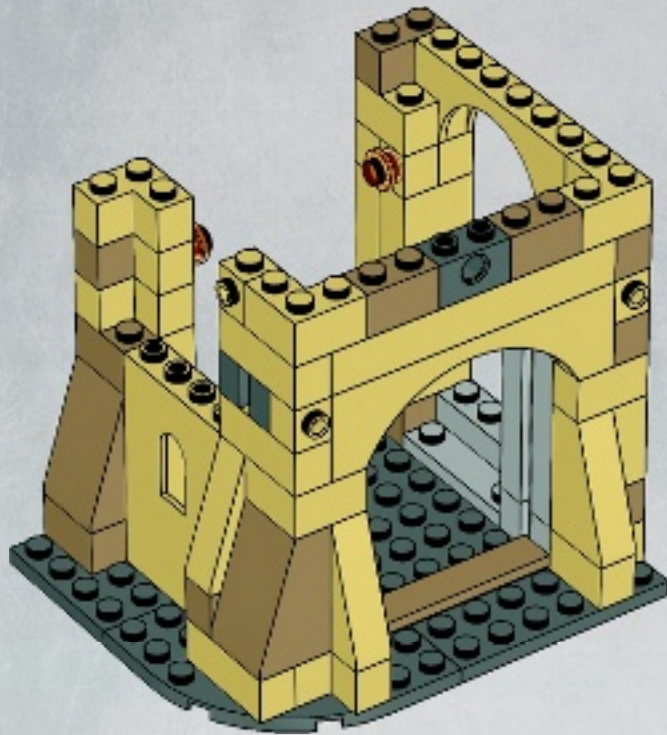

15

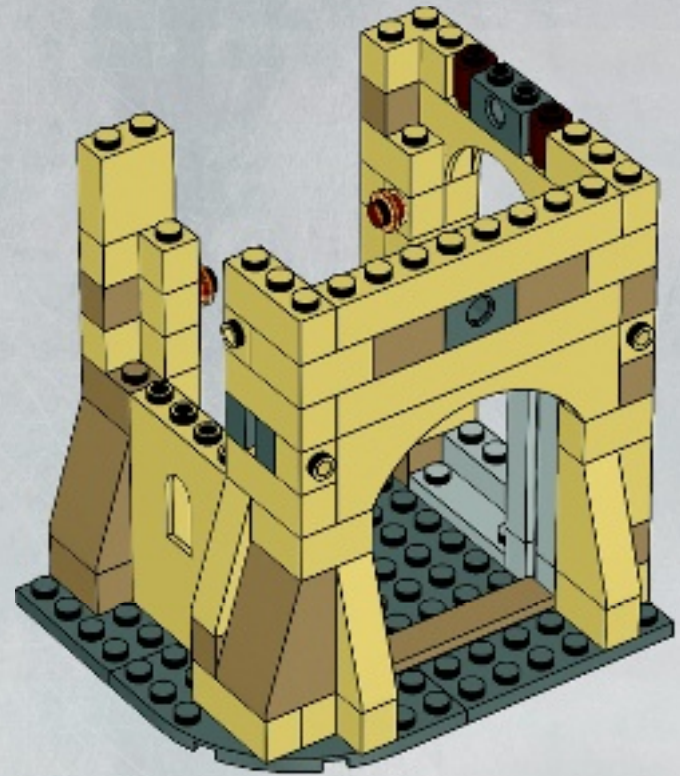

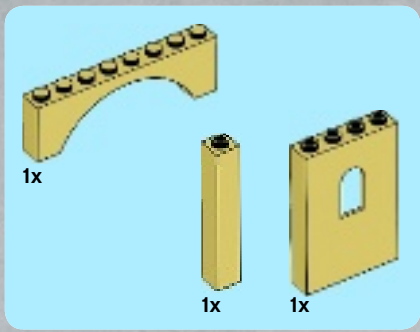

16

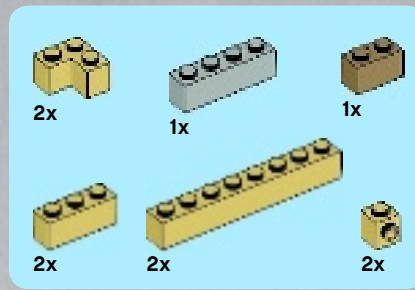
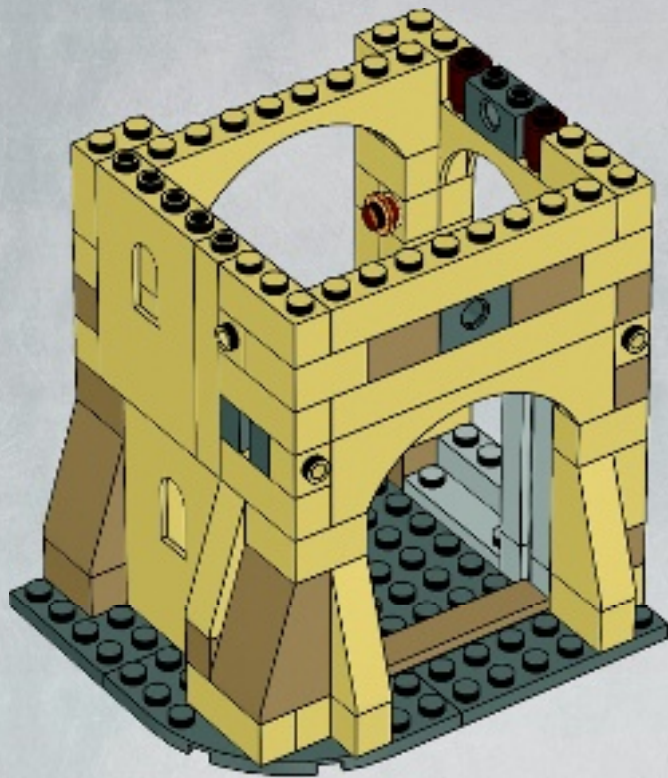

17

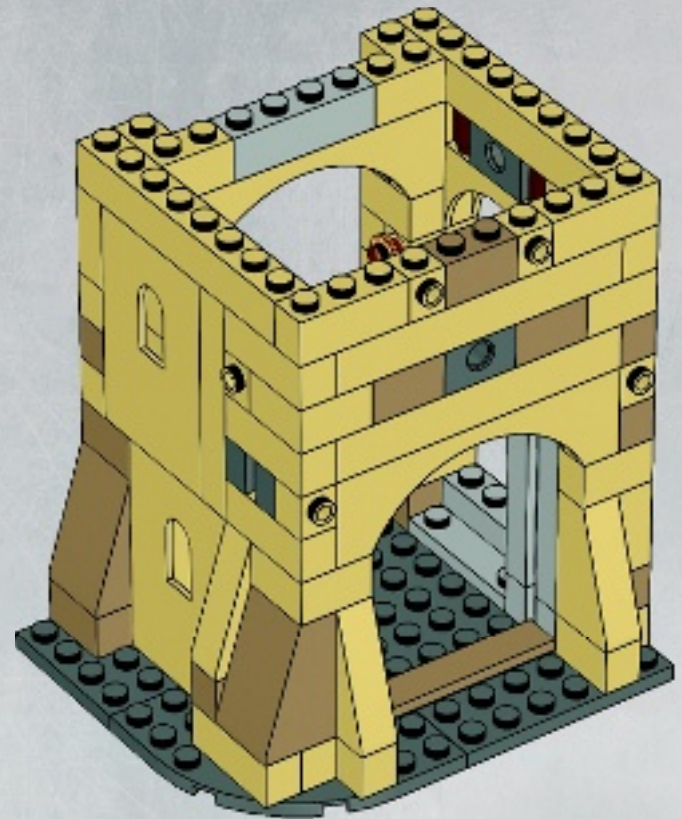

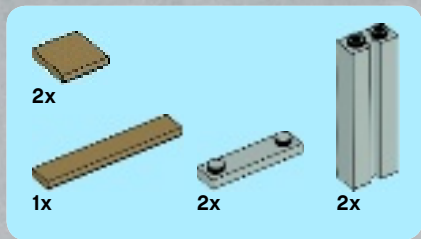

18

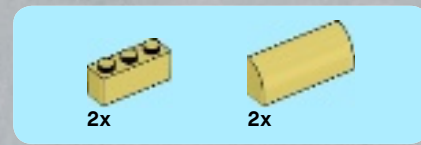
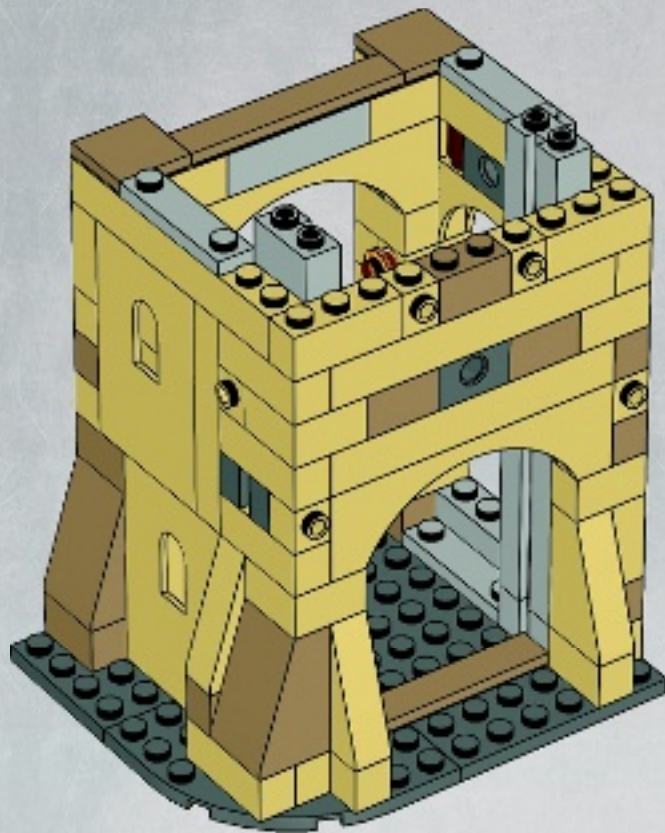

19

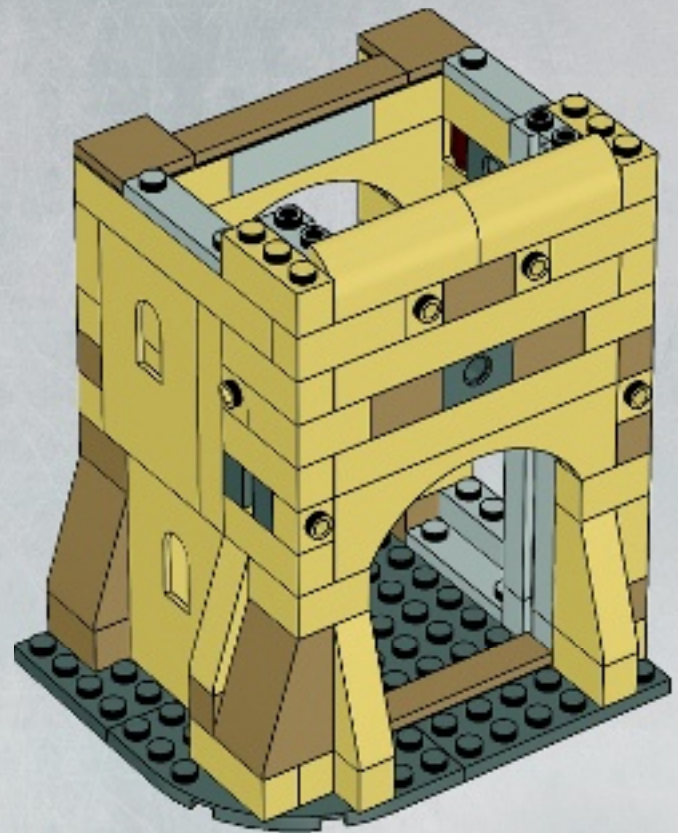



20

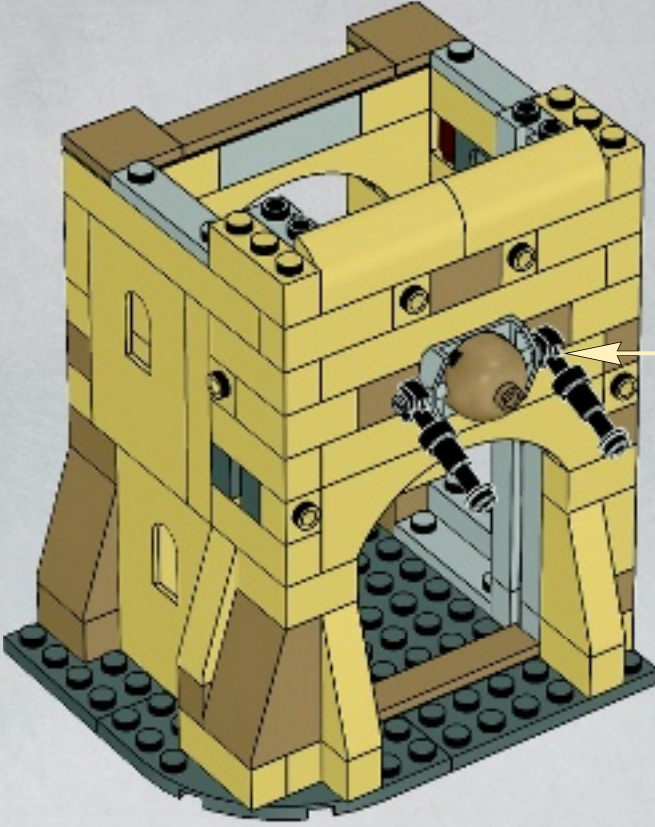

1. A tan ball is placed on a grey 1x3 Technic brick with two black pins inserted into the holes. Red arrows point to the pins.

2. The tan ball is rotated 180 degrees, as indicated by a blue circular arrow icon.

3. A black axle is inserted through the hole on the right side of the grey brick, passing through the ball.

4. A black pin is inserted into the hole on the left side of the grey brick, passing through the ball. A blue axle is inserted into the hole on the left side of the grey brick, passing through the ball.

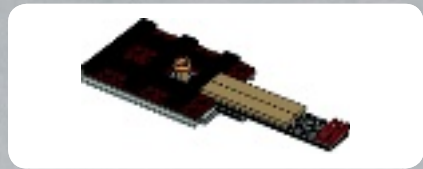

1

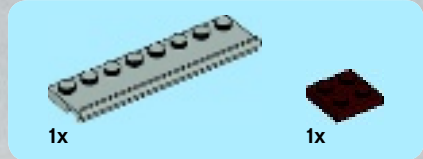
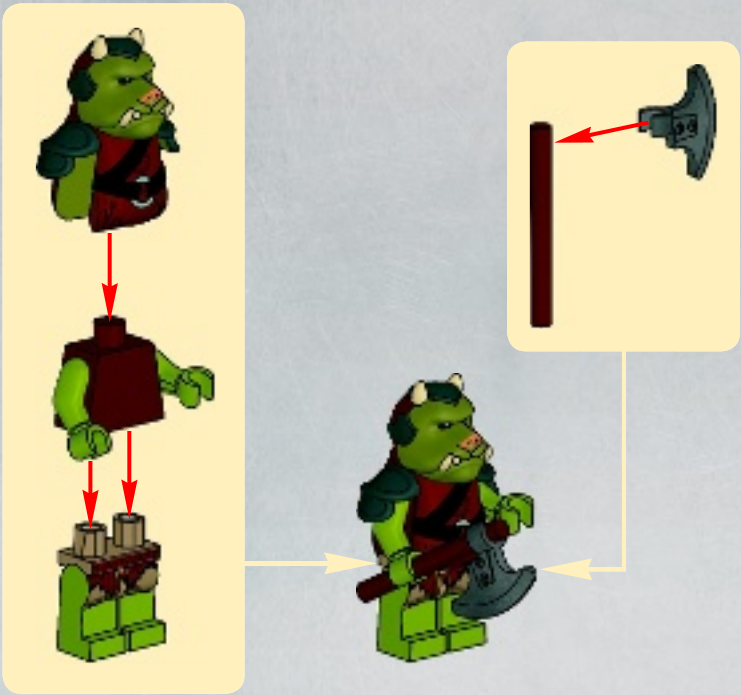

2

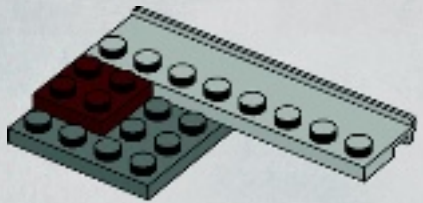



1x

# 3

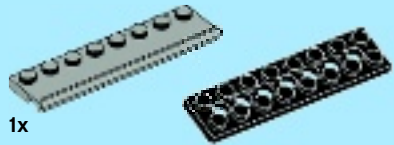
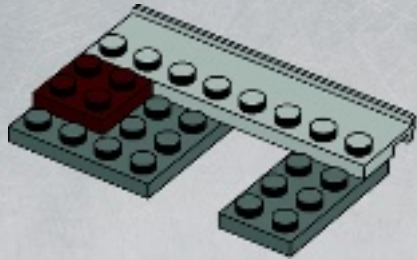

1x

1x

# 4

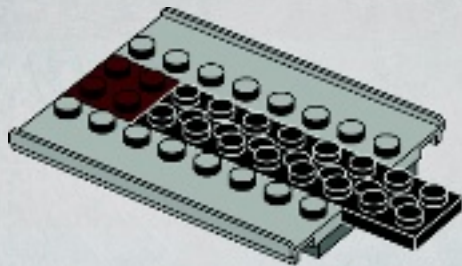

1x

2x

1x

1x

# 5

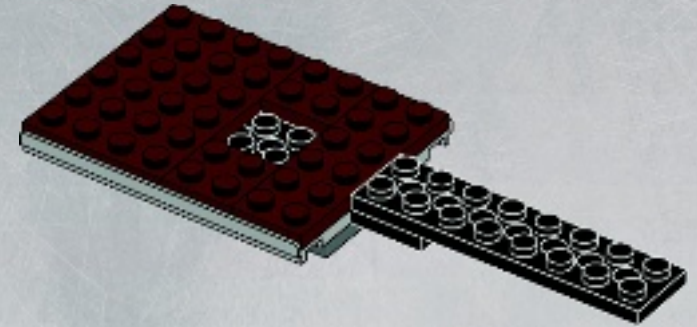

2x



1x



13x

# 6

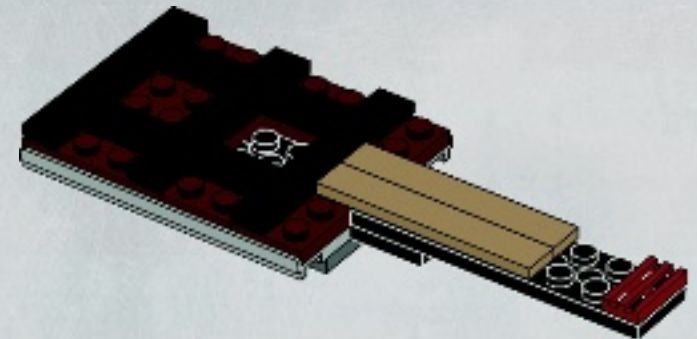





7

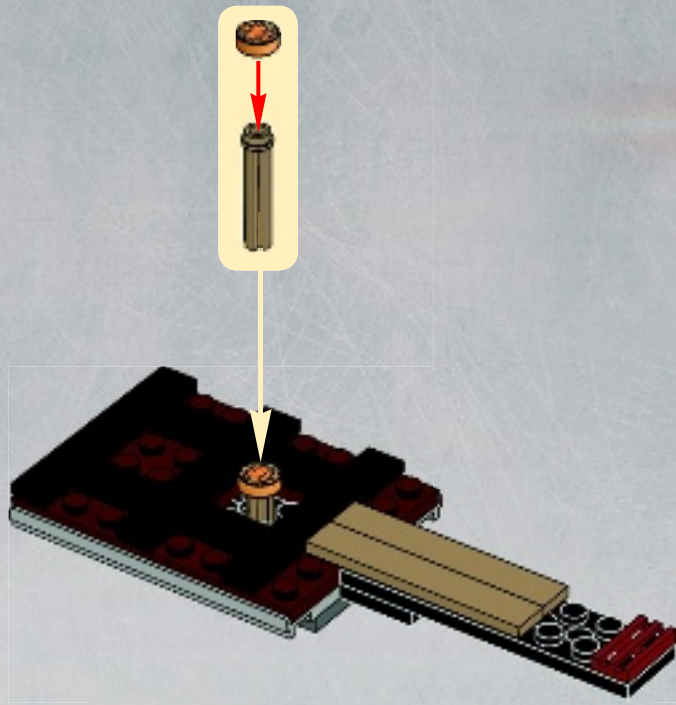

8



9

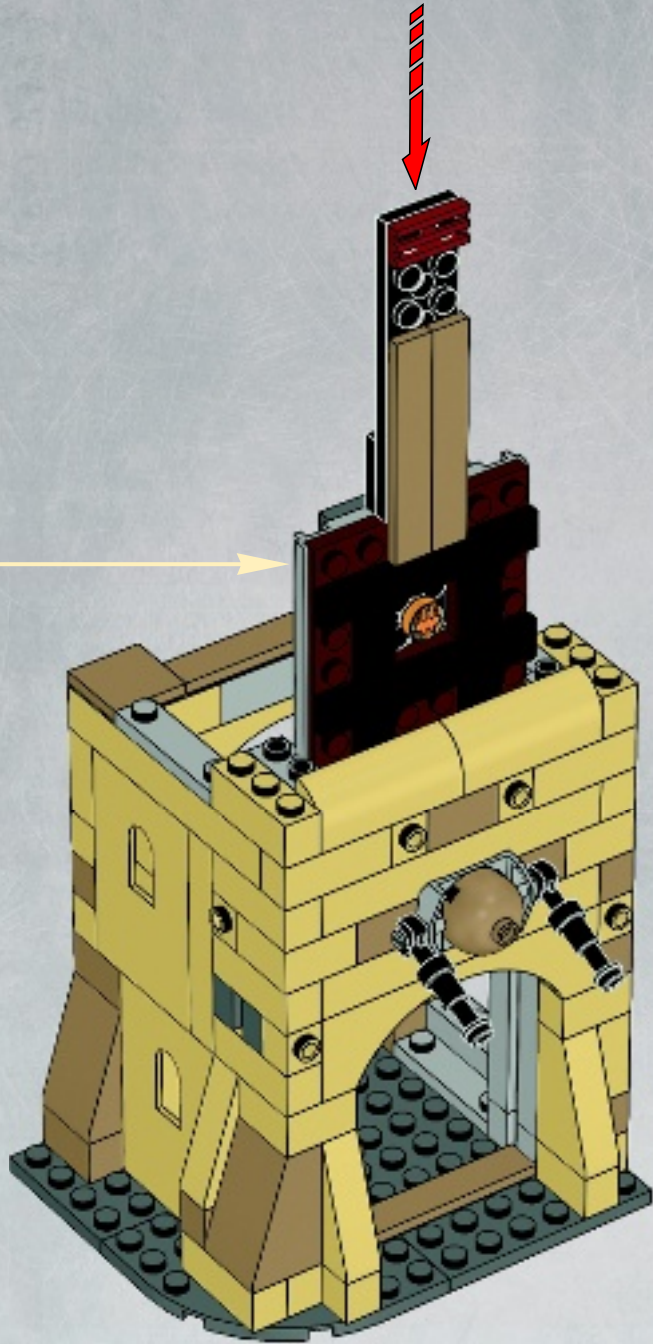

10

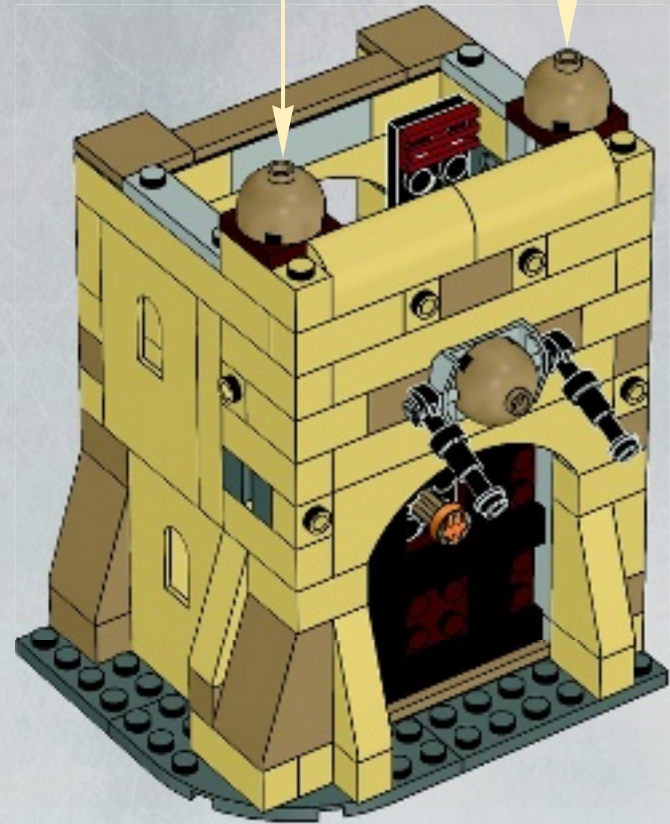

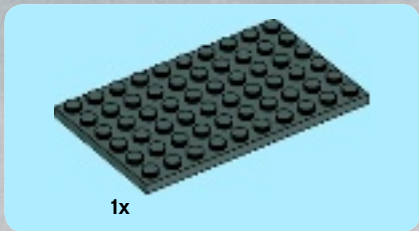
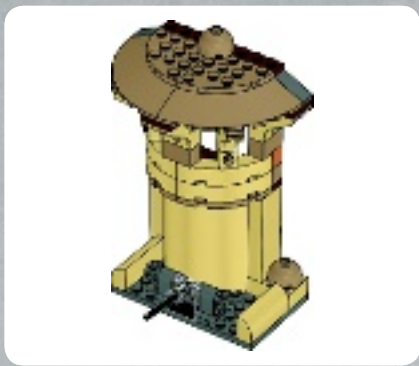

1x

1

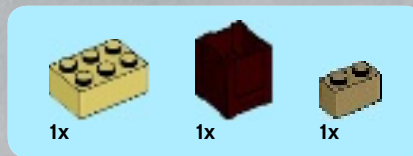

1x

1x

1x

2

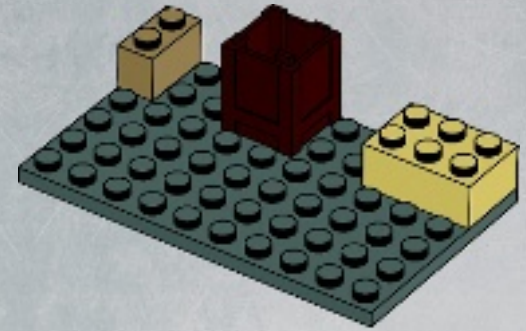

2x

1x

3

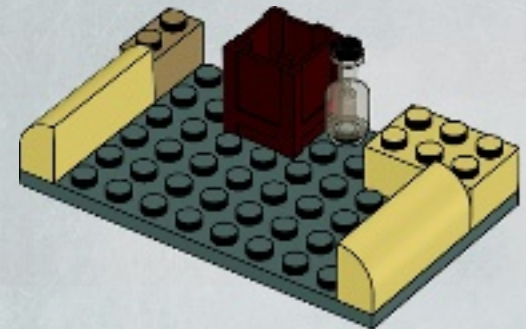

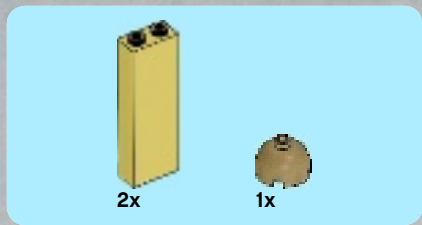

4

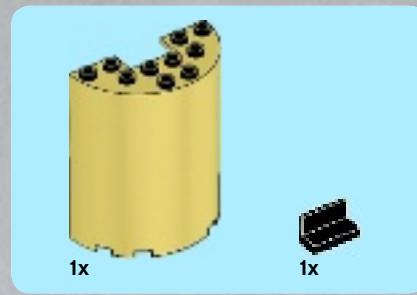
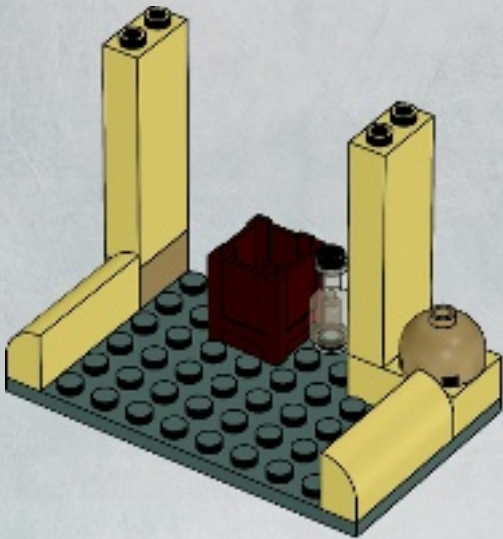

5

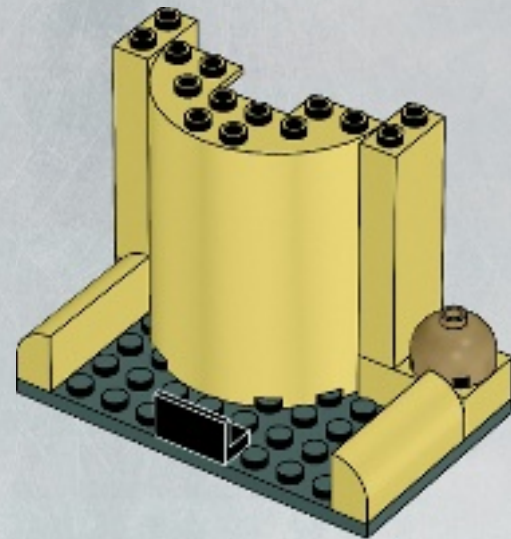



6

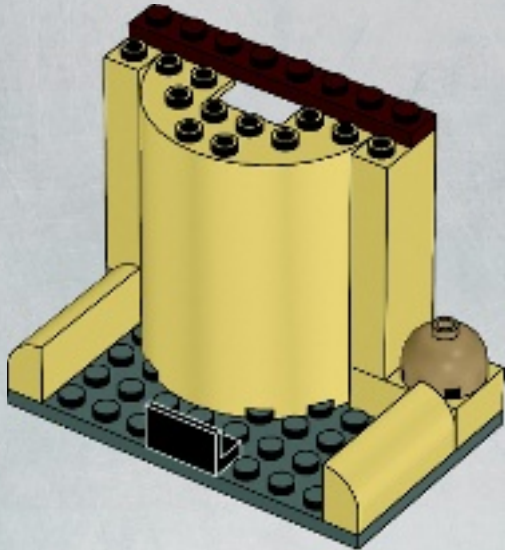

7

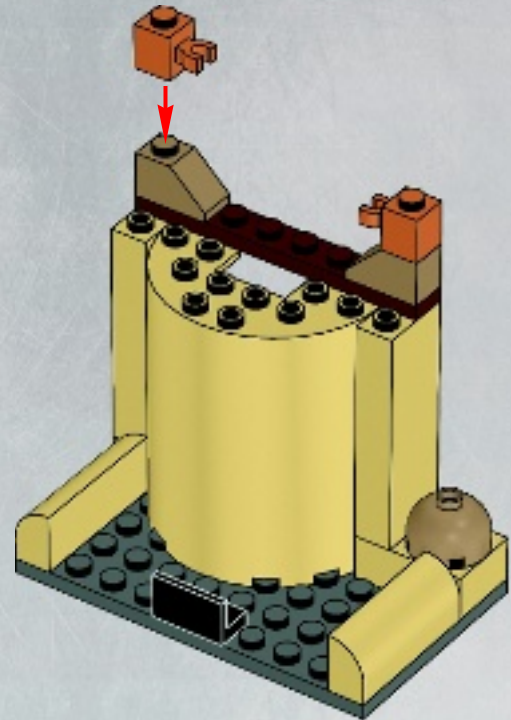



8

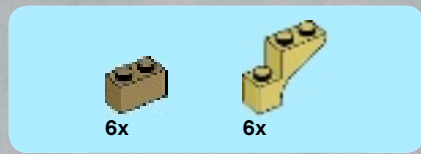
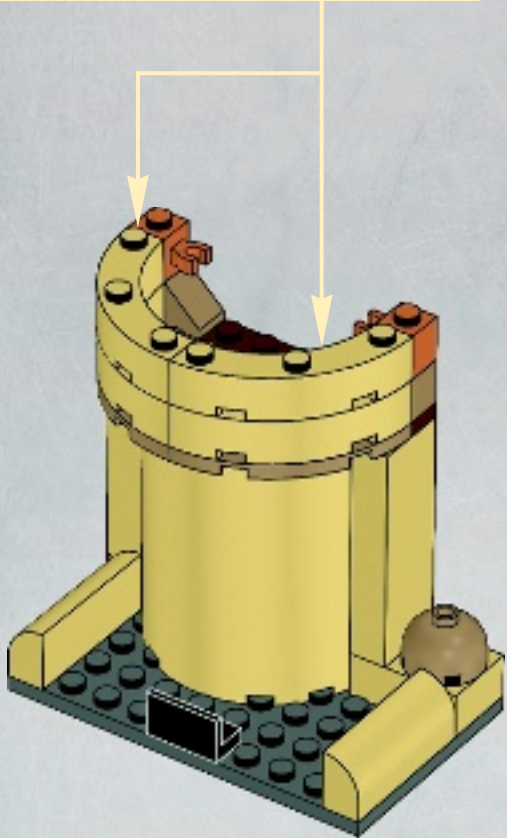
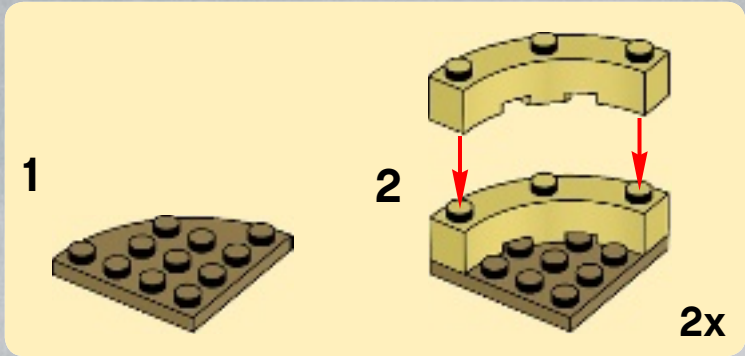

9

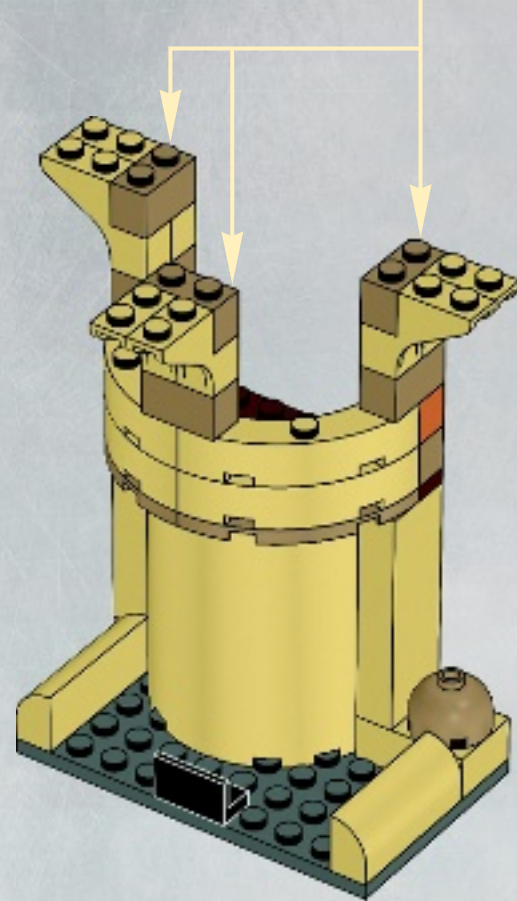
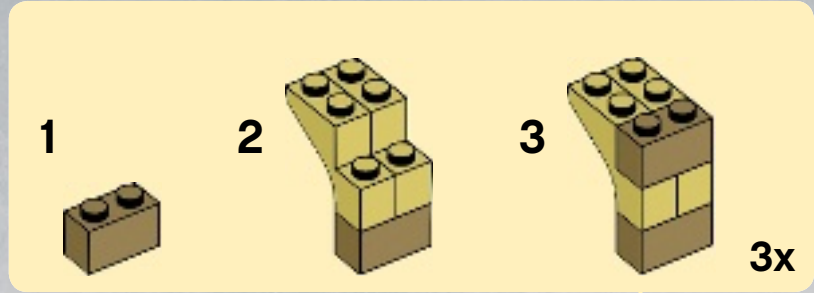

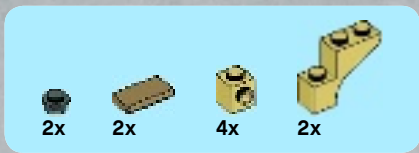

# 10

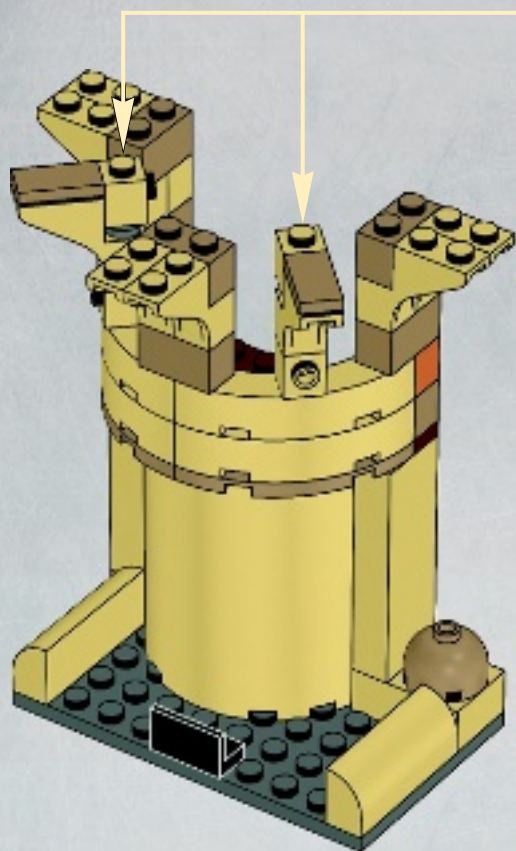
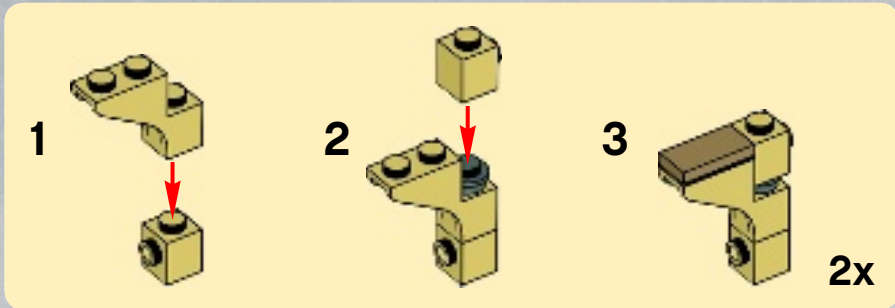

# 11

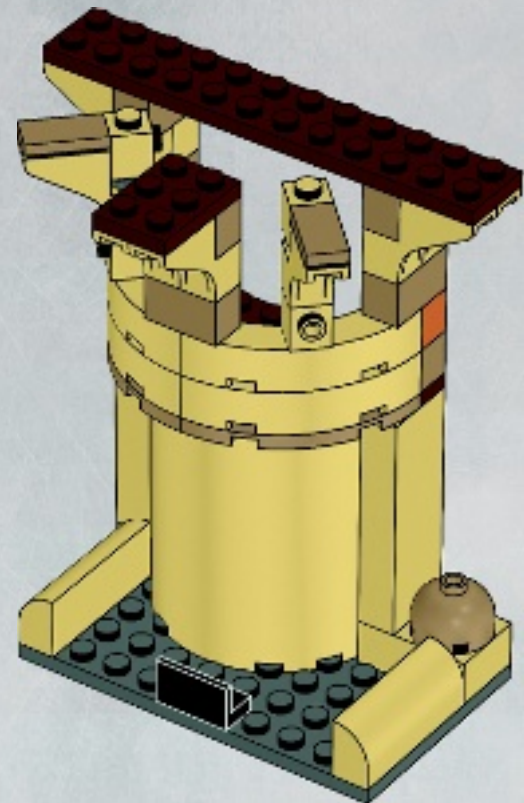

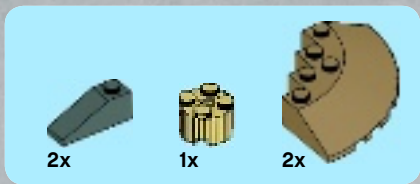

12

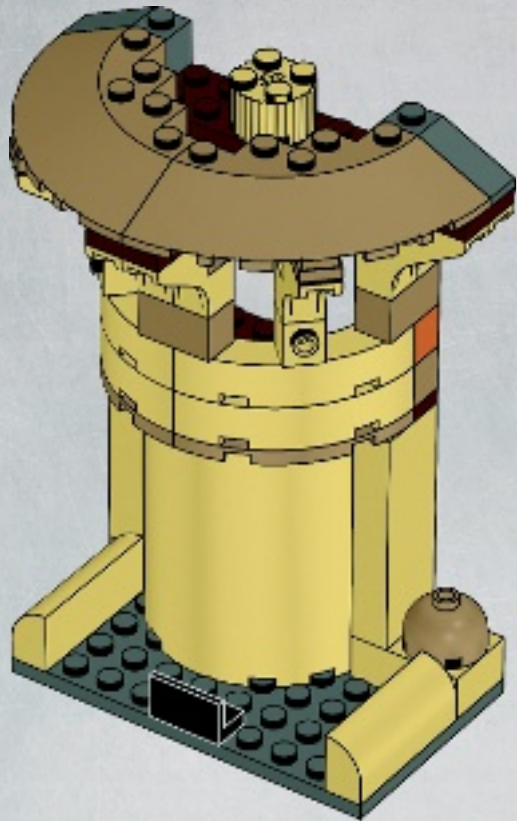

13

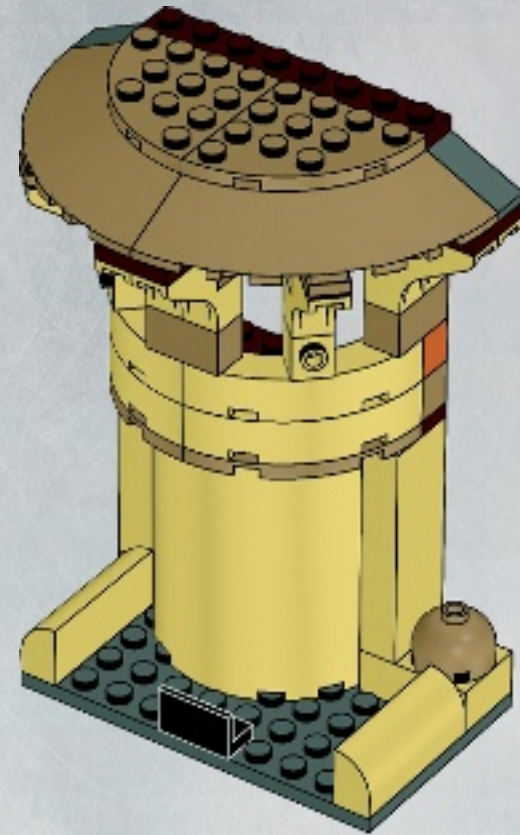



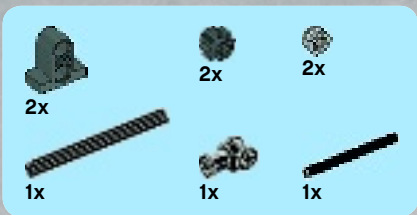

14

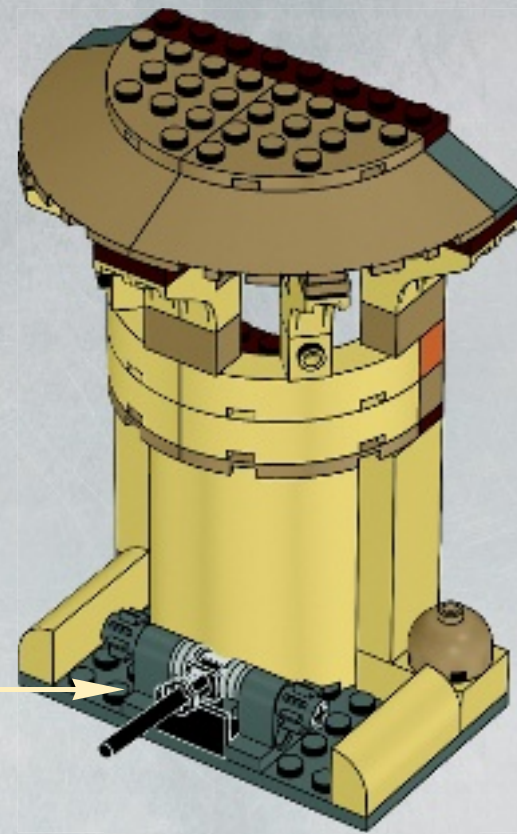
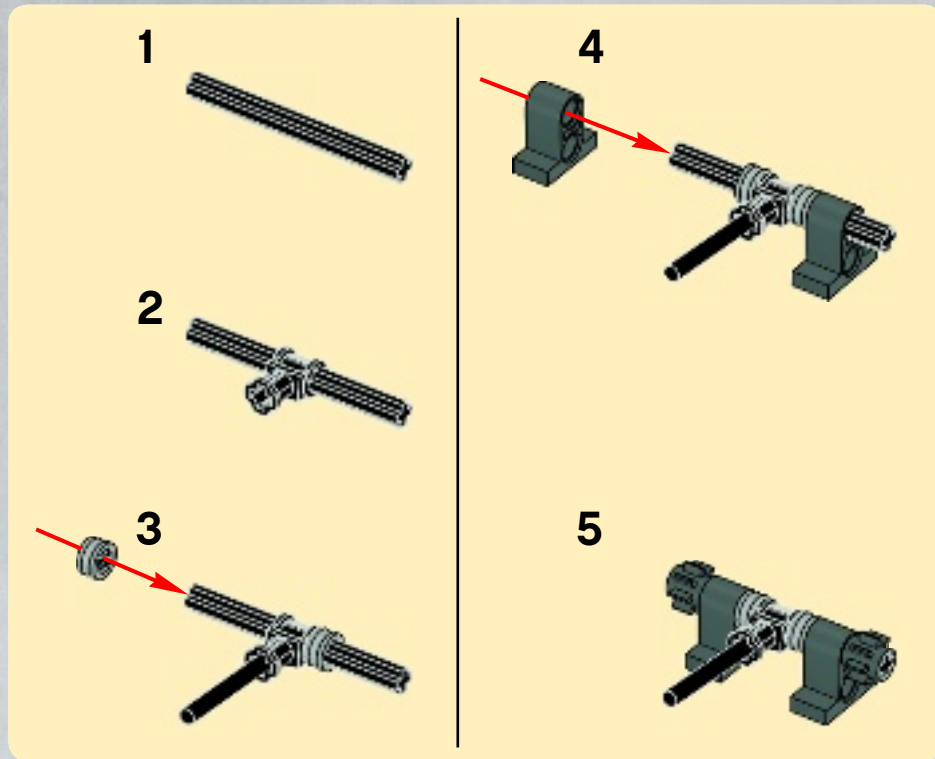



1x



1x



1x



1x

# 15

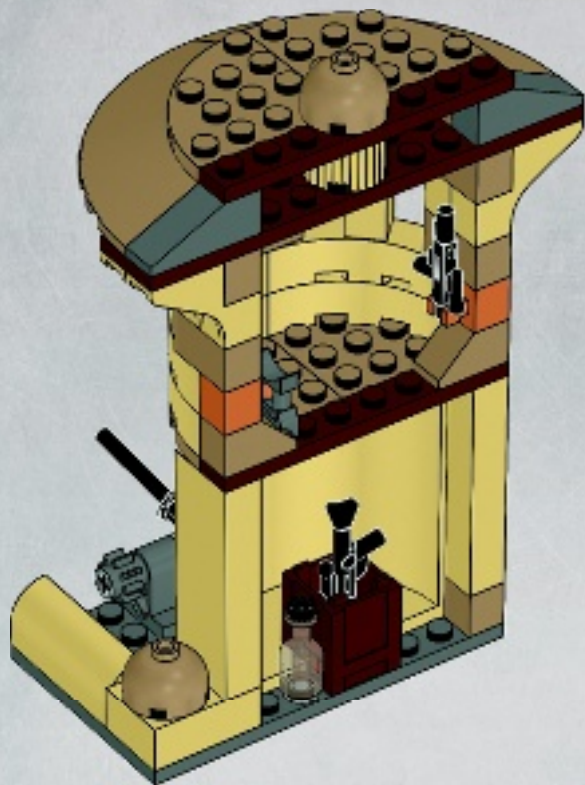

# 16

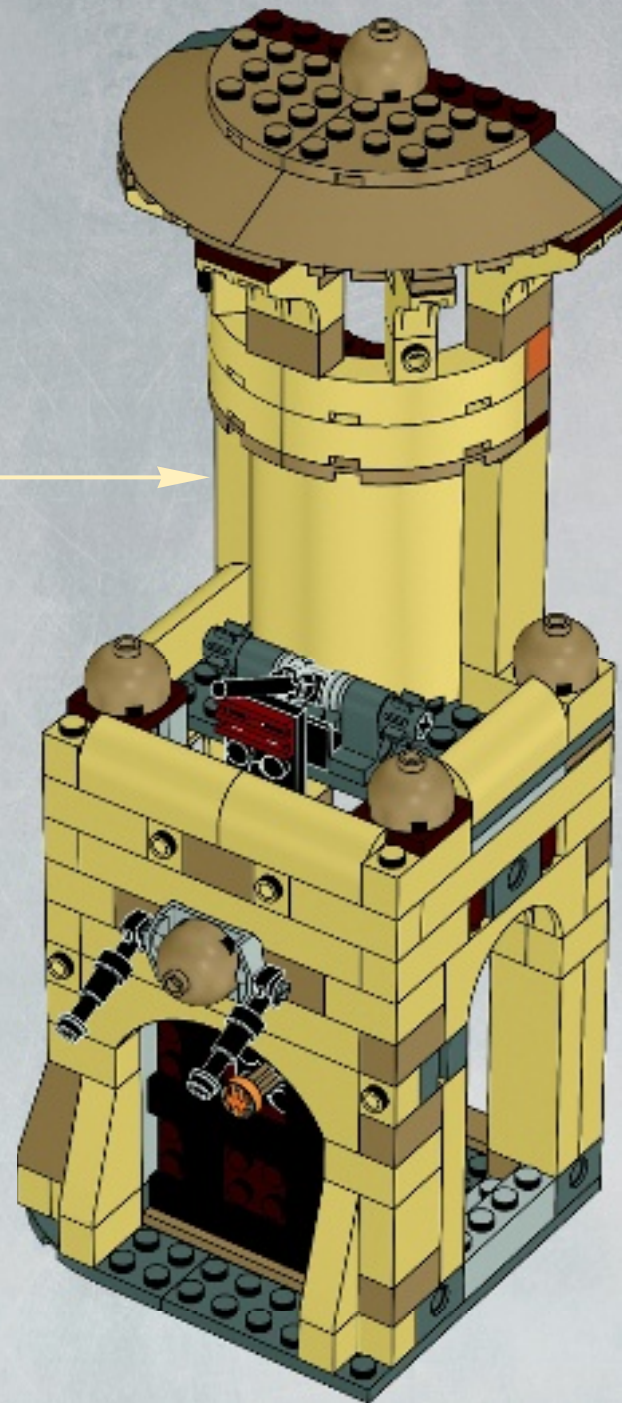

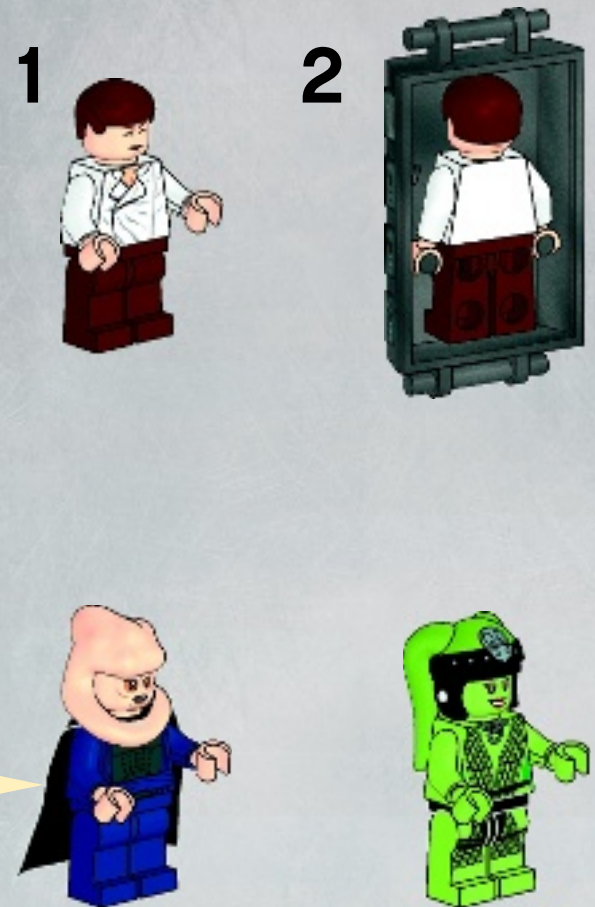
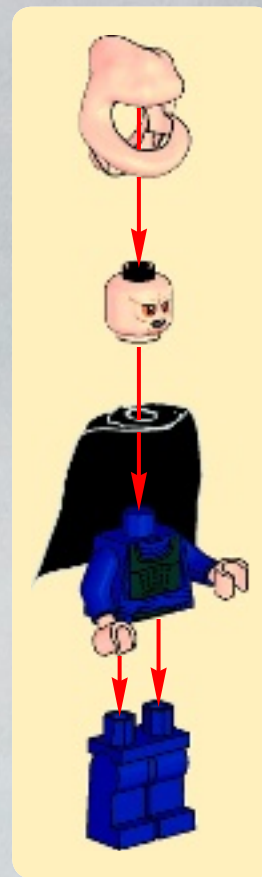
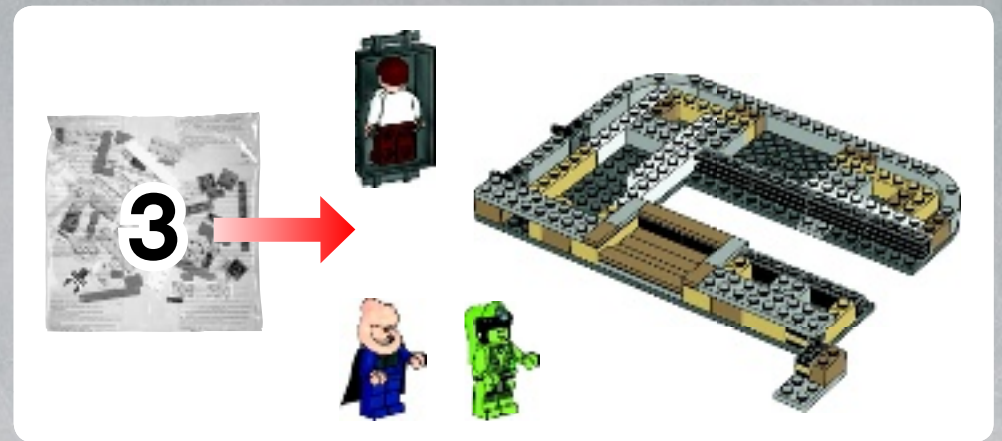
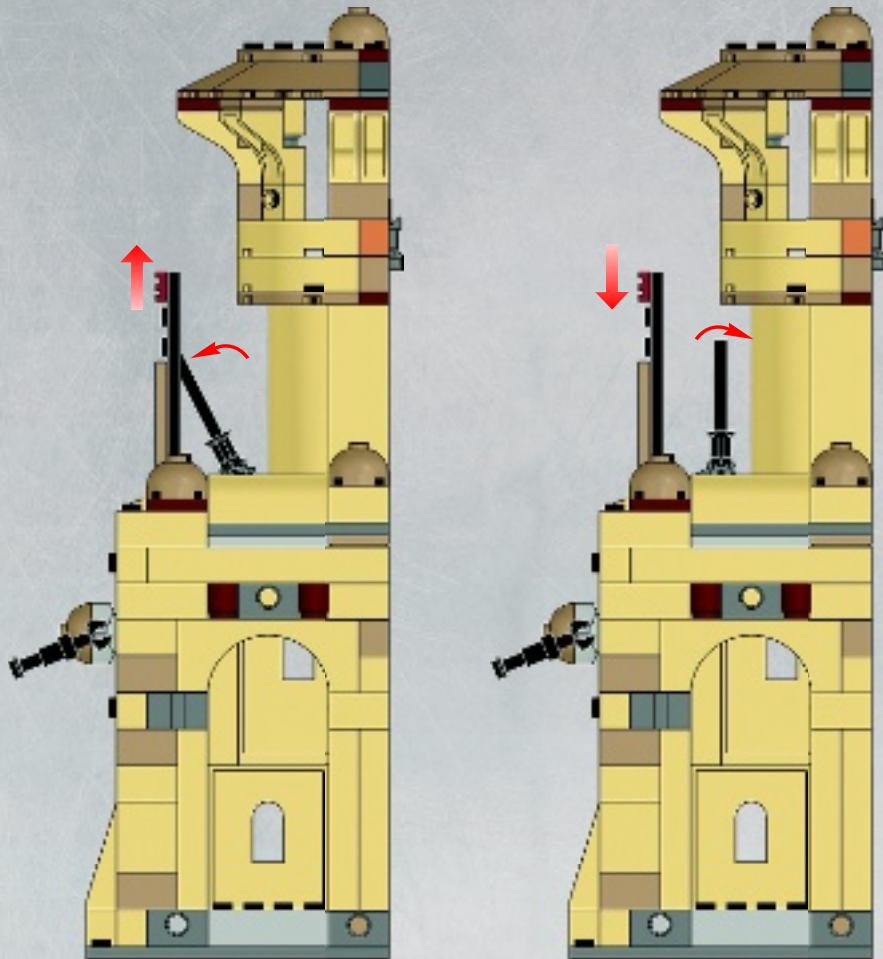

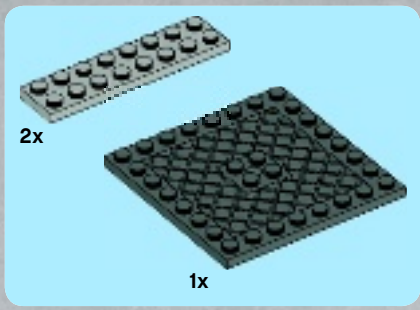

1

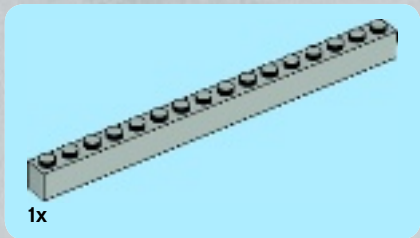
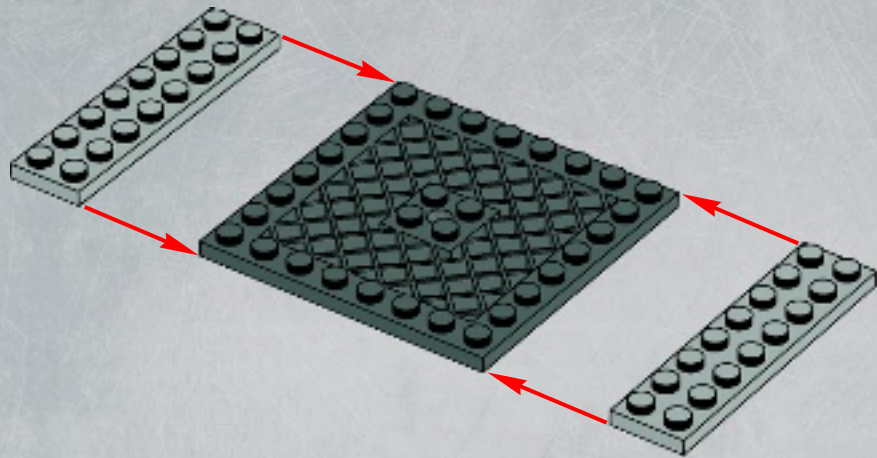

2

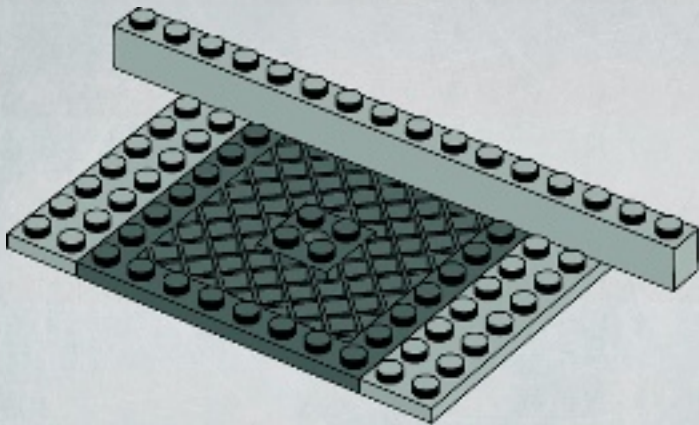

3

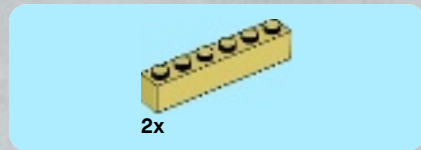
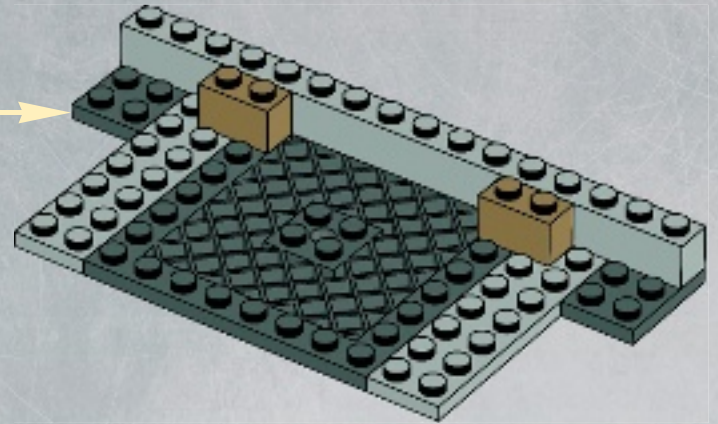

4

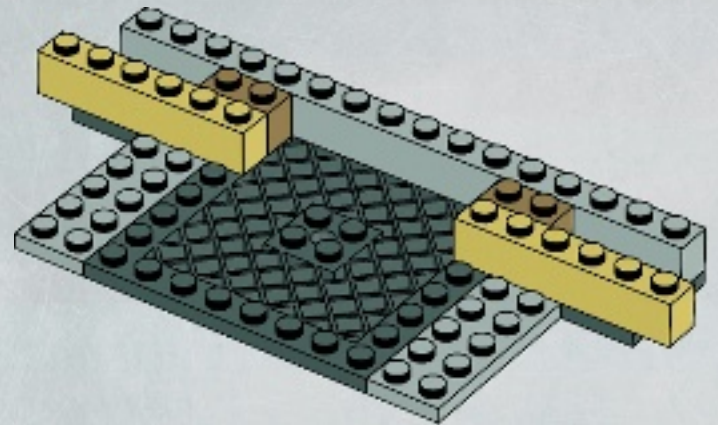

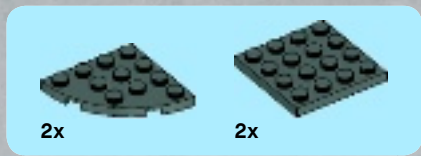

5

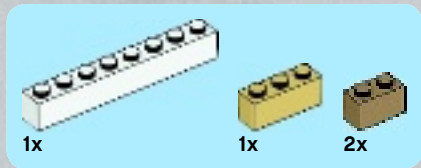
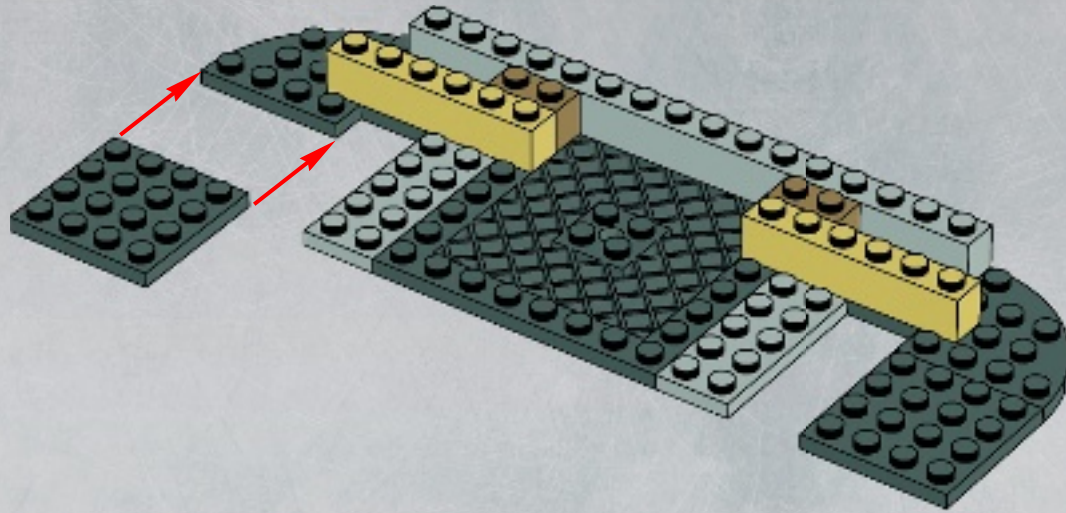

6

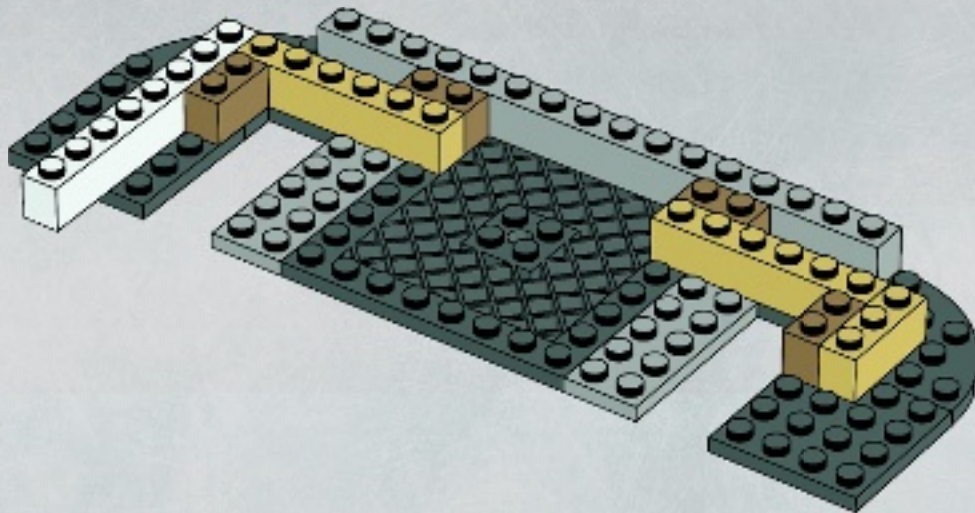

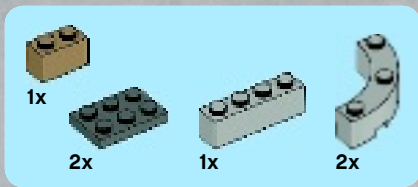

7

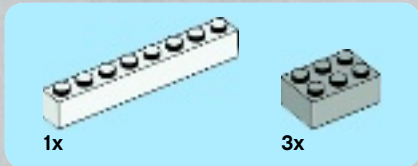
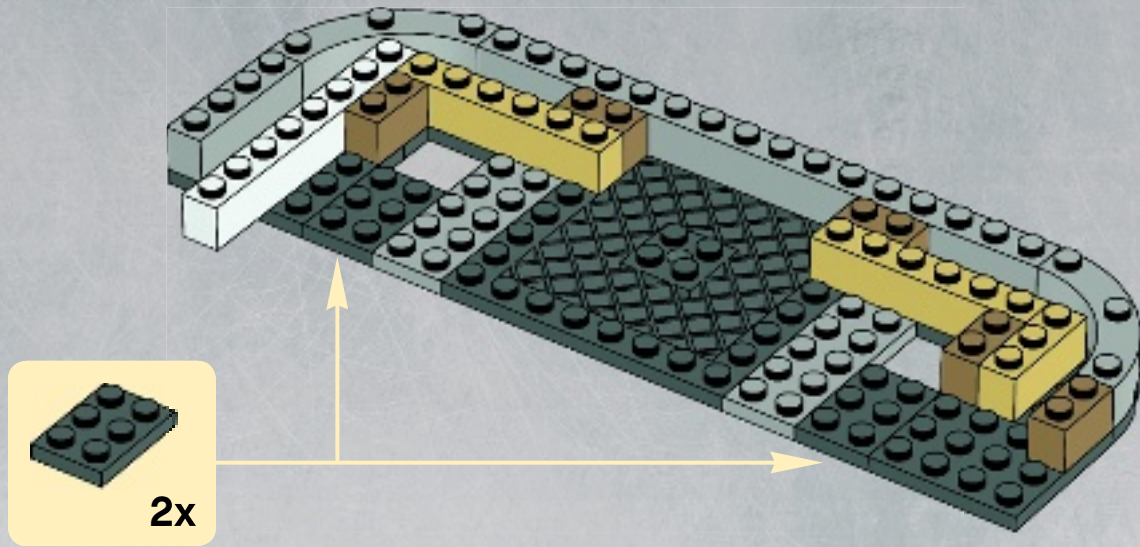

8

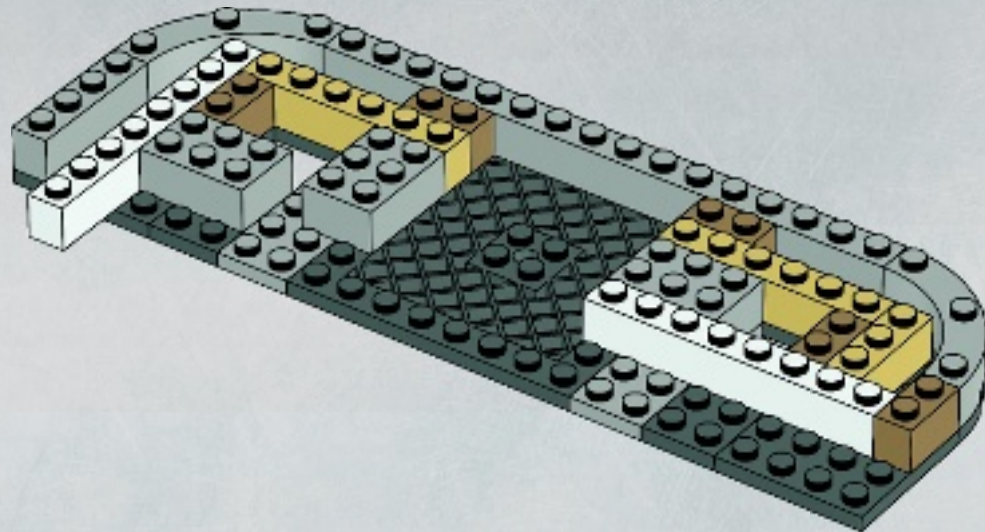

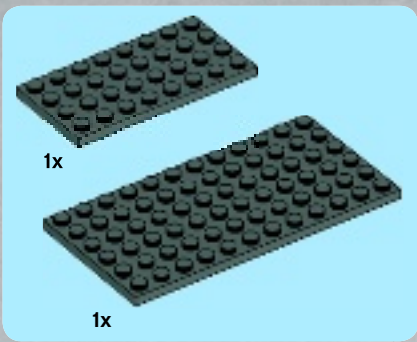

9

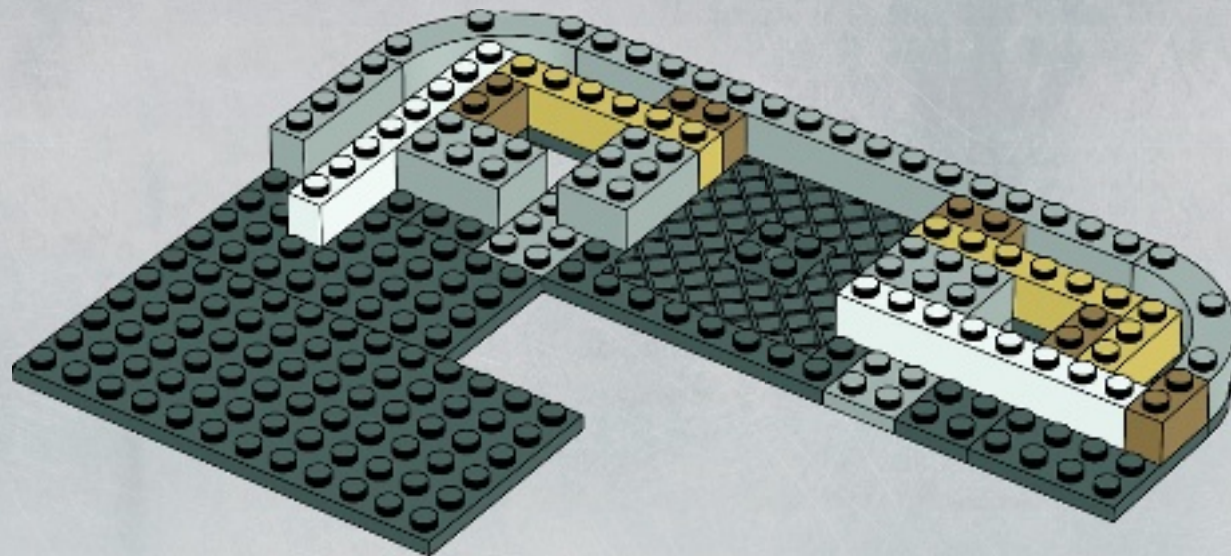

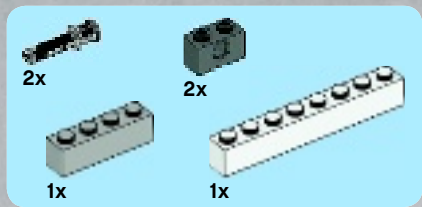

10

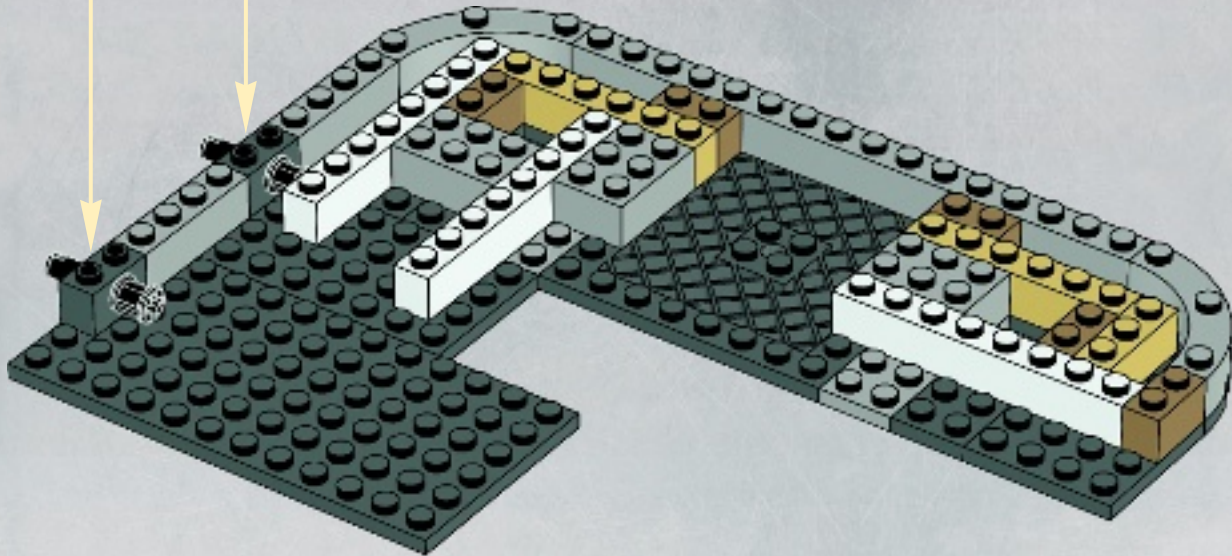
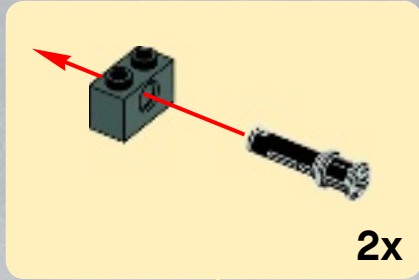



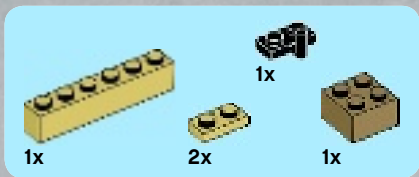

11

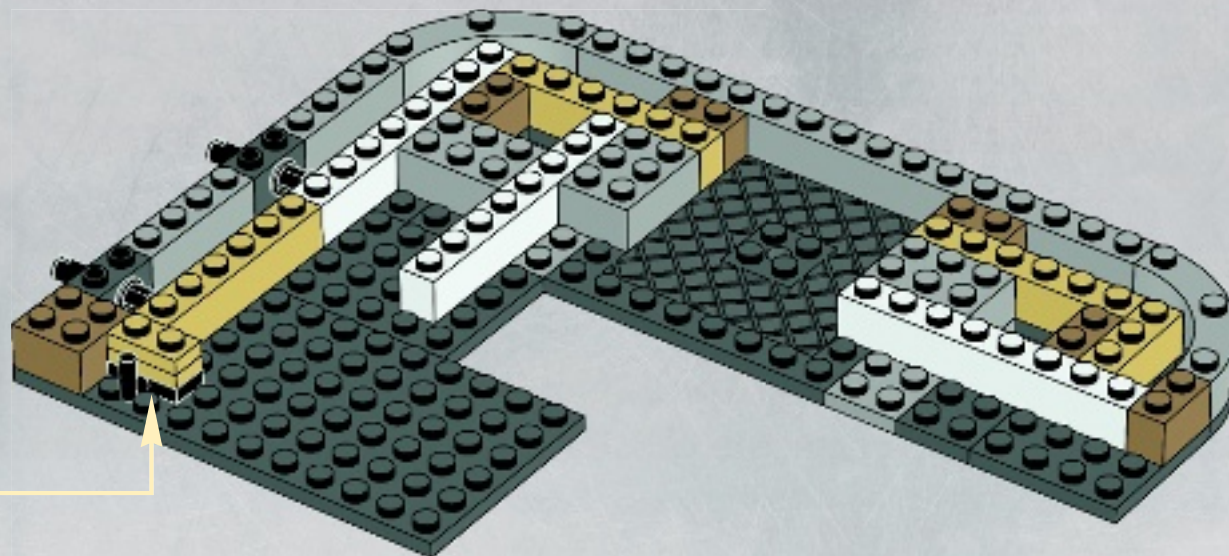
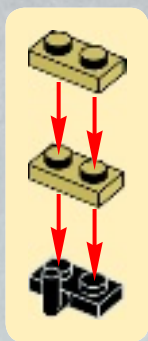

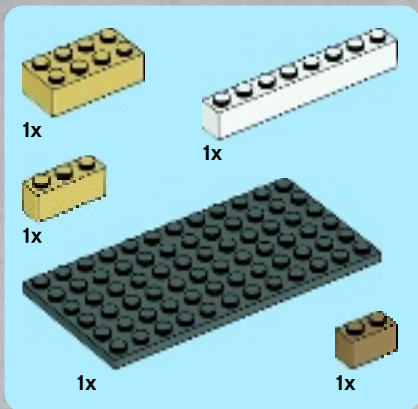

12

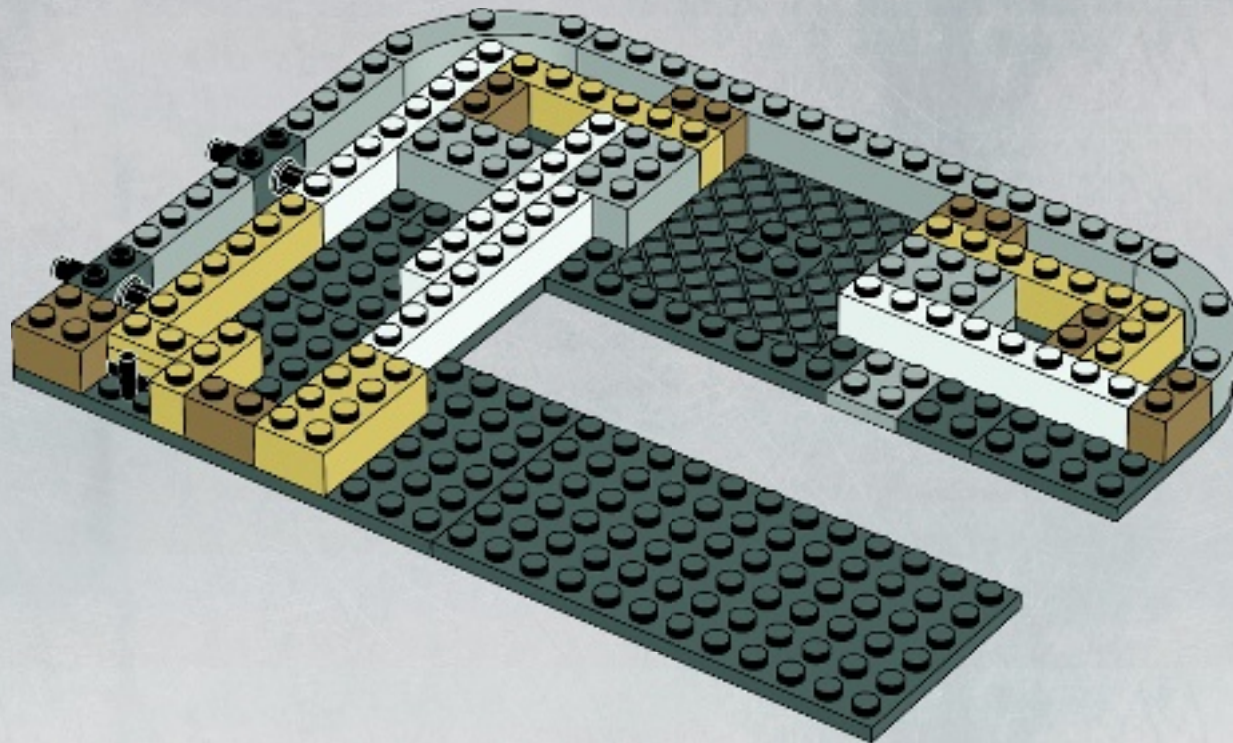

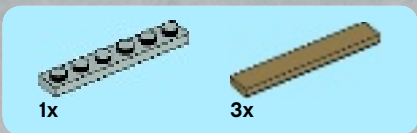

13

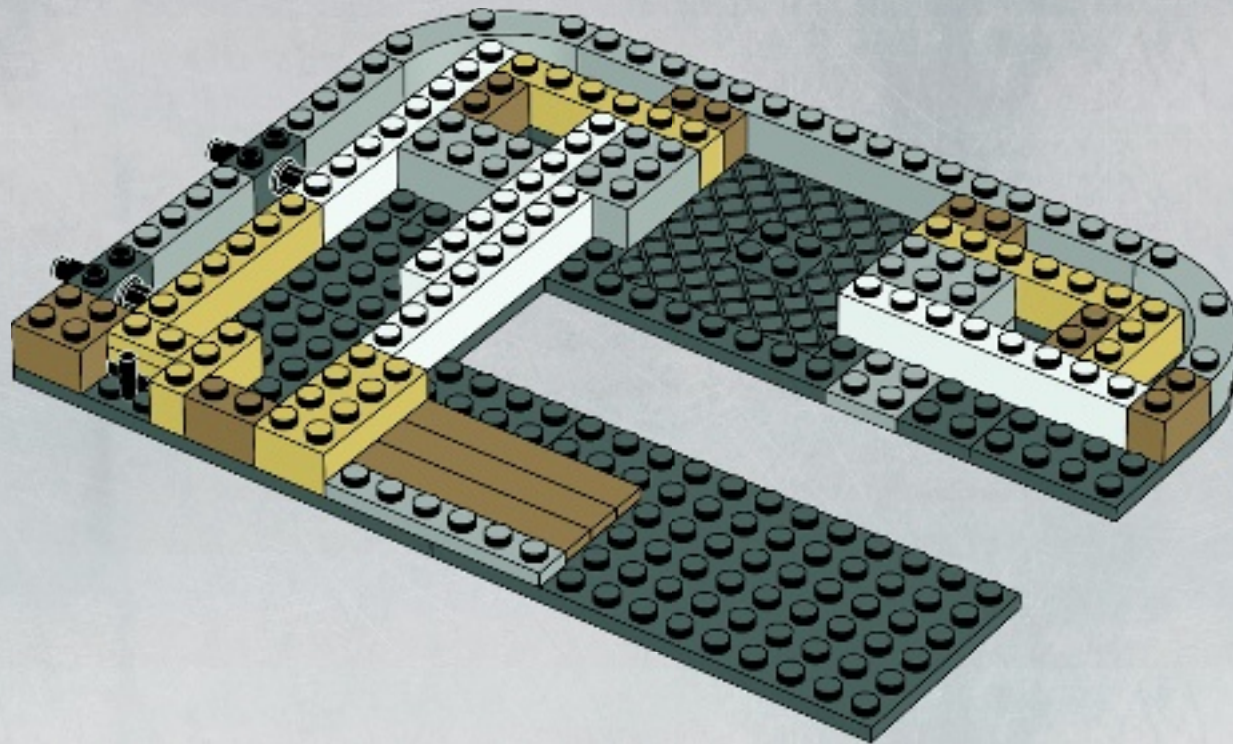

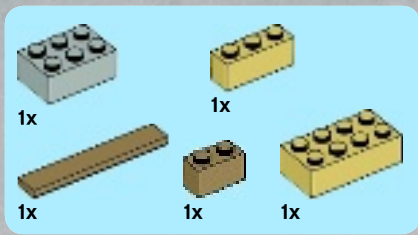

14

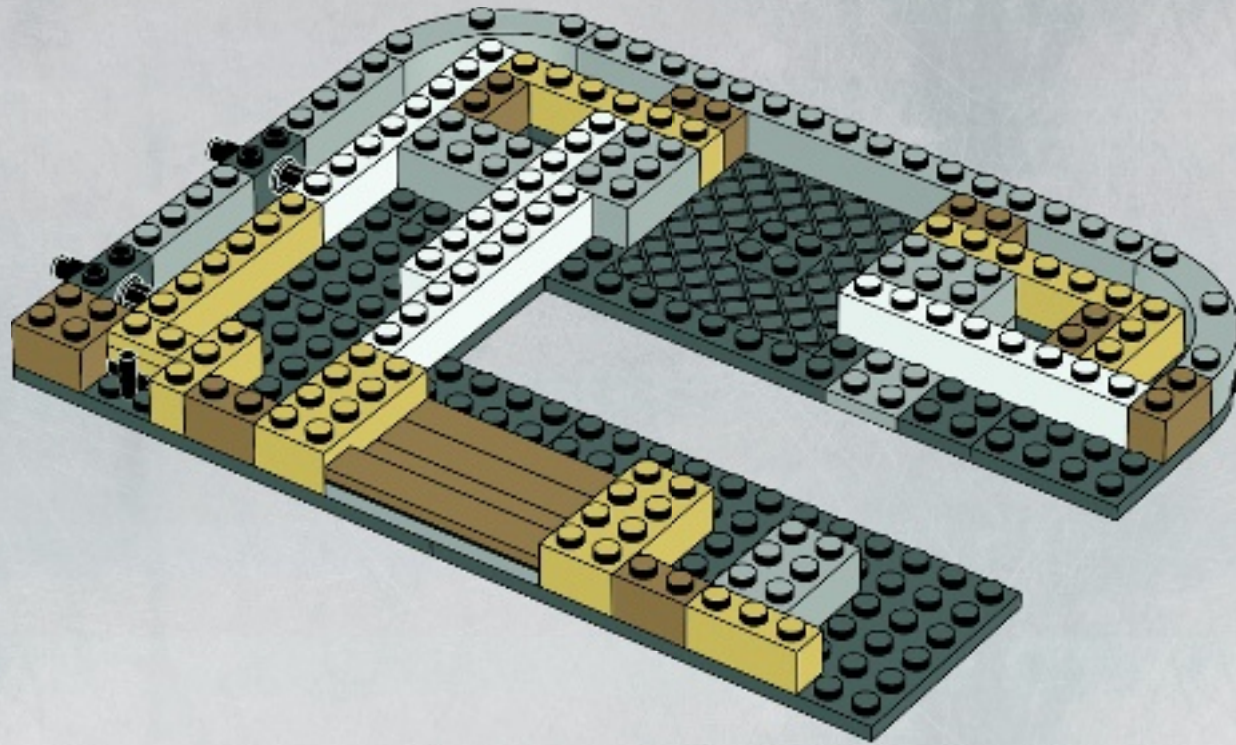



8x



1x

15

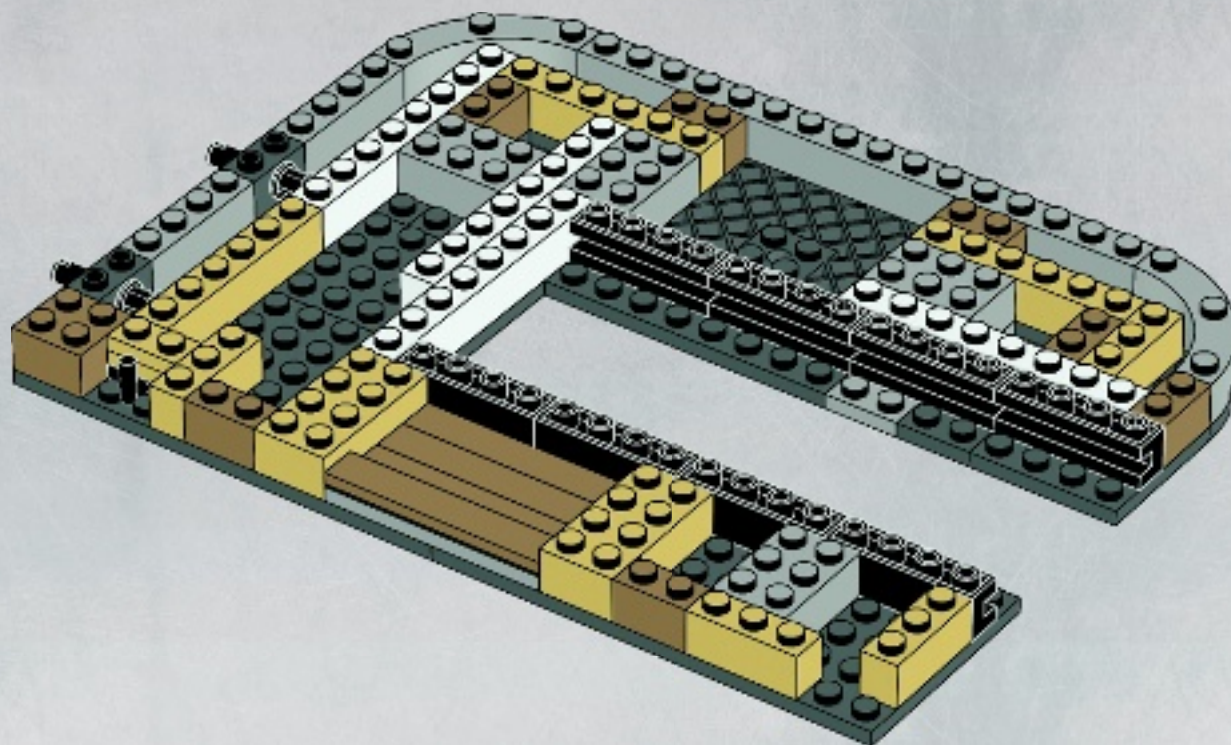



# 16

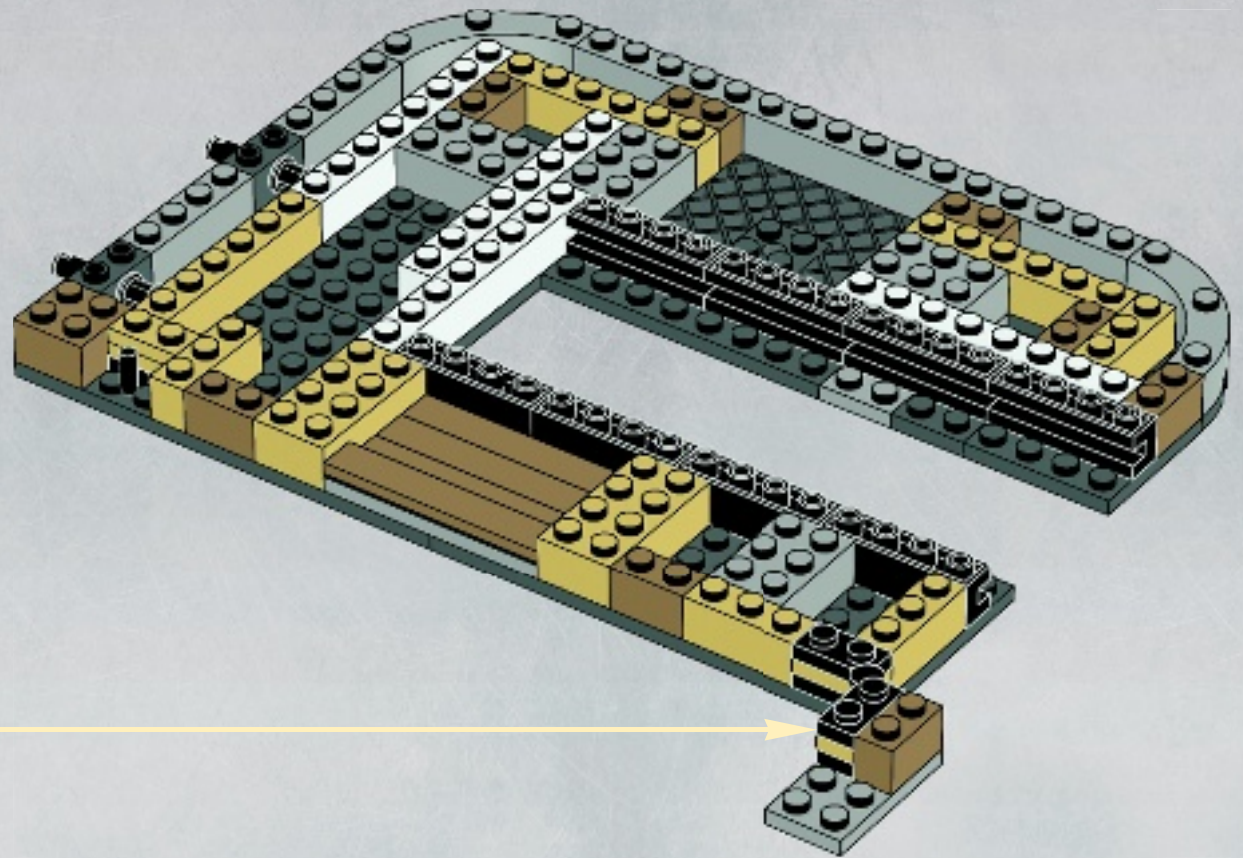
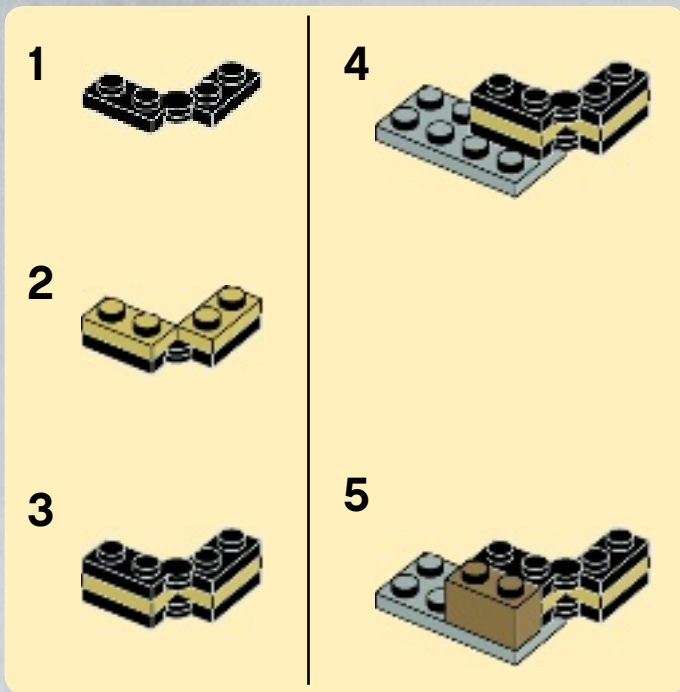

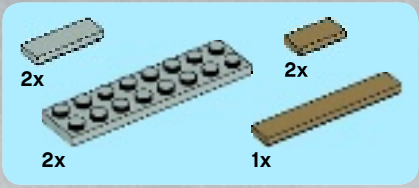
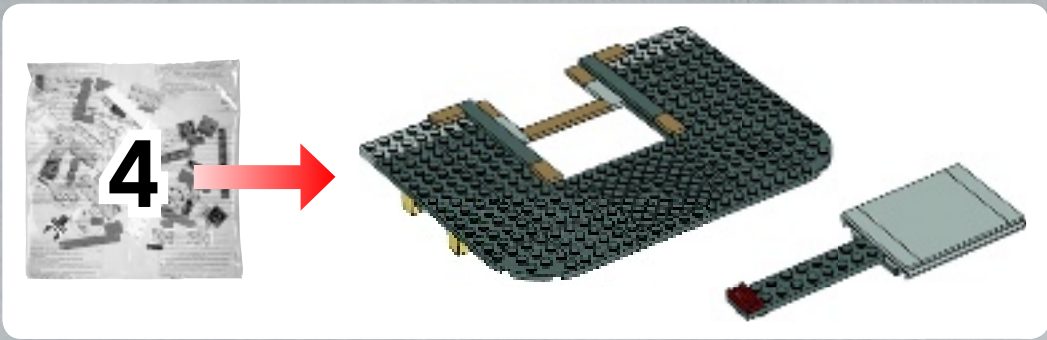

17

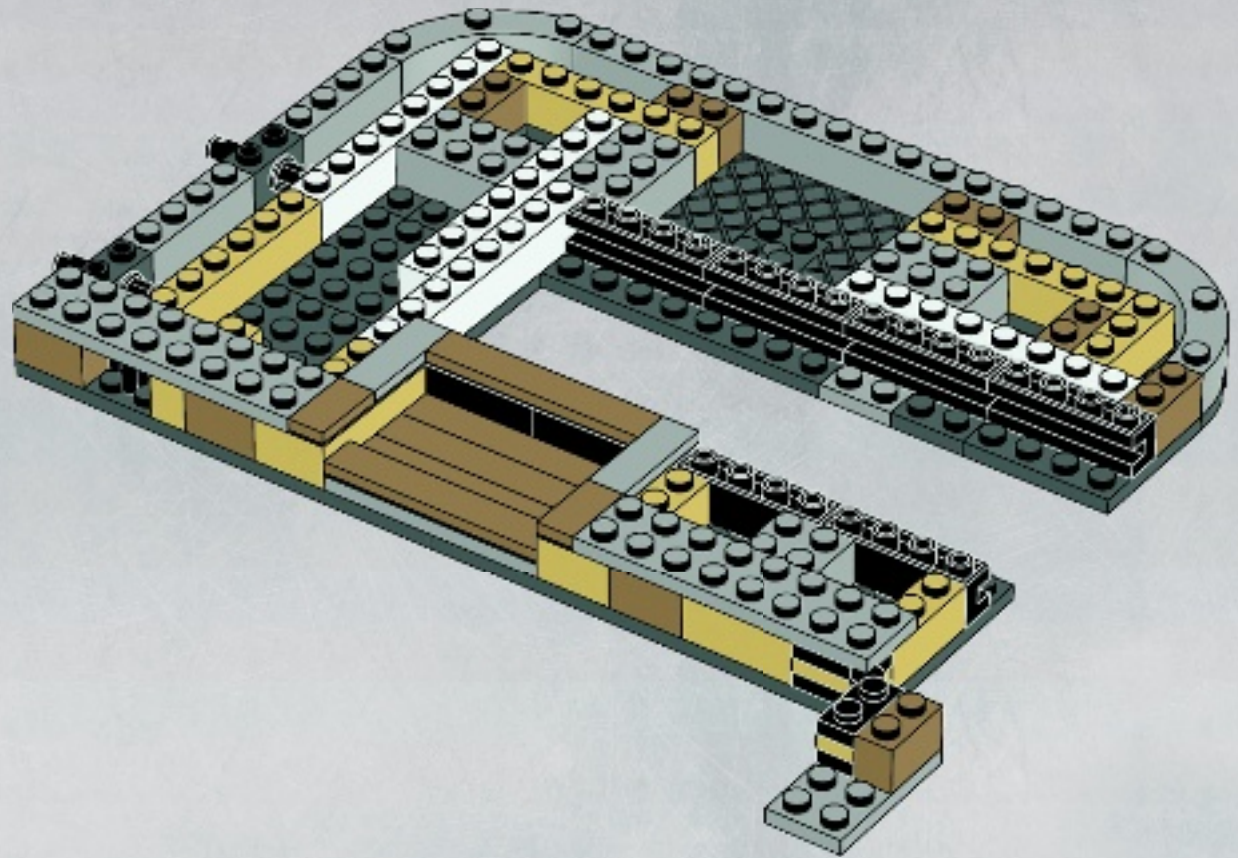



1

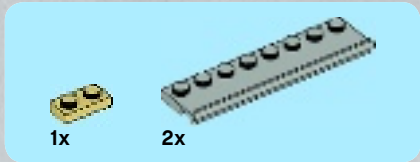
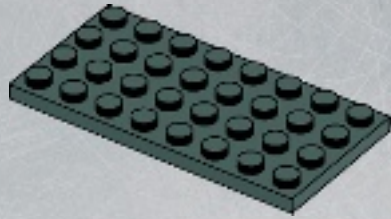

2

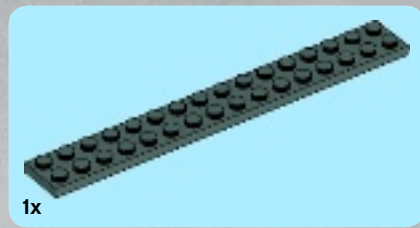
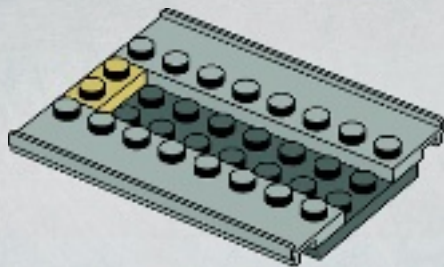

3

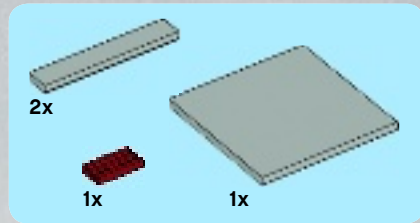
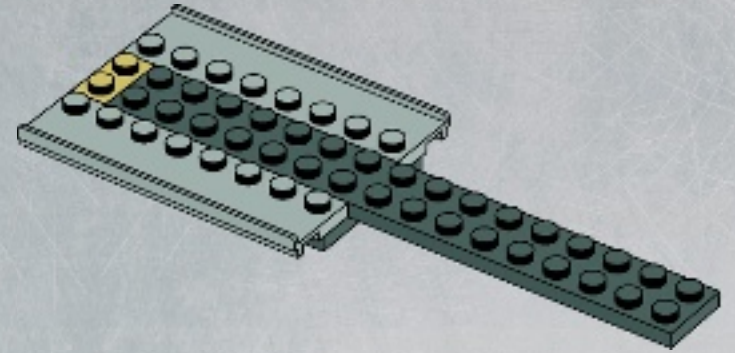

4

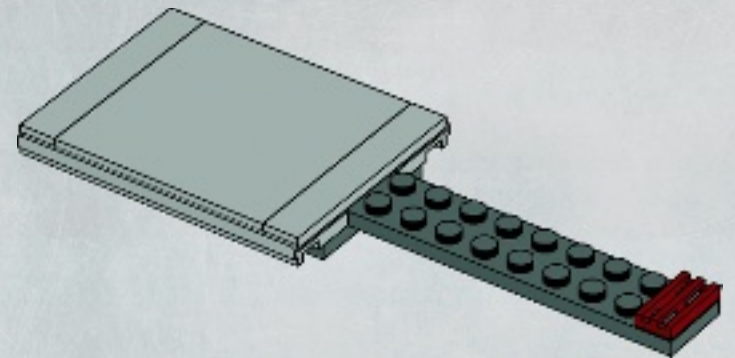





1x

5

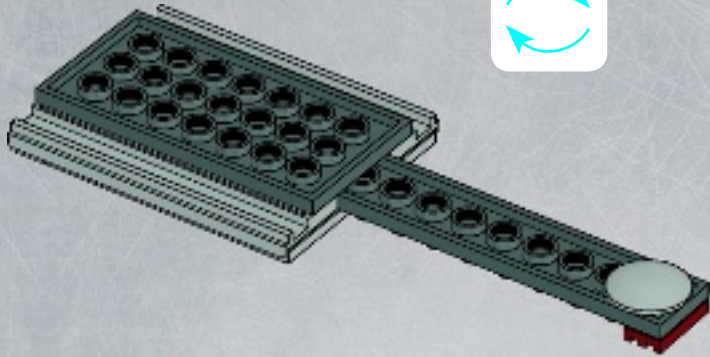

6

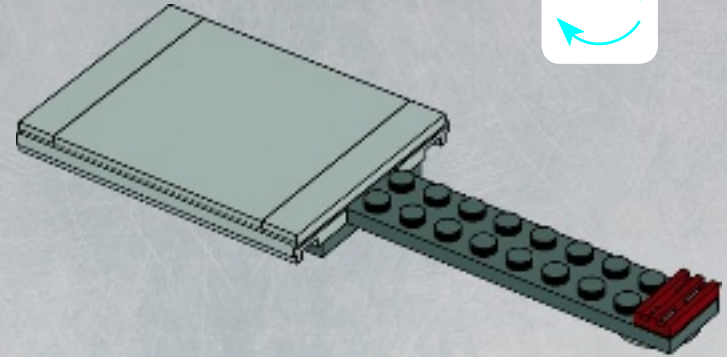

18

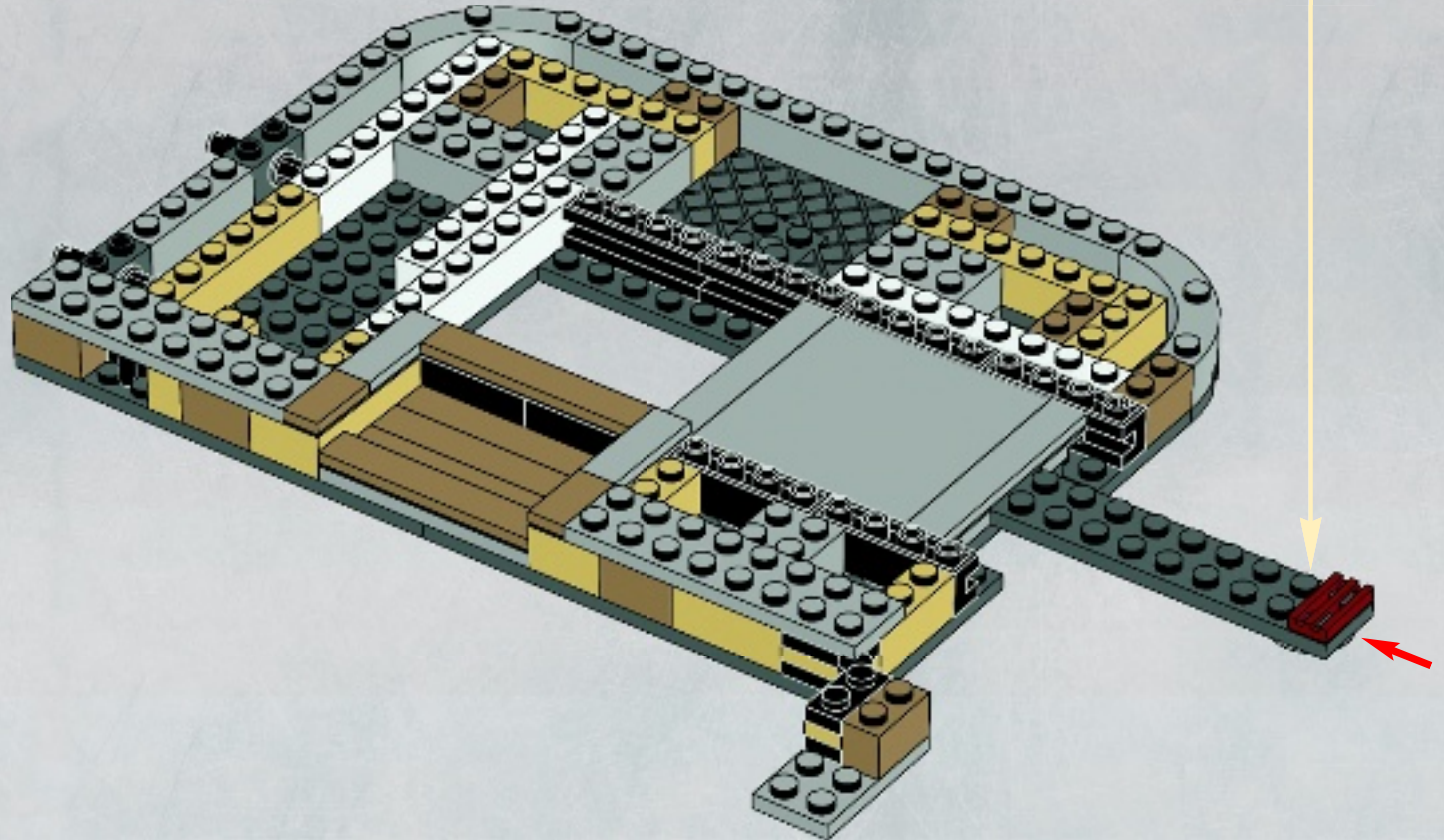



2x

# 19

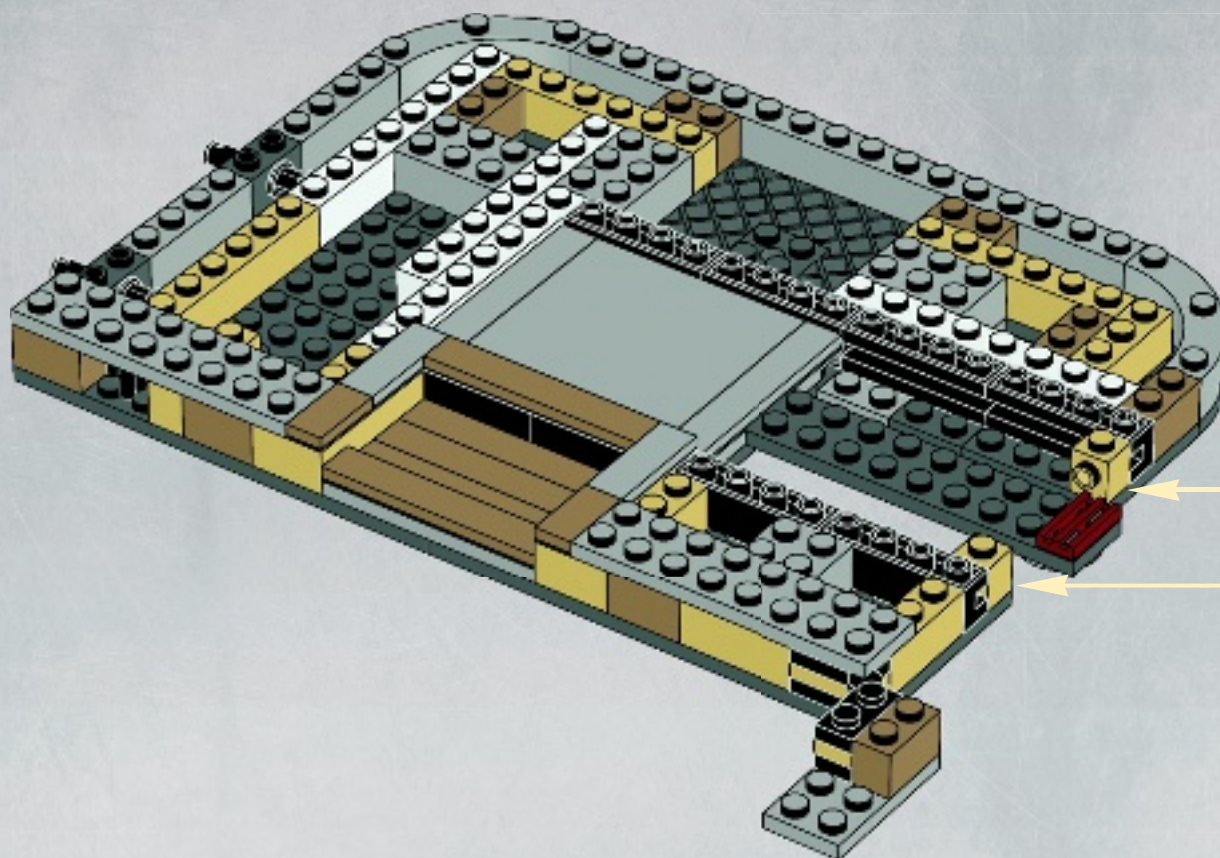

2x

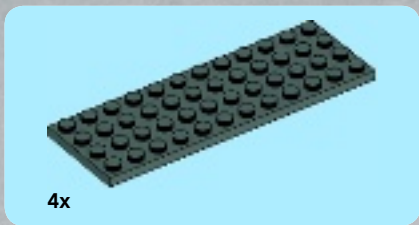

4x

20

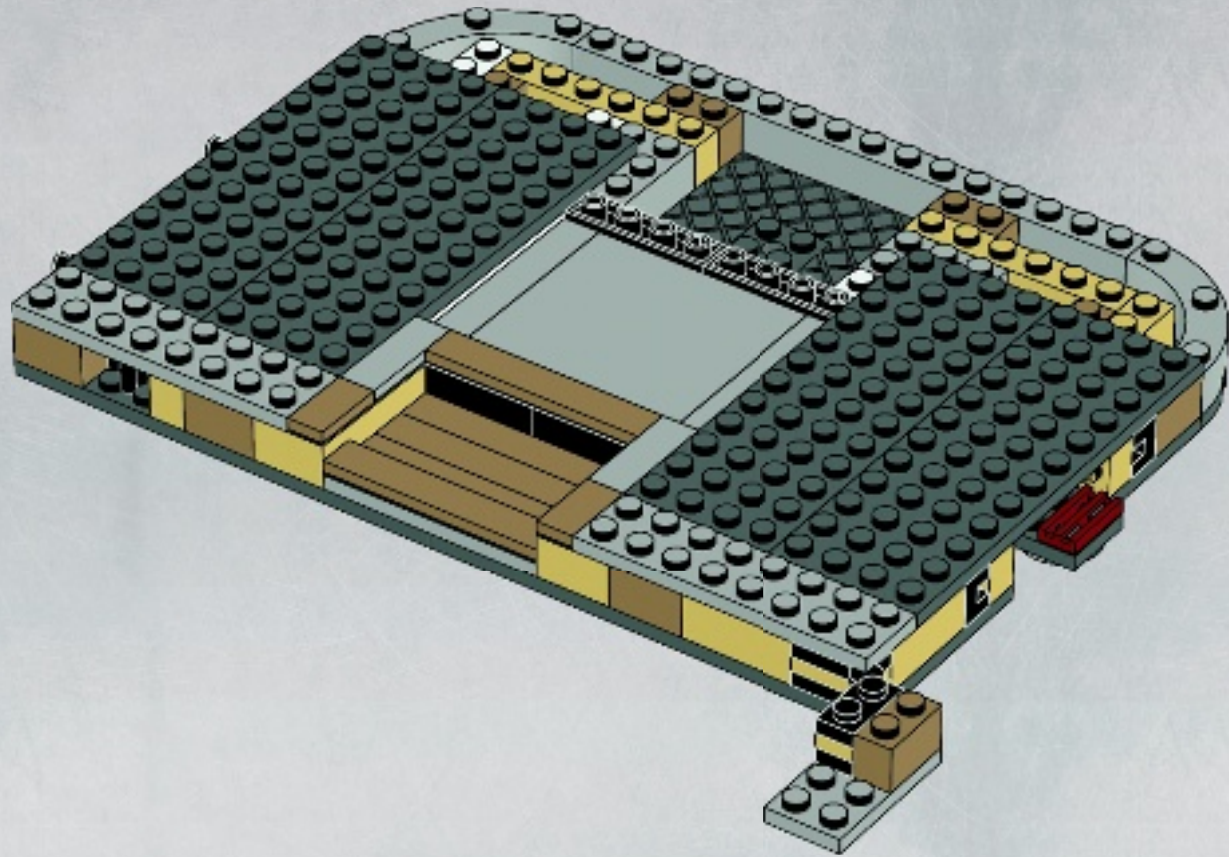

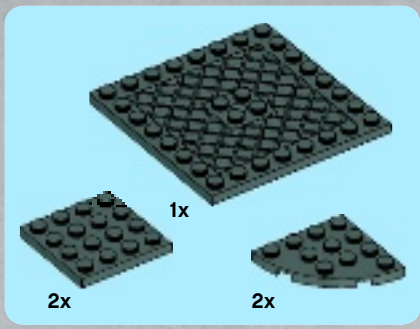

21

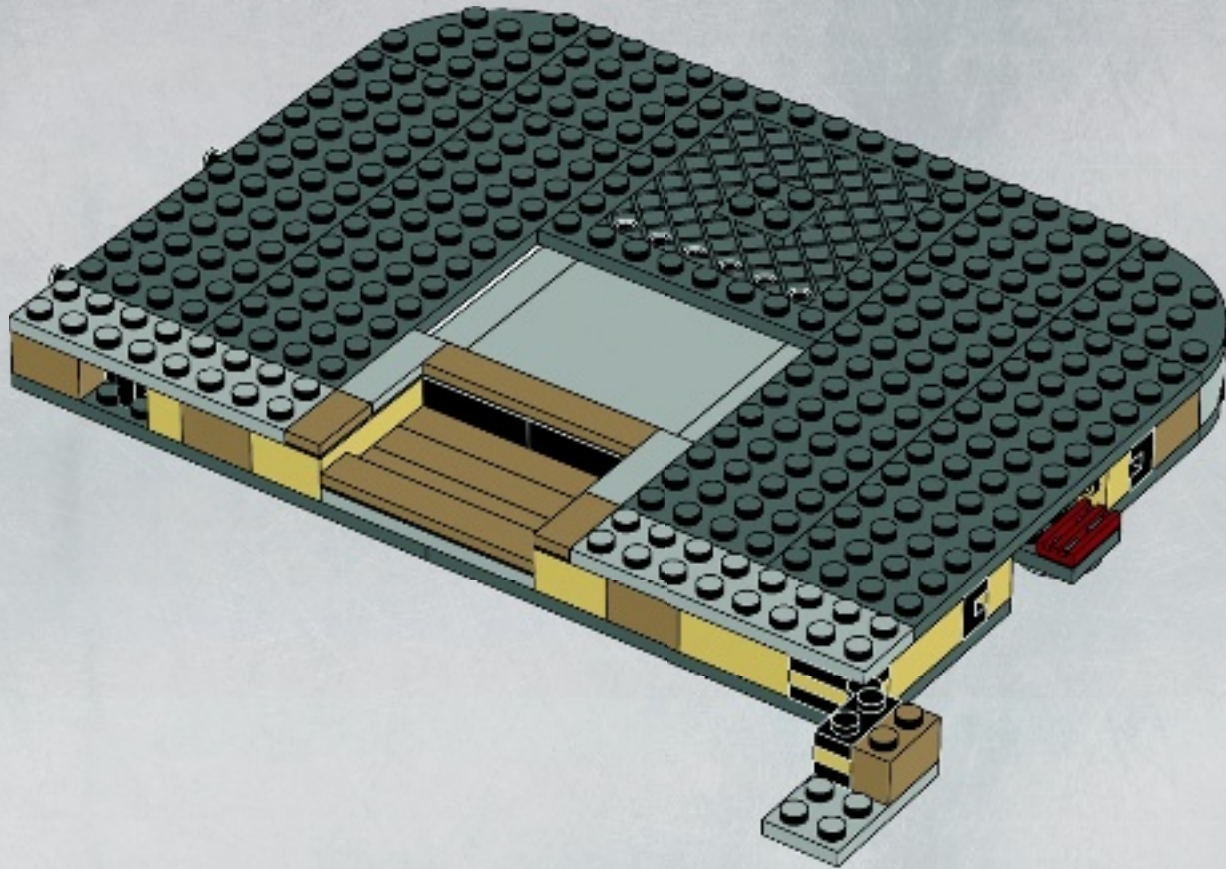



22

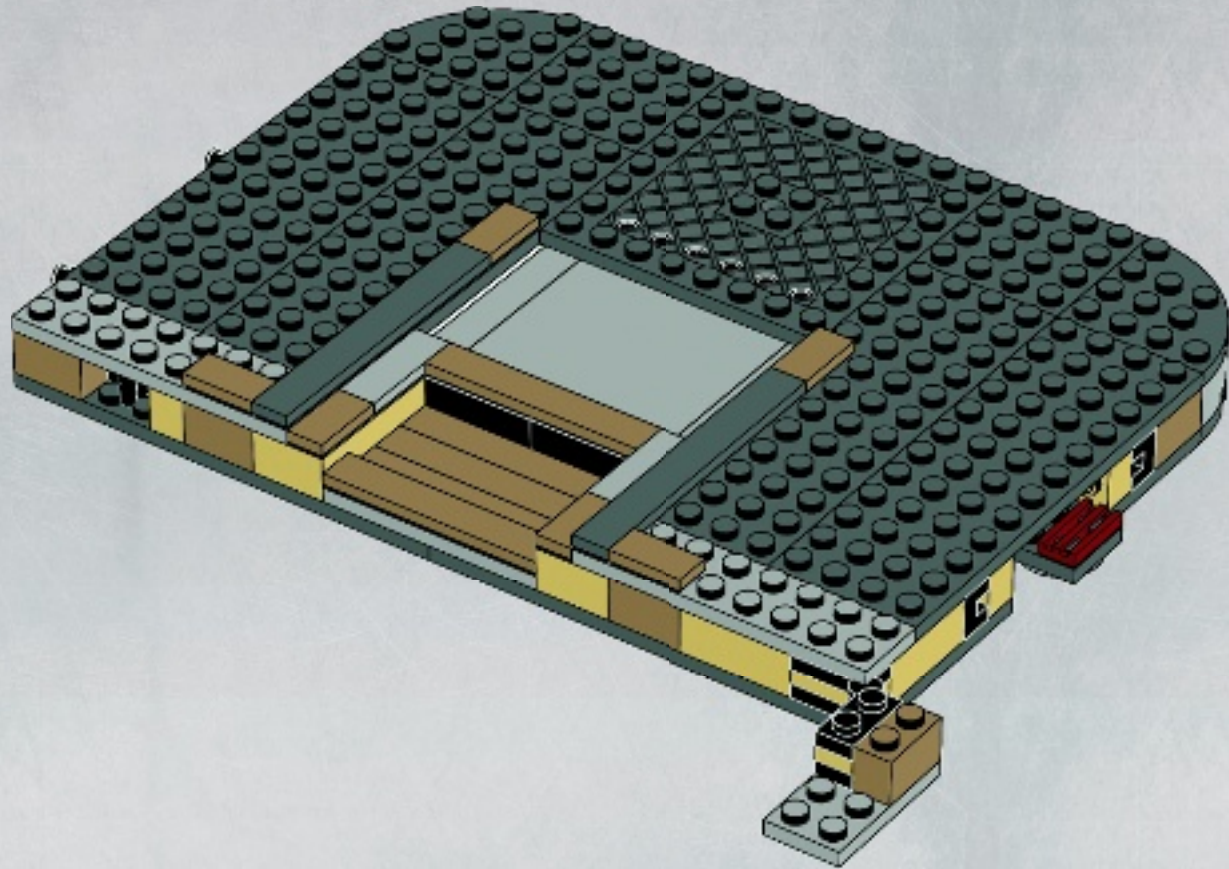

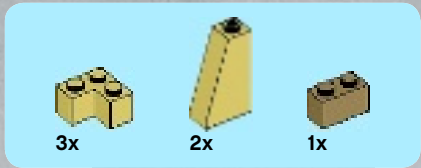

23

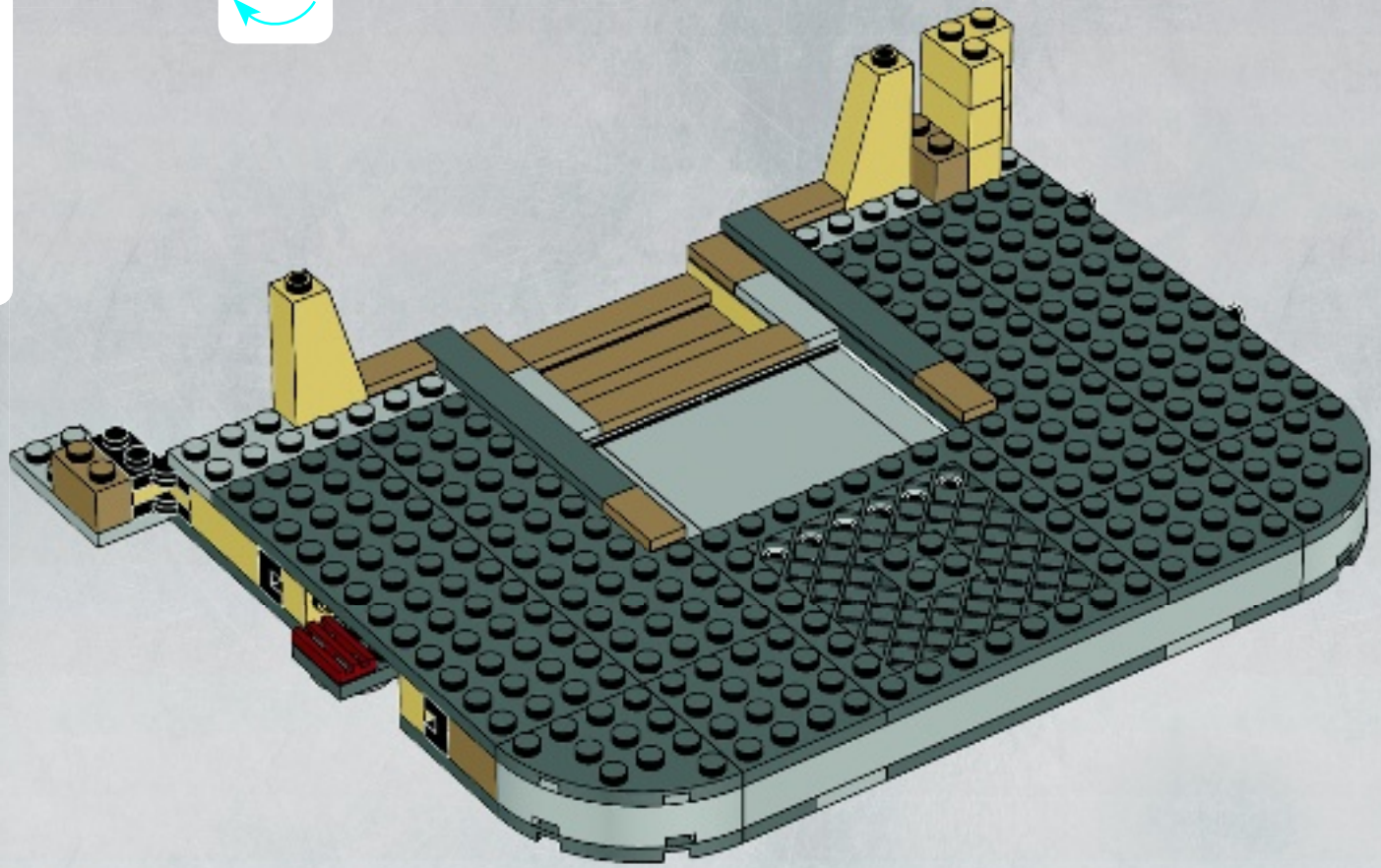
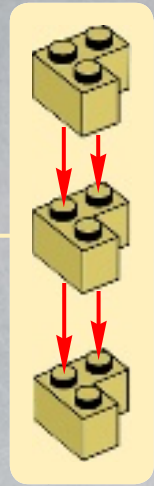



24

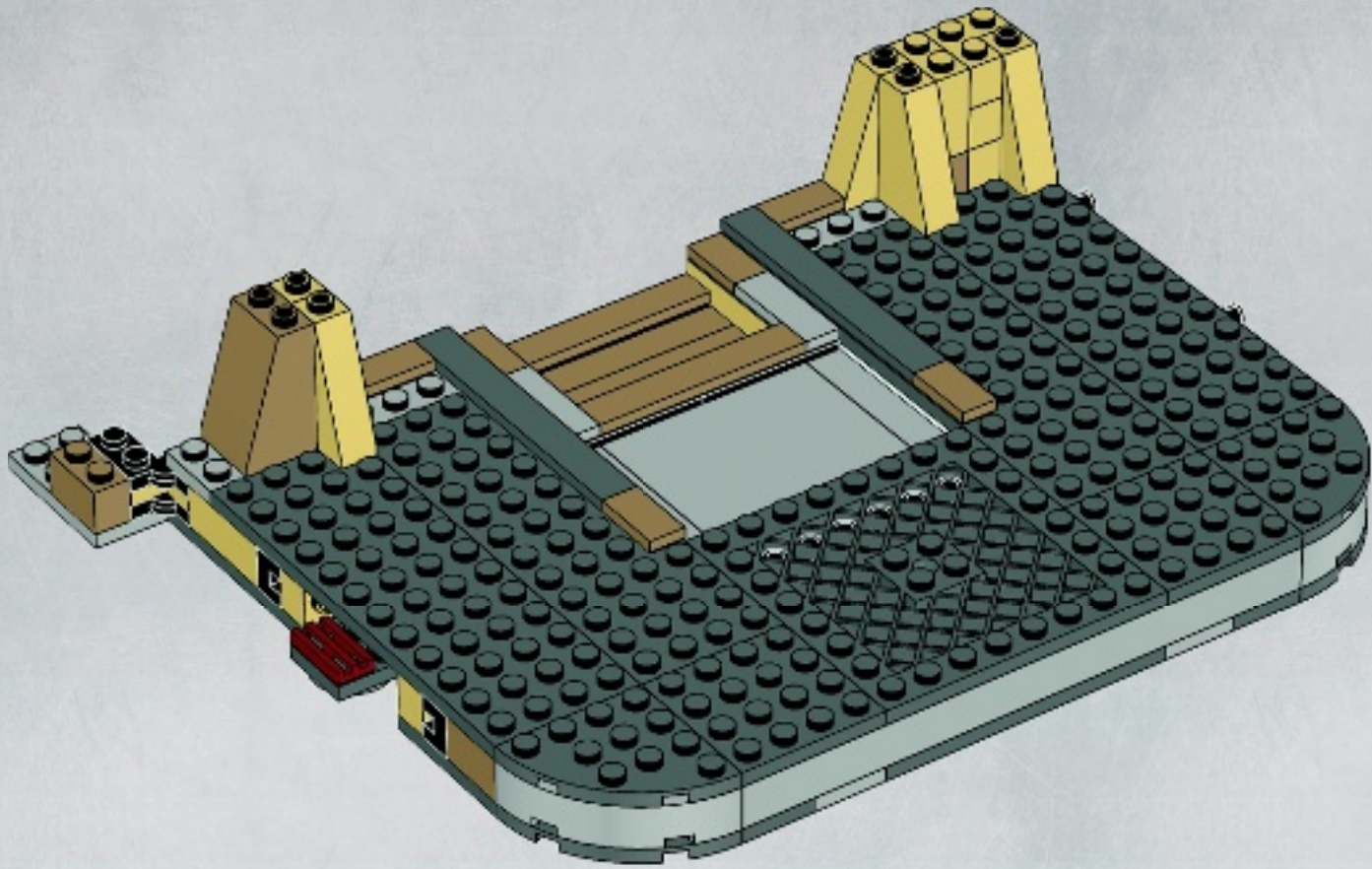

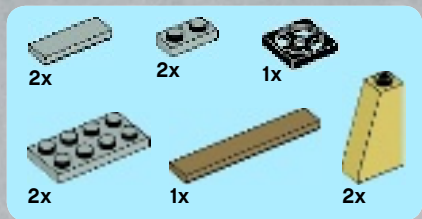

25

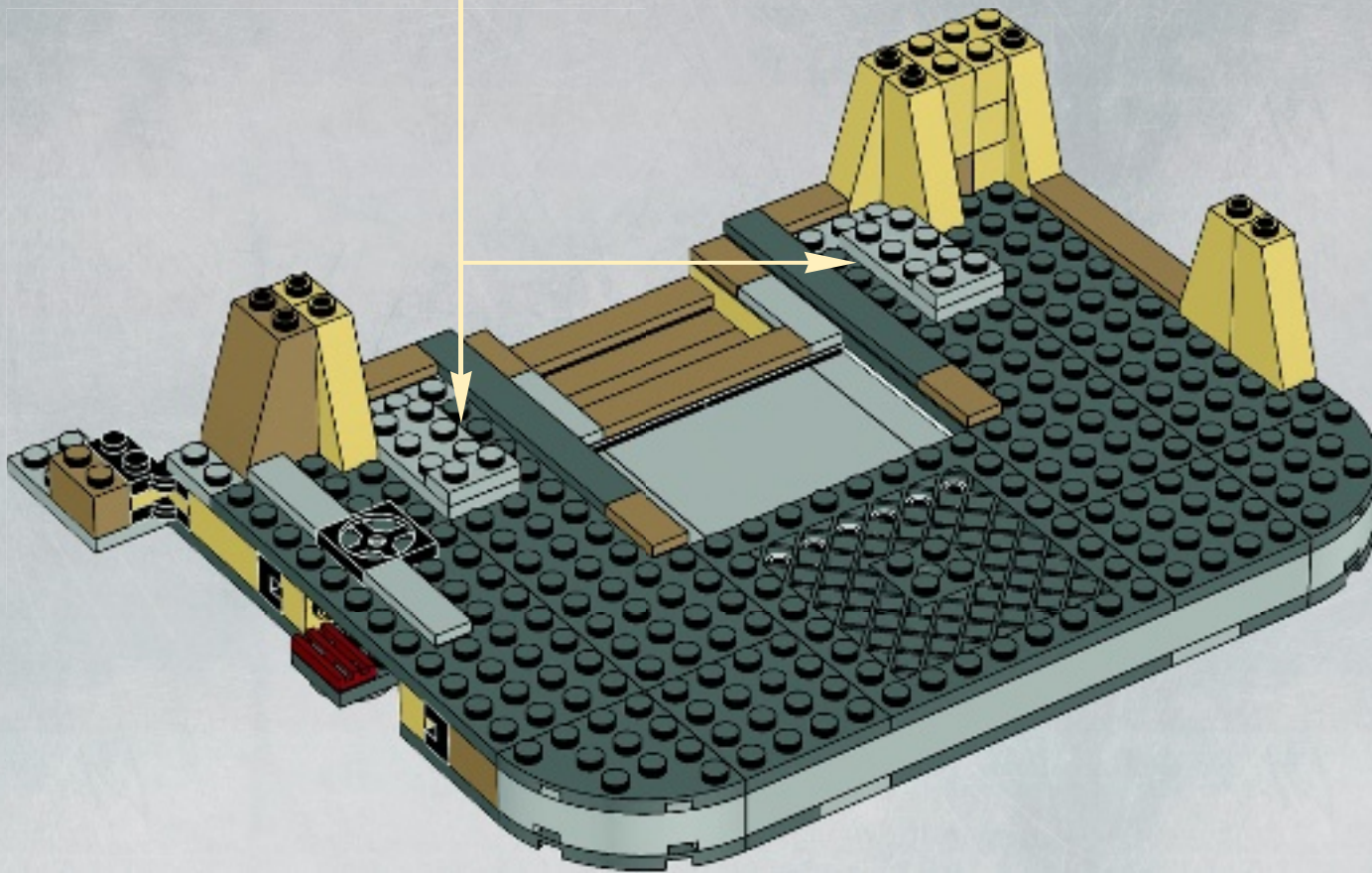
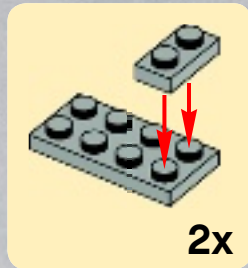



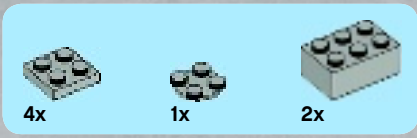

26

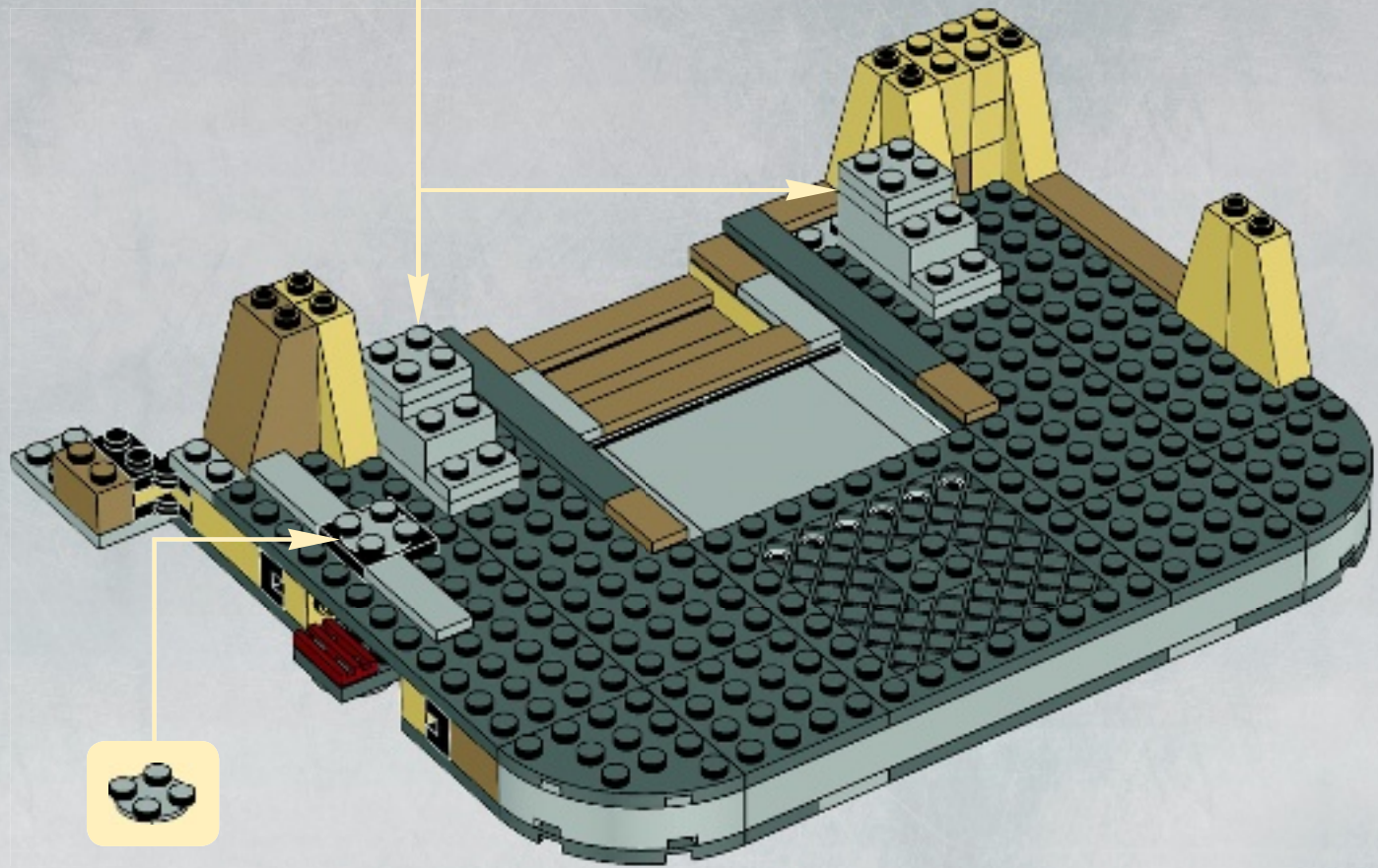
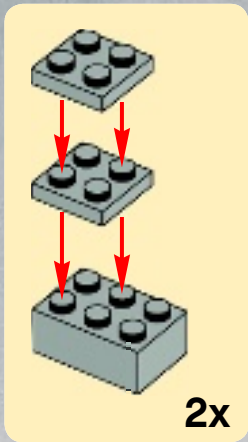



27

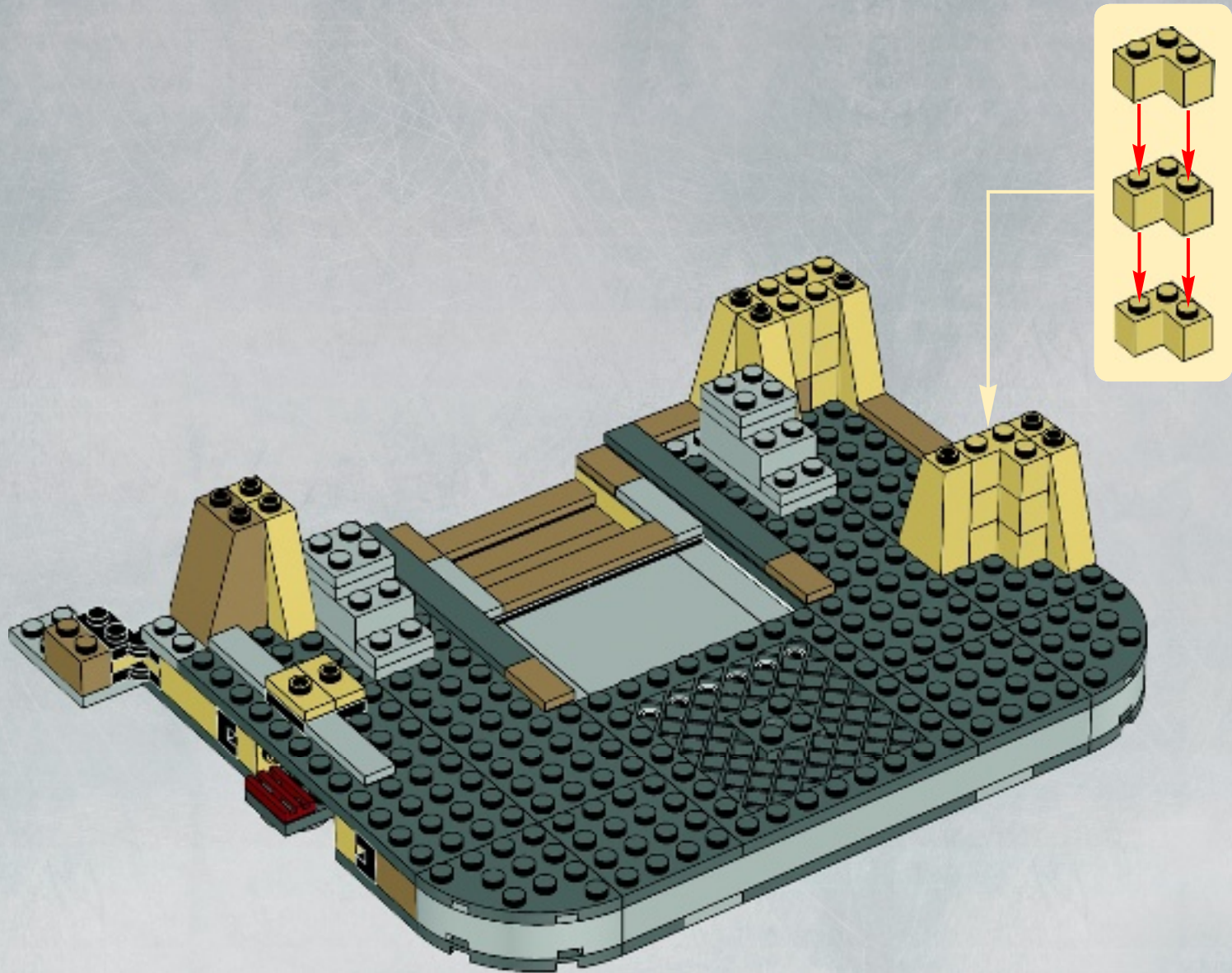



28

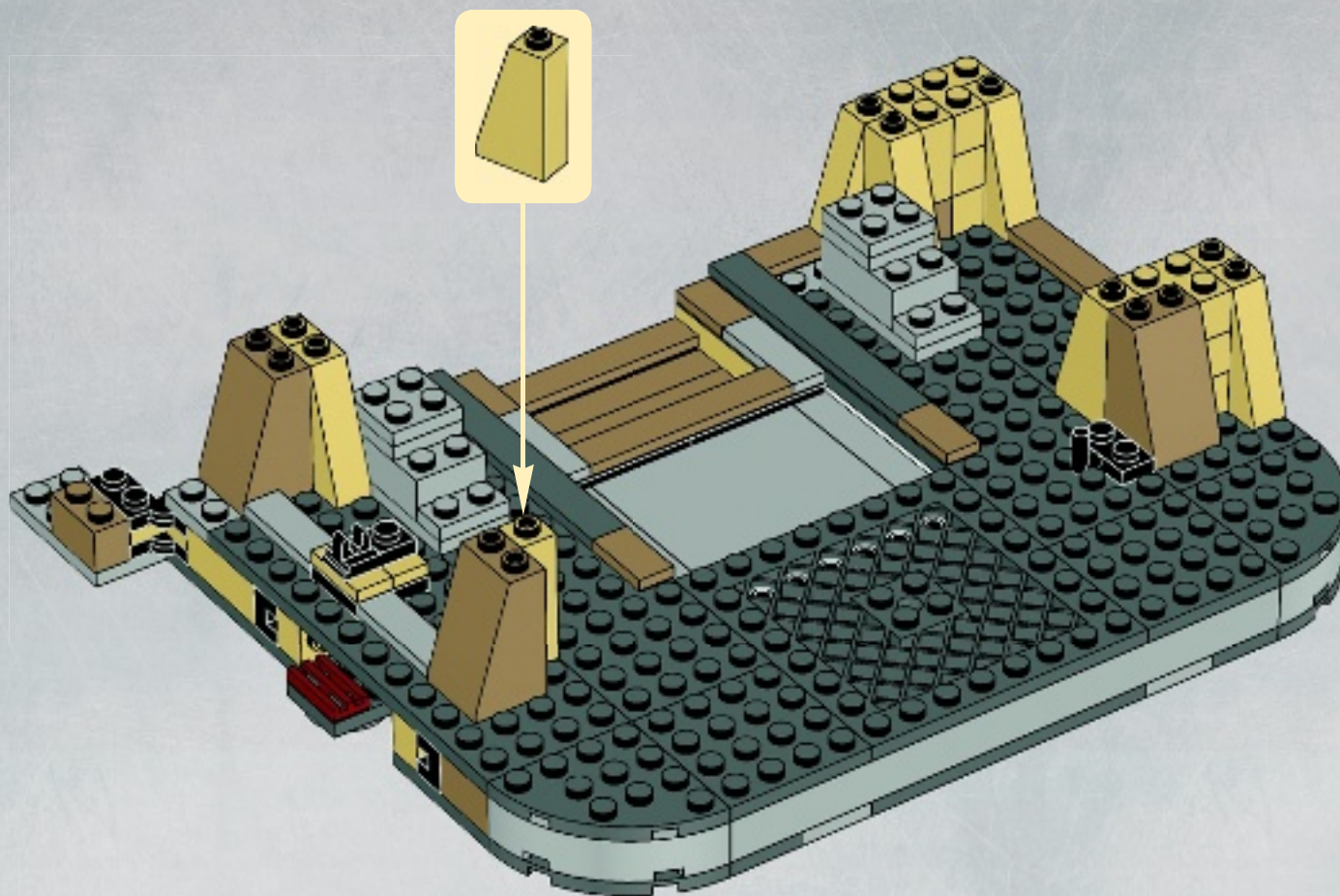

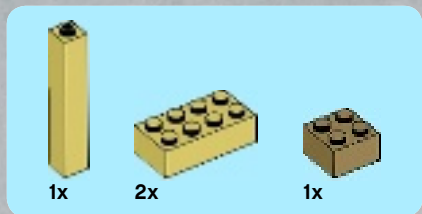

29

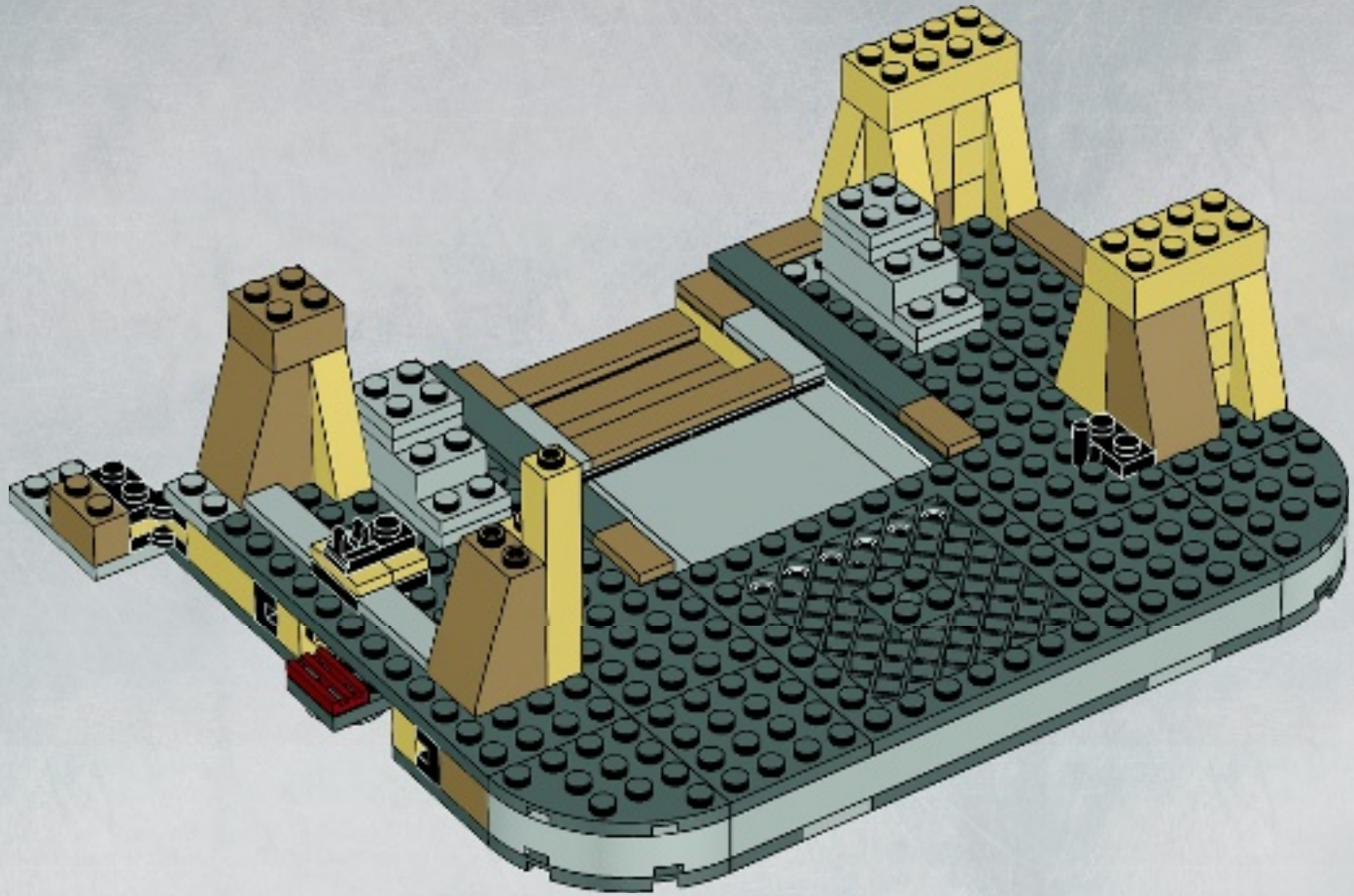



30

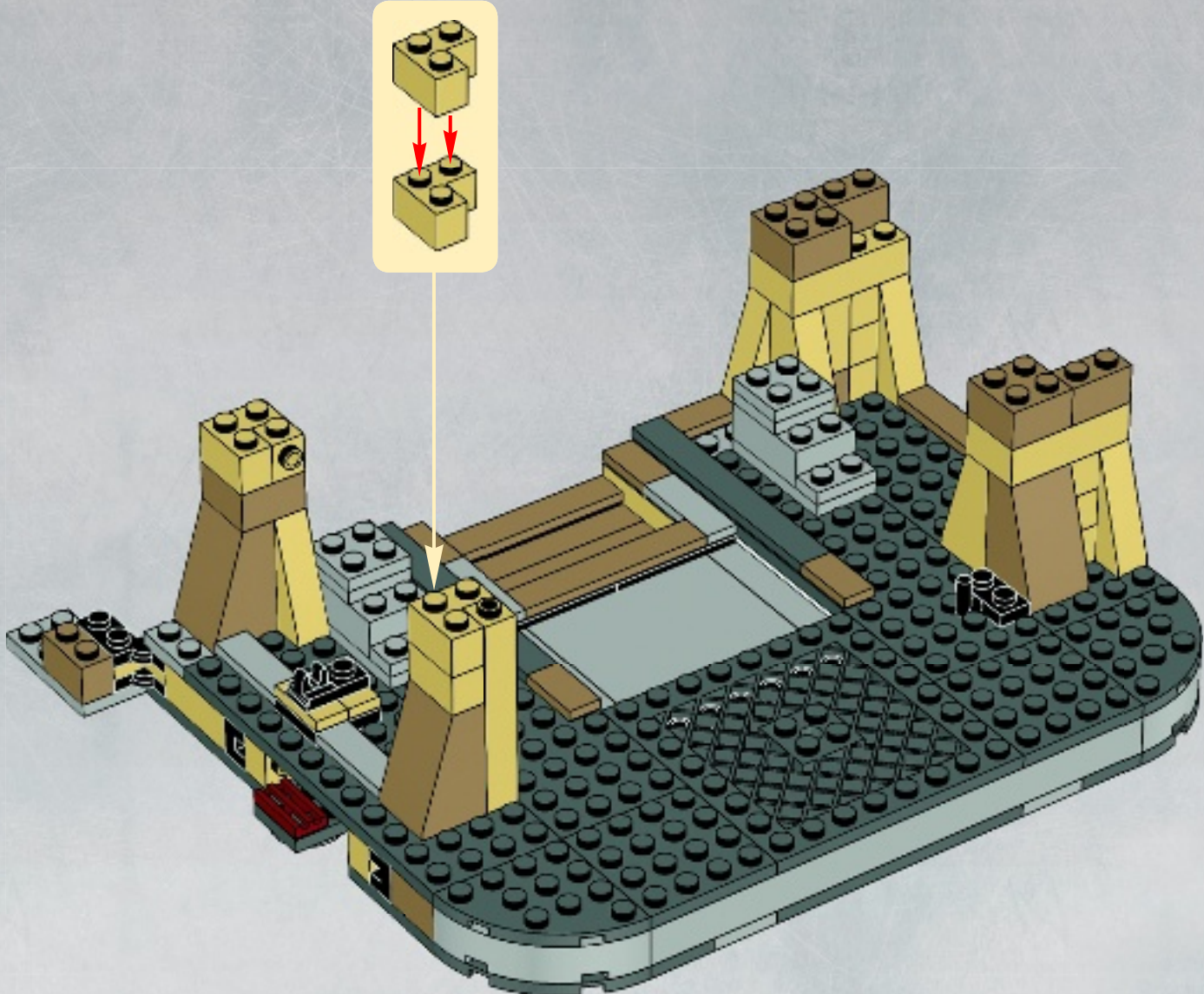

- 2x
- 4x
- 1x
- 4x

# 31

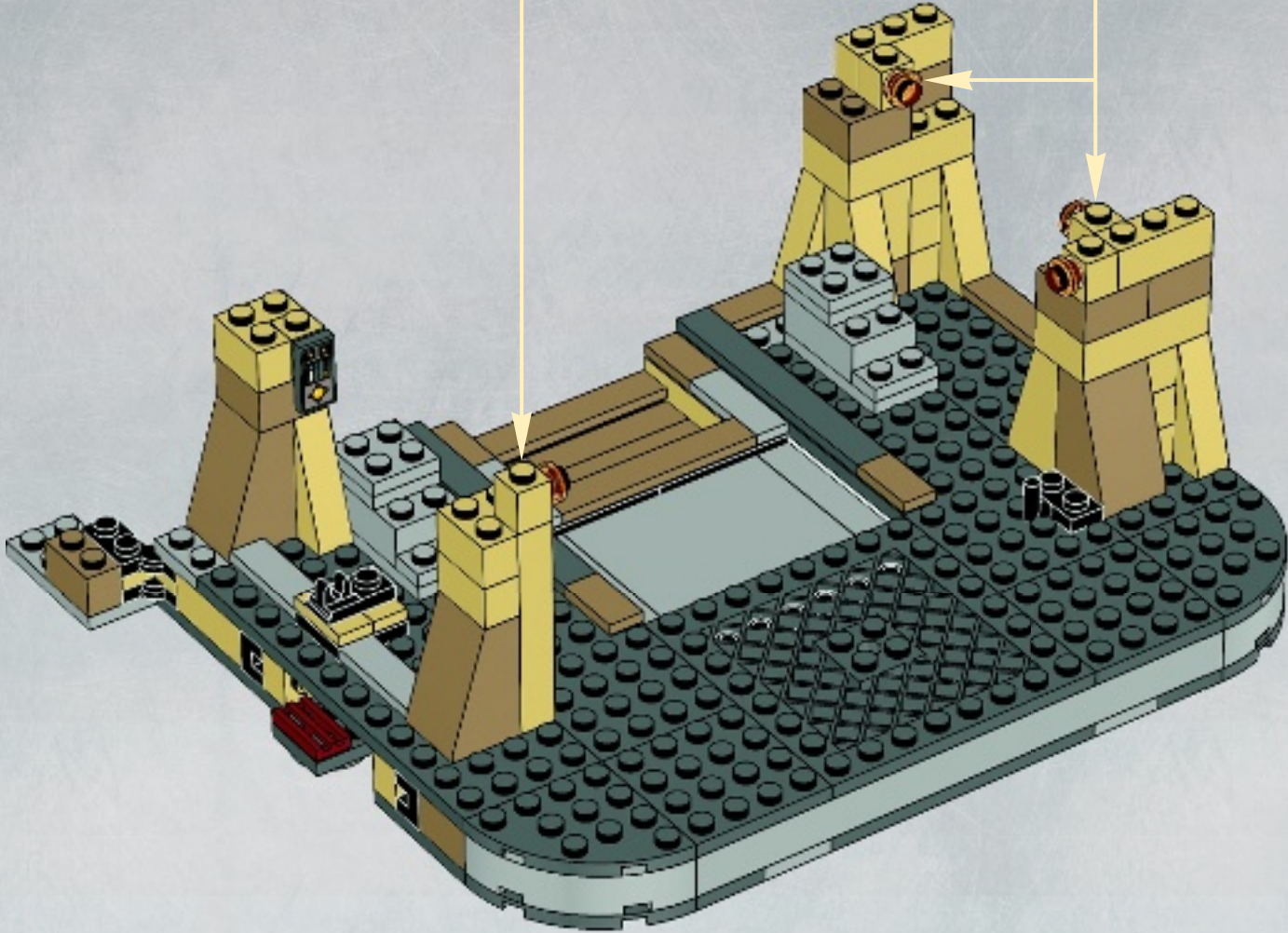
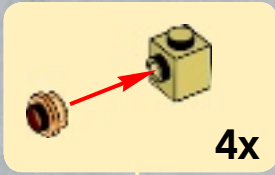

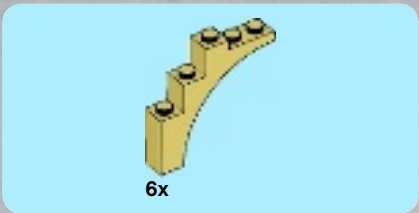

32

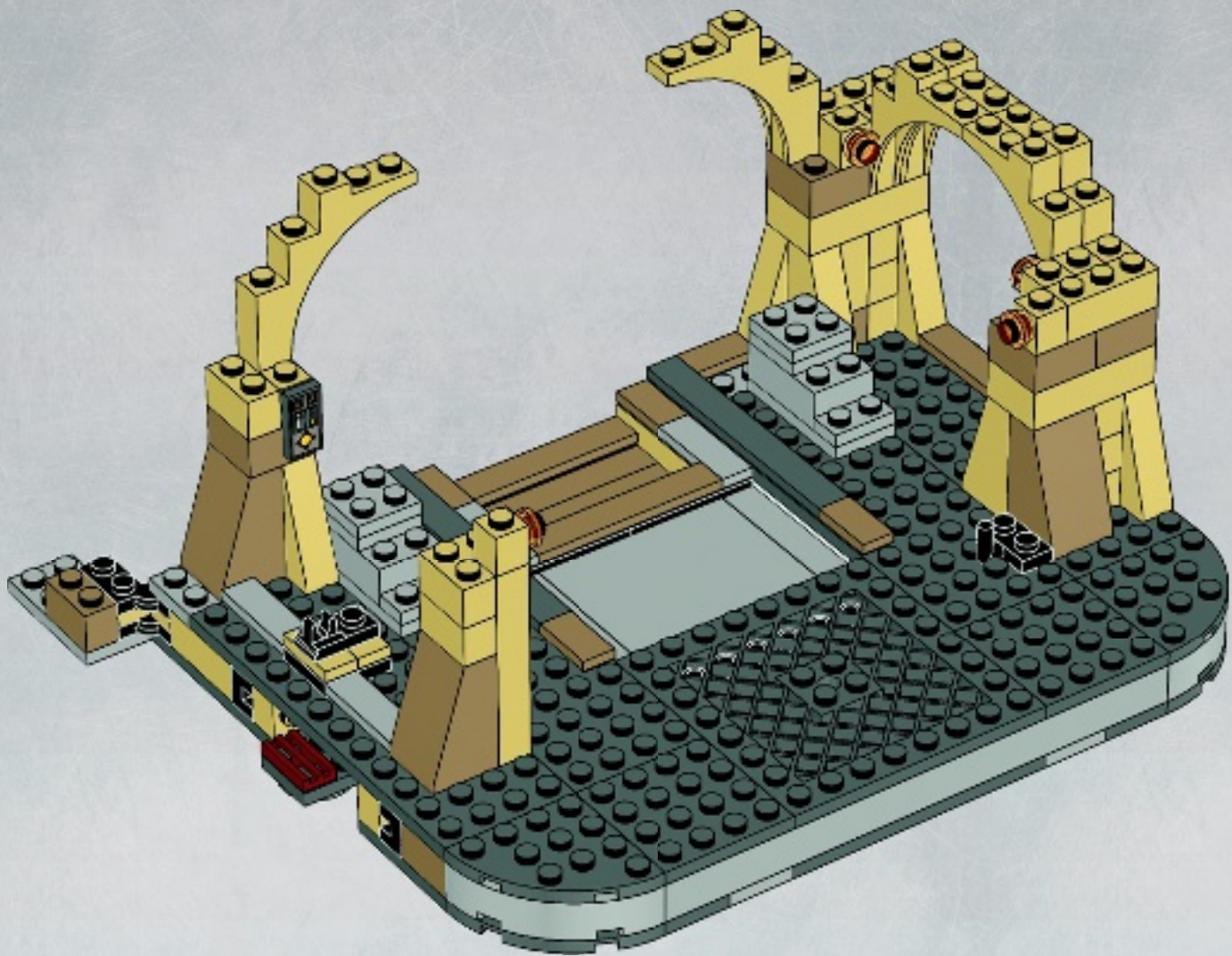



2x



2x



2x

# 33

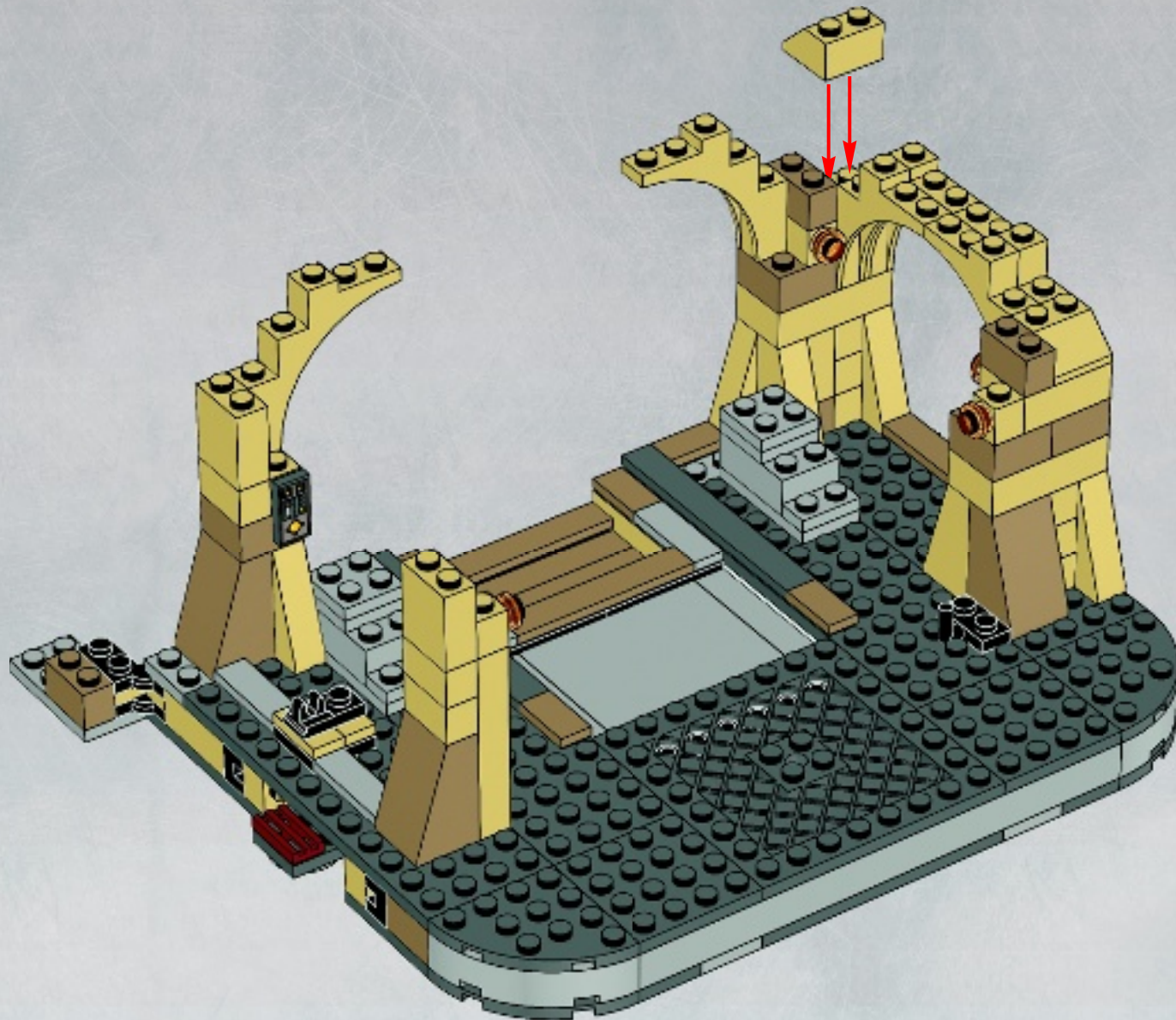



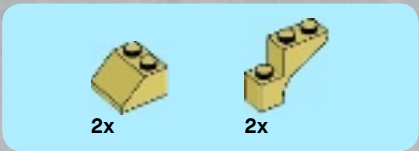

34

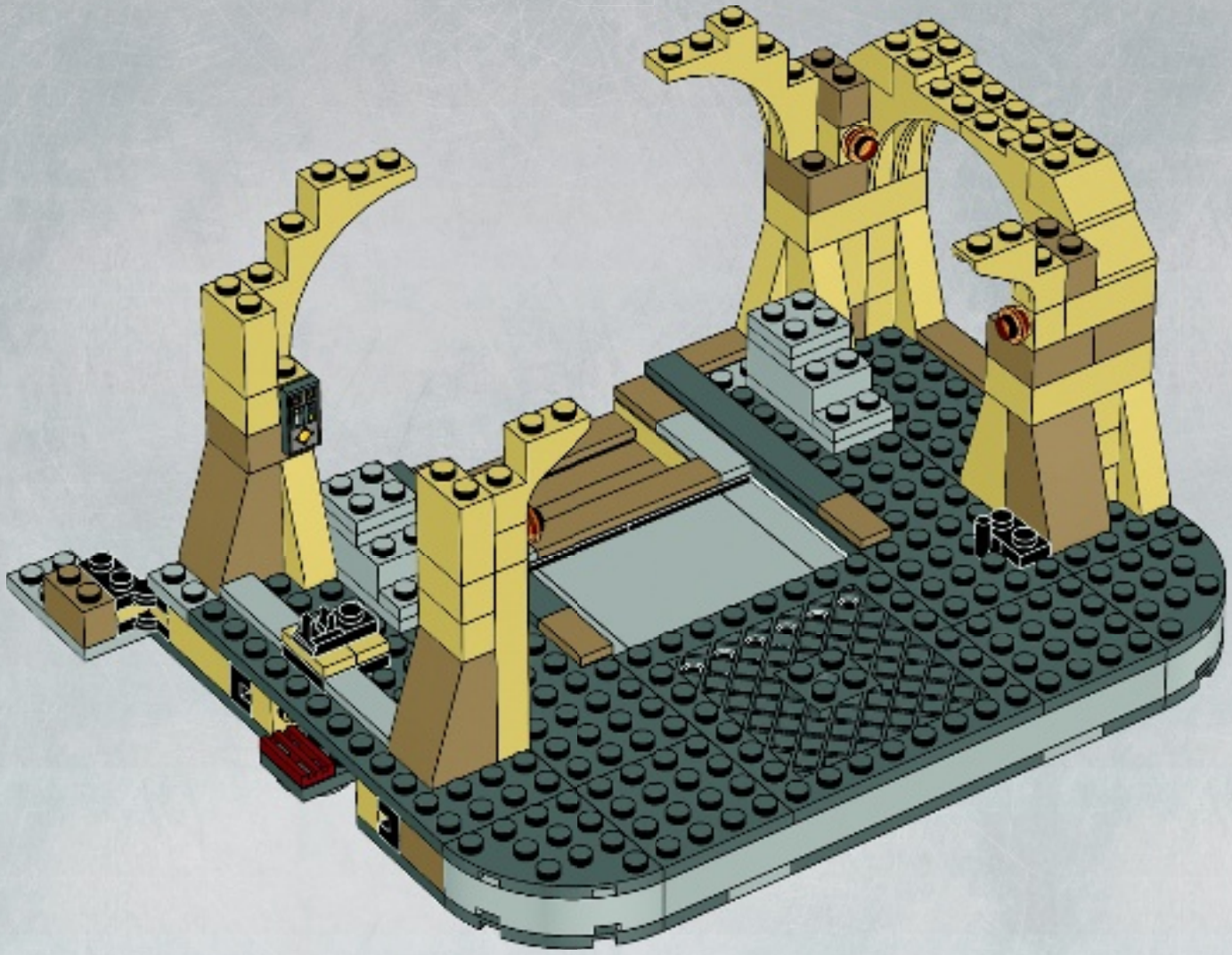



2x



2x



2x

# 35

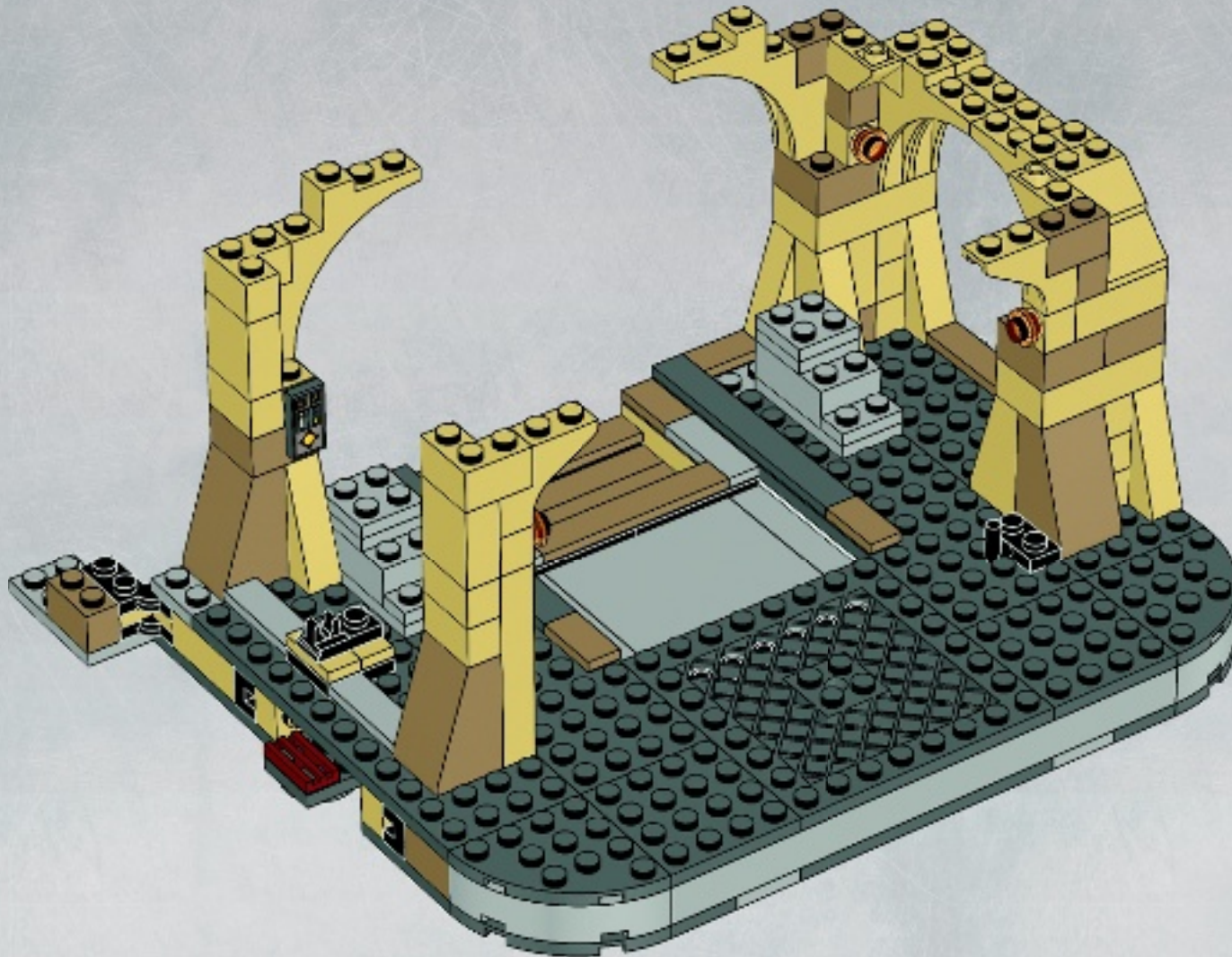

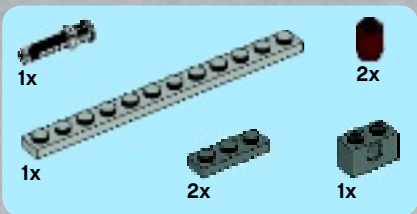

36

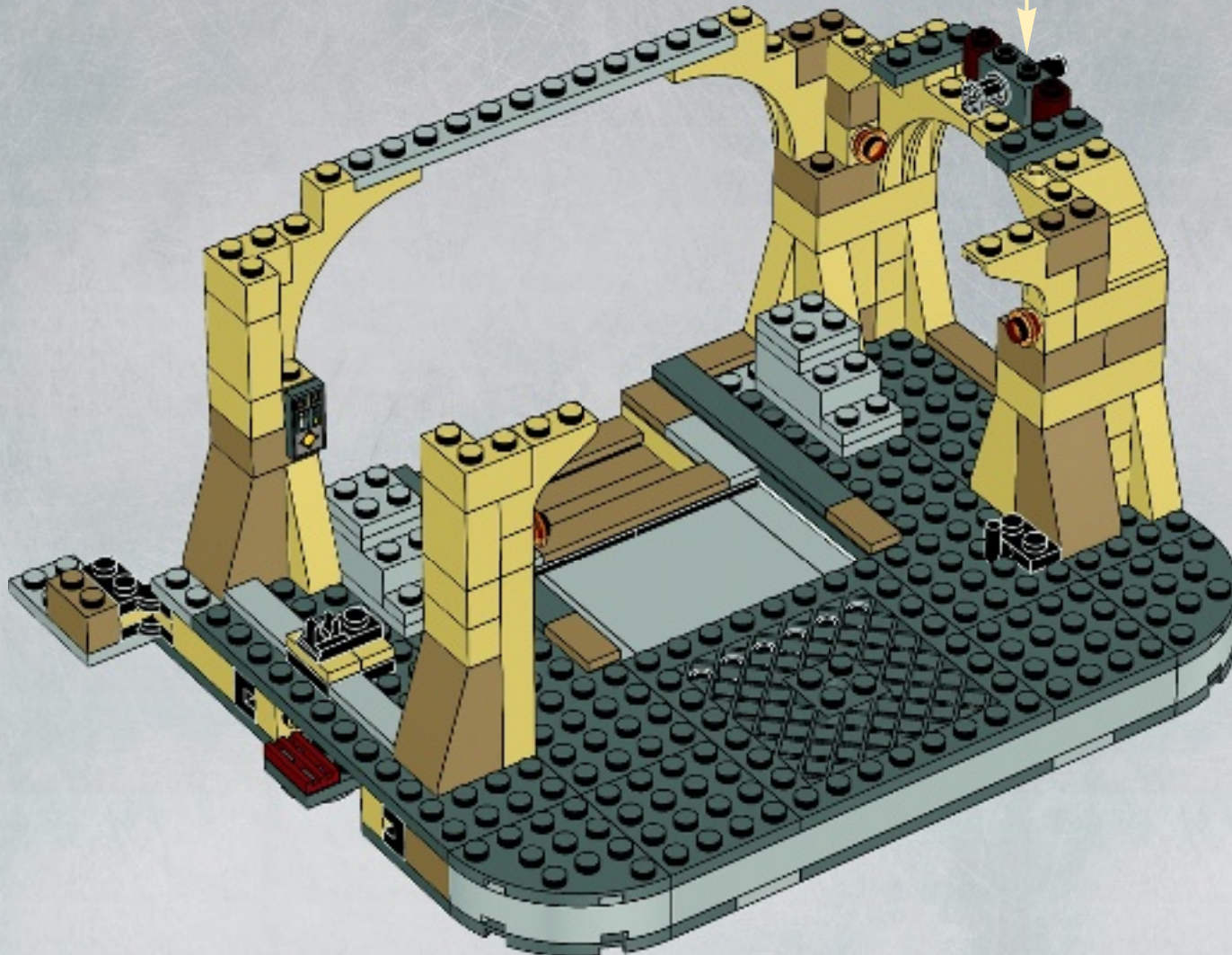
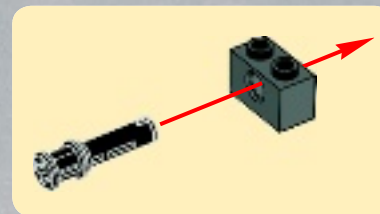

4x

2x

1x

# 37

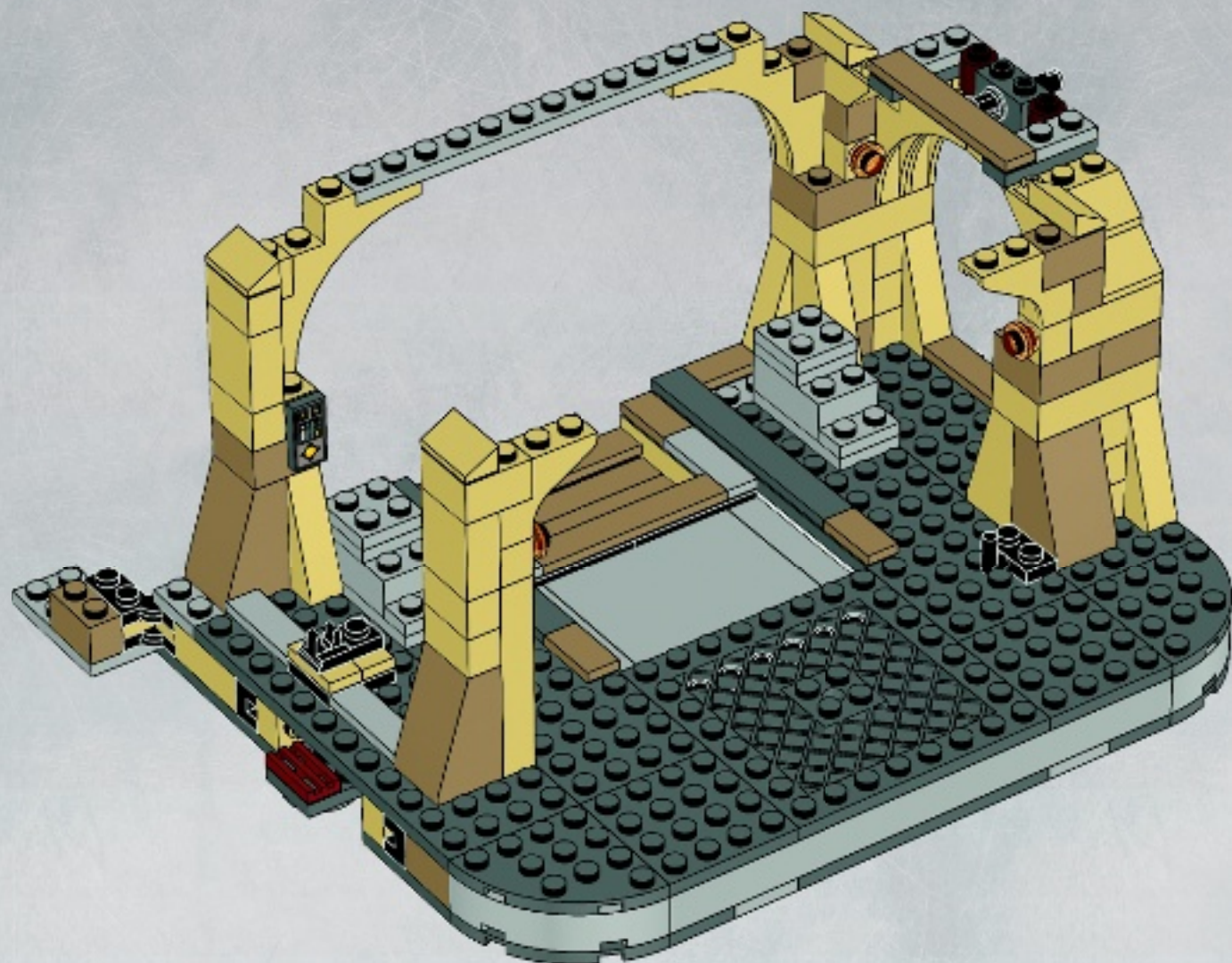

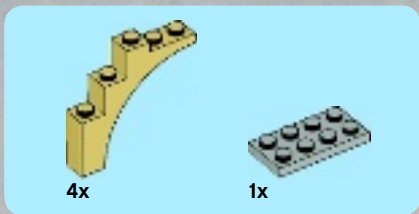

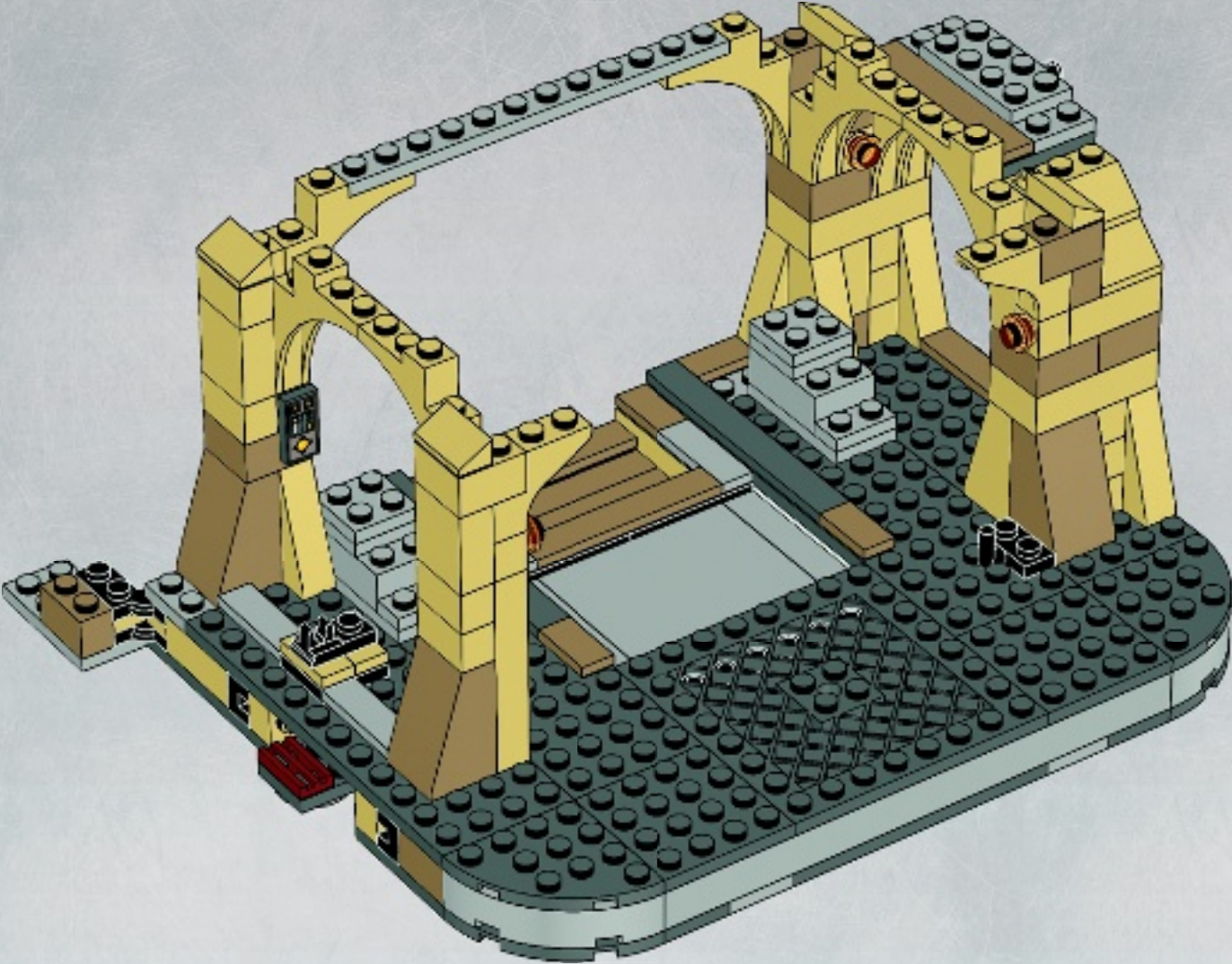

38





4x  6x 

40

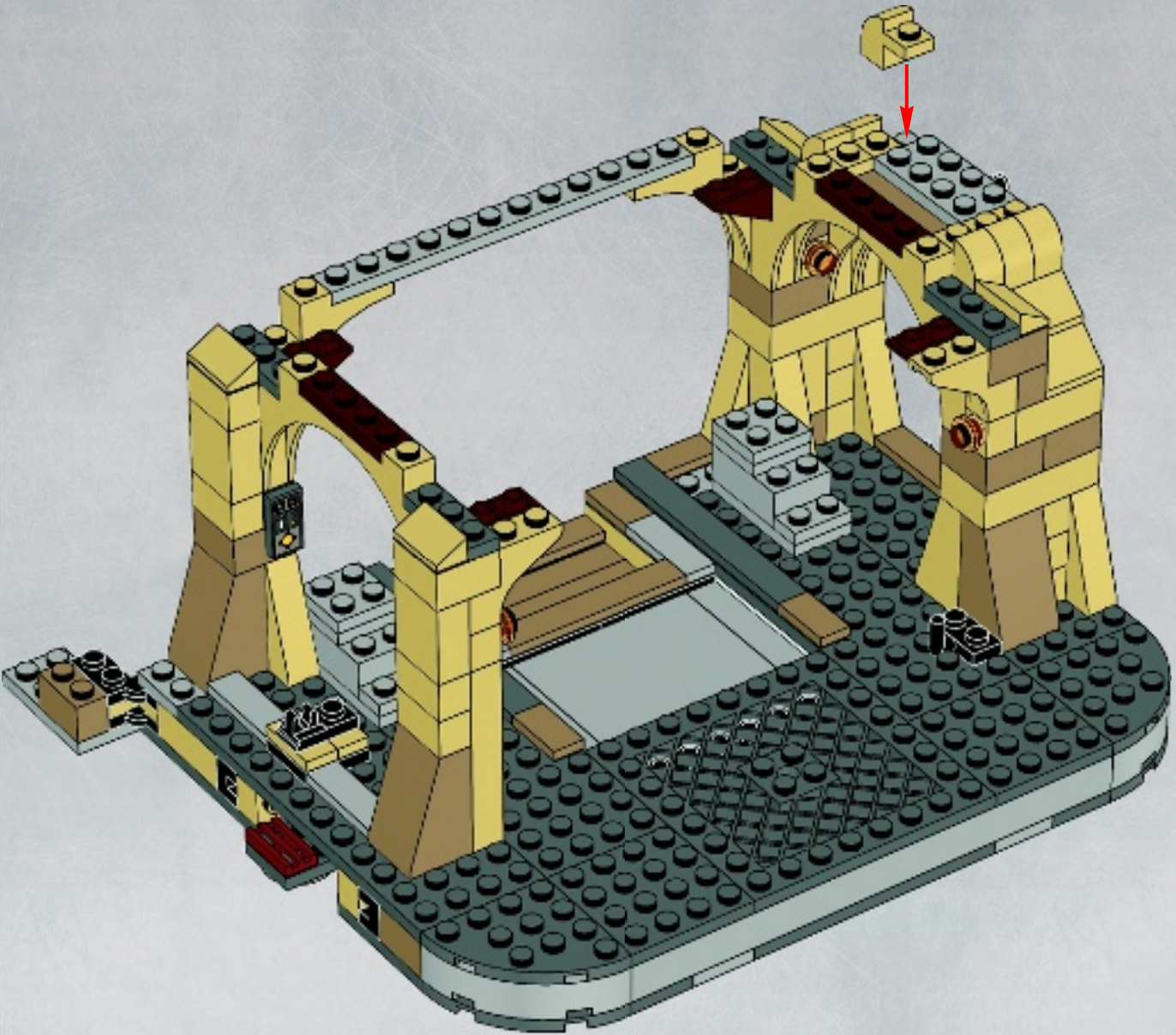



1x



2x

# 41

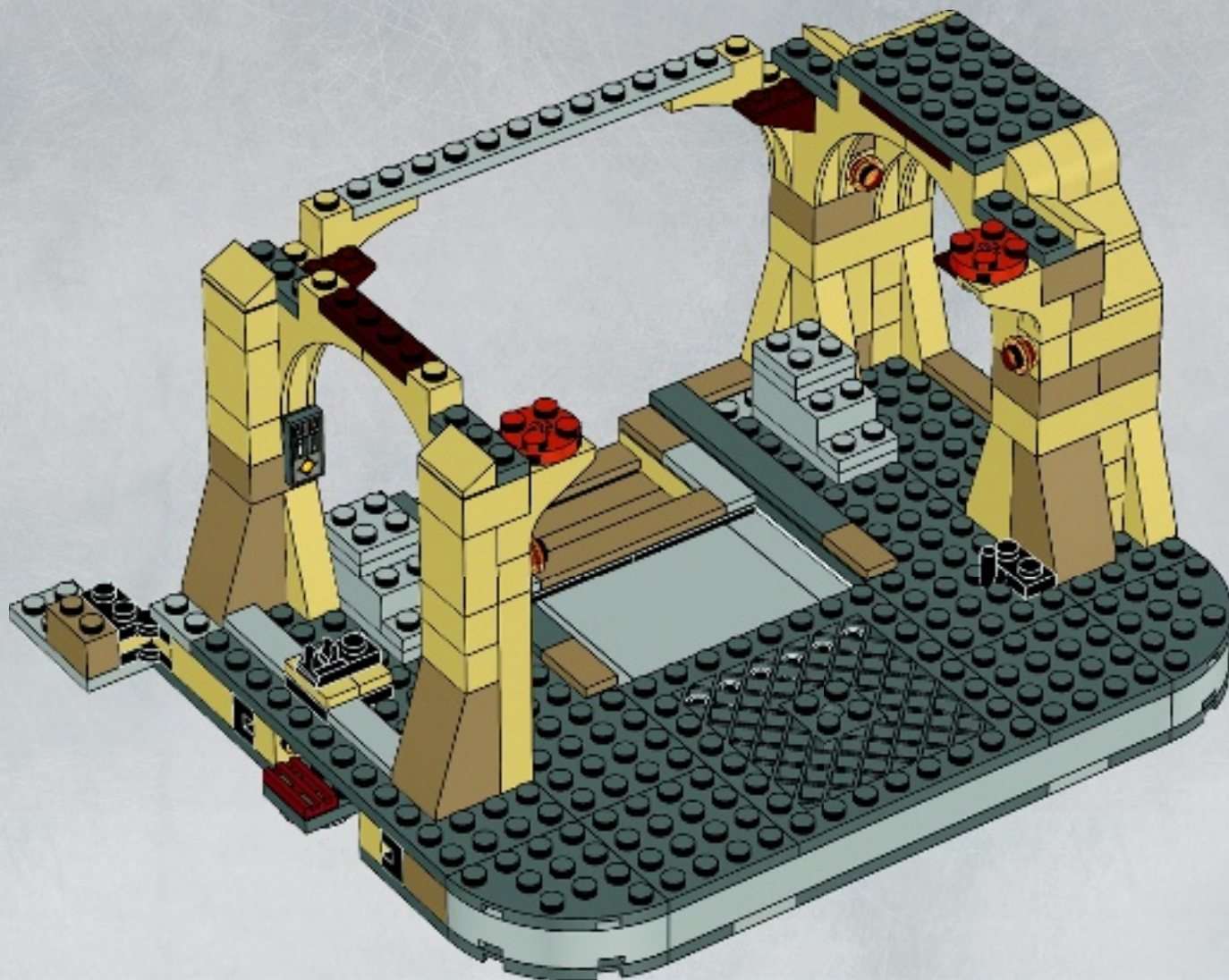



2x  2x  2x 

42

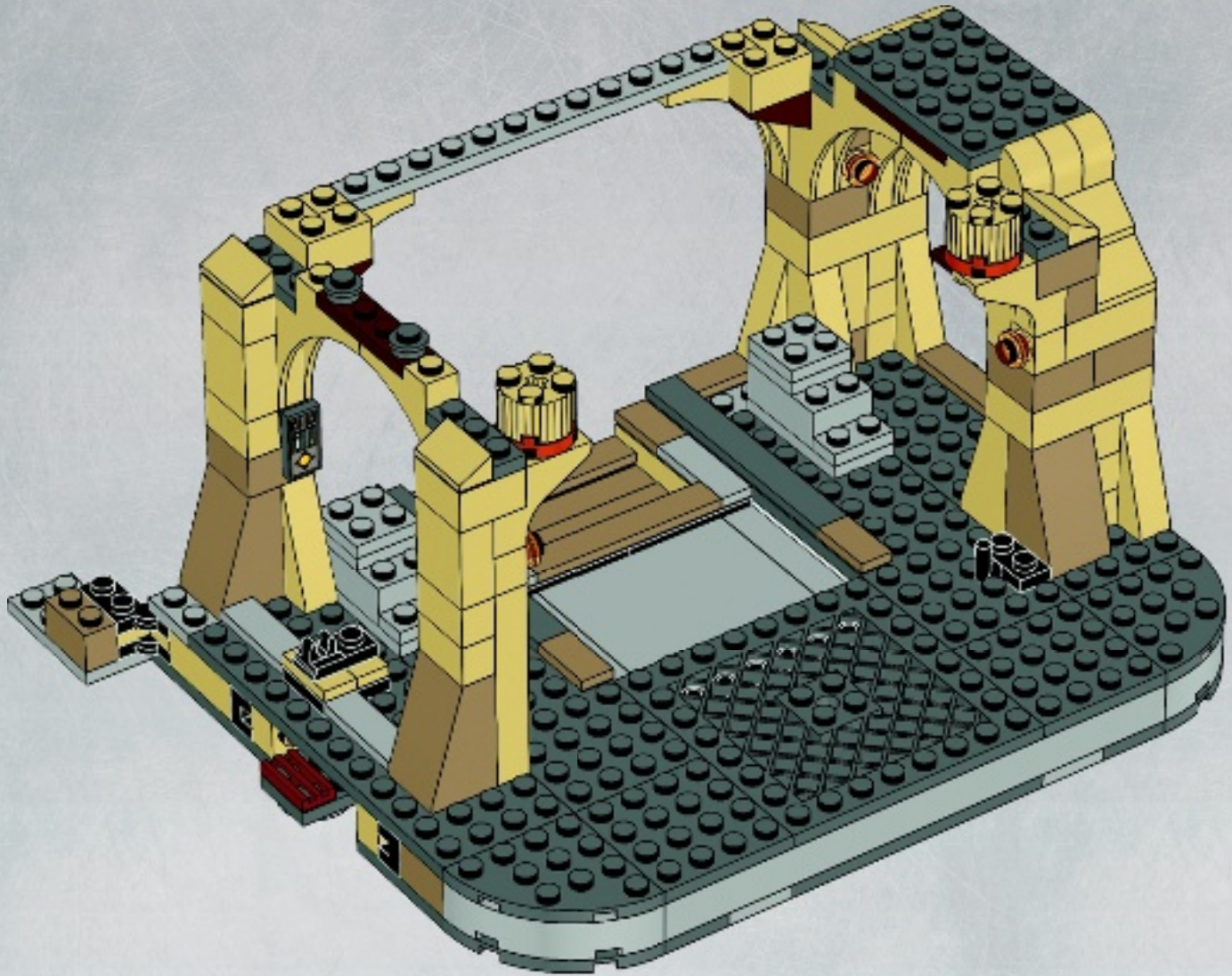



8x



2x



2x

# 43

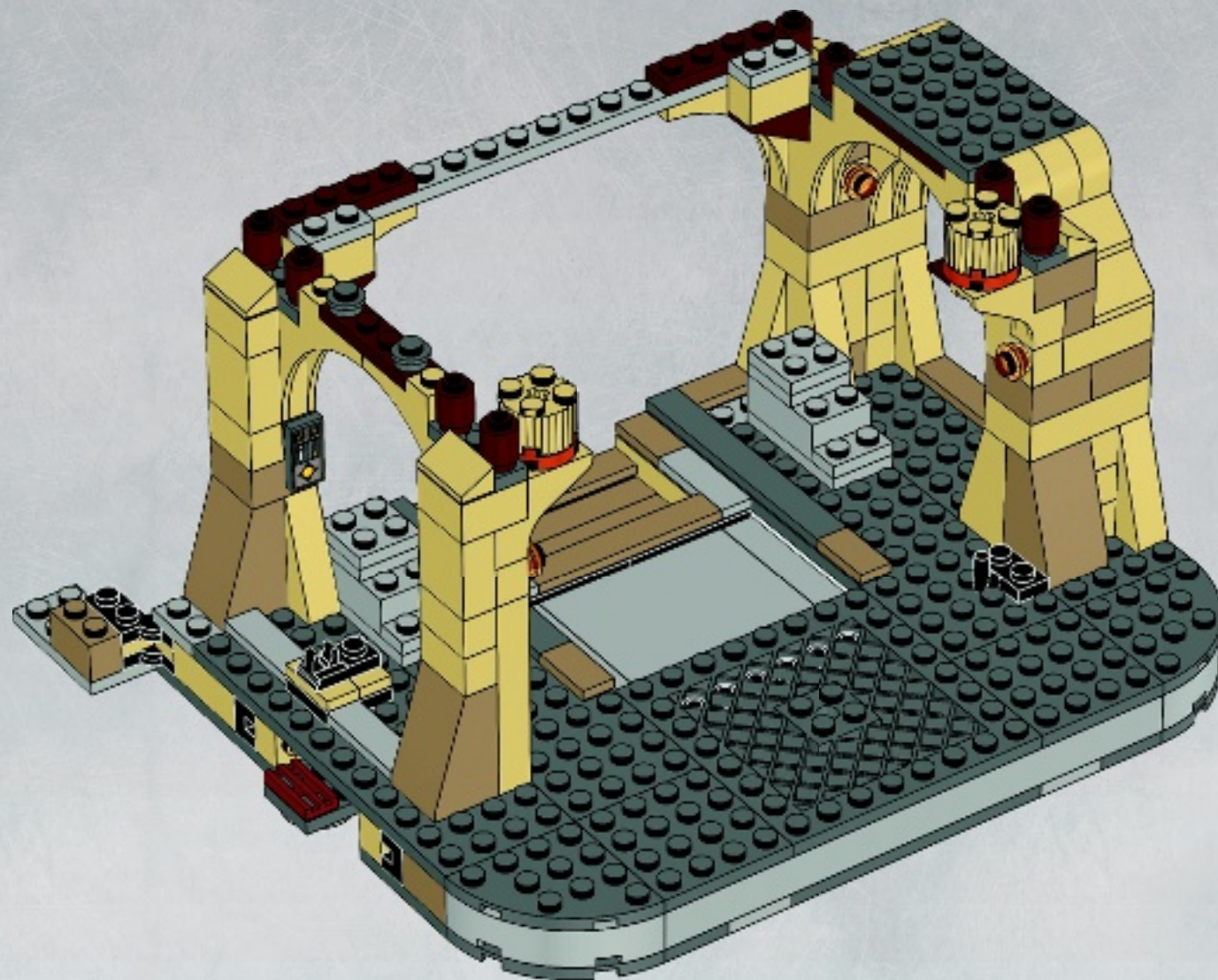

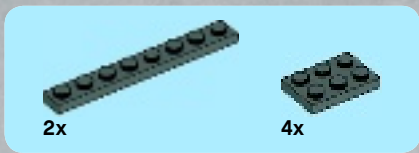

44

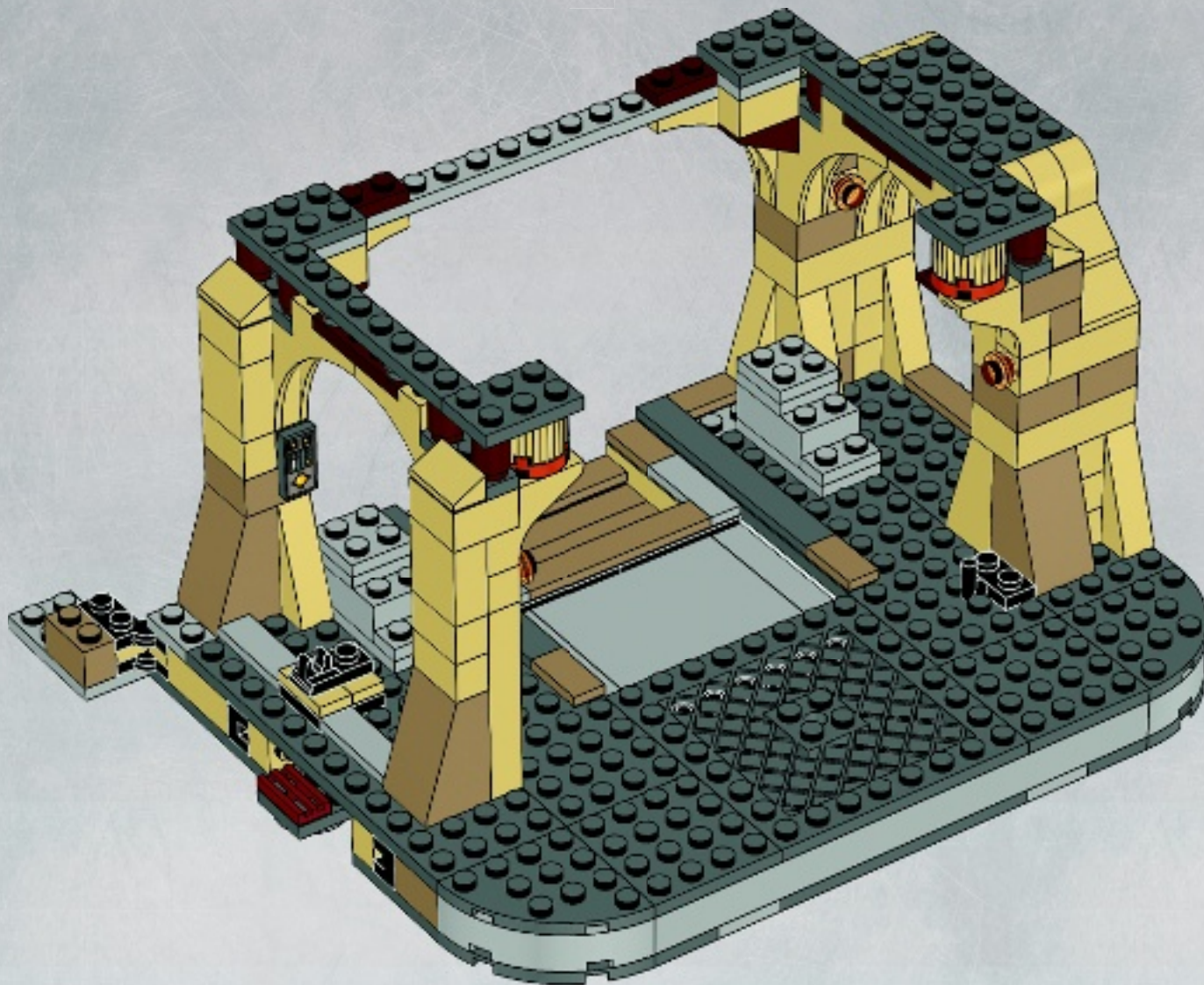



4x



4x

# 45

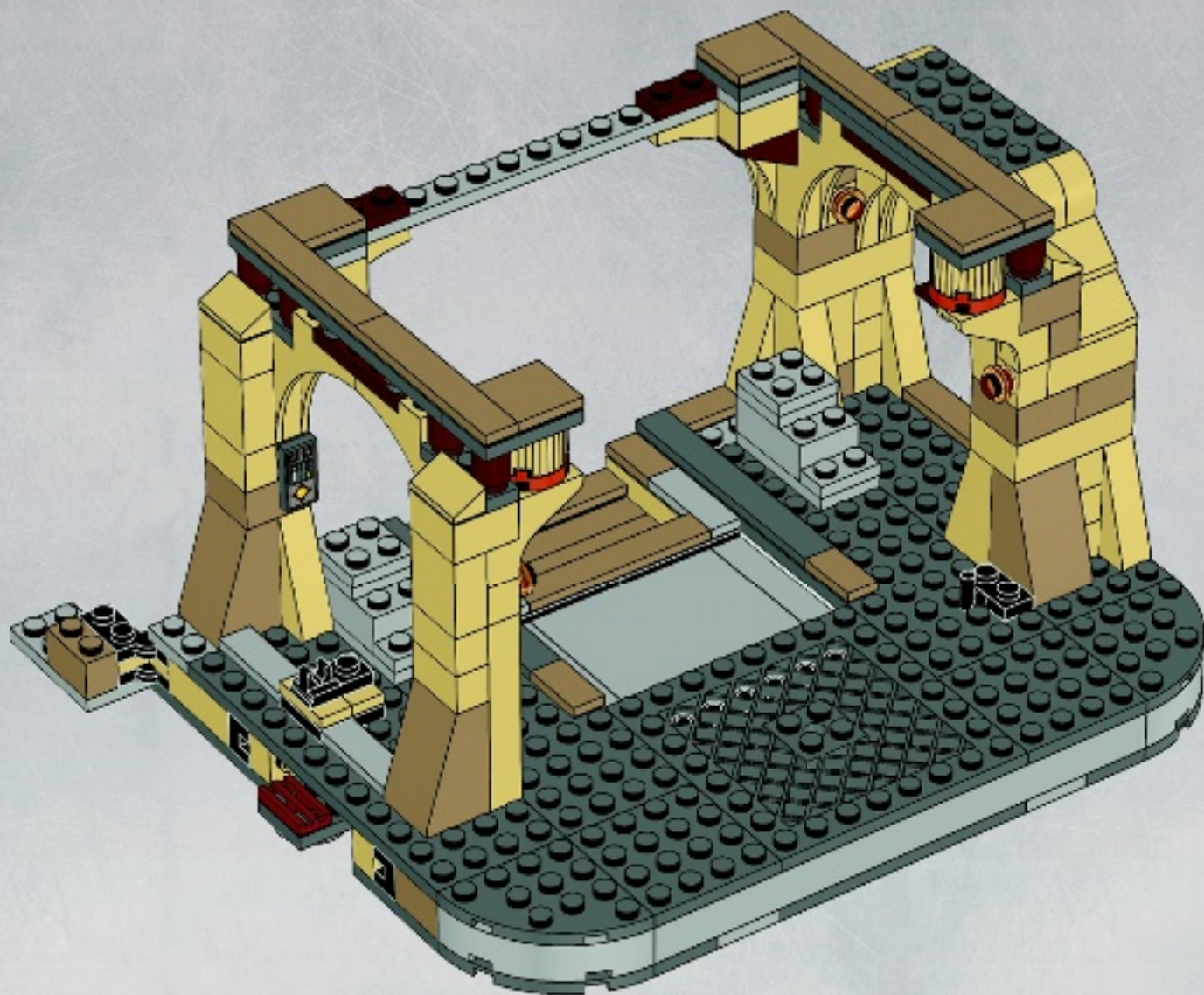



1

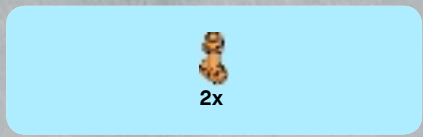

3

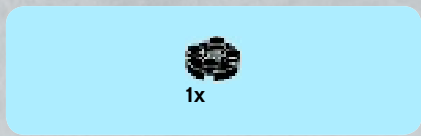

2

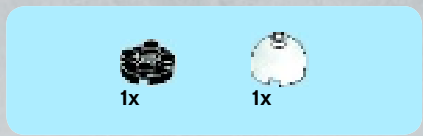

4

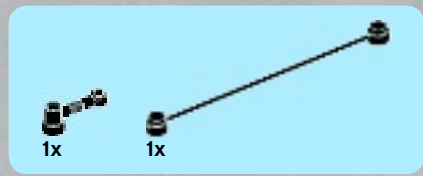

5

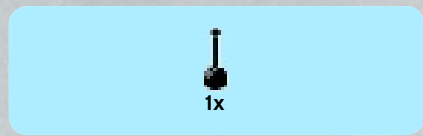

6



46

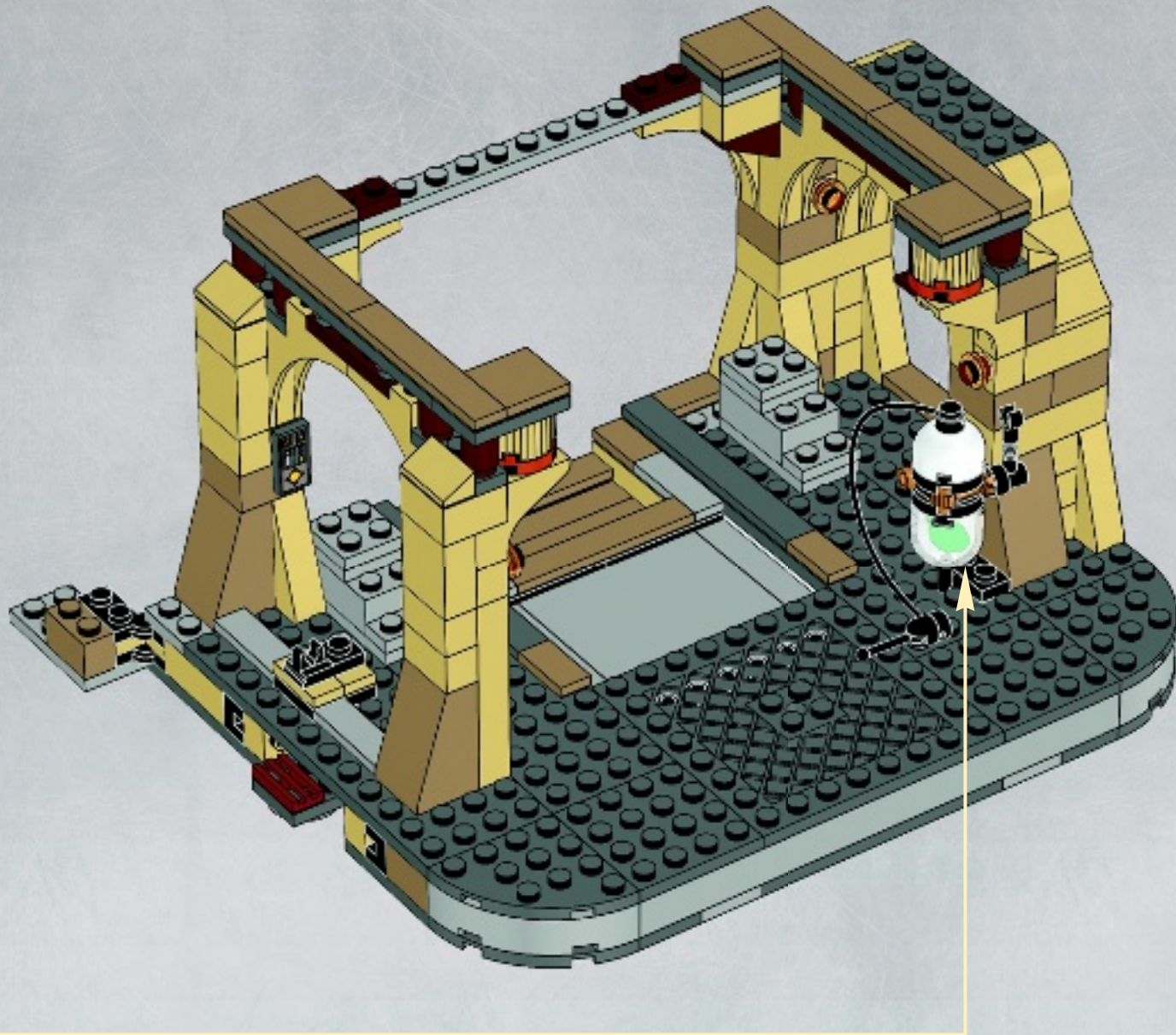

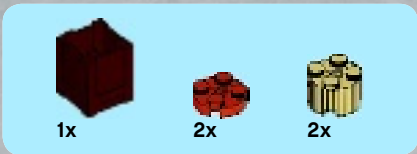

47

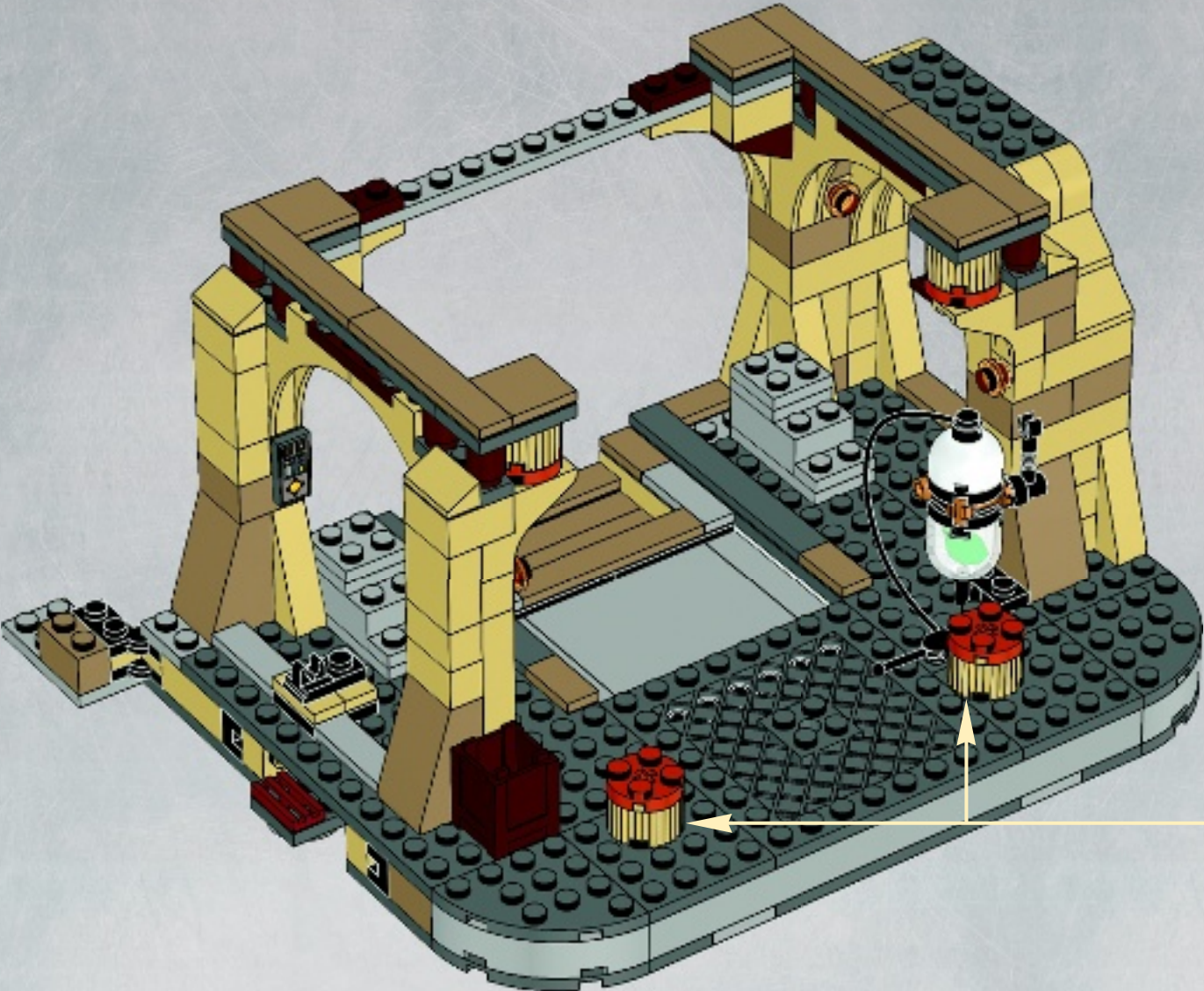



1x



1x



1x



2x



2x

# 48

