



# STAR WARS



9516



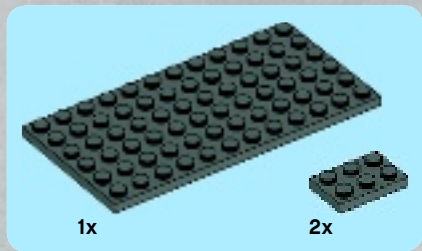
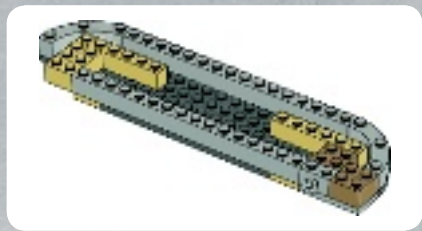
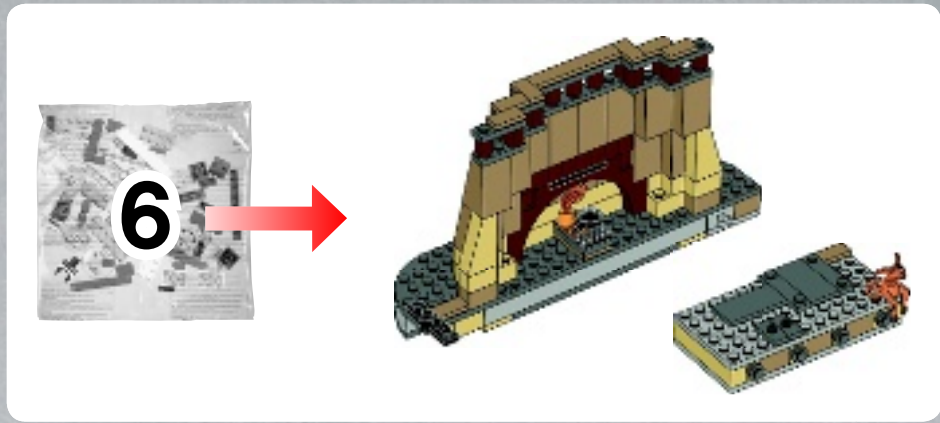

1

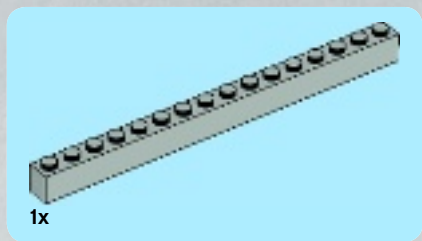
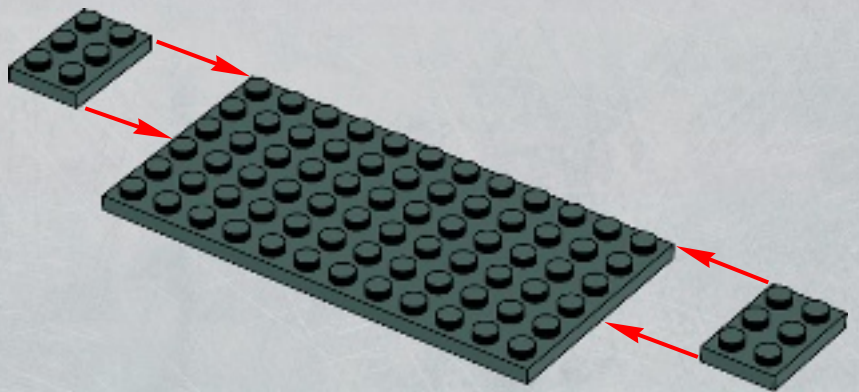

2

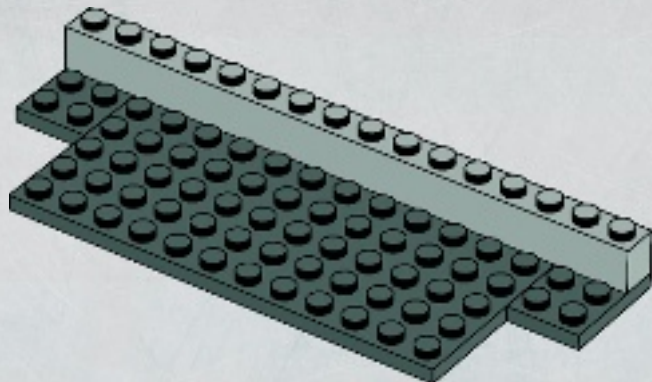



2x

3

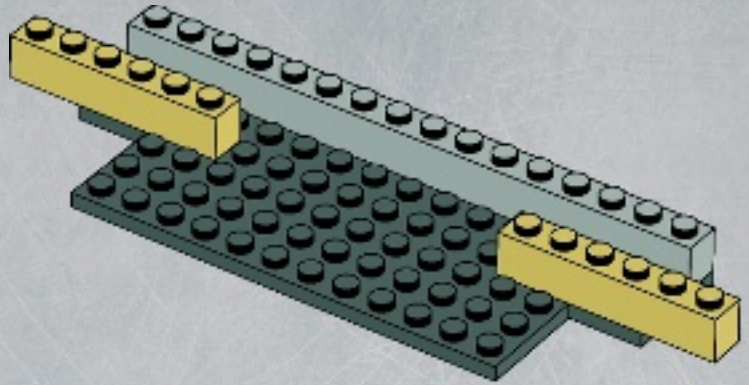

2x

4

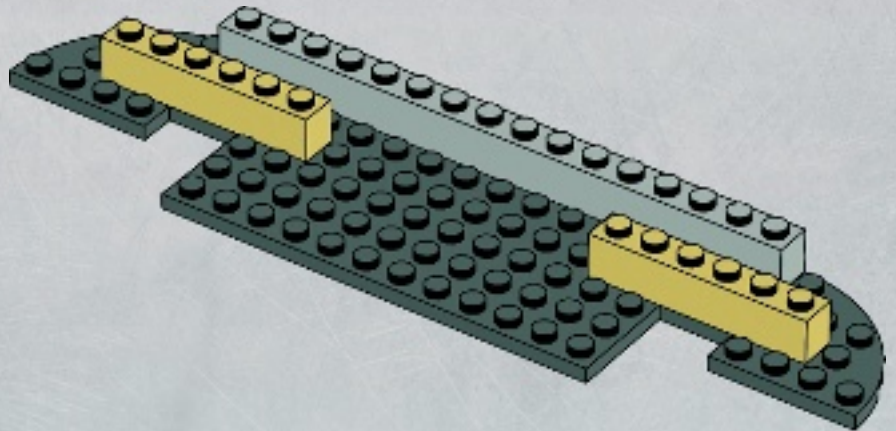

1x



2x

5

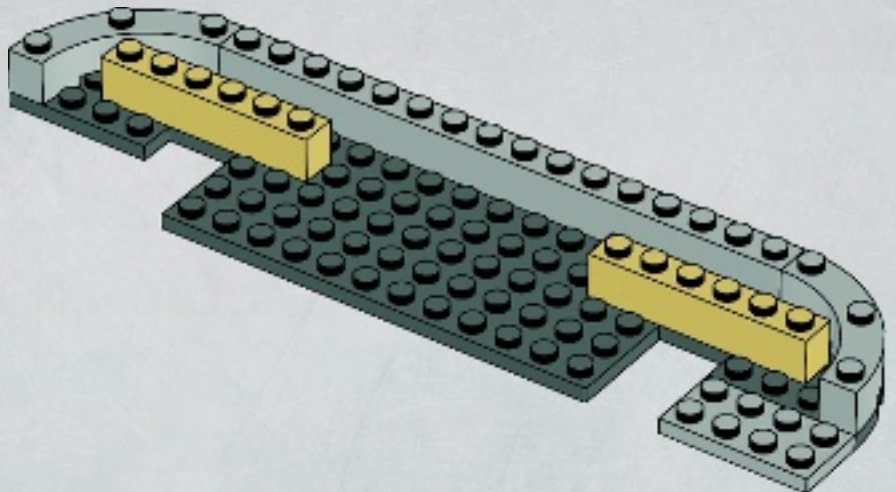



2x



1x

# 6

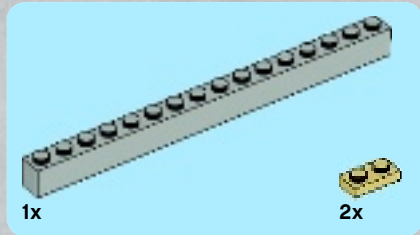
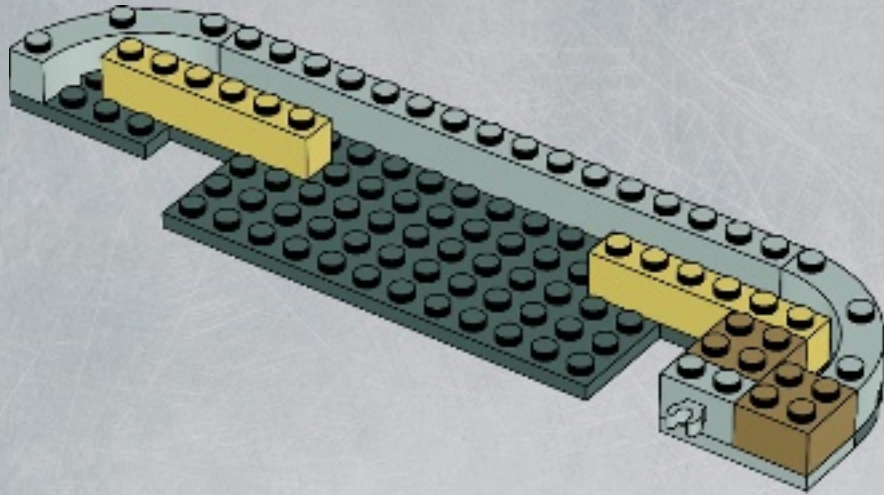

1x

2x

# 7

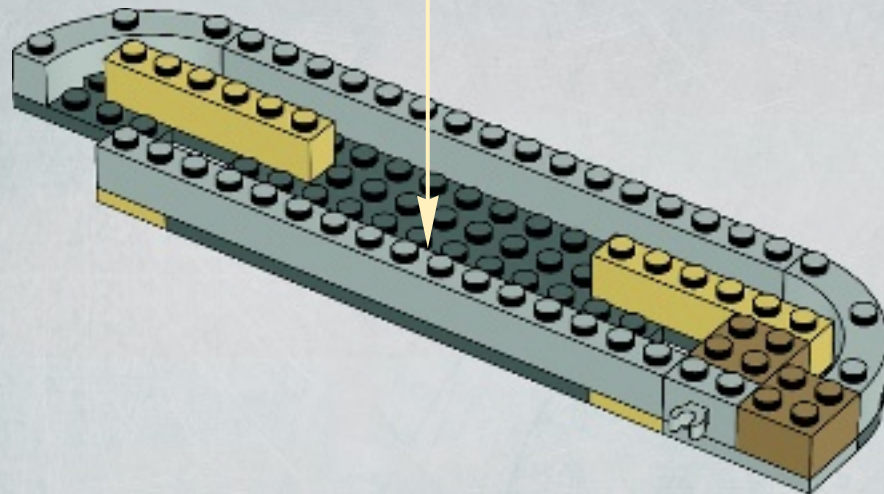
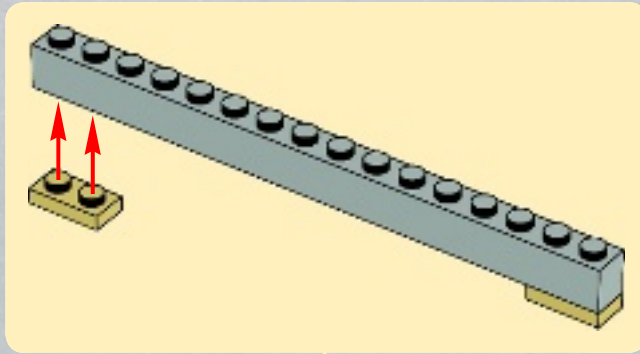



1x

8

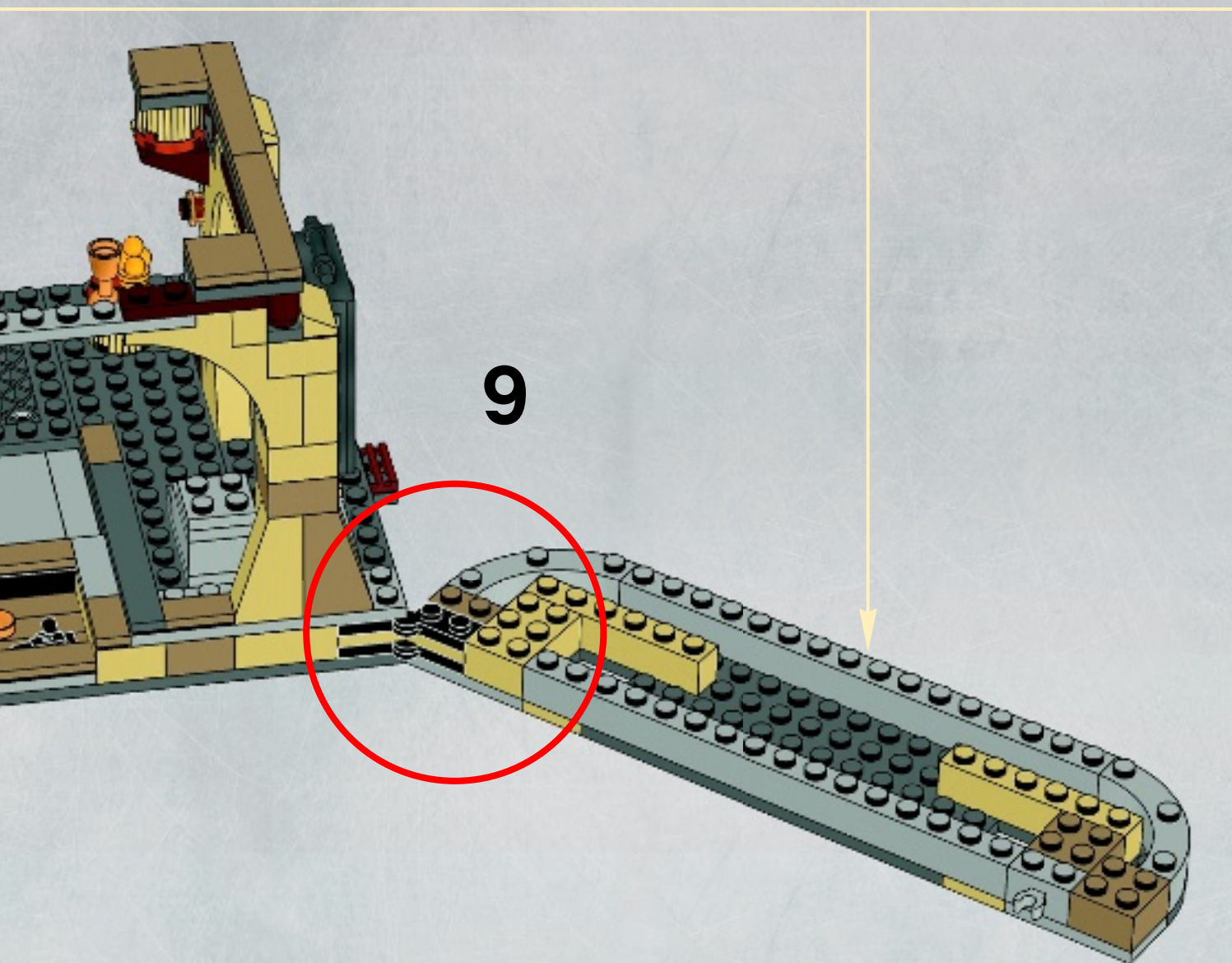
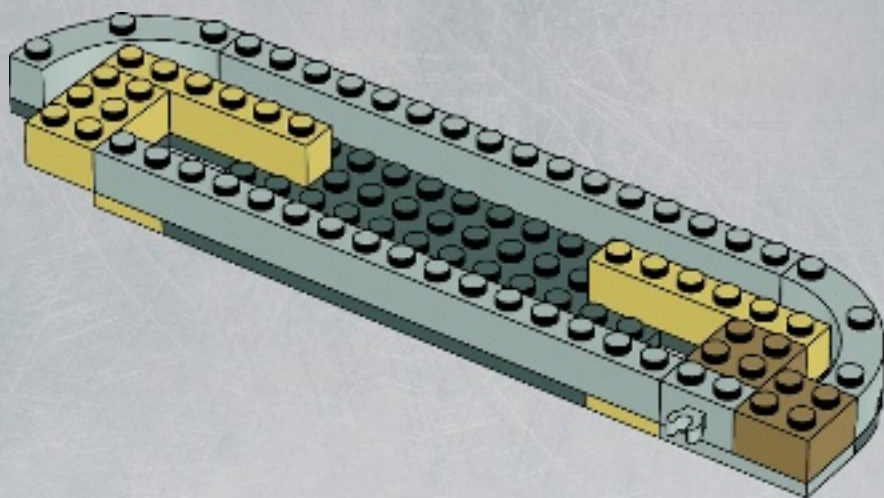

9

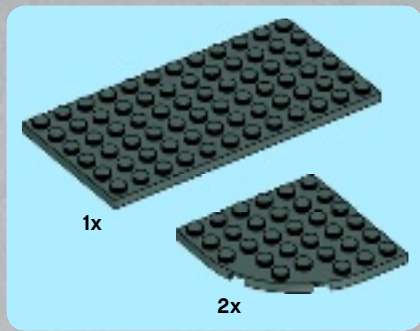

10

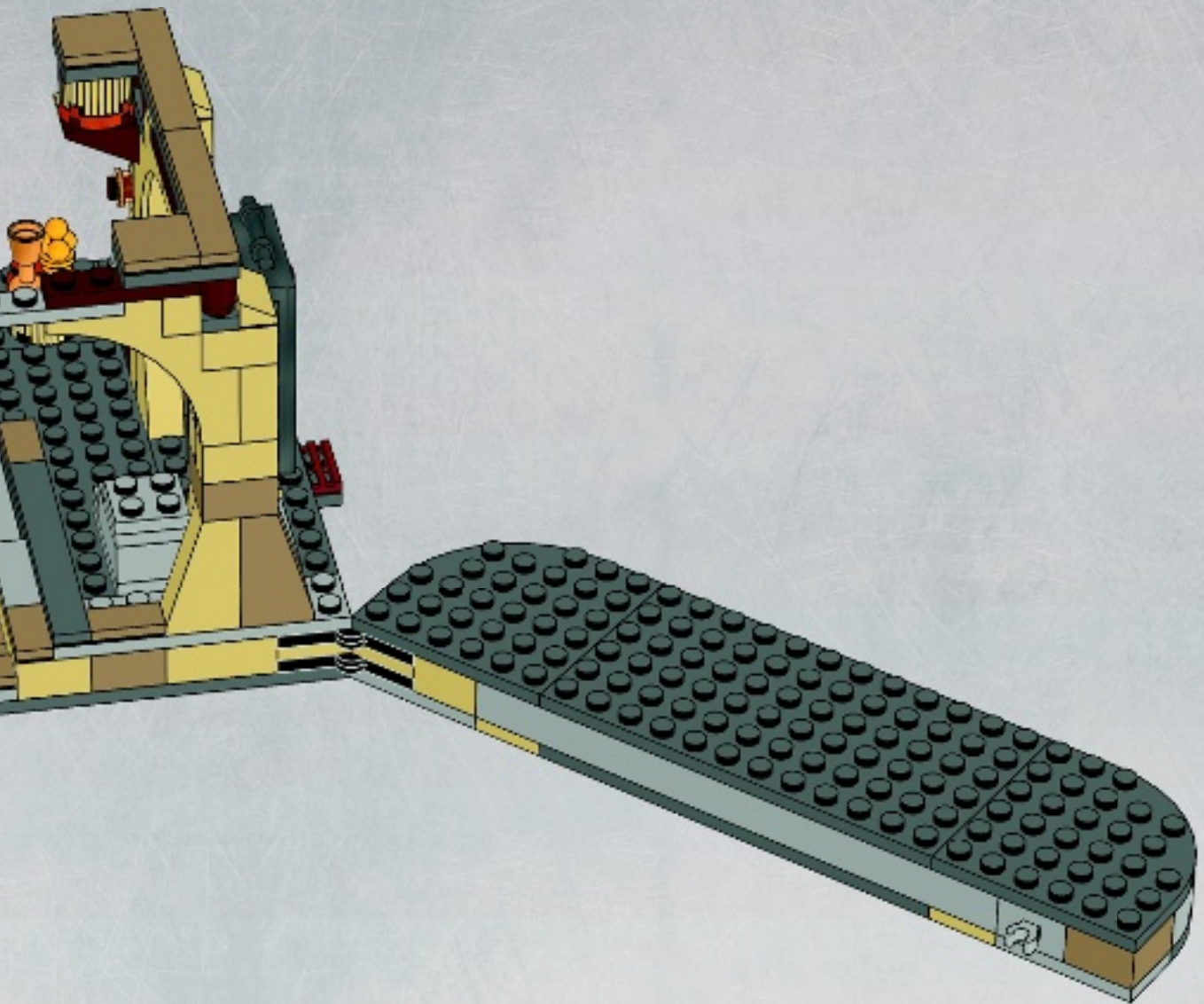

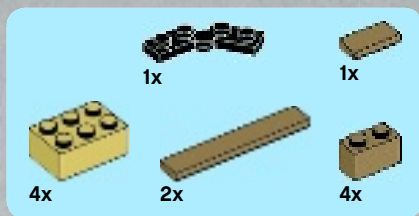

11

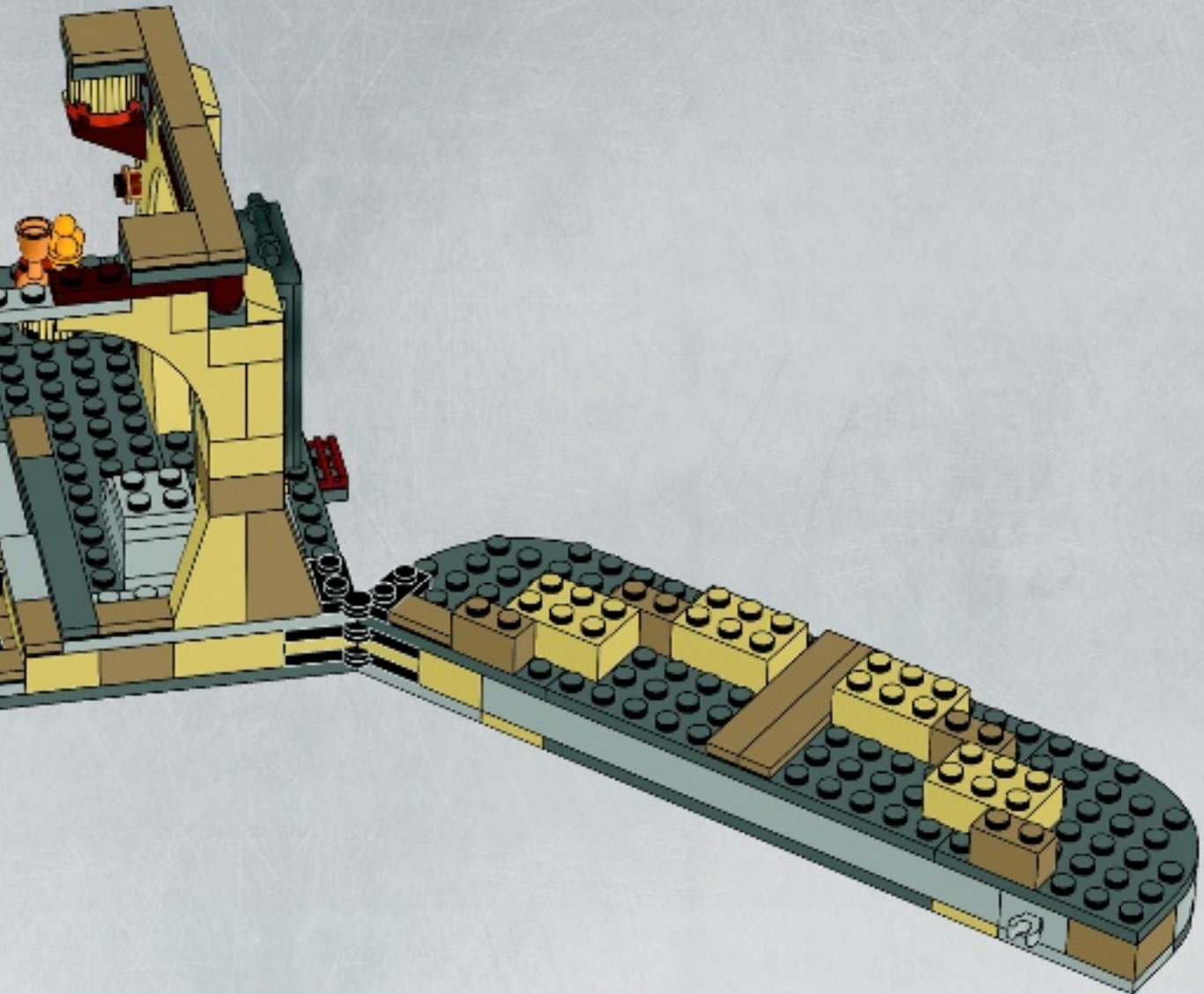

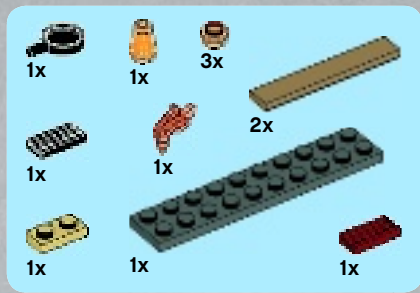

# 12

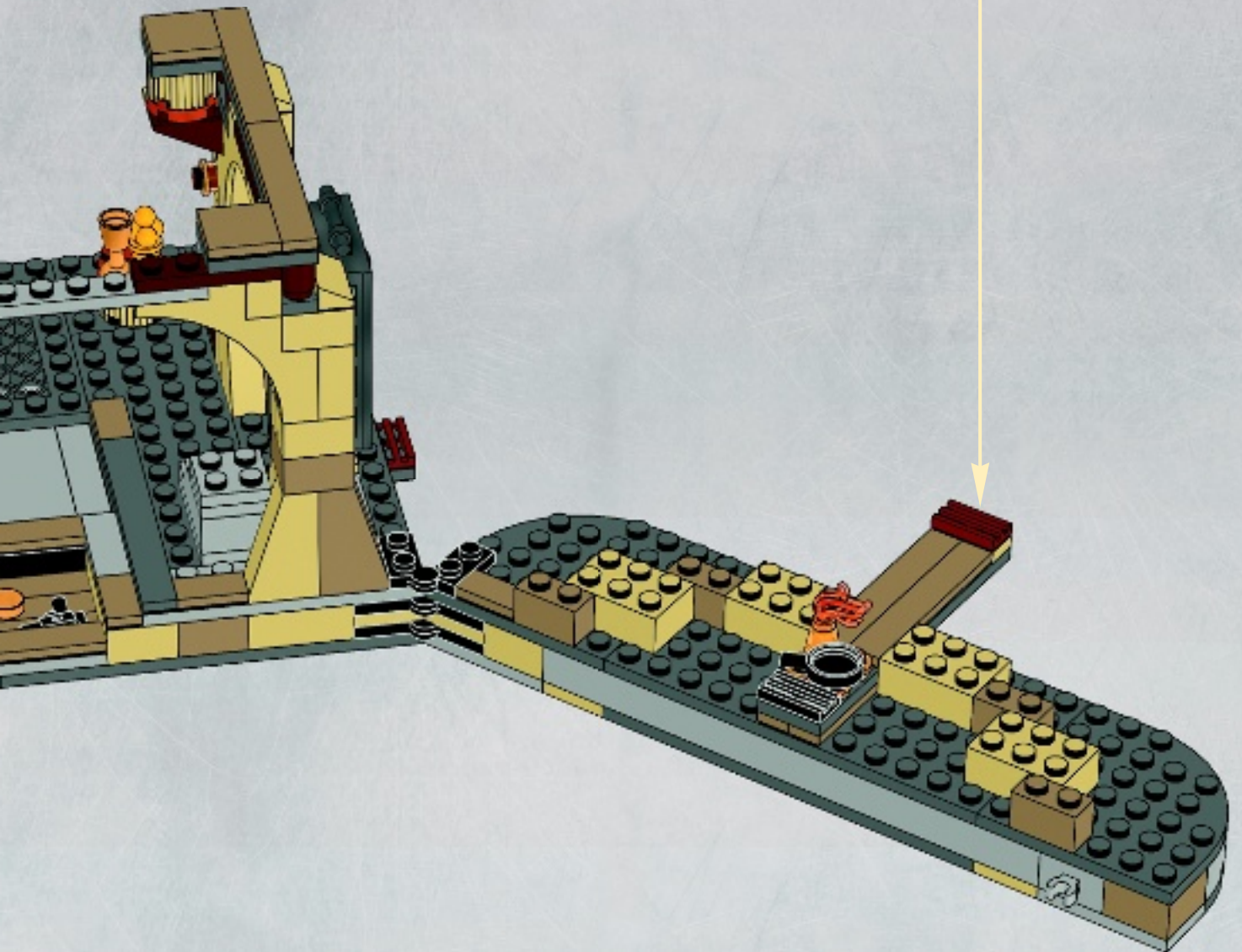
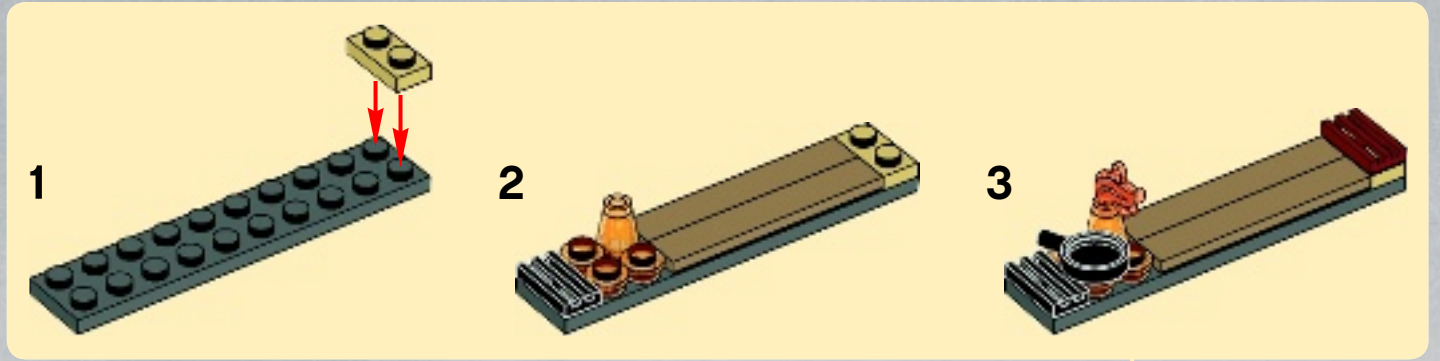



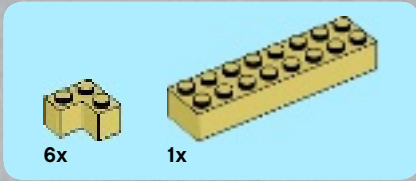

# 13

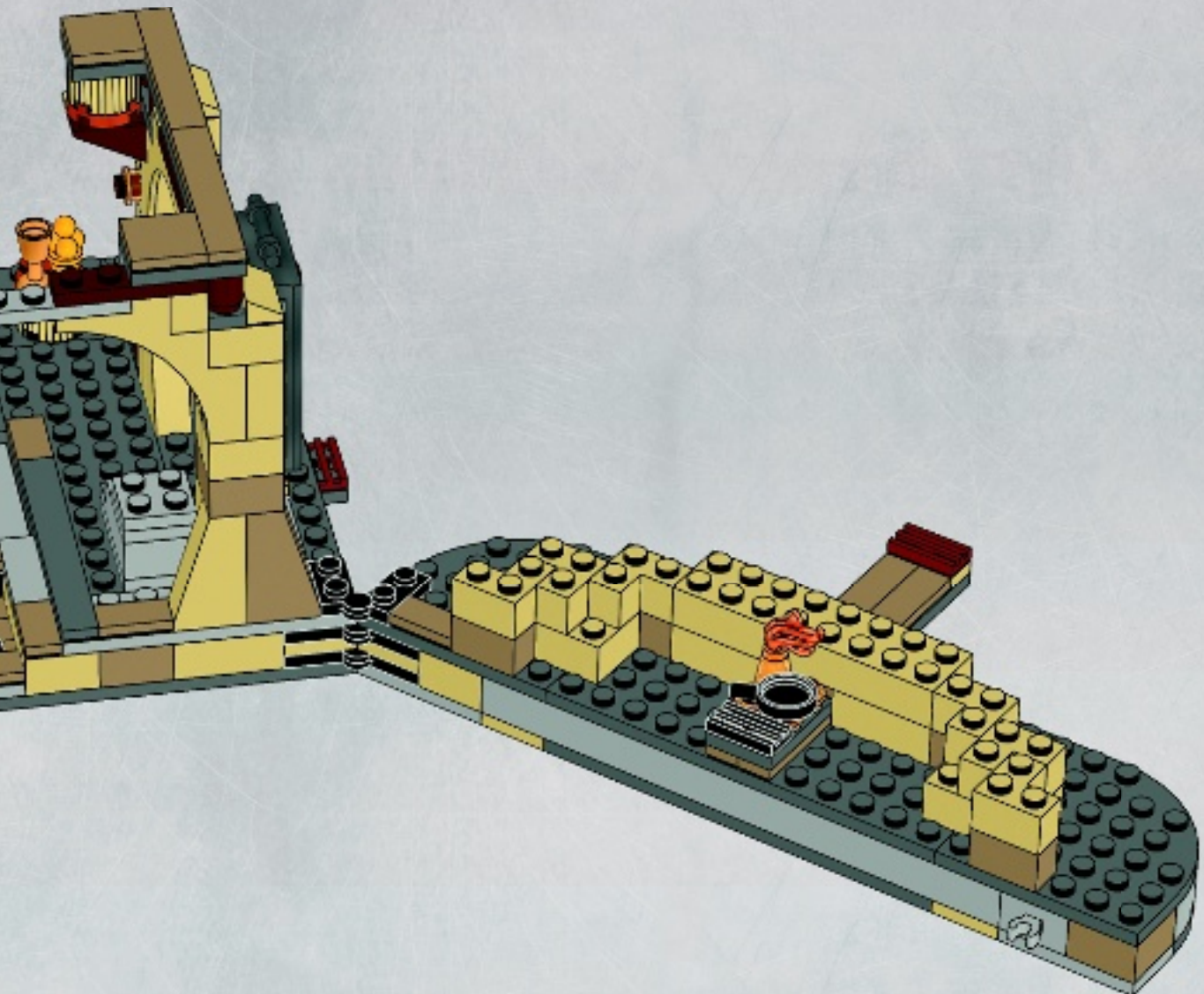

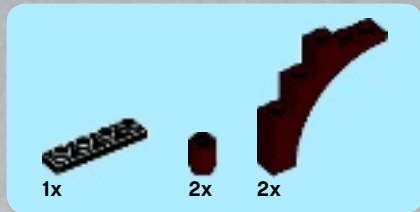

14

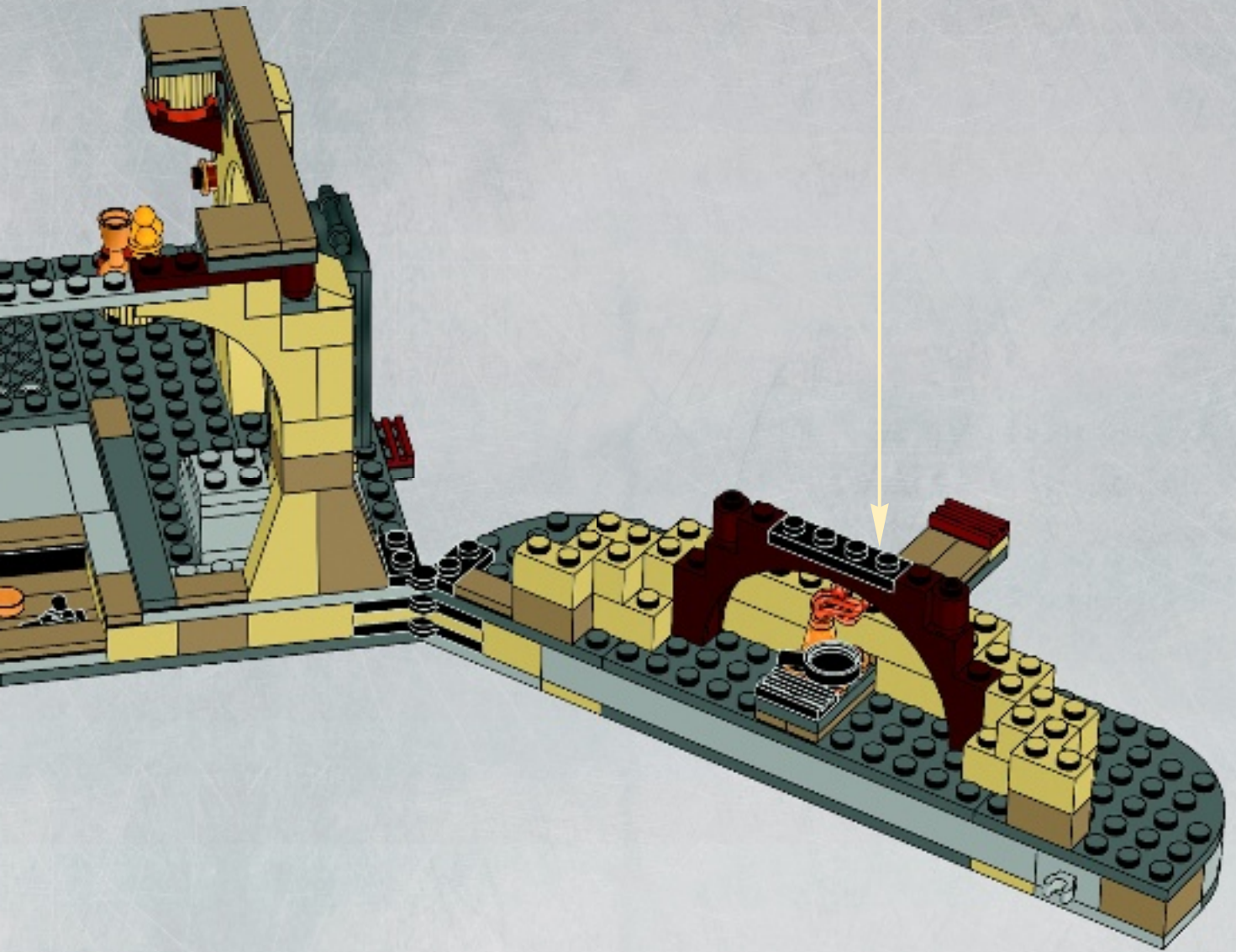
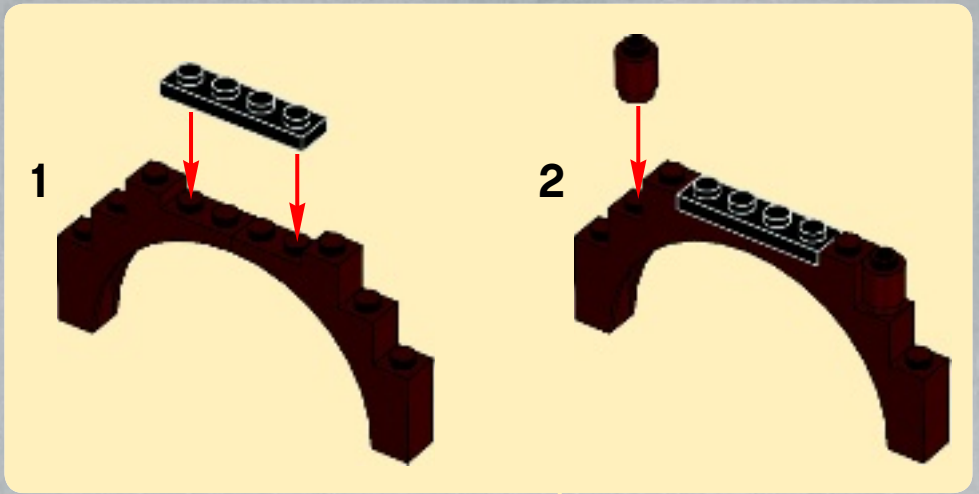



8x

15

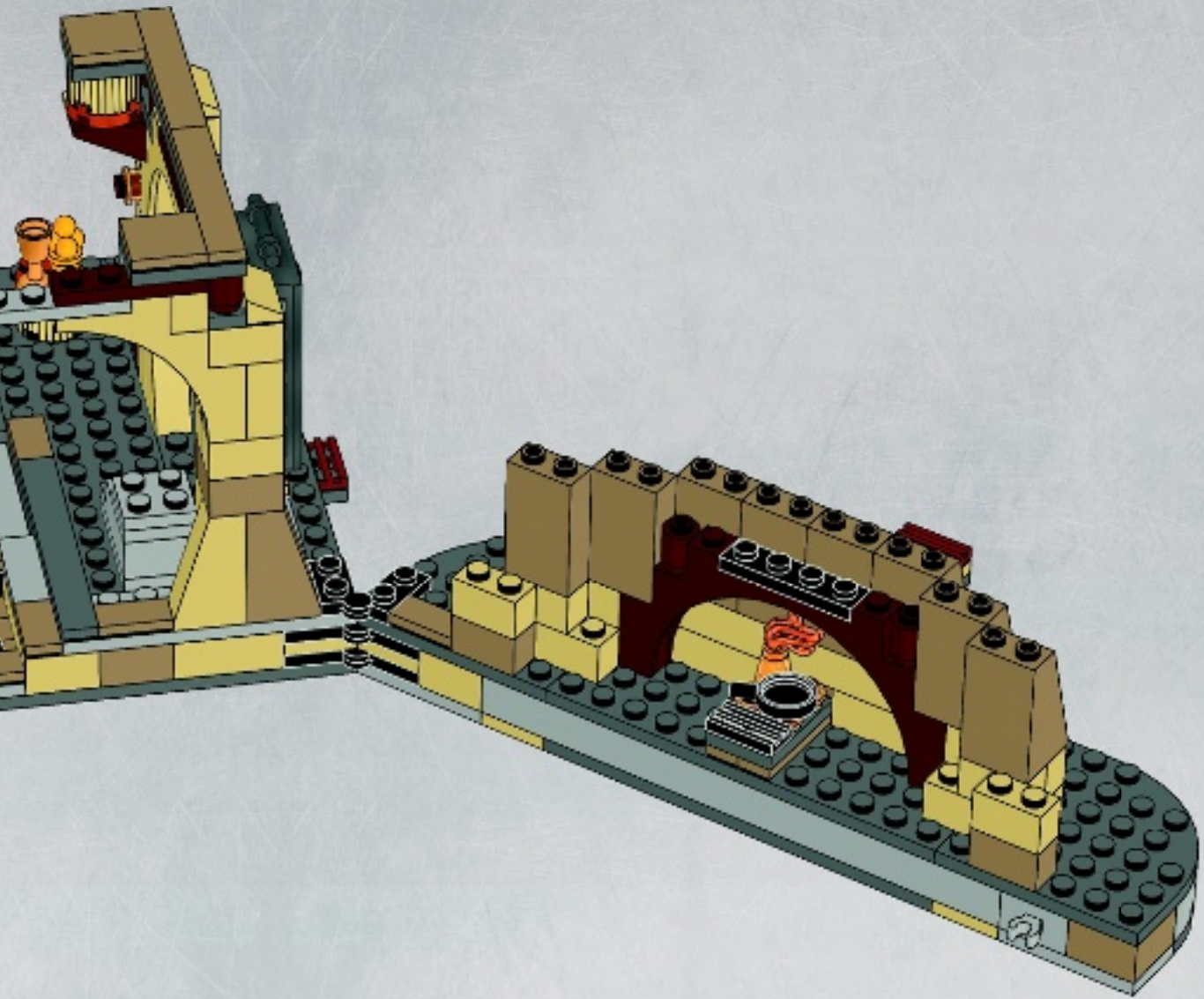



2x



4x

# 16

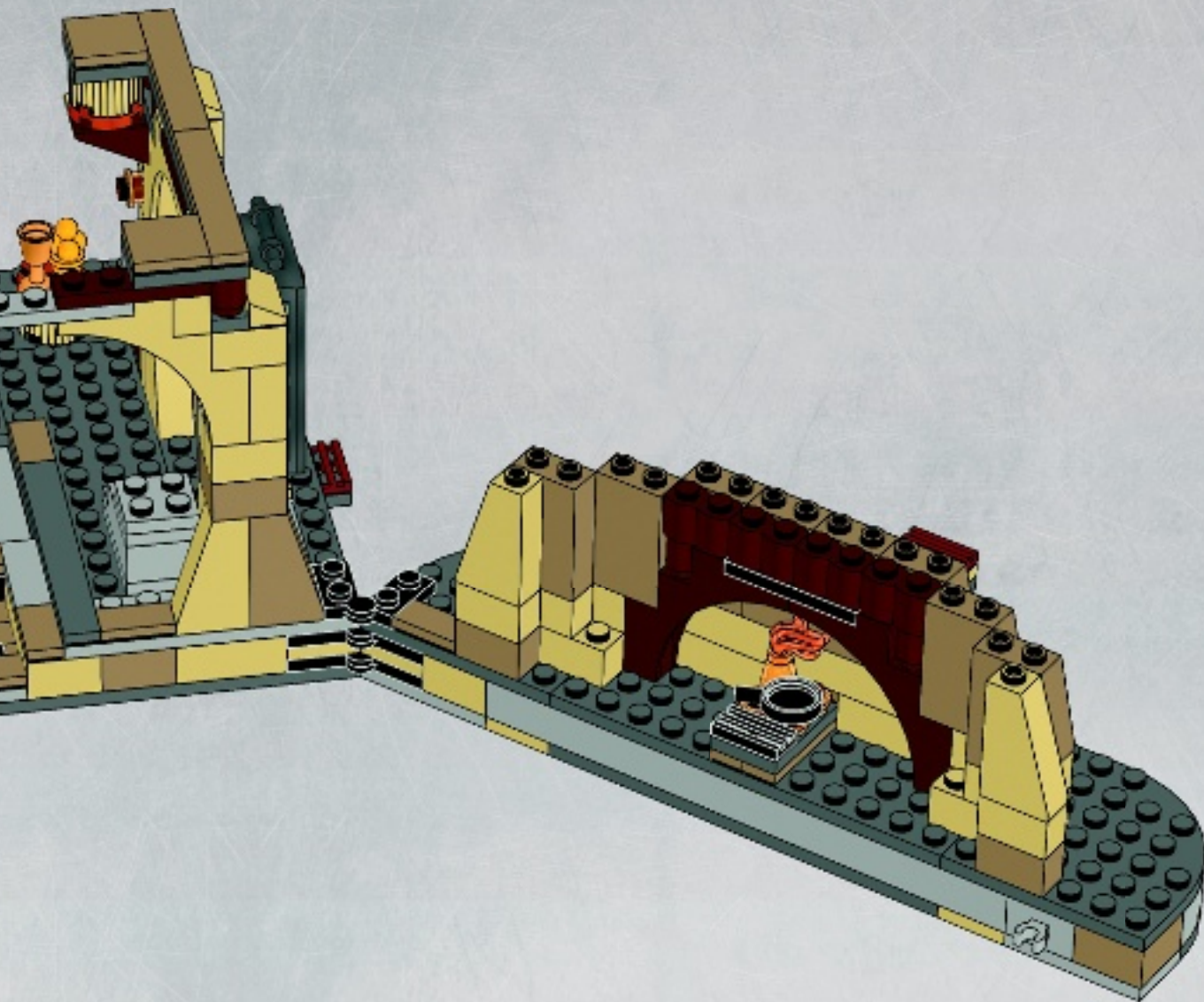



8x

17

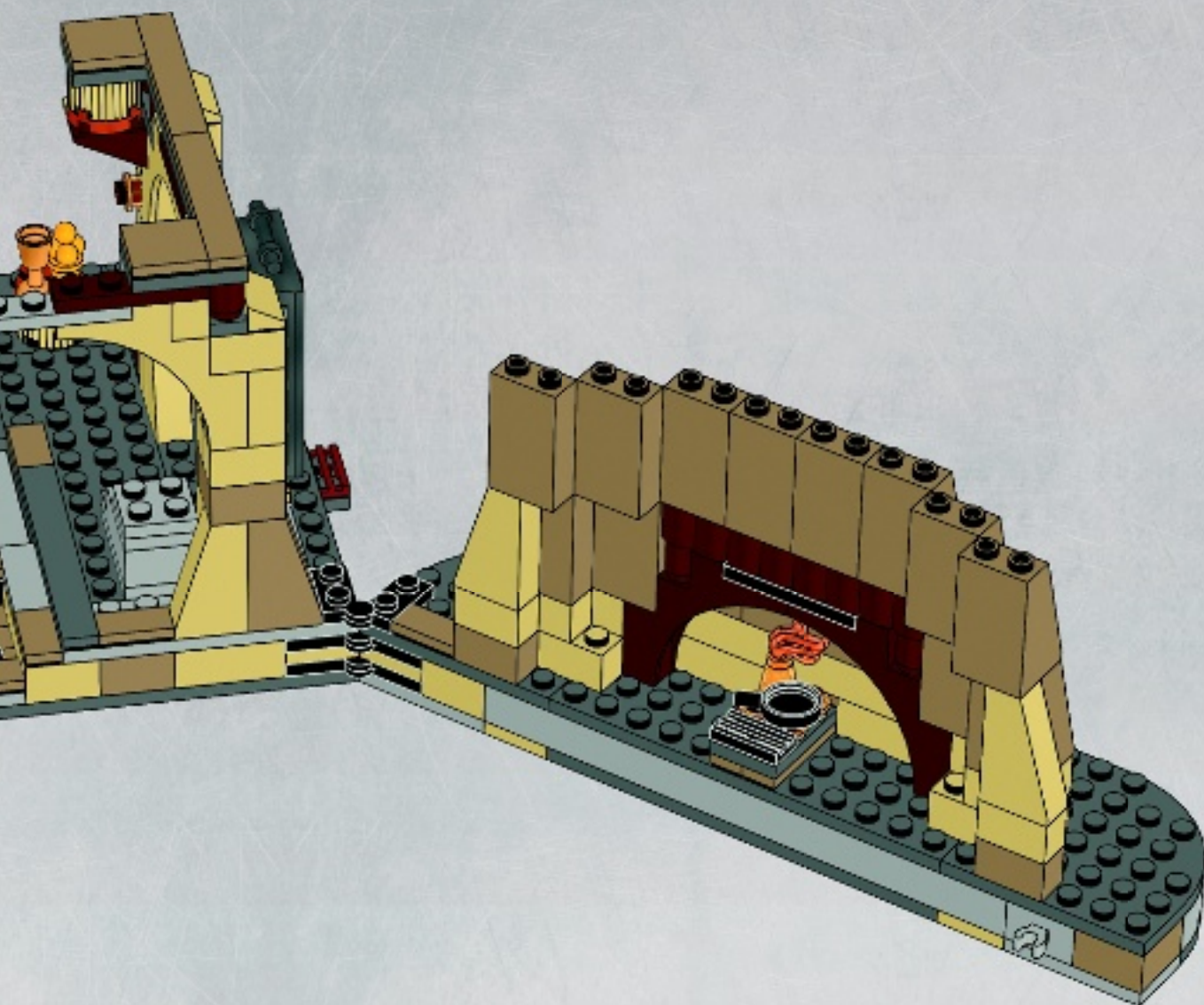



1x



4x

# 18

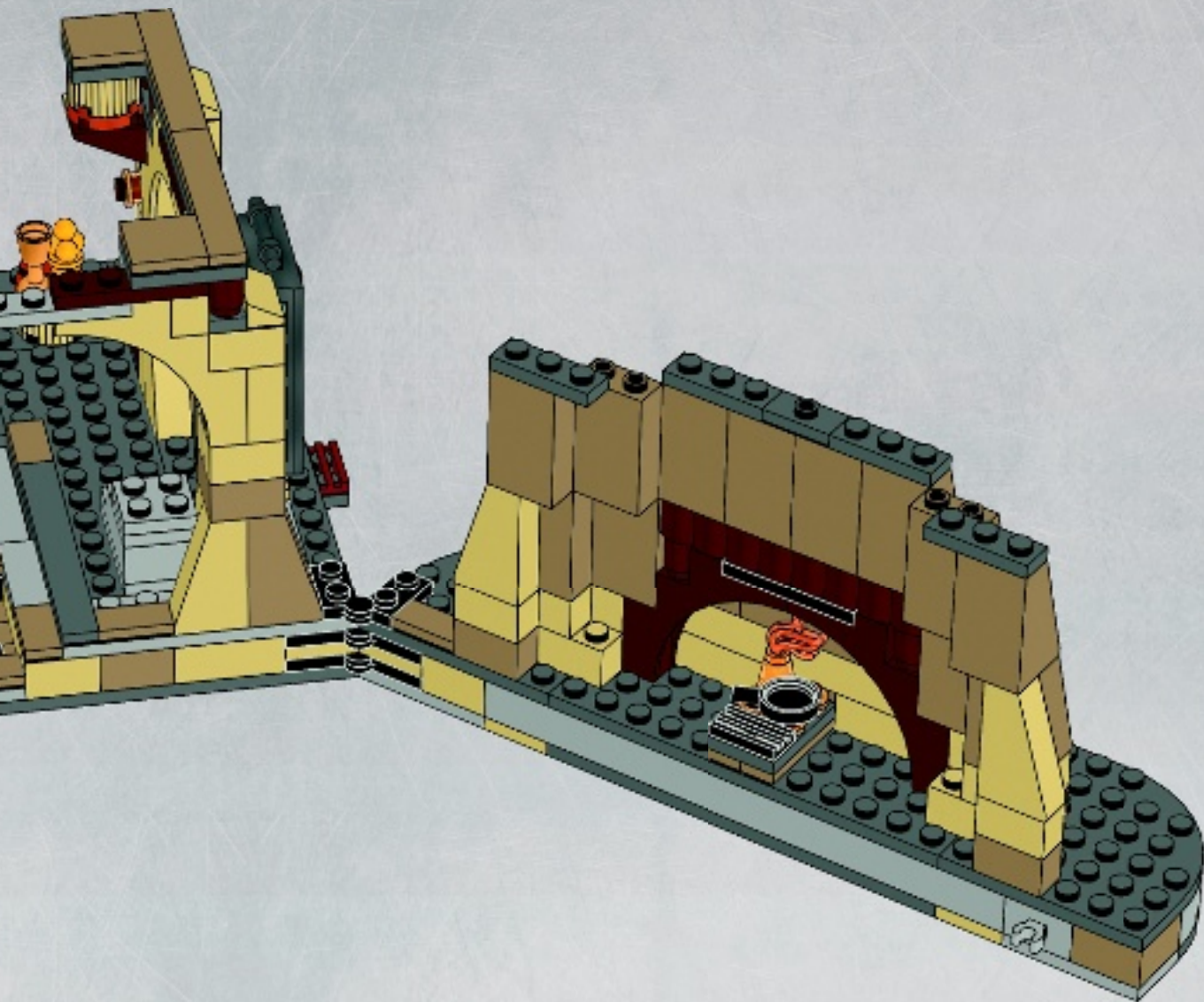



2x

# 19

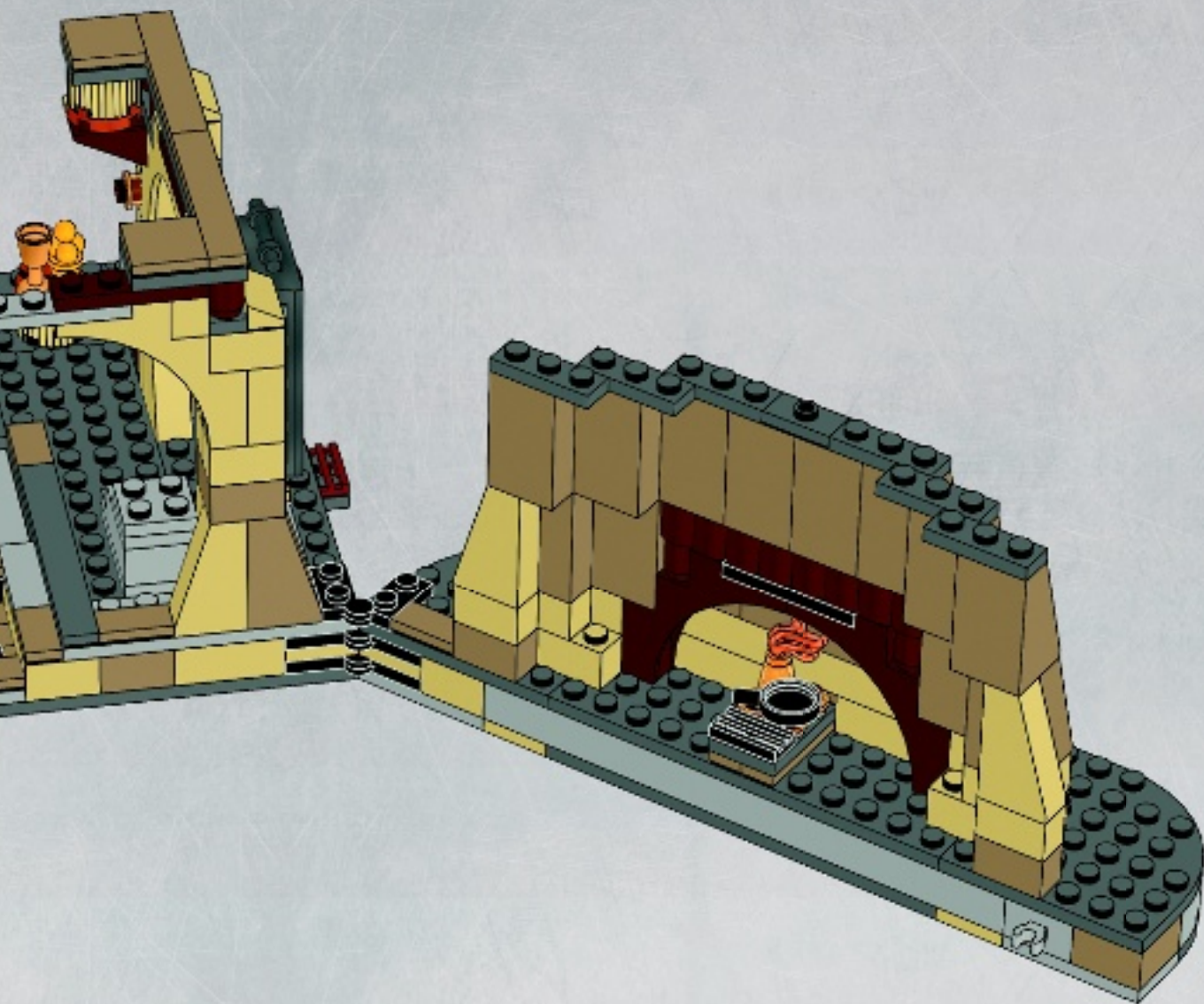



4x



5x

# 20

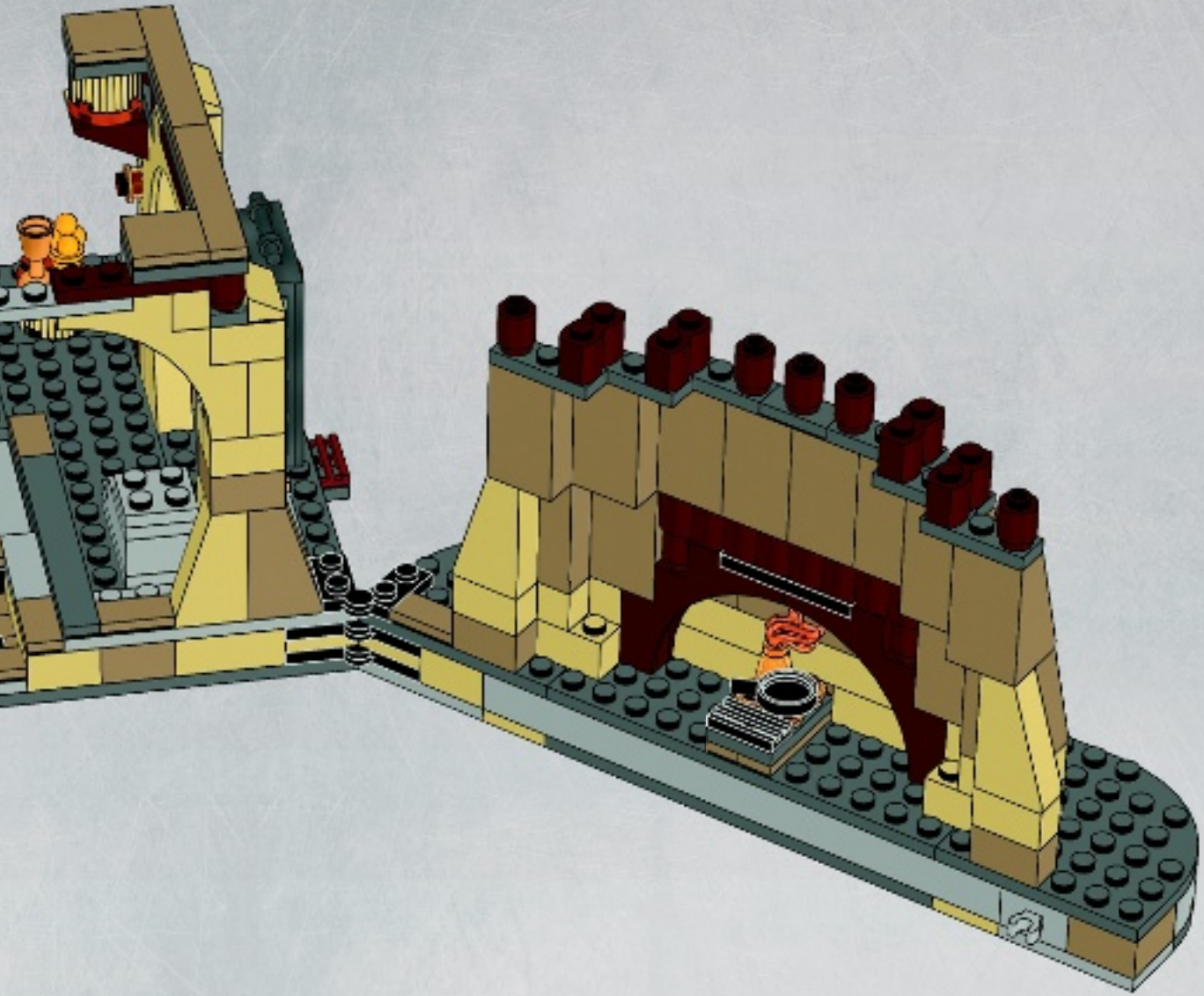





# 21

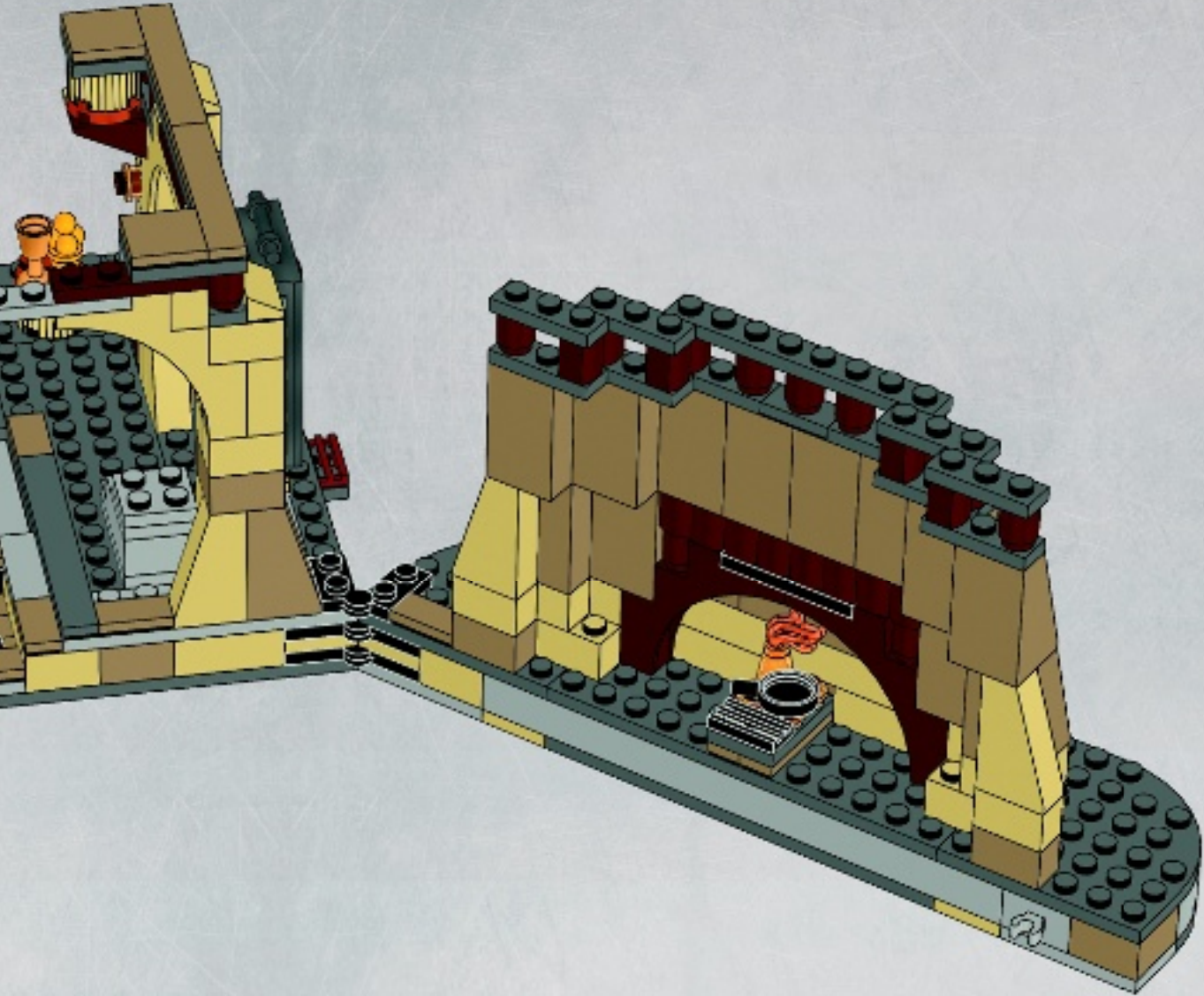

6x

1x

# 22

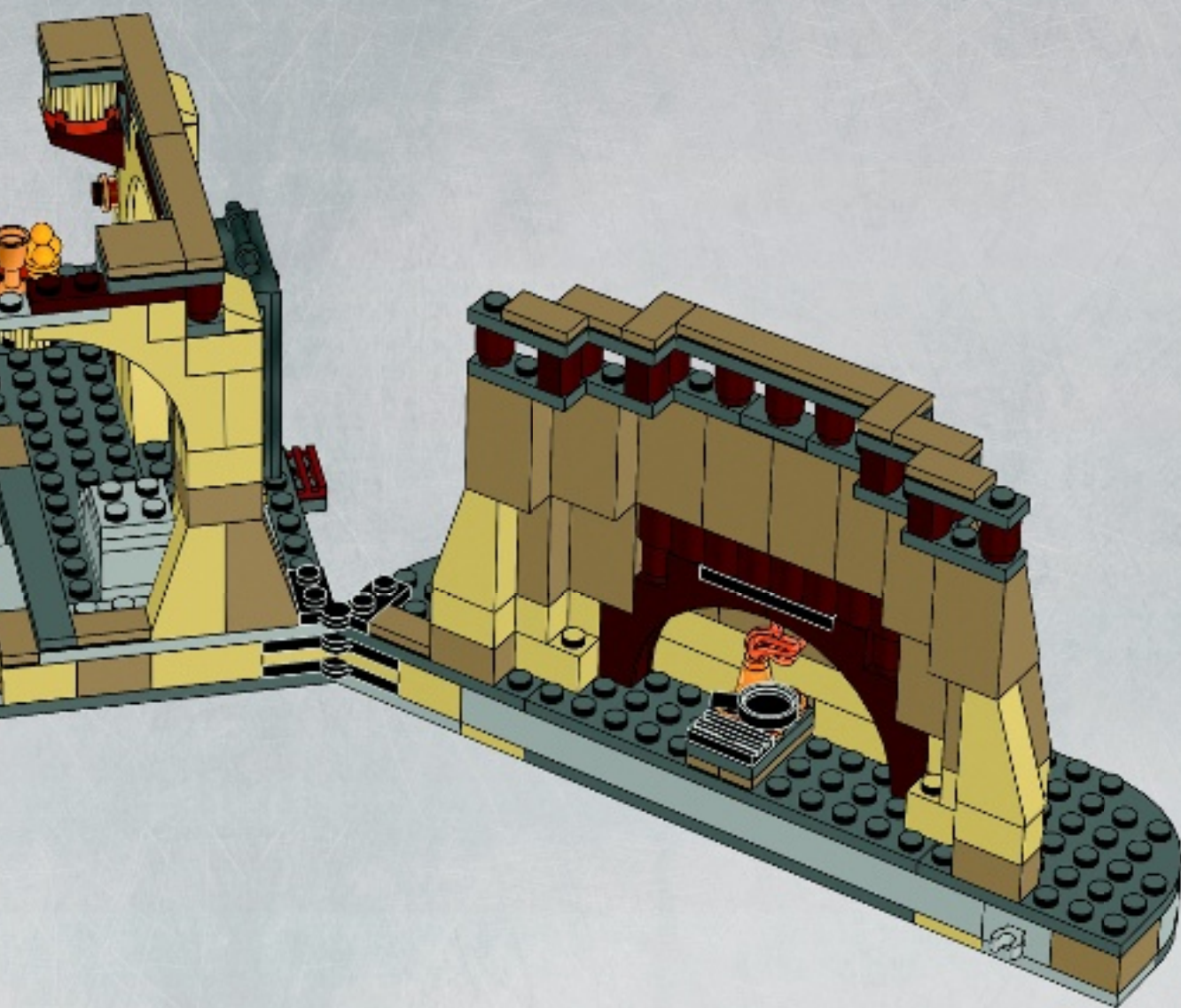

23

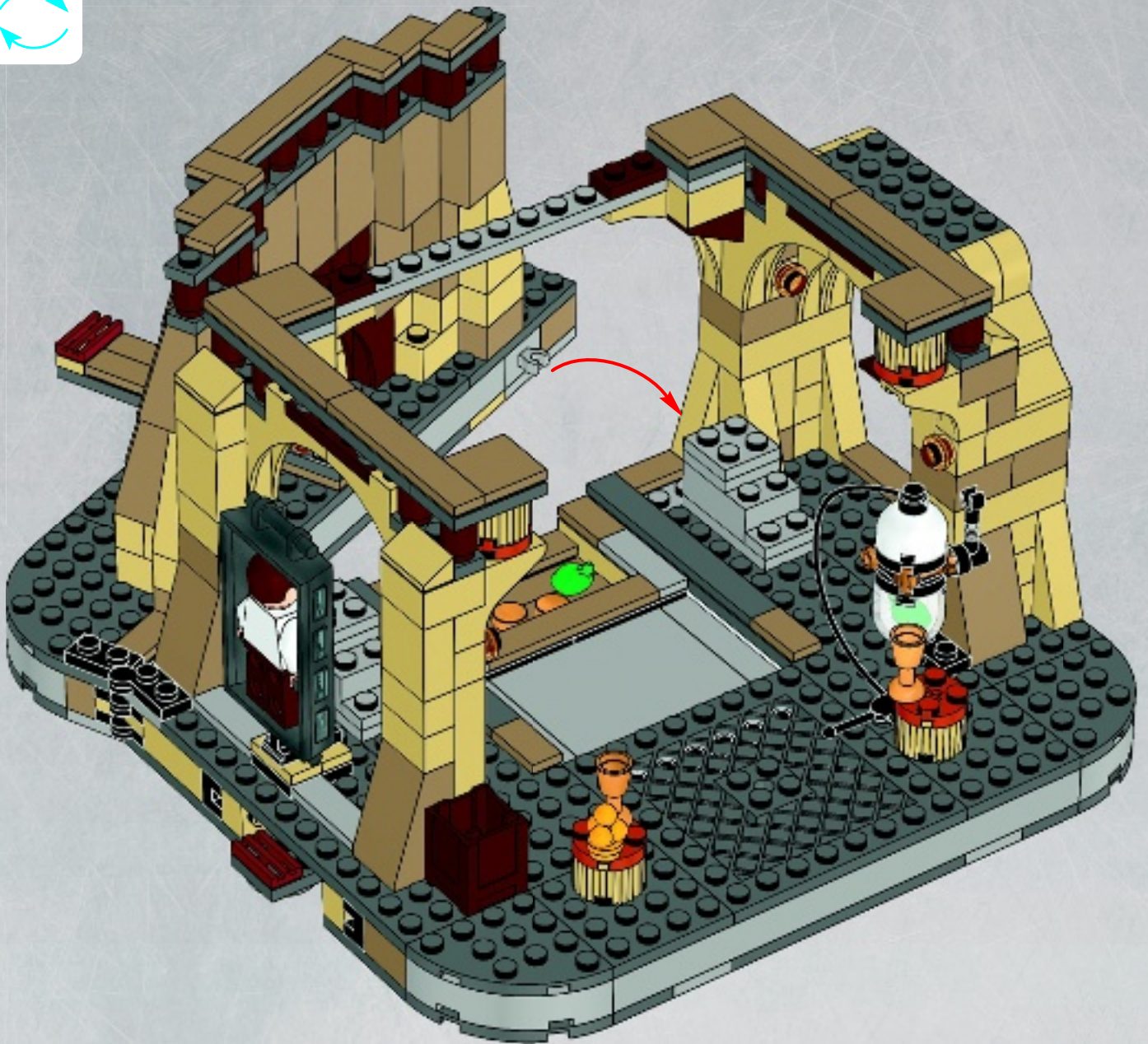

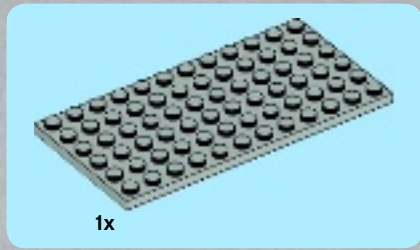

1x

1

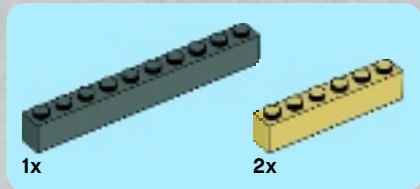
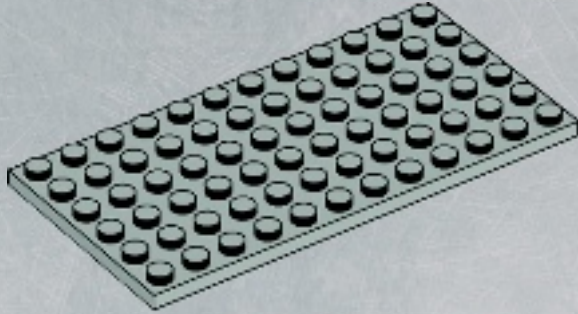

1x

2x

2

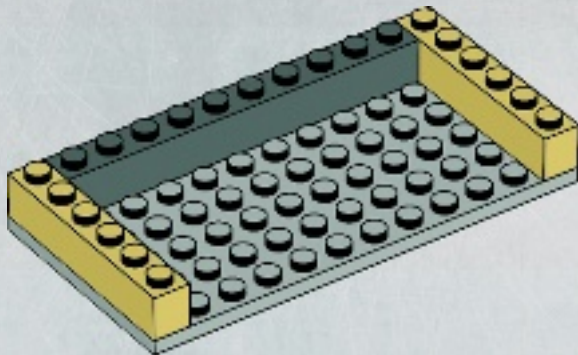

3

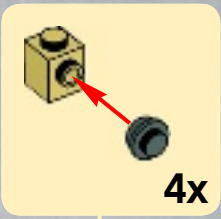

4x

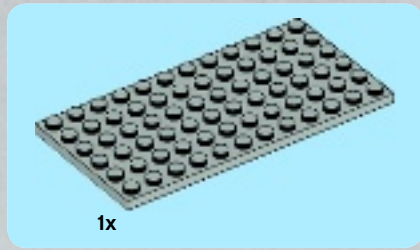
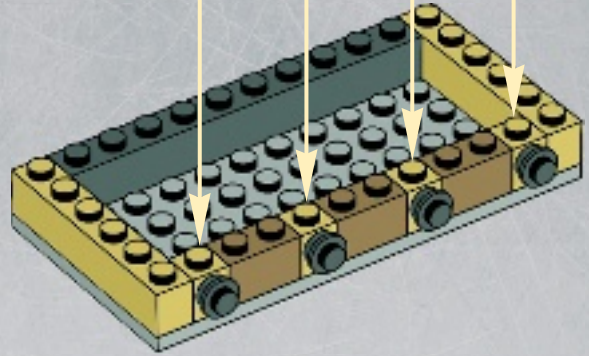

1x

4

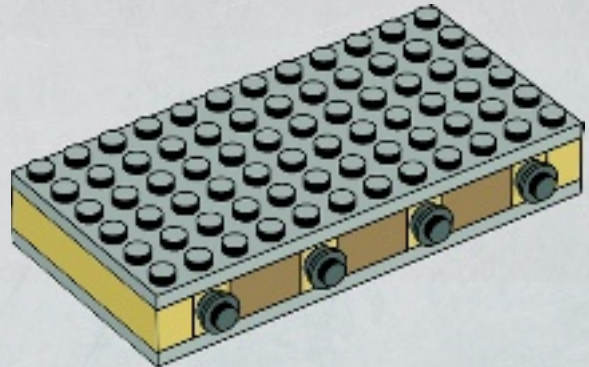



5

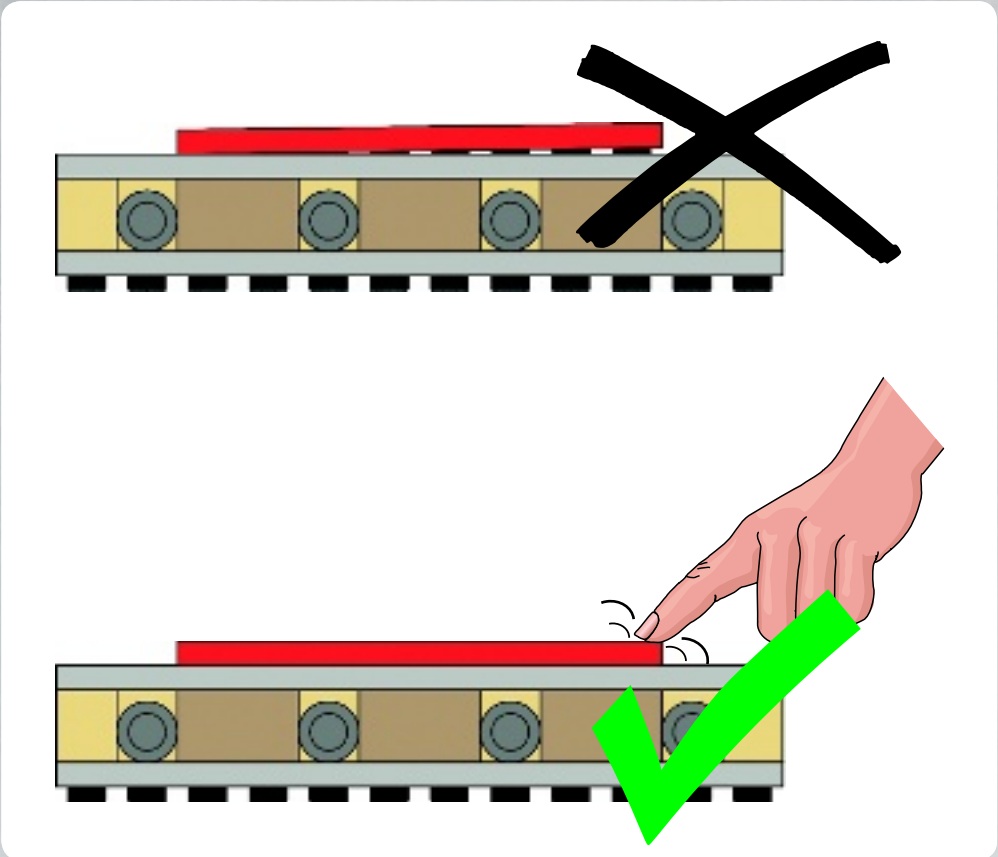
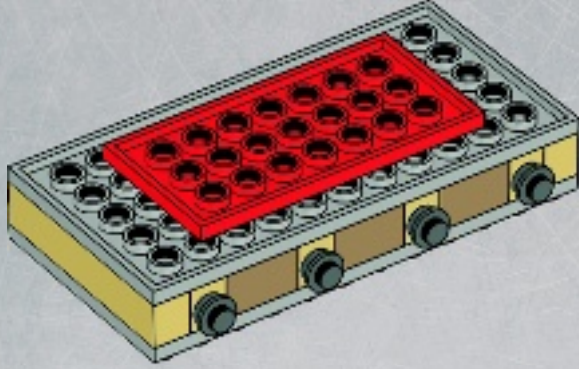



6

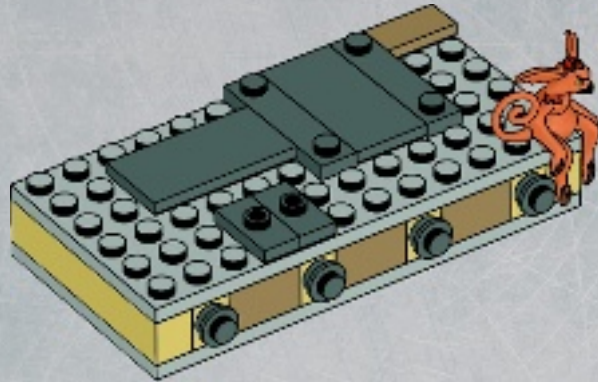

24

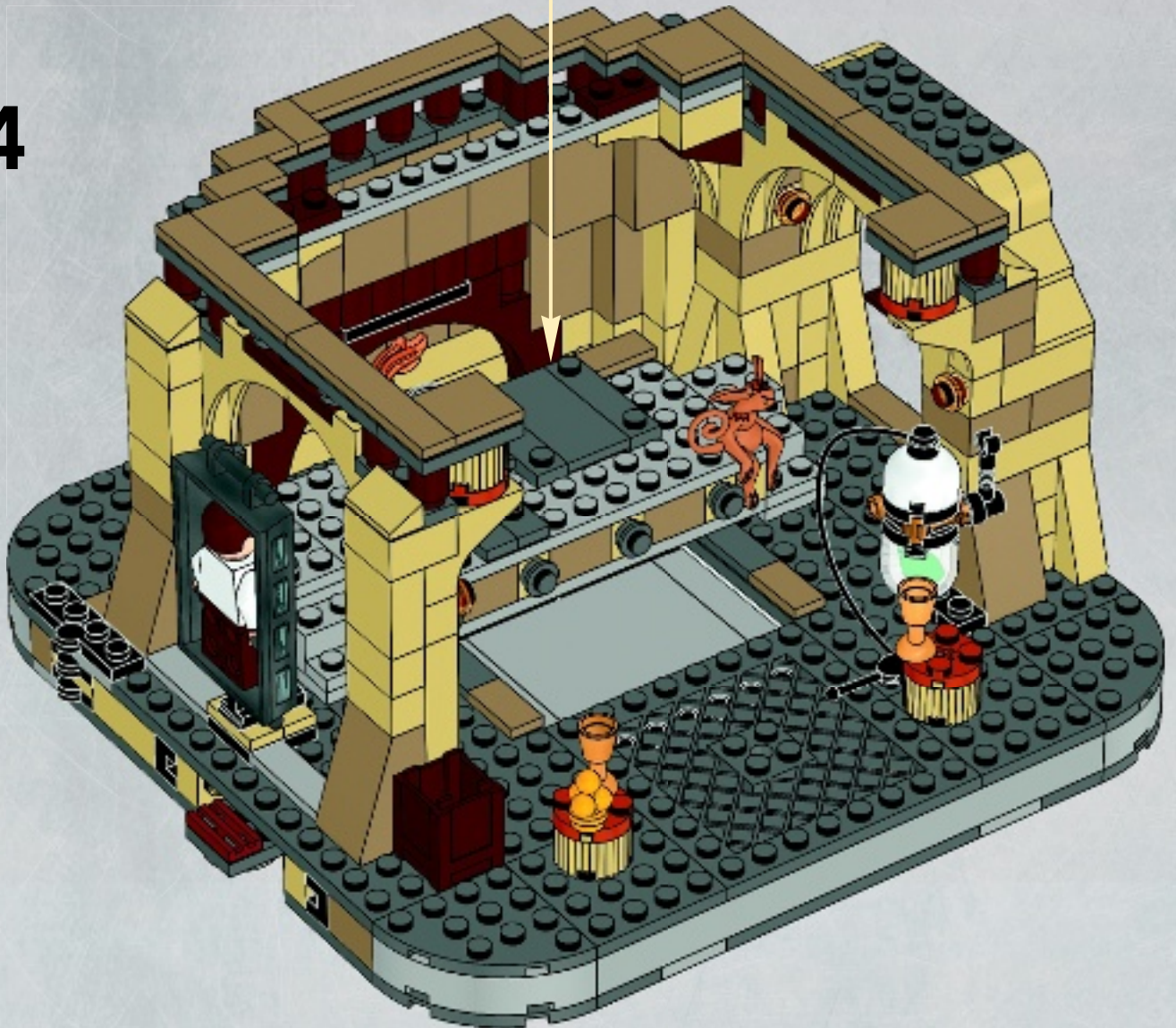

25





7

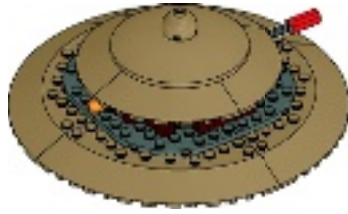

2x

1

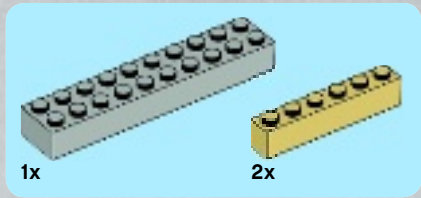
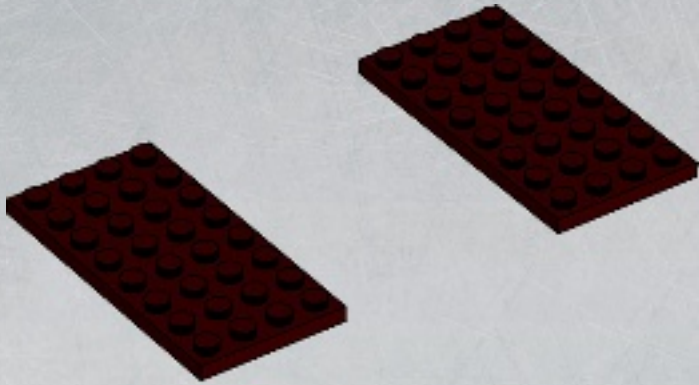

1x

2x

2

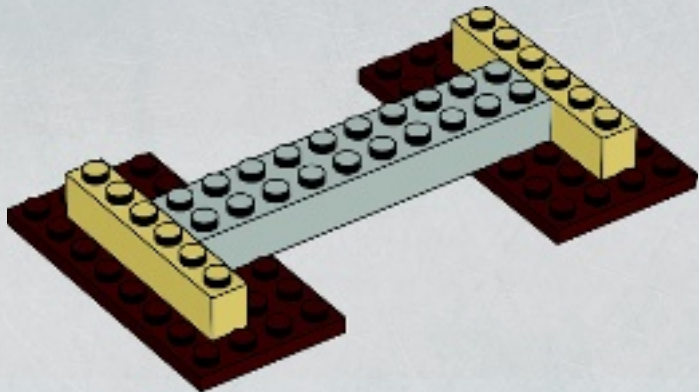



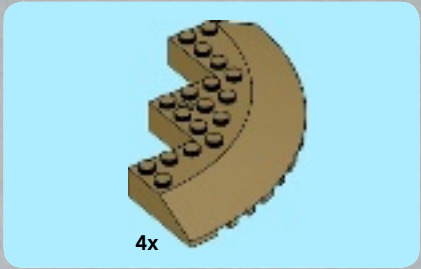

3

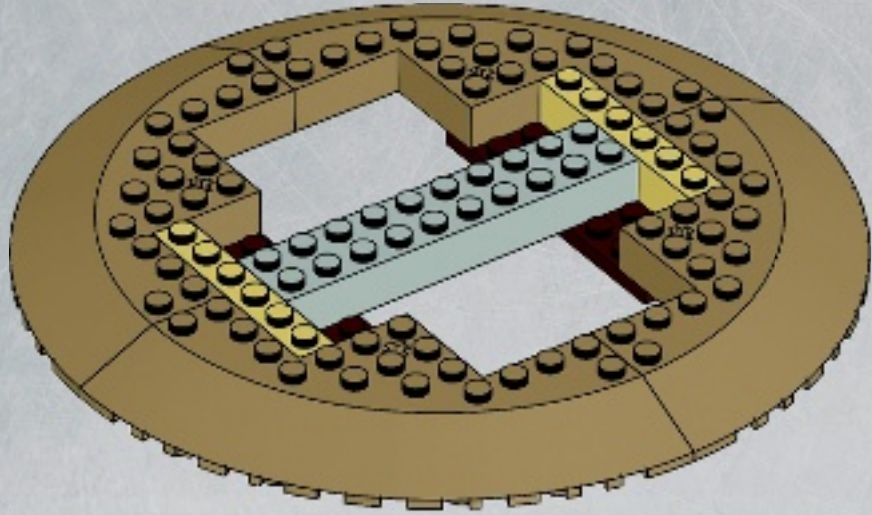

4

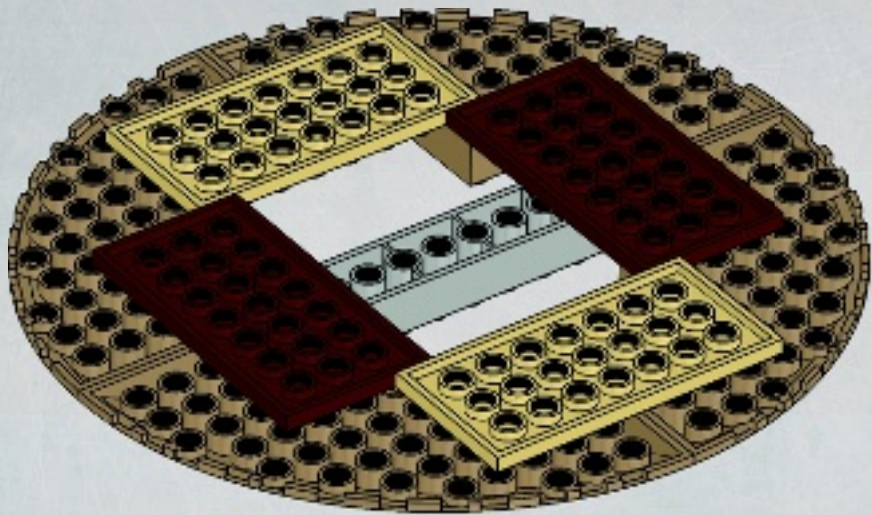



2x



5

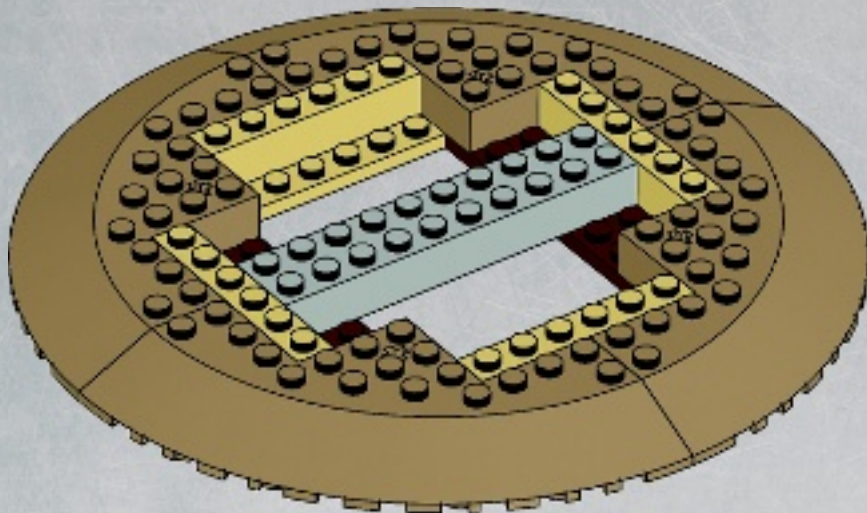

2x

6

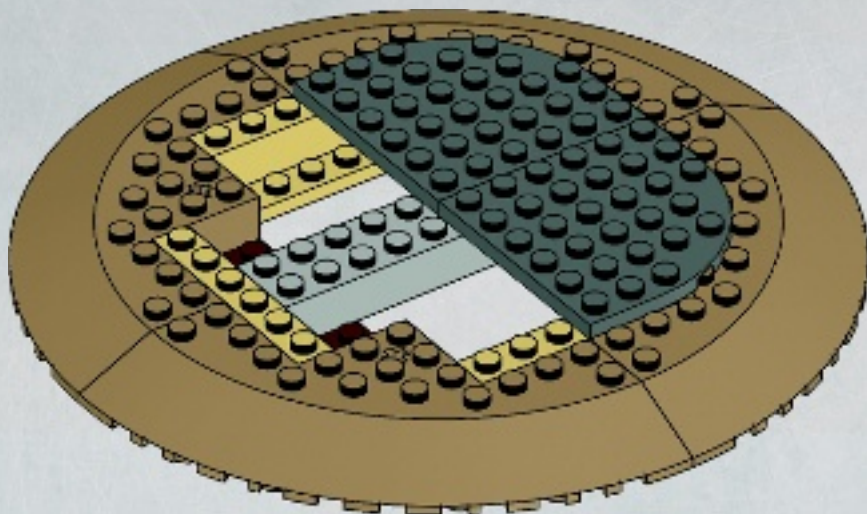

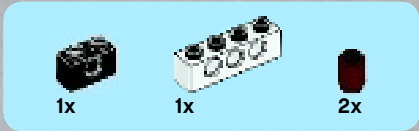

7

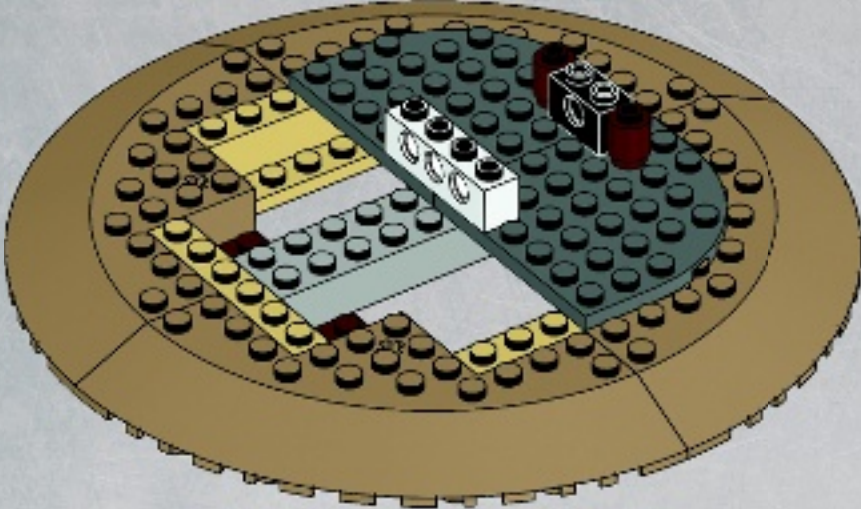

8

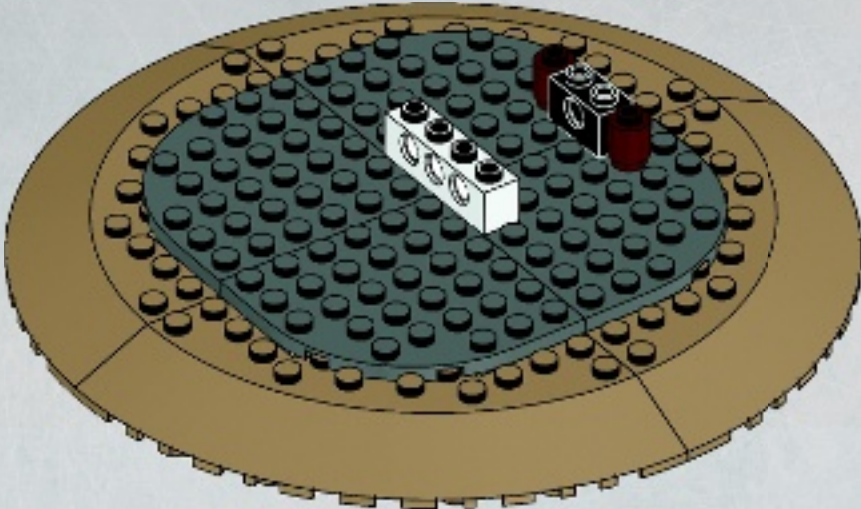

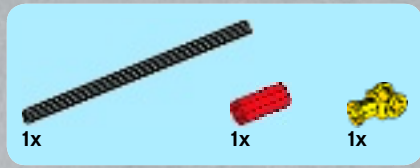

9

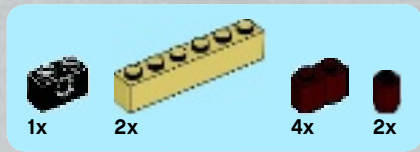
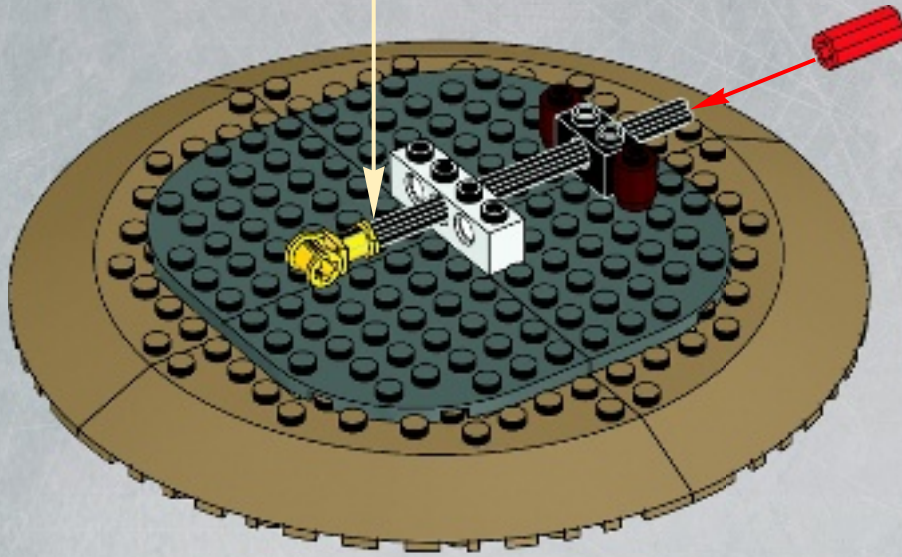
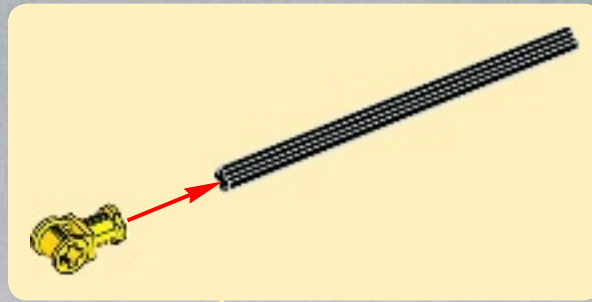

10

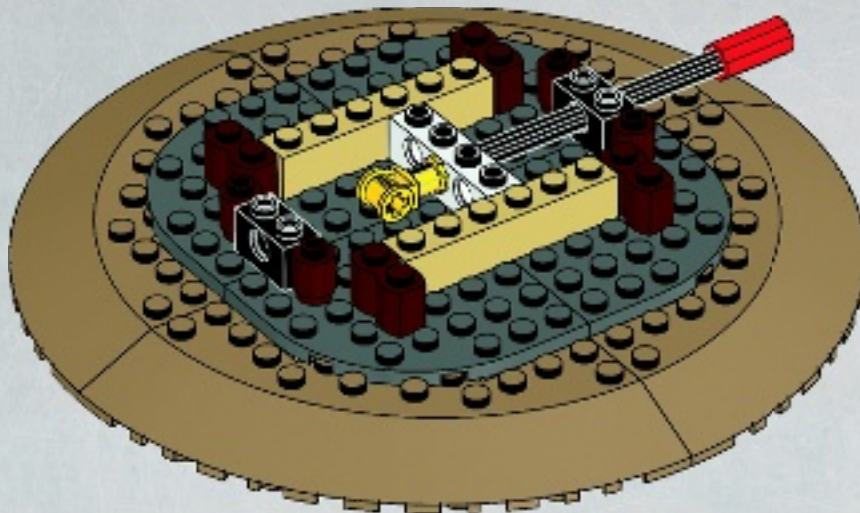



4x



1x



1x



# 11

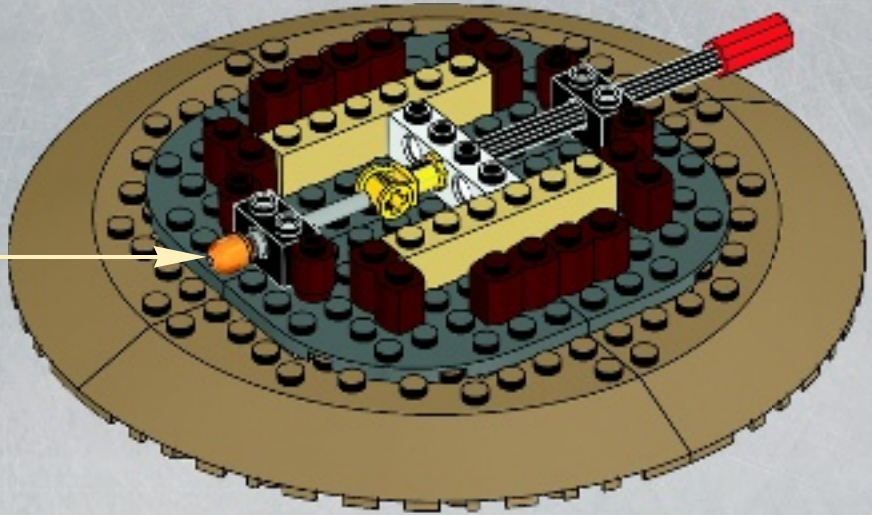
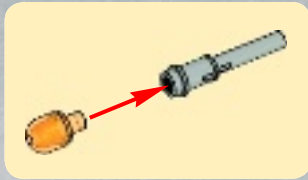

4x



# 12

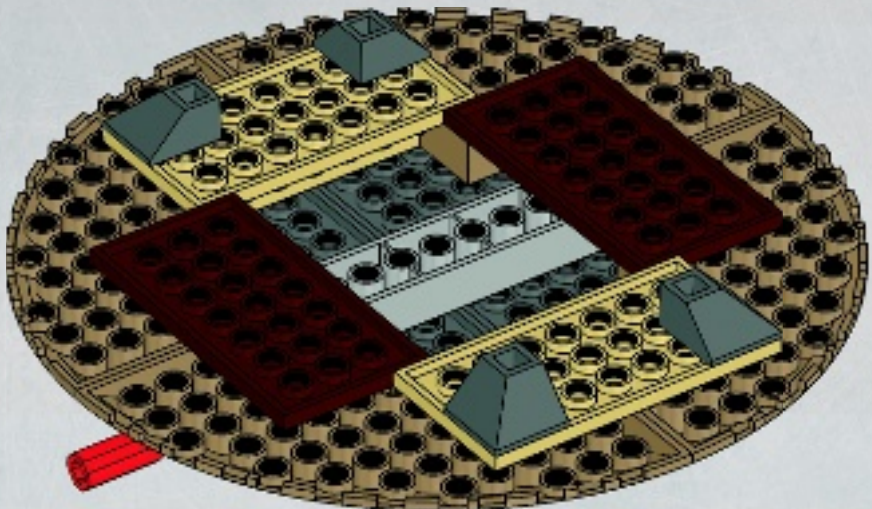

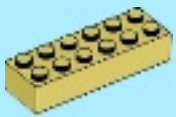

1x



# 13



4x

# 14

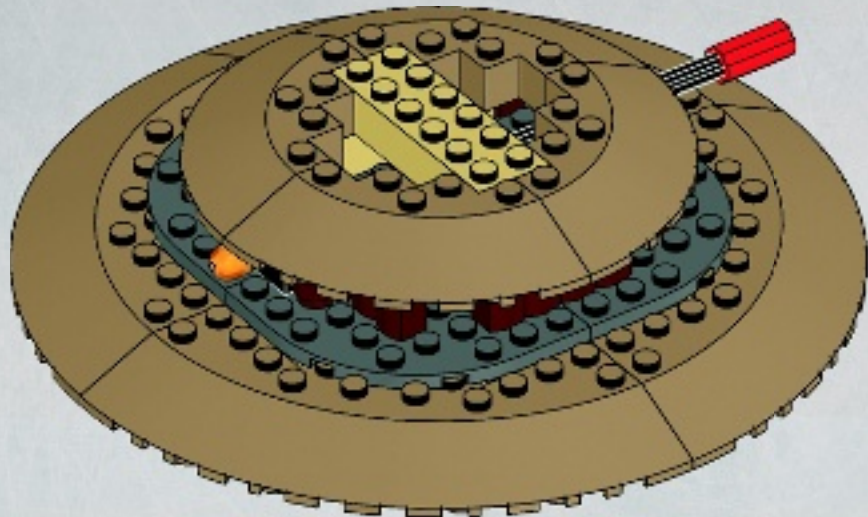



2x

15

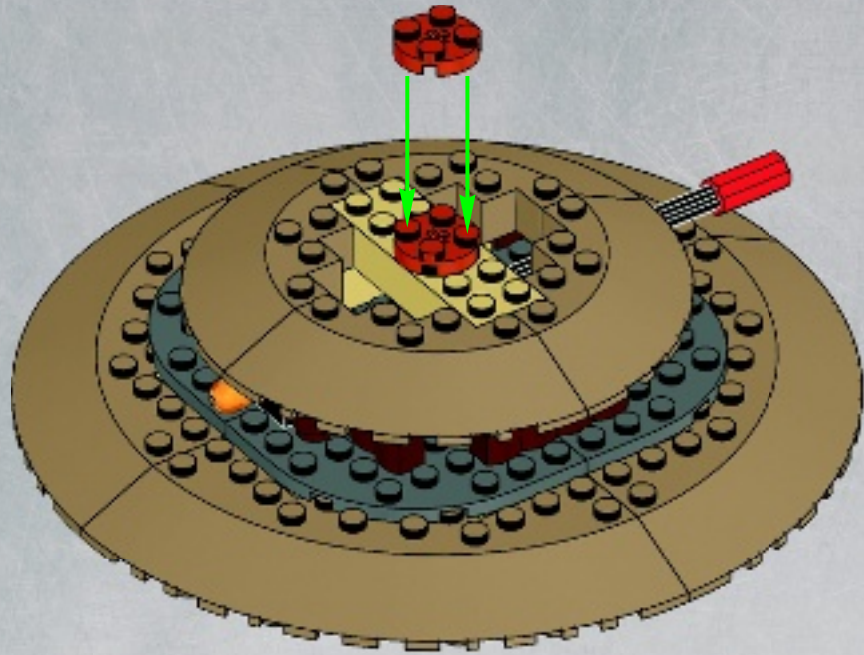

1x



1x

16

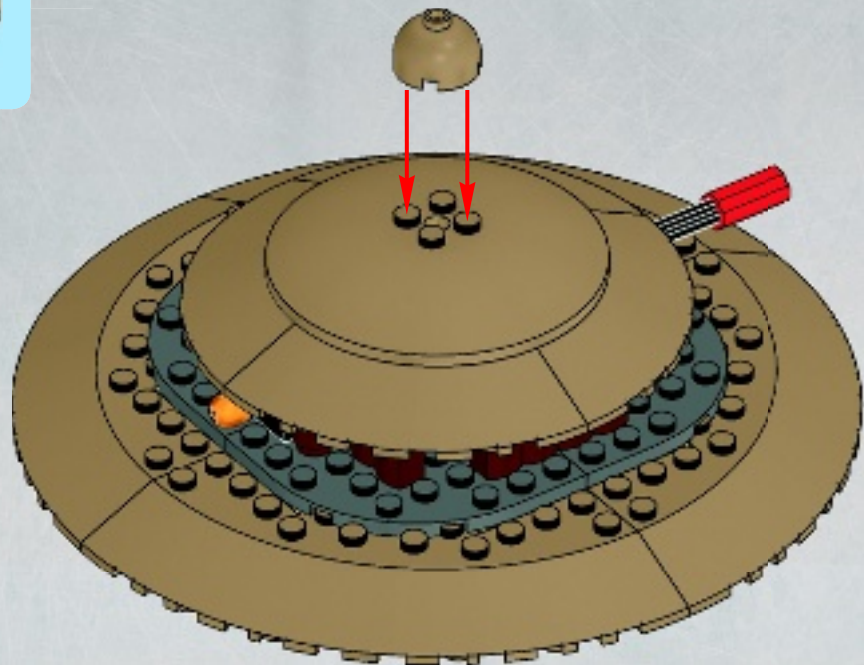

17





18

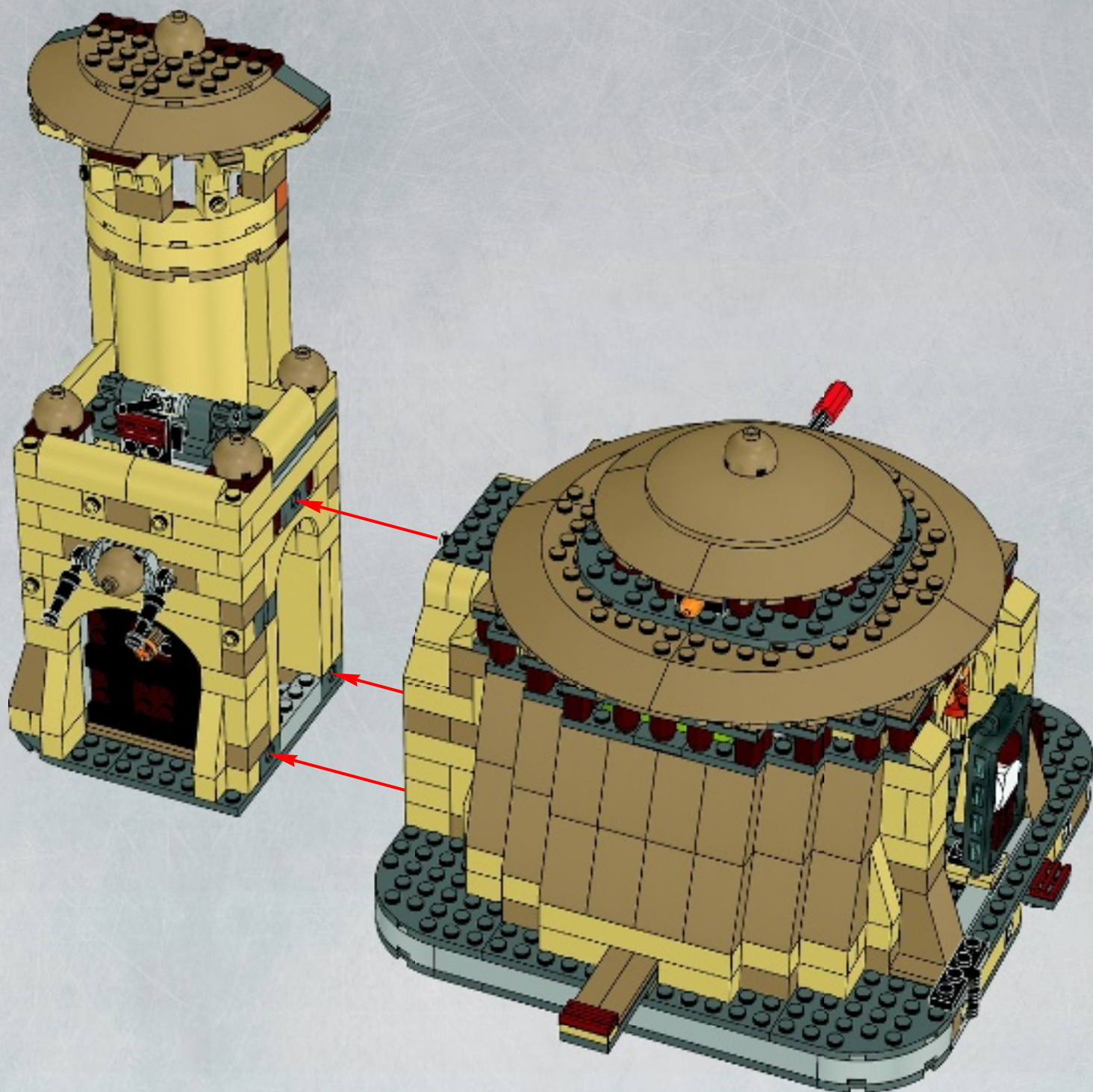





4x 300801



1x 4216652



1x 370101



1x 4584819



3 x 4112980



5x 4159279



5x 4114064



32x 4124455



15x 4162465



6x 4159739



4x 4114319



13x 4112982



1x 4181134



4x 4159774



1x 4141533



2x 4509897



4x 6006805



2x 4159196



4x 4624086



14x 4129996



4x 4114322



6x 4273526



10x 4579306



4x 6019724



10x 4587269



1x 4114073



2x 4596319



8x 4113917



2x 4155708



2x 6006789



22x 4579260



5x 4650647



1x 6006800



1x 6006528



1x 6006530



1x 303521



1x 4513174



2x 4206482



1x 4239601



1x 4107800



8x 265326



2x 370026



1x 302426



1x 371026



1x 4598528



1x 241226



2x 4569733



3x 74011



1x 486526



1x 73587



3x 4538456



2x 4140303



1x 452826



1x 4609050



1x 4498713



1x 4498712



4x 4114206



2x 4289538



5x 4141580



1x 368026



1x 4528331



1x 4107081



3x 4140801



1x 373726



2x 4157270



1x 4106556



1x 4540865



1x 4654448



1x 4620380



1x 6006540



1x 6006564



1x 6006537



1x 6016961



40x 4521914



7x 4255416



6x 4609875



6x 6006804



4x 6006809



2x 4530678



21x 6000852



16x 4496699



7x 4507045

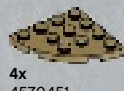

4x 4570451



1x 6006808



1x 4566927

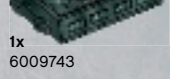

1x 6009743



3x 4541506



1x 4567338



10x 4222960



1x 4524365



1x 4286789



1x 4262974



16x 4211180



23x 4211183



4x 4211195



2x 6012805



5x 4216695



1x 4211189



4x 4211190



1x 4211247



2x 4216945



1x 4271874

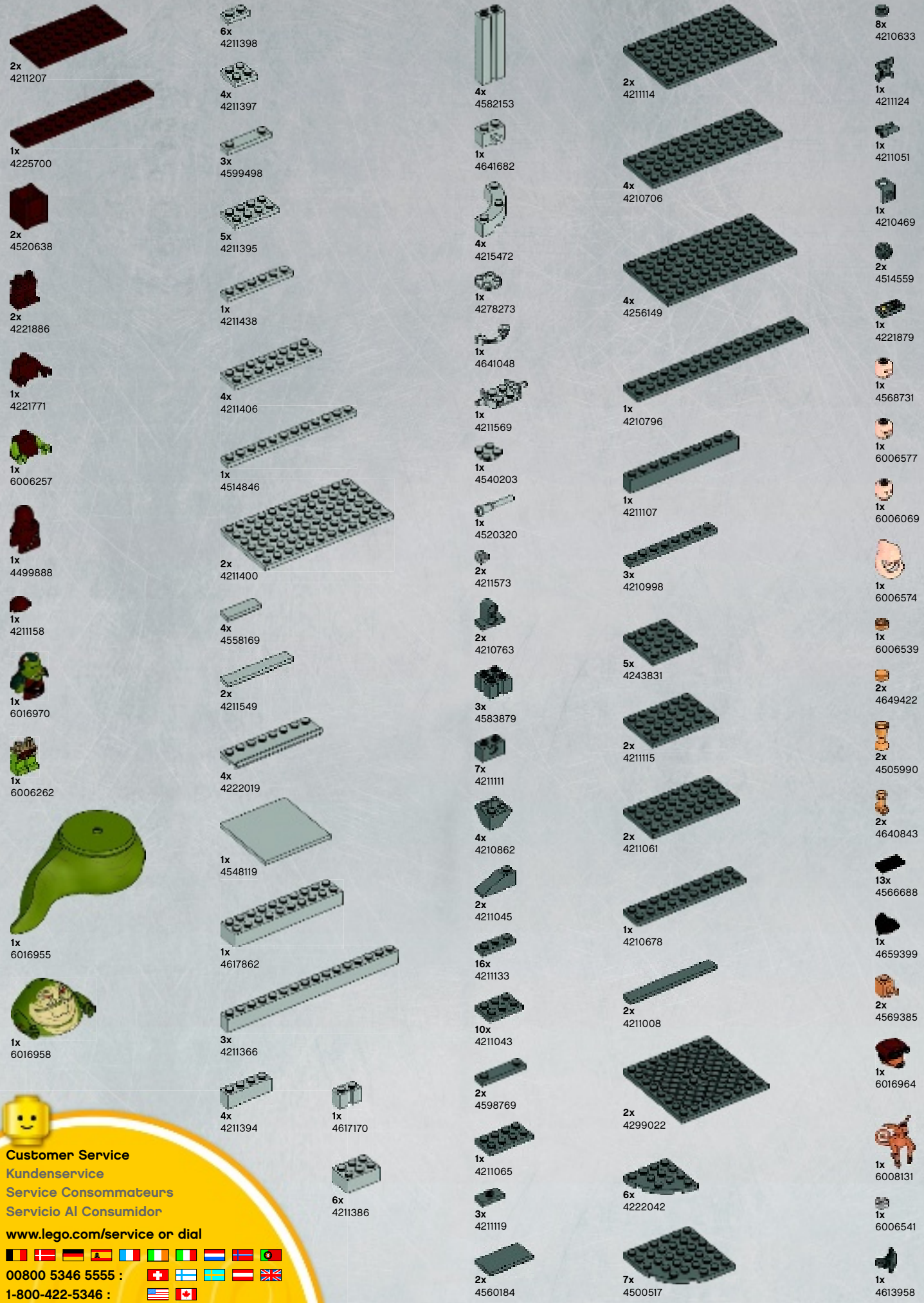

2x  
4211207

1x  
4225700

2x  
4520638

2x  
4221886

1x  
4221771

1x  
6006257

1x  
4499888

1x  
4211158

1x  
6016970

1x  
6006262

1x  
6016955

1x  
6016958

6x  
4211398

4x  
4211397

3x  
4599498

5x  
4211395

1x  
4211438

4x  
4211406

1x  
4514846

2x  
4211400

4x  
4558169

2x  
4211549

4x  
4222019

1x  
4548119

1x  
4617862

3x  
4211366

4x  
4211394

1x  
4617170

6x  
4211386

4x  
4582153

1x  
4641682

4x  
4215472

1x  
4278273

1x  
4641048

1x  
4211569

1x  
4540203

1x  
4520320

2x  
4211573

2x  
4210763

3x  
4583879

7x  
4211111

4x  
4210862

2x  
4211045

16x  
4211133

10x  
4211043

2x  
4598769

1x  
4211065

3x  
4211119

2x  
4560184

2x  
4211114

4x  
4210706

4x  
4256149

1x  
4210796

1x  
4211107

3x  
4210998

5x  
4243831

2x  
4211115

2x  
4211061

1x  
4210678

2x  
4211008

2x  
4299022

6x  
4222042

7x  
4500517

8x  
4210633

1x  
4211124

1x  
4211051

1x  
4210469

2x  
4514559

1x  
4221879

1x  
4568731

1x  
6006577

1x  
6006069

1x  
6006574

1x  
6006539

2x  
4649422

2x  
4505990

2x  
4640843

13x  
4566688

1x  
4659399

2x  
4569385

1x  
6016964

1x  
6008131

1x  
6006541



1x  
4613958

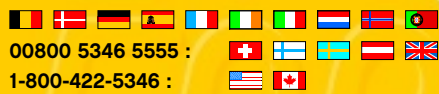

**Customer Service**  
**Kundenservice**  
**Service Consommateurs**  
**Servicio Al Consumidor**

[www.lego.com/service](http://www.lego.com/service) or dial



00800 5346 5555 :    

1-800-422-5346 :  



JABBA THE HUTT™



HAN SOLO™



HAN IN CARBONITE™



B'OMARR MONK™



BIB FORTUNA™



GAMORREAN GUARD™



CHEWBACCA™



OOLA™



BOUSHH™



SALACIOUS B. CRUMB™

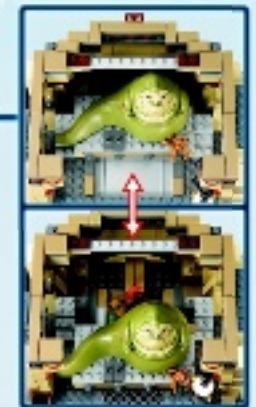



1



club™

FREE\*! GRATIS! GRATUIT!

www.LEGOclub.com/Max

2



3



©2012 The LEGO Group.

\*Paid subscription in Australia and New Zealand.  
\*Abonnement payant en Australie et Nouvelle-Zélande.



# WIN!

Go to [www.LEGOsurvey.com/product](http://www.LEGOsurvey.com/product) to fill out a survey for a chance to win a cool LEGO® Product.

No purchase necessary.

Open to all residents where not prohibited.



[www.LEGO.com](http://www.LEGO.com)



## [www.LEGOsurvey.com/product](http://www.LEGOsurvey.com/product)

### GEWINNE!

Nimm an der Umfrage auf [www.LEGOsurvey.com/product](http://www.LEGOsurvey.com/product) teil und hab die Chance ein cooles LEGO® Produkt zu gewinnen!

Die Teilnahme am Gewinnspiel führt zu keinerlei Kaufverpflichtungen. Teilnahme in allen nicht ausgeschlossenen Ländern möglich.

### WIN!

Ga naar [www.LEGOsurvey.com/product](http://www.LEGOsurvey.com/product), vul een enquêteformulier in en maak kans op een cool LEGO® product.

Geen aankoopverplichting. Iedereen mag deelnemen, uitgezonderd ingezetenden van landen waar een enquêteverbod geldt.

### GAGNE!

Visite [www.LEGOsurvey.com/product](http://www.LEGOsurvey.com/product) pour répondre à un questionnaire et avoir une chance de gagner un produit LEGO® très cool!

Aucune obligation d'achat. Ouvert à tous les résidents des pays autorisés.

### 当てよう!

[www.LEGOsurvey.com/product](http://www.LEGOsurvey.com/product) にアクセスして、アンケートにご記入ください。当選者にはレゴ®製品を差し上げます。

お買い上げの必要はありません。禁止されていない限り、すべての皆様にご利用いただけます。