



**STAR
WAR**

TM



9515



1

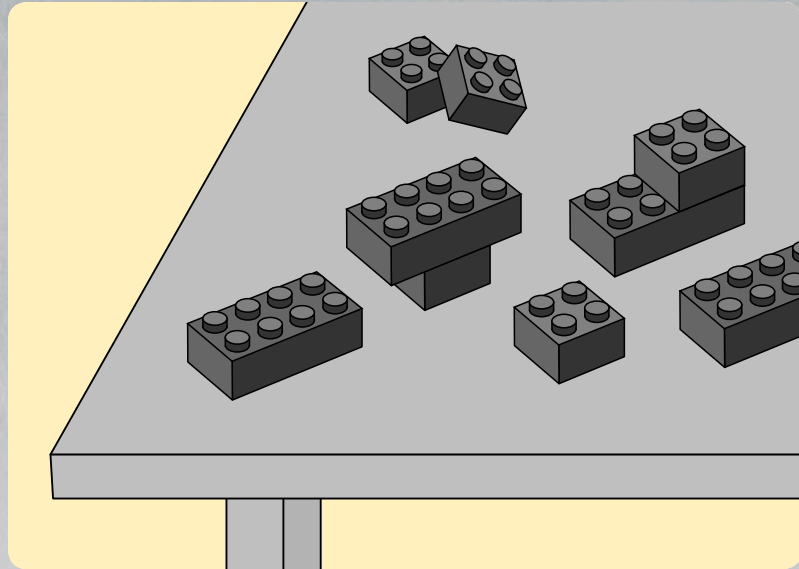
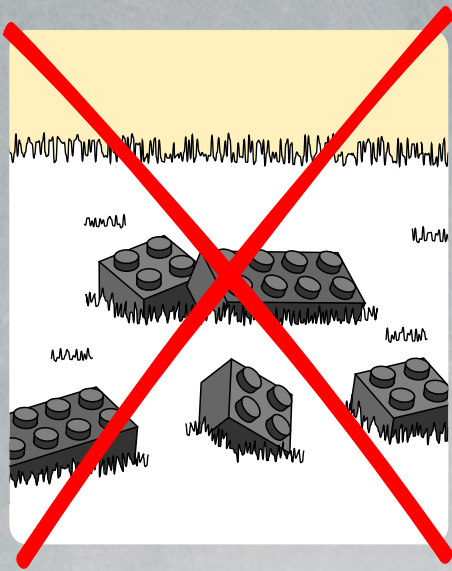

2

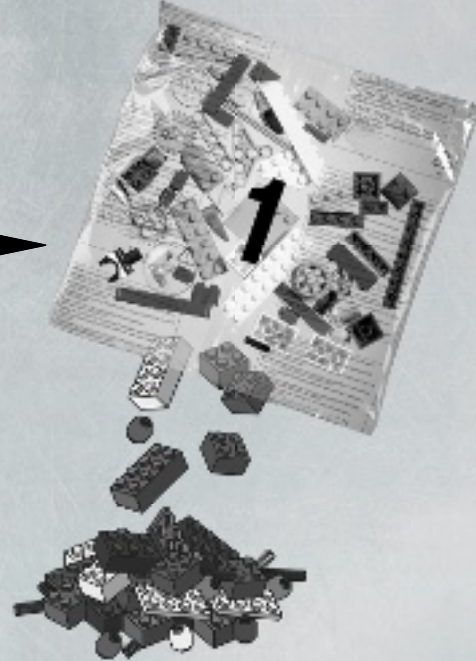

<http://lego.com/brickseparator>

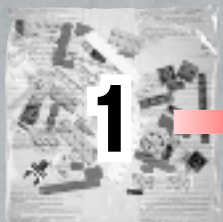

1

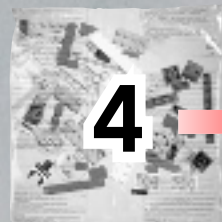

4

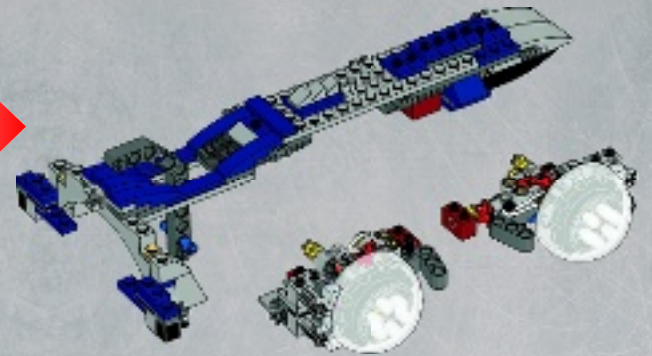
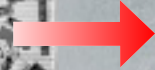

2

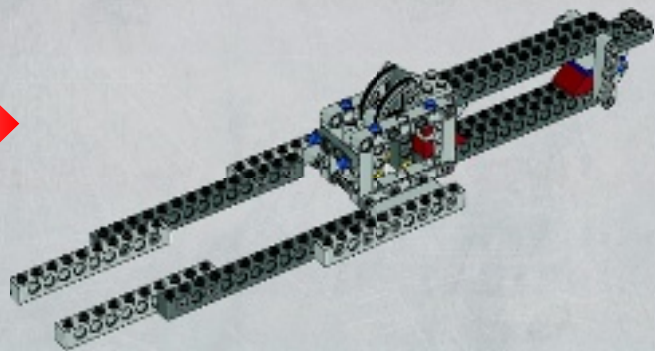

5

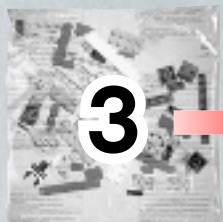
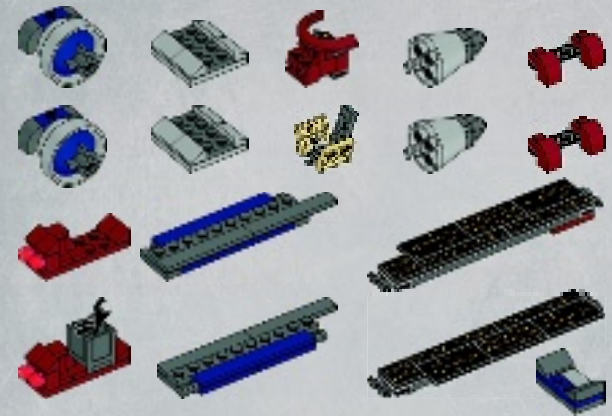

3

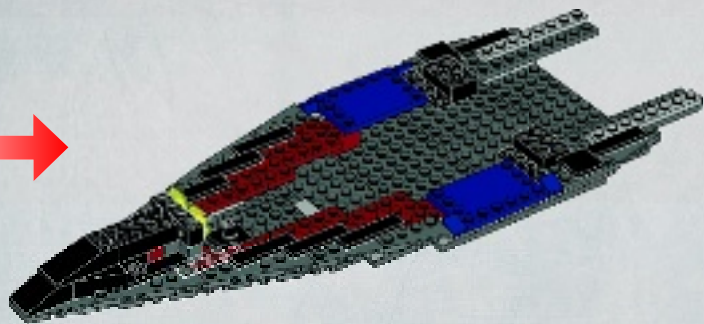
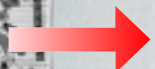

6

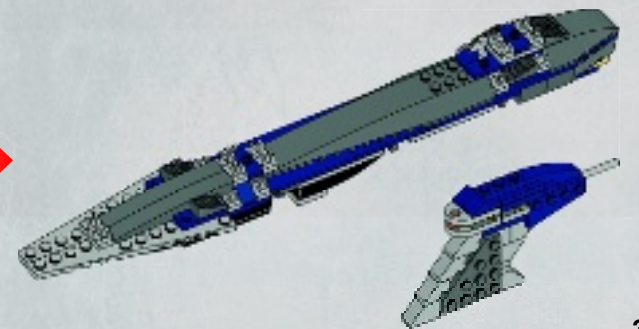

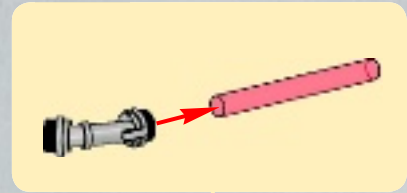
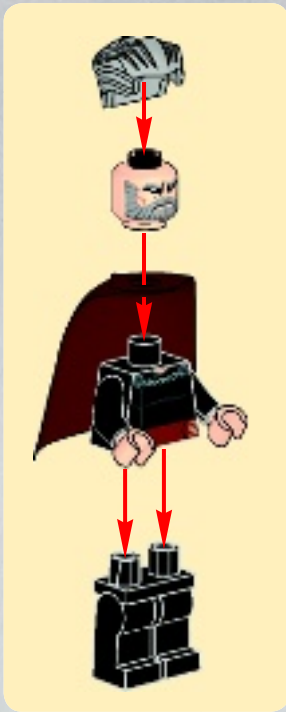
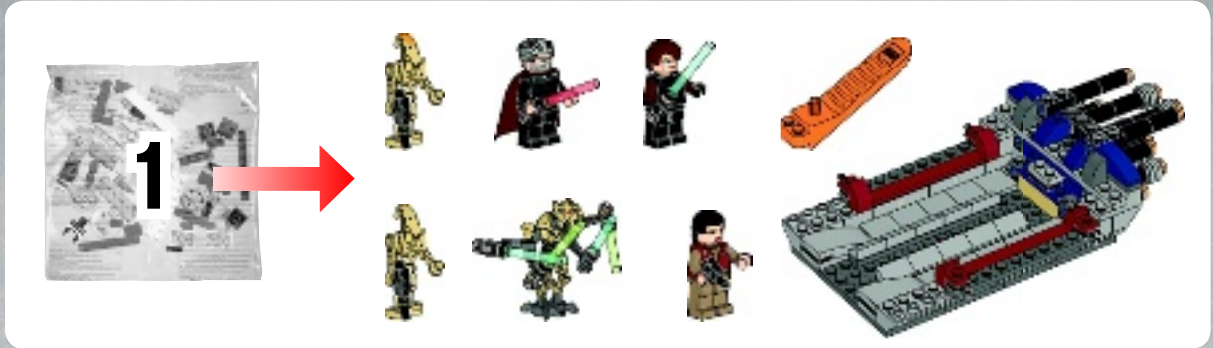
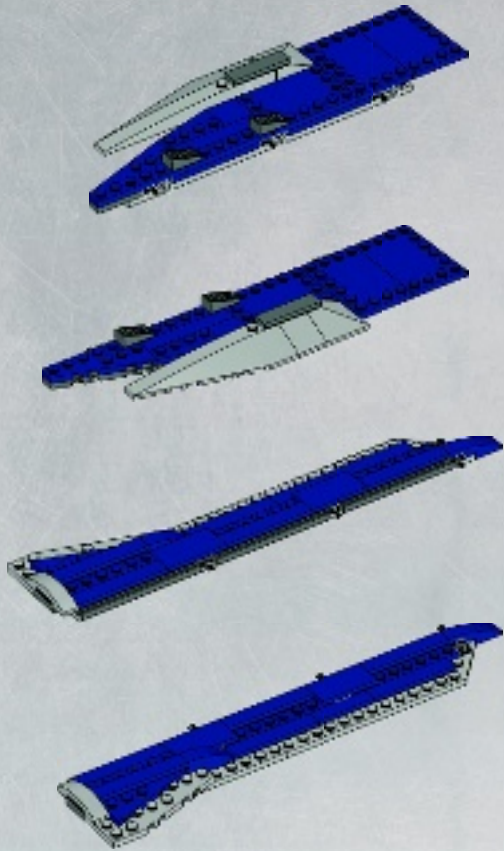

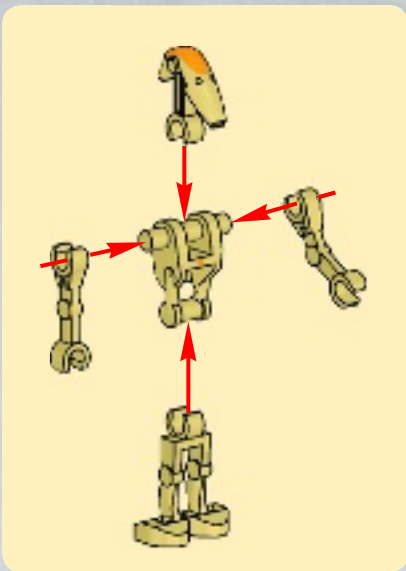
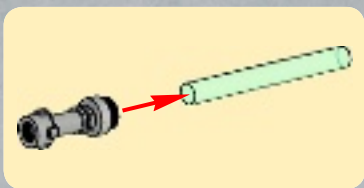

1



2

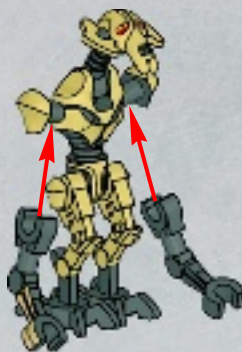

3

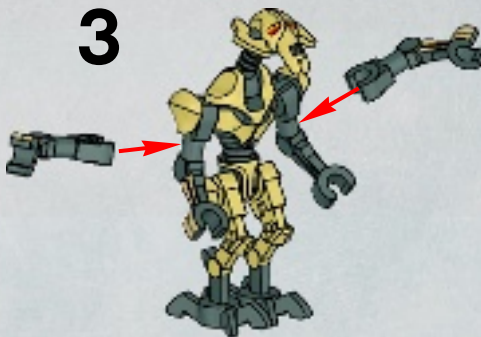

4

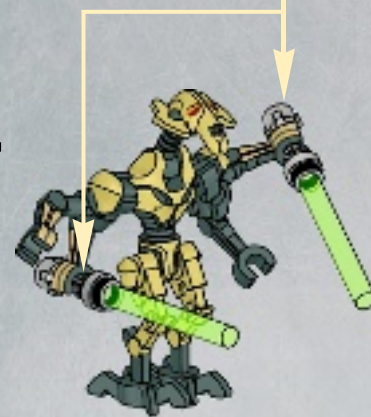
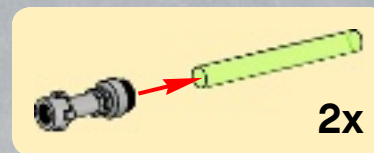

5

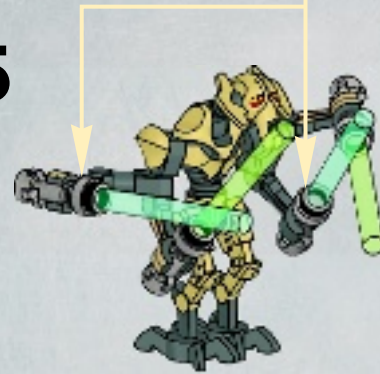
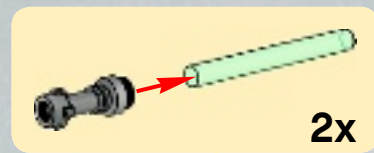



1x

1

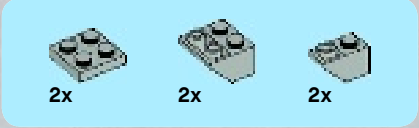

2x

2x

2x

2

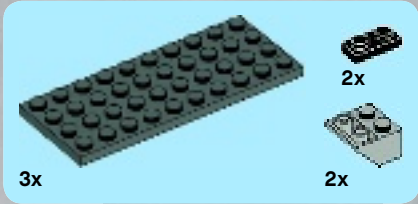
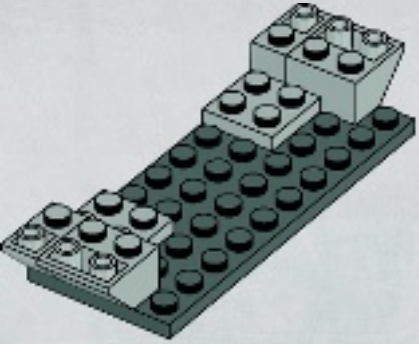

3x

2x

2x

3

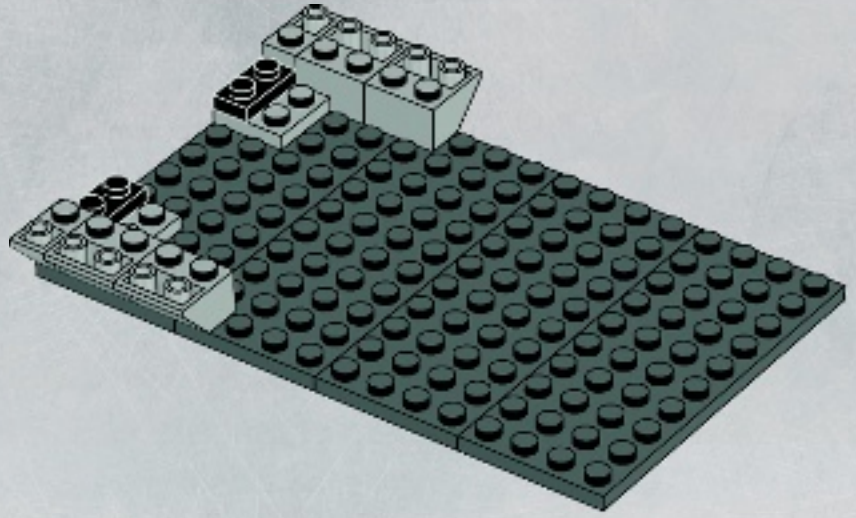

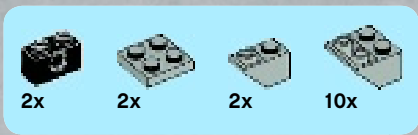

4

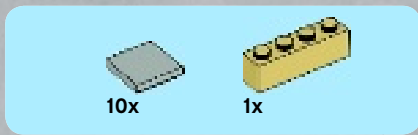
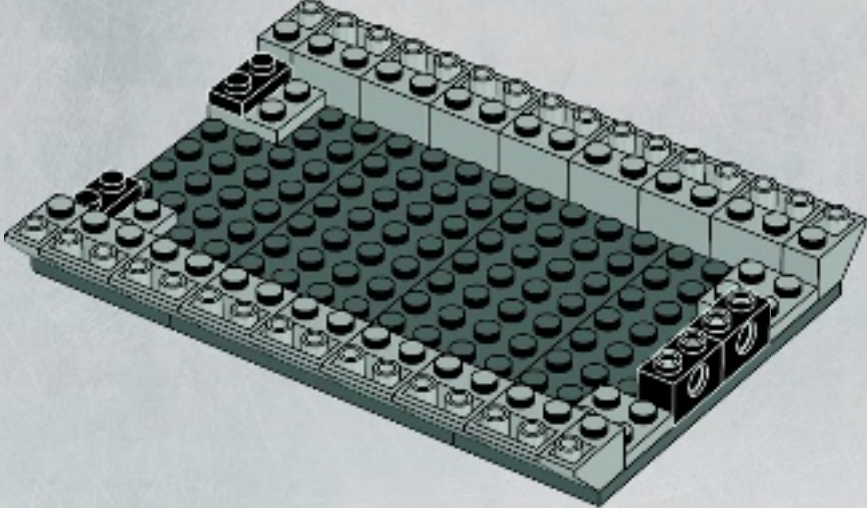

5

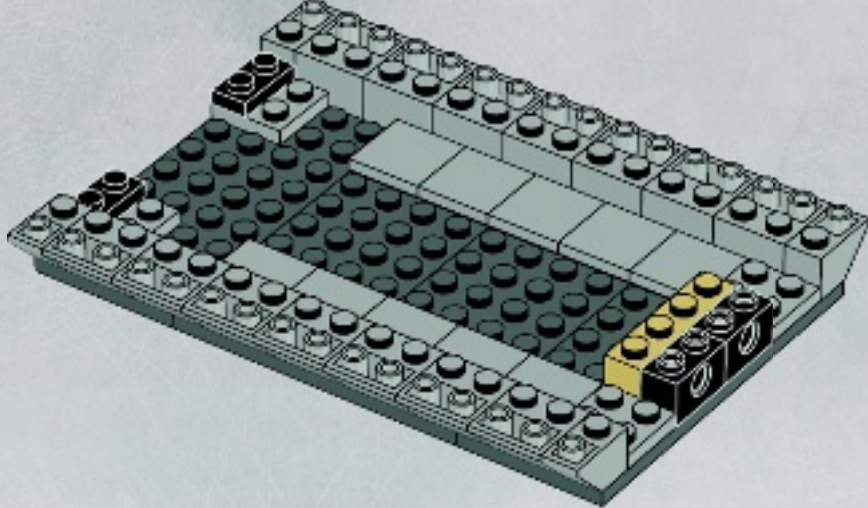



4x



2x



2x

6

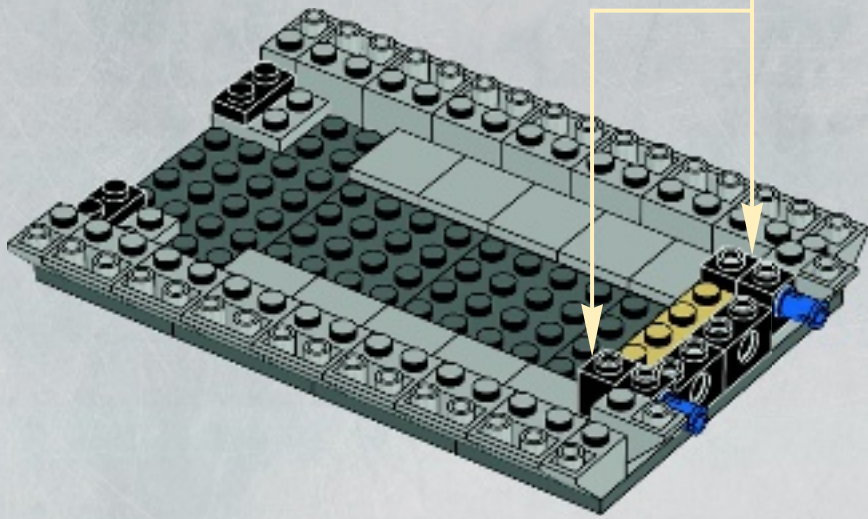
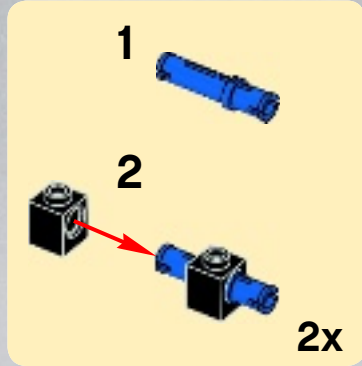

2x



2x



2x

7

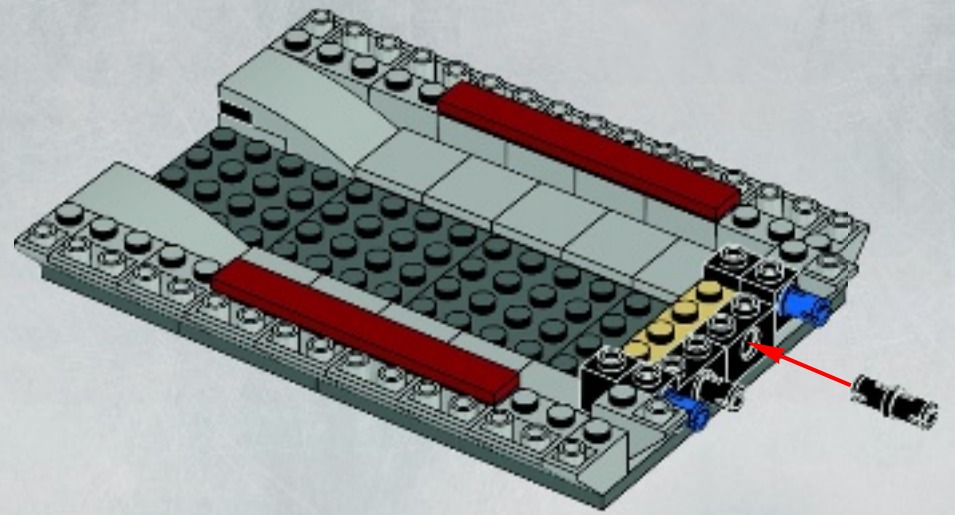

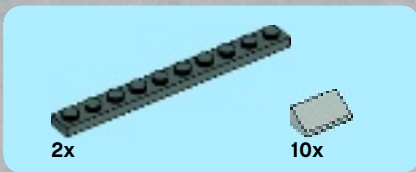

8

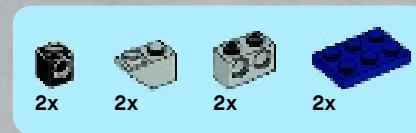
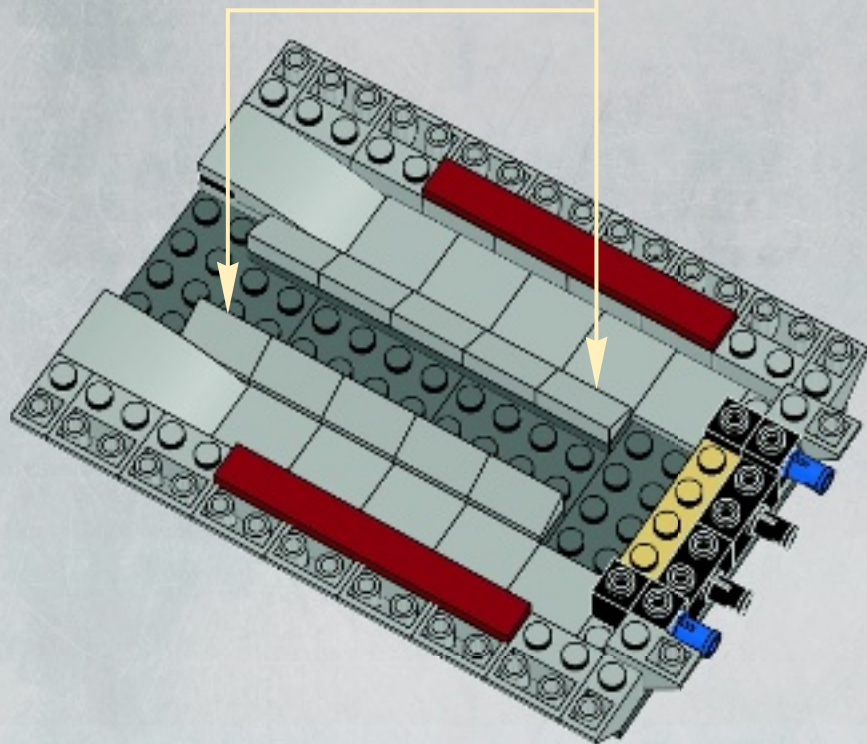
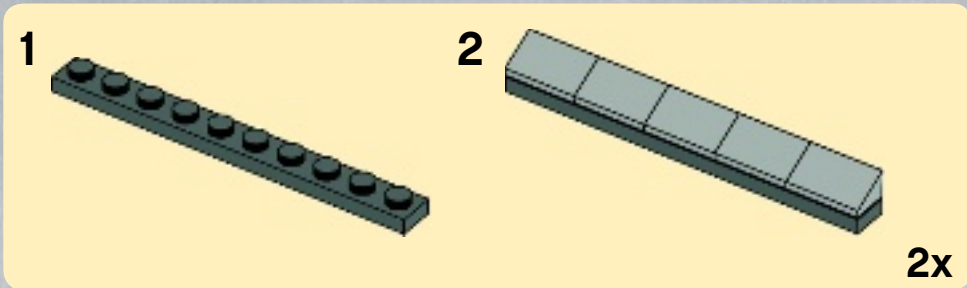

9

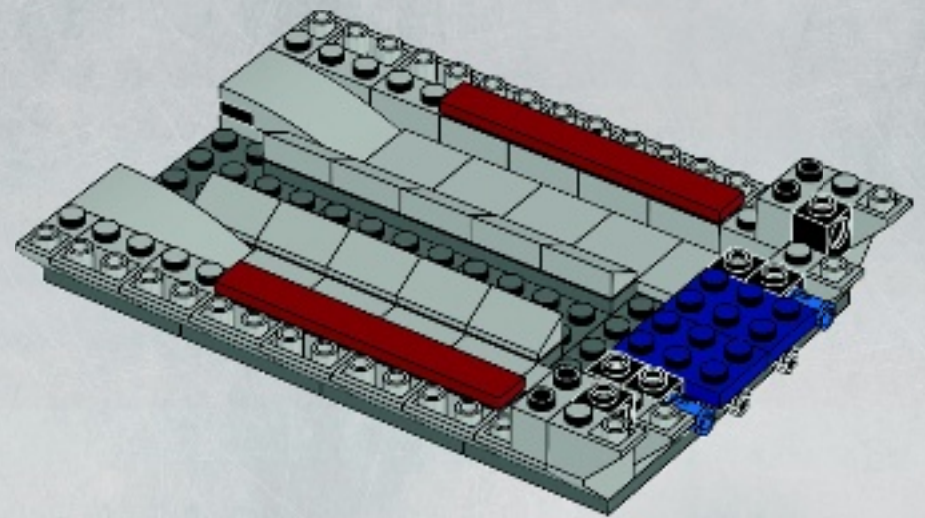

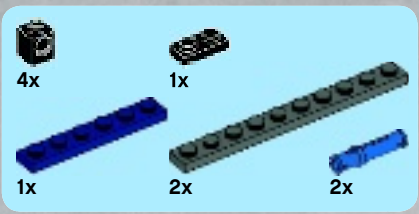

10

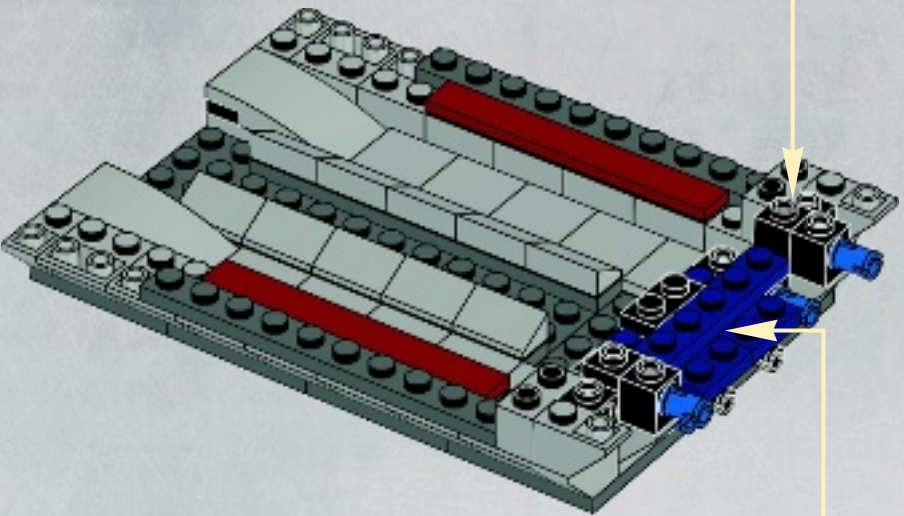
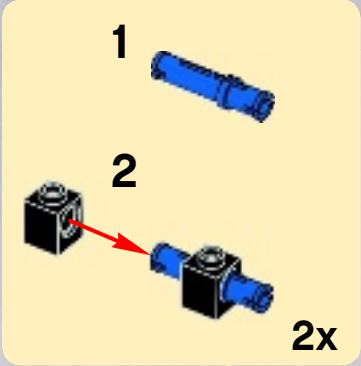

11

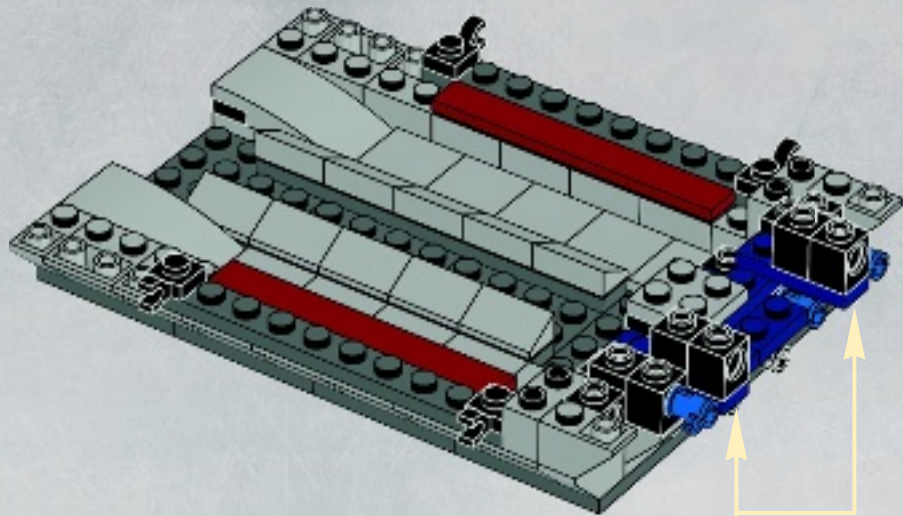
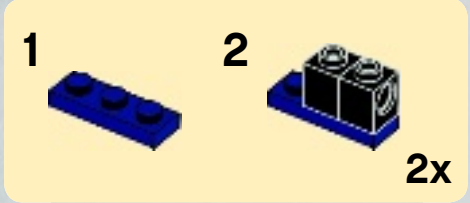



12

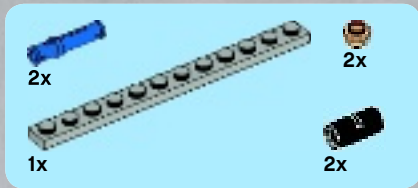
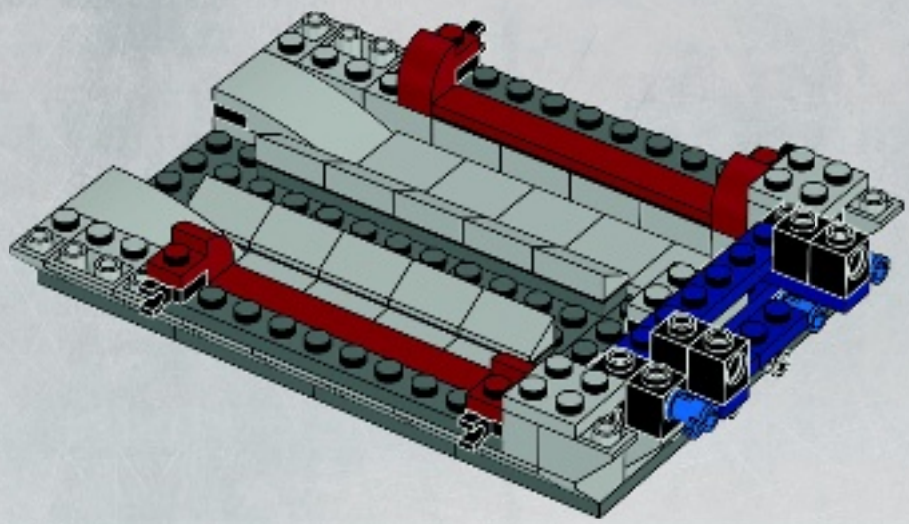

13

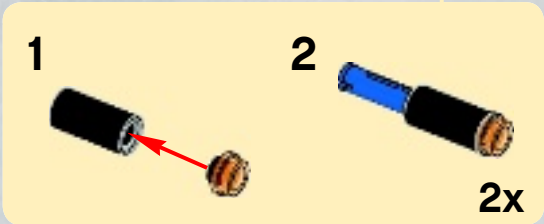
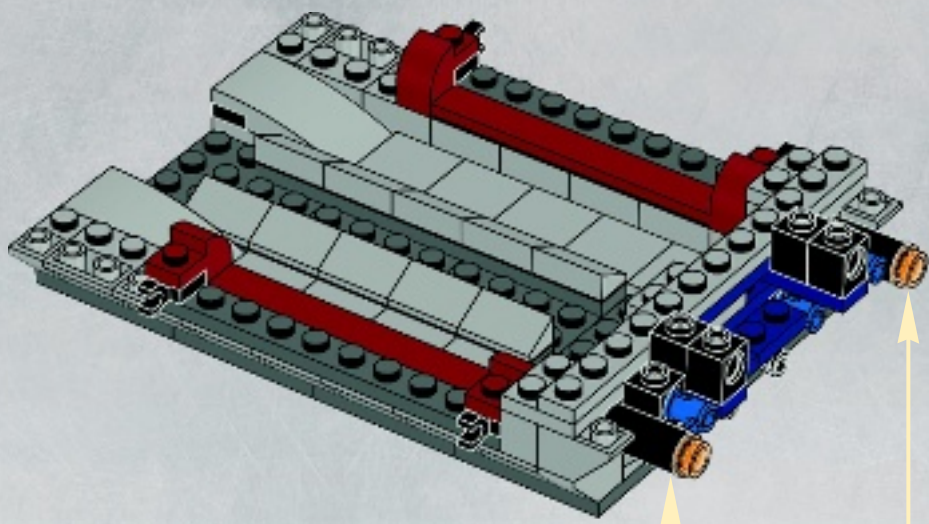

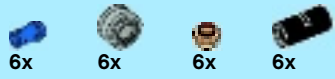

14

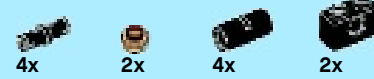
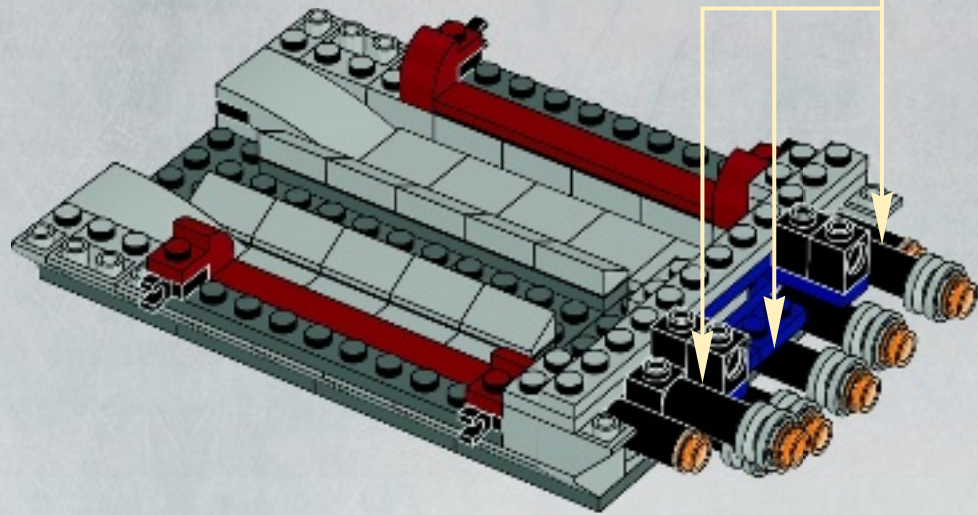
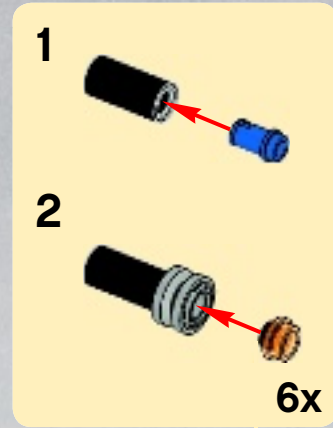

15

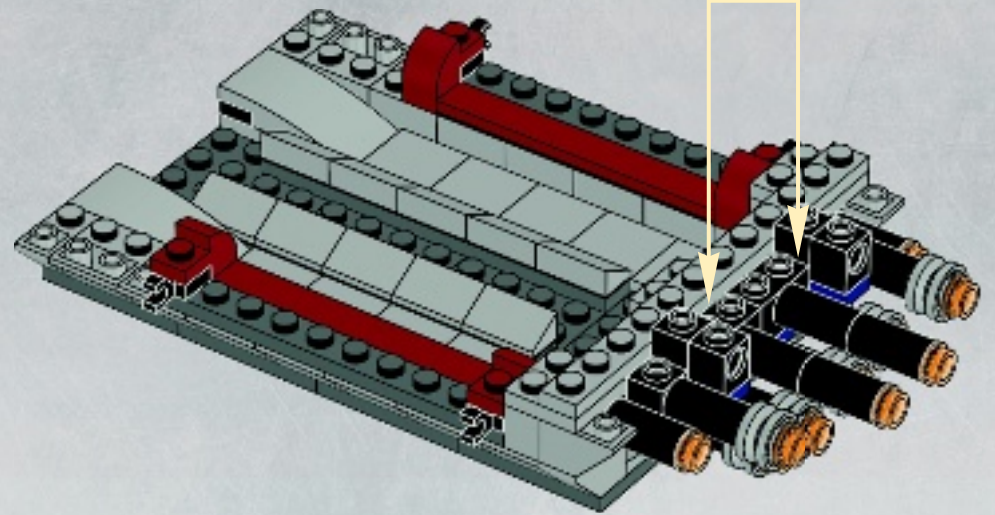
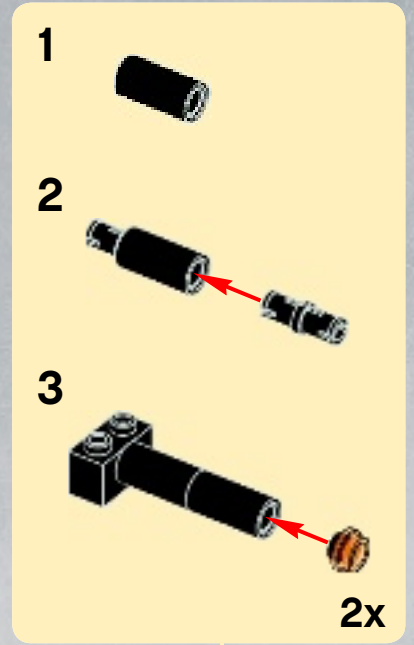



16

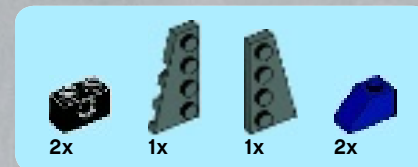
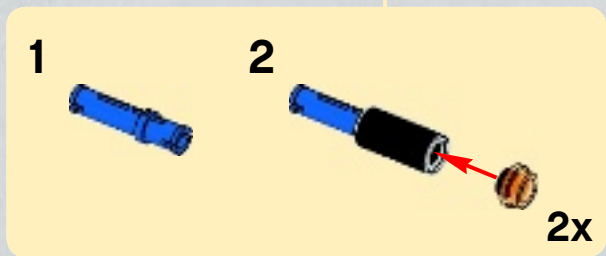
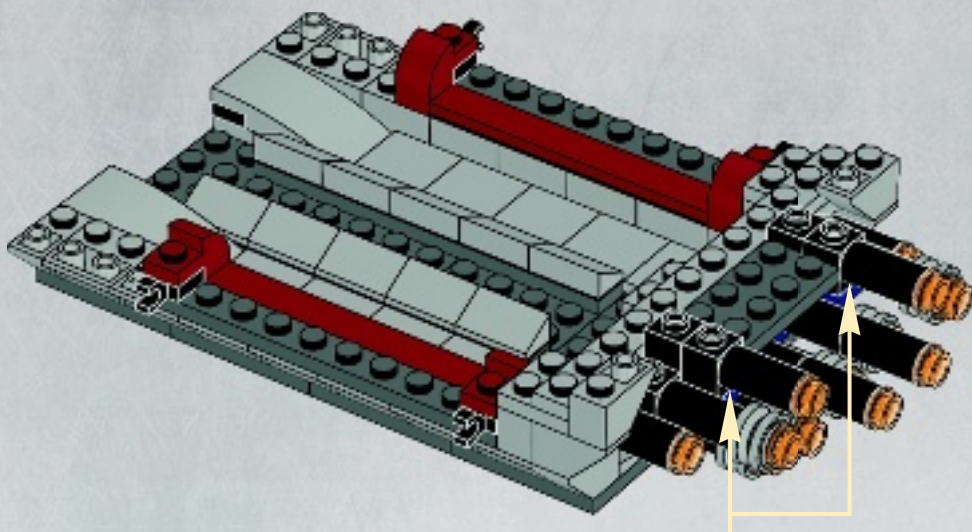

17

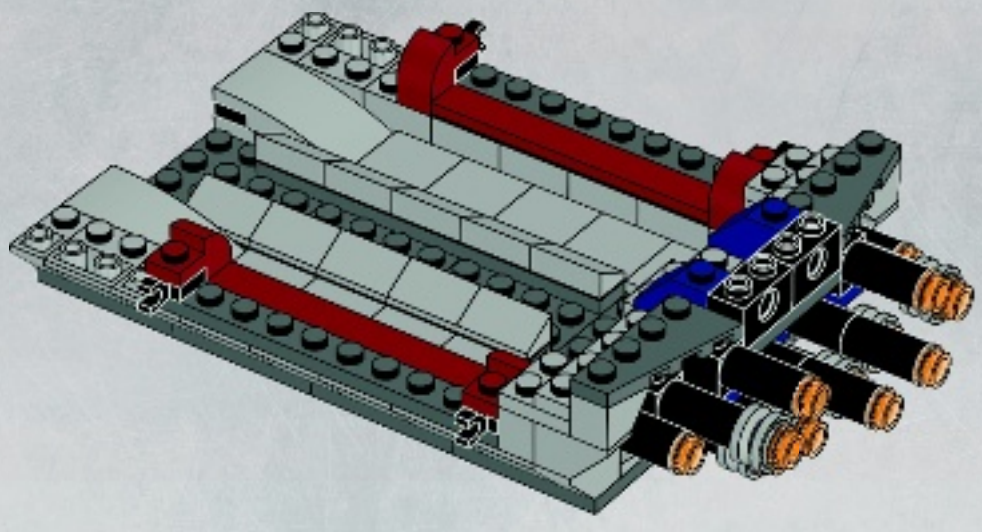

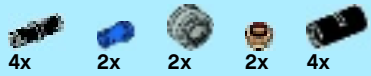

18

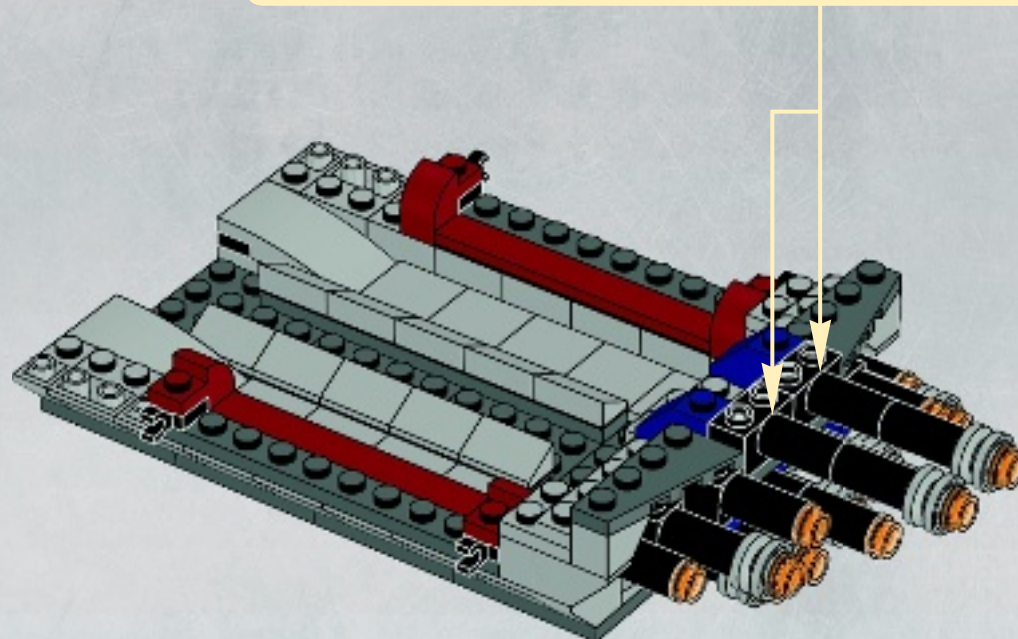
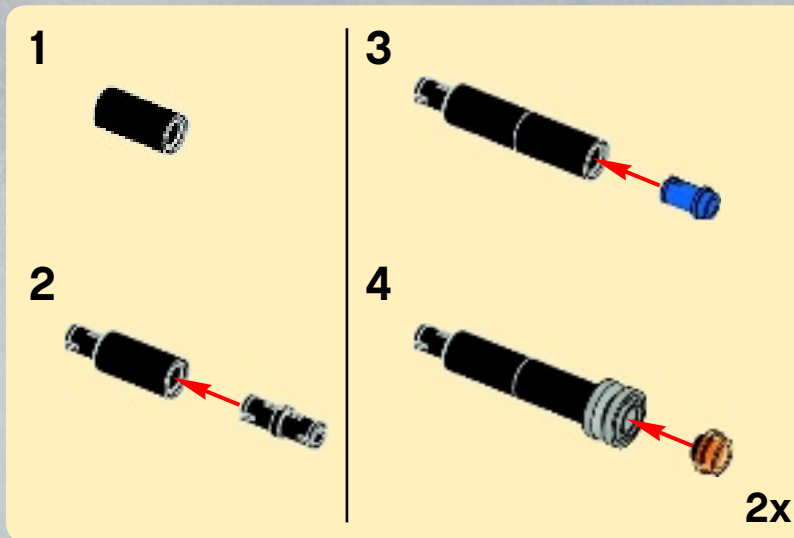



4x



2x



2x



2x



4x

19

1



2



3

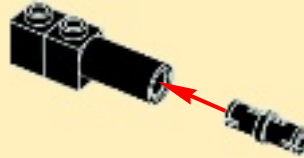

4

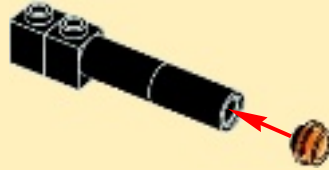

2x

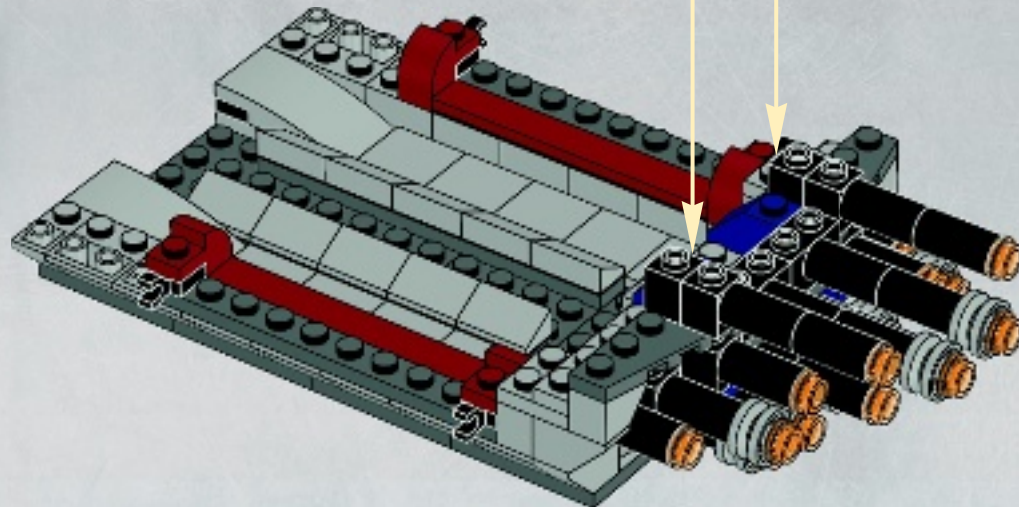



2x



2x

20

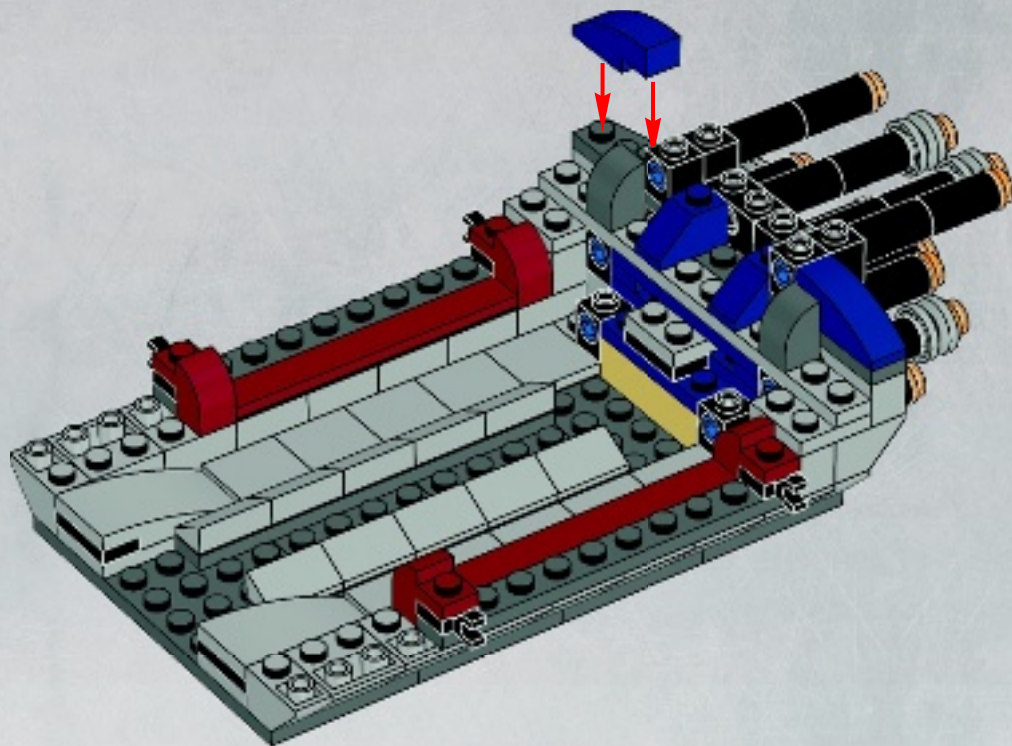

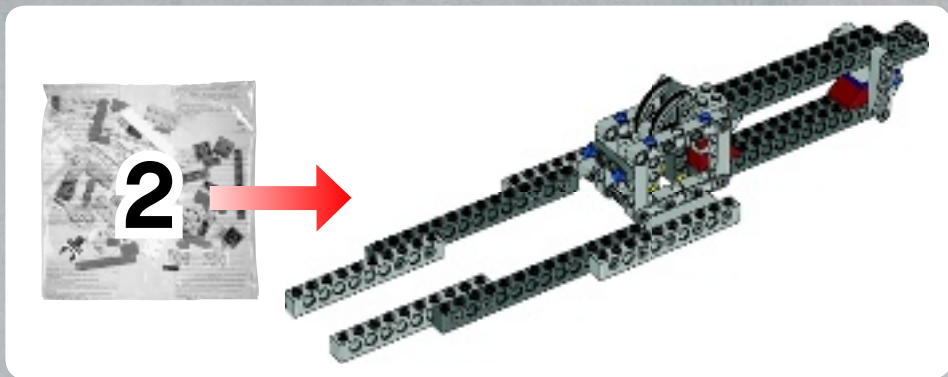

1

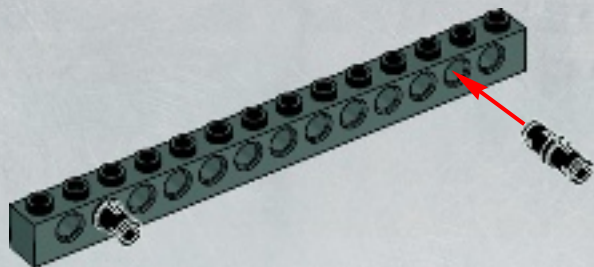

2

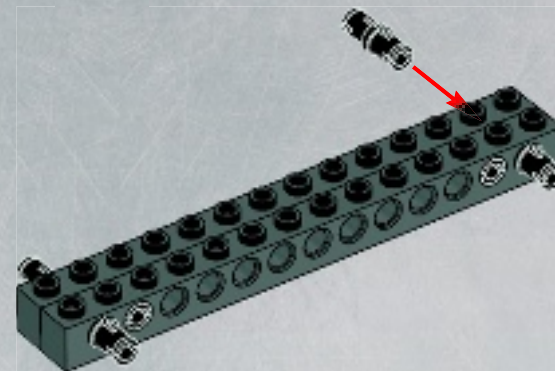

3

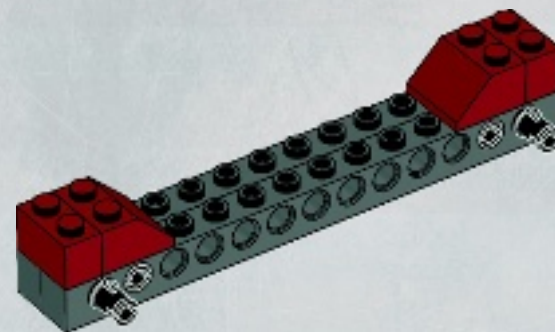



1x



1x

4

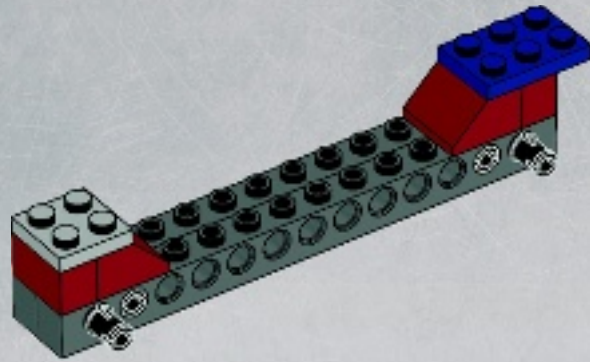

1x



2x



1x

5

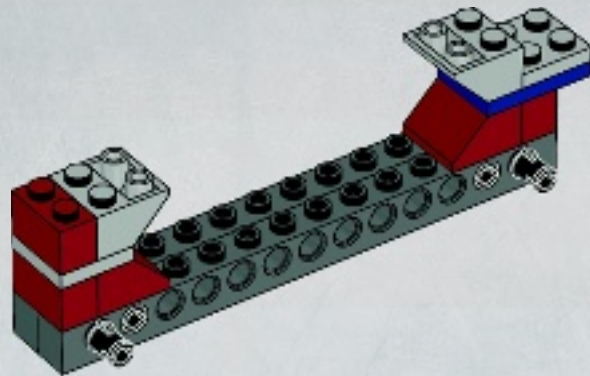

1x



2x

6

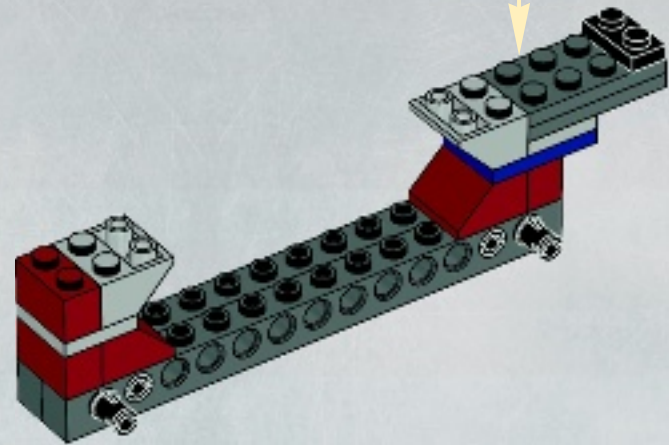
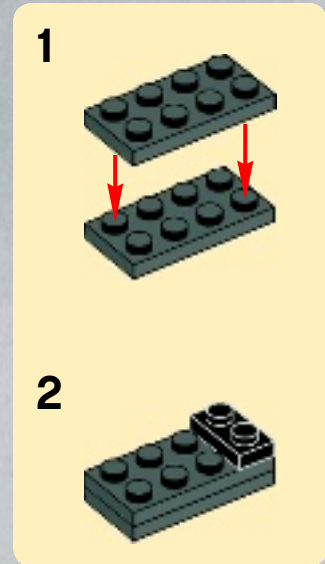



7

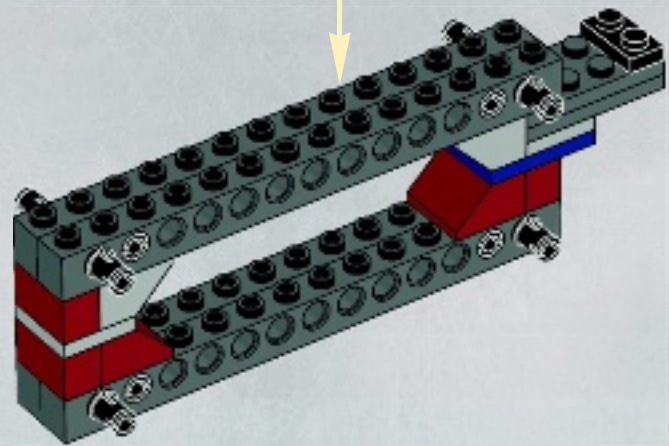
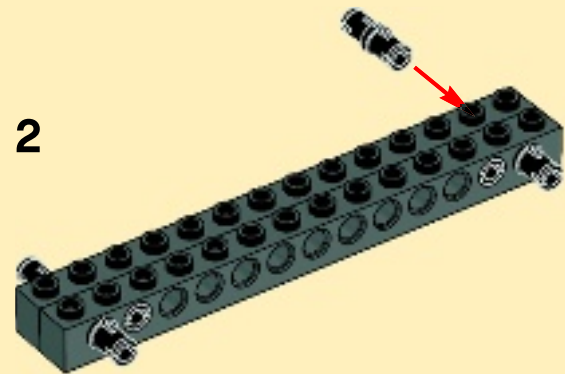
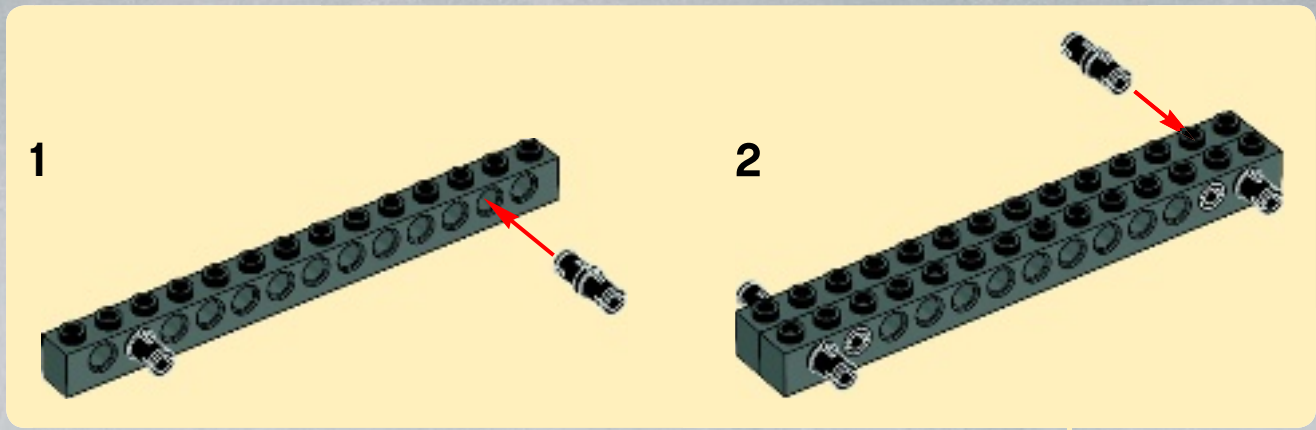

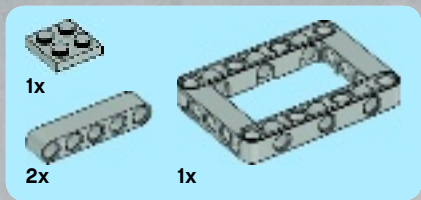

8

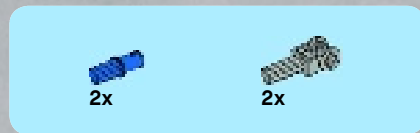
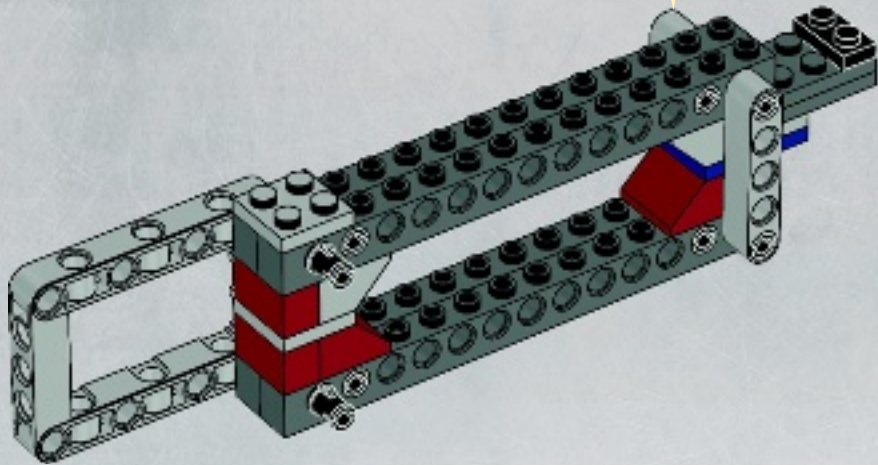
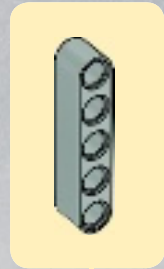

9

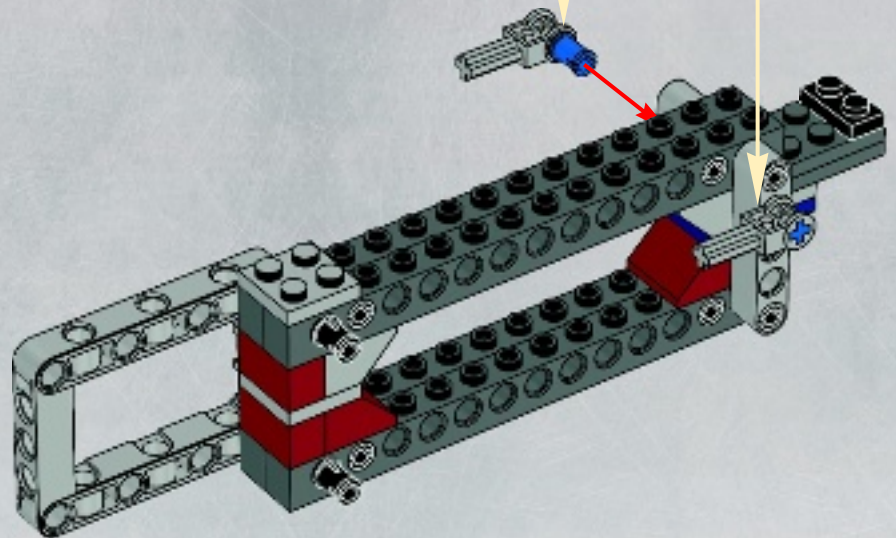
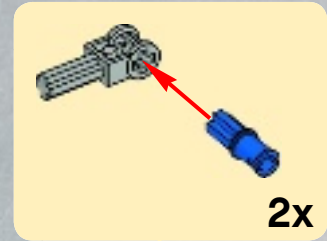

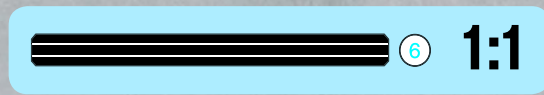
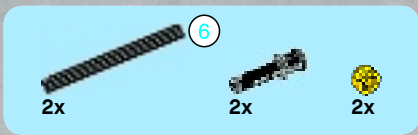

10

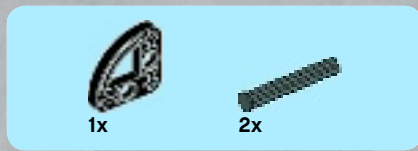
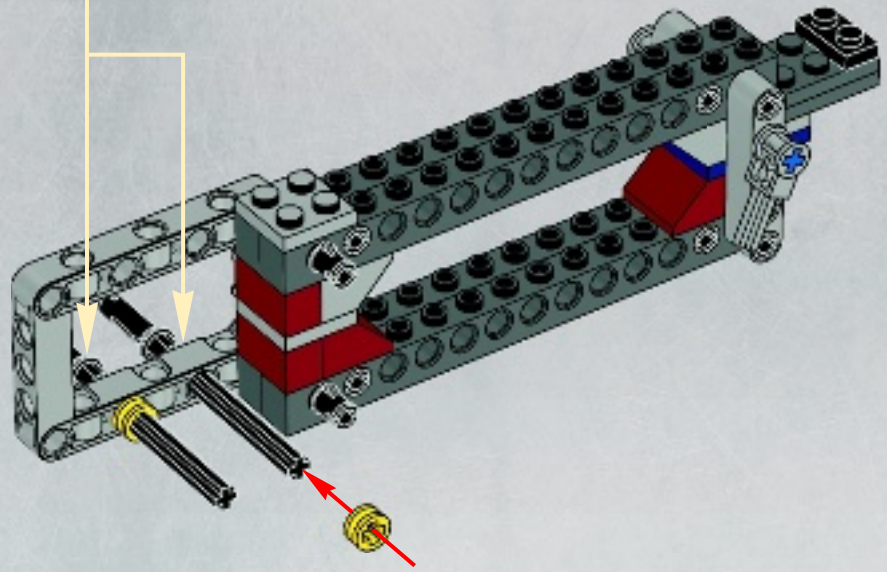
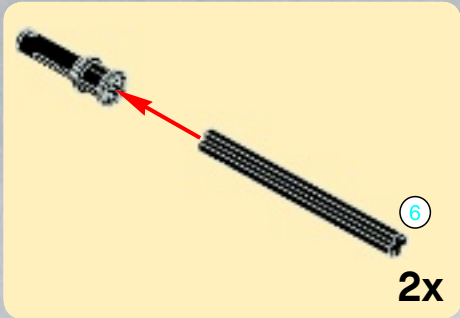

11

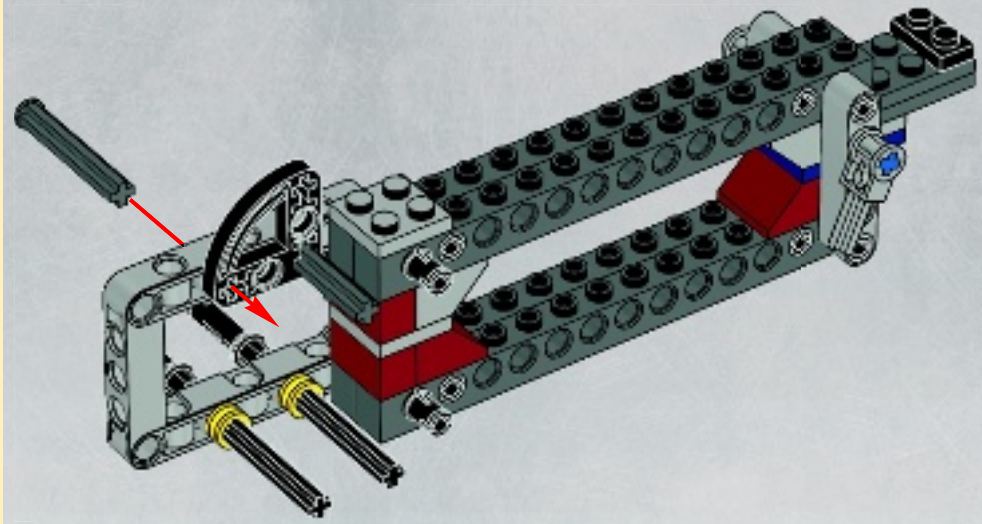

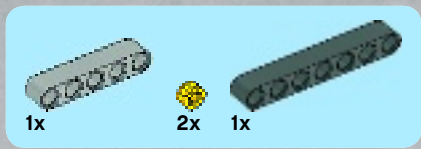

12

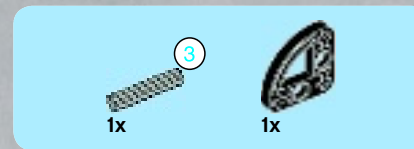
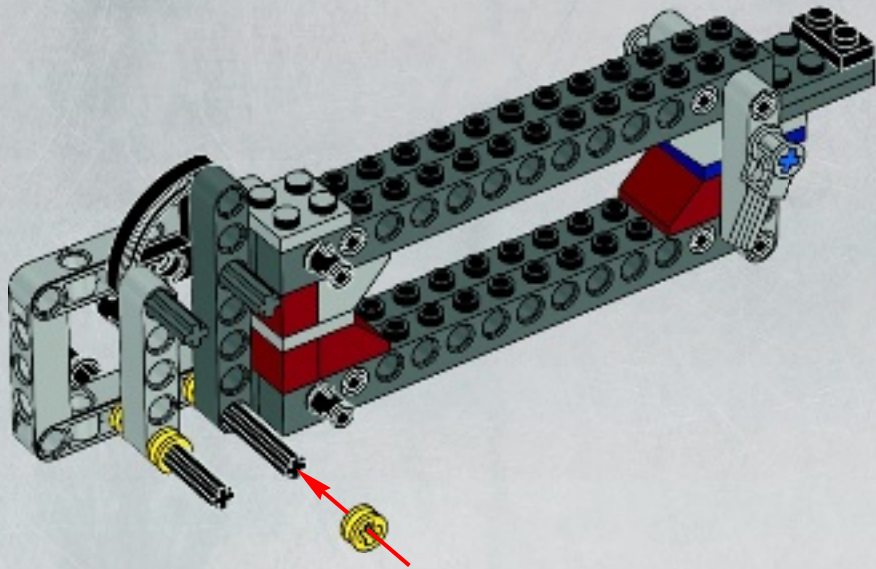

13

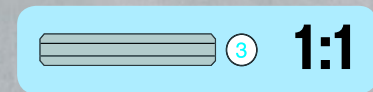
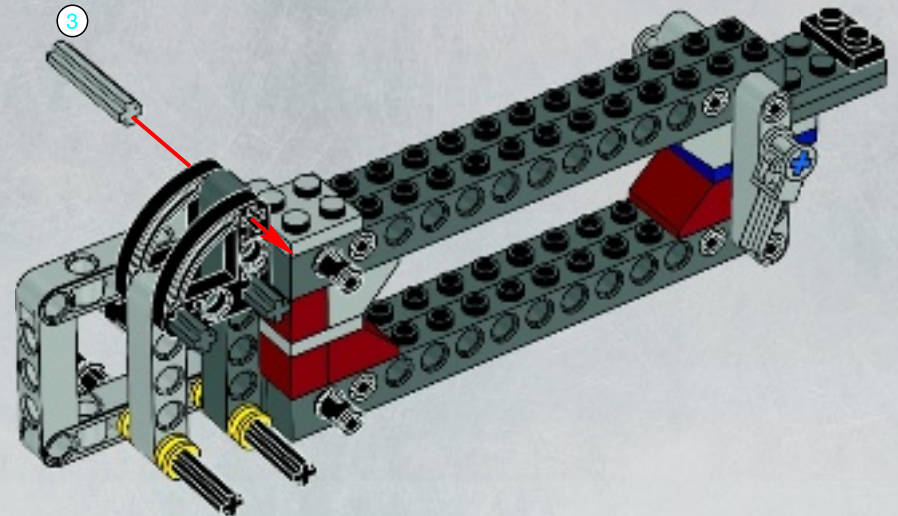

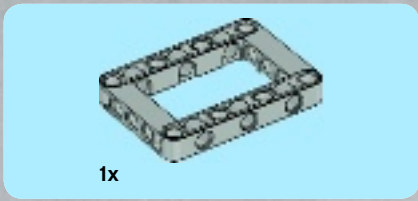

14

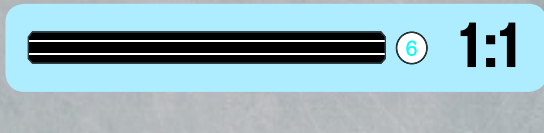
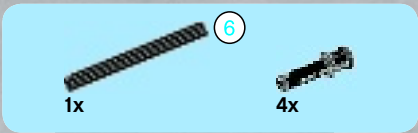
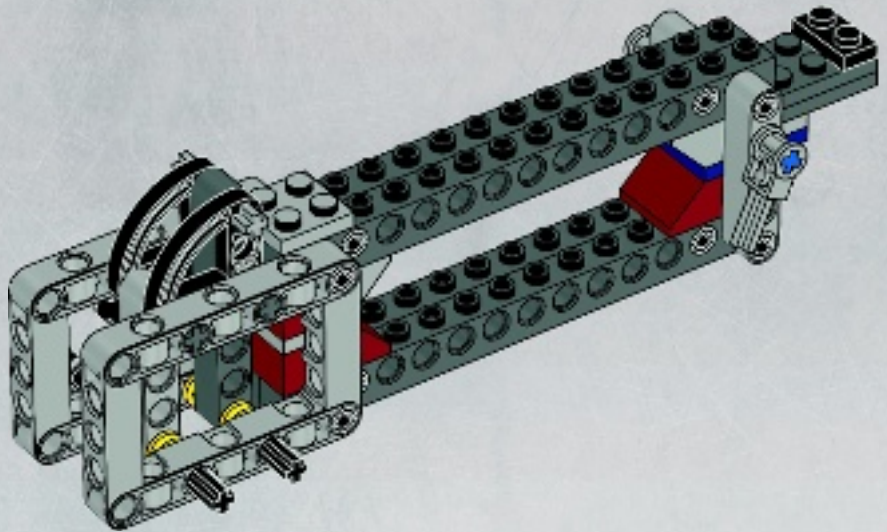

15

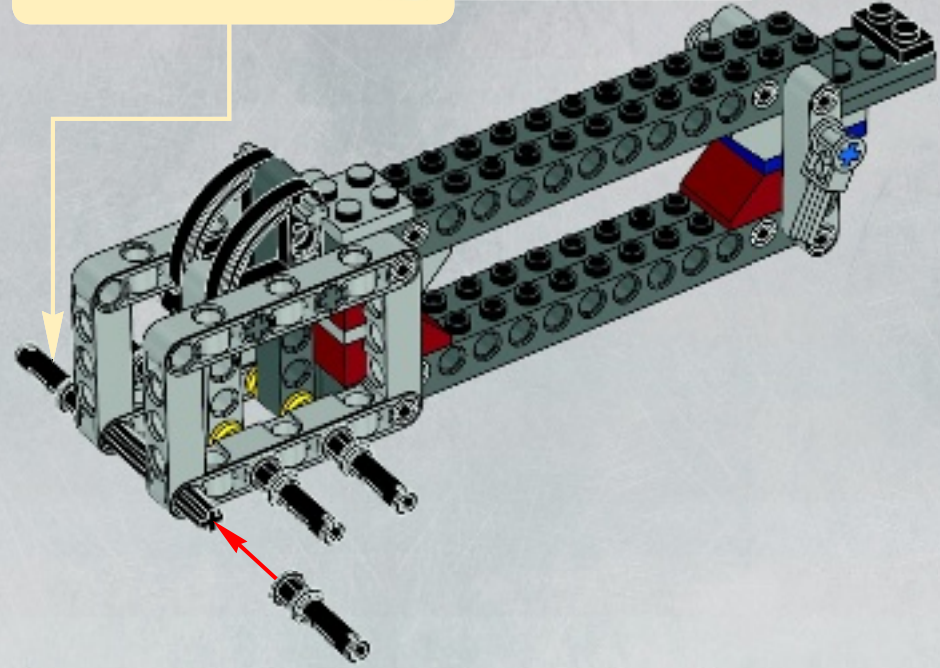
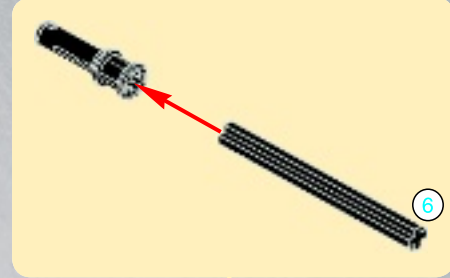



16

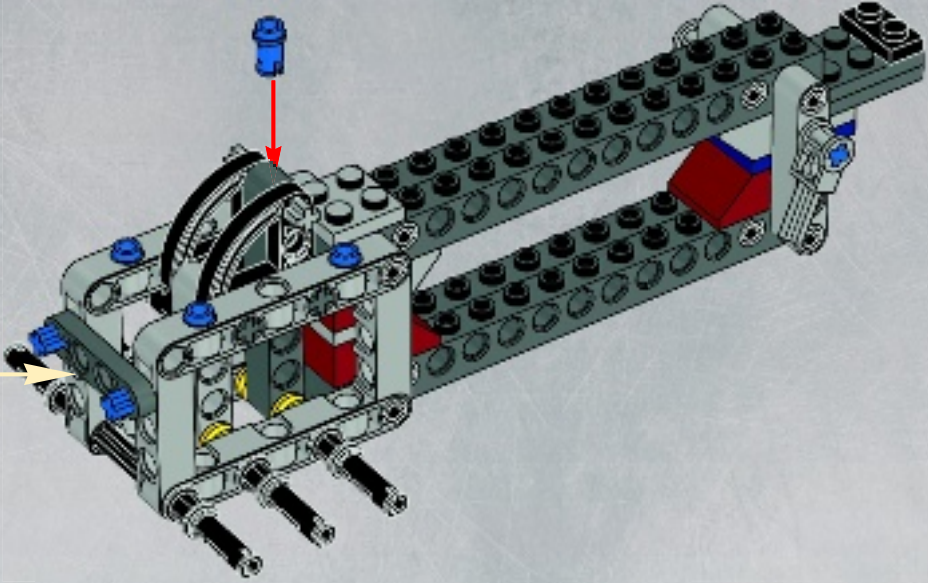
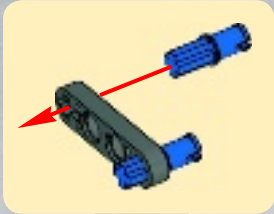

17

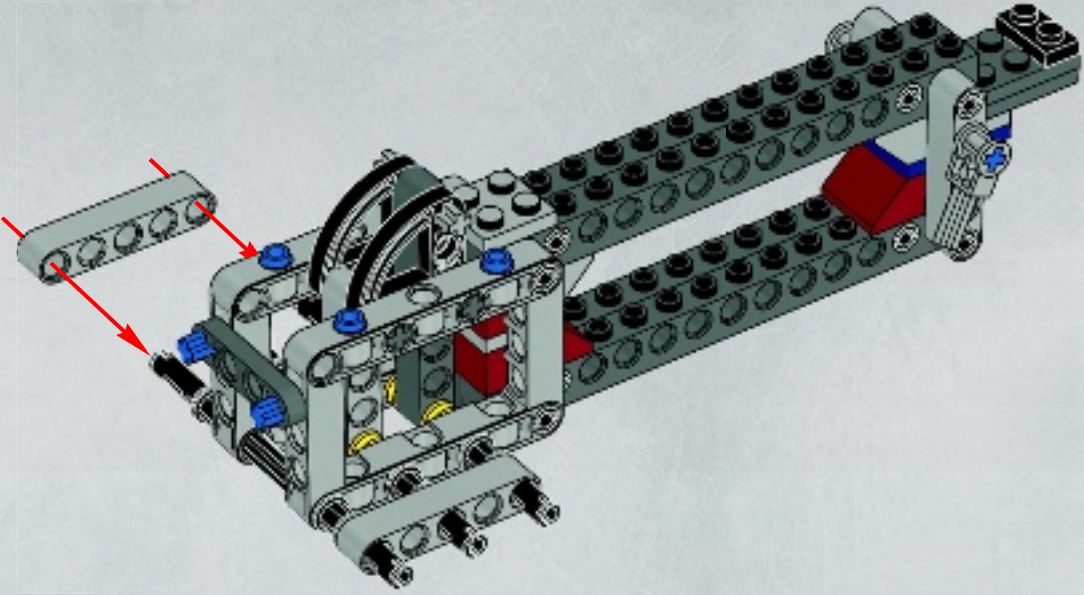

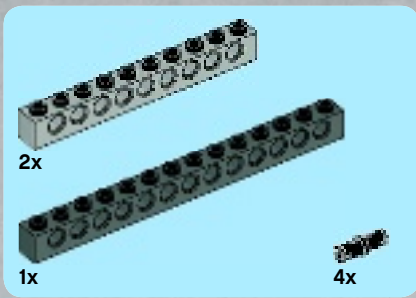

18

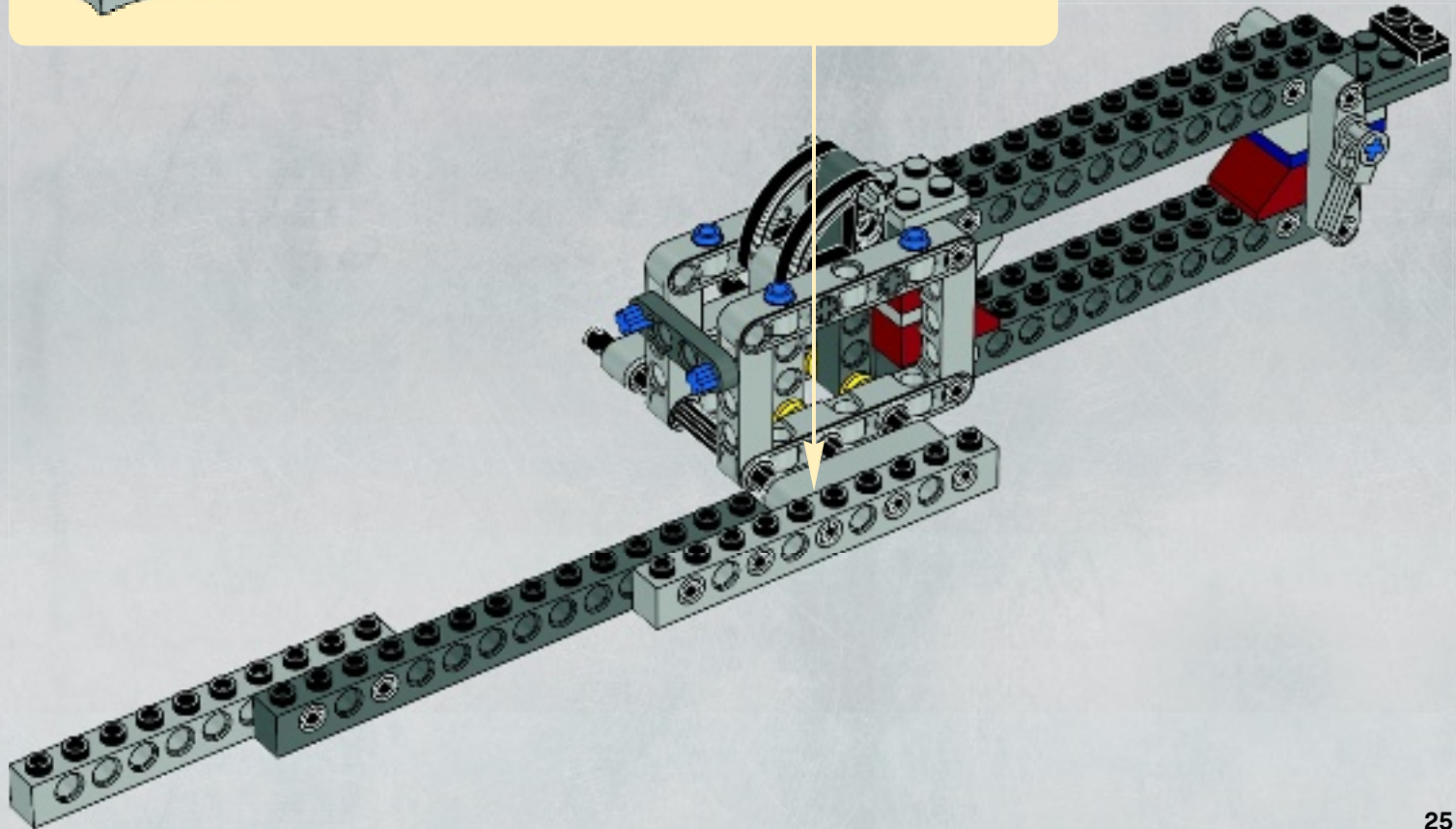
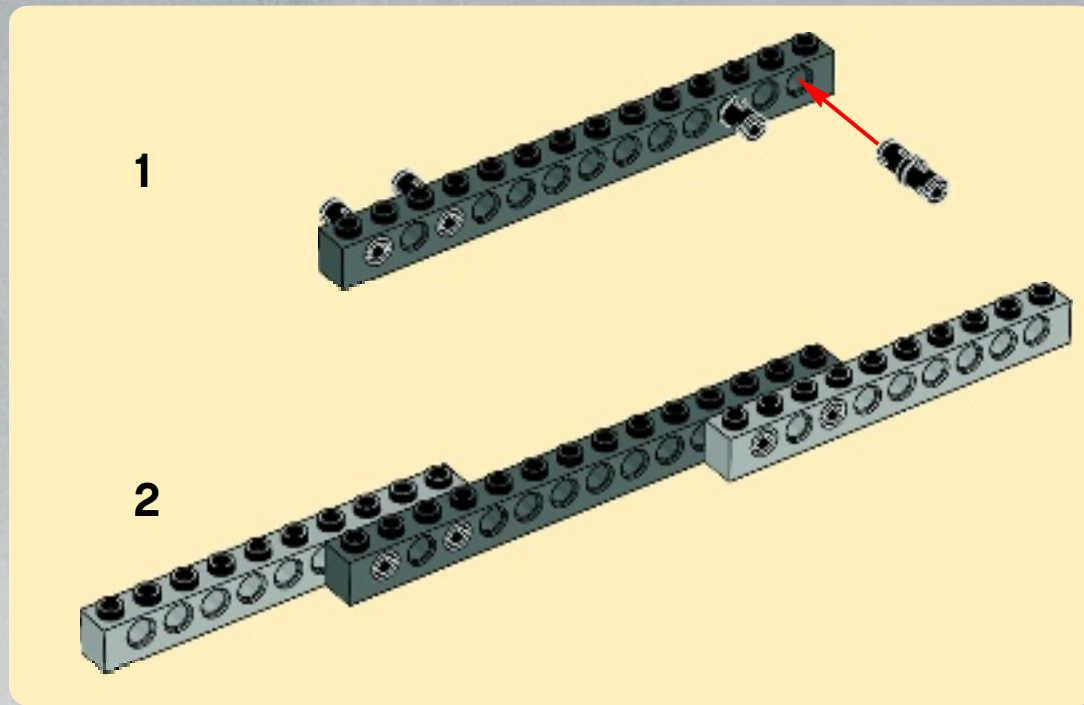

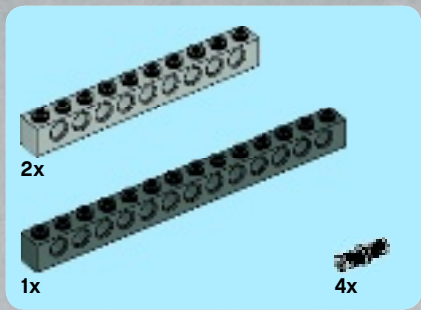

19

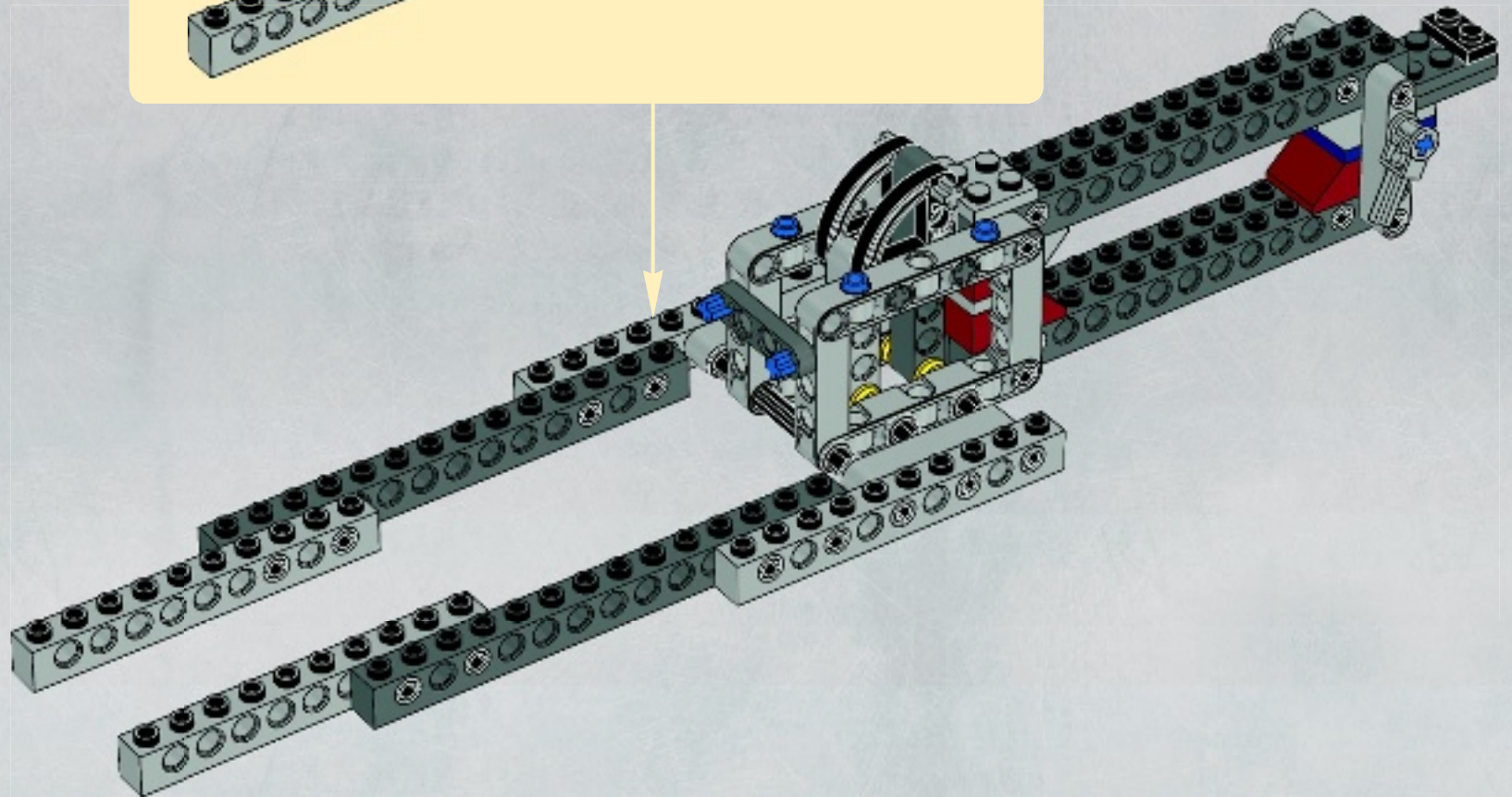
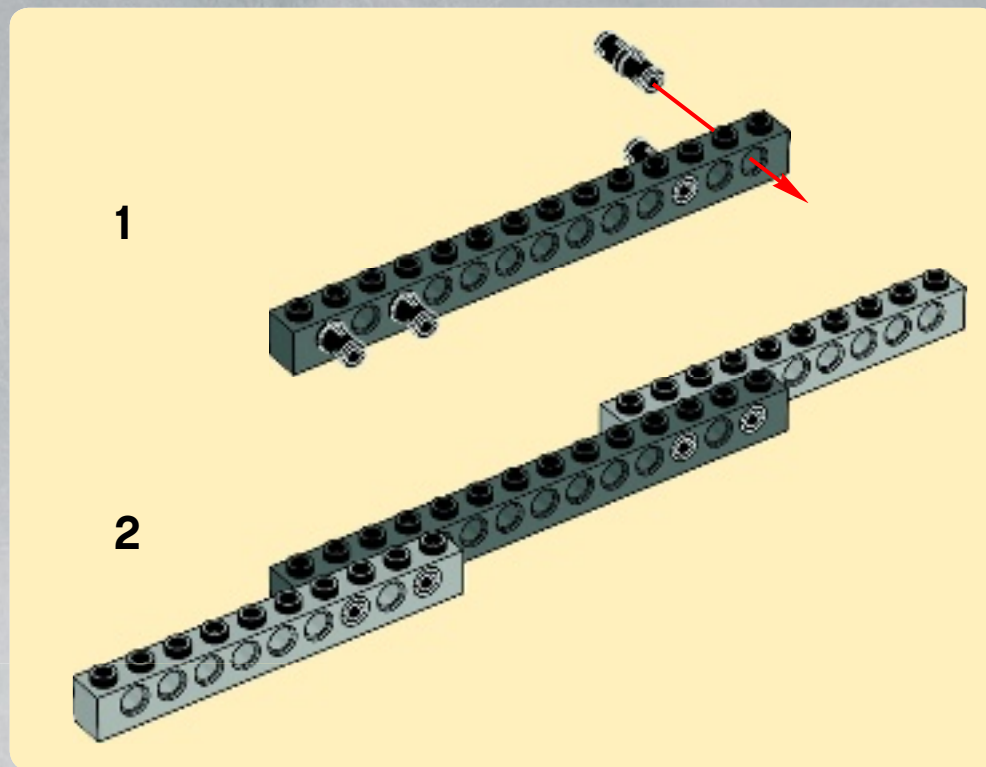

20

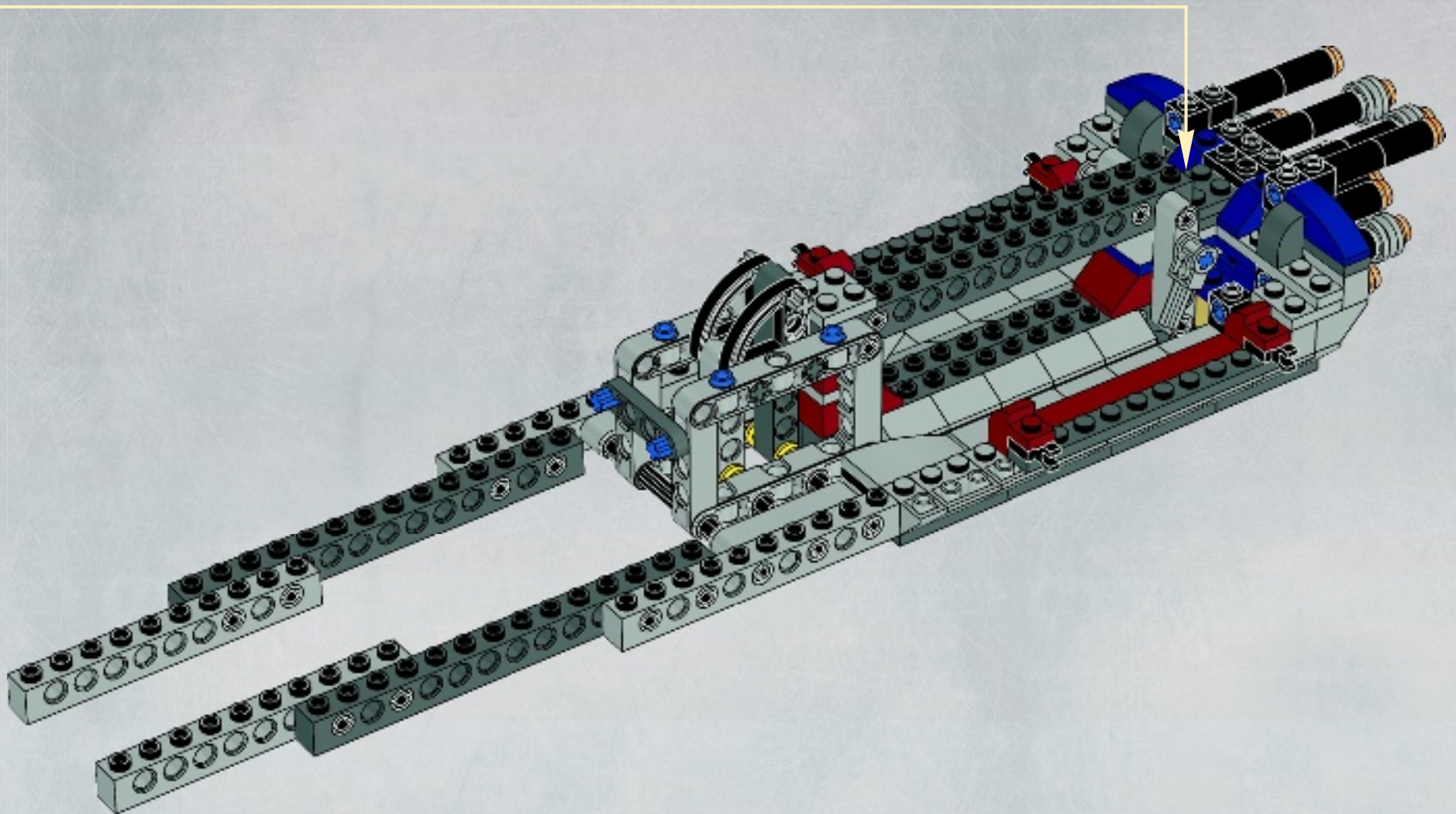

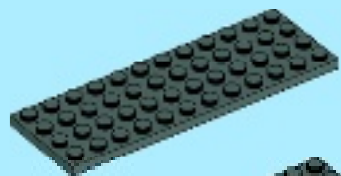
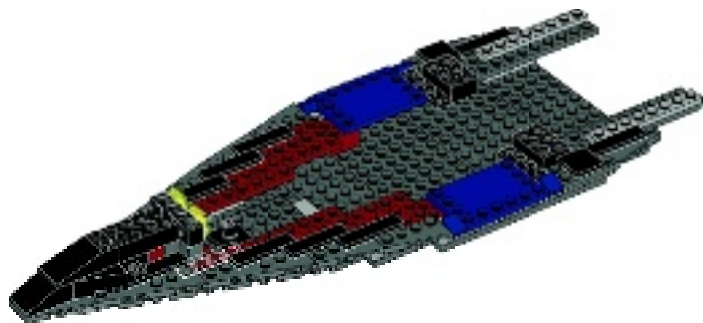

1x

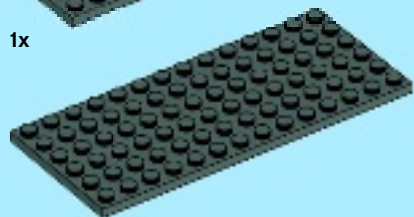

2x

21

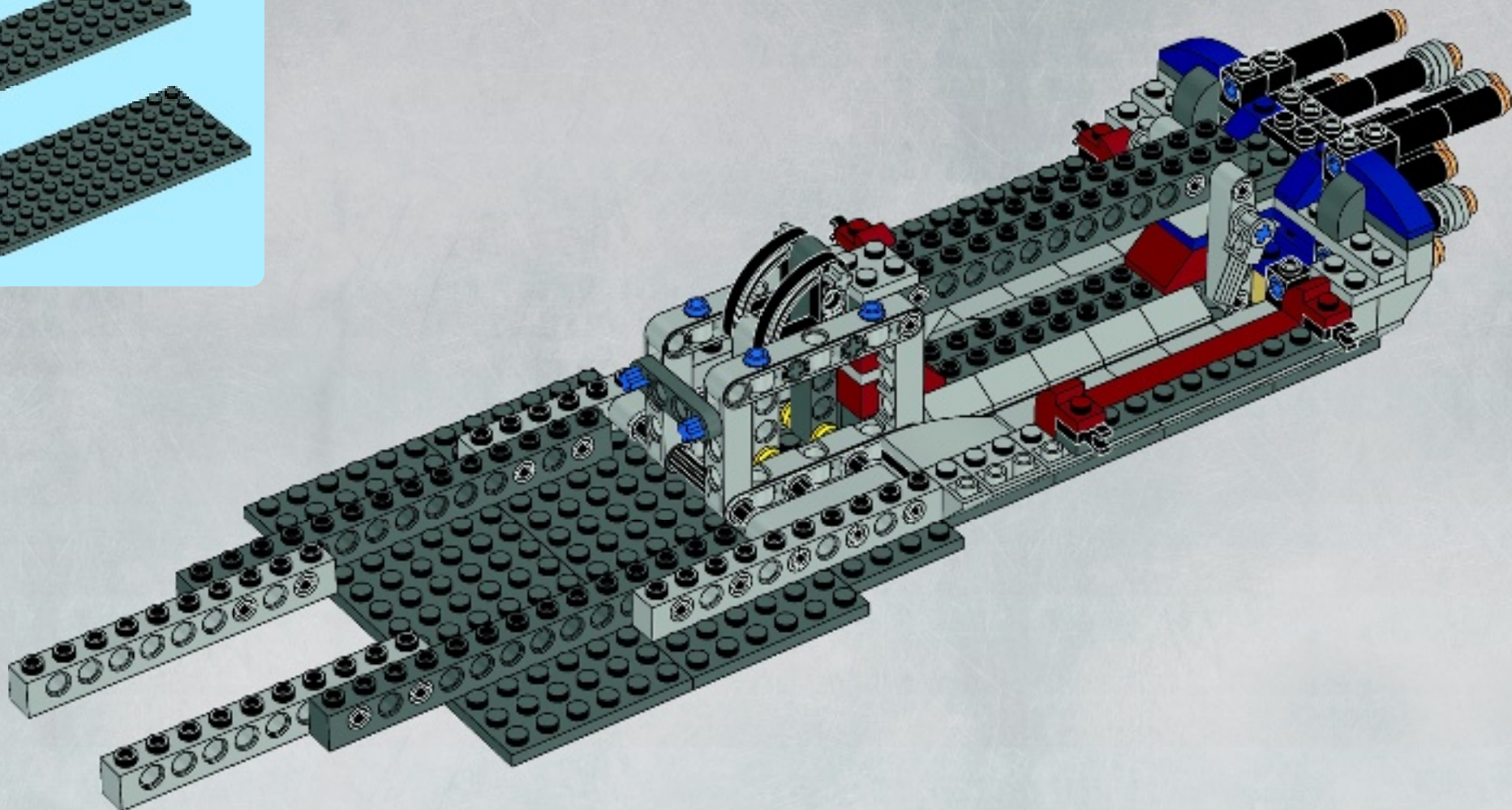



16x



2x

22

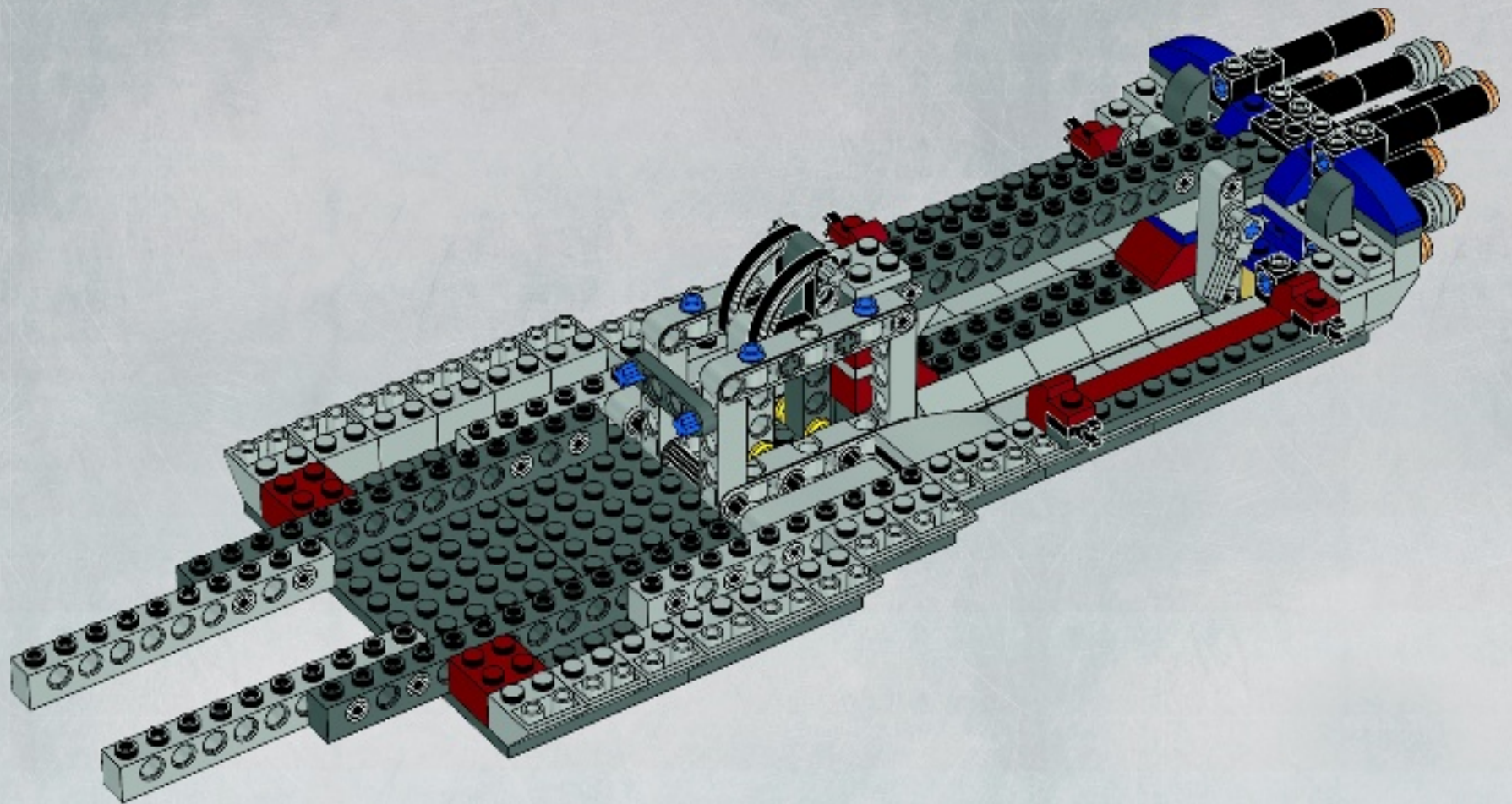

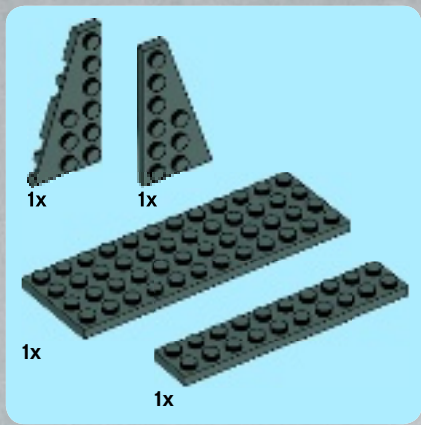

23

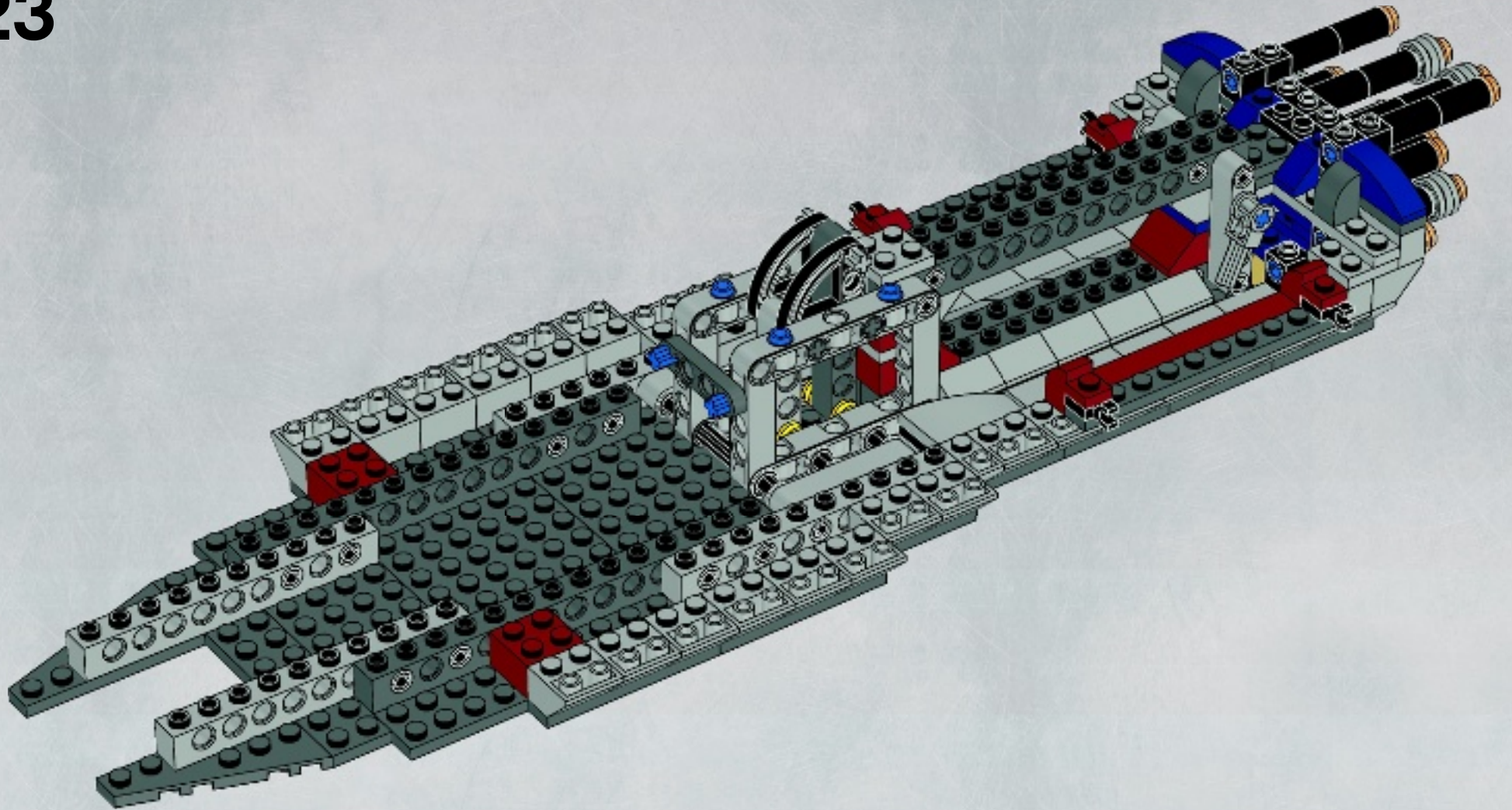

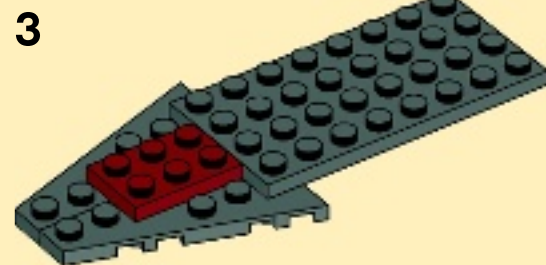
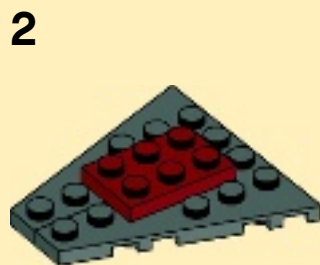
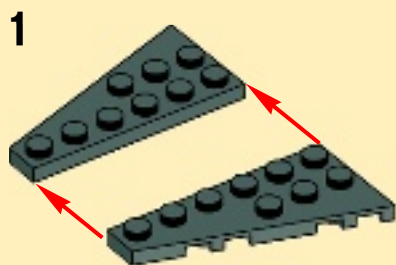
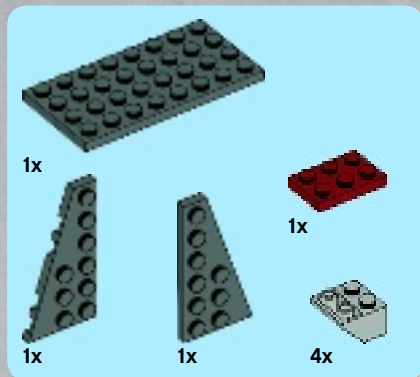

24

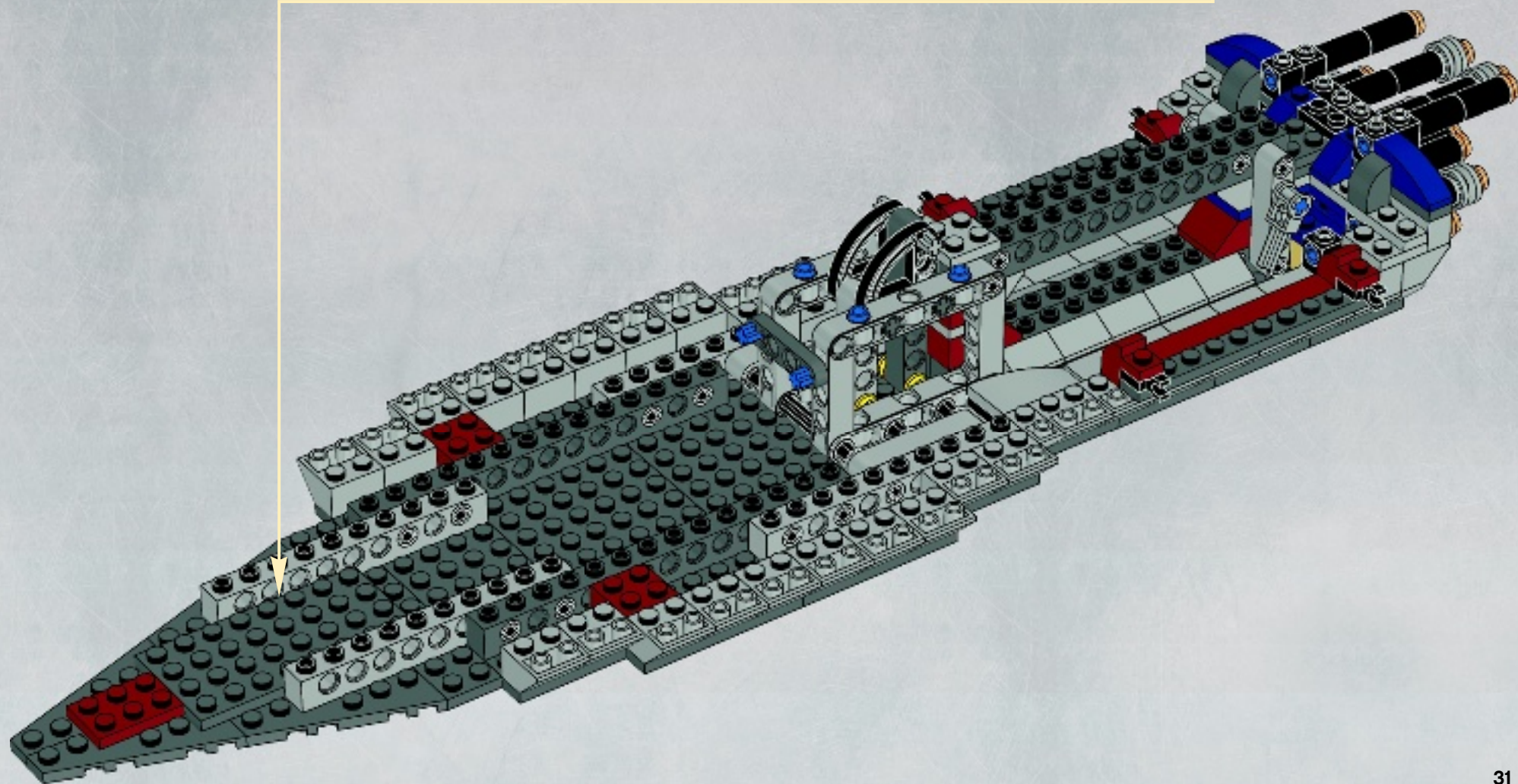



6x



8x

25

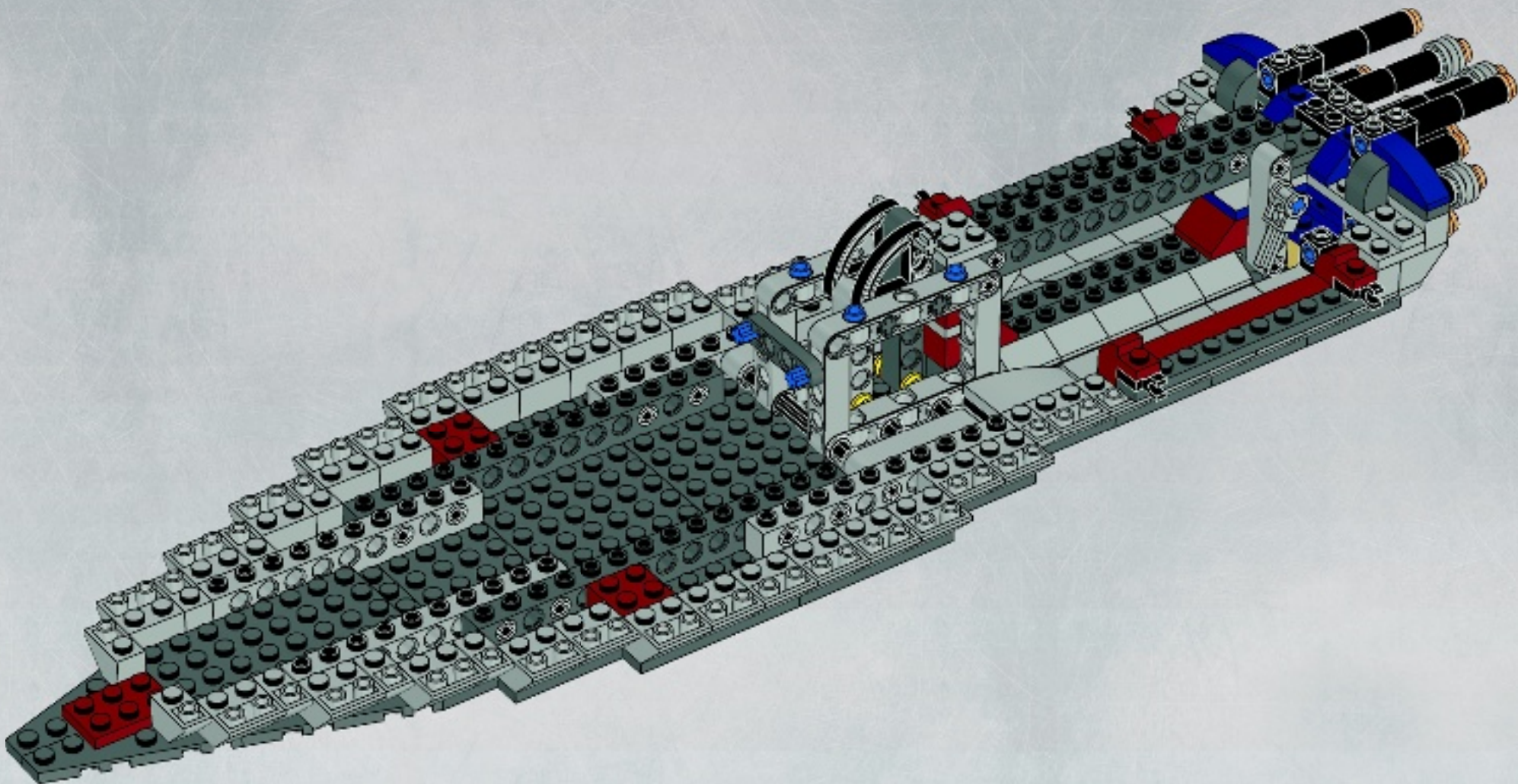

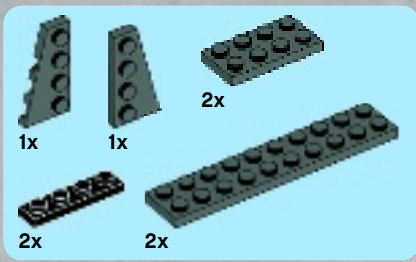

26

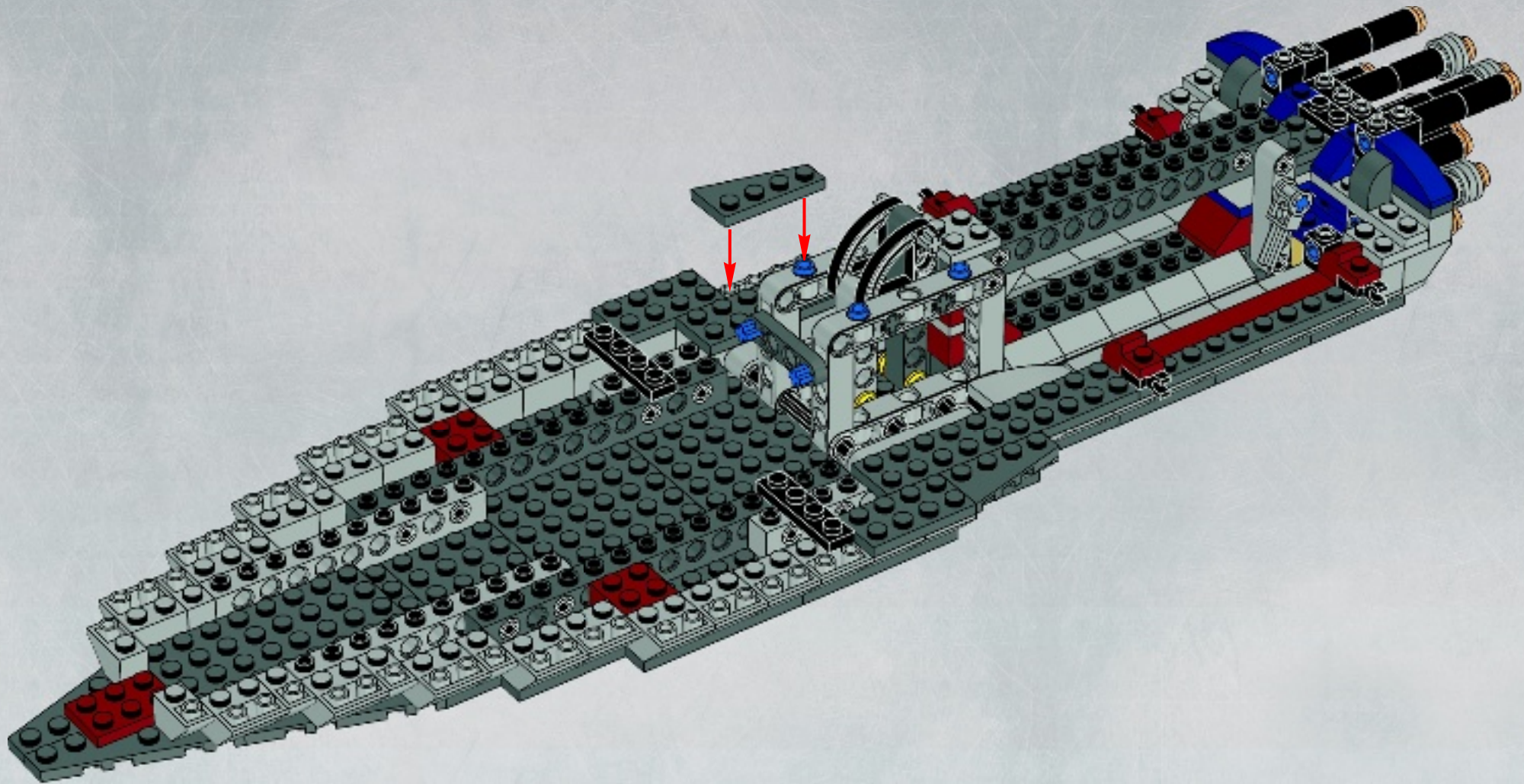

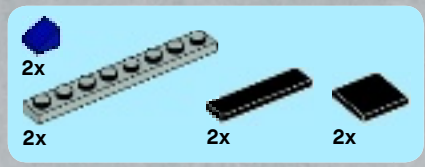

27

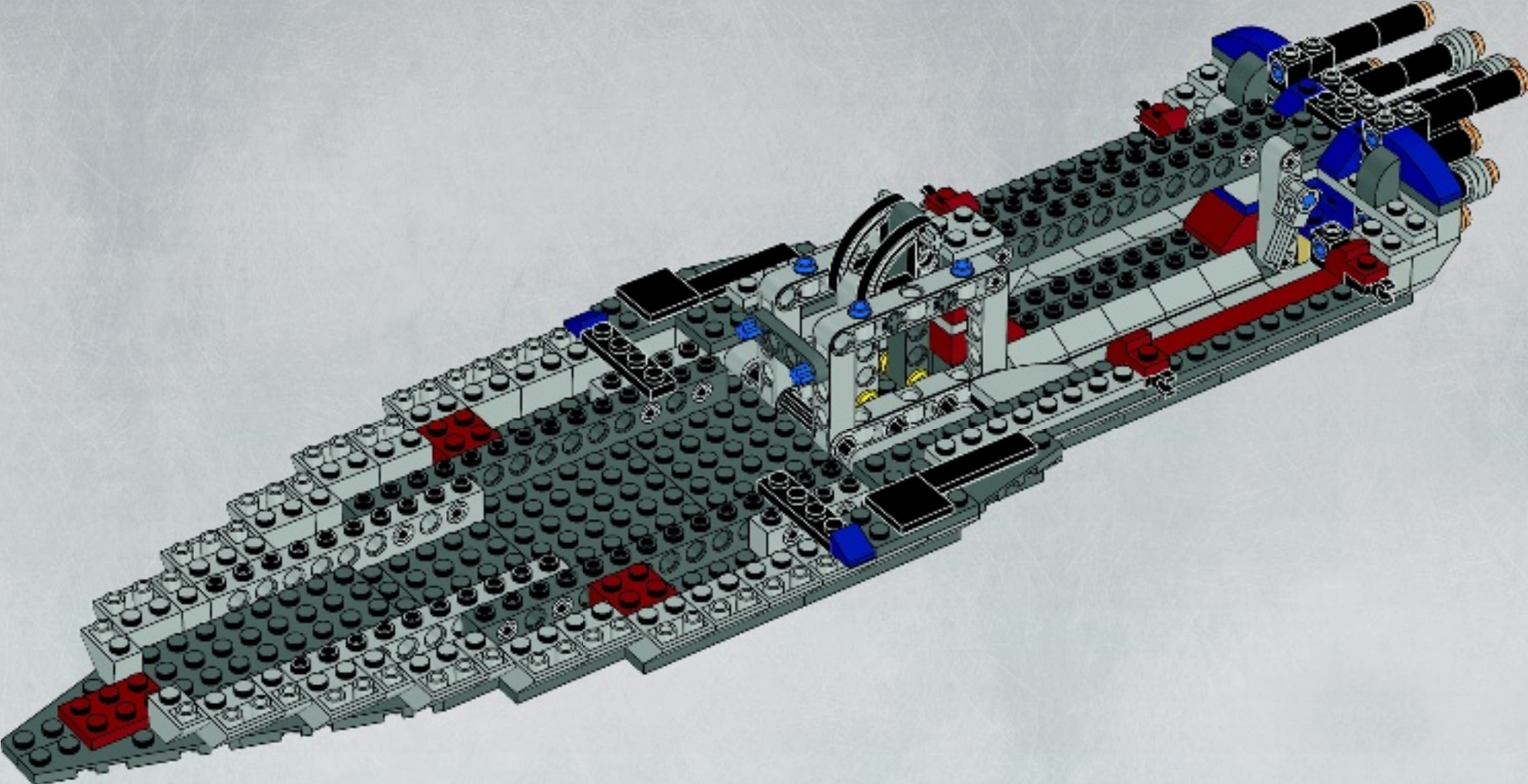

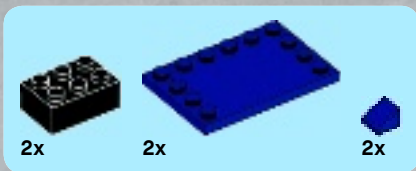

28

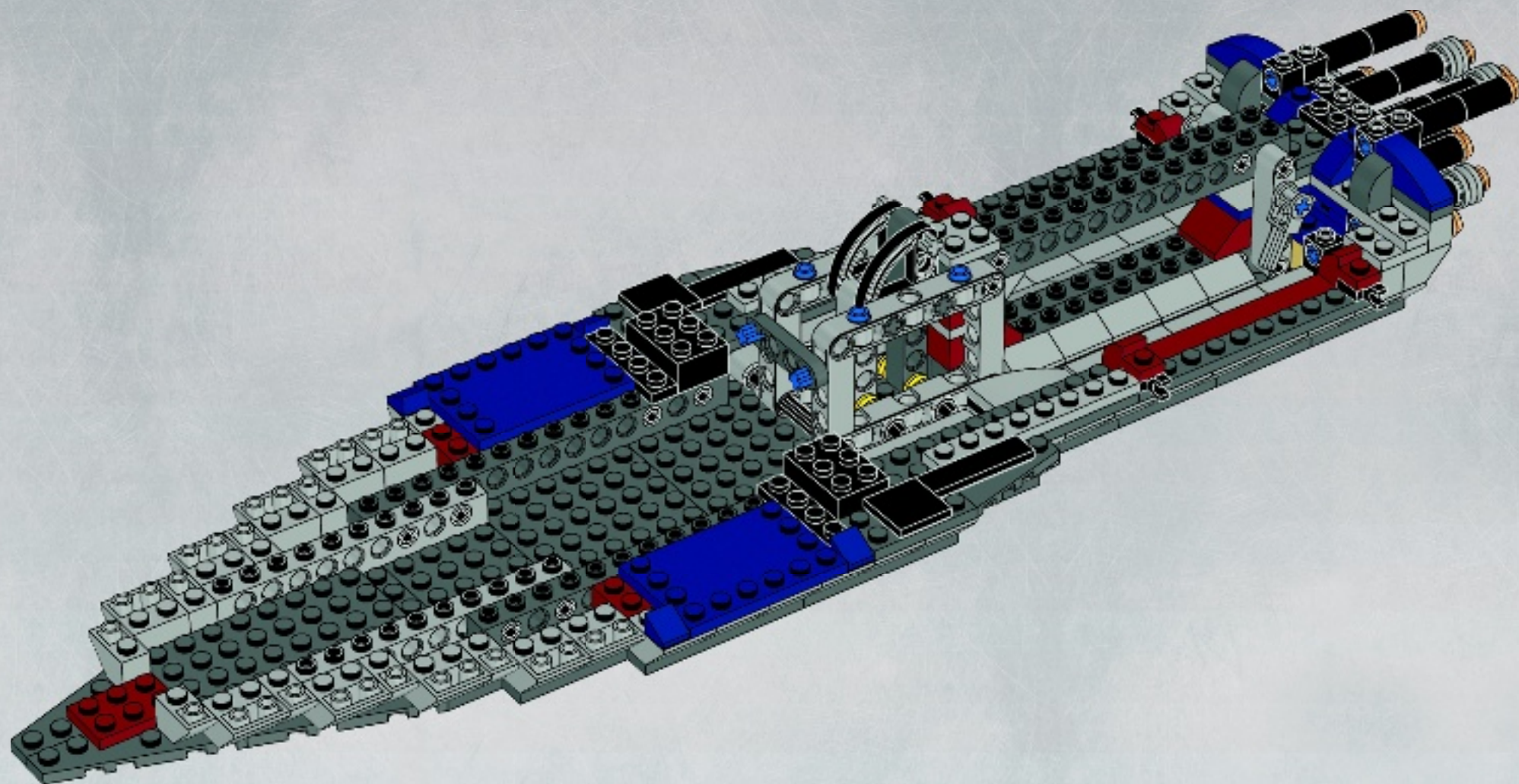

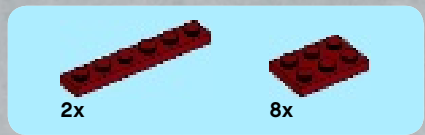

29

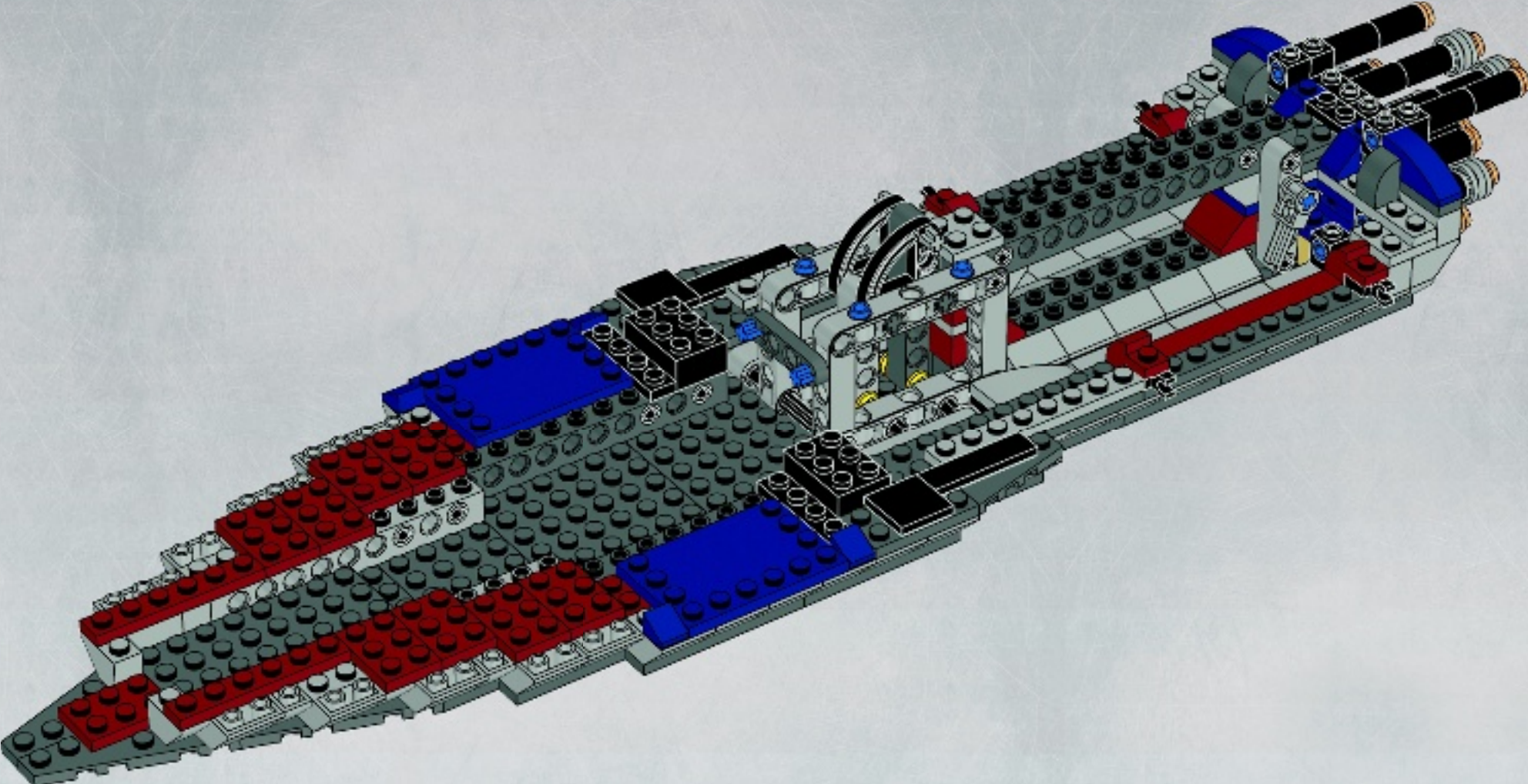

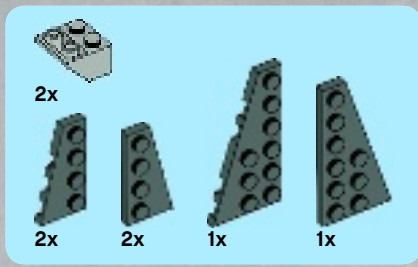

30

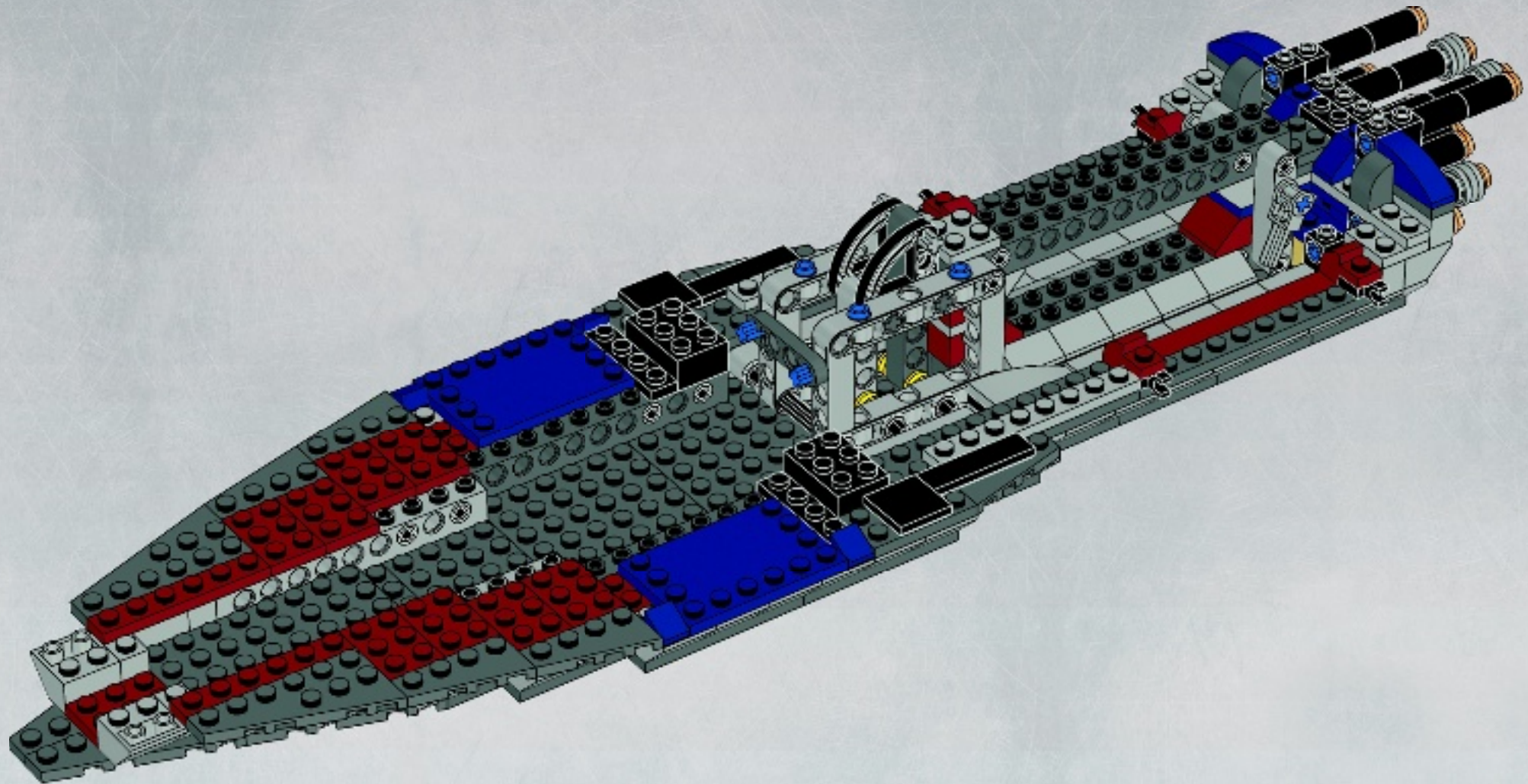

1x



1x



2x

31

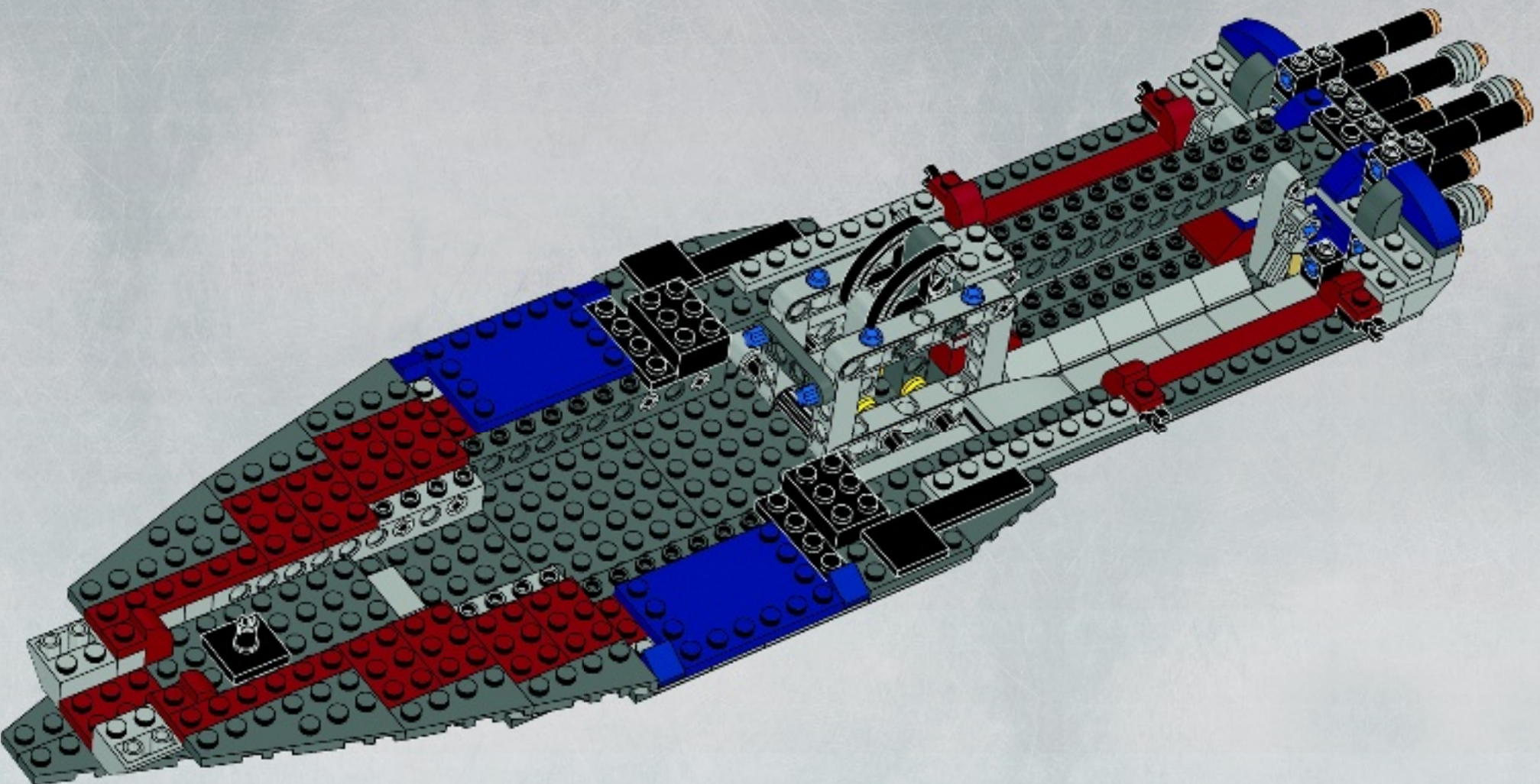

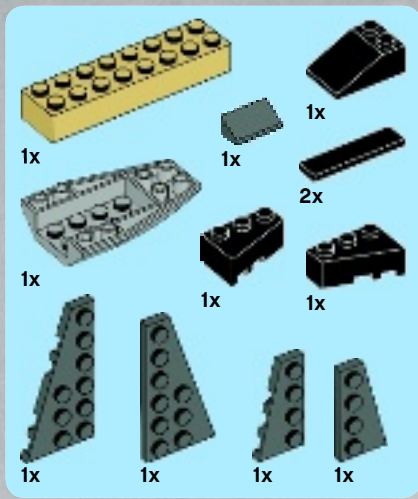

32

1

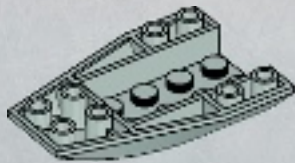

2

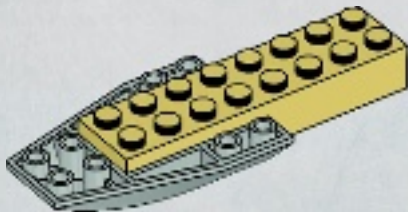

3

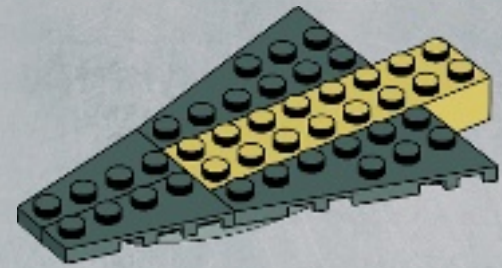

4

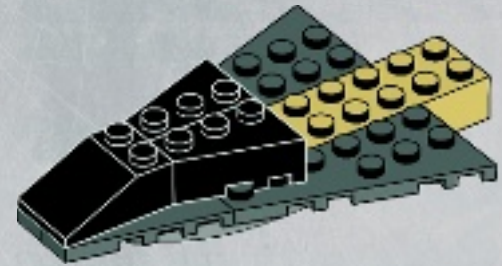

5



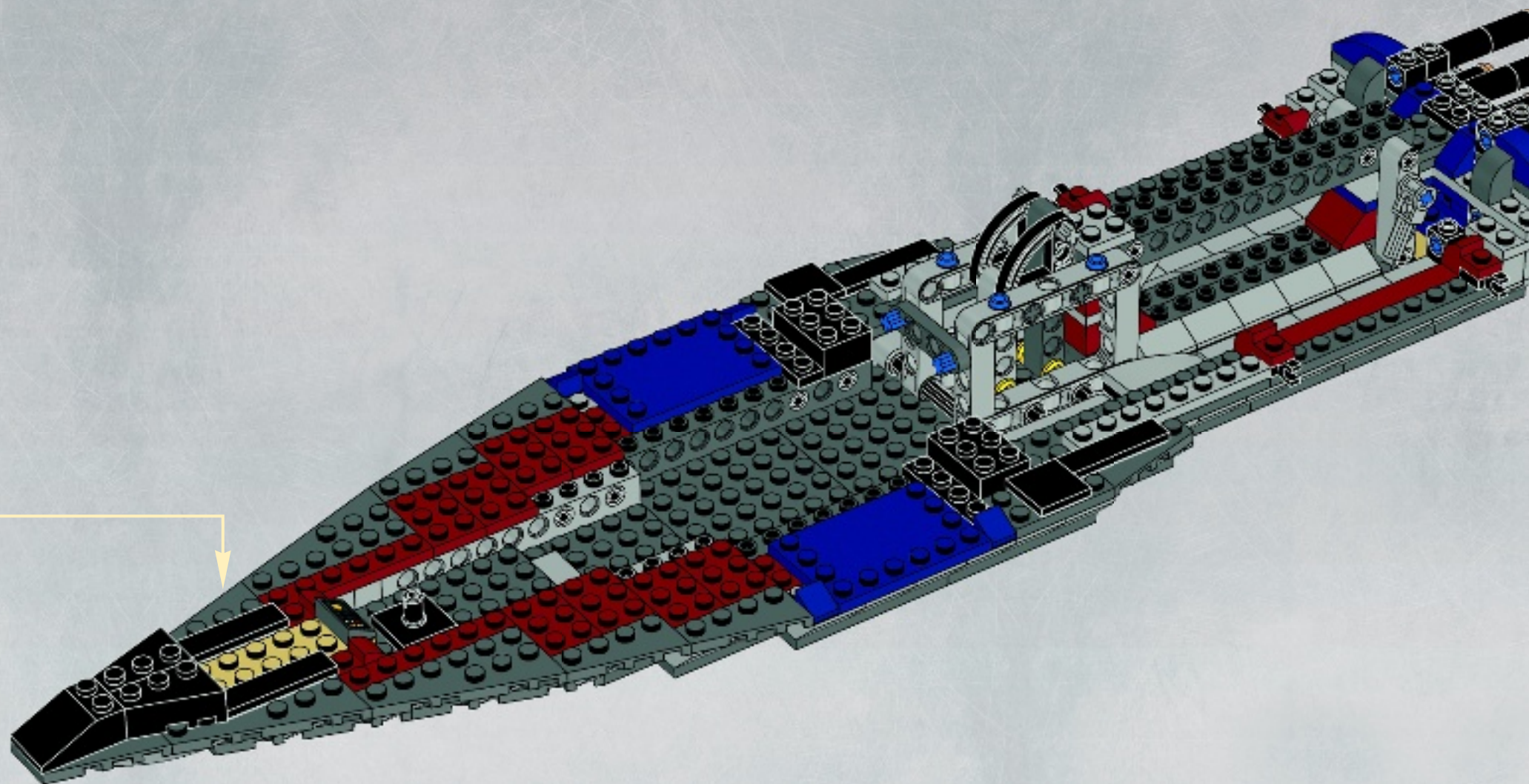



8x

33

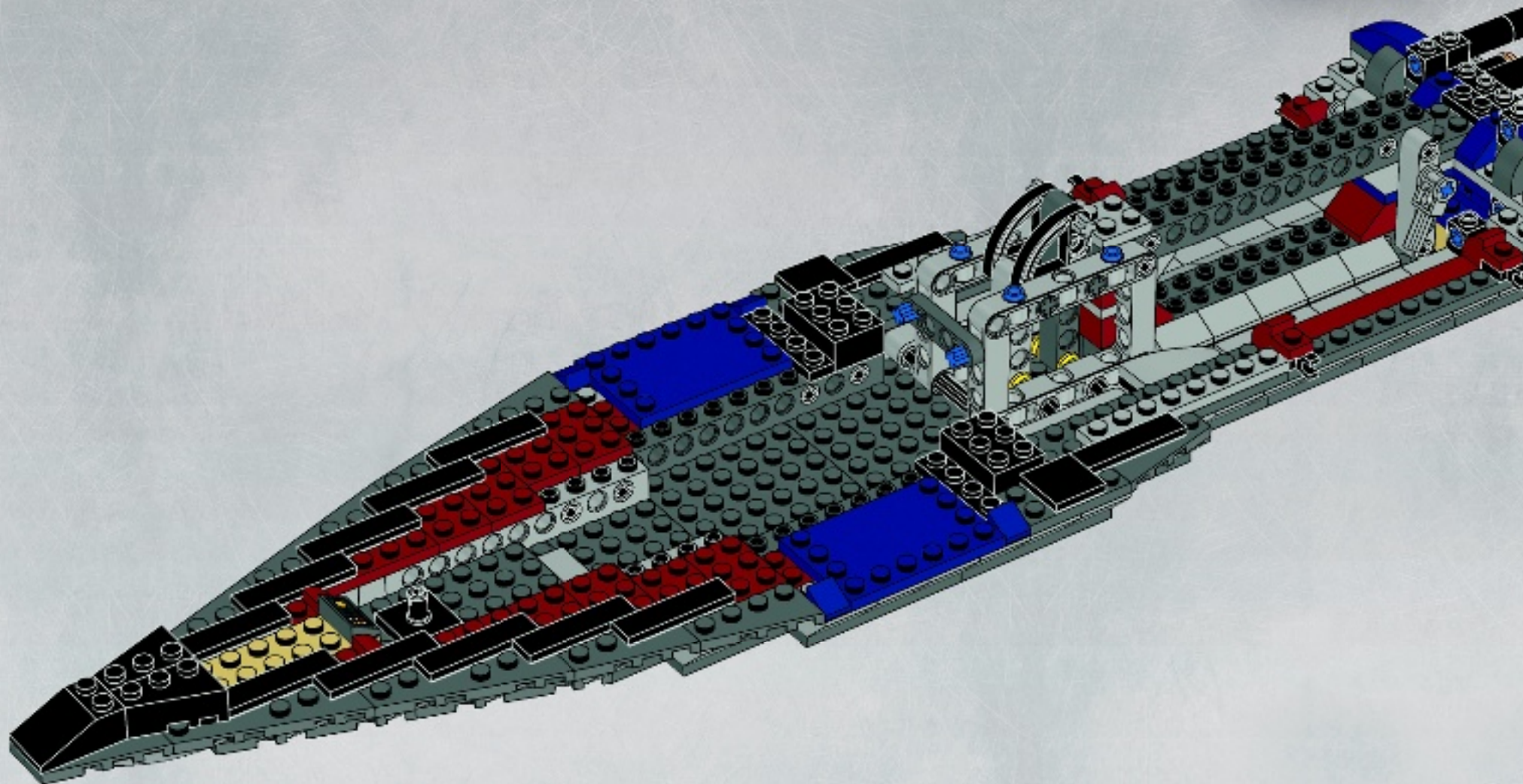



2x



2x



1x

34

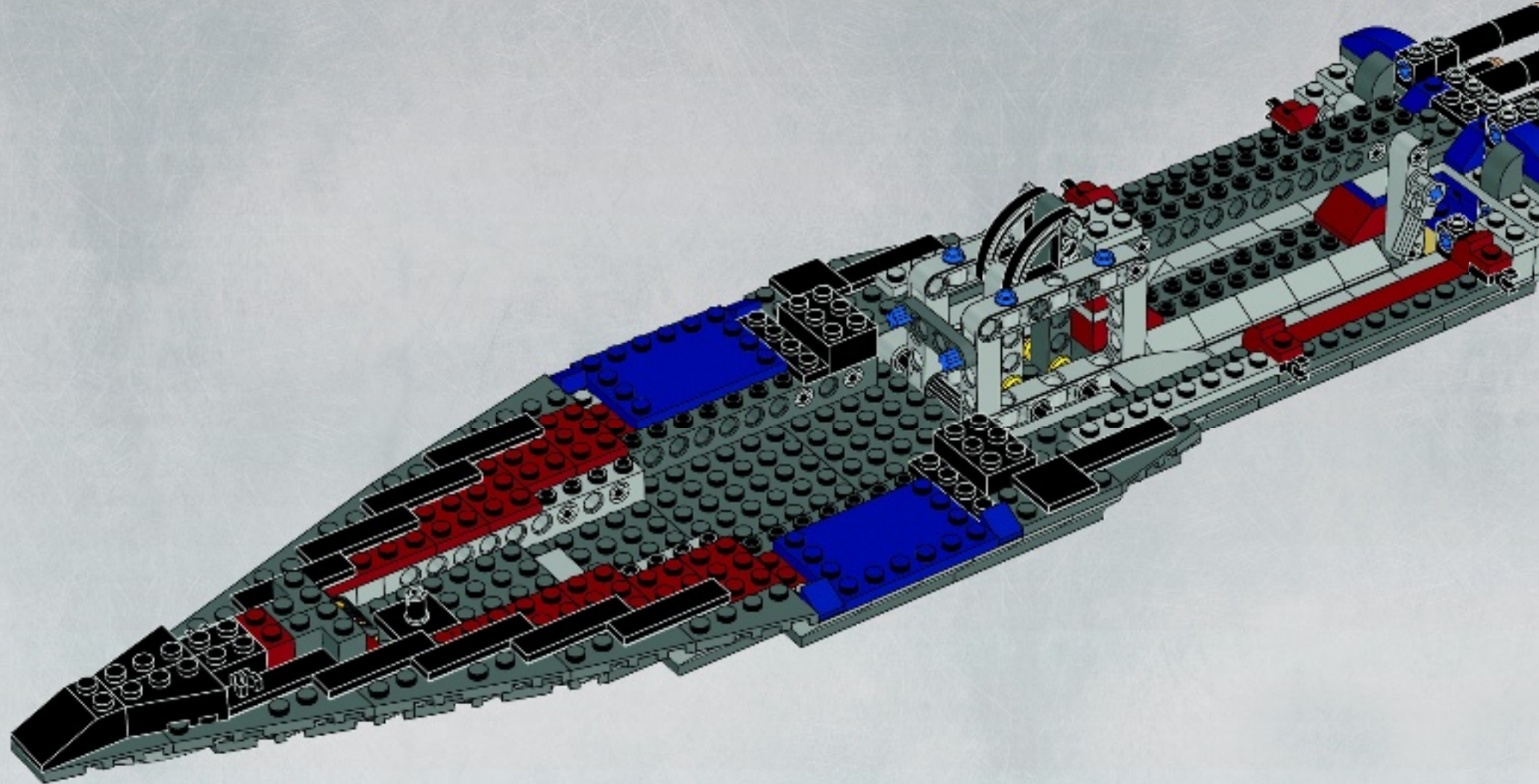

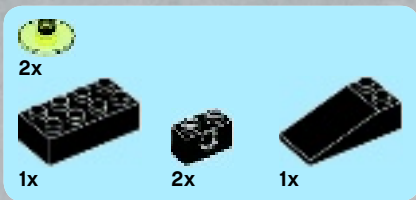

35

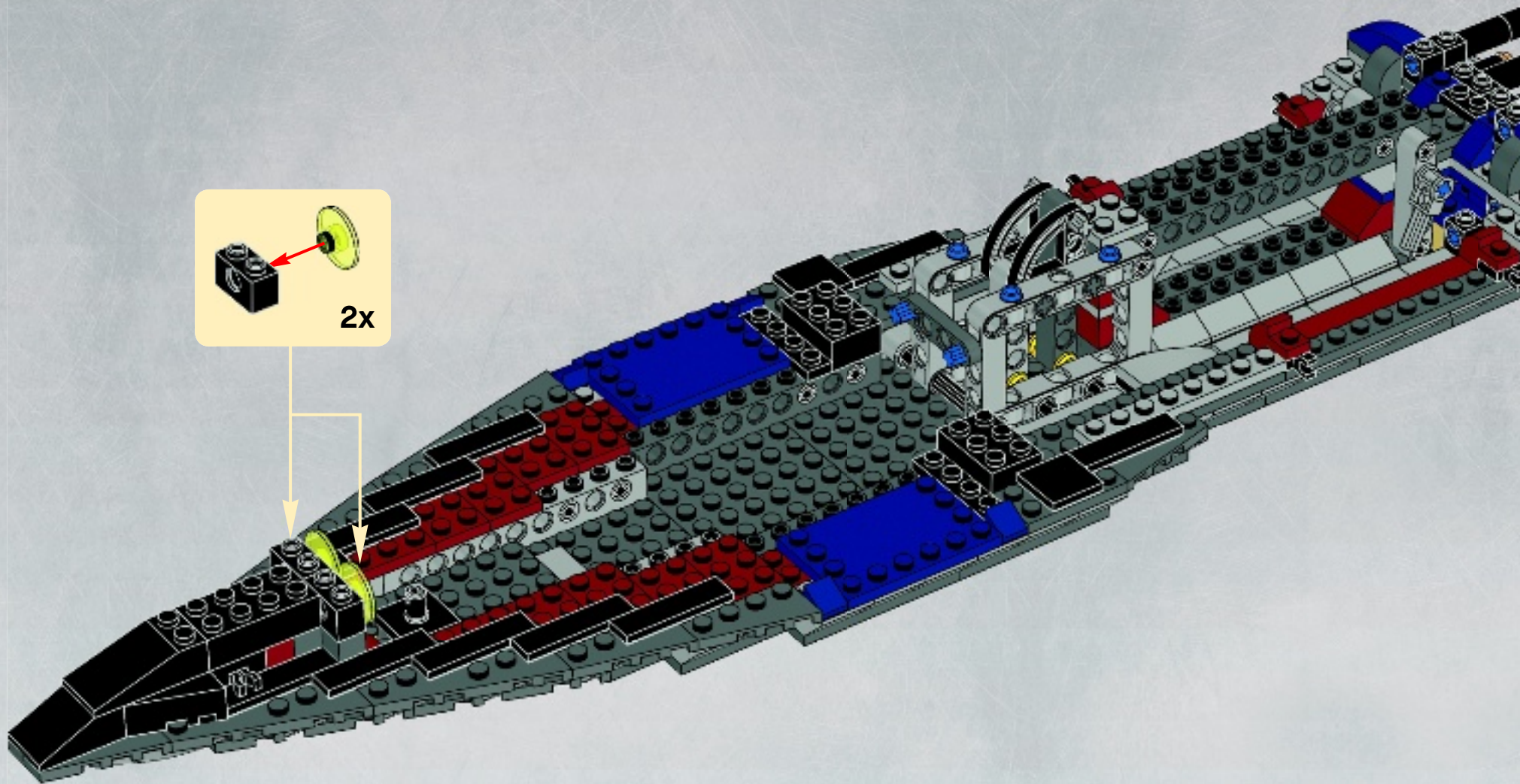
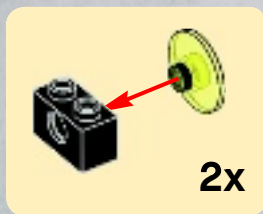

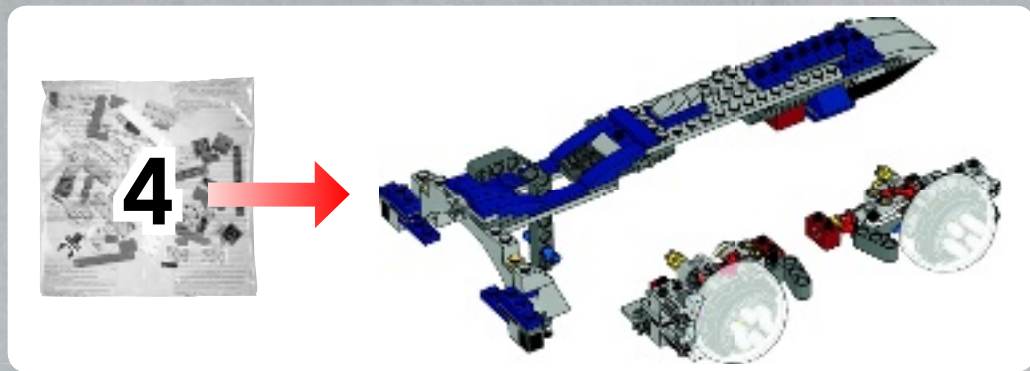

36

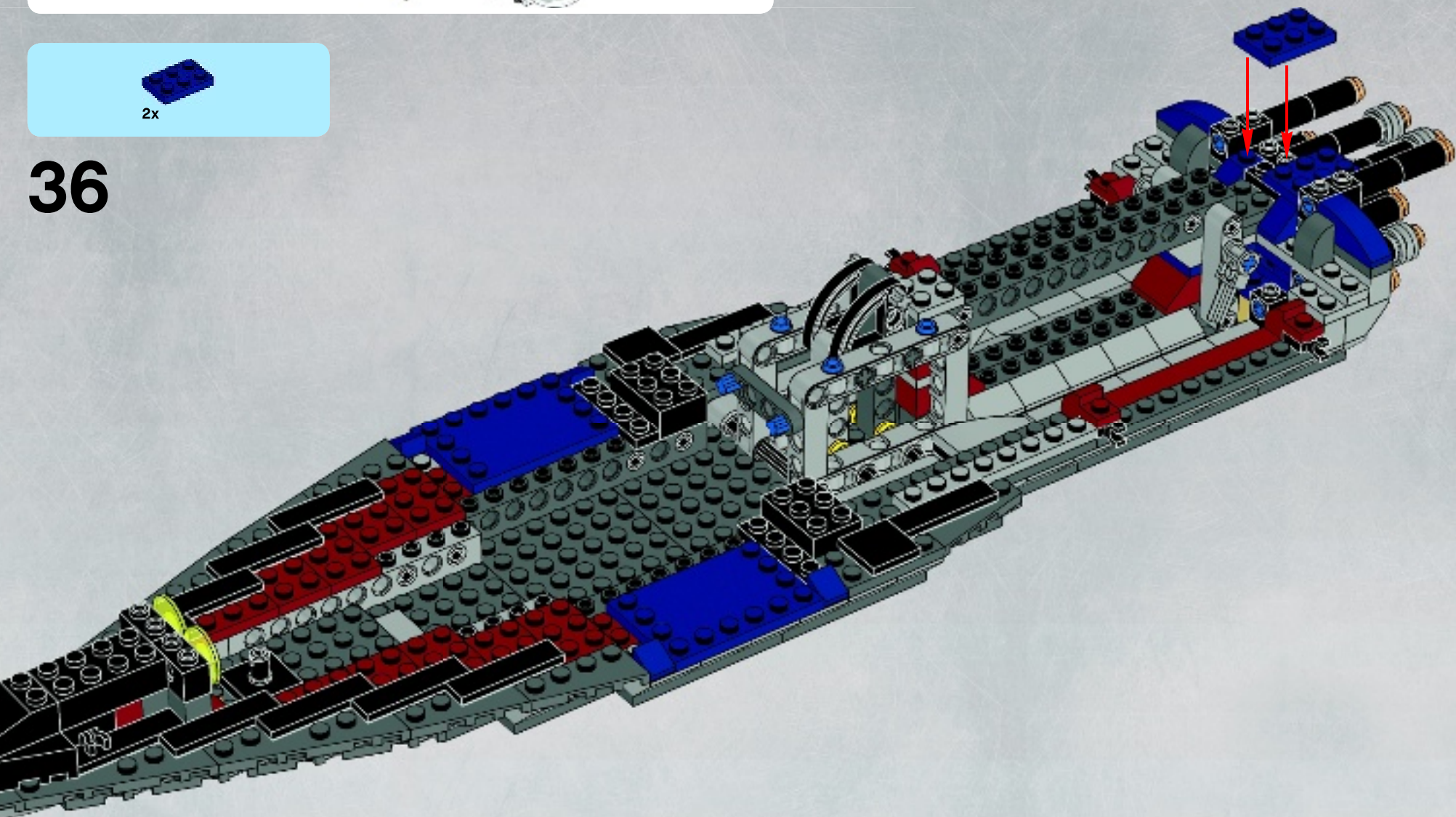



1x



1x

37

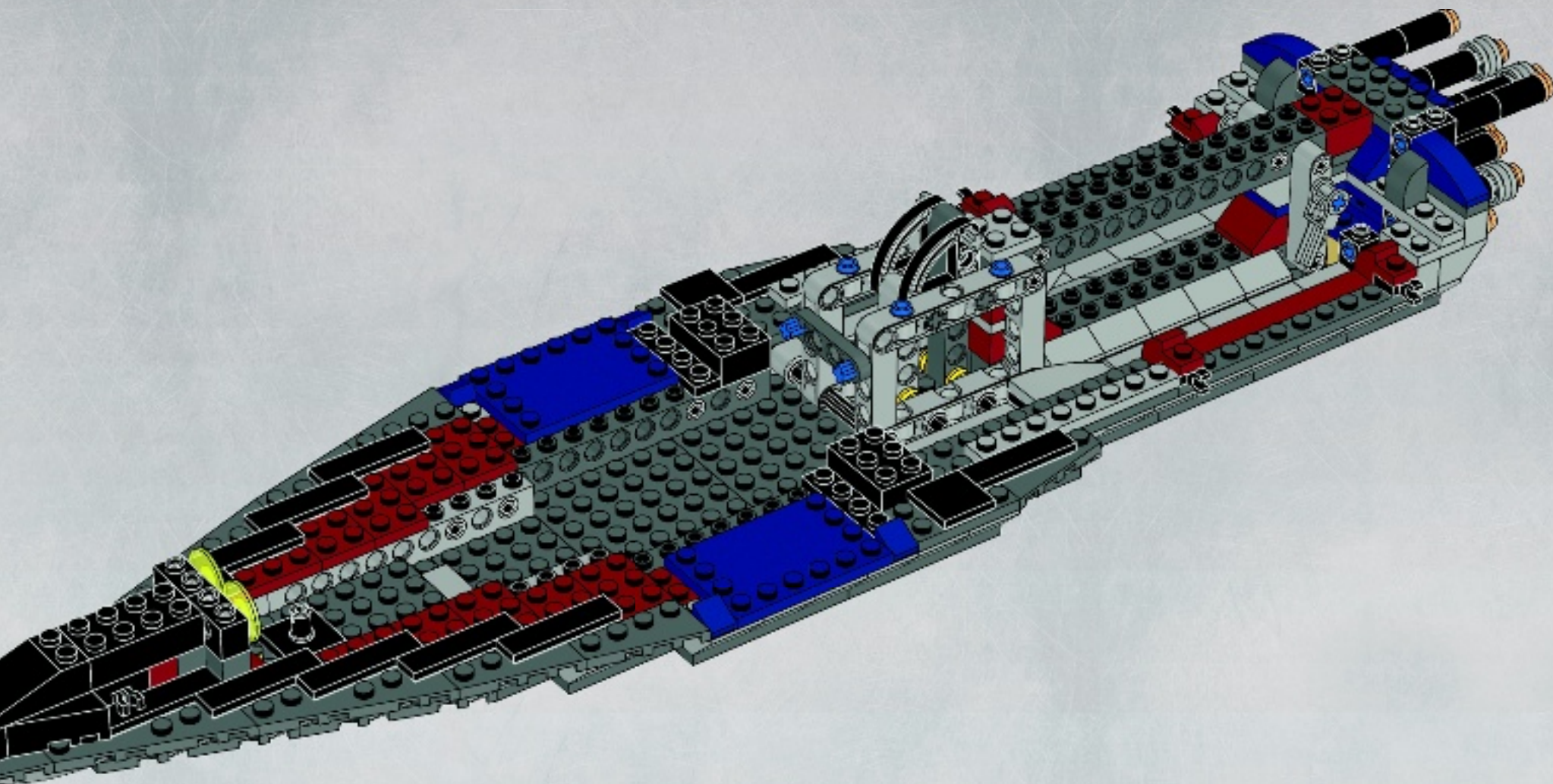



2x

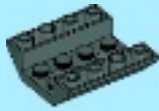

2x

38

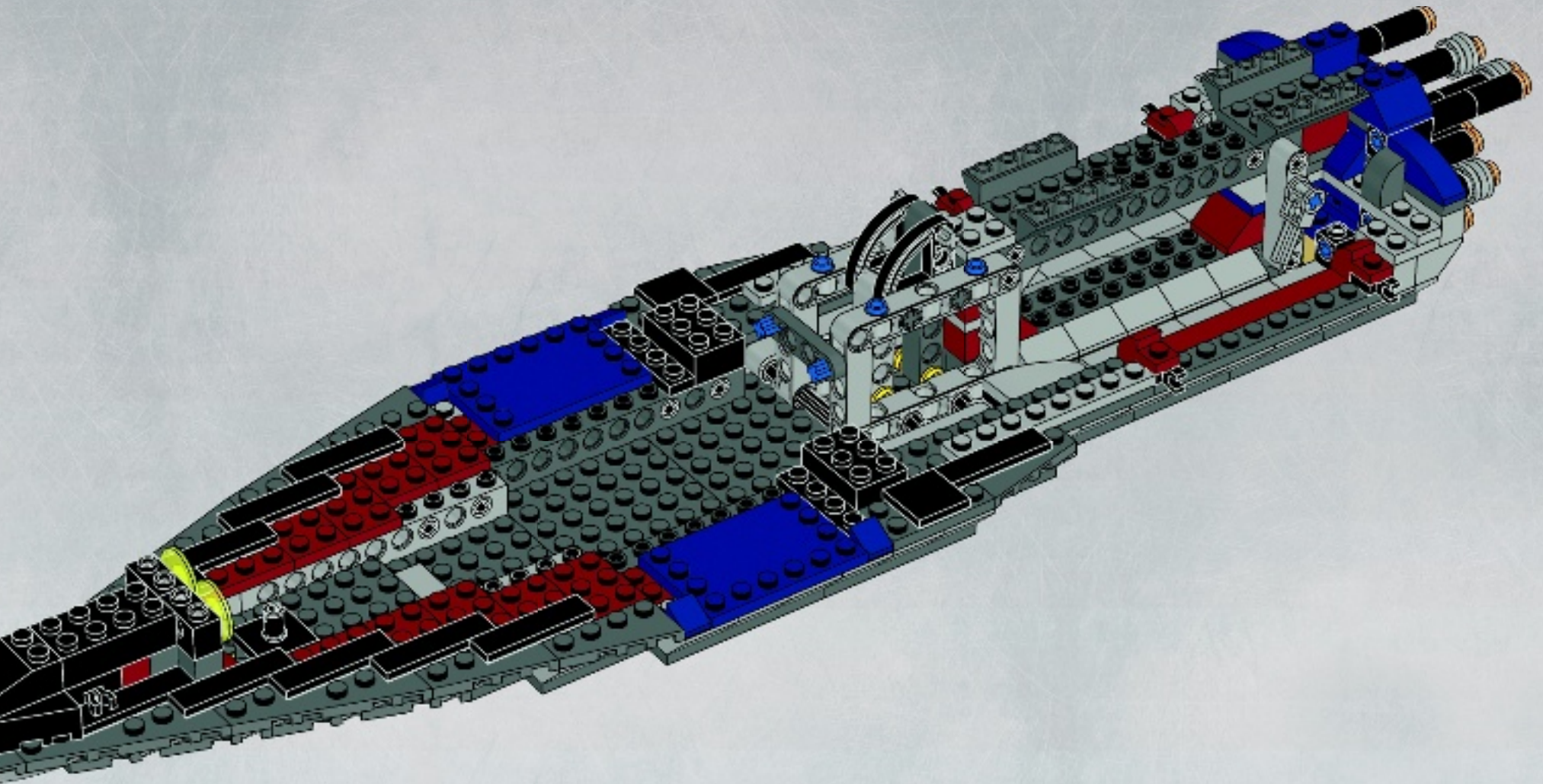

2x  2x 

39

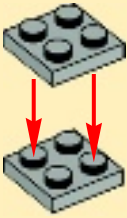

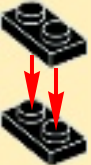

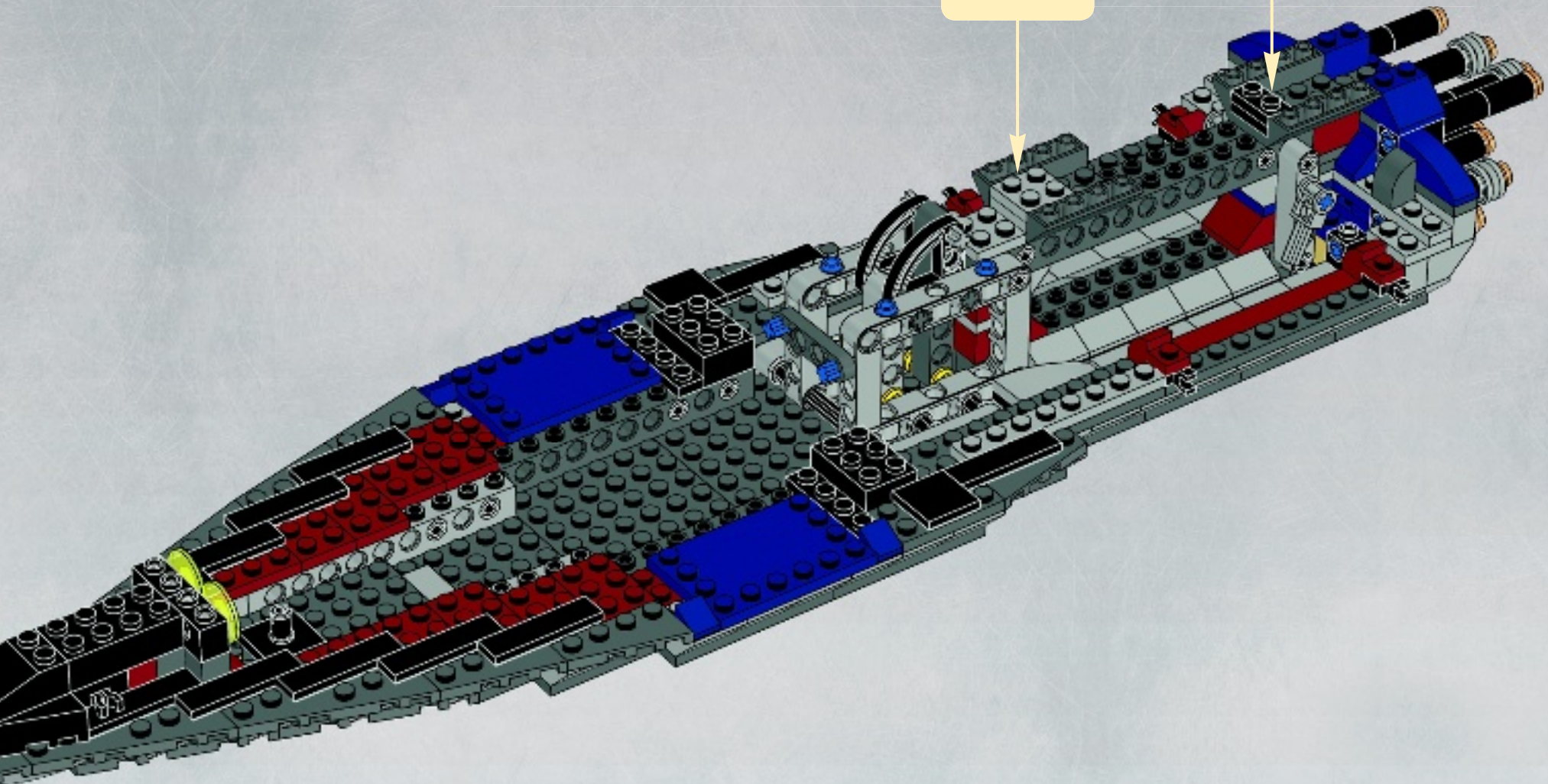

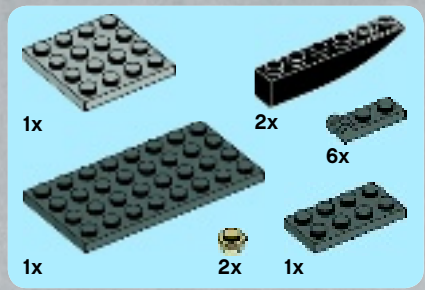

40

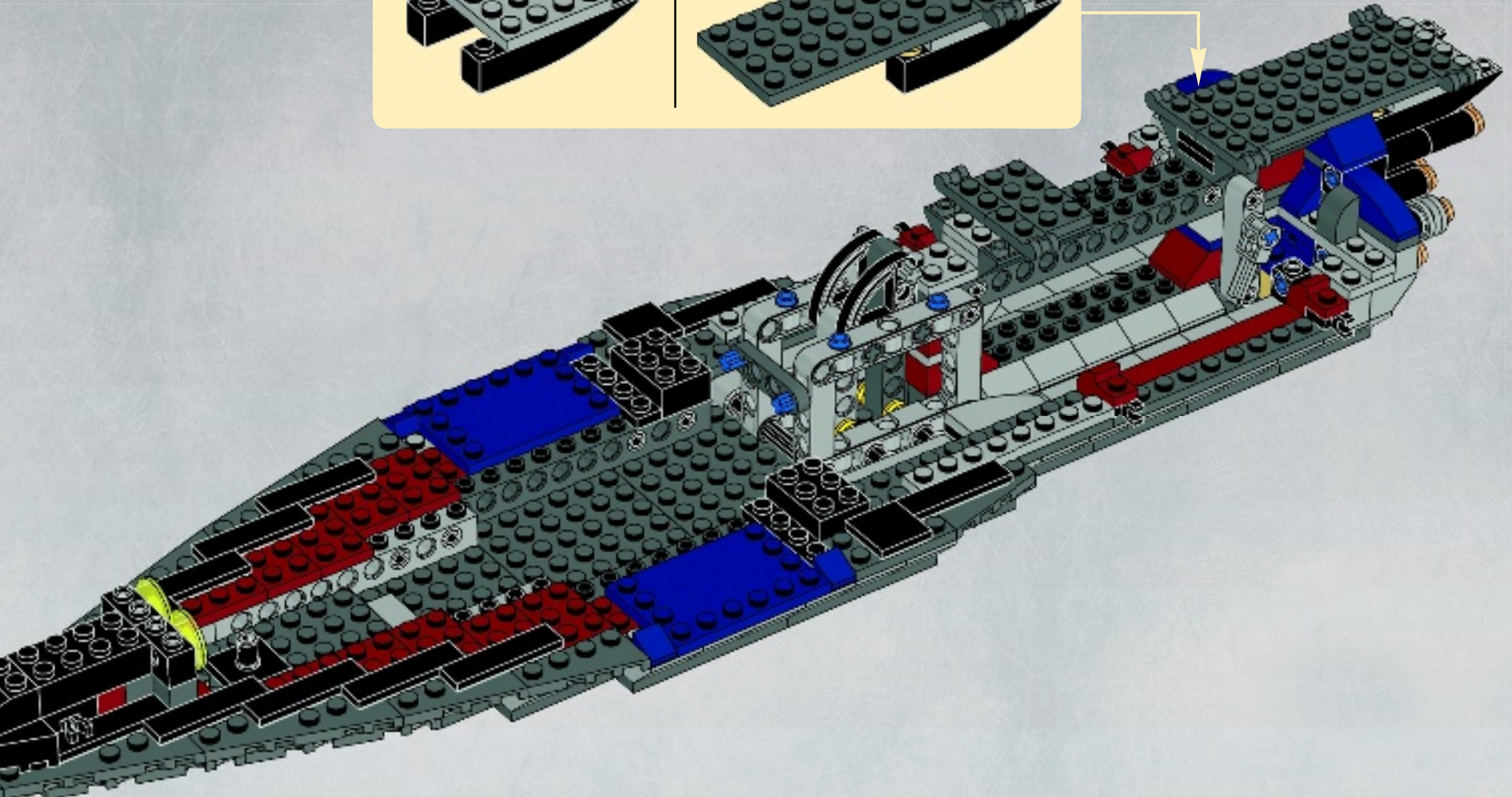
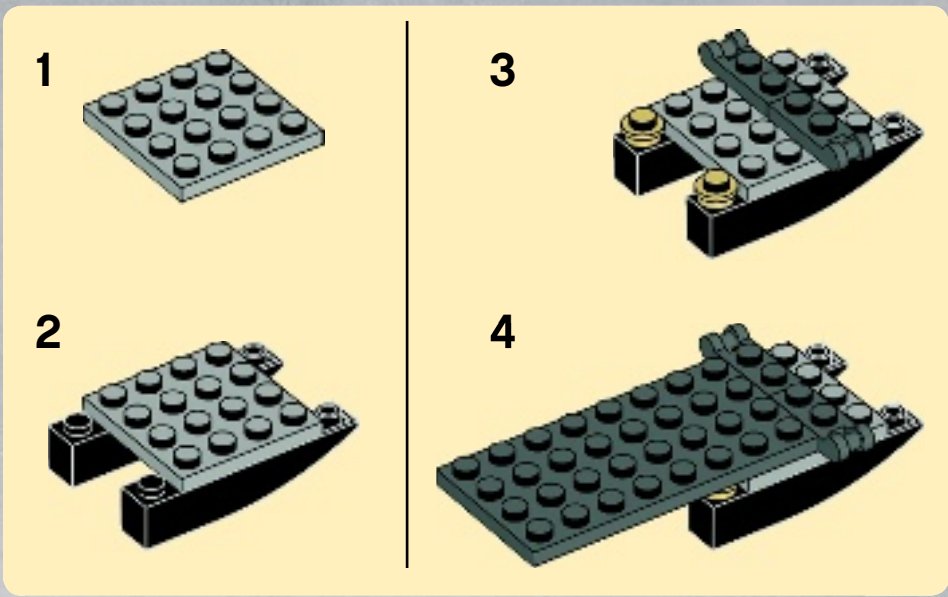

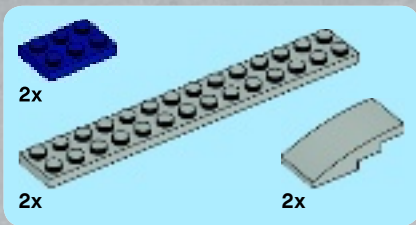

41

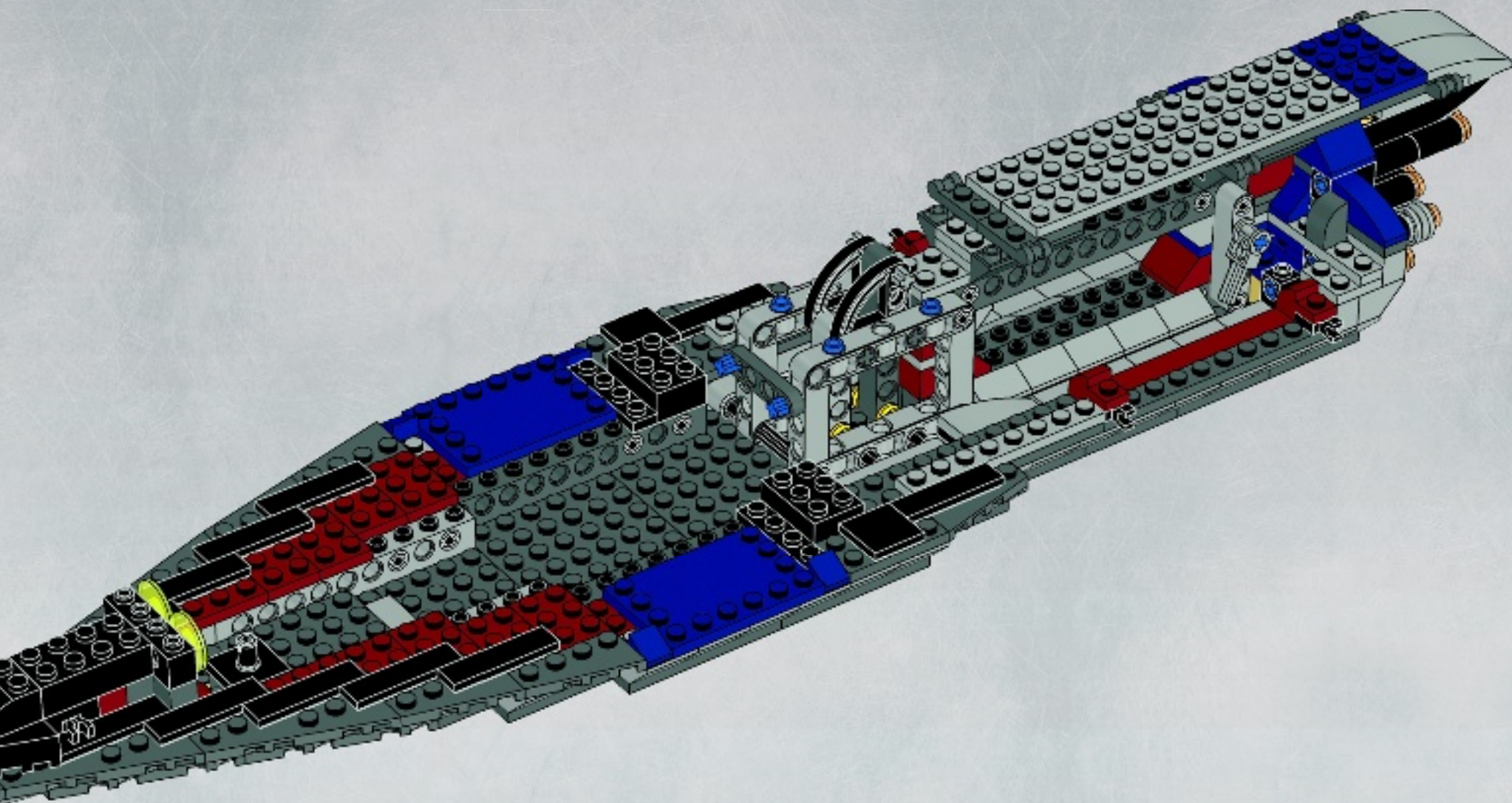

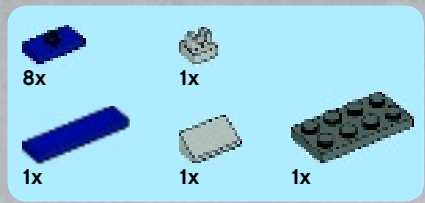

42

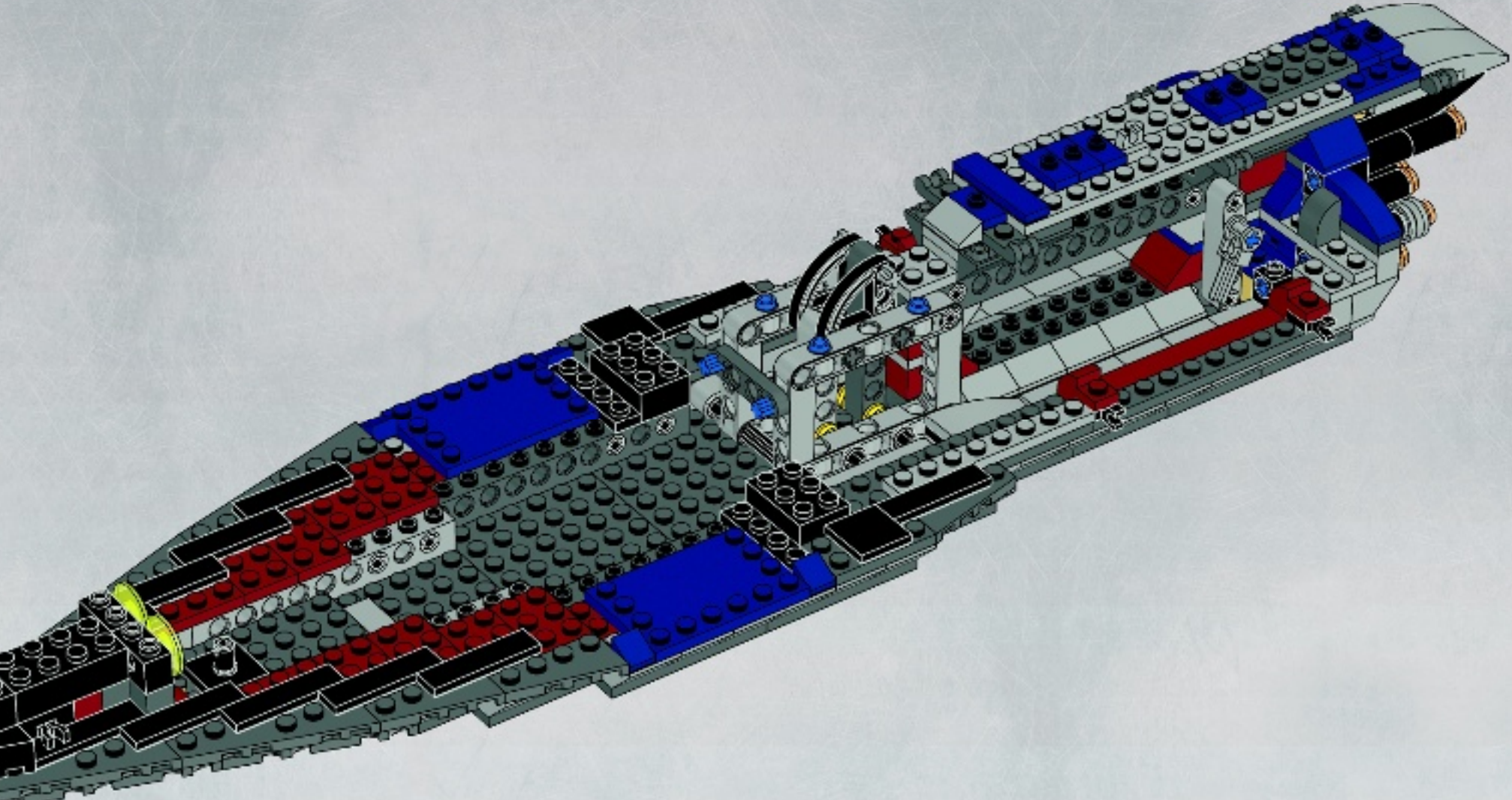



4x



3x

43

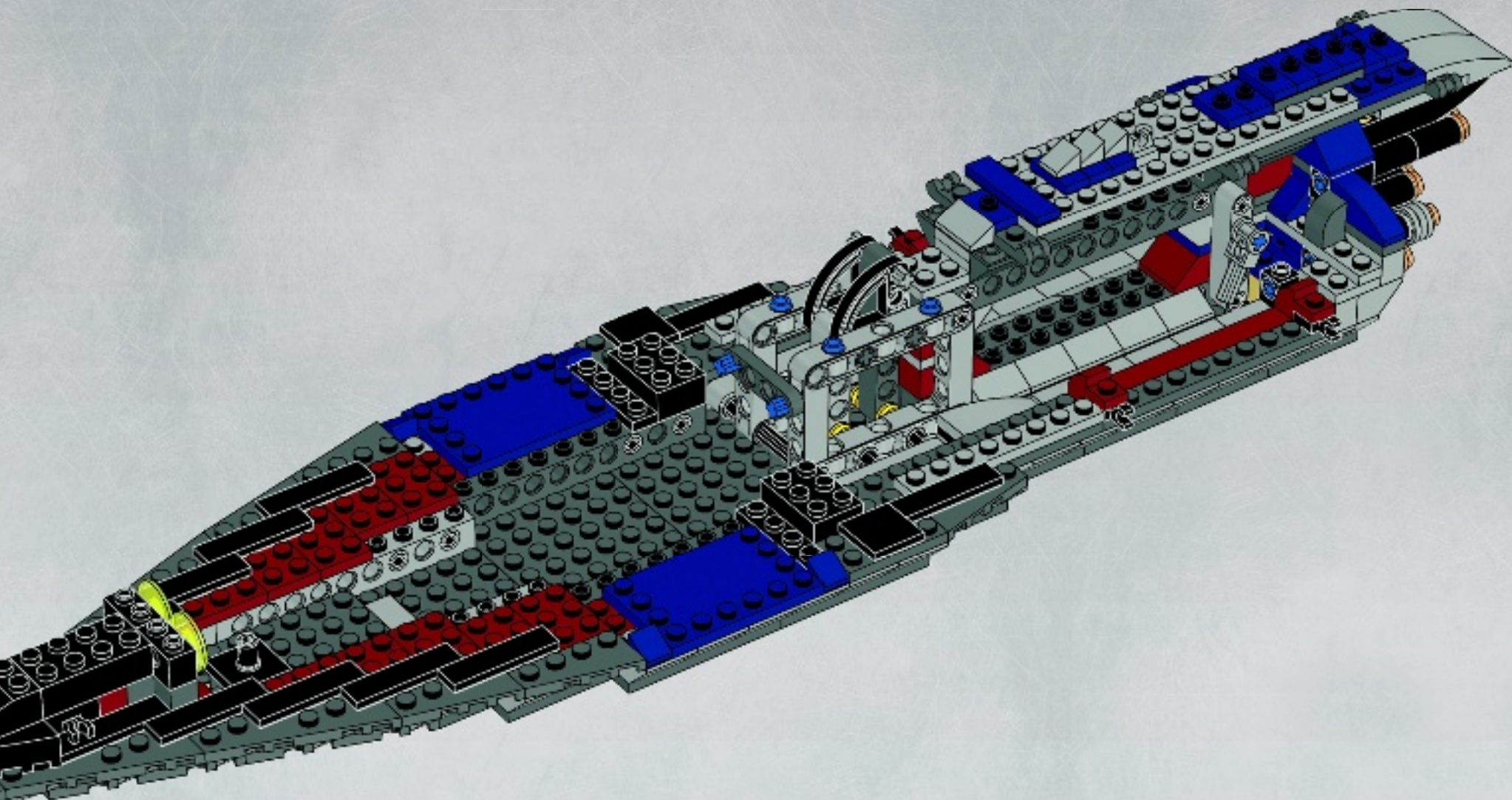

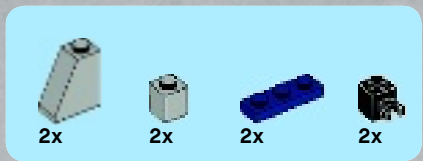

44

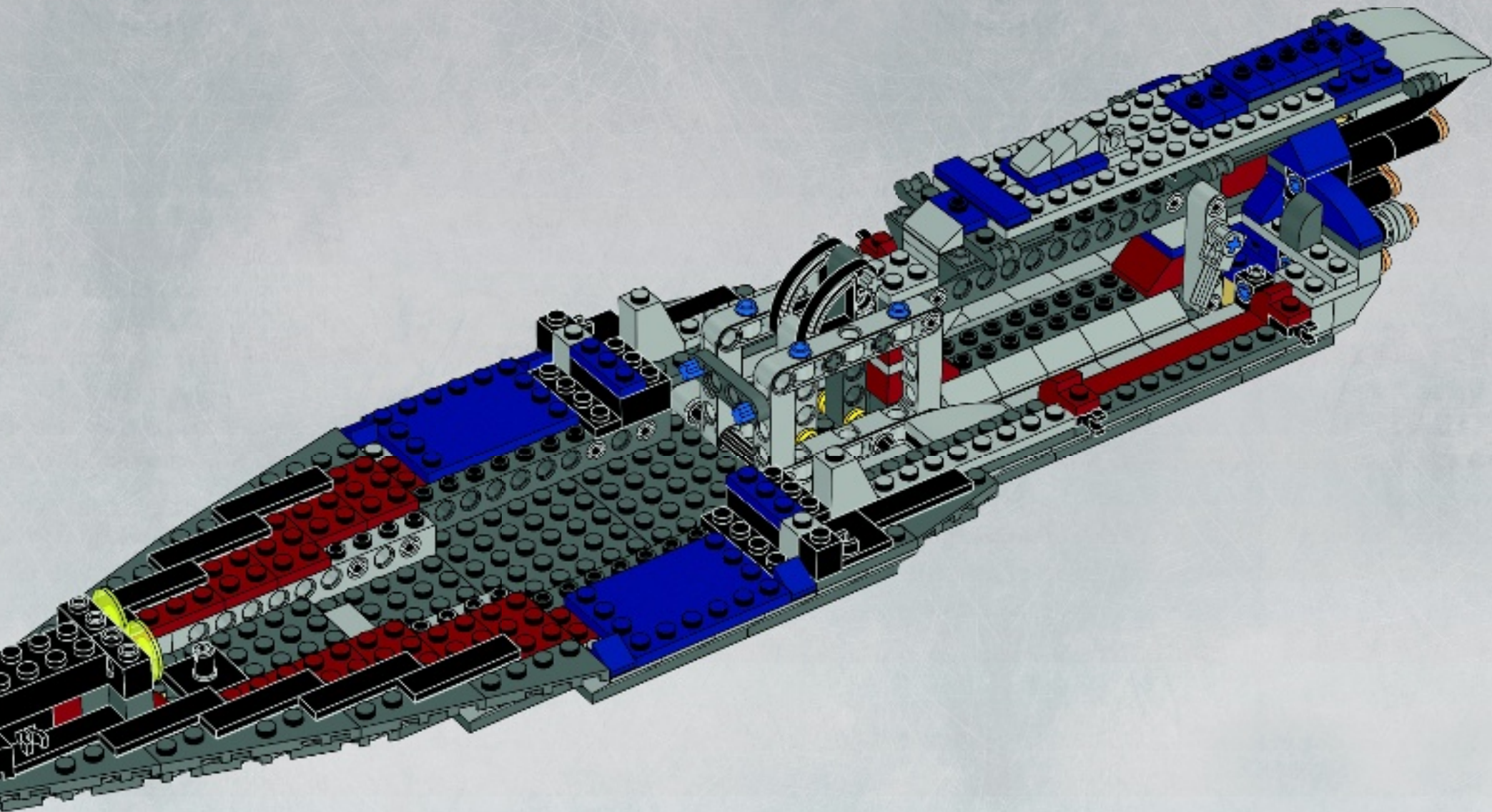

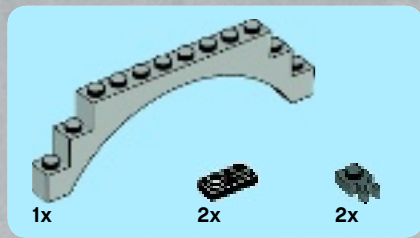

45

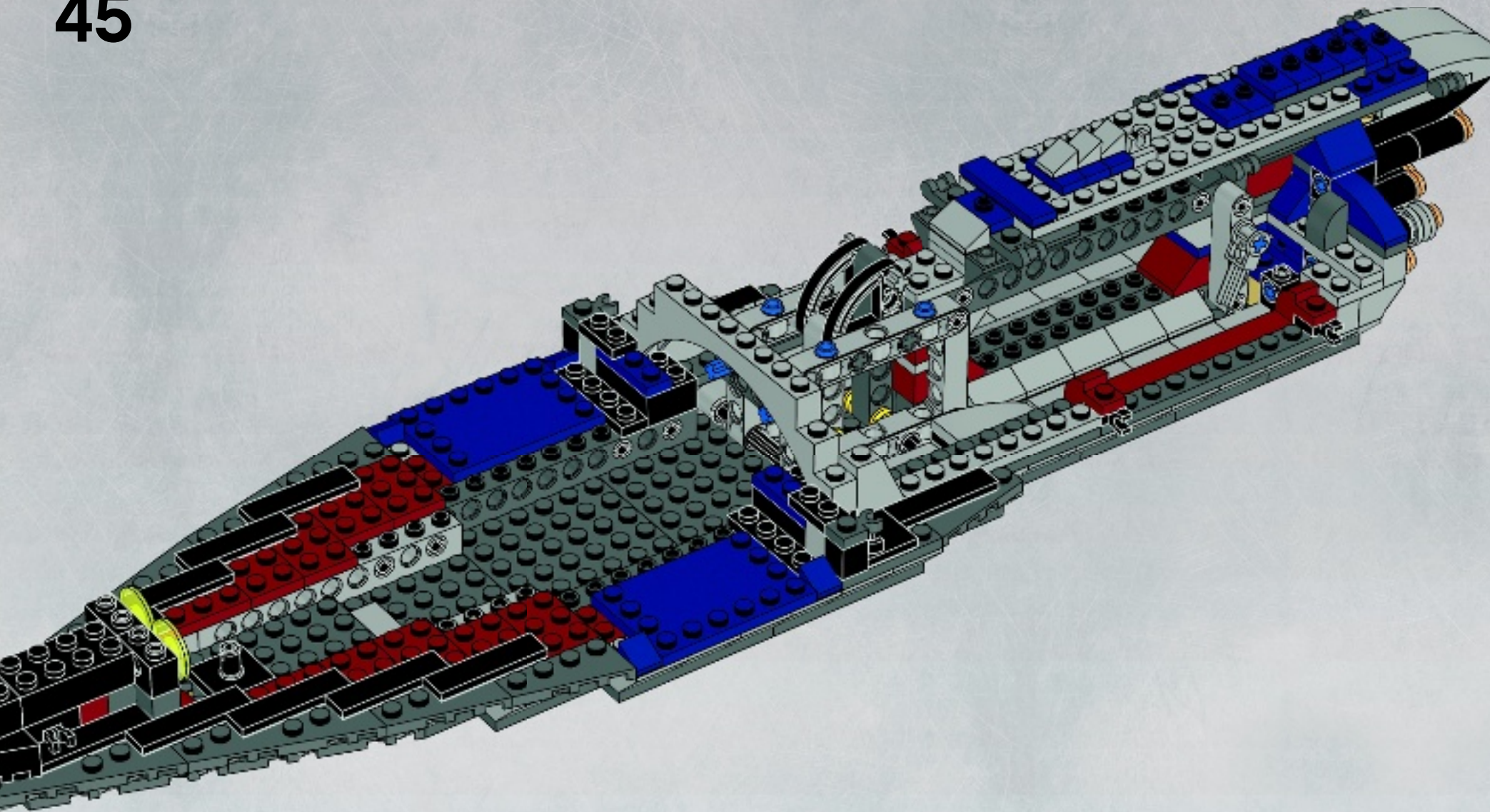

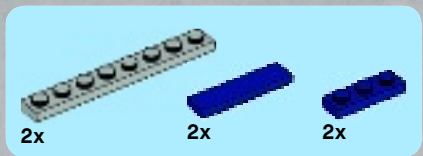

46

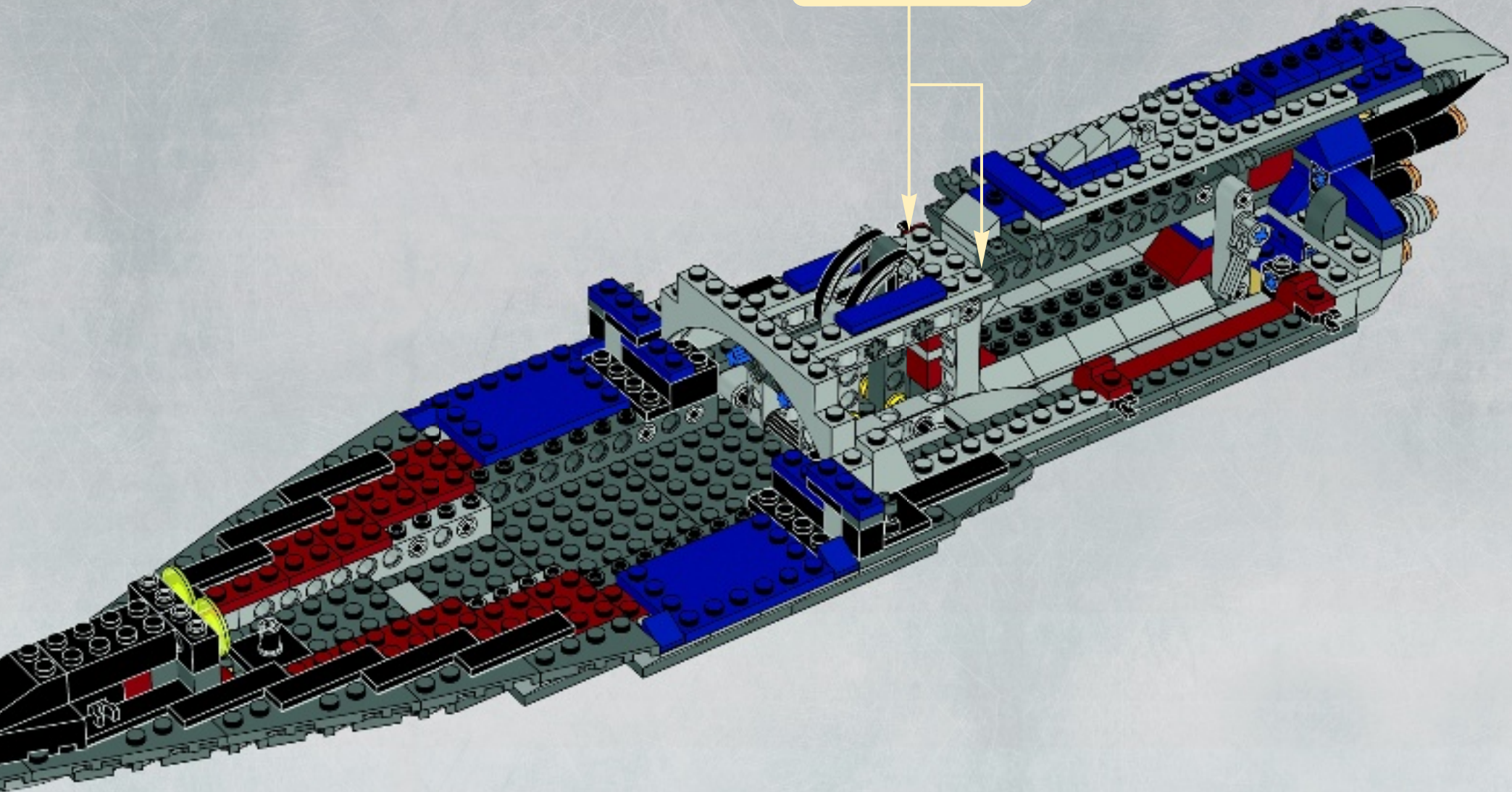
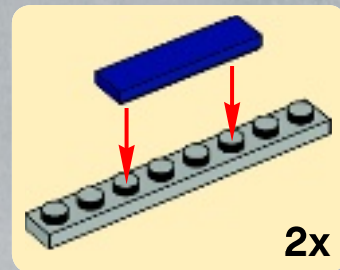

2x 2x 2x

47

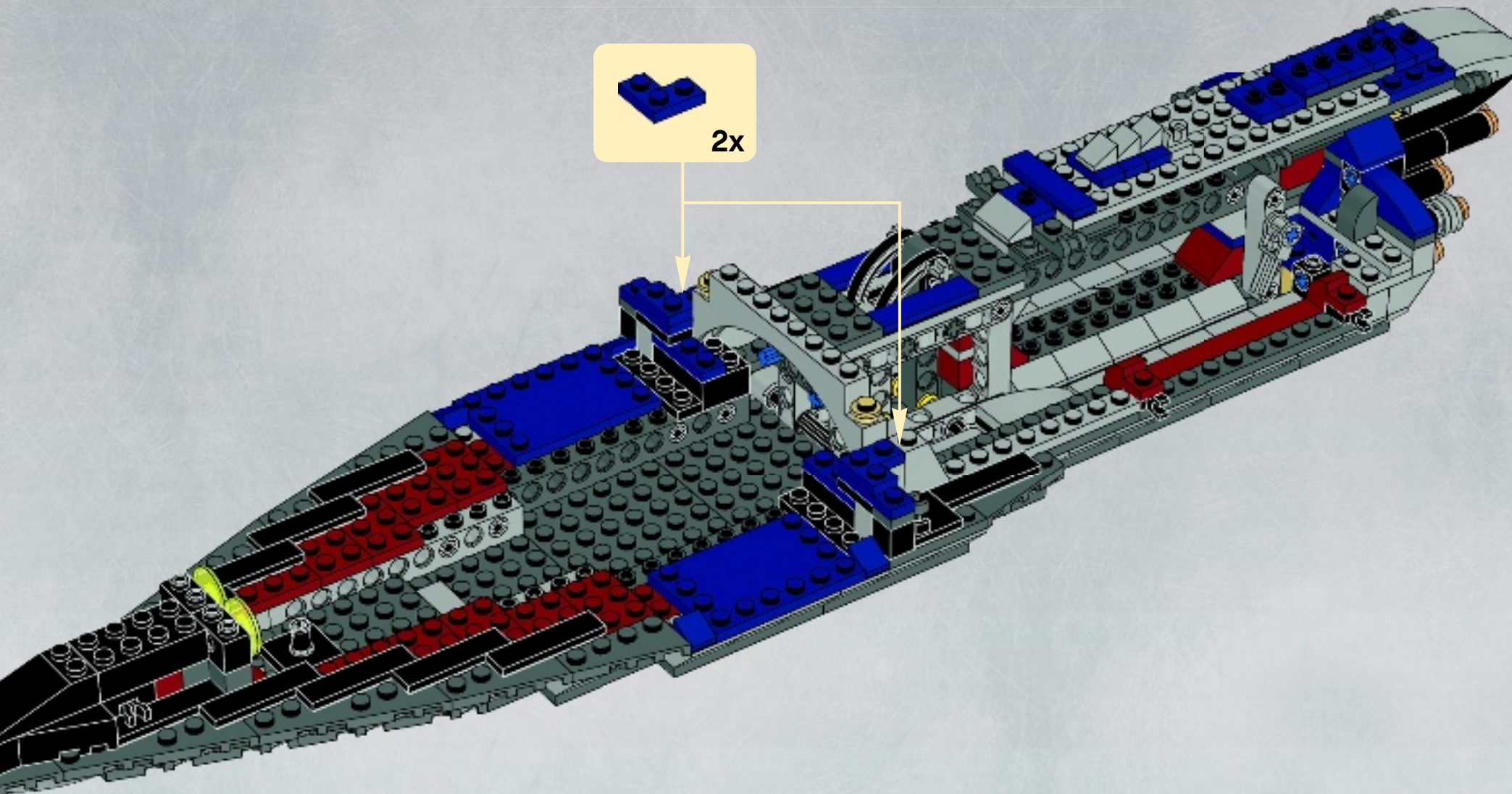

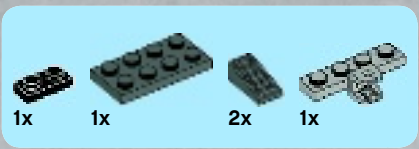

48

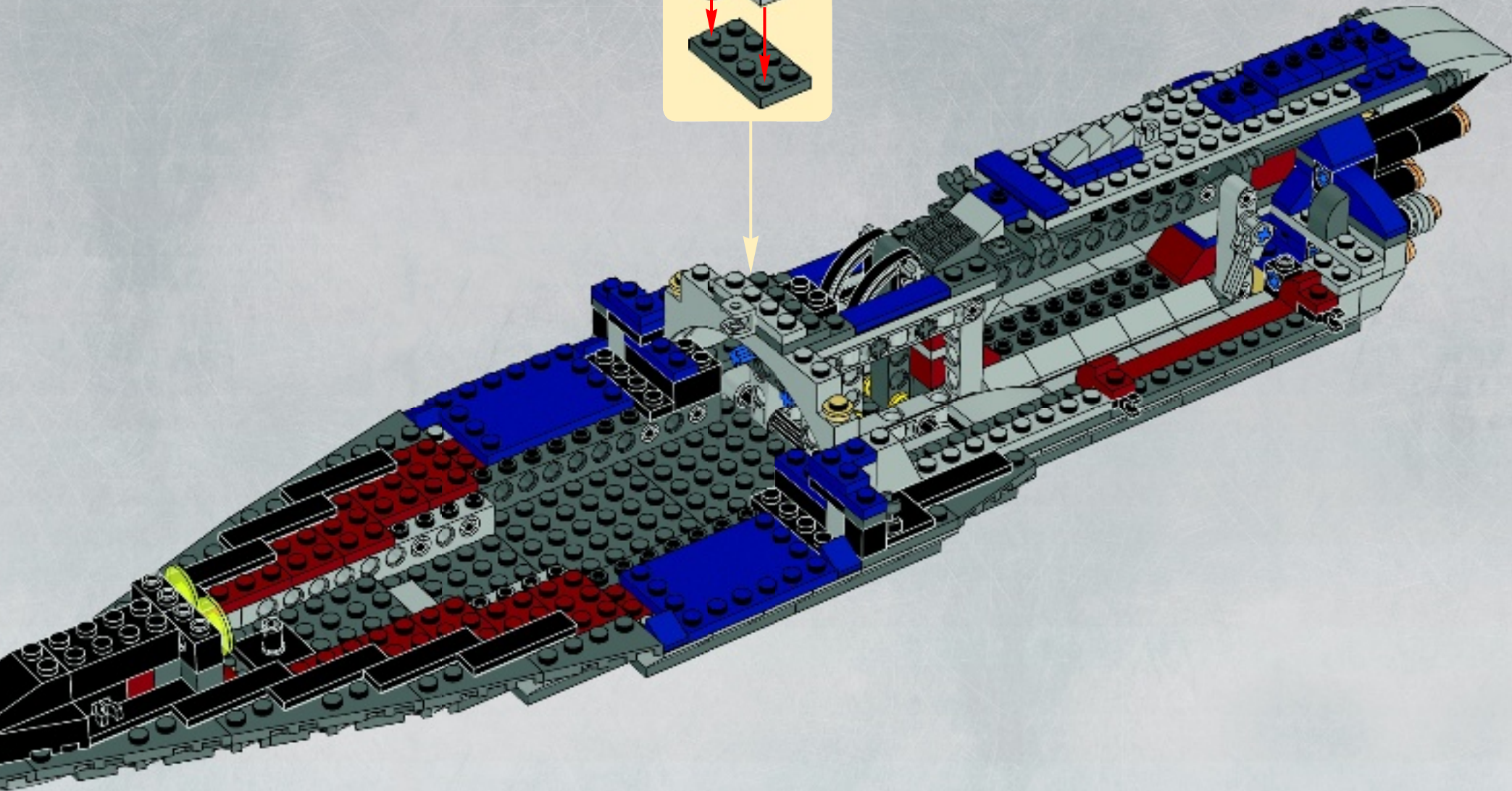
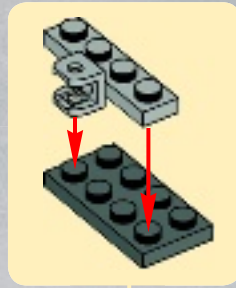

2x  2x 

49

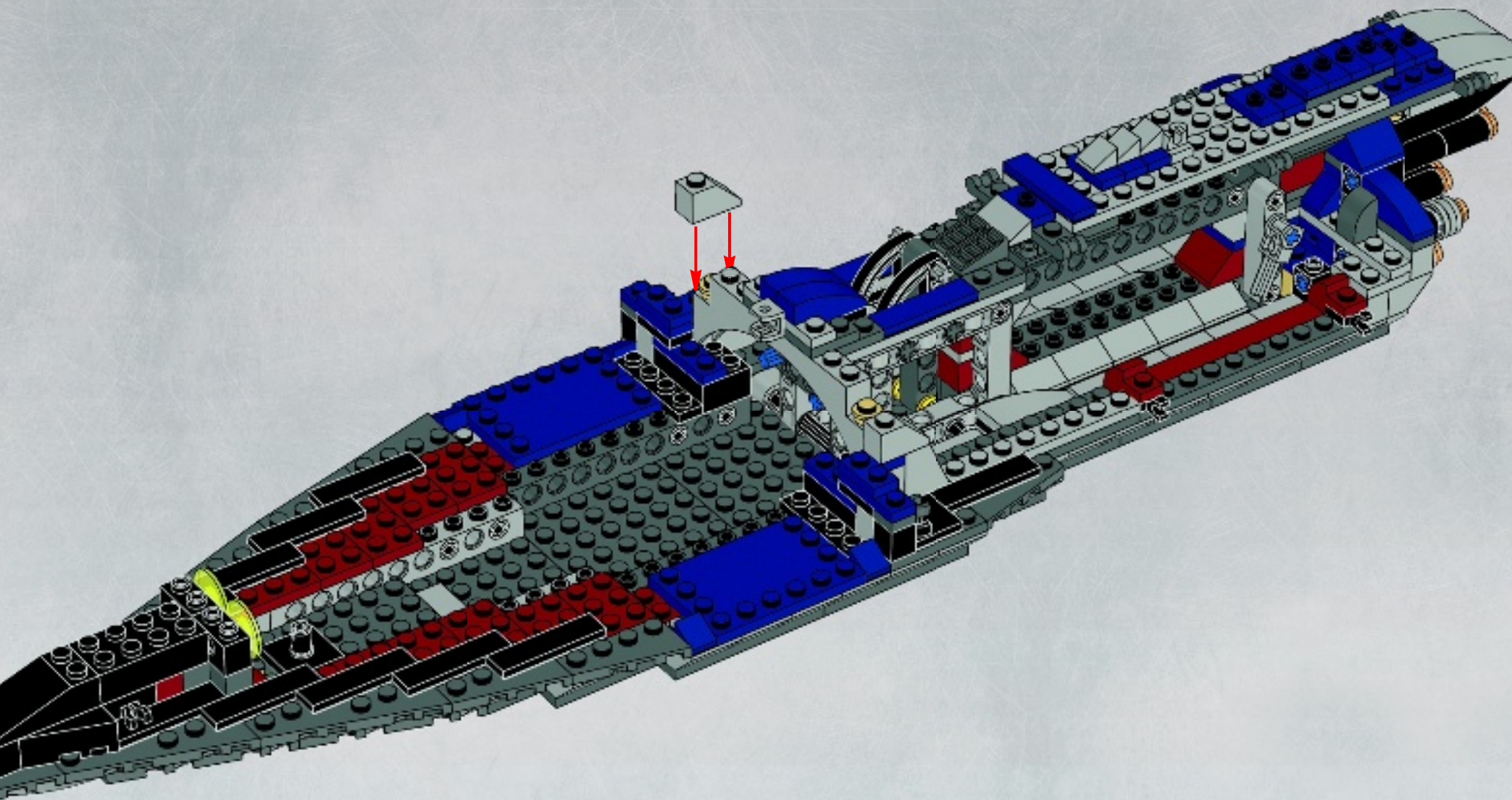



4x

50

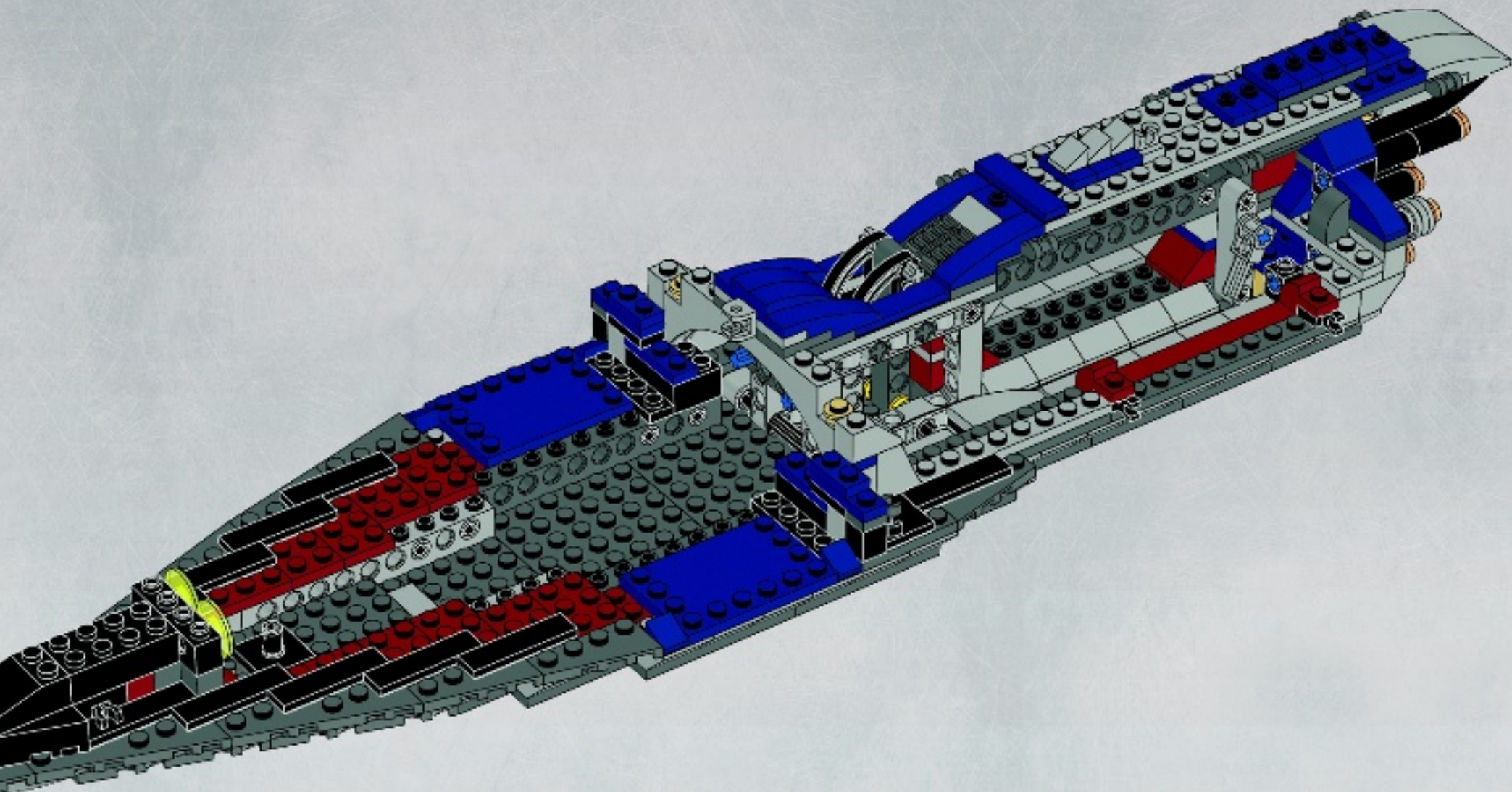

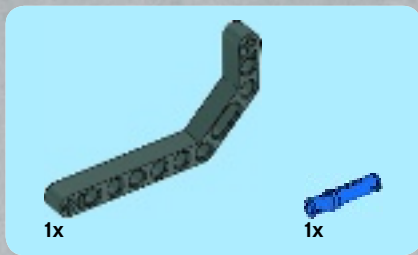

51

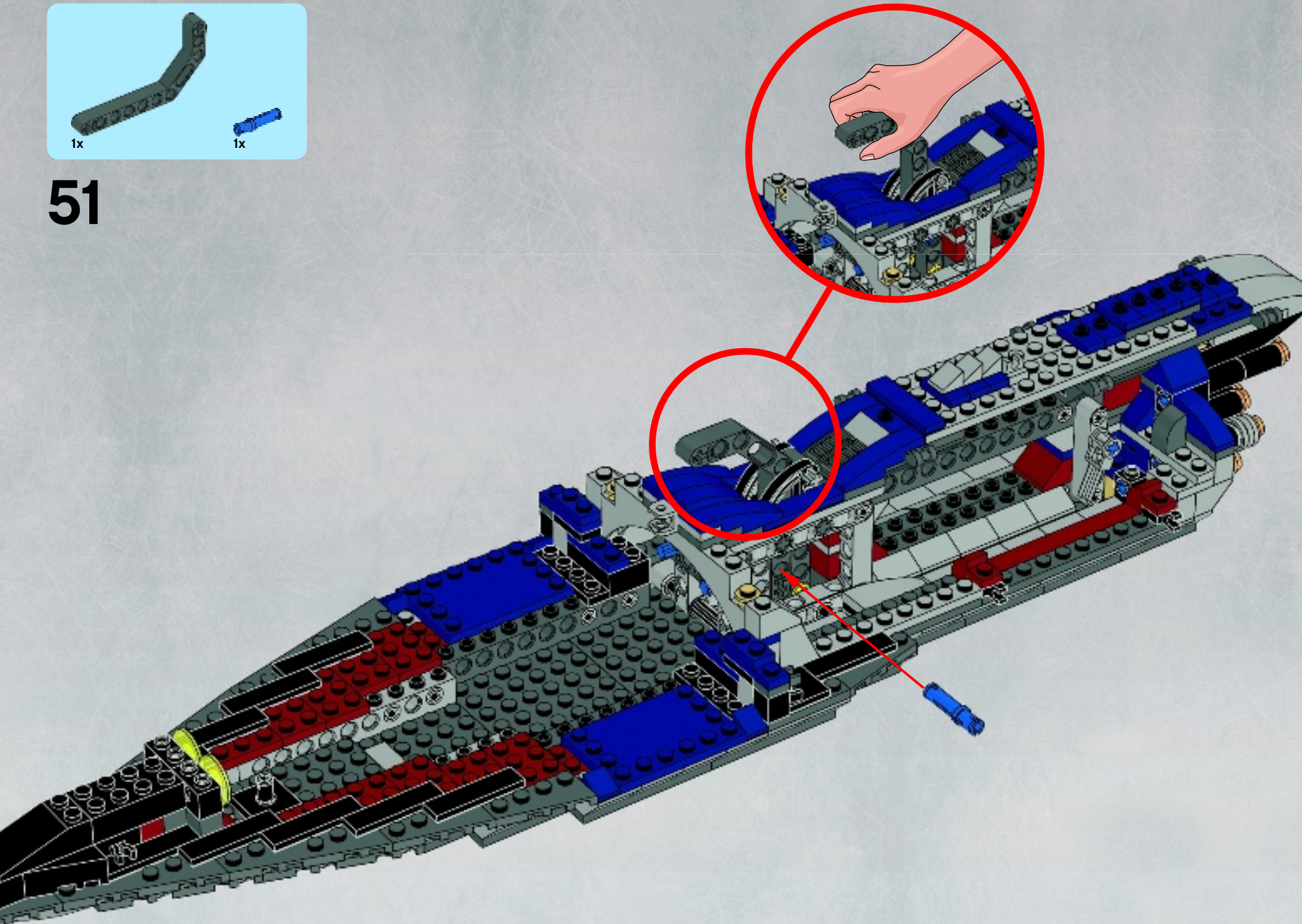

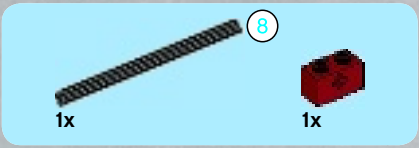

1

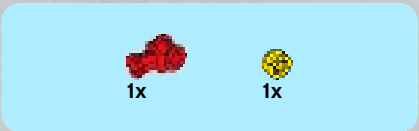
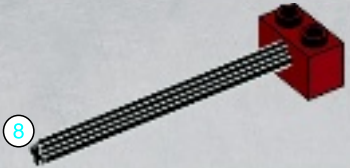

2

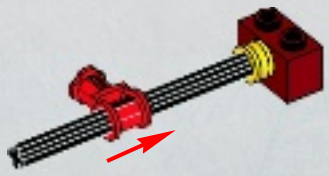

3

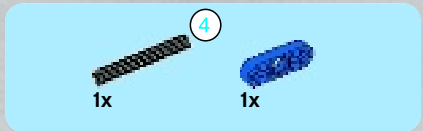
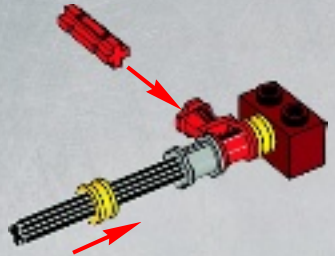

4

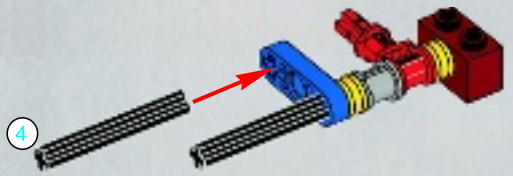

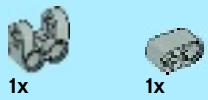

1x

1x

5

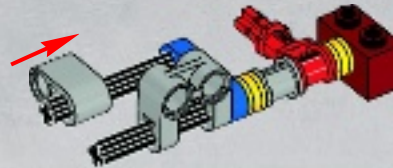

1x

2x

7

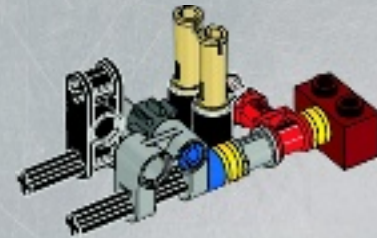

1x

1x

1x

6

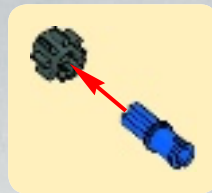

1x

1x

8

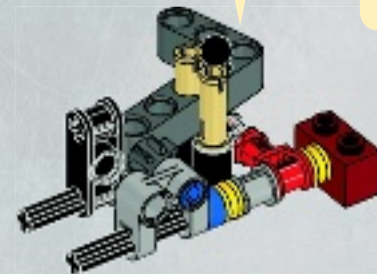
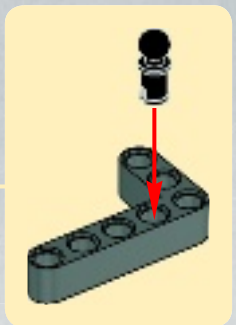



9

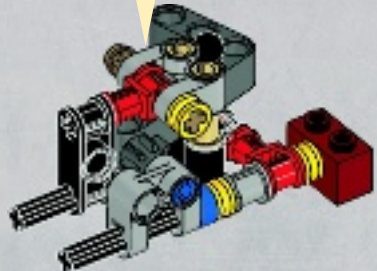
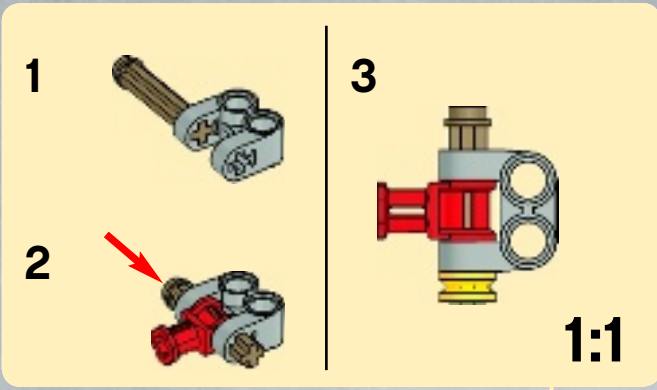

10

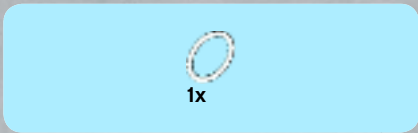
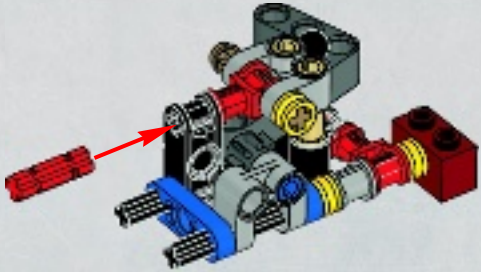

11

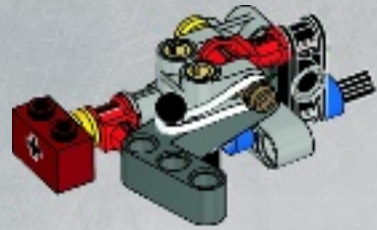

12

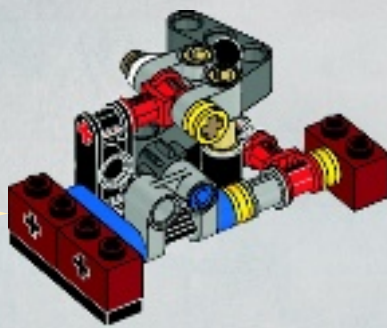
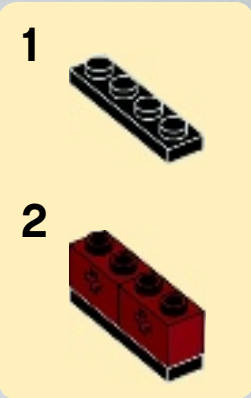

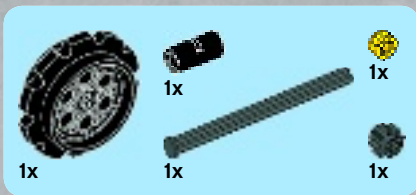

13

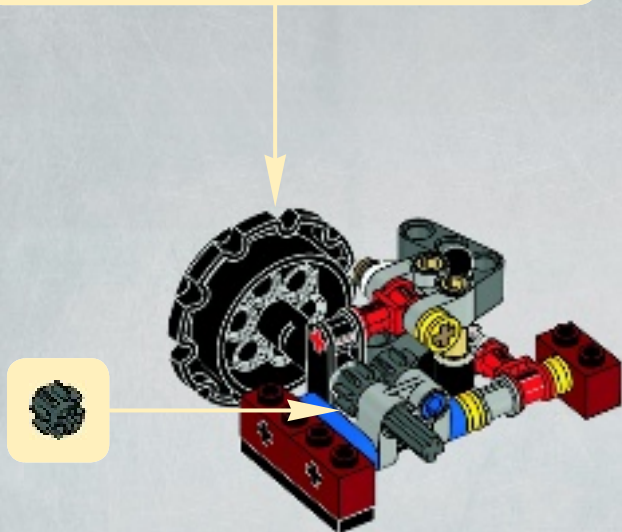
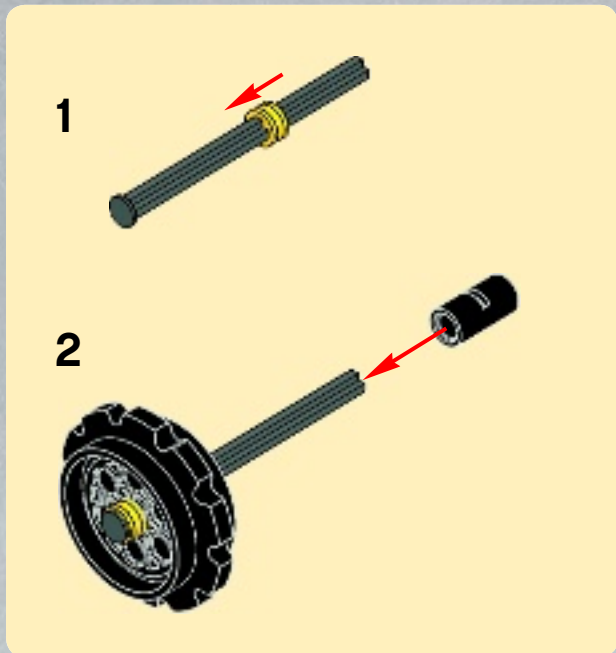

14

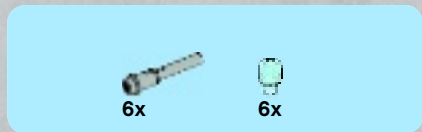
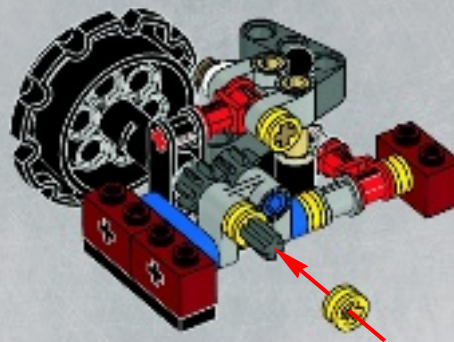

15

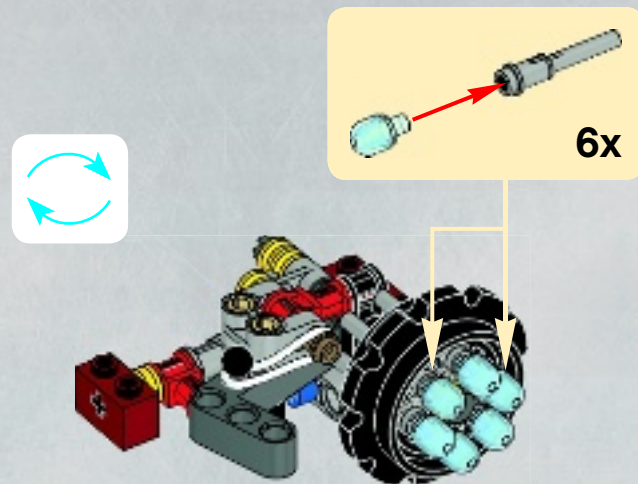

52

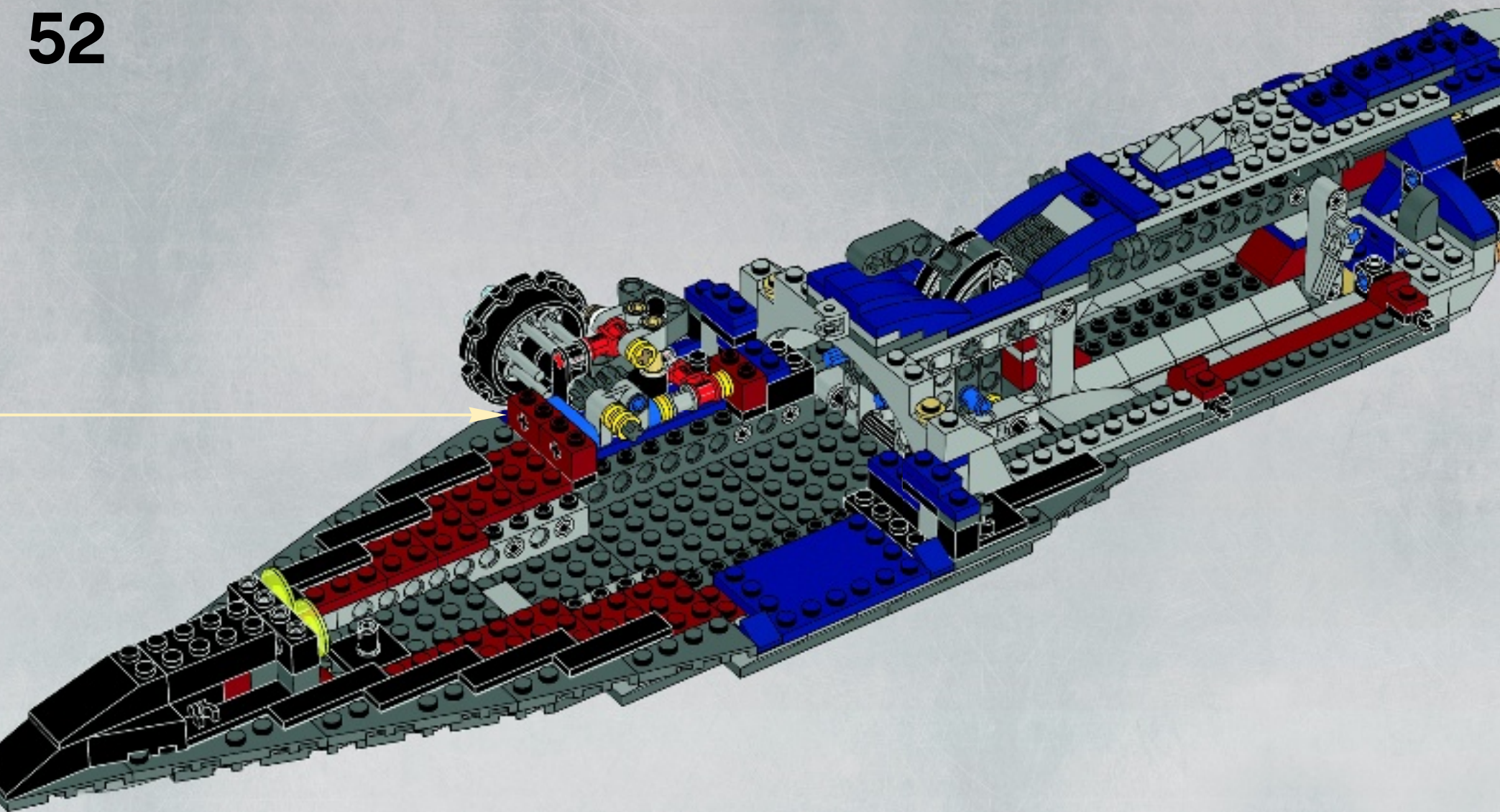

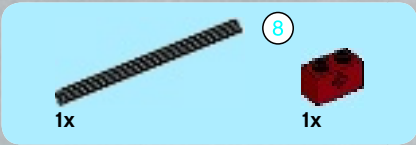

1

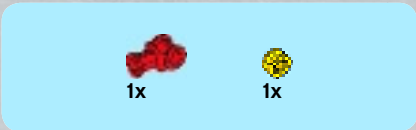

2

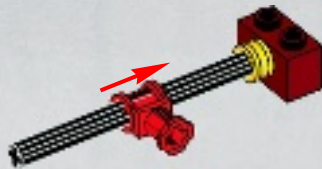

3

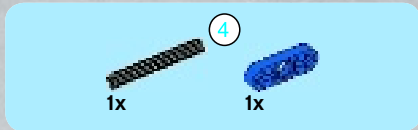
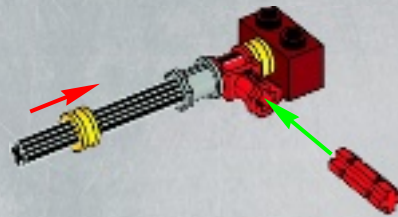

4

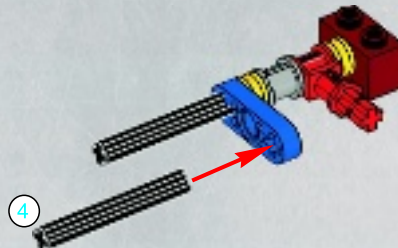



1x



1x

5

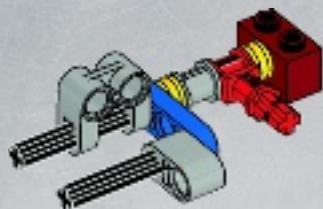

1x



2x

7



1x



1x



1x

6

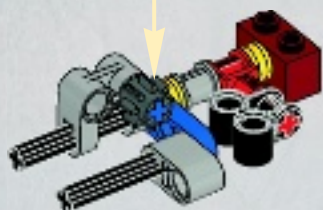
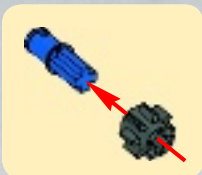

1x



1x

8

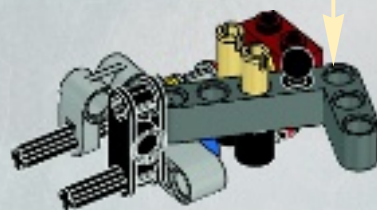
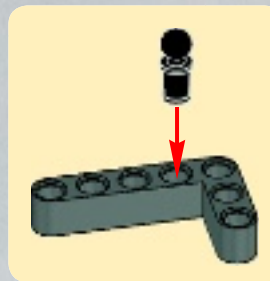



9

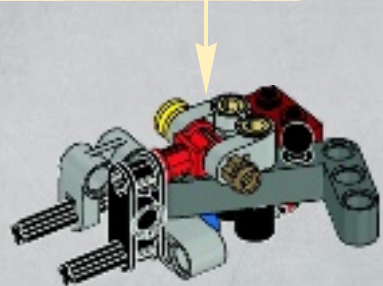
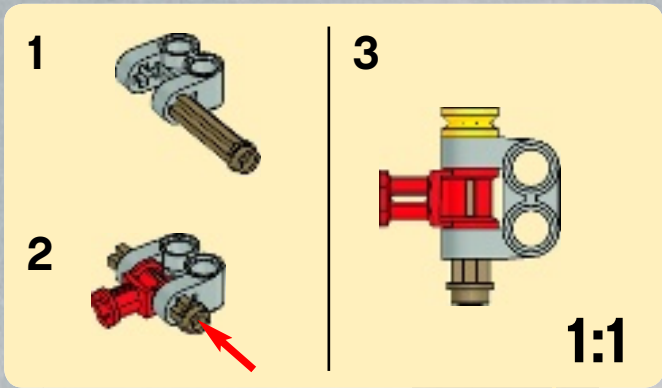

10

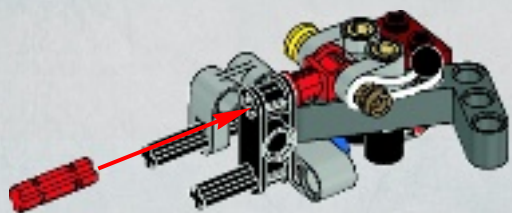

11

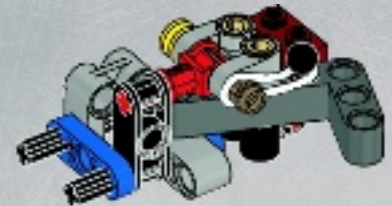

12

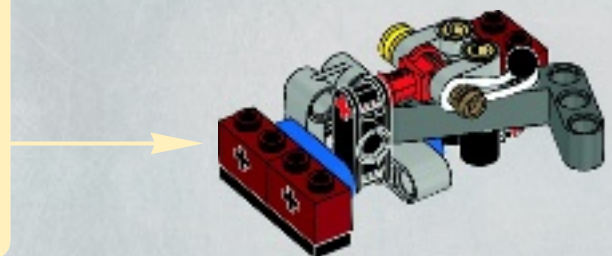
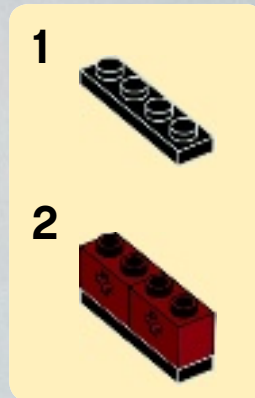

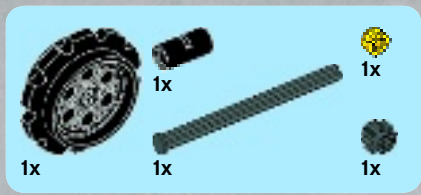

13

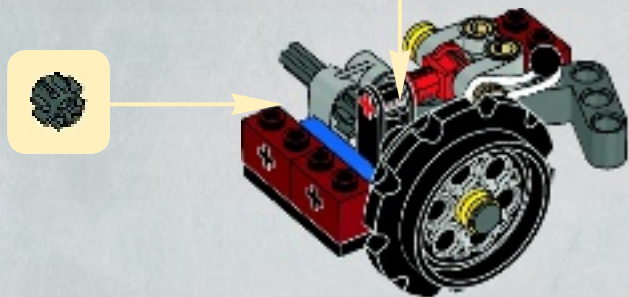
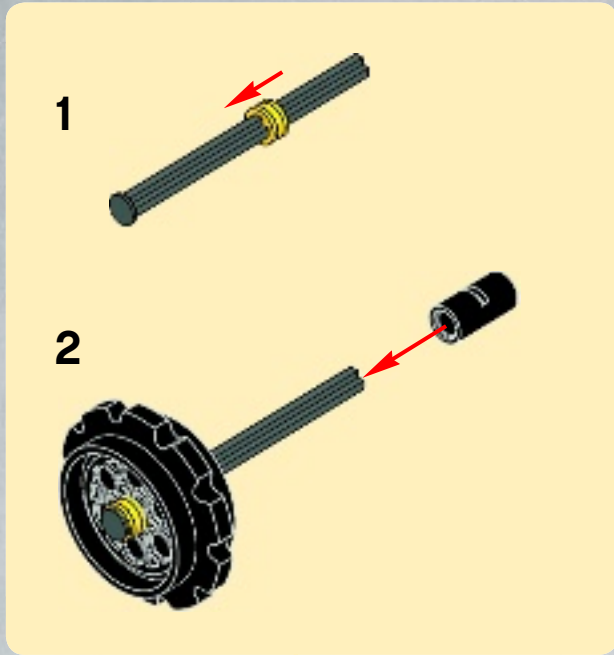

14

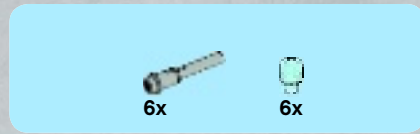
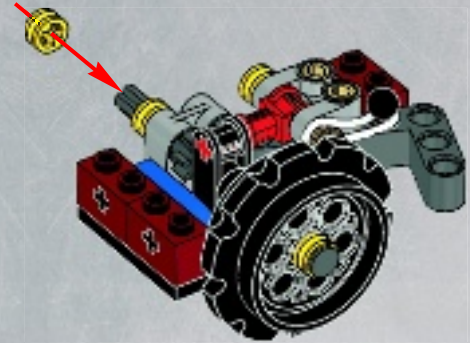

15

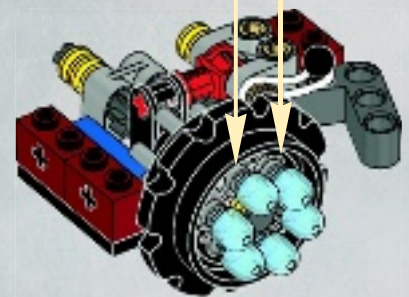
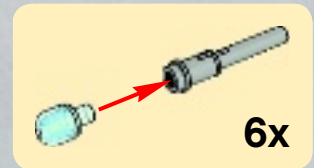

53

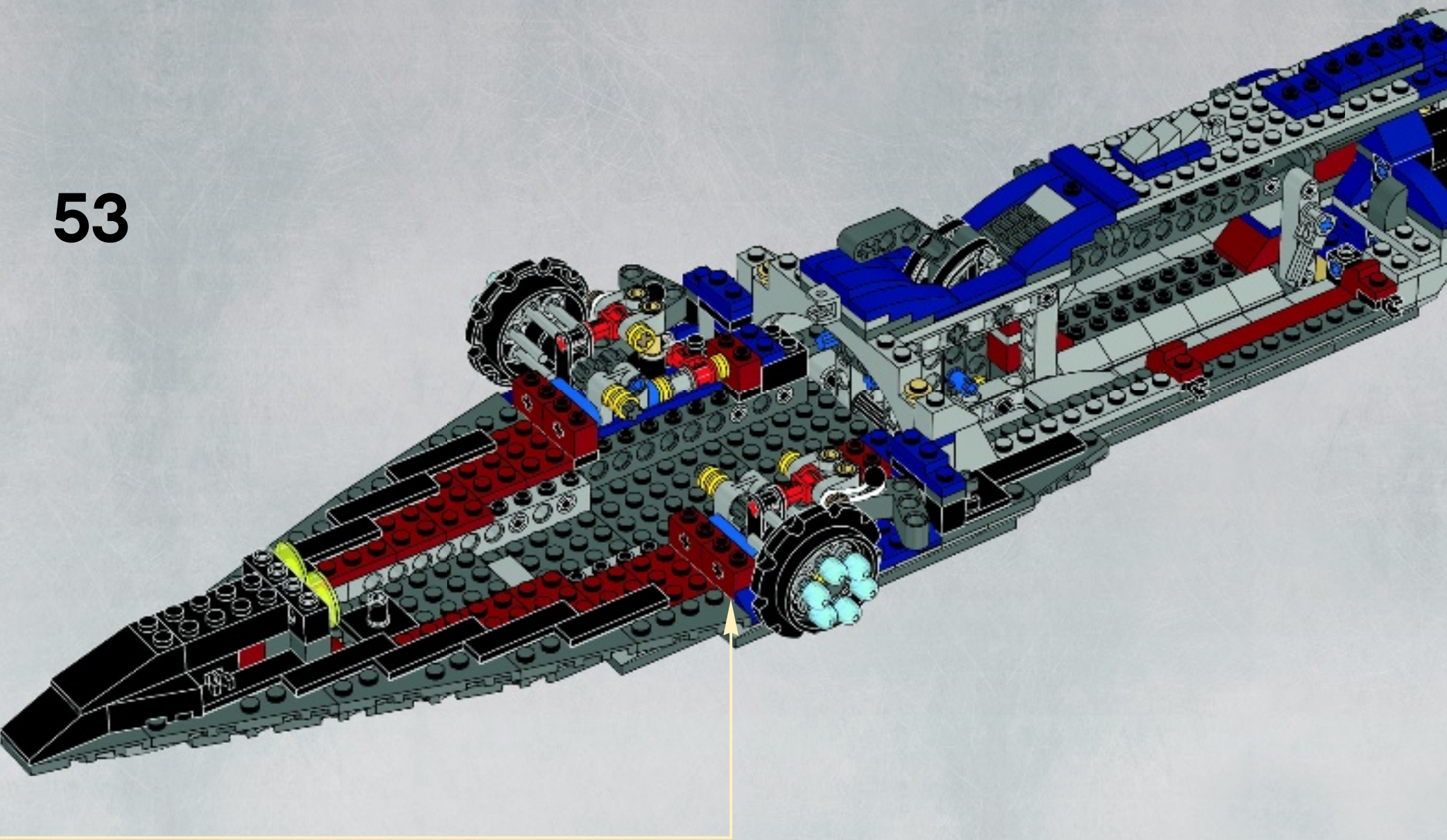



2x



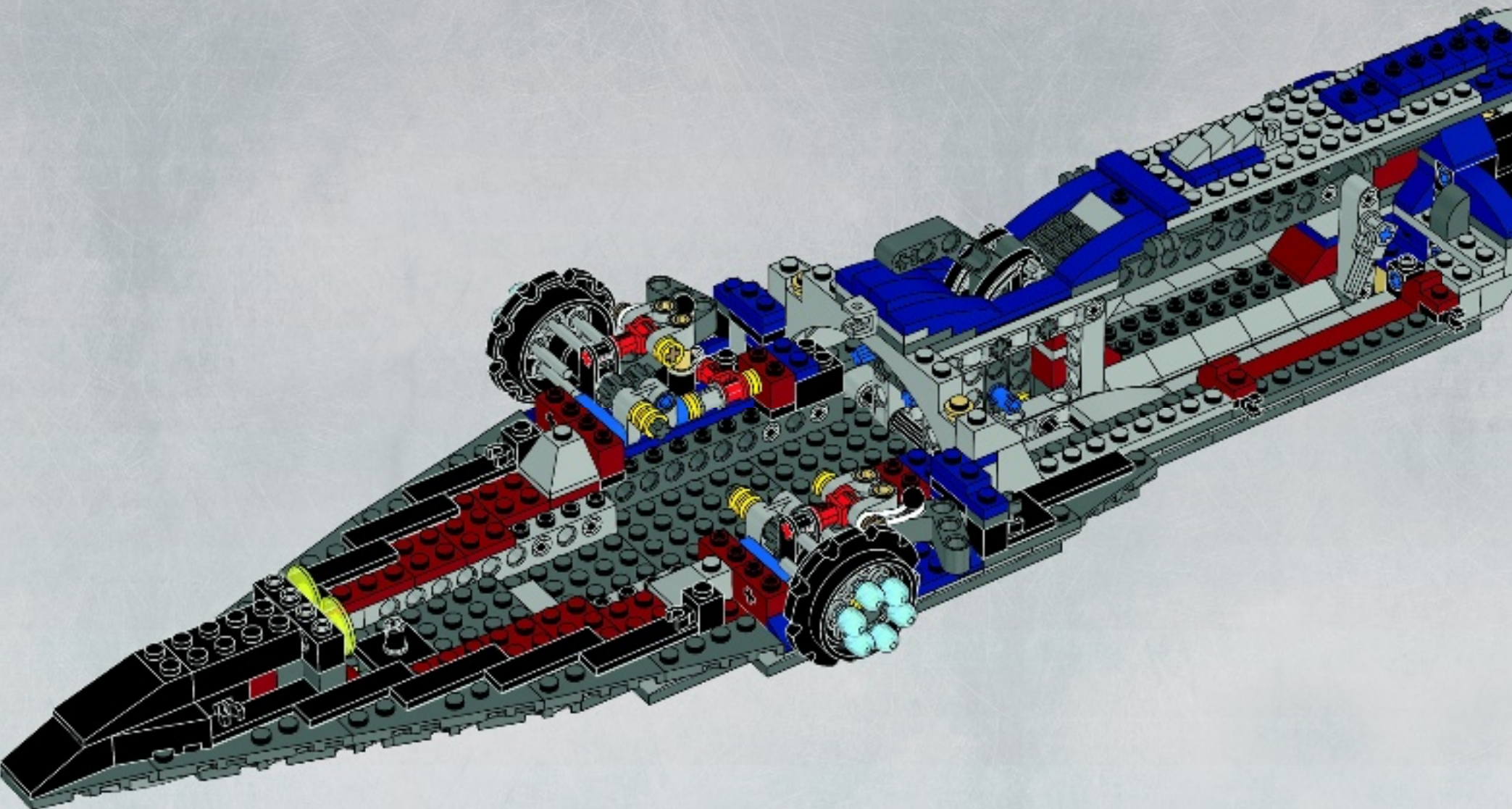

2x

54



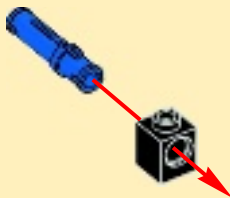

2x  2x  2x 

55

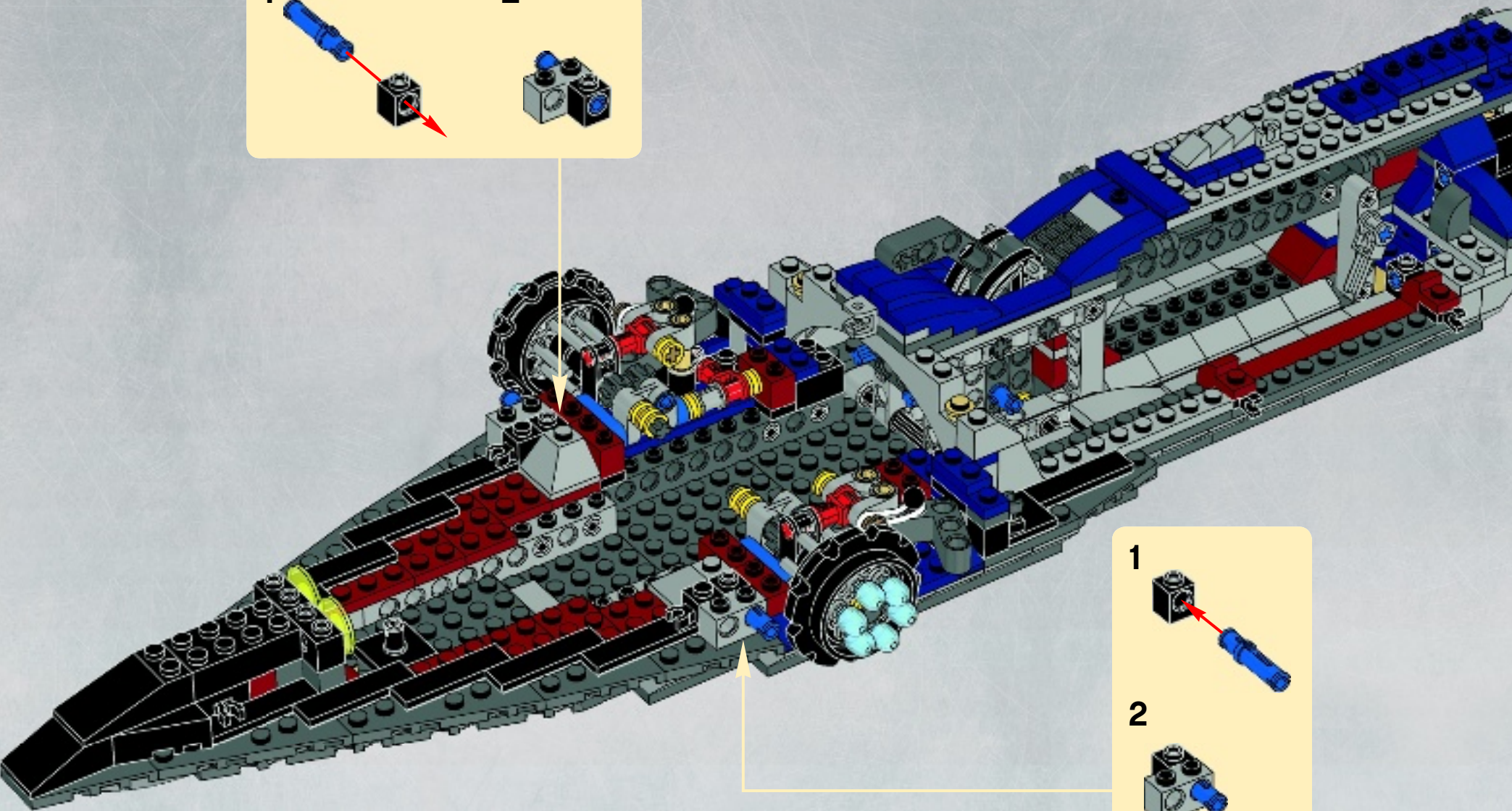
1  2 



1   2 



2x



2x



2x

56

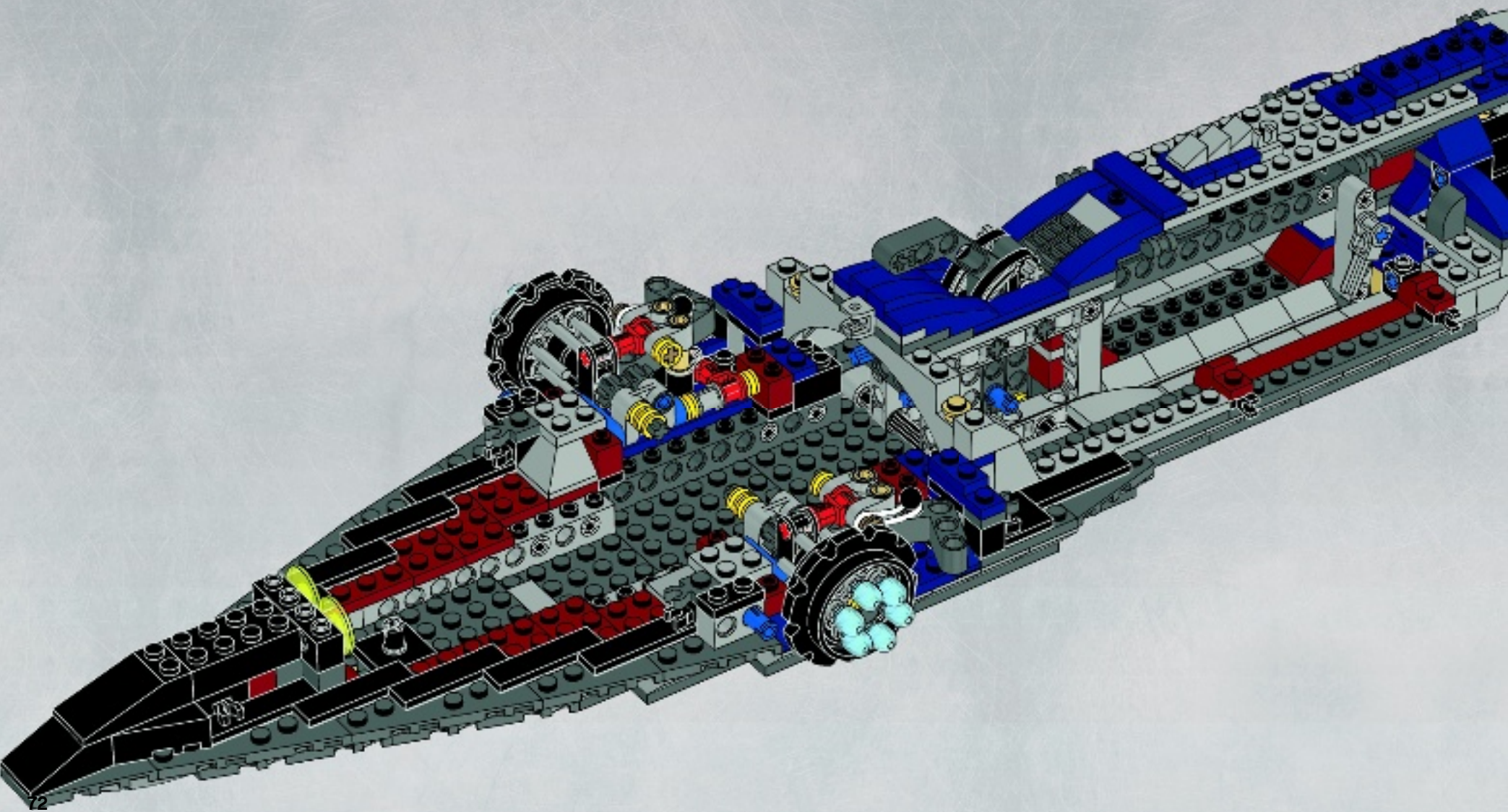



2x

57

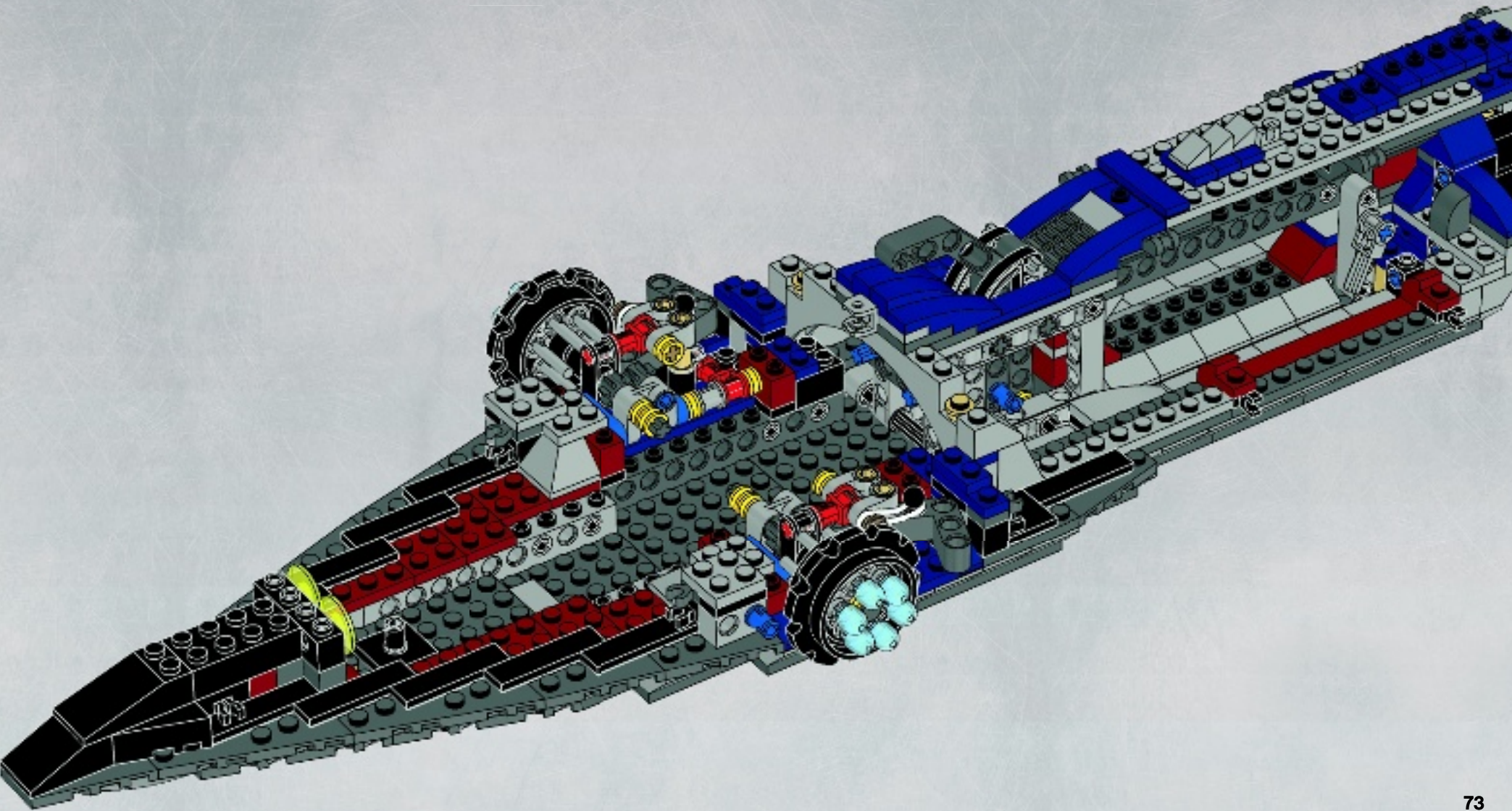



2x



2x

58

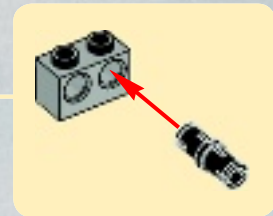
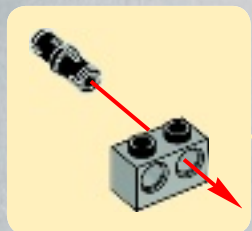
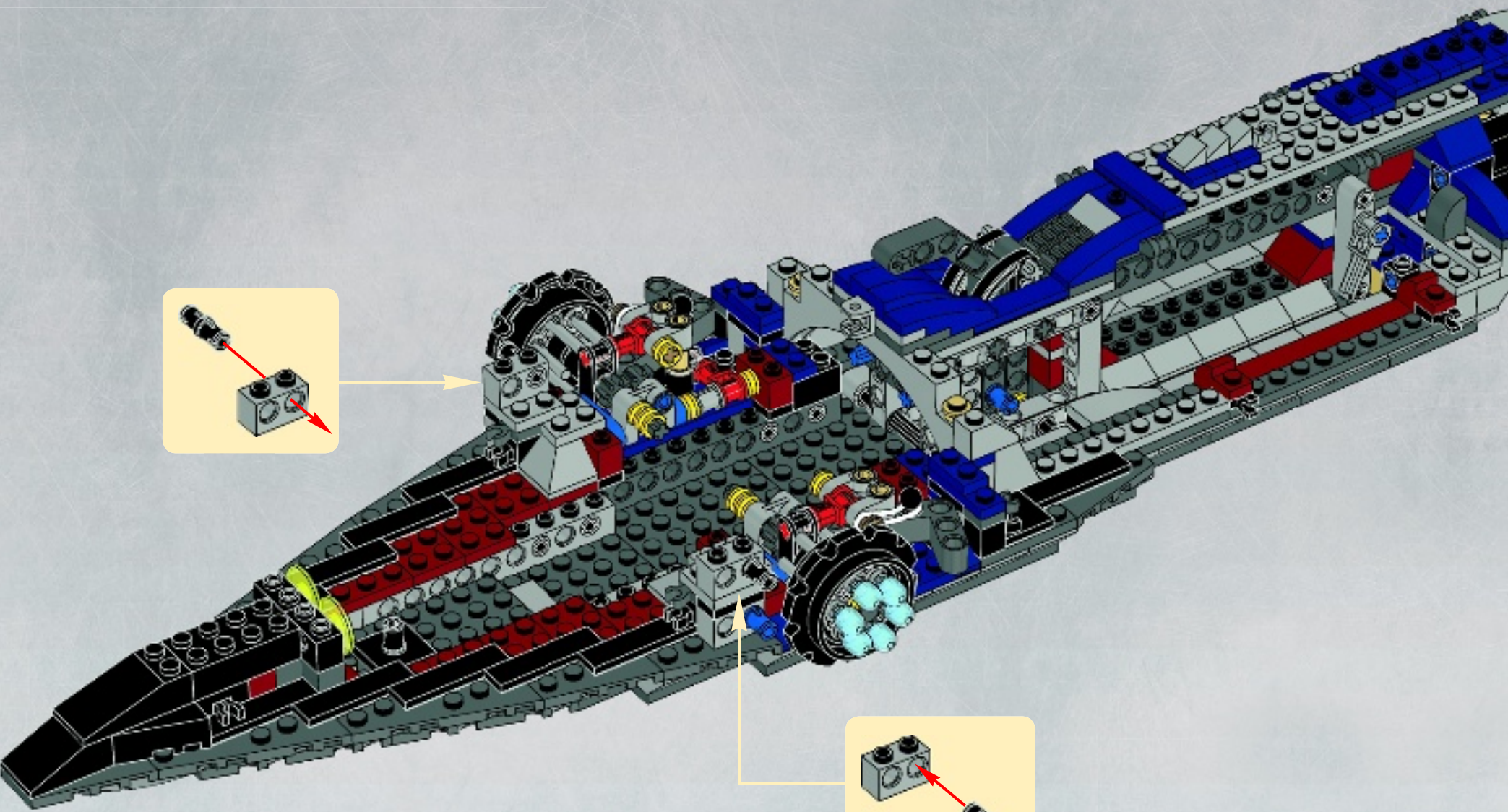



2x

59



2x

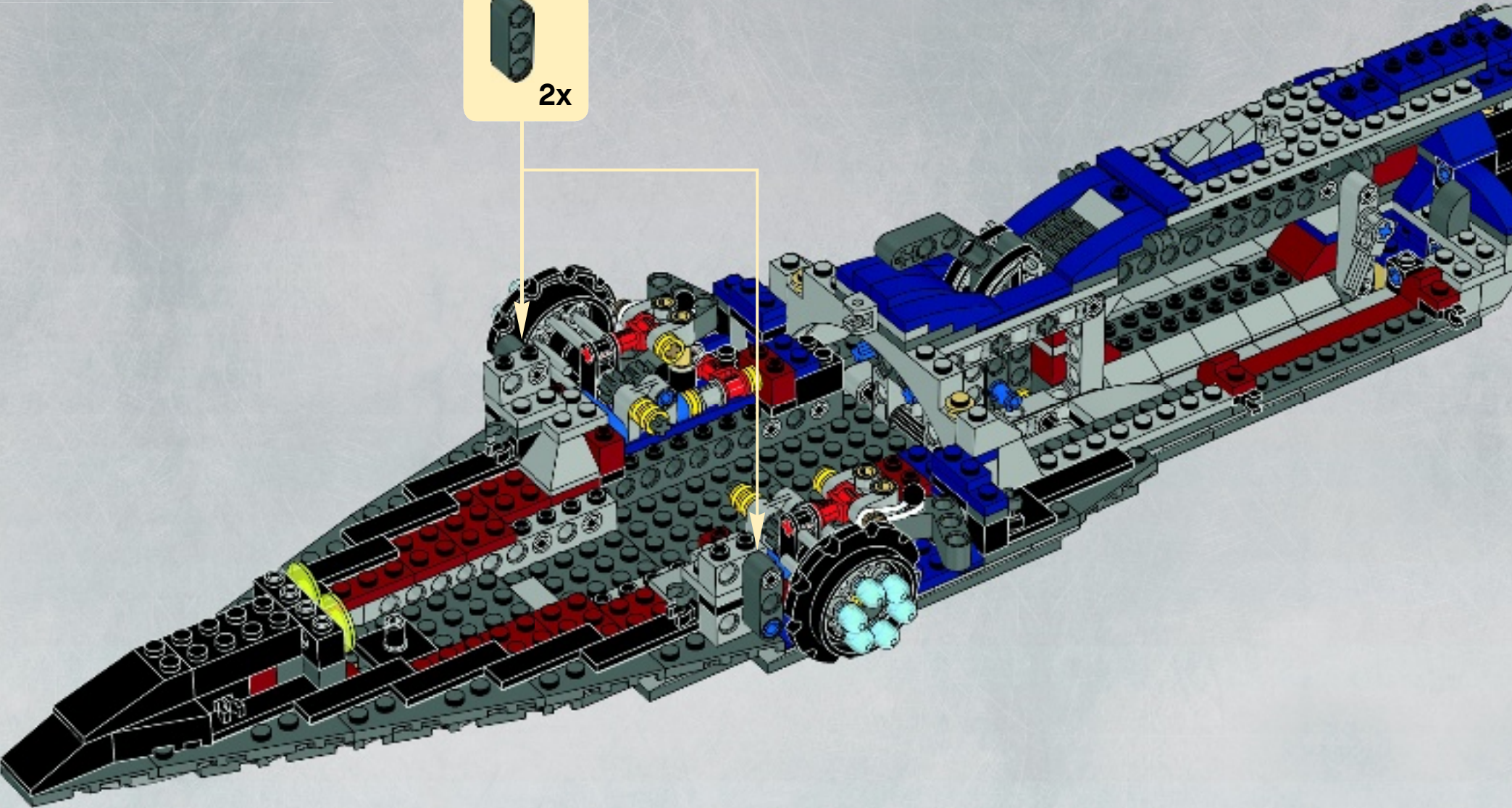



60

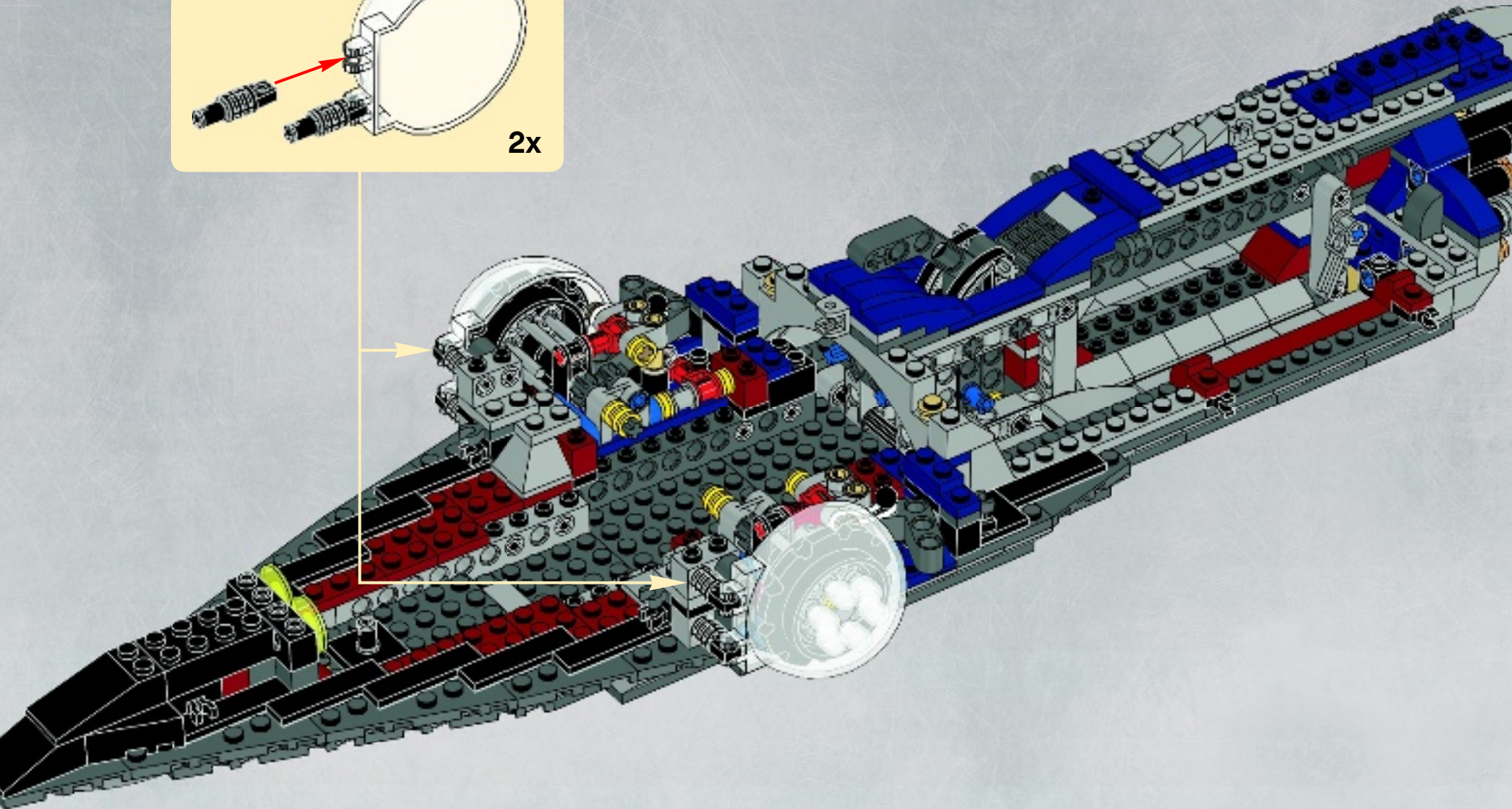
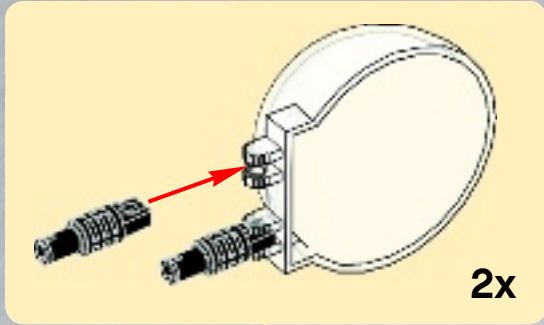

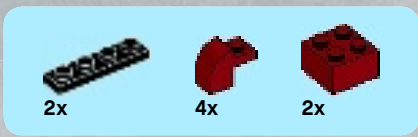
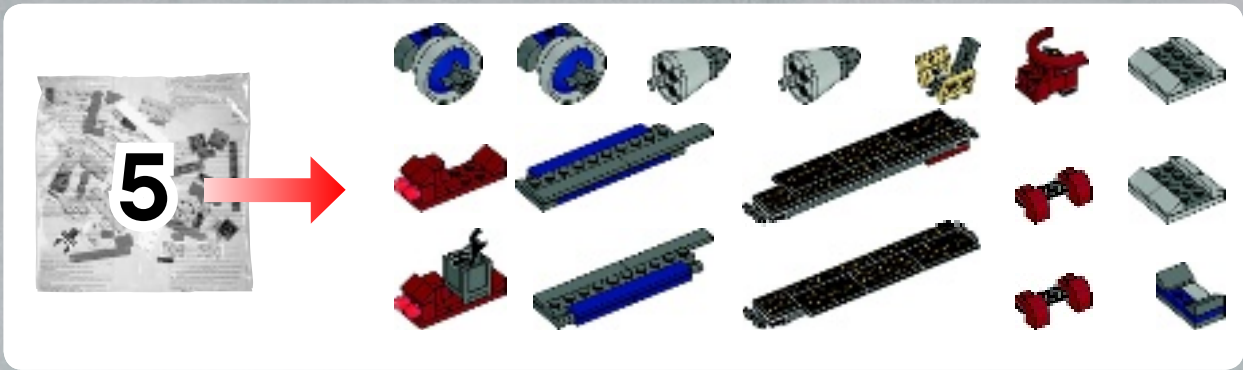

61

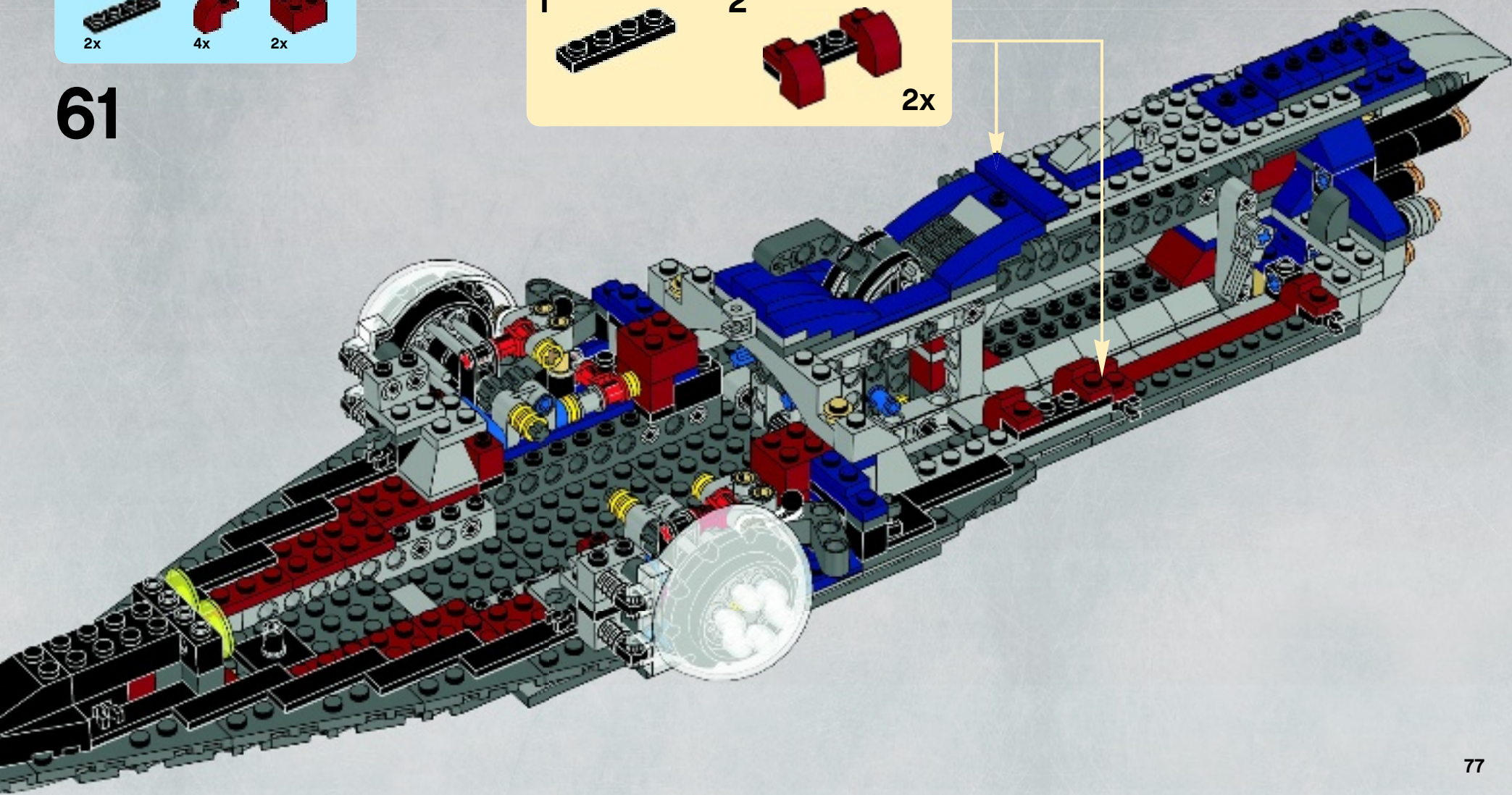

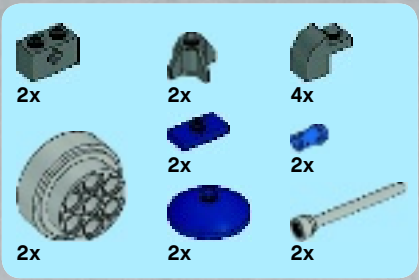

62

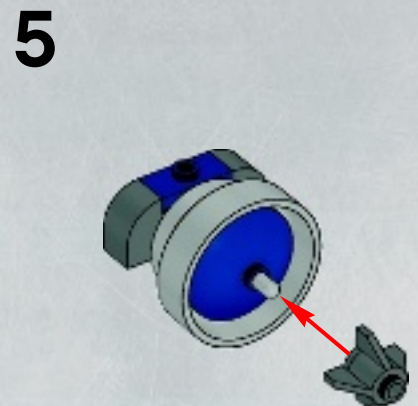
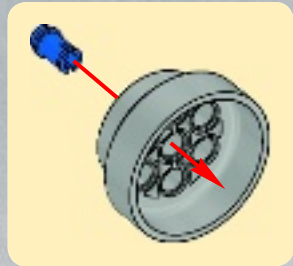
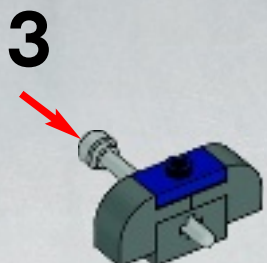

2x

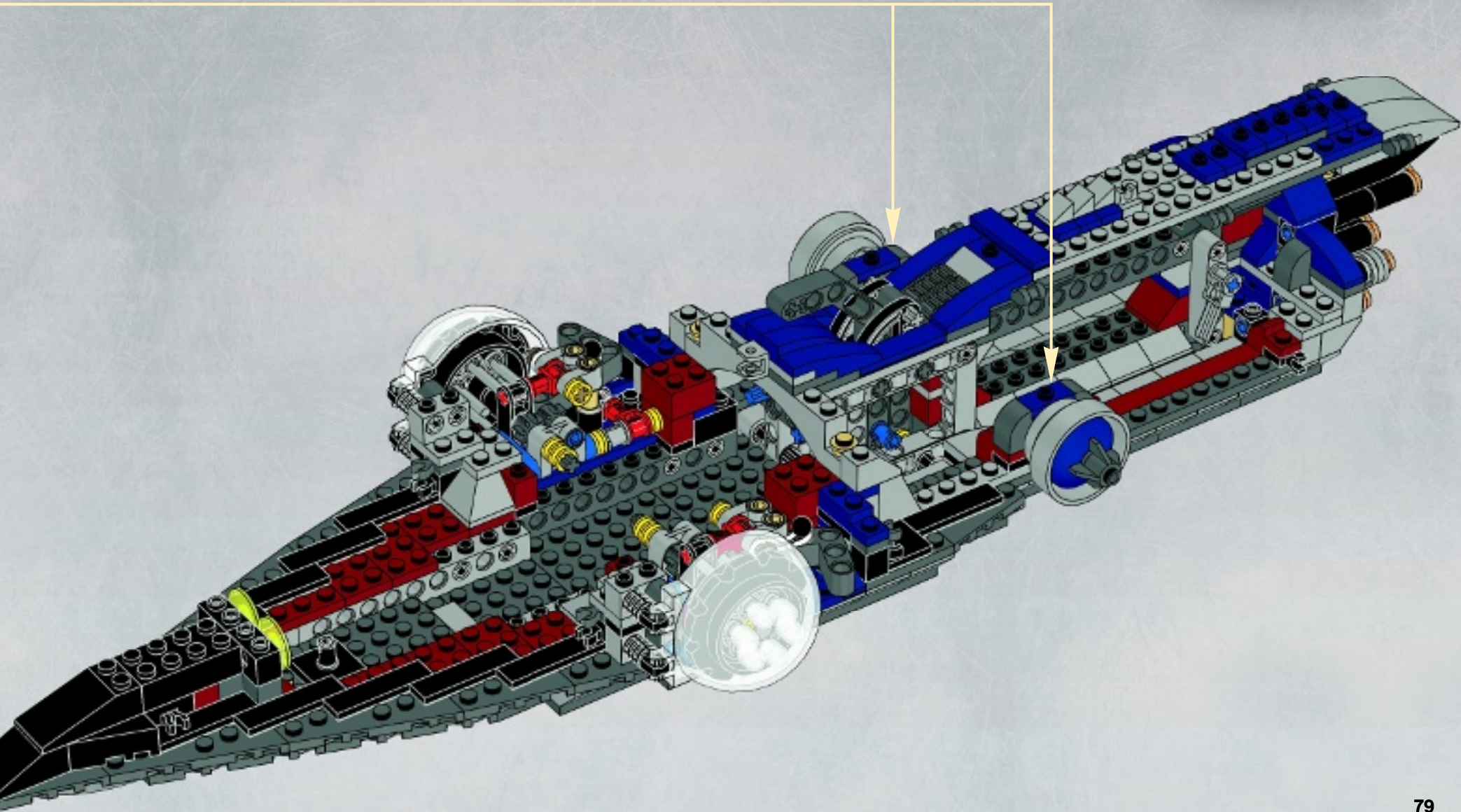







2x

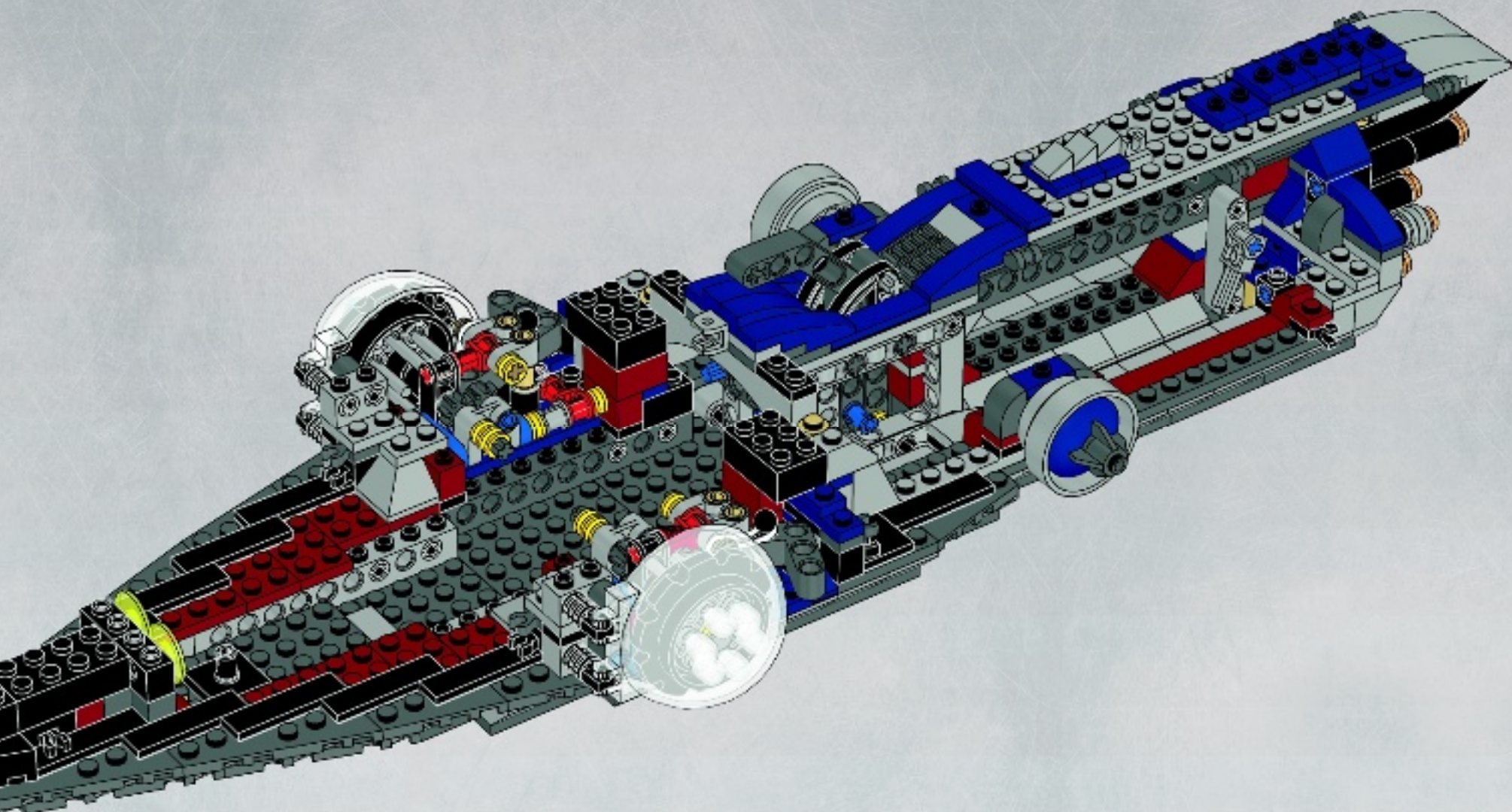

2x

63



	
2x	2x
	
2x	2x

64

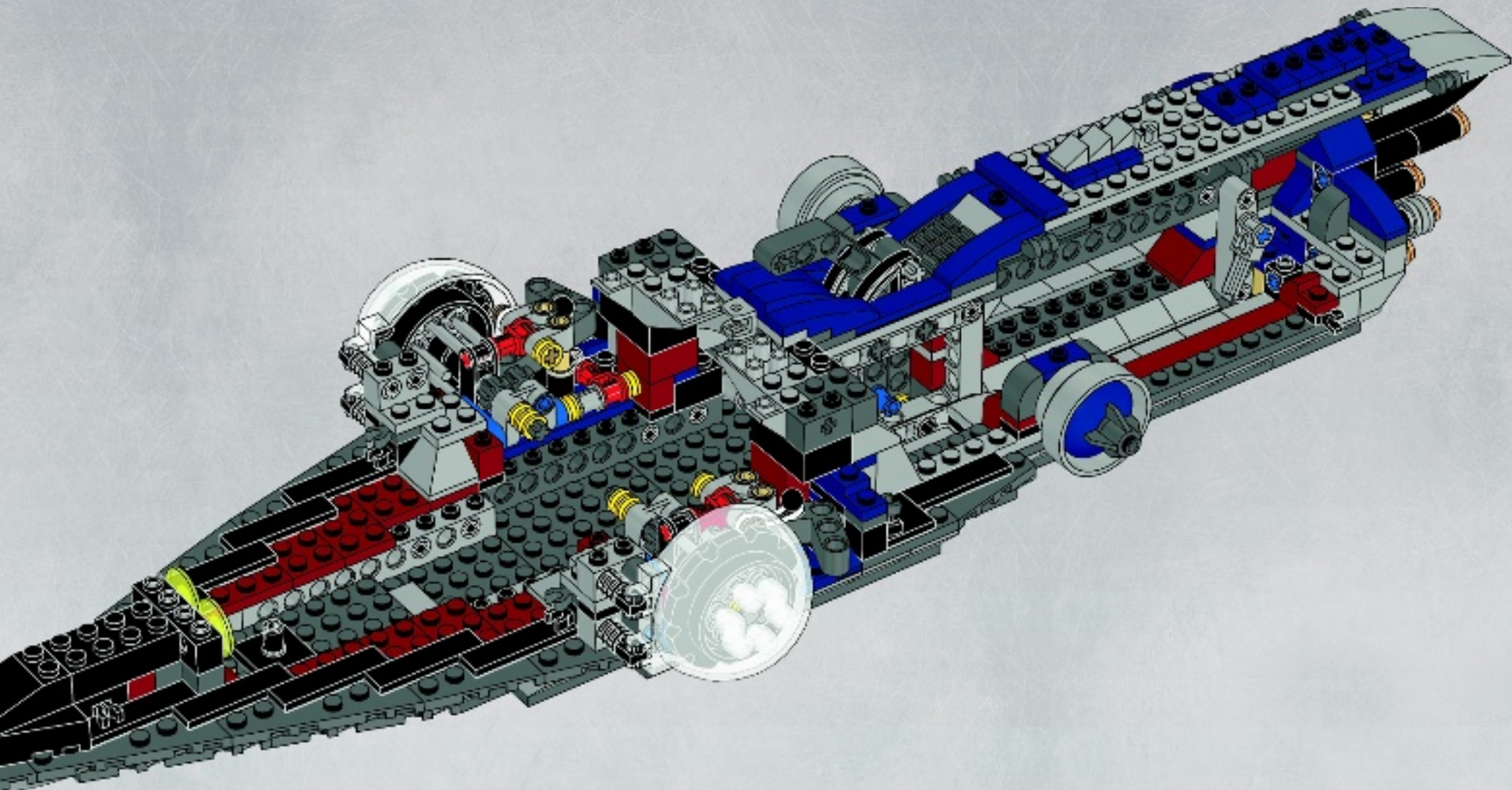

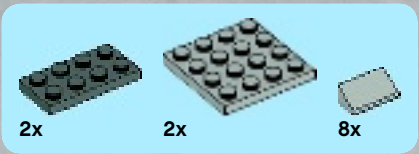

65

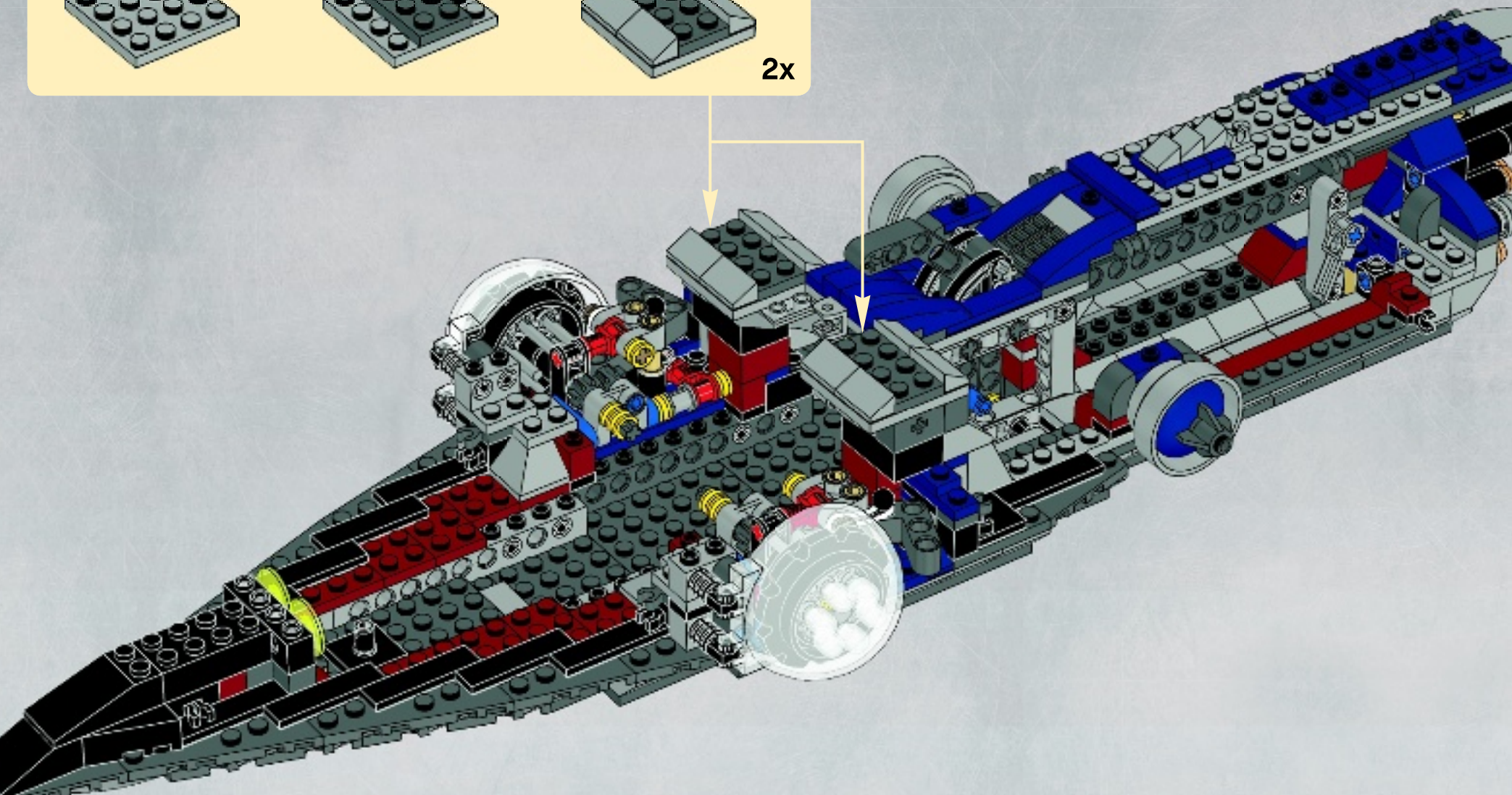

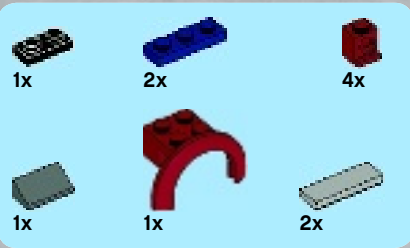

66

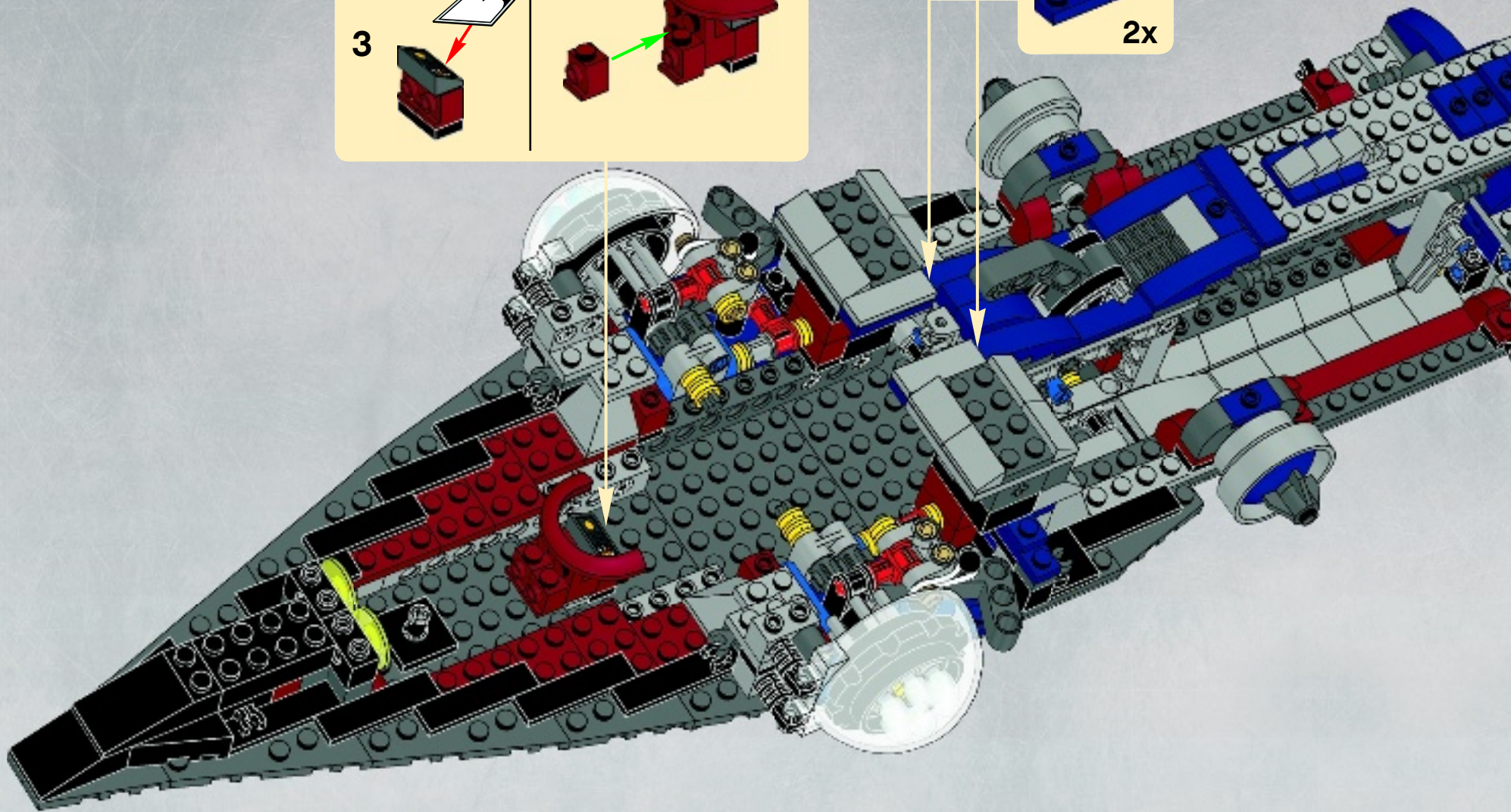
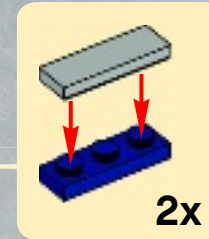
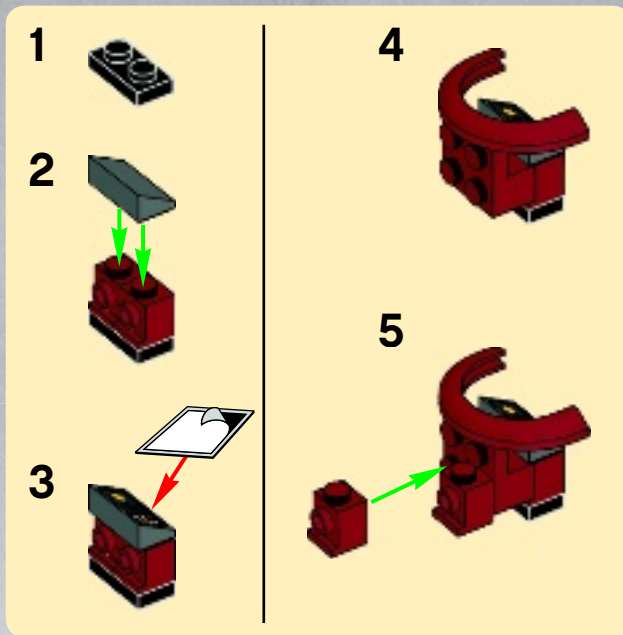

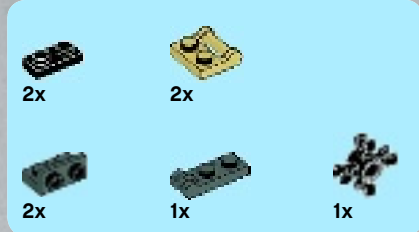

67

