

1

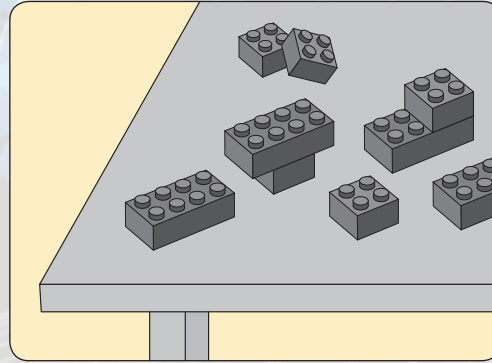

2

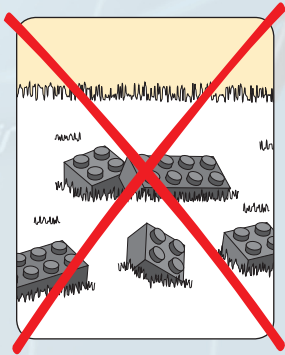

2

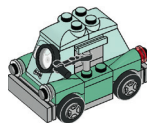
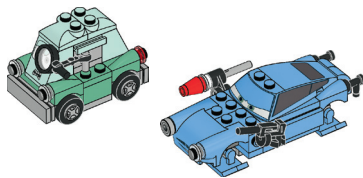
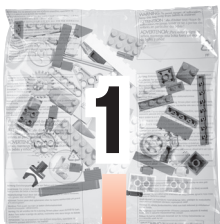

1x

1



3

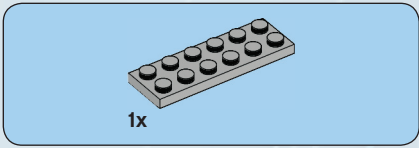

2

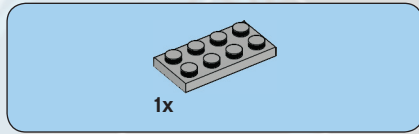
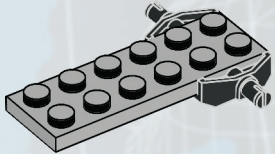

3

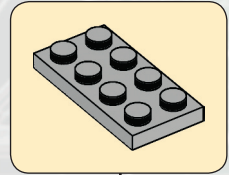

4

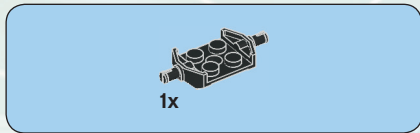

4

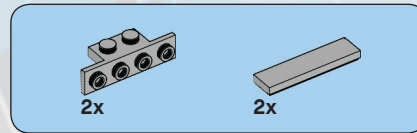
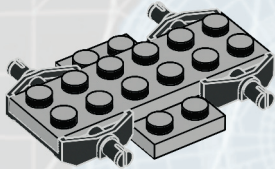

5

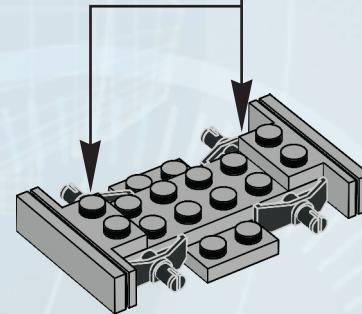
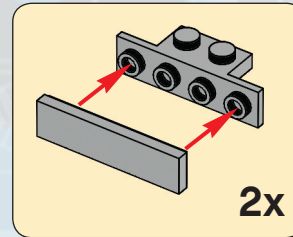

5

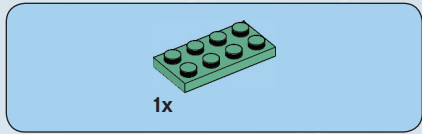

6

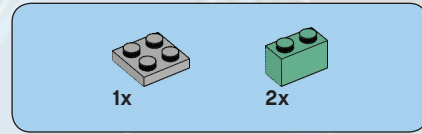
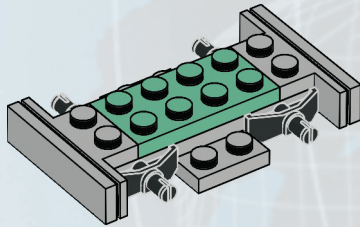

7

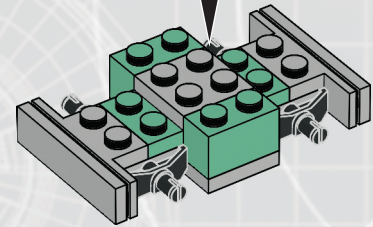
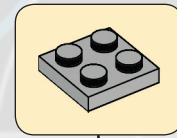

6

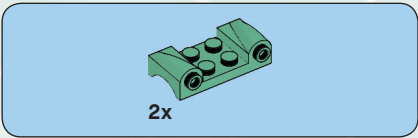

8

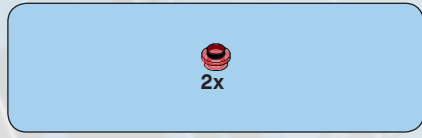
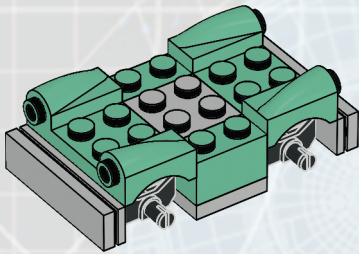

9

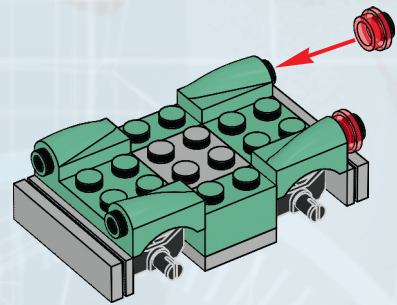

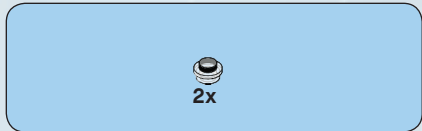

10

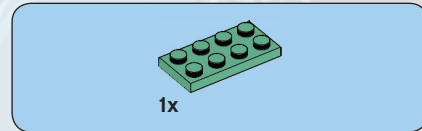
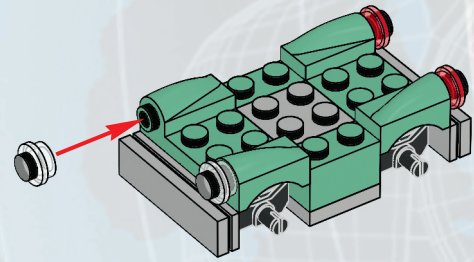

11

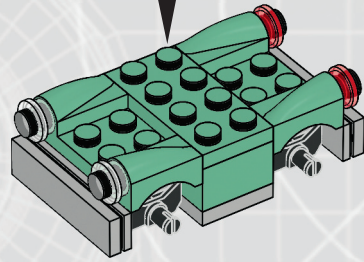
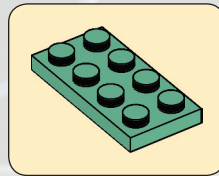

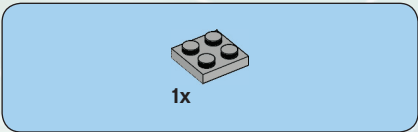

12

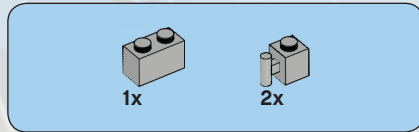
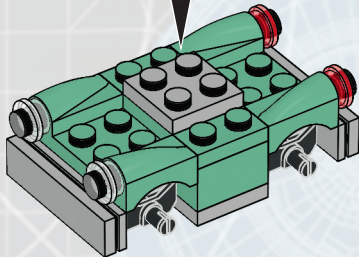
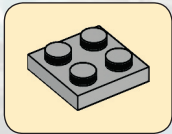

13

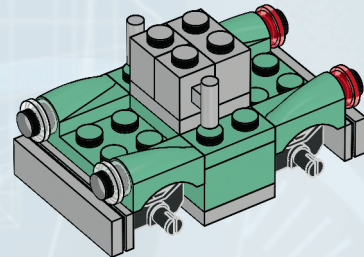

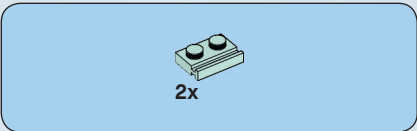

14

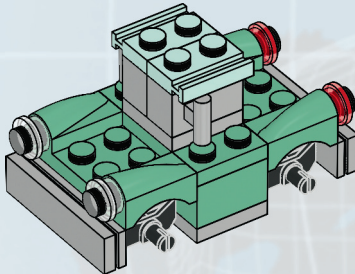

10

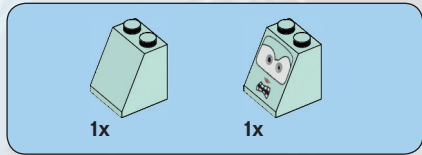

15

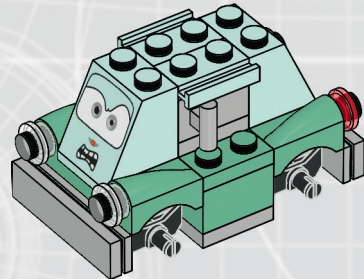



2x

16

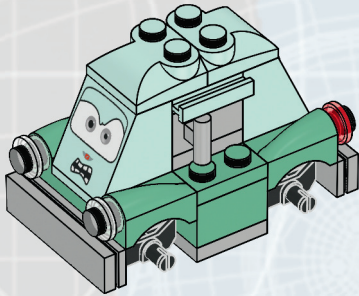

1x

17

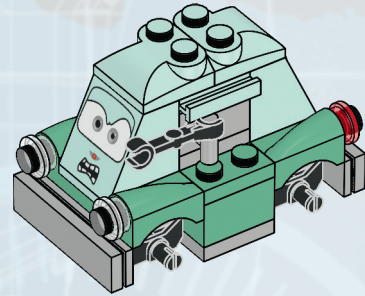



18

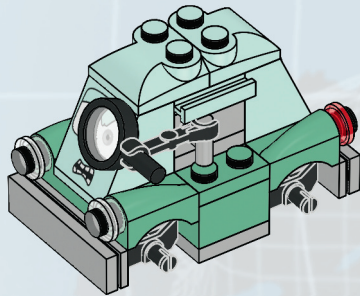

12



19

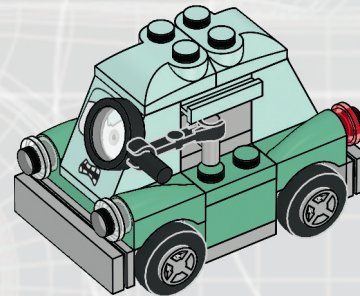

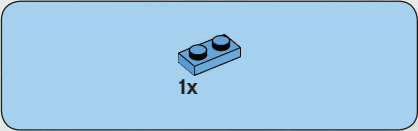
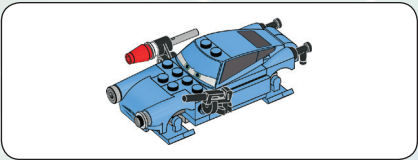

1x

1

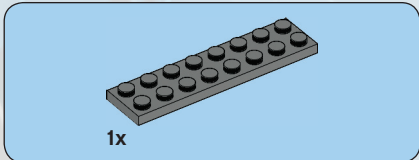

1x

2

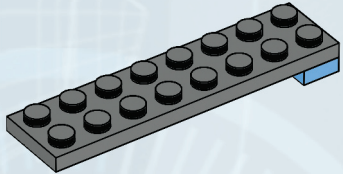

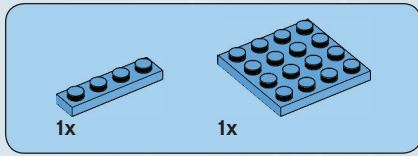

3

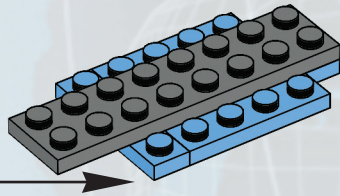
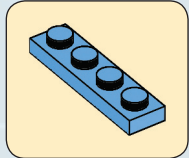

14

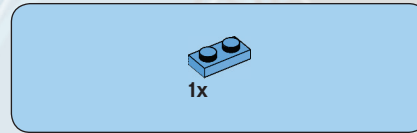

4

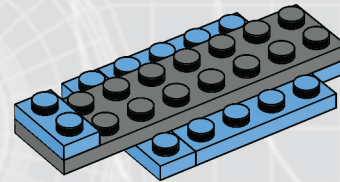

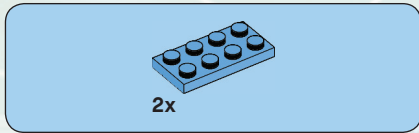

5

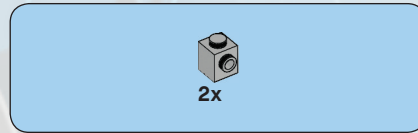
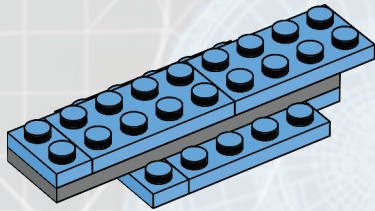

6

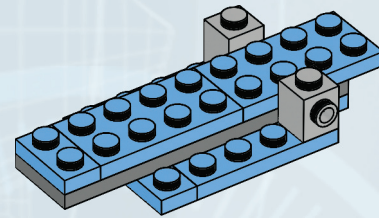

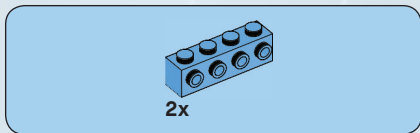

7 *waypoint*

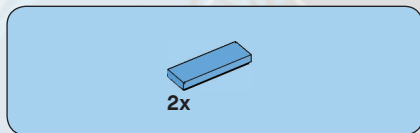
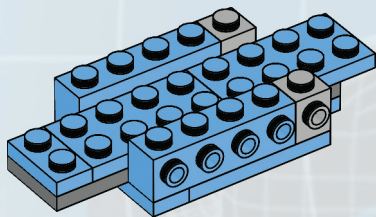

8

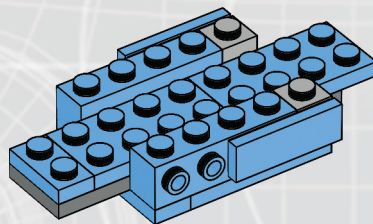

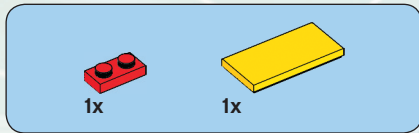

9

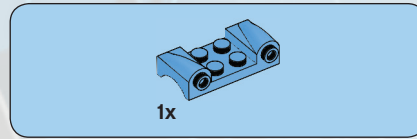
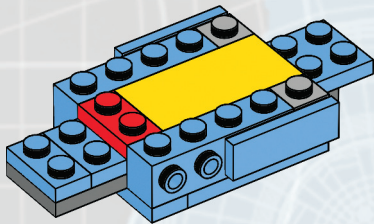

10

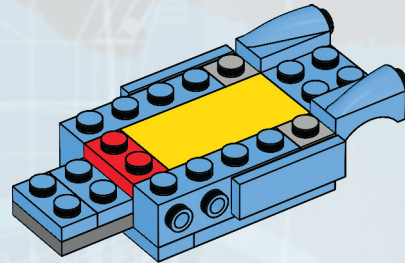



11

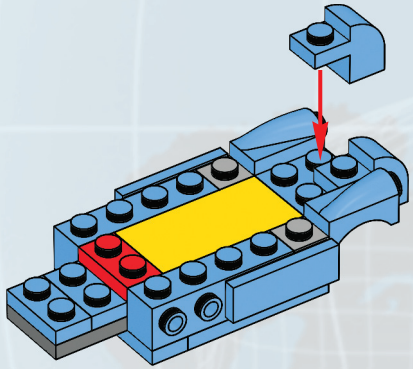

12

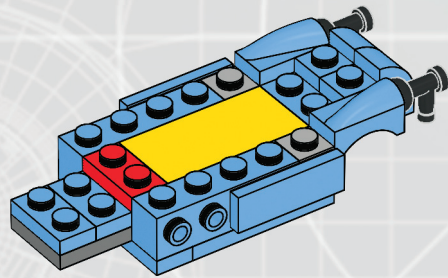

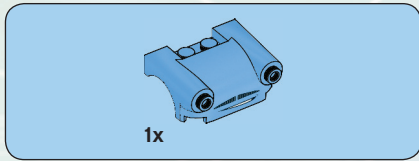

13

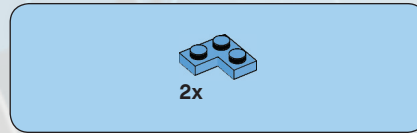
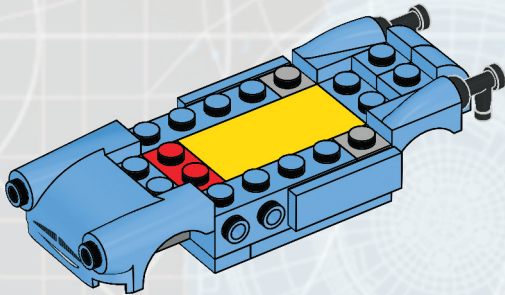

14

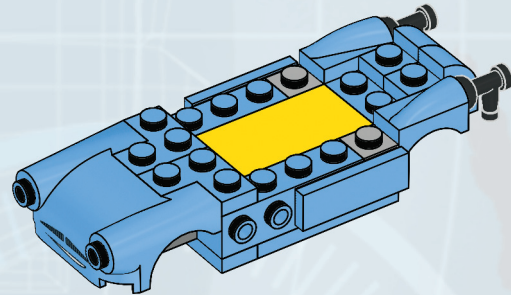

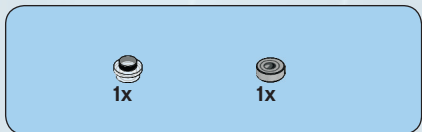

15

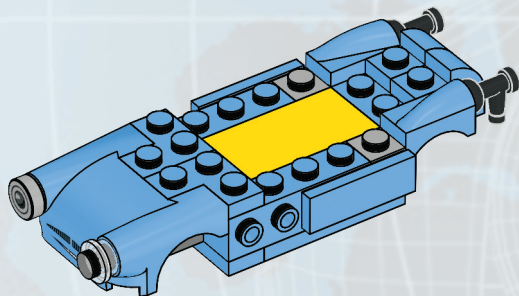

20

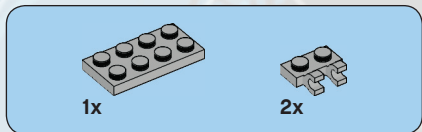

16

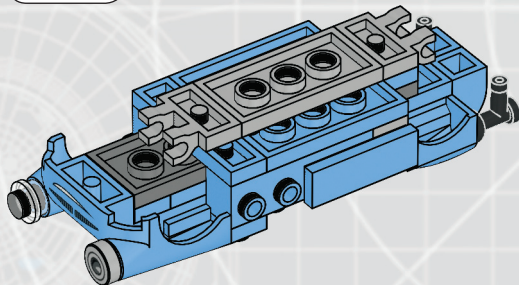
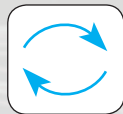

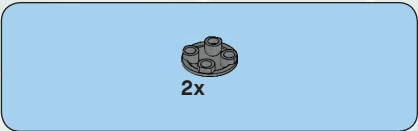

17

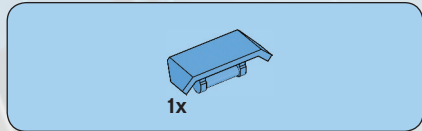
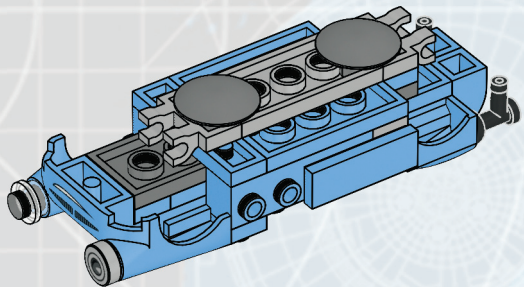

18

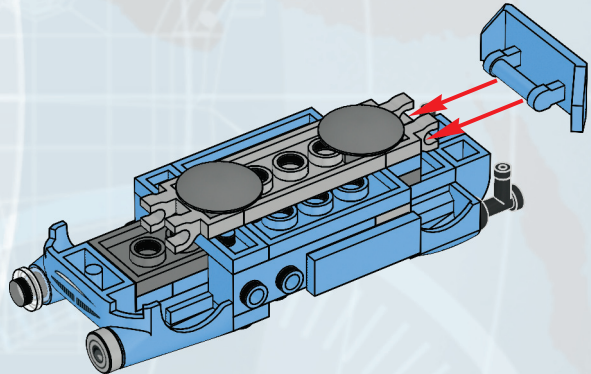

21

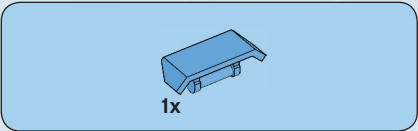

19

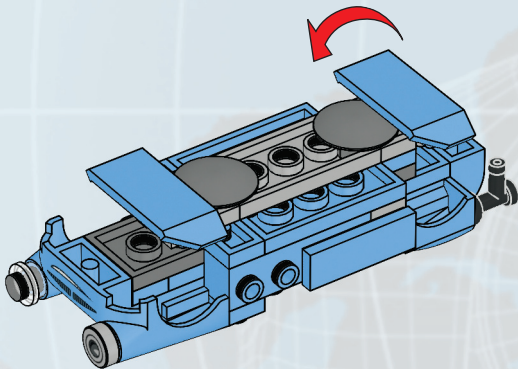

20

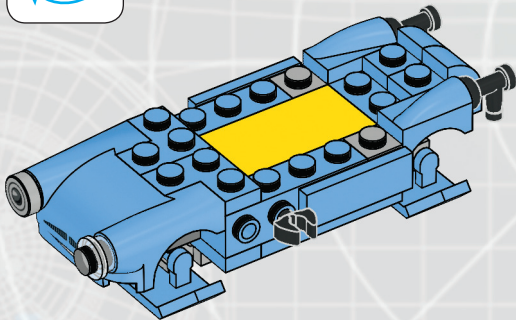
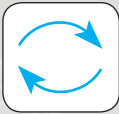

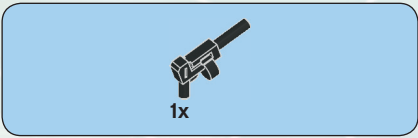

21

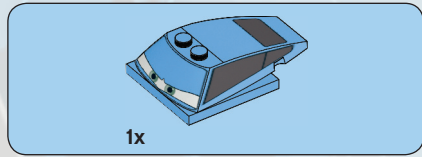
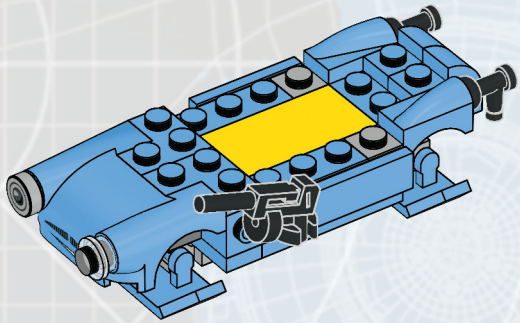

22

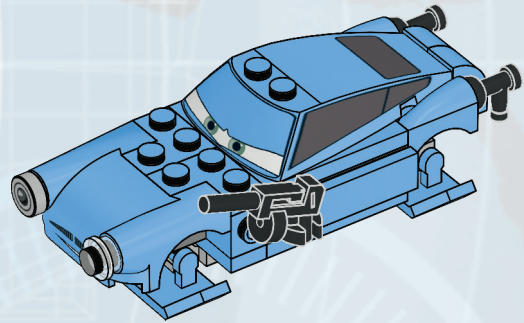

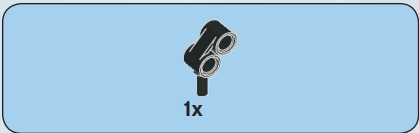

23

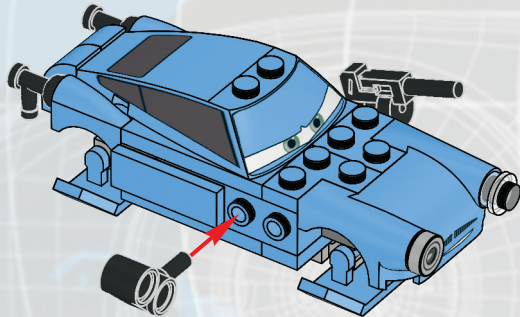
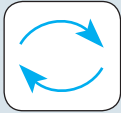

24

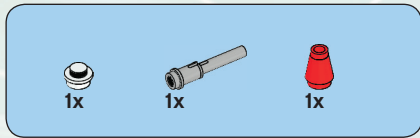

24

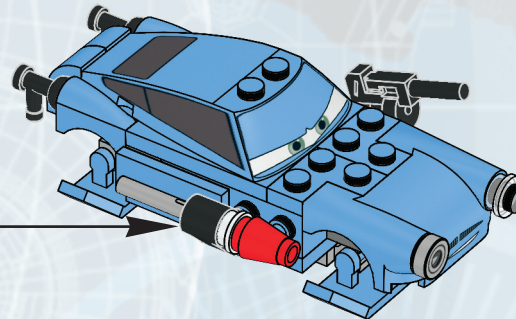
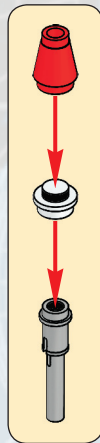

waypoint

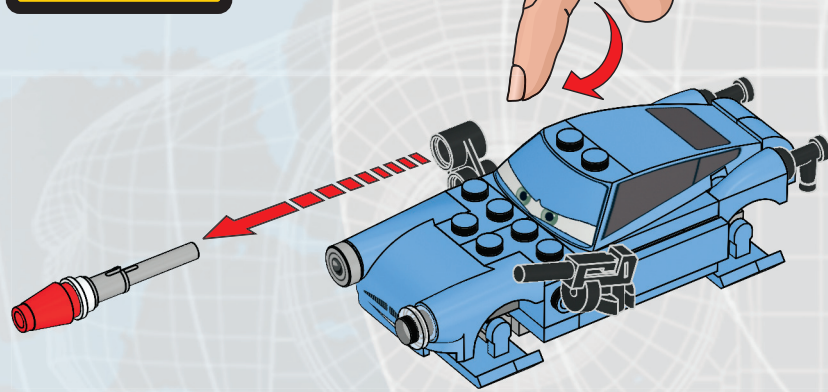

9483



9484



 www.LEGO.com

6006147 /
6006150

LEGO and the LEGO logo are trademarks of the/son des marques de commerce de/son marcas registradas de LEGO Group. ©2012 The LEGO Group.
Disney/Pixar elements: © Disney/Pixar, not including underlying vehicles owned by third parties: Gremlin is a trademark of Chrysler LLC
Les éléments Disney/Pixar : © Disney/Pixar, sans inclure les véhicules sous-jacents qui sont la propriété de tiers : Gremlin est une marque de commerce de Chrysler LLC.
Elementos Disney/Pixar: © Disney/Pixar, sin incluir los vehículos subyacentes propiedad de terceros: Gremlin es una marca registrada de Chrysler LLC.