



MONSTER FIGHTERS

9463



1

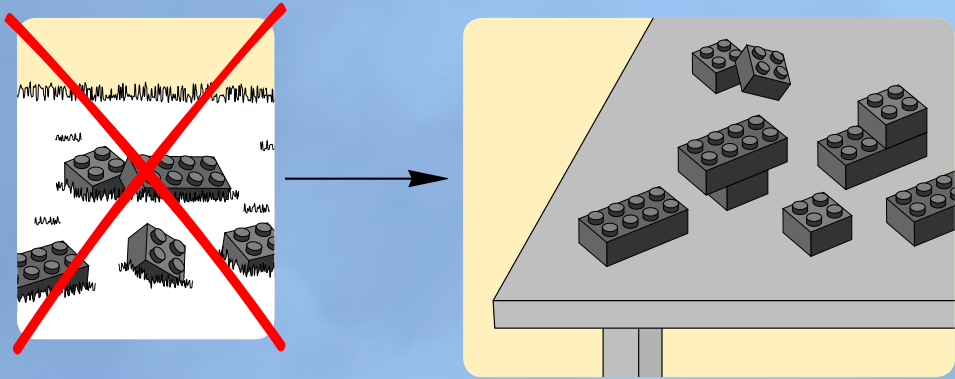

2

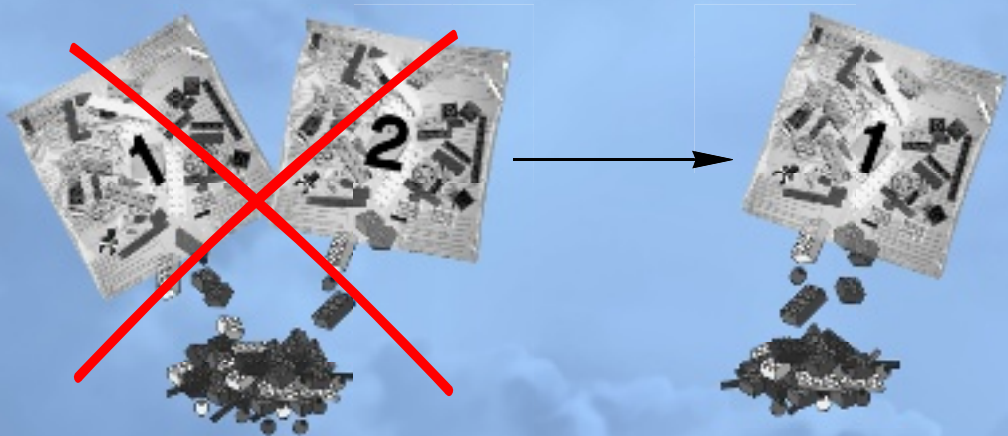

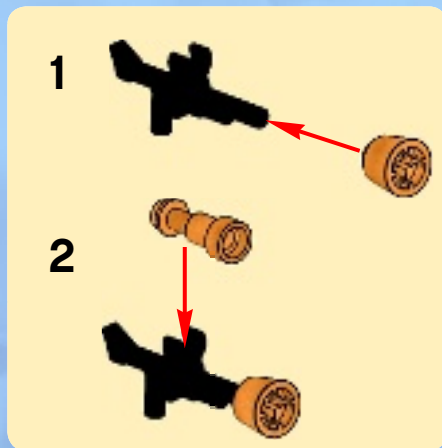

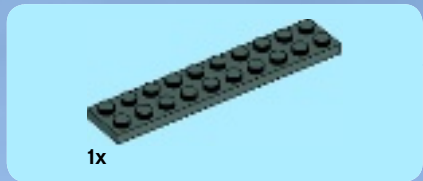

1



2

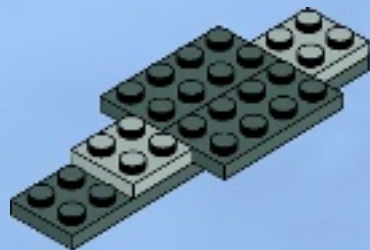



1x



2x

3

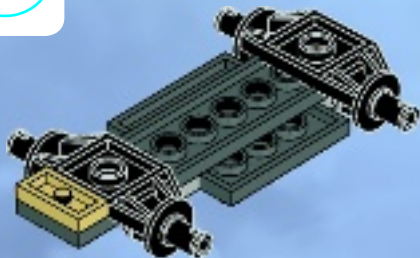

2x

4

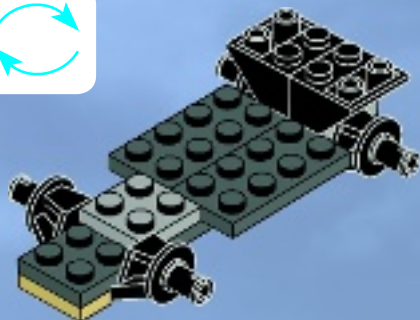



1x



1x

5

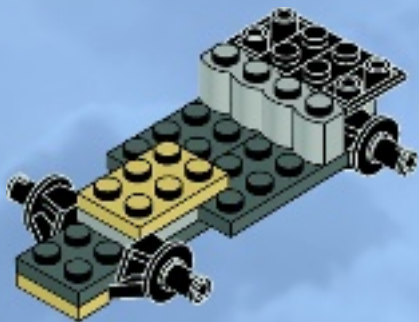

2x



2x

6

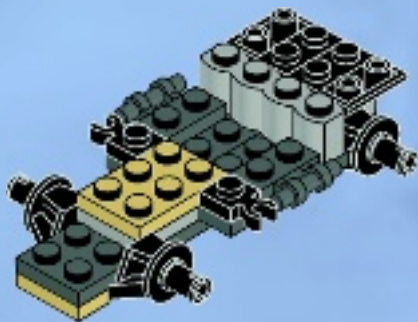



2x



1x



1x



1x

7

1

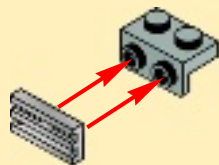

2

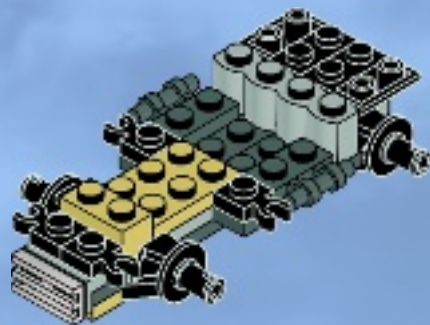
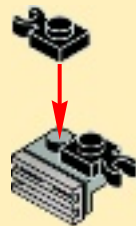

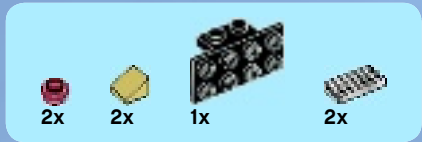

8

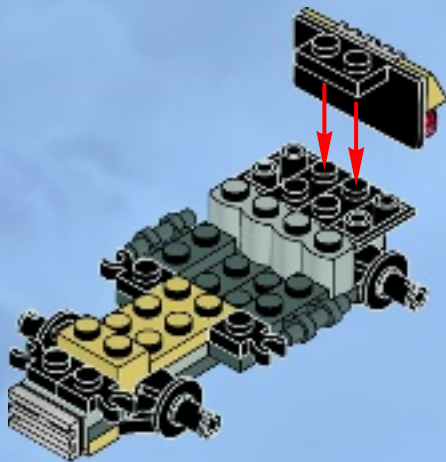
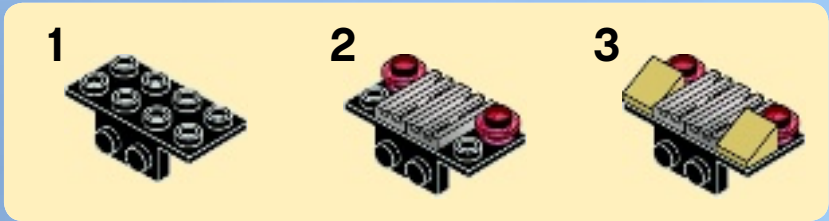



1x



2x

9

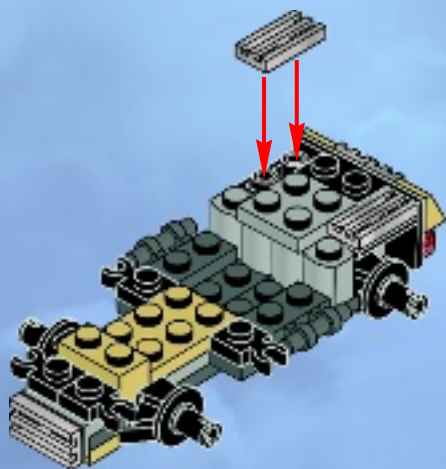

2x



2x

10

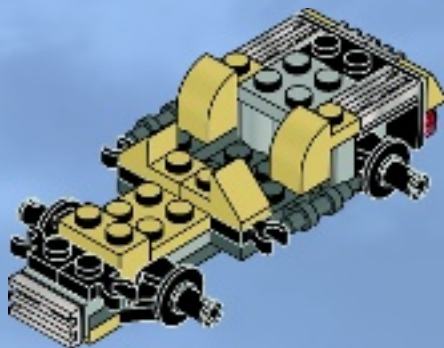



1x



1x

11

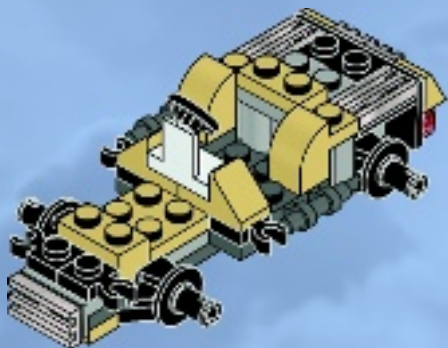

4x



1x

12

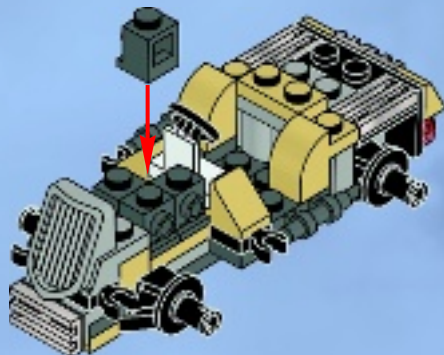



2x

13

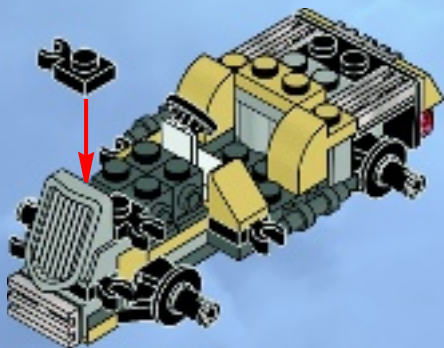

1x



1x

14

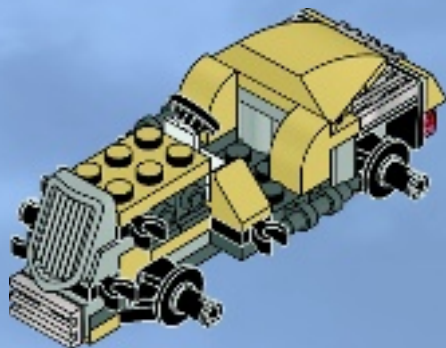



1x



1x



2x

15

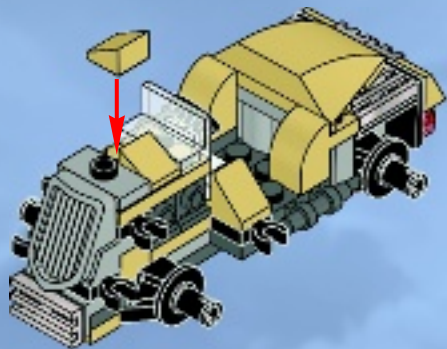

4x

16

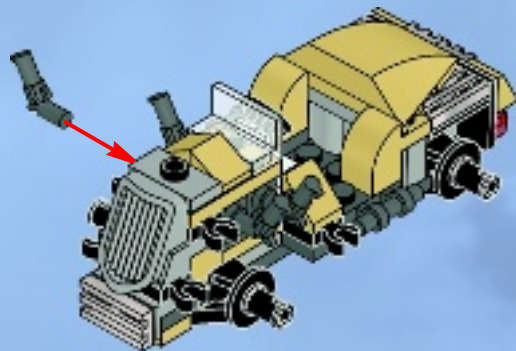



17

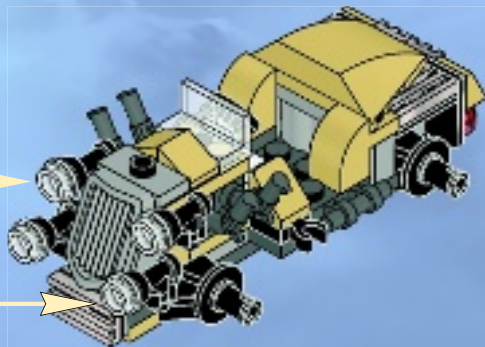
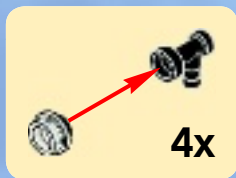

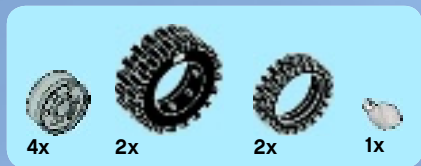

18

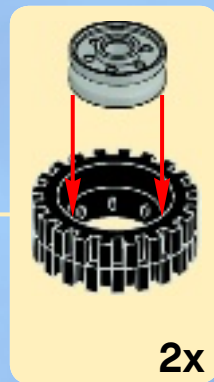
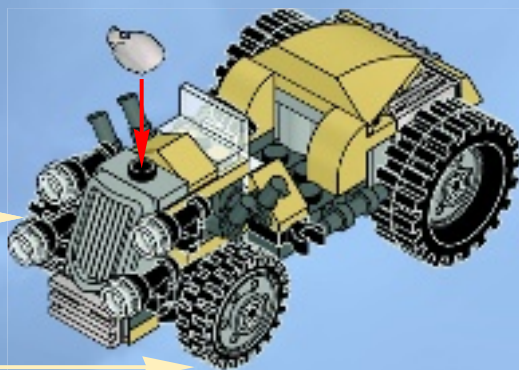
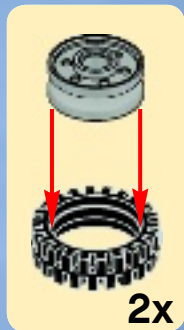

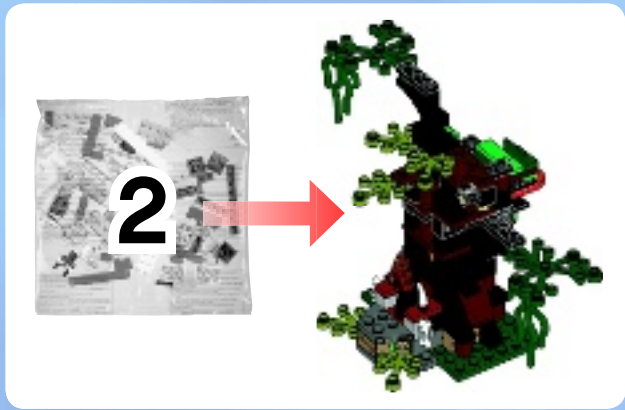

1

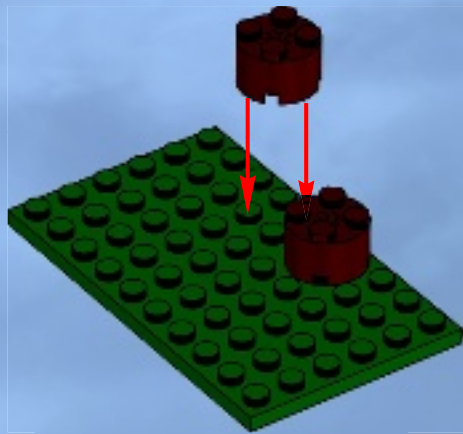

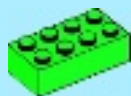

2x

2

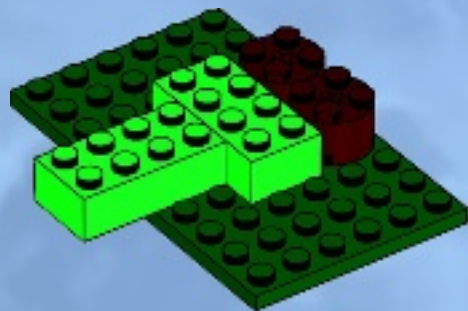

1x

3

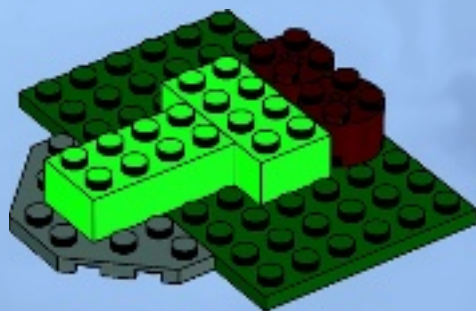



2x



1x

4

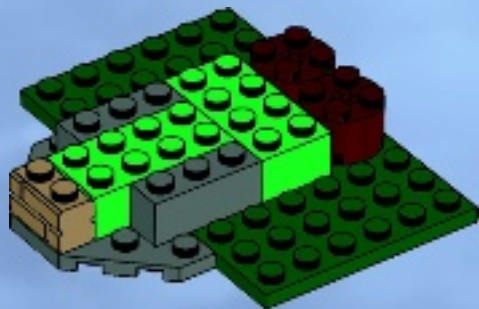

4x



2x

5

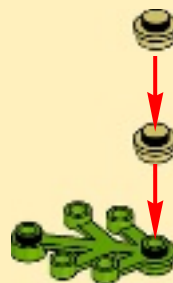

2x

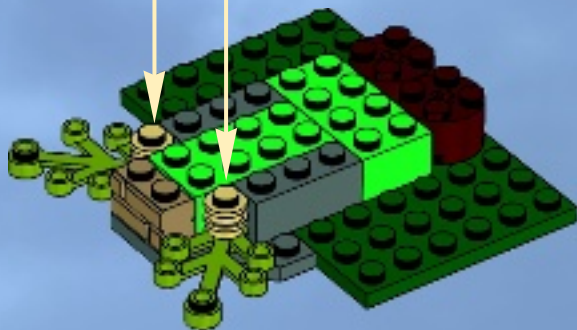



2x



2x

6

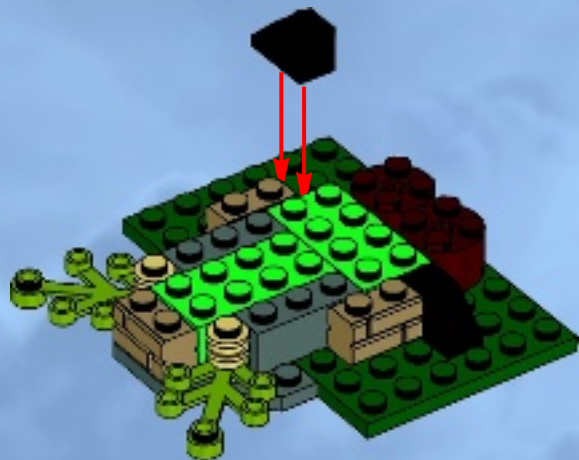

2x

7

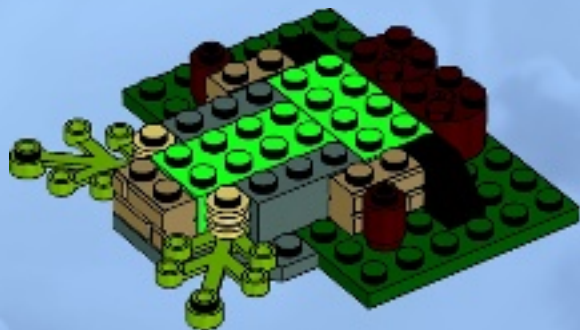



2x



1x

8

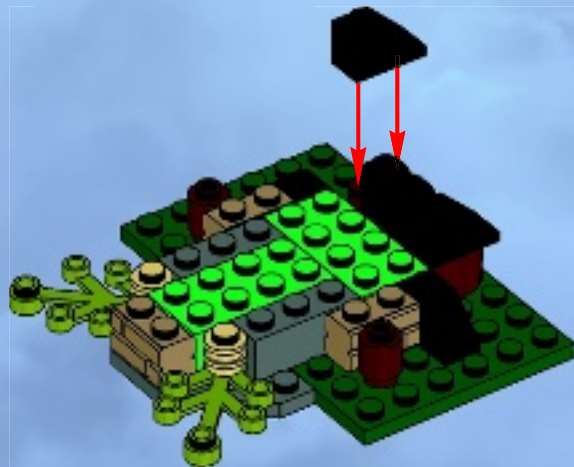

1x



2x

9

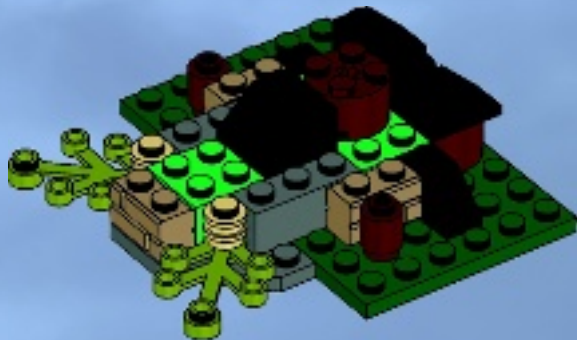



2x



2x

10

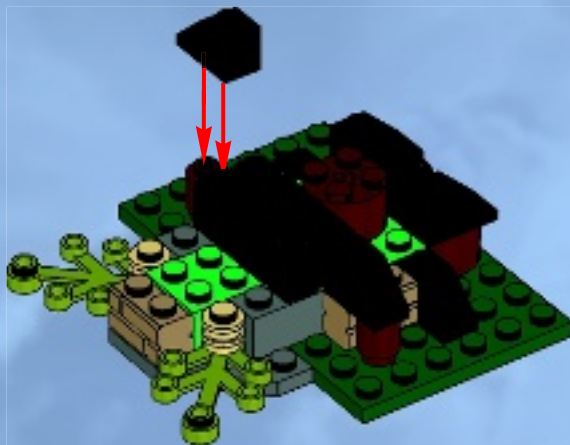

1x



1x

11

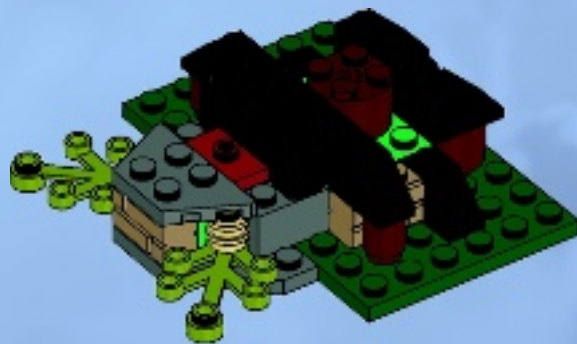



2x

12



2x



2x

13

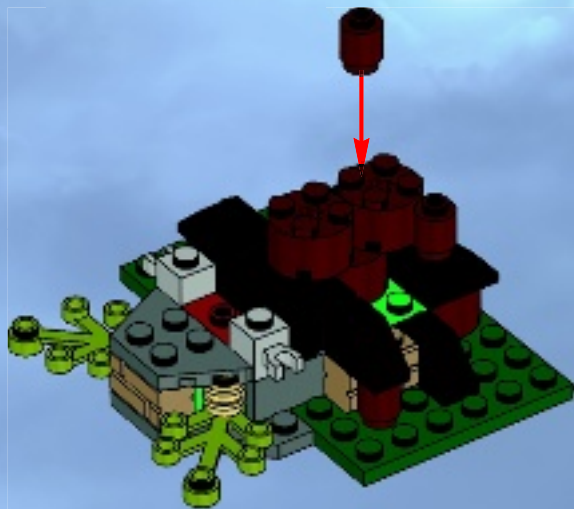



2x



2x

14

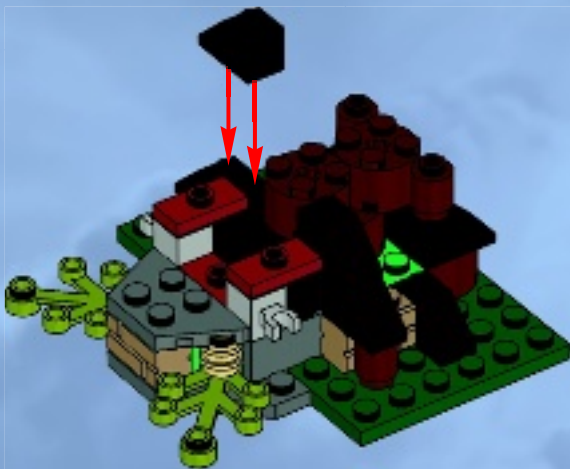

2x



2x



2x

15

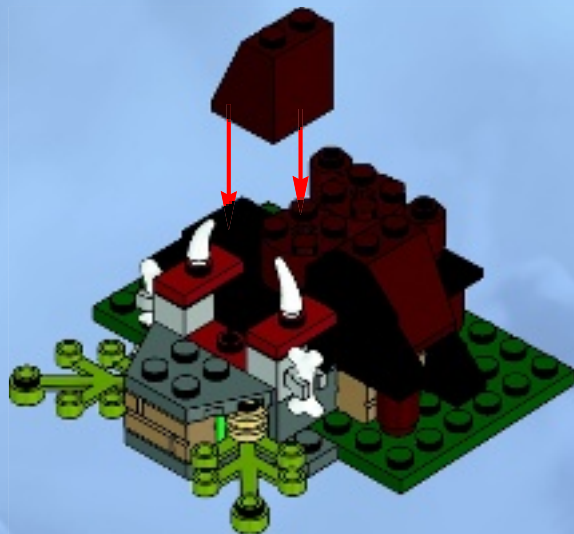



1x



1x

16



2x



1x

17



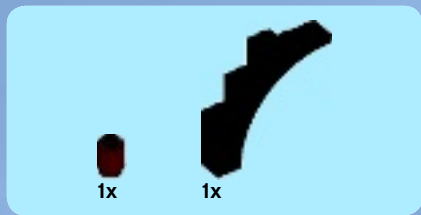

18

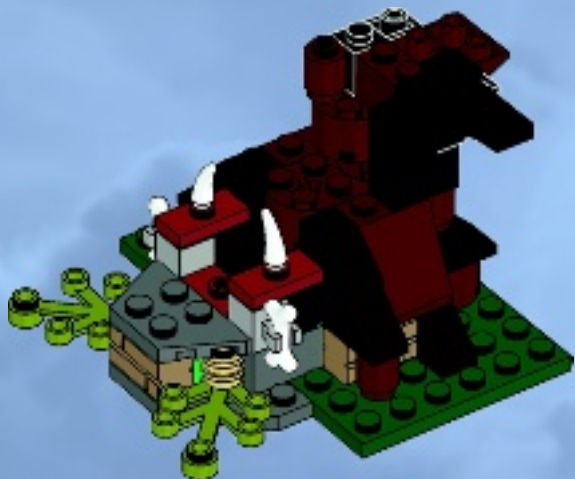

24

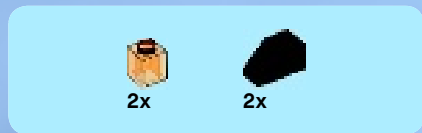

19

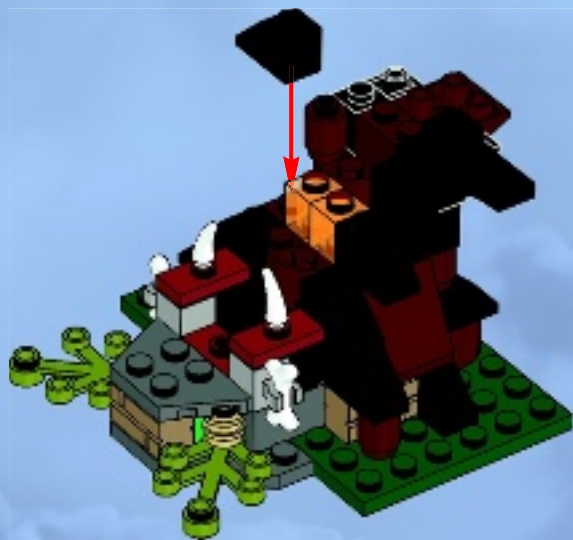



2x

20



2x



2x

21





1x

22



26



2x

23





2x



1x

24

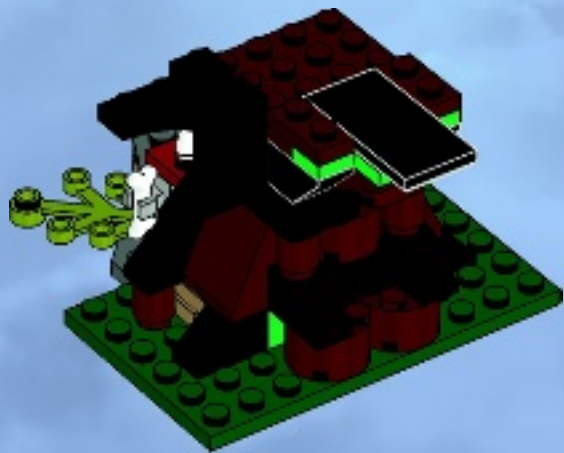

2x

25

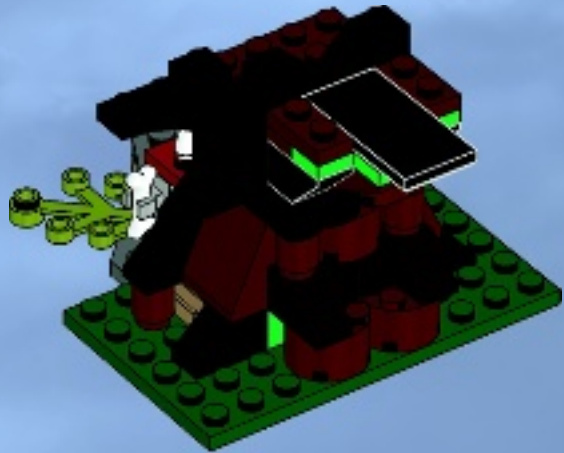



1x



2x

26

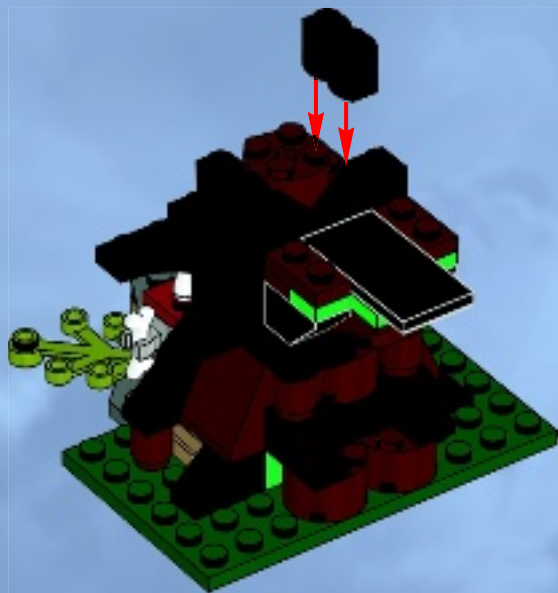

1x



2x



1x

27

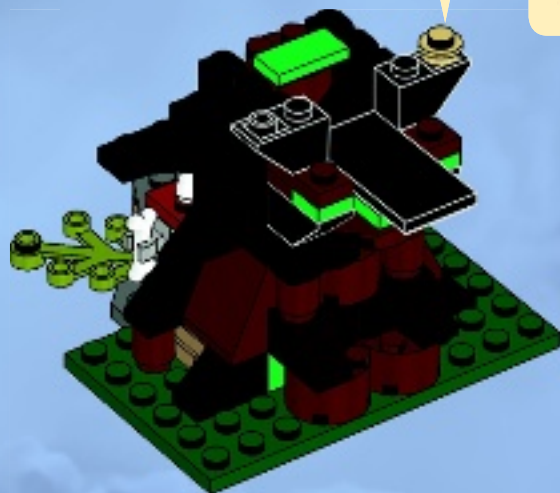

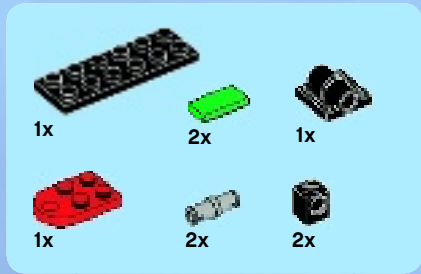

28

1

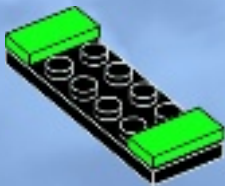

2

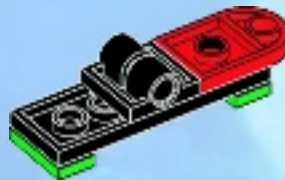

3

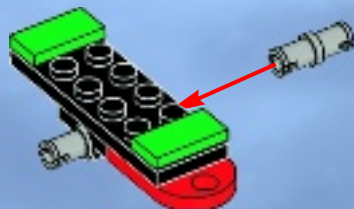

4

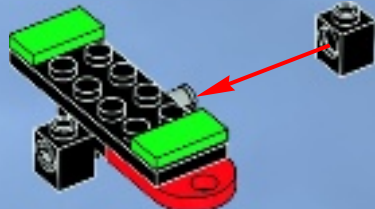

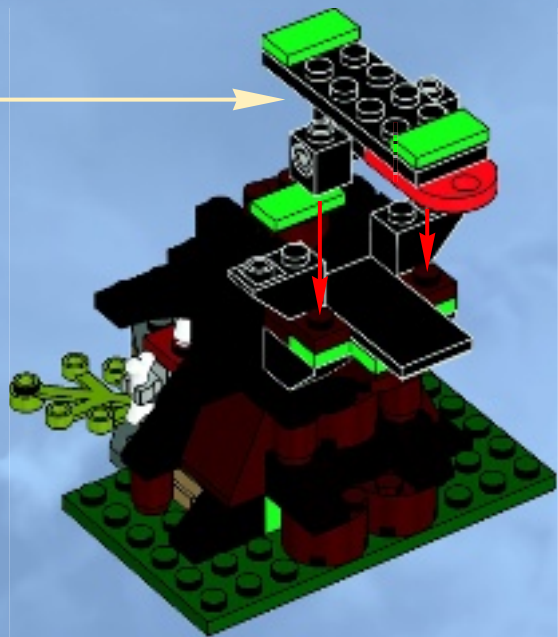

4x



2x

29

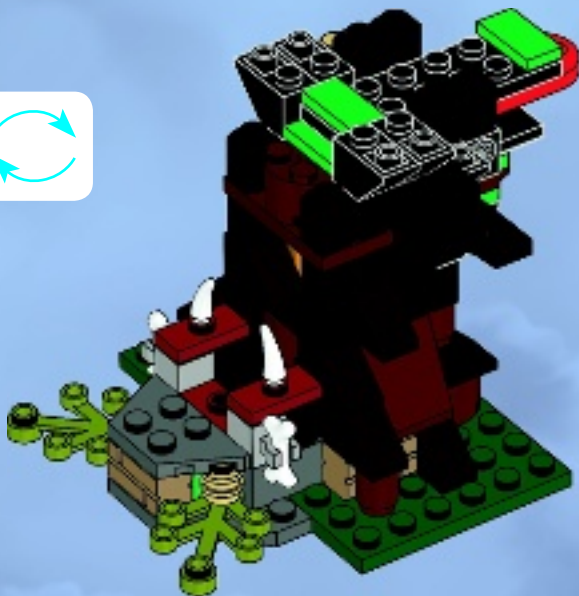



1



2



3

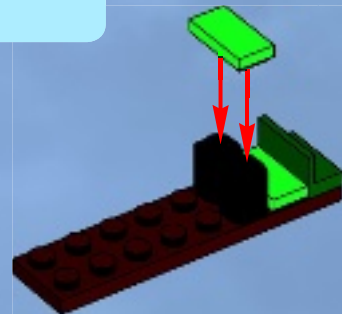



2x



1x

4

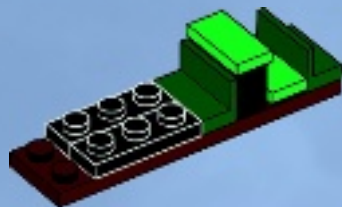

1x



1x



1x

5

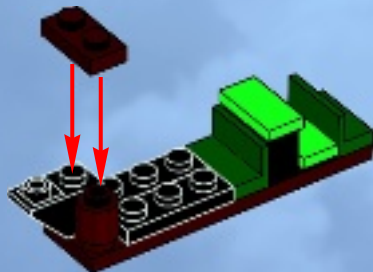

1x



1x

6

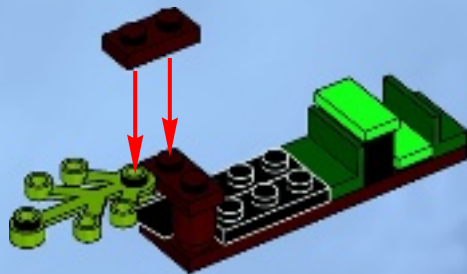



2x



1x



2x

7

1



2

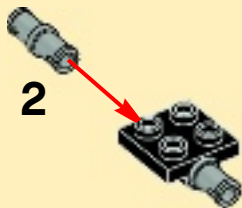

3

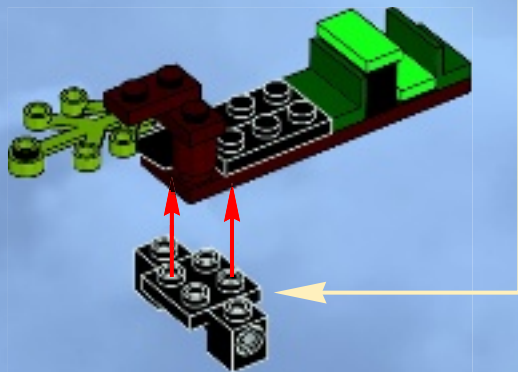
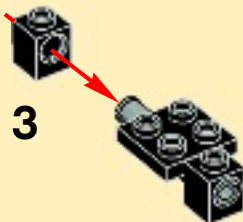

30





2x

31

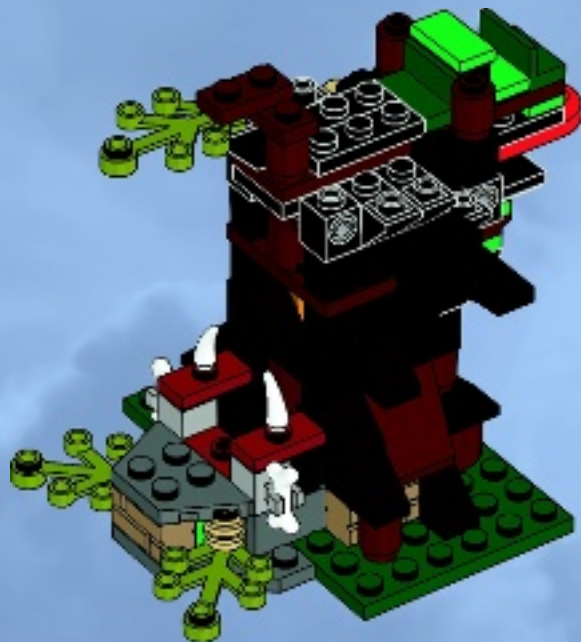

1x



1x



2x



1x



1x



1x



1x



1x



1x

32

1



2

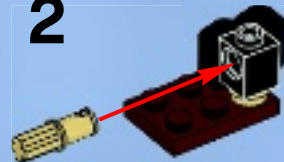

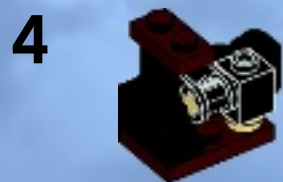
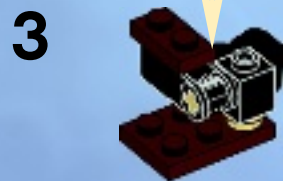
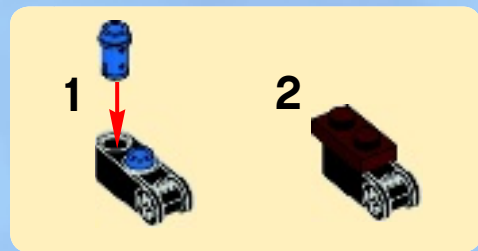



33

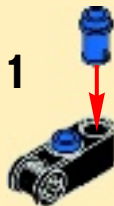





1x

34

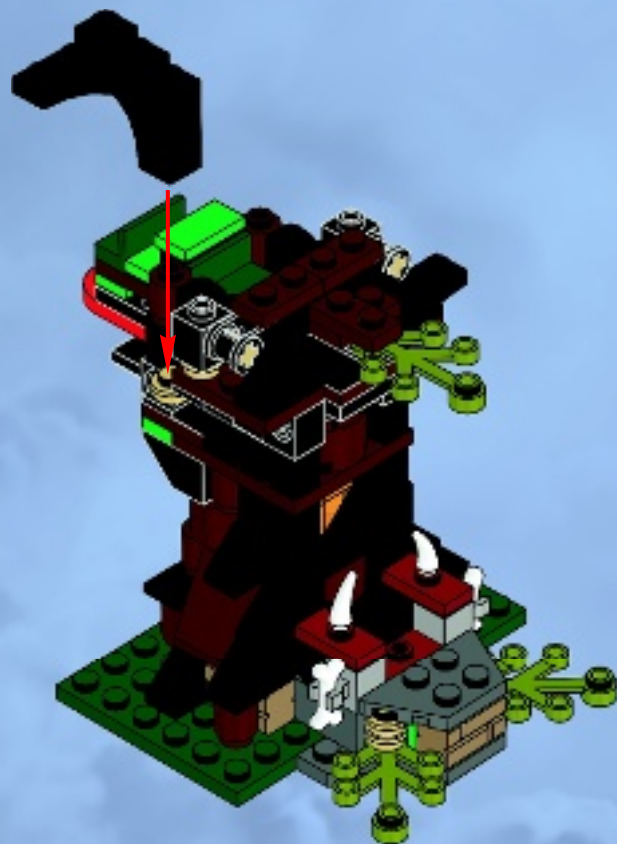



2x

35

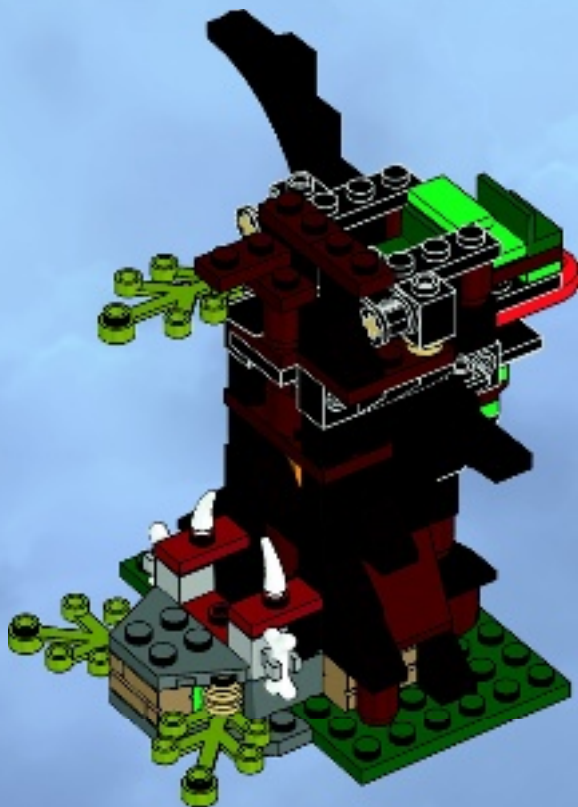



1x



1x

36

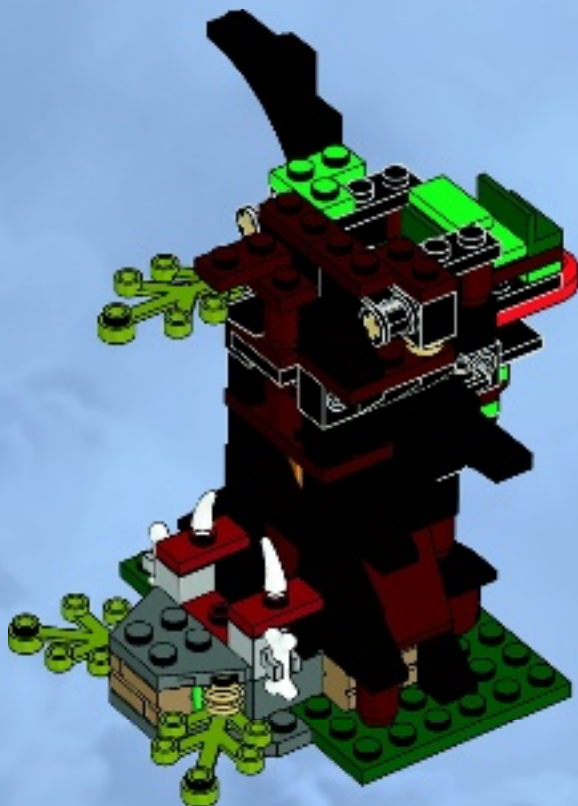



37





2x



2x

38

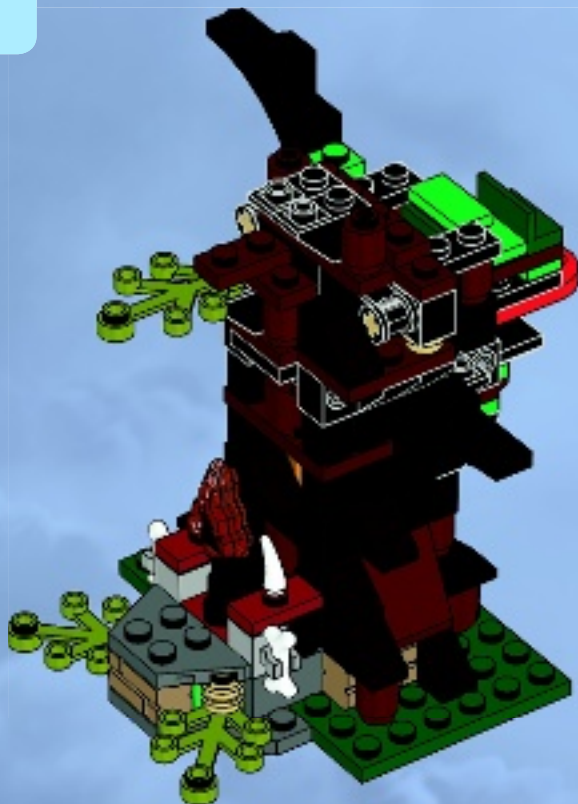



2x

39

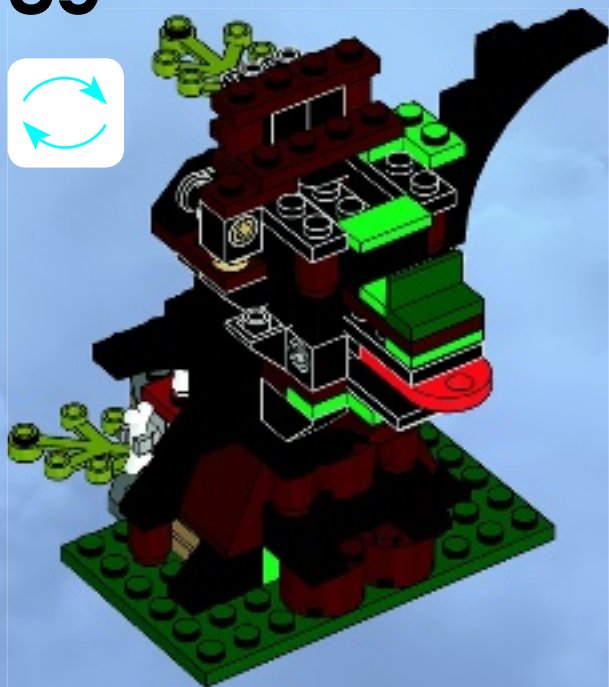

2x

40





2x



2x

41



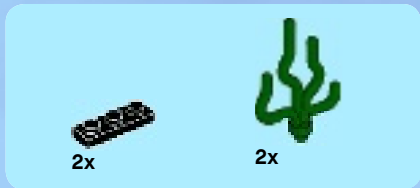

42



1



2





Customer Service

Kundenservice

Service Consommateurs

Servicio Al Consumidor

www.lego.com/service or dial



: 00800 5346 5555

: 1-800-422-5346

The LEGO logo is displayed in its characteristic white font with a black outline, set against a red rectangular background.

MONSTER FIGHTERS



Use this code in the online game to unlock scary content. If you dare ...

Schalte mit diesem Code den geheimen Inhalt frei. Traust du dich?

Utilise ce code dans le jeu en ligne pour débloquer des contenus effrayants. Si tu oses ...

Usa este código en el juego en línea para desbloquear una terrorífica sorpresa. Si te atreves ...

Usa este código no jogo online para abrires um conteúdo assustador. Se tiveres coragem ...

Ezzel a kóddal nyisd meg az online játékban az ijesztés témát. Ha mered ...



monsterfighters.LEGO.com



MONSTER FIGHTERS



9461



9462



9463



9464



9467



9466



9468

LEGO

MONSTER FIGHTERS





3

www.LEGOclub.com/Max

LEGO club™

FREE*! GRATIS! GRATUIT!

*Paid subscription in Australia and New Zealand.
*Abonnement payant en Australie et Nouvelle-Zélande.

©2012 The LEGO Group.





WIN!

Go to www.LEGOsurvey.com/product to fill out a survey for a chance to win a cool LEGO® Product.

No purchase necessary.

Open to all residents where not prohibited.



www.LEGOsurvey.com/product

GEWINNE!

Nimm an der Umfrage auf www.LEGOsurvey.com/product teil und hab die Chance ein cooles LEGO® Produkt zu gewinnen!

Die Teilnahme am Gewinnspiel führt zu keinerlei Kaufverpflichtungen. Teilnahme in allen nicht ausgeschlossenen Ländern möglich.

WIN!

Ga naar www.LEGOsurvey.com/product, vul een enquêteformulier in en maak kans op een cool LEGO® product.

Geen aankoopverplichting. Iedereen mag deelnemen, uitgezonderd ingezetenden van landen waar een enquêteverbod geldt.

GAGNE!

Visite www.LEGOsurvey.com/product pour répondre à un questionnaire et avoir une chance de gagner un produit LEGO® très cool!

Aucune obligation d'achat. Ouvert à tous les résidents des pays autorisés.

当てよう!

www.LEGOsurvey.com/product にアクセスして、アンケートにご記入ください。当選者にはレゴ製品を差し上げます。

お買い上げの必要はありません。禁止されていない限り、すべての皆様にご利用いただけます。



www.LEGO.com

6015177 / 6015180

LEGO and the LEGO logo are trademarks of the/son des marques de commerce de/son marcas registradas de LEGO Group. ©2012 The LEGO Group.