



NINJAGO

Masters of Spinjitzu



9440





1

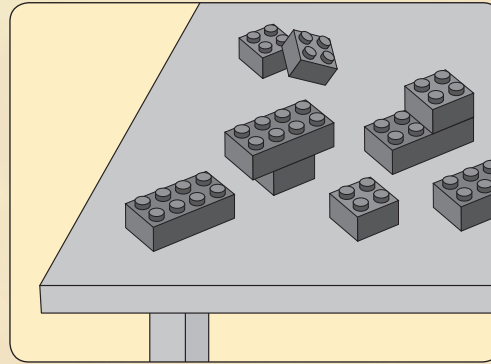
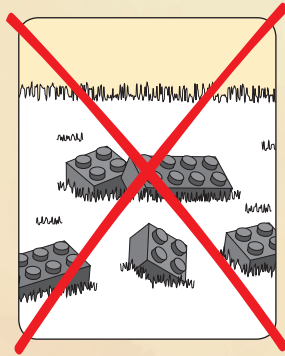

2

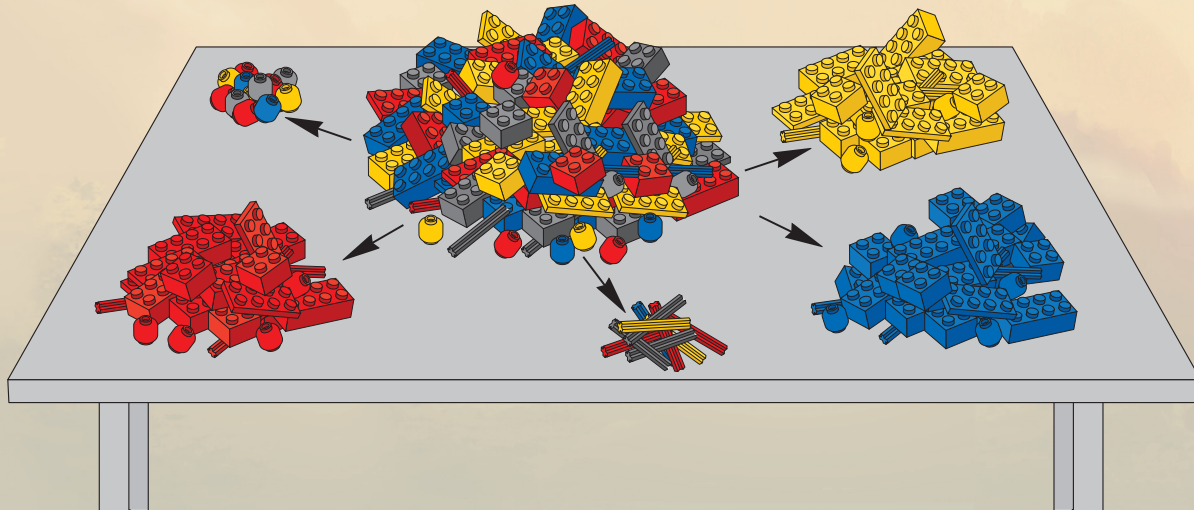

2



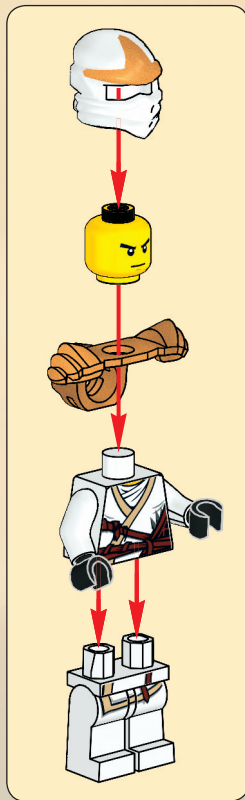

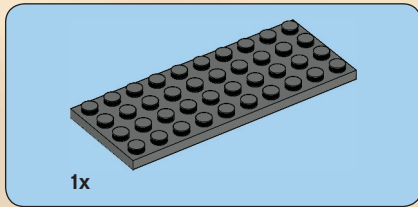
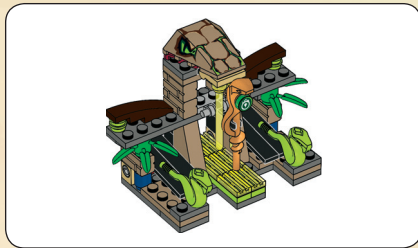

1

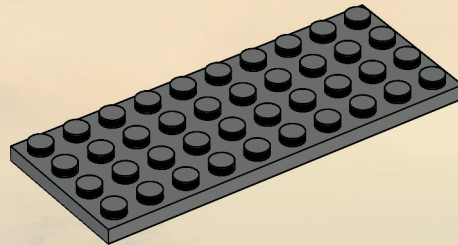

4





2

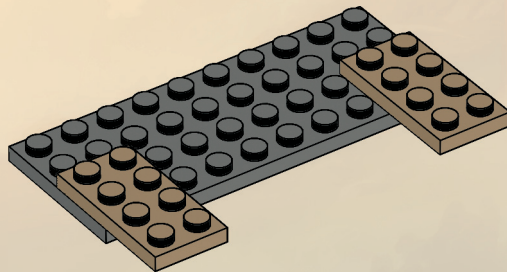

5



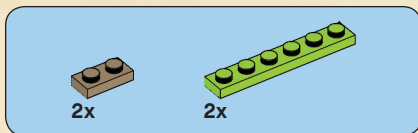

3

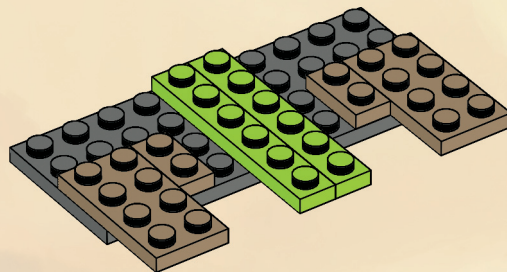

6





4

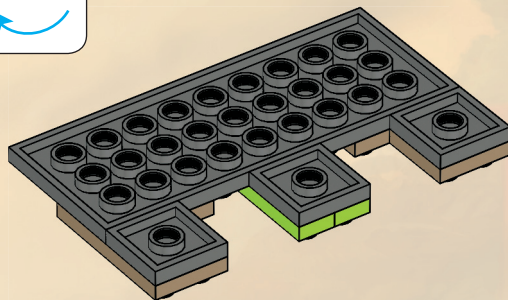
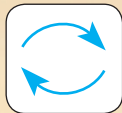

7



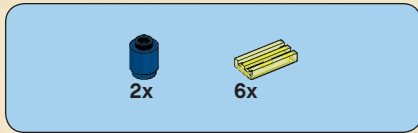

5

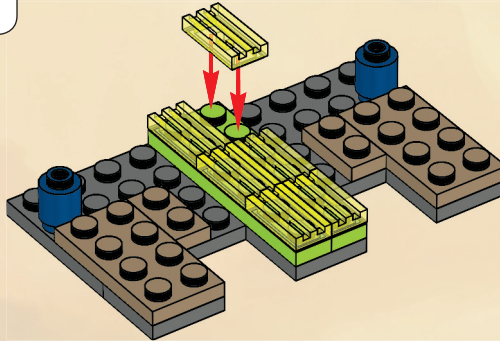
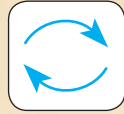

8



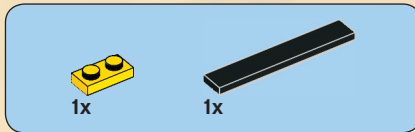
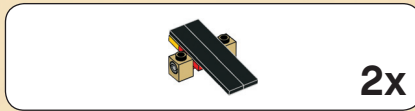

1

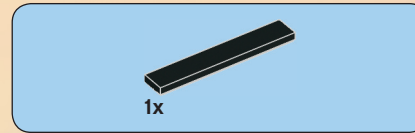

2

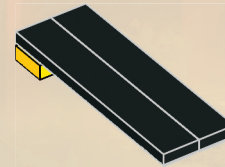

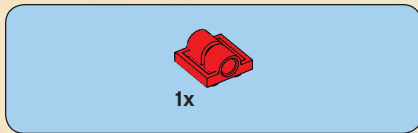

3

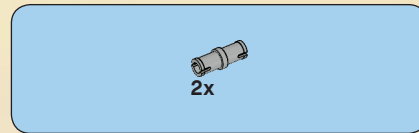
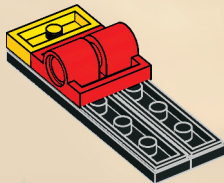
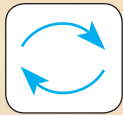

4

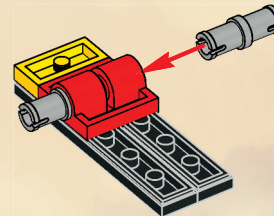

10





5

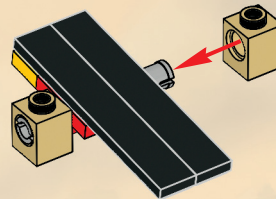
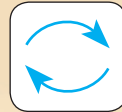

2x

6

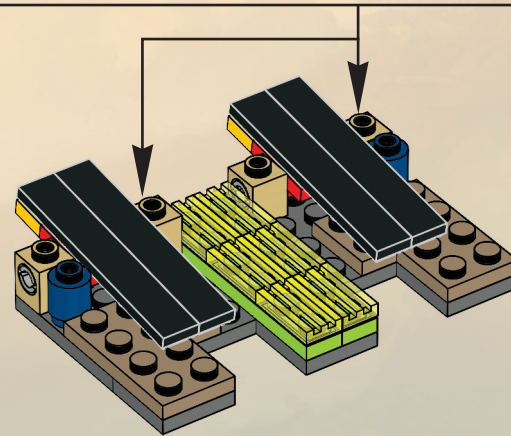

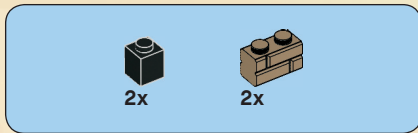

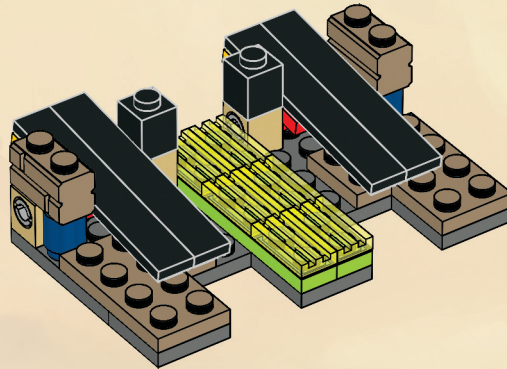

7



12





2x  2x 

8

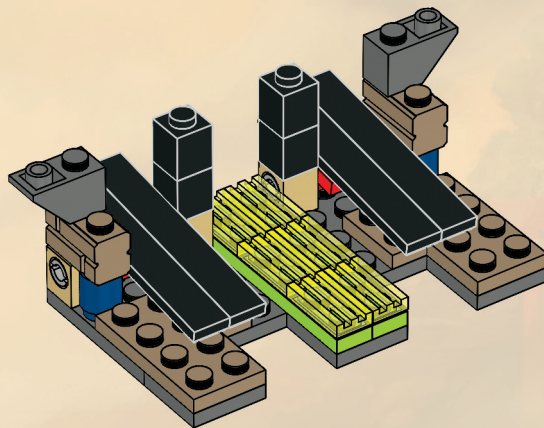

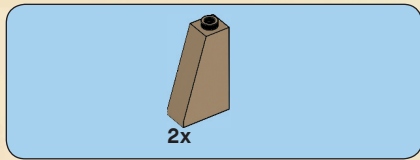

9

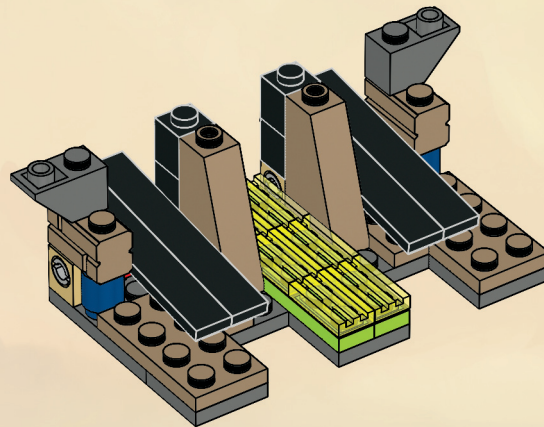

14





2x  2x 

10

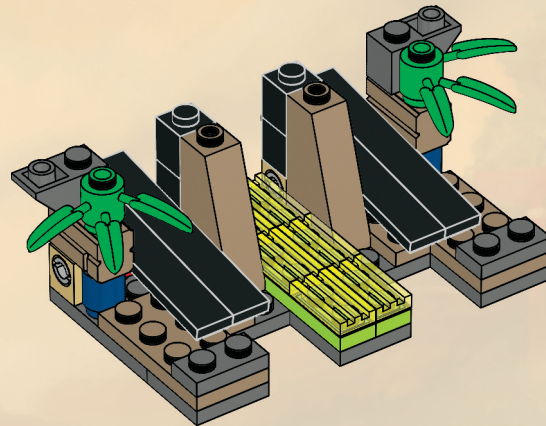

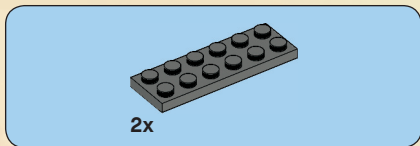

11

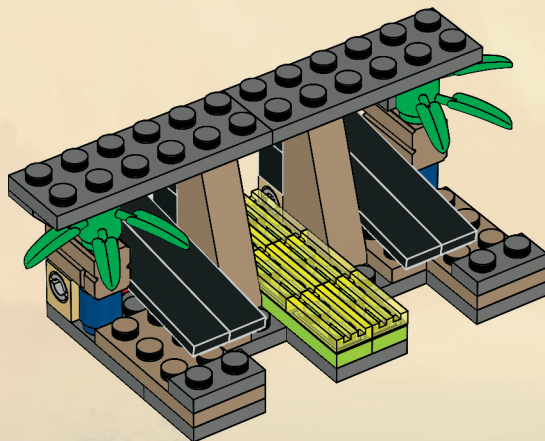

16





NINJAGO

Masters of Spinjitzu



NINJAGO.COM





NINJAGO

Masters of Spinjitzu



9445



9442



9443



9446



9567 9552



9564



9563



9561



9552



9566



9566



9441 9558
9579



9444



9441 9558



9441 9444
9446



9579



9562 9440



9444 9566



9551



9440 9445
9446 9553
9558



9562



9558



9563 9567



9564



9551

9443

9446

9446

9443

9446

9552

9444 9579

9561 9553

9442 9558

9579 9558

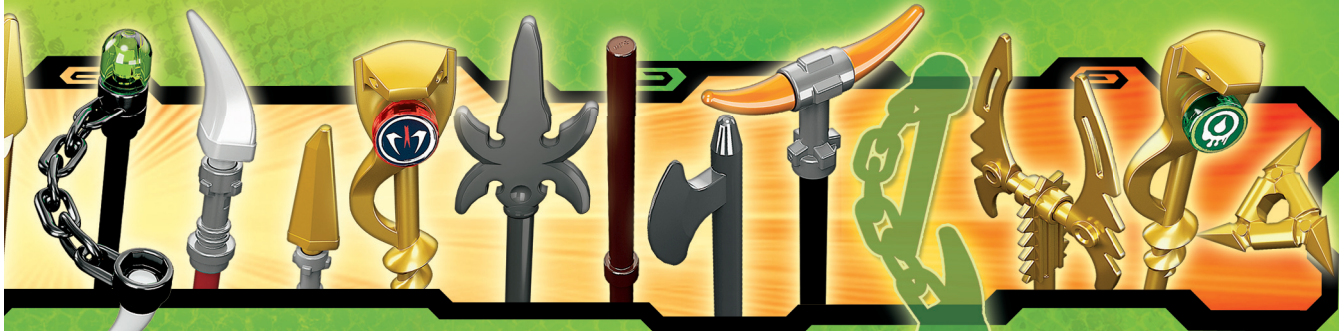

9562

9564

9443

9442 9445

9446

9446 9551 9558 9561

9558 9579

9579

9567

9553

9440

9445





NINJAGO

Masters of Spinjitzu



9446



9445



9443



9444

9446



9445



9444



9443



9442



9441



9440



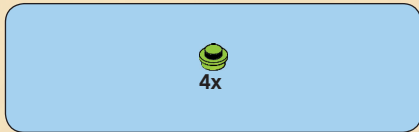

12

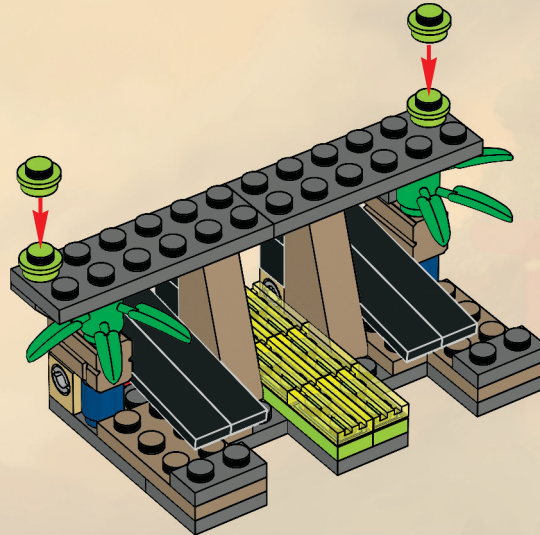



13

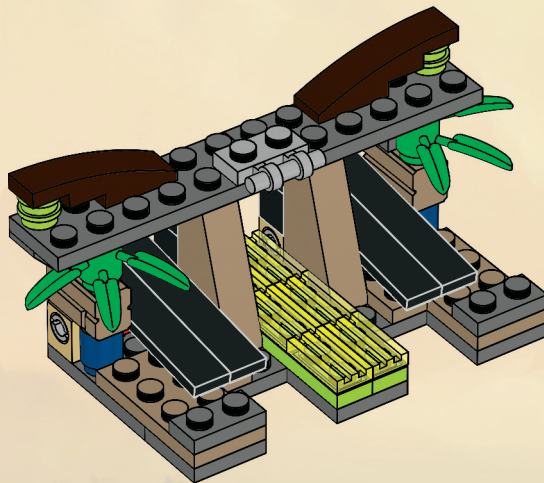

22





14

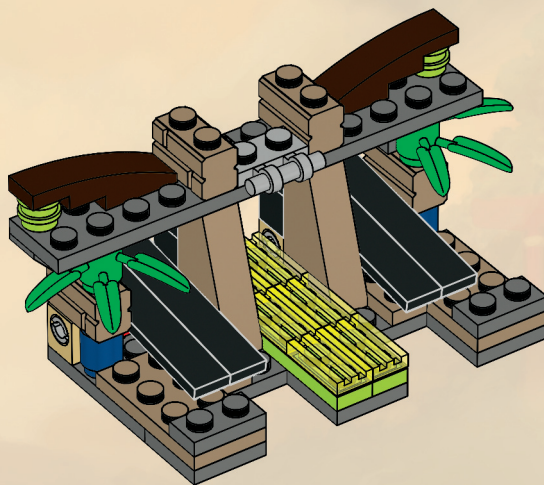

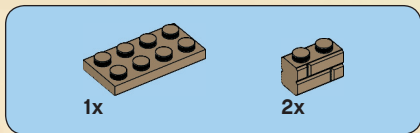

15

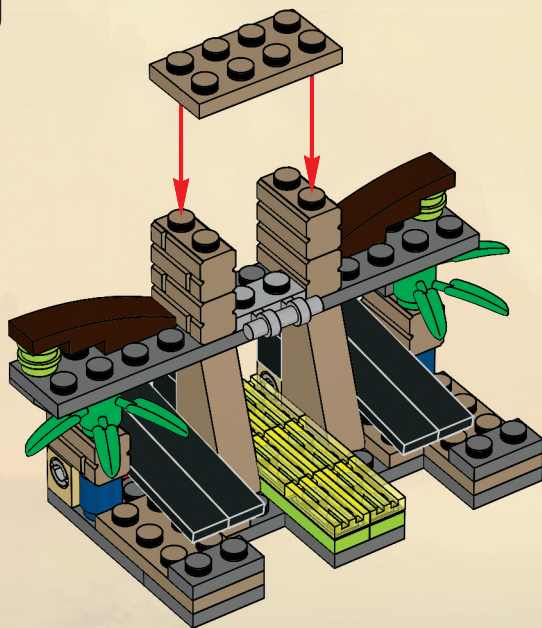

24





16

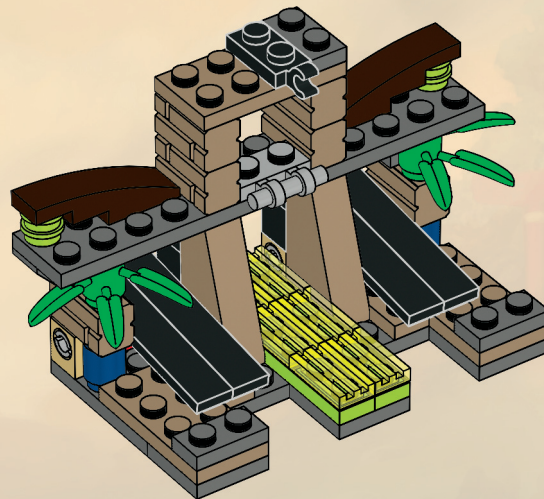

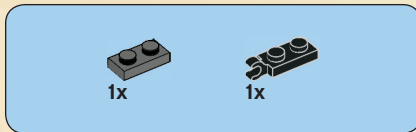

17

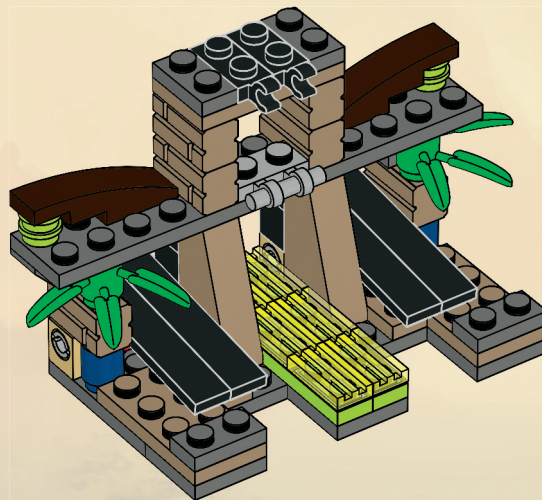

26



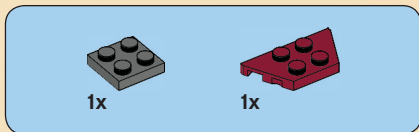

18

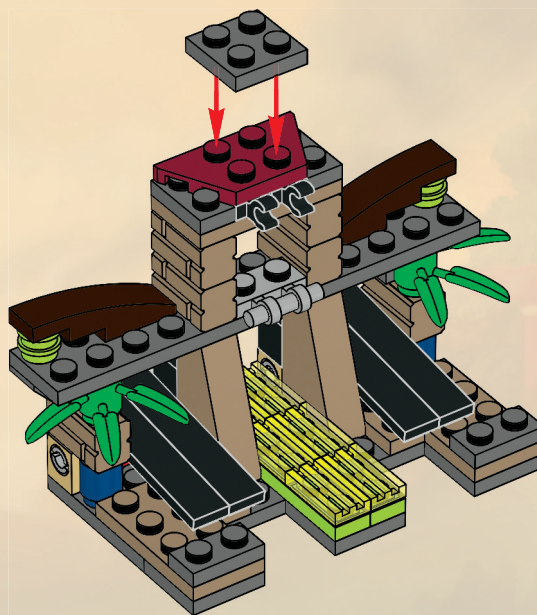



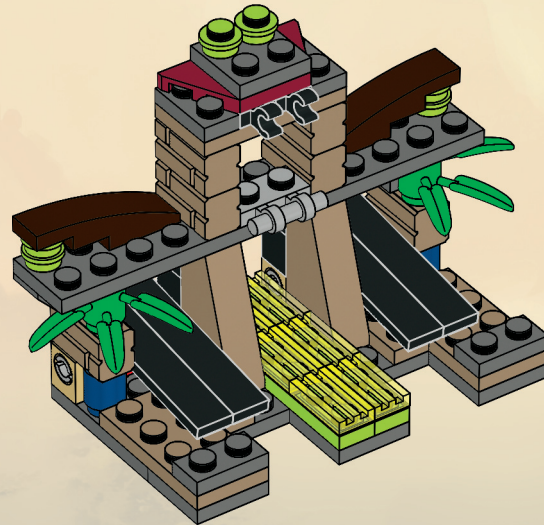

2x

19



28

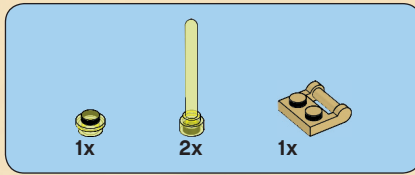



20

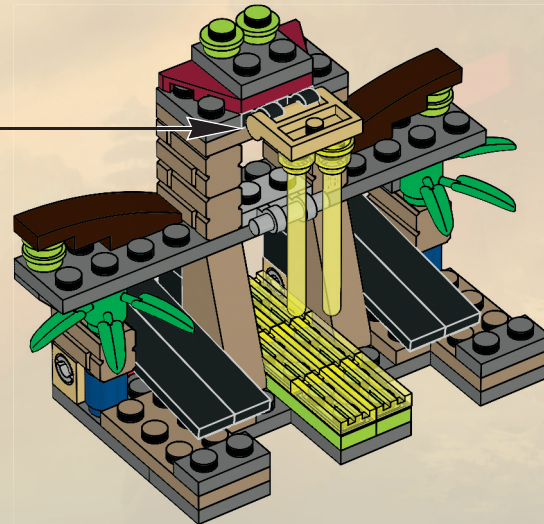
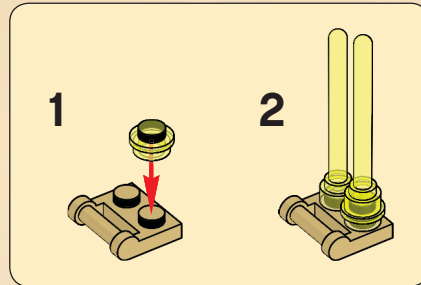

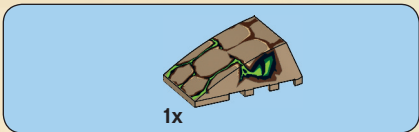

21

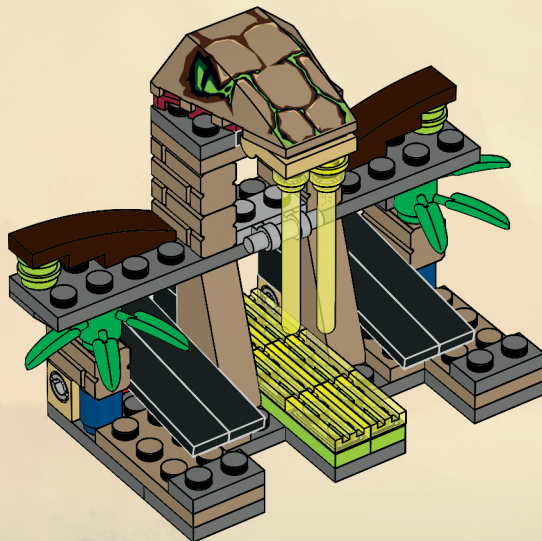

30



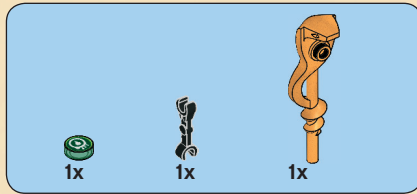

22

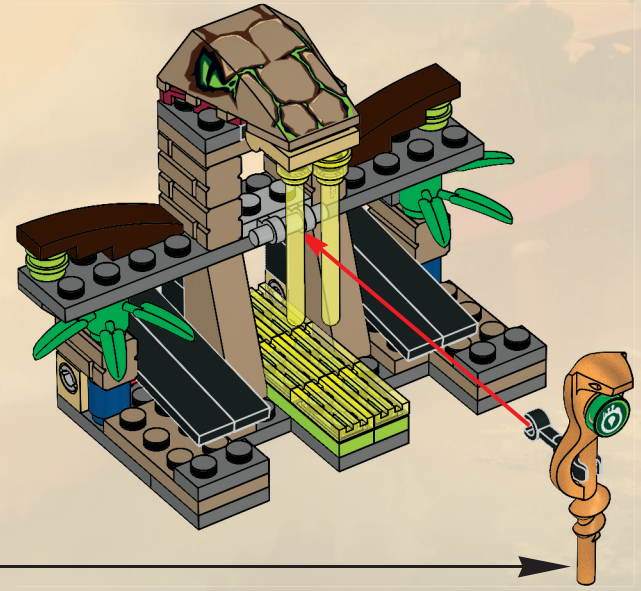
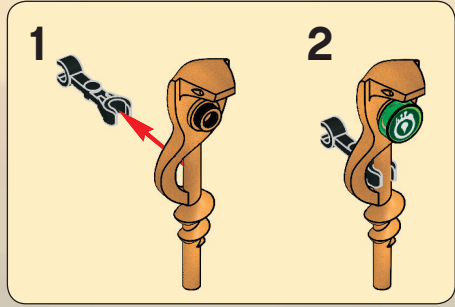

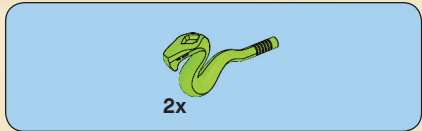

23

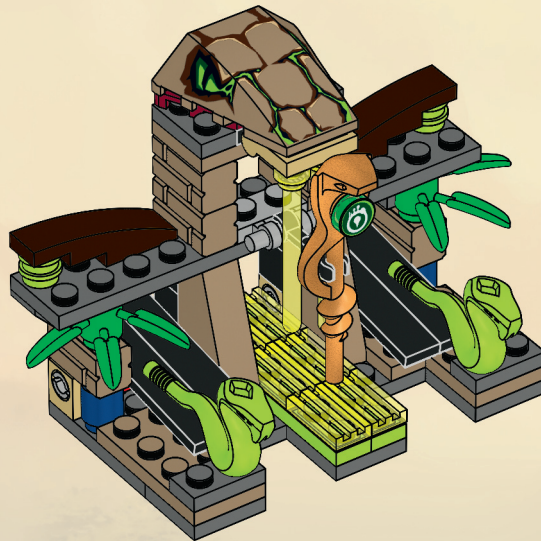

32



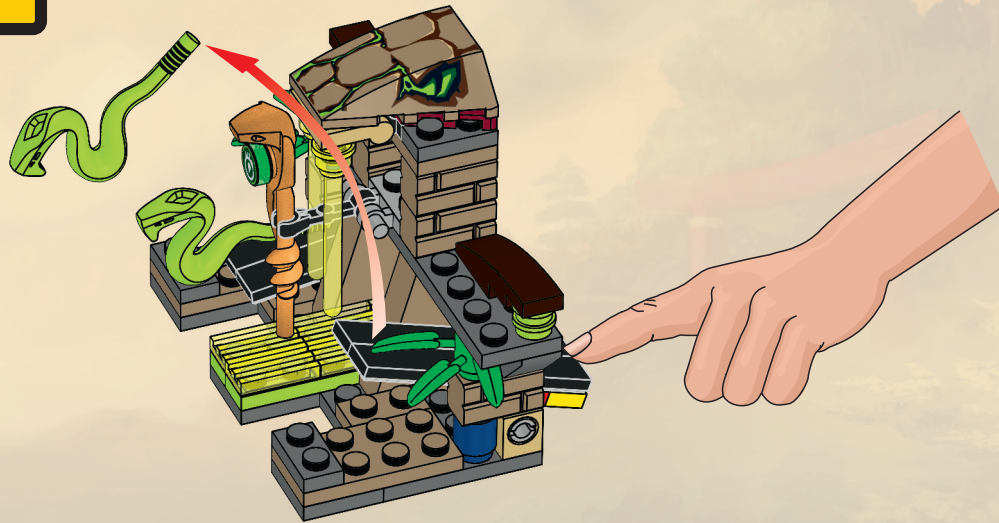



1x
4650494



1x
4650130



1x
4650119



4x
4179771



1x
4217562



2x
281721



2x
302324



1x
4611429



4x
300526



2x
4535739



4x
663626



1x
4505757



2x
4114348



1x
4653403



6x
4272661



1x
3005749



2x
4114011



6x
4183133



2x
4529160



2x
4646644



6x
4646577



2x
4653509



1x
4653511



2x
4528604



3x
4267874



2x
4177741



1x
4541544



2x
4211096



4x
4211063



4x
4211094



2x
4211002



1x
4211122



1x
4211632



4x
4211807



2x
4563023



1x
4612900



1x
4646814



1x
4646828



Customer Service

Kundenservice

Service Consommateurs

Servicio Al Consumidor

www.lego.com/service or dial



00800 5346 5555 :



1-800-422-5346 :





www.LEGOclub.com



LEGO® Club Email



LEGO® Club Magazine

LEGO club™

FREE! GRATIS! GRATUIT!

SIGN UP ONLINE!

www.LEGOclub.com



00800 5346 5555*



1-866-534-6258 • 1-877-518-5346

US & Canada only

Canada seulement

- * Freephone. Mobile charges may apply.
- * Numéro sans frais. Des frais peuvent s'appliquer avec les téléphones cellulaires.
- * Gebührenfrei, Kosten für Anrufe aus Mobilfunknetzen können abweichen.
- * Gratis telefoonnummer vanaf vaste lijn.
- * Det er et gratis nummer, når du ringer fra fasttelefon.
- * Det är gratis, när du ringer från en fast telefon.
- * Numéro sans frais. Des frais peuvent s'appliquer avec les téléphones portables.

B1114



WIN!

Go to www.LEGOsurvey.com/product
to fill out a survey for a chance
to win a cool LEGO® Product.

No purchase necessary.

Open to all residents where not prohibited.

www.LEGOsurvey.com/product

GEWINNE!

Nimm an der Umfrage auf www.LEGOsurvey.com/product teil und hab die Chance ein cooles LEGO® Produkt zu gewinnen!
Die Teilnahme am Gewinnspiel führt zu keinerlei Kaufverpflichtungen. Teilnahme in allen nicht ausgeschlossenen Ländern möglich.

WIN!

Ga naar www.LEGOsurvey.com/product, vul een enquêteformulier in en maak kans op een cool LEGO® product.
Geen aankoopverplichting. Iedereen mag deelnemen, uitgezonderd ingezetenden van landen waar een enquêteverbod geldt.

GAGNE!

Visite www.LEGOsurvey.com/product pour répondre à un questionnaire et avoir une chance de gagner un produit LEGO® très cool!
Aucune obligation d'achat. Ouvert à tous les résidents des pays autorisés.

当てよう!

www.LEGOsurvey.com/product にアクセスして、アンケートにご記入ください。
当選者にはレゴ®製品を差し上げます。
お買い上げの必要はありません。
禁止されていない限り、すべての皆様にご利用いただけます。

 www.LEGO.com

6003142

LEGO and the LEGO logo are trademarks of the/sont des marques de commerce de/son marcas registradas de LEGO Group. ©2012 The LEGO Group.