

BIONICLE

MAXILOS & SPINAX

WWW.BIONICLE.COM



8924

LEGO

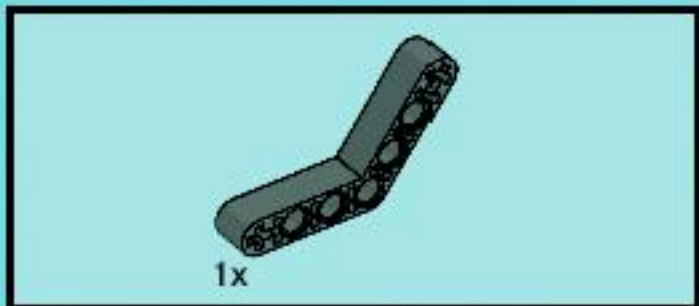
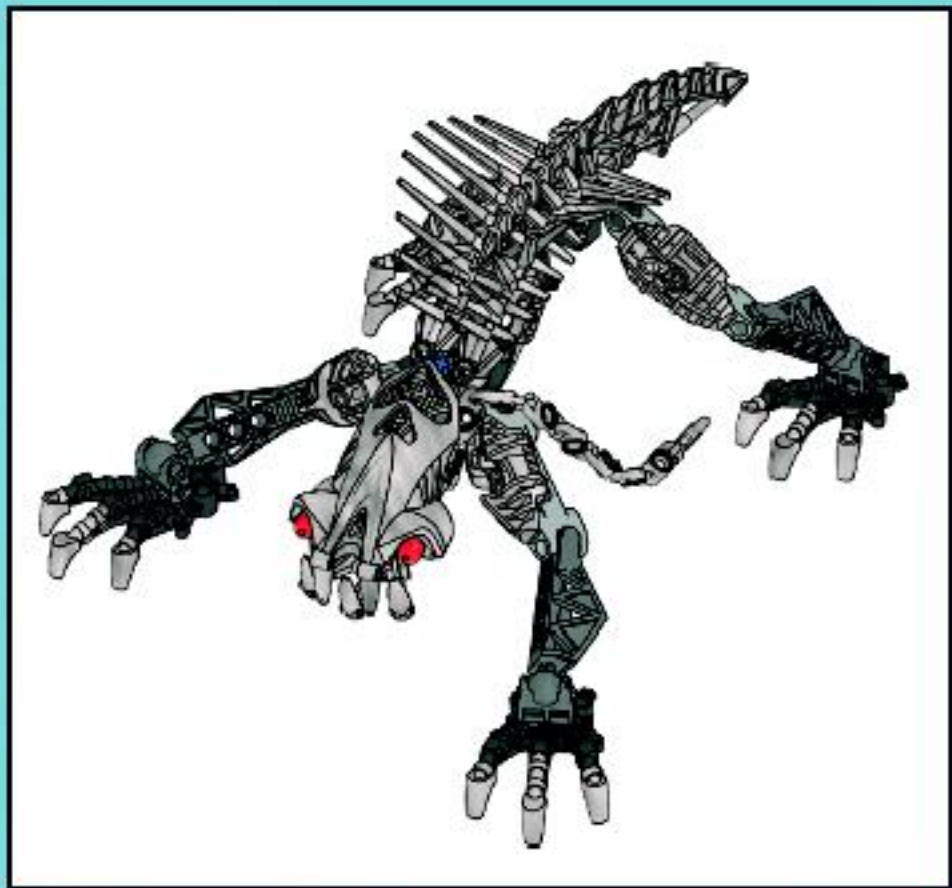

1

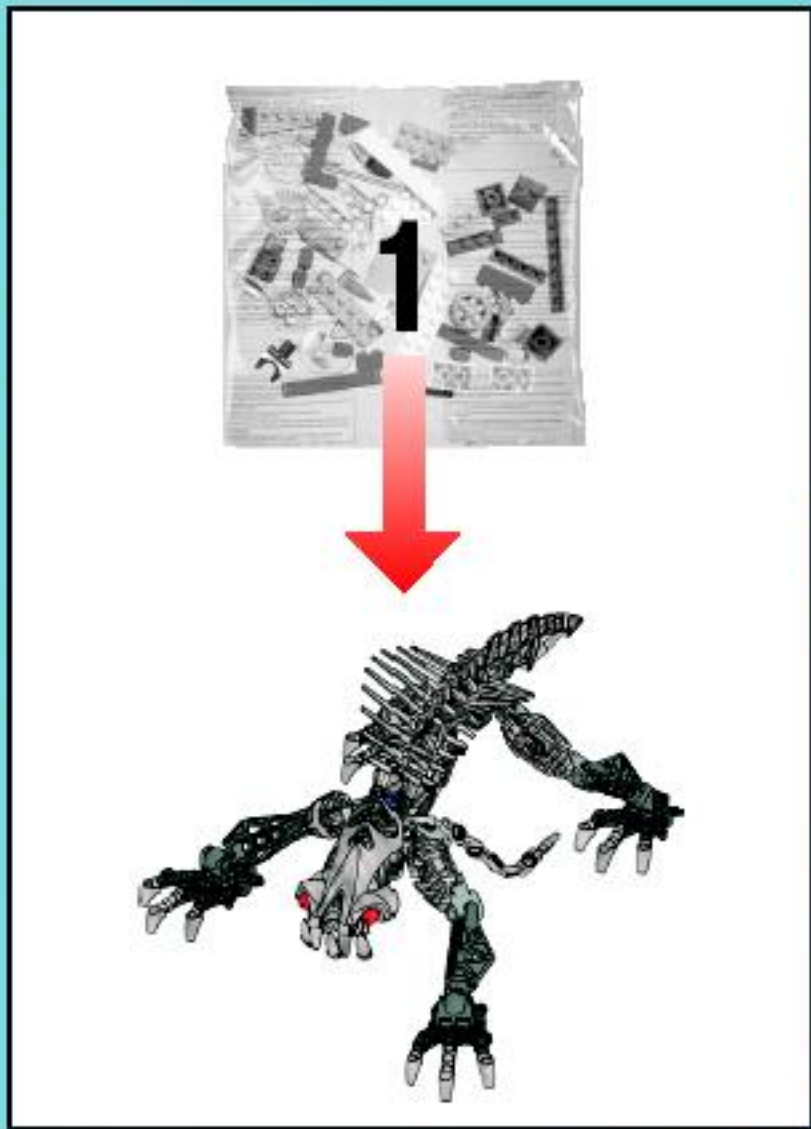

2

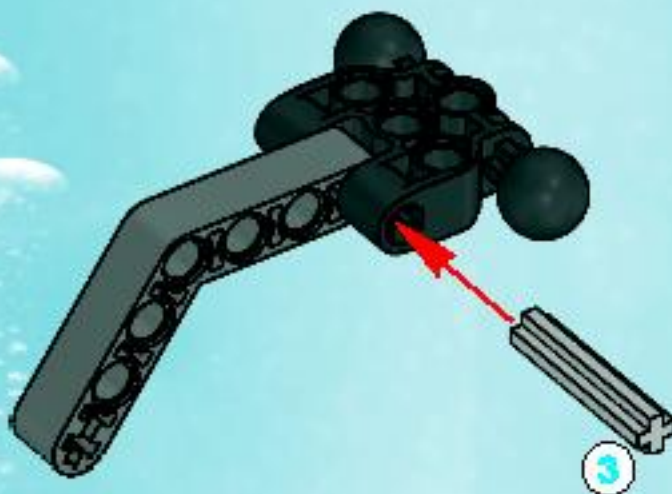

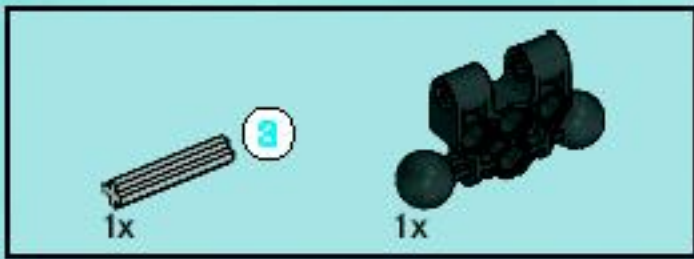

3

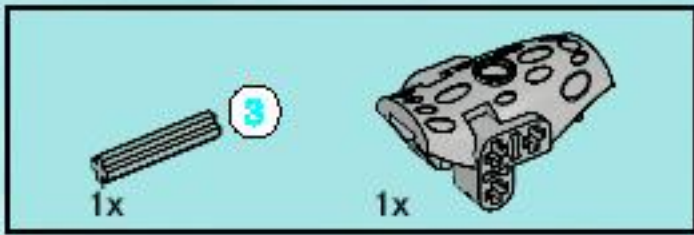
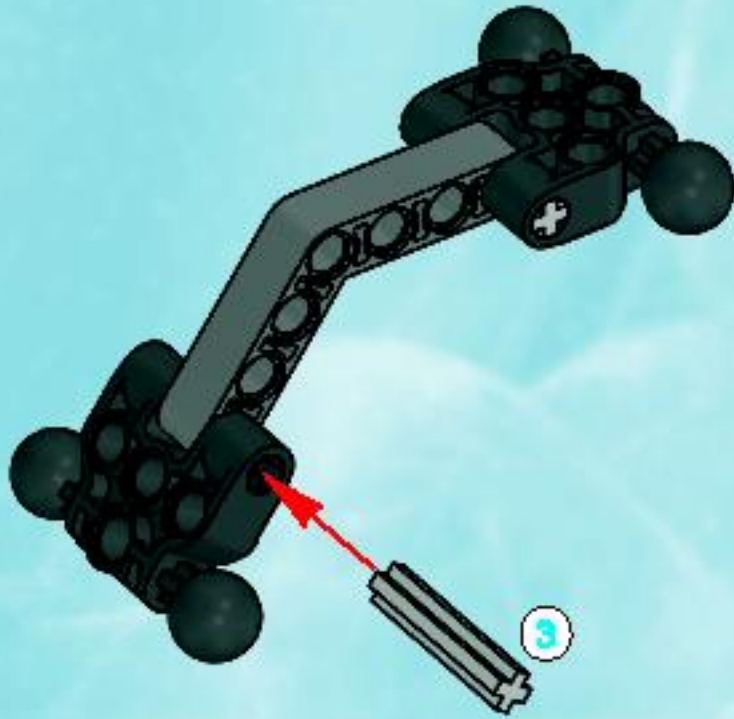

4

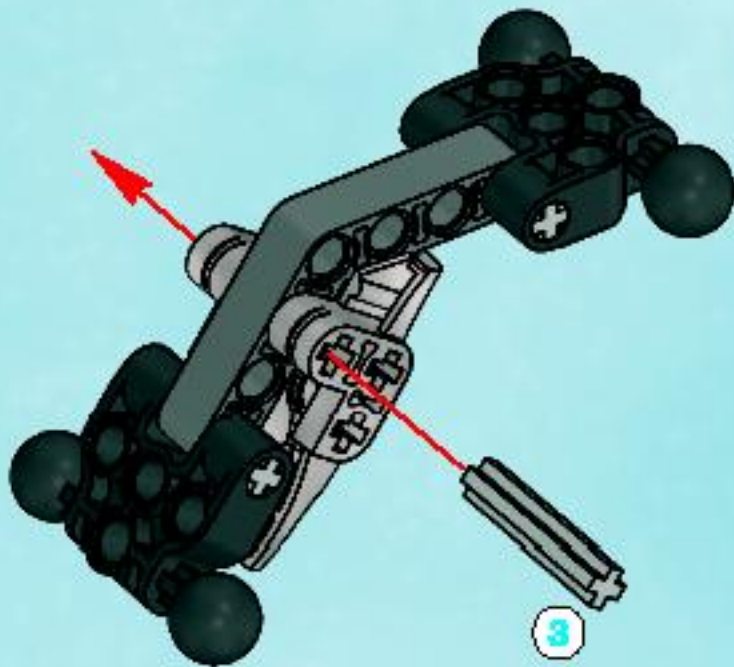

5

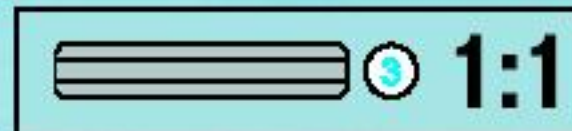
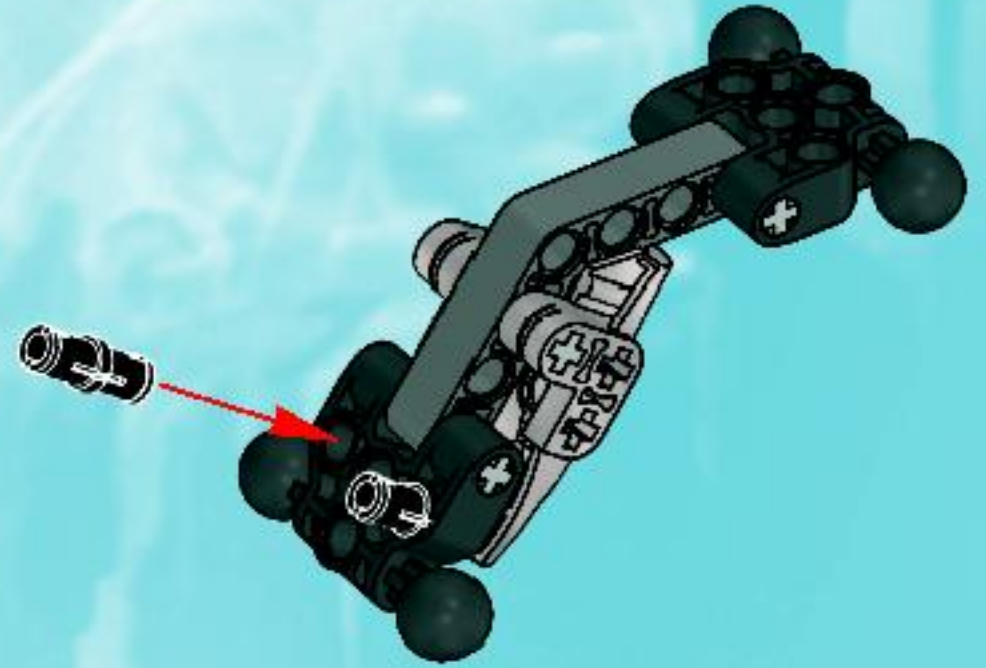

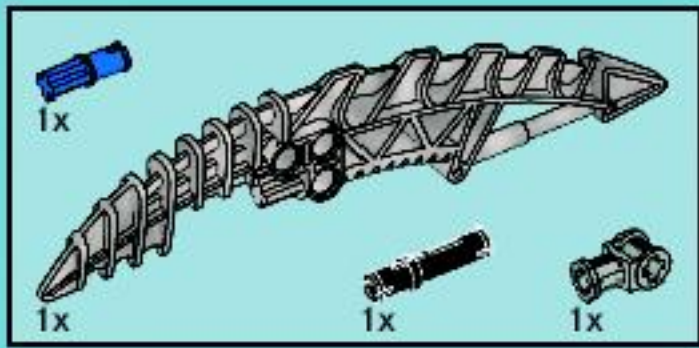

6

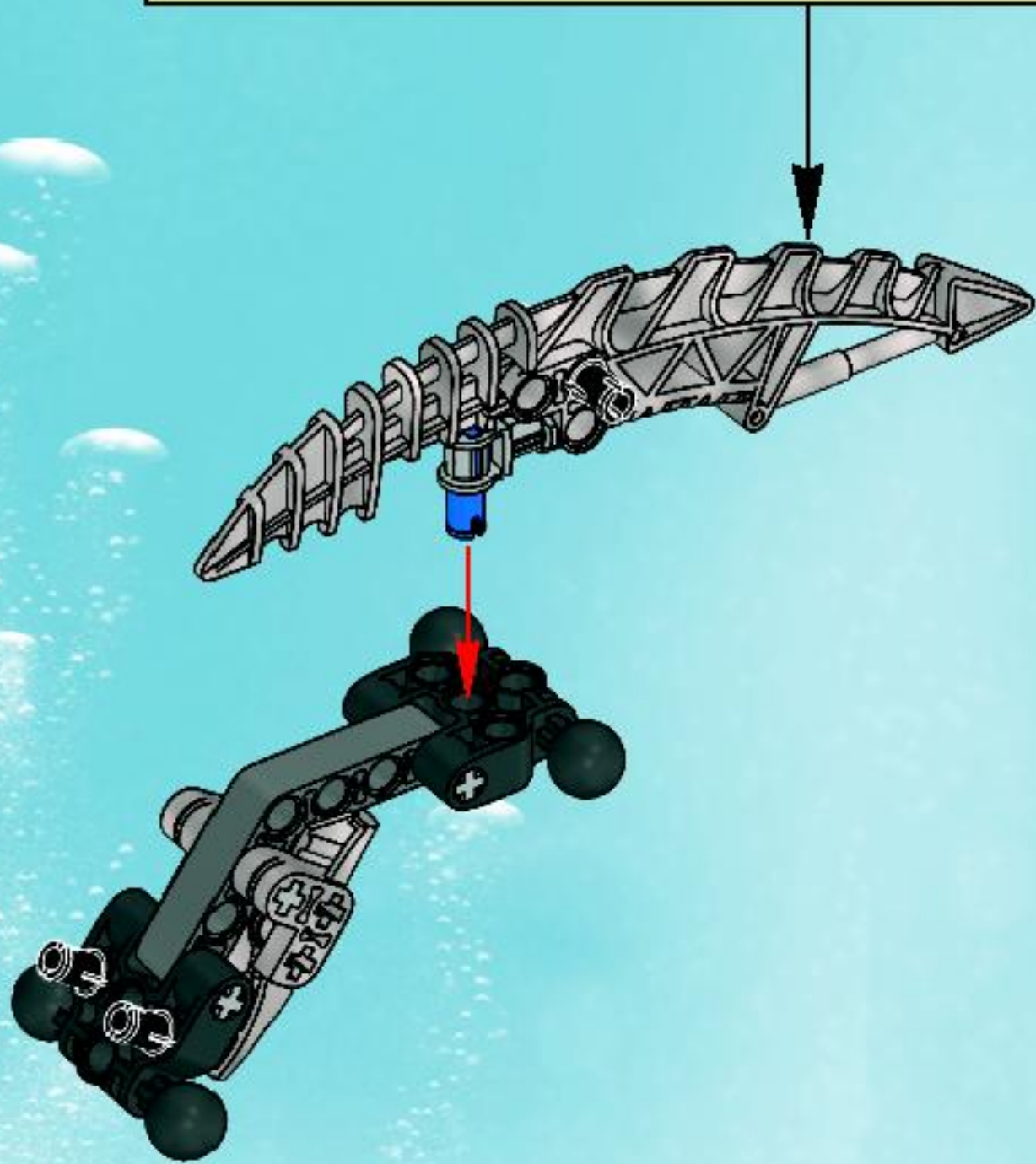
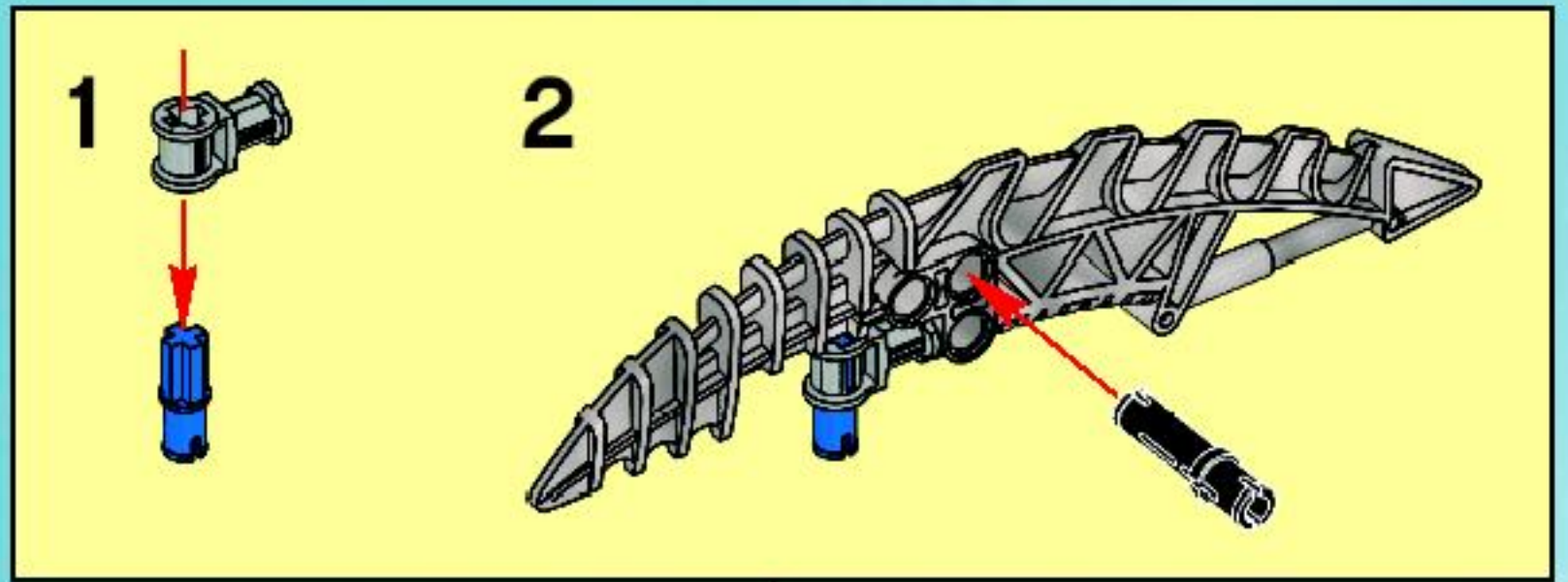

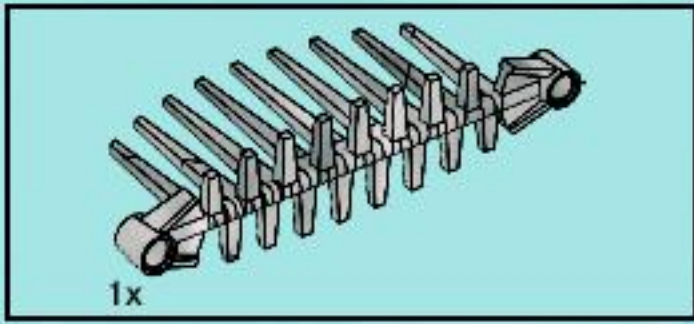

7

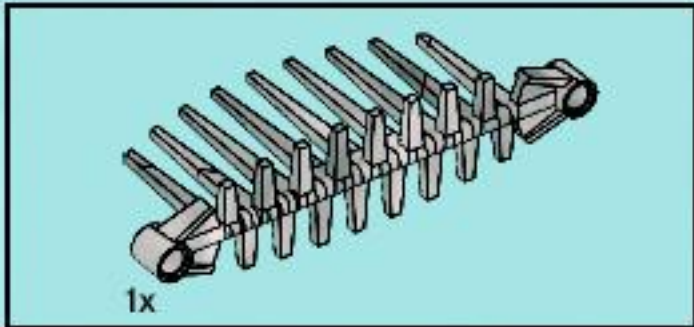
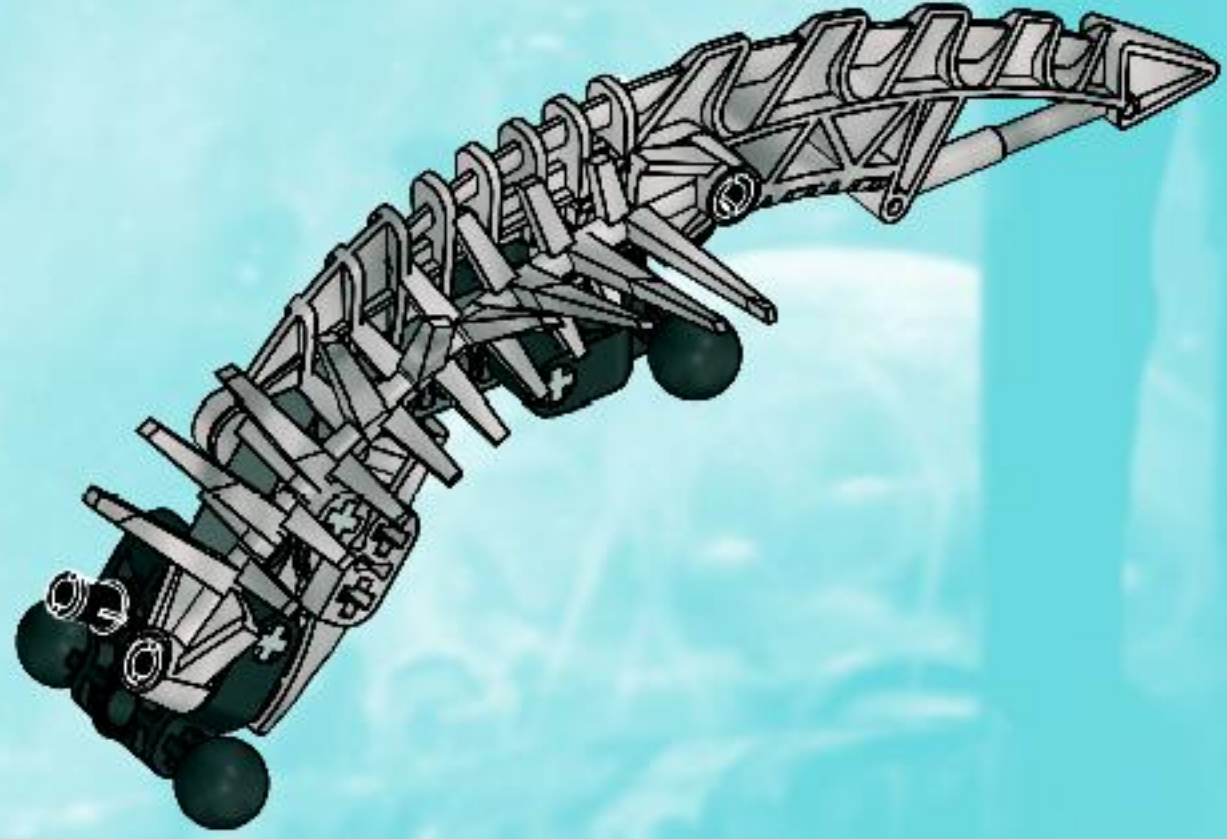

8

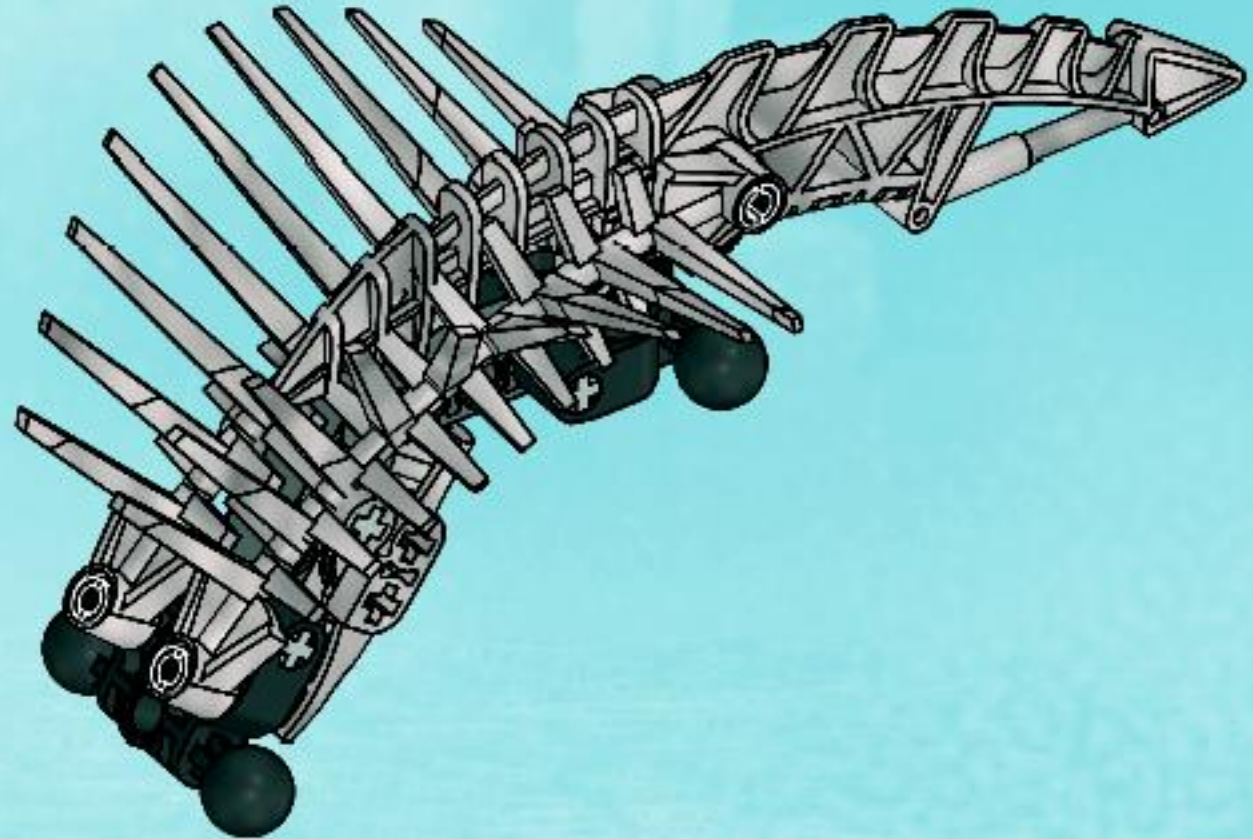

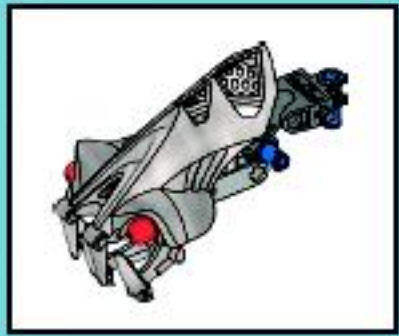

1

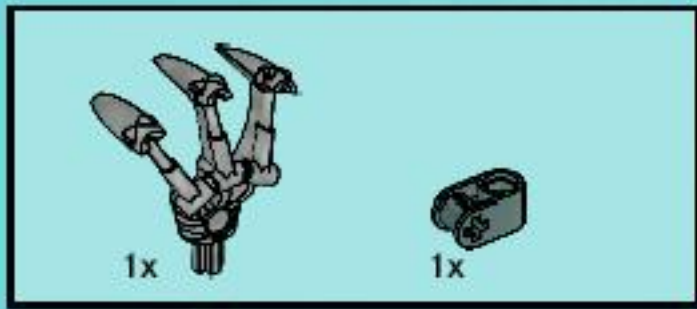
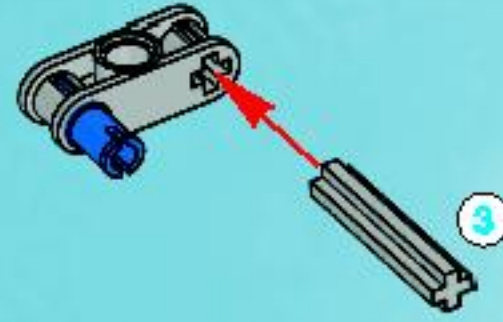

2

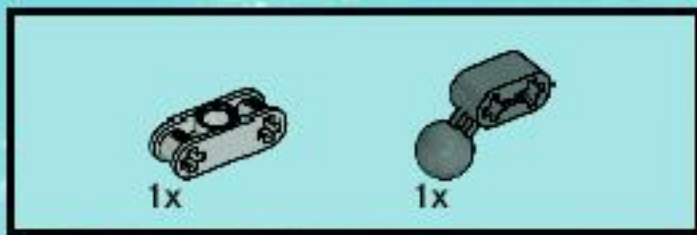
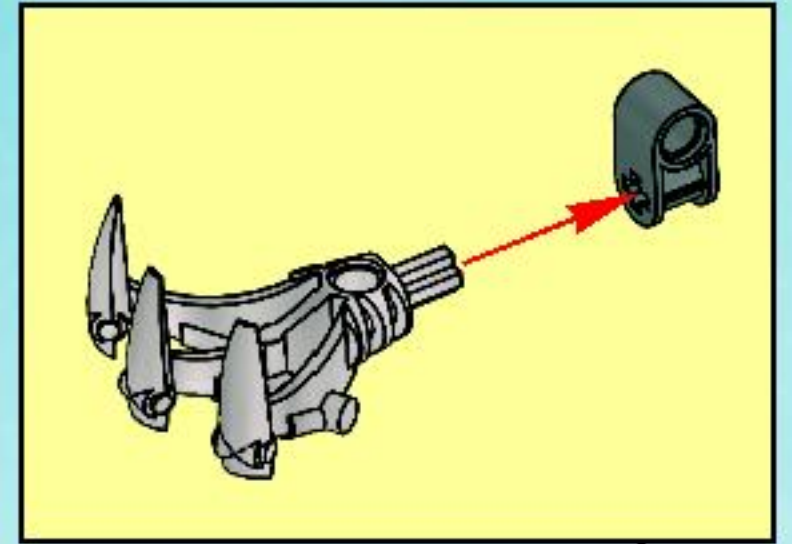

3

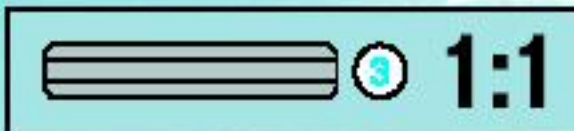
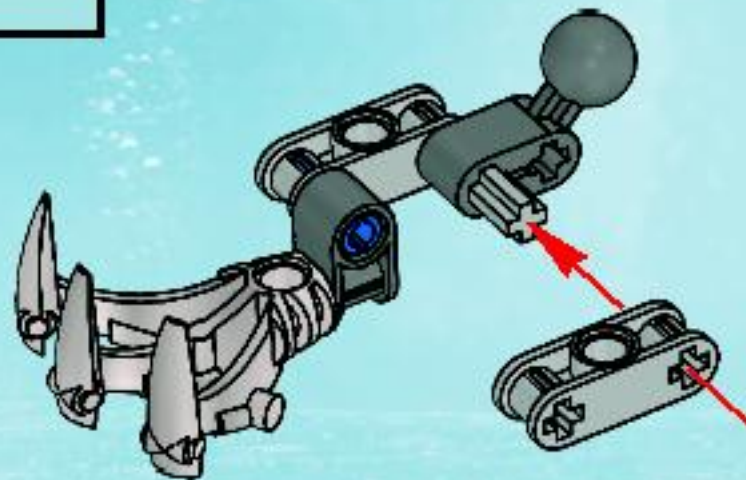



4

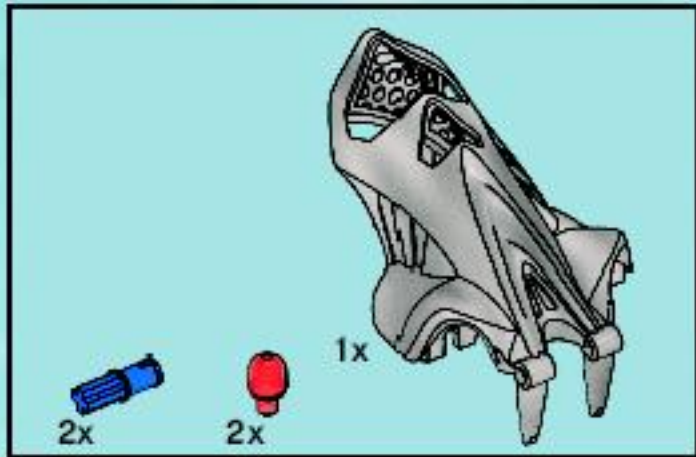
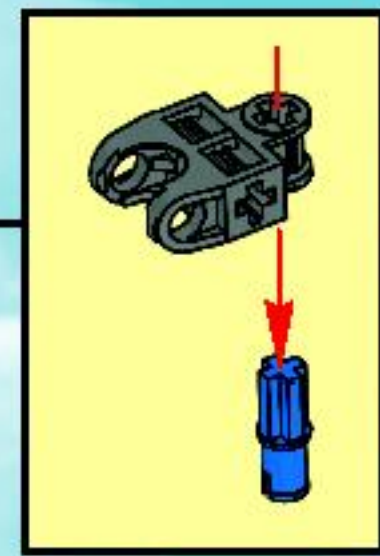
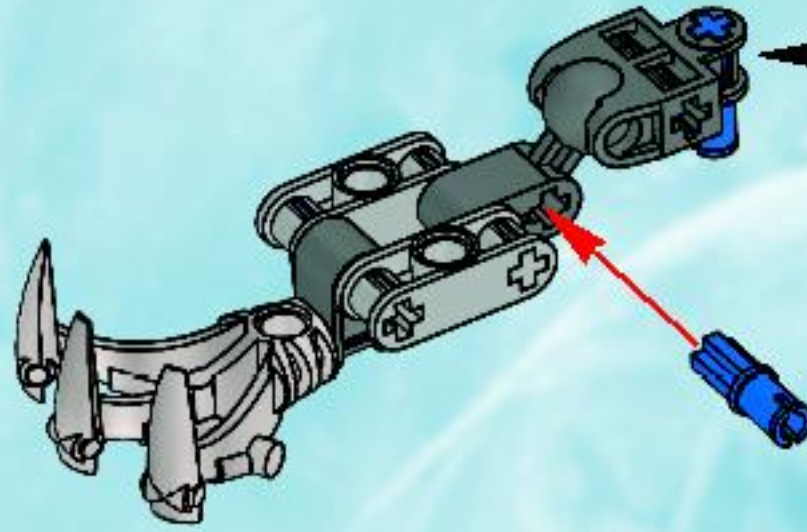

5

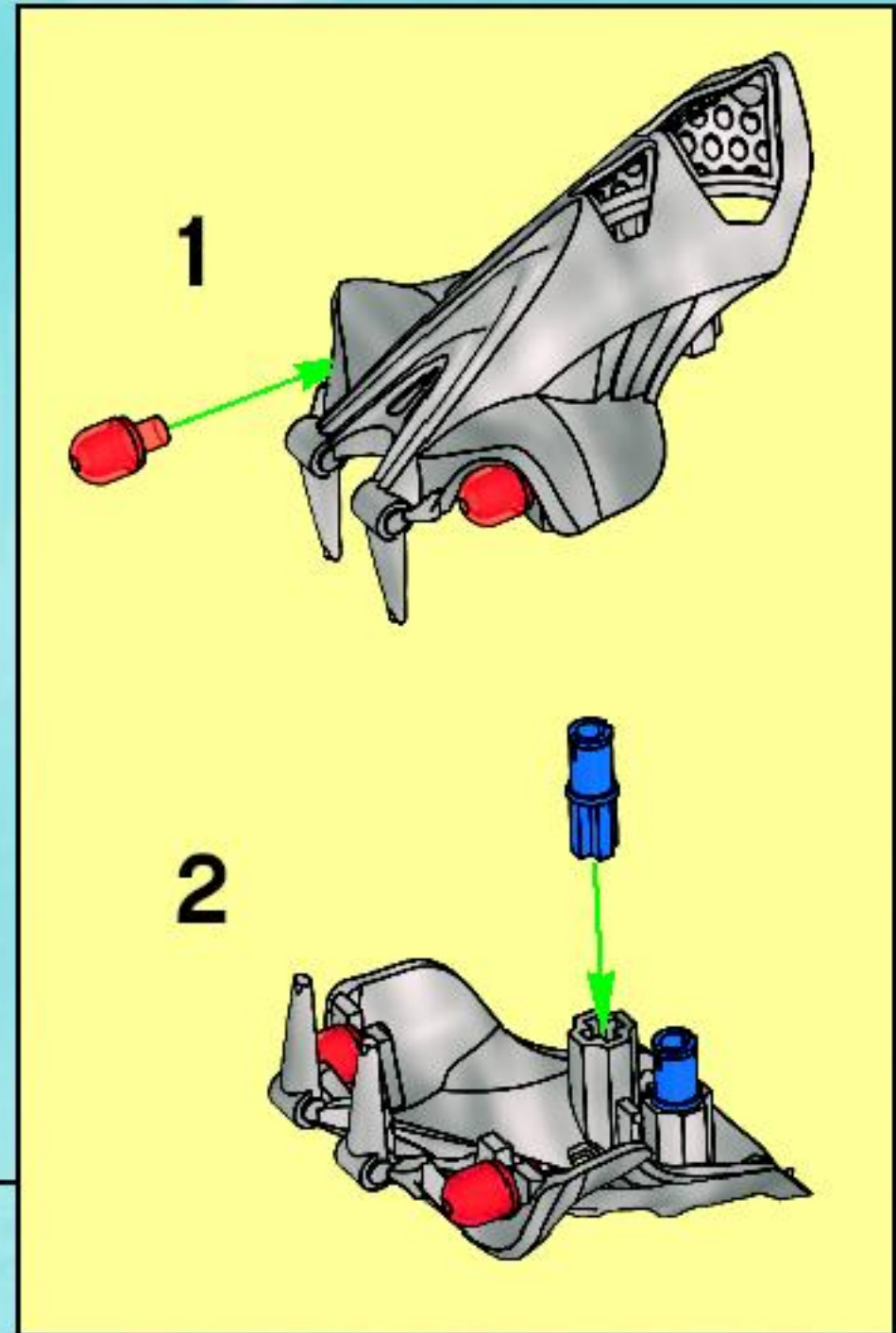
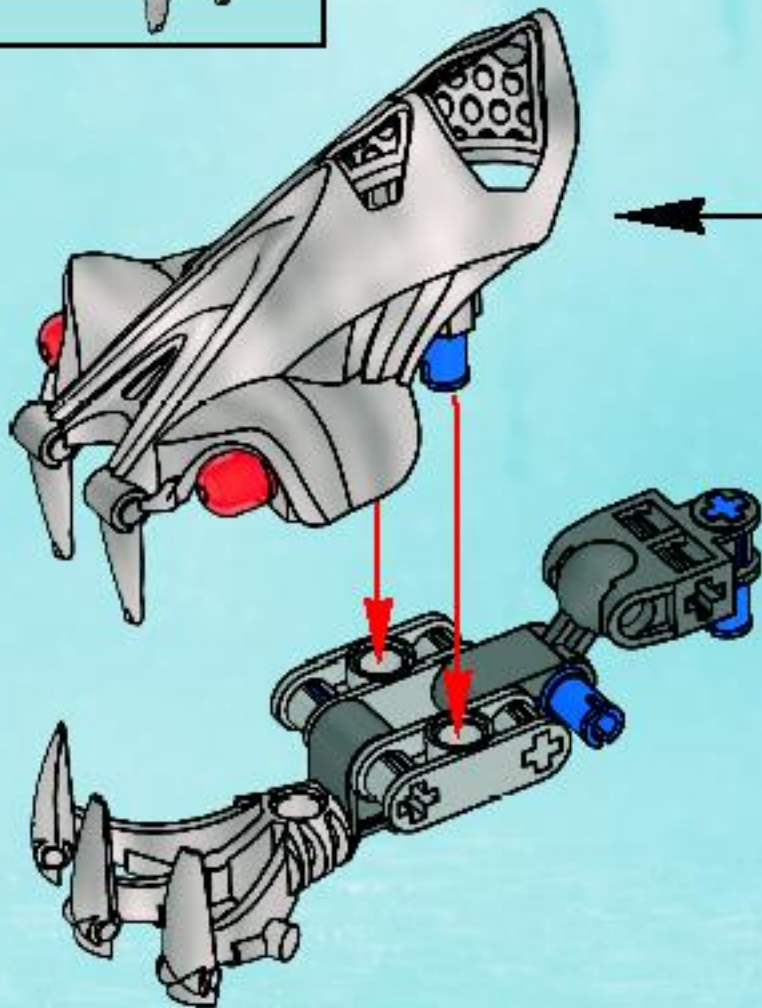

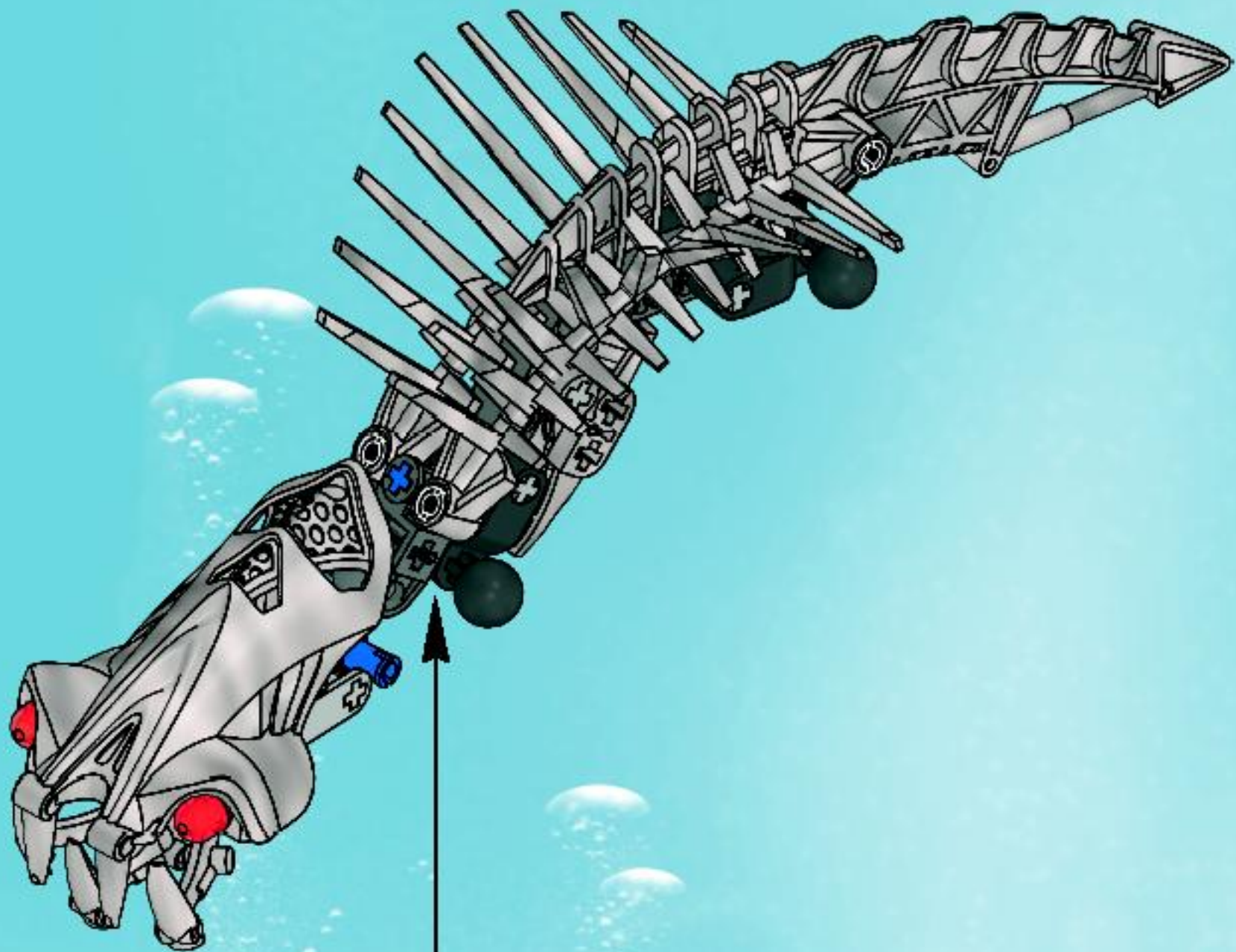



10

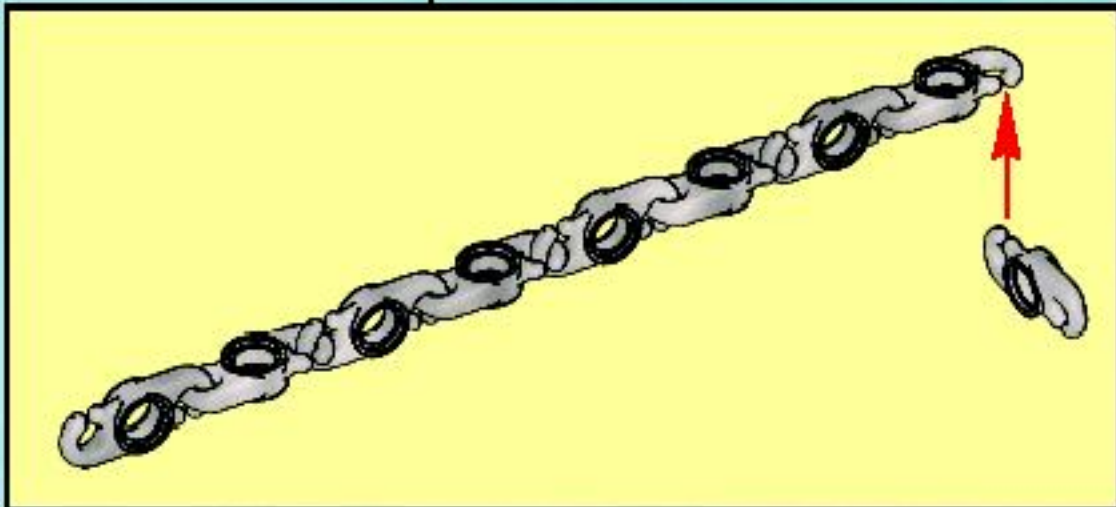
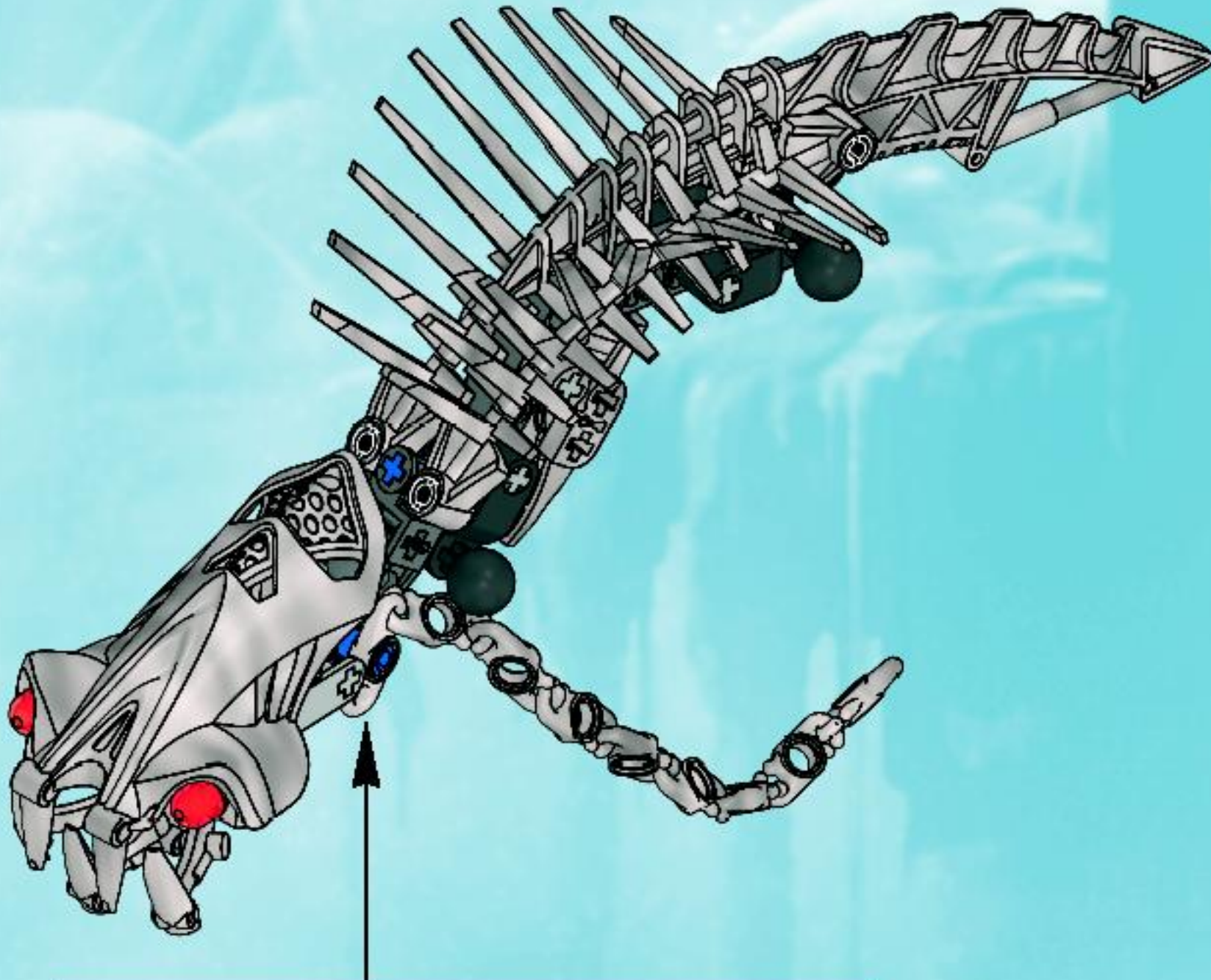

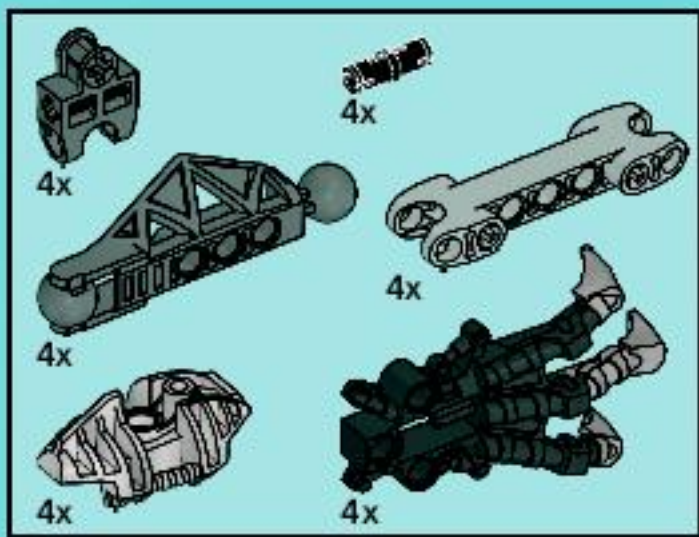

11

1

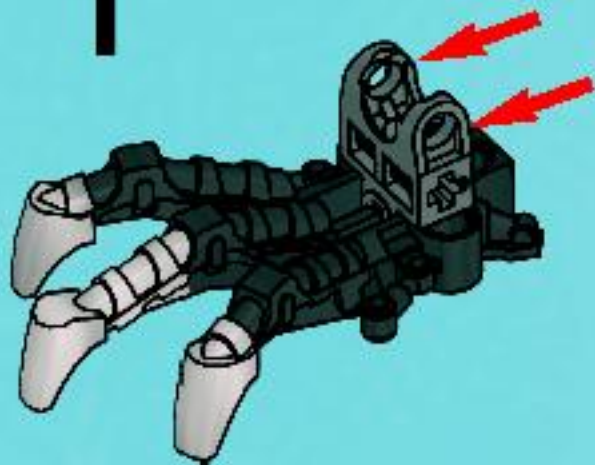

2

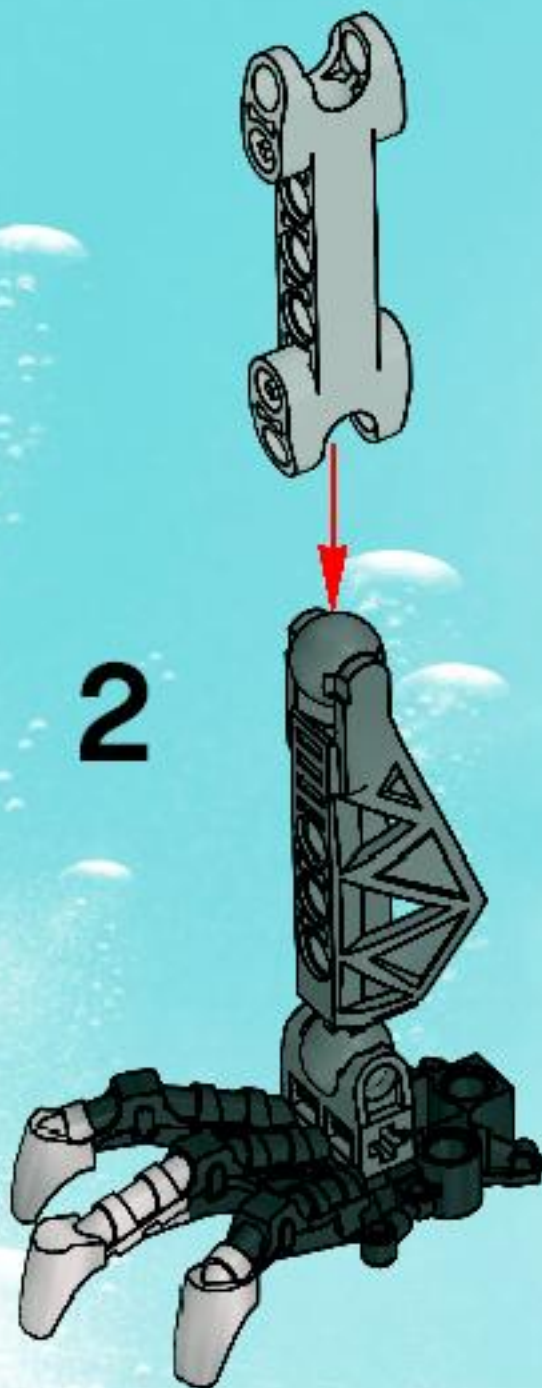

3

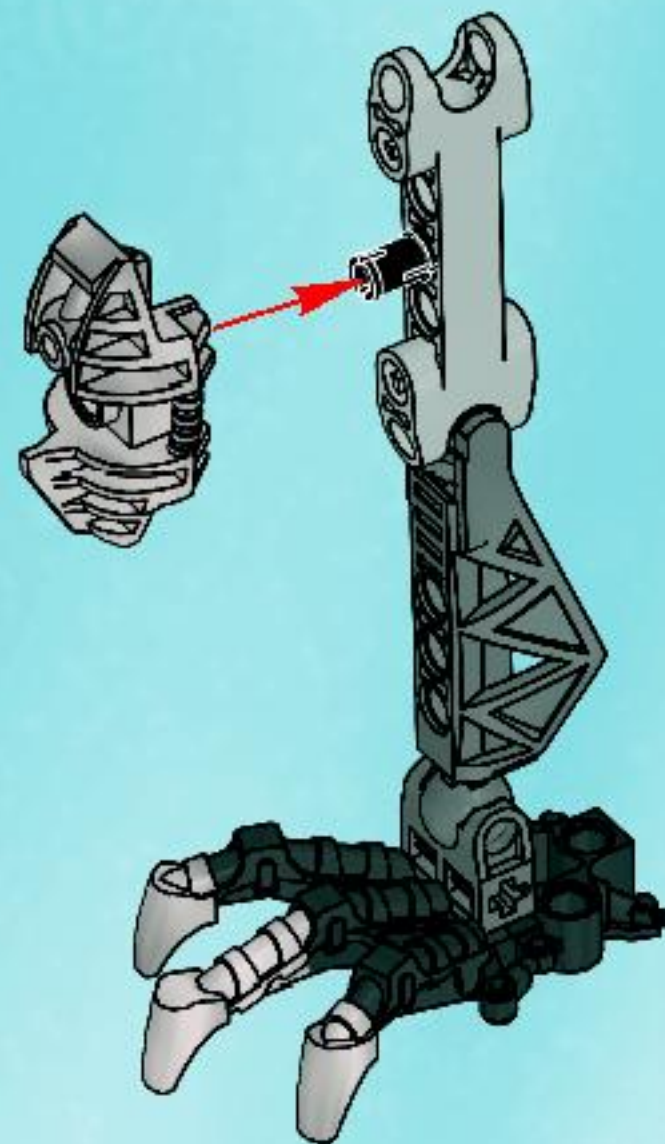

4x

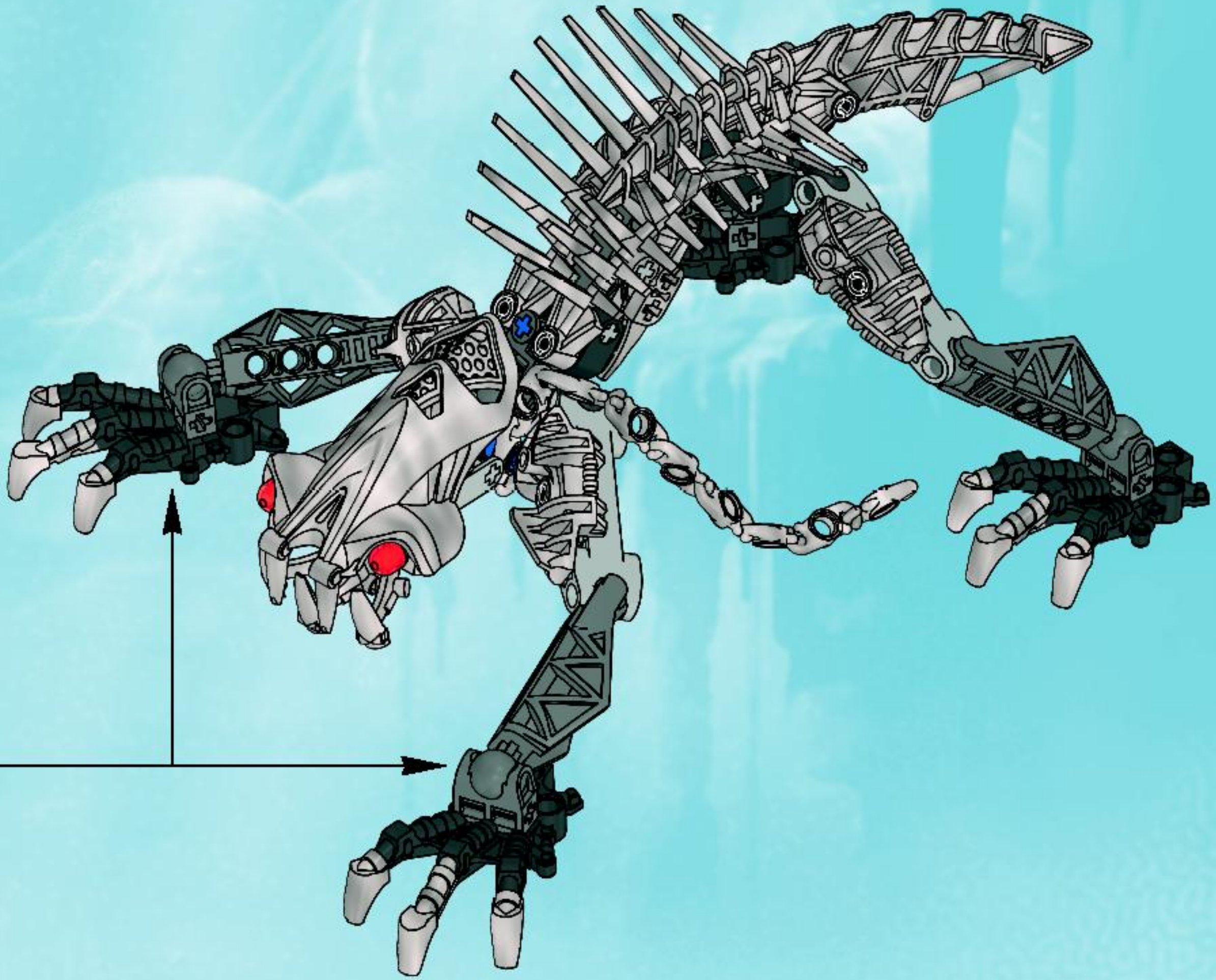

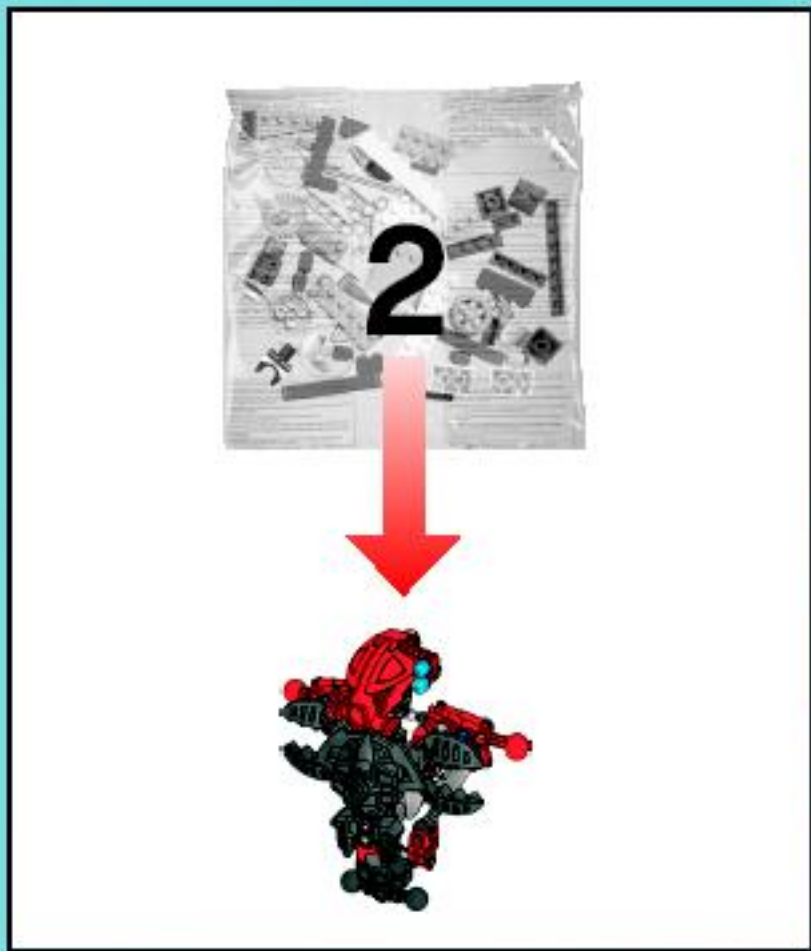
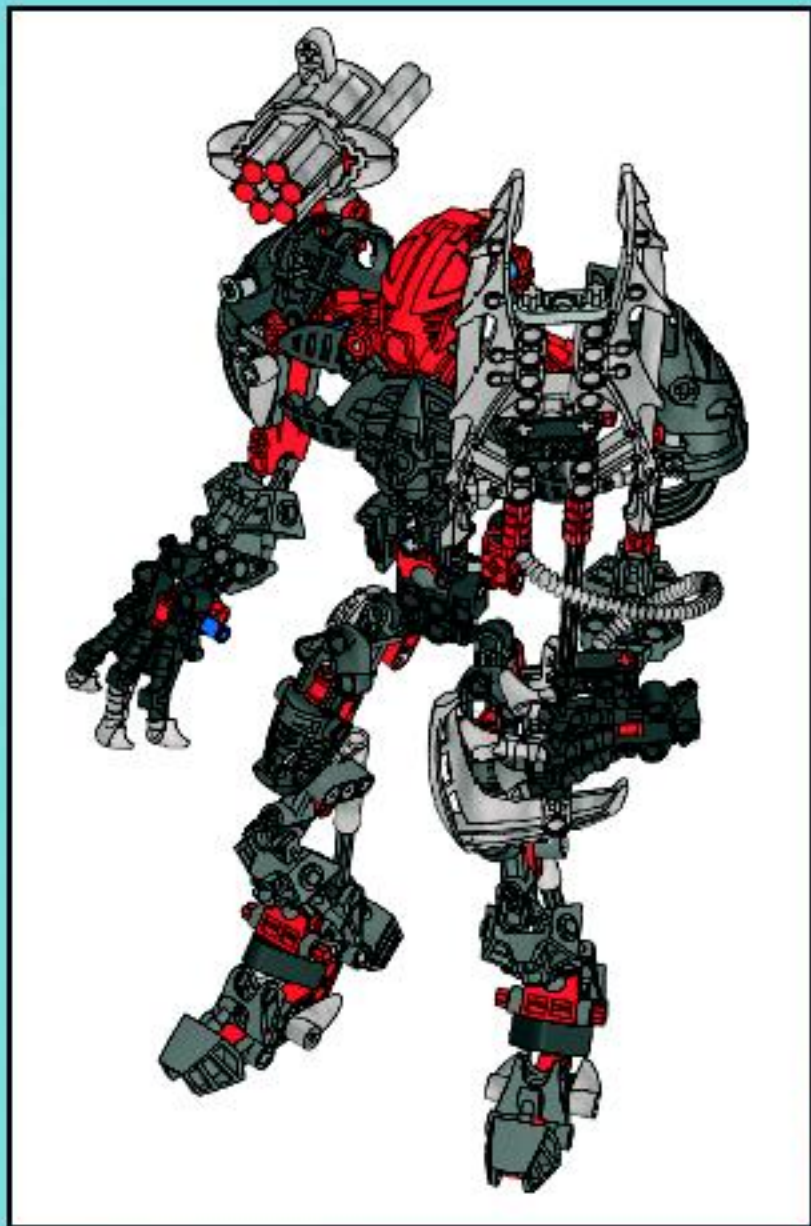

1

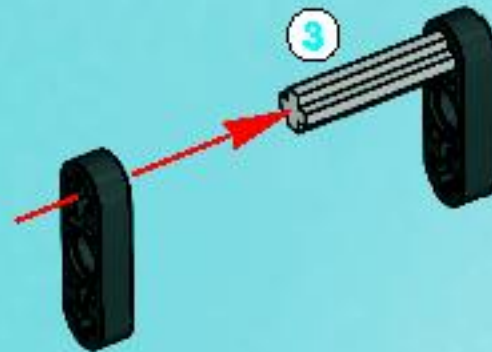

2

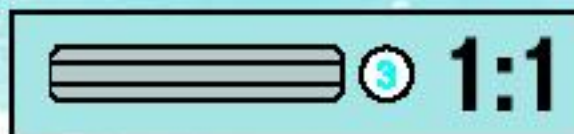
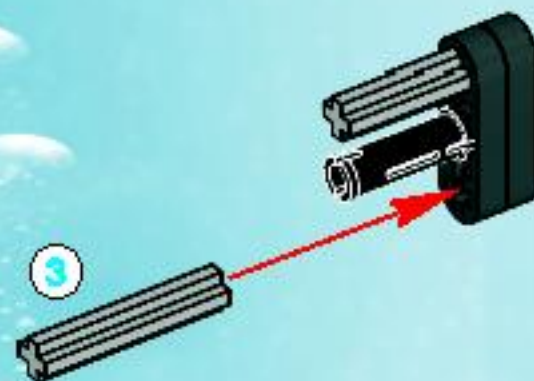

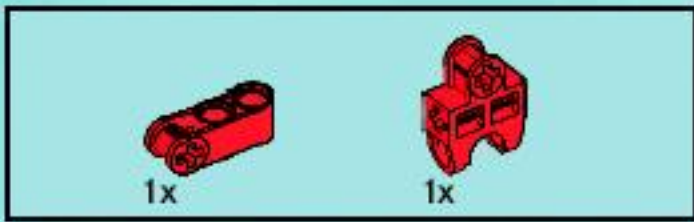

3

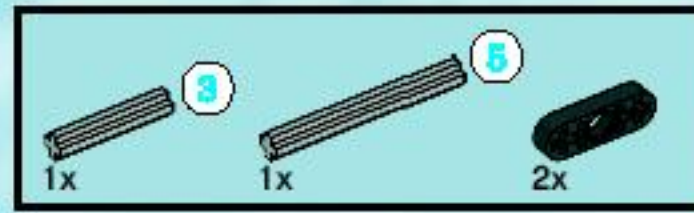
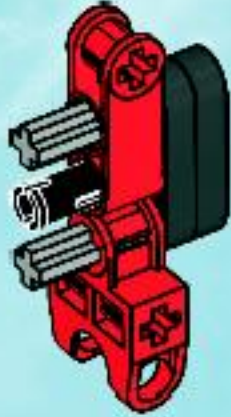

4

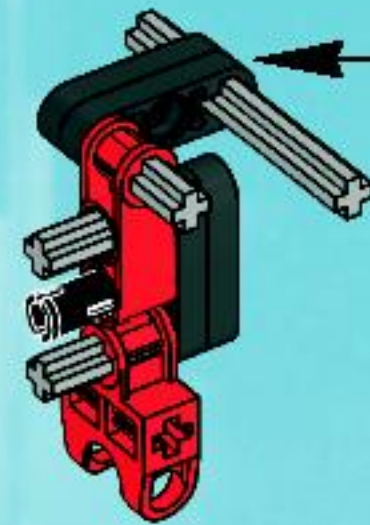
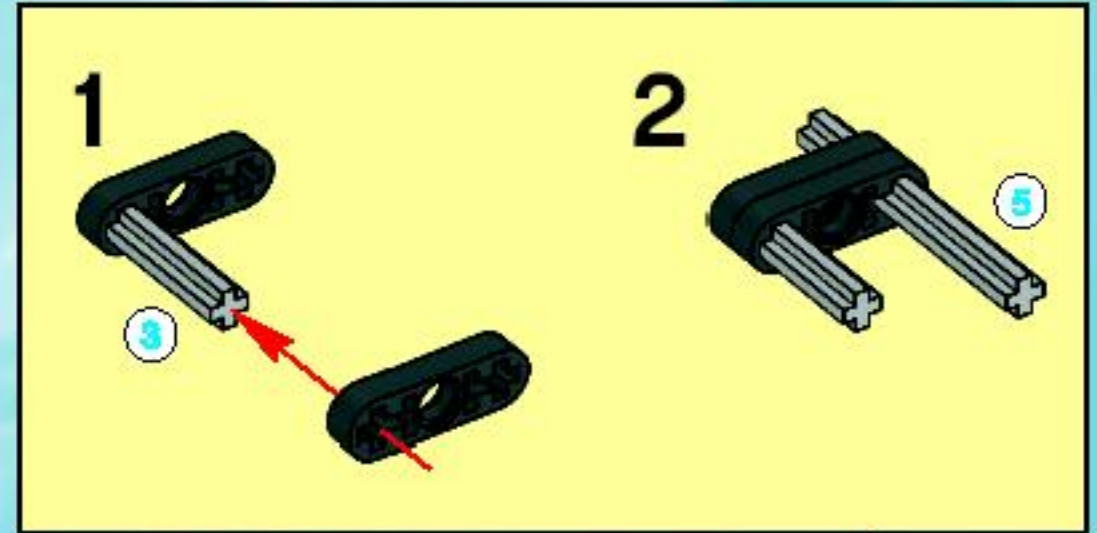



5

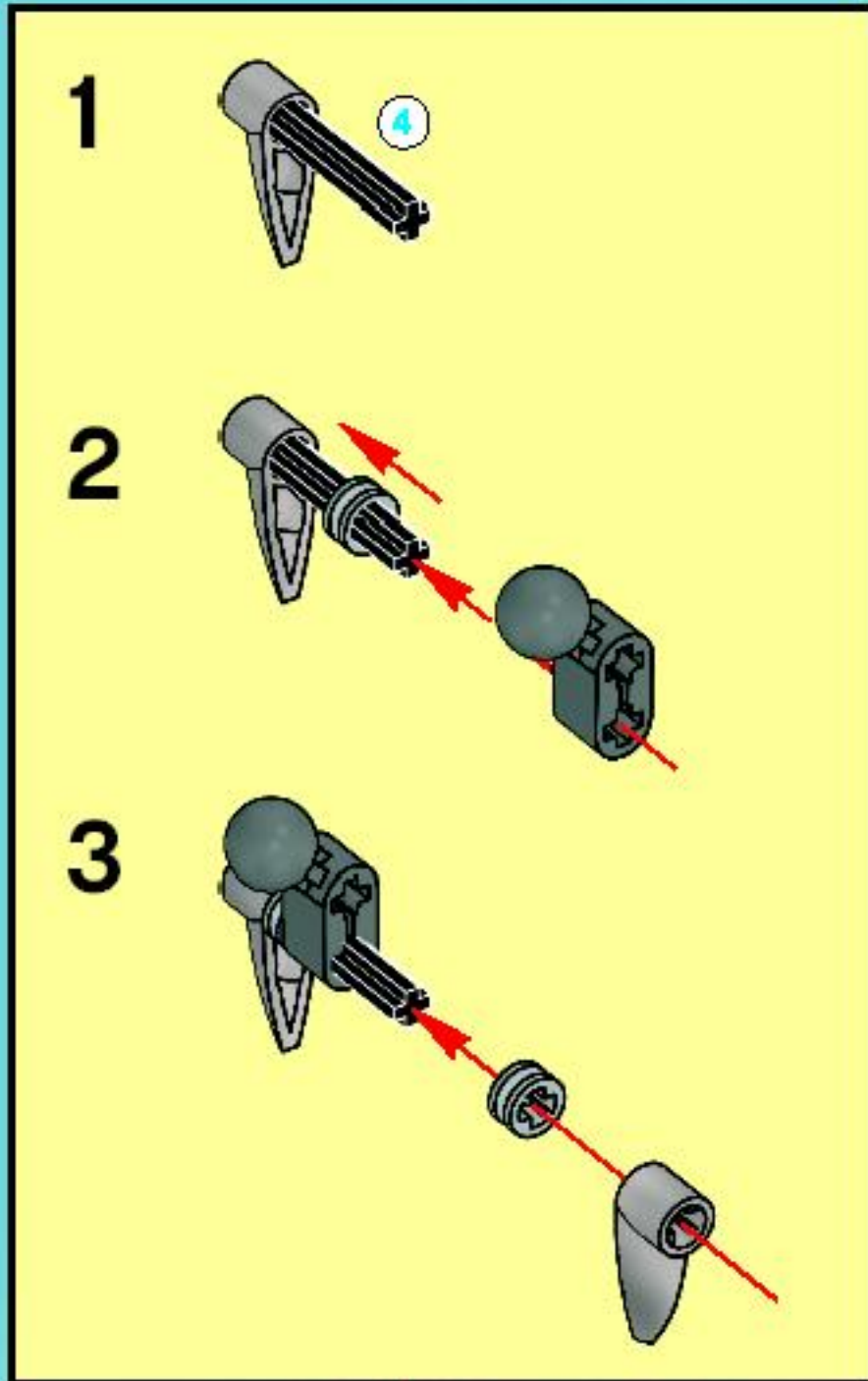

6

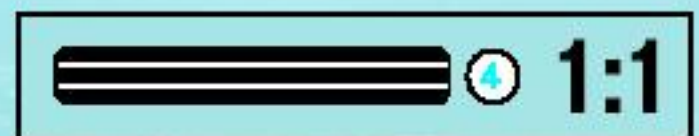
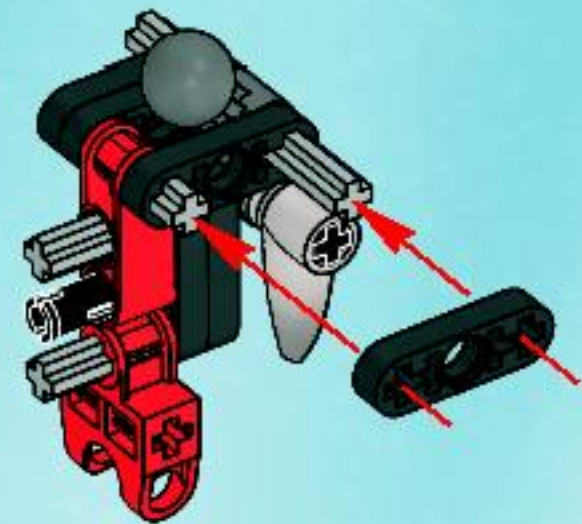

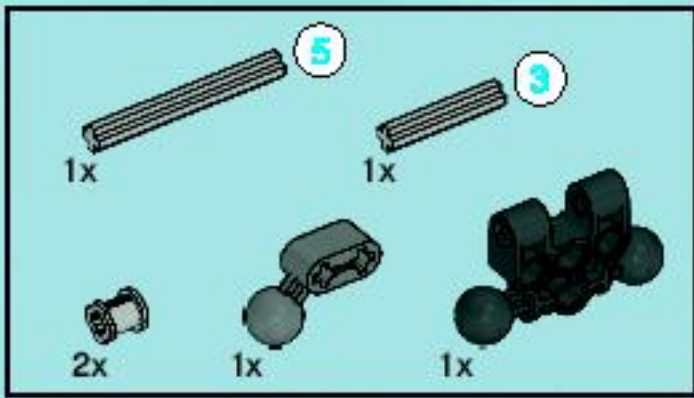

7

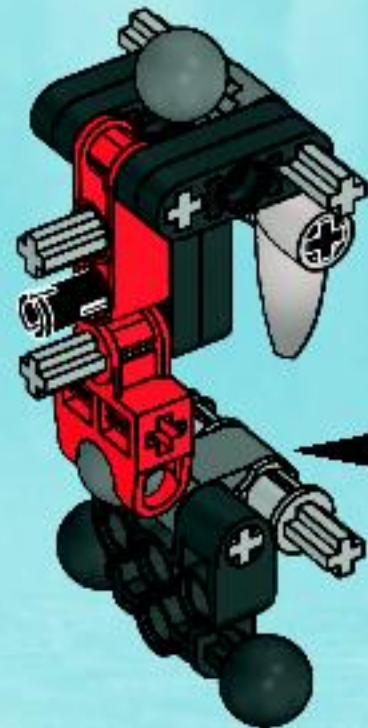
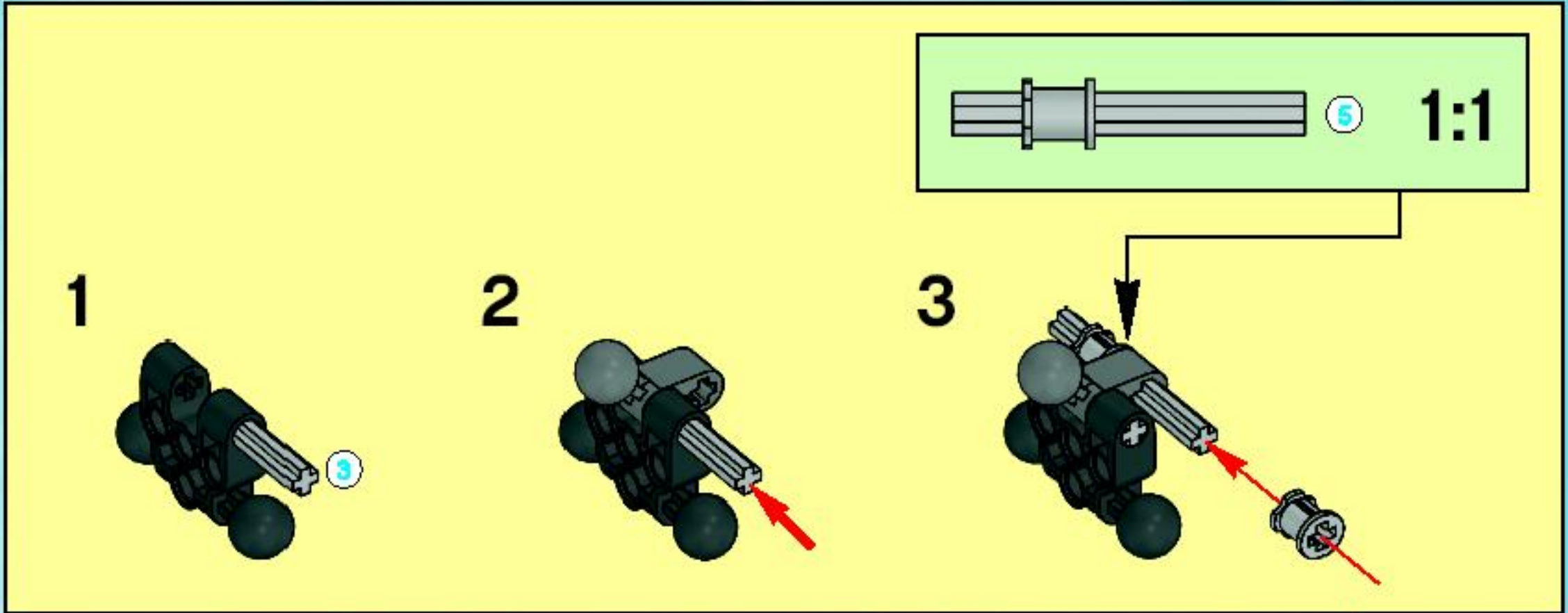

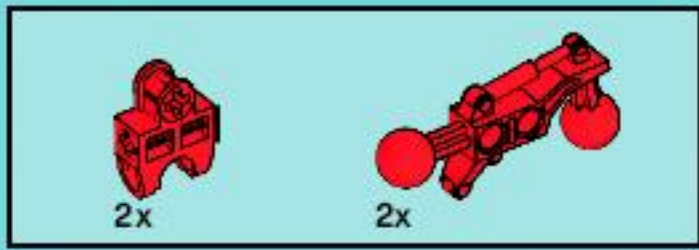

8

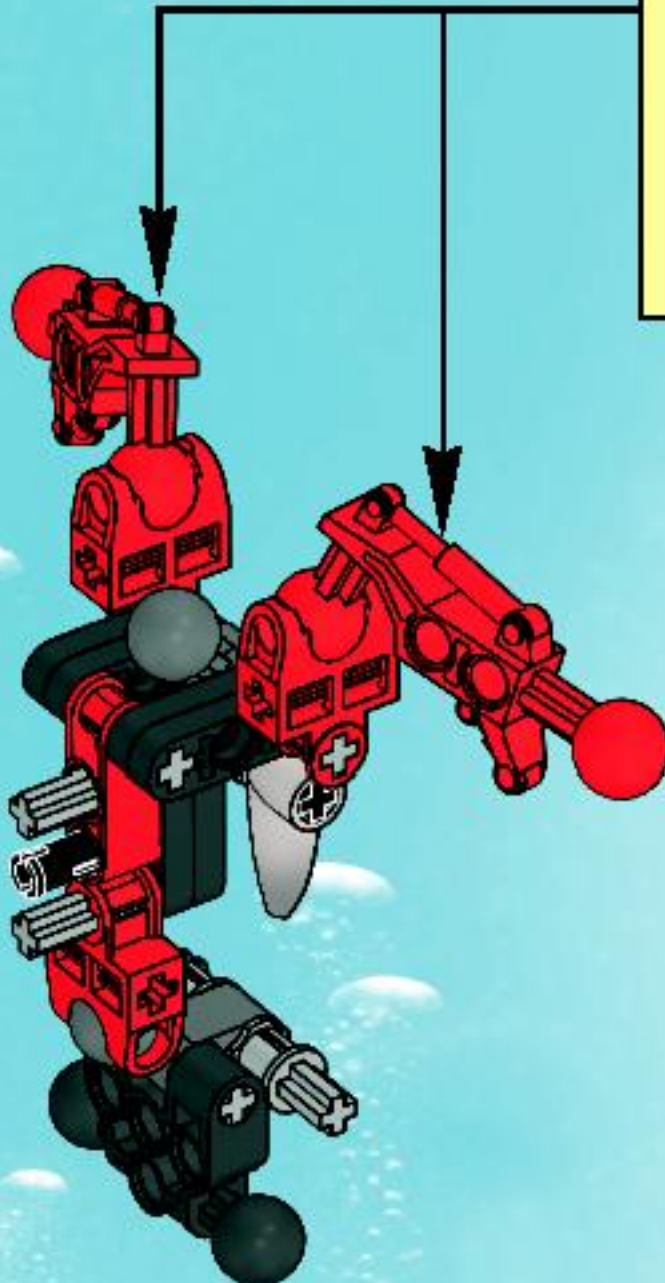
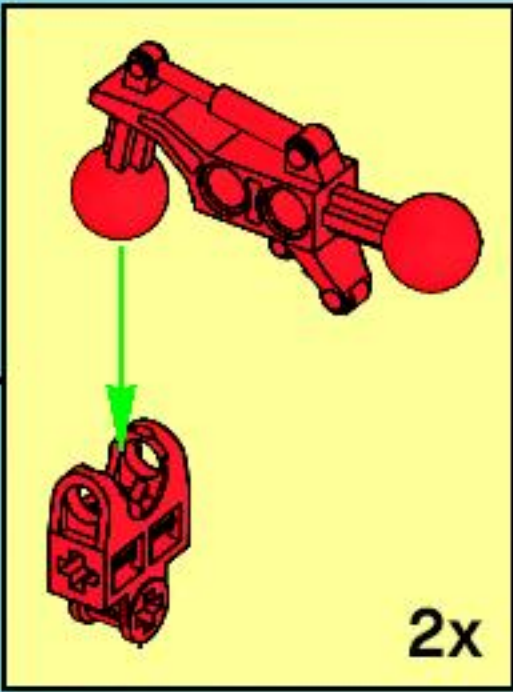

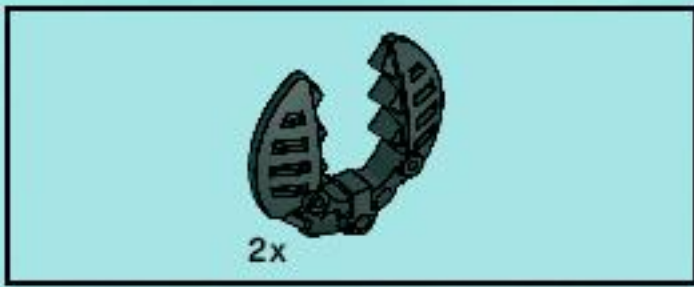

9

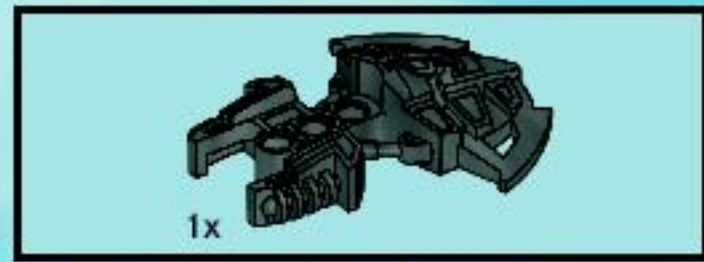
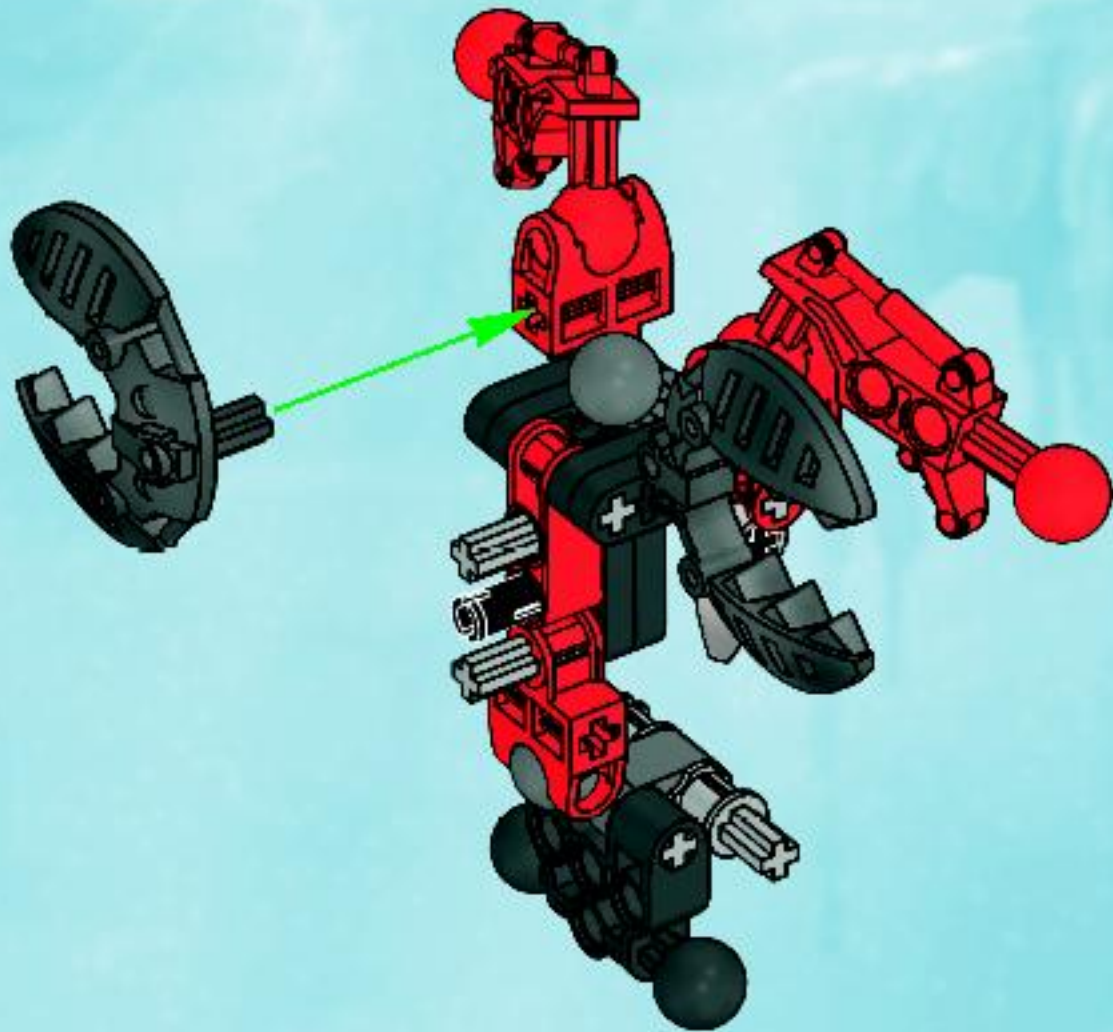

10



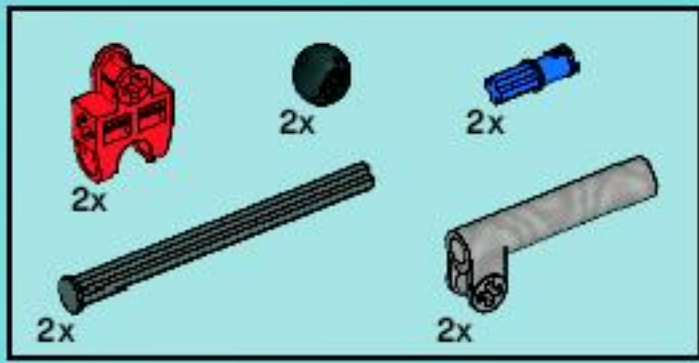

11

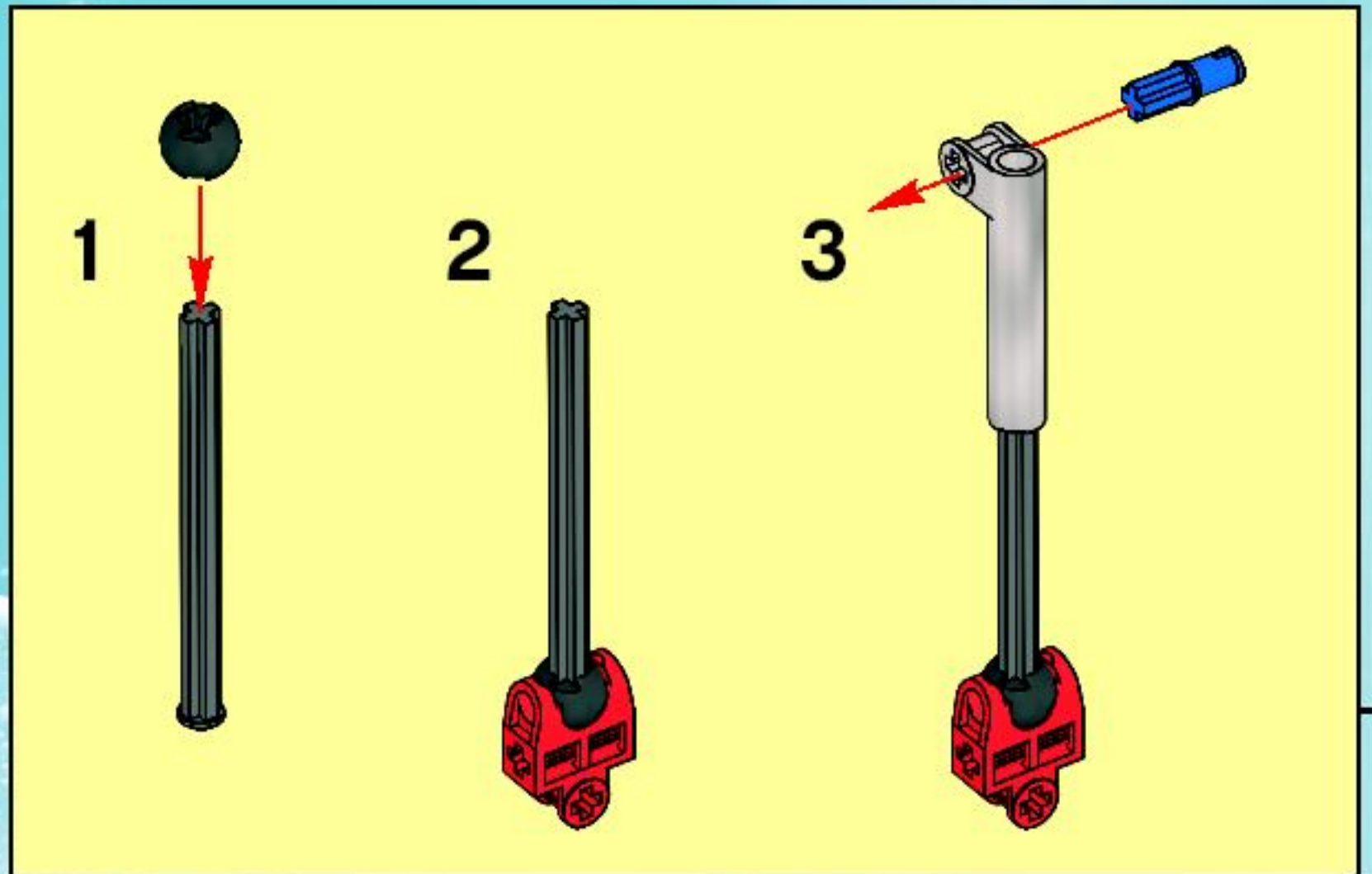
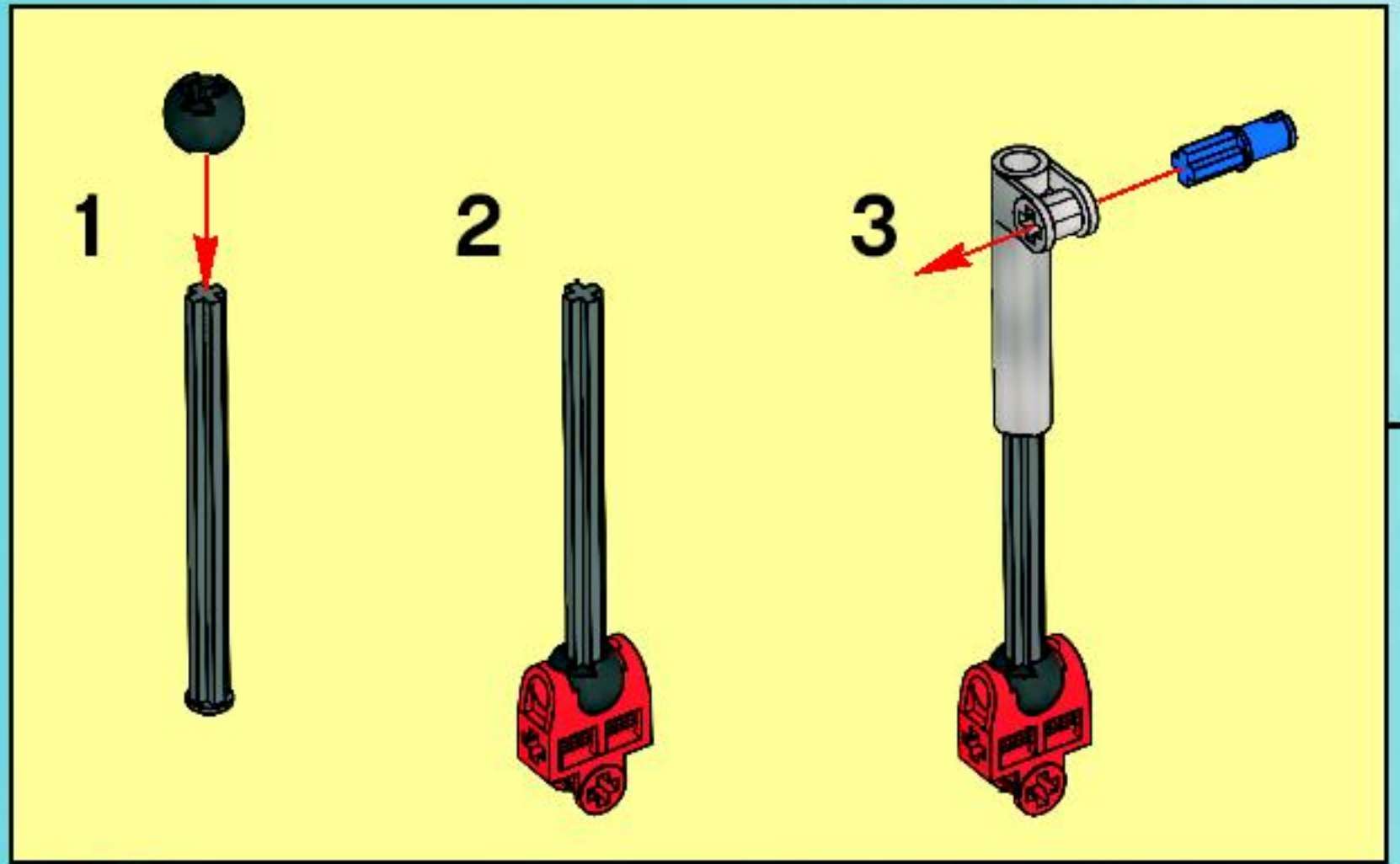

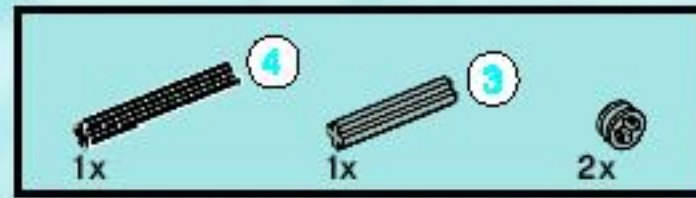
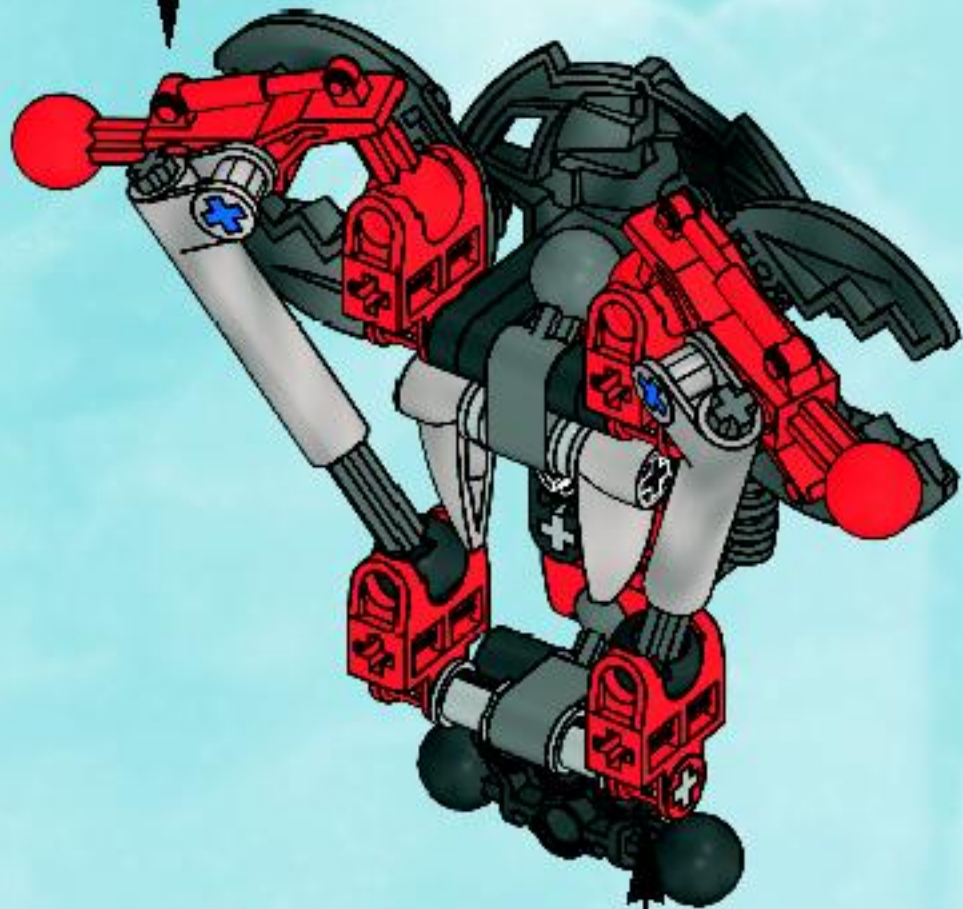

12

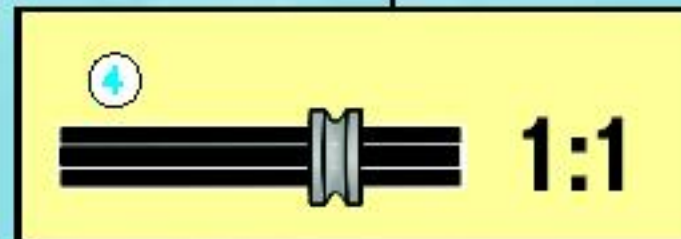
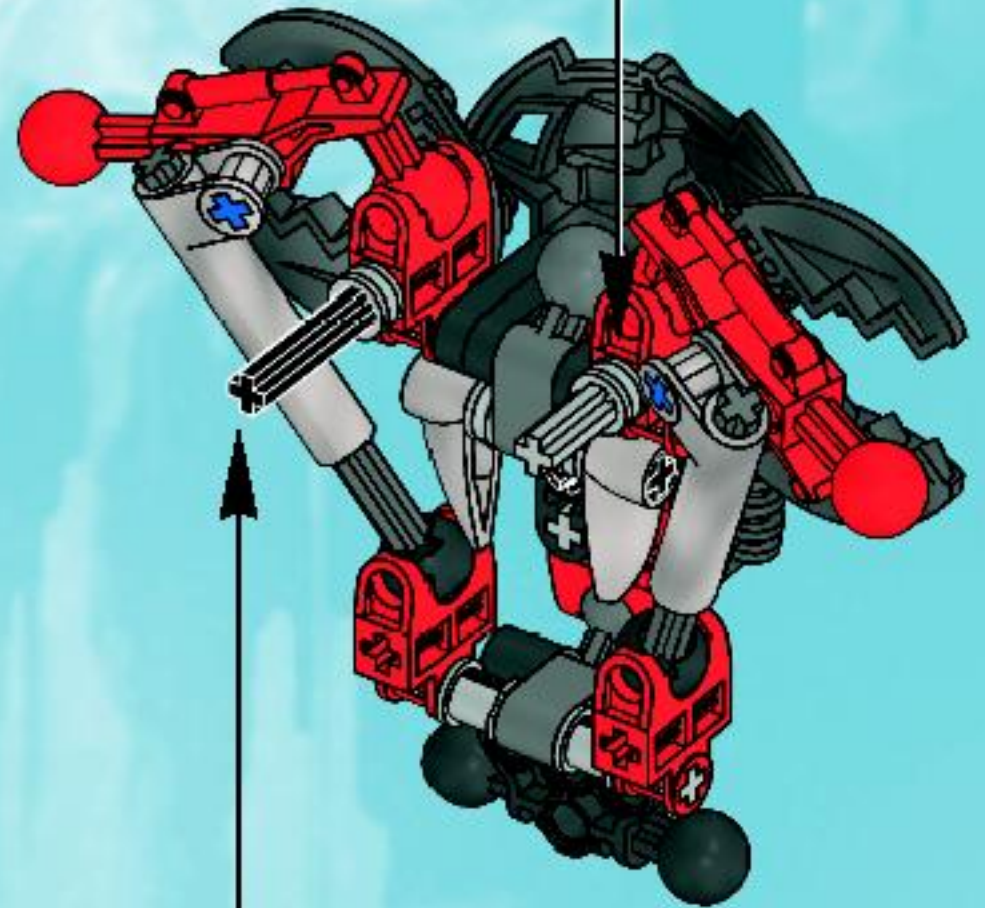
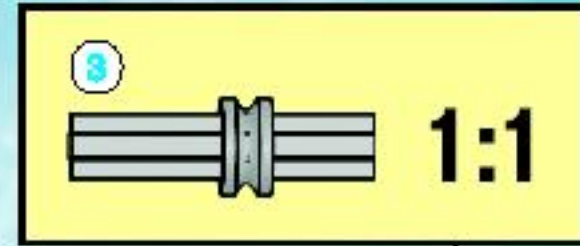

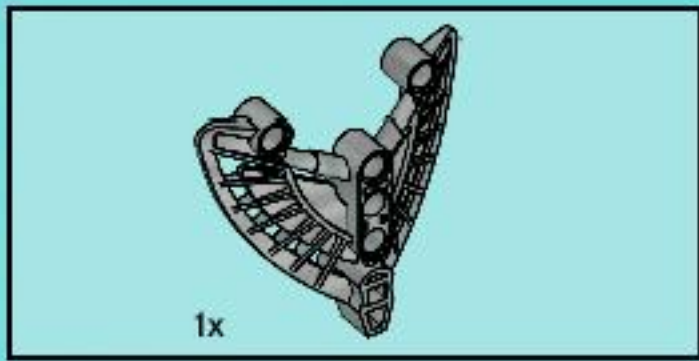

13

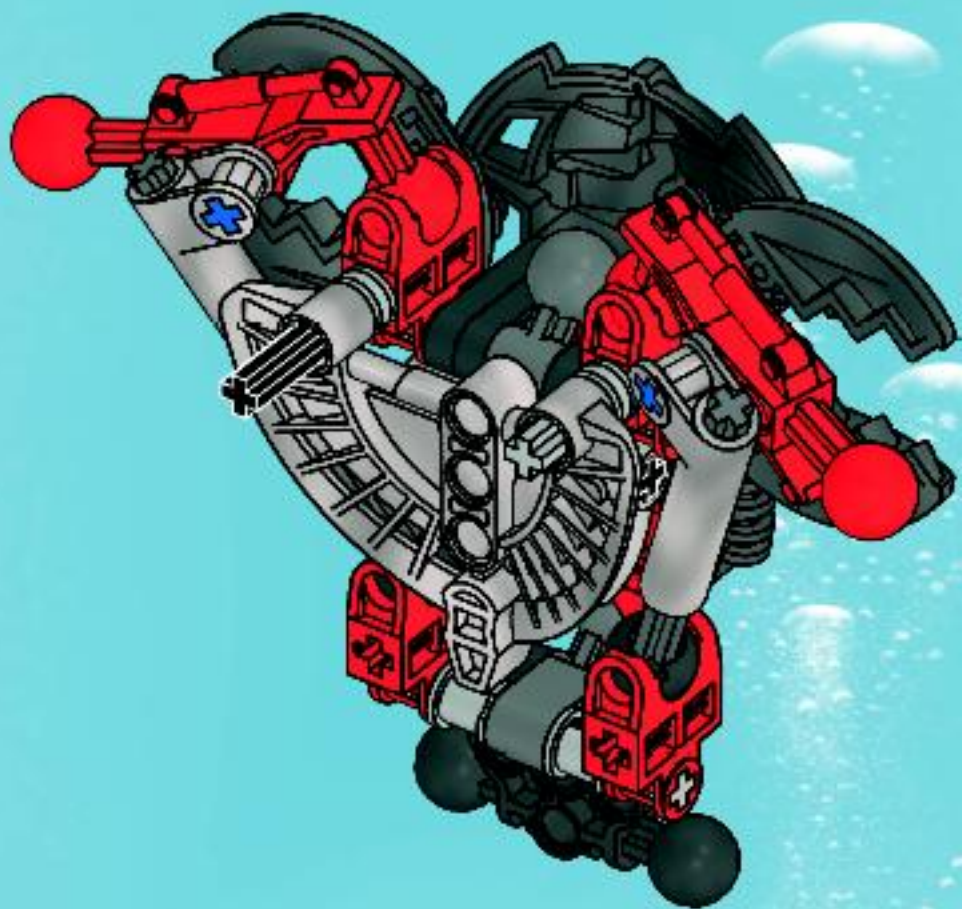

14

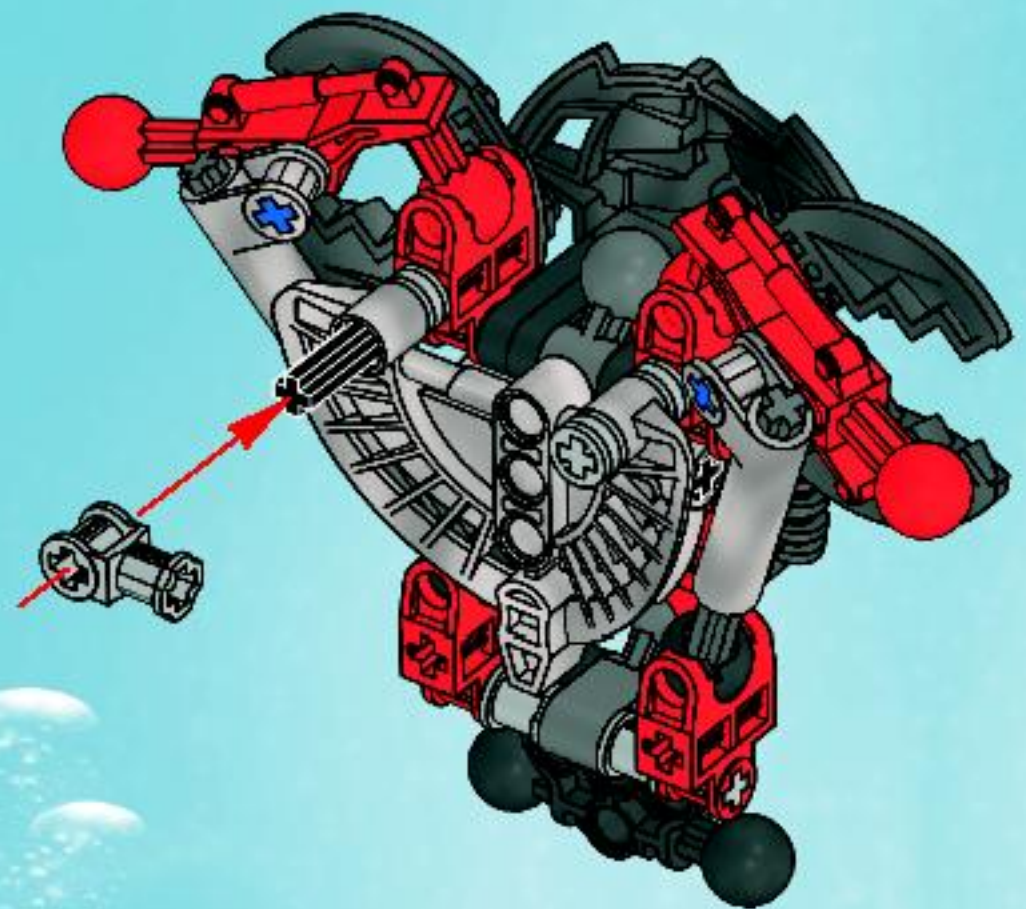

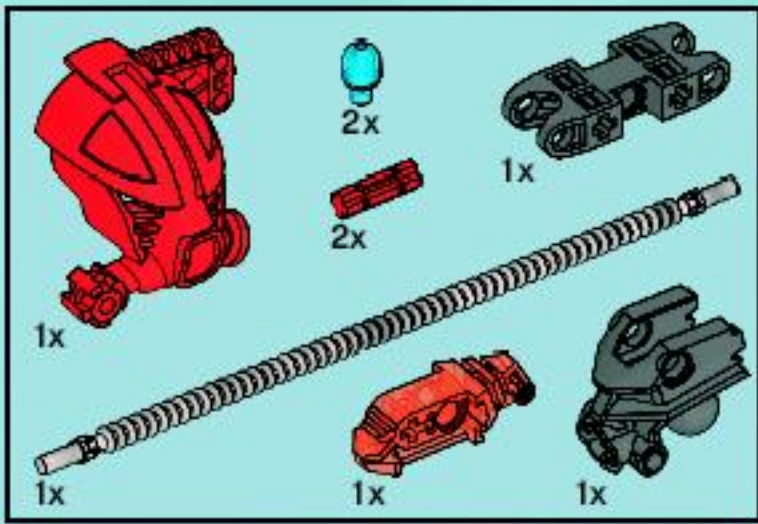

15

1

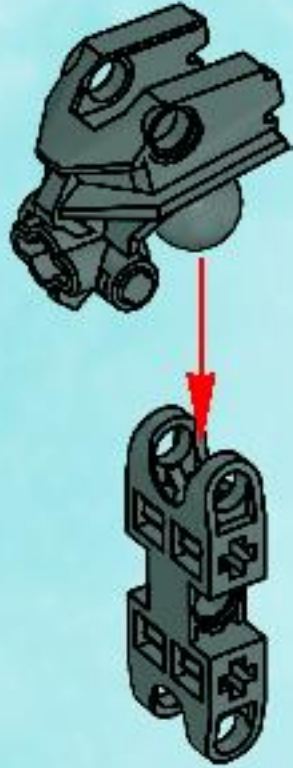

2



3

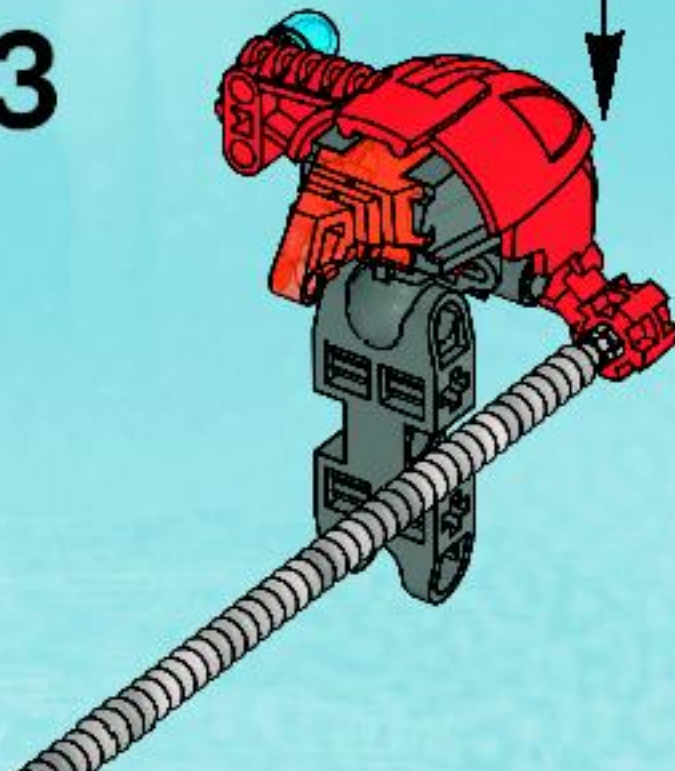

1

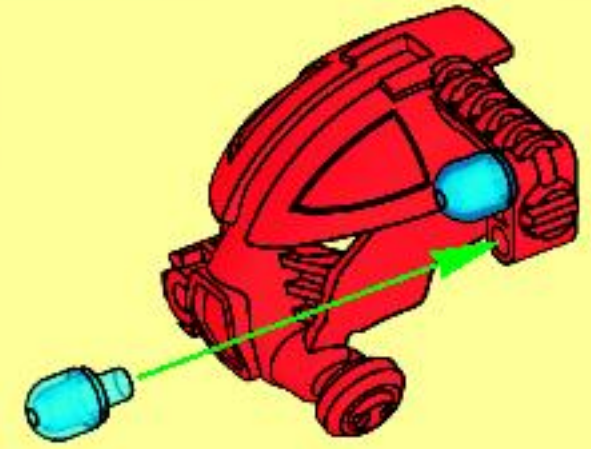

2

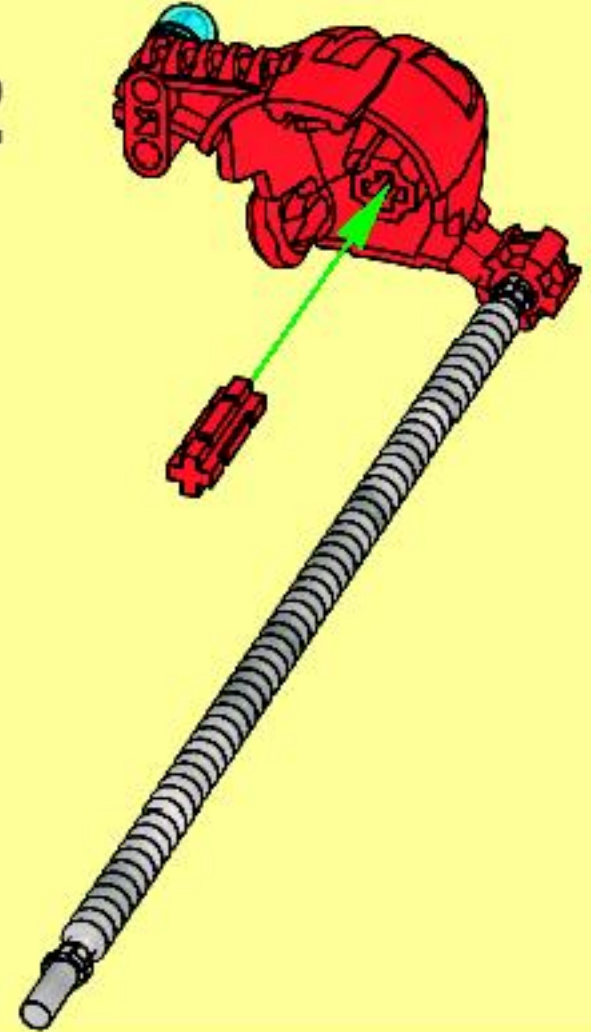

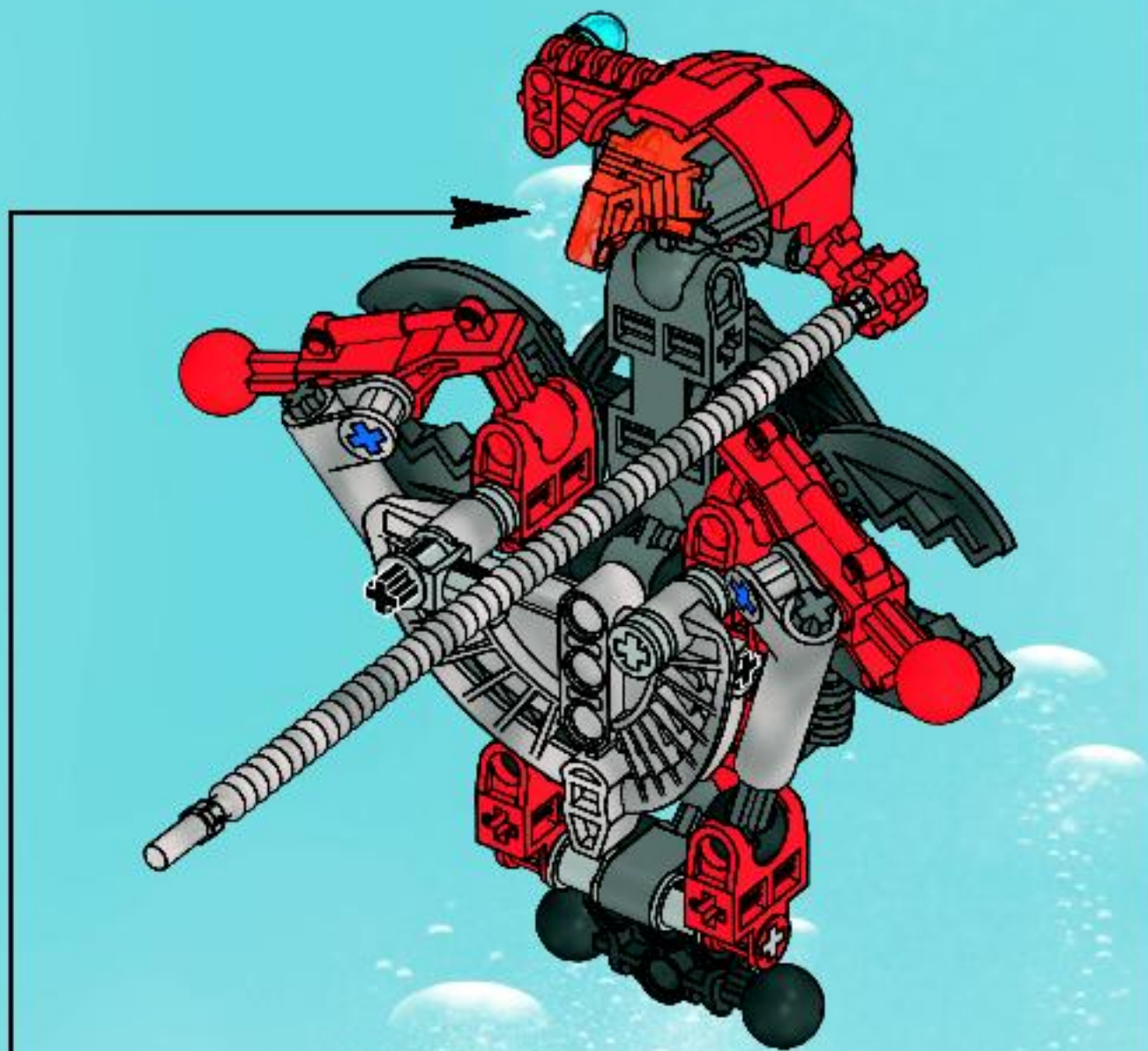

16

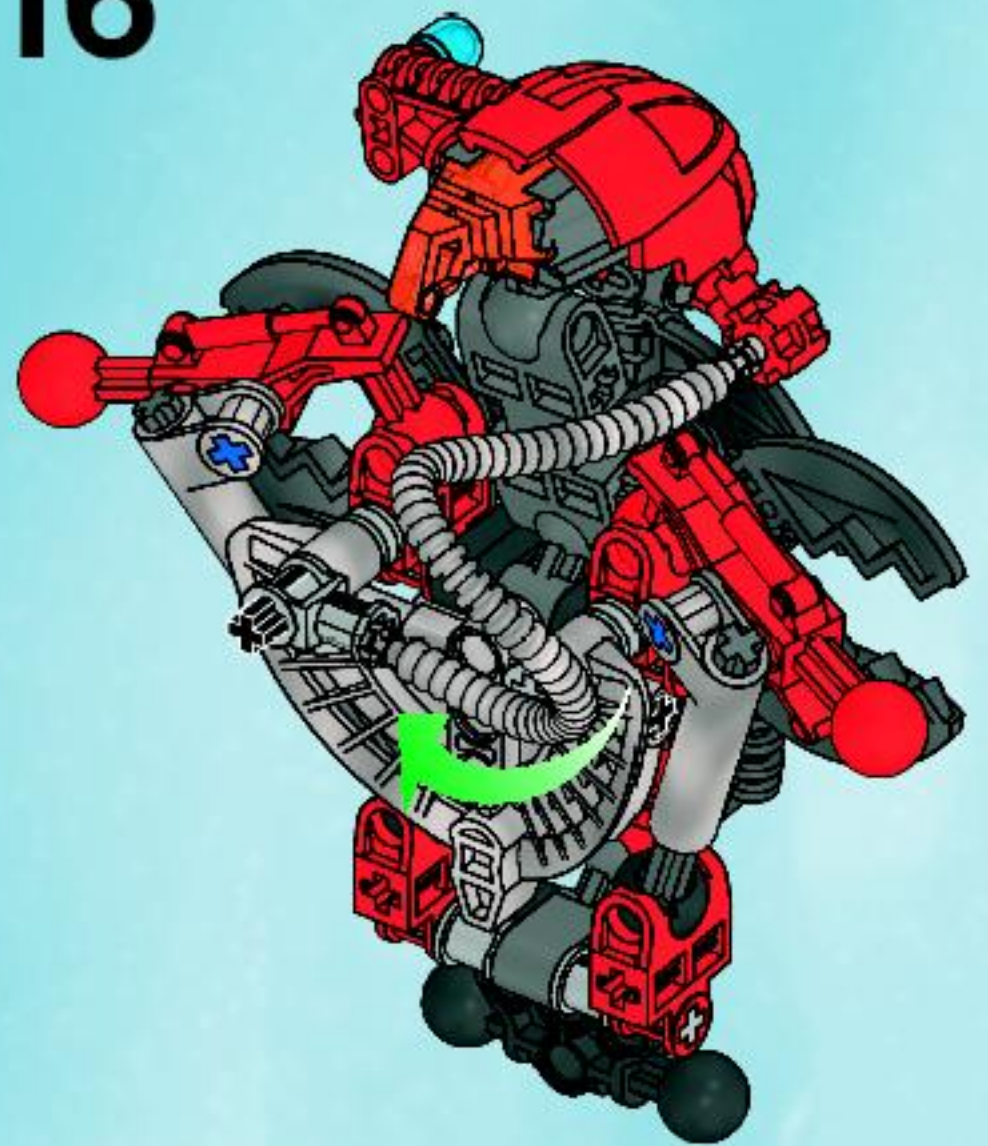

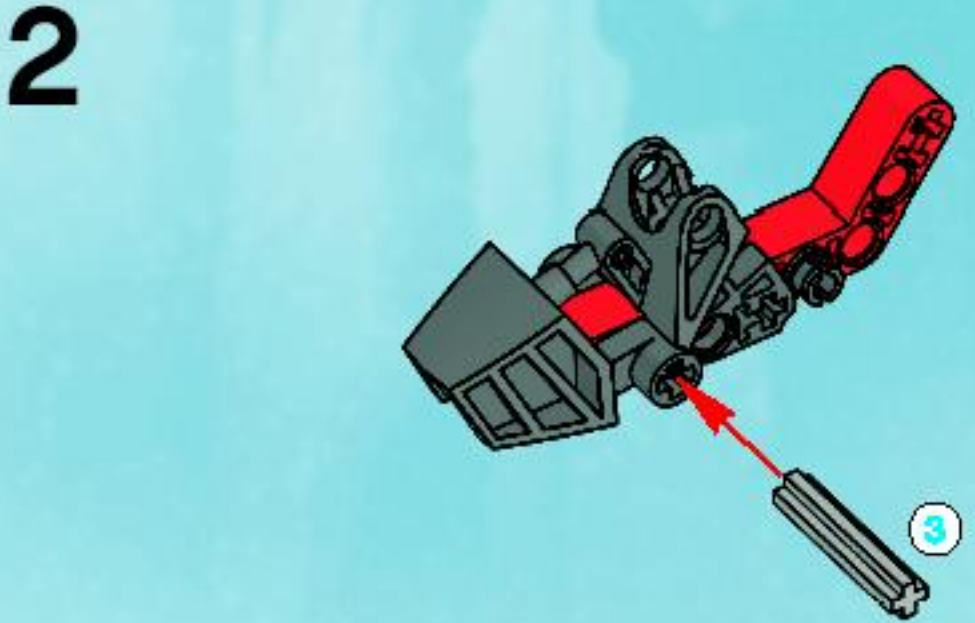
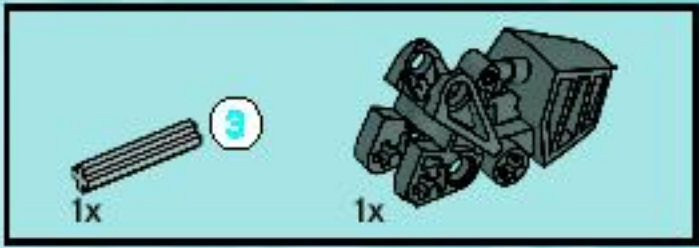
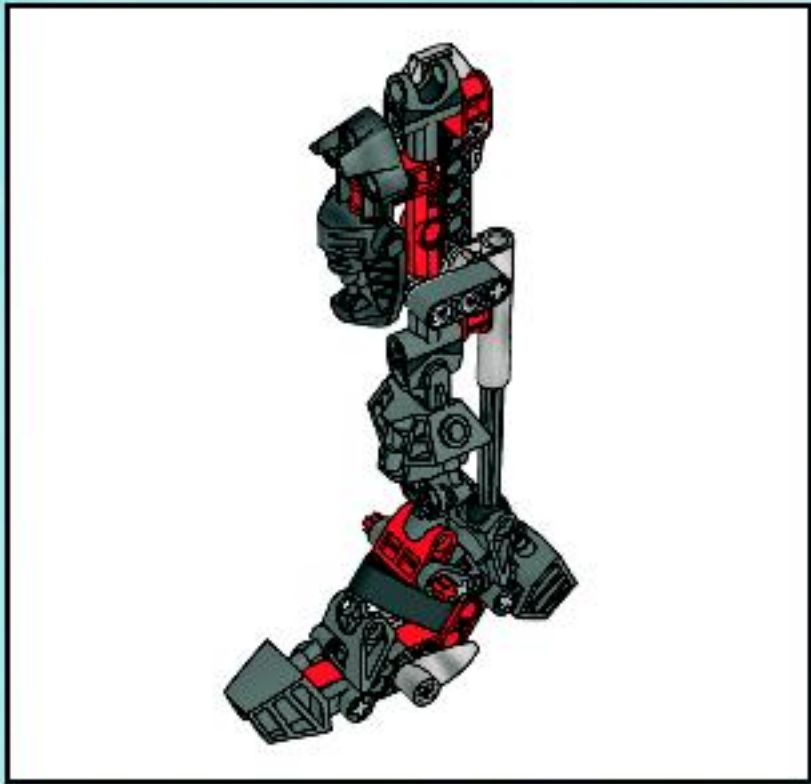
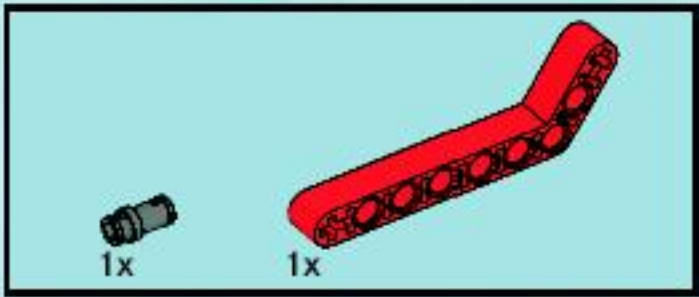
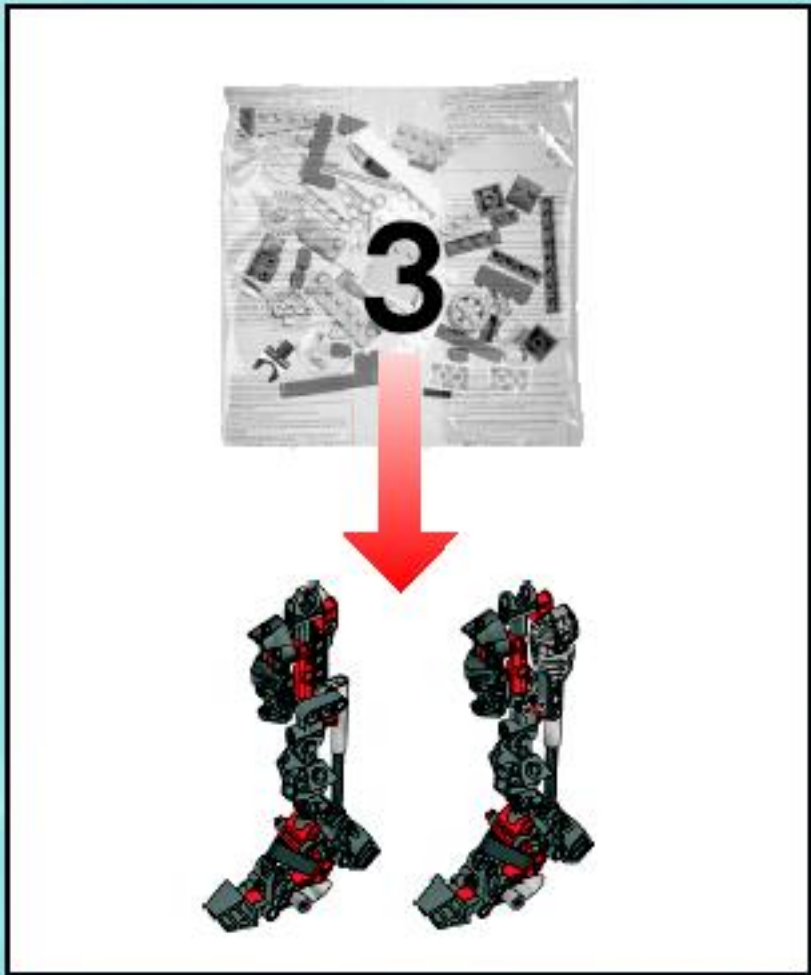



3

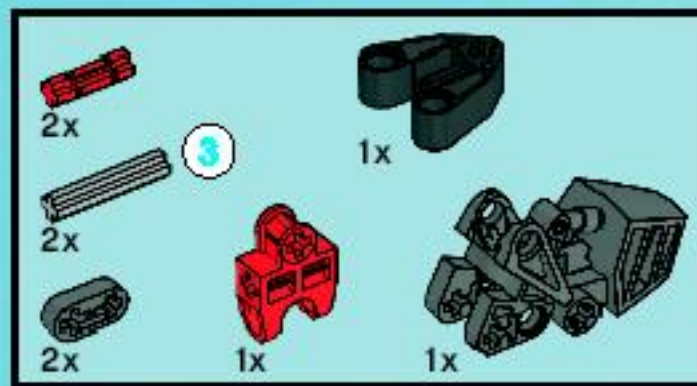
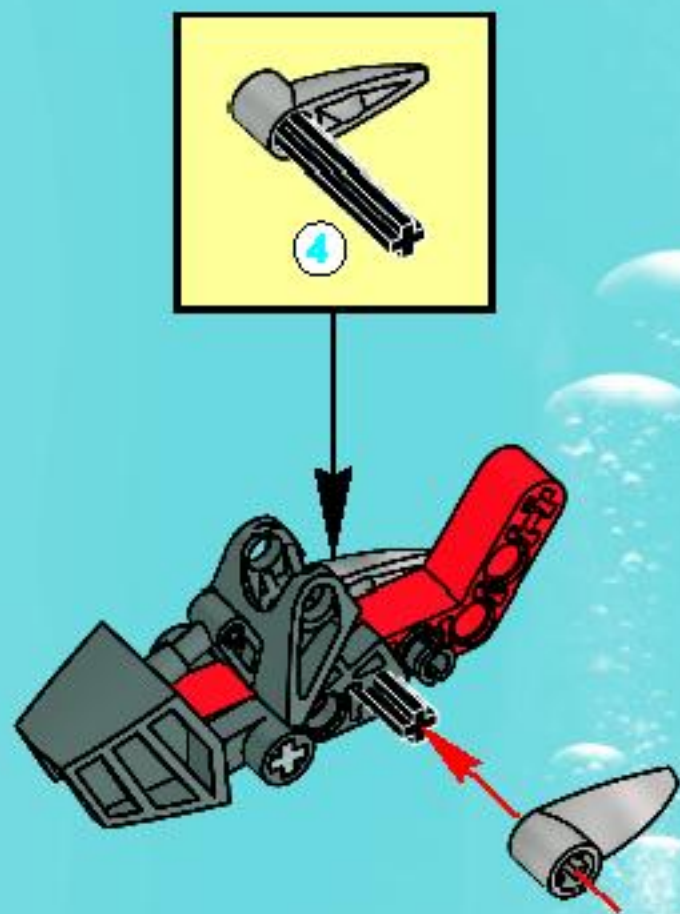

4

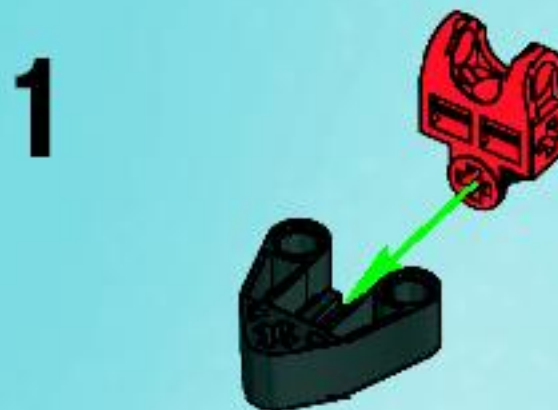

2

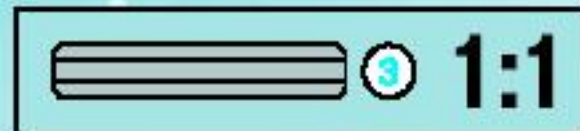
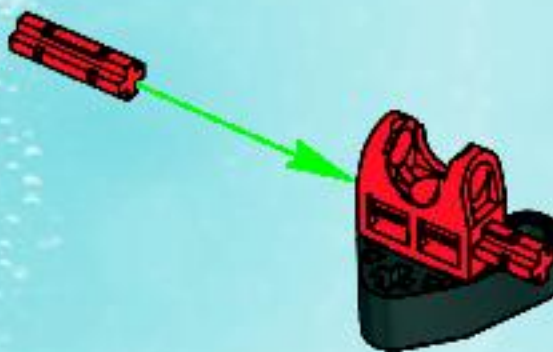

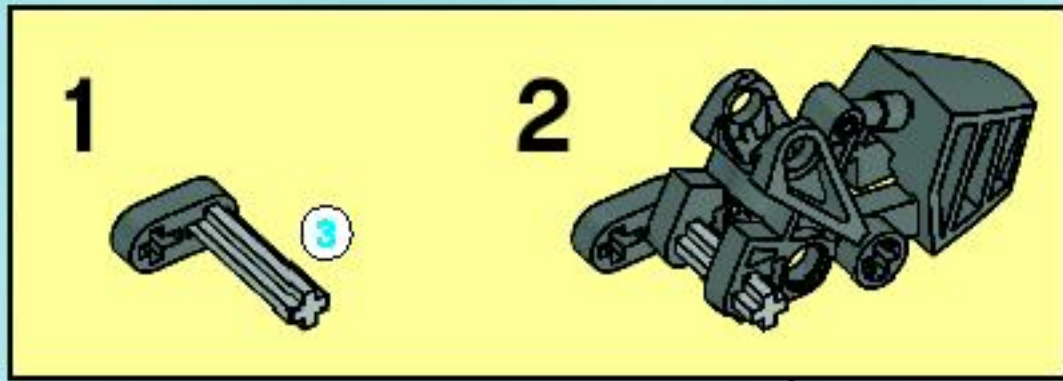

3

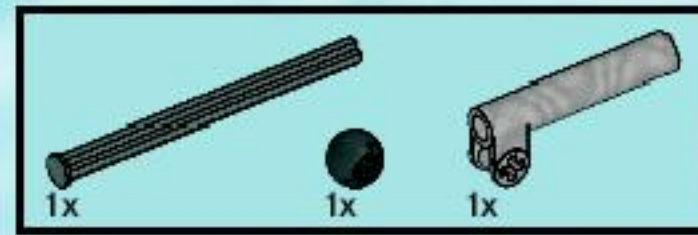
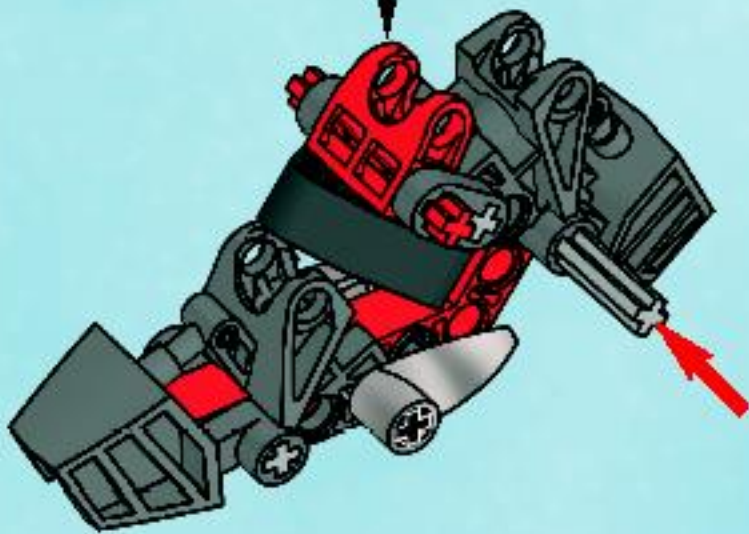
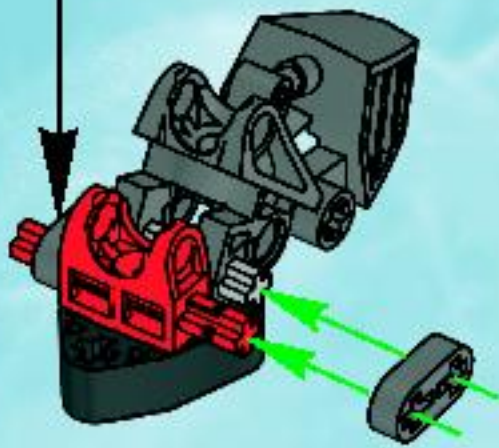

5

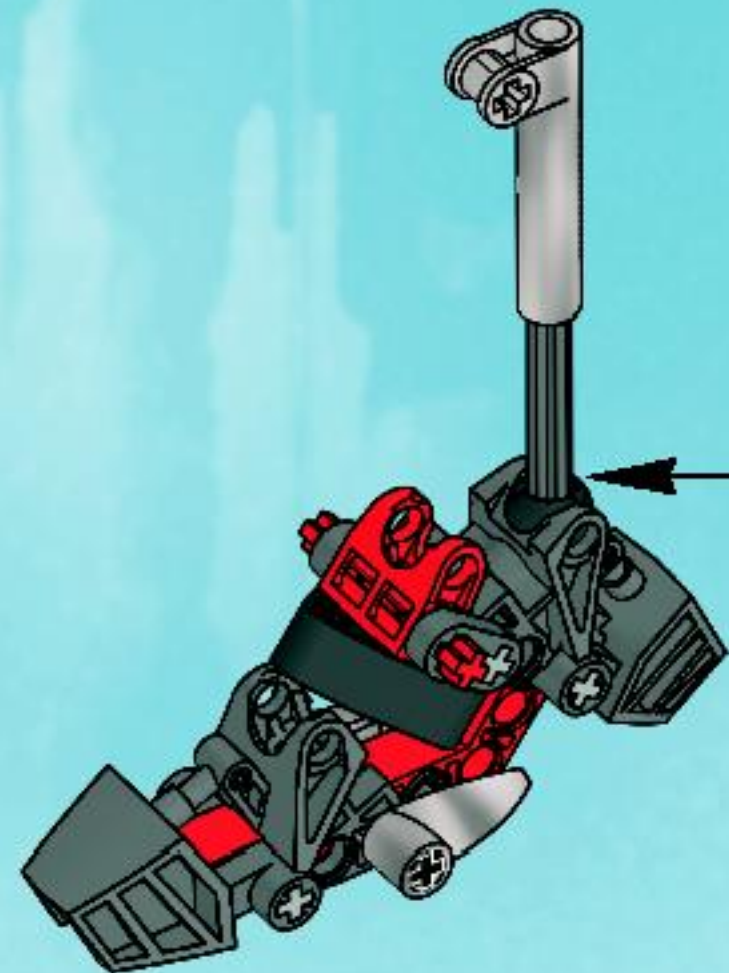
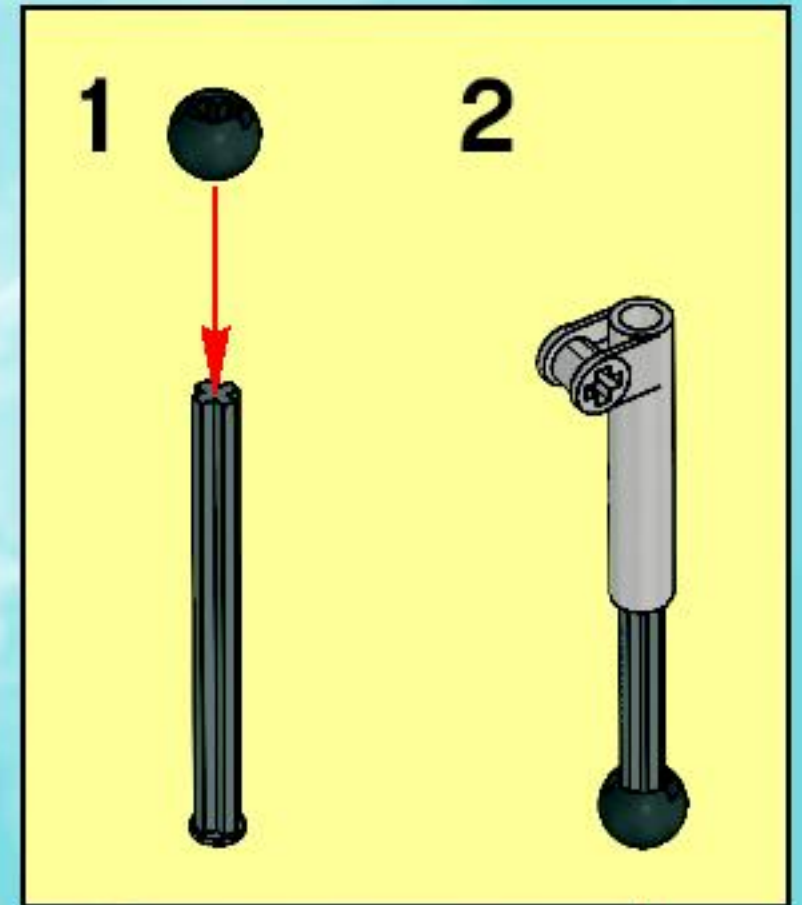

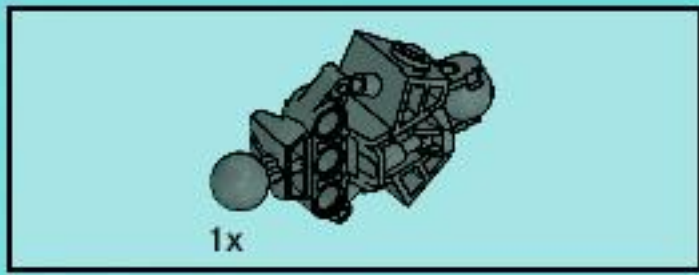

6

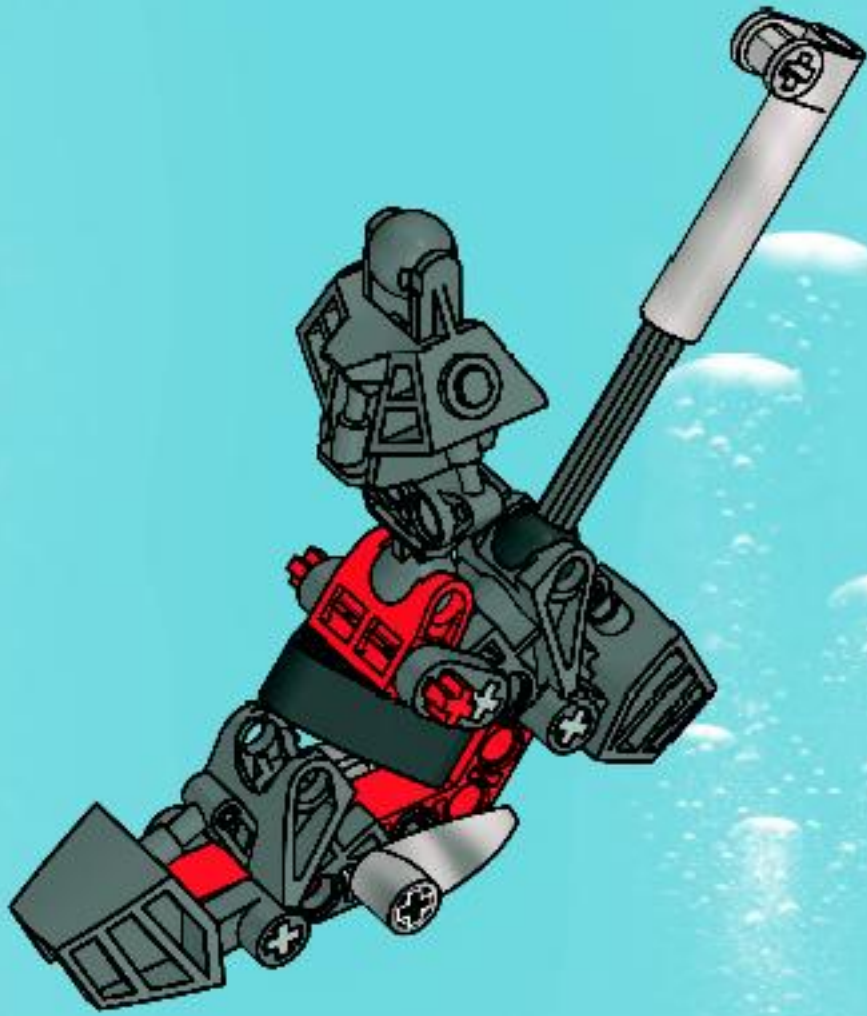

1



2

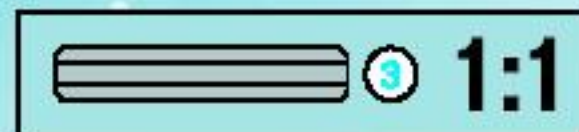



3

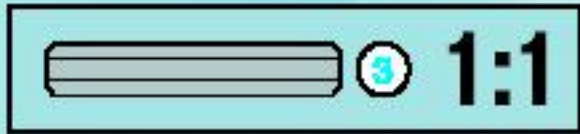

4

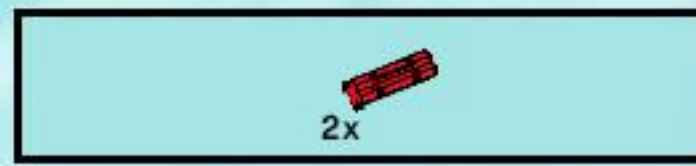
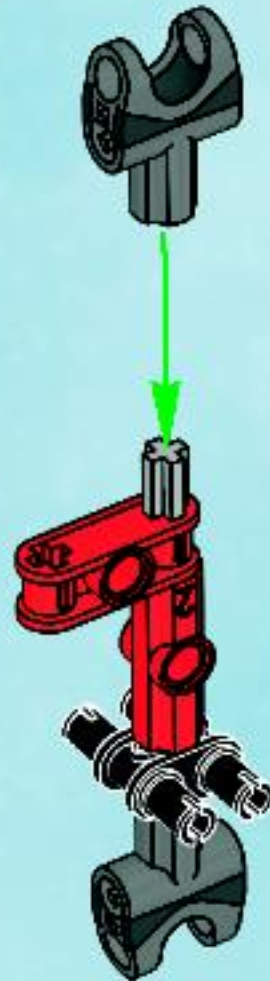

5

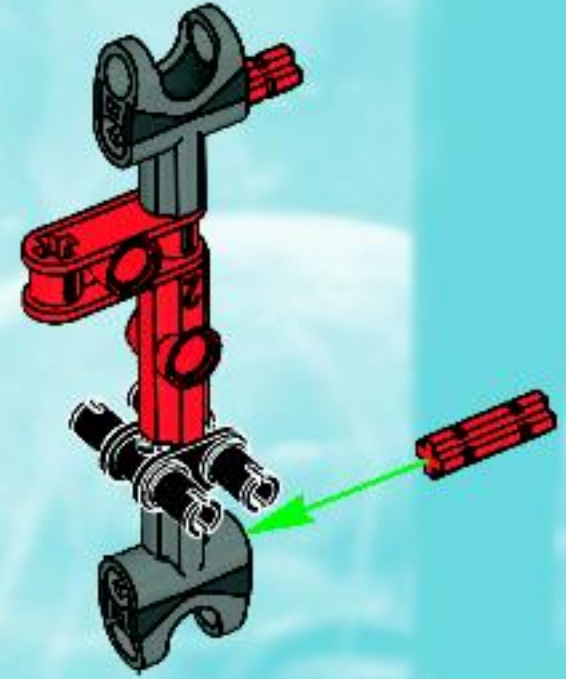

6

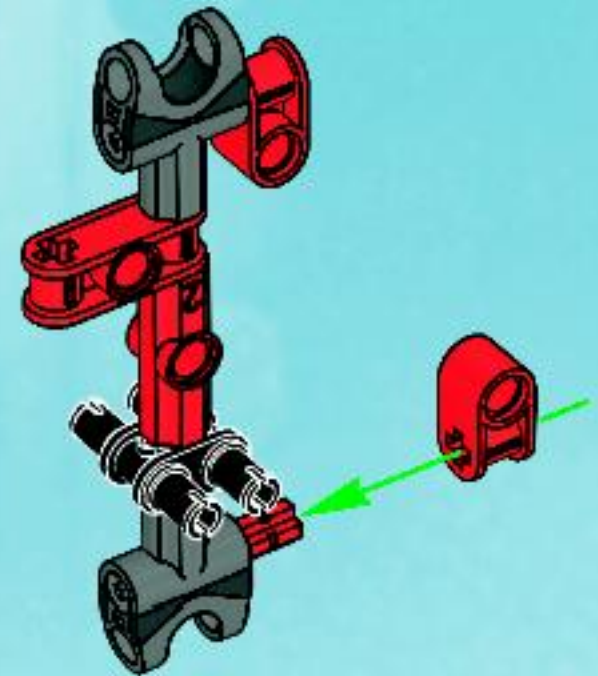

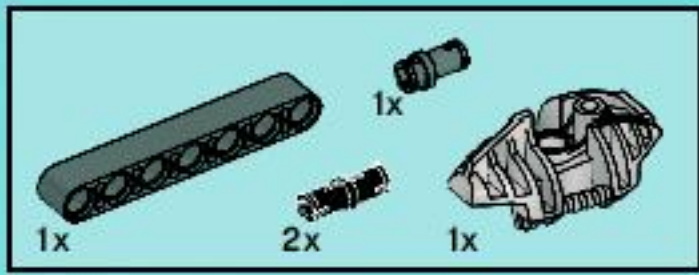

7

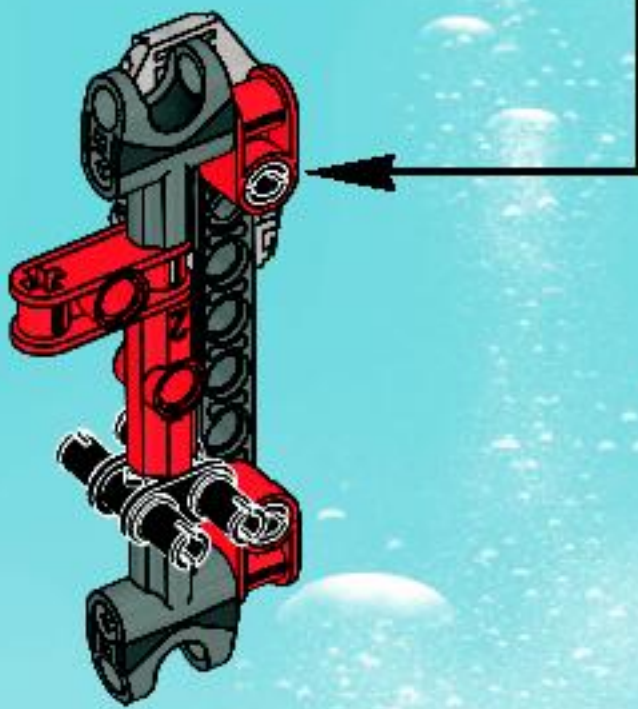
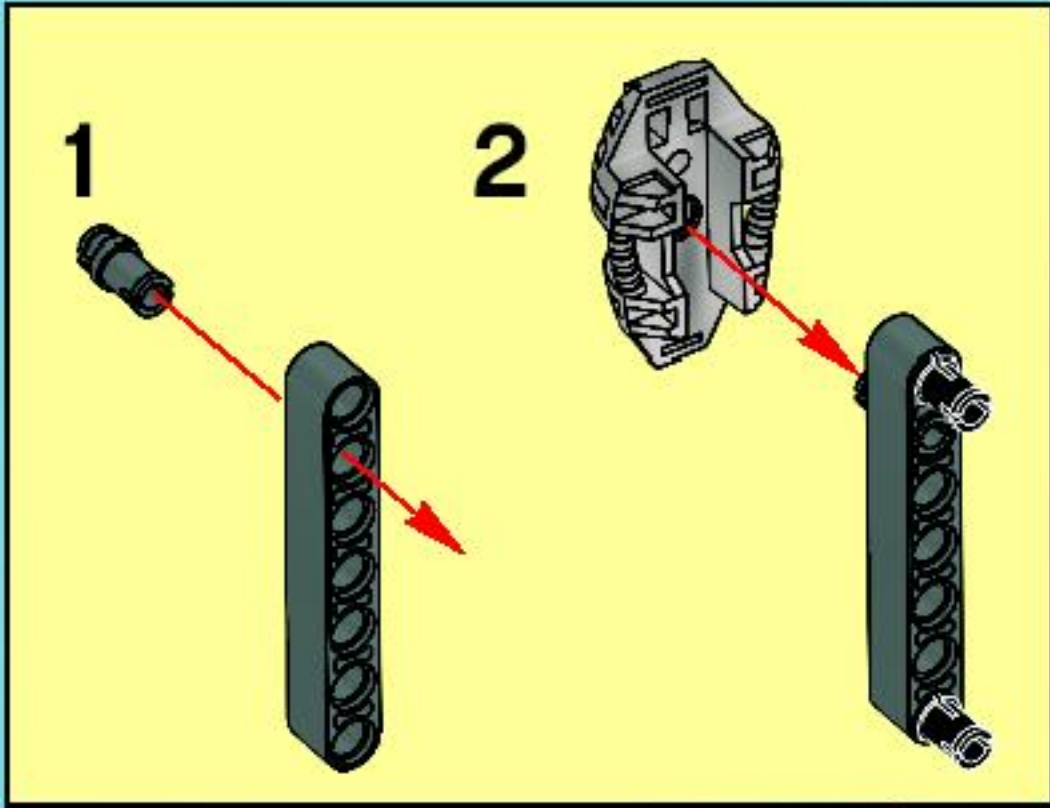

8



7

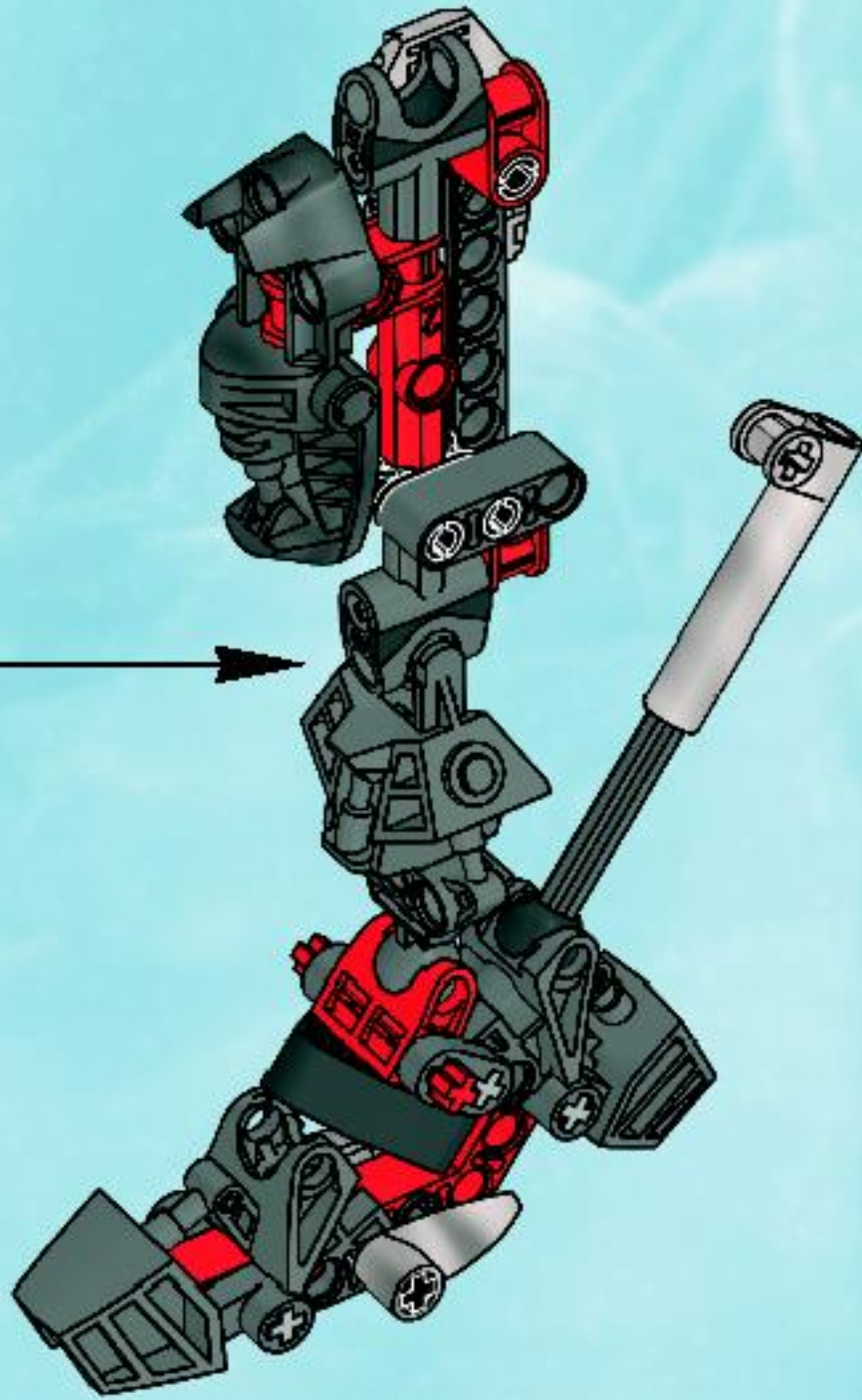

8

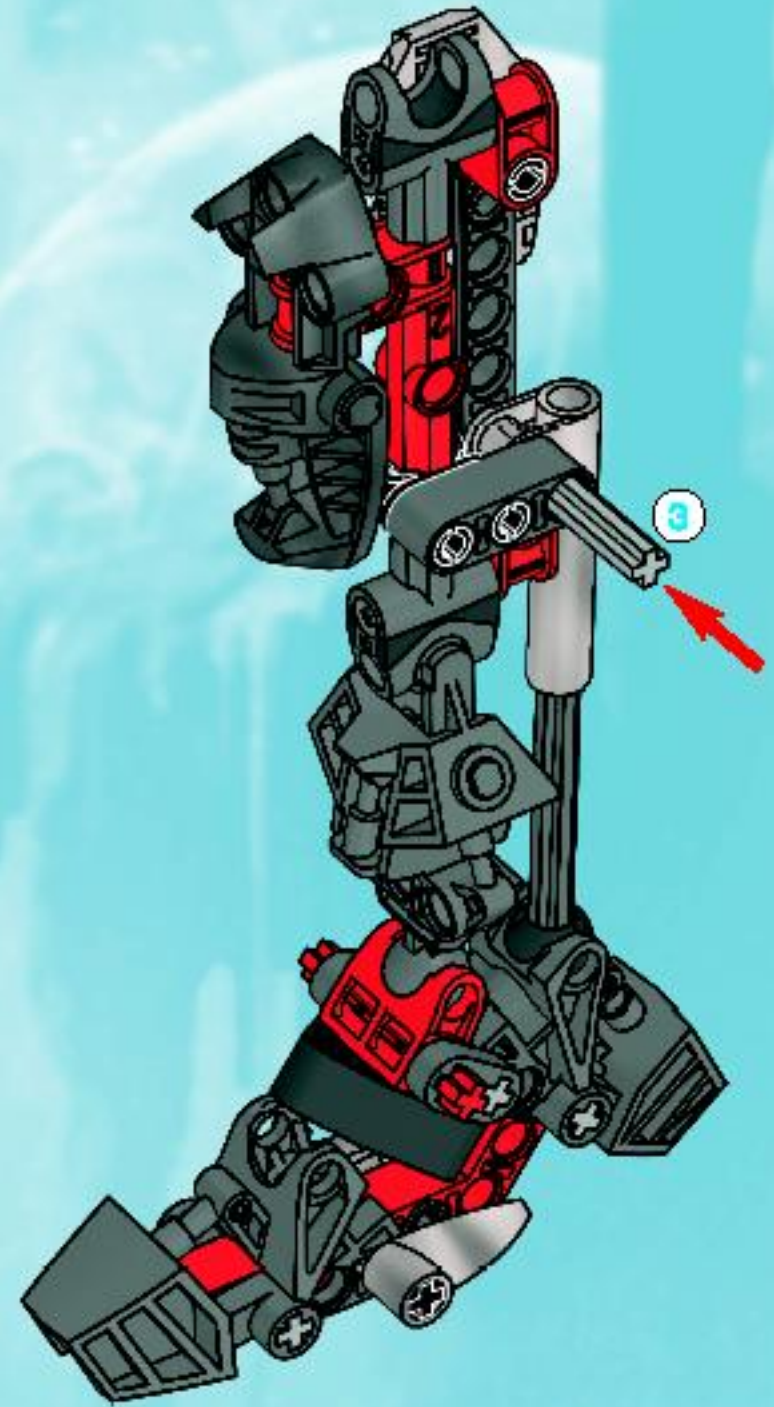
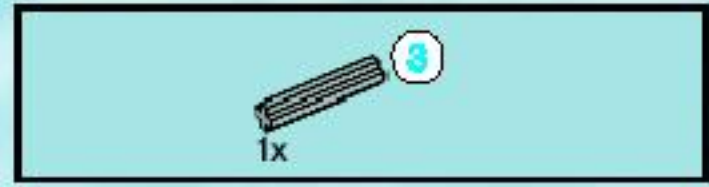

17

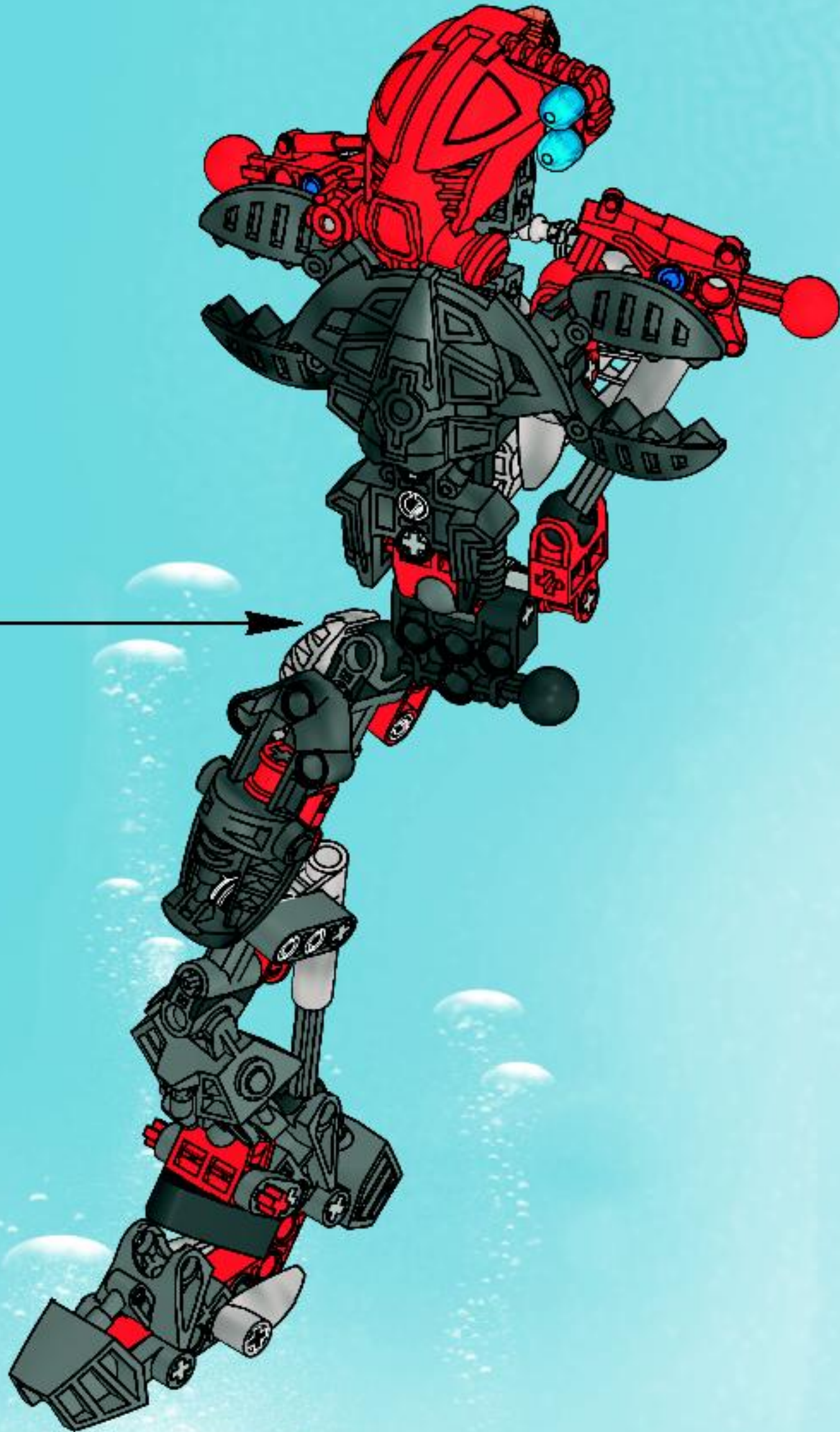

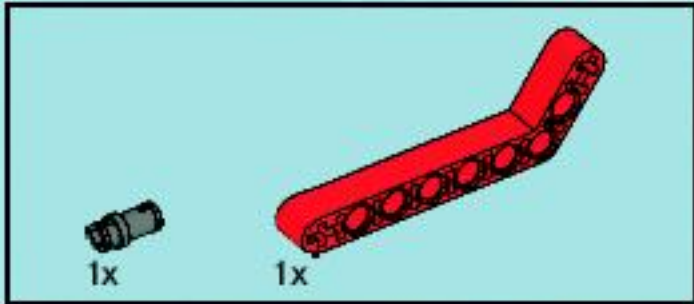
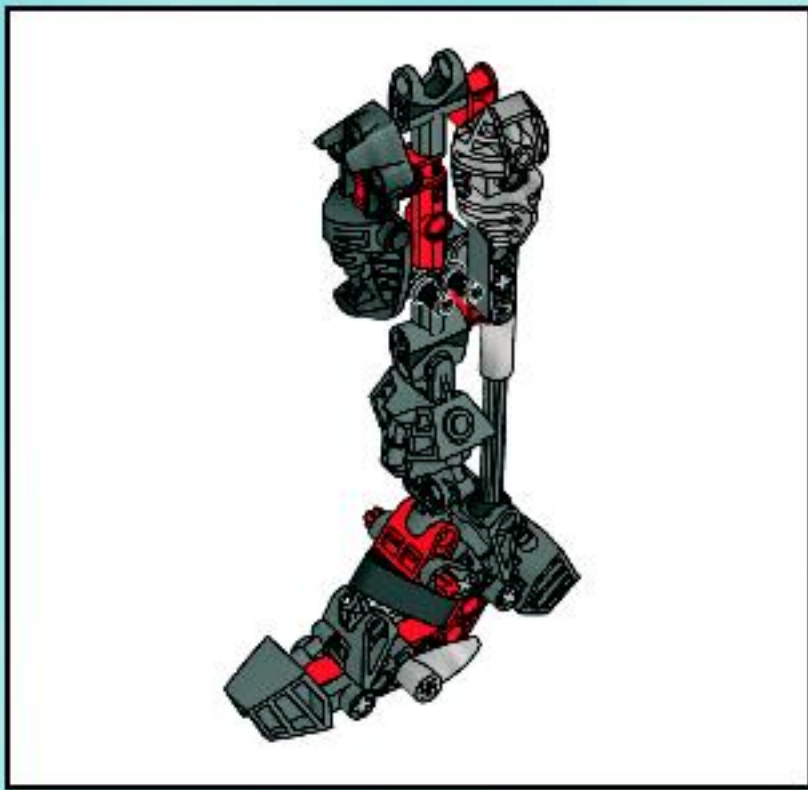

1

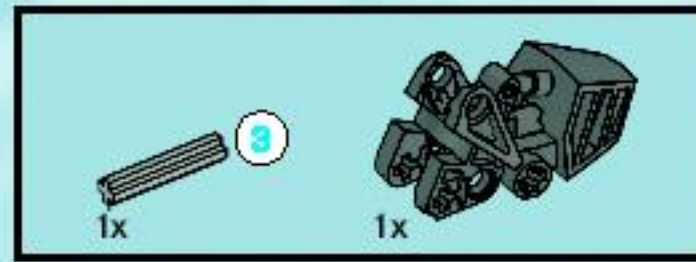
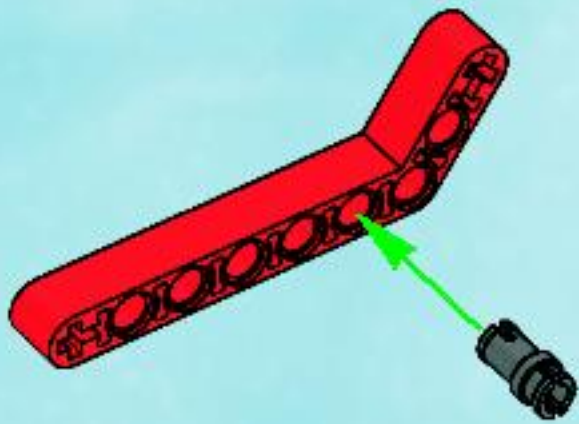

2

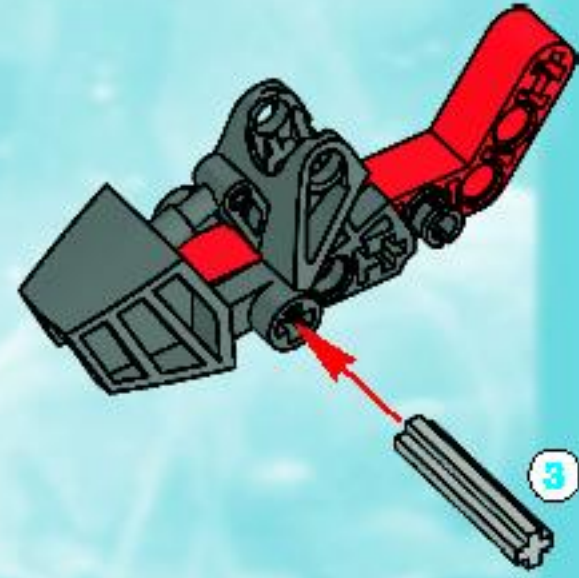

3

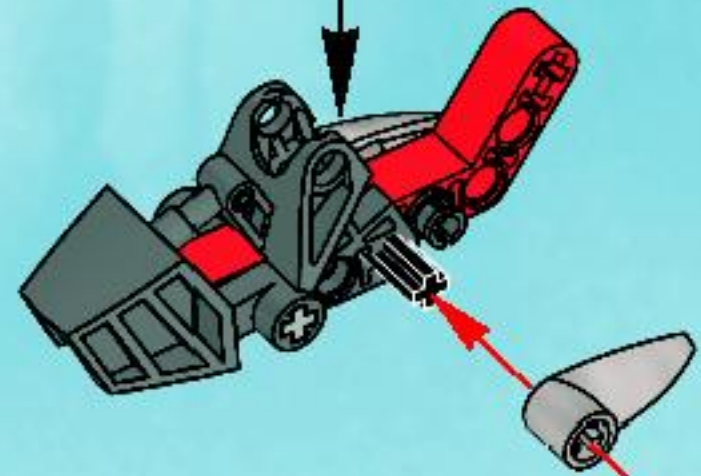

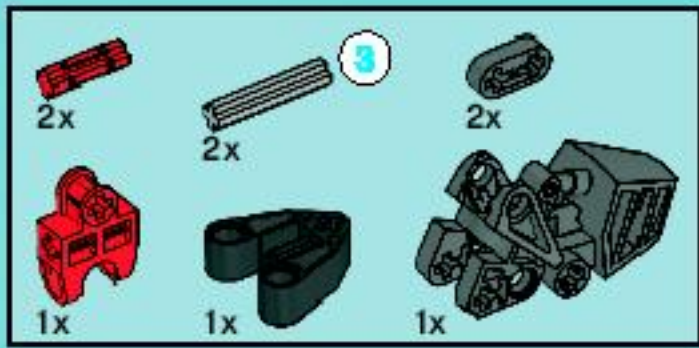

4

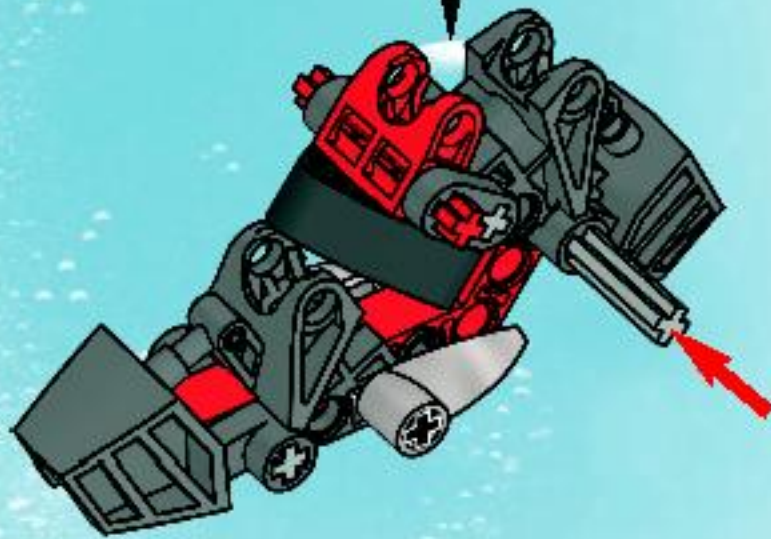
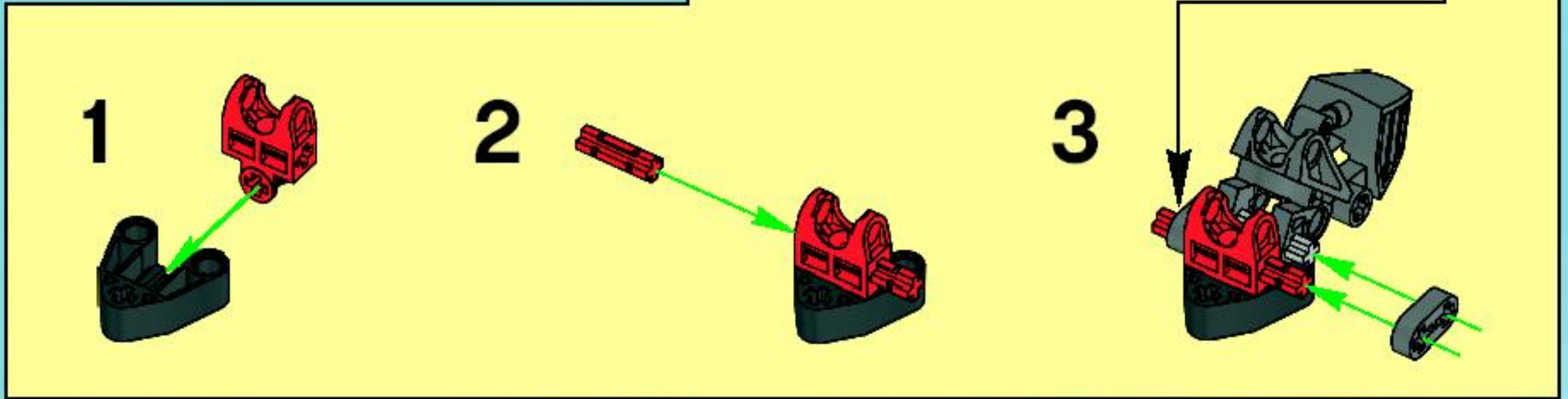
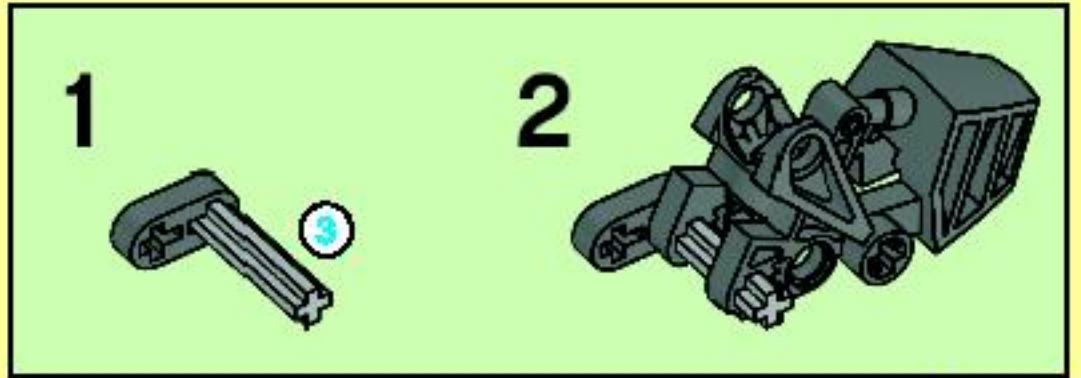

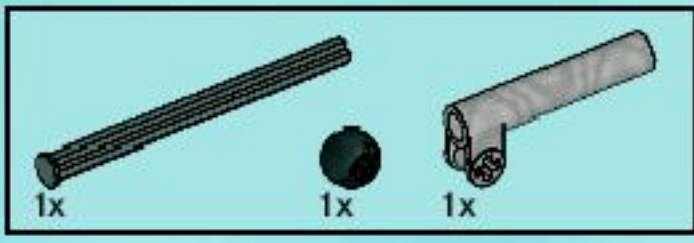

5

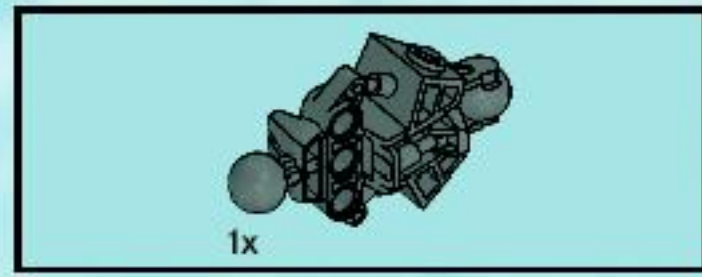
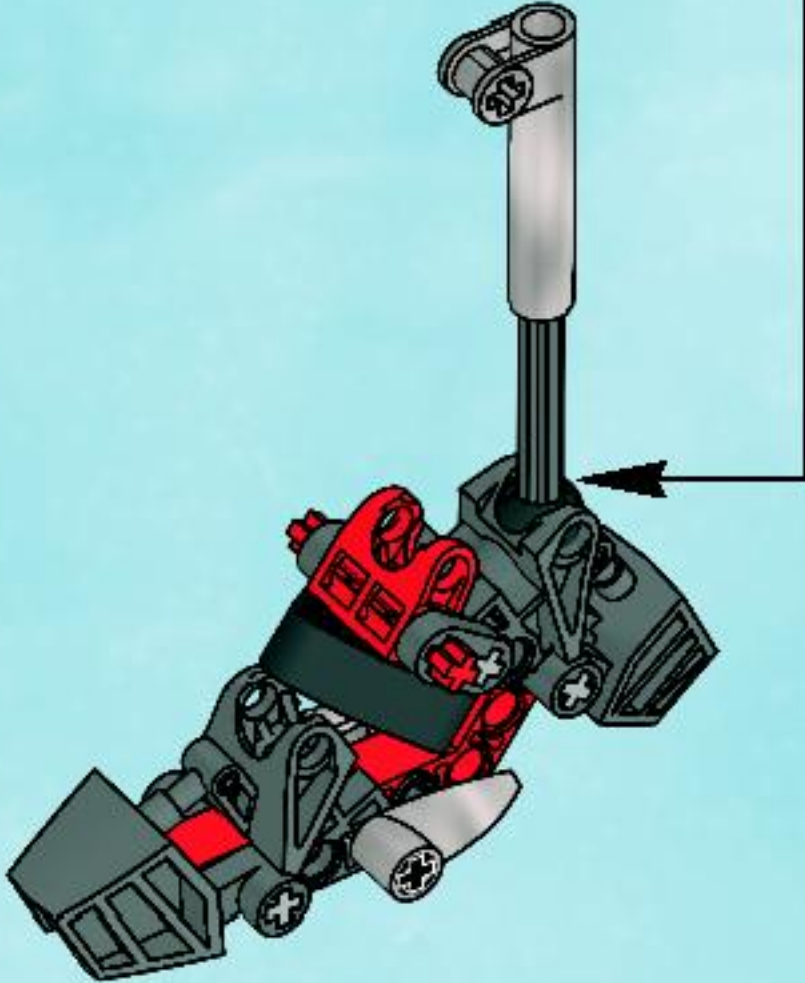
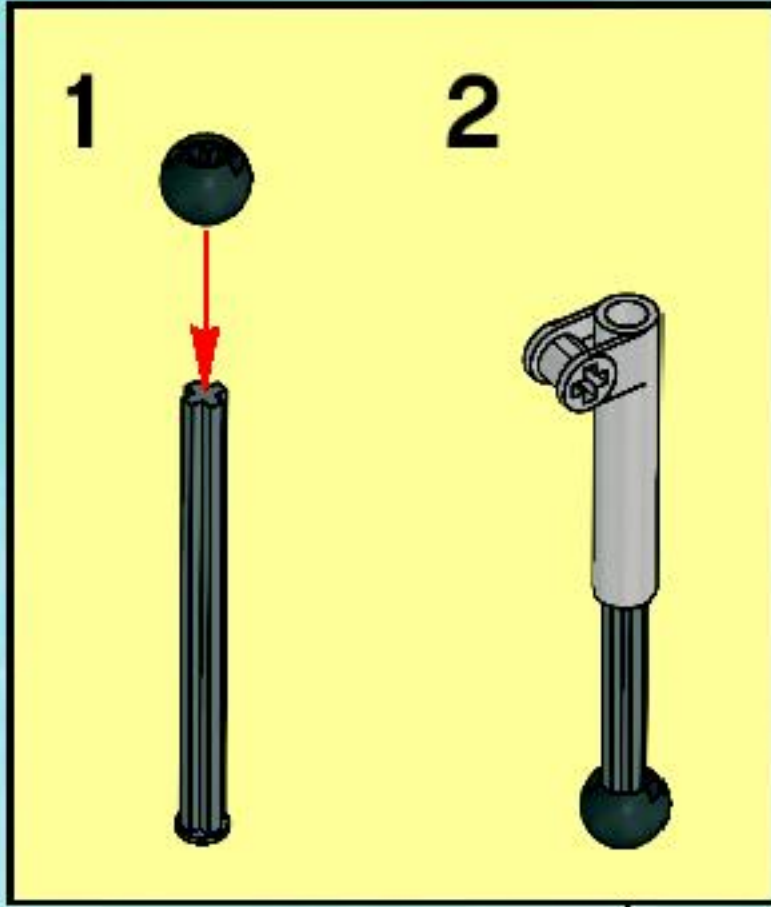

6

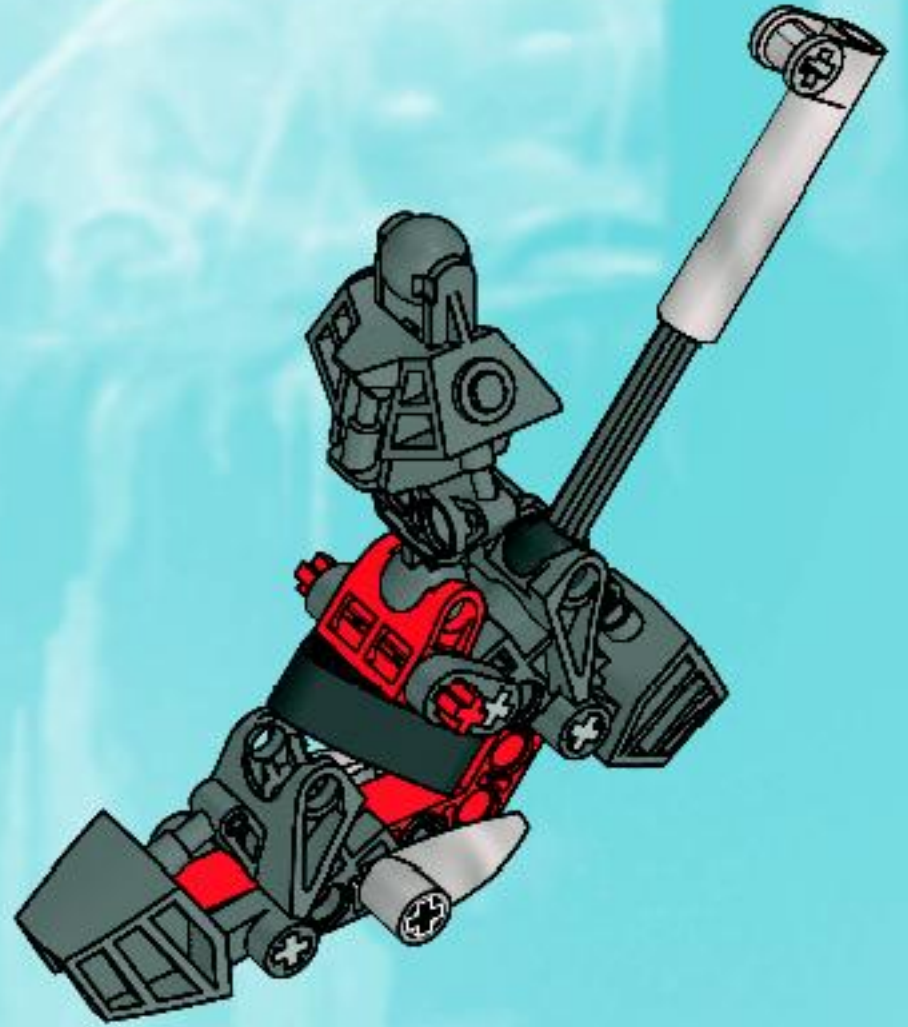



1

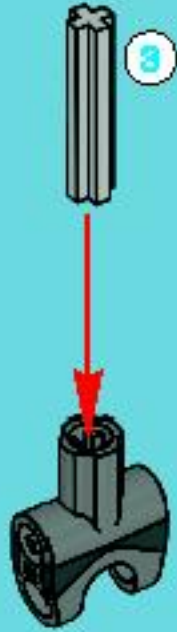

2

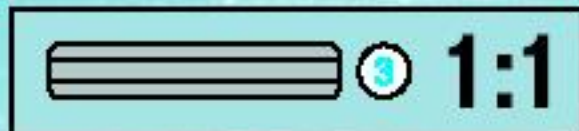
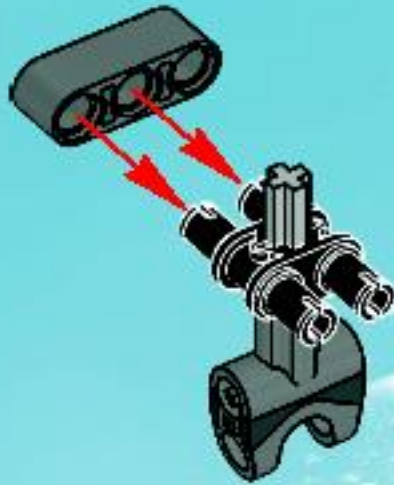

3





4

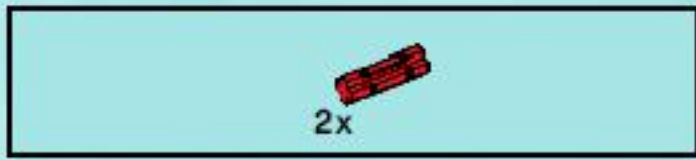
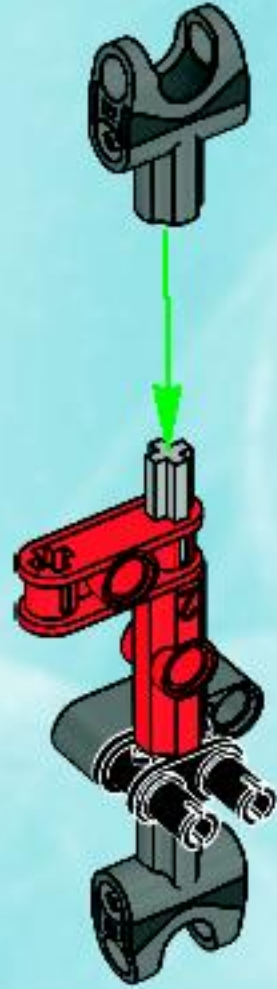

5

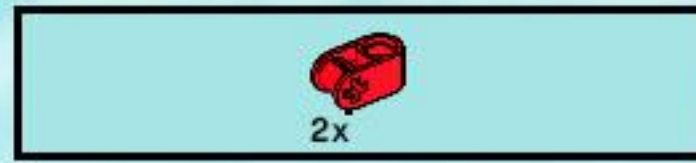
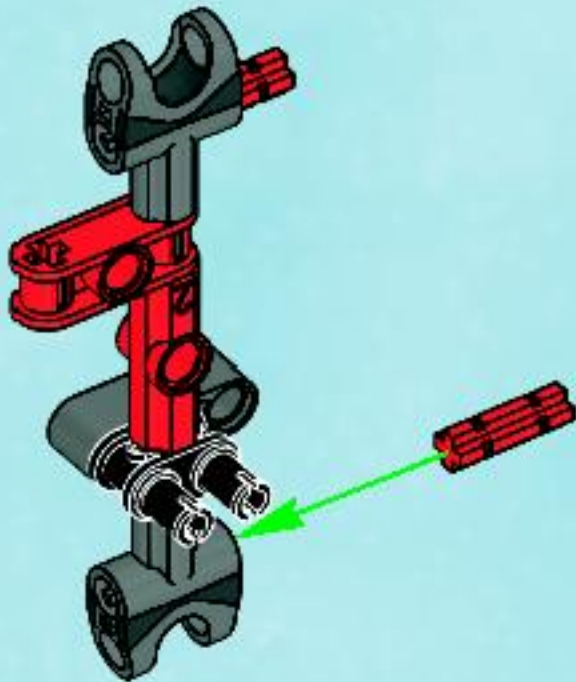

6

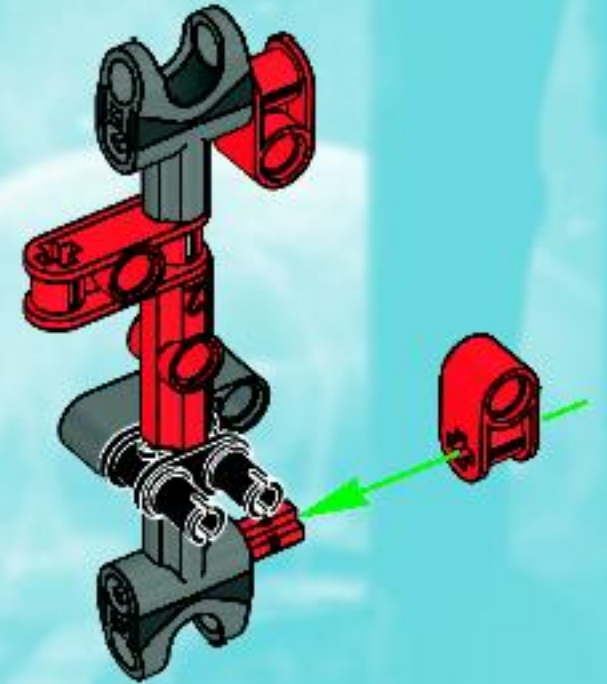

7



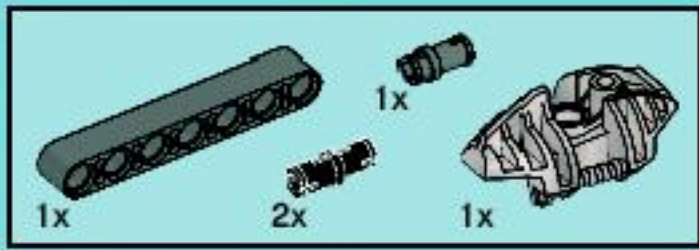

8

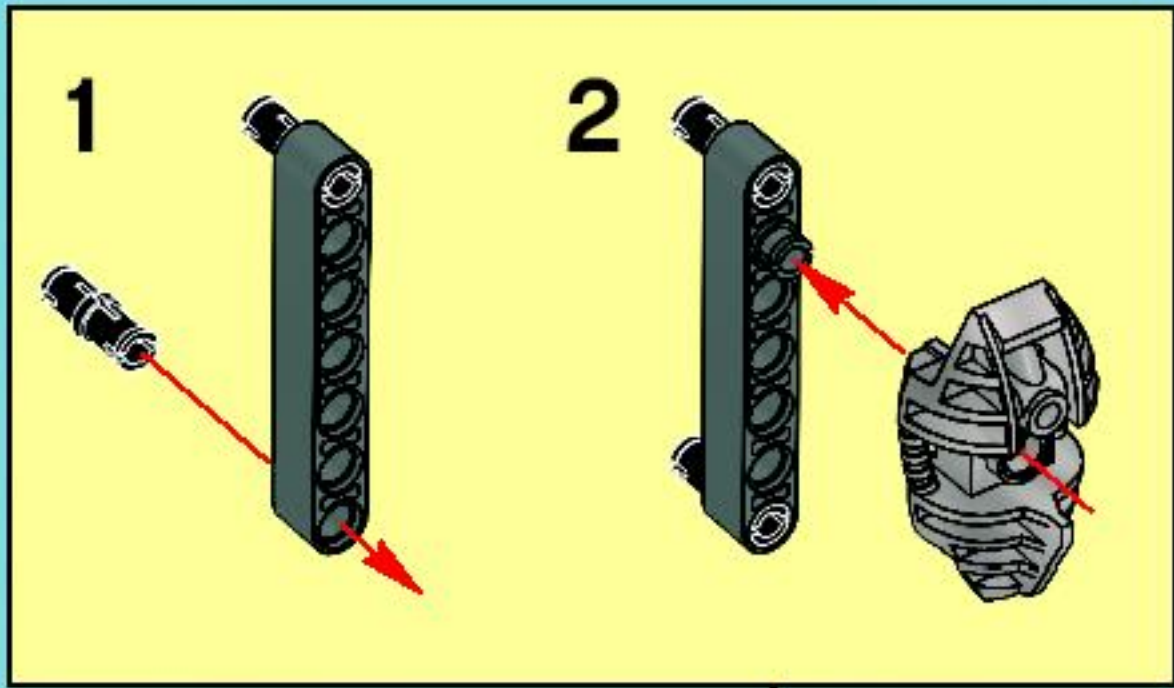

7

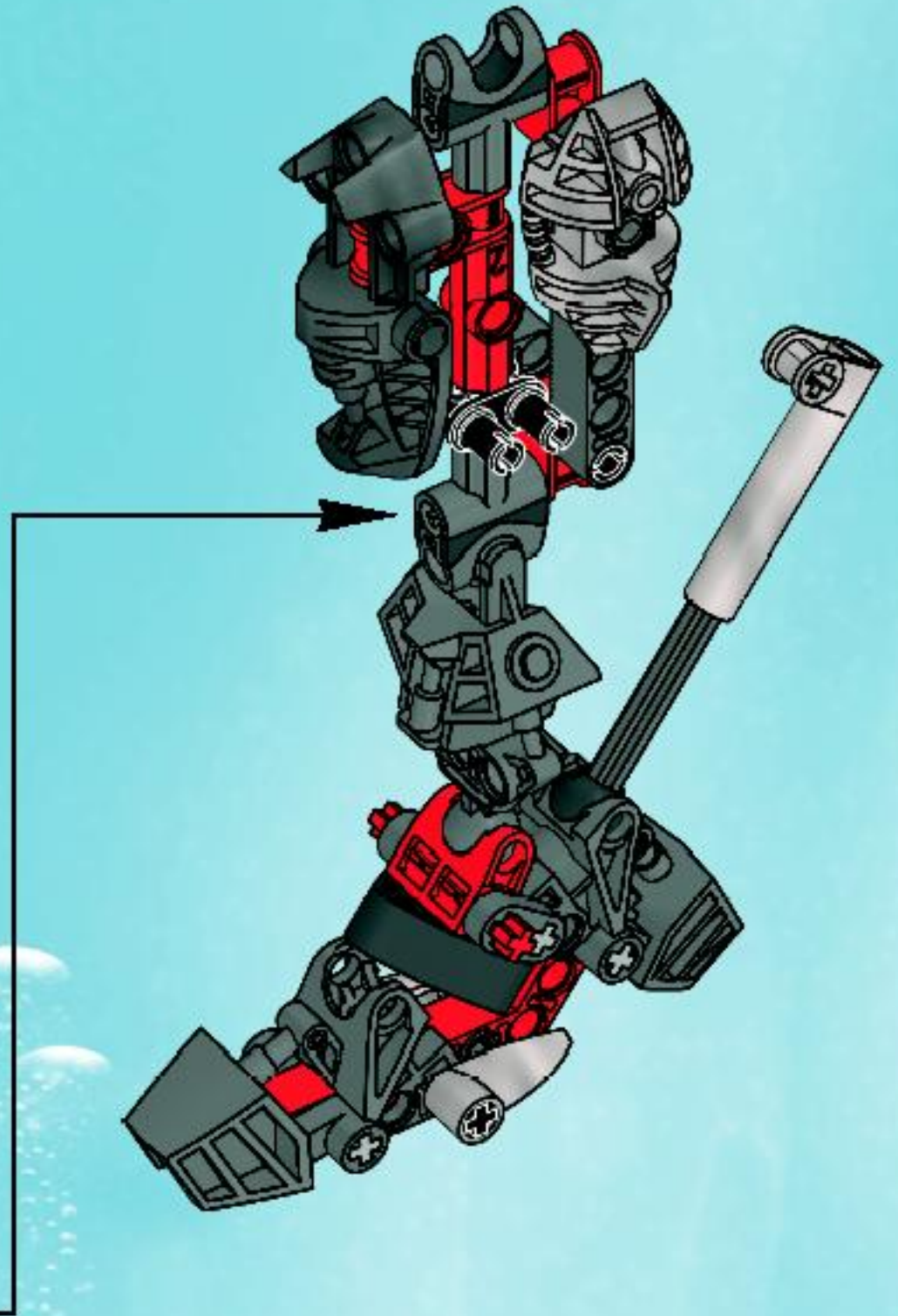

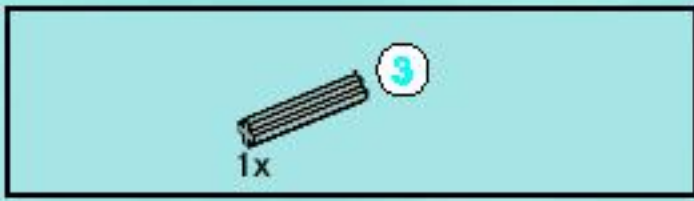

8



18

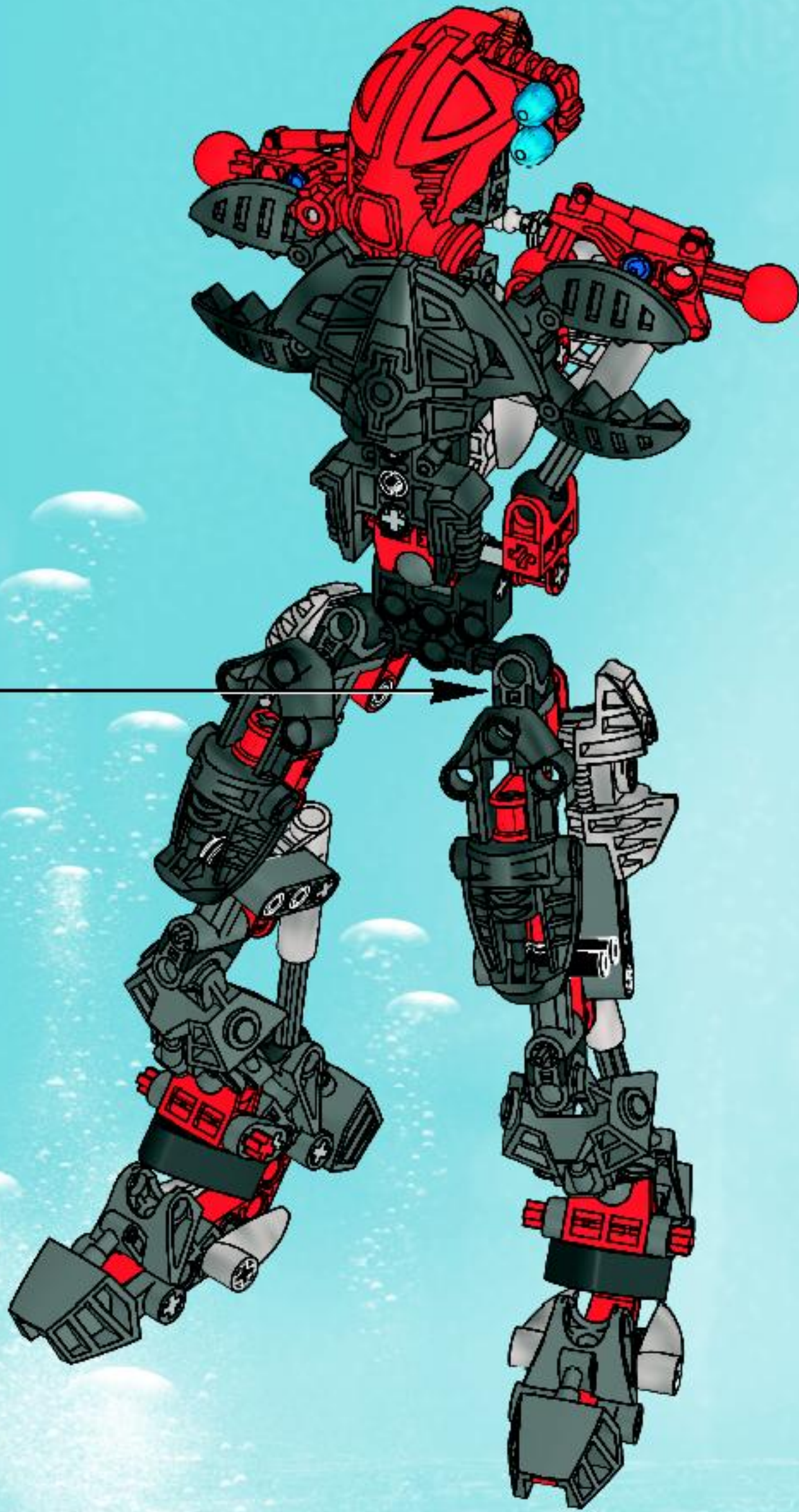

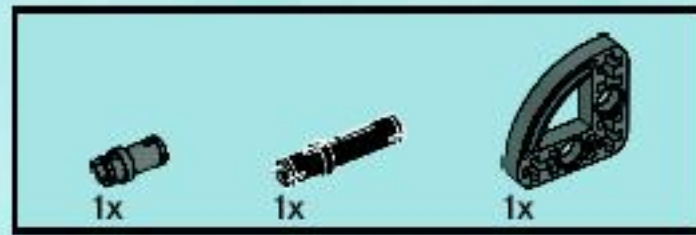
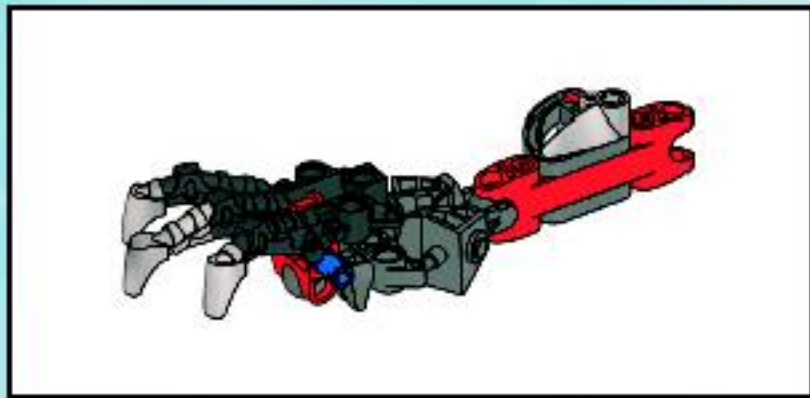
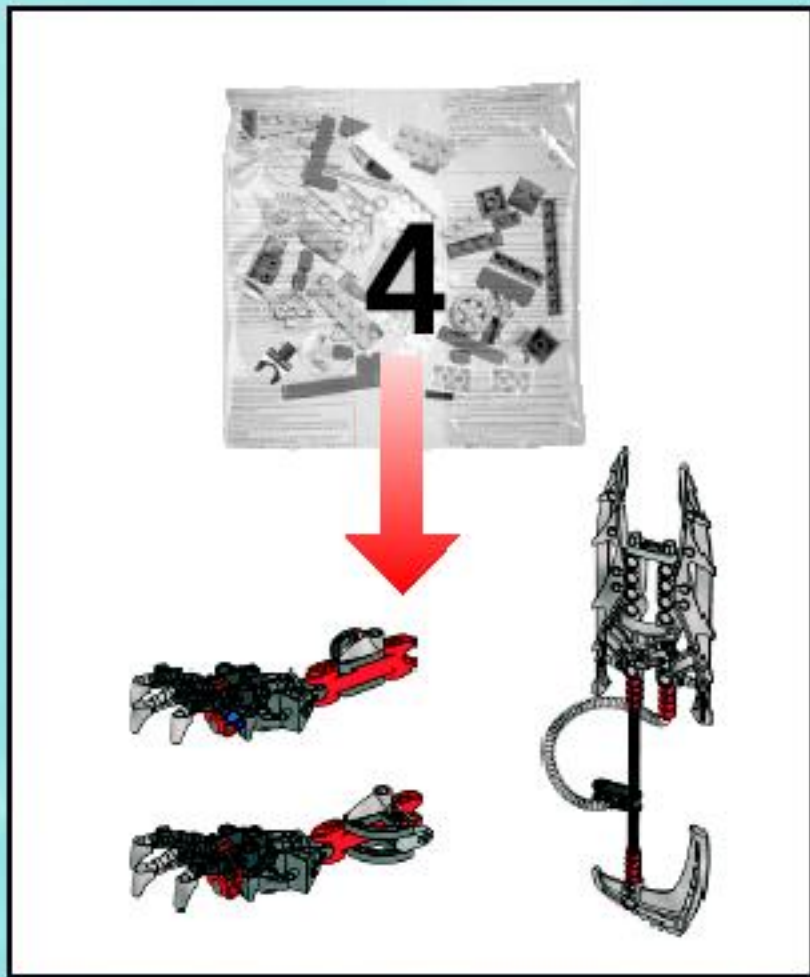

1



2



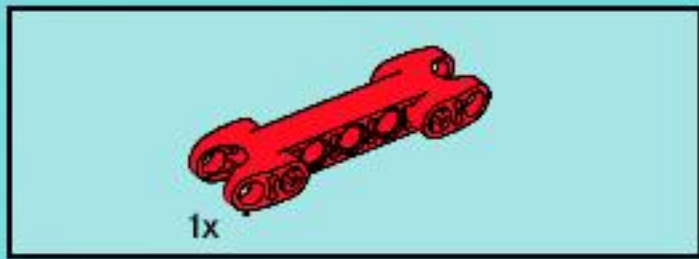

3



4

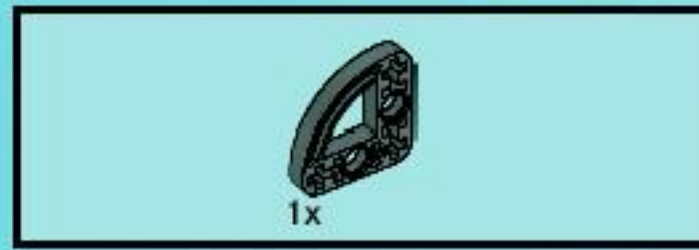

5



6

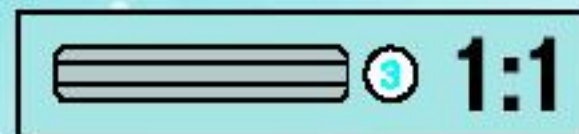
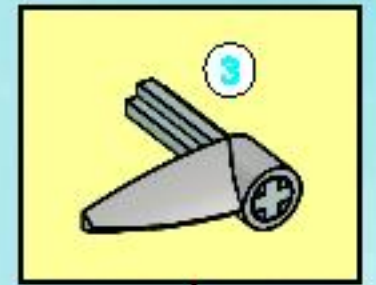

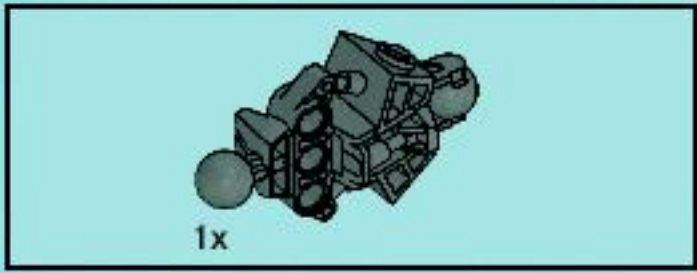

7

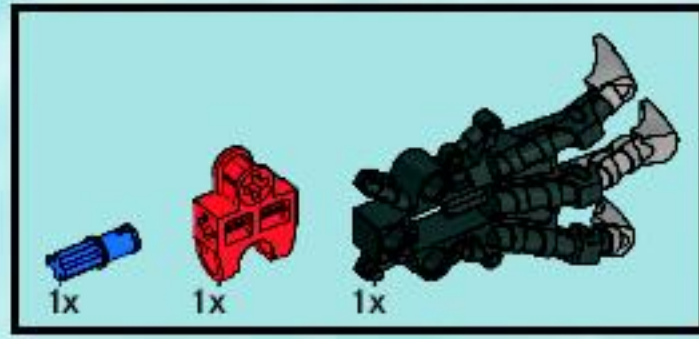
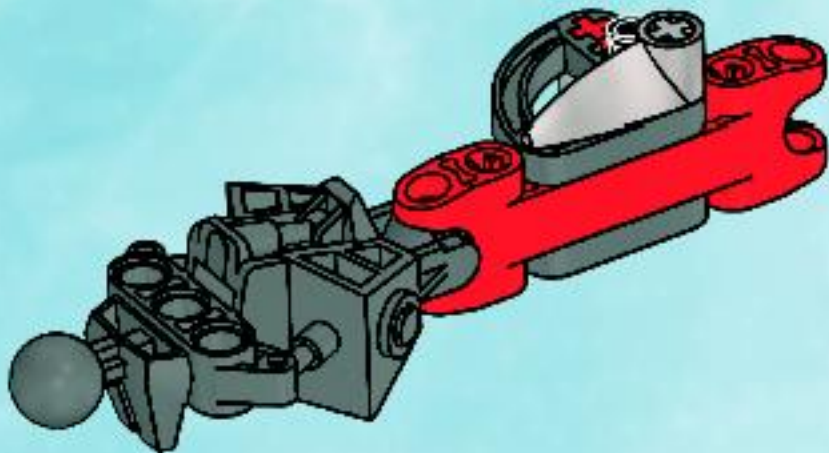

8

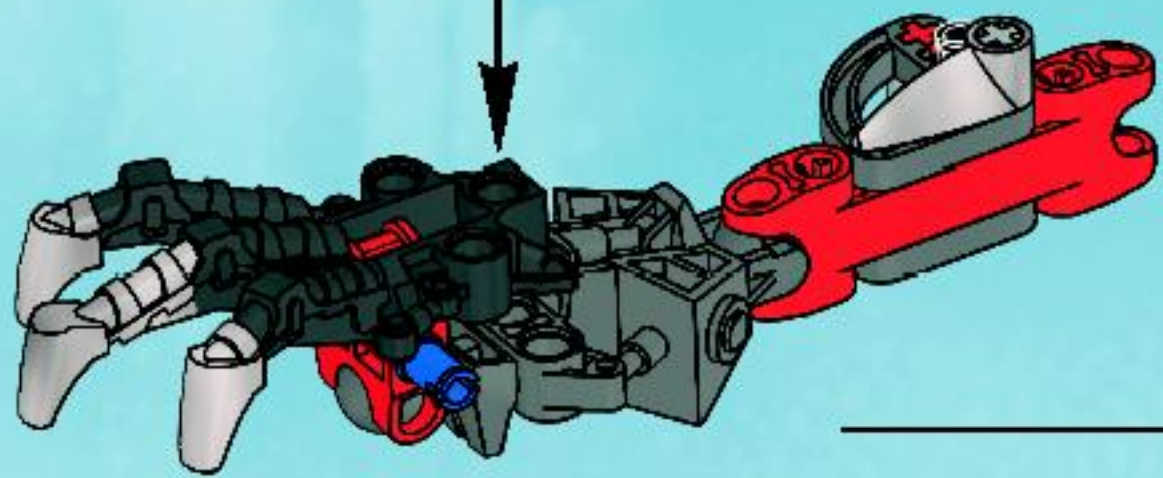
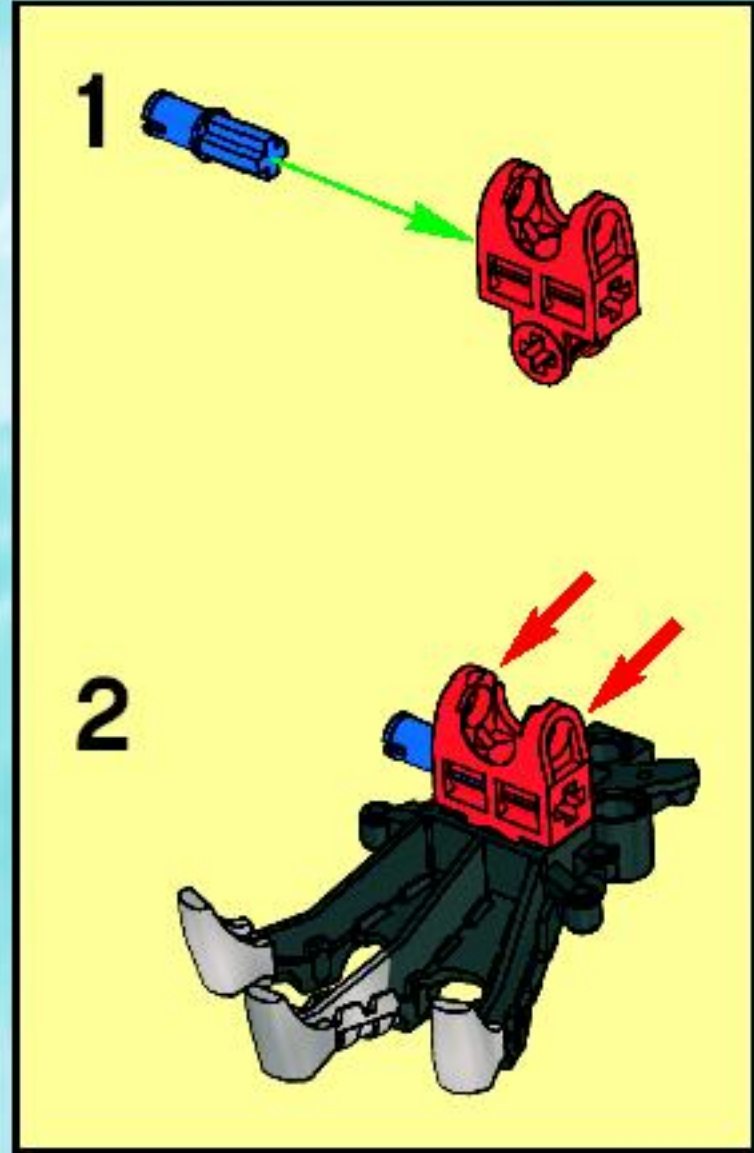

19



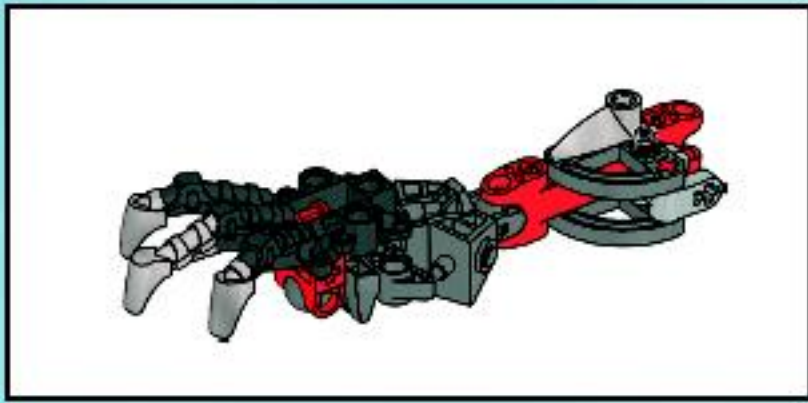

1

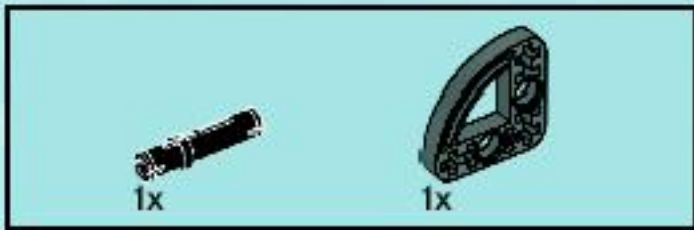
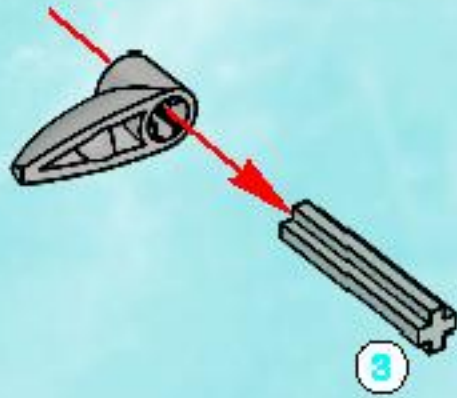

2

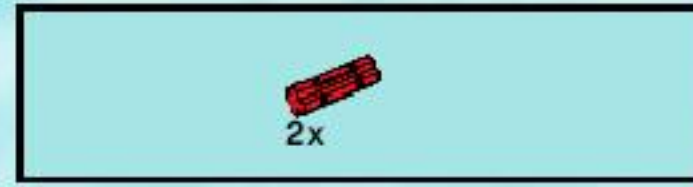
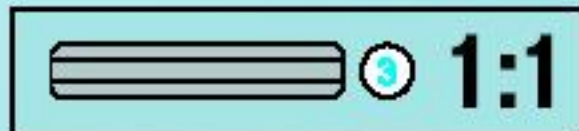
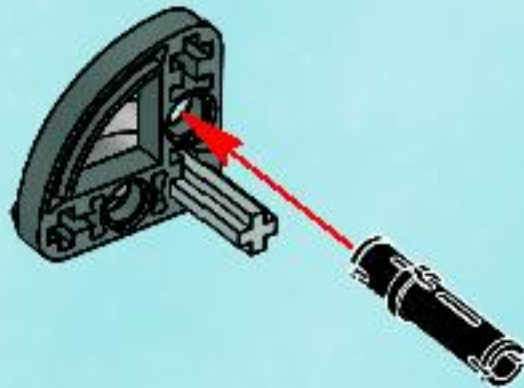

3



4

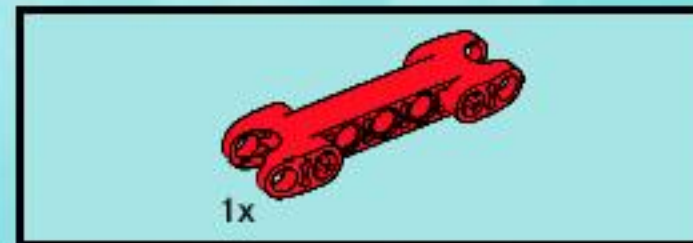
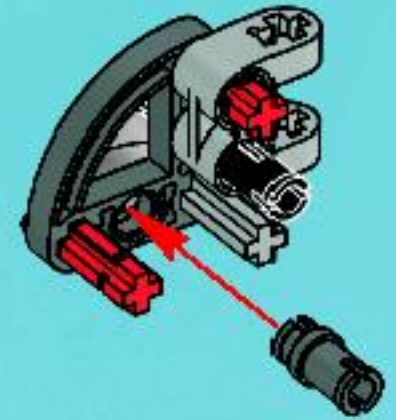

5

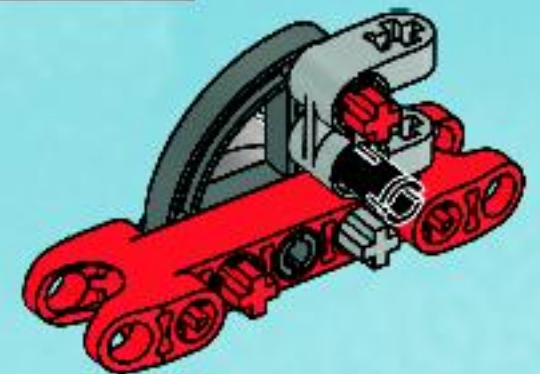



6

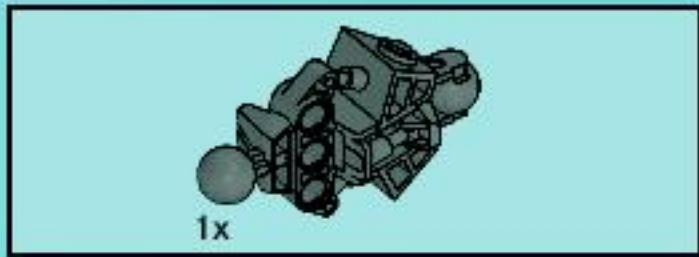

7

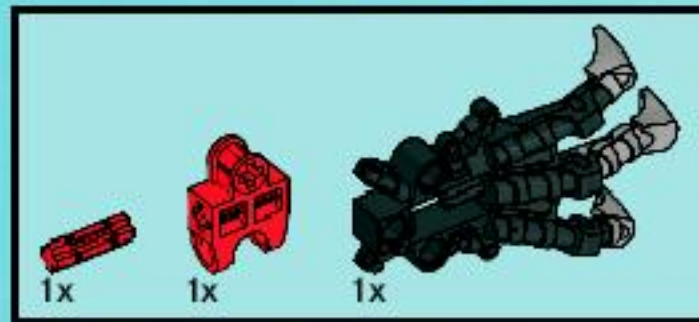
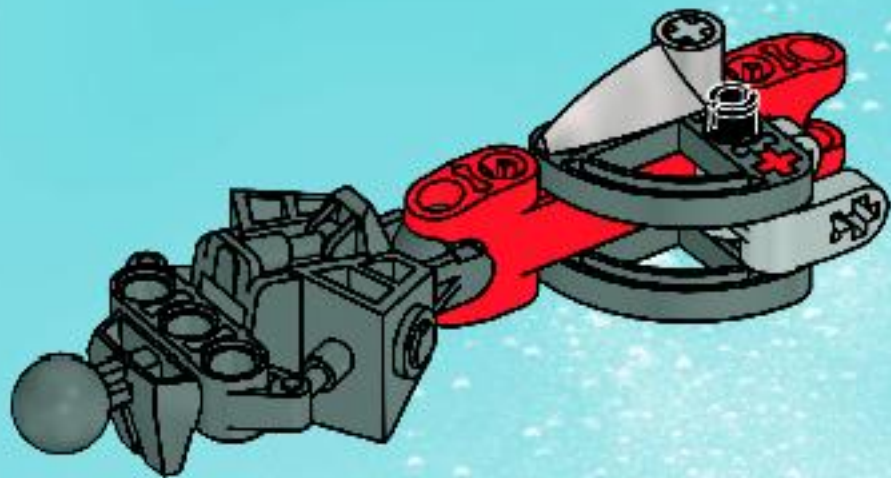

8

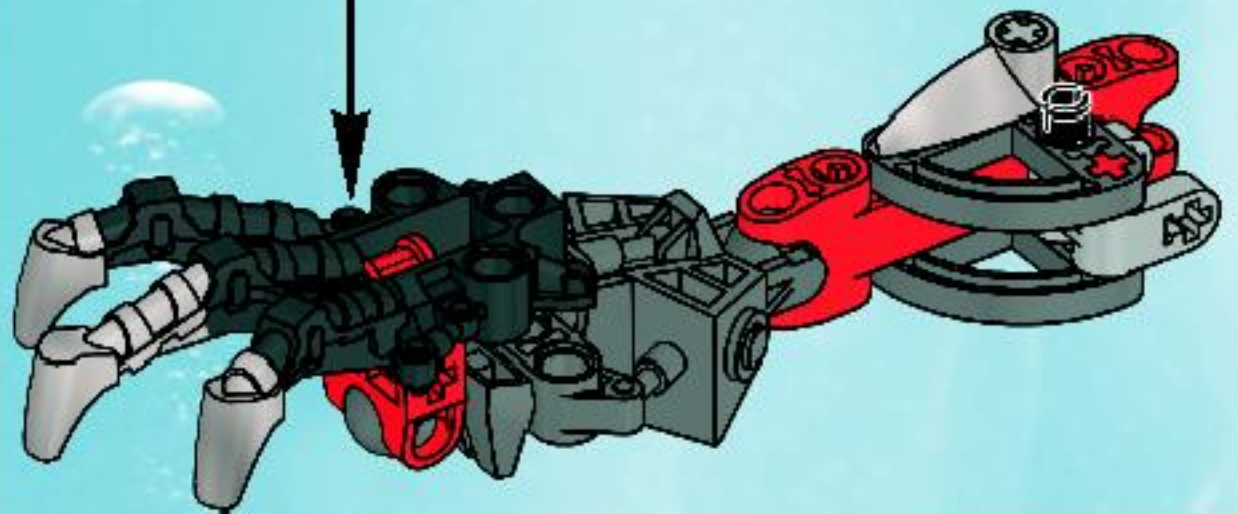
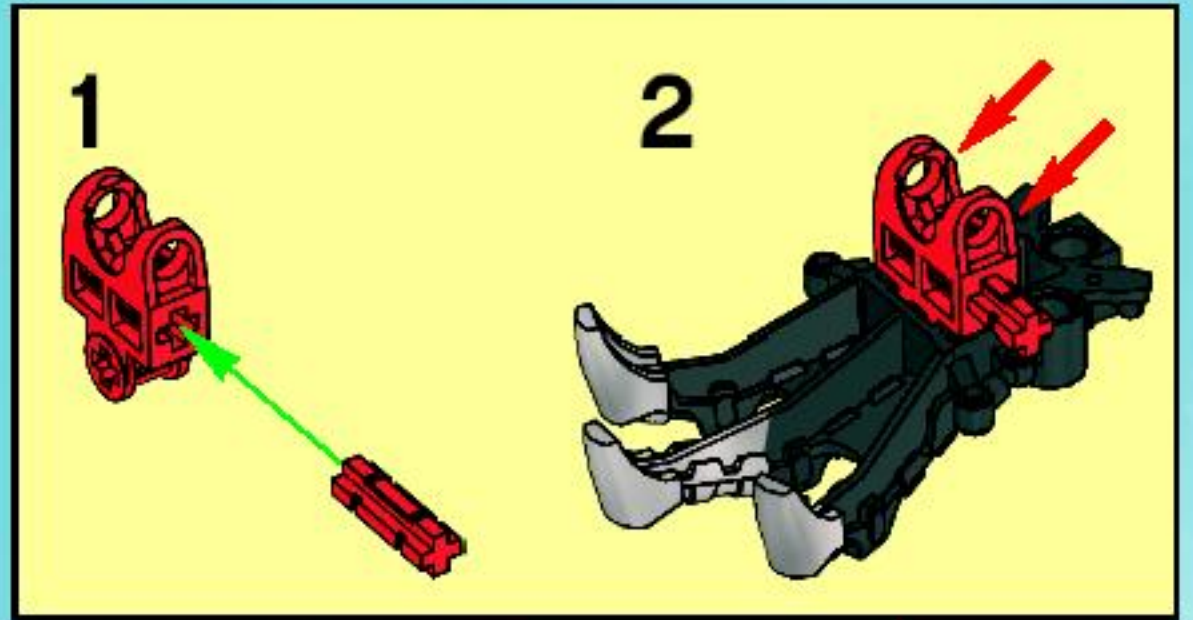

20

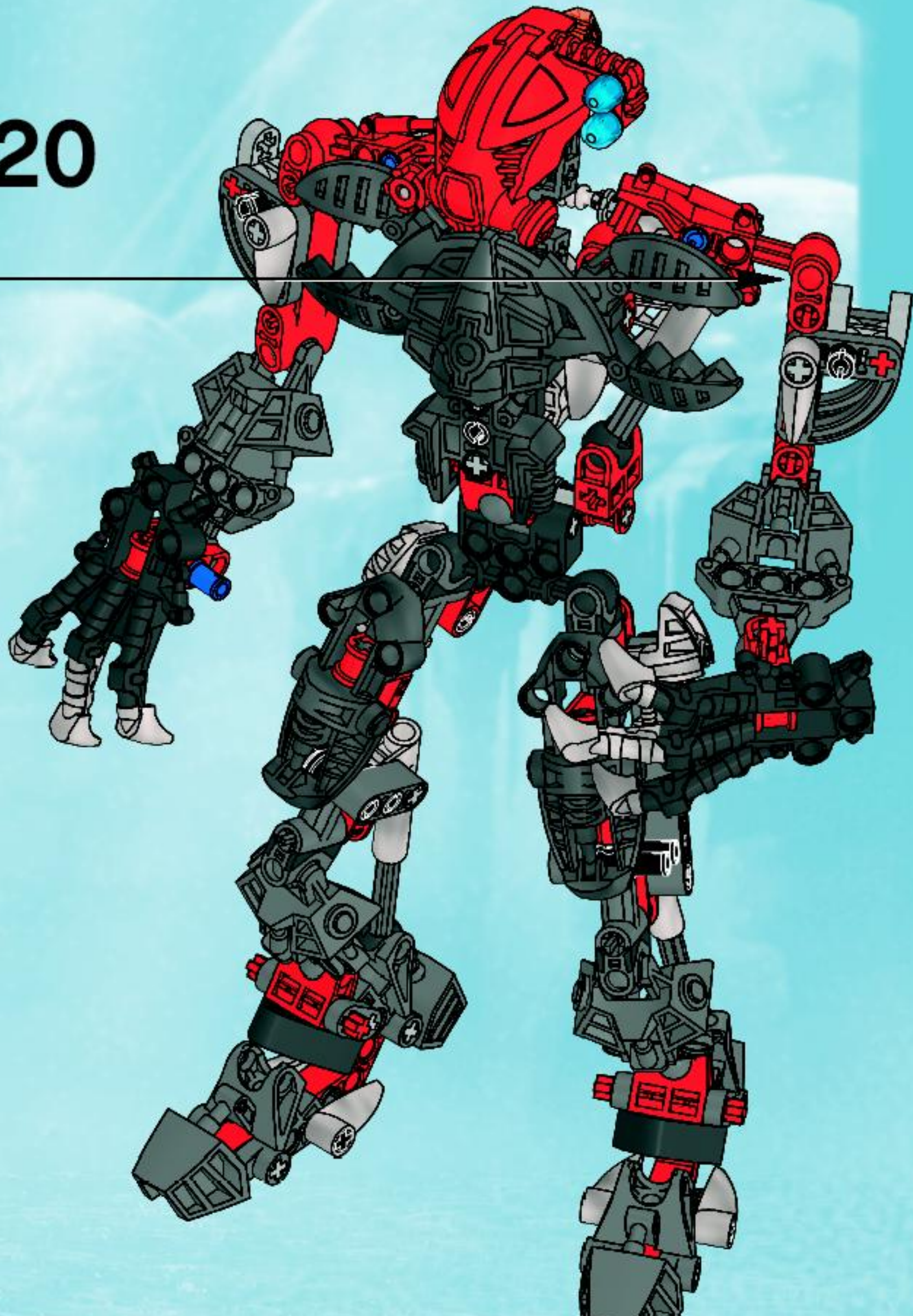



21



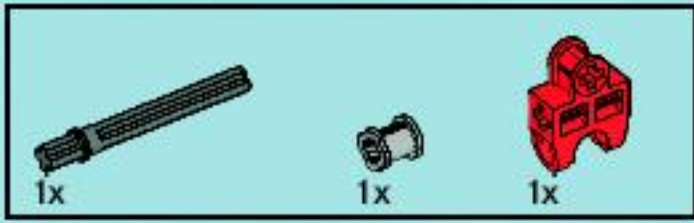

22

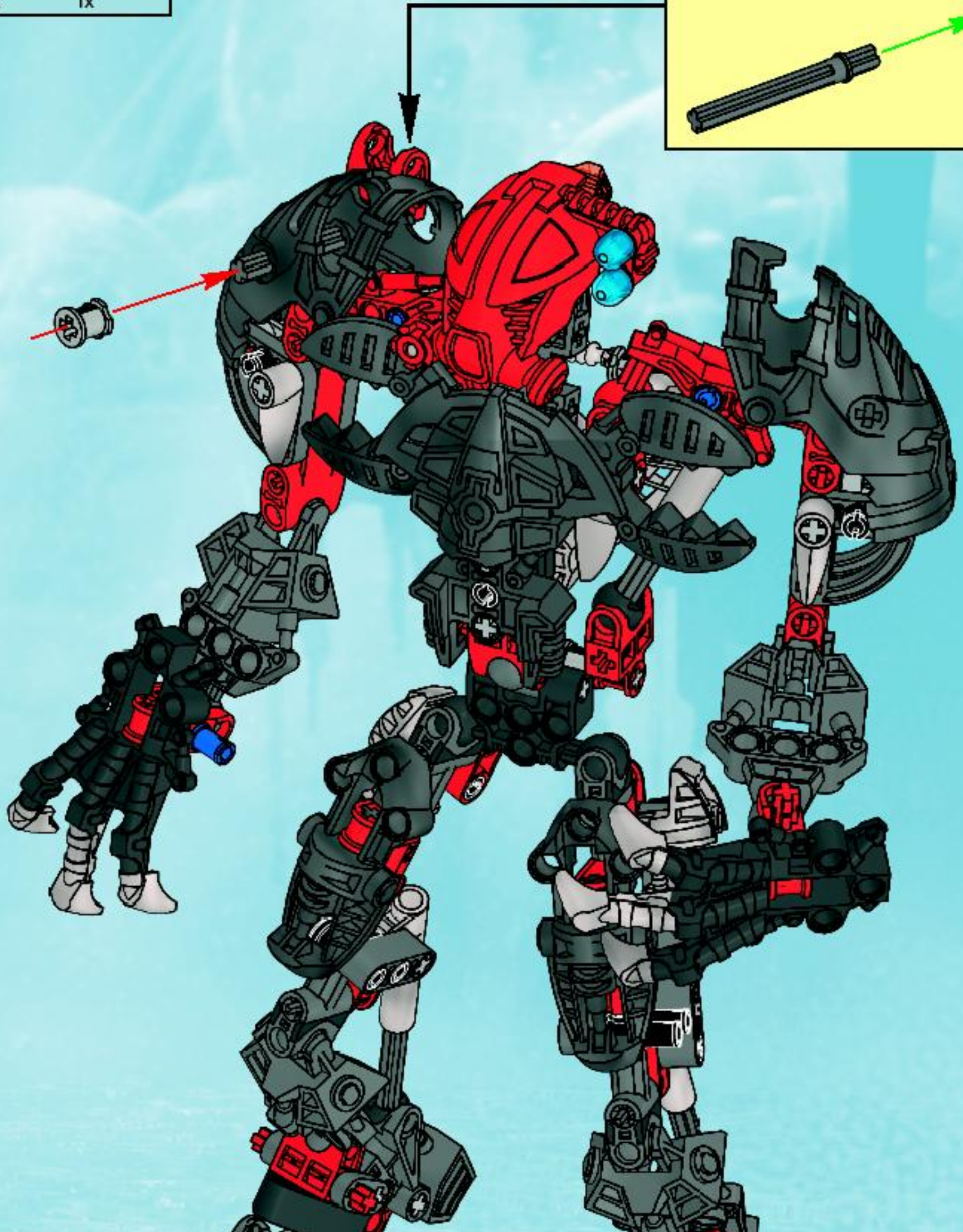
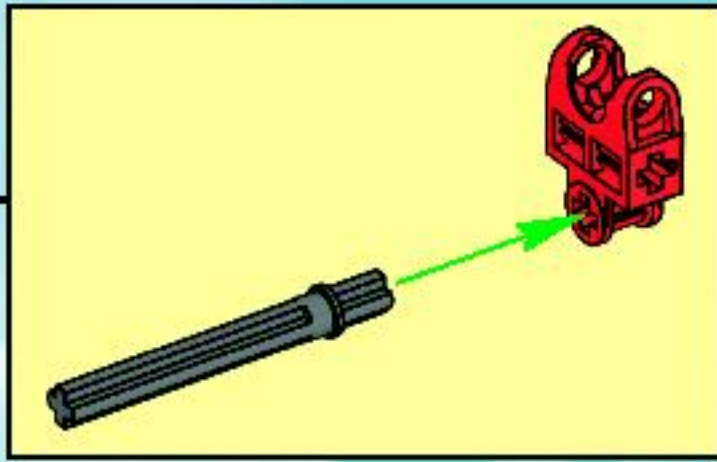

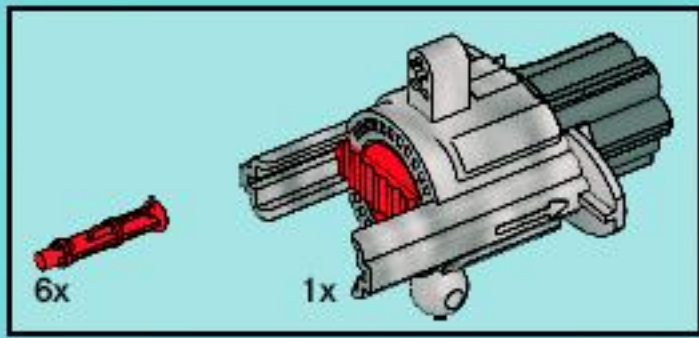

23



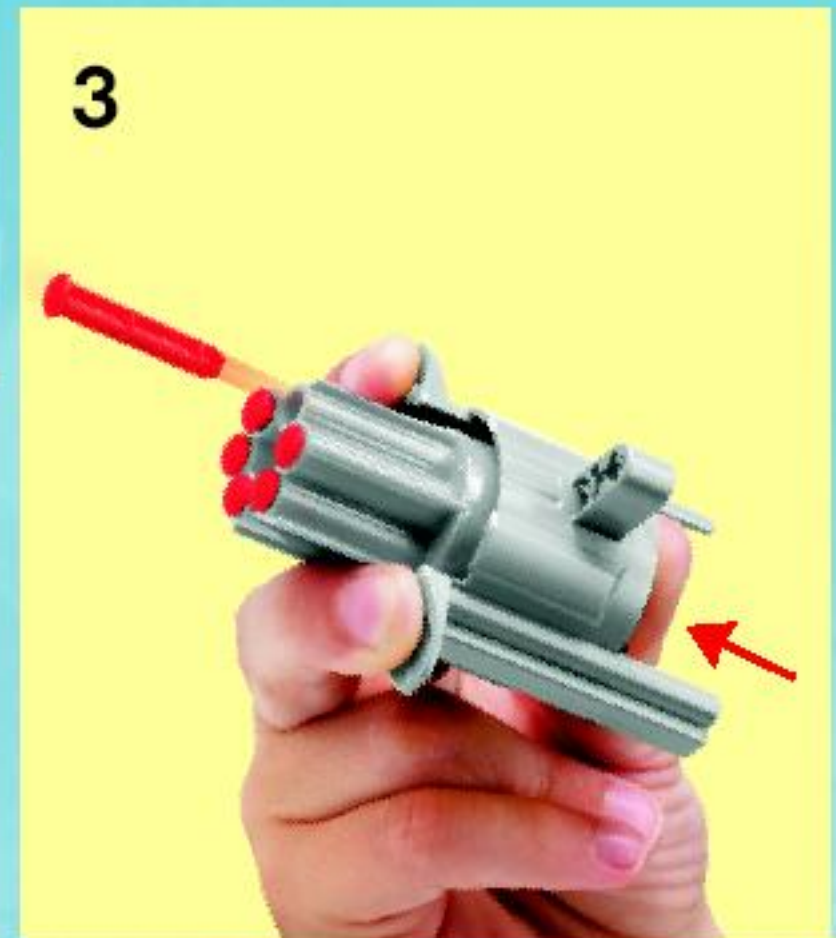
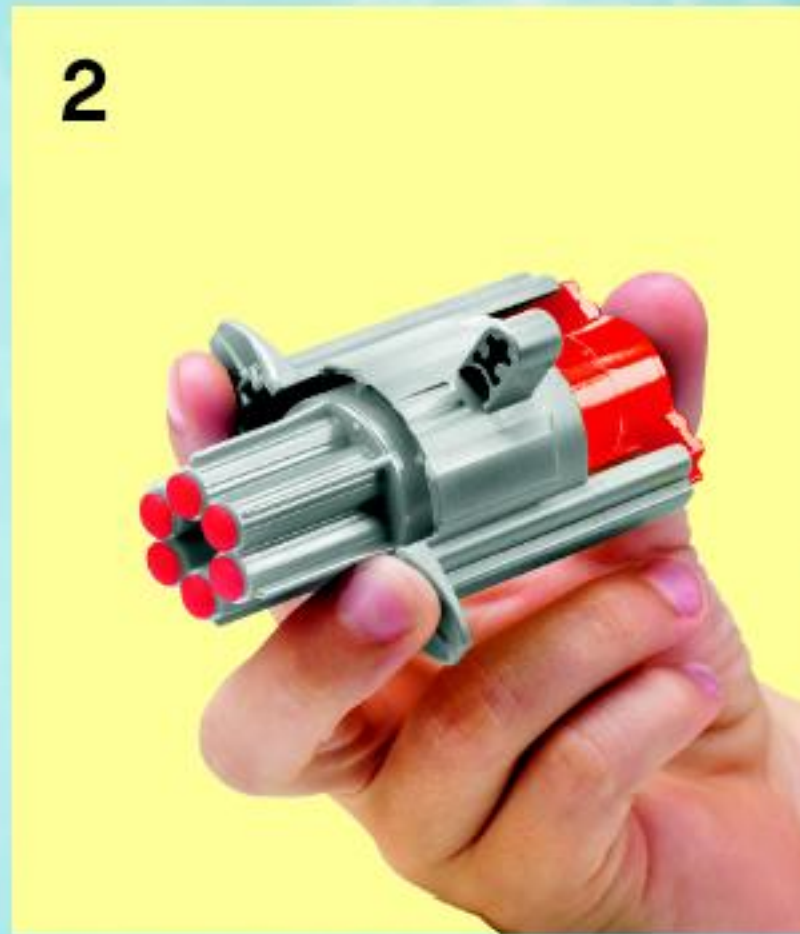
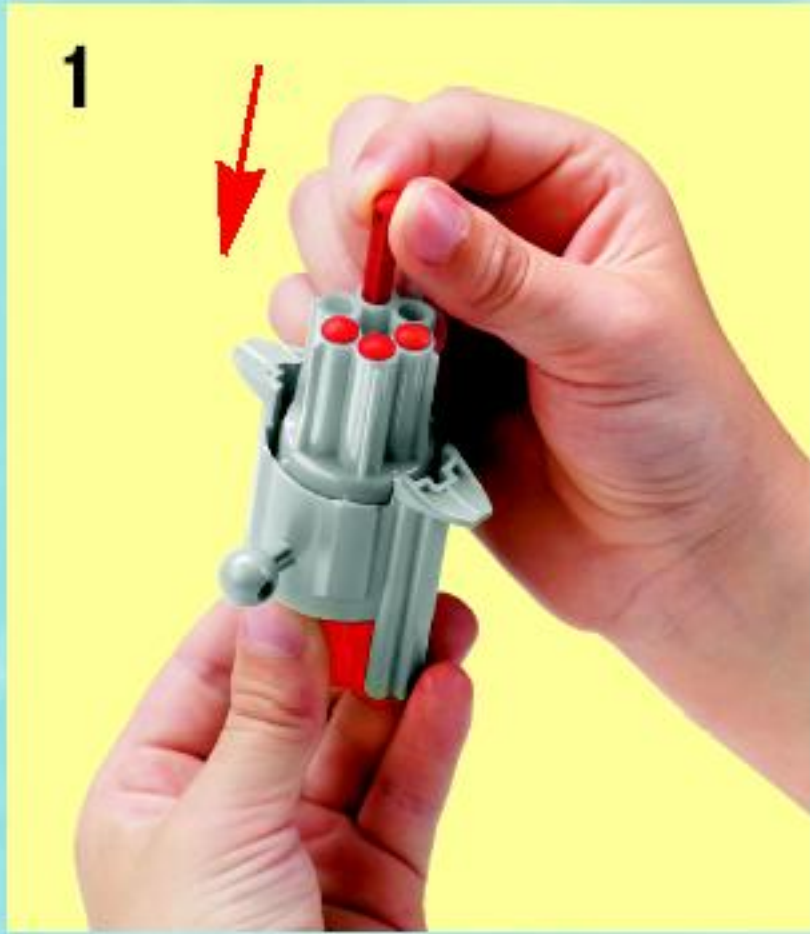



24

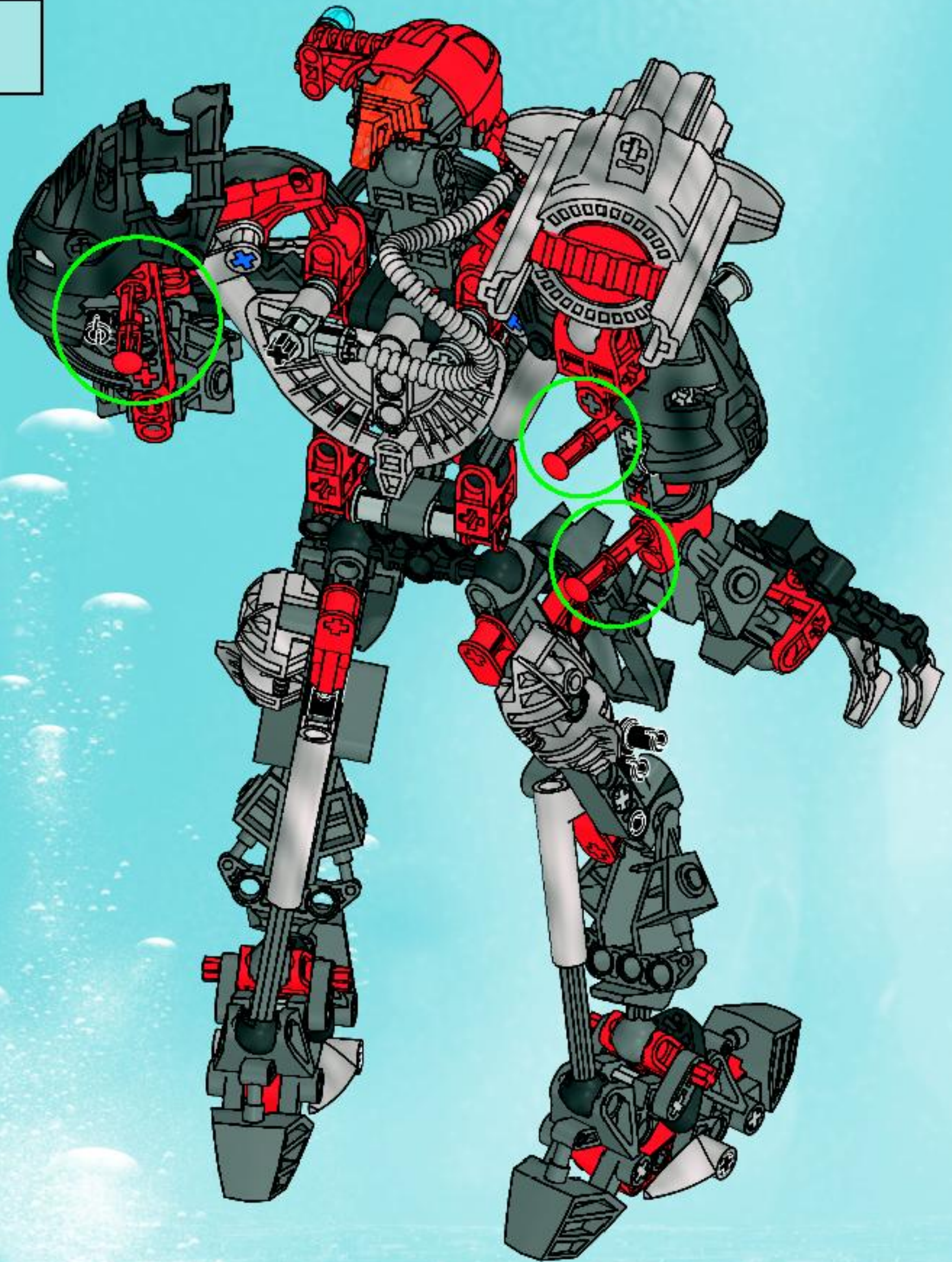

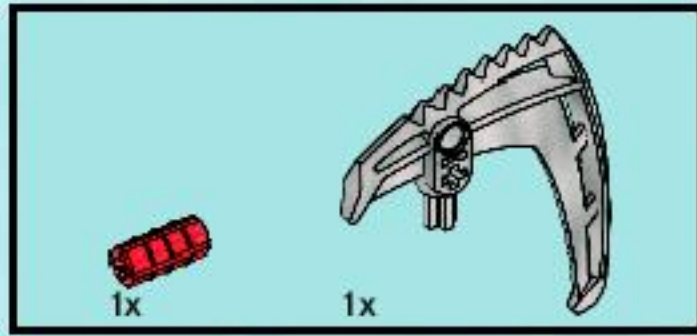
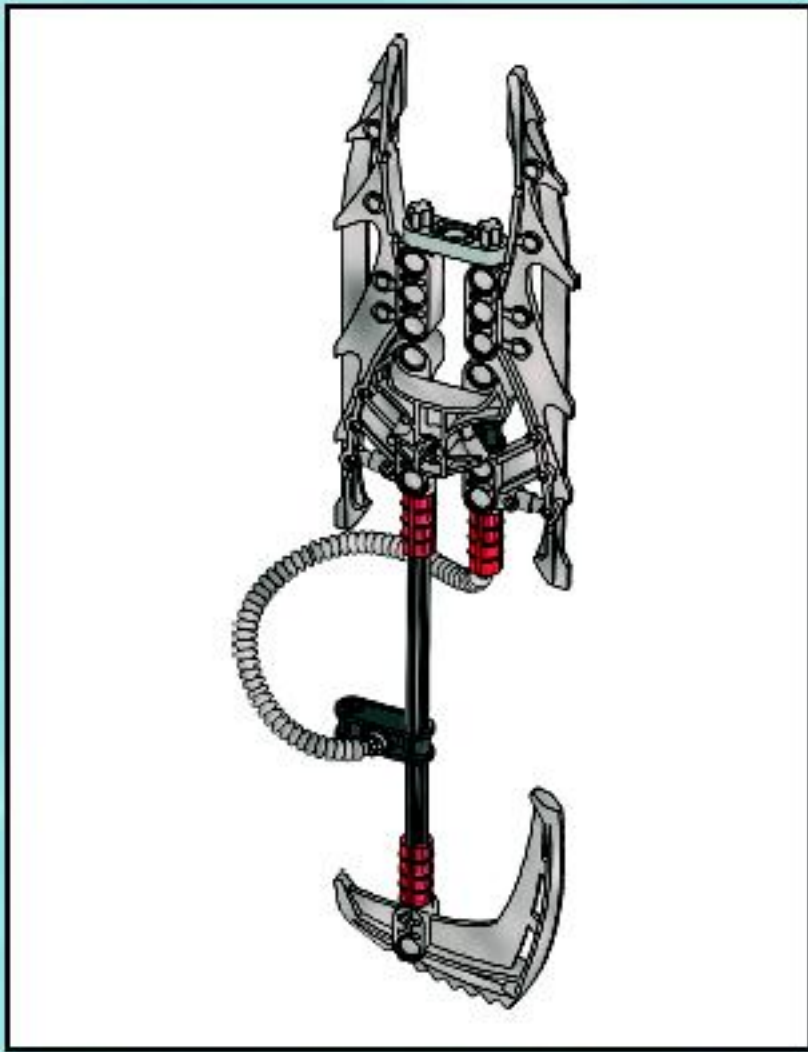

1

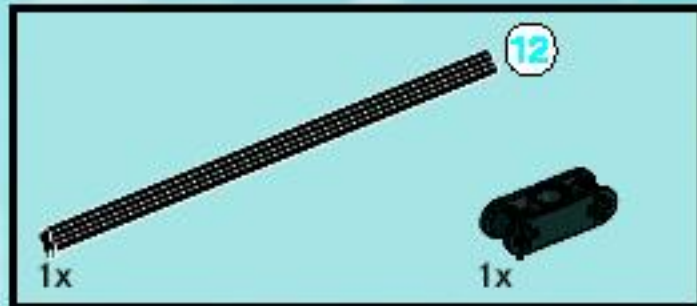
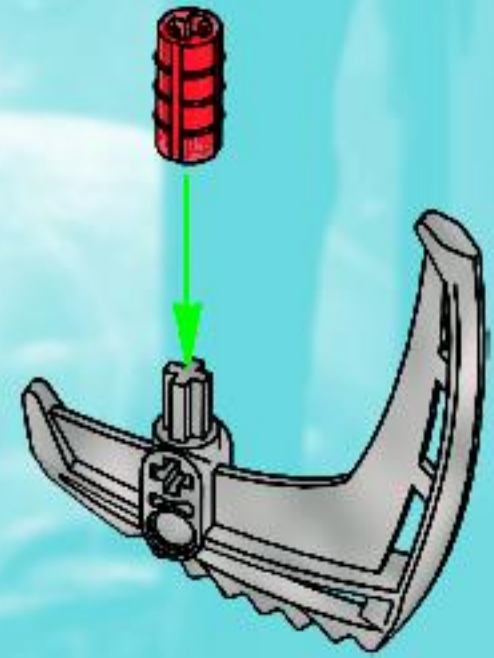

2





3

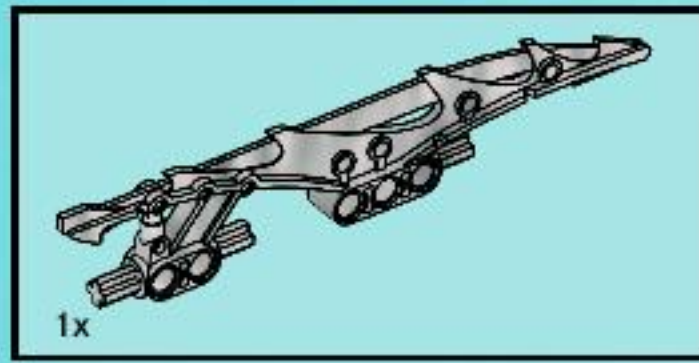

4





5

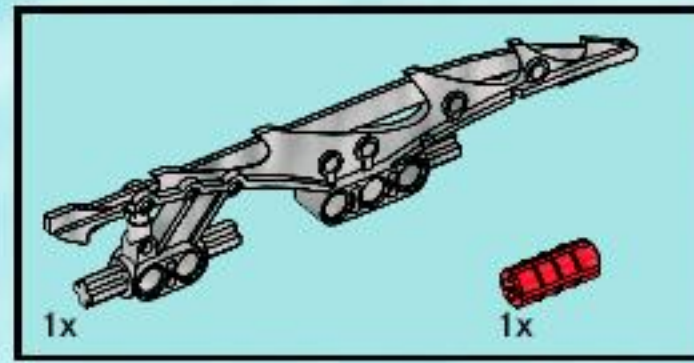
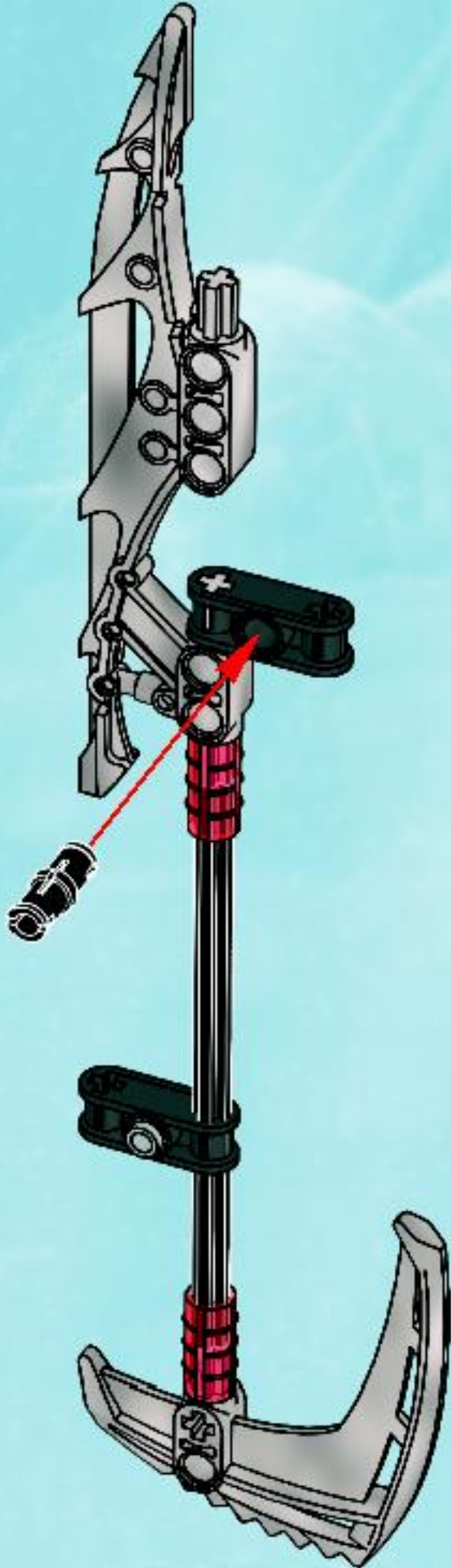

6

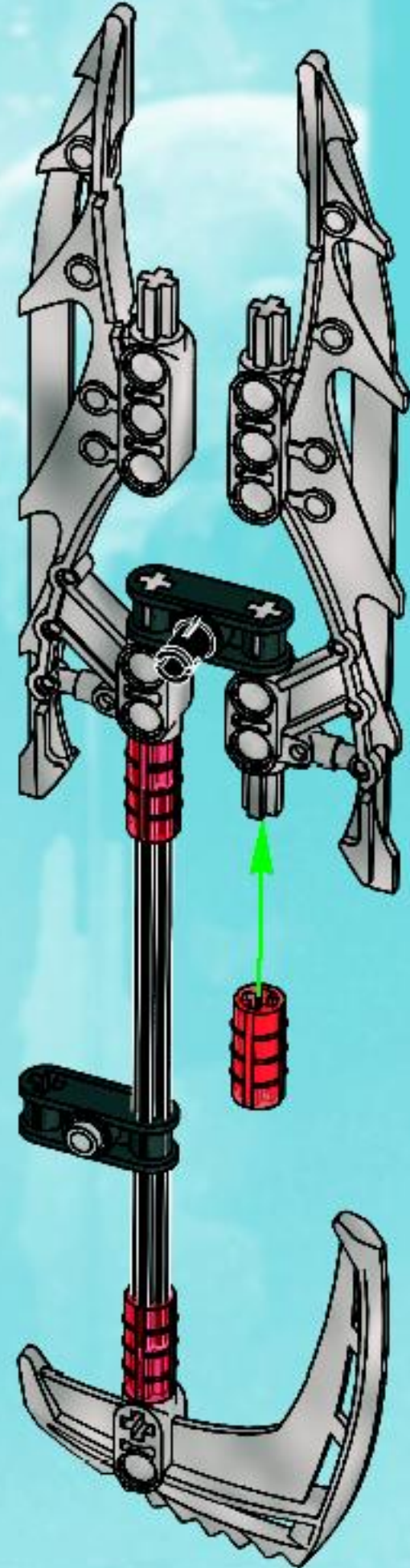

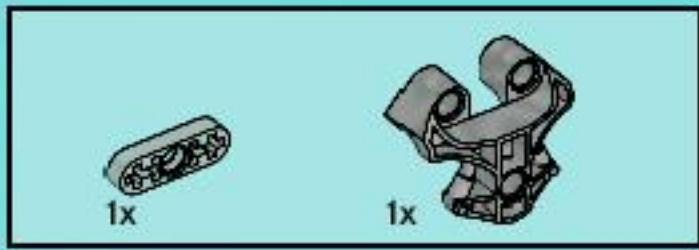

7

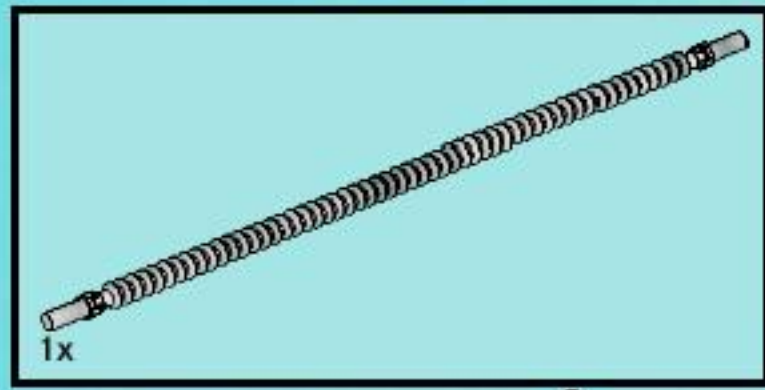
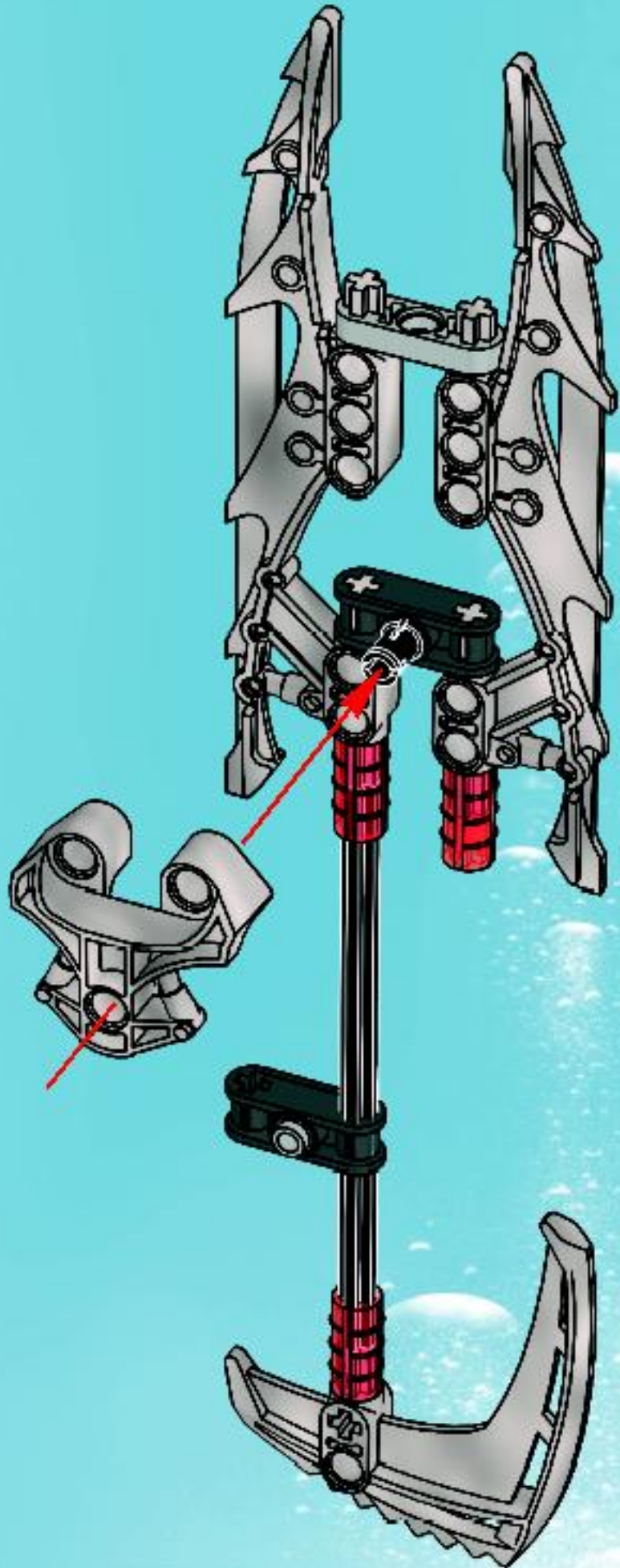

8

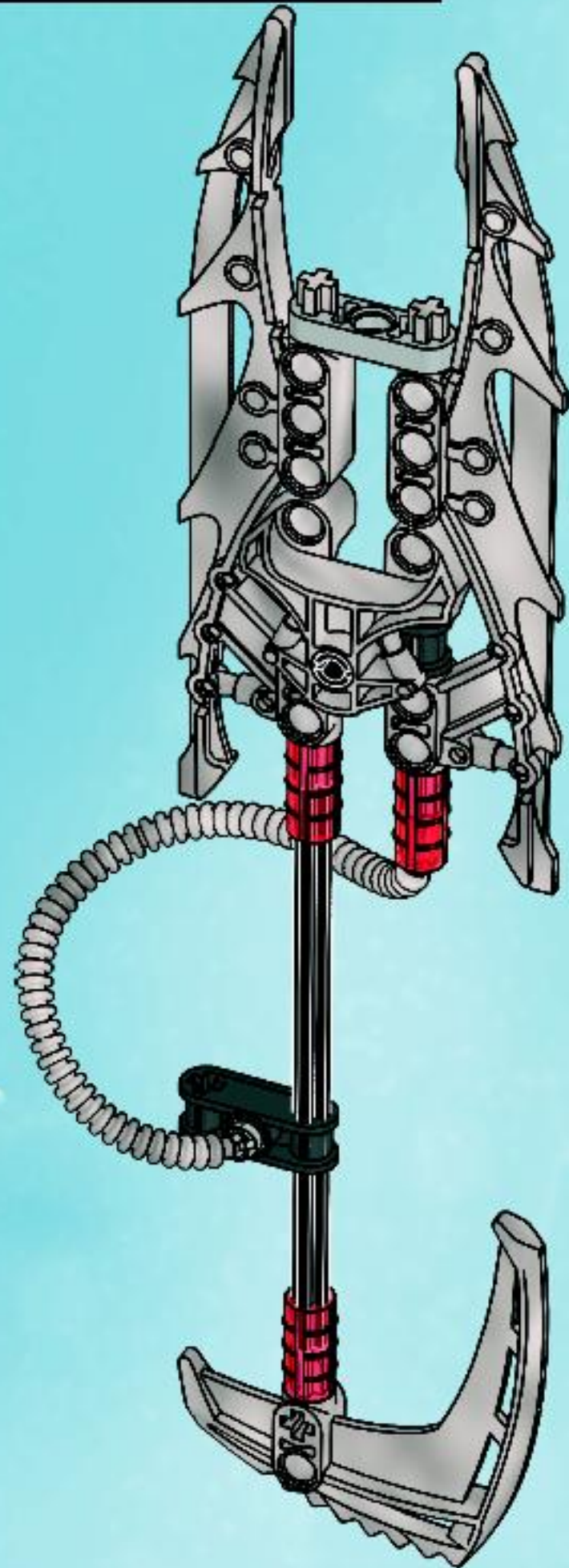

25

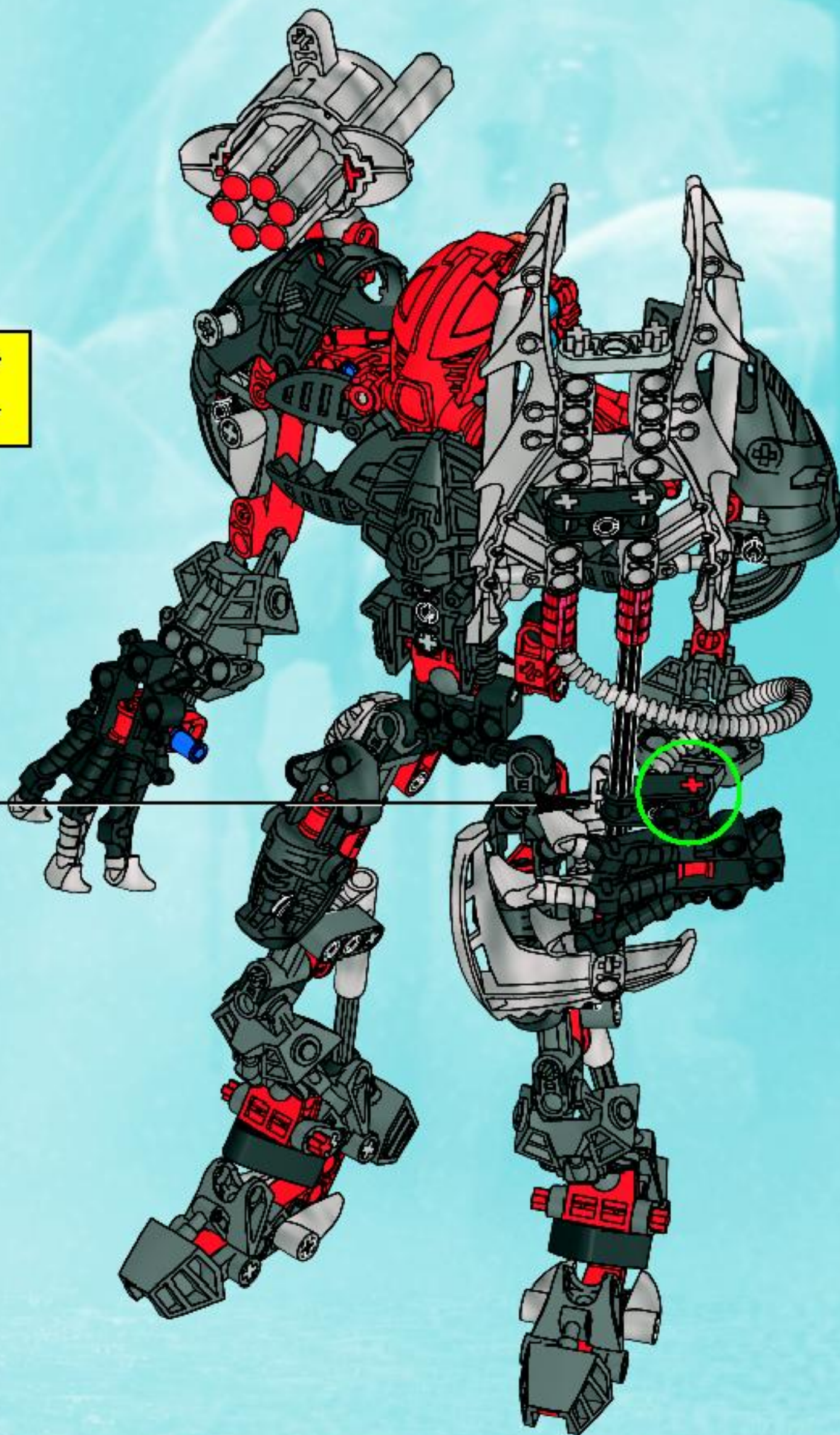

- 15x 4142865
- 2x 4234429
- 9x 4497796
- 2x 4252659
- 4x 4188298
- 1x 4175442
- 2x 4128598
- 2x 4289779
- 10x 4119331
- 1x 4508211
- 2x 4141743
- 9x 4206482
- 1x 4238919
- 3x 4289927
- 2x 4497946
- 11x 4121715
- 4x 655826
- 1x 370826
- 4x 370526
- 2x 4121667
- 4x 4286267
- 2x 4119589
- 6x 4107828
- 2x 4506758
- 6x 4294808
- 2x 4506737
- 1x 4506736
- 2x 4506734
- 5x 4211573
- 4x 4292654
- 3x 4211622
- 2x 4211553
- 1x 4211483
- 23x 4211815
- 2x 4211639
- 2x 4211621
- 2x 4211889
- 1x 4211566
- 6x 4211050
- 1x 4263624
- 1x 4217826
- 4x 4289386
- 3x 4289258
- 1x 4210851
- 4x 4499858
- 4x 4234386
- 1x 4278473
- 5x 4217829
- 4x 4294580
- 2x 4210751
- 2x 4495931
- 1x 4210656
- 4x 4210980
- 4x 4227757
- 4x 4223771
- 2x 4497943
- 3x 4163625
- 8x 4177440
- 1x 4247224
- 9x 4494087
- 4x 4494486
- 1x 4497146
- 2x 4497952
- 2x 4506460
- 1x 4505846
- 6x 4507719
- 2x 4506045
- 1x 4255123
- 1x 4227883
- 1x 4236020
- 2x 4504534
- 1x 4504505
- 1x 4504538





8922
Gadunka

8923
Hydraxon

8924
Maxilos & Spinax

Win! Gagne! 当たります Gewinne!

Win LEGO products

We would like to know what you think about your new LEGO product. Log on to the web address below for further instructions.

Gagne des produits LEGO

Nous aimerions savoir ce que tu penses de ton nouveau produit LEGO. Tu obtiendras davantage d'informations en visitant le site Internet indique ci-dessous.

Gewinne LEGO produkte

Wir sind sehr an deiner Meinung über dein neues LEGO Produkt interessiert. Gehe einfach zu der unten angegebenen Webadresse – dort findest du weitere Informationen.

Estimado usuario LEGO

Al contestar algunas preguntas en inglés, francés, alemán o japonés, en el sitio www.acnielsen.aim.dk/lego, podrás participar en el sorteo de algunos valiosos premios LEGO.

Caro Consumidor da LEGO

Ao responder a algumas perguntas em Inglês, Francês, Alemão ou Japonês no endereço www.acnielsen.aim.dk/lego irá participar num concurso para ganhar valiosos prémios da LEGO.

Kedves ifjú LEGO Vásárló

Ha ellátogatsz a www.acnielsen.aim.dk/lego honlapra és ott angol, francia, német vagy japán nyelven megválaszolsz néhány kérdést, akkor részt veszel egy versenyben, amelyben értékes LEGO díjakat nyerhetsz.

抽選でレゴ製品が当たります

私たちは、皆さんがお買い求めのレゴ製品についてどんな感想をお持ちか、知りたいと思っています。質問に答えて、楽しいレゴ製品の抽選に応募しませんか。アンケートの回答には、ほんの3分ほどしかかかりません！詳しくは、以下のウェブアドレスまでアクセスしてください。

www.acnielsen.aim.dk/LEGO



Any questions regarding your new LEGO product, please contact:

Customer Service | Kundenservice

Service Consommateurs | Servicio Al Consumidor

at www.lego.com/service or dial

 : 00800 5346 5555

 : 1-800-422-5346



club™

FREE LEGO Magazine • GRATUIT • GRATIS LEGO Magazin



Join Today!

Abonne-toi dès aujourd'hui !

Meld je nu aan!

Jetzt anmelden!

US & Canada only

1-866-534-6258 / 1-877-518-5346

(en Français)

00800 5346 5555

www.LEGOclub.com



VISIT THE
WORLD'S BIGGEST
LEGO® SHOP!
www.LEGOshop.com



BIONICLE

STORY PRODUCTS FUN ZONE KANOKA CLUB



NEW PRODUCTS

Merciless and armed to the fangs with Squid ammo, the Barraki know what they want and stop at nothing to get it! Join in the quest for the Mask with all the new characters.



Escape the vile creatures prowling in the seaweed in this hostile trench of darkness.



Introducing BIONICLEStory.com
New Kanoka Club website!
New Products: Barraki

