

# BIONICLE™

GAHLOK



LEGO

8562



1

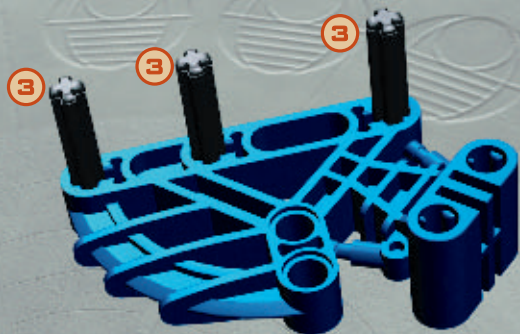

1:1

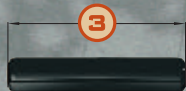

2

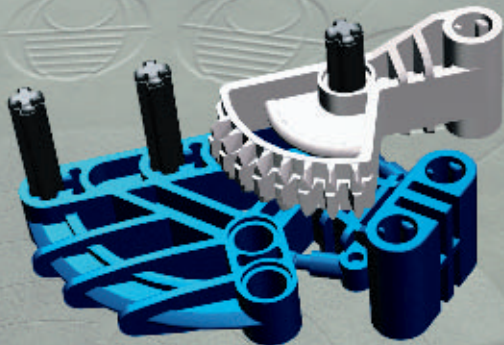

3

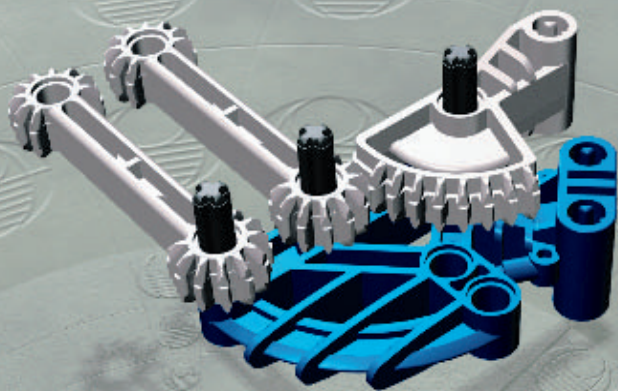

4

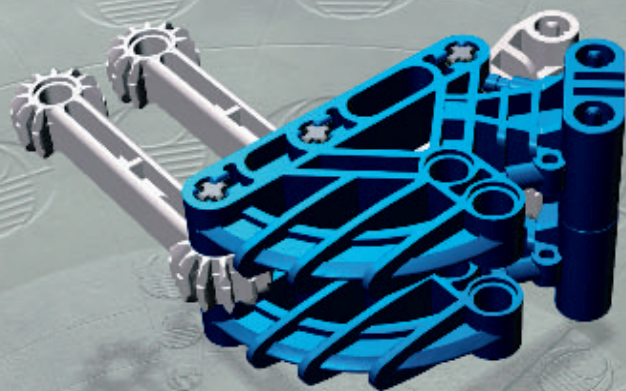

5

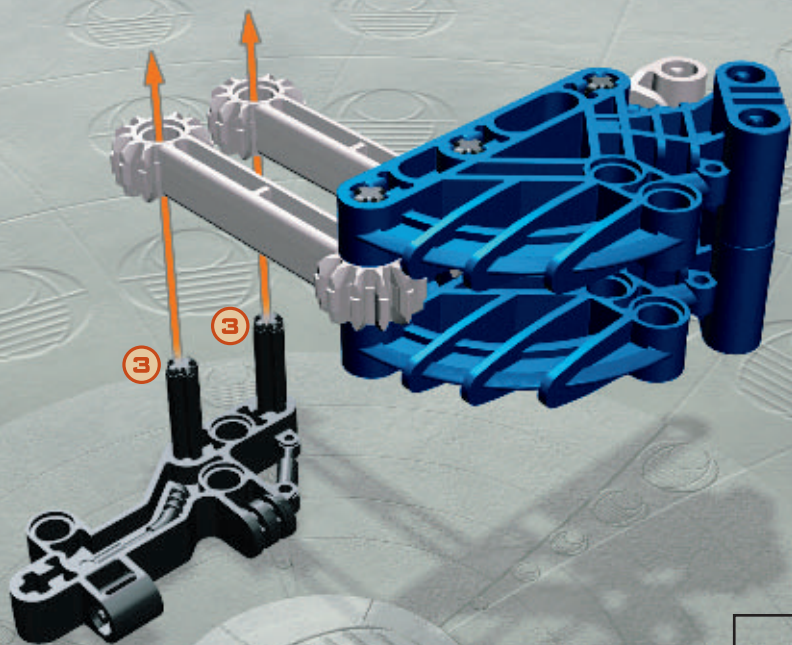

1:1

3

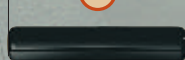

6

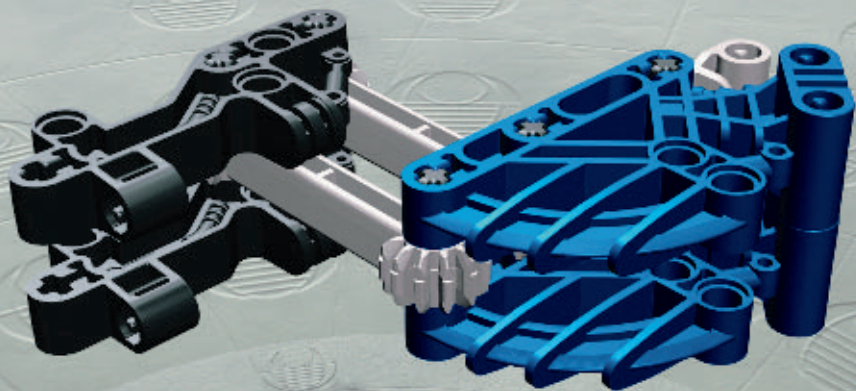

7

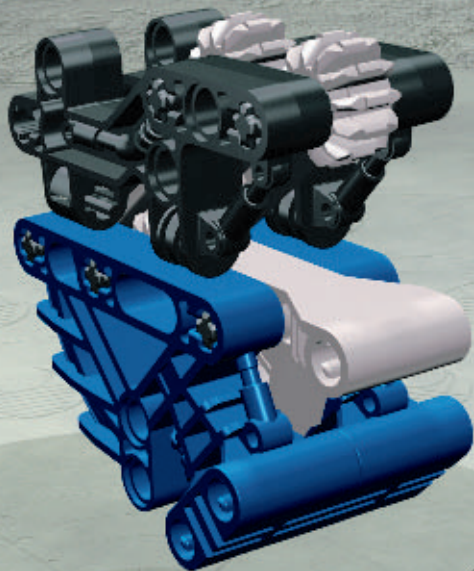

8

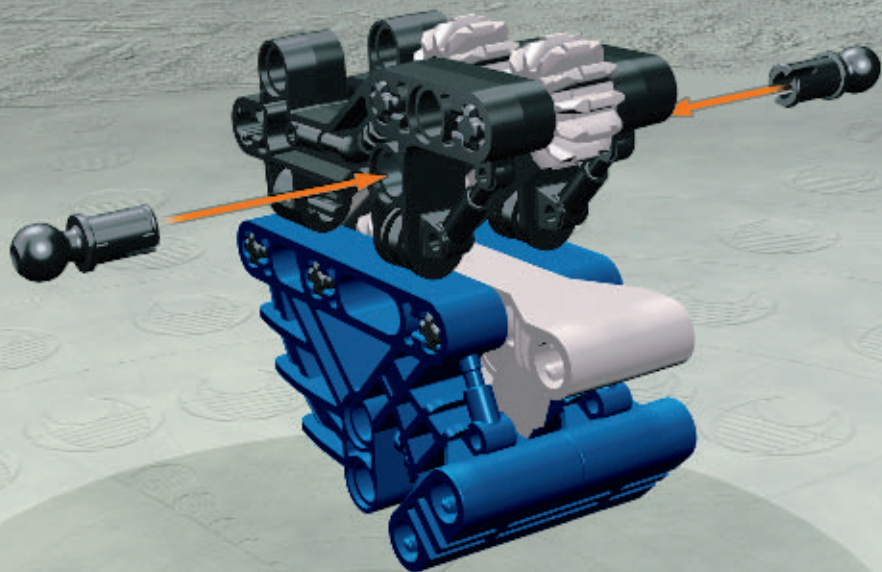



9

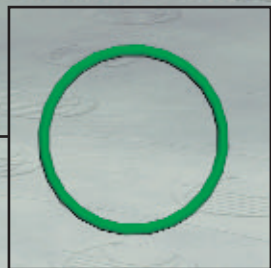
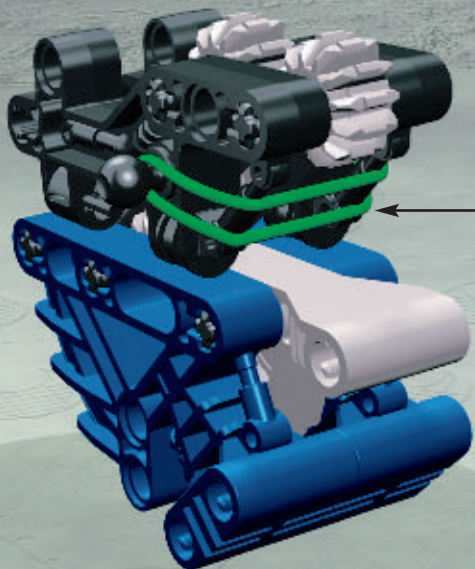

10

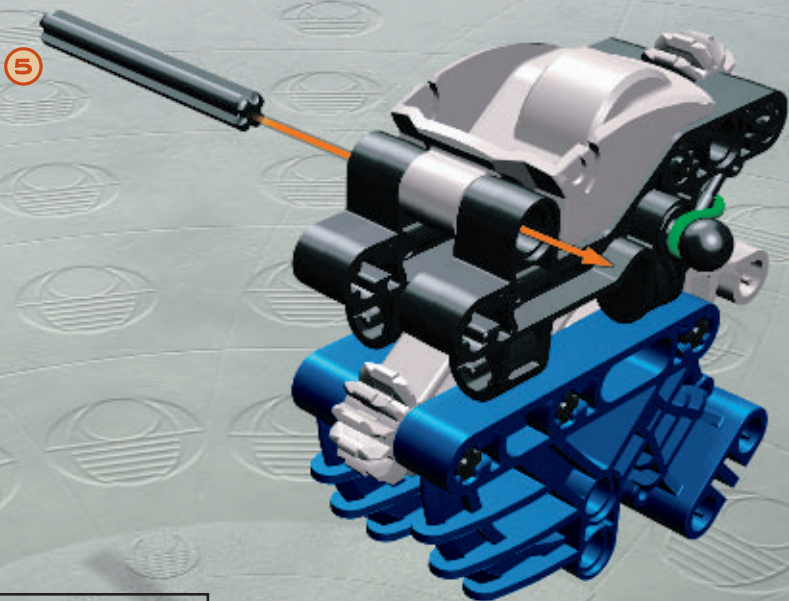

1:1

5

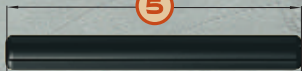

11

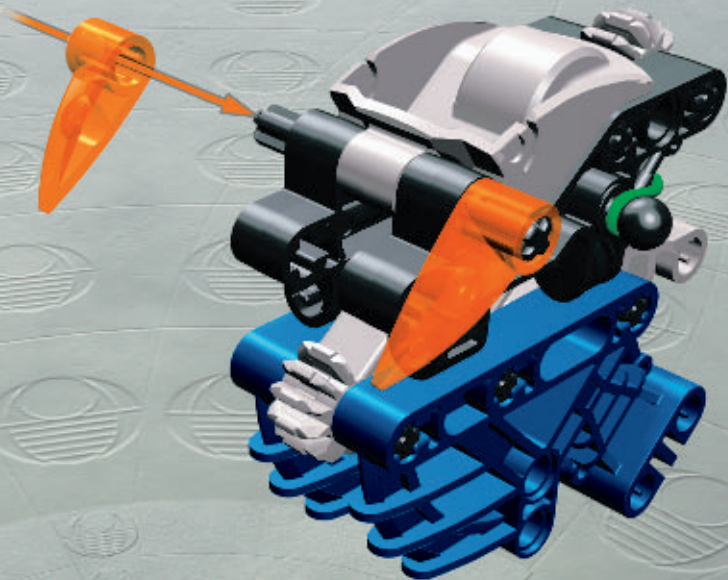

12

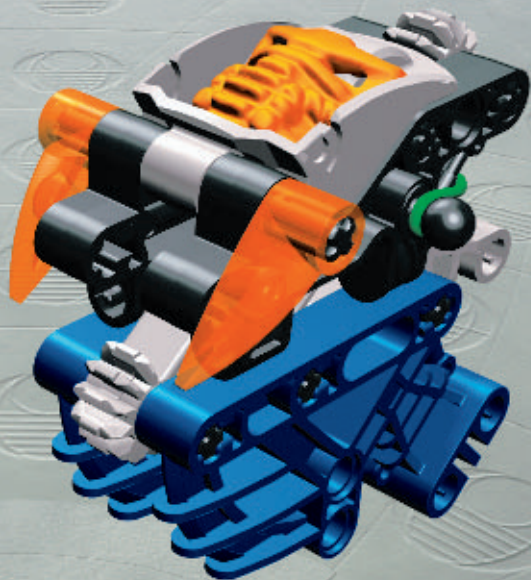

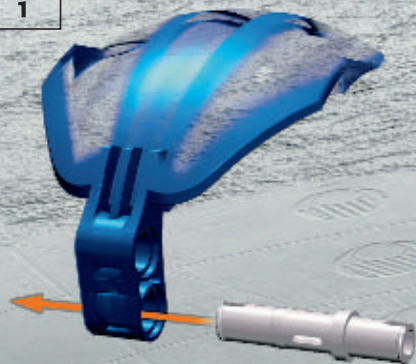
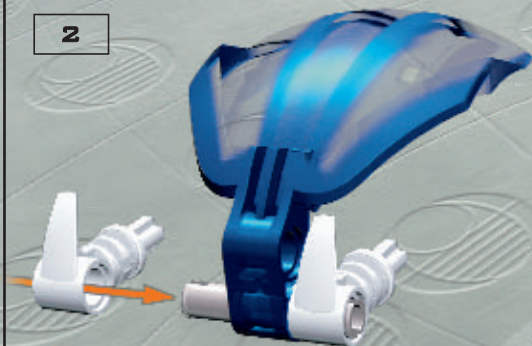
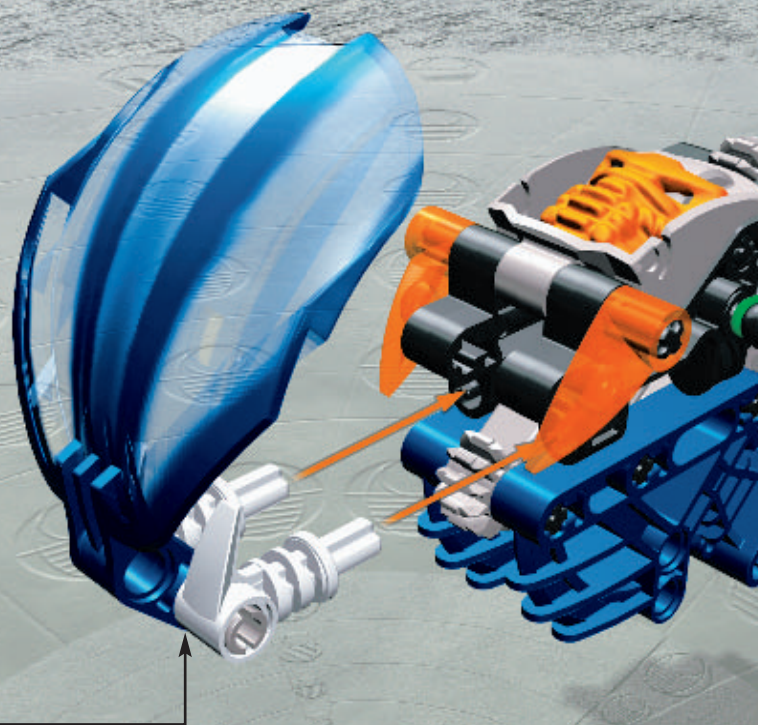
**1****2****13**

14



1:1

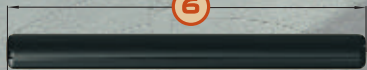

15

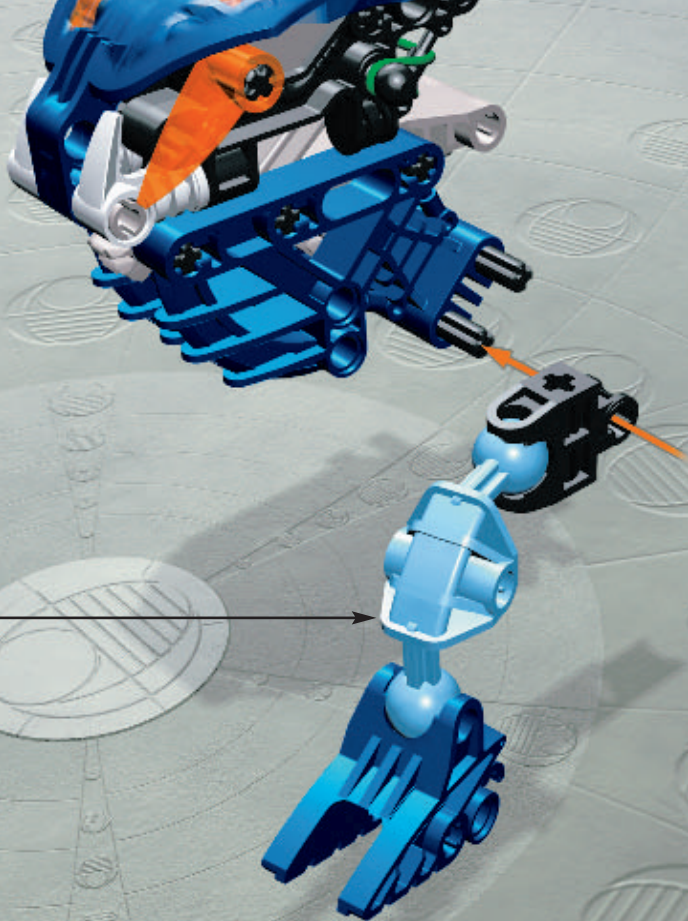
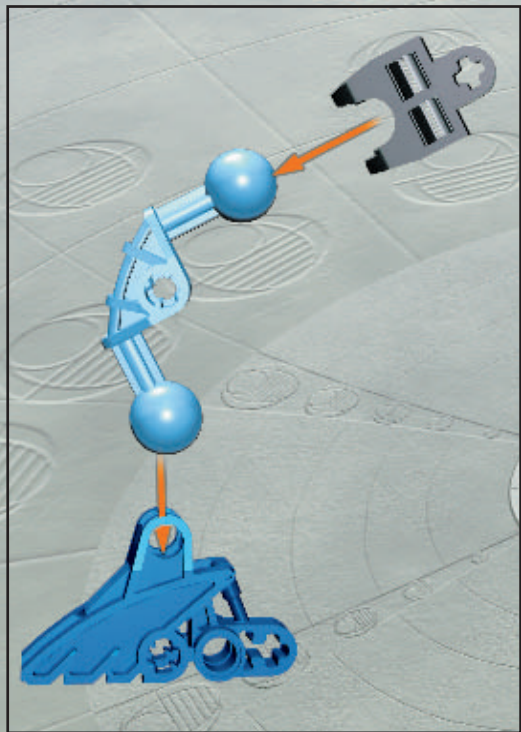

16

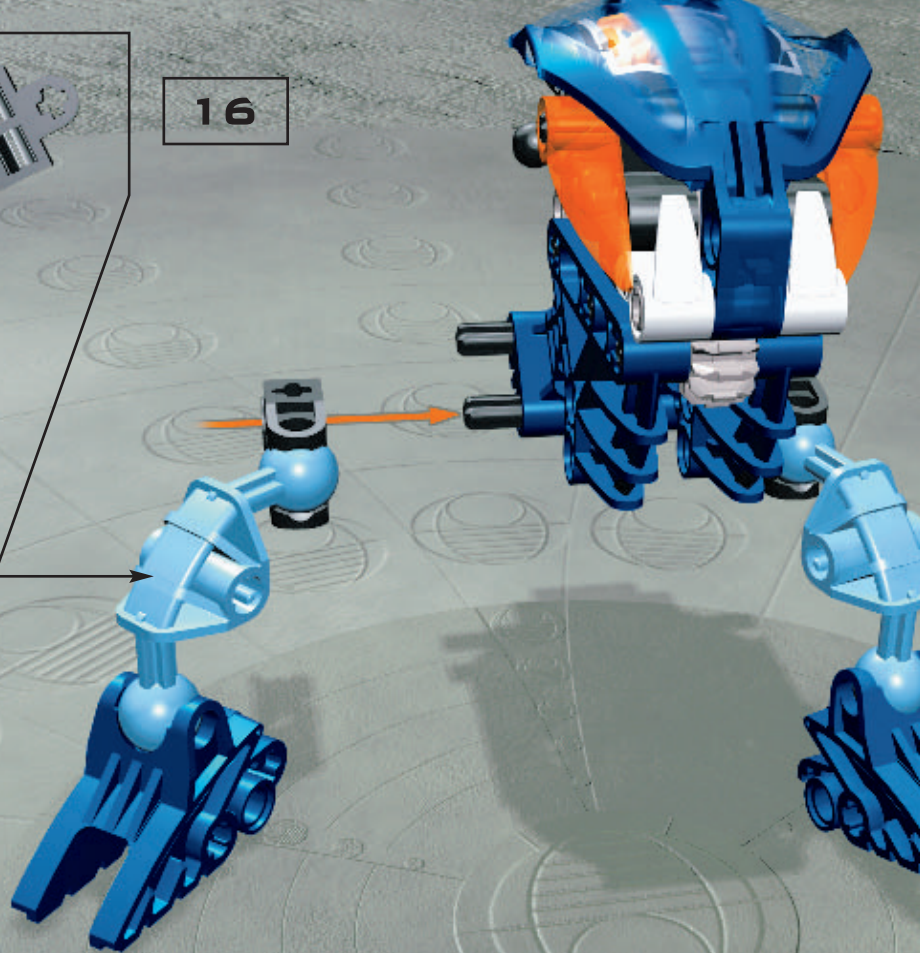
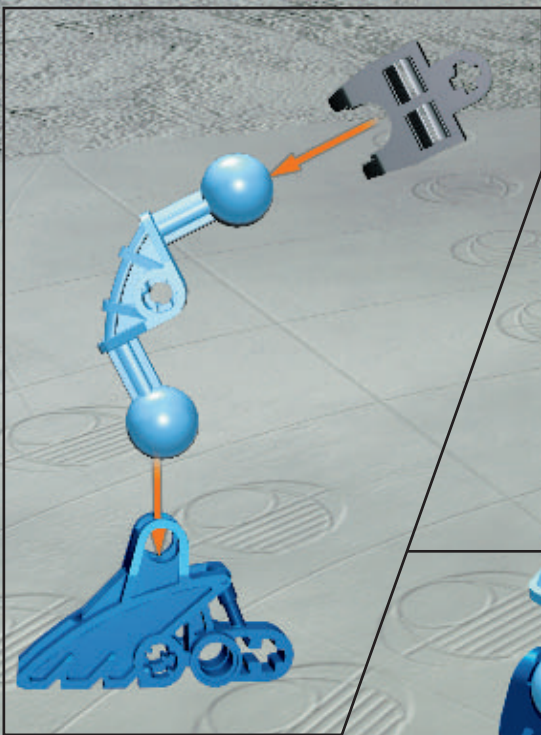



17

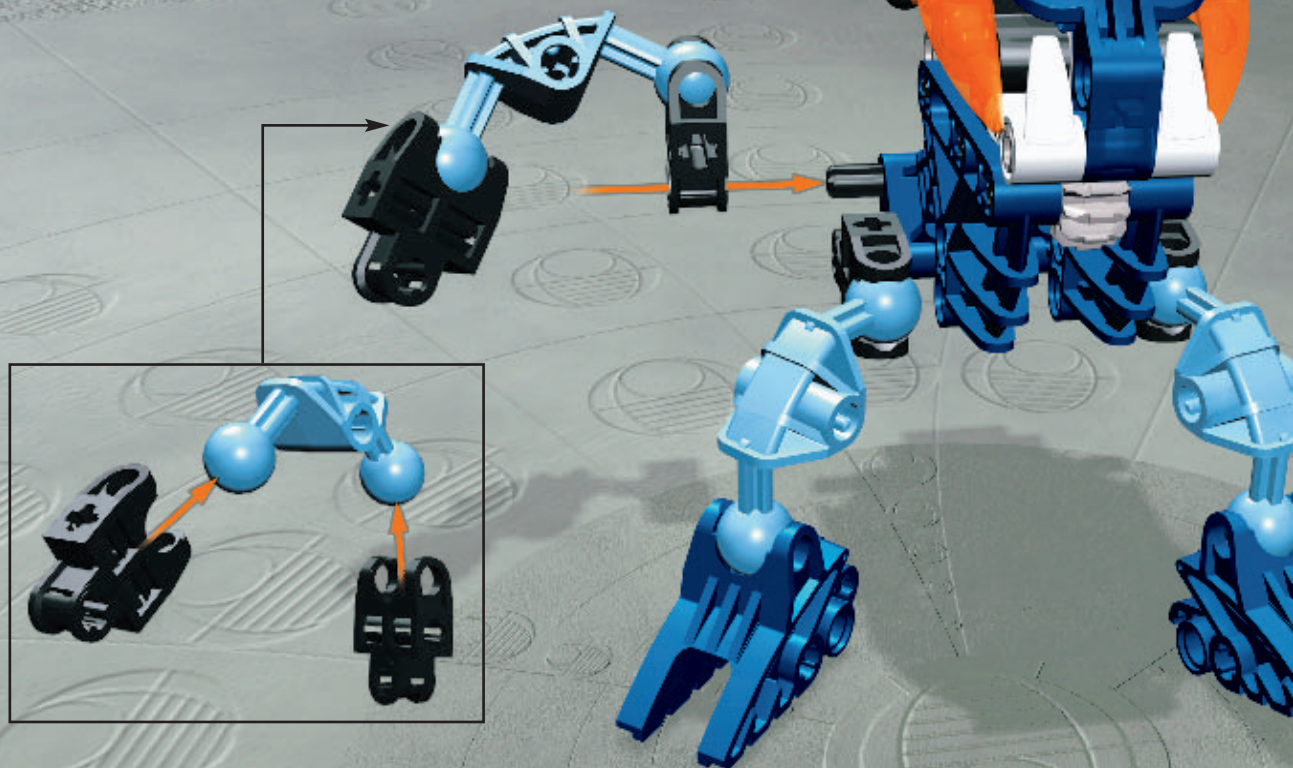

18



19







1



2



3



4





5

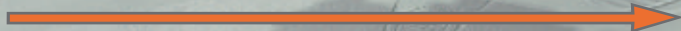

[www.bionicle.com](http://www.bionicle.com)

1



2



3





8564

+



8562

+



8565



1

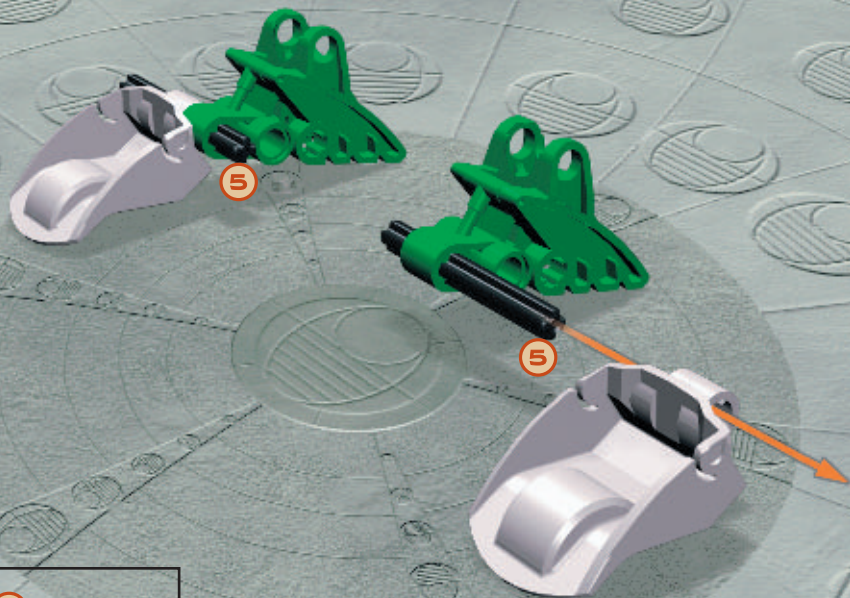

1:1

5

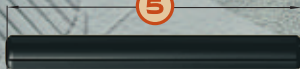

2

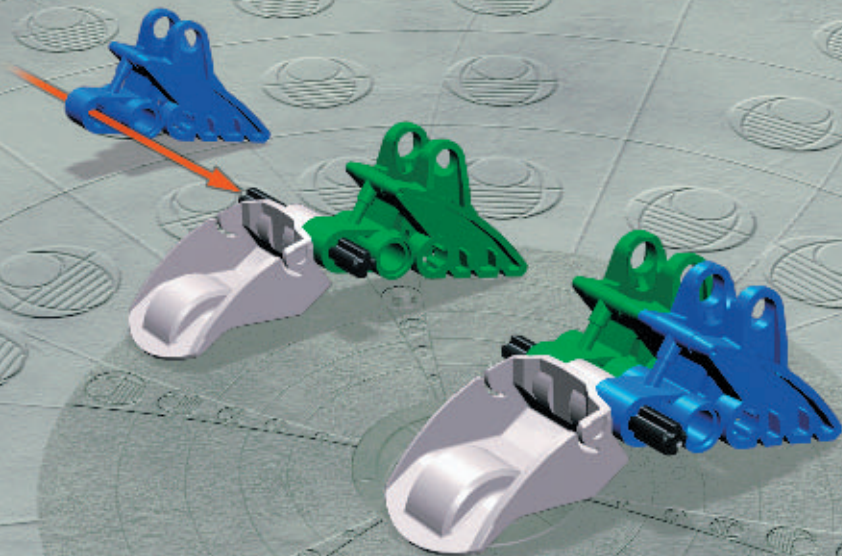

1

2

3

1:1

3



4x



3

3

1:1

3

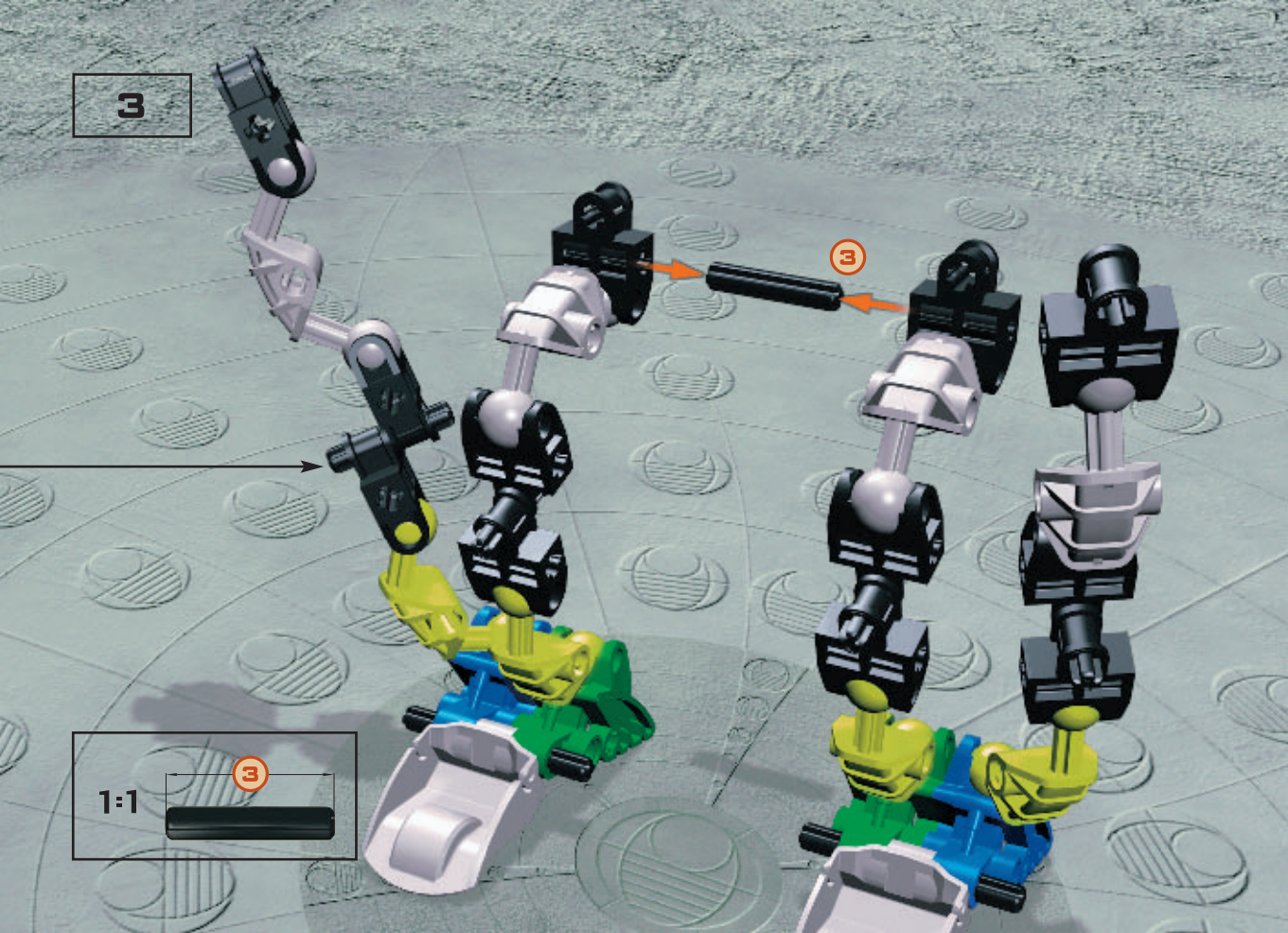



4

1:1

3

3

3

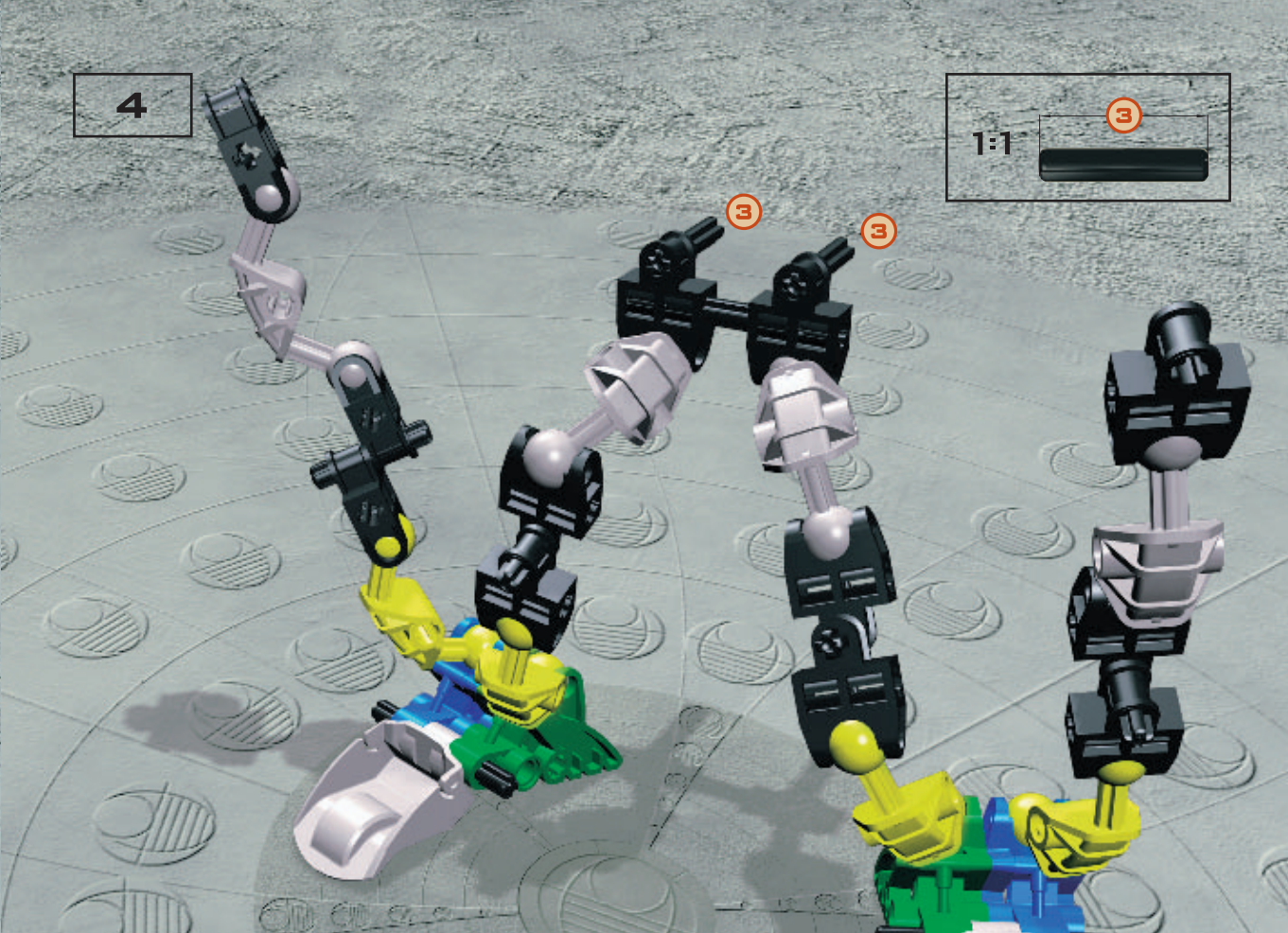

5

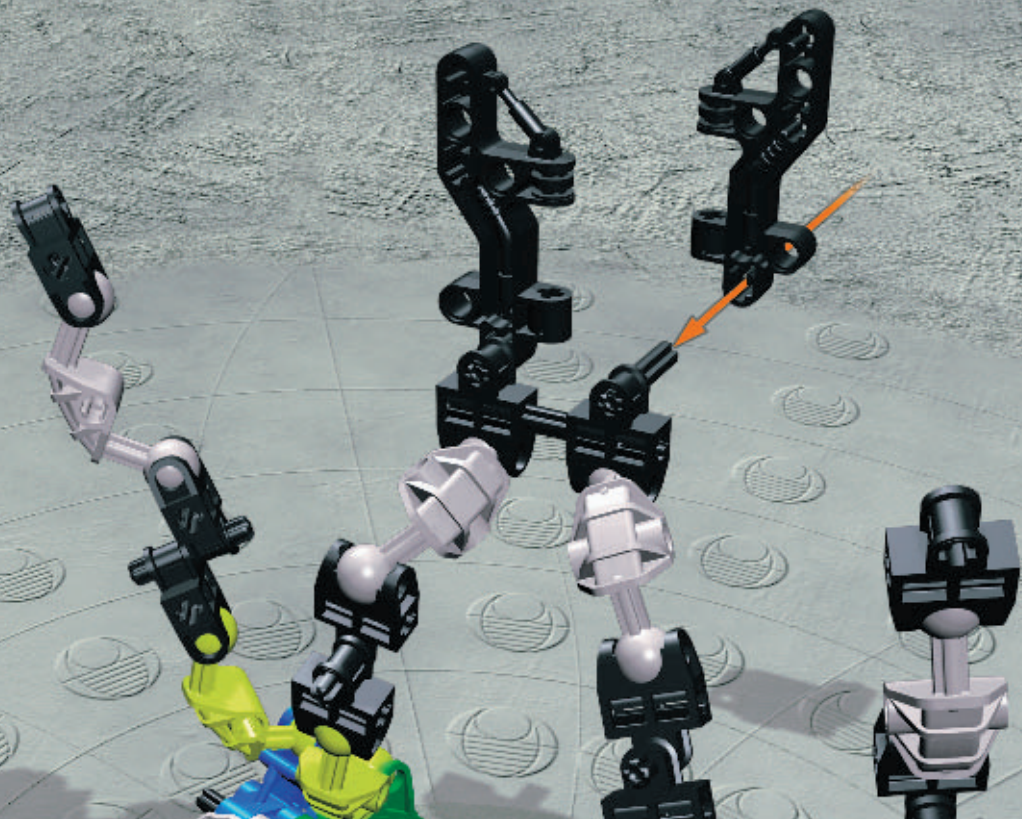

6

1:1

6



6

6

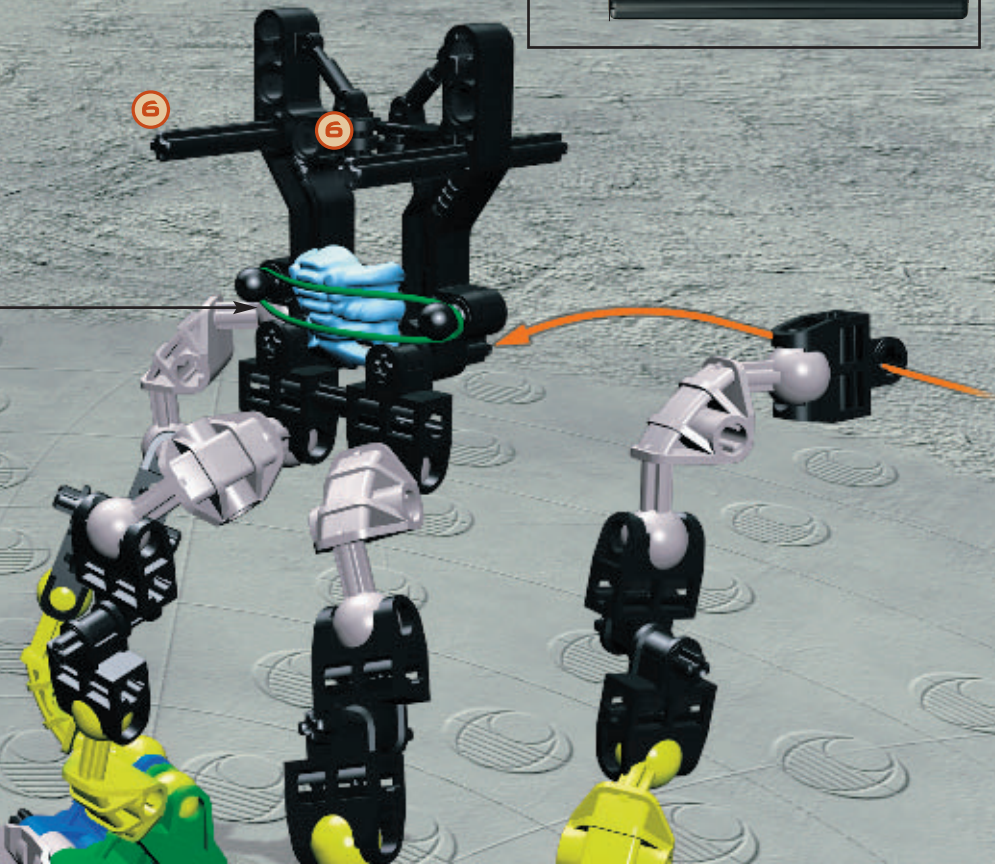
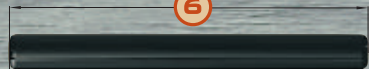

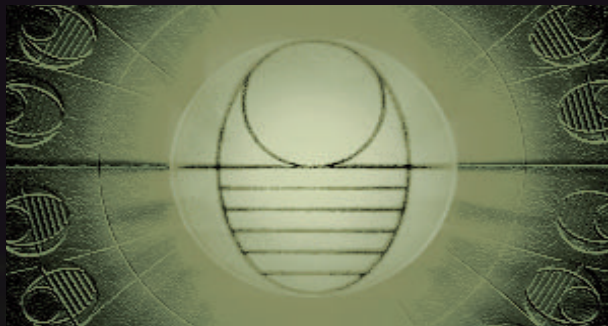

[www.bionicle.com](http://www.bionicle.com)



[www.bionicle.com](http://www.bionicle.com)





[www.bionicle.com](http://www.bionicle.com)

# BIONICLE

