

8504

JUDGE SLIZER

LEGO Technic

4124716

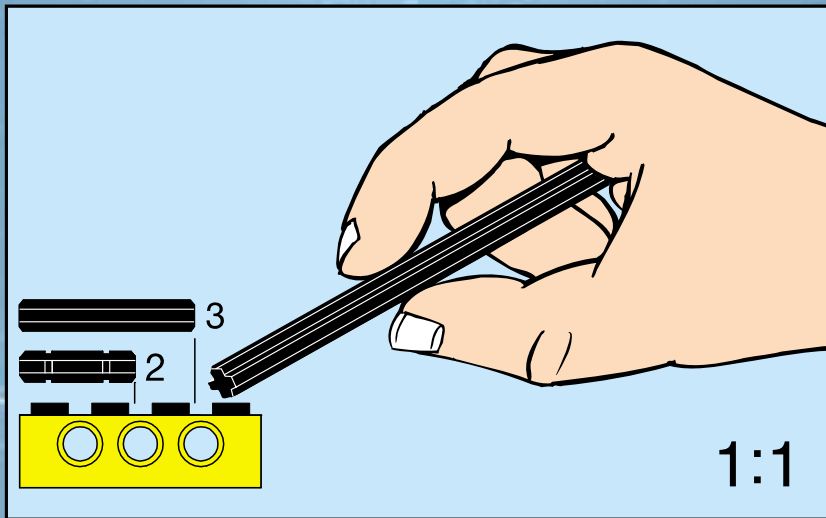

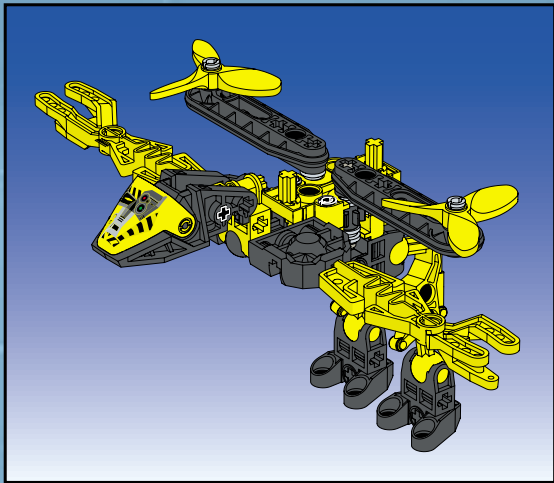

1

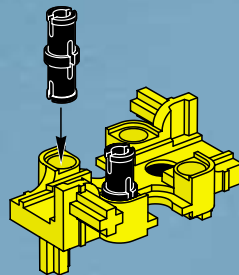

2

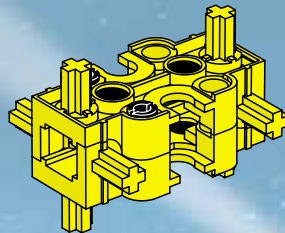

3

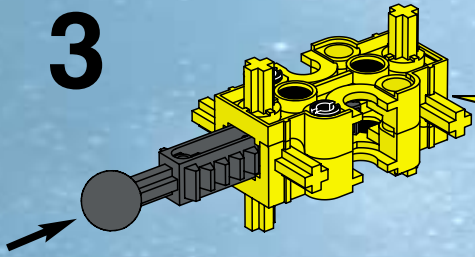

4

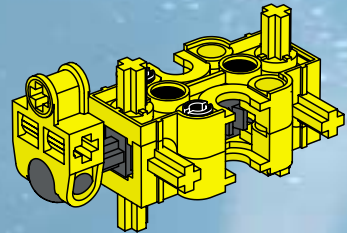

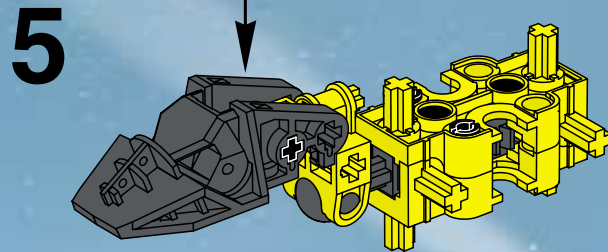
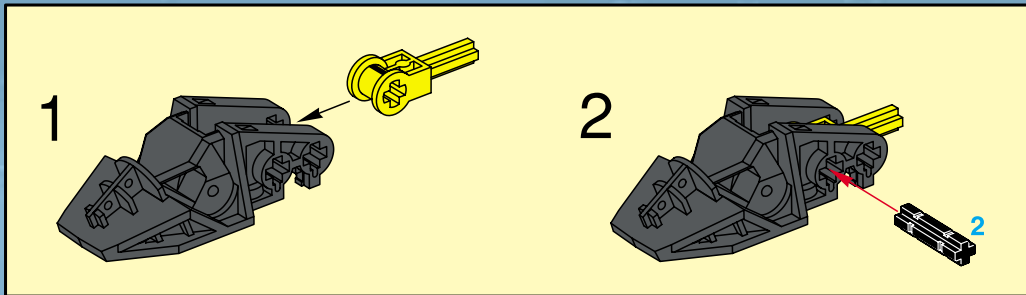

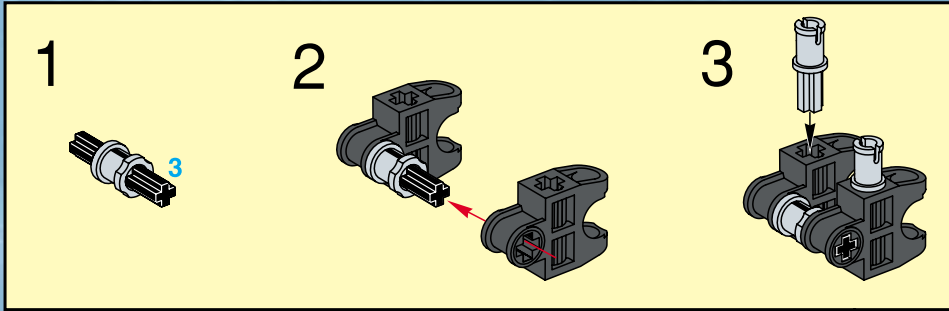

6

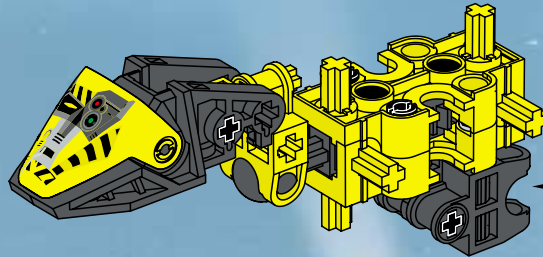

7

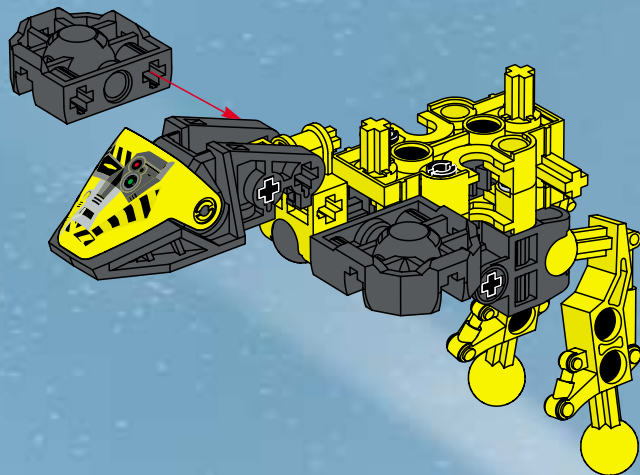

8

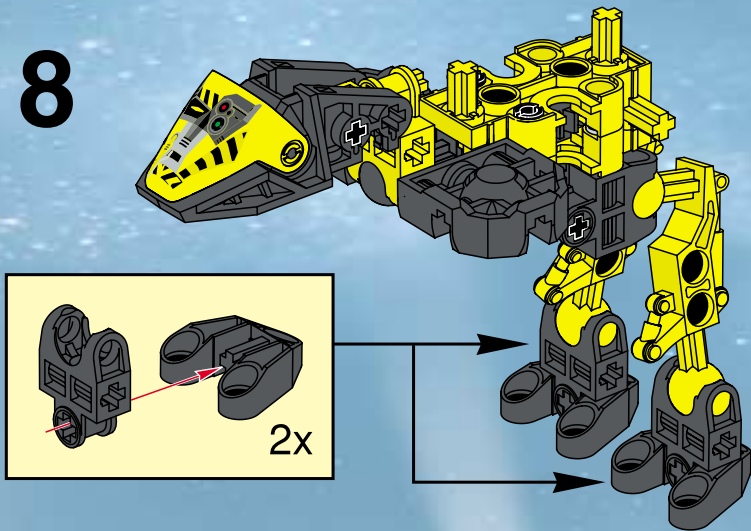

9

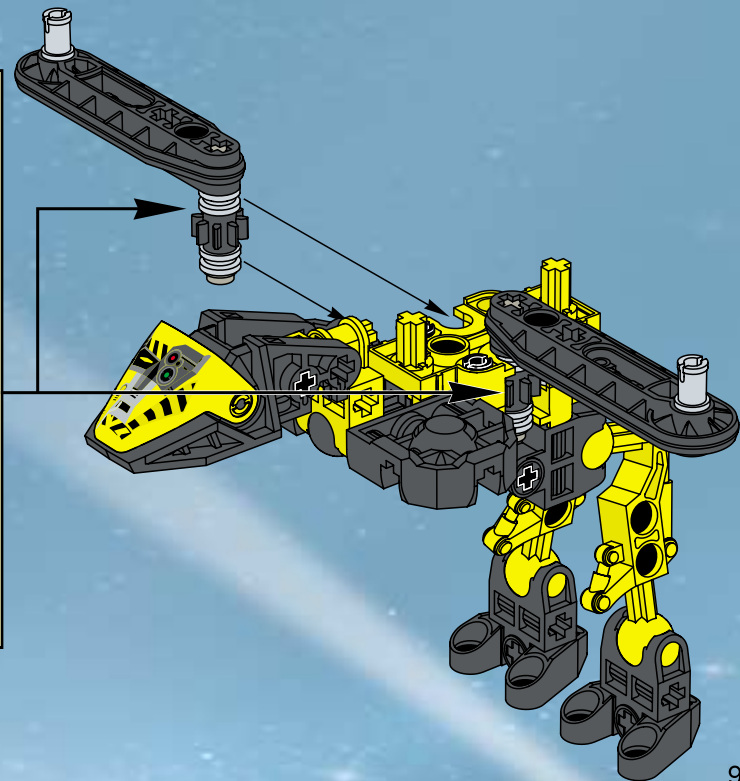
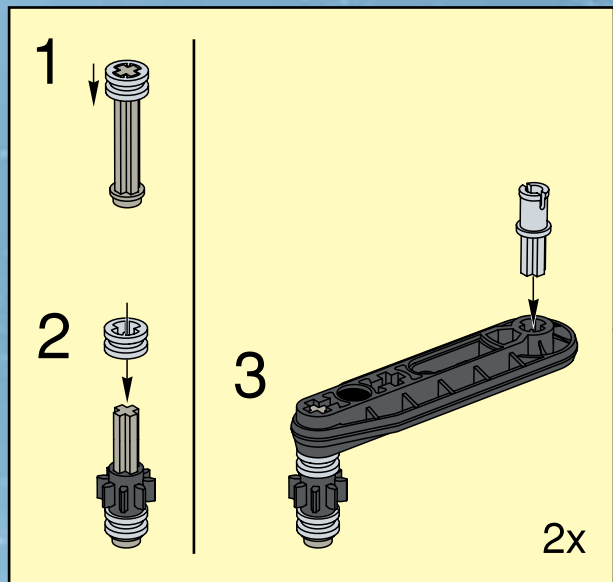

10

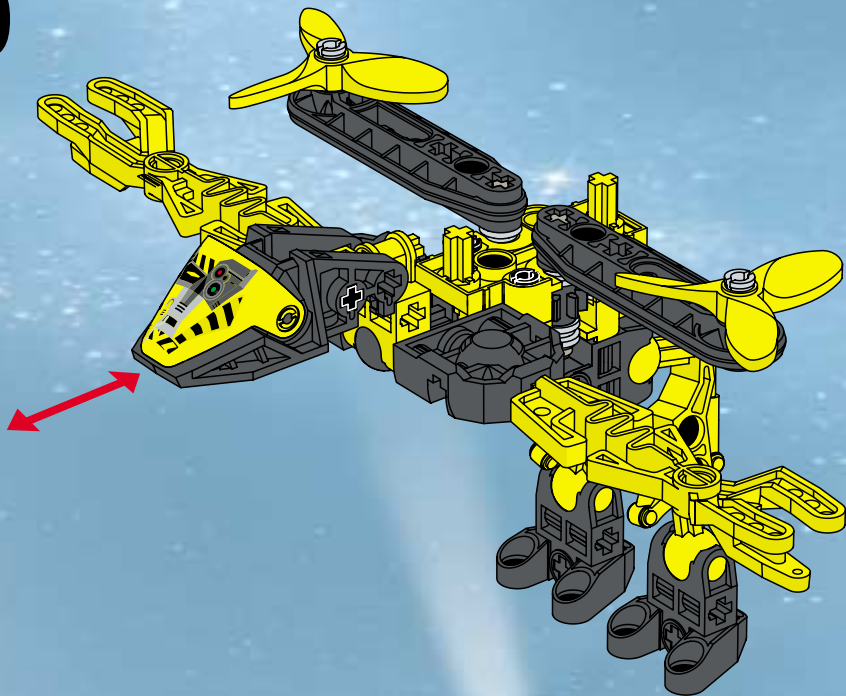





1



2



3



4



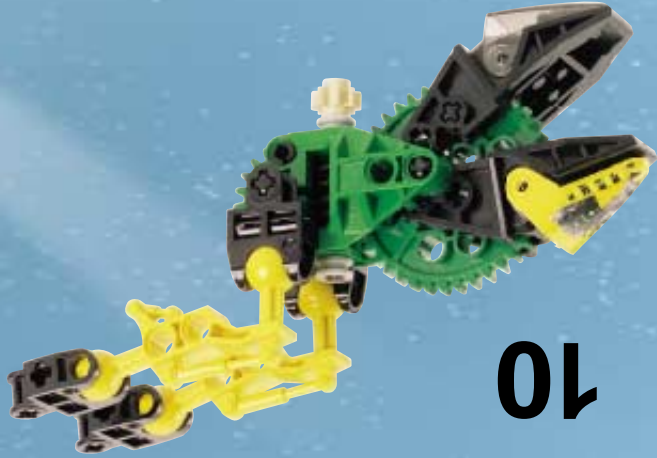

10



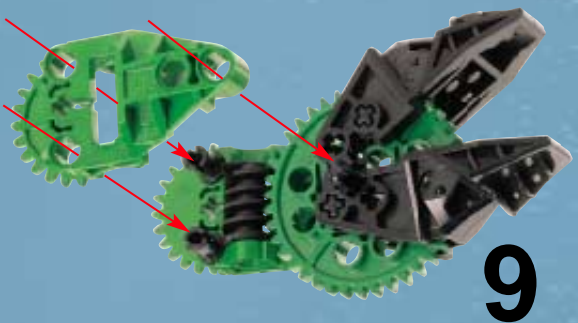
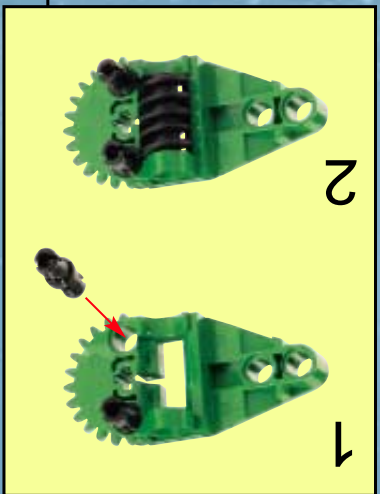

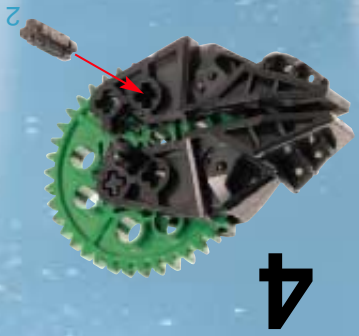
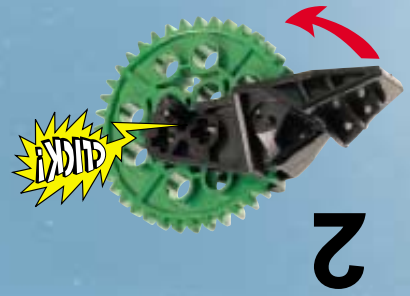



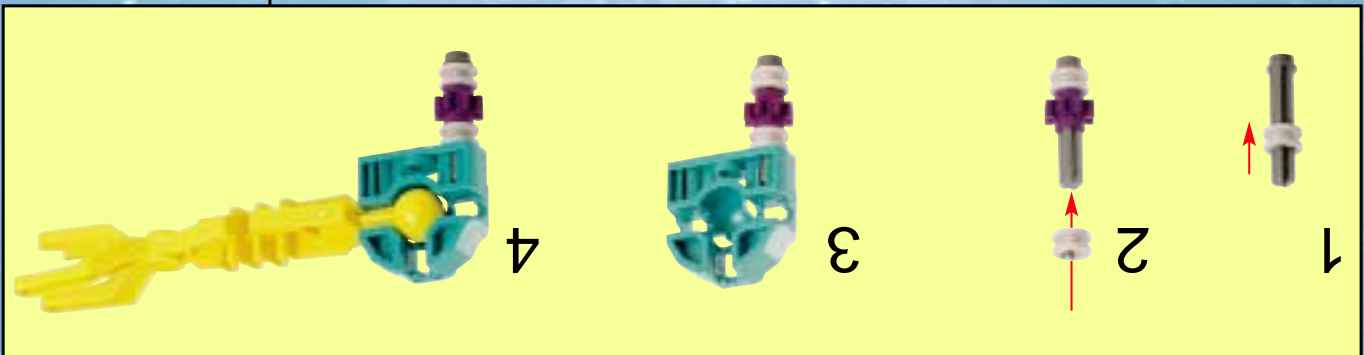
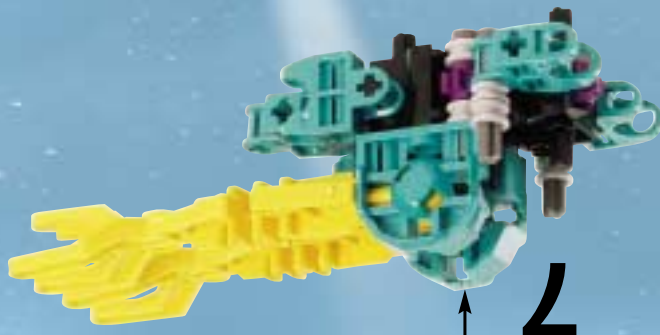

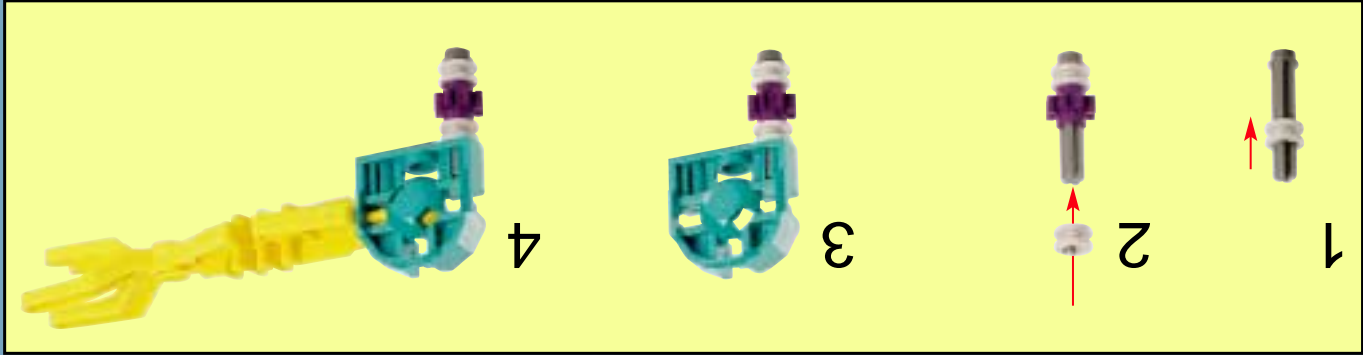
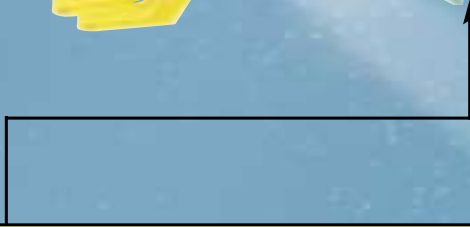
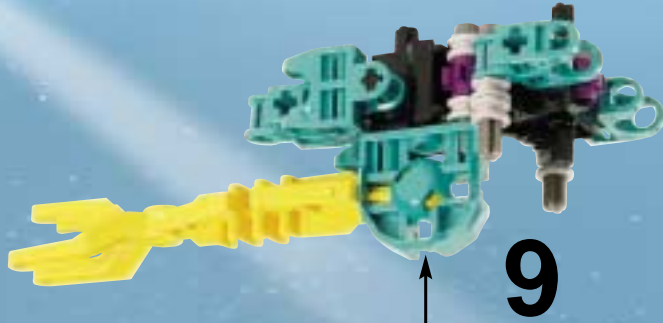

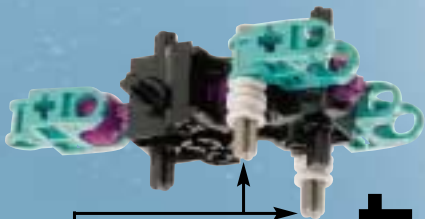

4

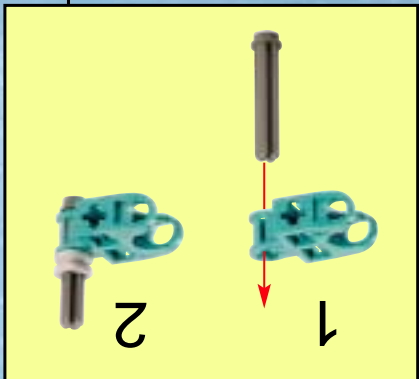

1

2

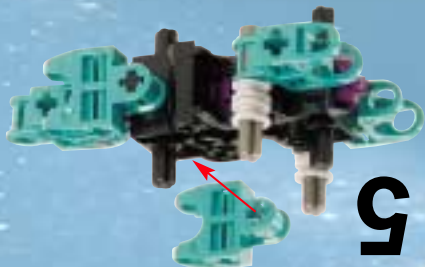

5



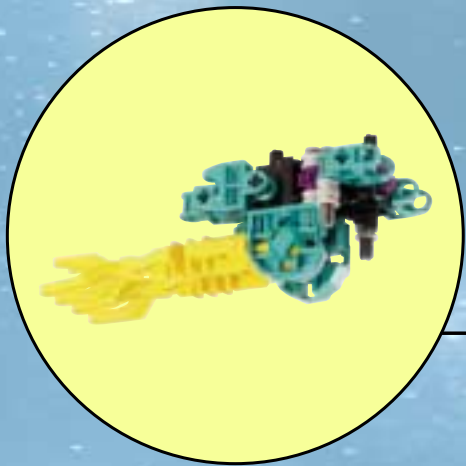



8507



+

8506



+

8505

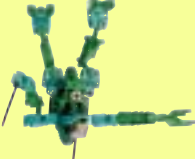

+

8504

