



LEGO

8206



WARNING: CHOKING HAZARD.
Toy contains small parts and a small ball.
Not for children under 3 years.

1

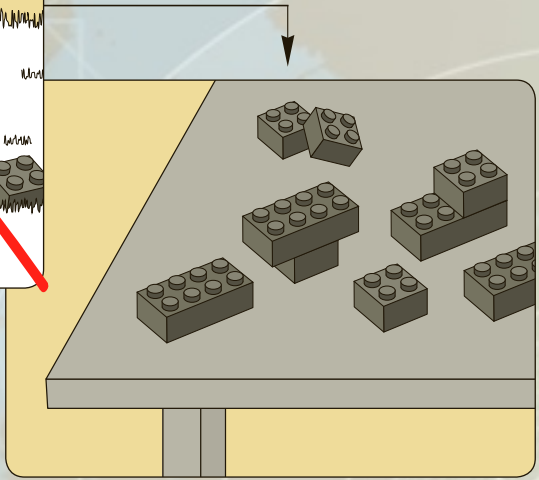
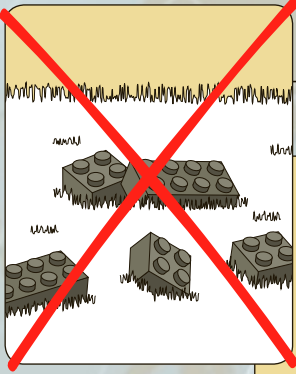

2





1



2



AVERTISSEMENT : RISQUE D'ÉTOUFFEMENT.
Le jouet contient des petites pièces ainsi qu'une petite boule.
Il ne convient pas aux enfants de moins de 3 ans.



ADVERTENCIA: PELIGRO DE ASFIXIA.
Juguete que contiene partes pequeñas y una pelota pequeña.
No recomendado para niños menores de 3 años.

шаг 3



4

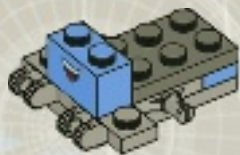

5

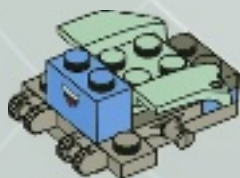

6

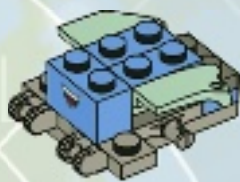

*target
acquired*

waypoint

2

7

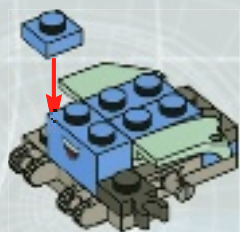

8



9

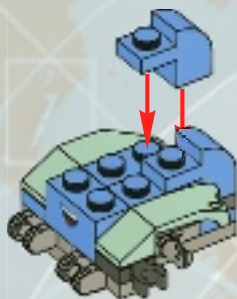

10

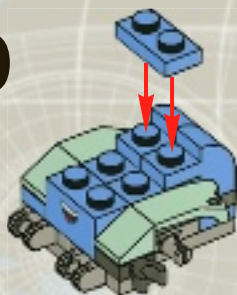

11

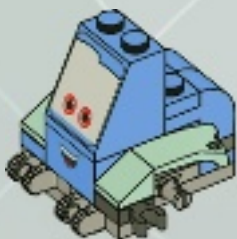

12

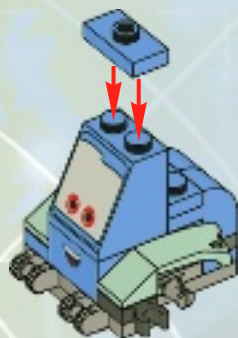

target
acquired

13

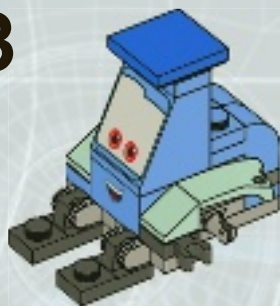

14





waypoint

1



2





3



4



waypoint

7

5



6



7



8



9

waypoint



10



11



12

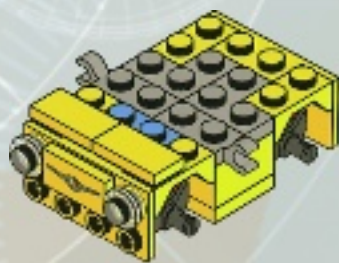

13

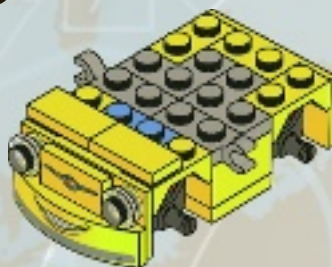

14



15



*target
acquired*

16





17

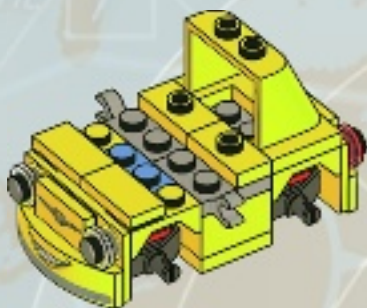

18

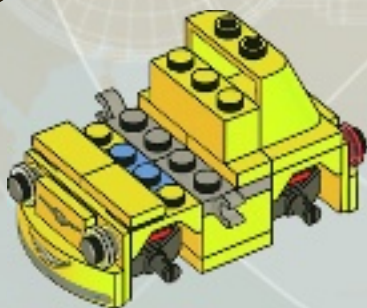

19

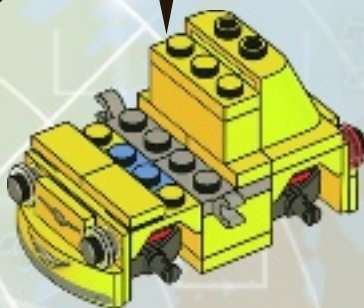

target
acquired

20

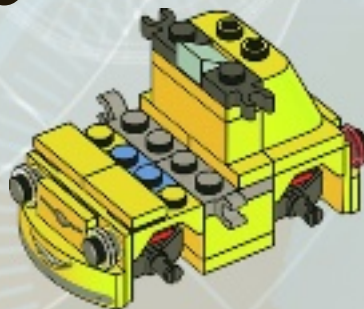

21

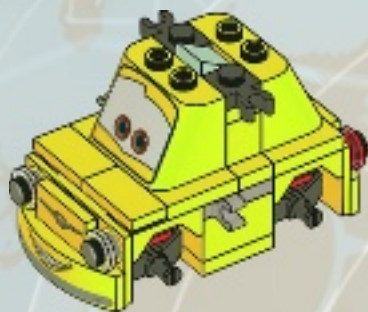

22



23



*target
acquired*

24

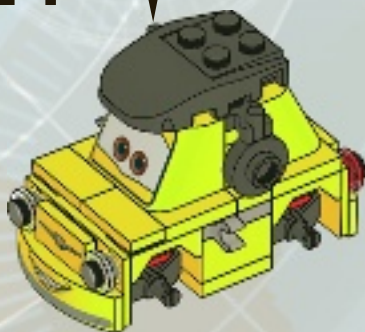
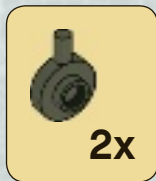

Waypoint 7

25

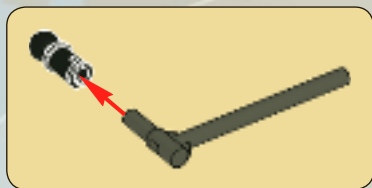

26





1



2

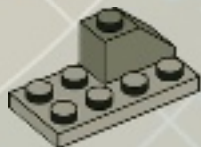

3



4



1



2

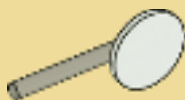

3



5

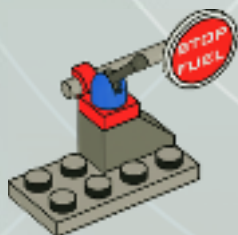

6



target
acquired

7



8



9



10



11





1



2



3



waypoint

7

4



5

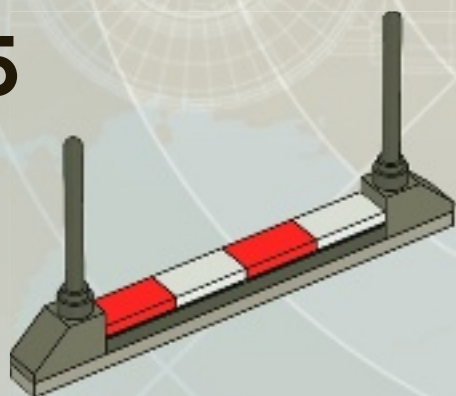

6

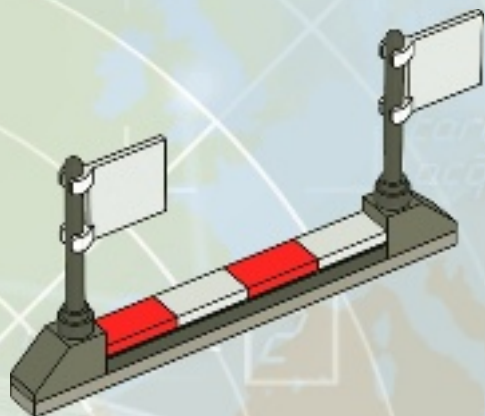

7

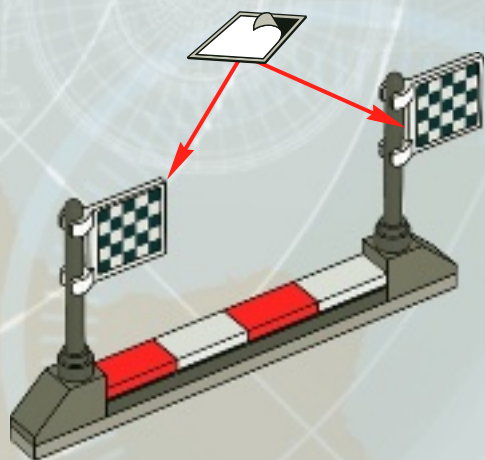



1



2



3

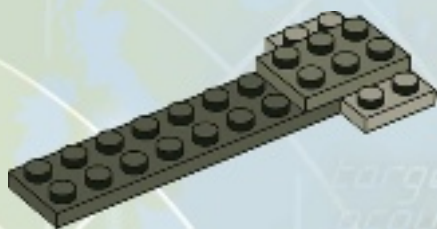

*target
acquired*

4

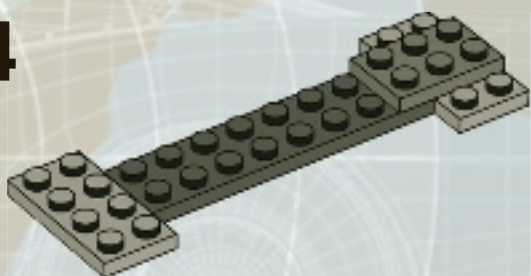

5

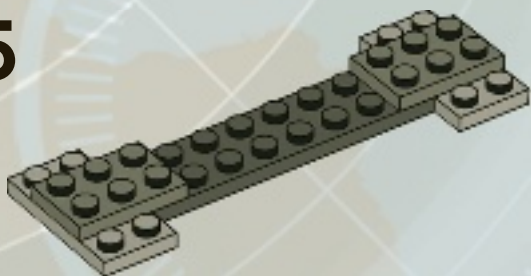

6

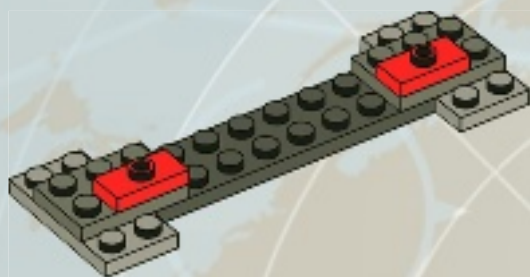

7

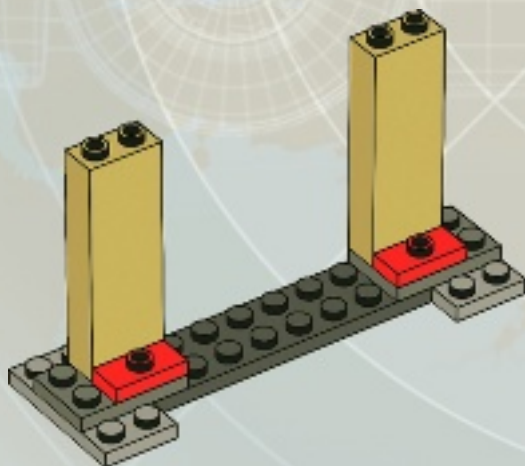

8

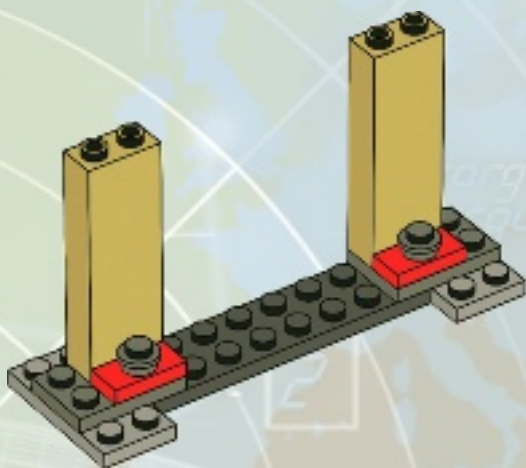

target
required

9

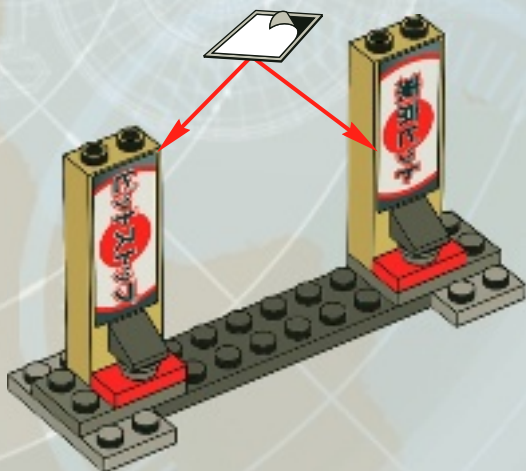

10

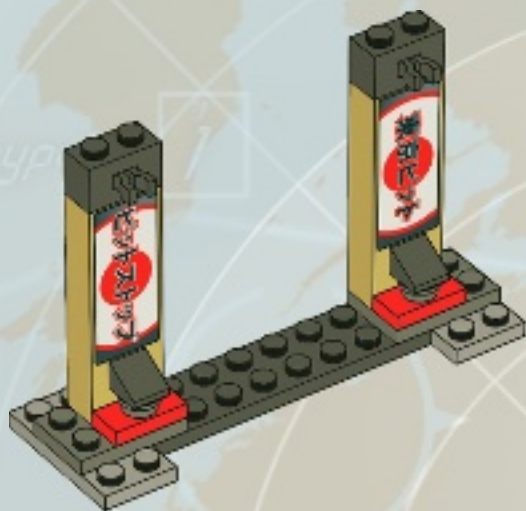

11

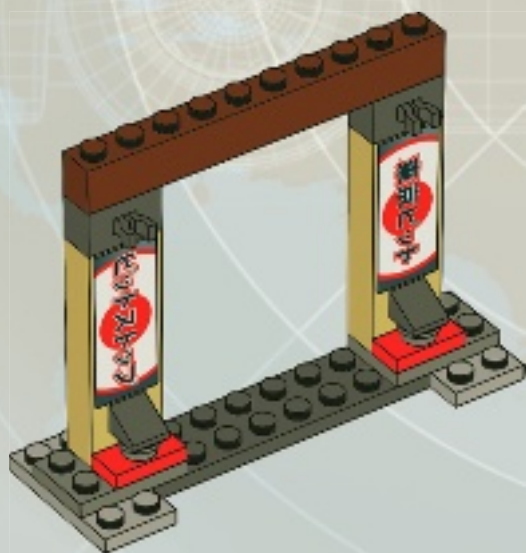

12

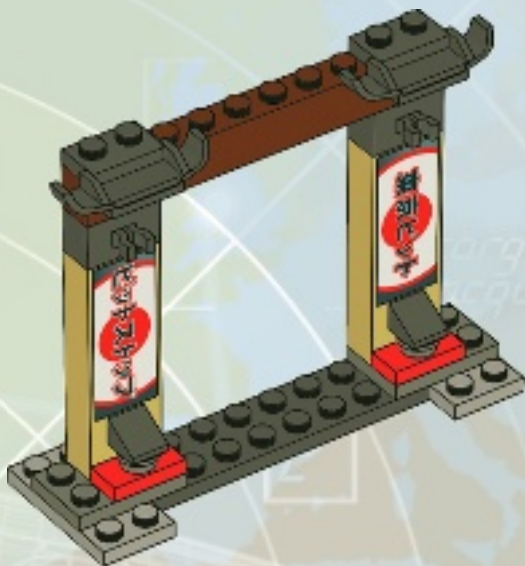

target
acquired

13



waypoint

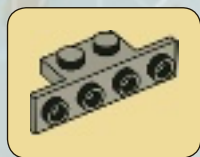

14



15

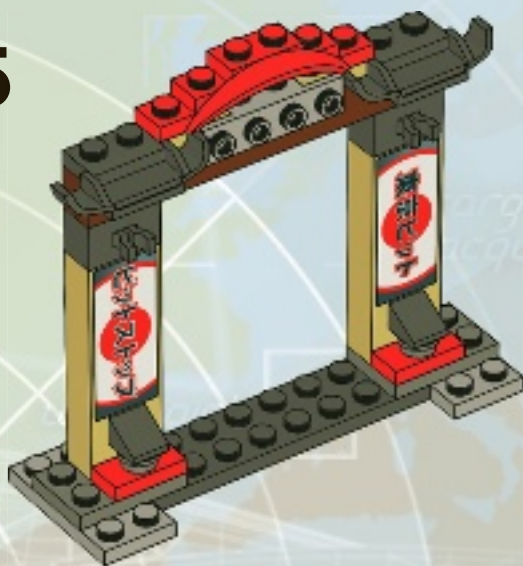

16



waypoint 7



17



18



19



waypoint

7

20



21



waypoint

7

22





23



waypoint

7

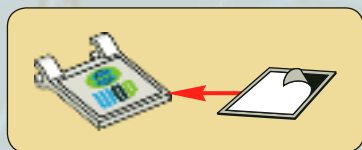

24







2x
4216652



1x
614301



2x
306901



1x
403201



1x
4278271



1x
4116816



3x
4523403



2x
4114064



2x
4113917



1x
306823



1x
4296152



2x
4540382



2x
306921



1x
4560179



1x
379521



3x
4524644



2x
379421



1x
403221



1x
4525791



2x
300424



1x
362224



1x
4617051



1x
4613151



3x
306924



1x
4617057



1x
4617052



1x
4617046



1x
362324



1x
302024



2x
379424



2x
4613344



2x
4600177



1x
4541482



1x
4184169



1x
255526



3x
4550017



2x
4144575



2x
615726



3x
4623113



2x
395726



1x
400626



2x
452826



6x
4246901



2x
4504187



2x
4118624



1x
4253815



2x
4504382



2x
302226



1x
346026



1x
303426



1x
4264633



4x
4504376



4x
4211395



1x
4514846



2x
4211353



2x
4515341



2x
4535738



1x
4211504



1x
4282740



1x
4211475



1x
4211503



1x
4211628



1x
4490599



4x
4523159



3x
4211135



5x
4211043



2x
4210633



3x
4616645



1x
4616969



6x
4624473



1x
4251378



2x
3005740



2x
3005741



1x
4616975



1x
4617006



2x
4617019



1x
4179826



5x
4179825



1x
4617013

Customer Service

Kundenservice

Service Consommateurs

Servicio Al Consumidor

www.lego.com/service or dial



: 00800 5346 5555

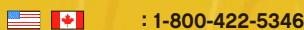

: 1-800-422-5346







LEGO club™

FREE! GRATIS! GRATUIT!



SIGN UP ONLINE!
www.LEGOclub.com

VISIT THE WORLD'S
BIGGEST LEGO® SHOP!
www.LEGOshop.com

00800 5346 5555



1-866-534-6258 • 1-877-518-5346

USA & Canada only

CONTACT 00800/0800



* Freephone. Mobile charges may apply. * Numéro sans frais. Des frais peuvent s'appliquer avec les téléphones cellulaires. * Gebührenfrei, Kosten für Anrufe aus Mobilfunknetzen können abweichen. * Gratis telefoonnummer vanaf vaste lijn. * Det er et gratis nummer, når du ringer fra fasttelefon. * Det är gratis, när du ringer från en fast telefon. * Numéro sans frais. Des frais peuvent s'appliquer avec les téléphones portables.

BI112



www.LEGO.com

WIN!

Go to www.LEGOsurvey.com/product to fill out a survey for a chance to win a cool LEGO® Product.

No purchase necessary.

Open to all residents where not prohibited.

www.LEGOsurvey.com/product

GEWINNE!

Nimm an der Umfrage auf www.LEGOsurvey.com/product teil und hab die Chance ein cooles LEGO® Produkt zu gewinnen!

Die Teilnahme am Gewinnspiel führt zu keinerlei Kaufverpflichtungen. Teilnahme in allen nicht ausgeschlossenen Ländern möglich.

WIN!

Ga naar www.LEGOsurvey.com/product, vul een enquêteformulier in en maak kans op een cool LEGO® product.

Geen aankoopverplichting. Iedereen mag deelnemen, uitgezonderd ingezetenden van landen waar een enquêteverbod geldt.

GAGNE!

Visite www.LEGOsurvey.com/product pour répondre à un questionnaire et avoir une chance de gagner un produit LEGO® très cool!

Aucune obligation d'achat. Ouvert à tous les résidents des pays autorisés.

当てよう!

www.LEGOsurvey.com/product にアクセスして、アンケートにご記入ください。当選者にはレゴ製品を差し上げます。

お買い上げの必要はありません。禁止されていない限り、すべての皆様にご利用いただけます。

LEGO and the LEGO logo are trademarks of the/son des marques de commerce de/son marcas registradas de LEGO Group. ©2011 The LEGO Group.
Disney/Pixar elements: © Disney/Pixar, not including underlying vehicles owned by third parties: Fiat™
Les éléments Disney/Pixar : © Disney/Pixar, sans inclure les véhicules sous-jacents qui sont la propriété de tiers : Fiat™
Elementos Disney/Pixar: © Disney/Pixar, sin incluir los vehículos subyacentes propiedad de terceros: Fiat™