



# ATLANTIS

8078



2

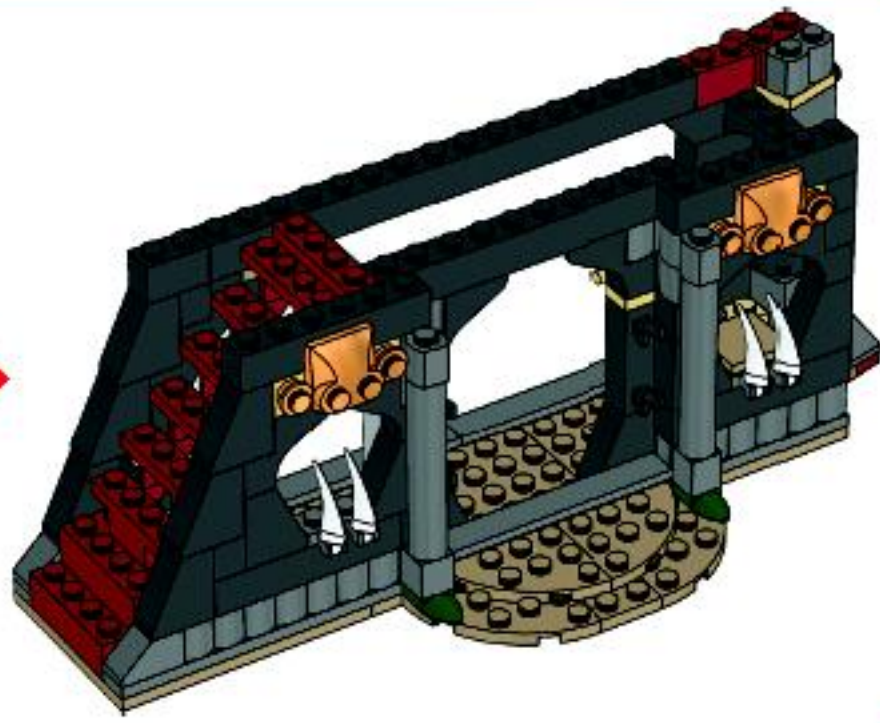

2x

1

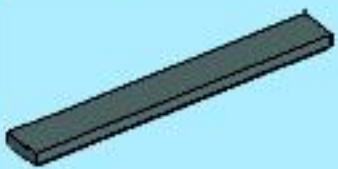
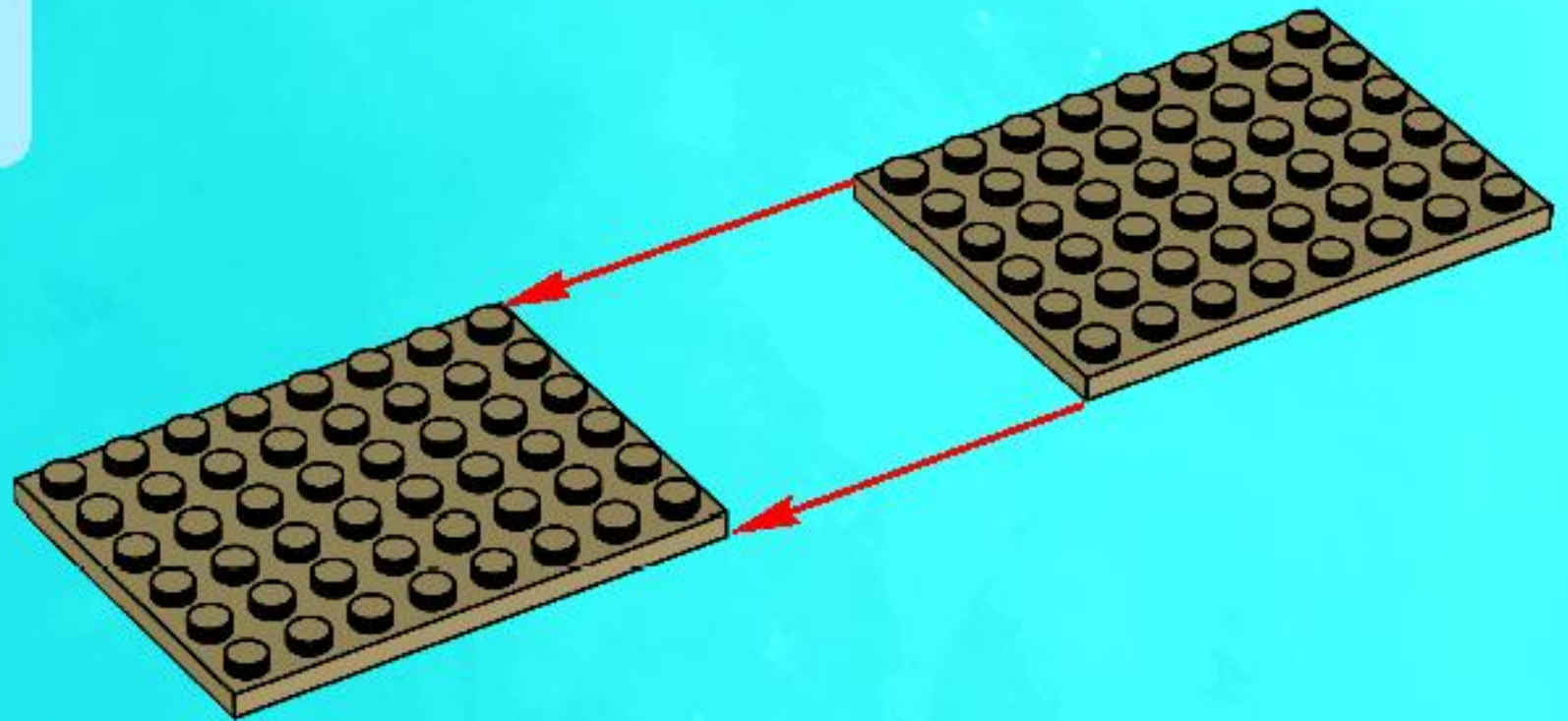

2x

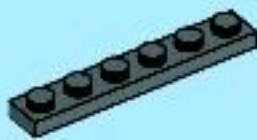

1x

2

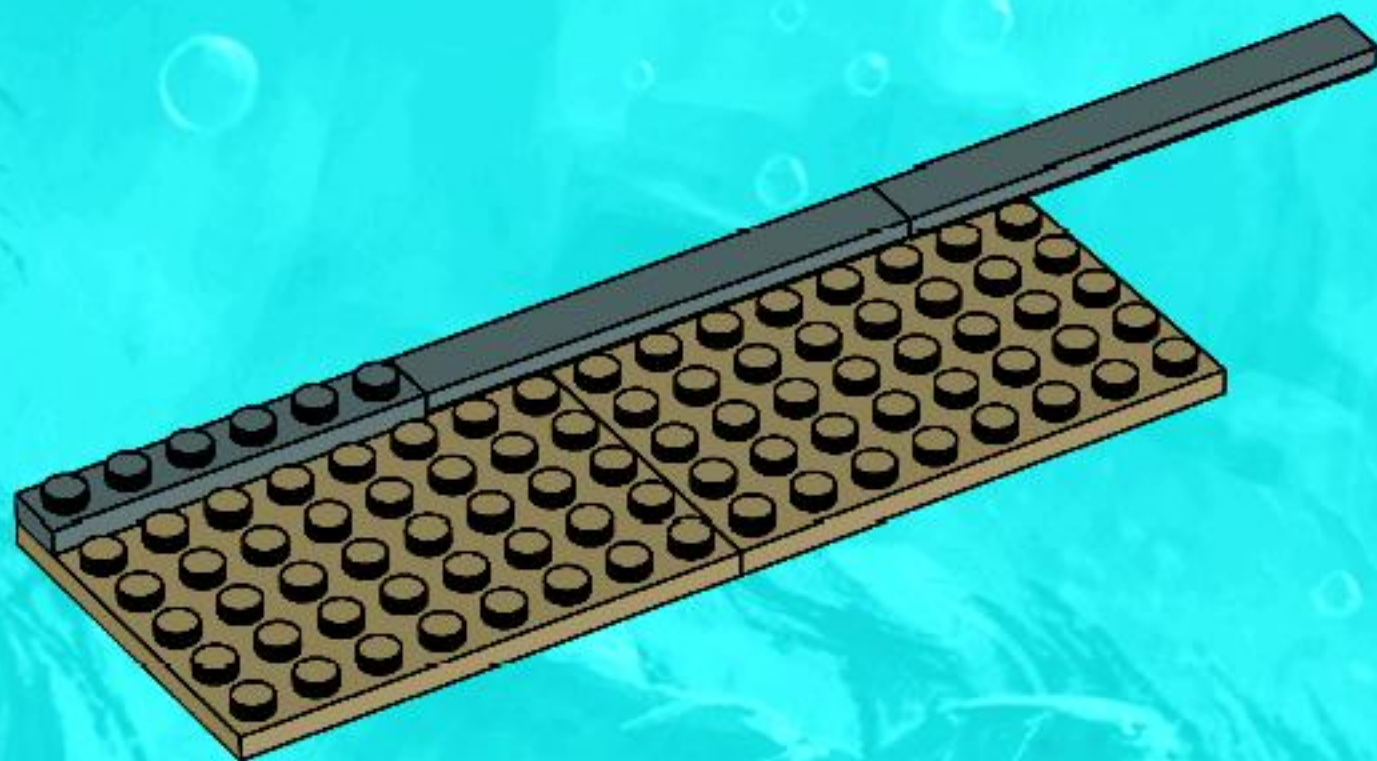



3

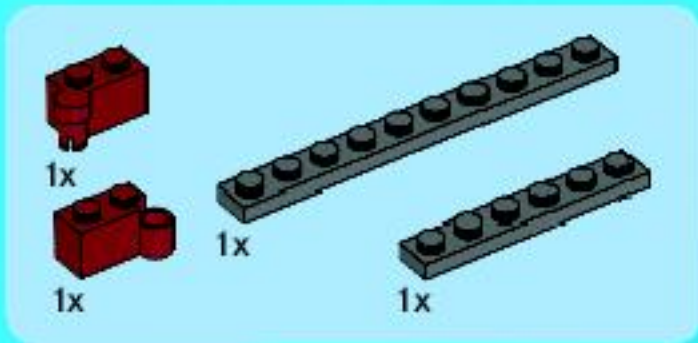
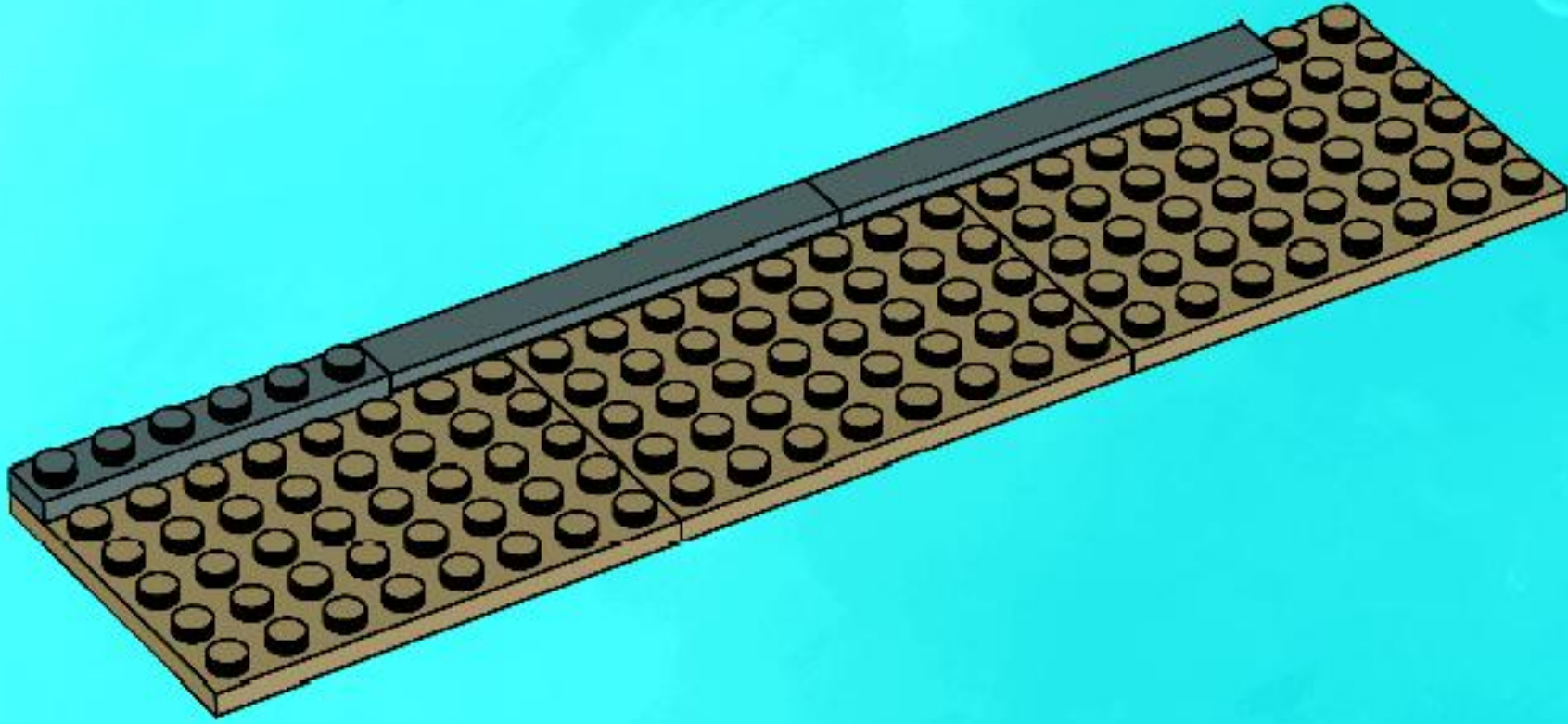

4

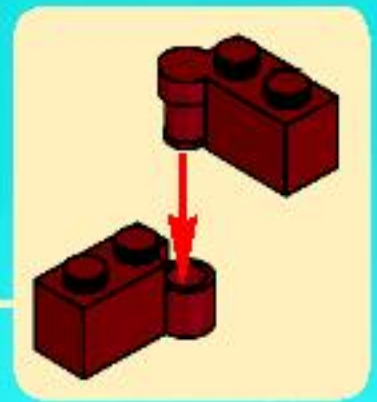
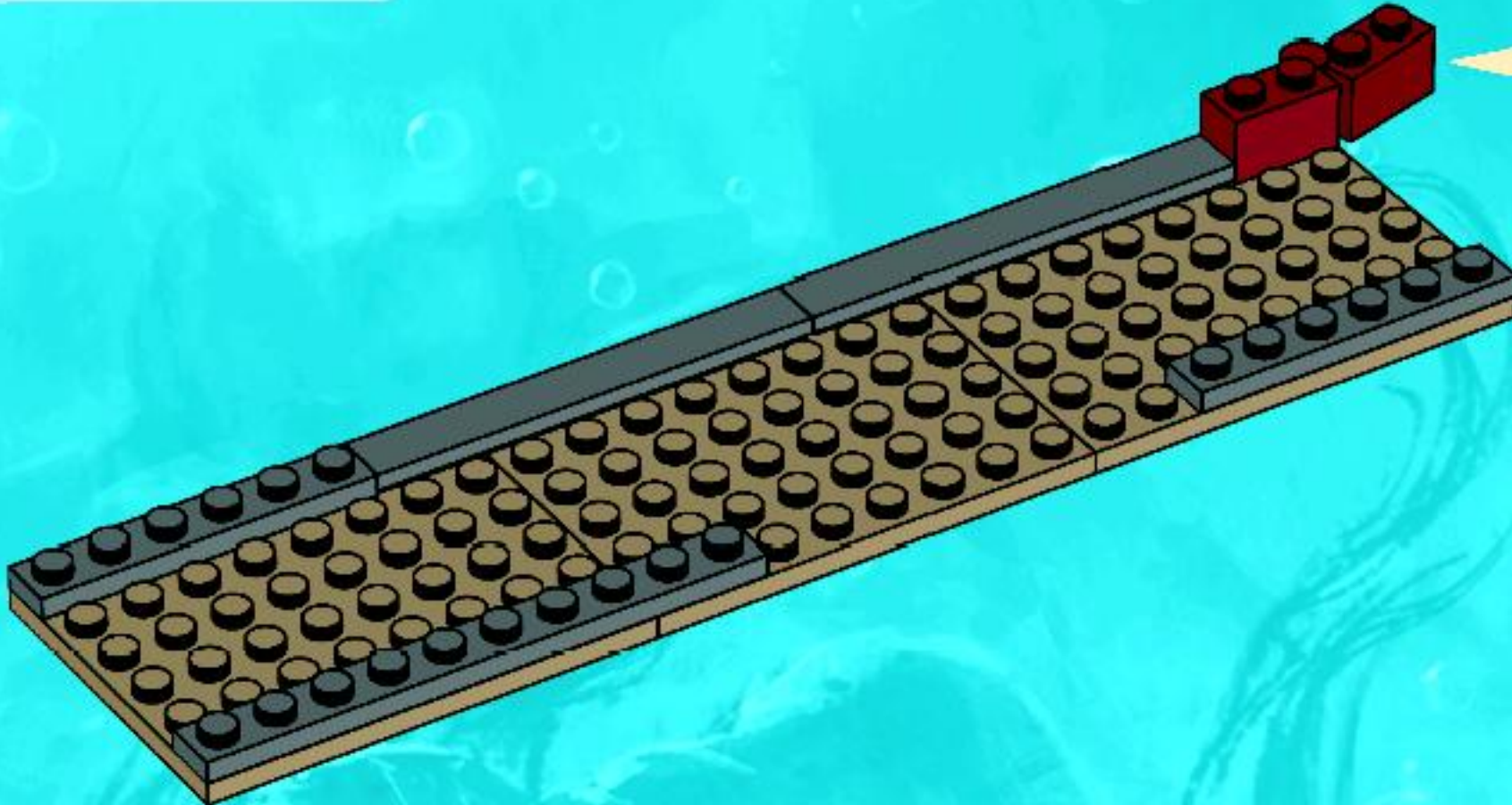

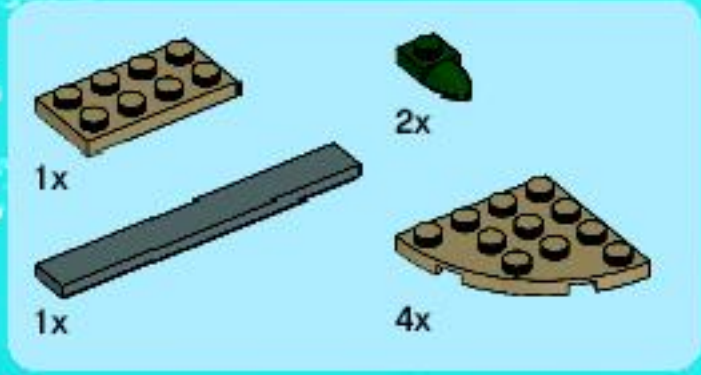

# 5

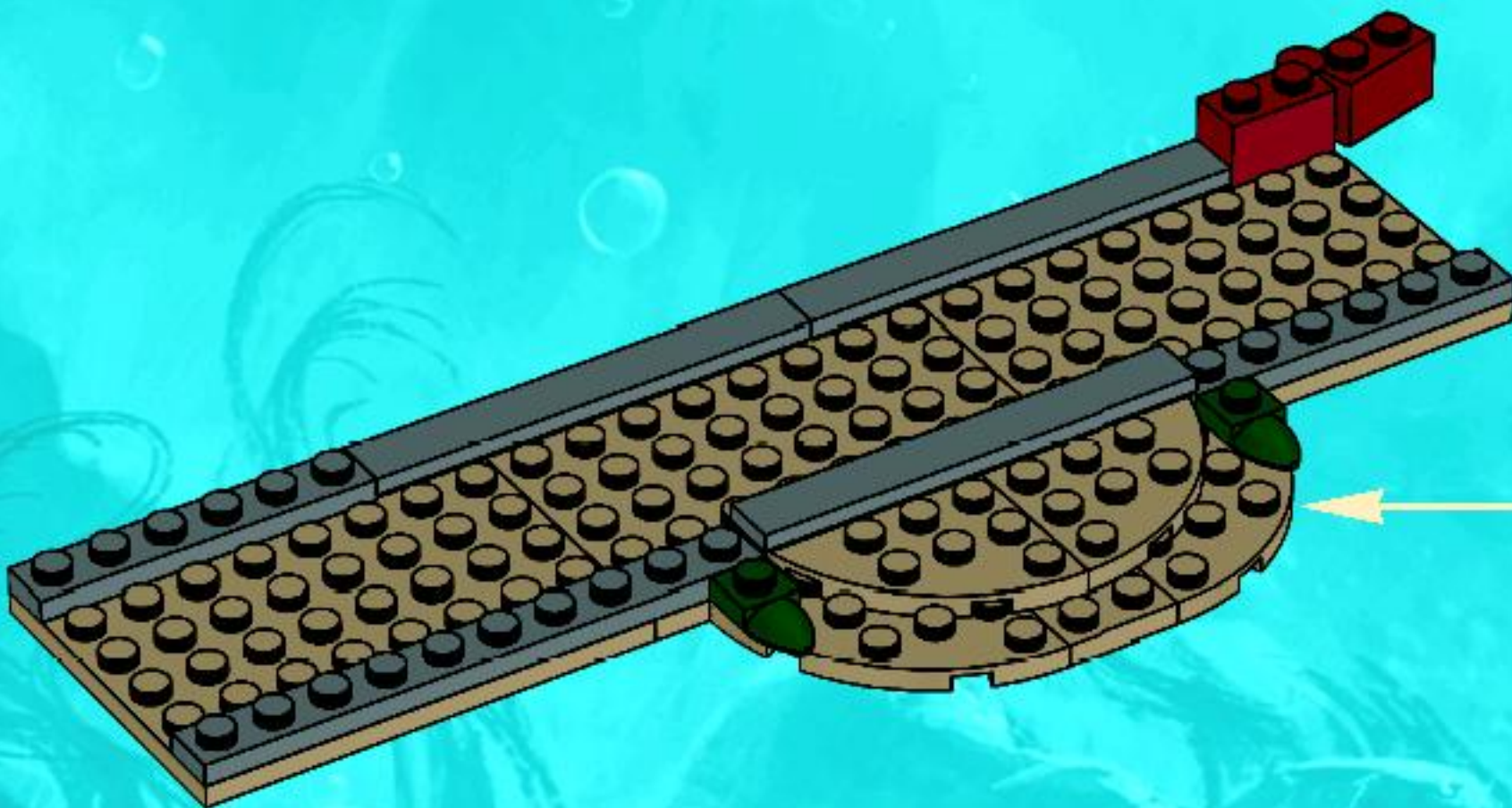
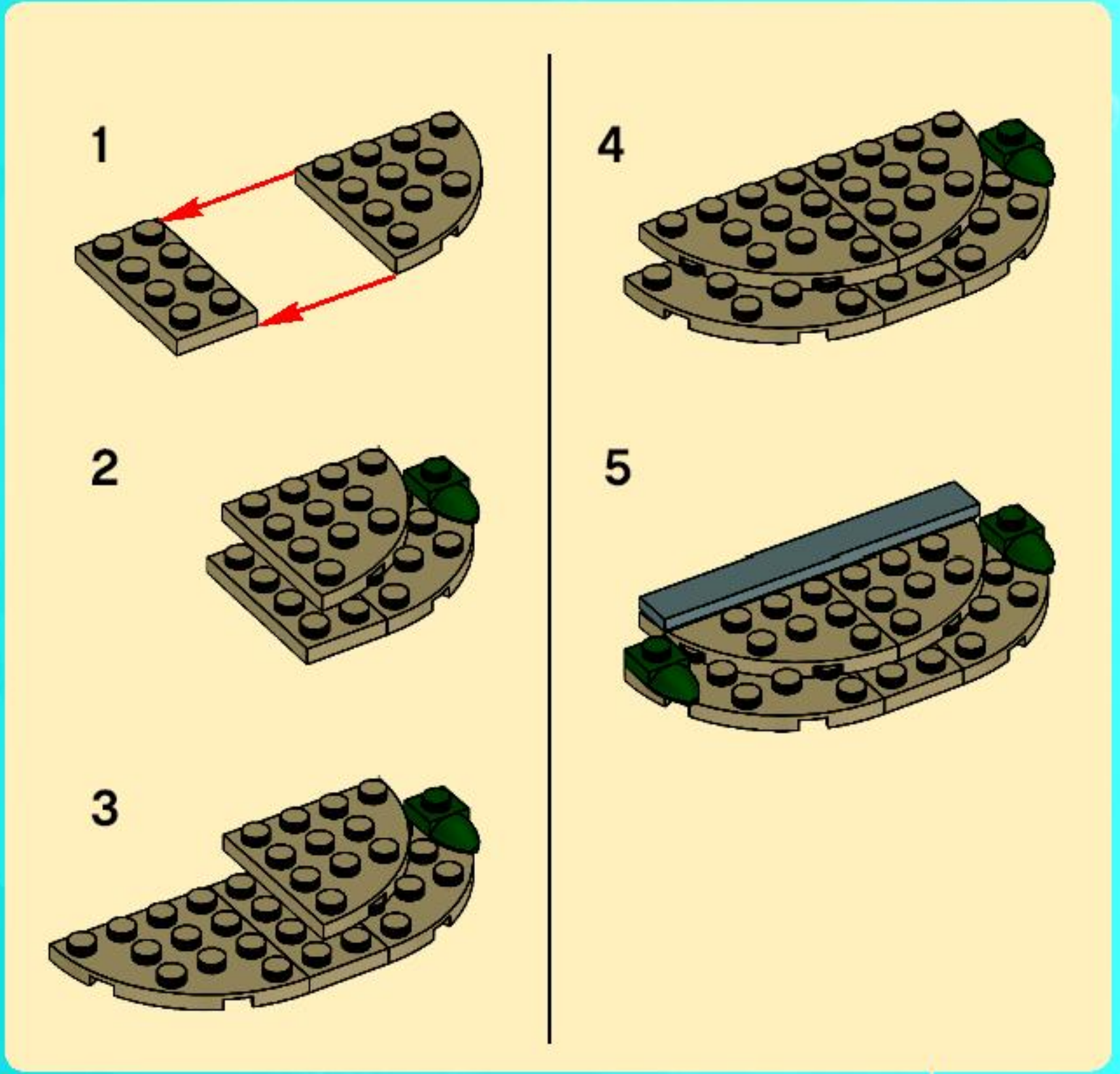

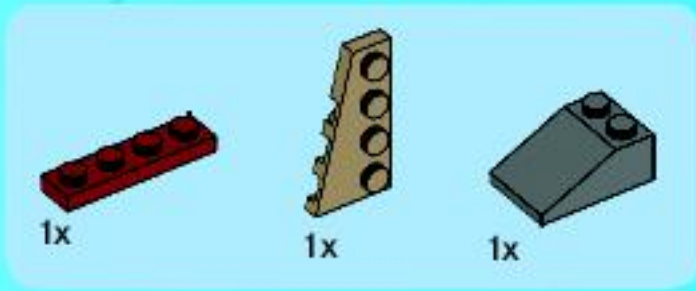

6

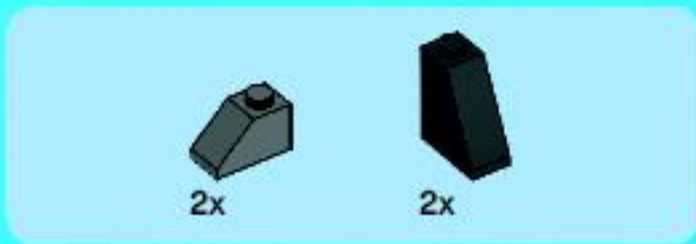
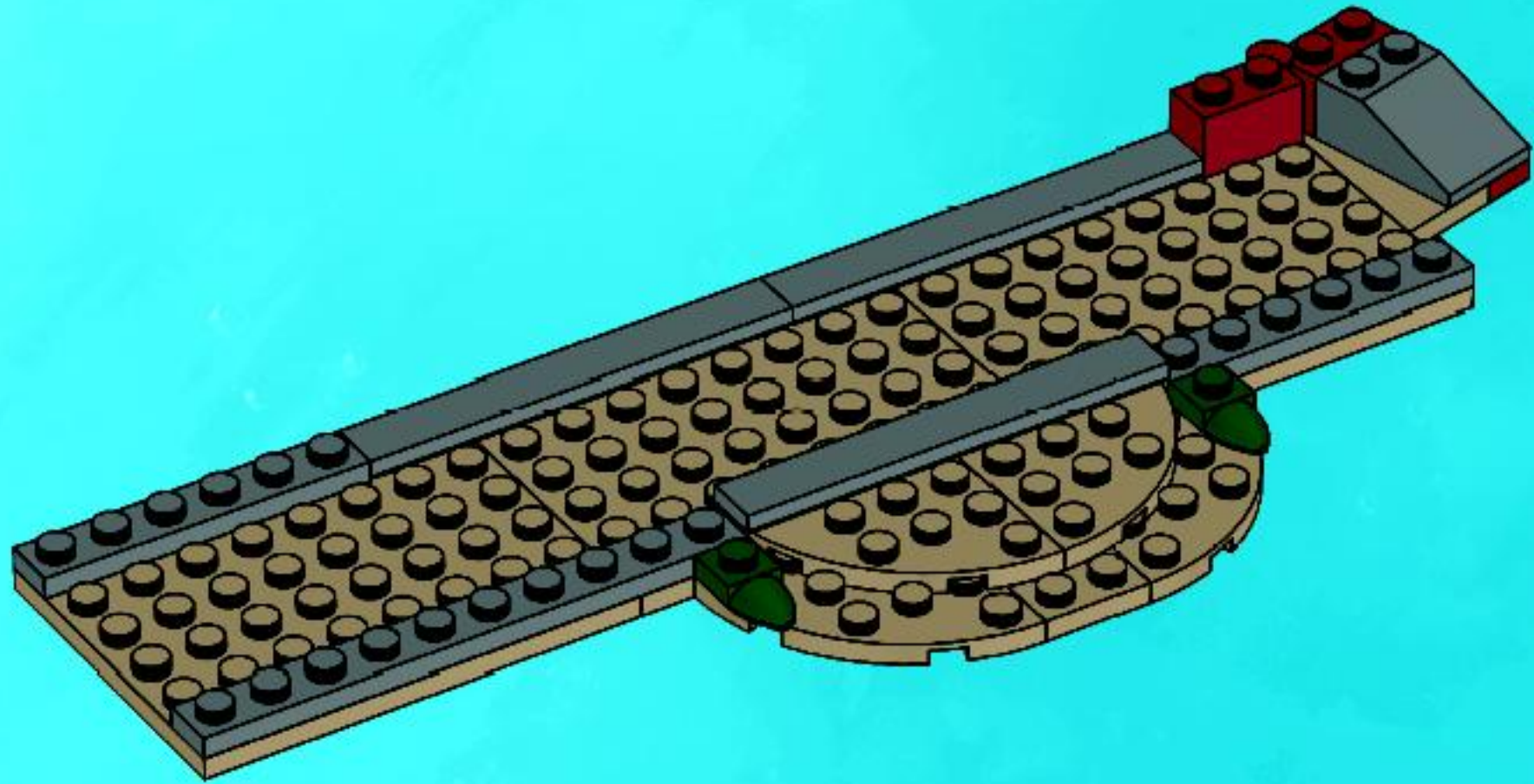
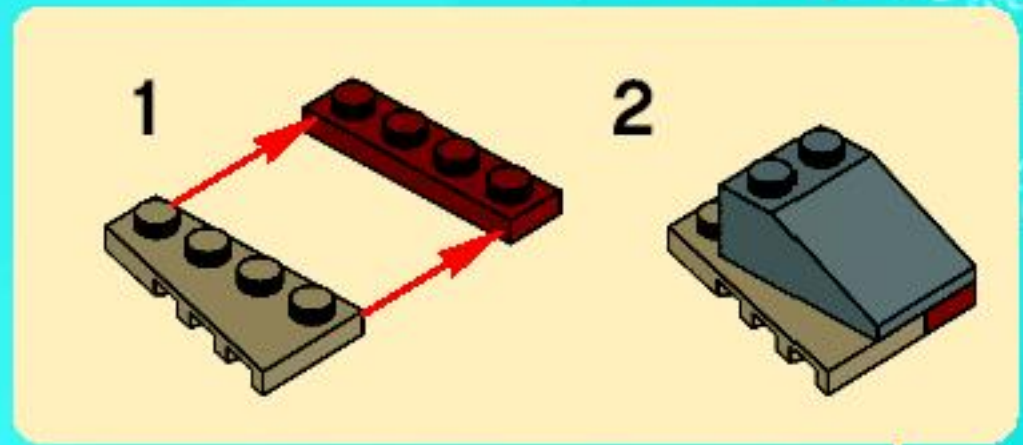

7

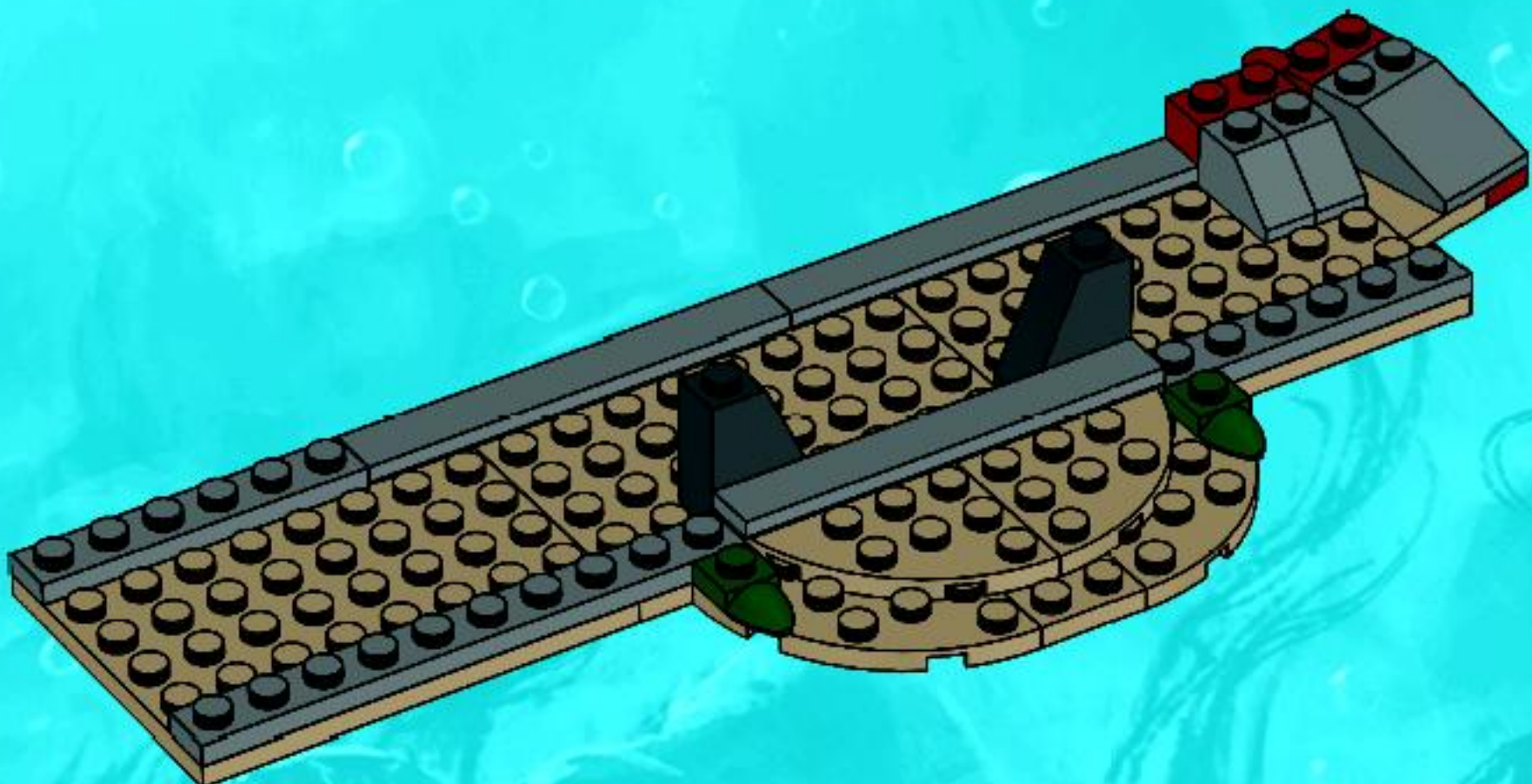

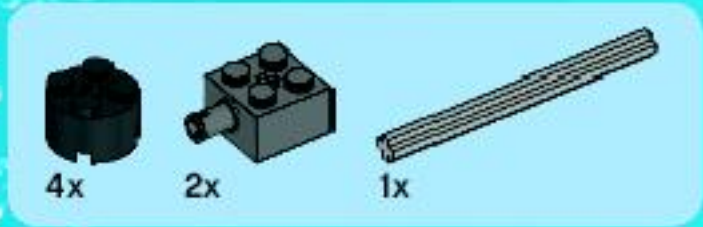

8

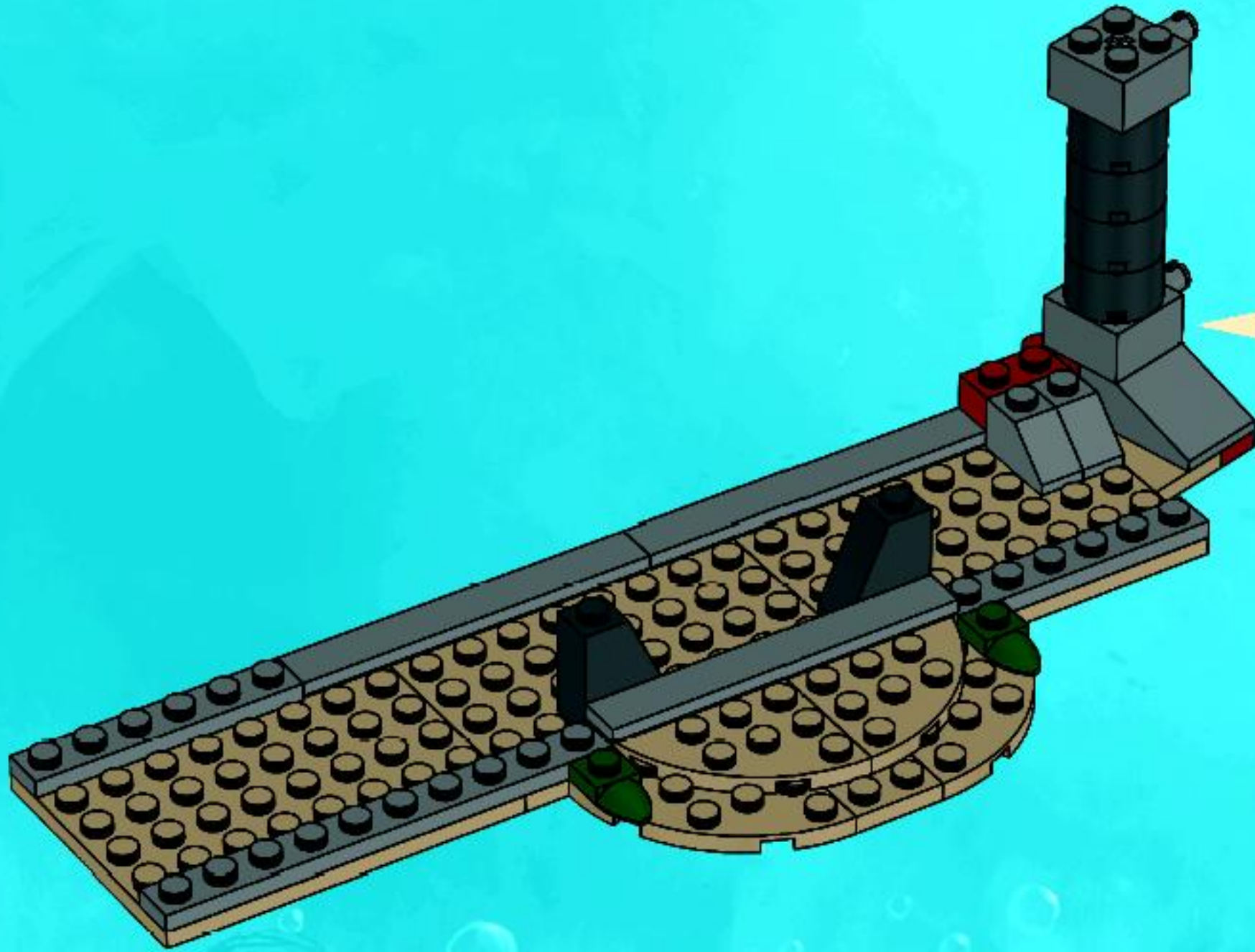
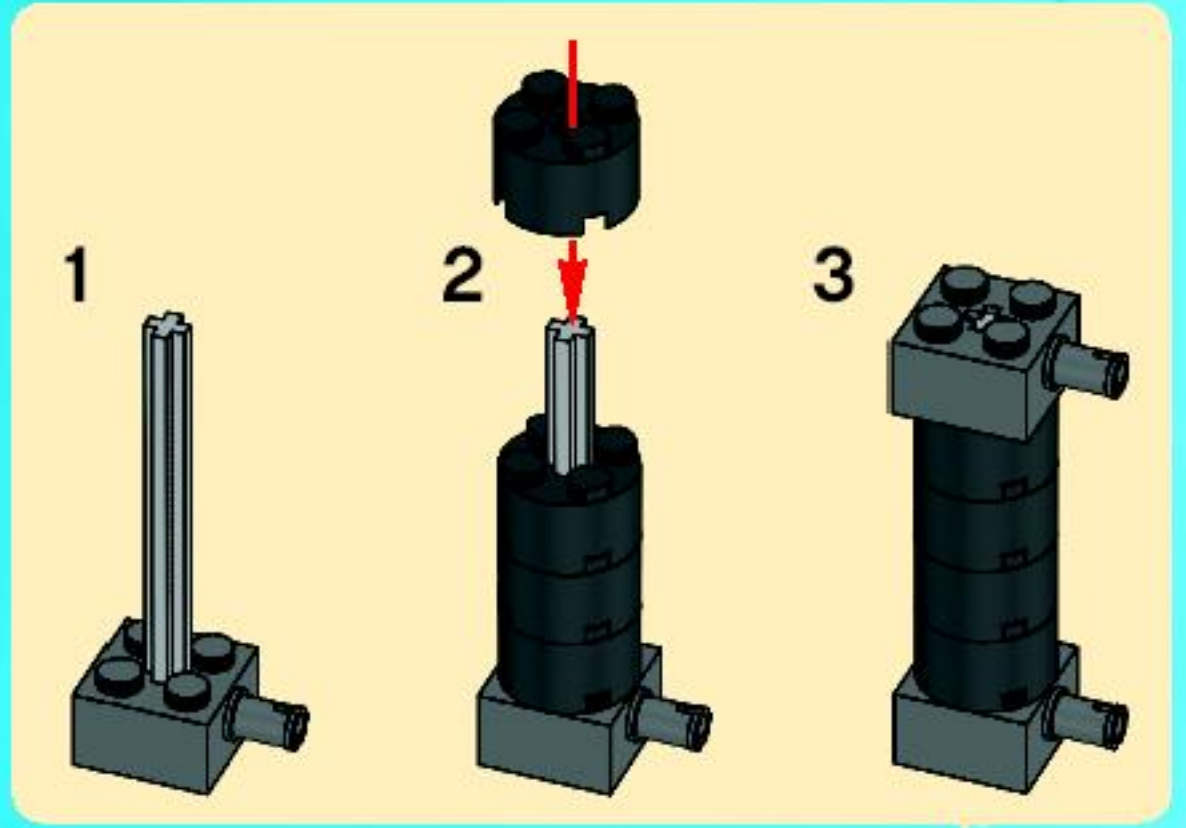

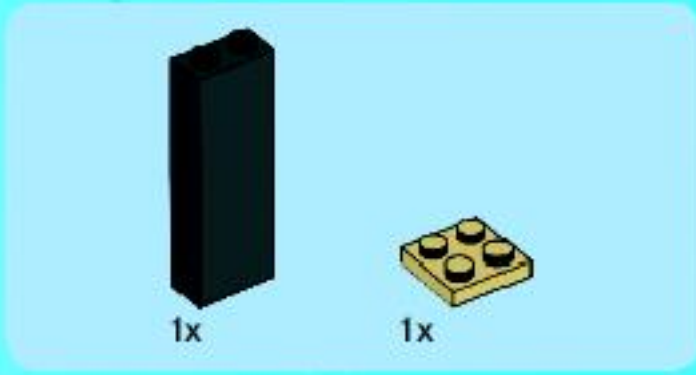

9

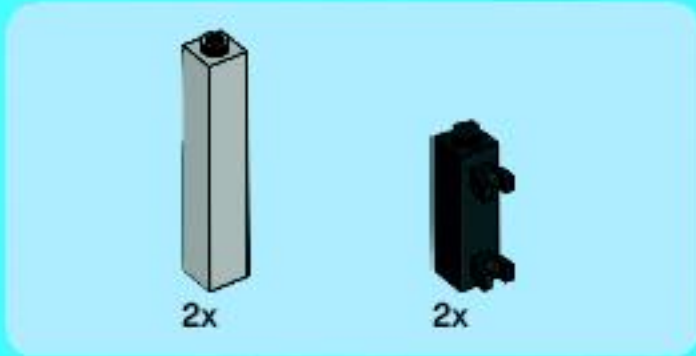
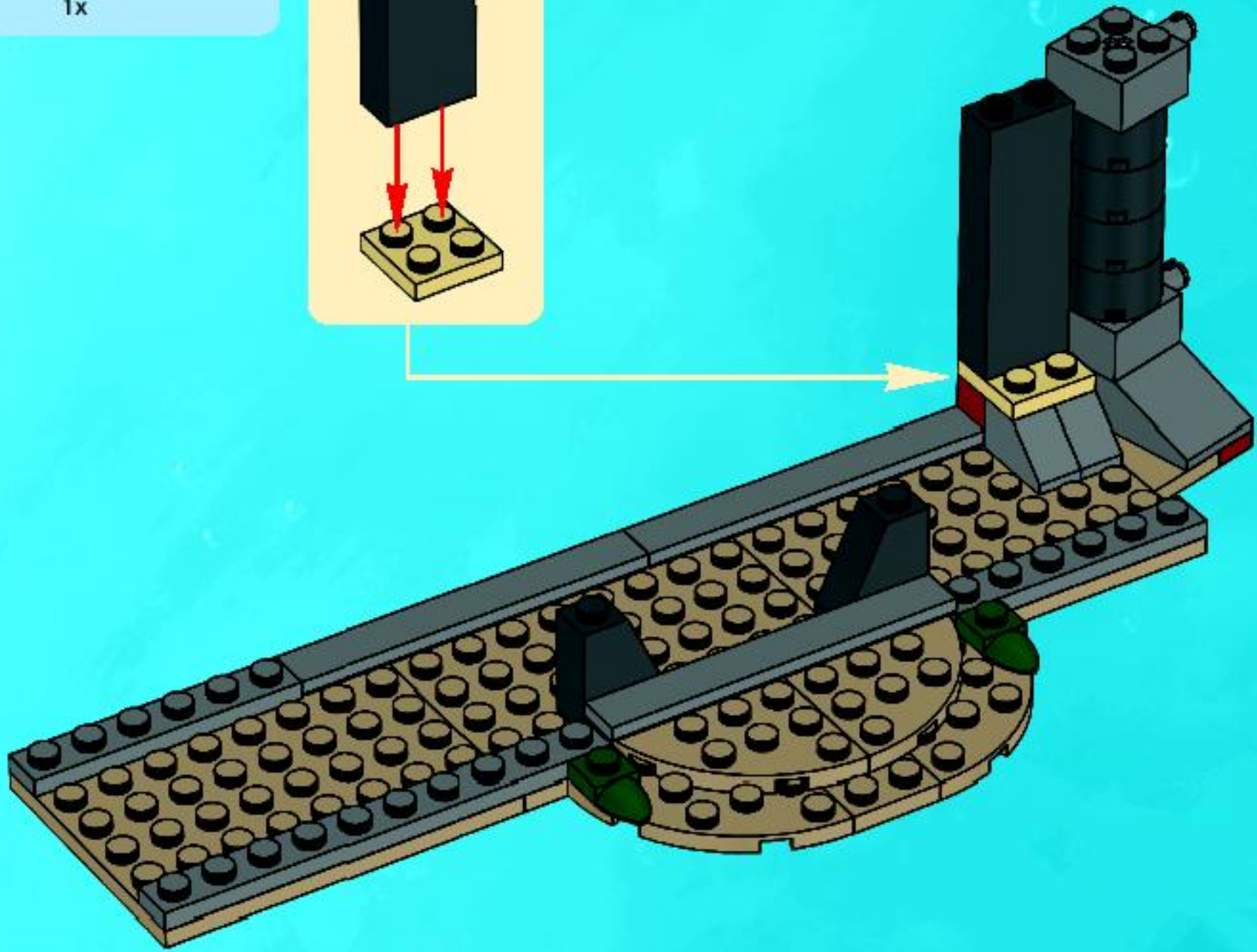
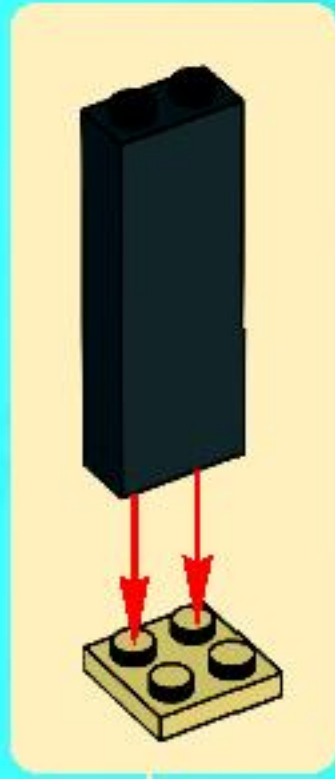

10

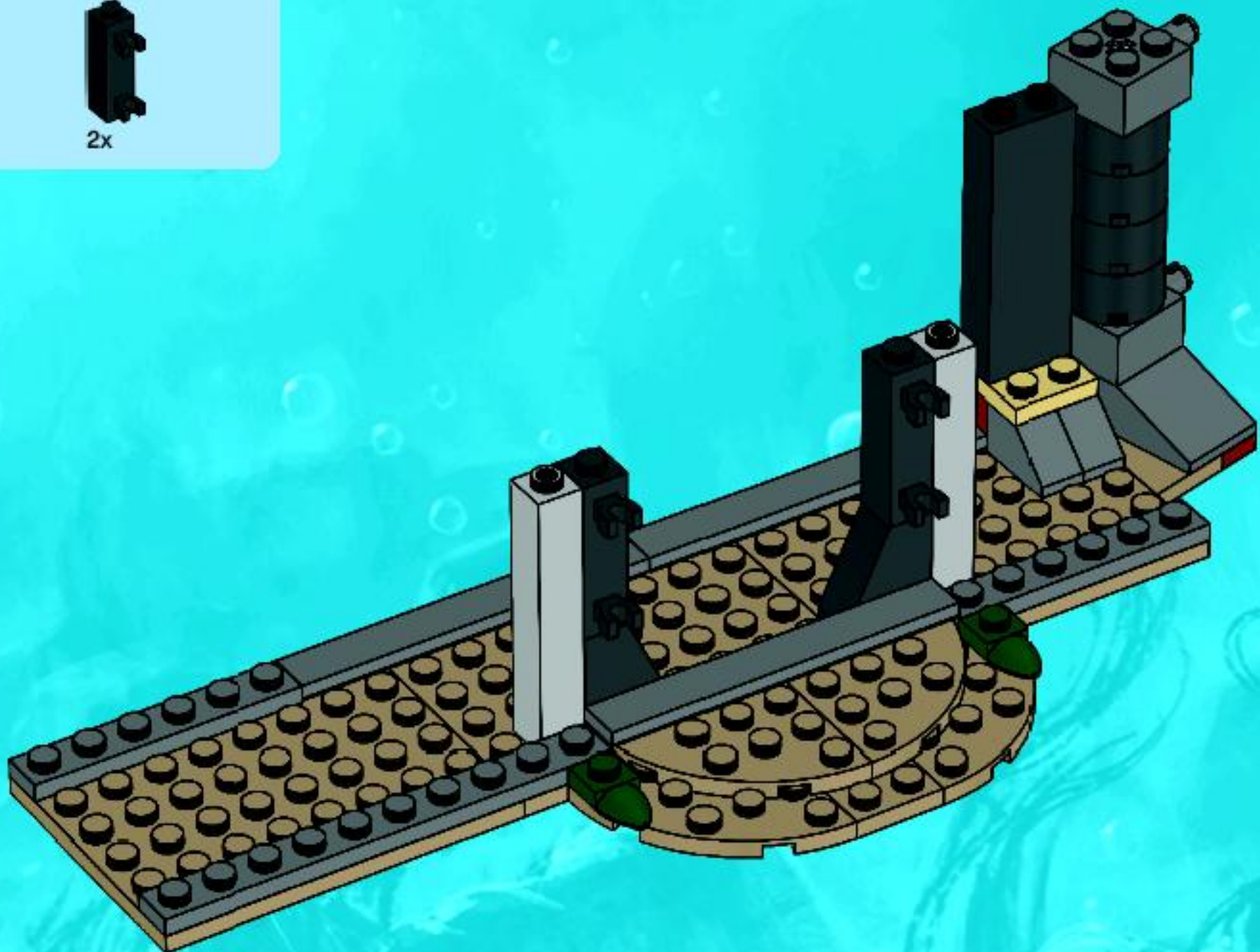







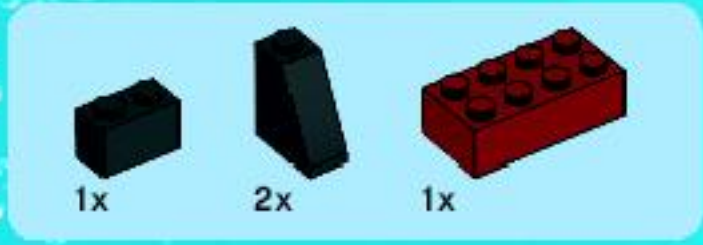

15

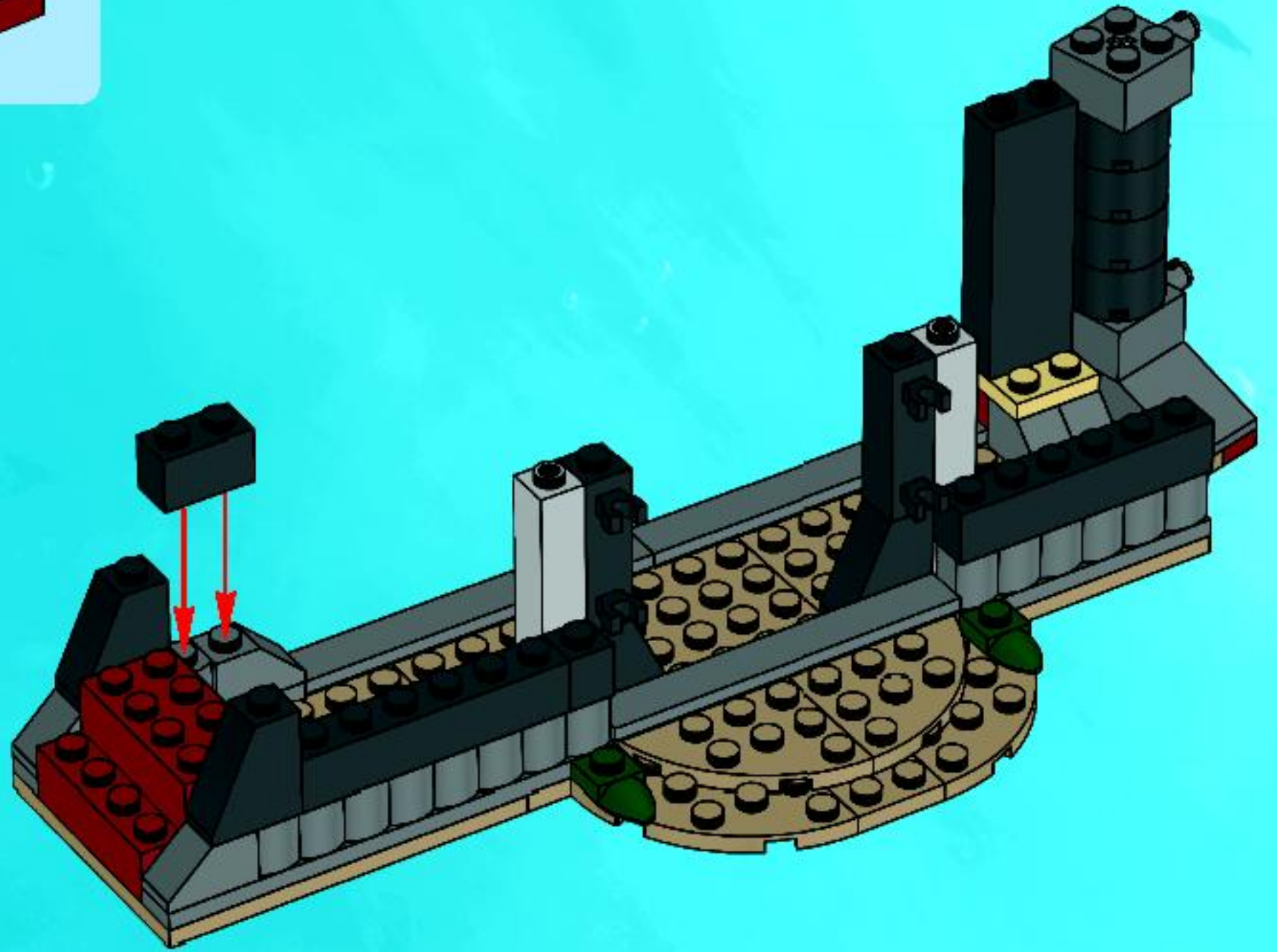

16

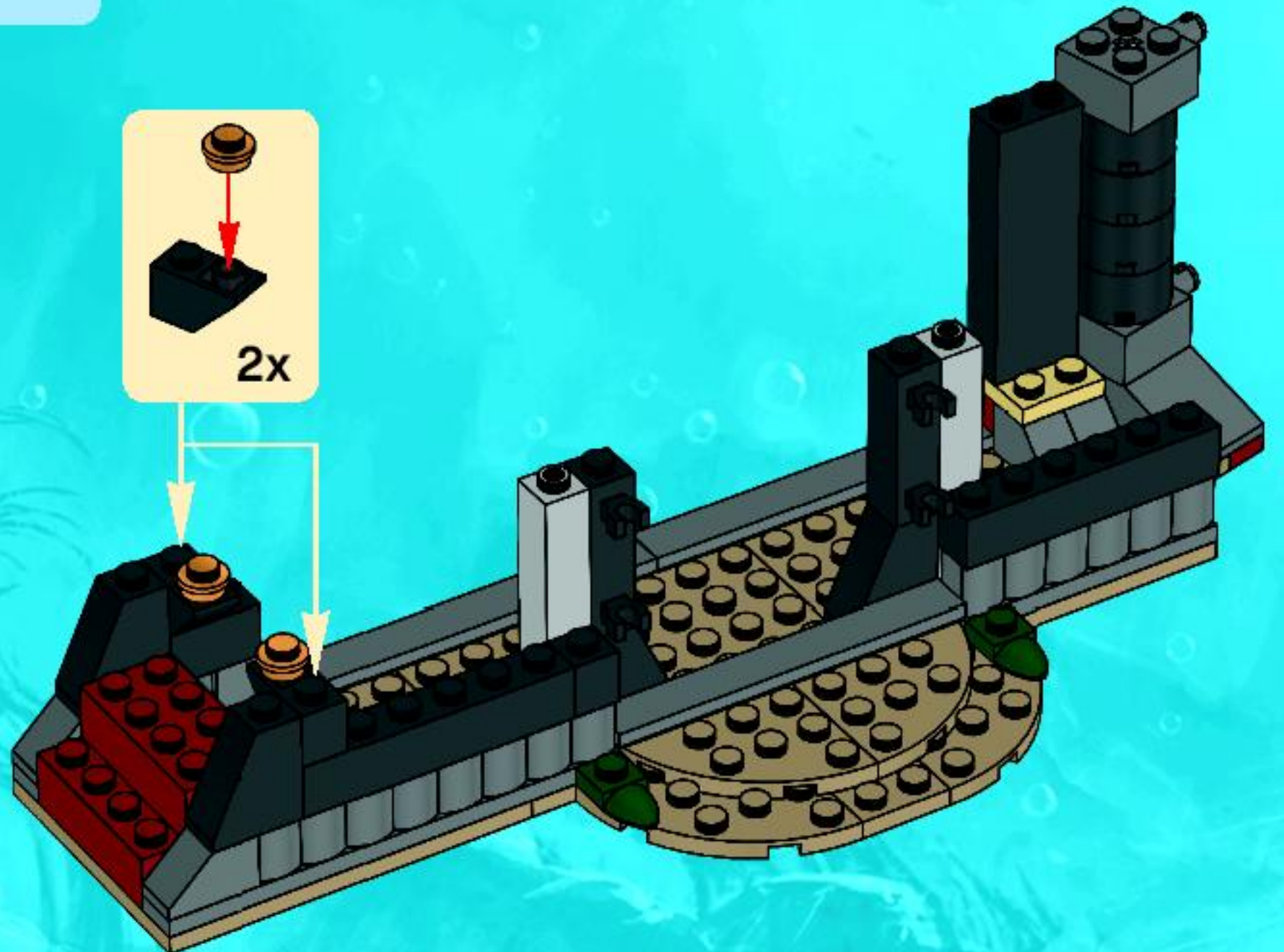



1x



4x



4x

# 17



1x



2x



4x

# 18



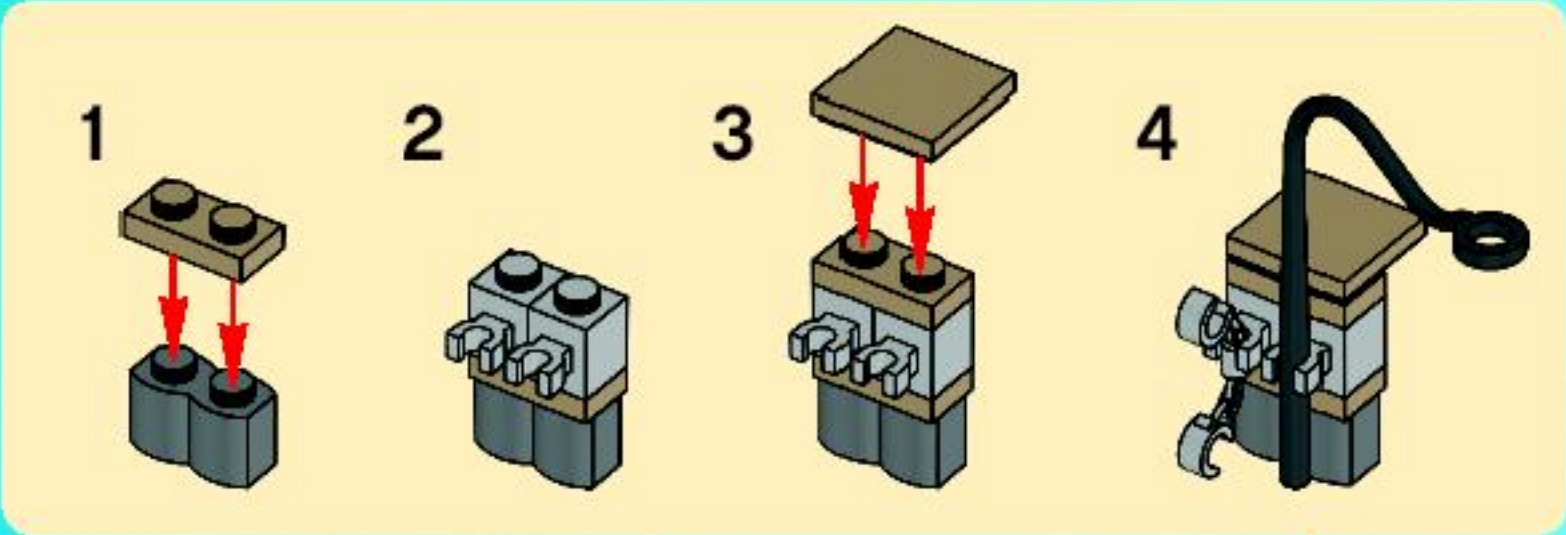
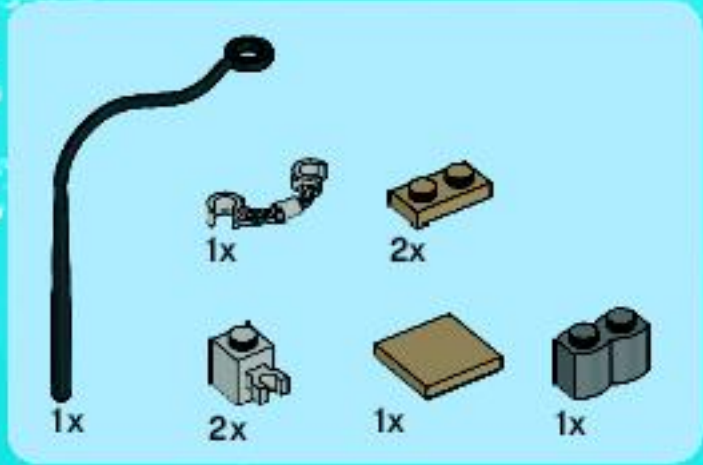

19





4x



2x

# 20



2x



2x

# 21



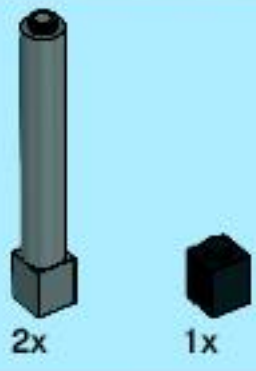

22

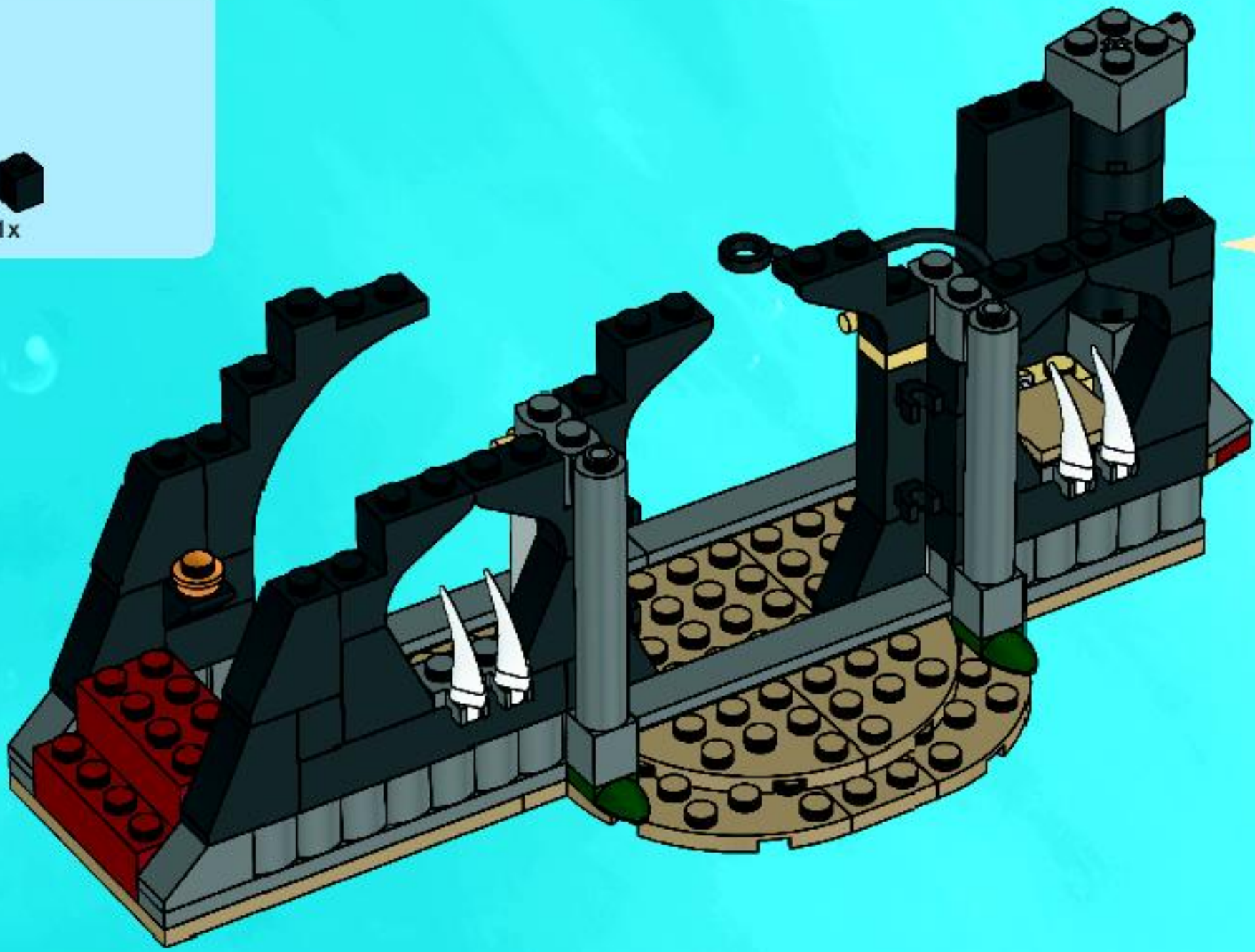

23

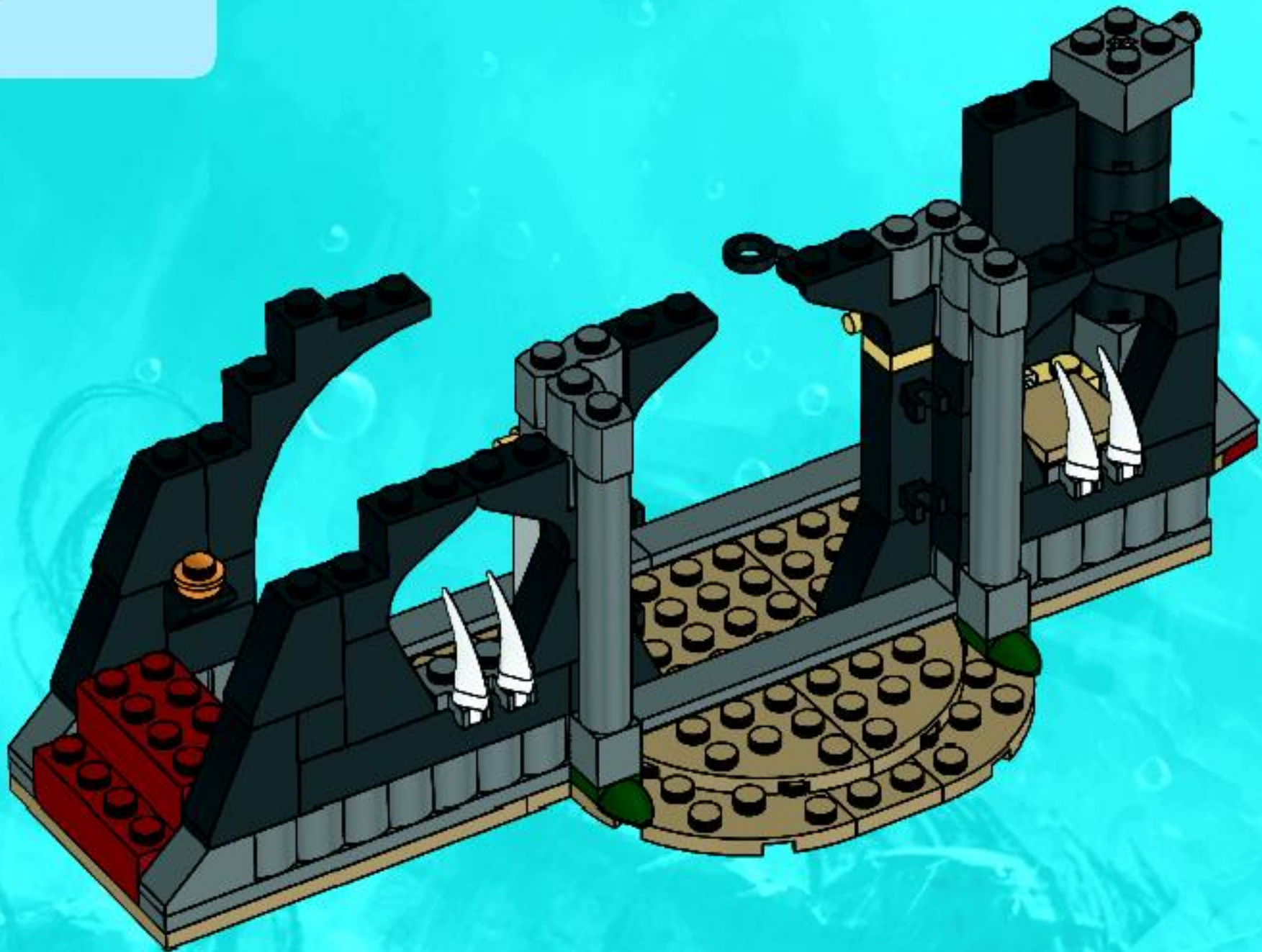



1x



2x

# 24

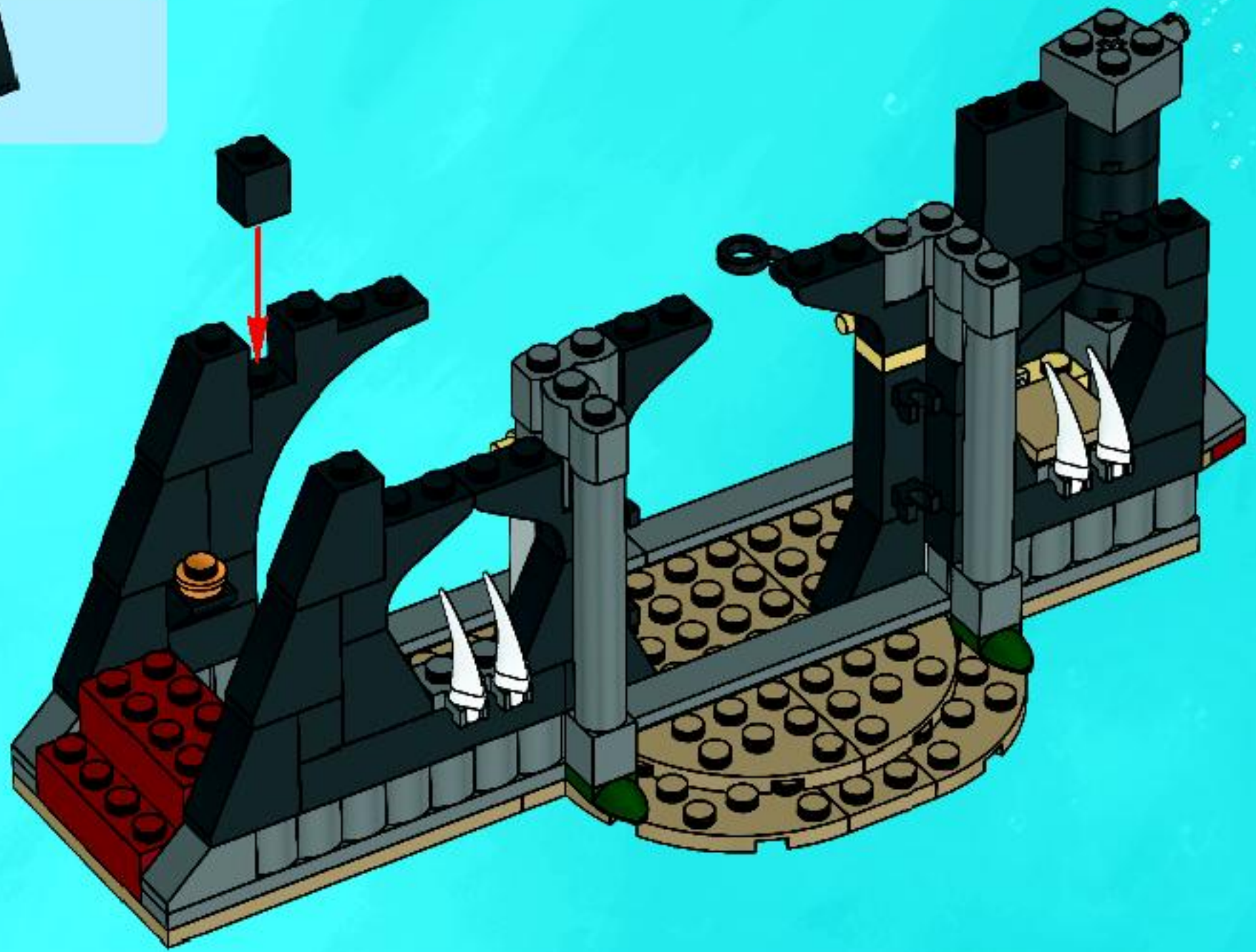

1x



1x



1x

# 25

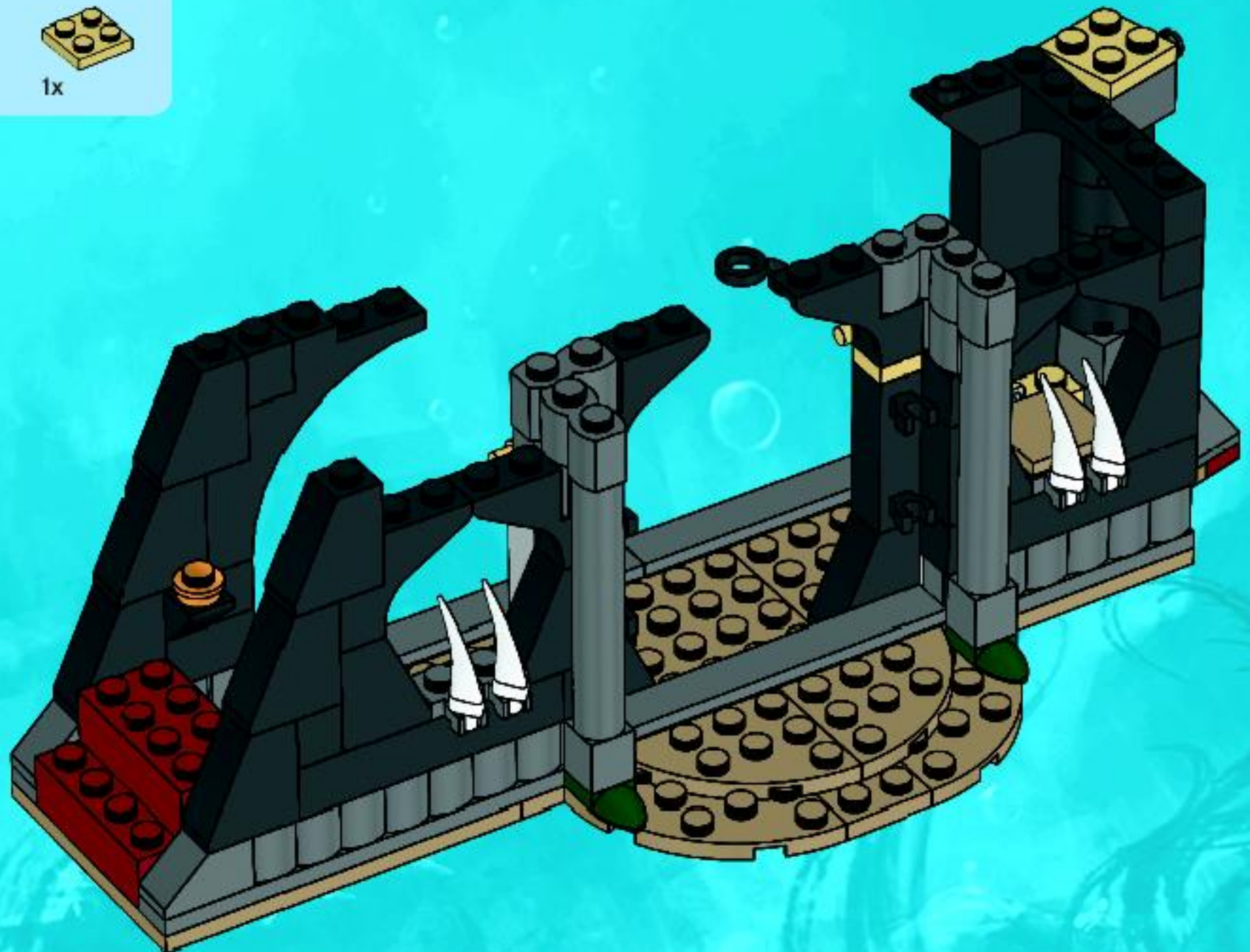

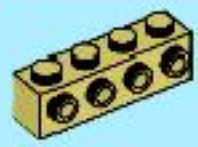

2x



2x



4x



1x

# 26

1

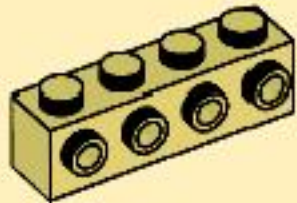

2



3



2x

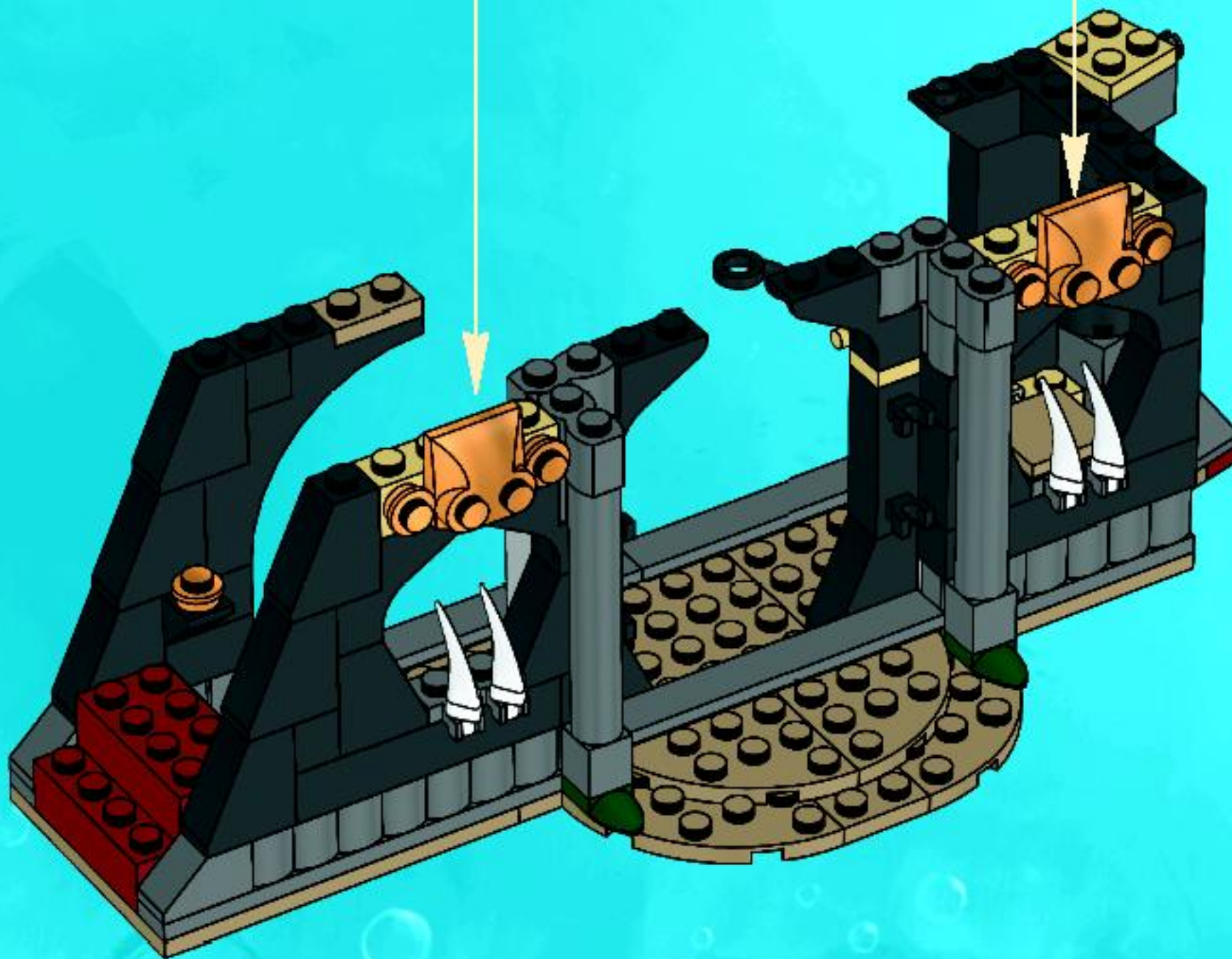





1x



1x



1x

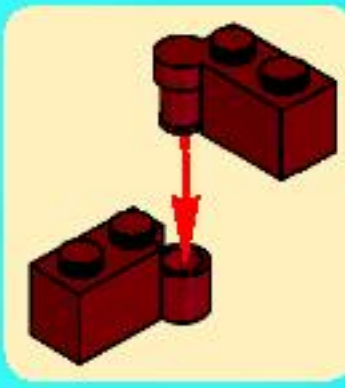

# 27

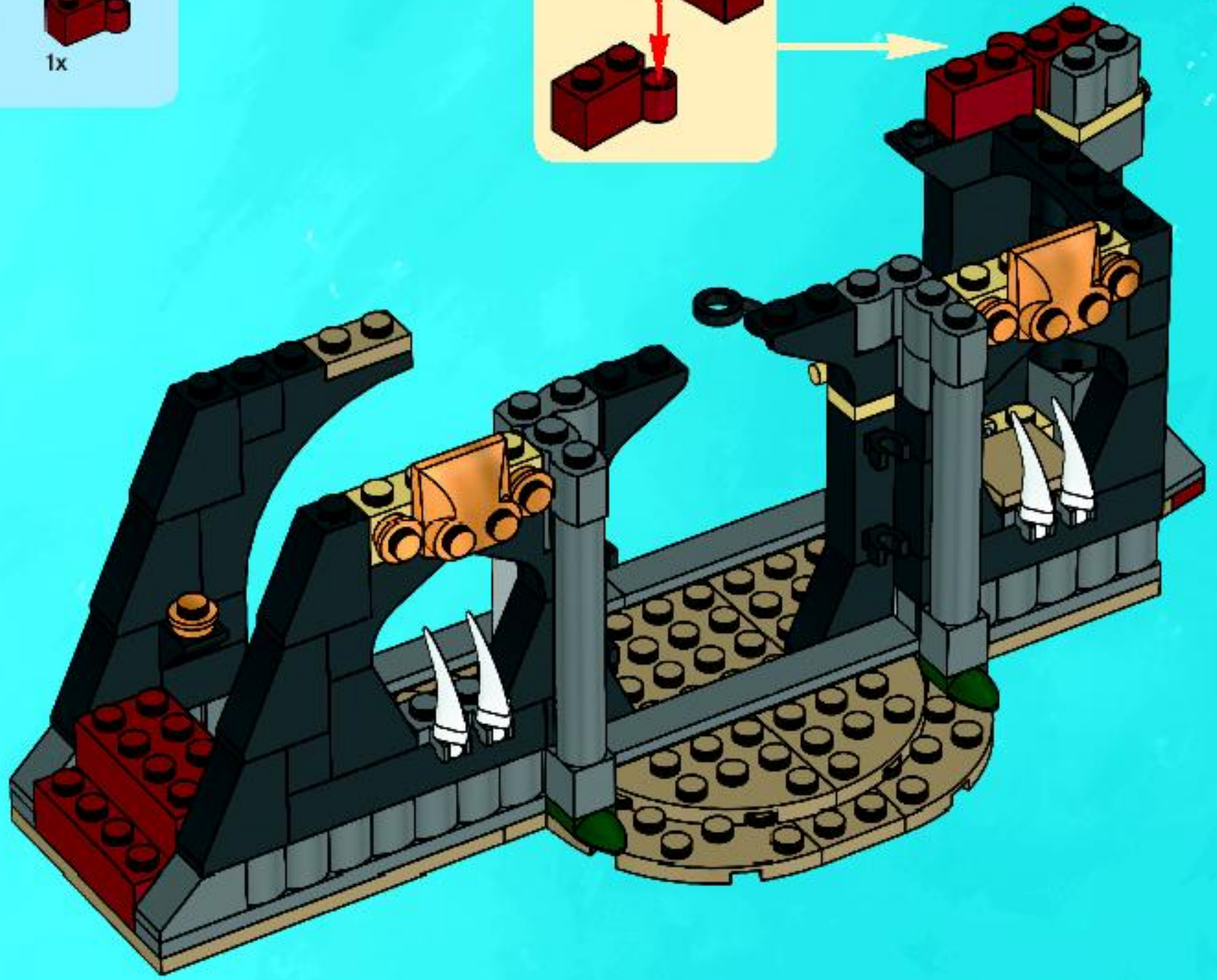

1x



1x

# 28



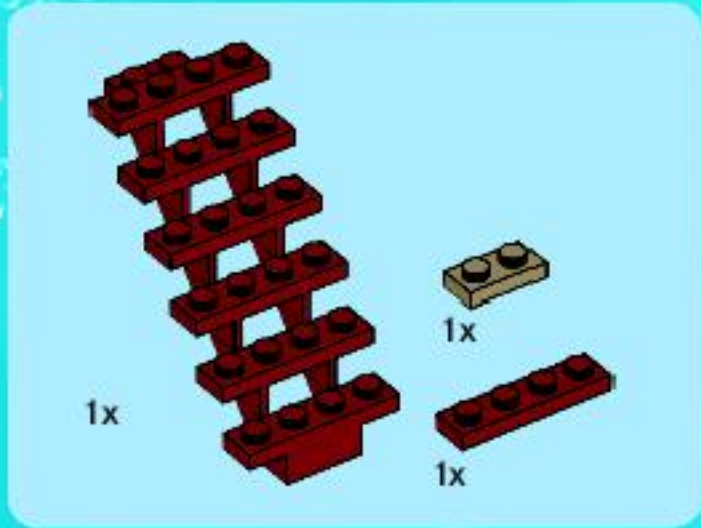

# 29

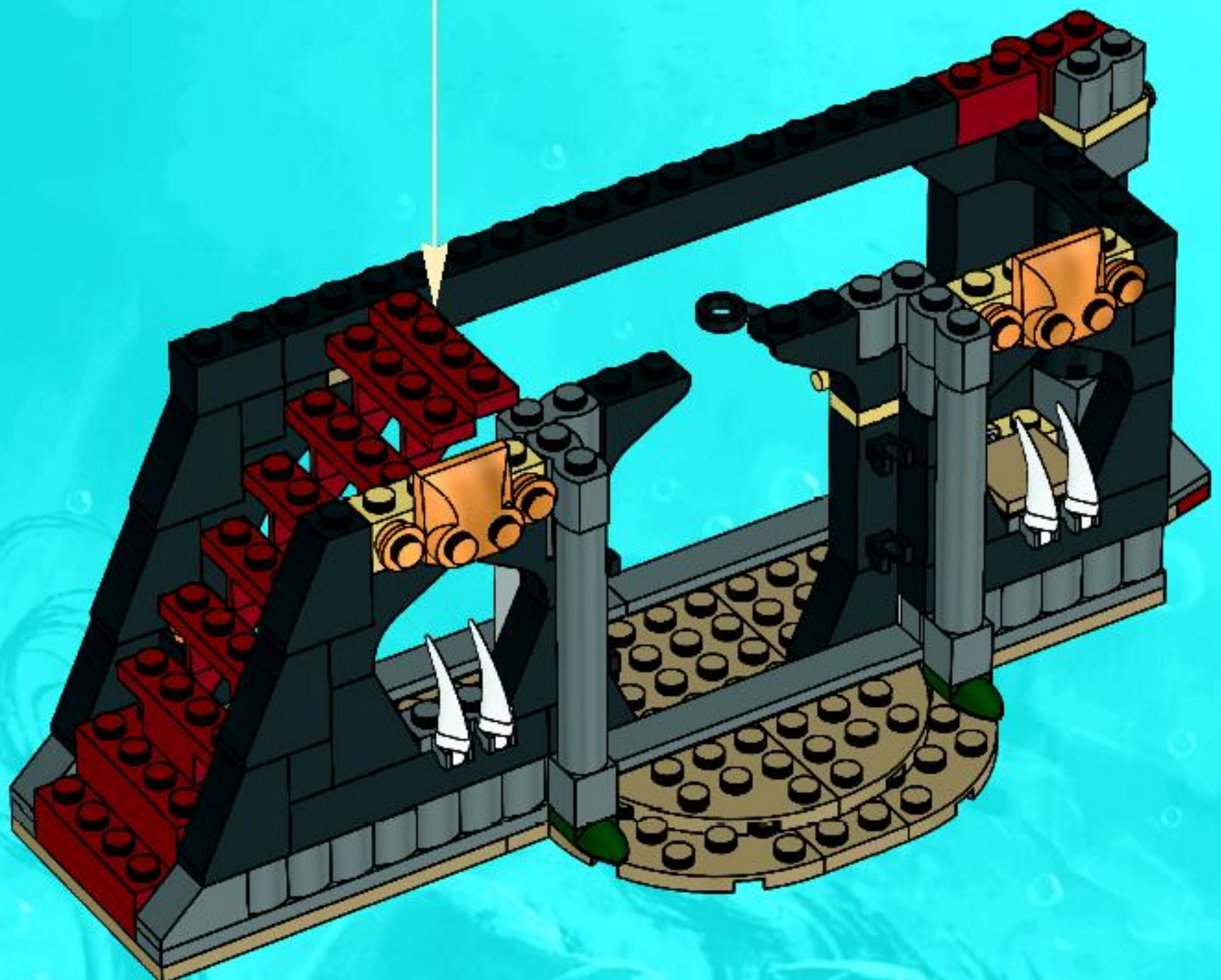
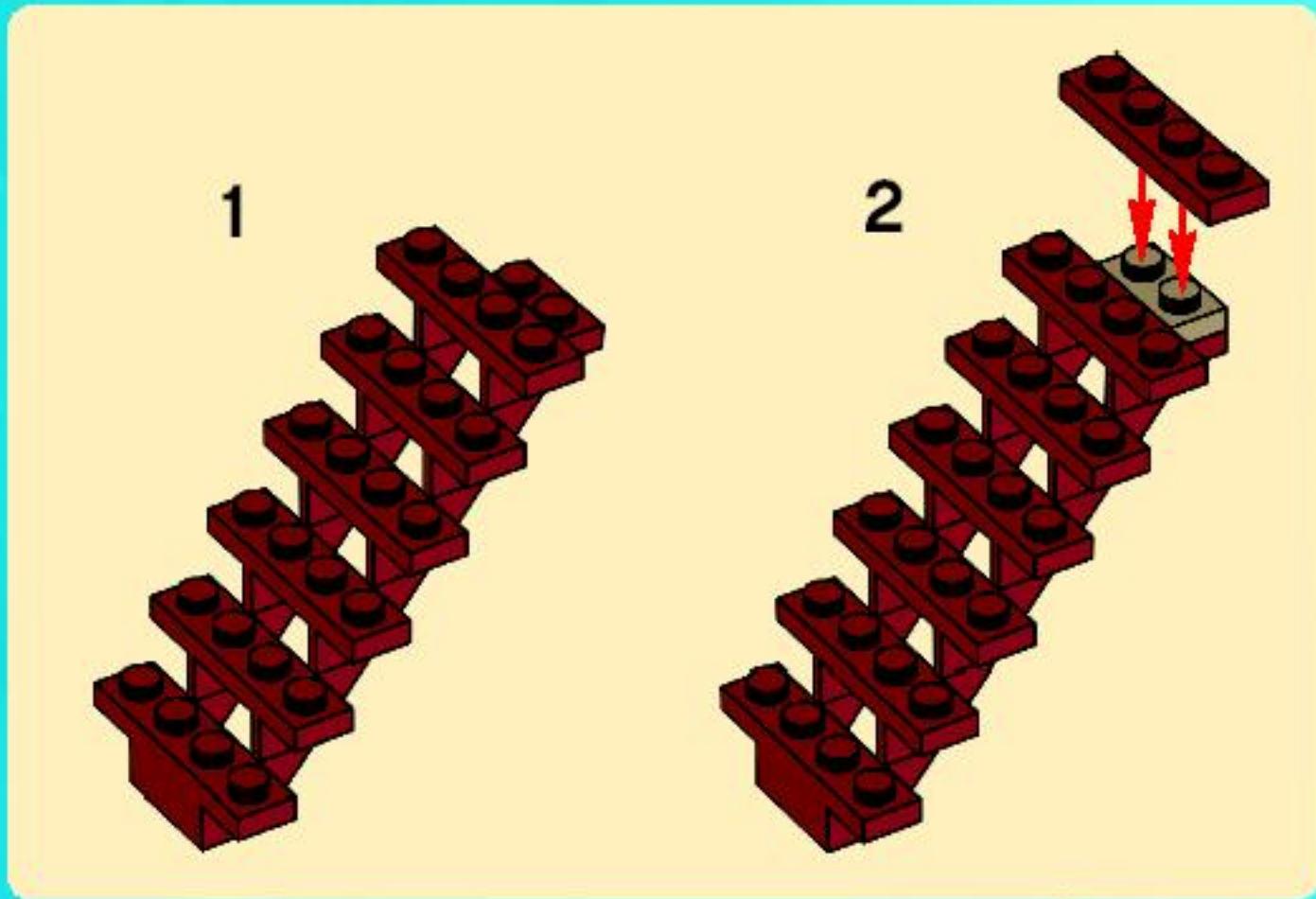

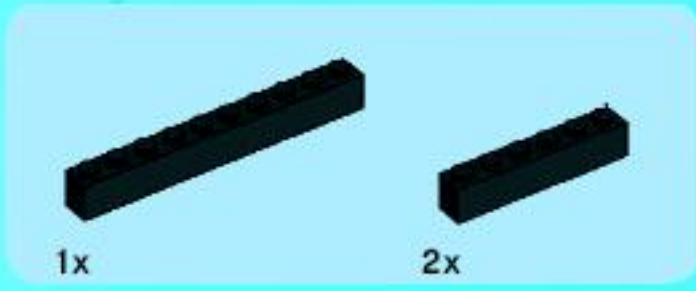

30

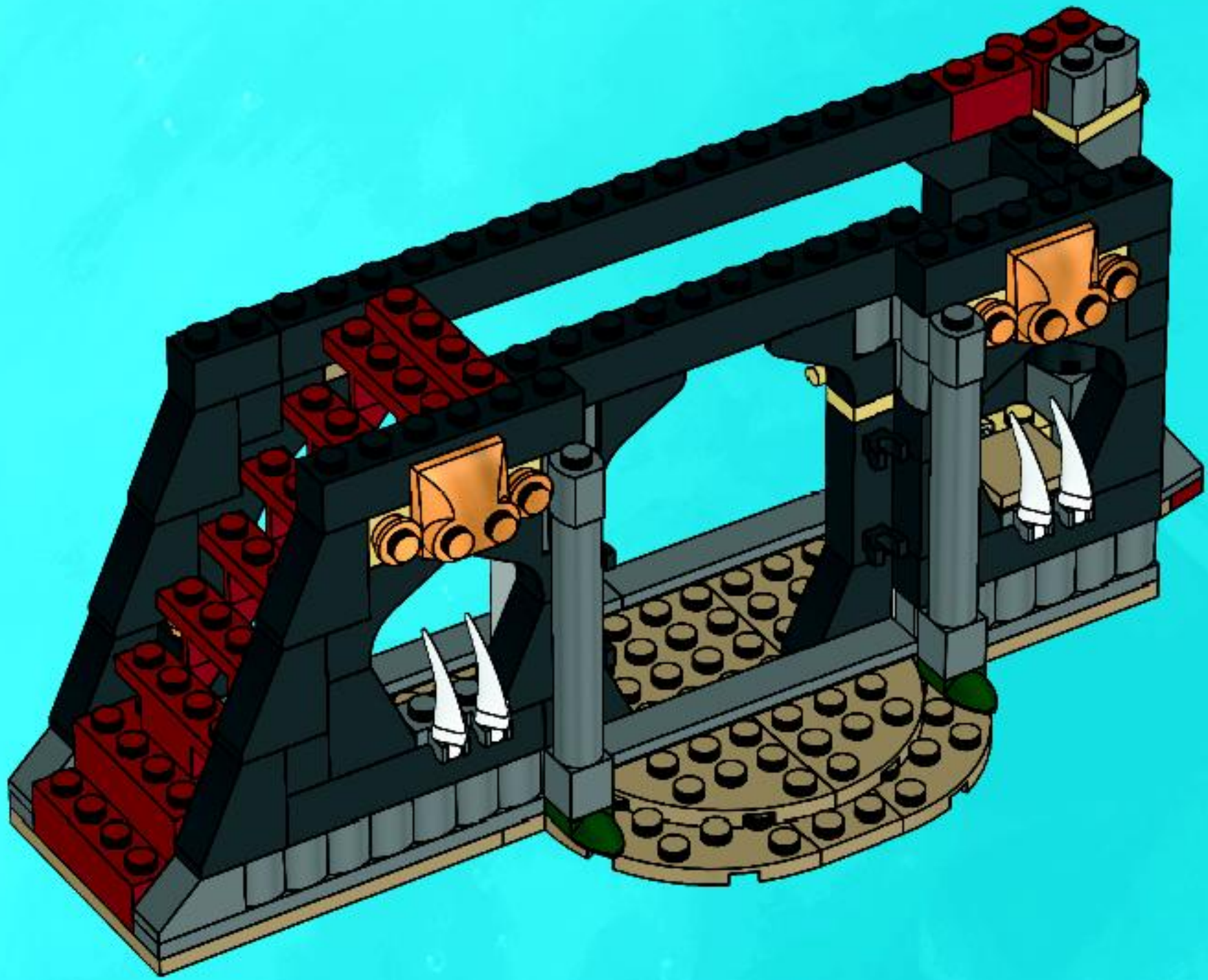

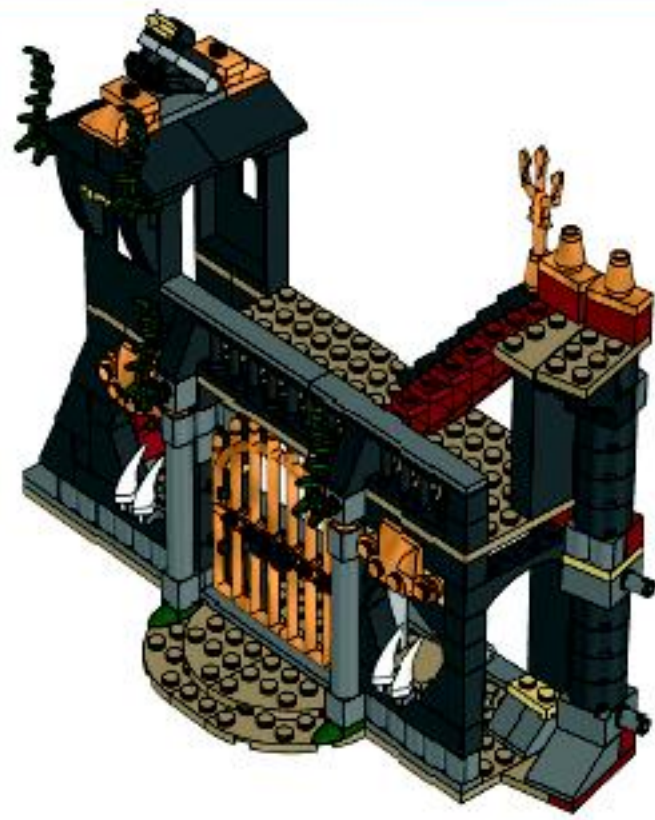

2x

31

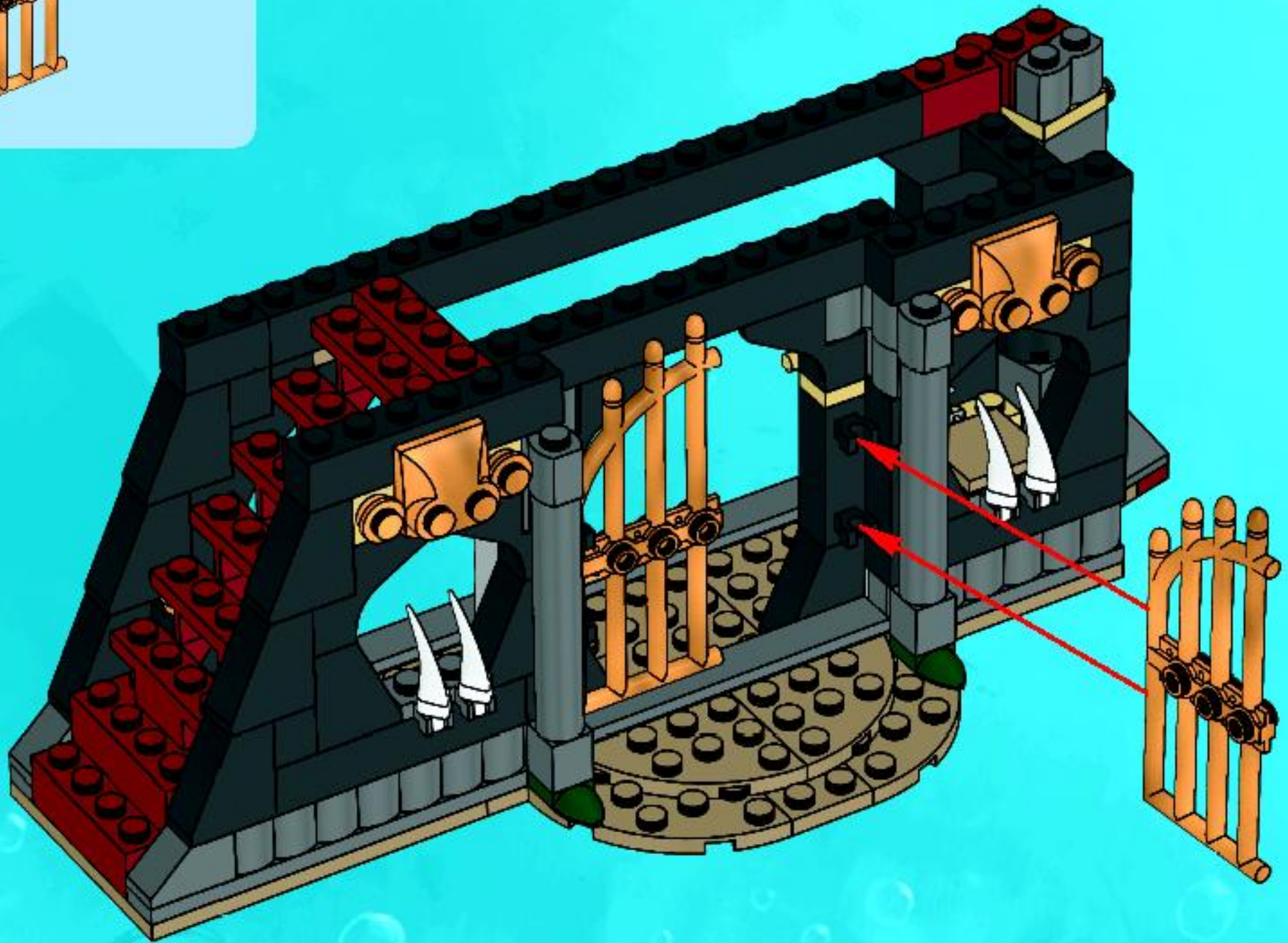



2x



2x

# 32

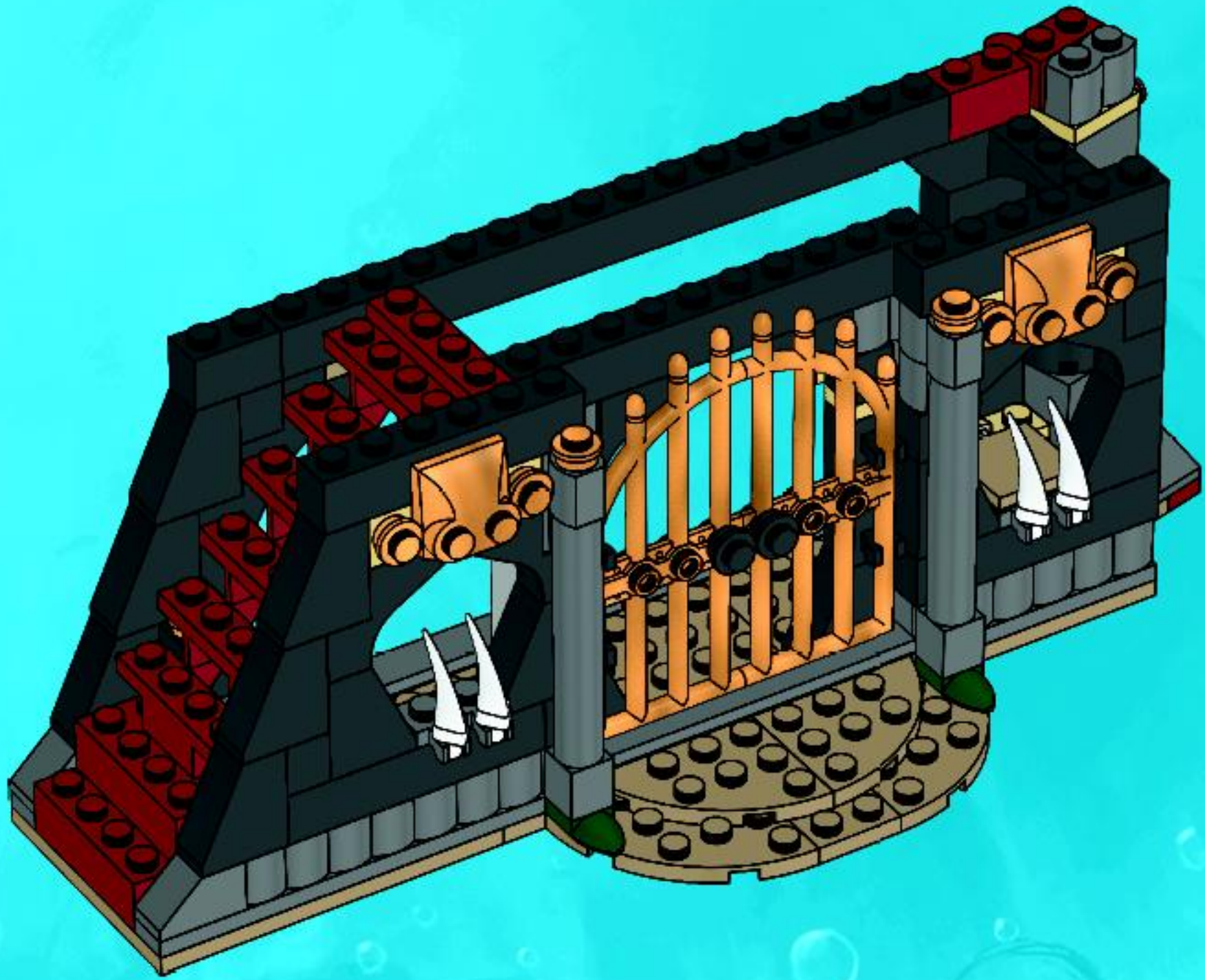



# 33

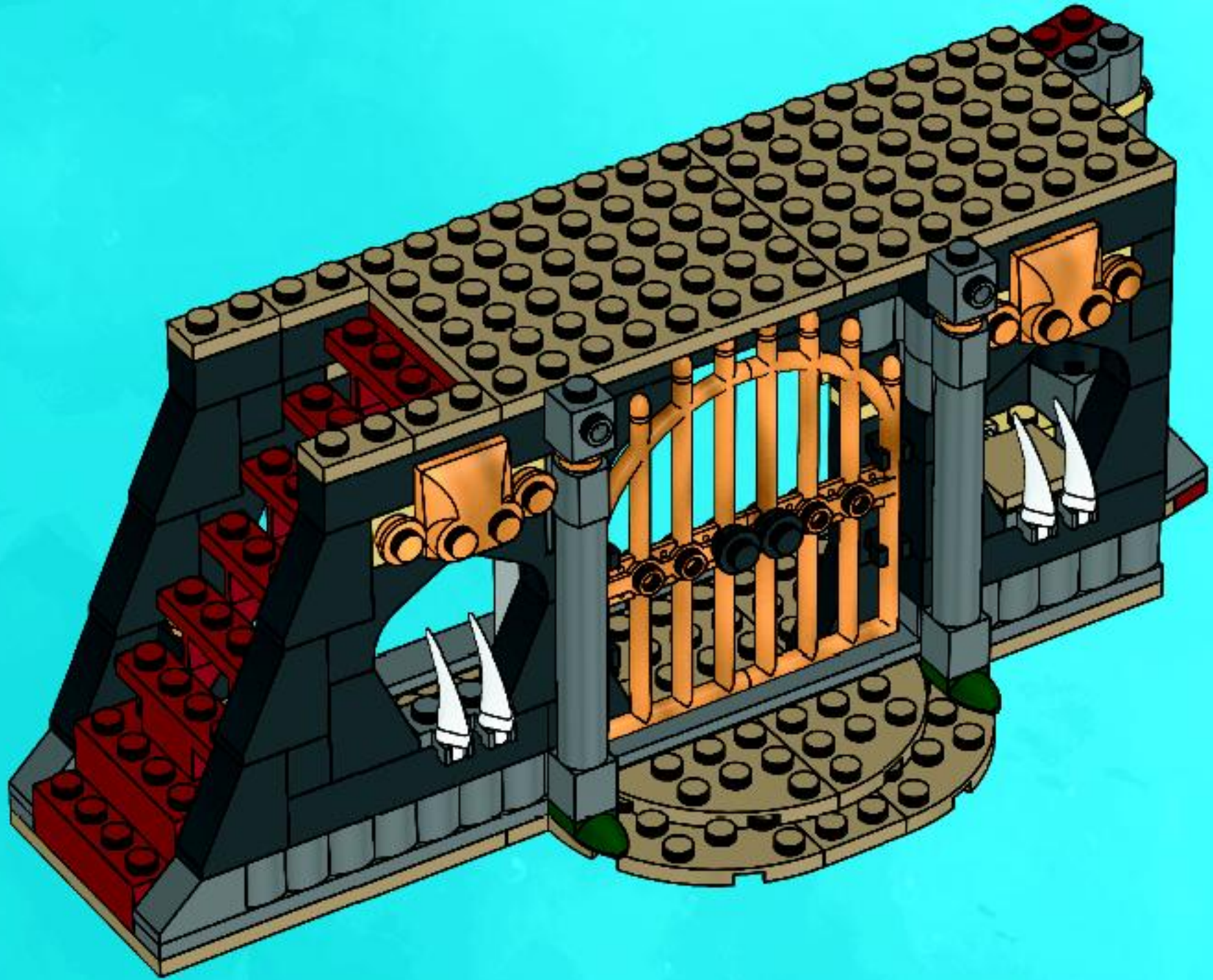



# 34

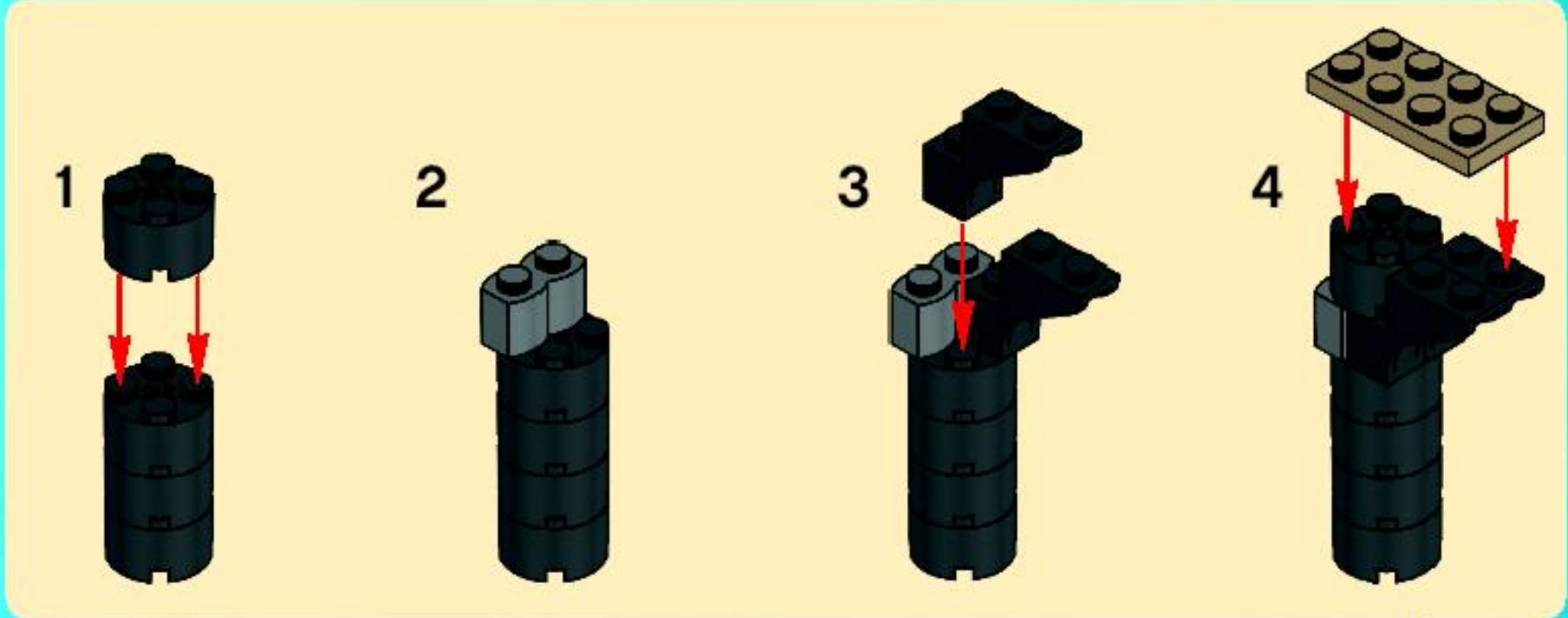

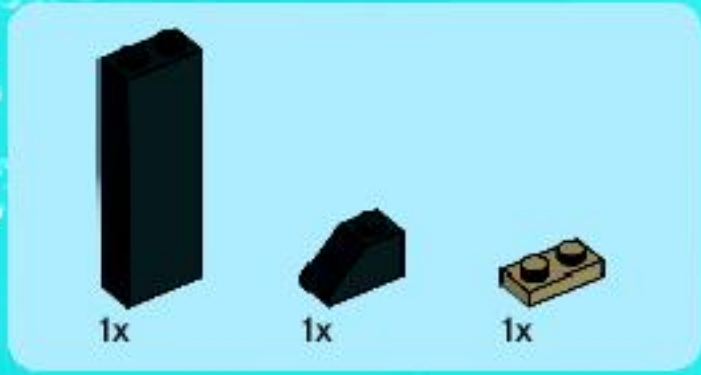

35





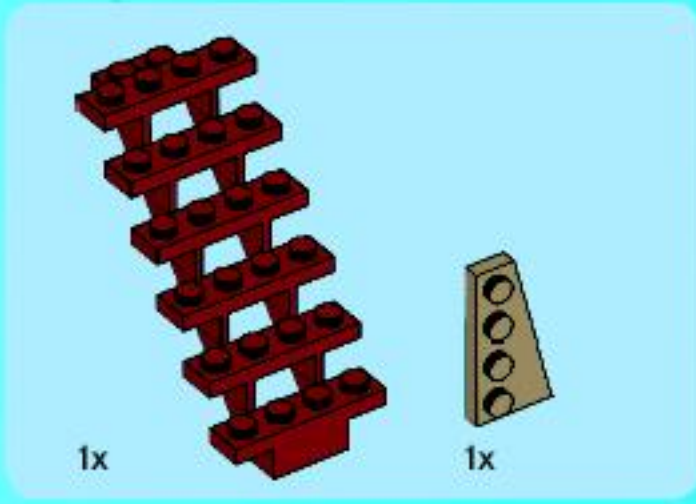

36

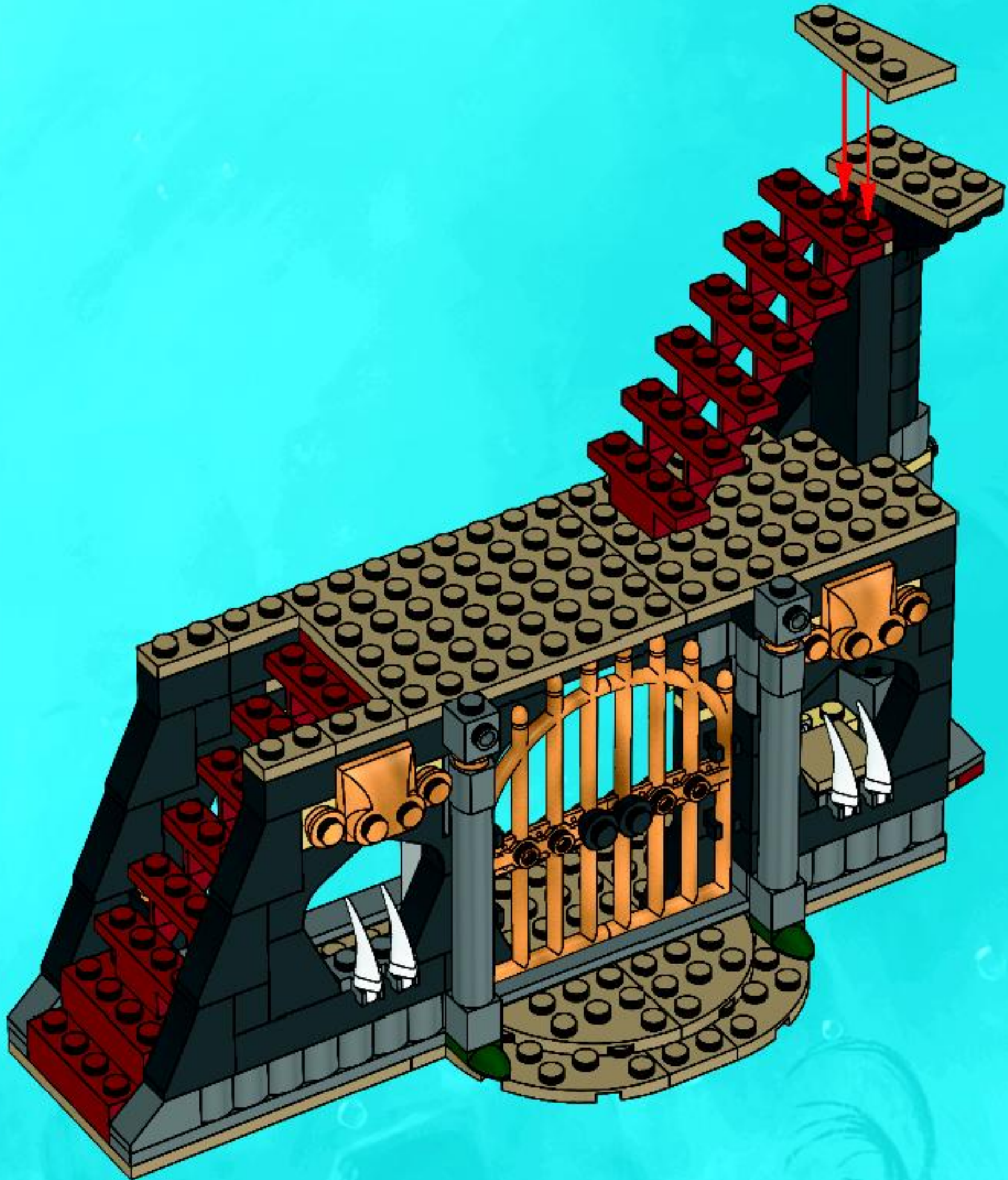



6x

# 37





1x



1x



1x

# 38

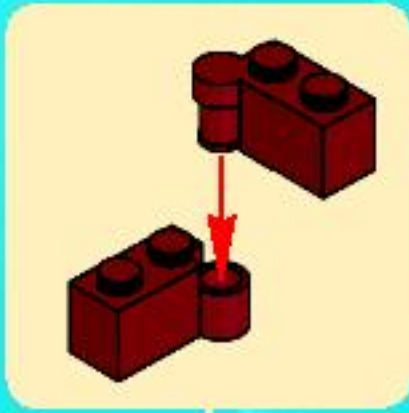



2x



1x

# 39

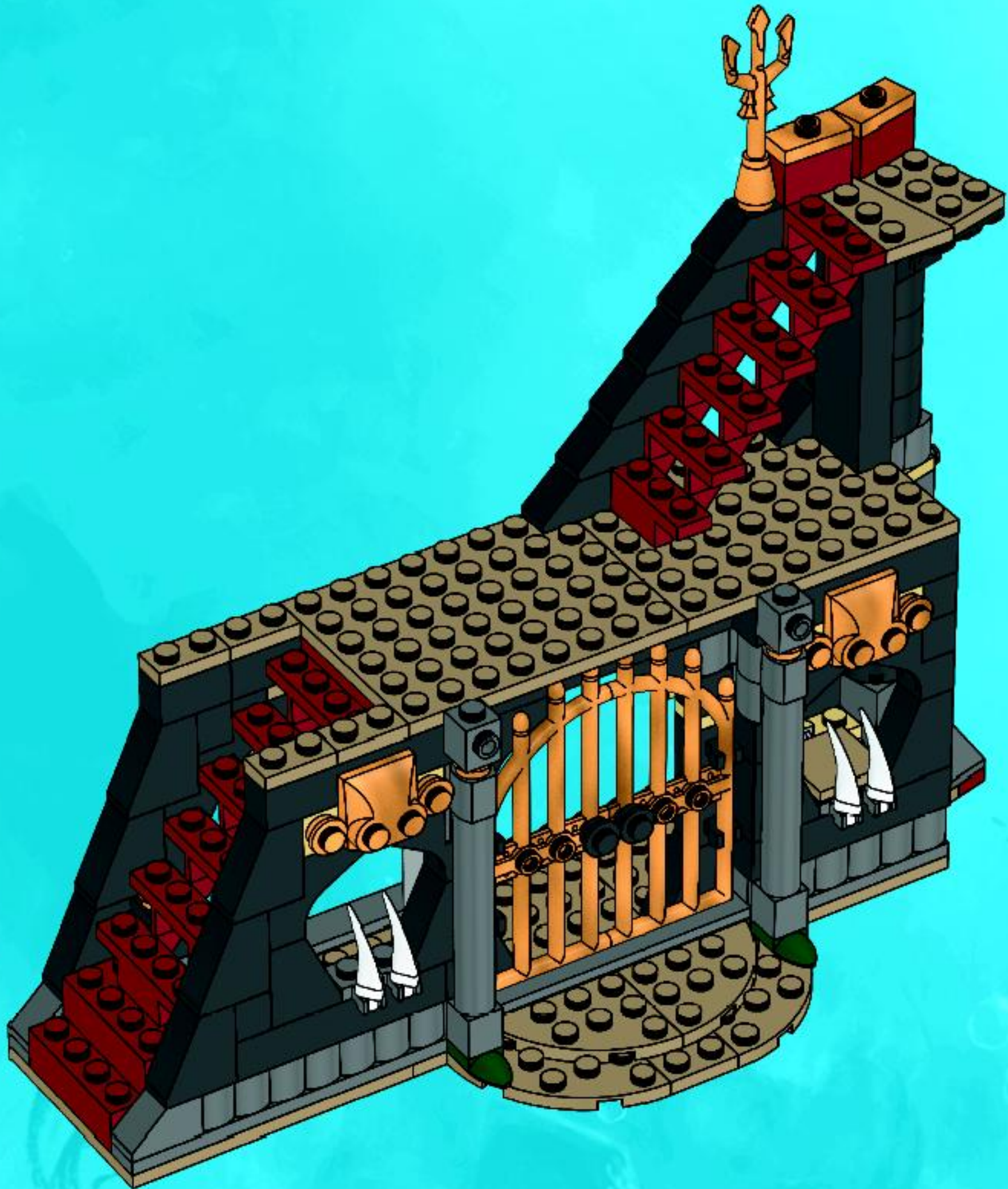



2x

# 40



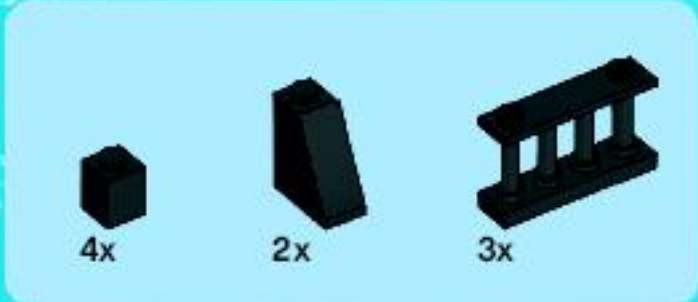

# 41

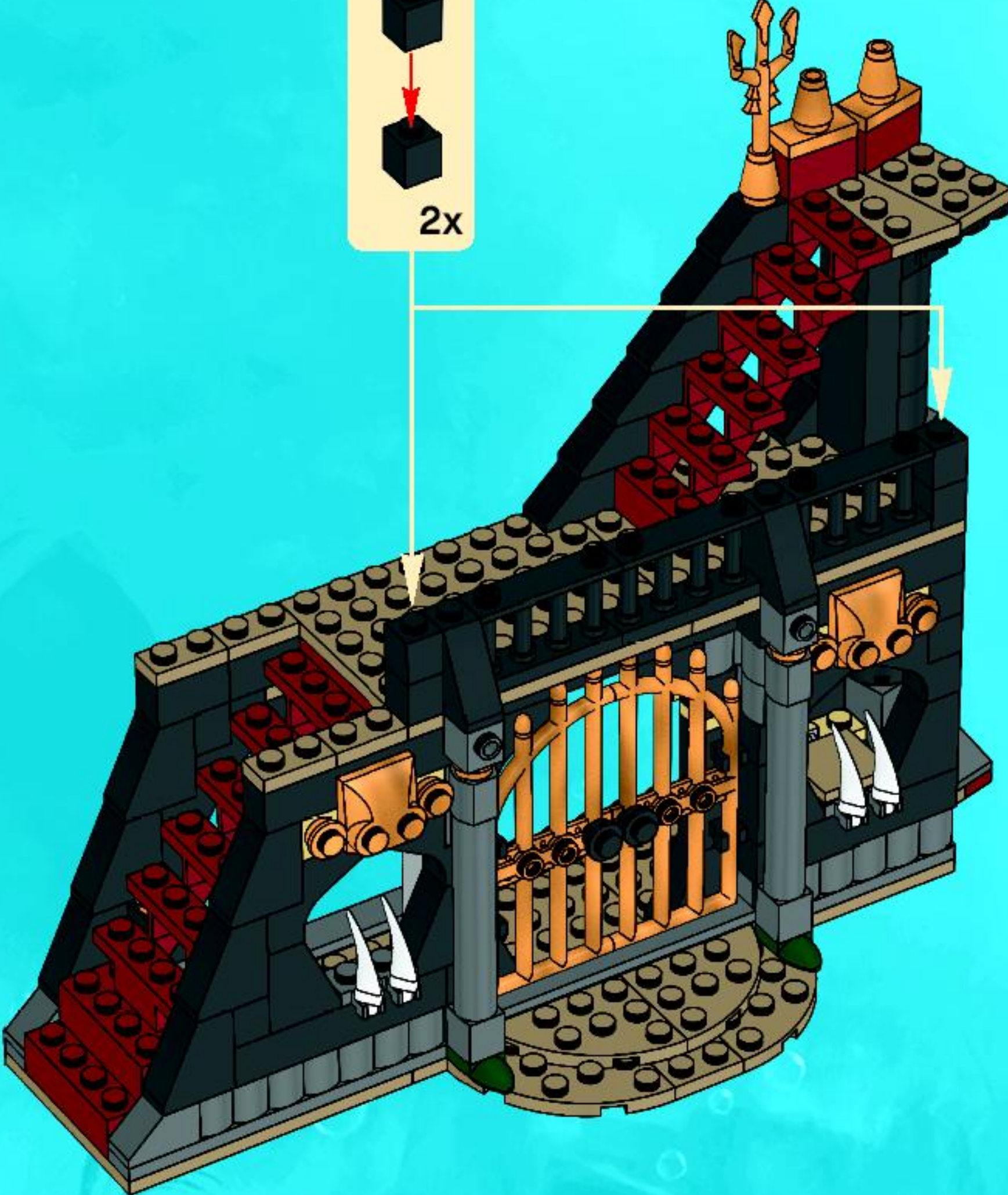
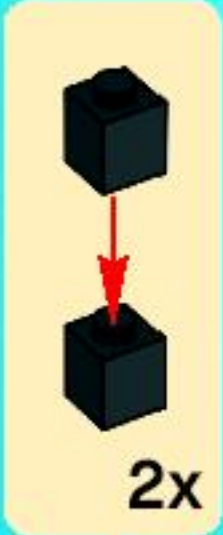

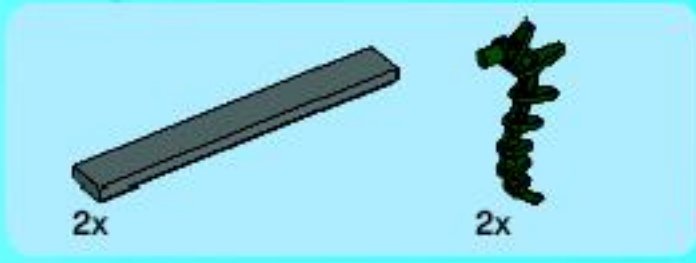

42

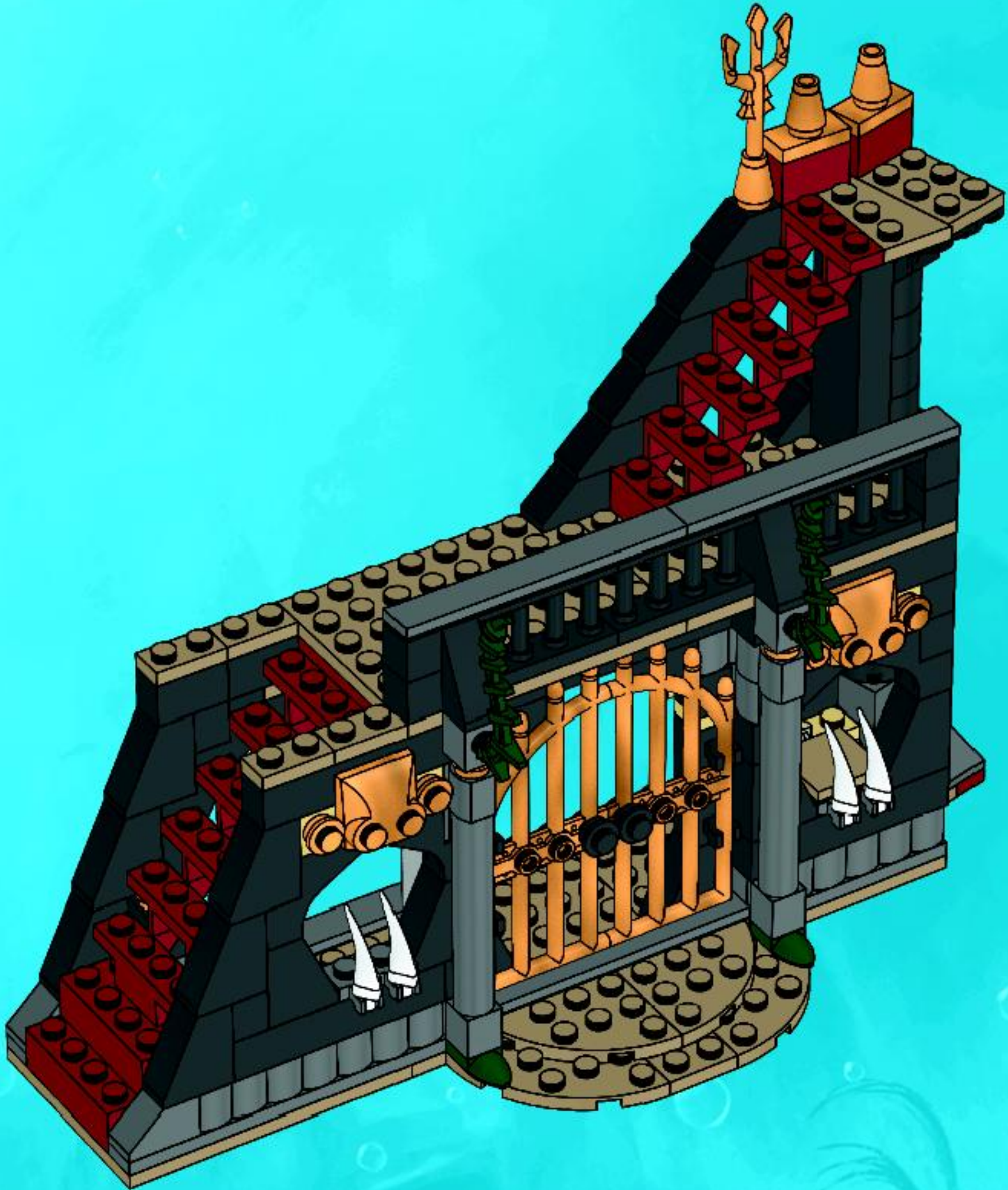



2x

# 43

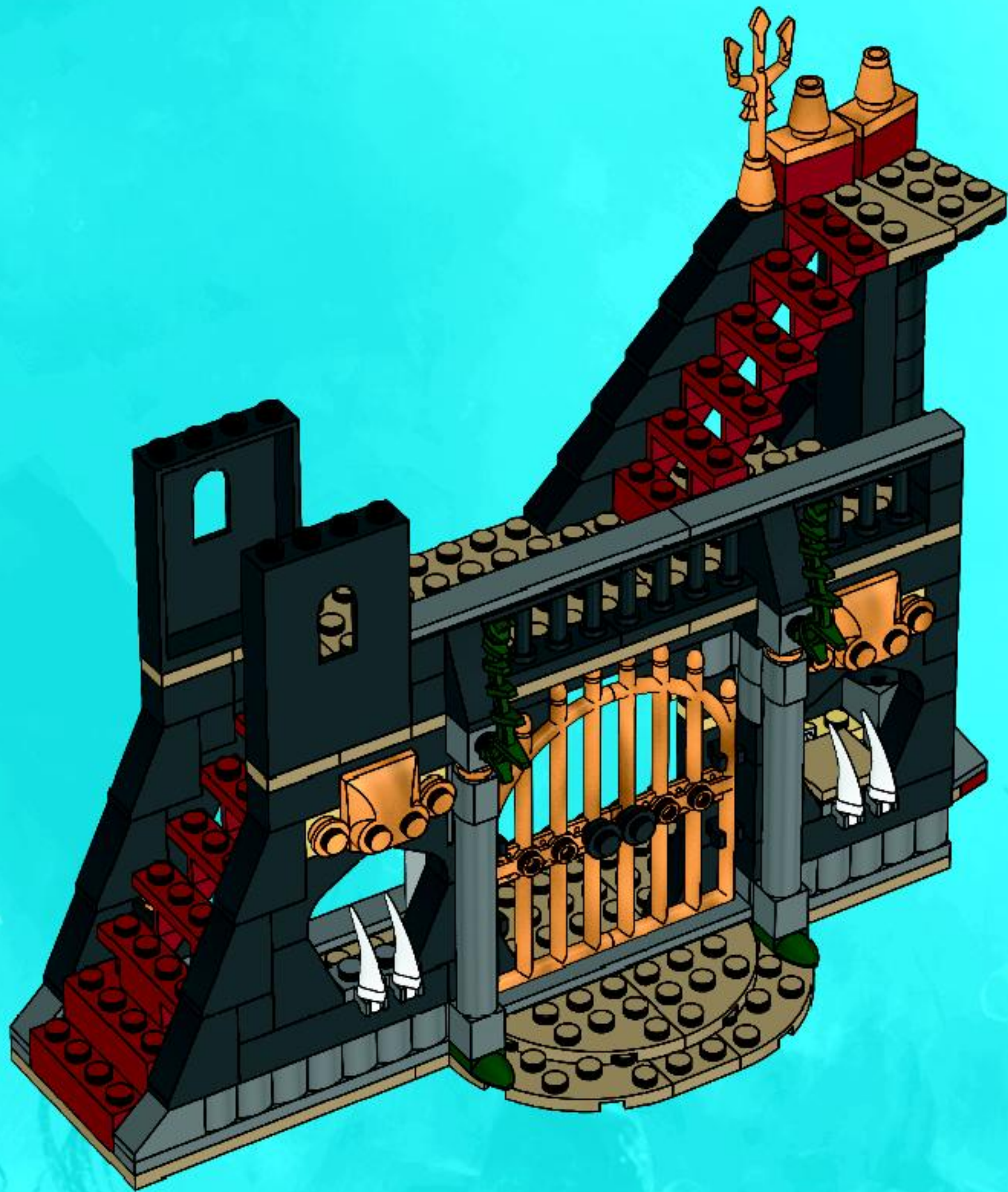



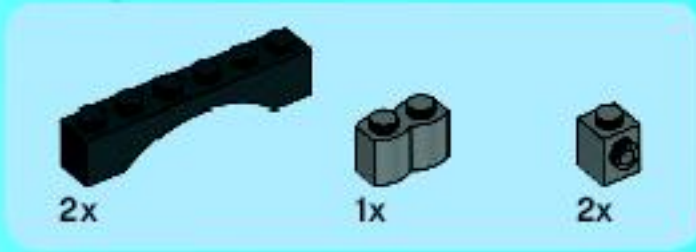

44

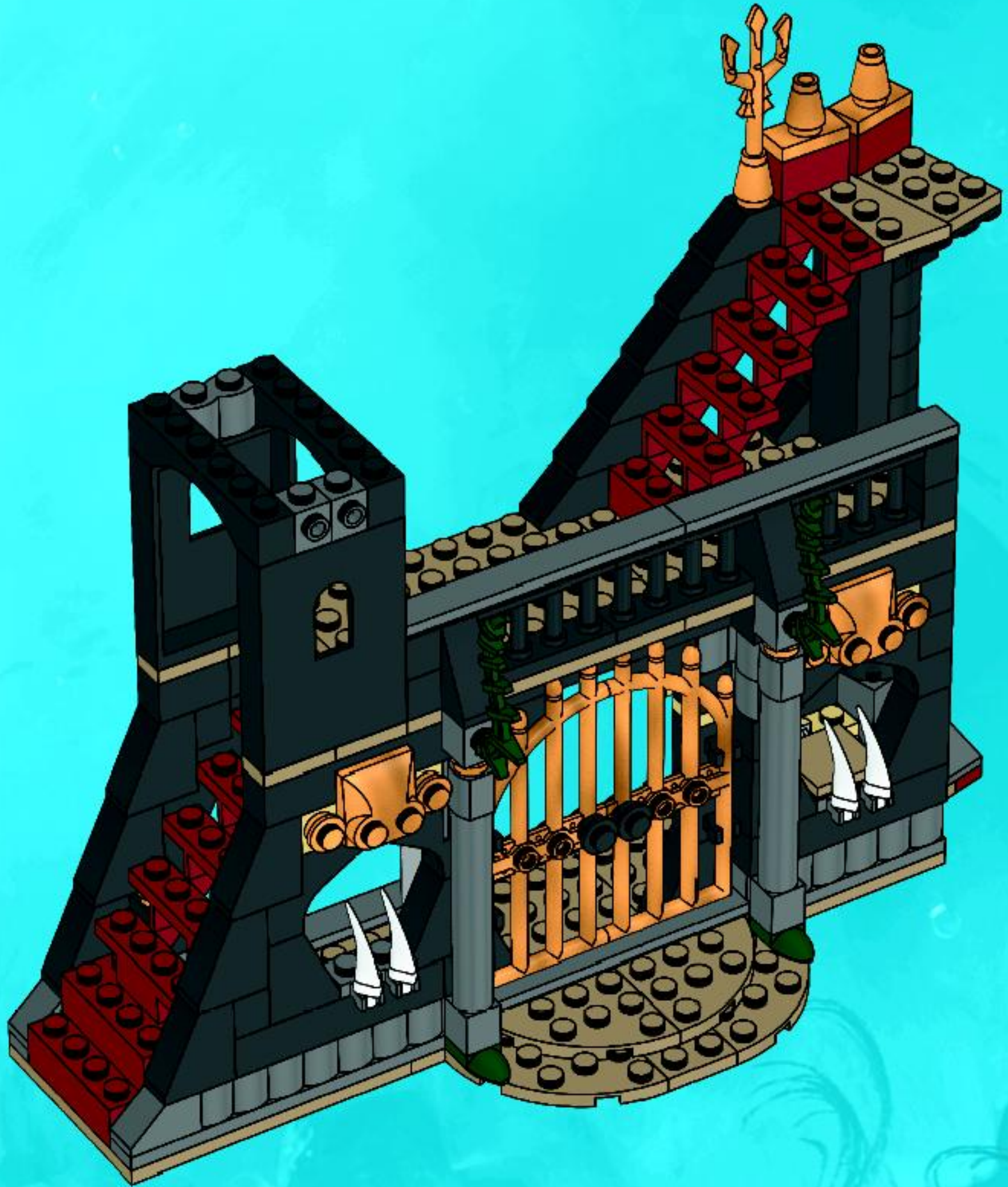

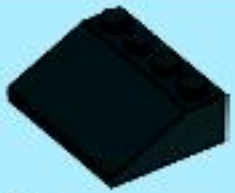

2x



2x

# 45

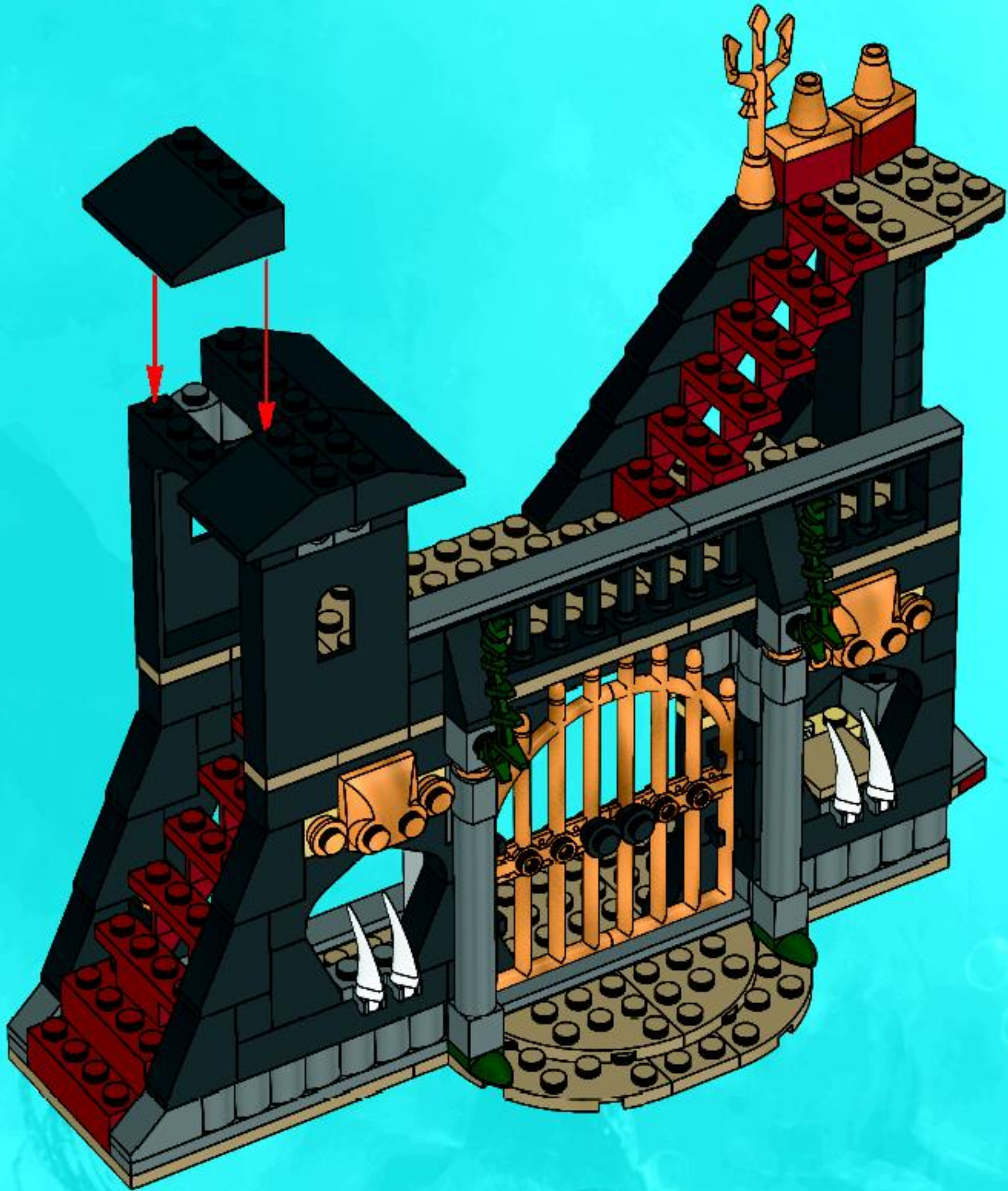



2x

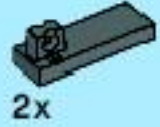

2x



2x

# 46

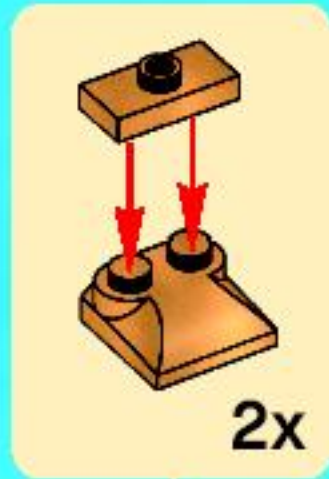



47

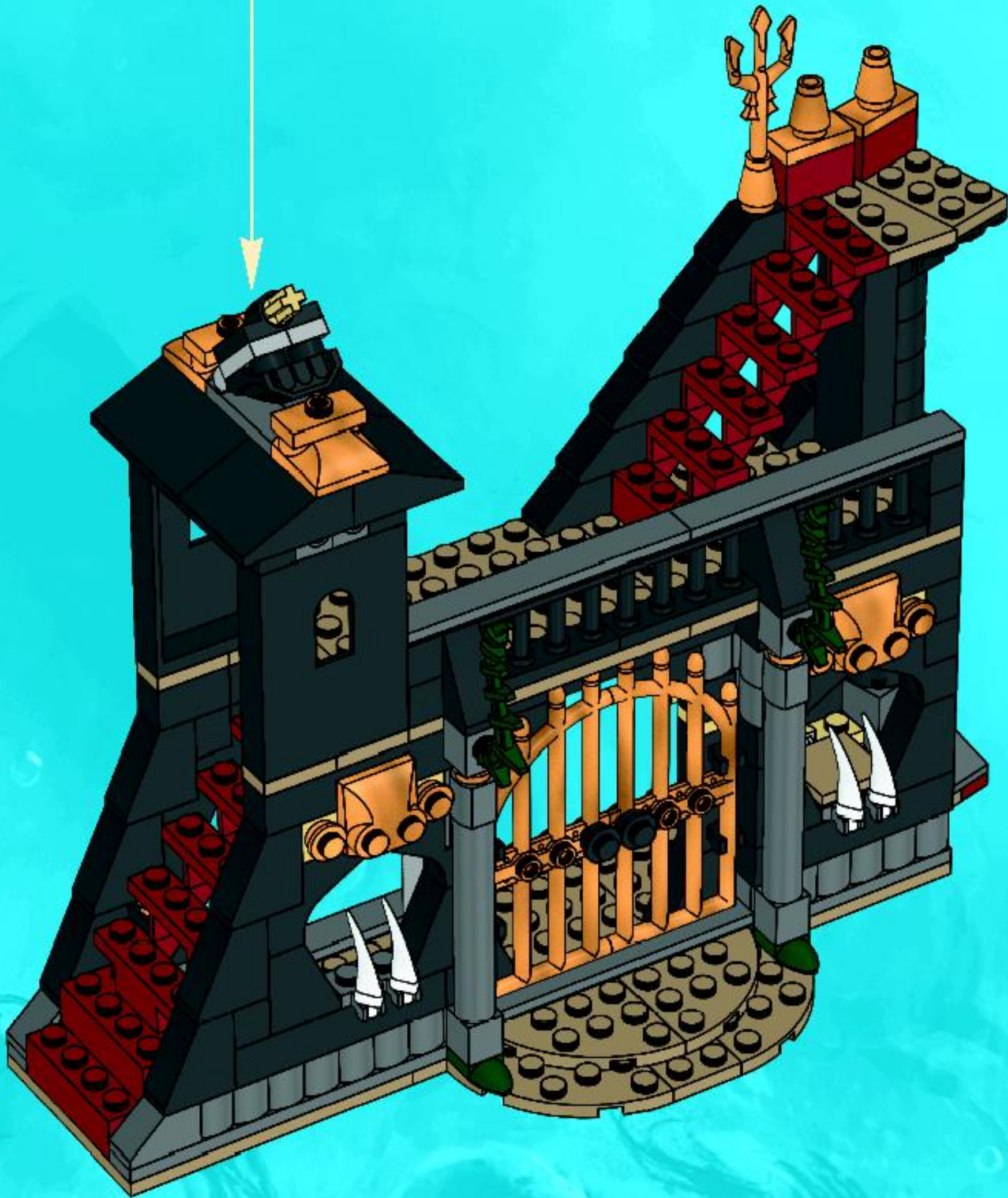
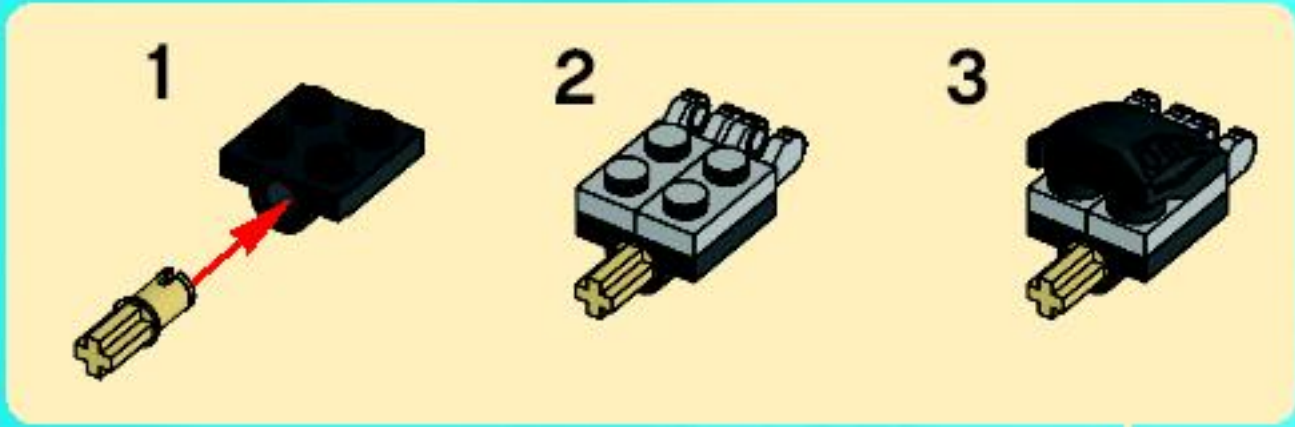

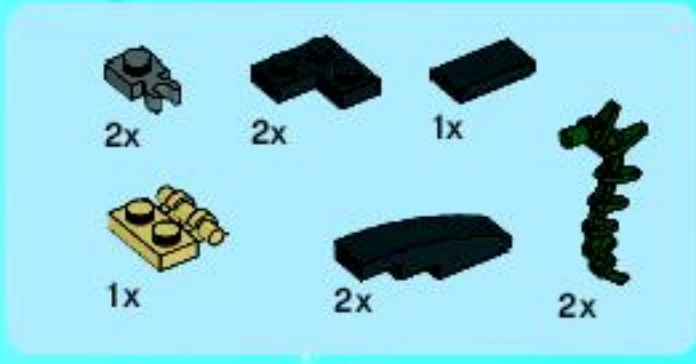

48

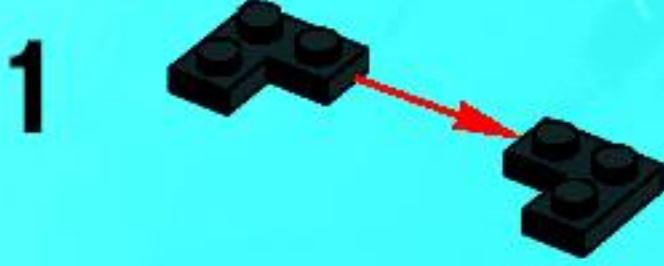

3



4



5

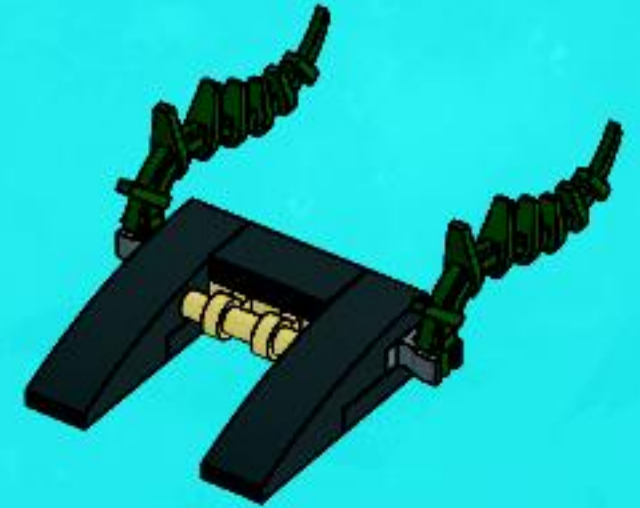





8

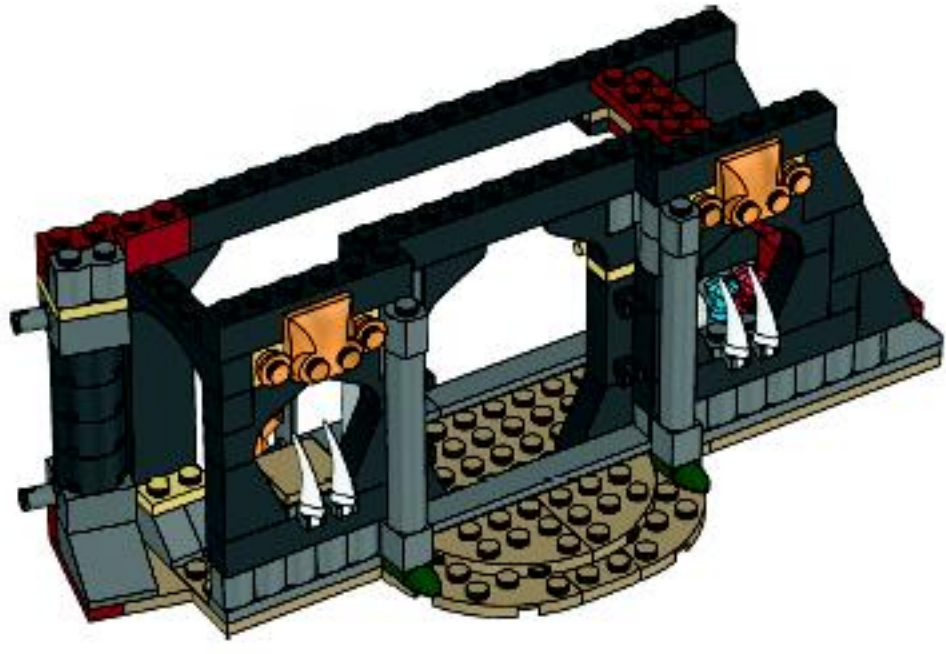

2x

1

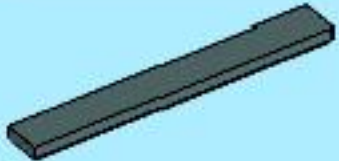
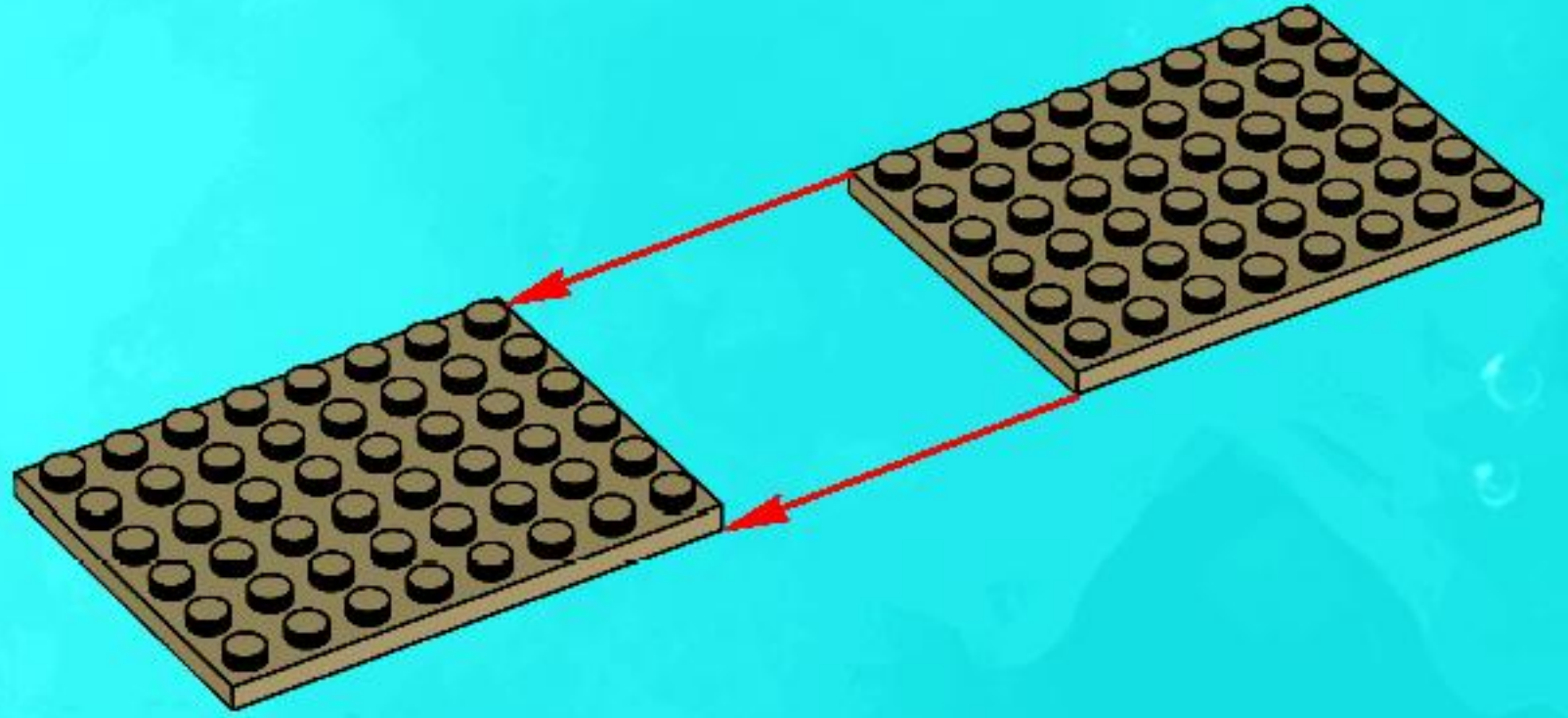

2x

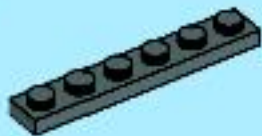

1x

2

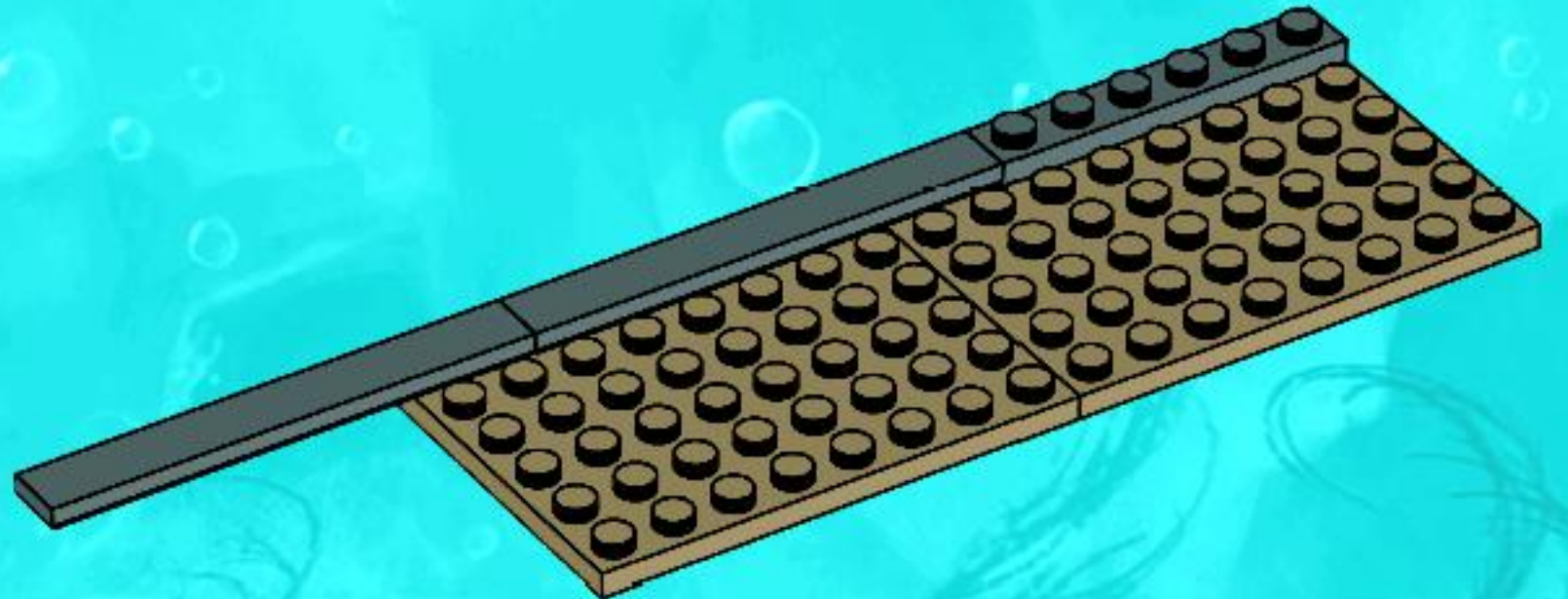

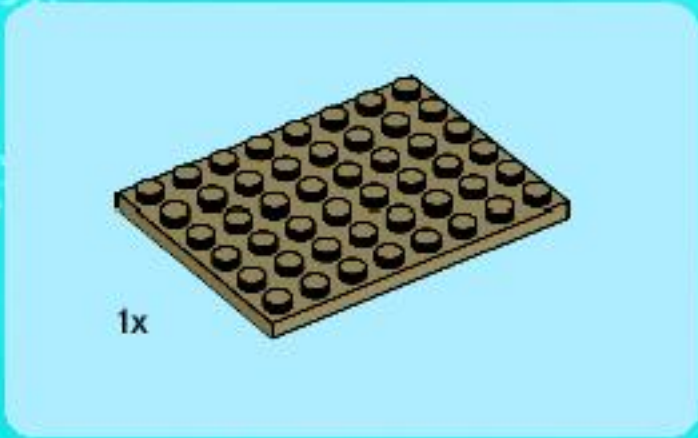

3

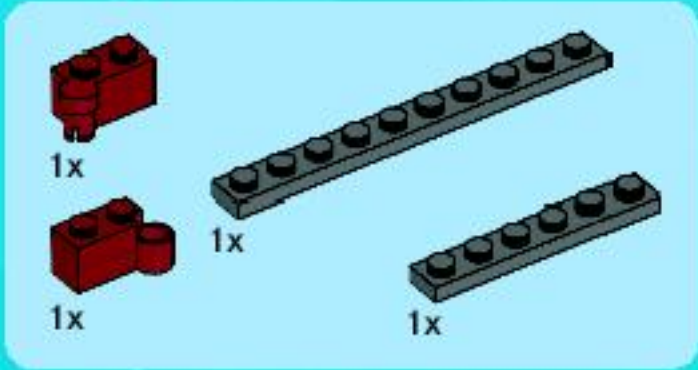
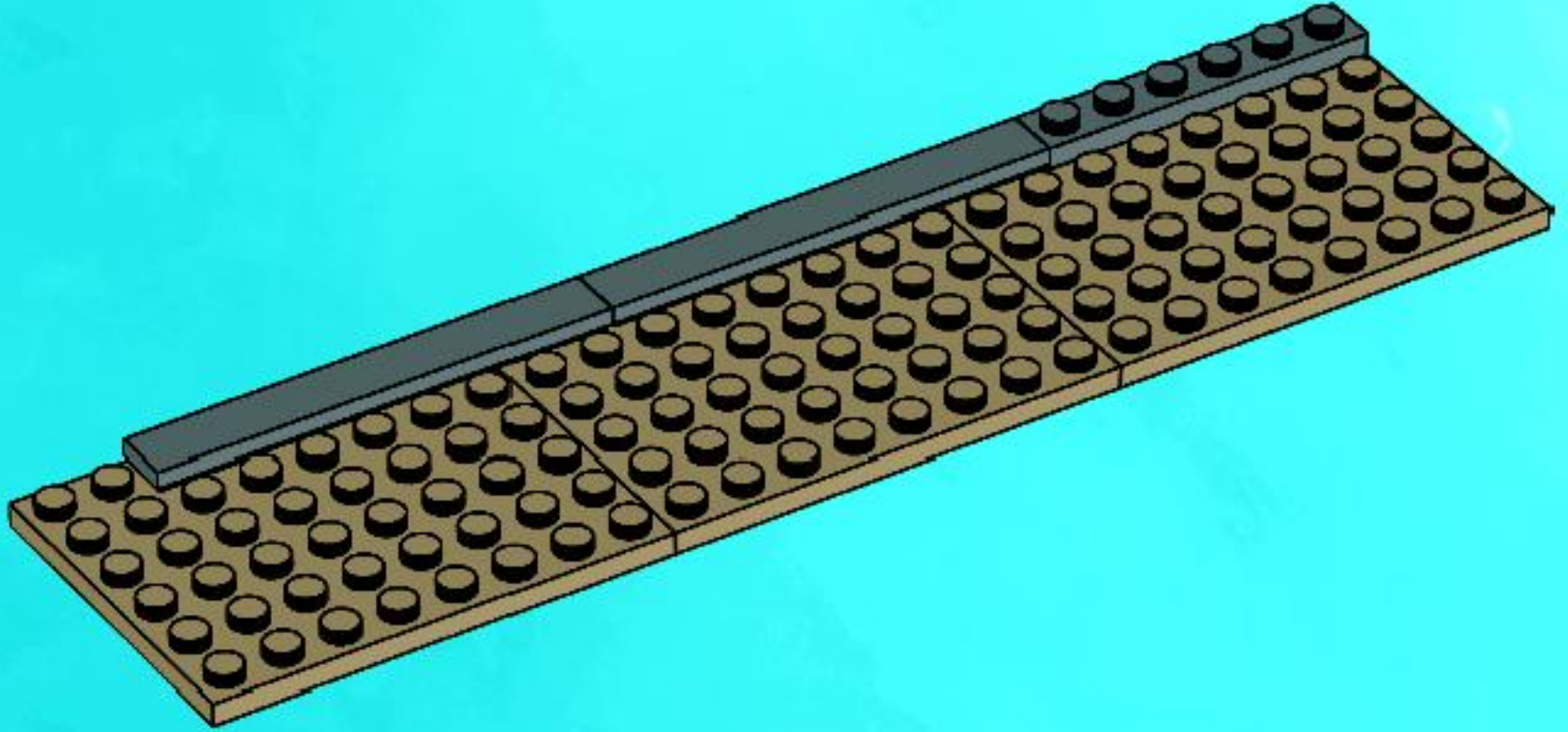

4

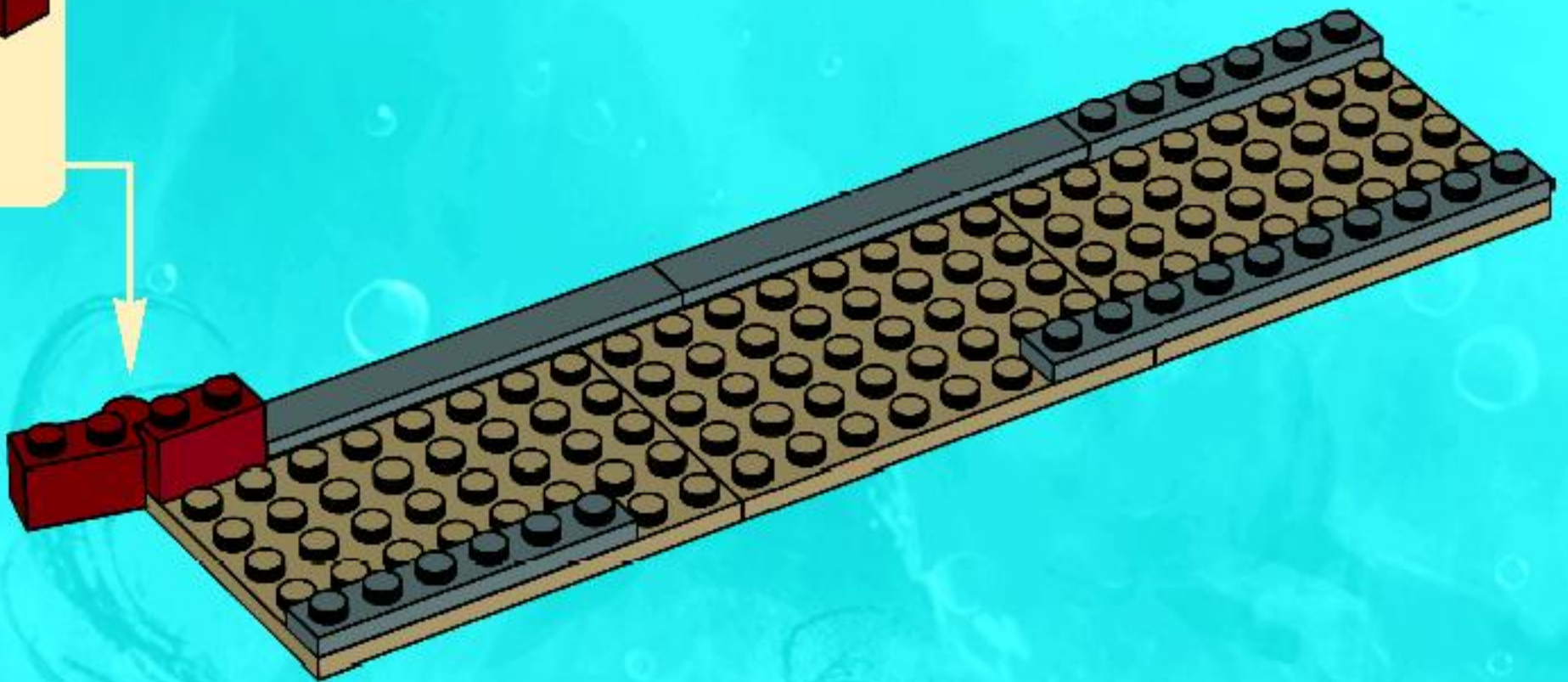
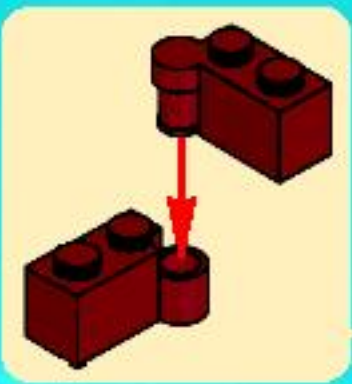



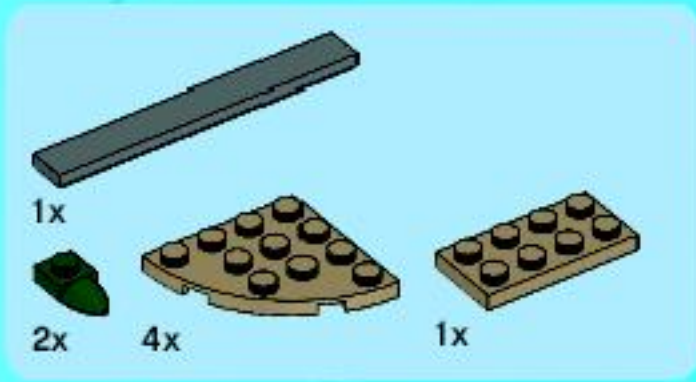

# 5

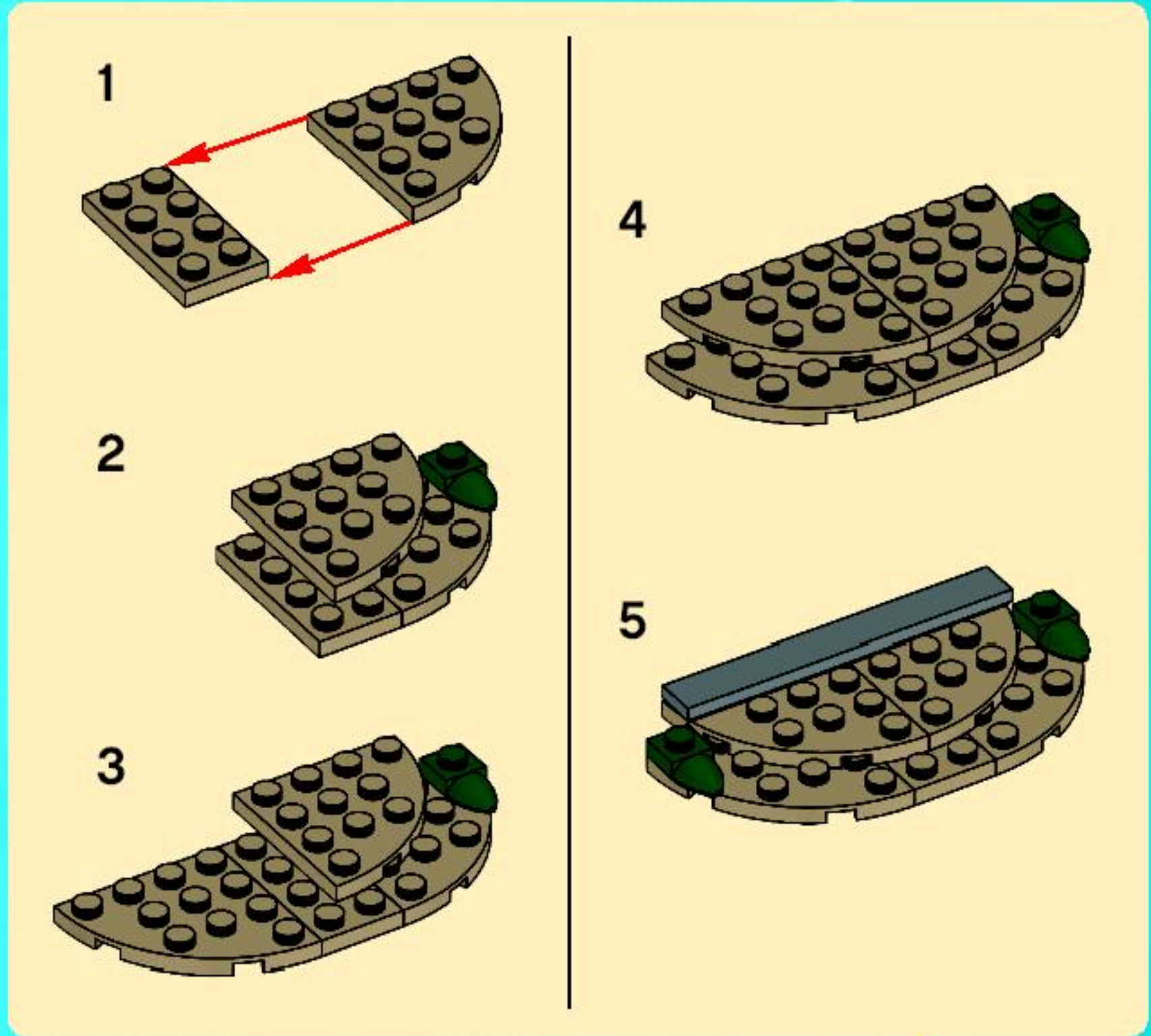

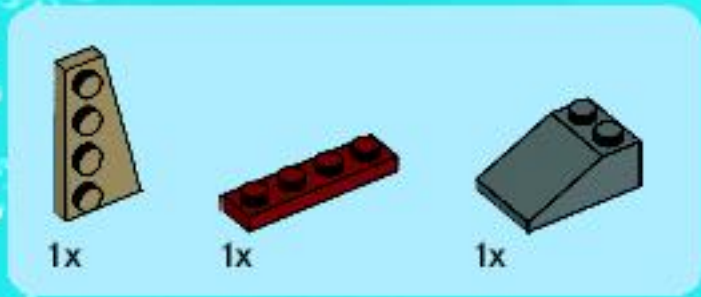

6

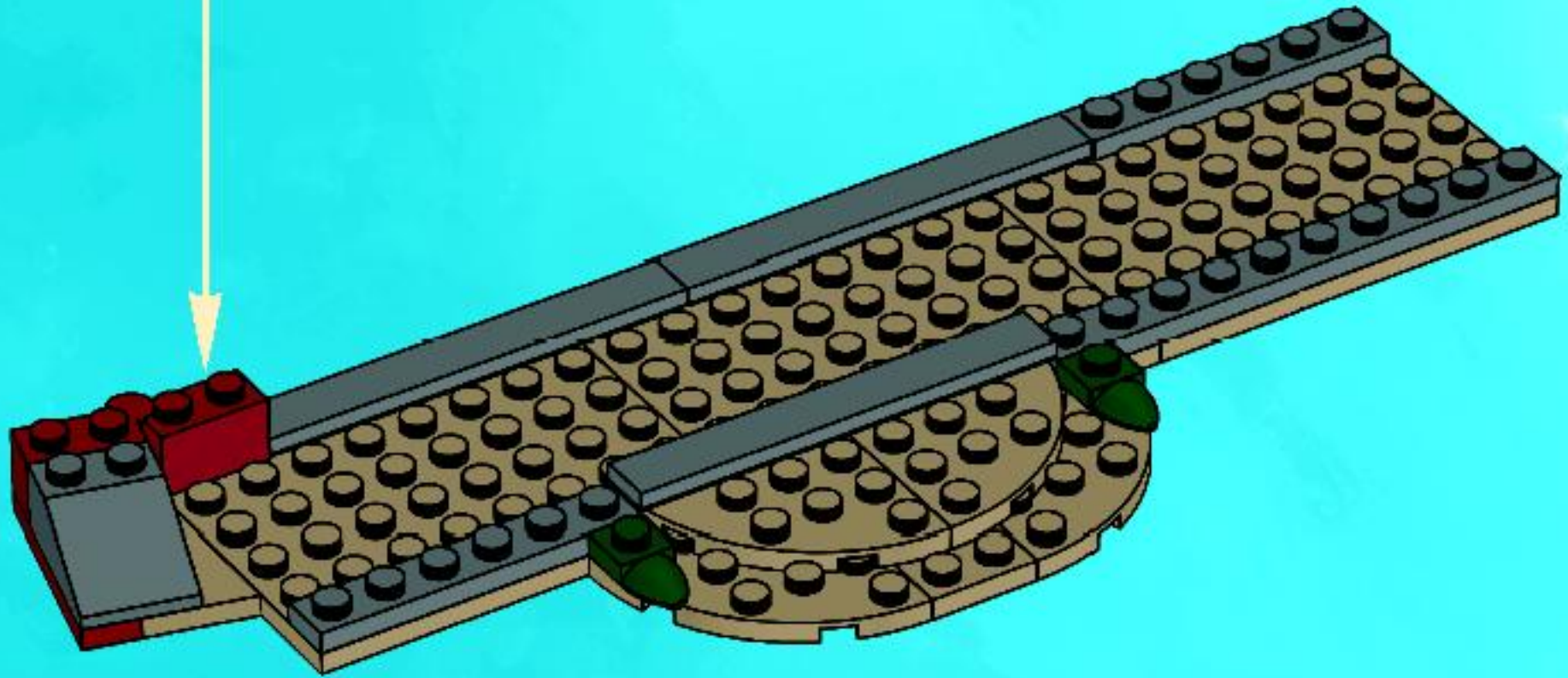
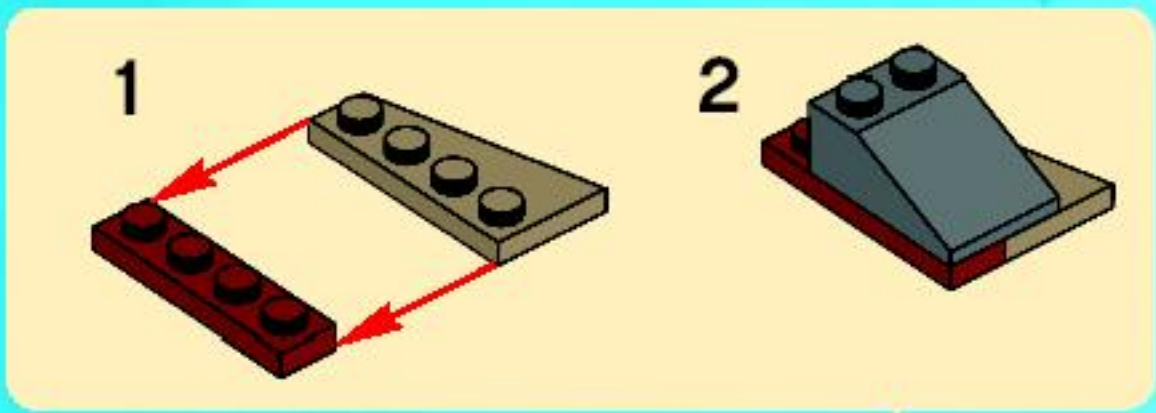

7

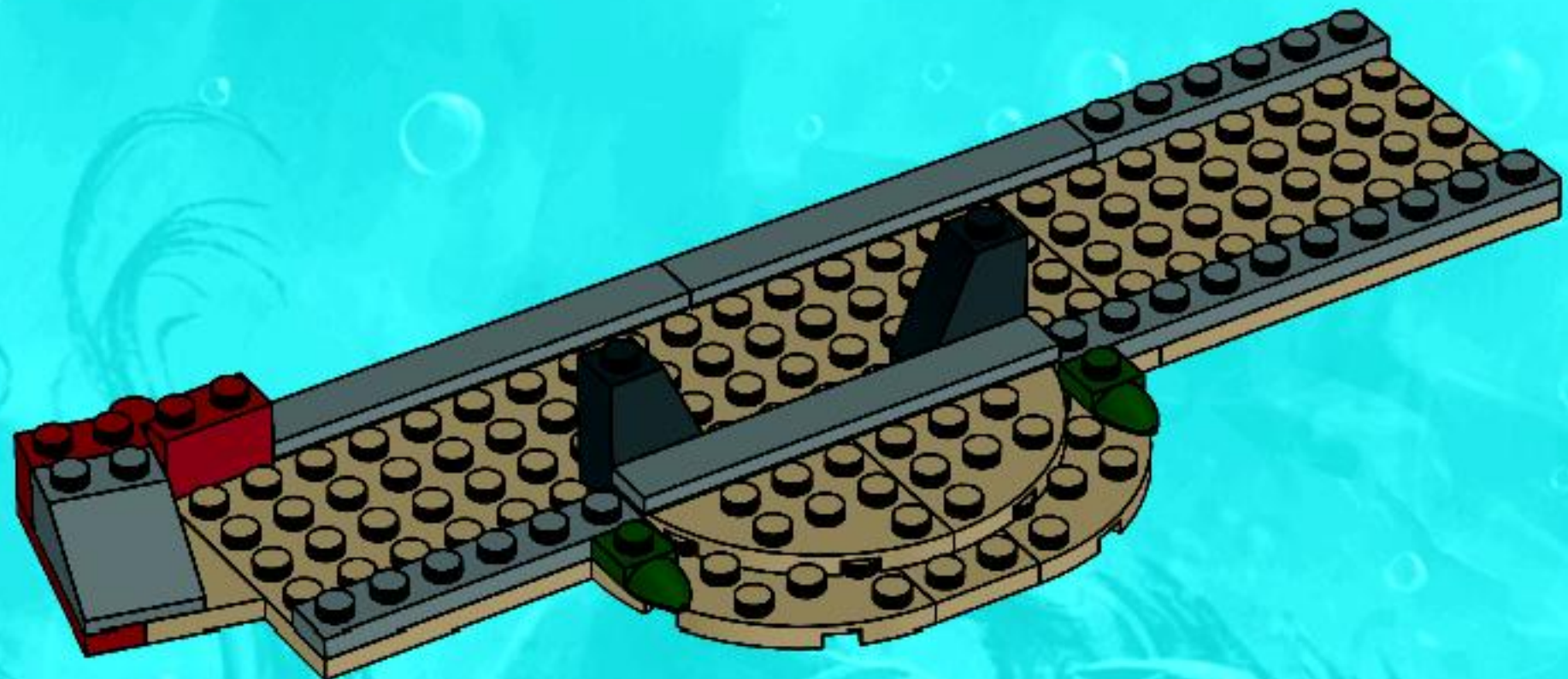



2x



1x

8

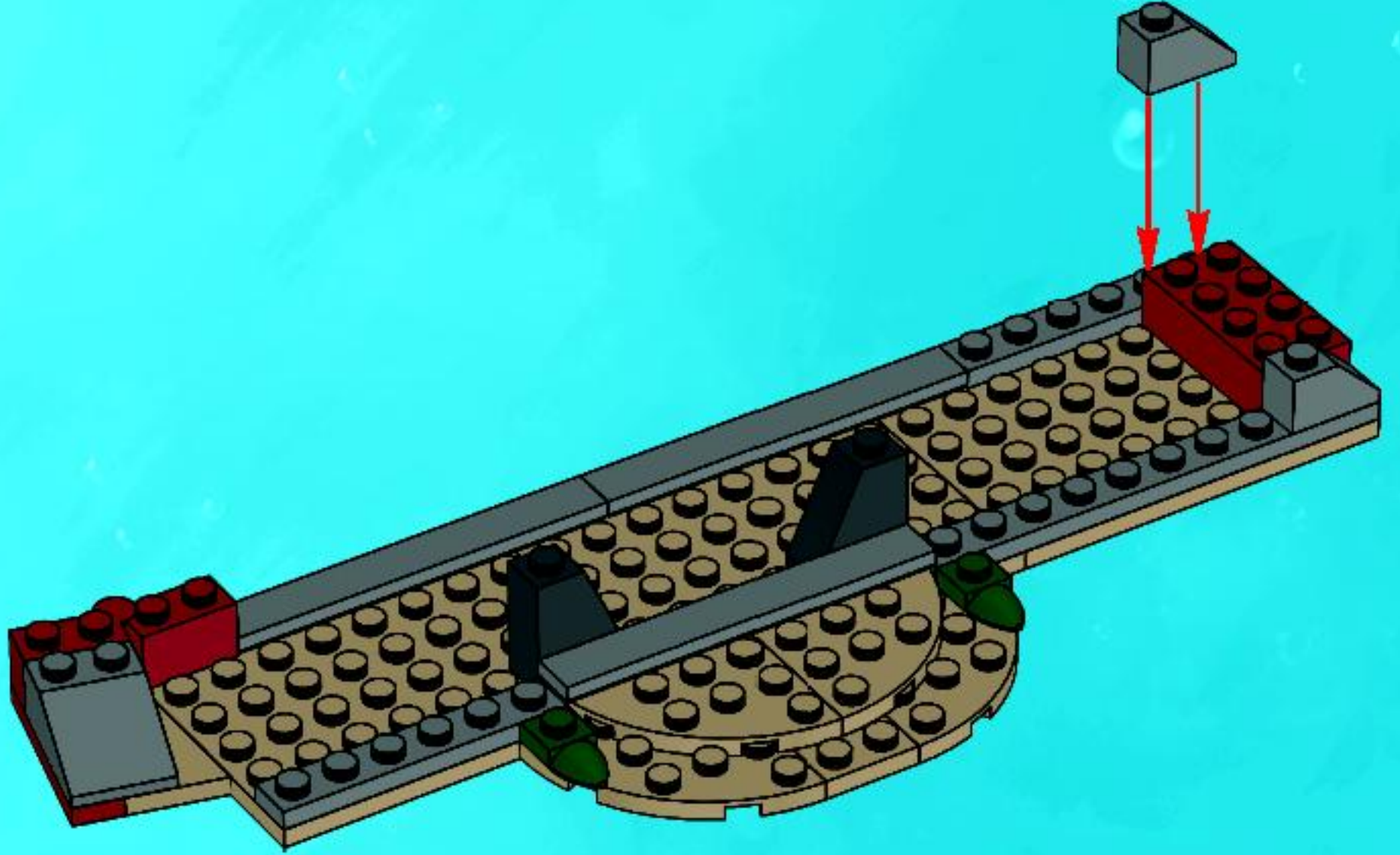

2x



1x

9

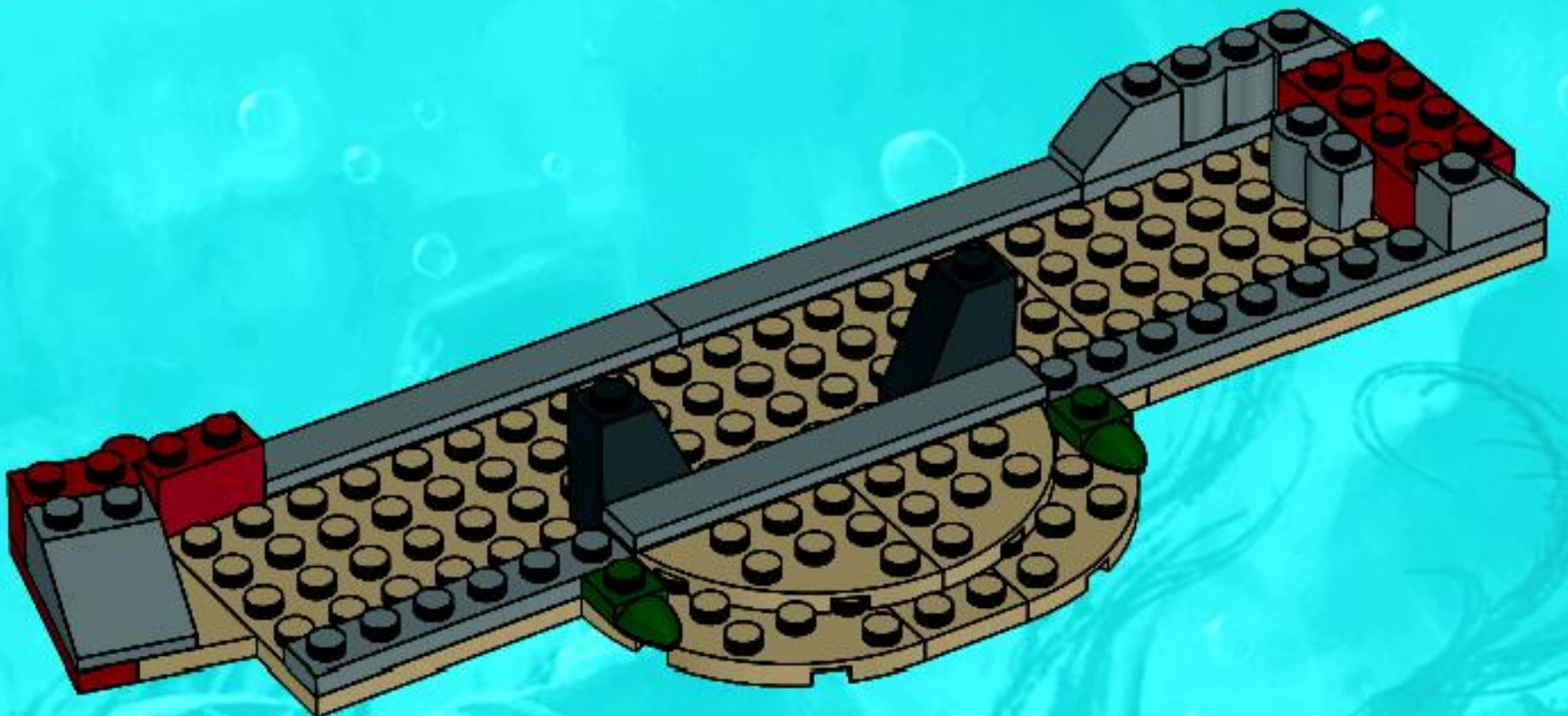



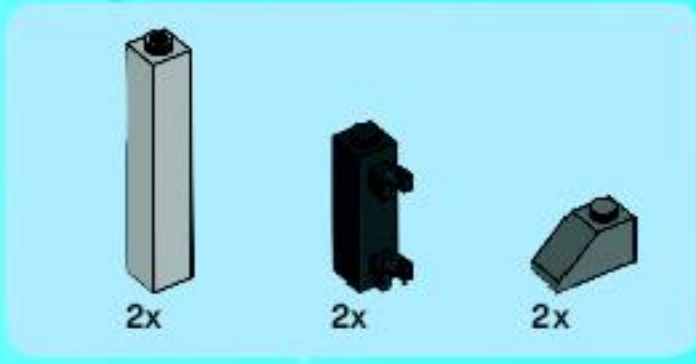

12



13

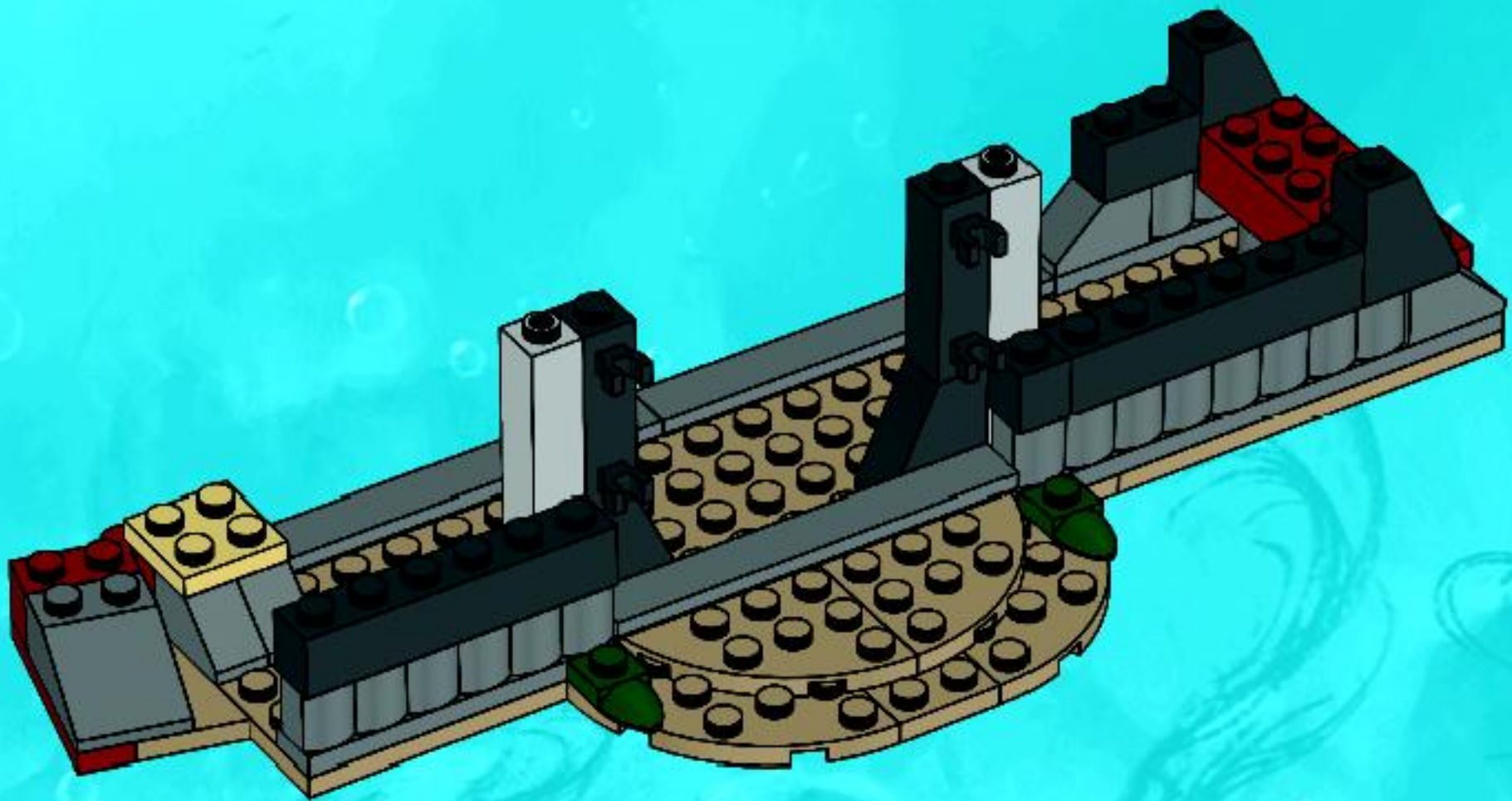



2x



2x

# 14

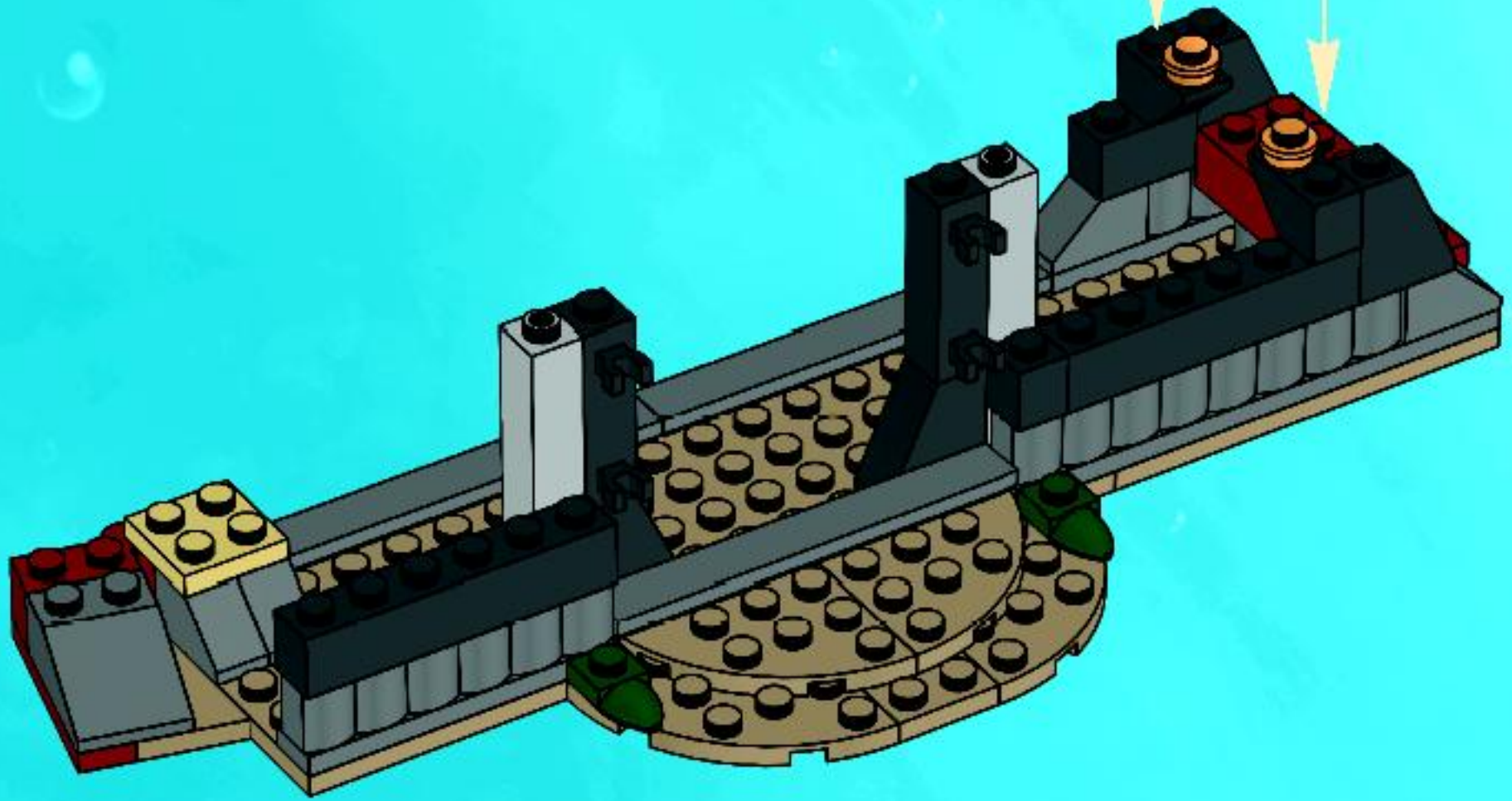

4x



4x



1x

# 15





# 16



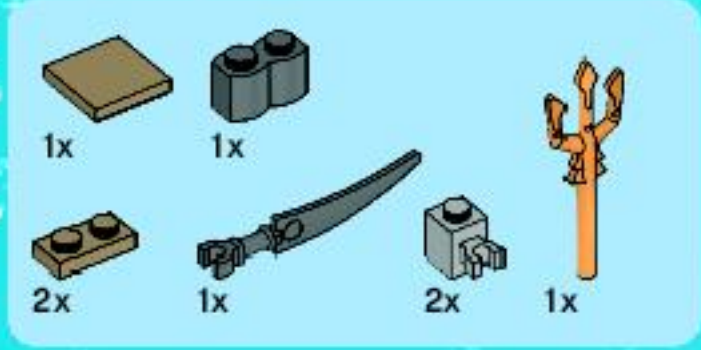

17

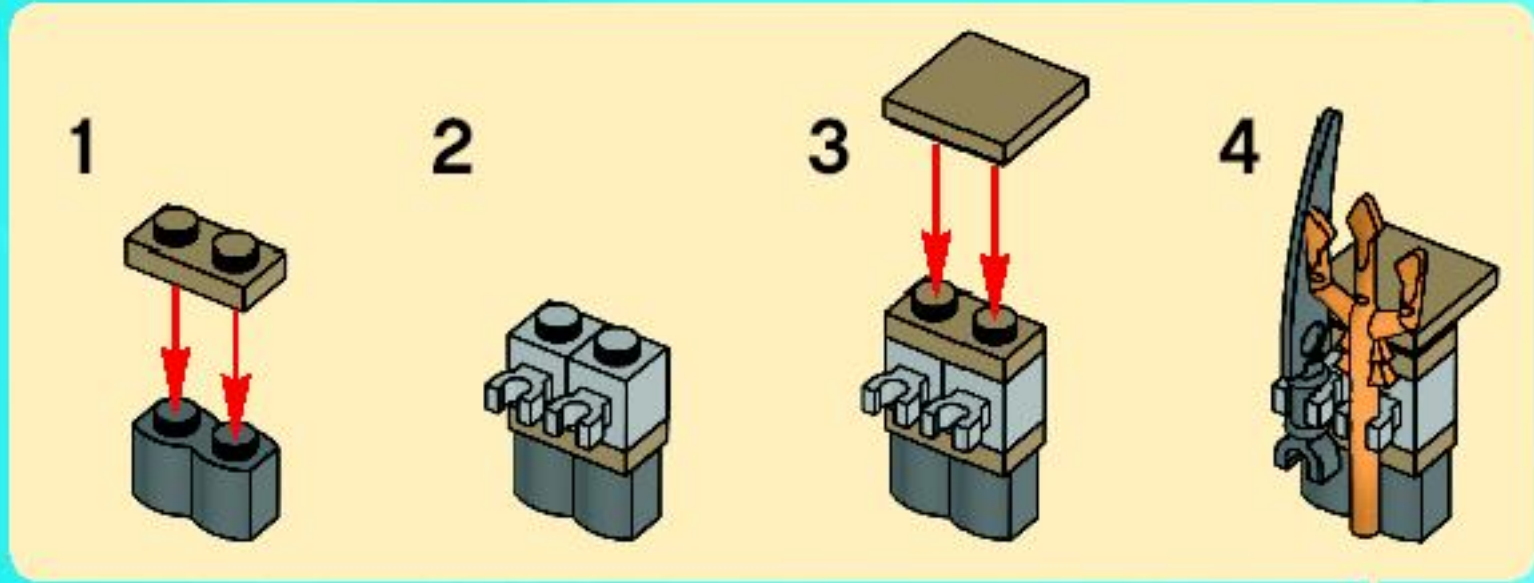

18

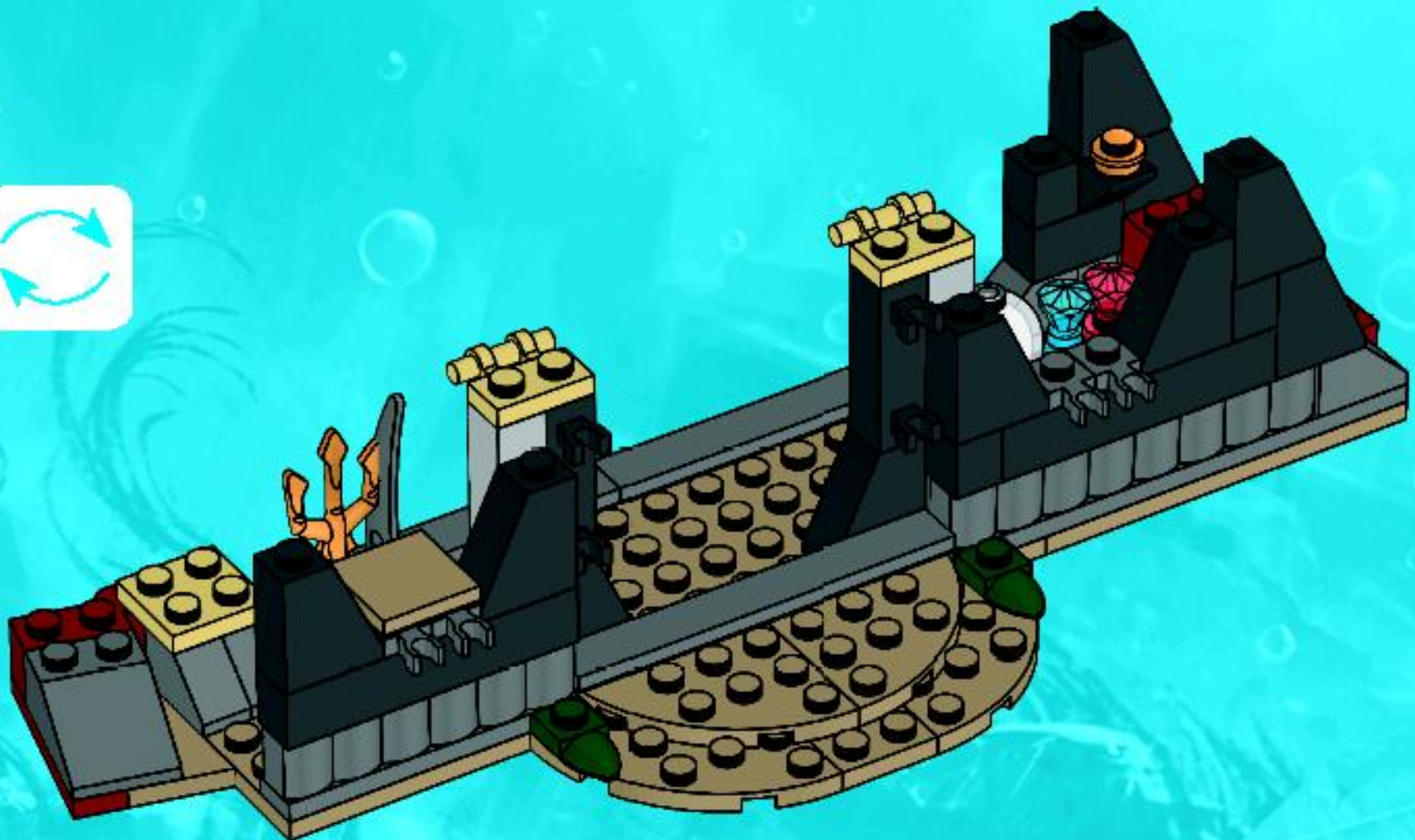



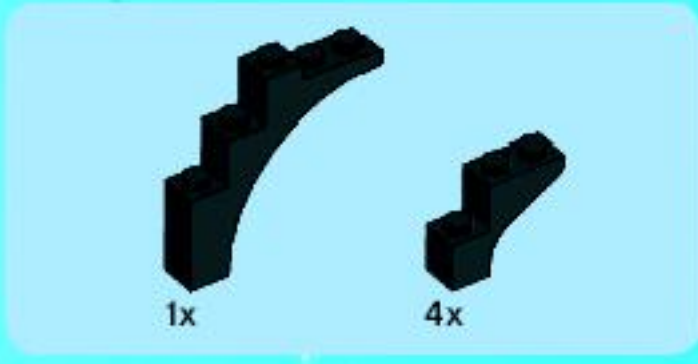

19

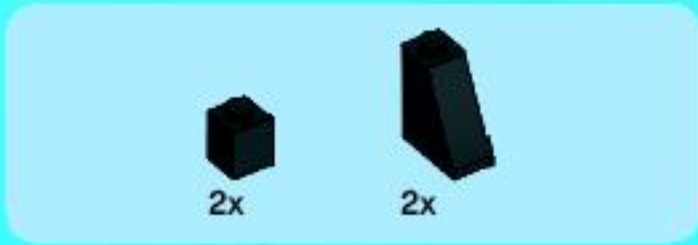
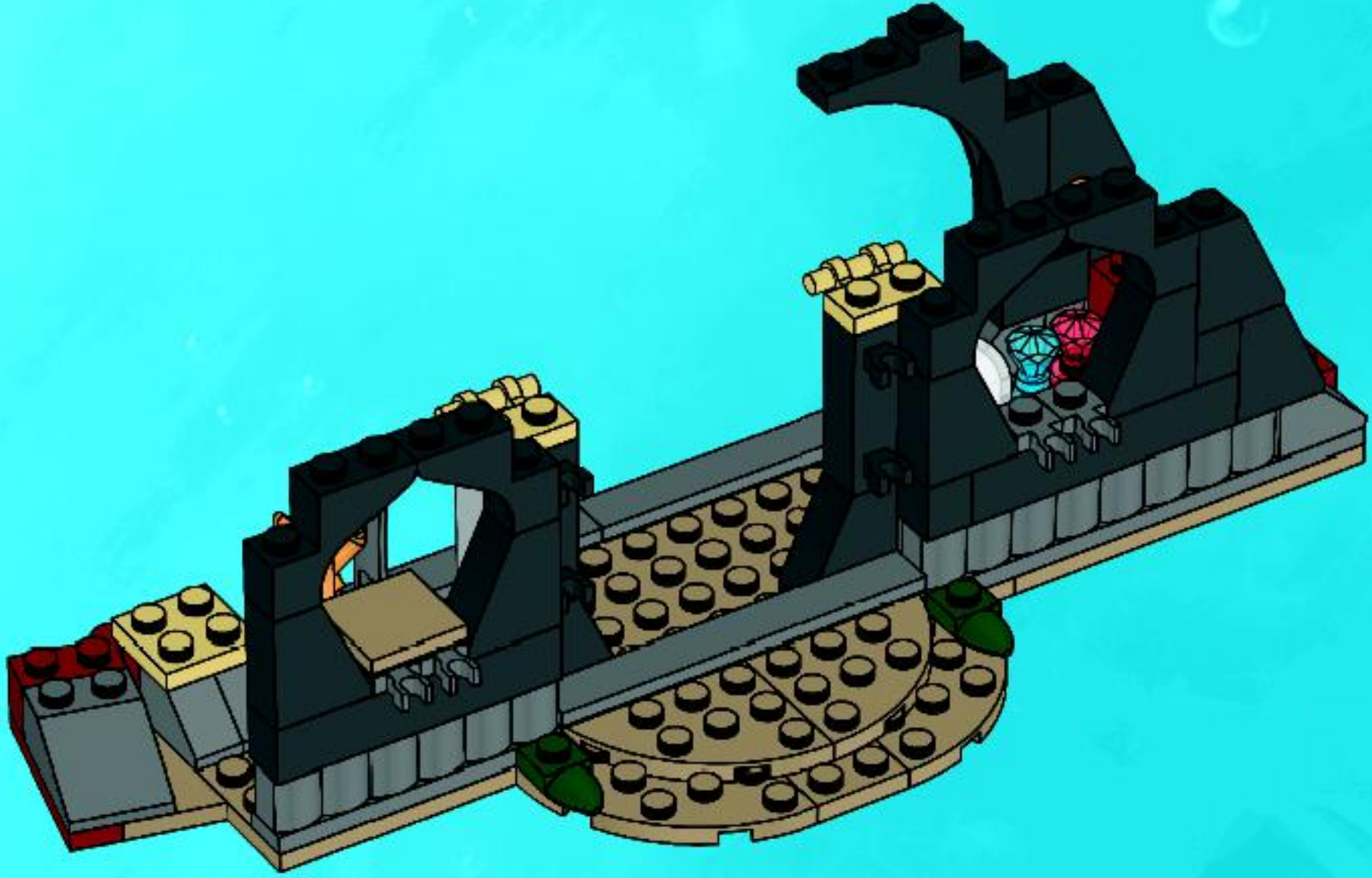

20





2x



2x

# 21

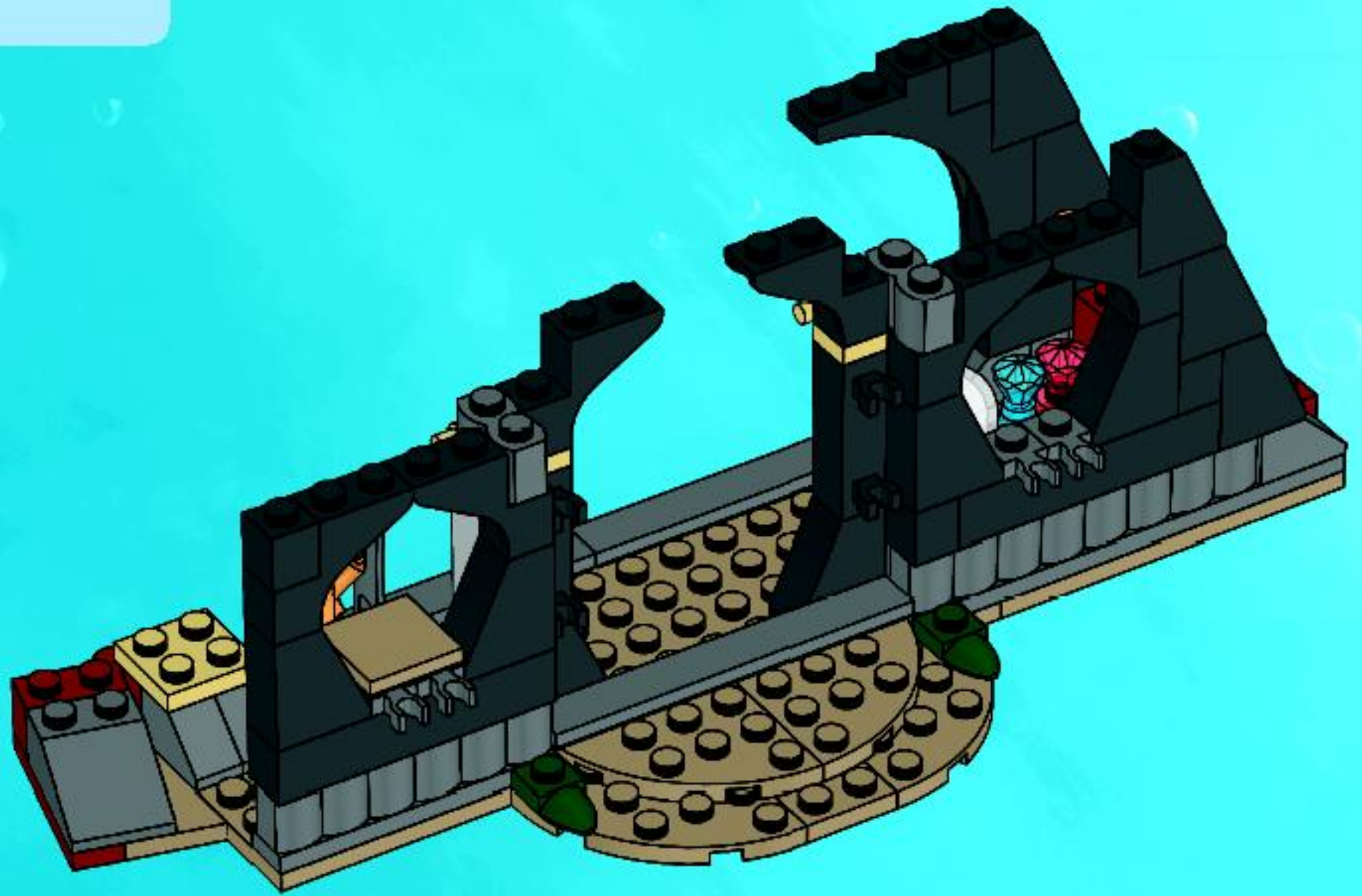

1x



2x



4x

# 22

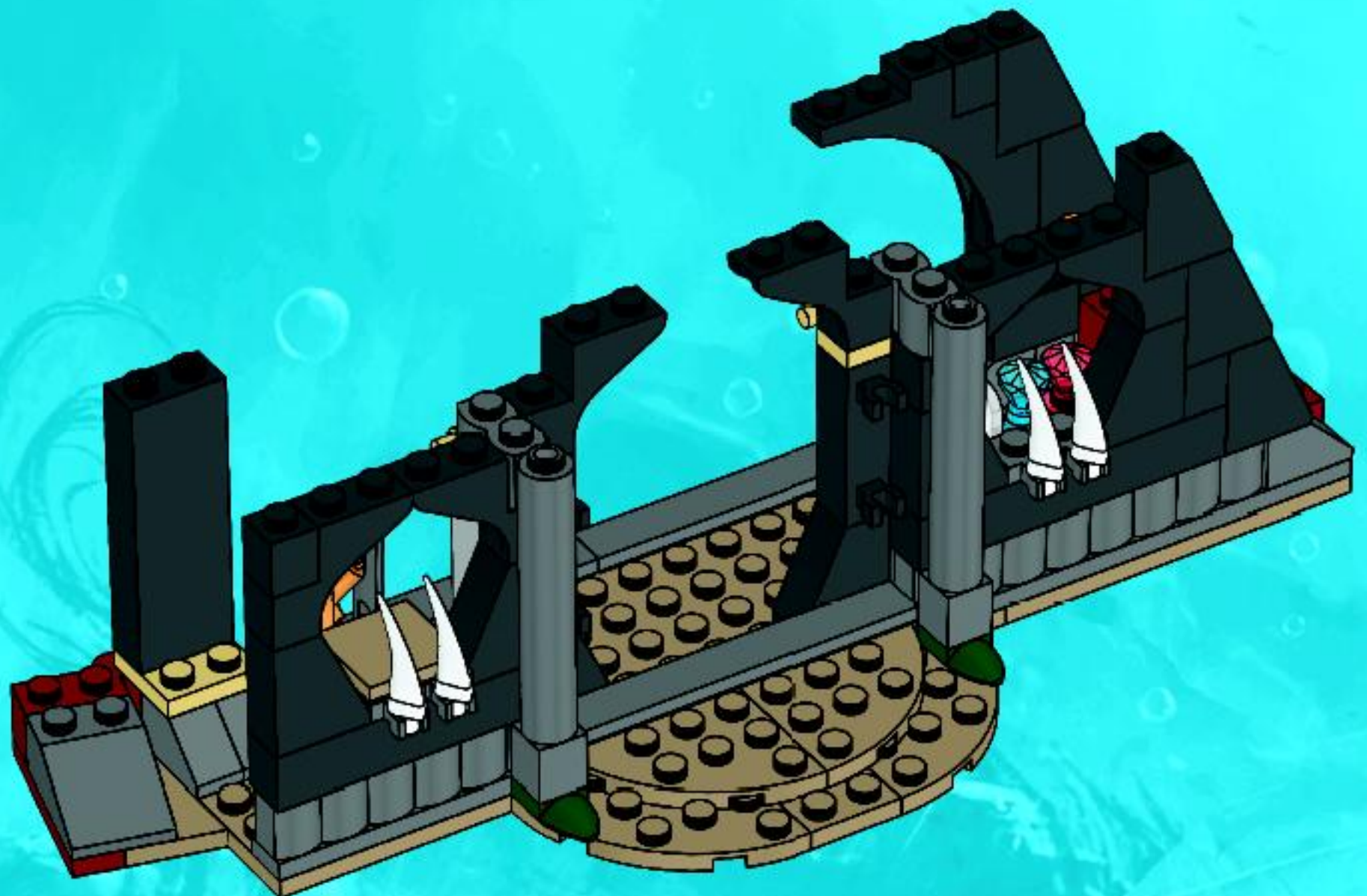



4x



1x

# 23

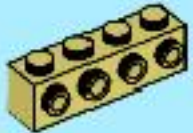
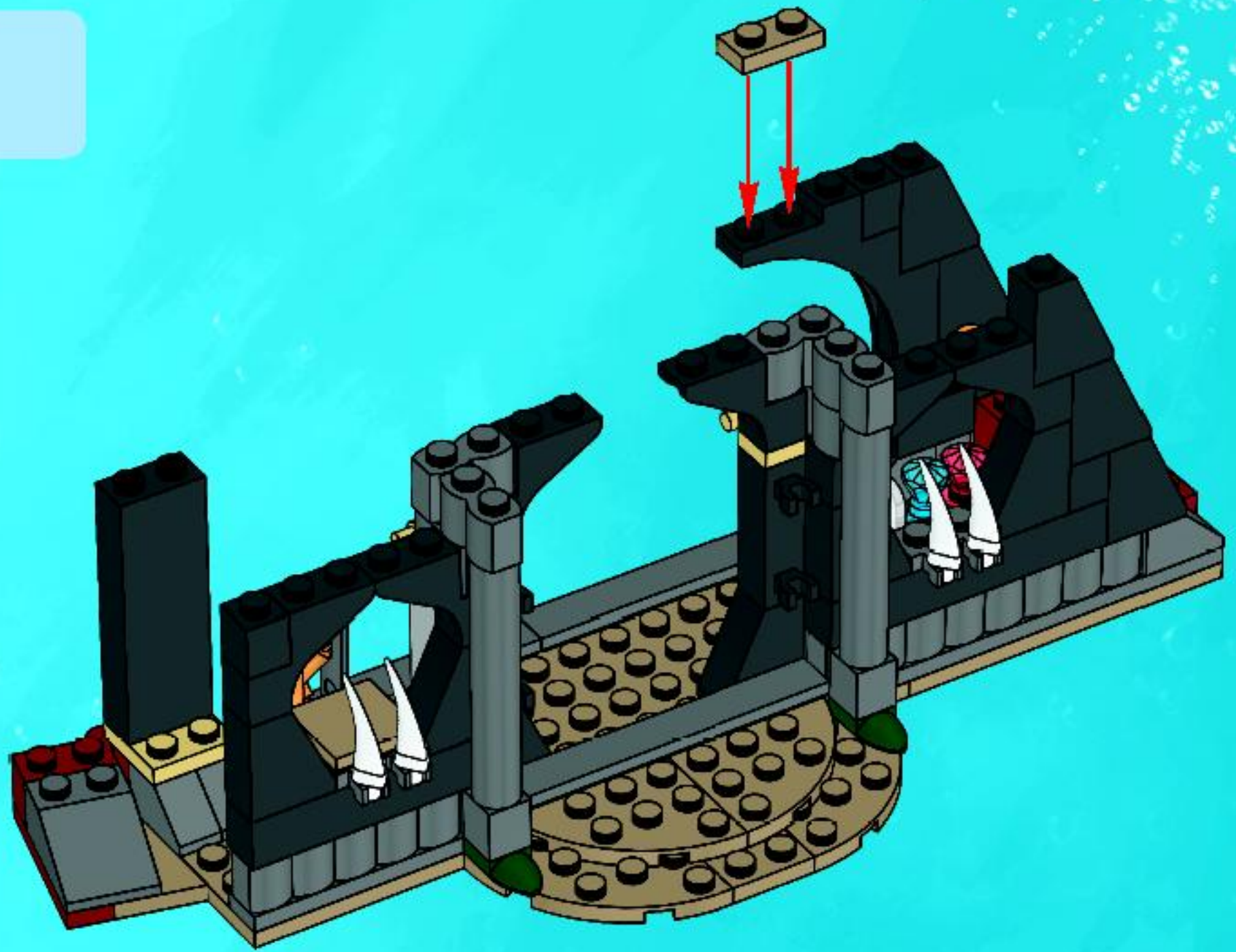

2x



2x



4x

# 24

1

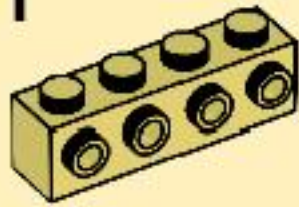

2



3



2x

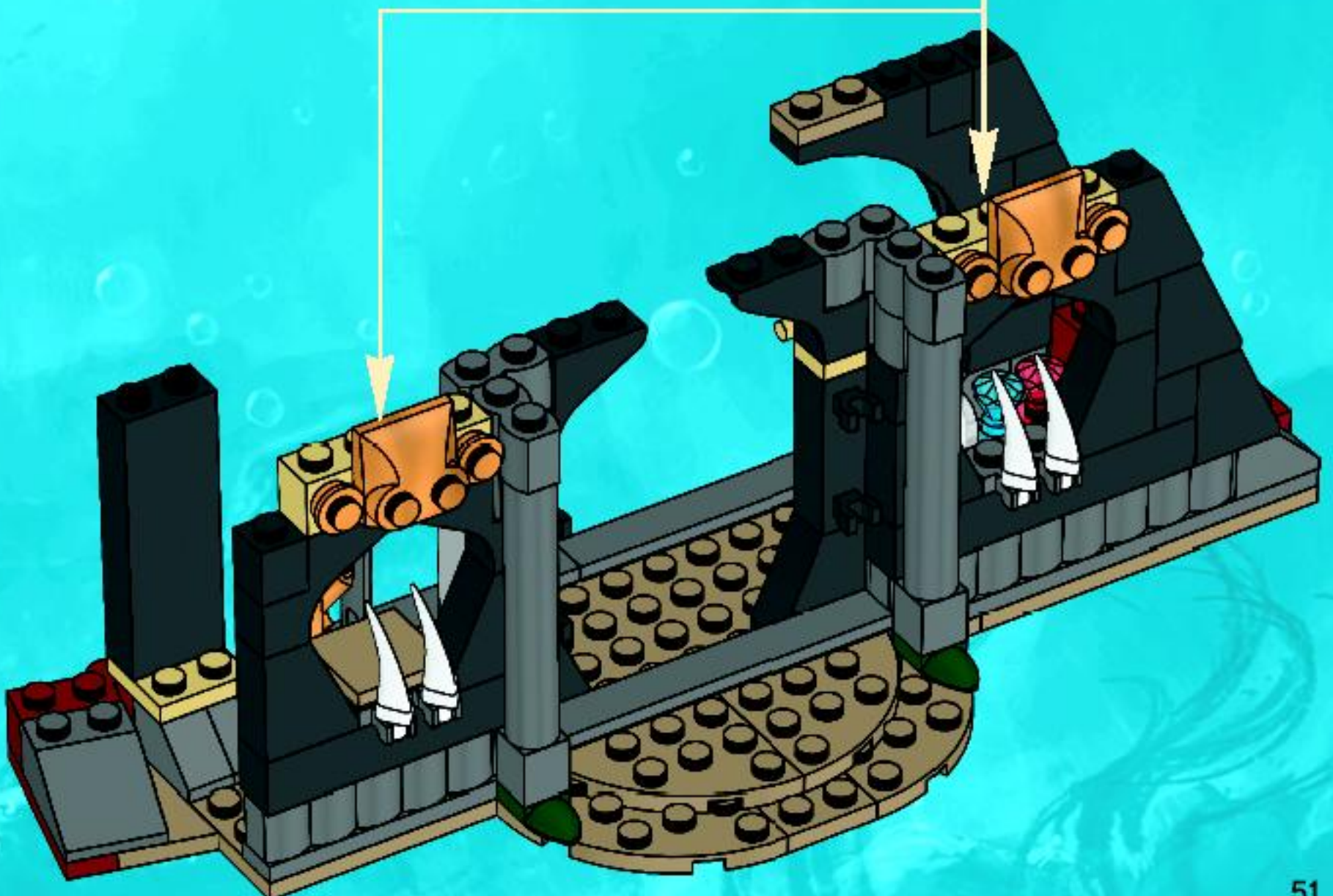

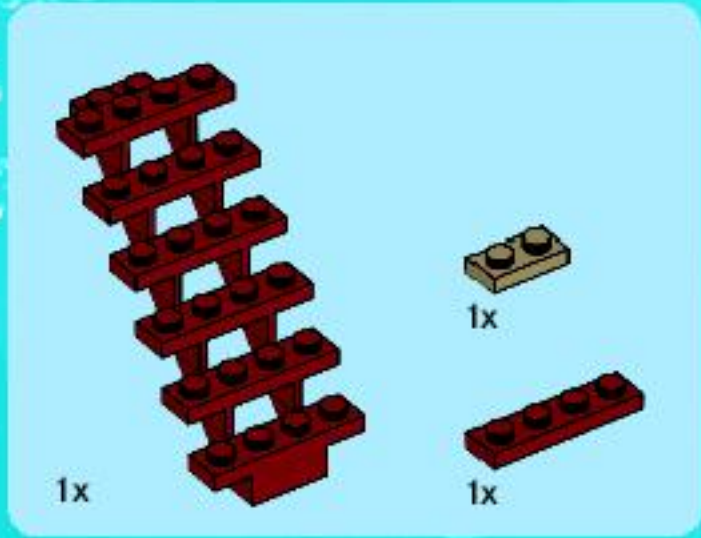

25

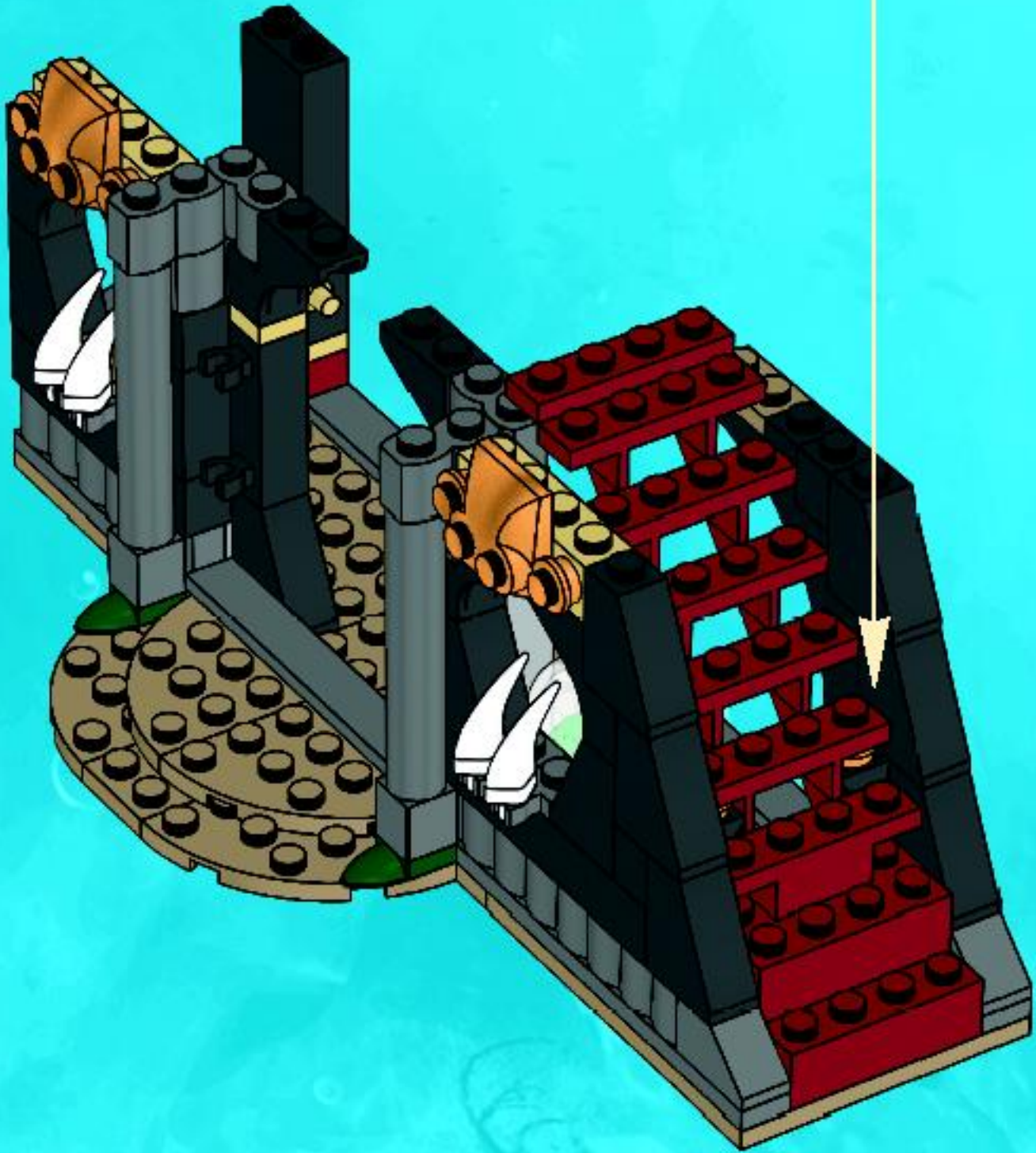
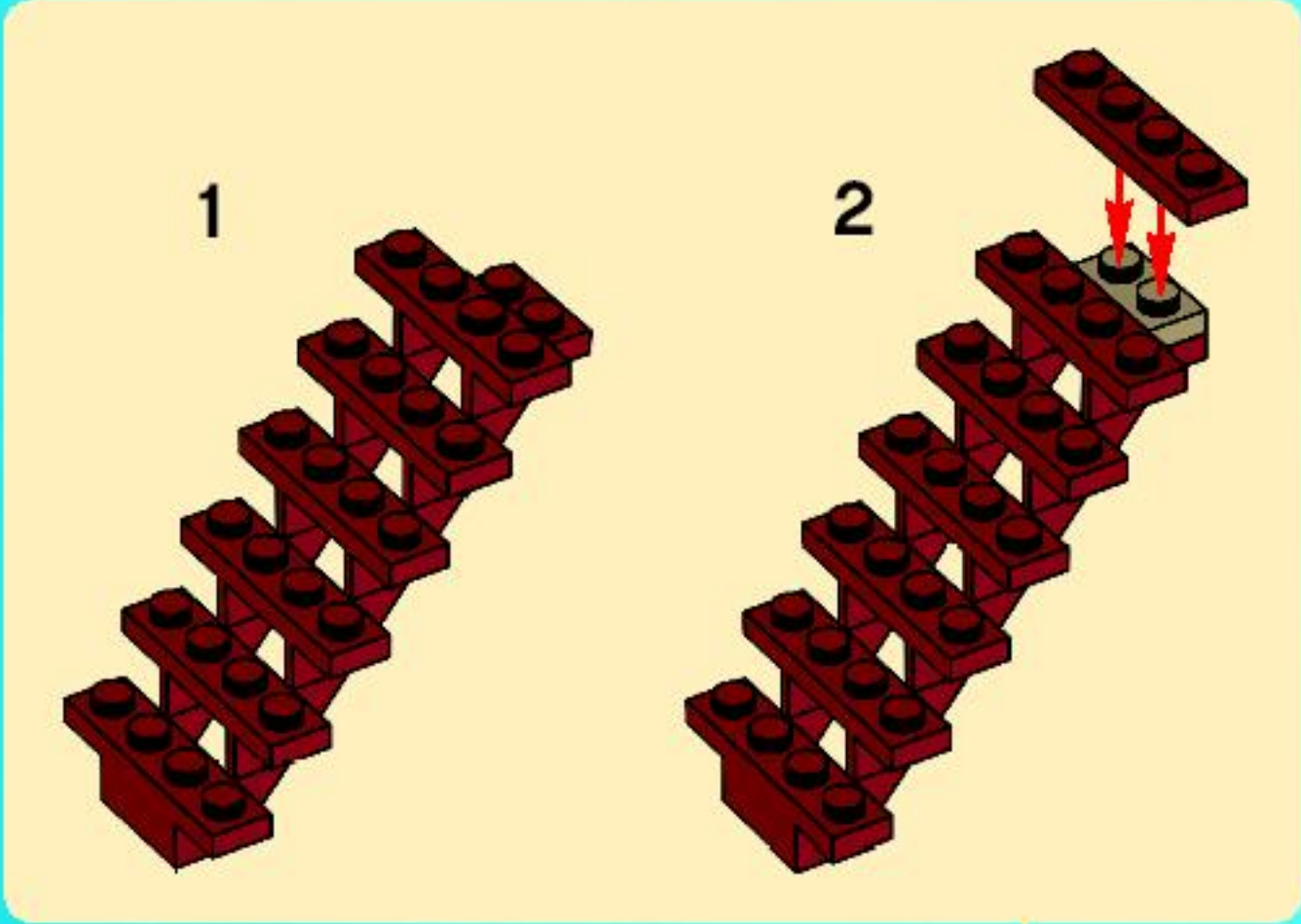



26

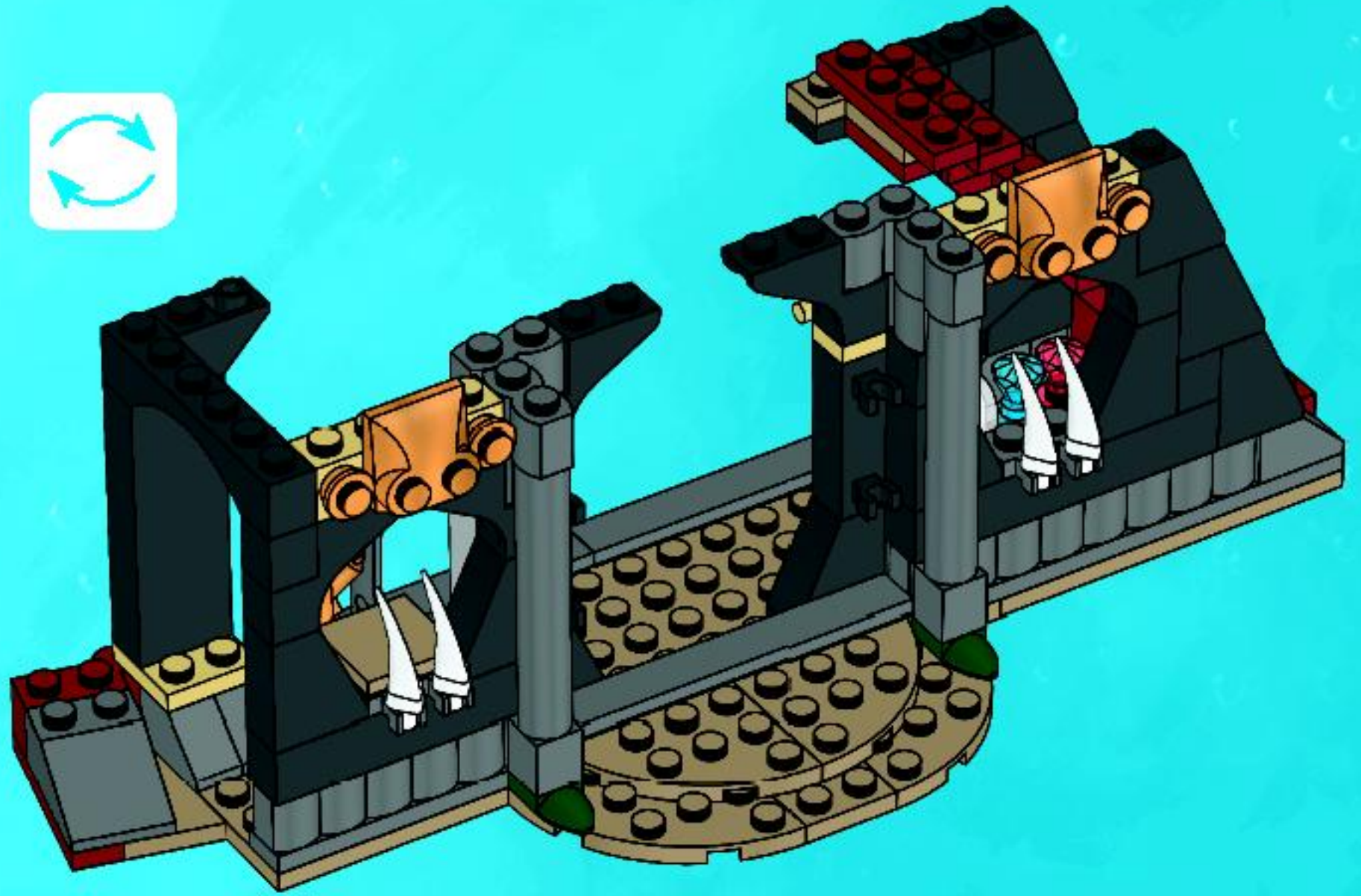

27

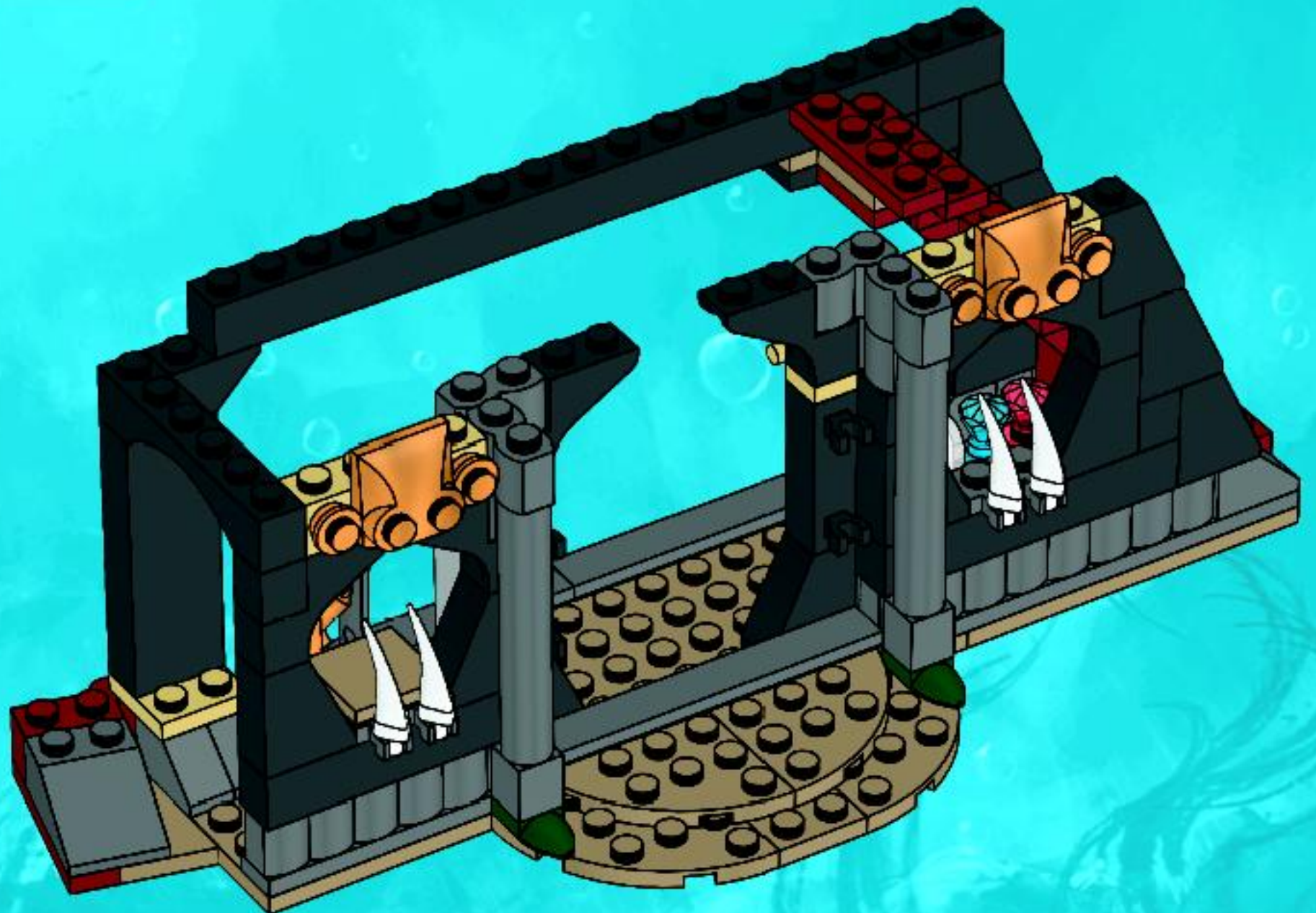

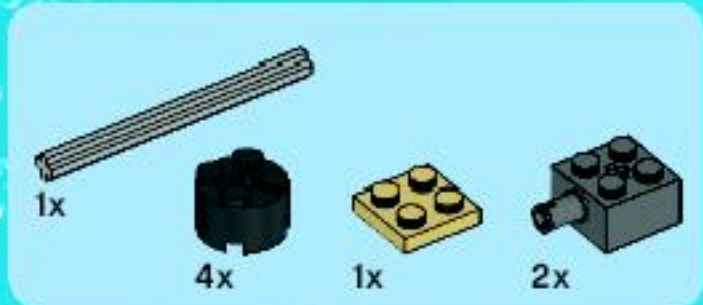

28

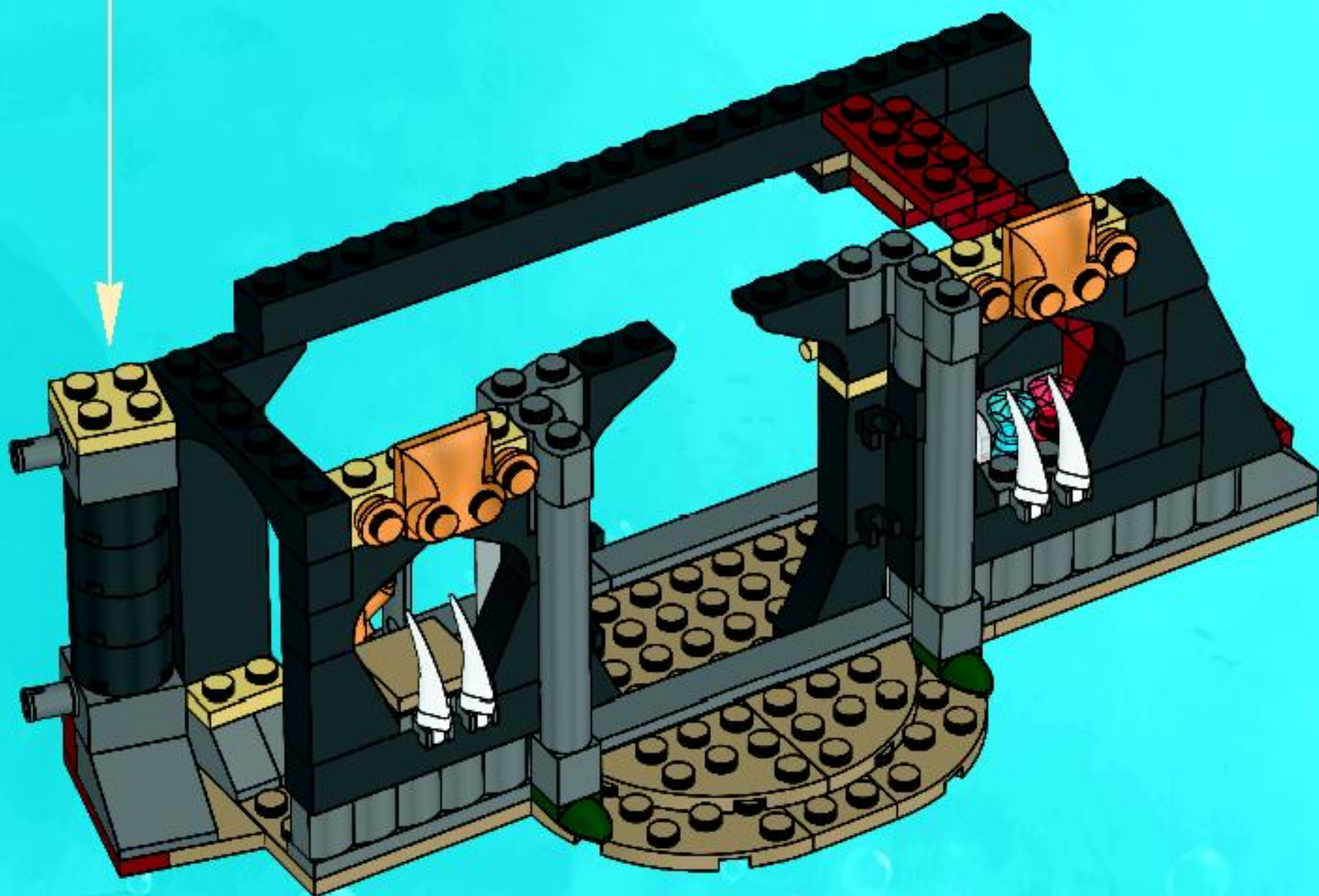
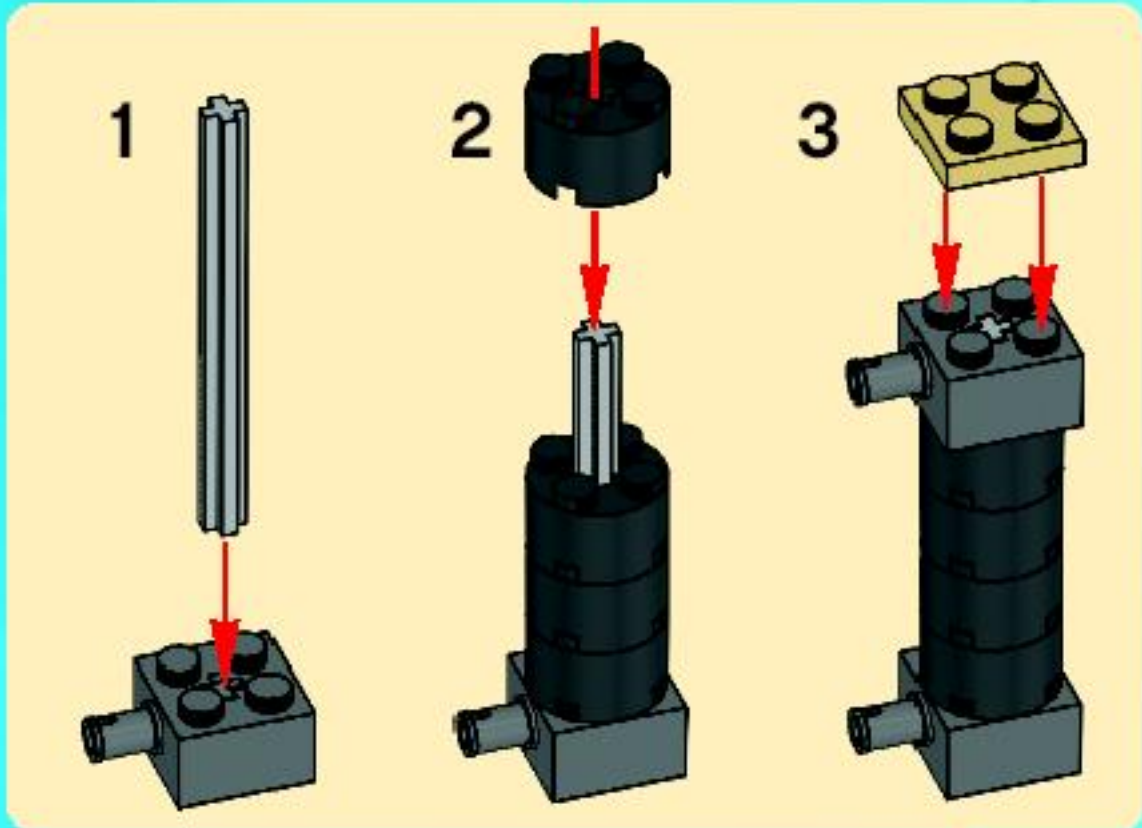



1x



1x



1x

# 29

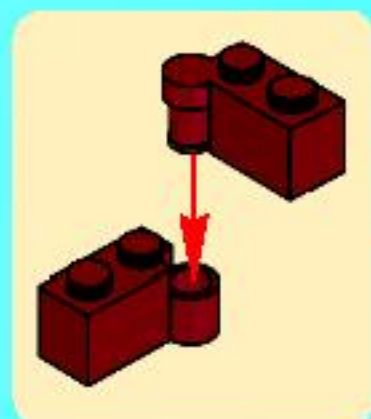

1x



2x

# 30



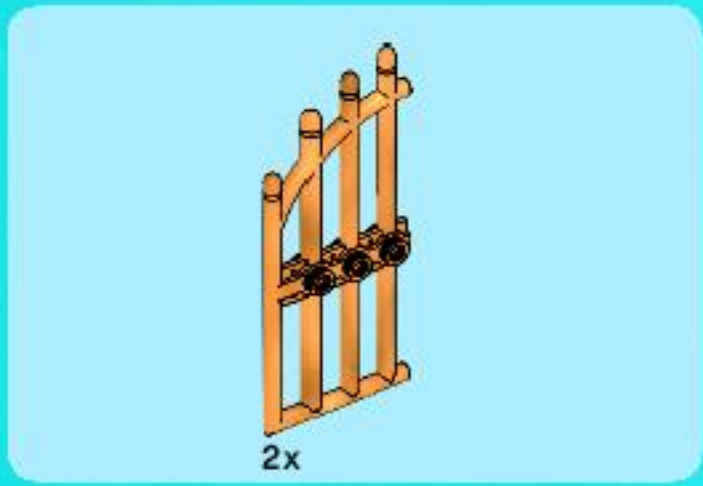
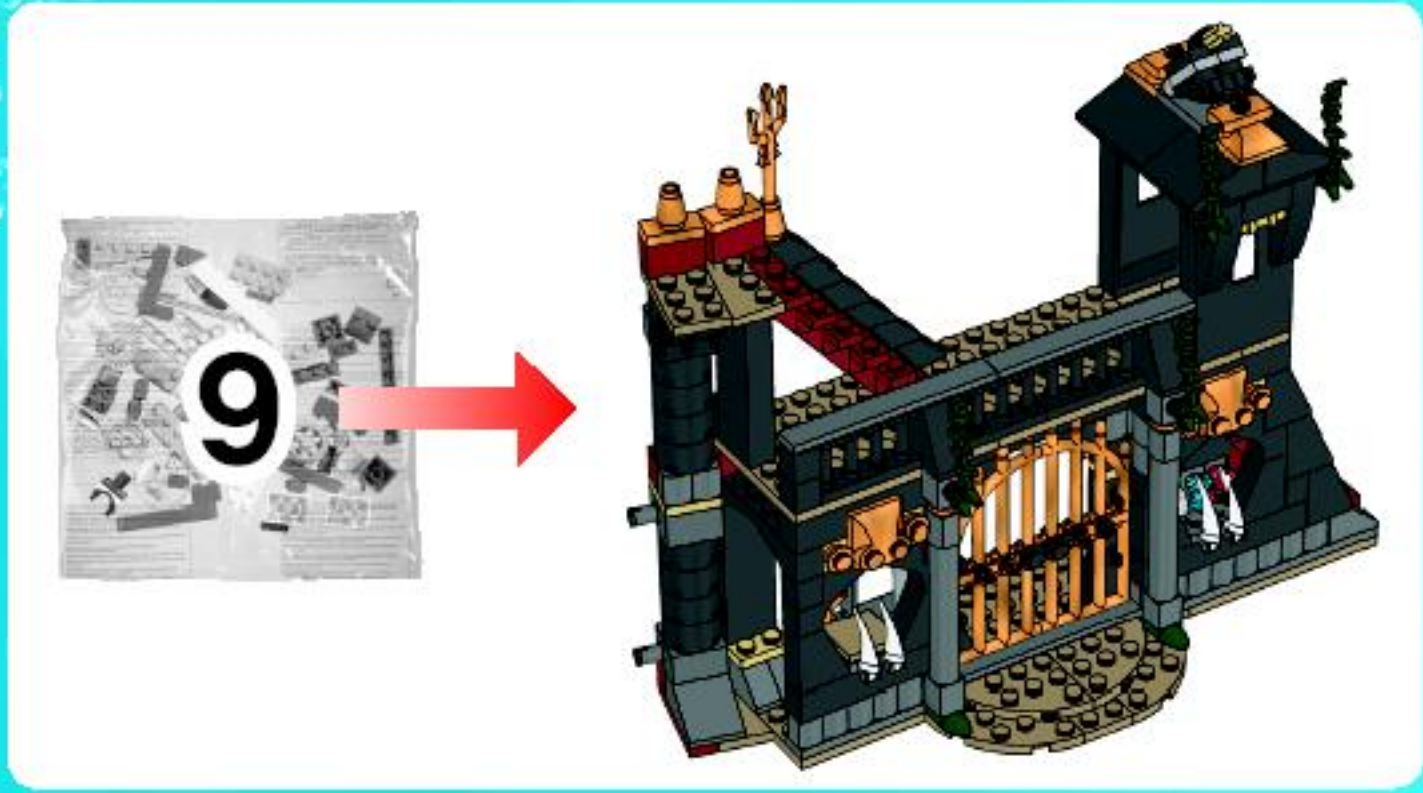

31

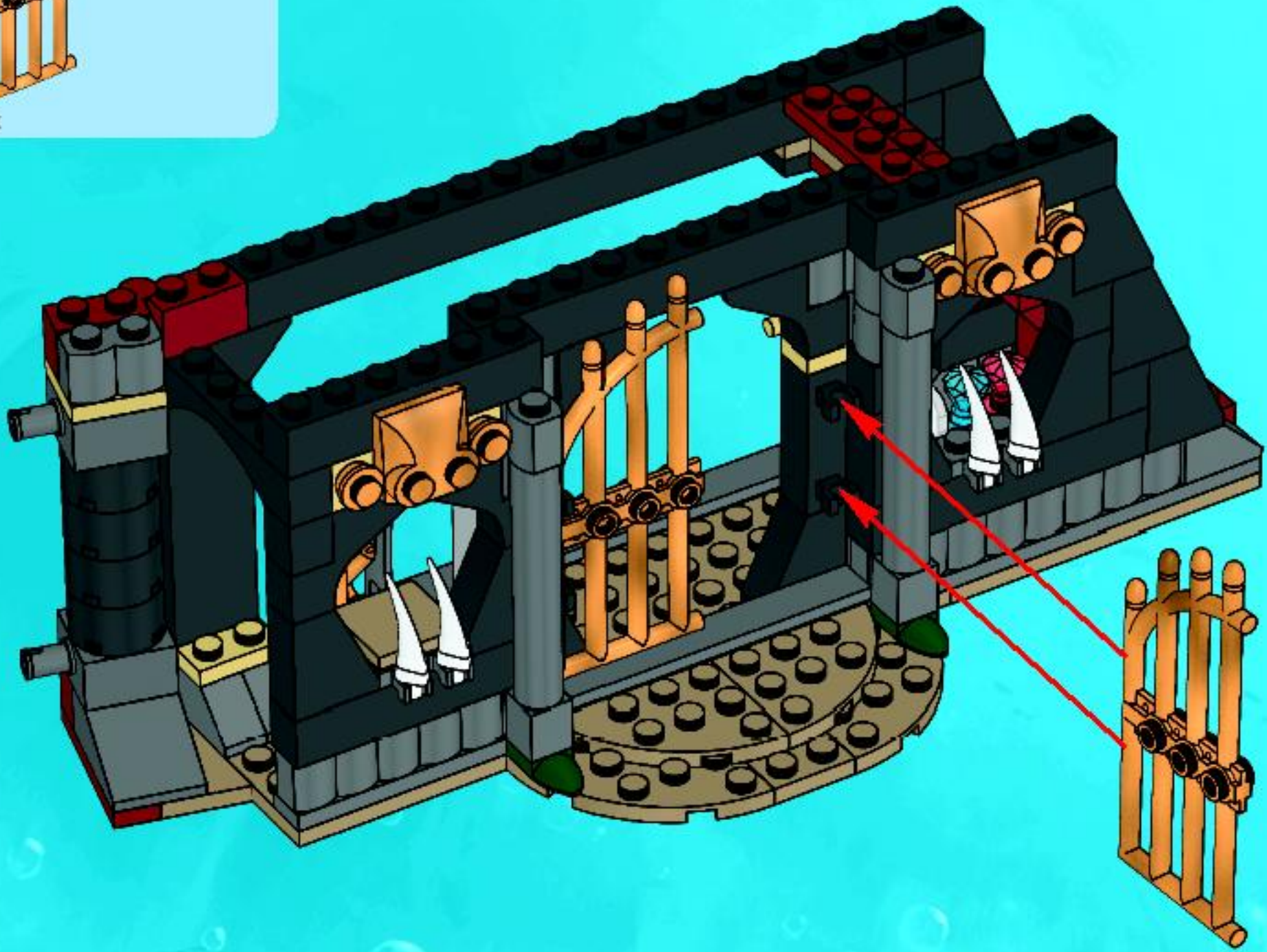



●  
2x

●  
2x

# 32

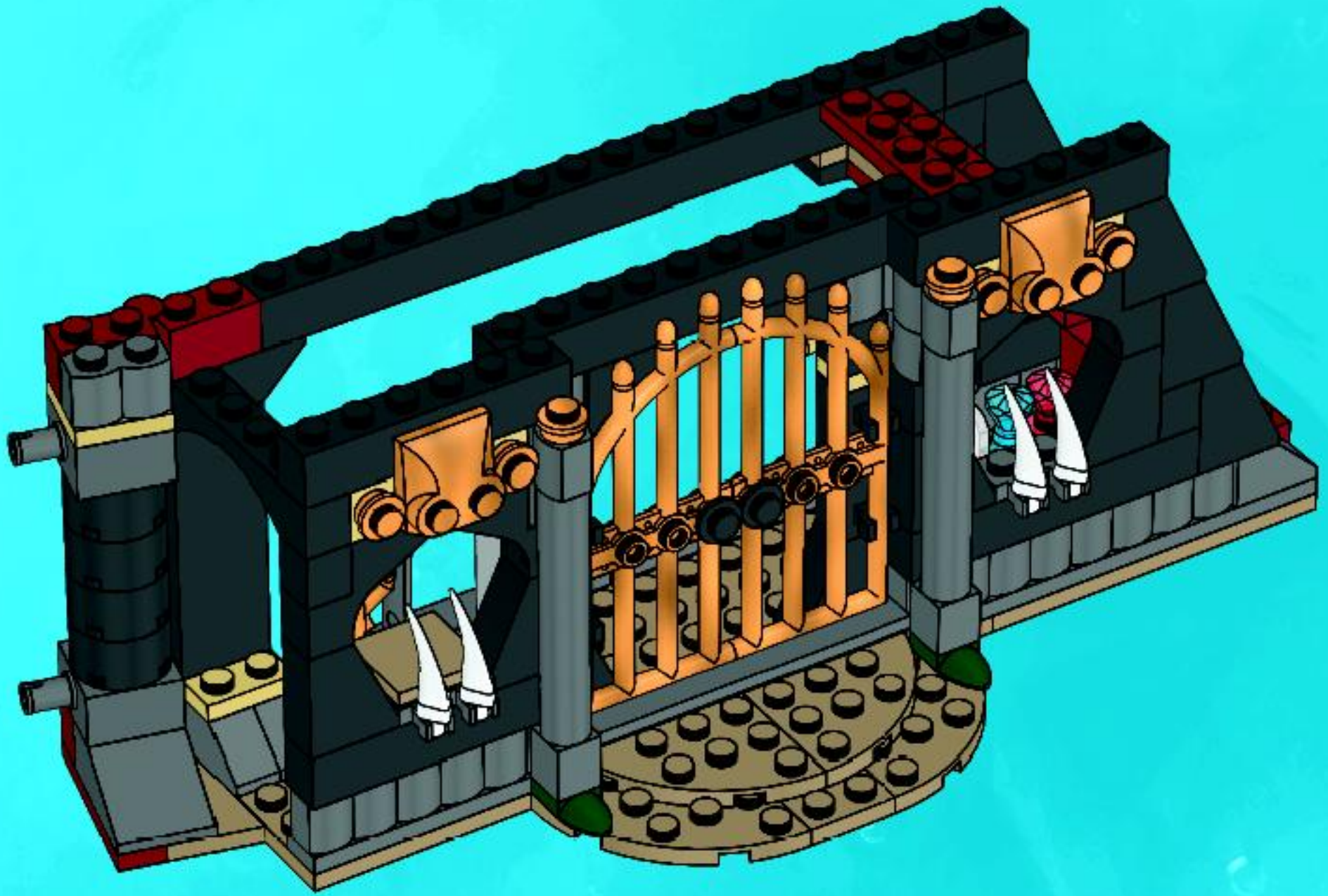



# 33



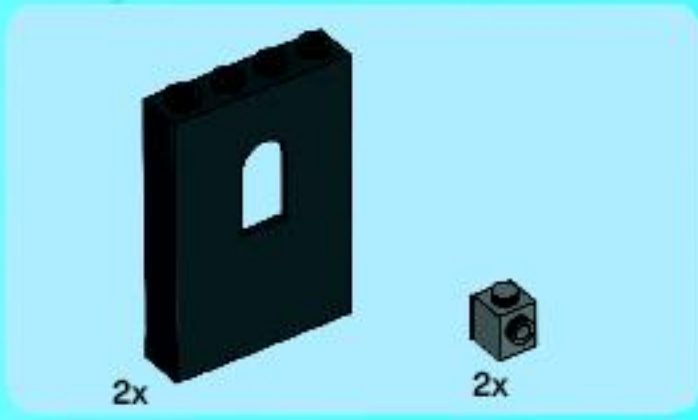

34





2x



1x



2x

# 35

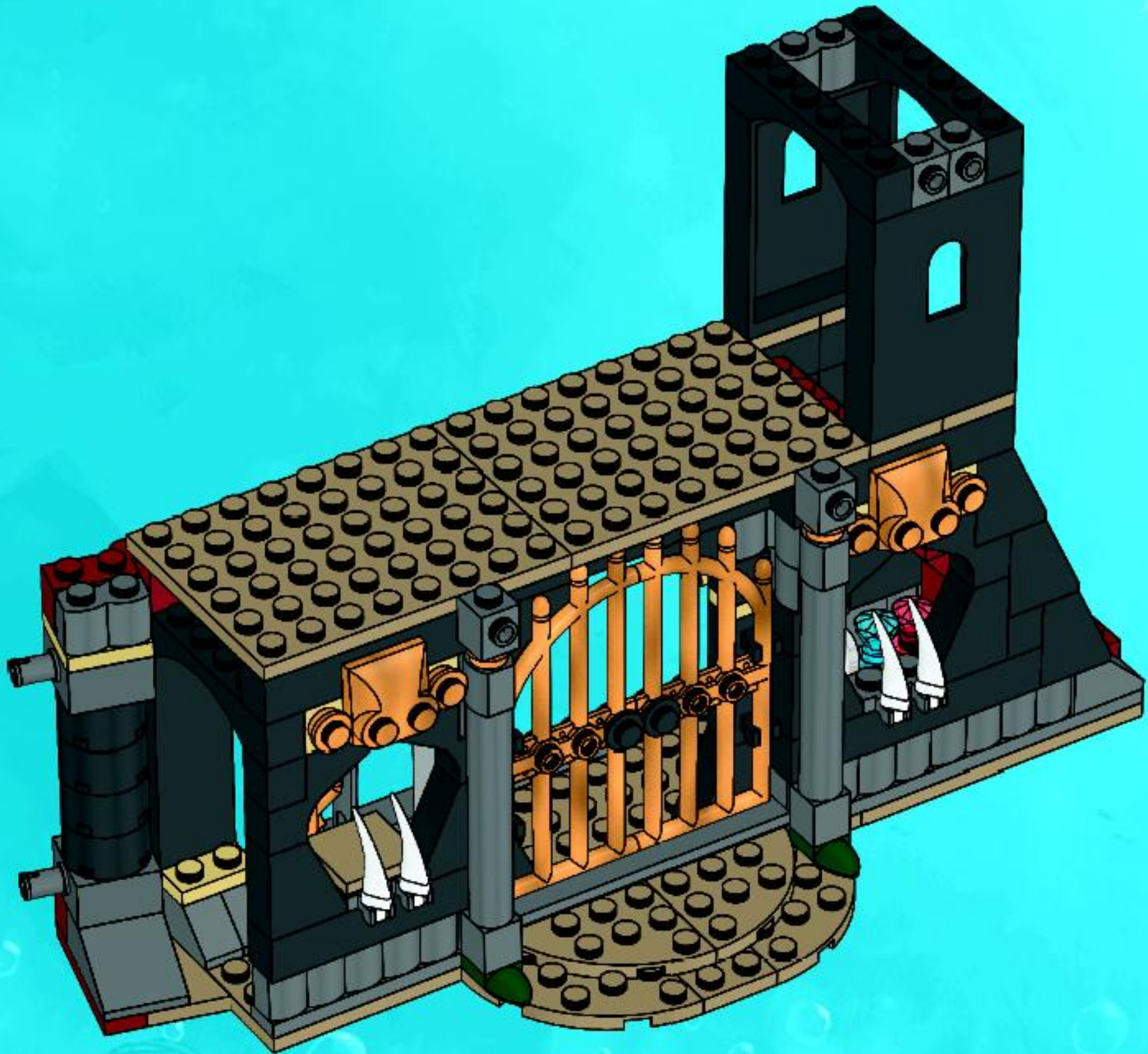

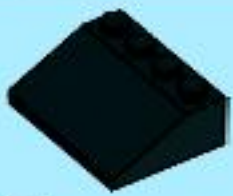

2x



2x

# 36



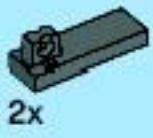

2x



2x



2x

# 37

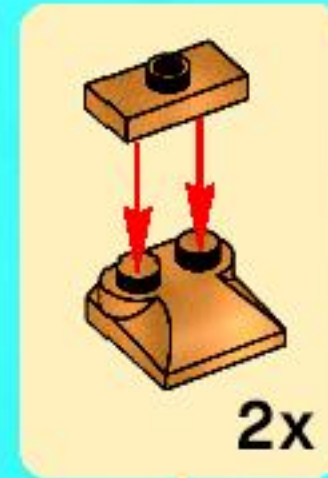

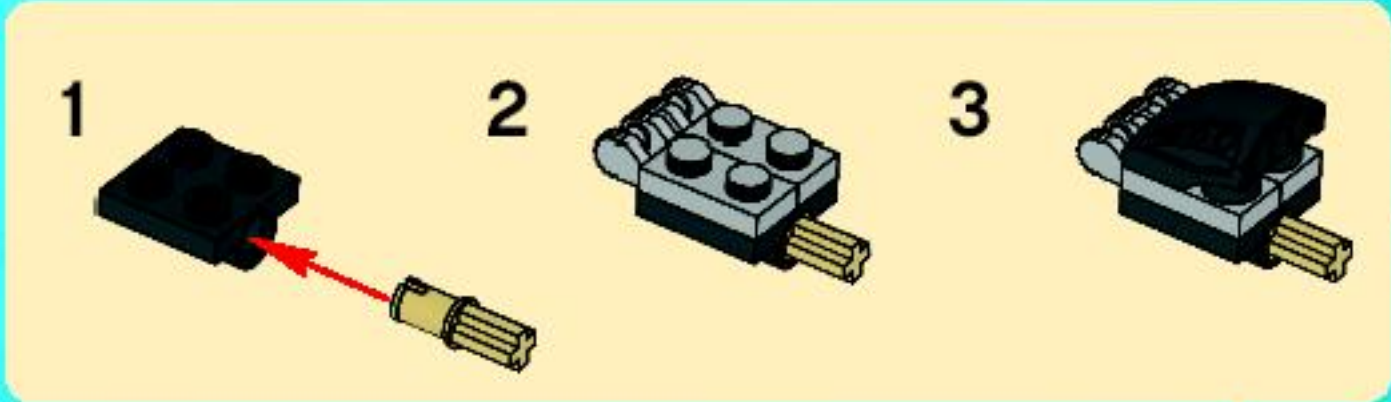
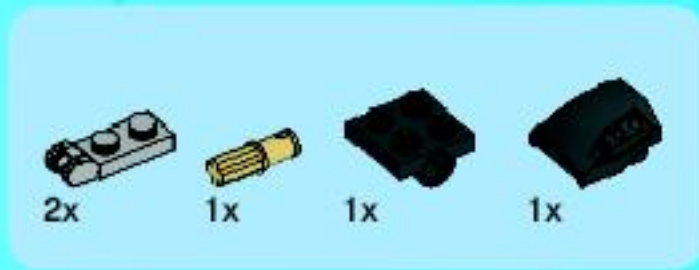

38





1x



4x

# 39

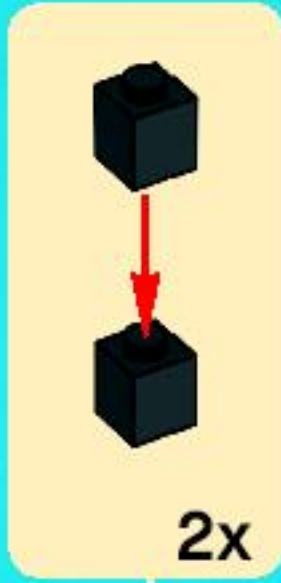

2x

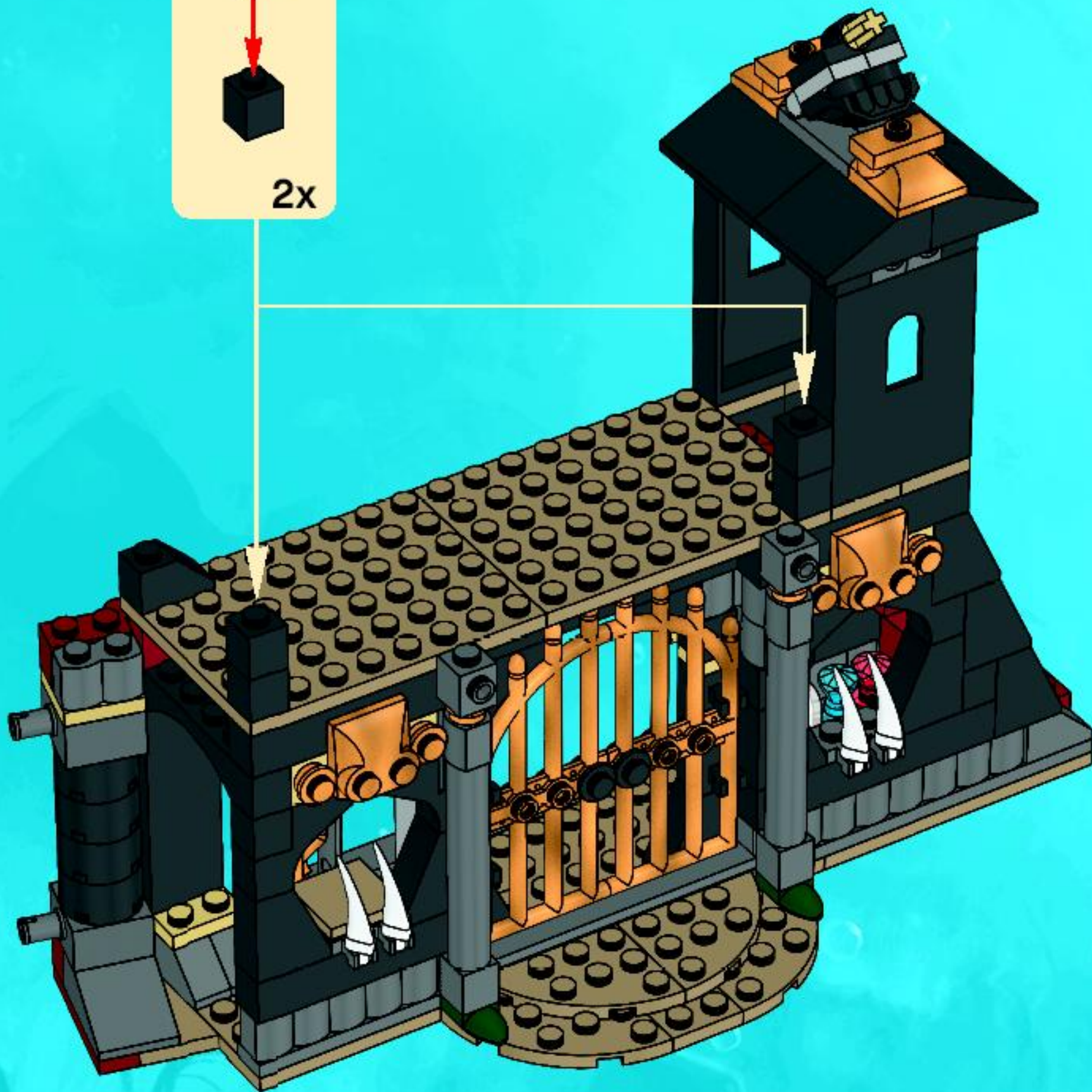



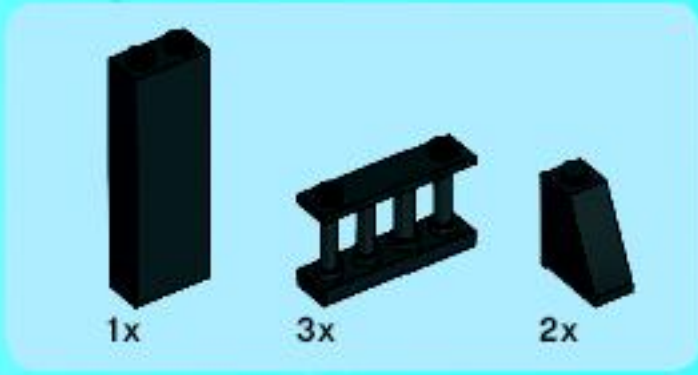

40



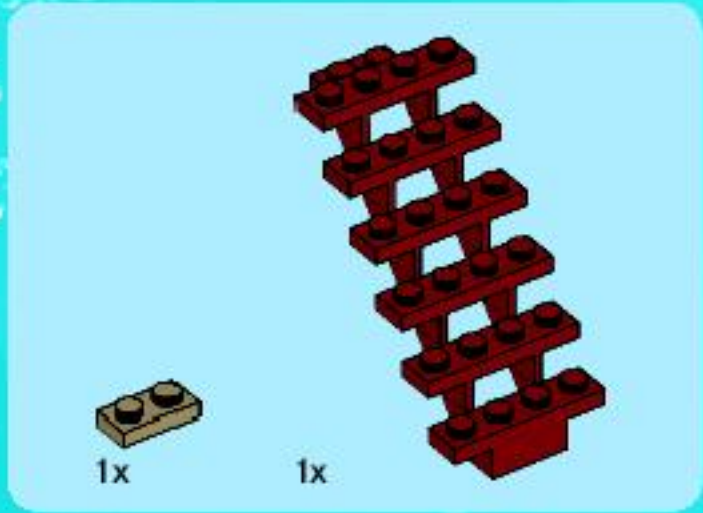

41

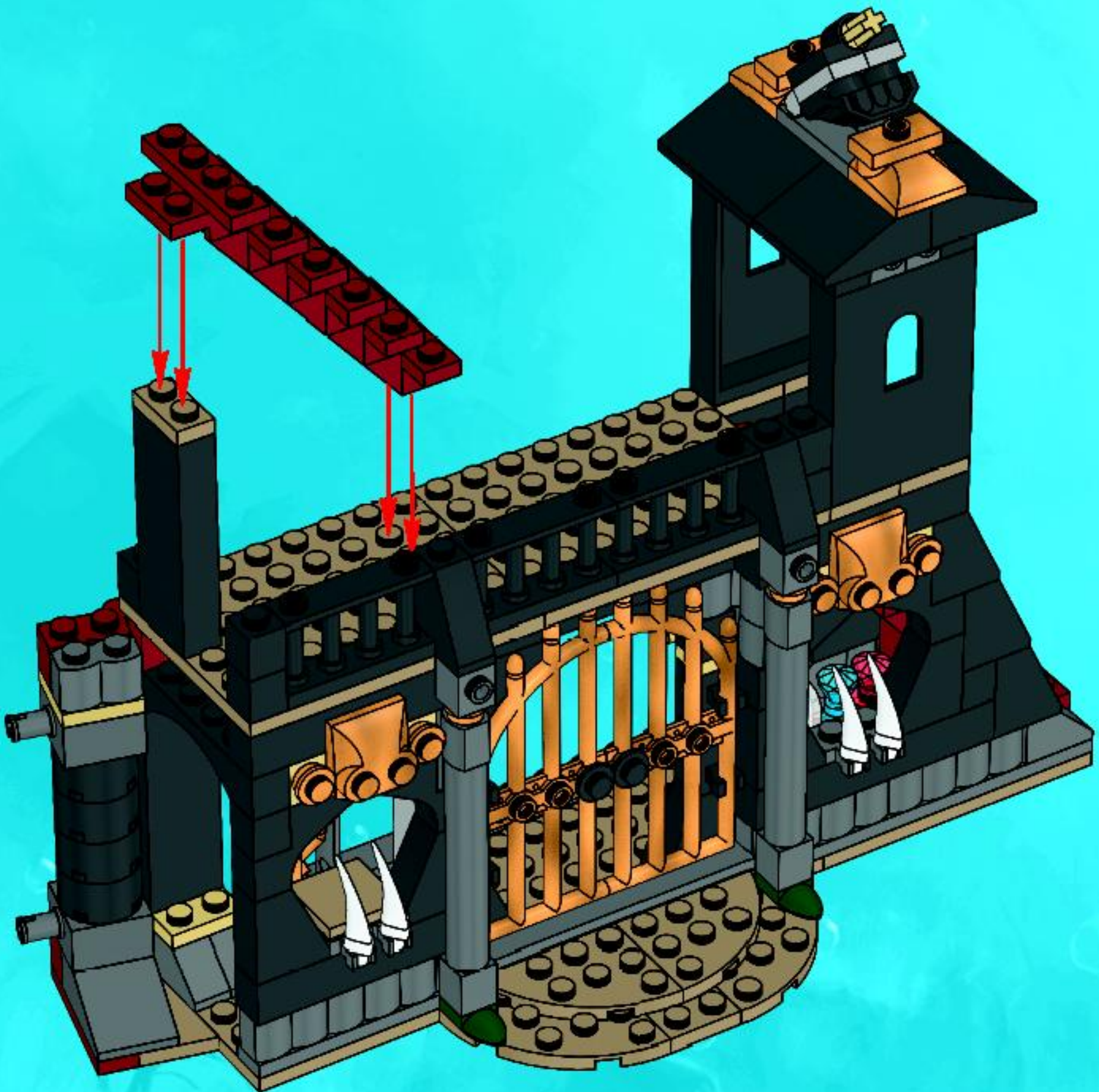



6x

42

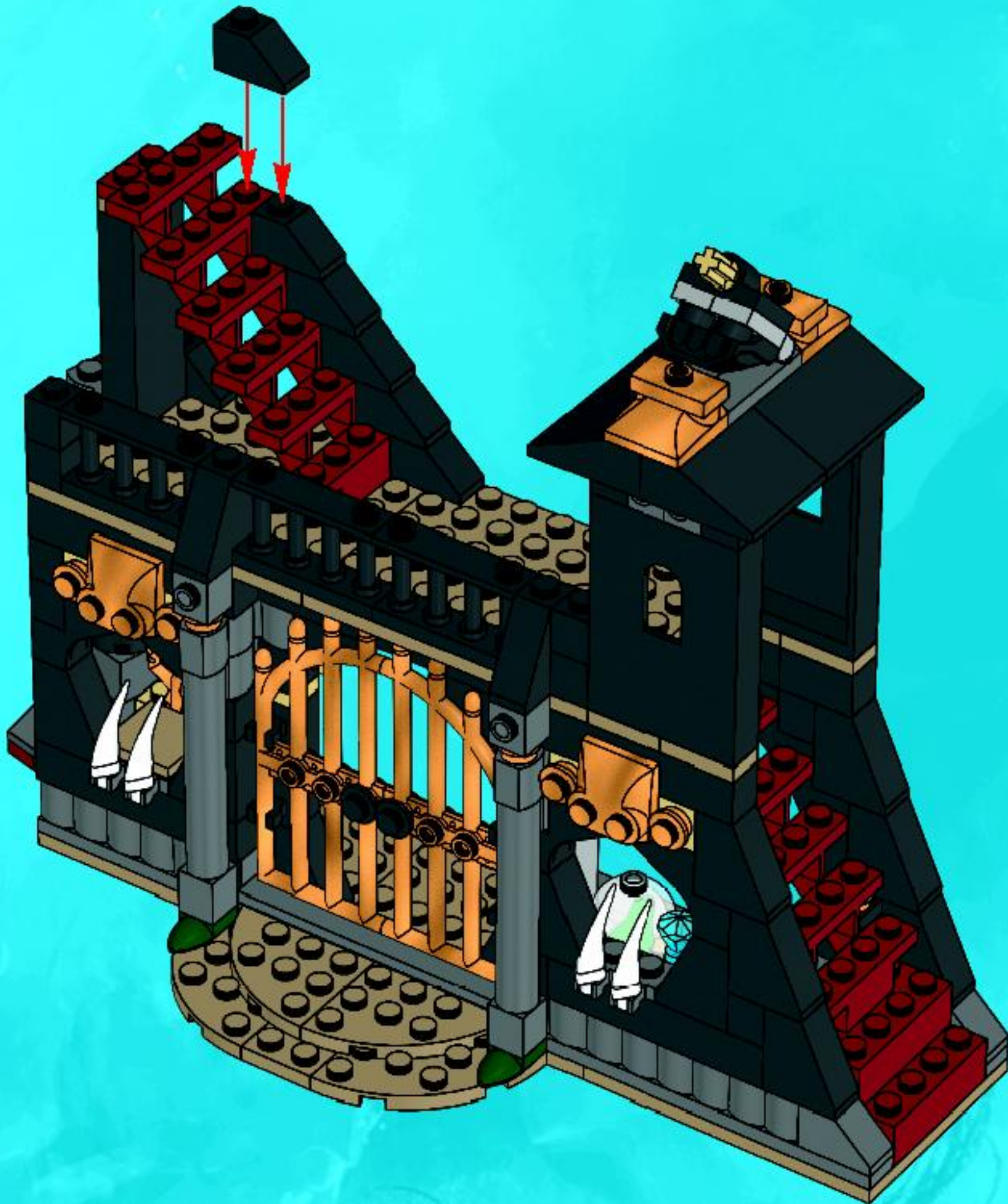

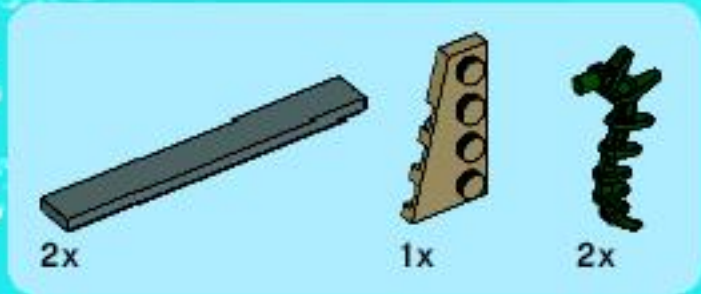

# 43

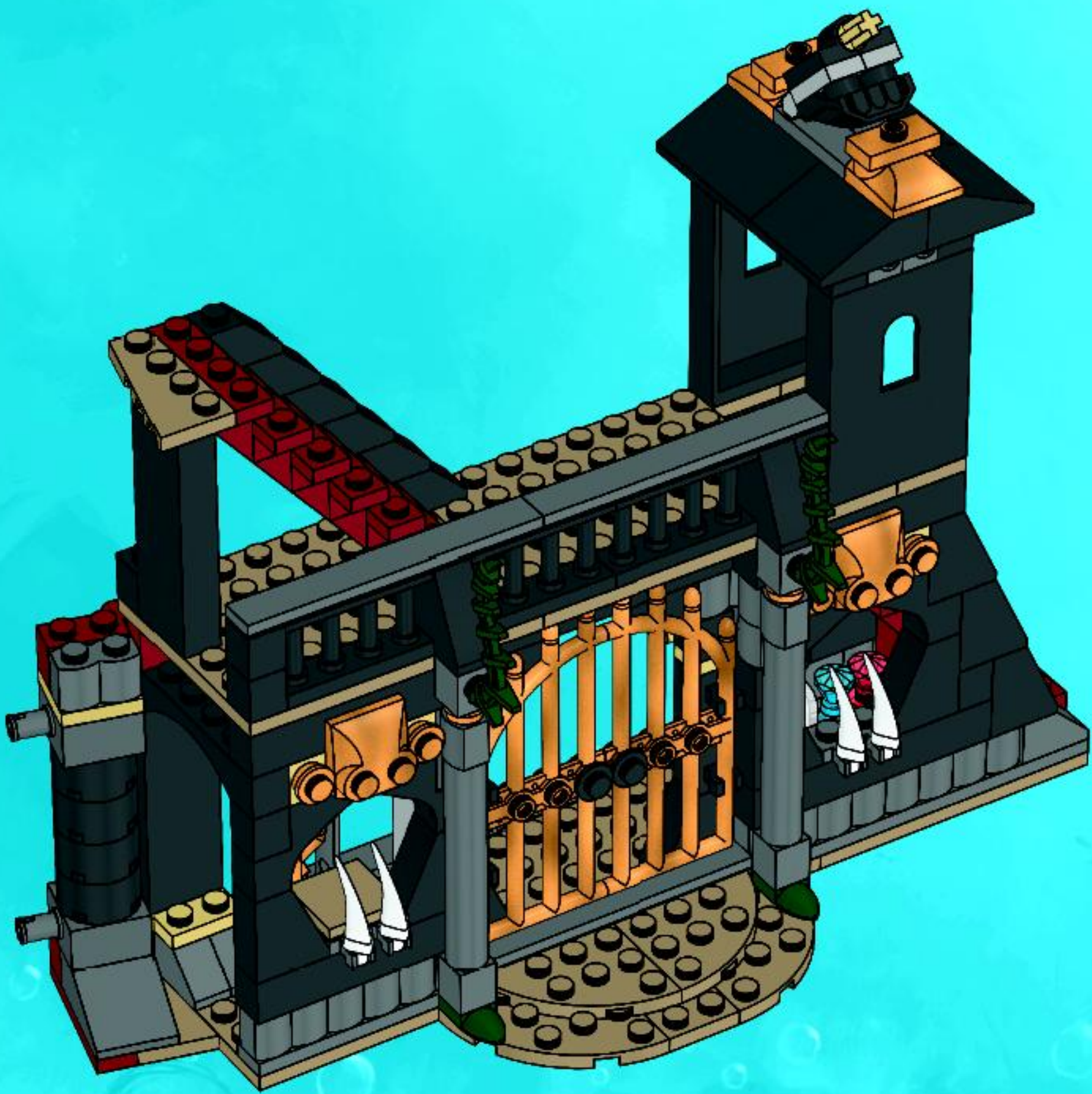

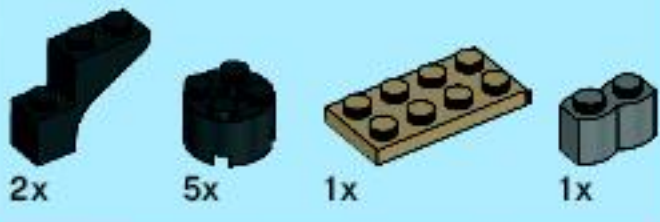

# 44

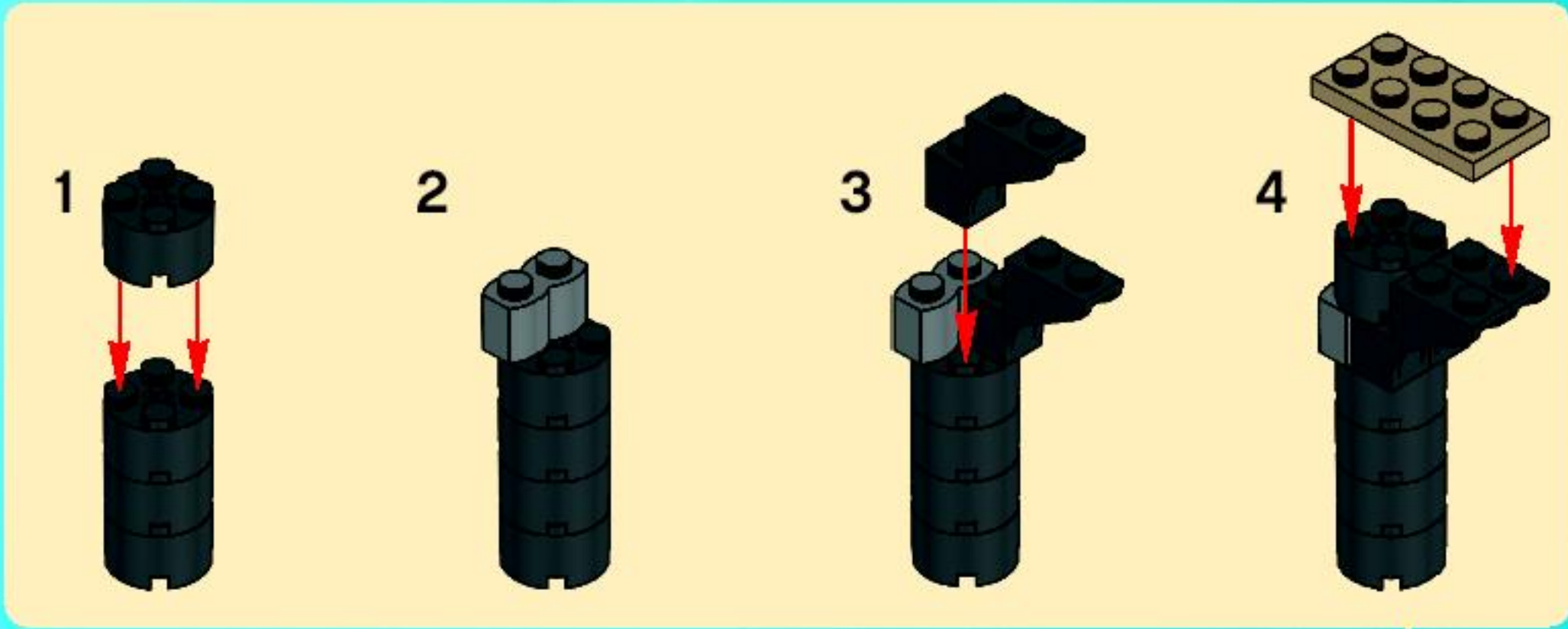



1x



1x



1x

# 45

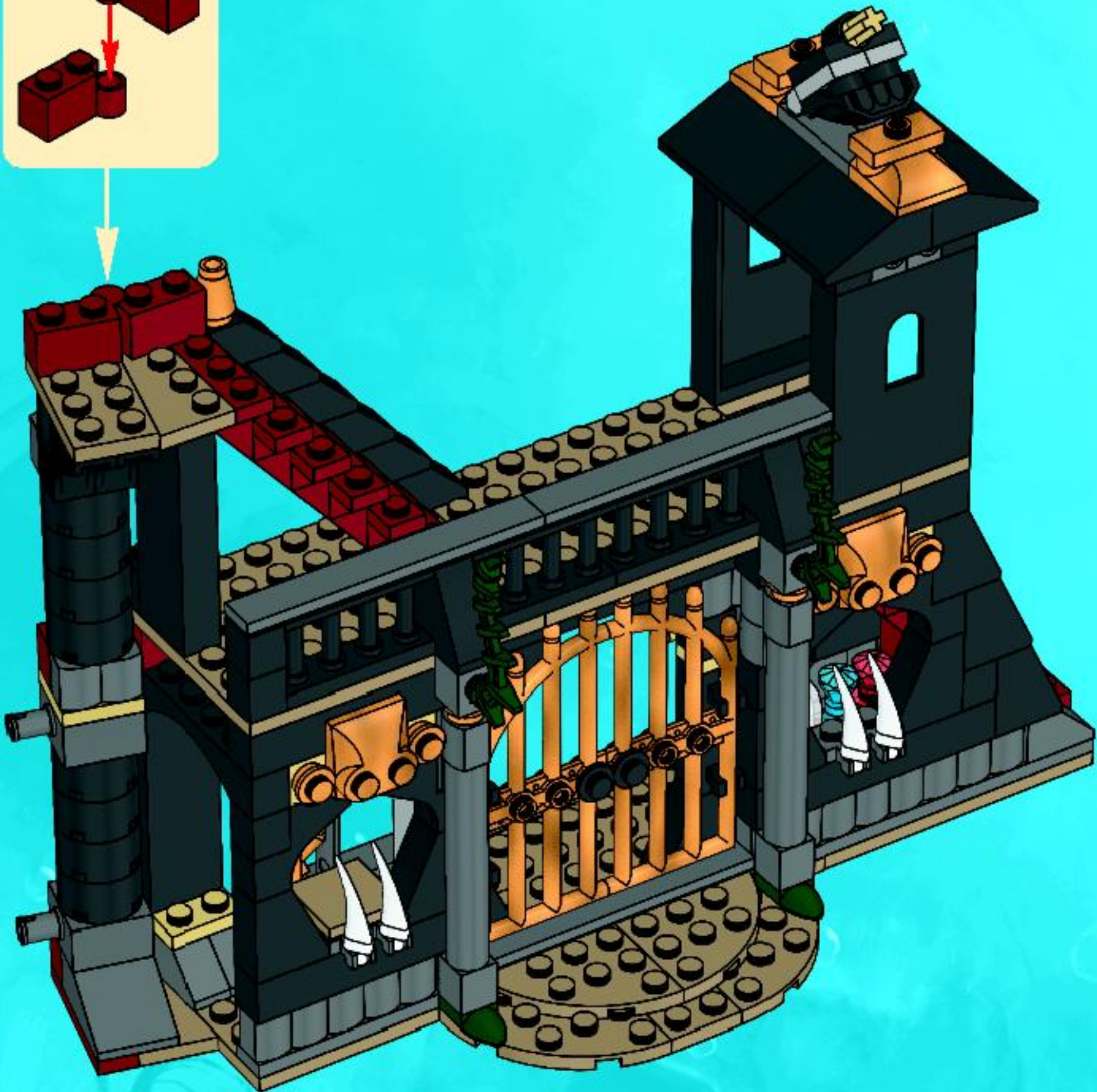
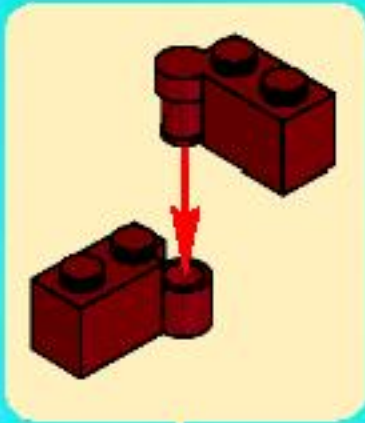



2x

# 46





2x



1x

# 47





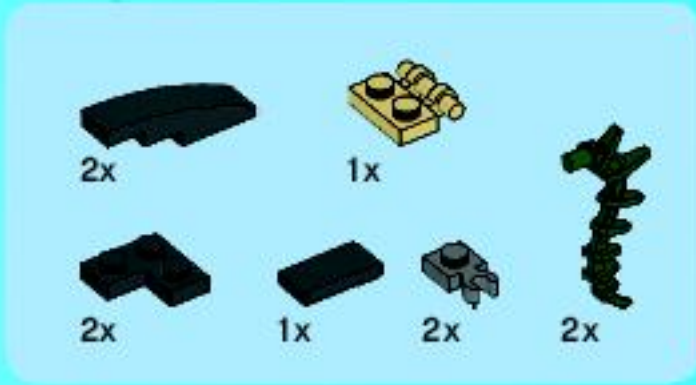

# 48

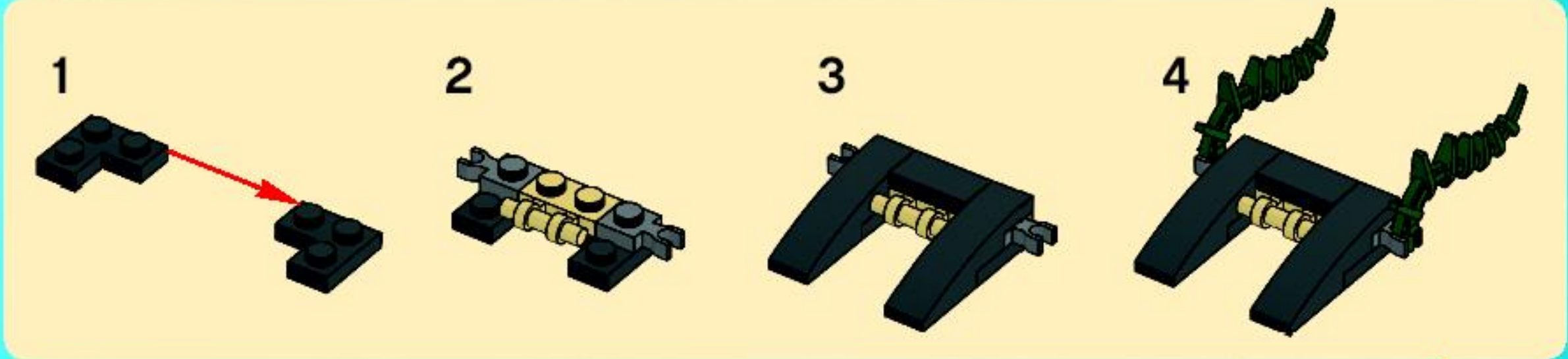

49





50







8058



8075



8077



8058



8075



8077



8078



8078



8076



8076



2x 4142875  
 2x 626601  
 1x 626001  
 1x 82359  
 24x 4566256  
 10x 4494474  
 1x 4159739  
 2x 4205105  
 4x 4201062  
 3x 4523145  
 1x 4114073  
 6x 4114084  
 1x 4585203  
 6x 4140593  
 3x 4186017  
 3x 4514554  
 3x 4565452  
 1x 4107798  
 4x 4143005  
 5x 4206482

1x 4513987  
 6x 302321  
 2x 302221  
 2x 242021  
 2x 393721  
 2x 613421  
 1x 4189936  
 6x 4142865  
 2x 4558172  
 1x 303224  
 1x 4570009  
 1x 4570002  
 1x 4549621  
 16x 300526  
 4x 300426  
 2x 4514845  
 8x 300926  
 2x 300726  
 6x 611126  
 2x 246526

4x 245426  
 26x 614326  
 2x 4504382  
 30x 4515373  
 6x 366526  
 14x 4121966  
 4x 4273703  
 4x 428726  
 4x 416126  
 4x 329726  
 22x 4581280  
 4x 4522034  
 2x 4519925  
 8x 345526  
 2x 306926  
 3x 371026  
 4x 242026  
 2x 4141300

2x 366626  
 4x 4563681  
 2x 4225201  
 4x 614126  
 2x 244426  
 2x 4515368  
 2x 3004326  
 4x 370926  
 1x 74011  
 1x 4180508  
 1x 4180536  
 4x 4537058  
 4x 4584483  
 6x 4185652  
 1x 4500440  
 1x 4587498  
 1x 4106552  
 2x 4287672

1x 4161403  
 1x 4587501  
 2x 4185272  
 1x 4517986  
 1x 4500902  
 4x 4184169  
 2x 4121715  
 2x 370526  
 1x 4157270  
 1x 4113949  
 1x 3005740  
 2x 4100381  
 1x 4248937  
 1x 3006841  
 4x 3000841  
 2x 4113954  
 1x 4565199  
 2x 4163567  
 16x 4586557  
 1x 4499885

8x 4584484  
 2x 4119483  
 1x 4570660  
 2x 3005744  
 1x 4128576  
 1x 4570662  
 1x 4113955  
 3x 4569900  
 30x 4528604  
 1x 4567331  
 1x 4570508  
 2x 4507045  
 5x 4267874  
 1x 4550329  
 10x 4251796  
 3x 4266897  
 2x 4578032  
 3x 4583977  
 1x 4584485

4x 4501970  
 1x 4585596  
 1x 4585624  
 1x 4585610  
 5x 4541369  
 4x 4541528  
 8x 4568757  
 8x 4568761  
 11x 4539061  
 13x 4539071  
 2x 4539069  
 2x 4539070  
 2x 4539068  
 10x 4294148  
 1x 4563657  
 1x 4570532  
 3x 4583978  
 10x 4570451



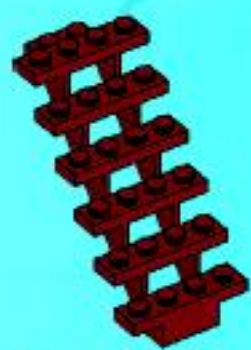

6x  
4581277



1x  
4567459



1x  
4563475



1x  
4570659



2x  
4211197



2x  
4211186



4x  
4211362



6x  
4211389



4x  
4533772



2x  
4552348



2x  
4211865



7x  
4211639

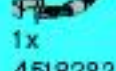

1x  
4518282

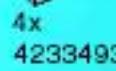

4x  
4233493

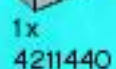

1x  
4211440



4x  
4211466



1x  
4211442

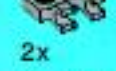

2x  
4566157

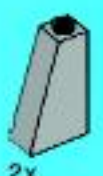

2x  
4211494



2x  
4180464



1x  
4211397



10x  
4211429



2x  
4211356



1x  
4243797



1x  
4211404

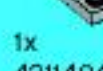

2x  
4594238

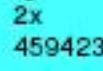

4x  
4251163

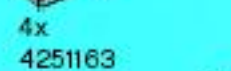

2x  
4211805

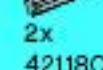

7x  
4211632

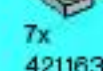

4x  
4211804

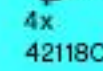

4x  
4211419

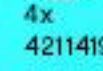

1x  
4282789



1x  
4282786

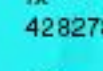

1x  
4282786



2x  
4594243



1x  
4567457



1x  
4563652



1x  
4570535



2x  
4535930



1x  
4211060



10x  
4211109



18x  
4558955



1x  
4210875



42x  
4211095



6x  
4211087



4x  
4211046



8x  
4268139



4x  
4180811



4x  
4582257



6x  
4211111



8x  
4504378



4x  
4552203



22x  
4211135



2x  
4211045



2x  
421106



4x  
4246896



1x  
4210782

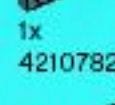

1x  
4210637

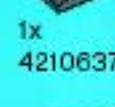

2x  
4210906



1x  
4210873



1x  
4210771



1x  
4210772

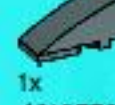

2x  
4180486



1x  
4161210



4x  
4210882

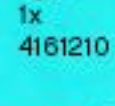

9x  
4581225



4x  
4215387



1x  
4210788



7x  
4210688



1x  
4508553



4x  
4514559



2x  
4210851



1x  
4161224



2x  
4211094



2x  
4211001



1x  
4211053



2x  
4211065



6x  
4211056

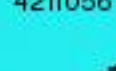

10x  
4211008

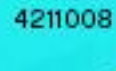

2x  
4257526

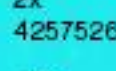

24x  
4587212

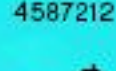

4x  
4521187

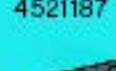

2x  
4561036

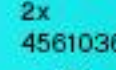

3x  
4568036

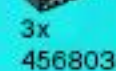

3x  
4570036

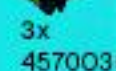

3x  
4563473



1x  
4509194



2x  
4582820



5x  
4563480



2x  
4585622



14x  
4523157



6x  
4563483

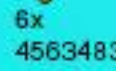

13x  
4529247

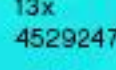

1x  
4570651

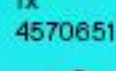

1x  
4584099



8x  
4519970



3x  
4570738

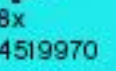

2x  
4585621



26x  
4523159



4x  
4566967



1x  
4541394



1x  
4541393

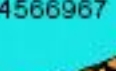

1x  
4505990

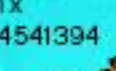

8x  
4286597



Customer Service

Kundenservice

Service Consommateurs

Servicio Al Consumidor

[www.lego.com/service](http://www.lego.com/service) or dial



: 00800 5346 5555

: 1-800-422-5346



# Atlantis.LEGO.com





# WIN!

Go to [www.nielsen.com/LEGO](http://www.nielsen.com/LEGO) to fill out a survey for a chance to win a cool LEGO® Product. No purchase necessary. Open to all residents where not prohibited.

 [www.LEGO.com](http://www.LEGO.com)



## [www.nielsen.com/LEGO](http://www.nielsen.com/LEGO)

### GEWINNE!

Nimm an der Umfrage auf [www.nielsen.com/LEGO](http://www.nielsen.com/LEGO) teil und hab die Chance ein cooles LEGO® Produkt zu gewinnen!

Die Teilnahme am Gewinnspiel führt zu keinerlei Kaufverpflichtungen. Teilnahme in allen nicht aus geschlossenen Ländern möglich.

### WIN!

Ga naar [www.nielsen.com/LEGO](http://www.nielsen.com/LEGO), vul een enquêteformulier in en maak kans op een cool LEGO® product.

Geen aankoopverplichting. Iedereen mag deelnemen, uitgezonderd ingezetenden van landen waar een enquêteverbod geldt.

### GAGNE!

Visite [www.nielsen.com/LEGO](http://www.nielsen.com/LEGO) pour répondre à un questionnaire et avoir une chance de gagner un produit LEGO® très cool!

Aucune obligation d'achat. Ouvert à tous les résidents des pays autorisés.

### 当てよう!

[www.nielsen.com/LEGO](http://www.nielsen.com/LEGO)にアクセスして、アンケートにご記入ください。当選者にはレゴ製品を差し上げます。

お買い上げの必要はありません。禁止されていない限り、すべての年齢にご利用いただけます。