



ATLANTIS

8078



2

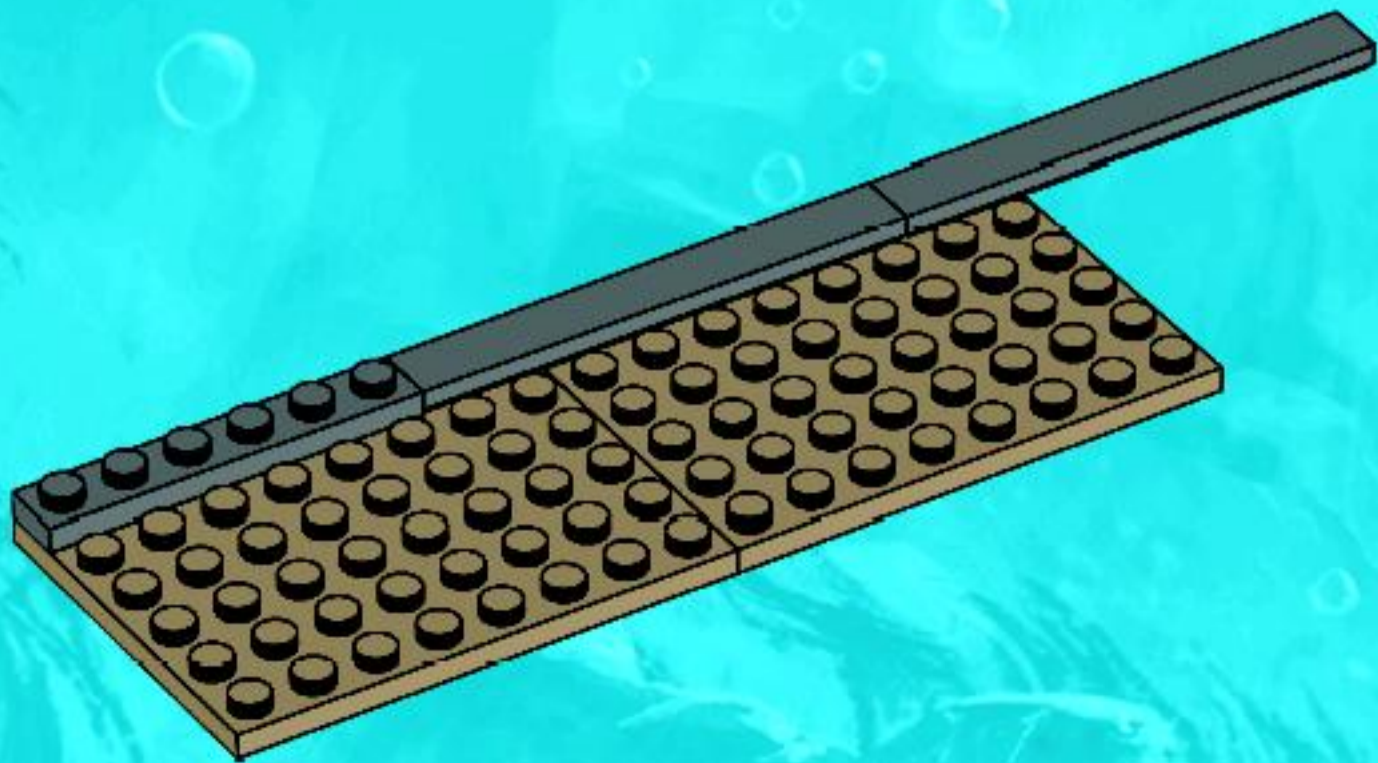
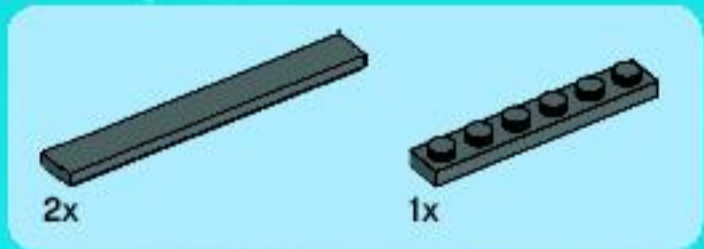
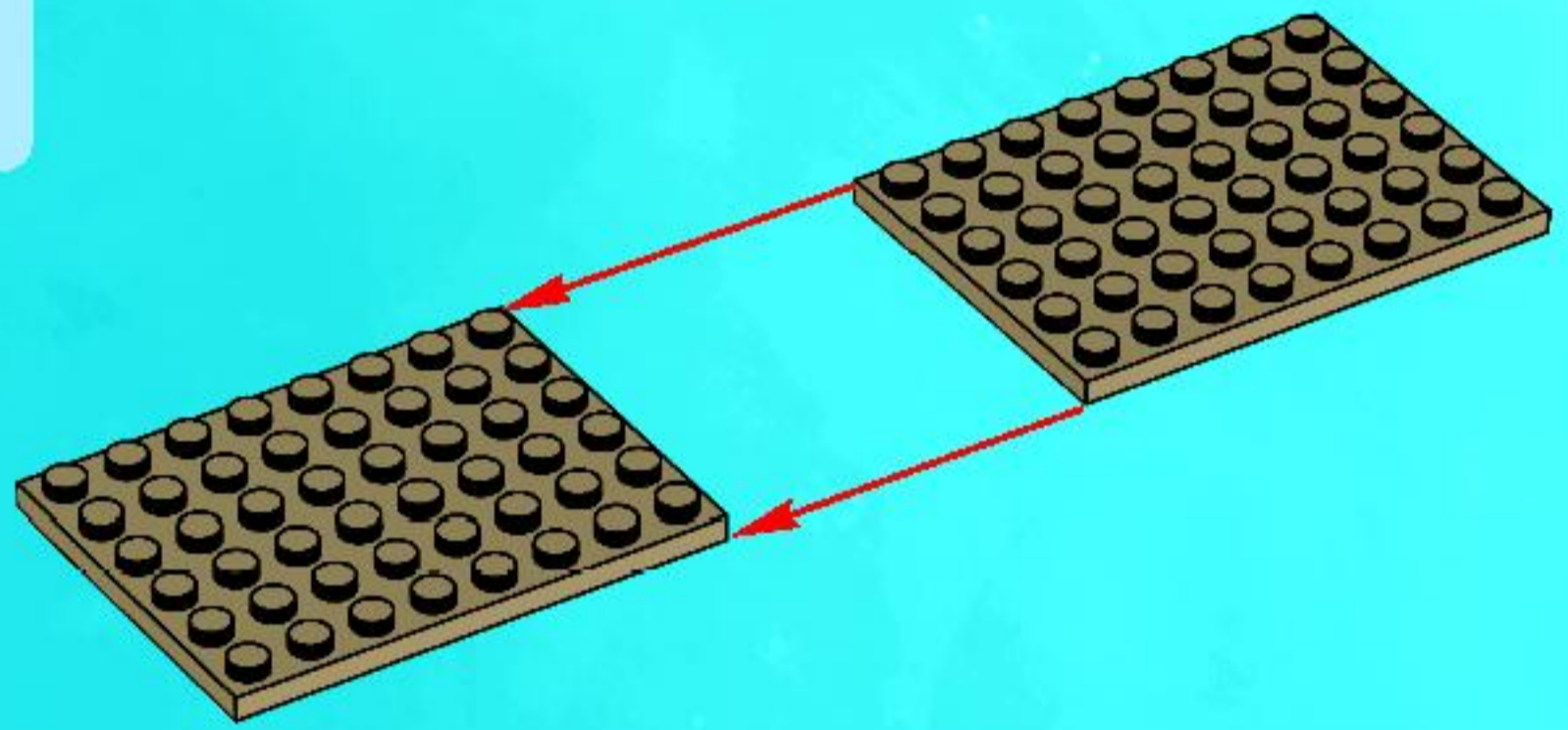
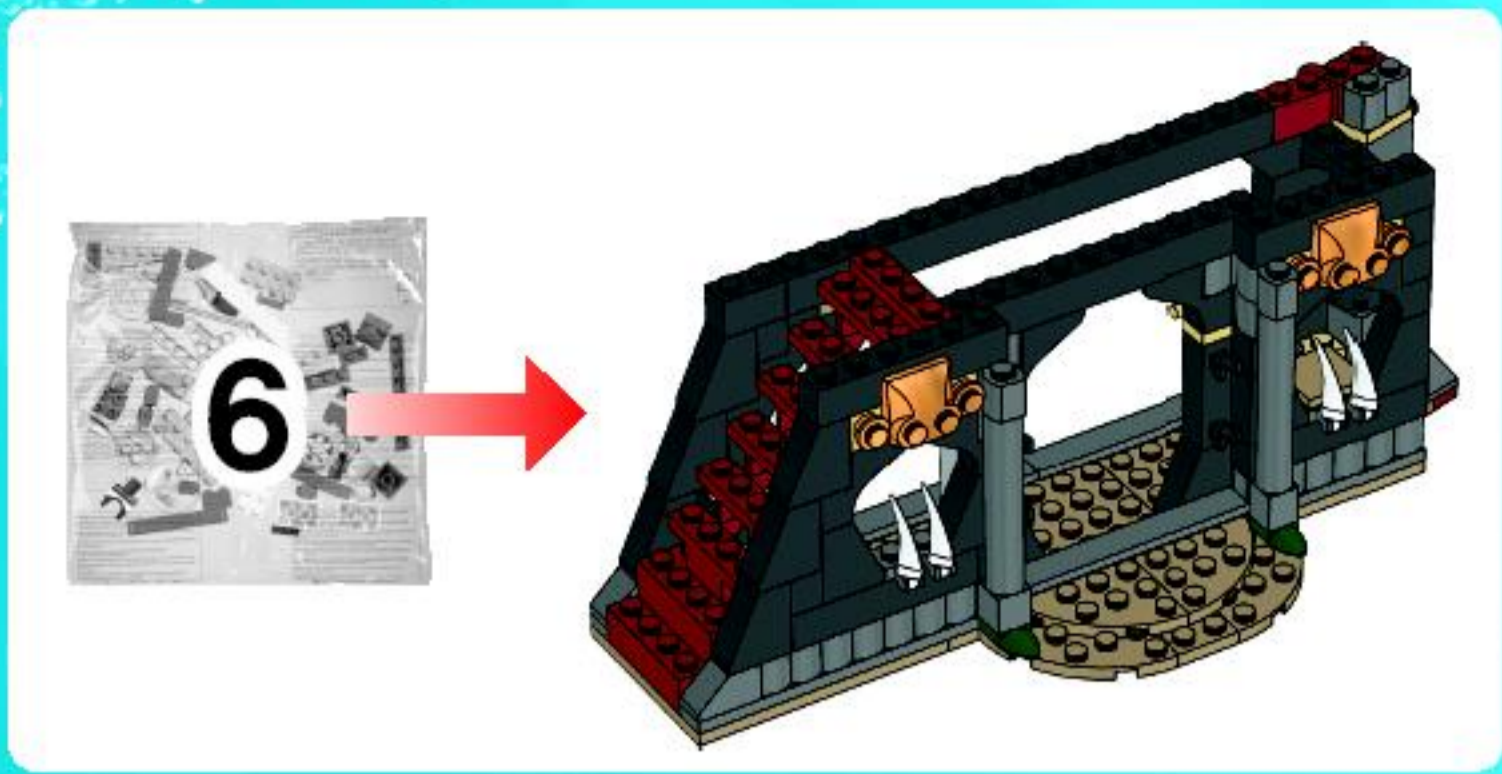



3

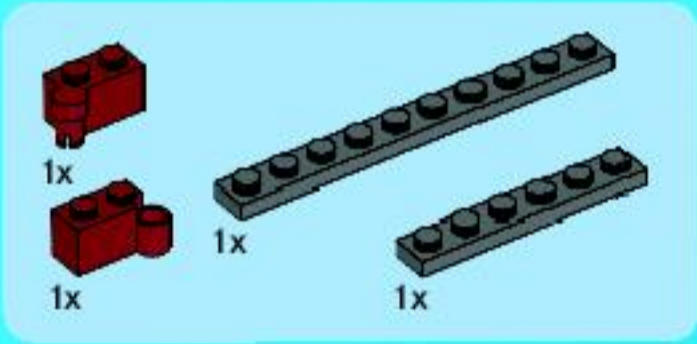
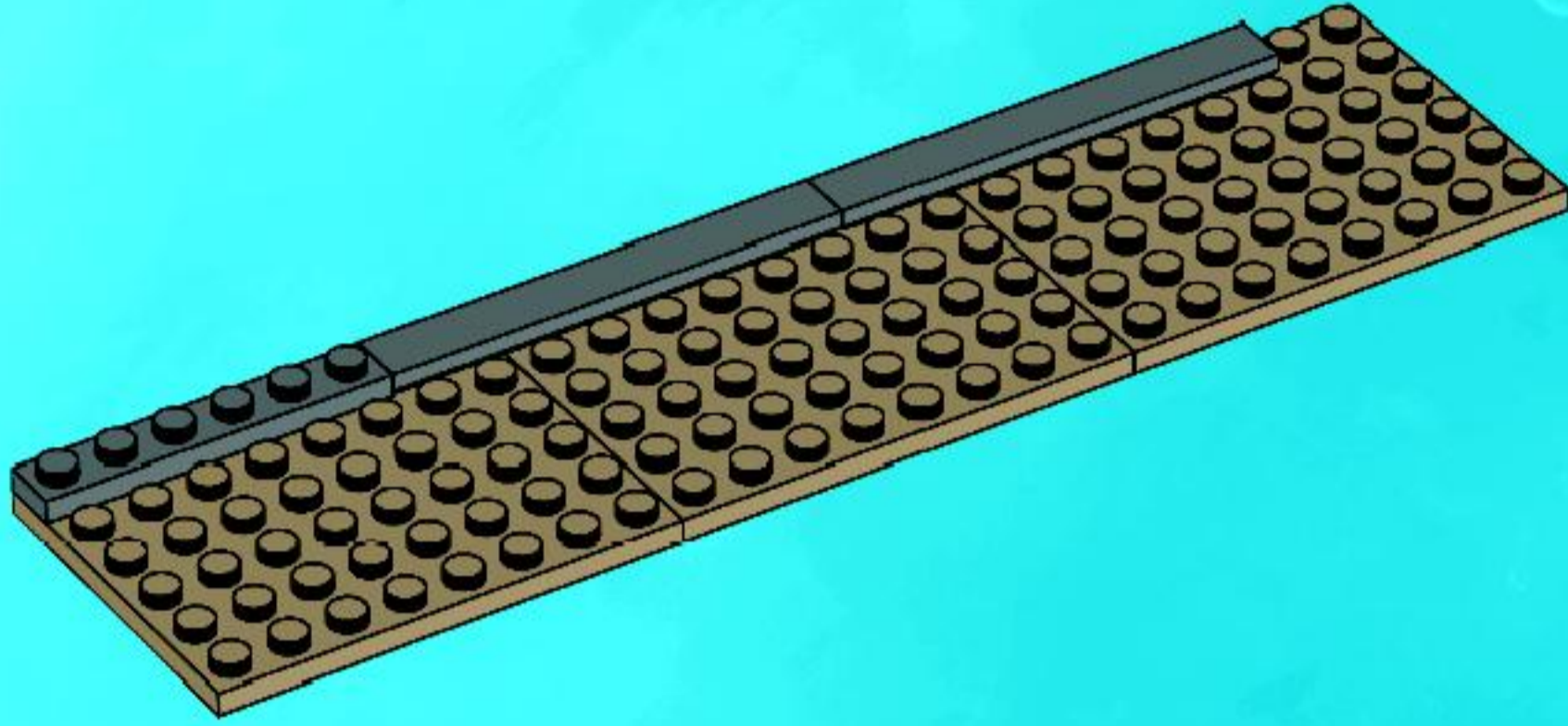

4

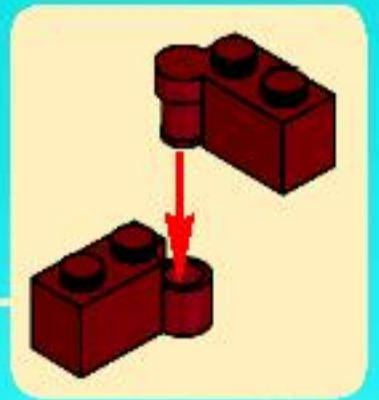
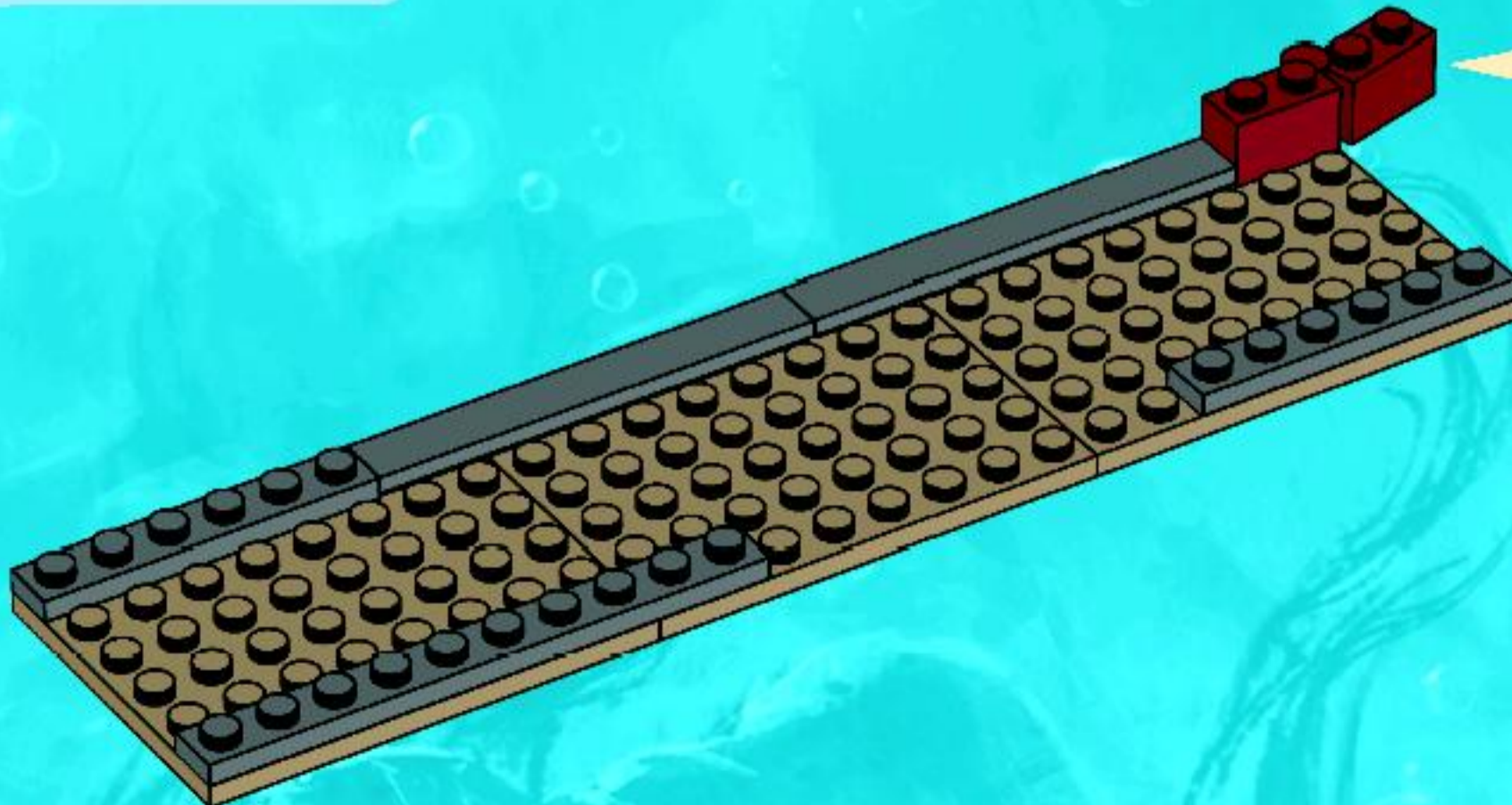

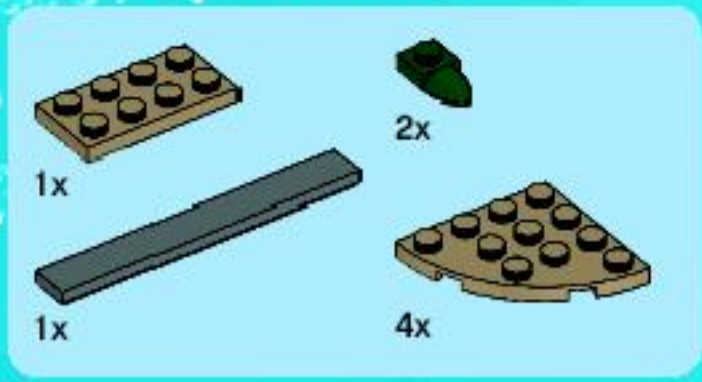

5

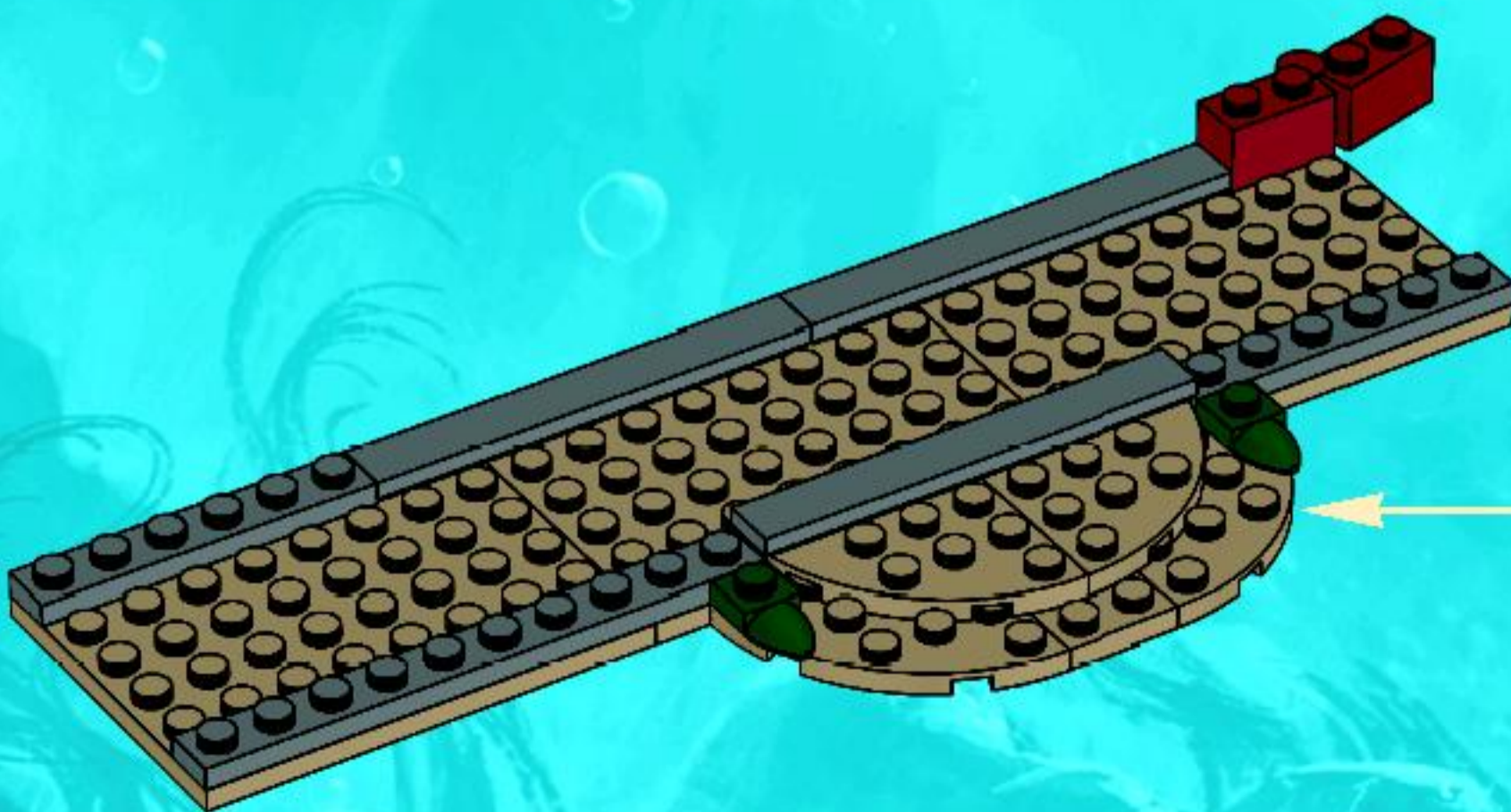
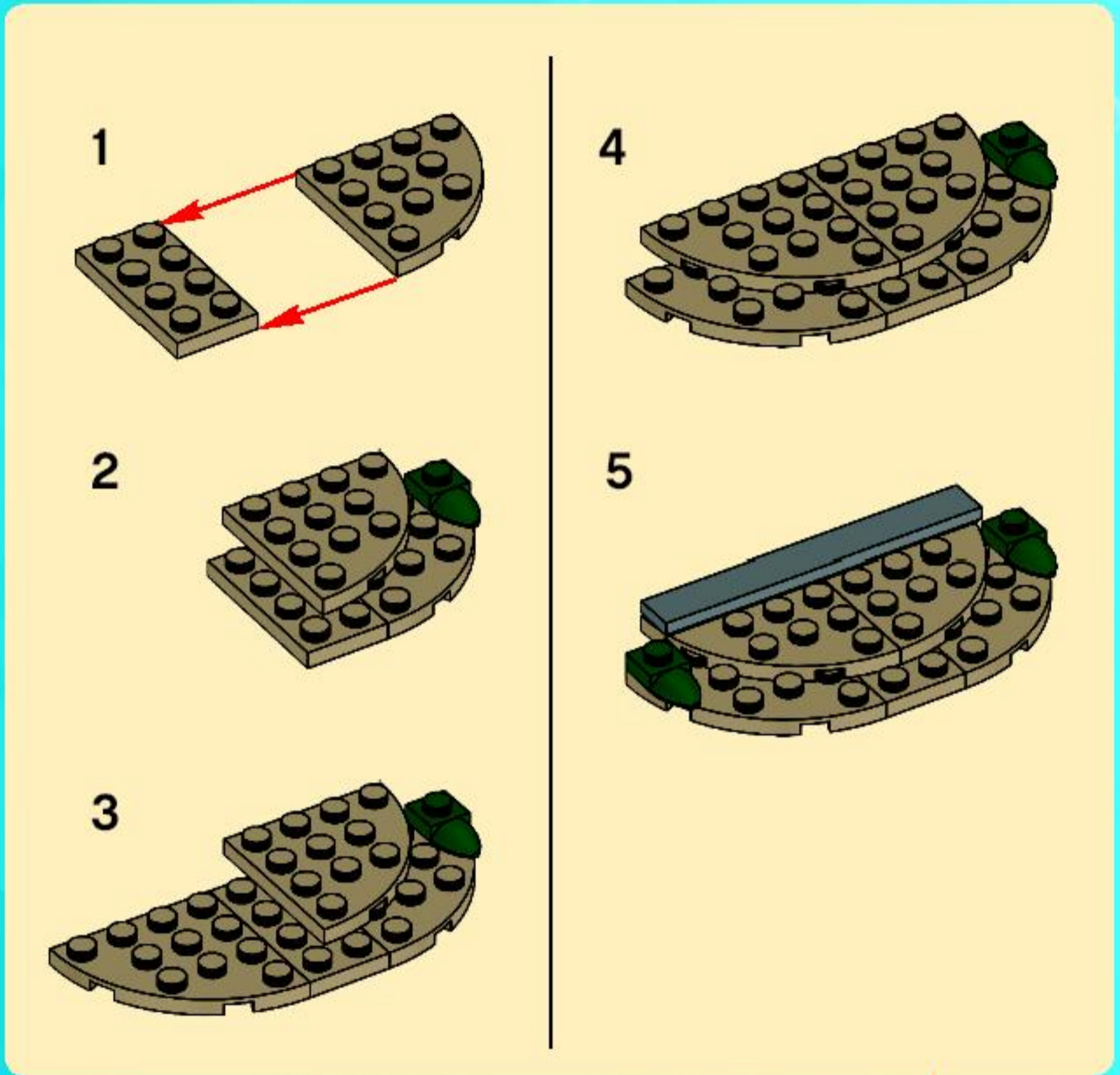

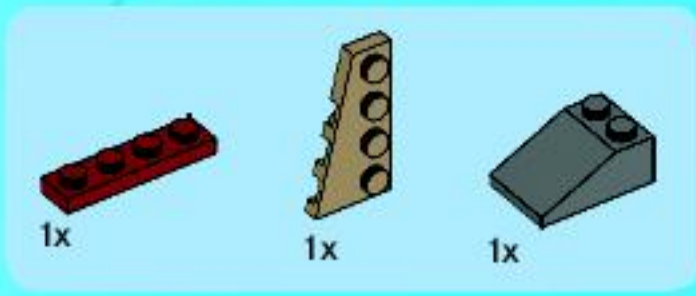

6

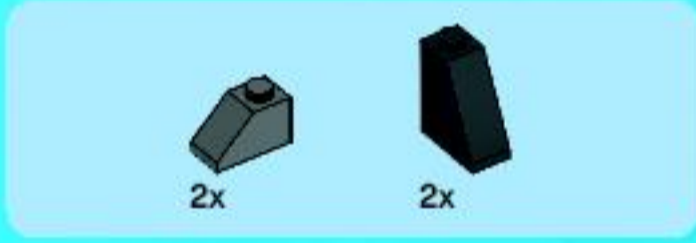
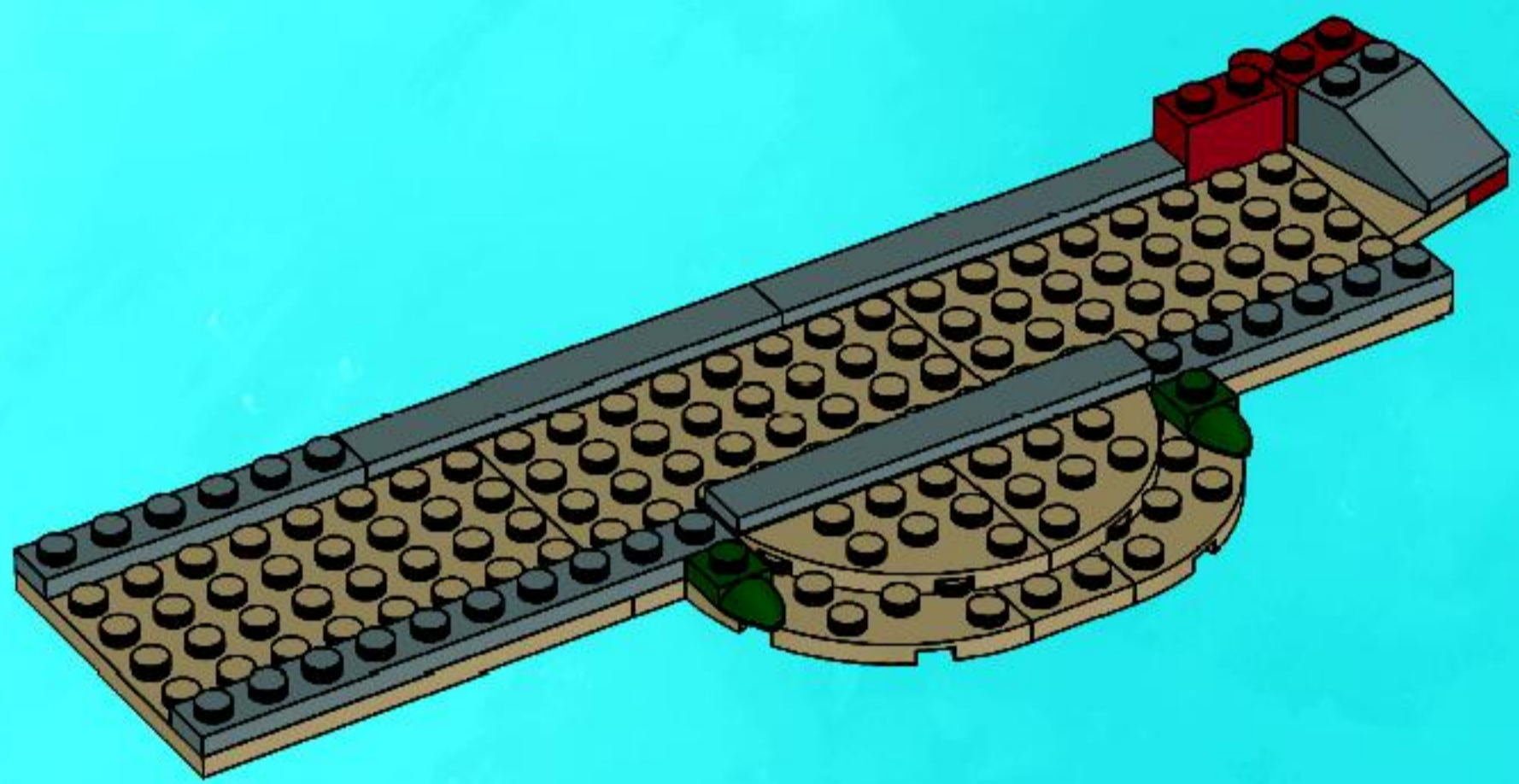
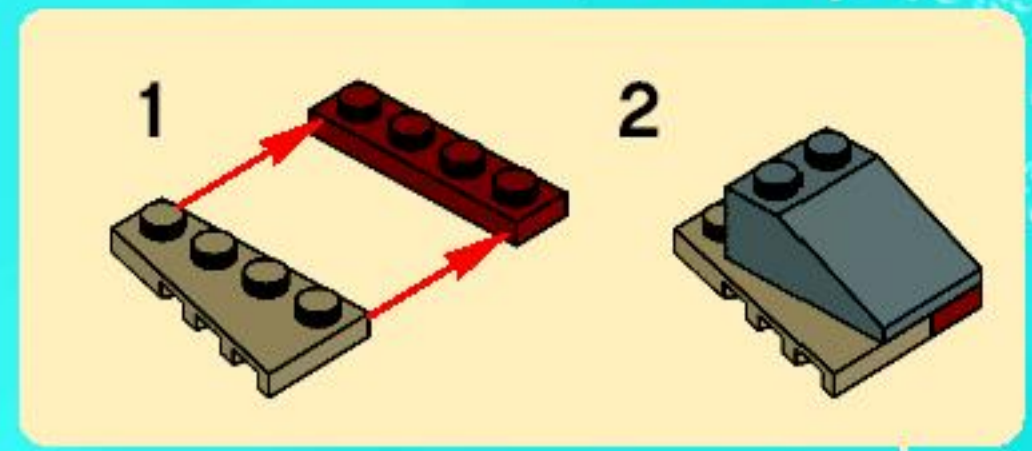

7



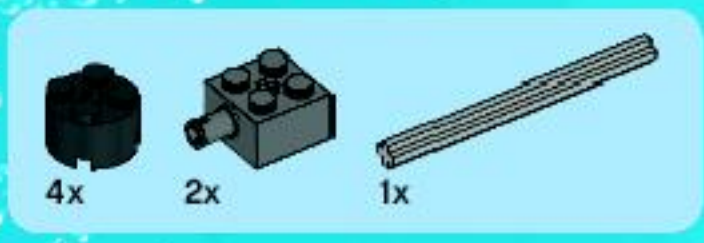

8

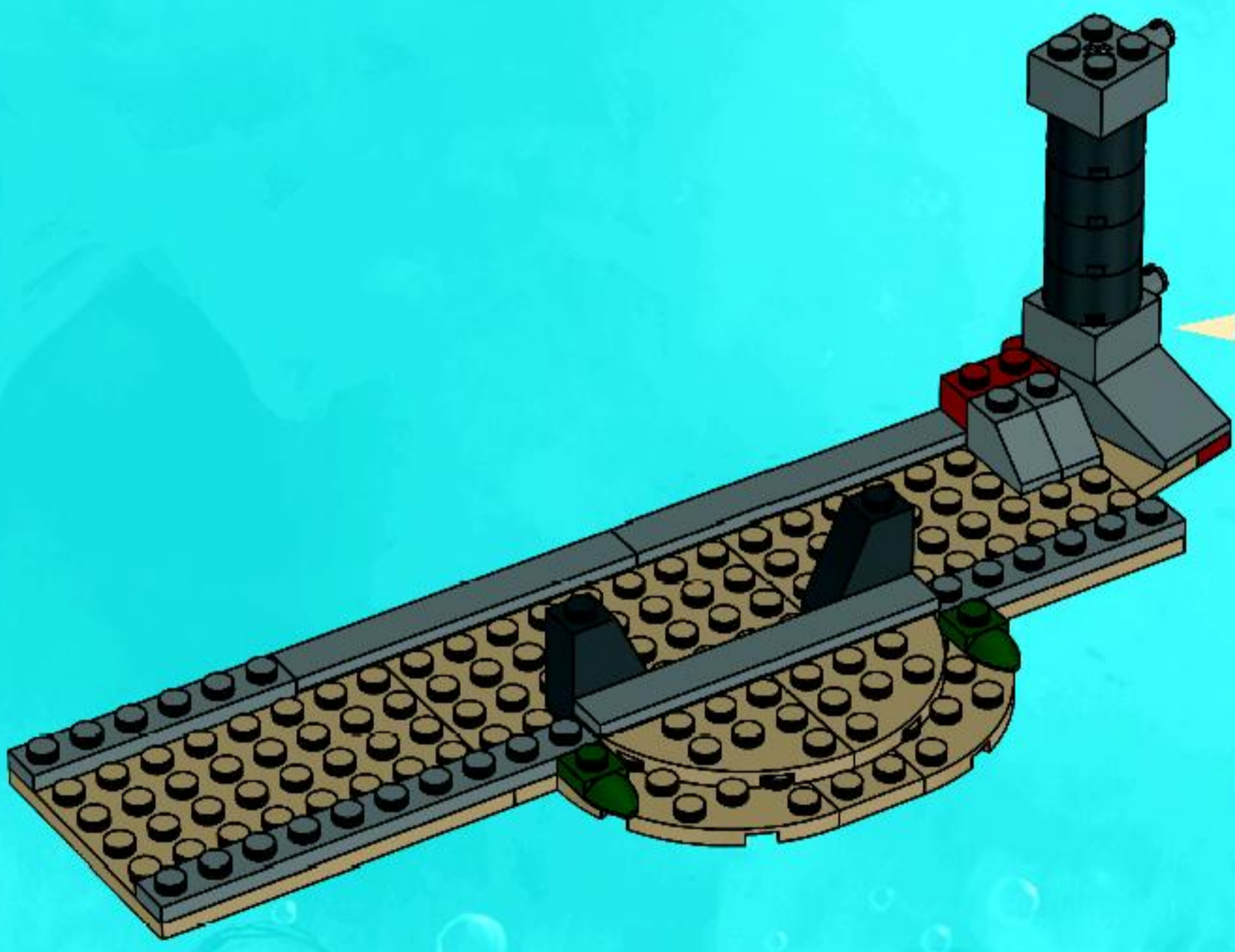
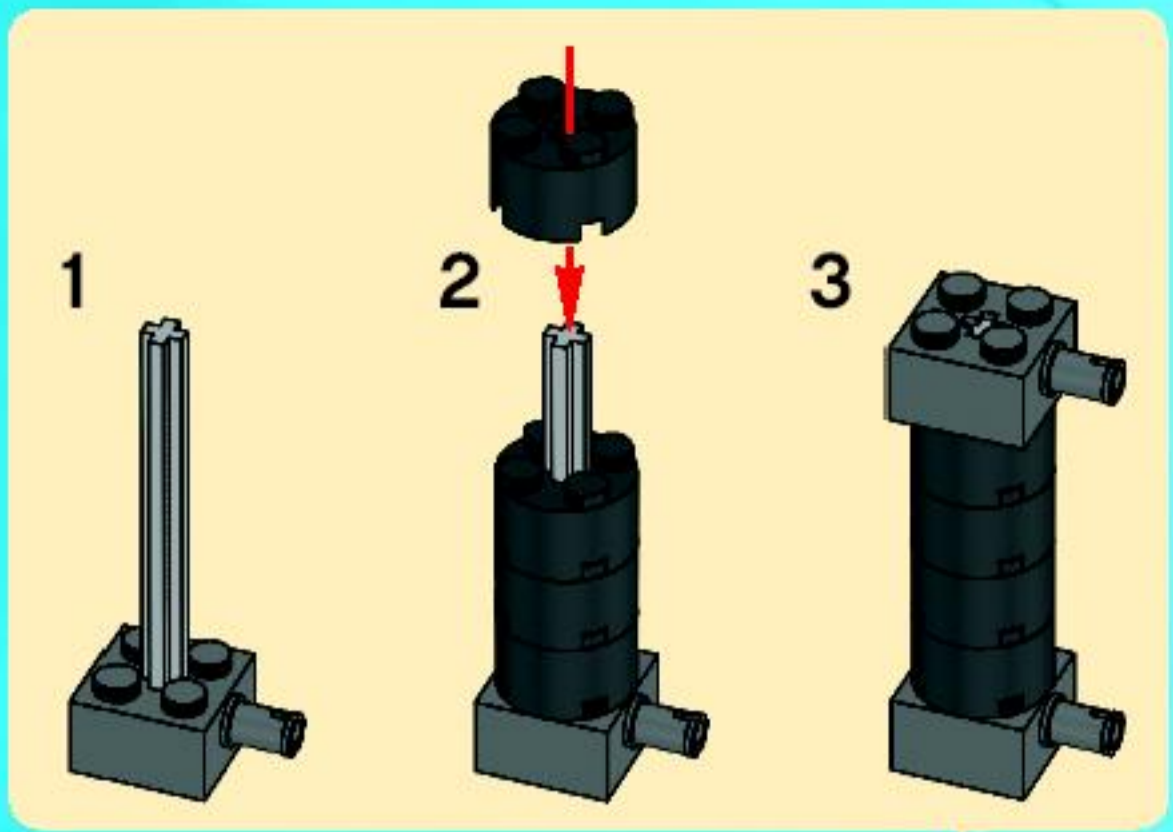



1x



1x

9

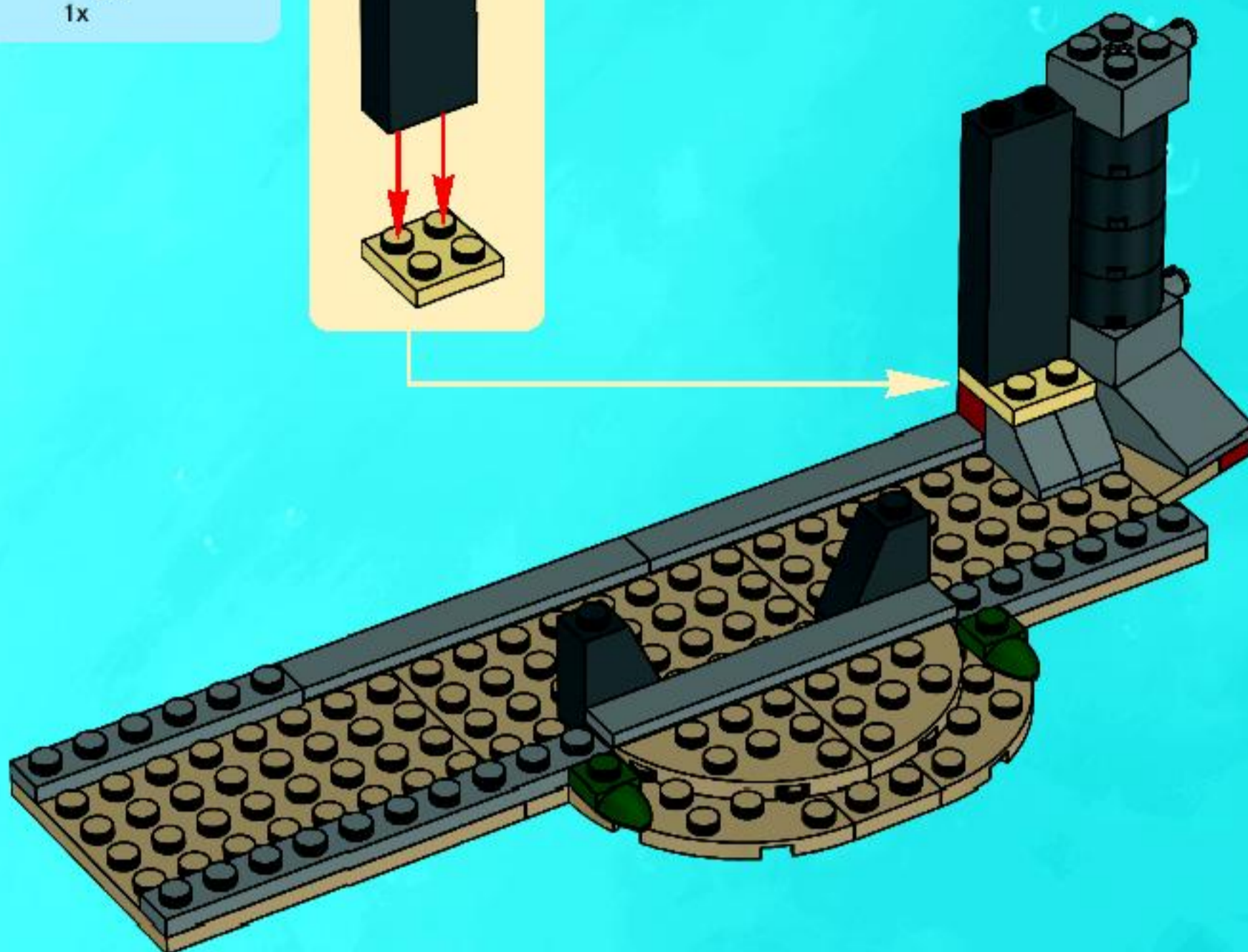
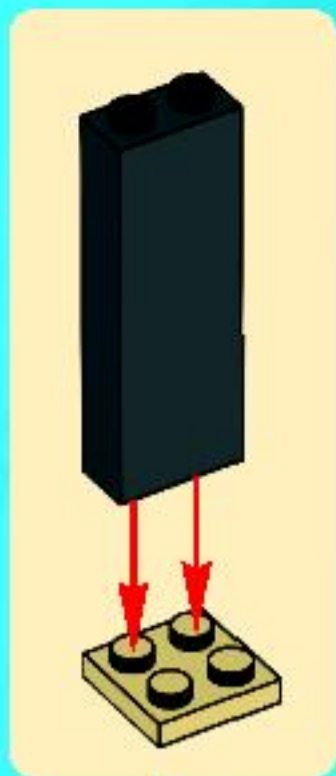

2x



2x

10

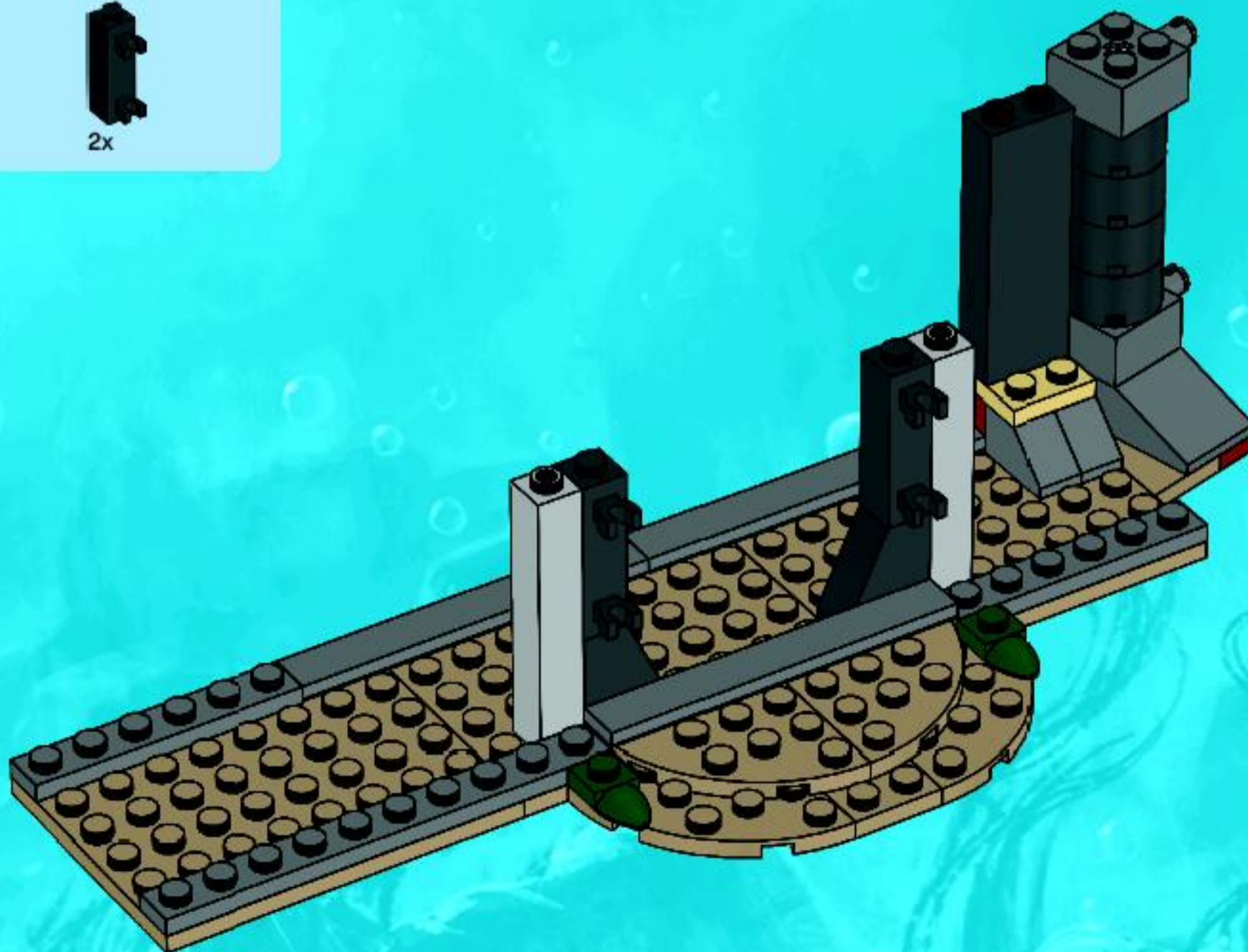



1x



2x

11

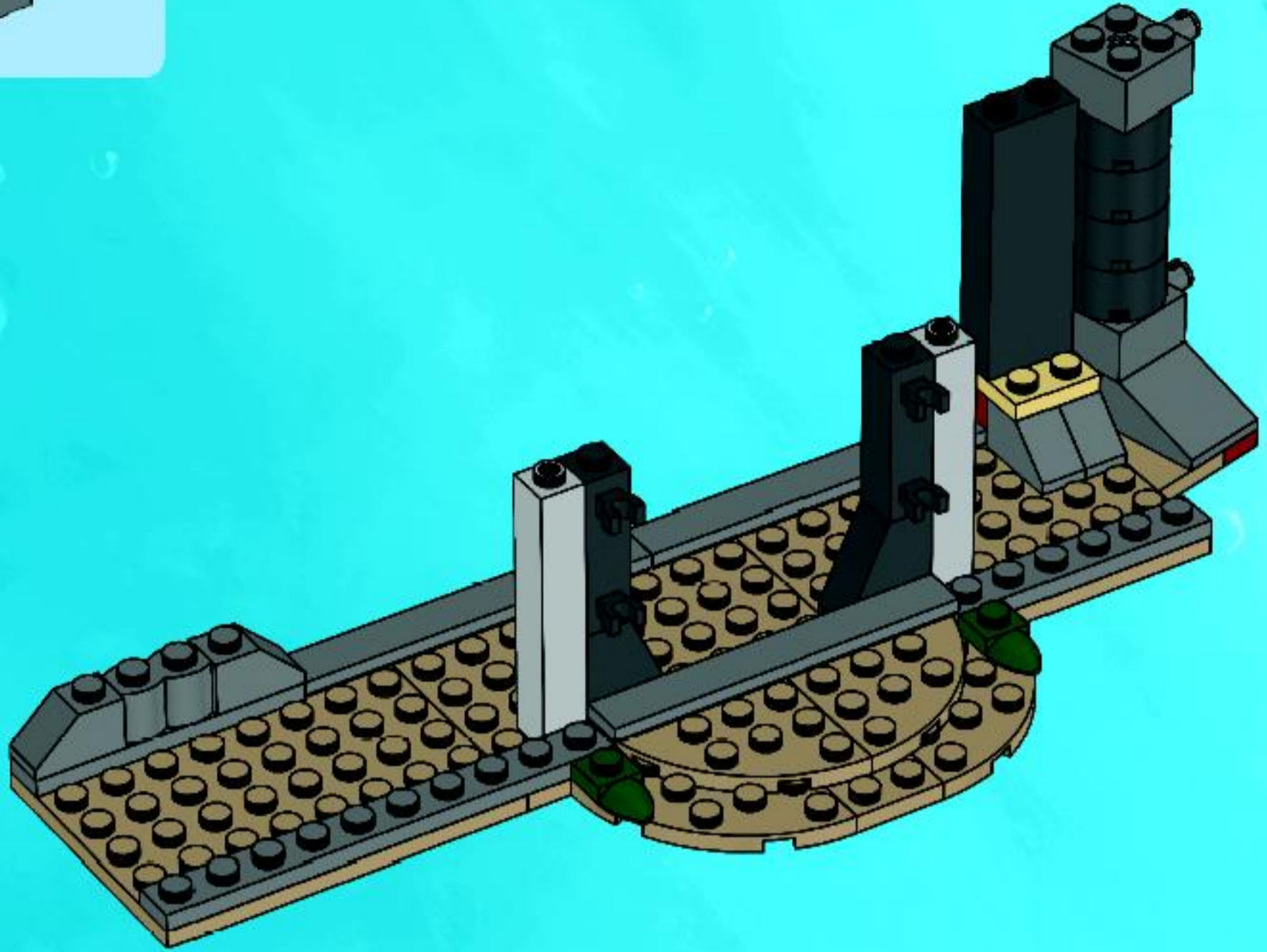

1x



1x

12

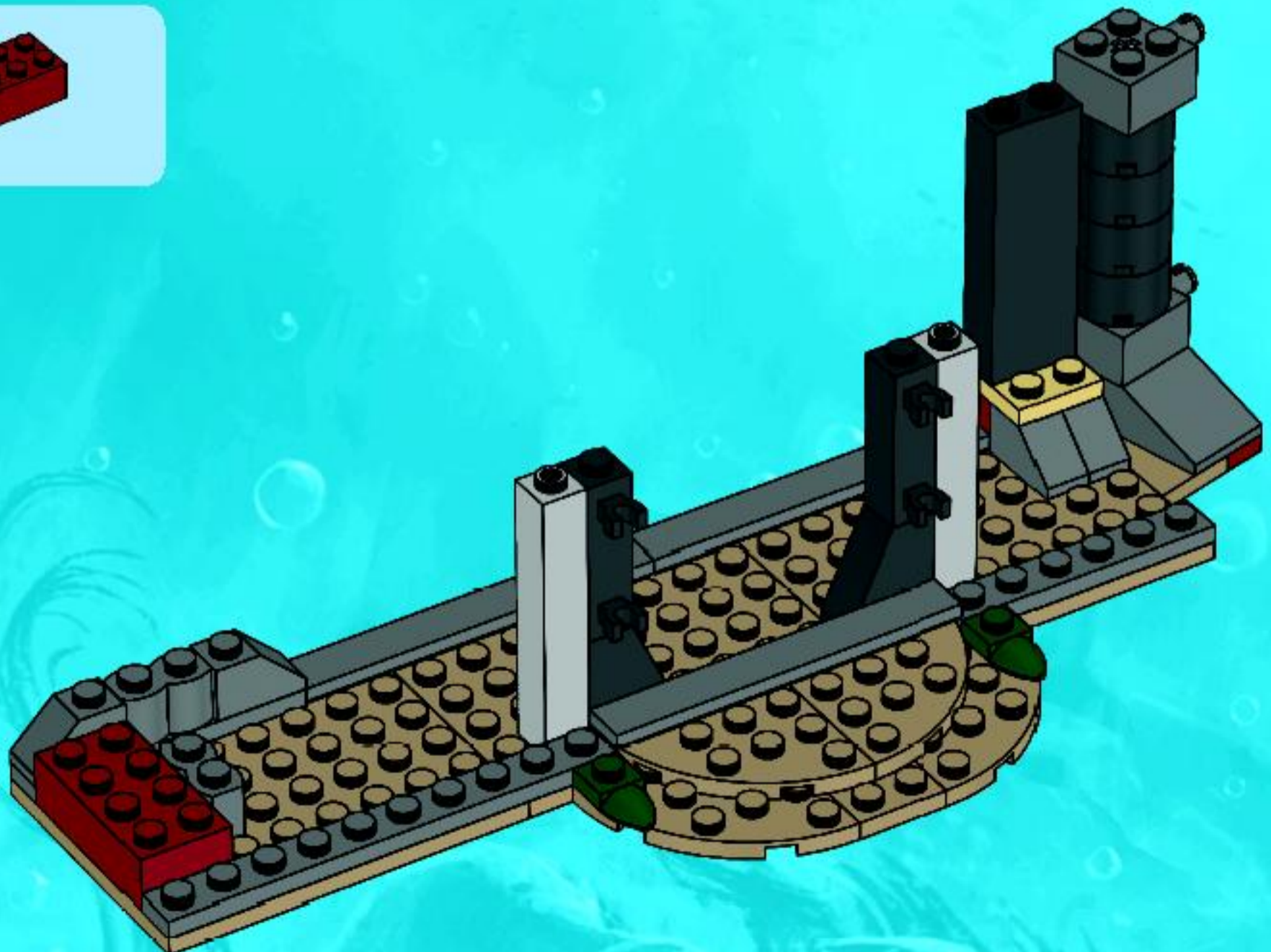



1x



1x



3x

13



1x



2x

14

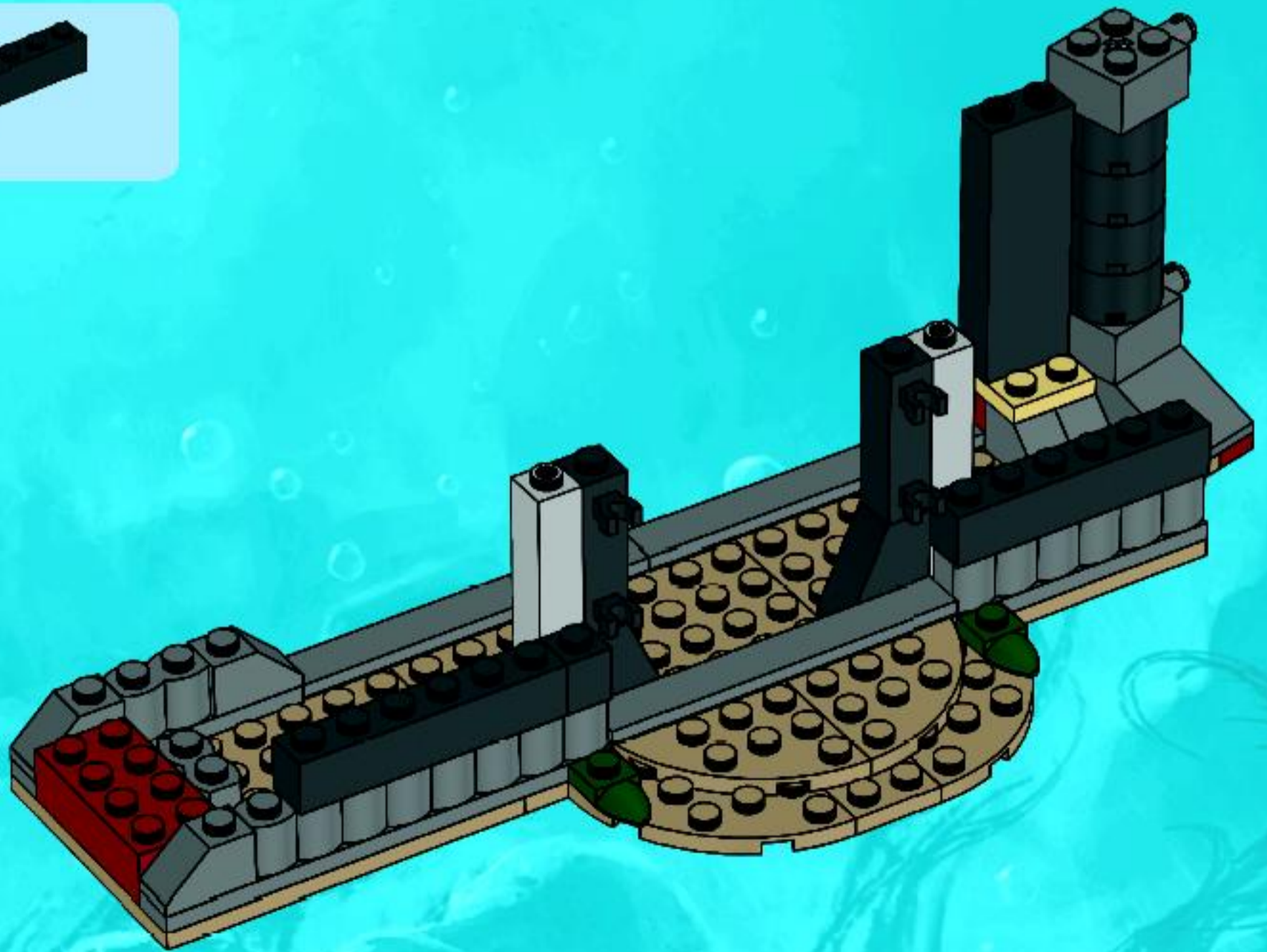

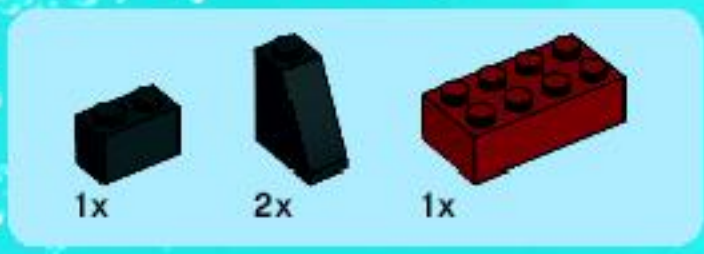

15

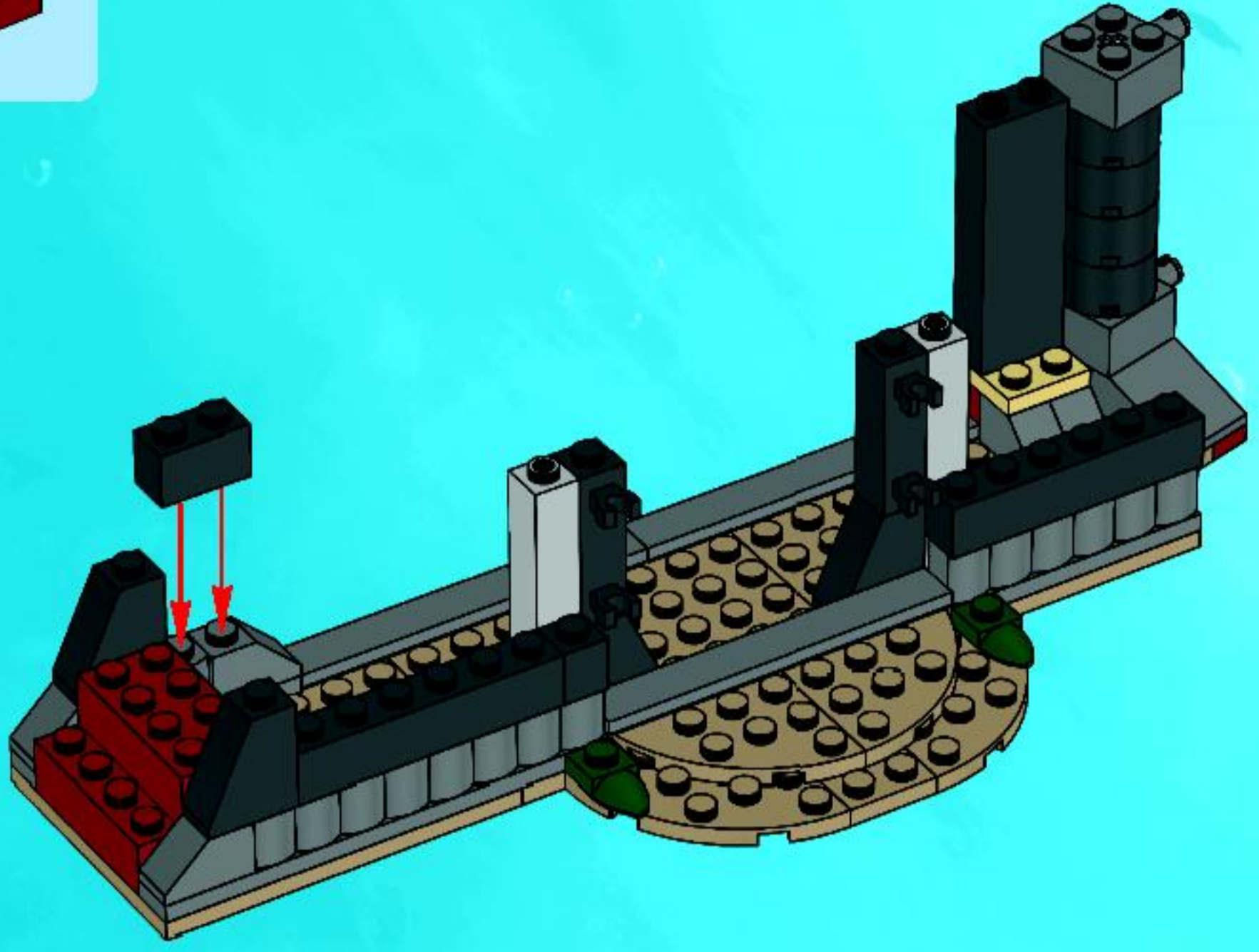

16

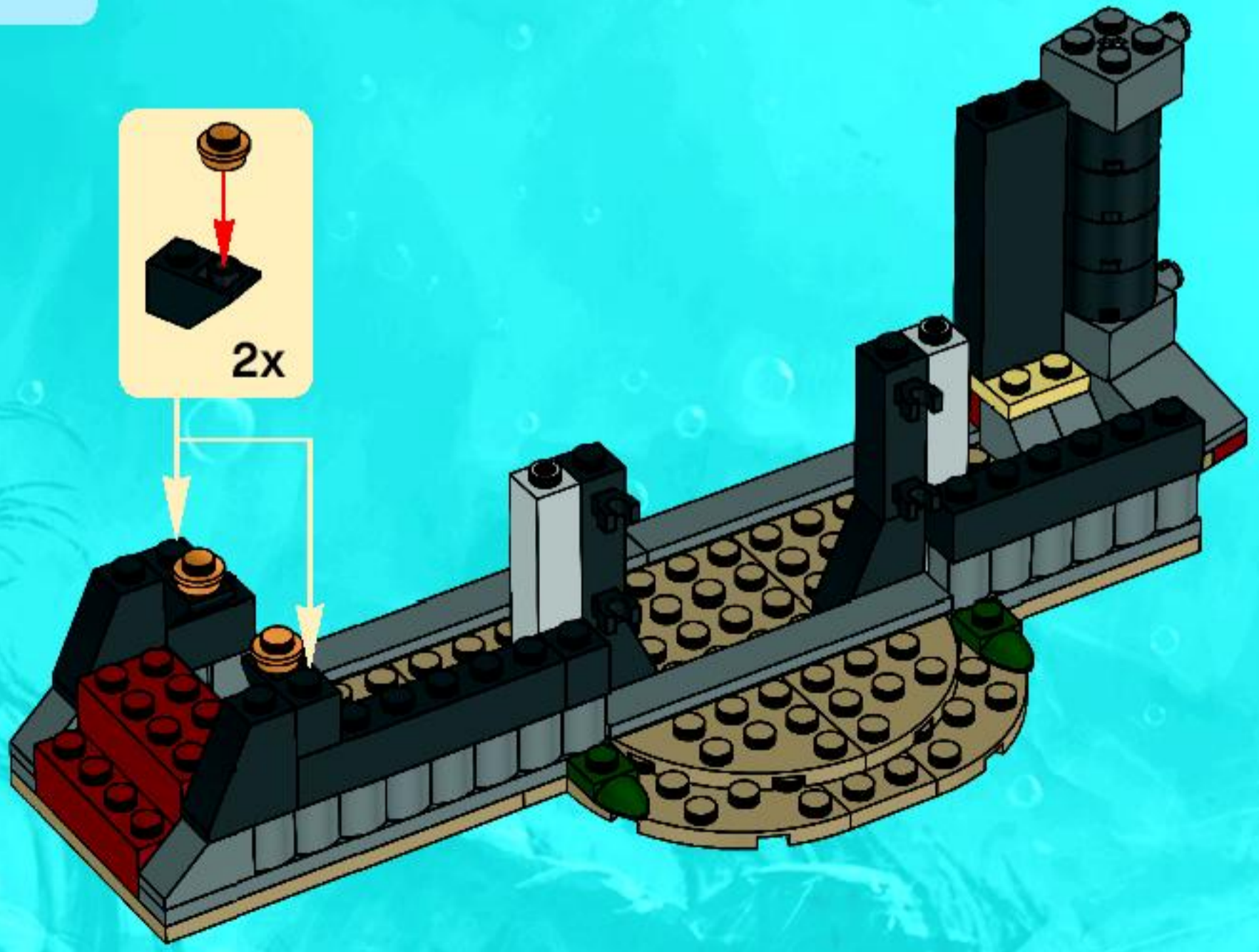



1x



4x



4x

17



1x



2x



4x

18



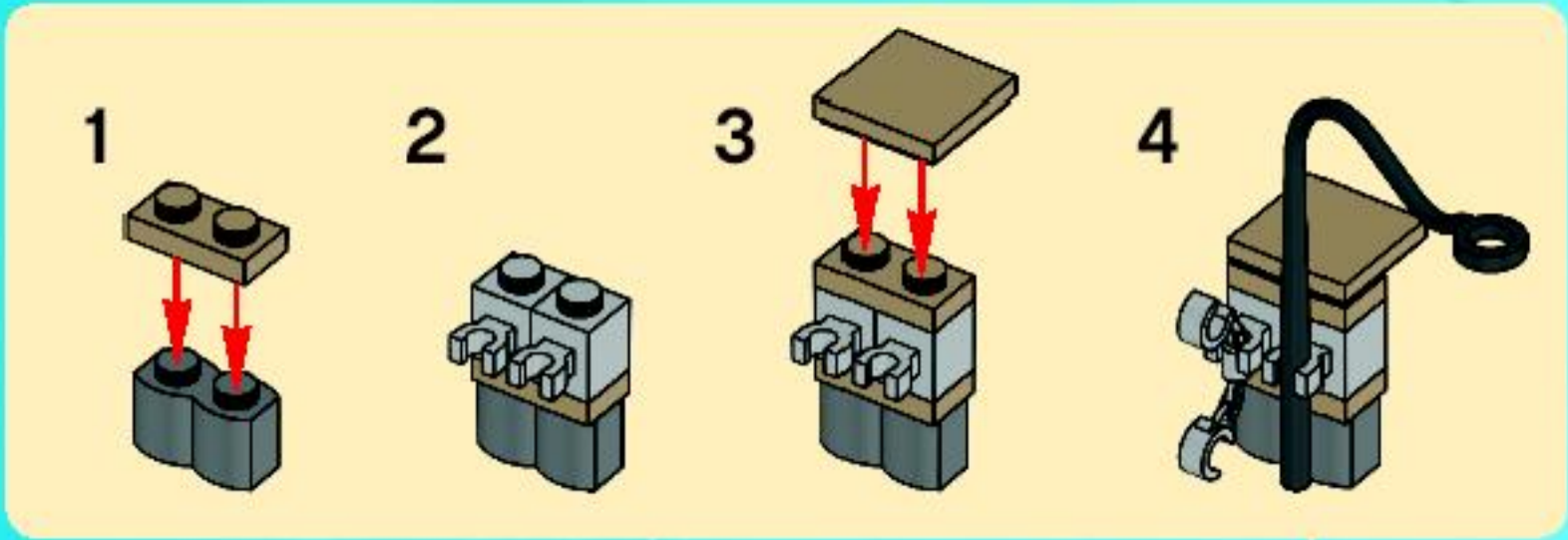
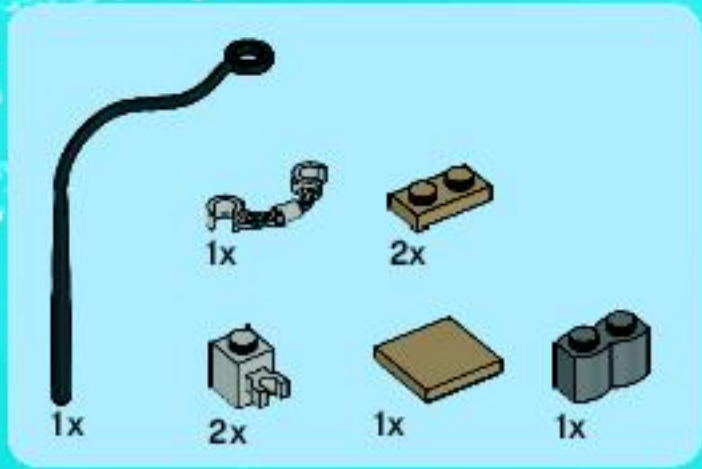

19





4x



2x

20

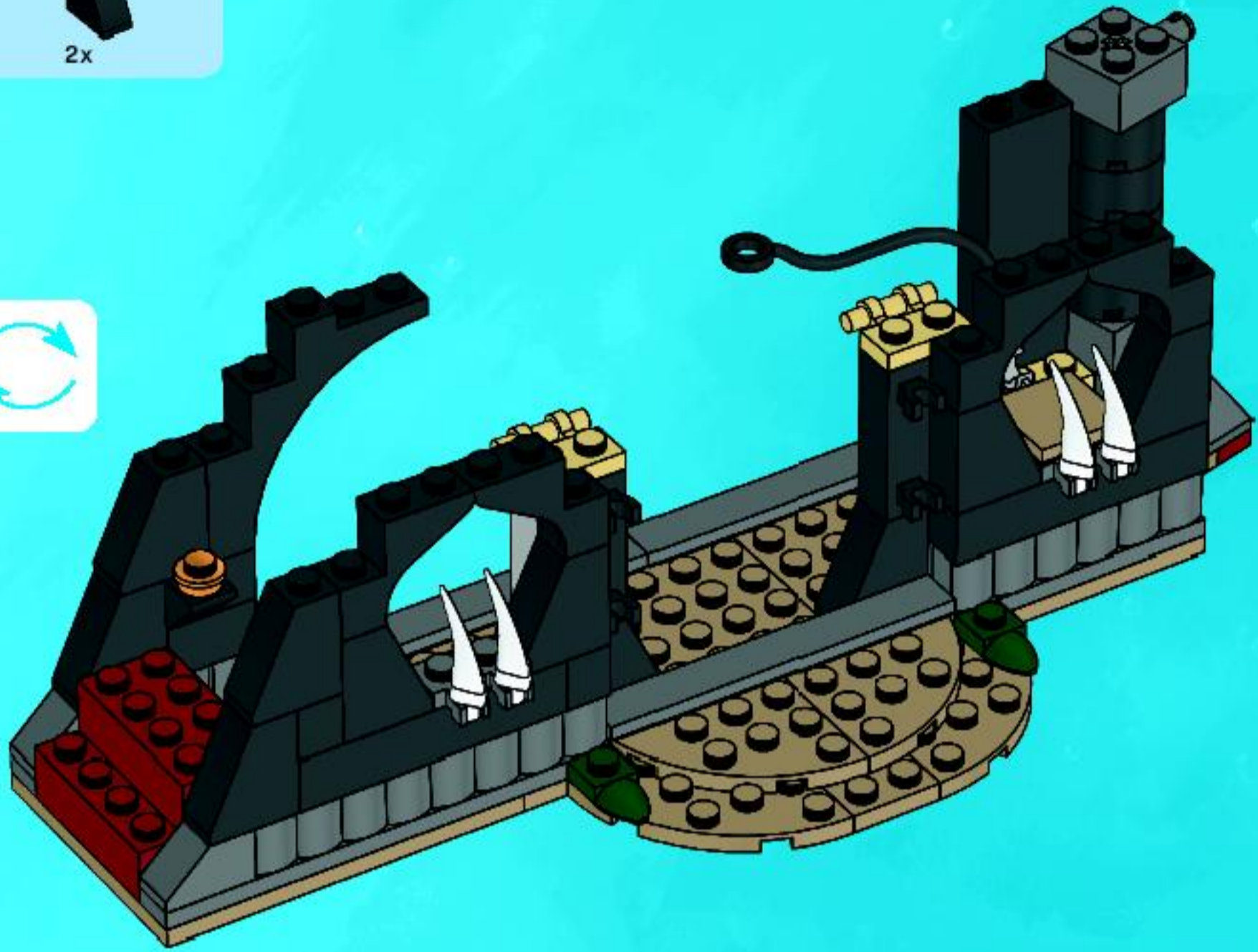

2x



2x

21



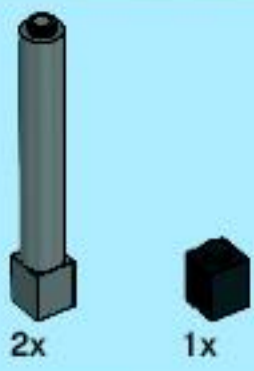

22

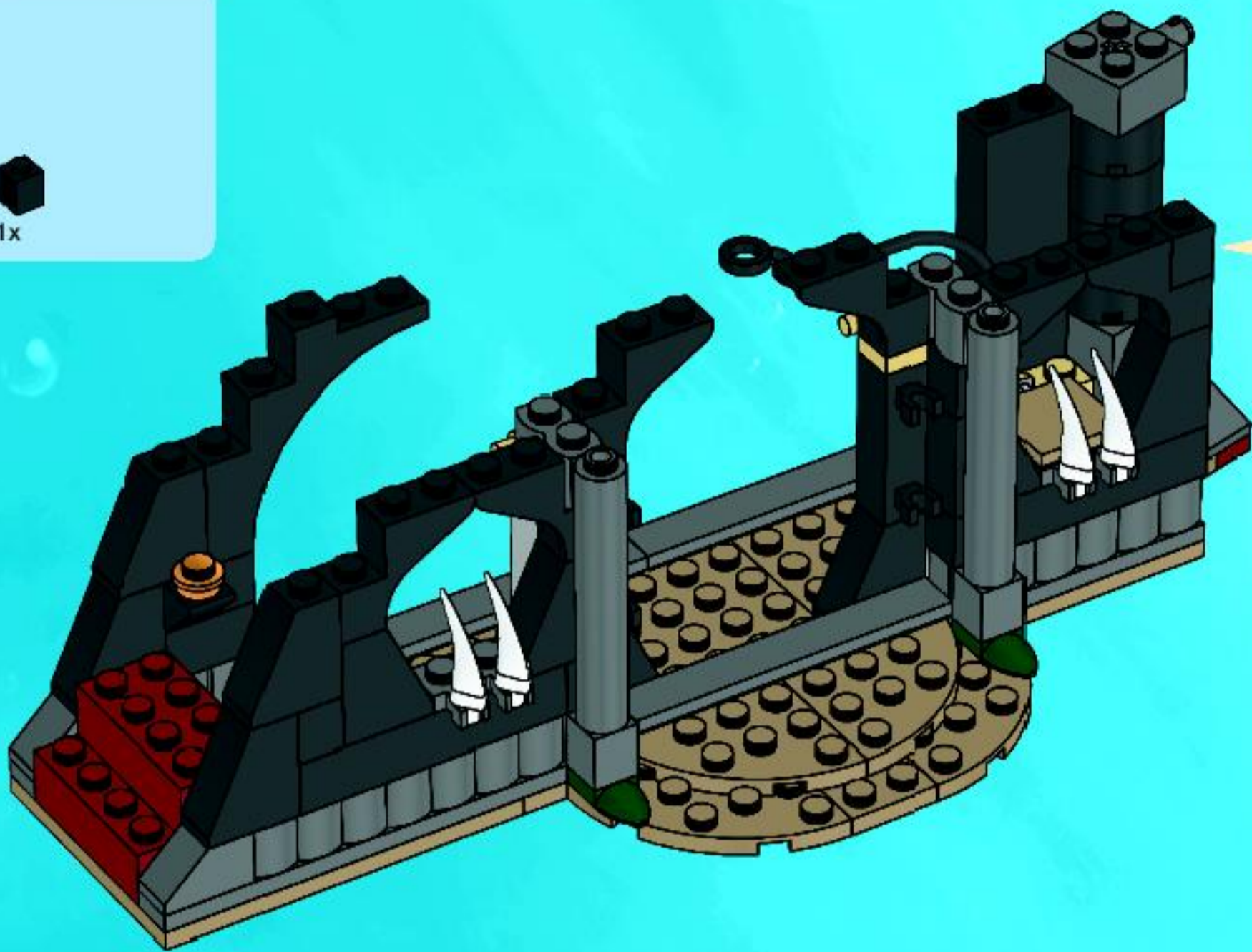

23

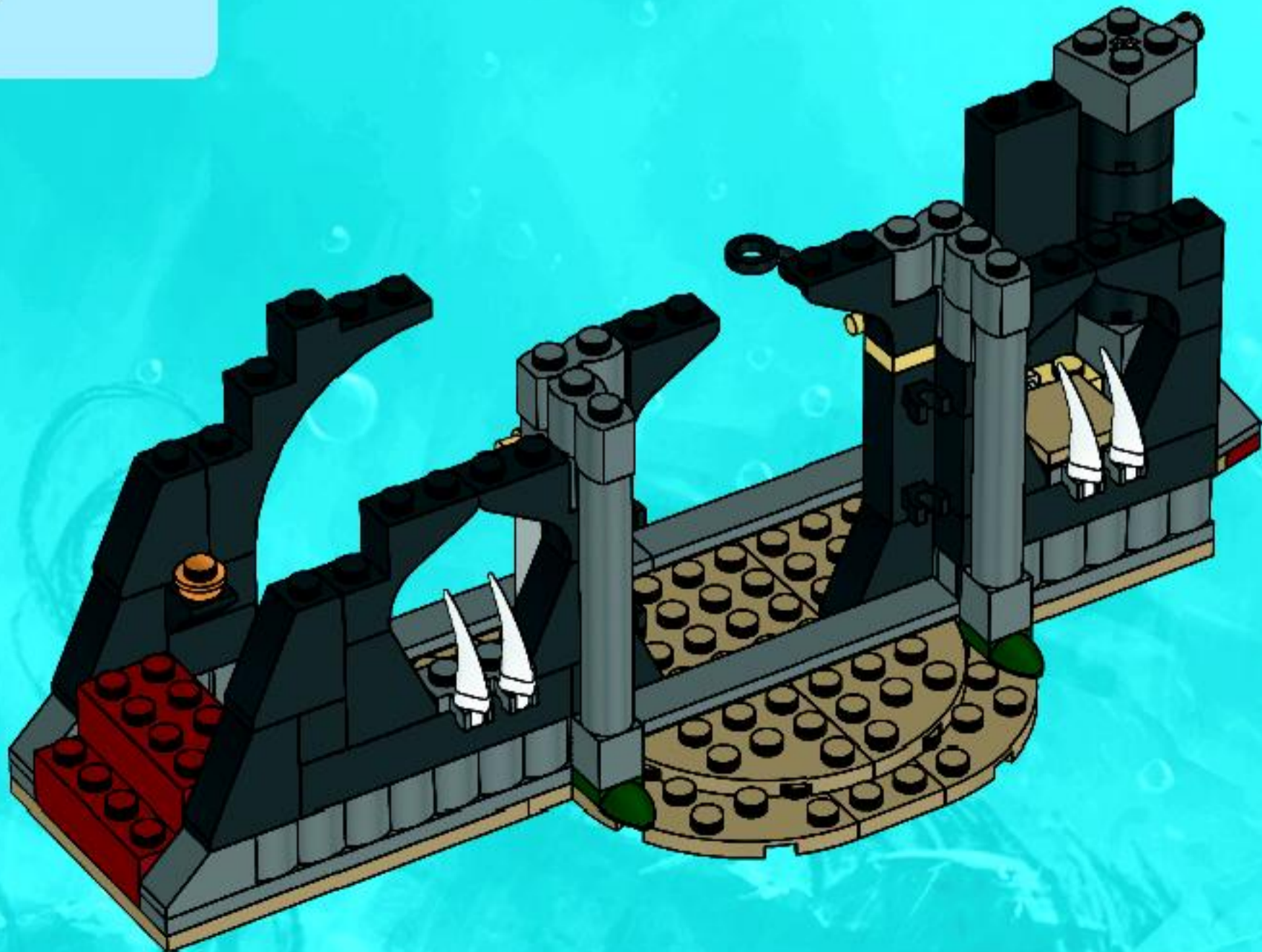



1x



2x

24

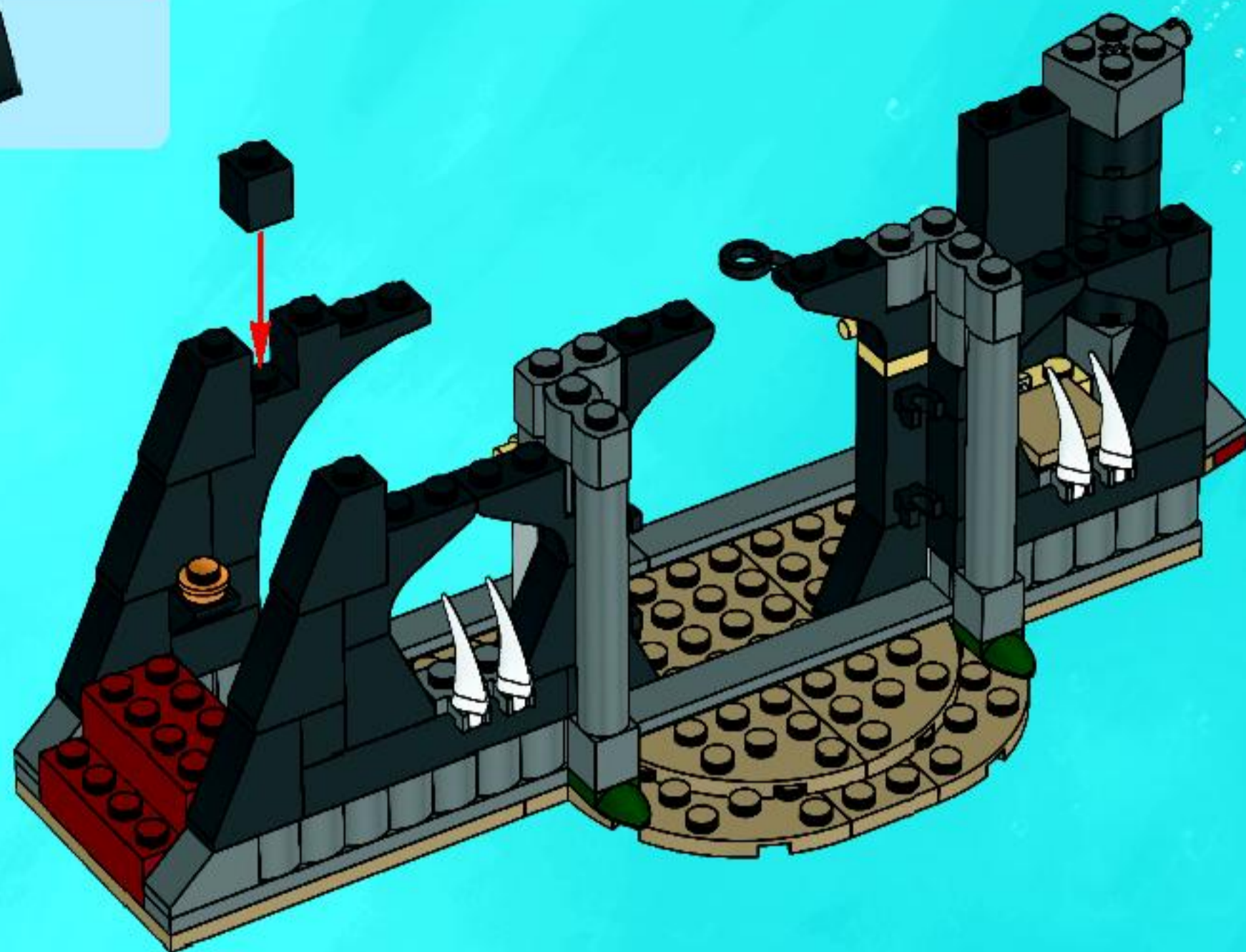

1x



1x



1x

25



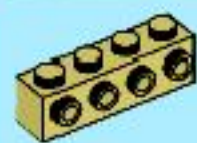

2x



2x



4x



1x

26

1

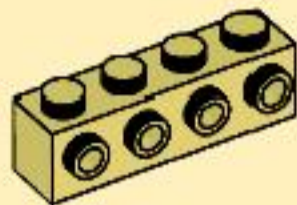

2



3



2x

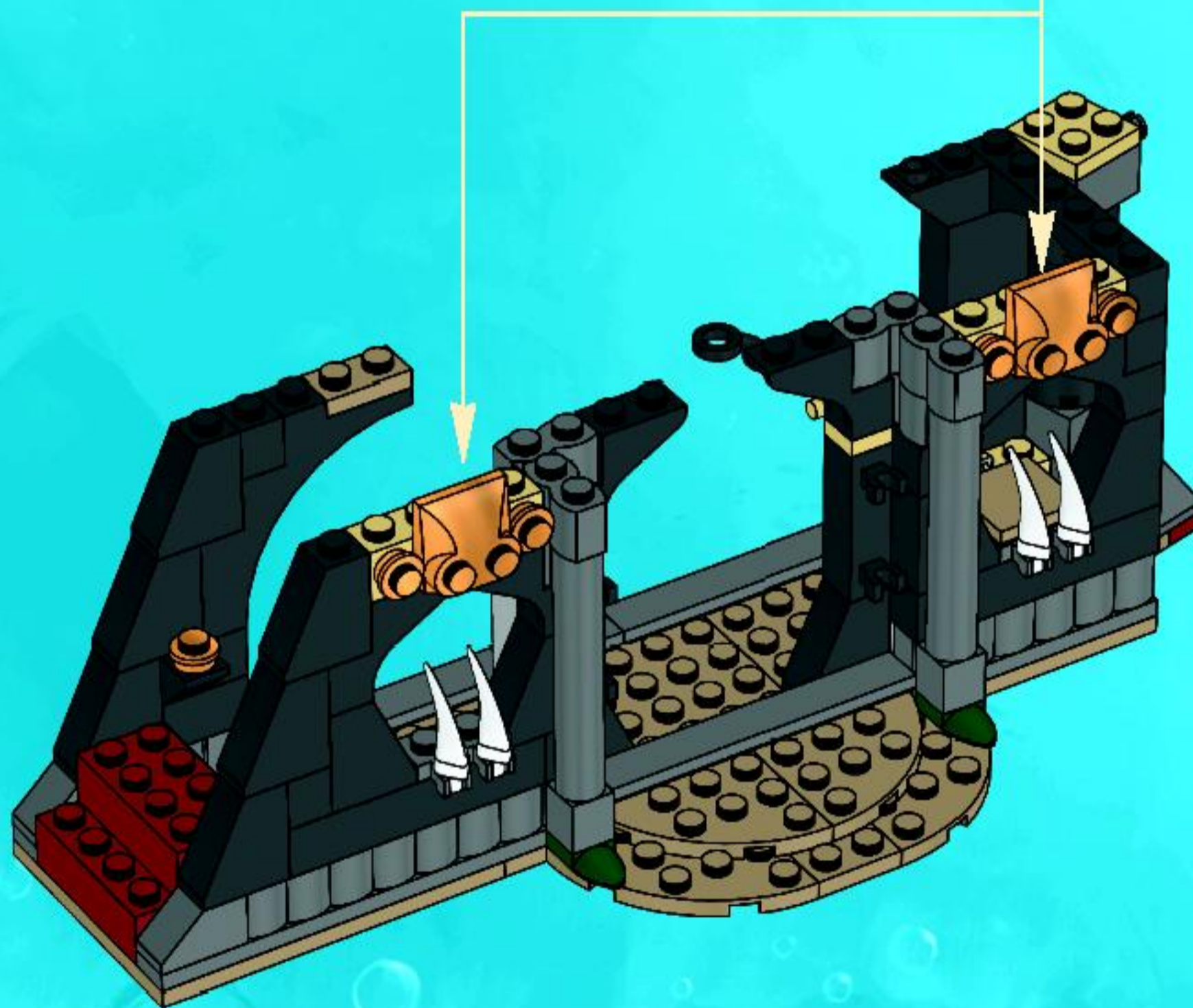



1x

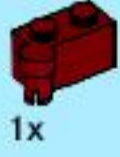

1x



1x

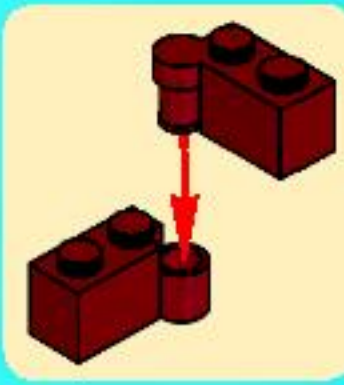

27

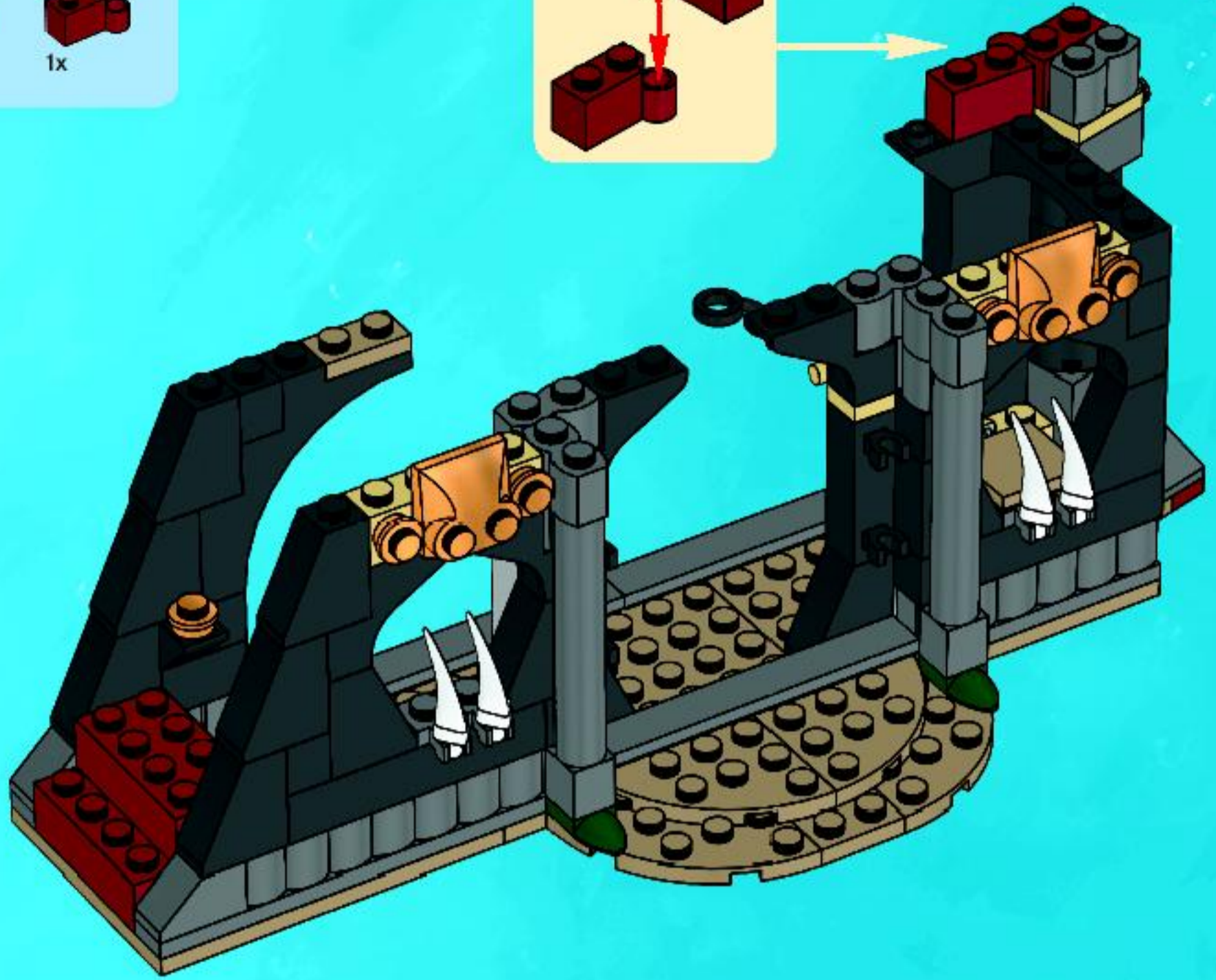

1x

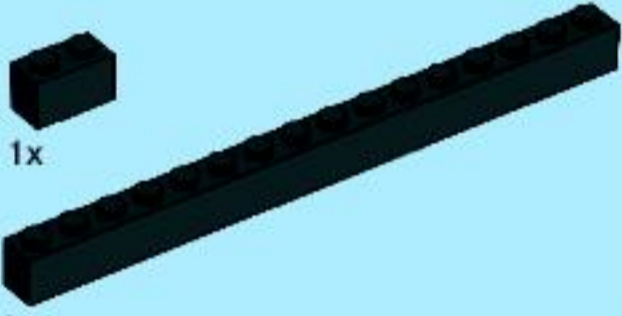

1x

28



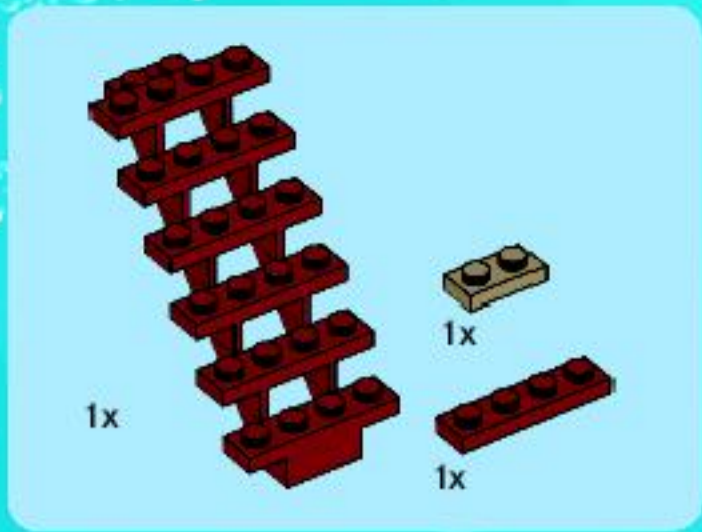

29

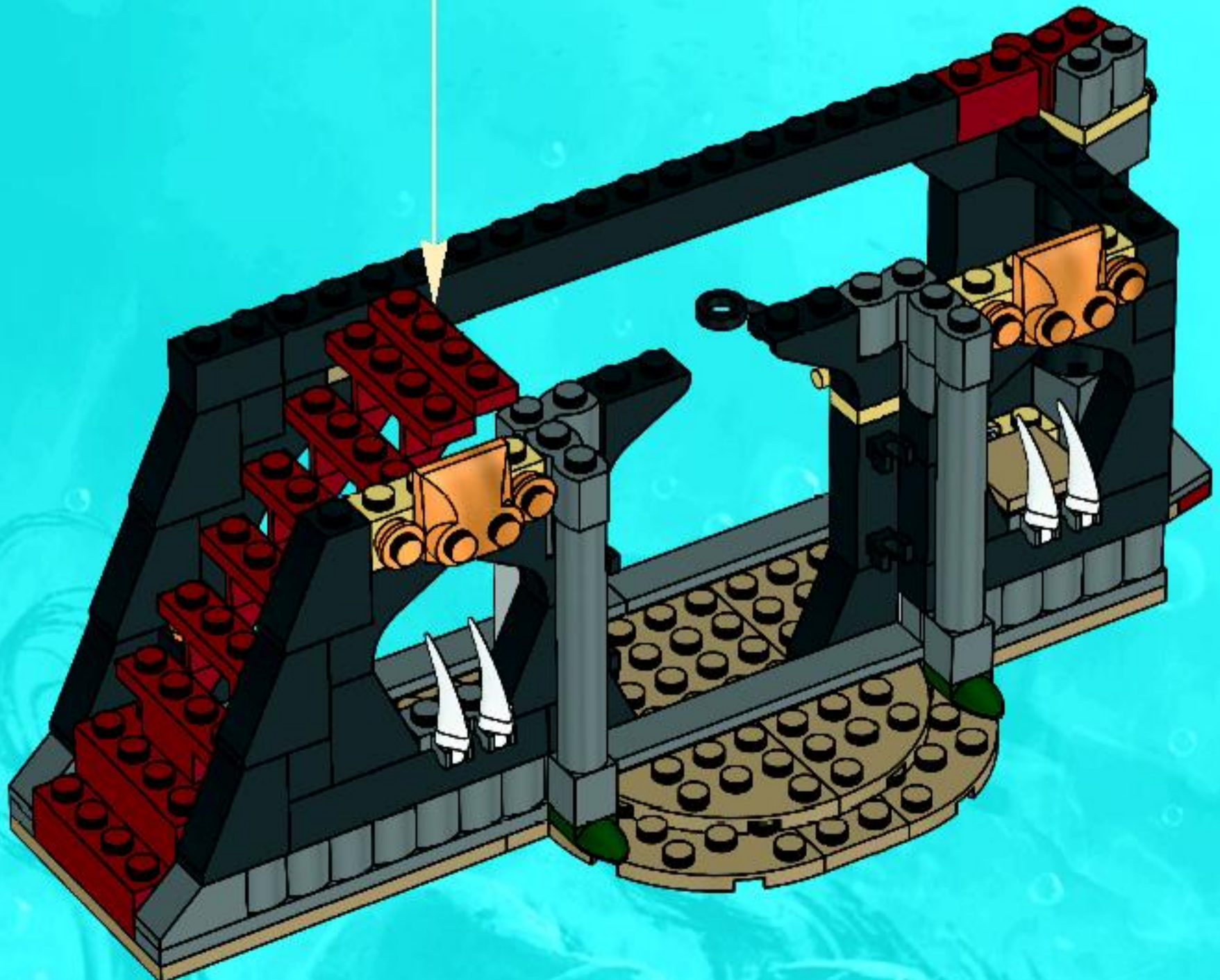
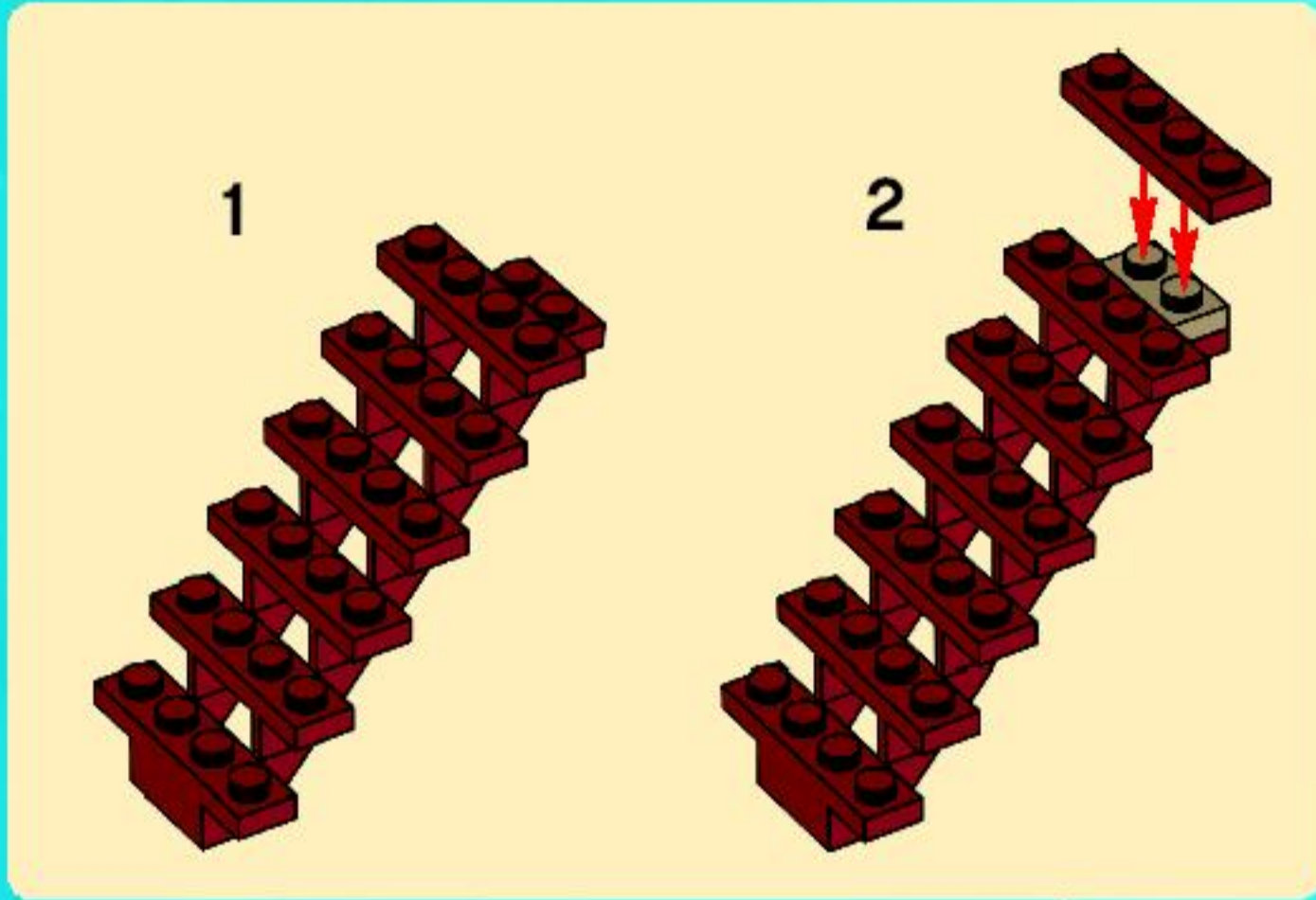

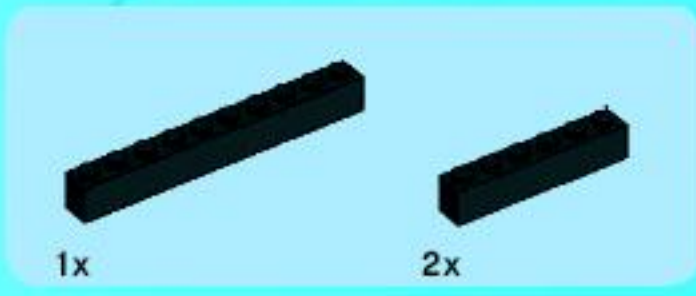

30

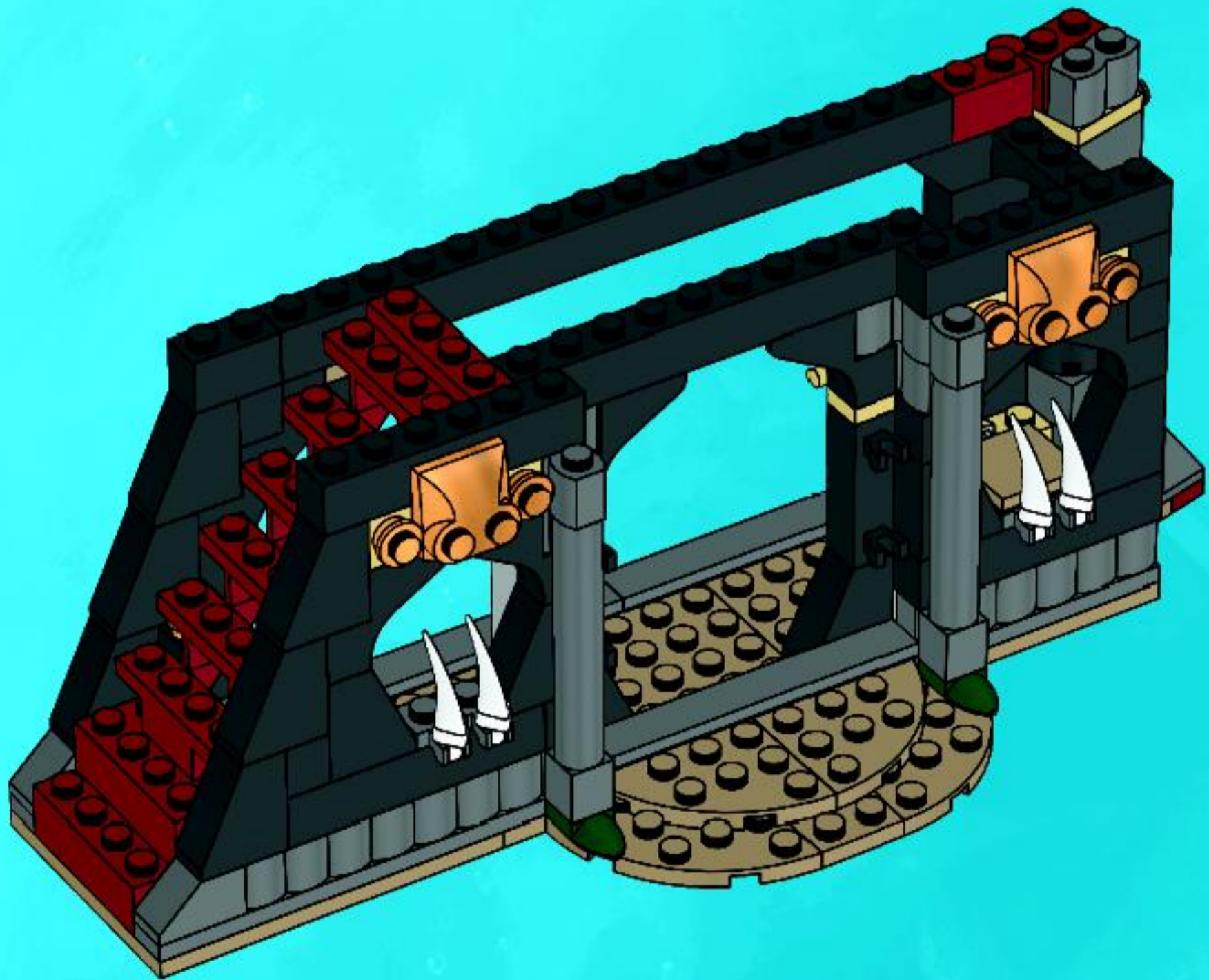

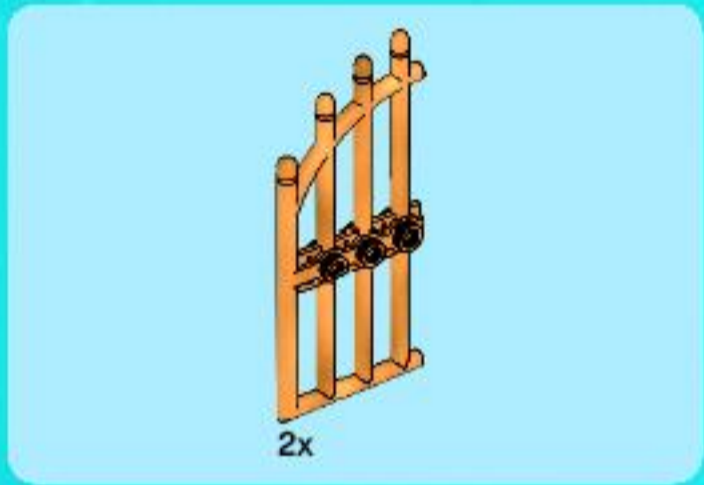
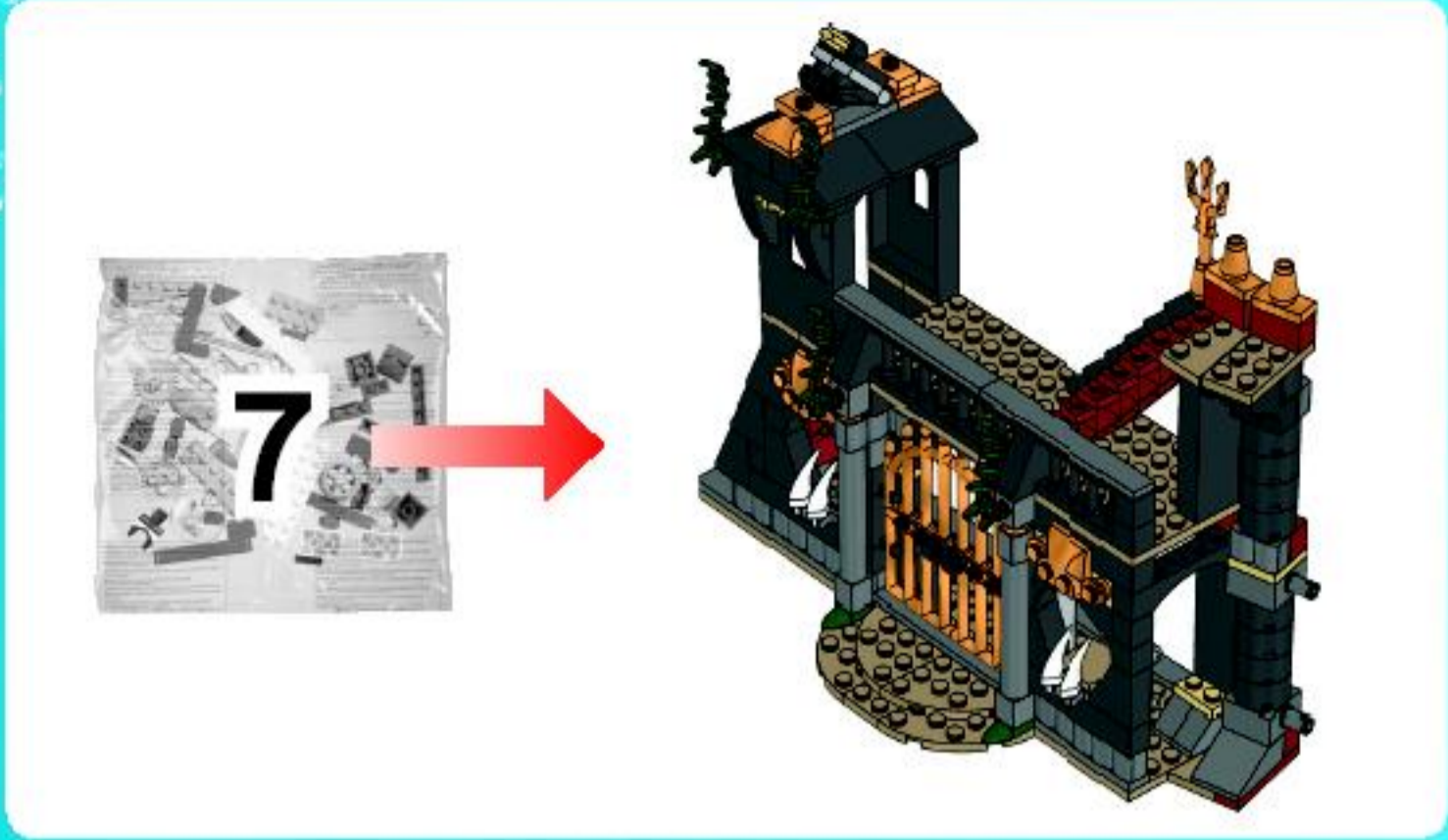

31

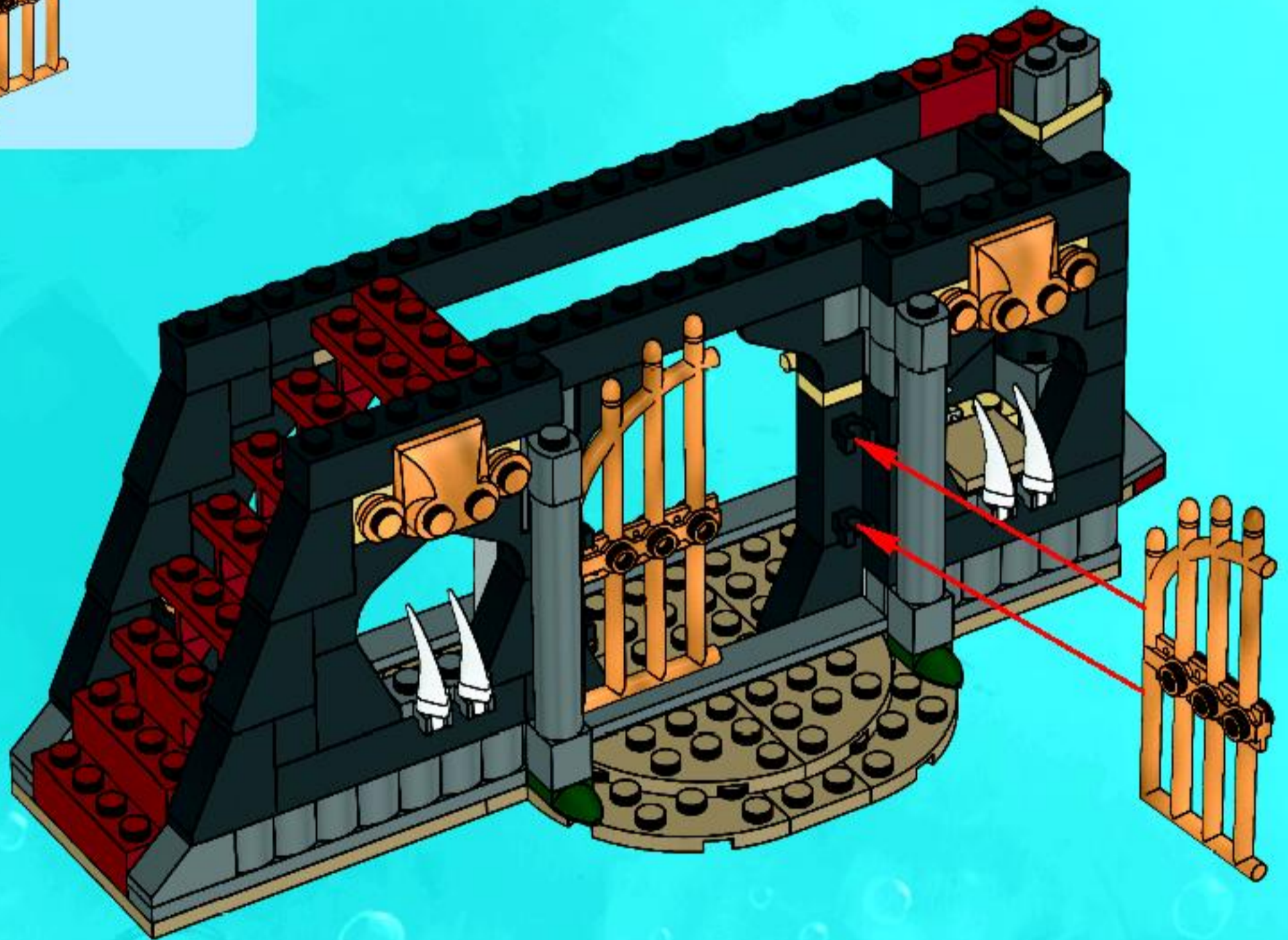



2x



2x

32

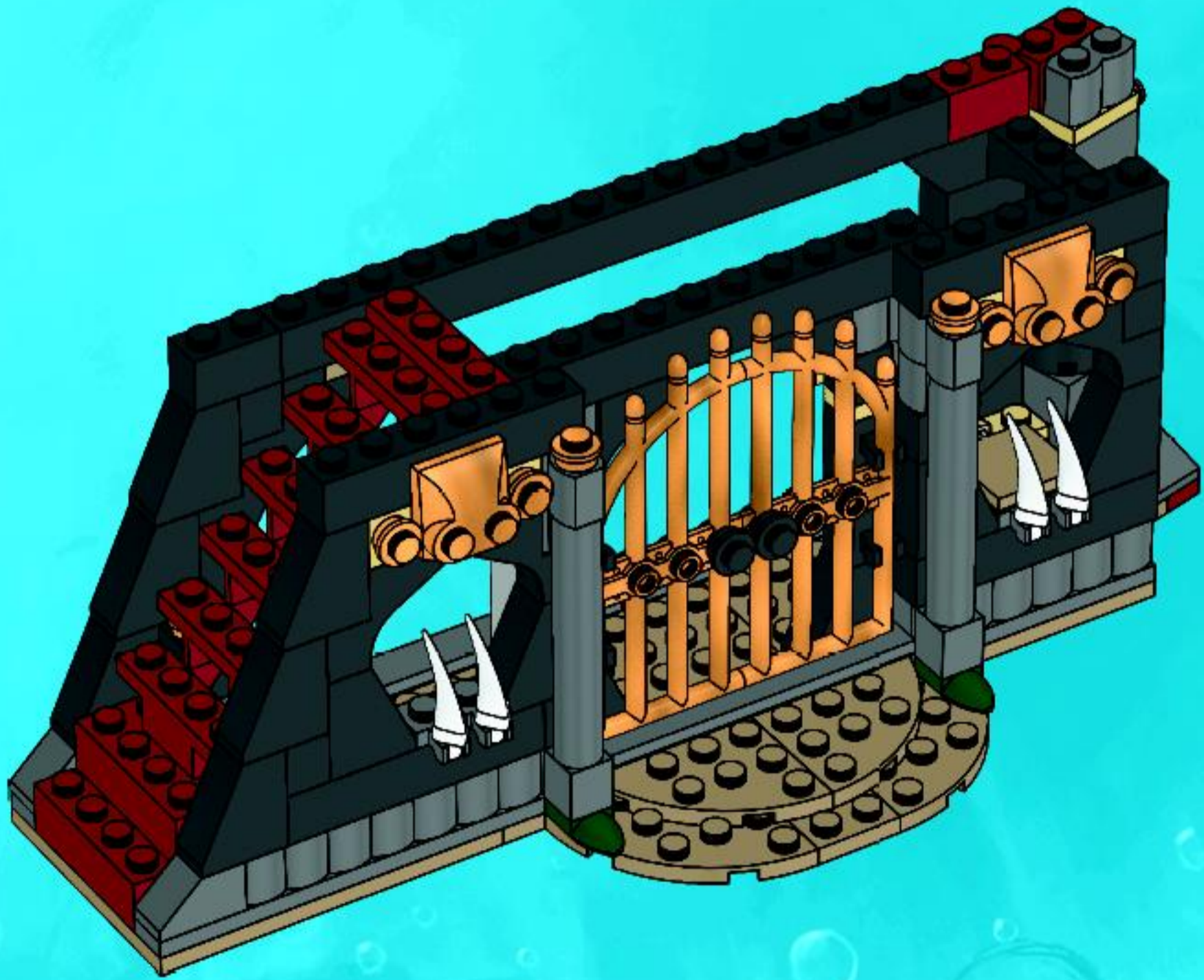



33

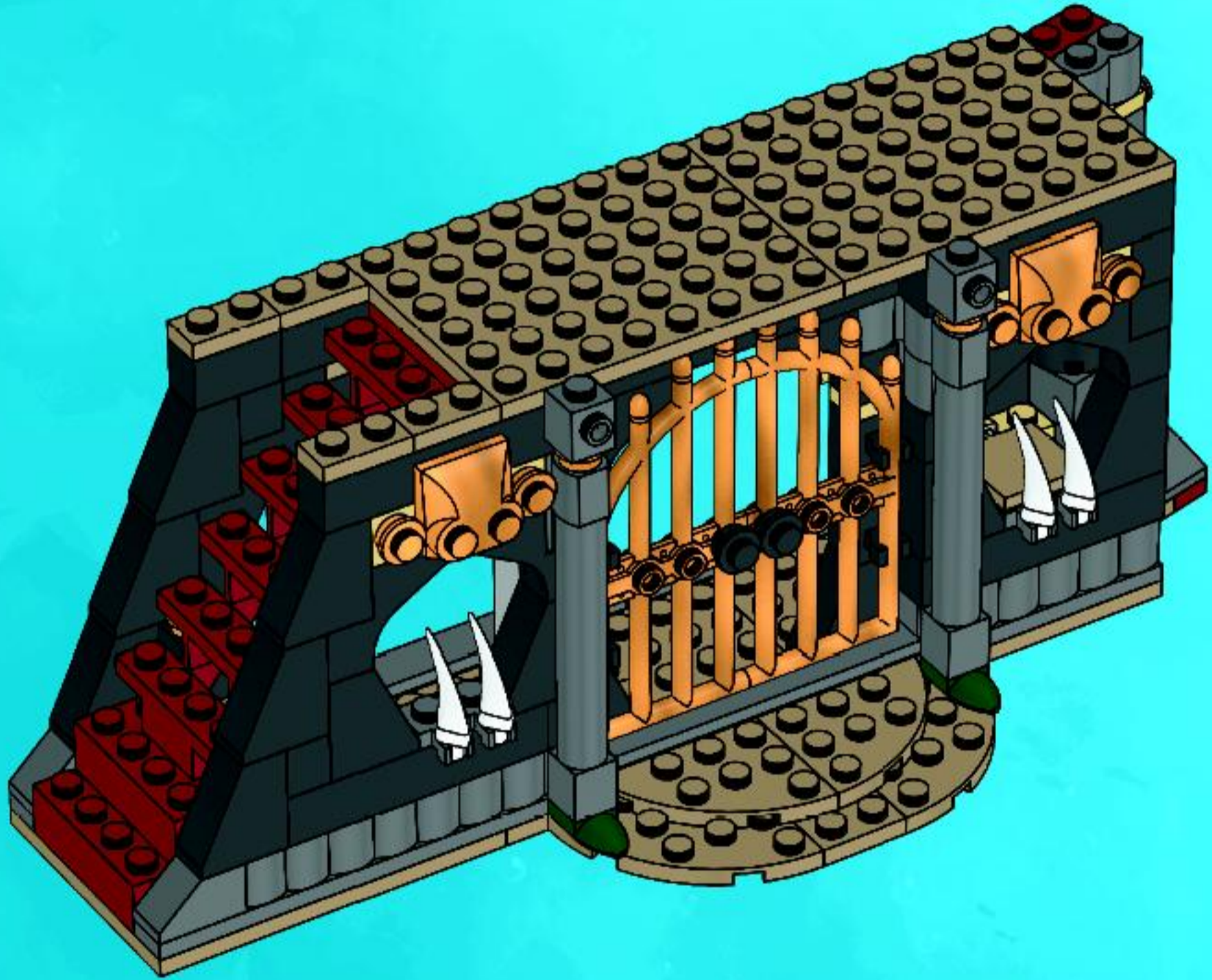

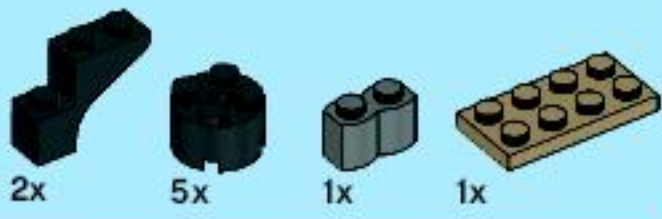

34

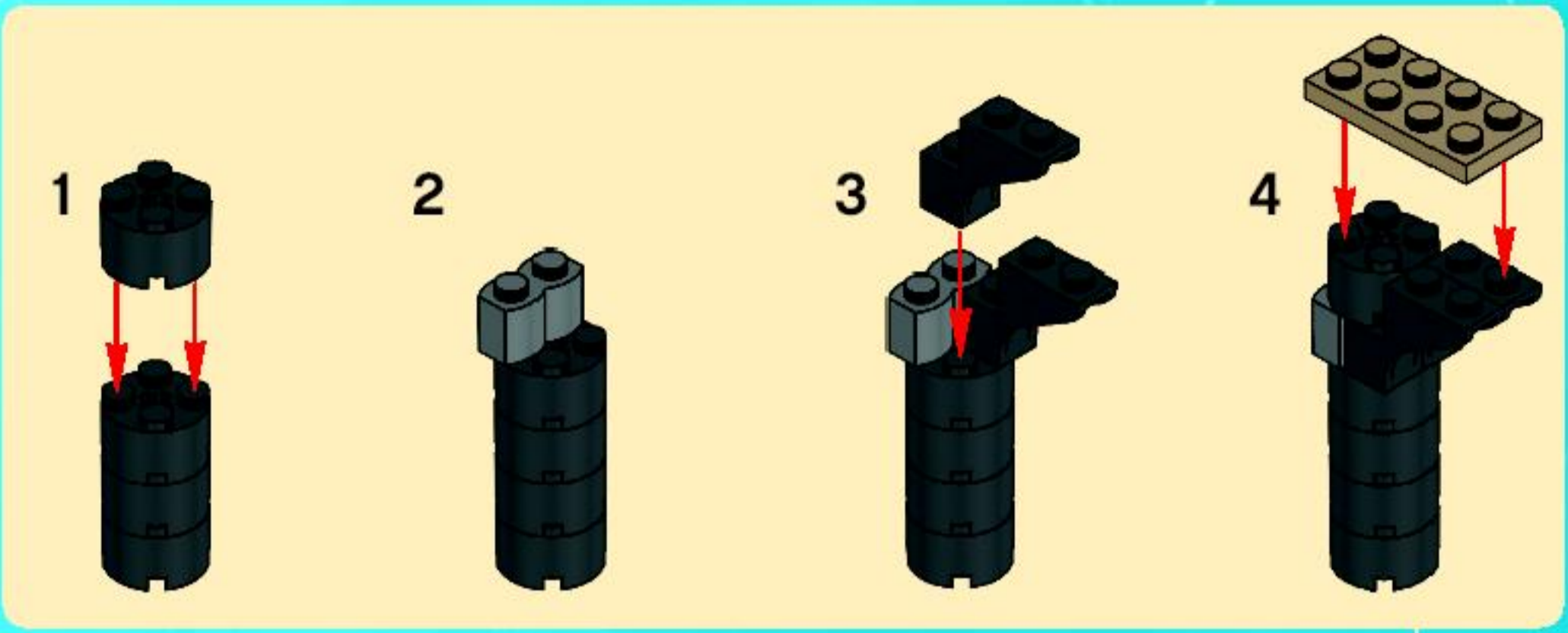

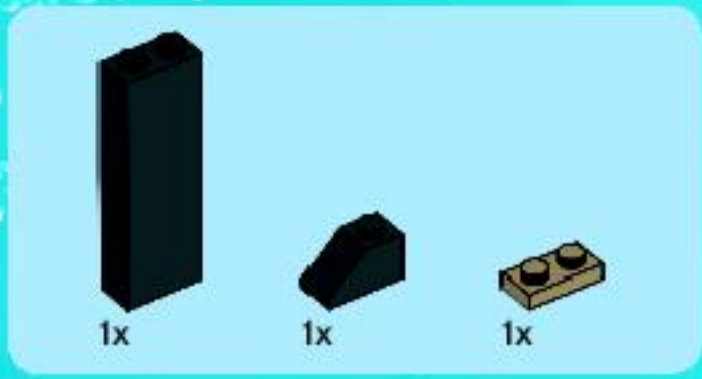

35



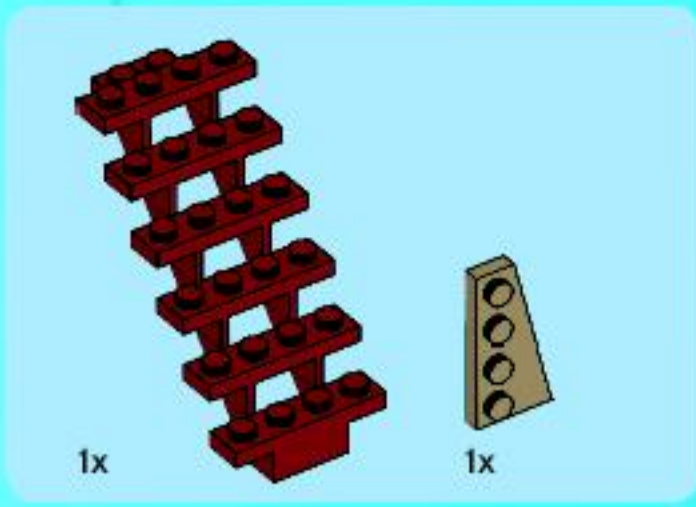

36

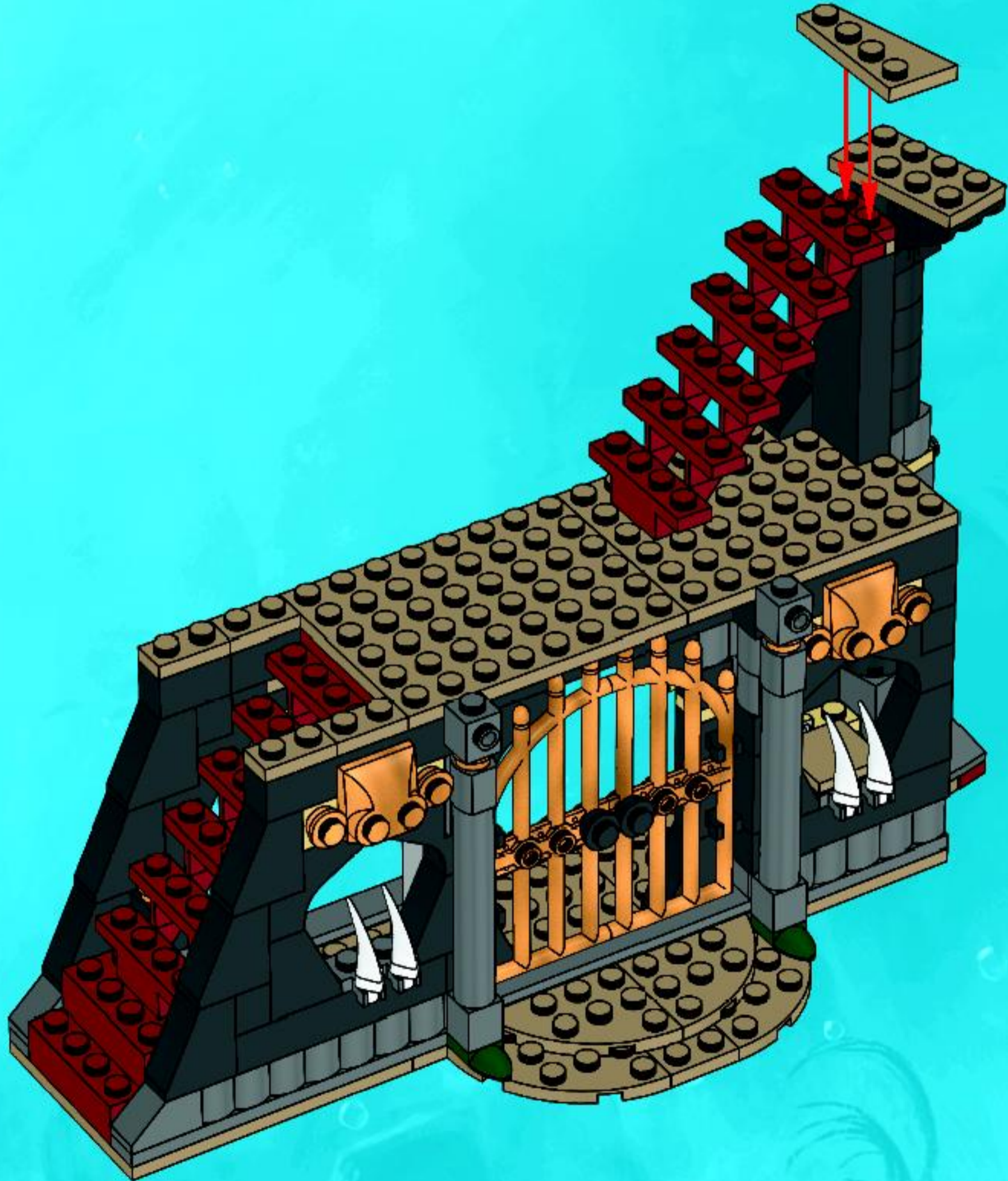



6x

37





1x



1x



1x

38

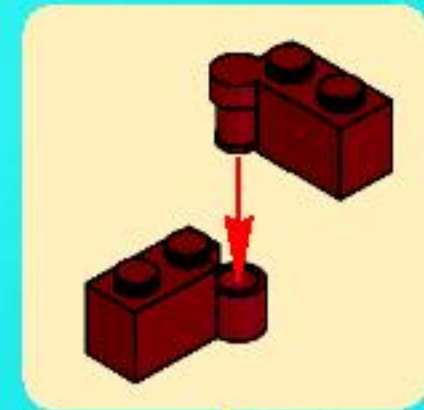



2x



1x

39

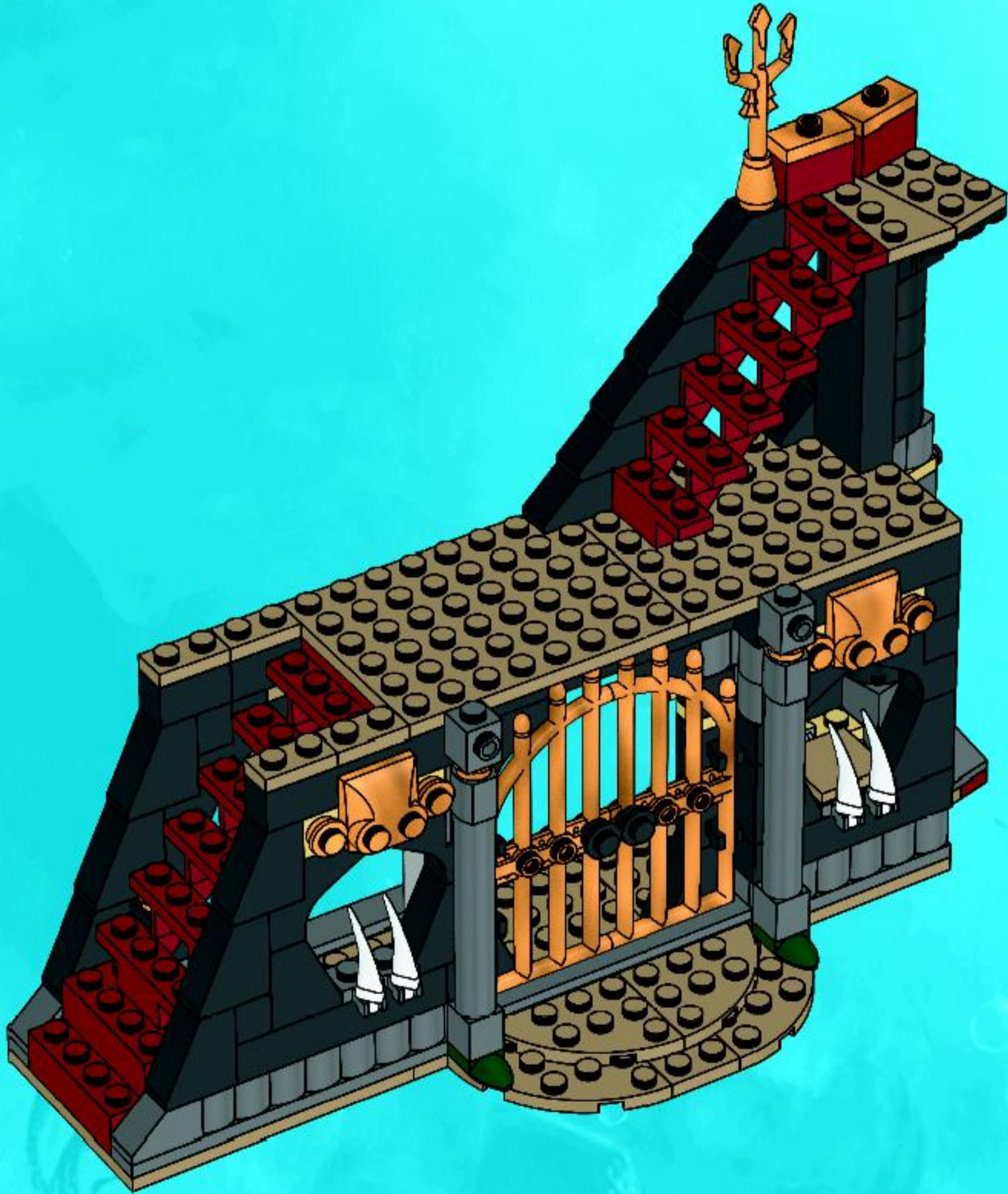



40

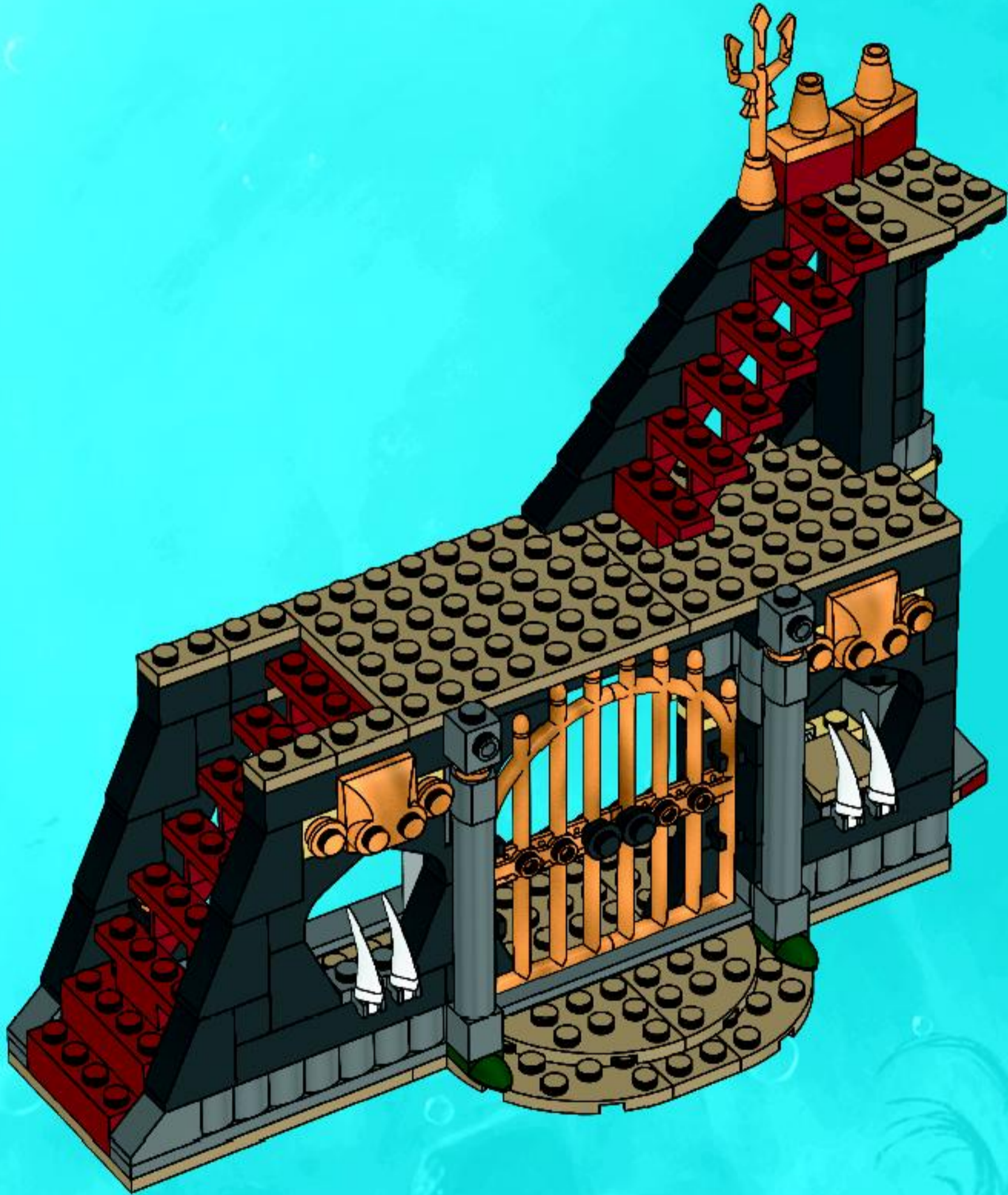



4x



2x



3x

41

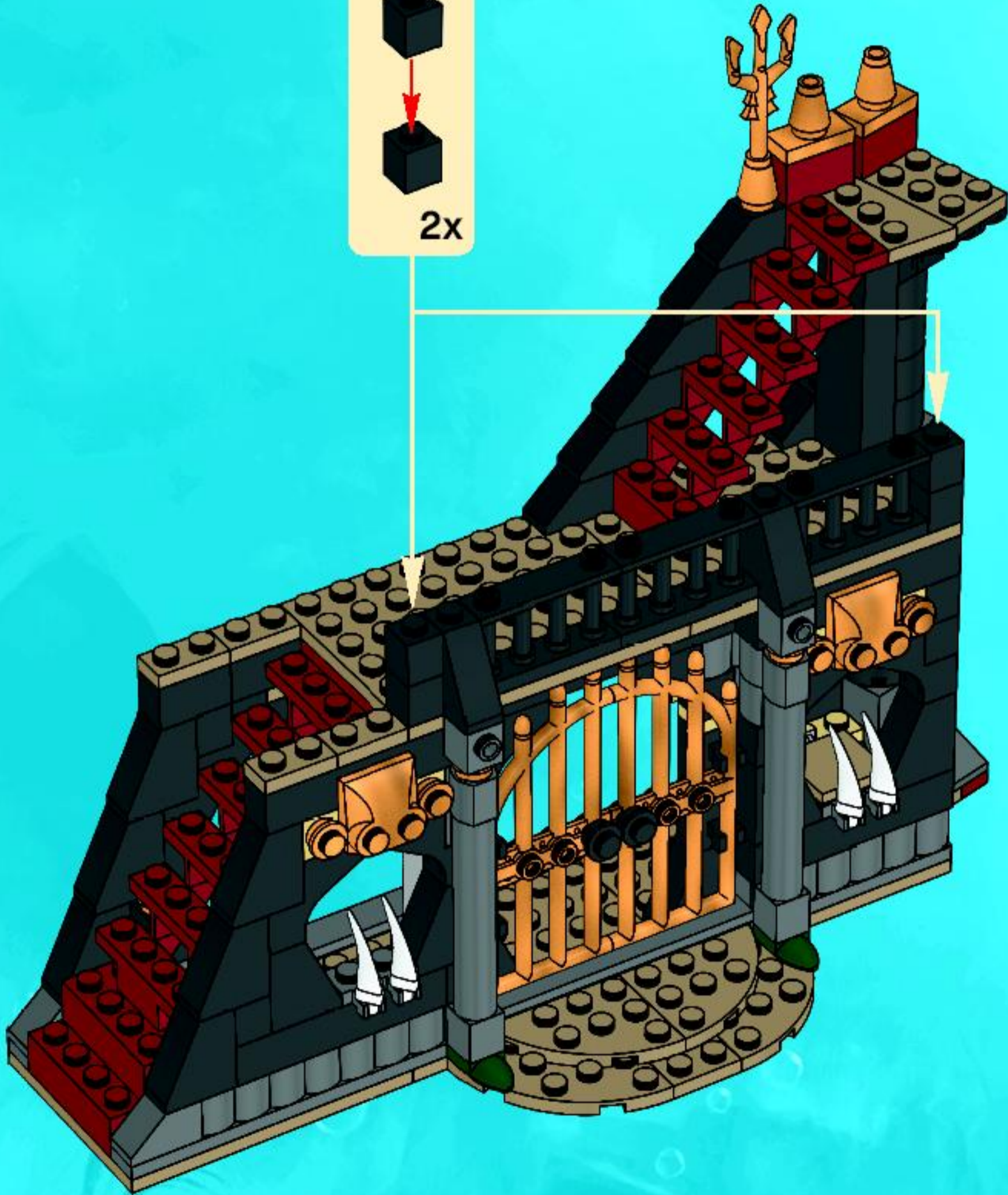
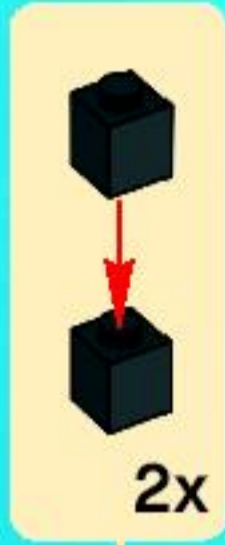

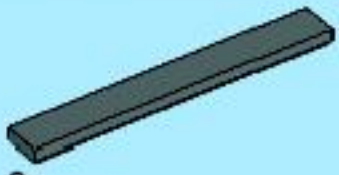

2x



2x

42

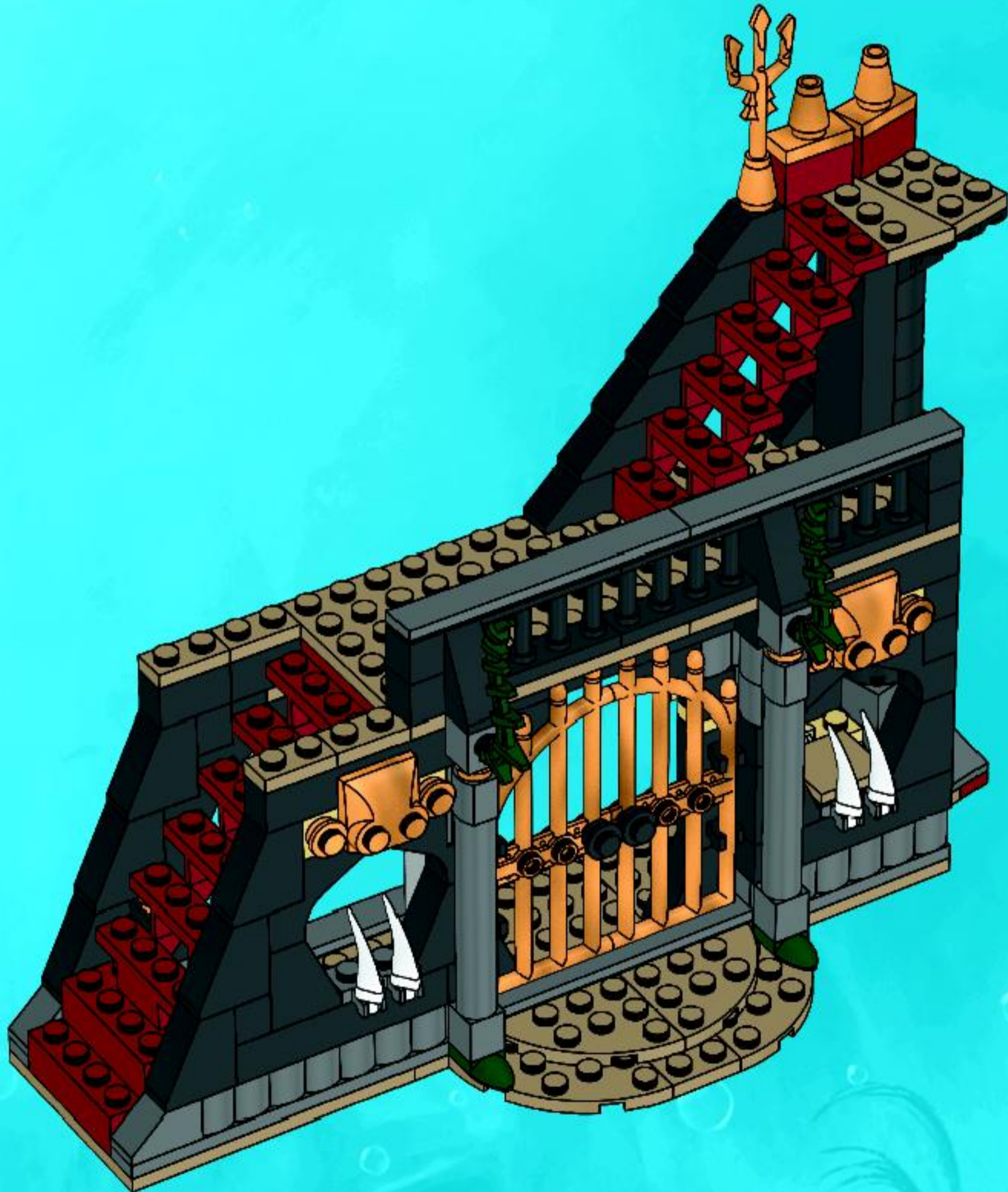



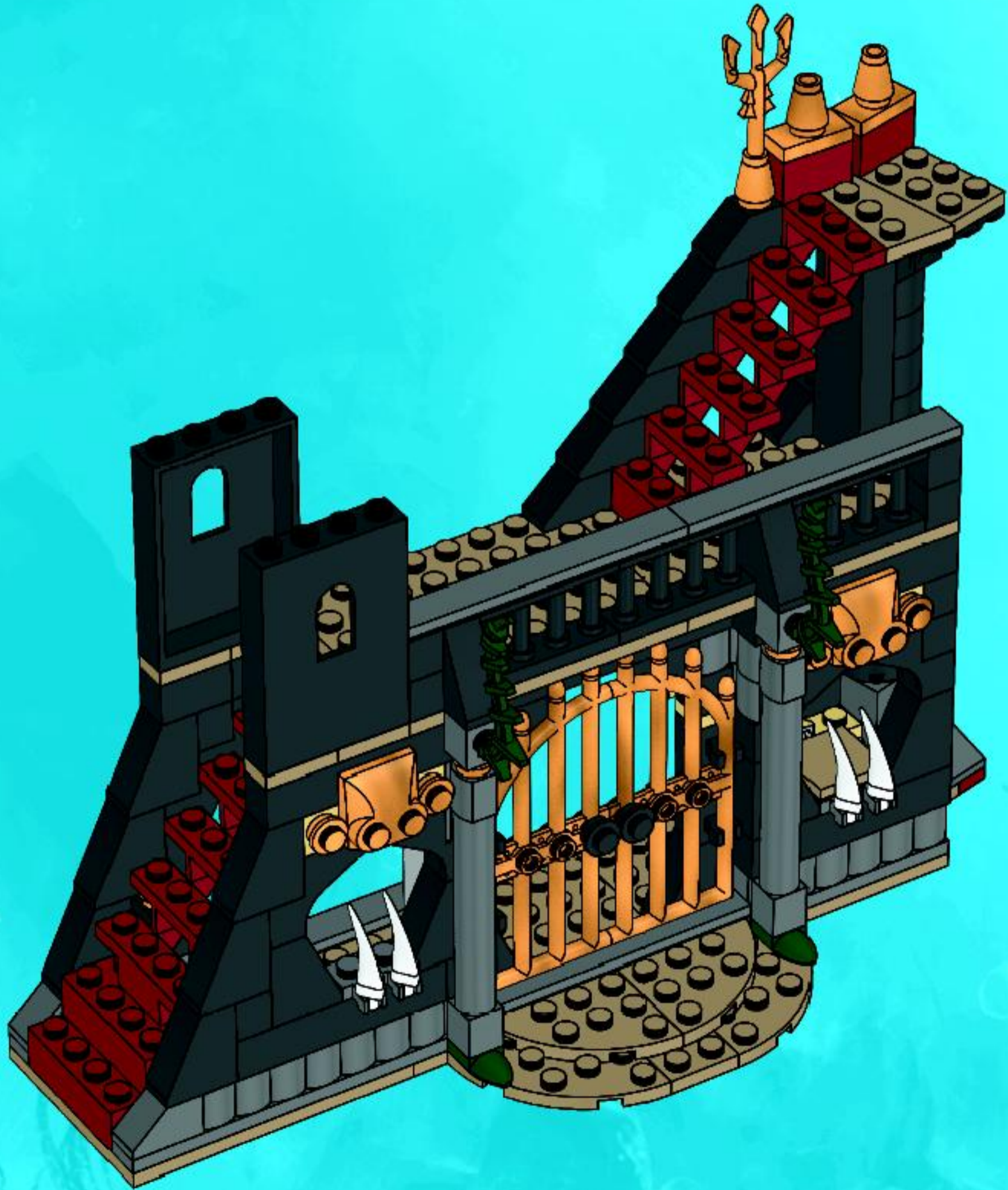

2x

43



2x  1x  2x 

44

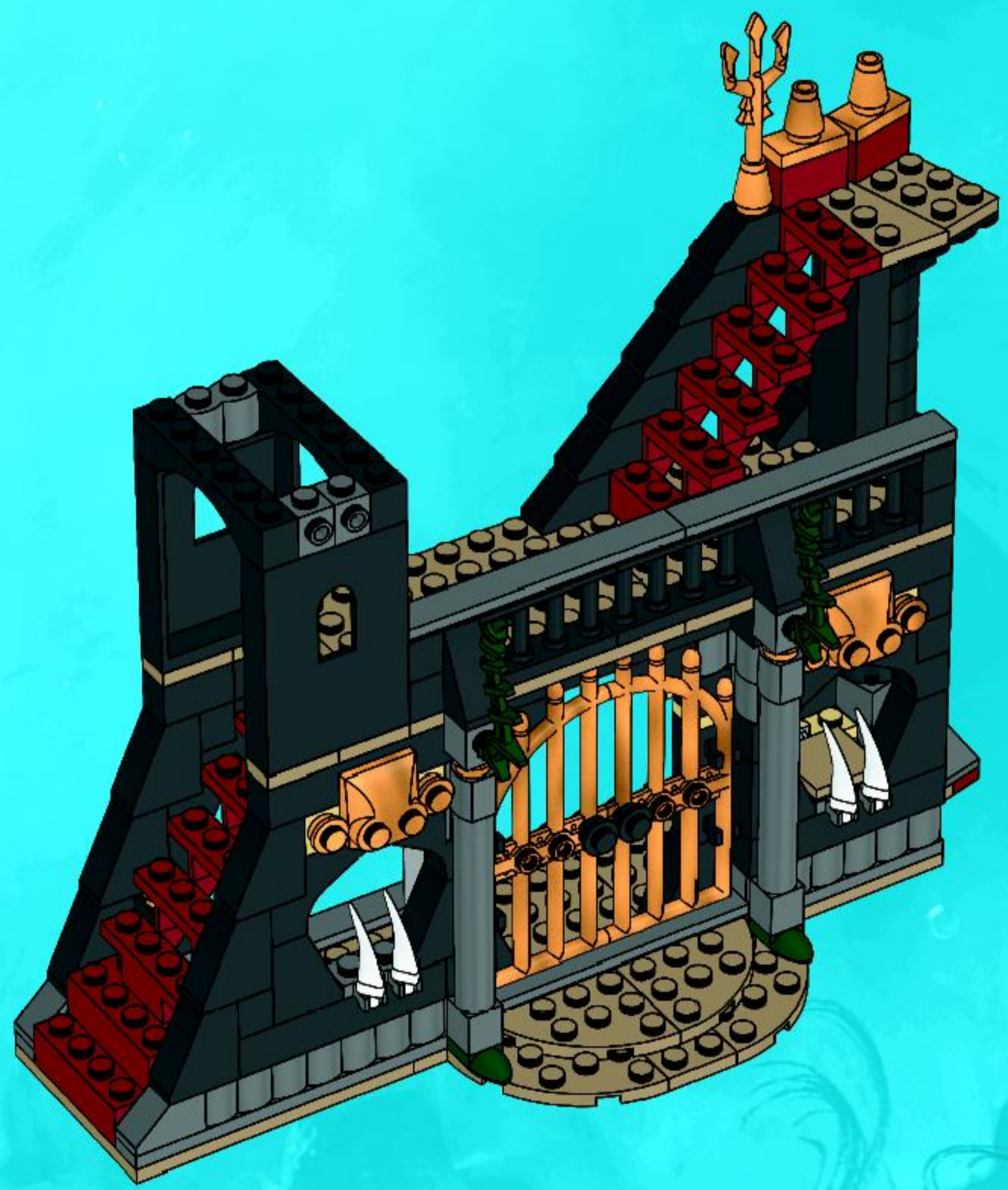

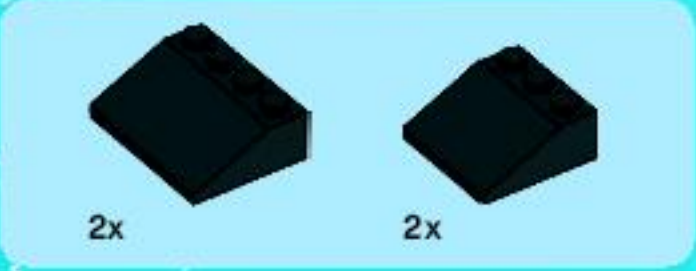

45

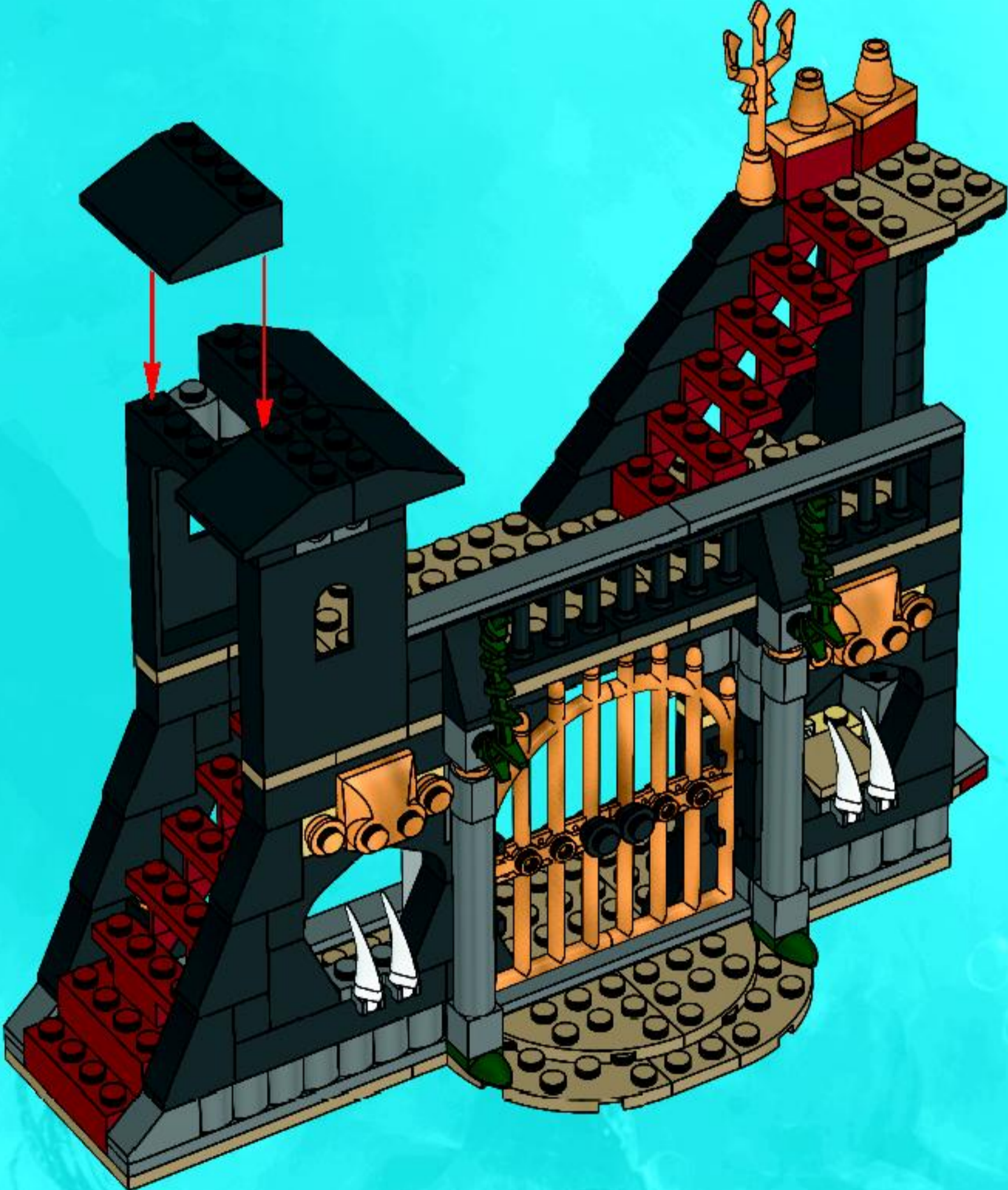



2x



2x



2x

46

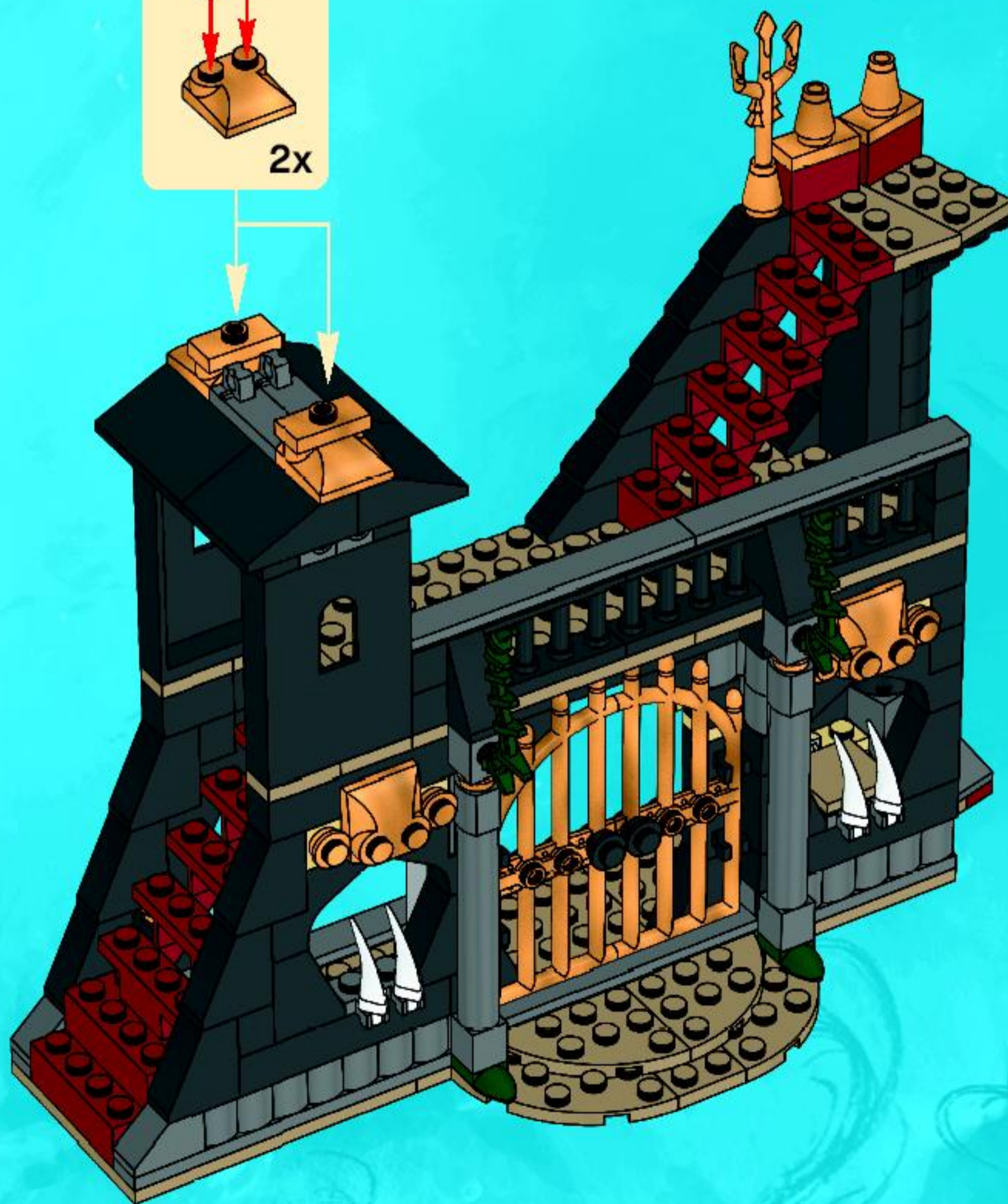
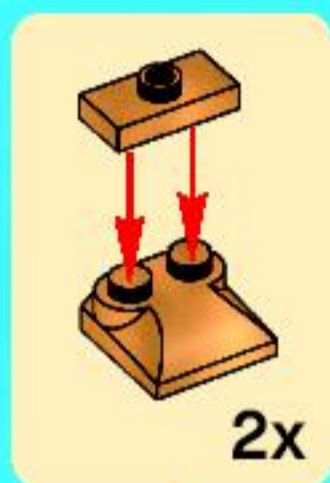



47

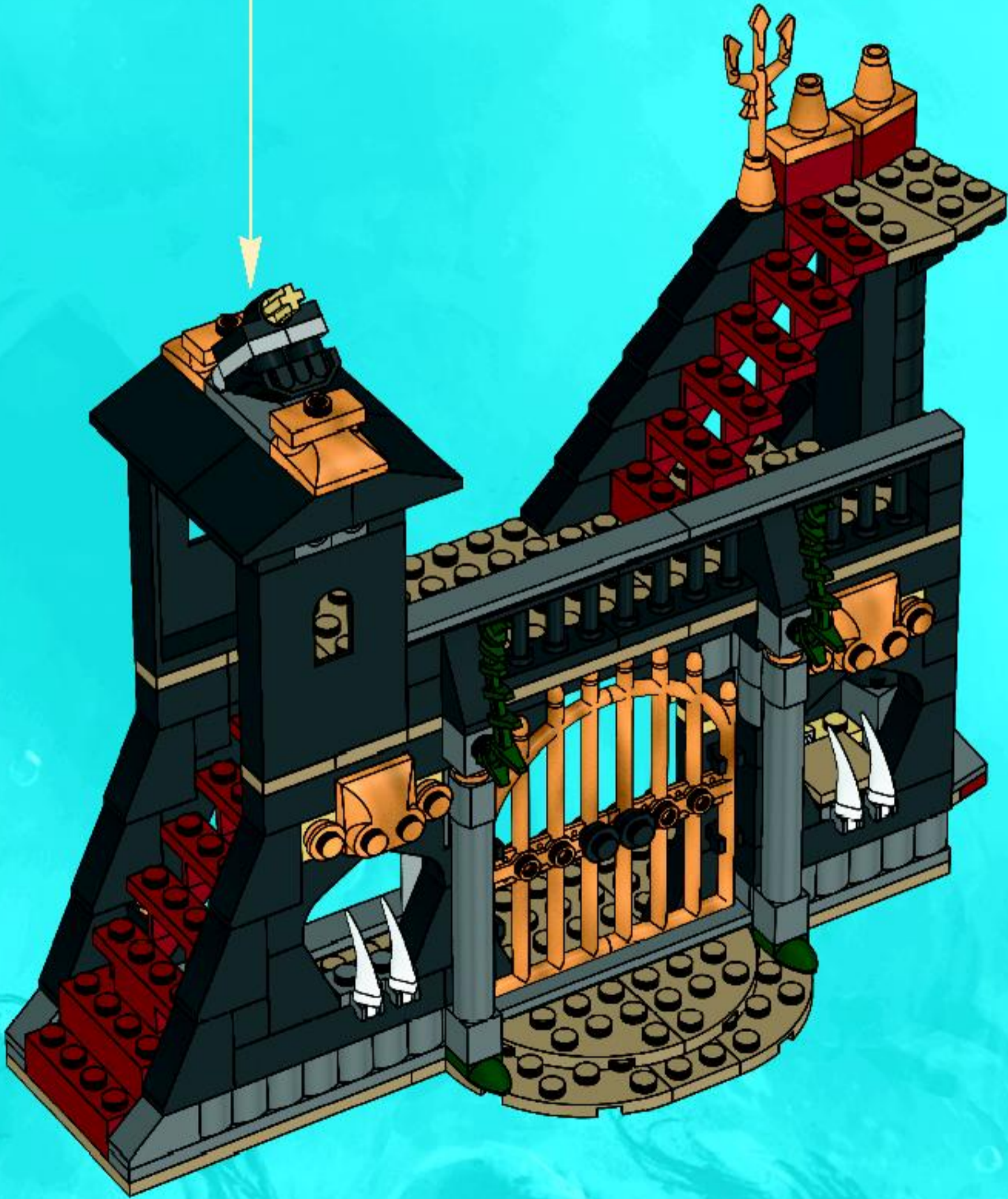
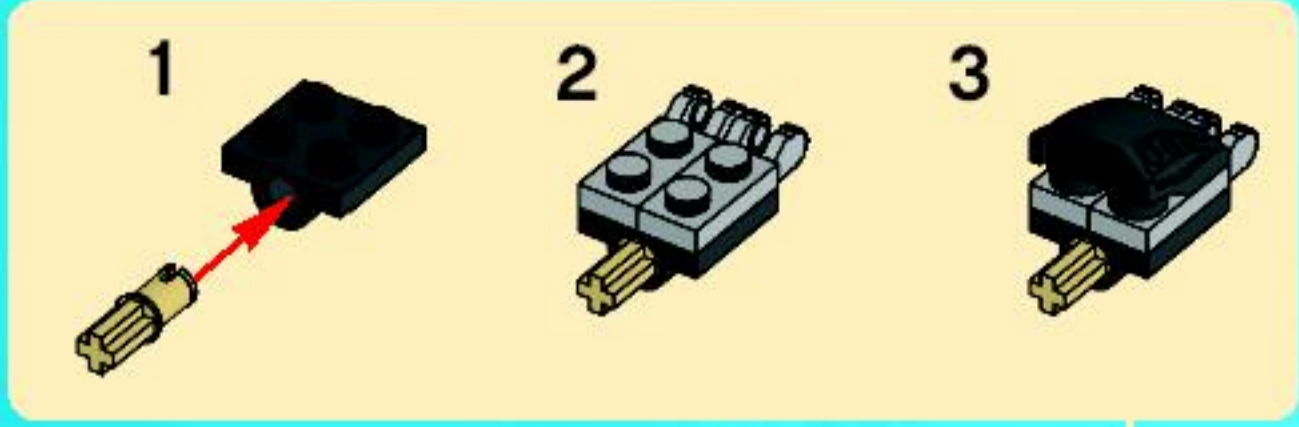

- 2x
- 2x
- 1x
- 1x
- 2x
- 2x

48

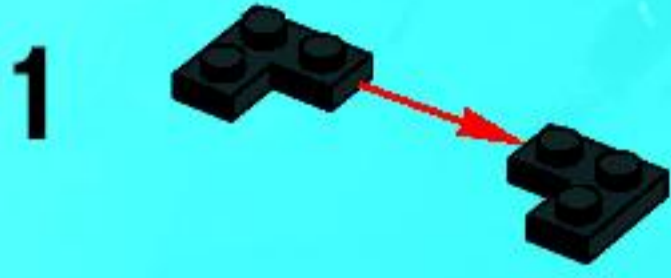

3



4



5

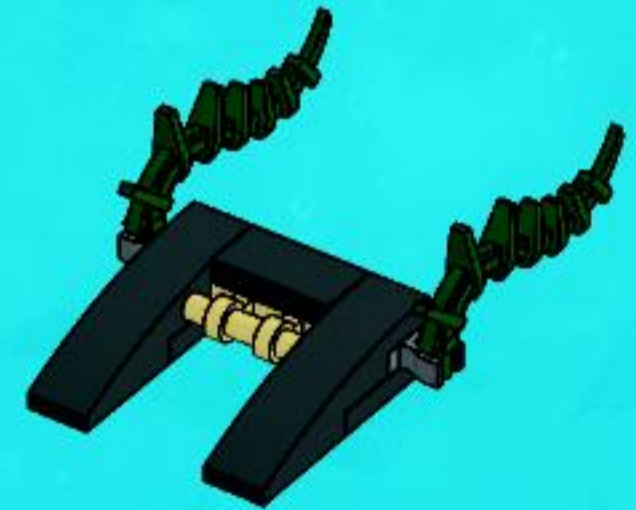



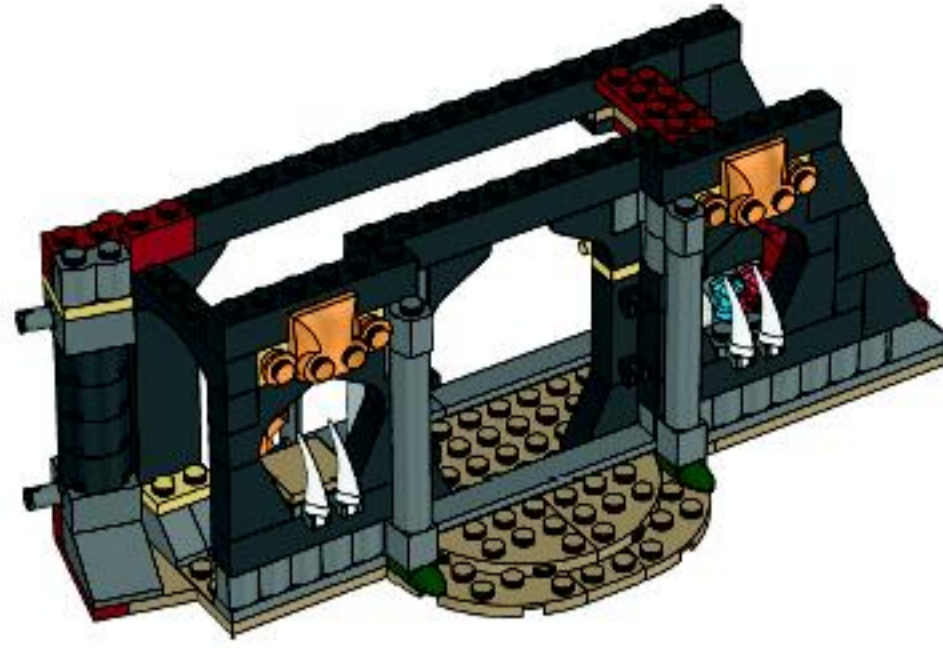

2x

1

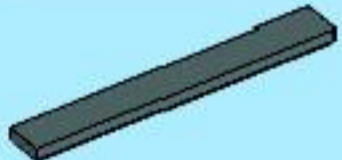
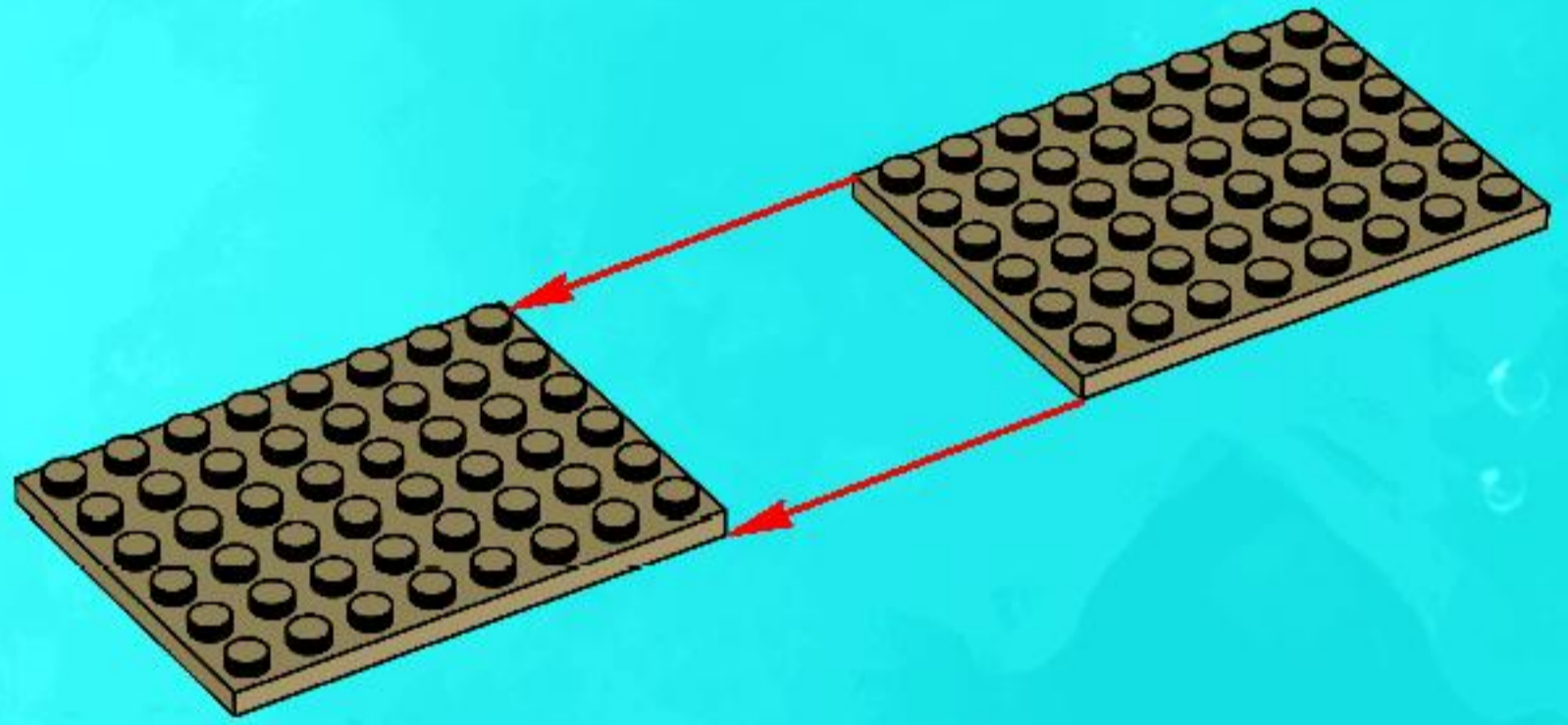

2x

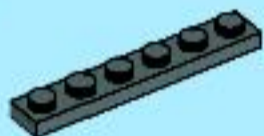

1x

2

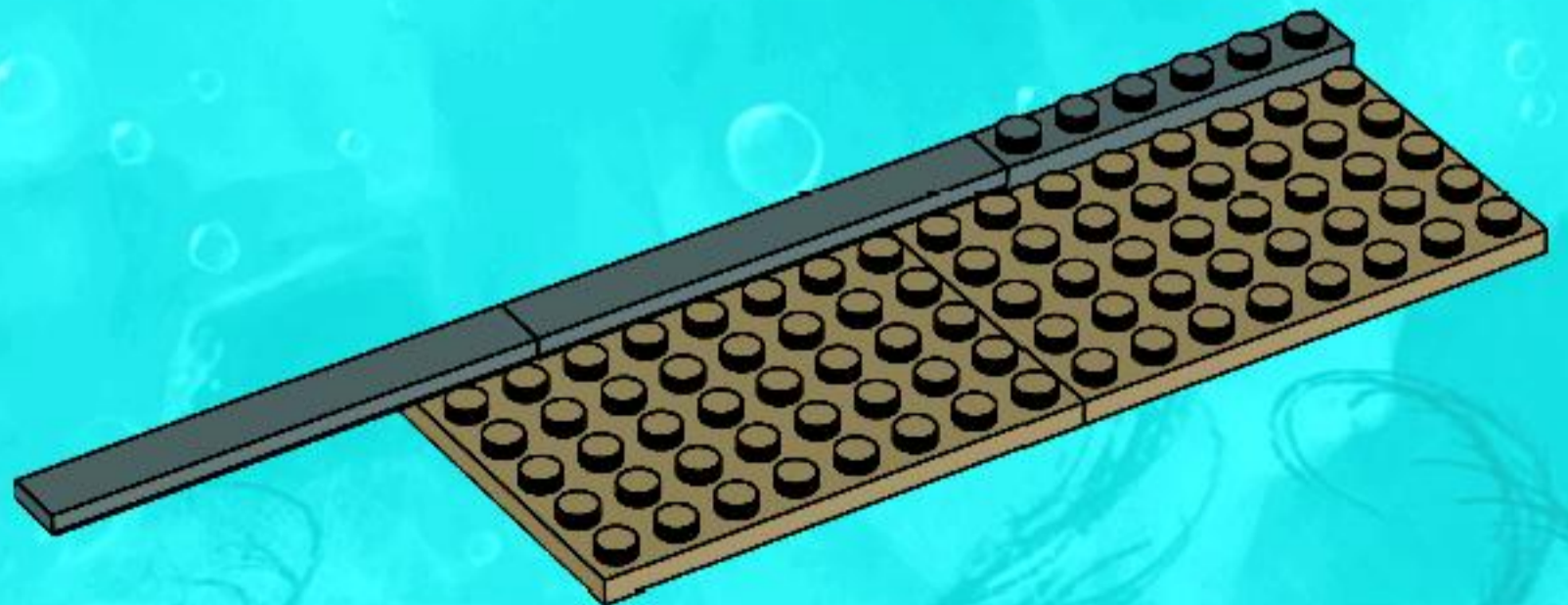

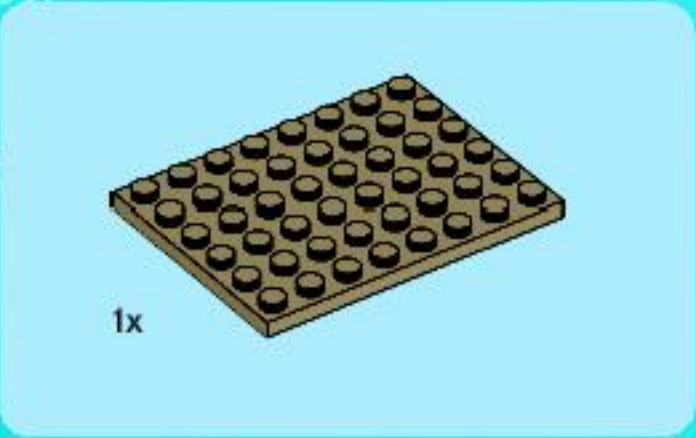

3

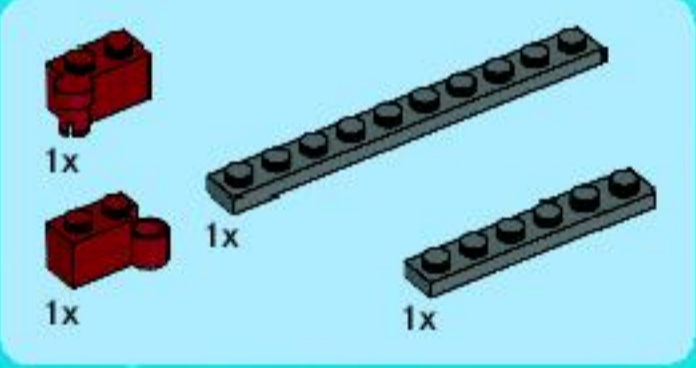
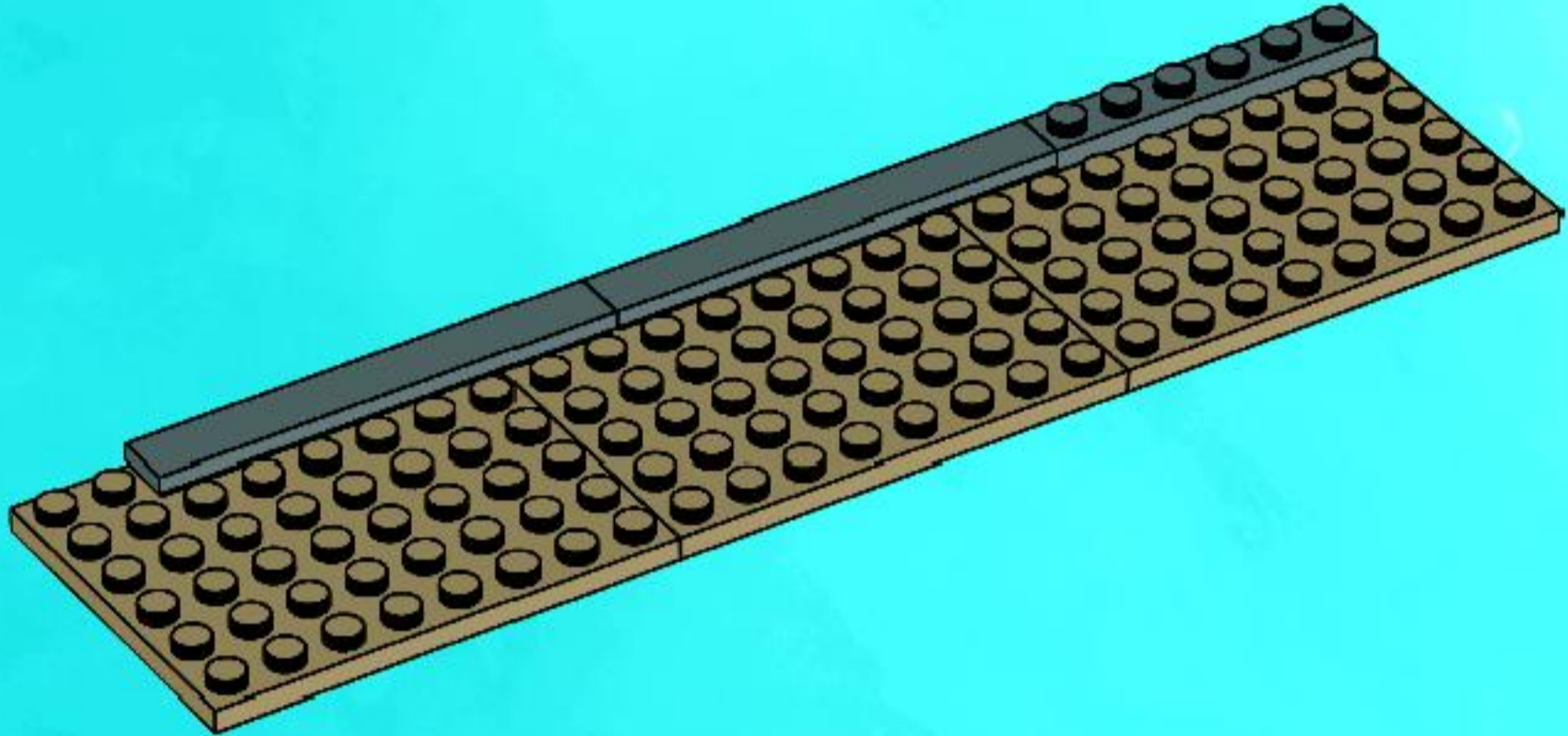

4

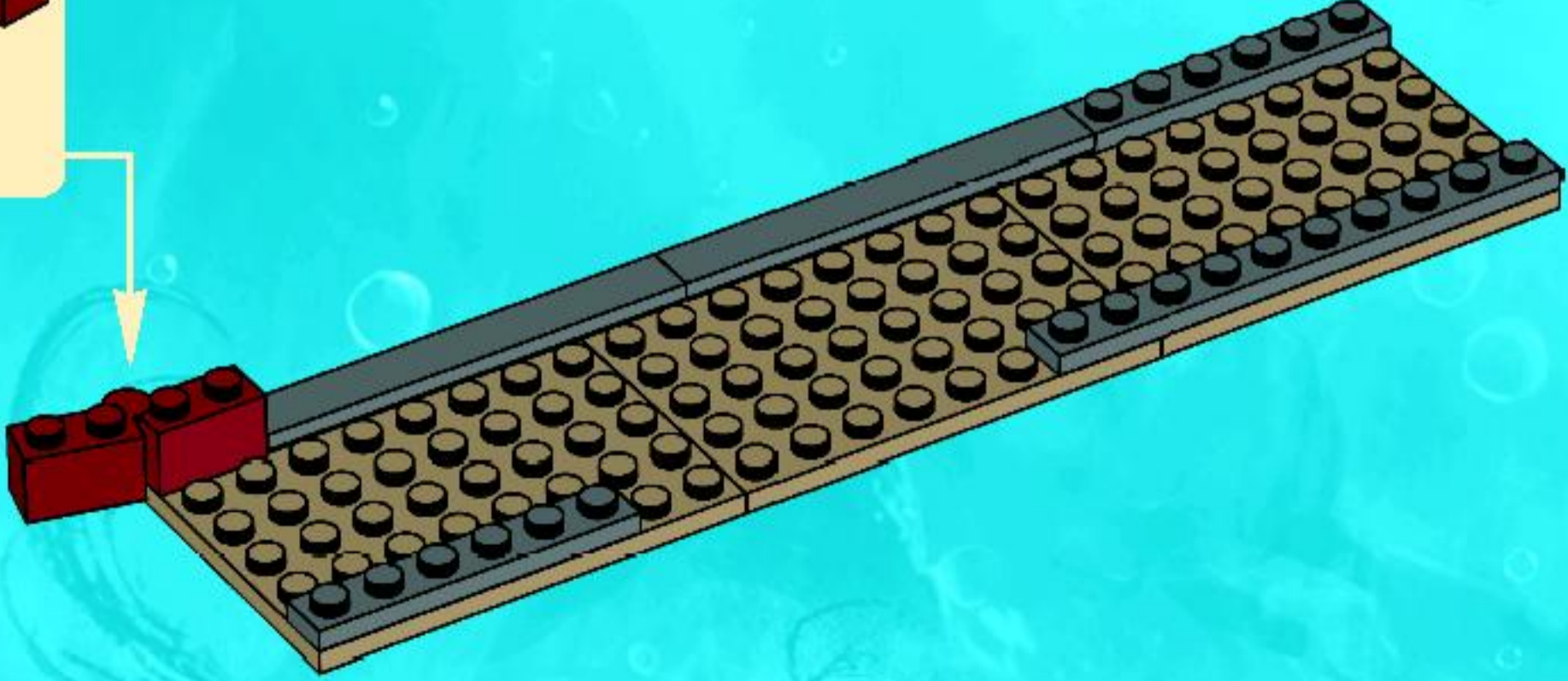
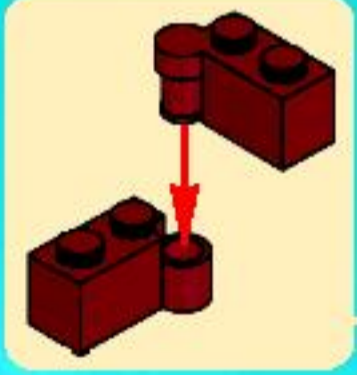

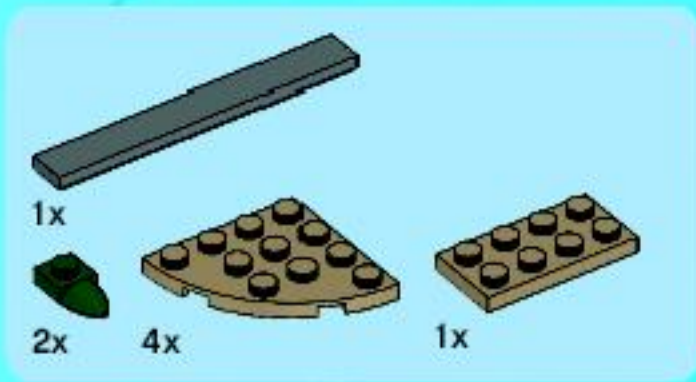

5

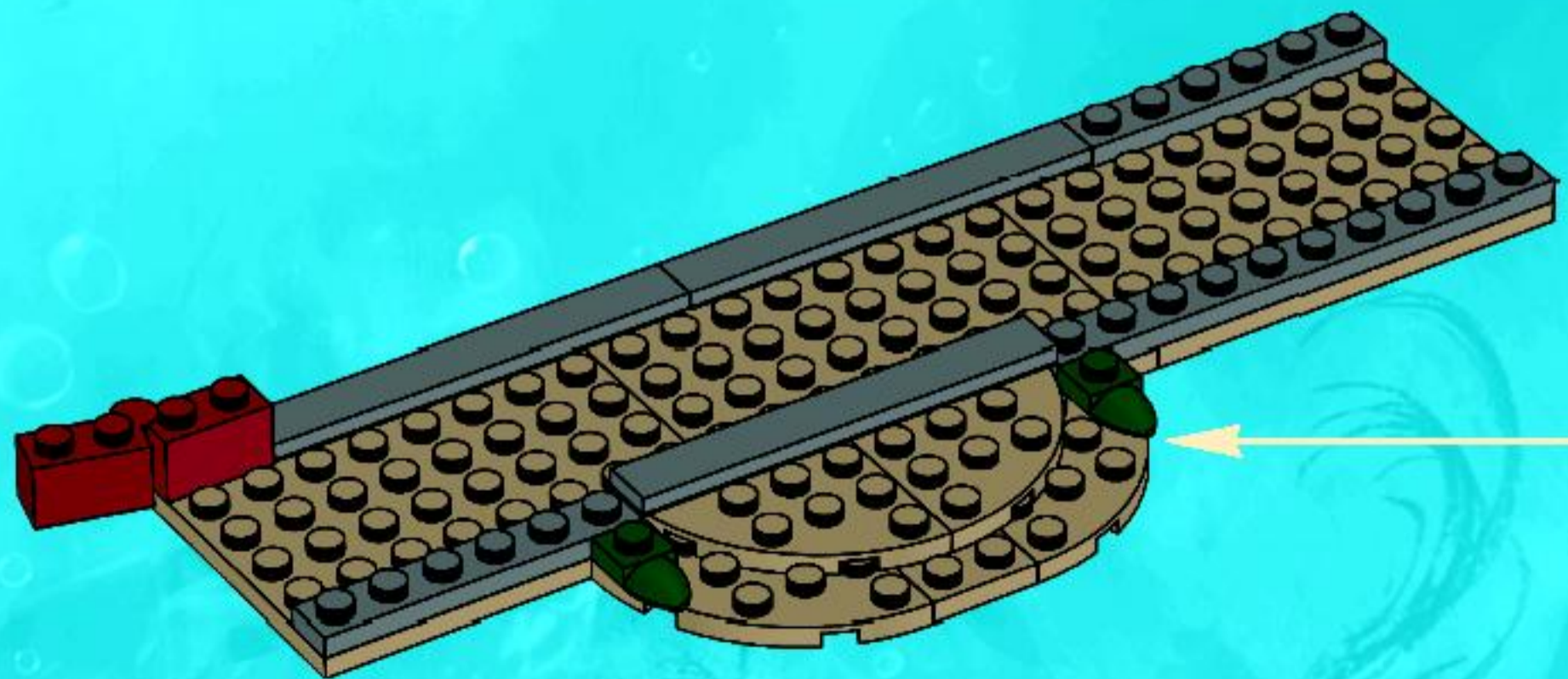
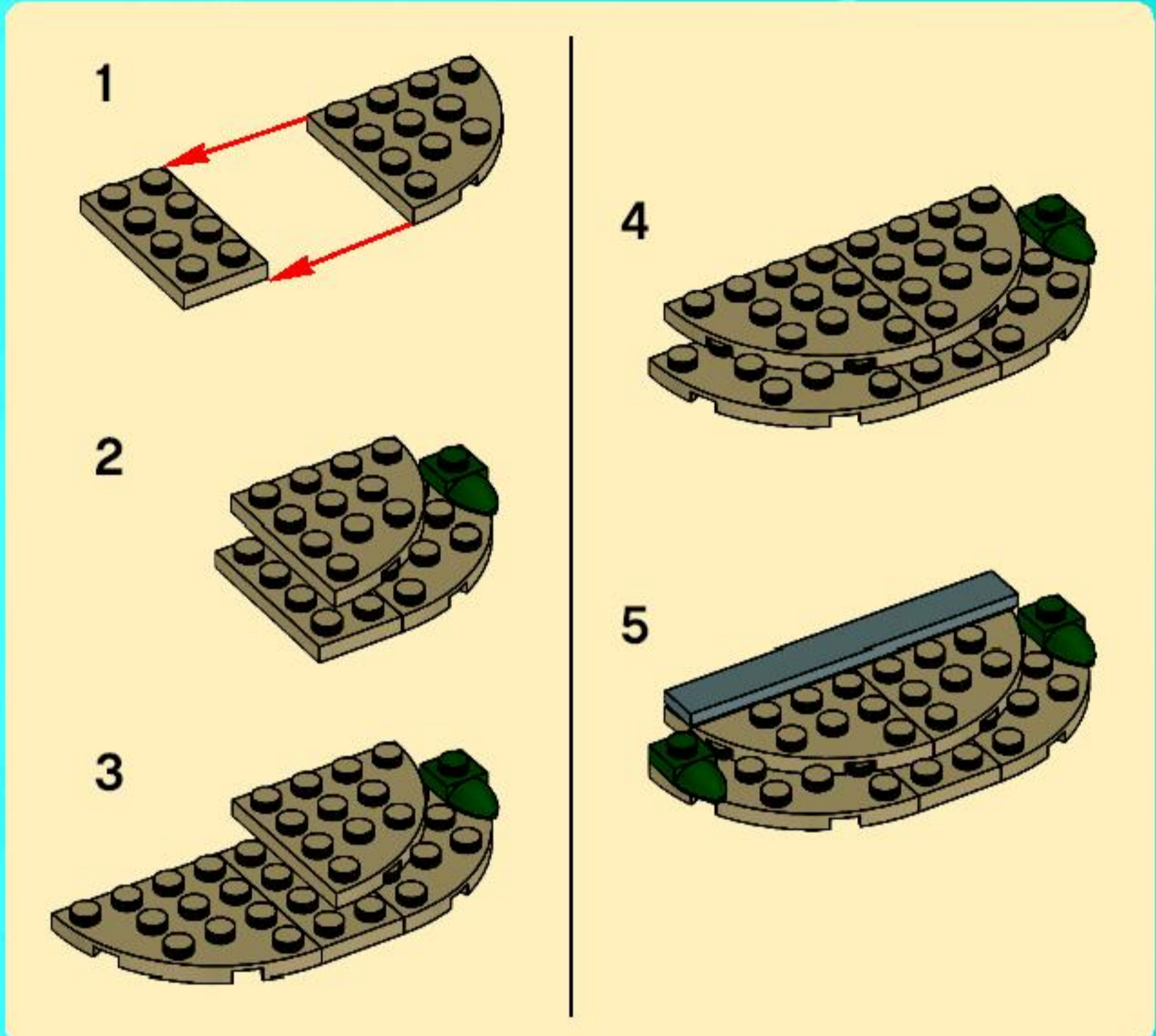

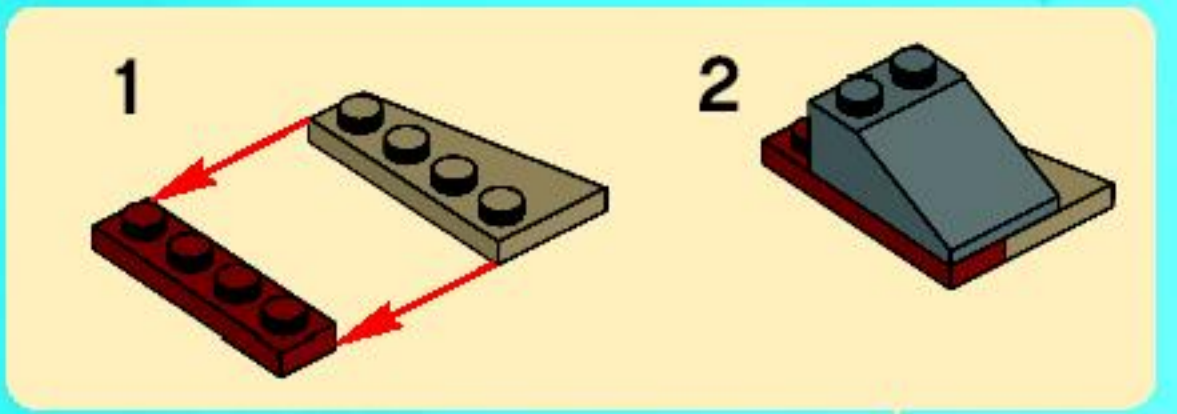
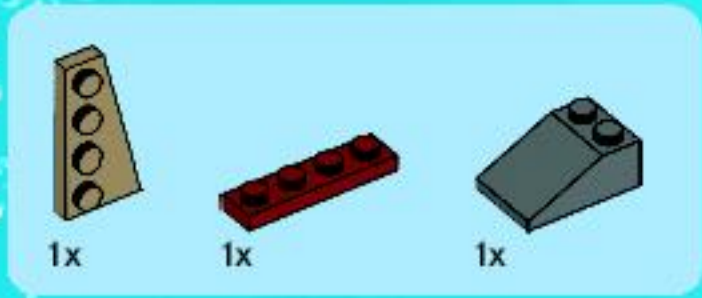

6

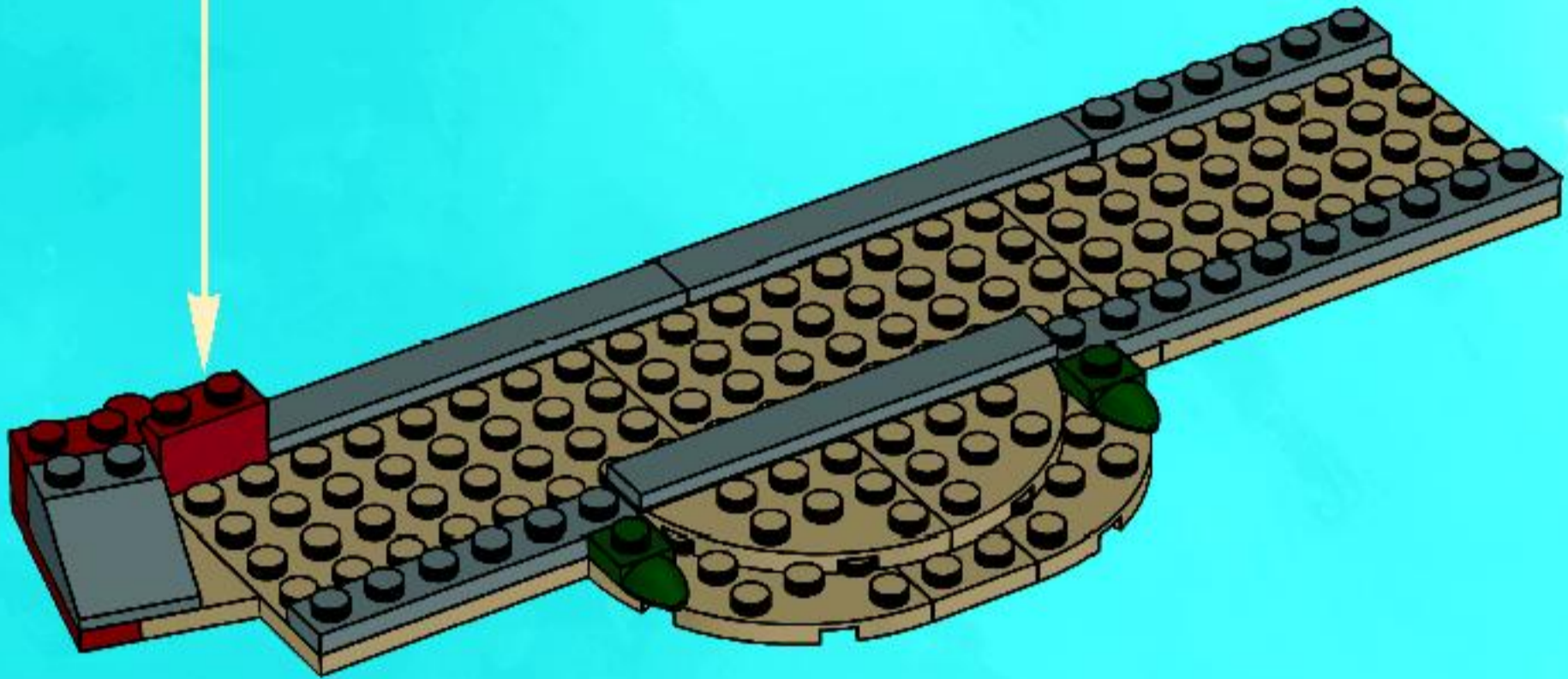

7

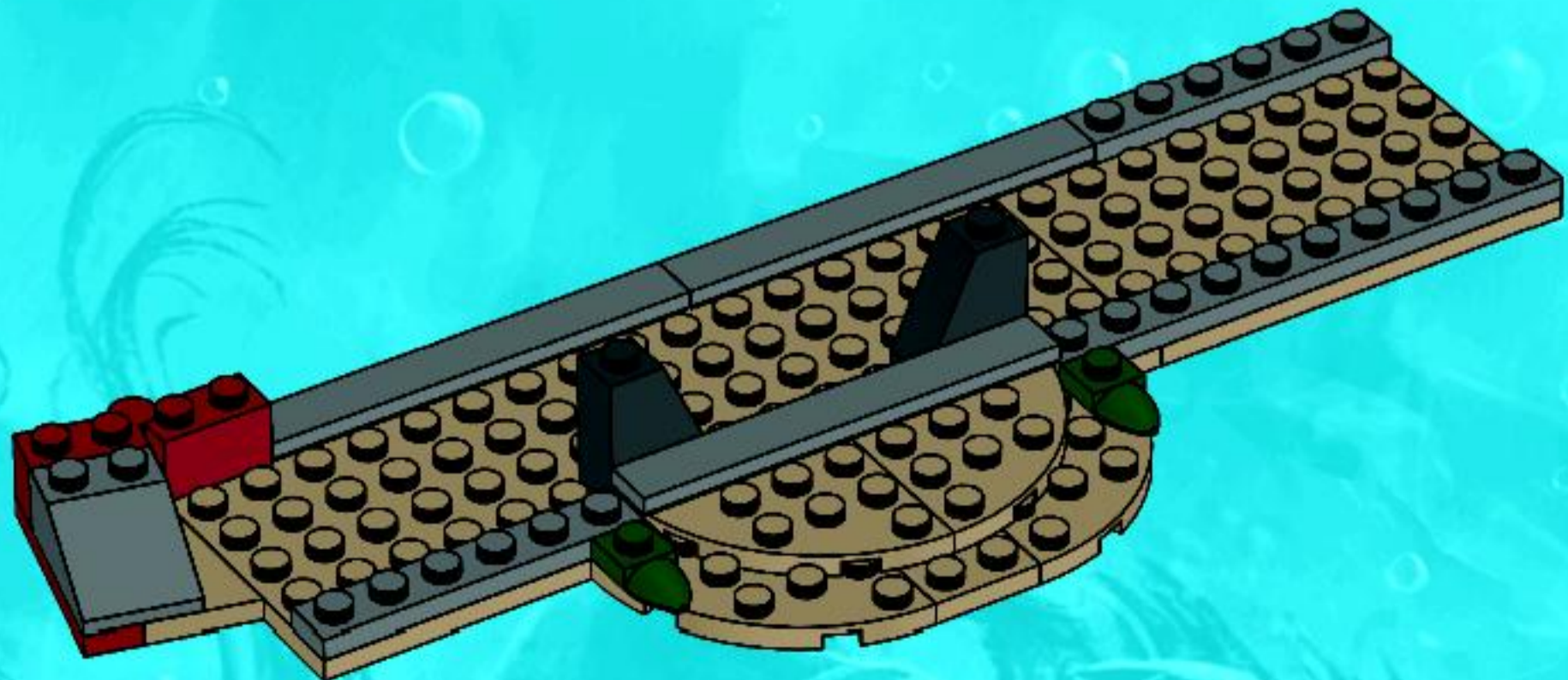



2x



1x

8

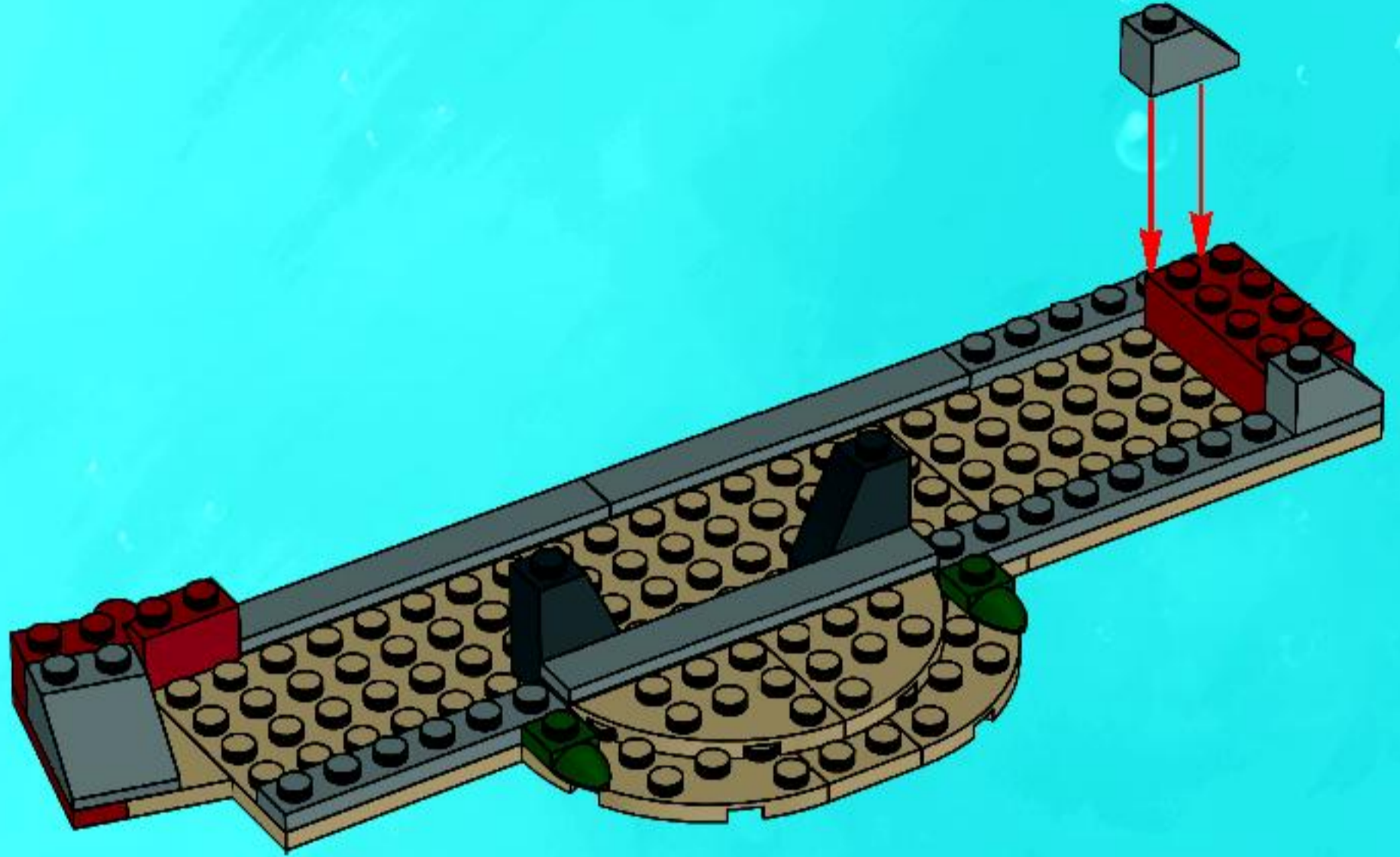

2x



1x

9

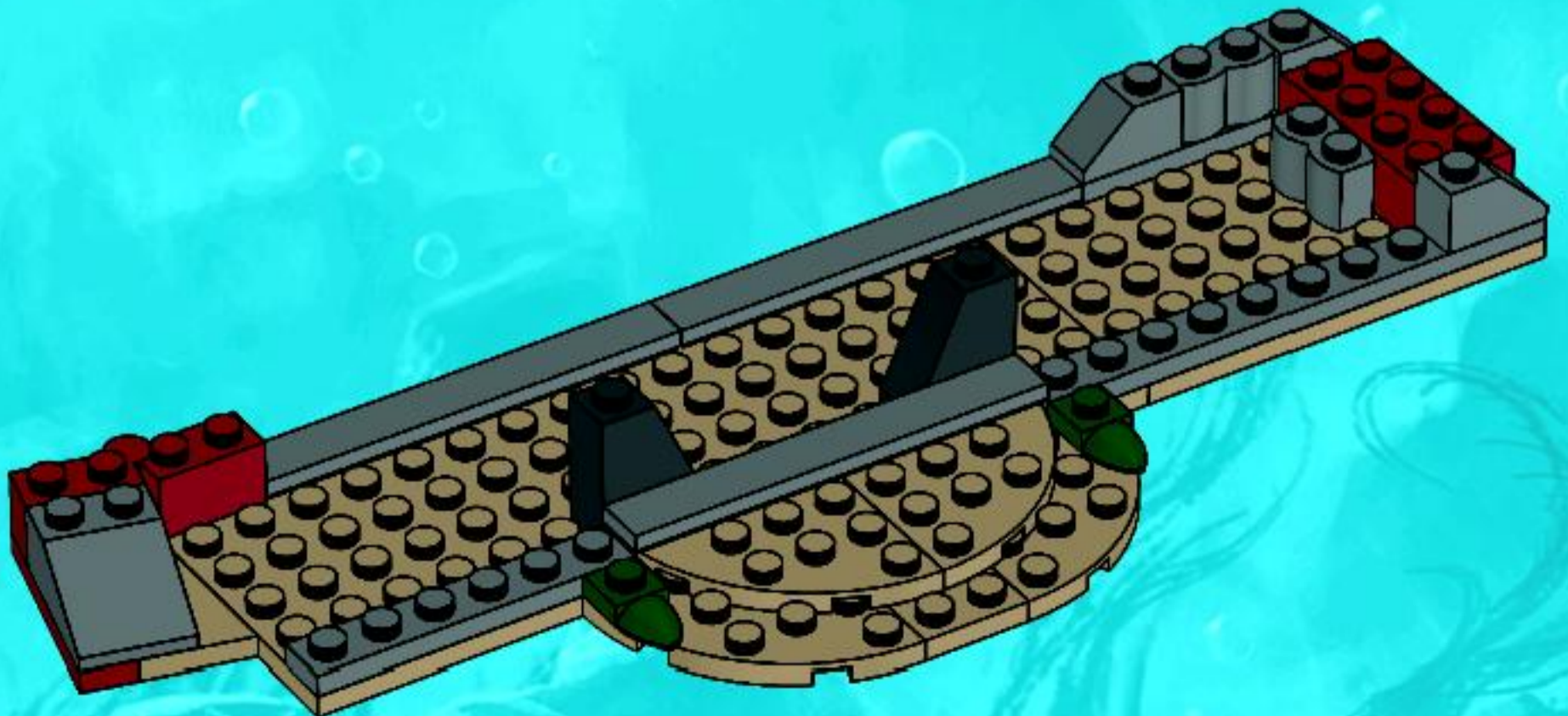



1x



3x

10

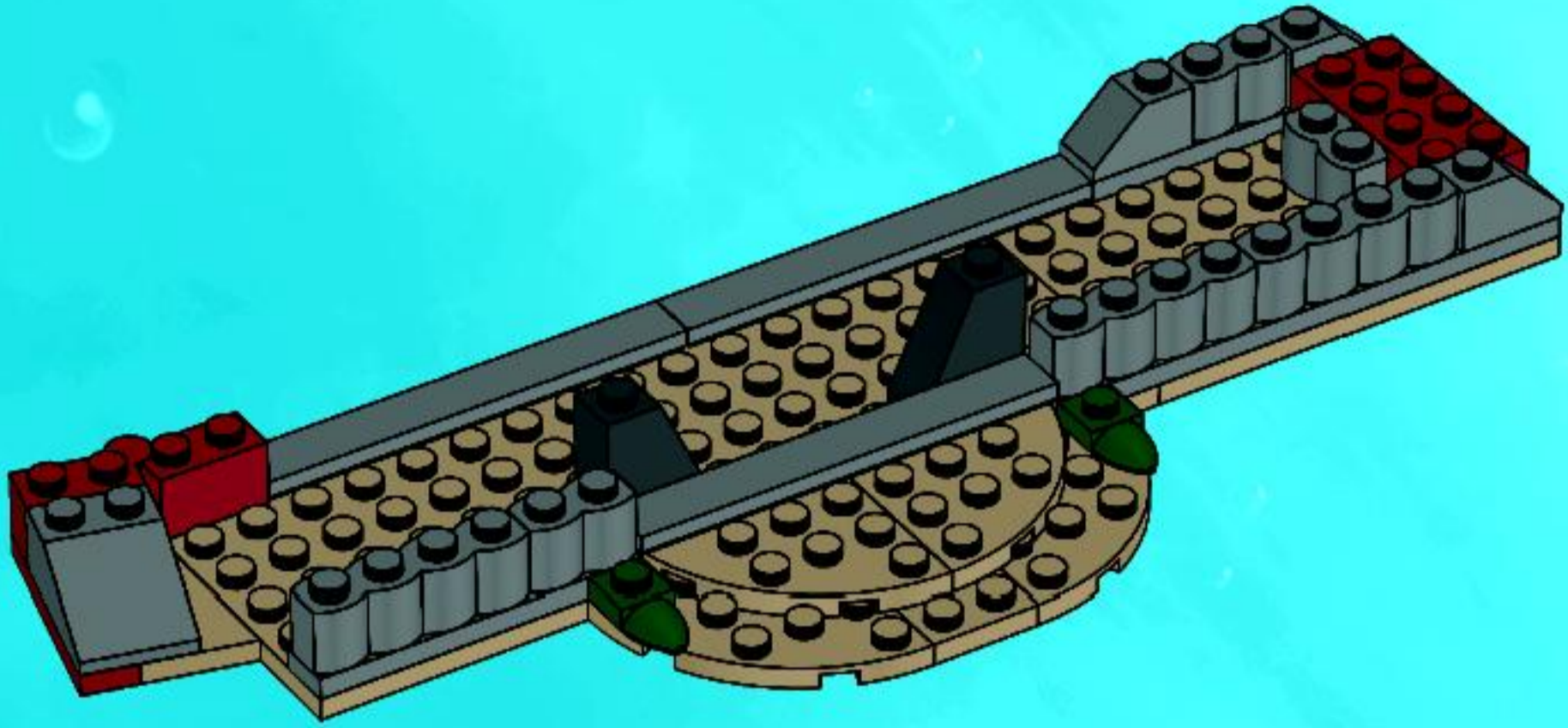

1x



2x



1x

11

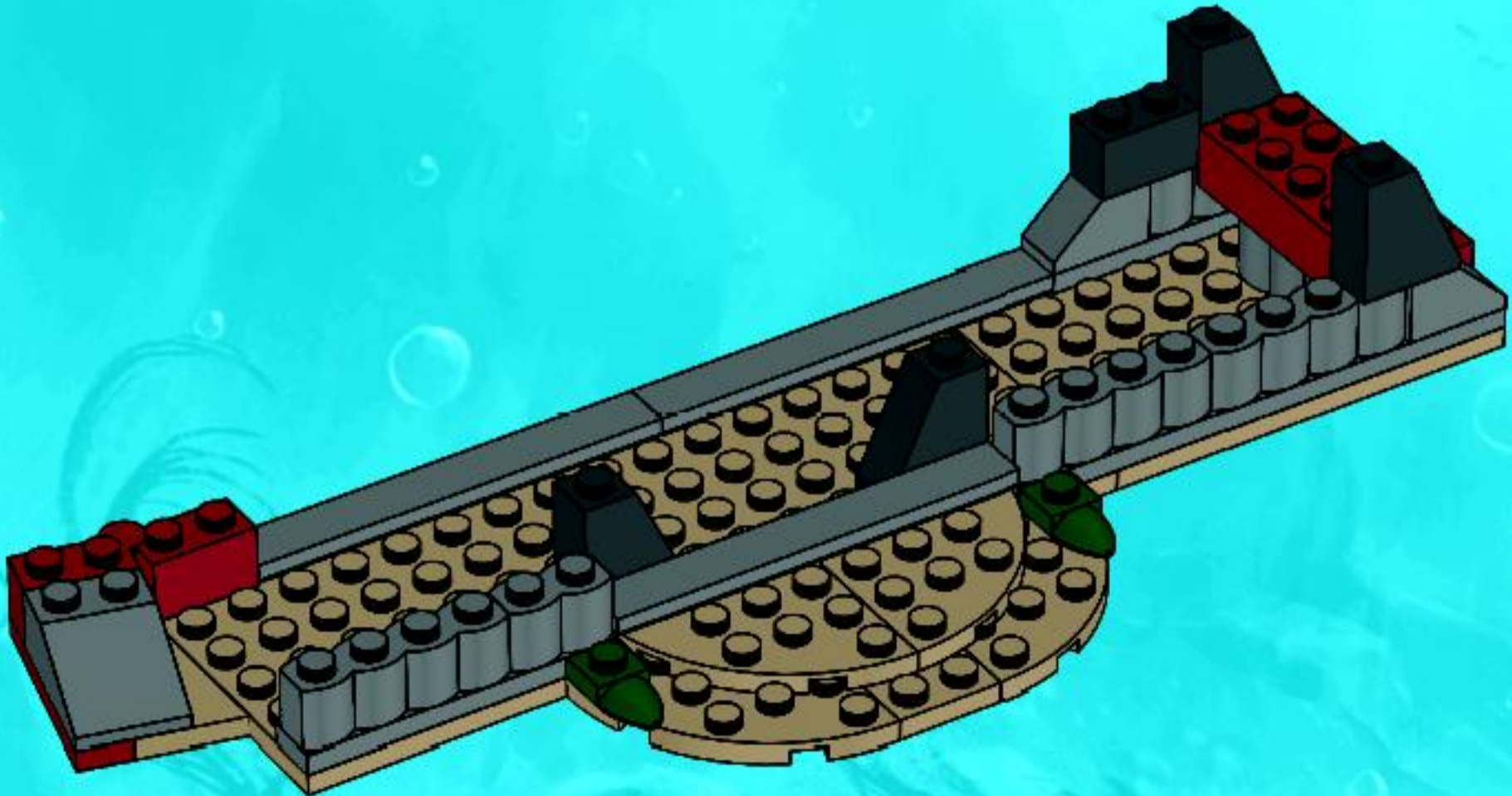

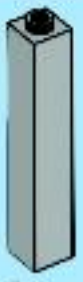

2x



2x



2x

12



1x



2x



1x

13

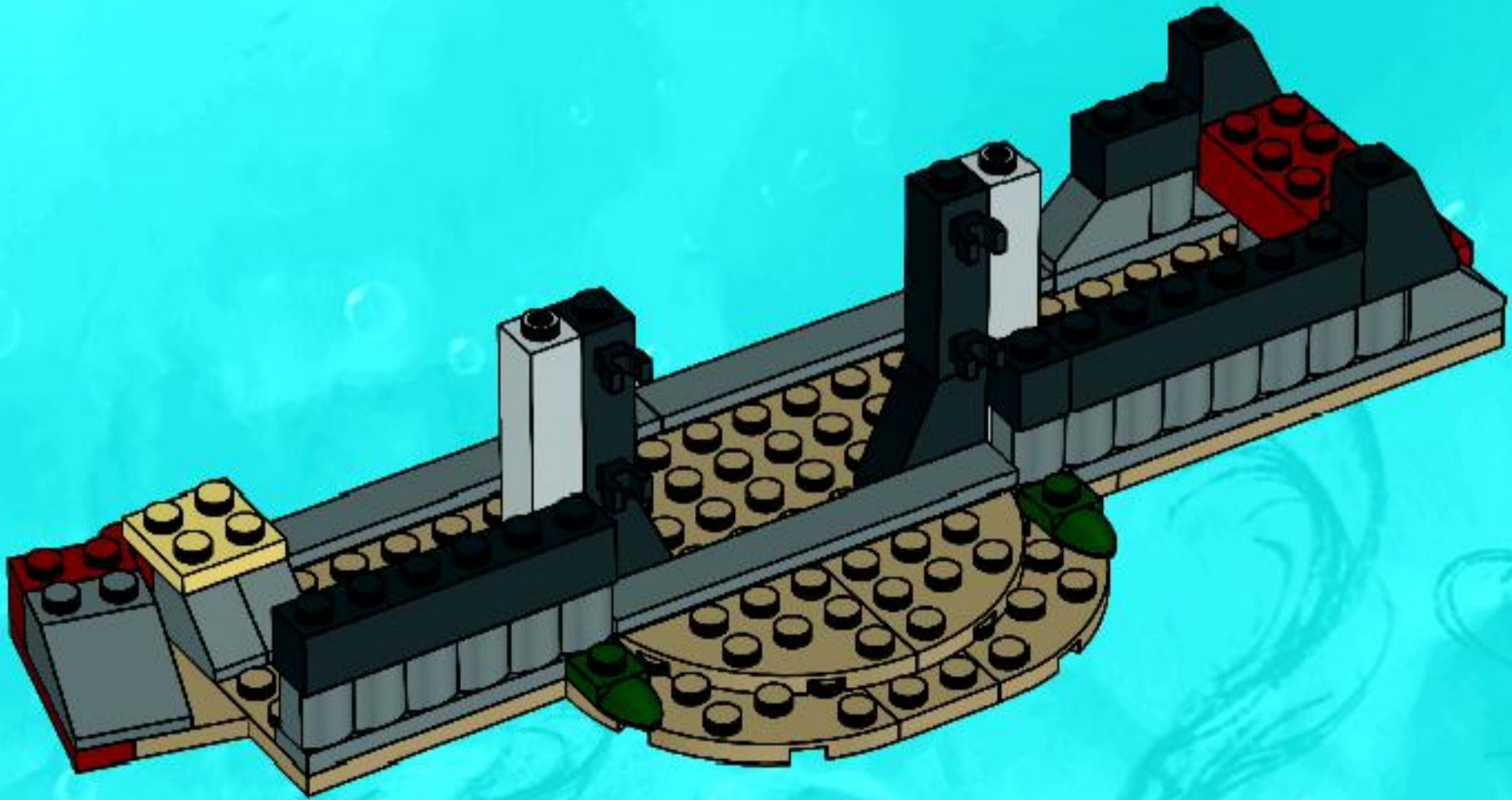



2x



2x

14



2x

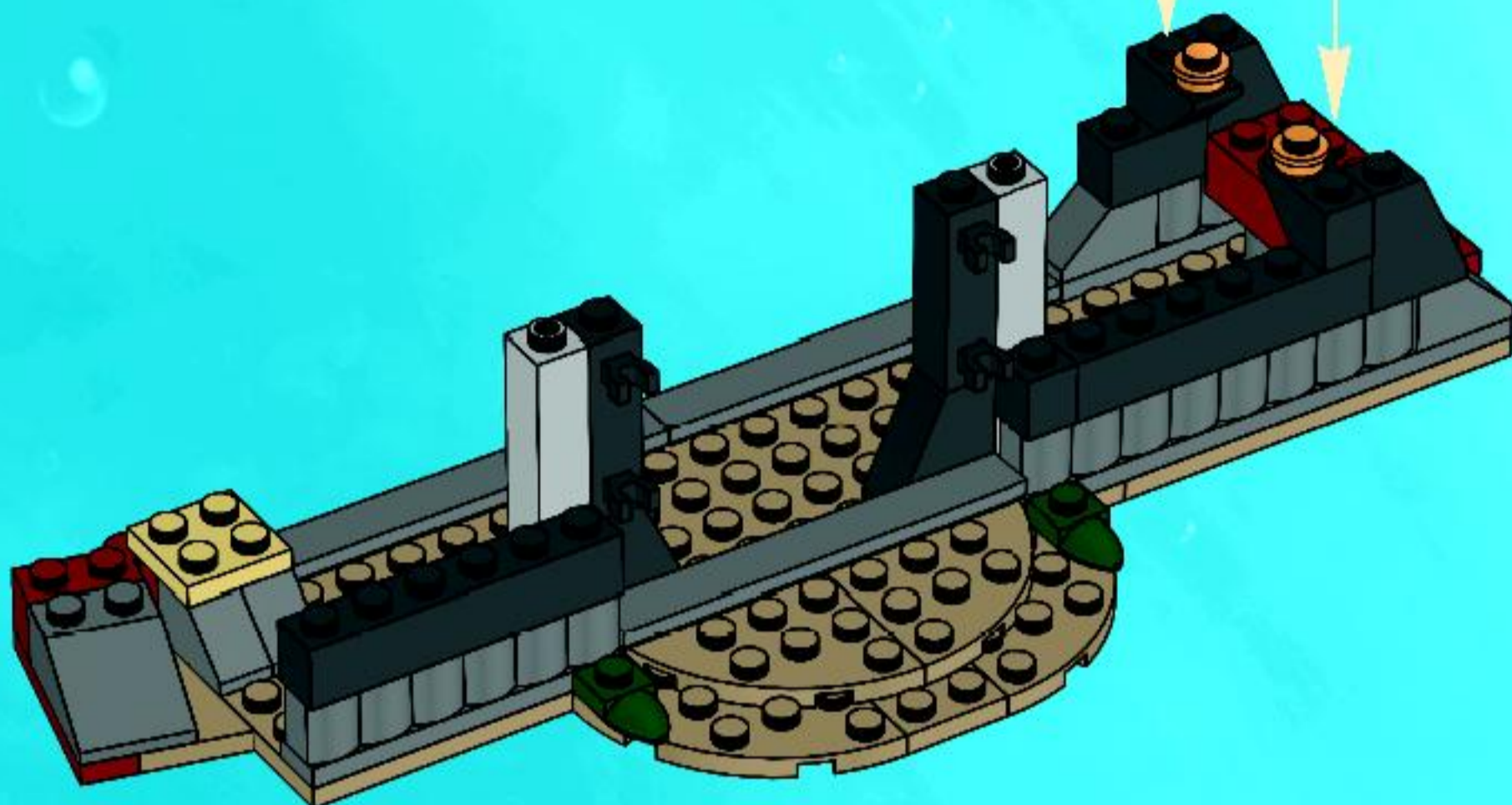

4x



4x



1x

15





16

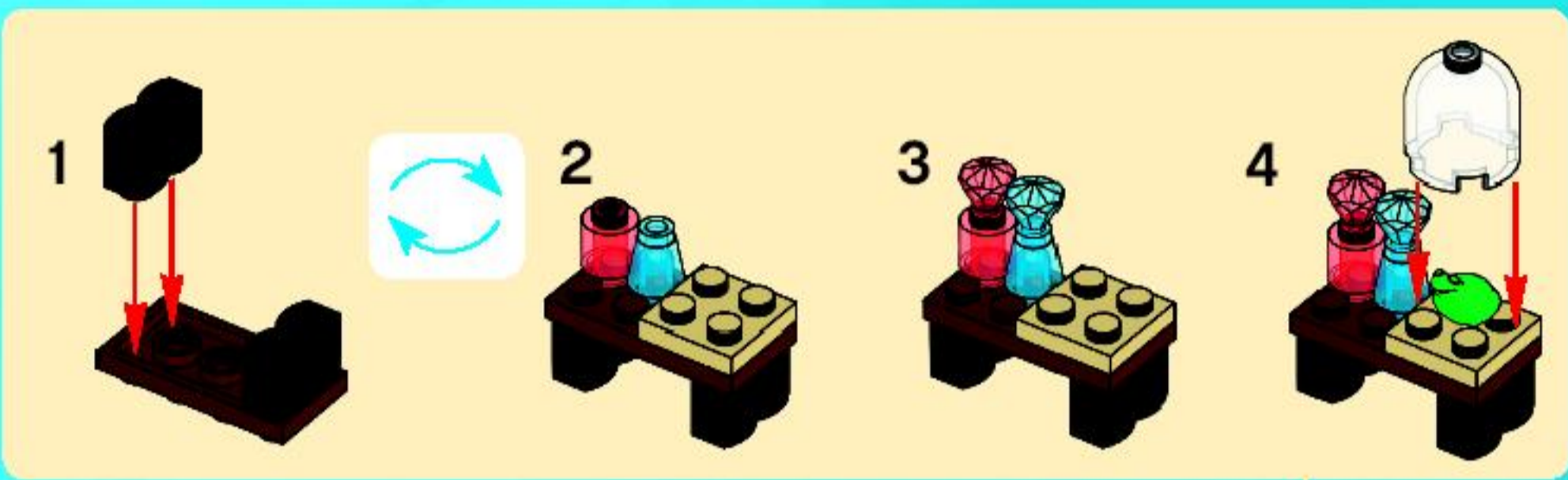

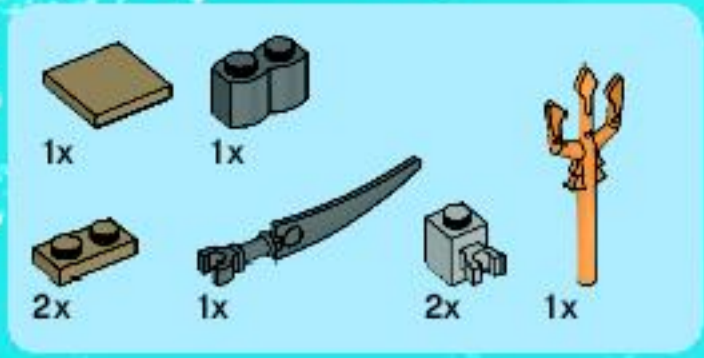

17

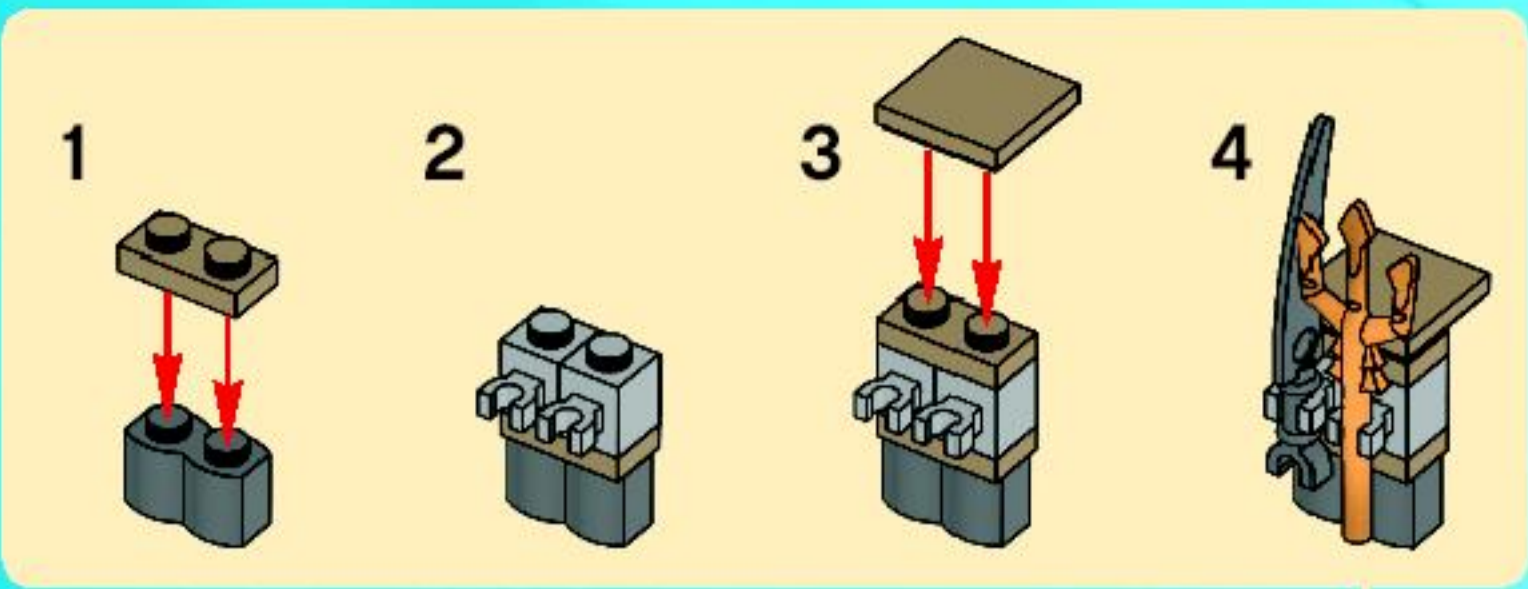

18

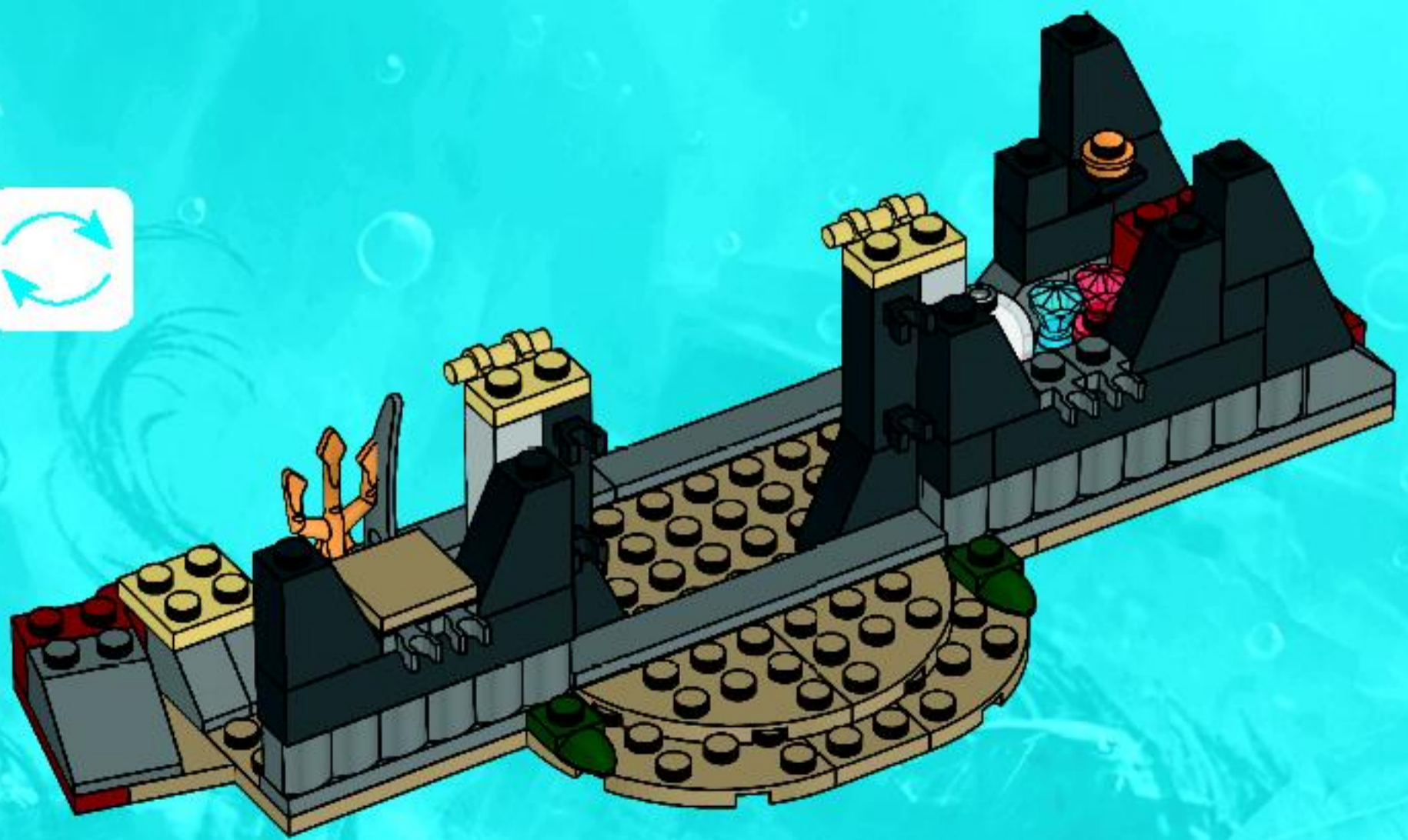

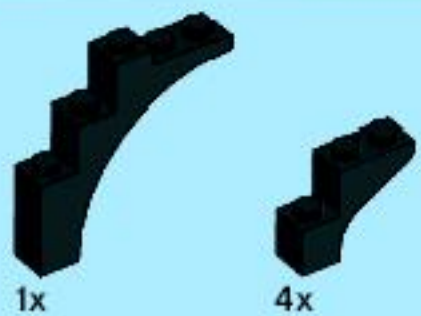

1x

4x

19

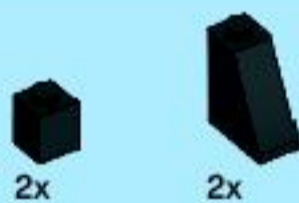
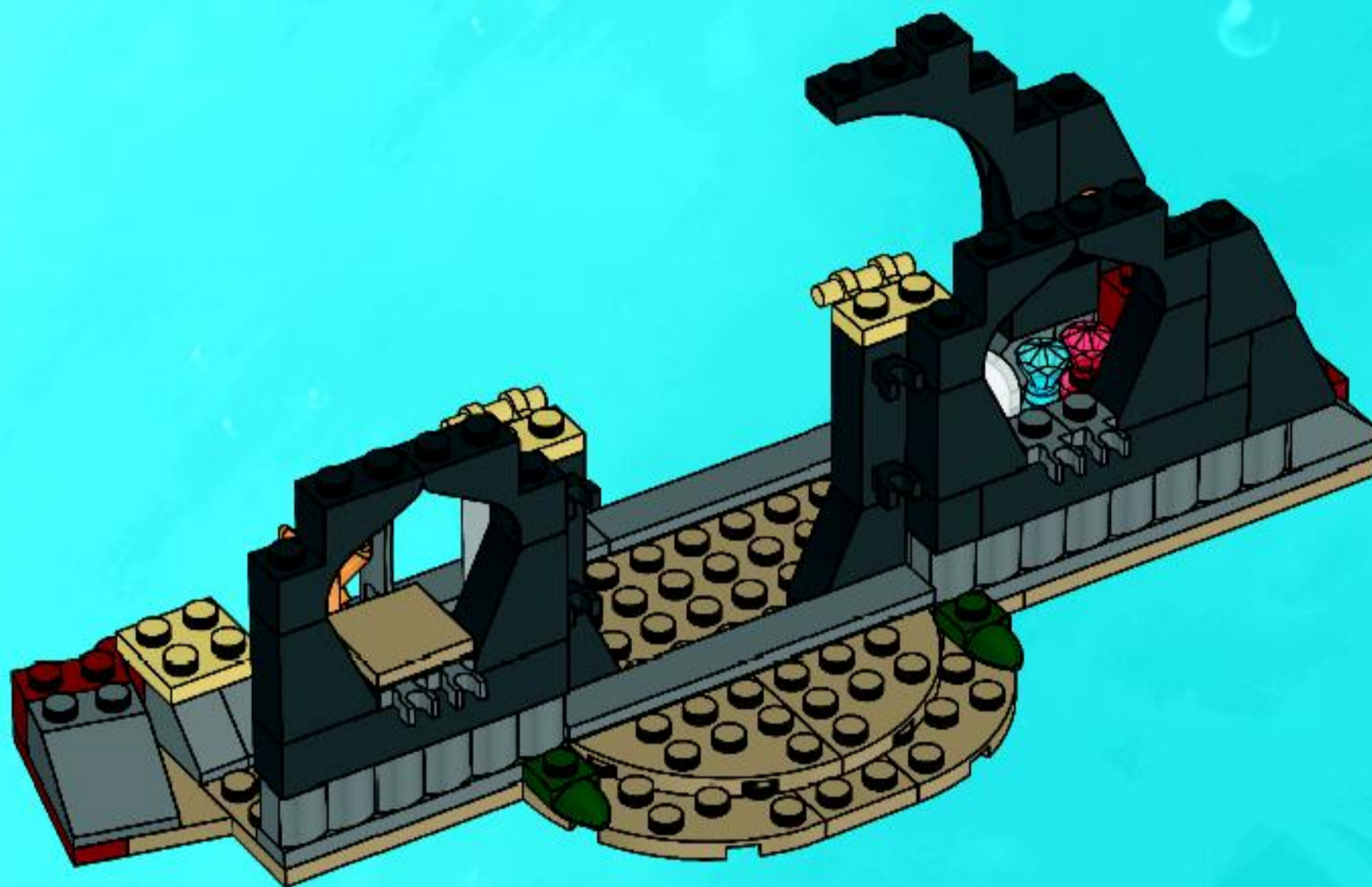

2x

2x

20





2x



2x

21

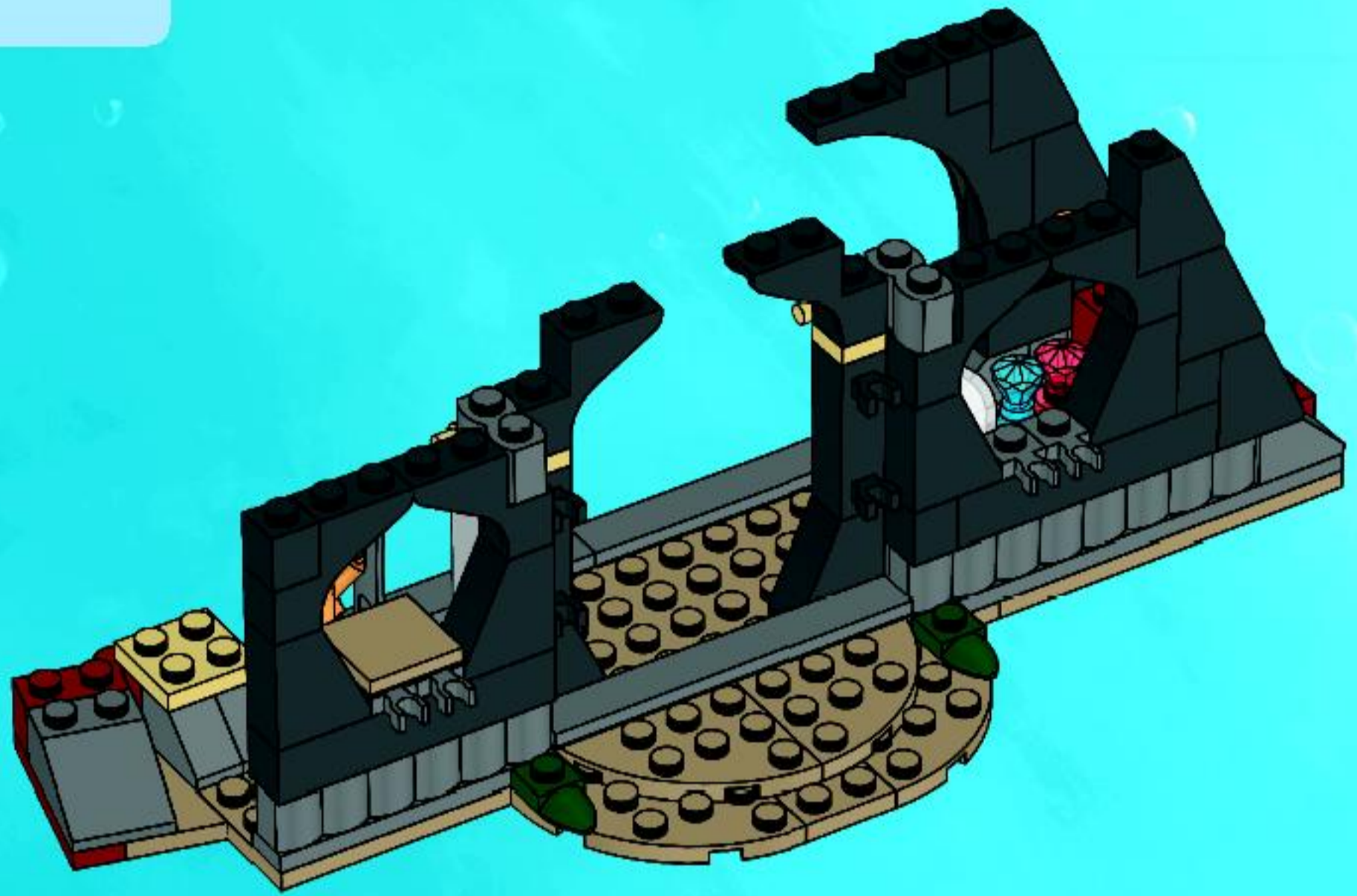

1x



2x



4x

22

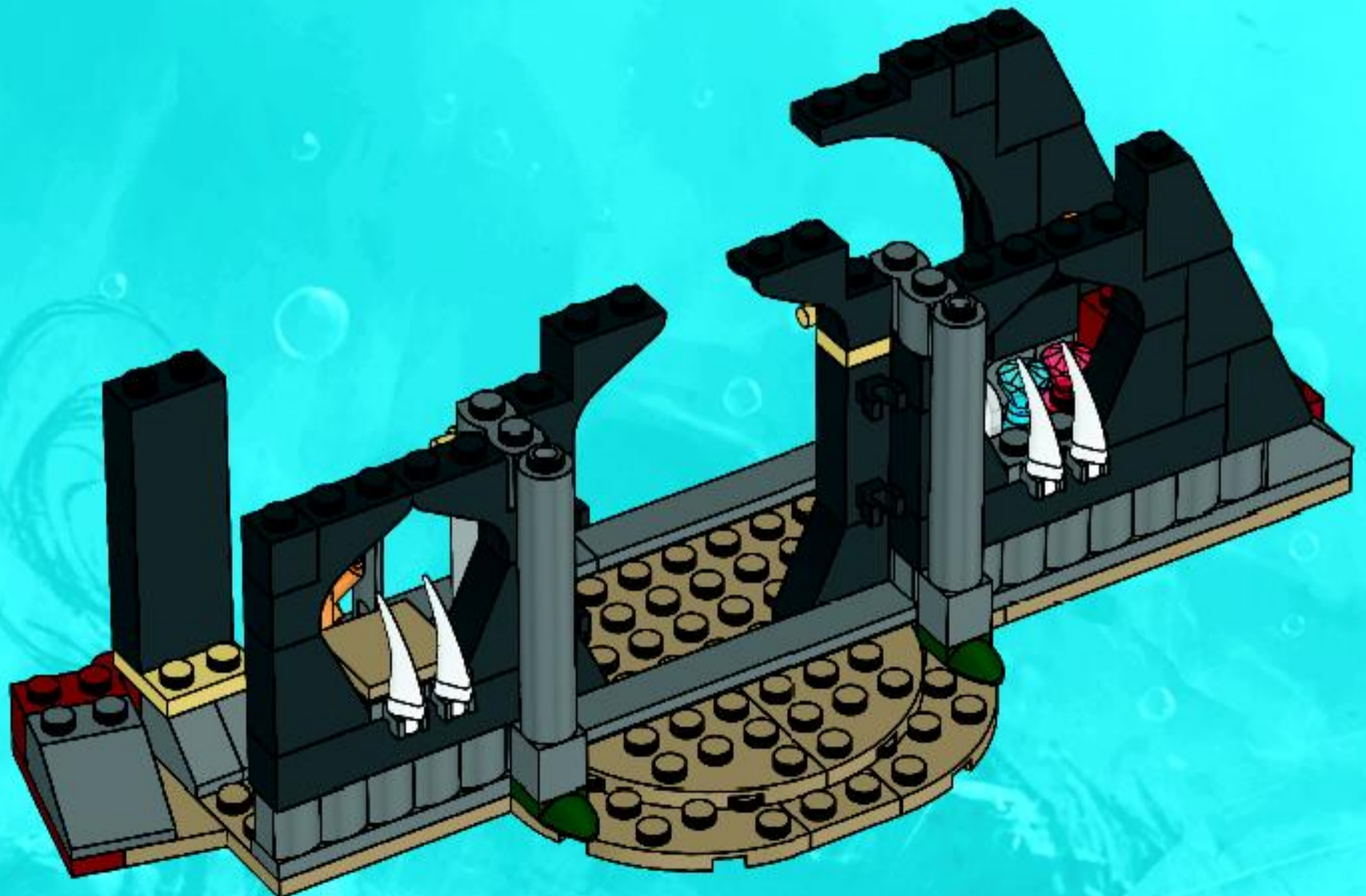



23

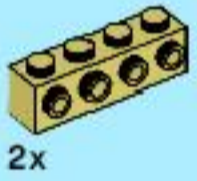
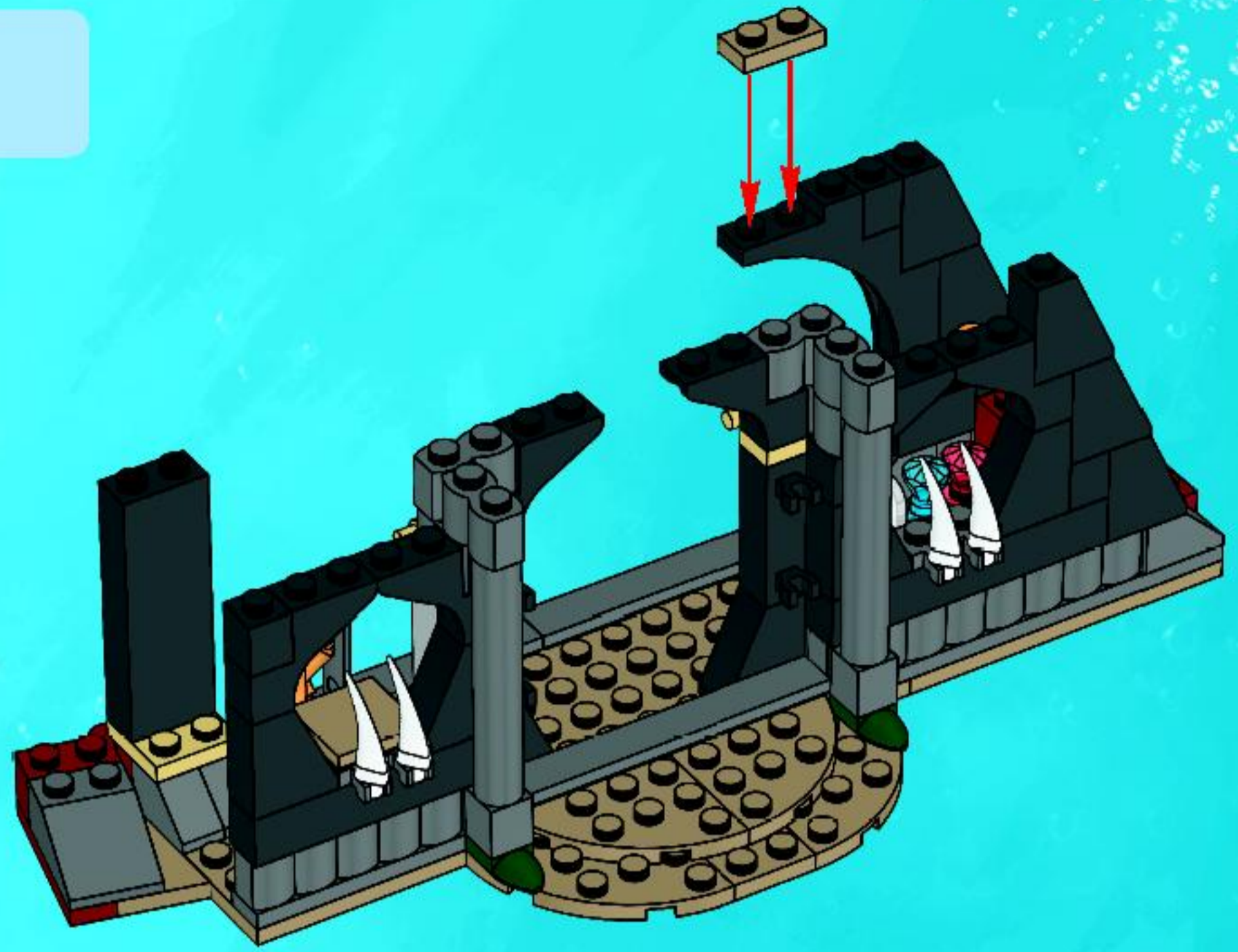

24

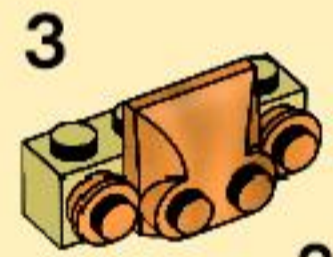
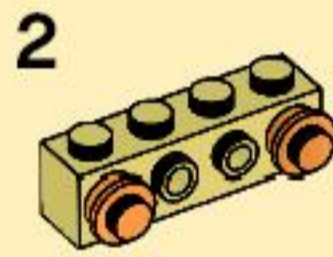
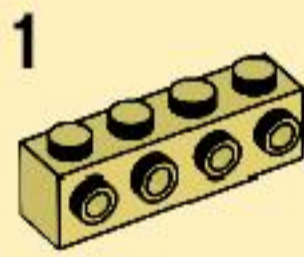

2x

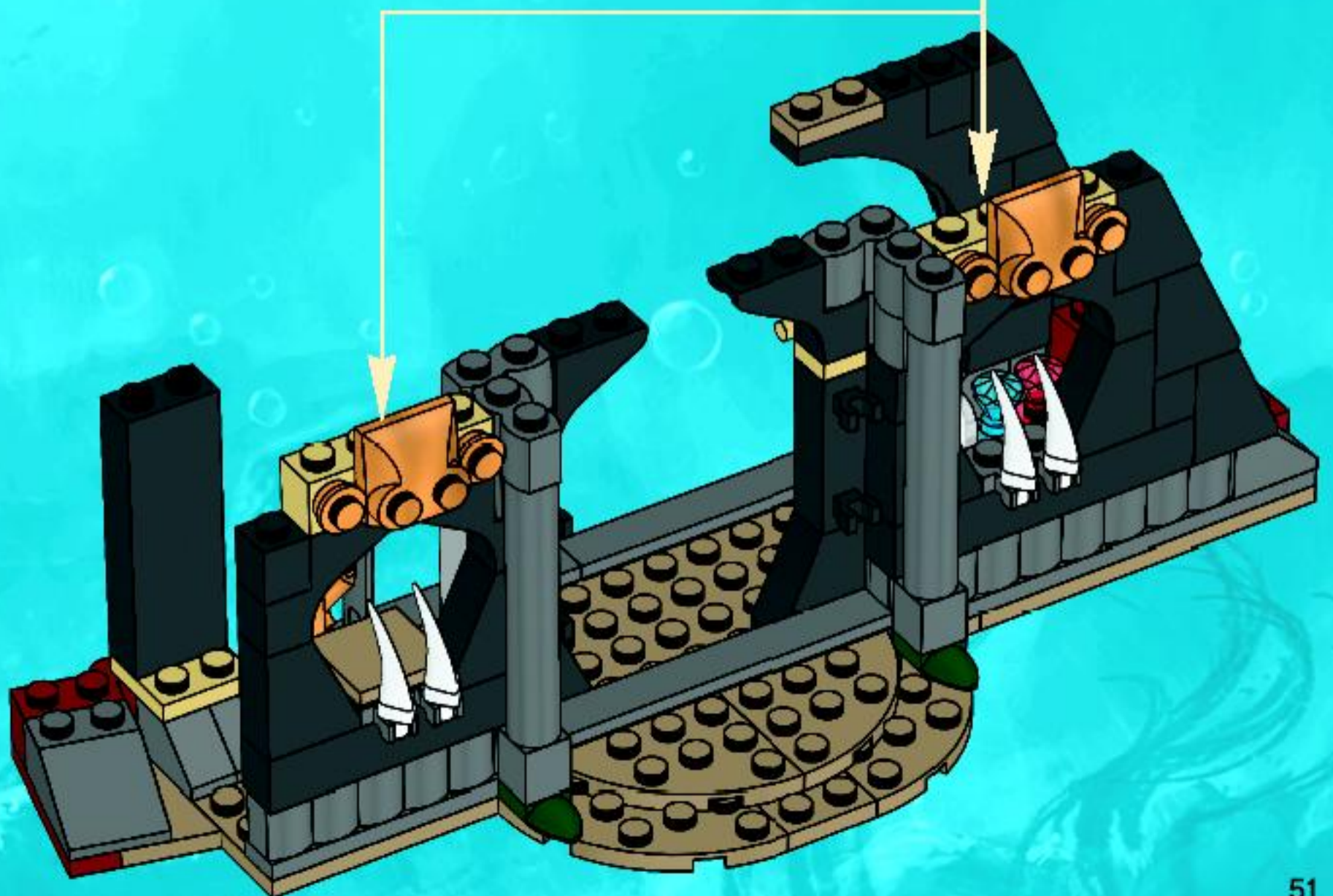

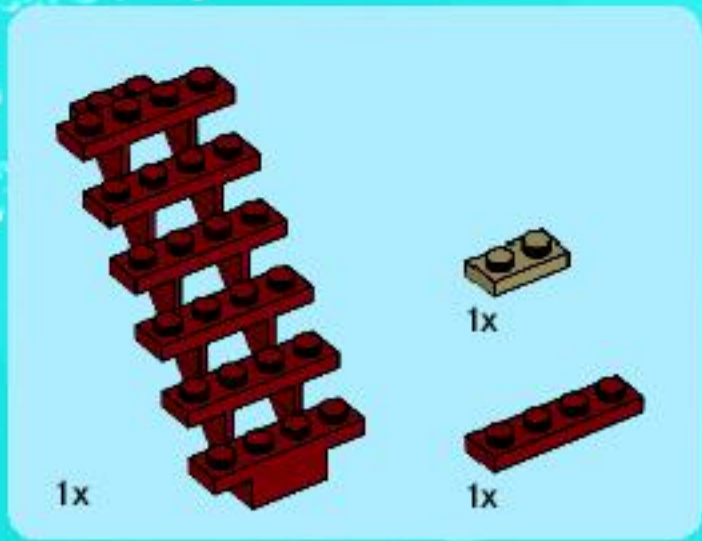

25

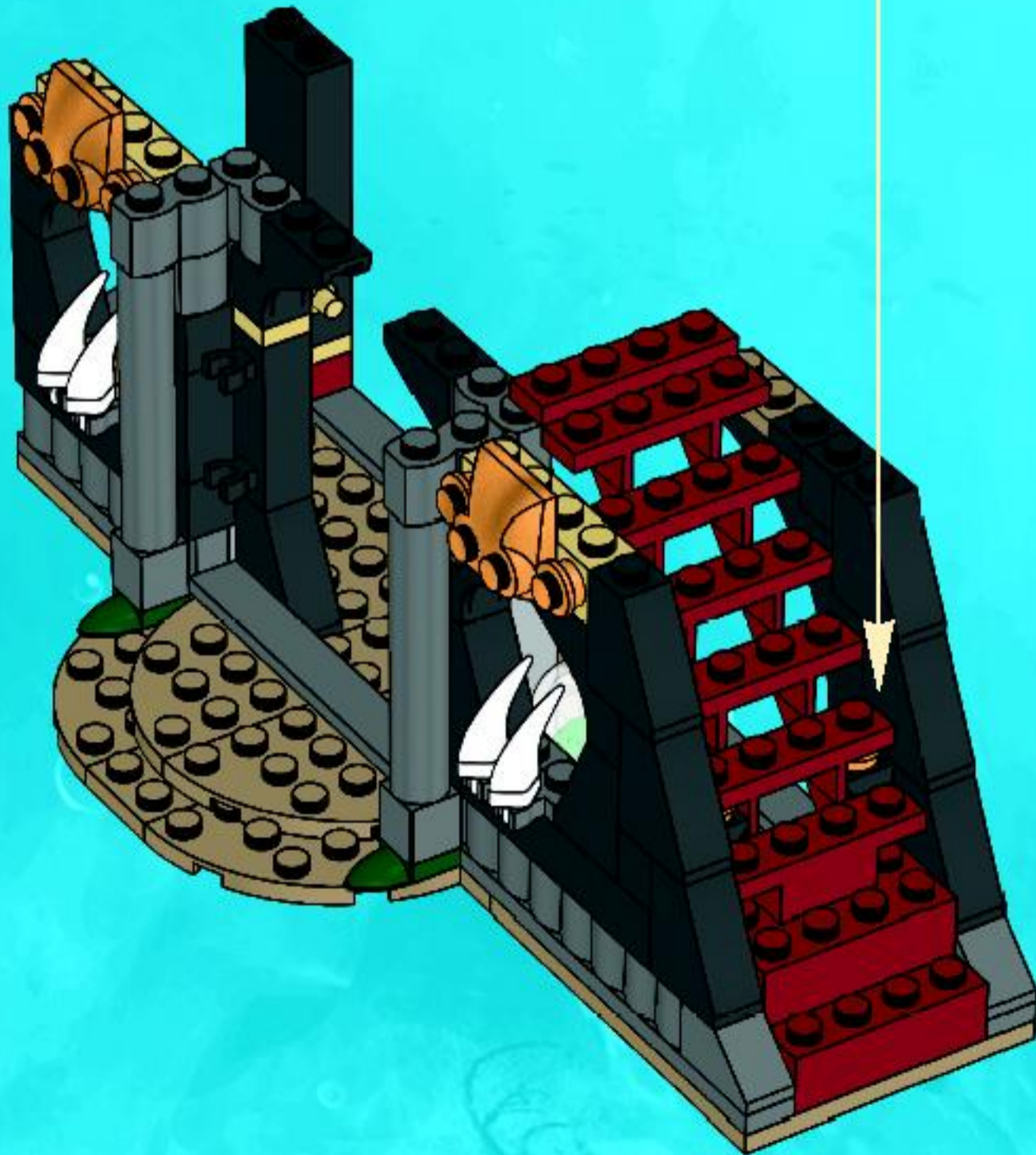
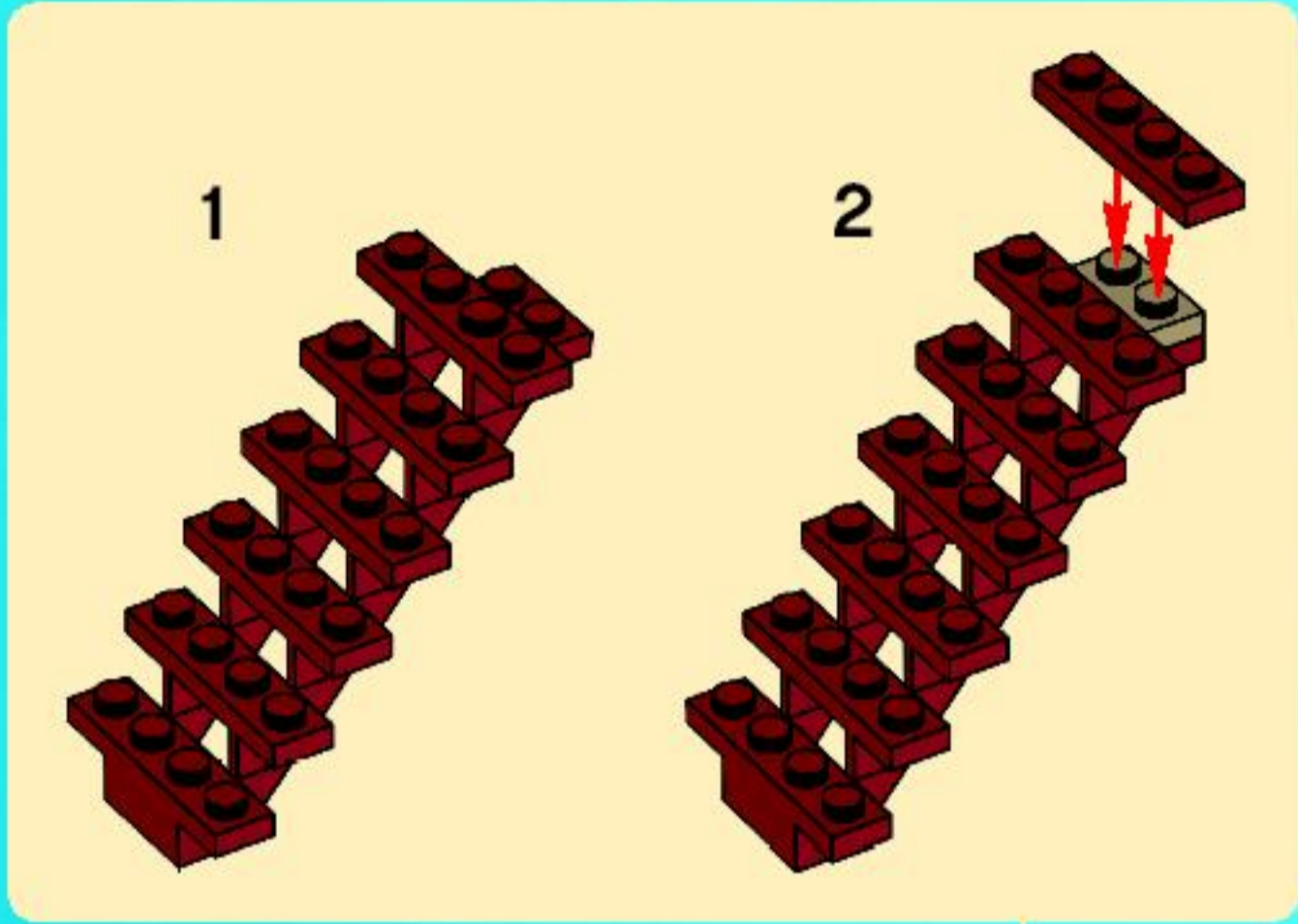



26

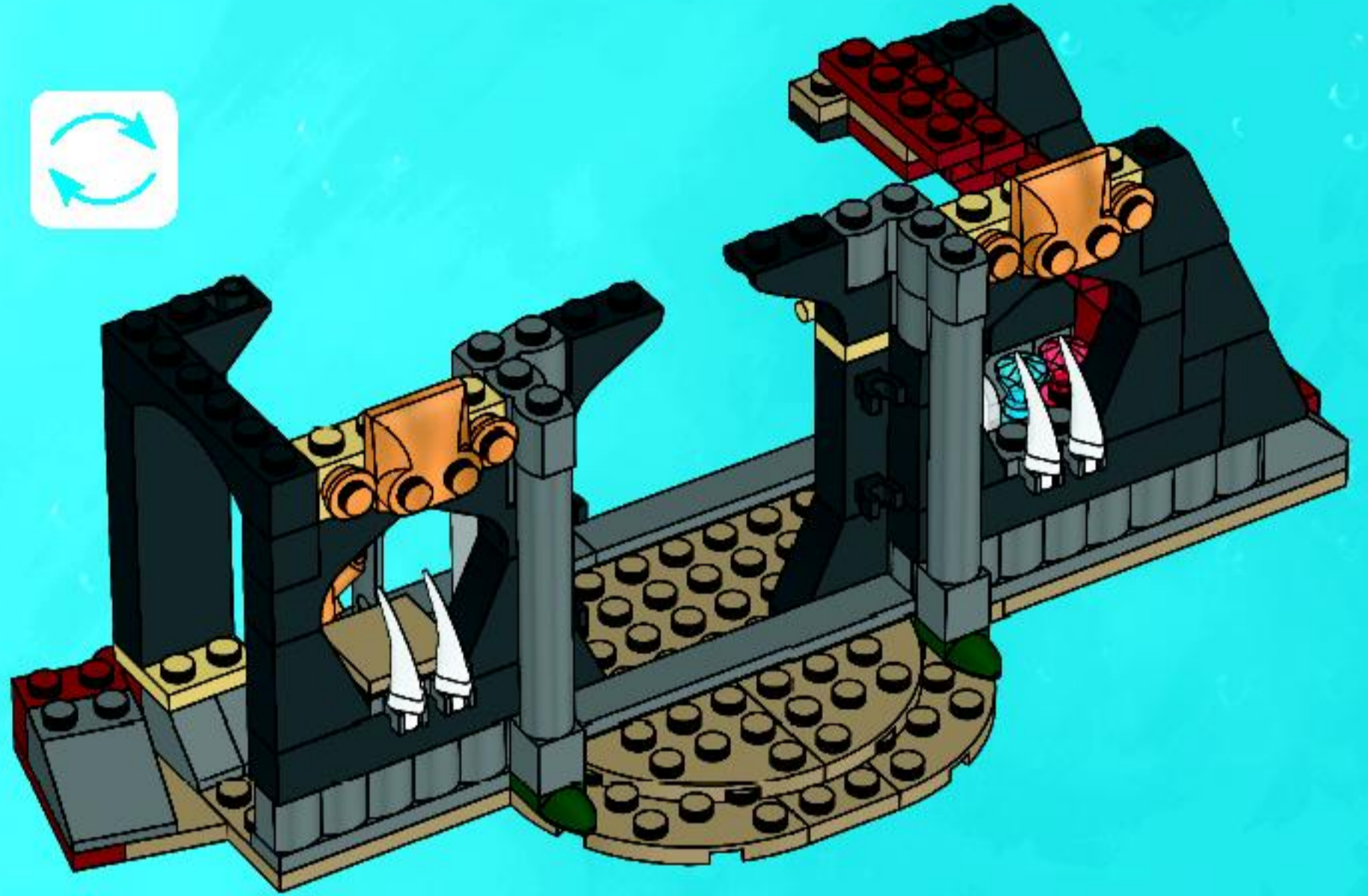

27

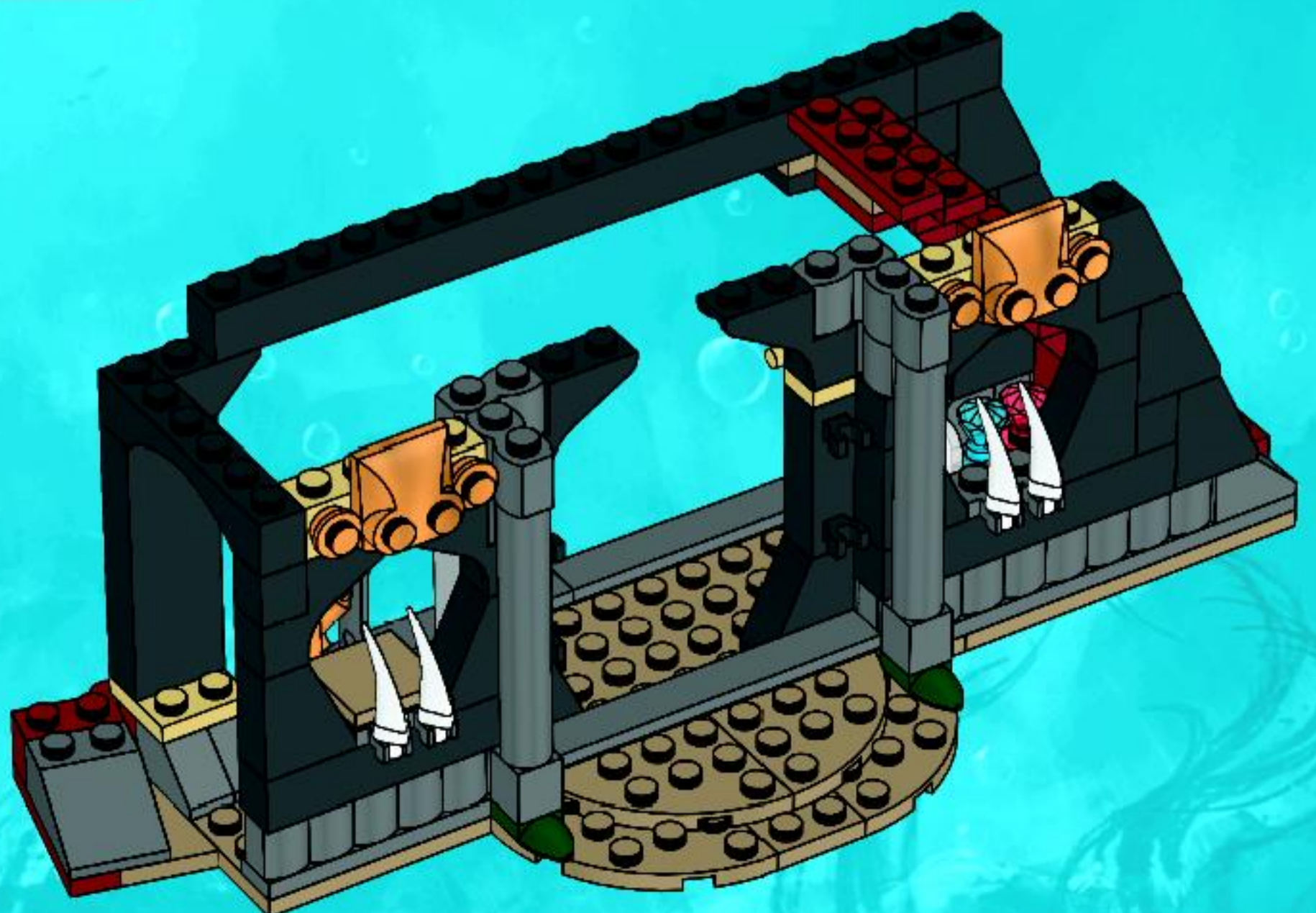

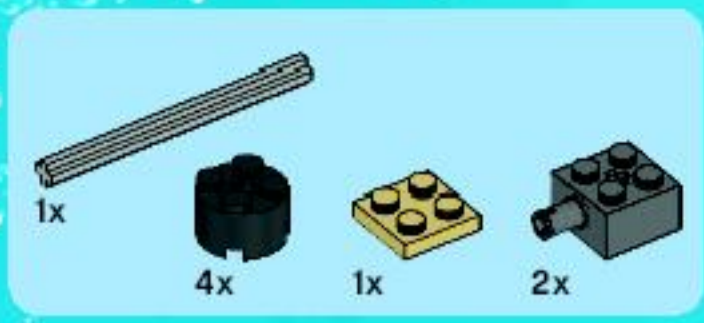

28

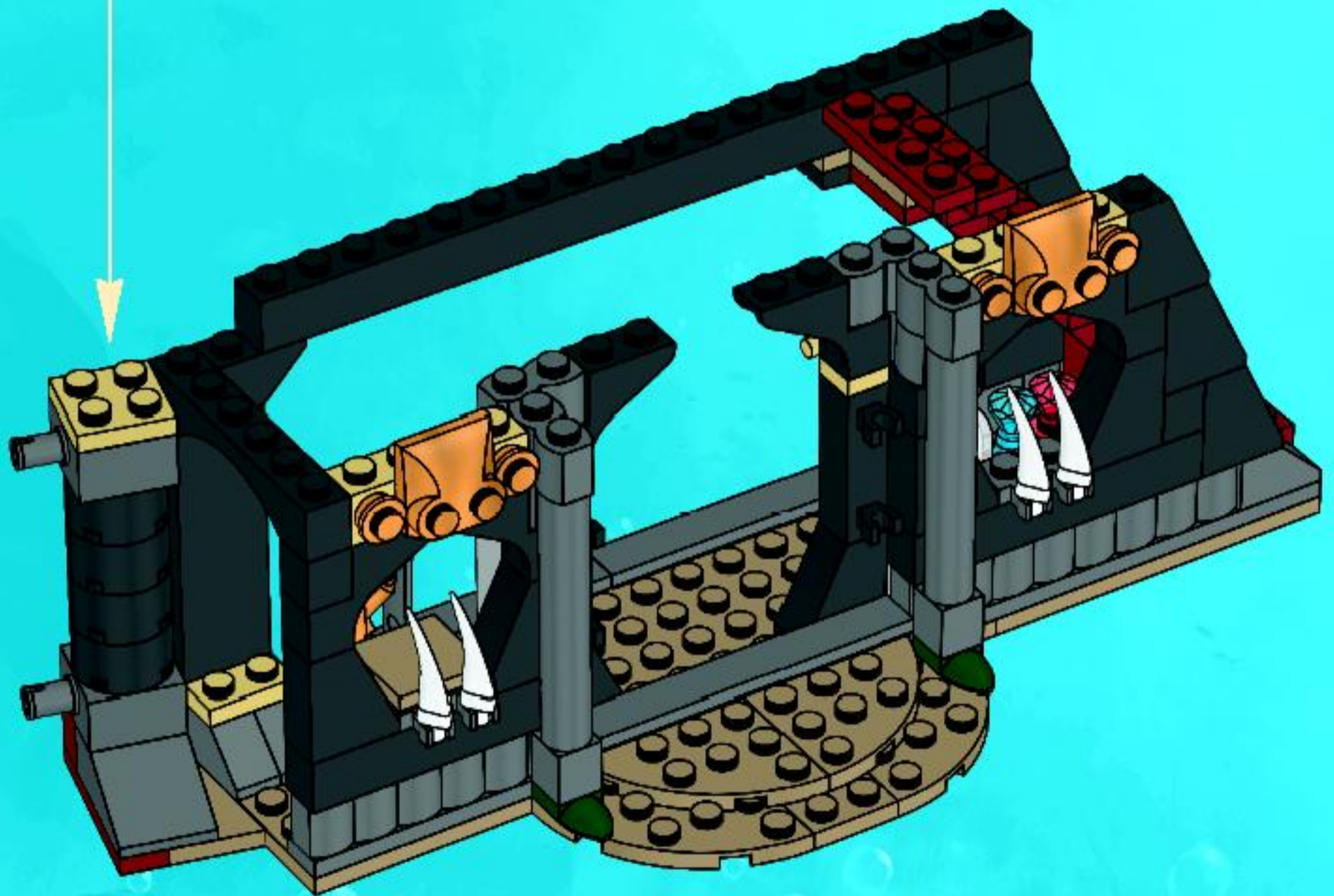
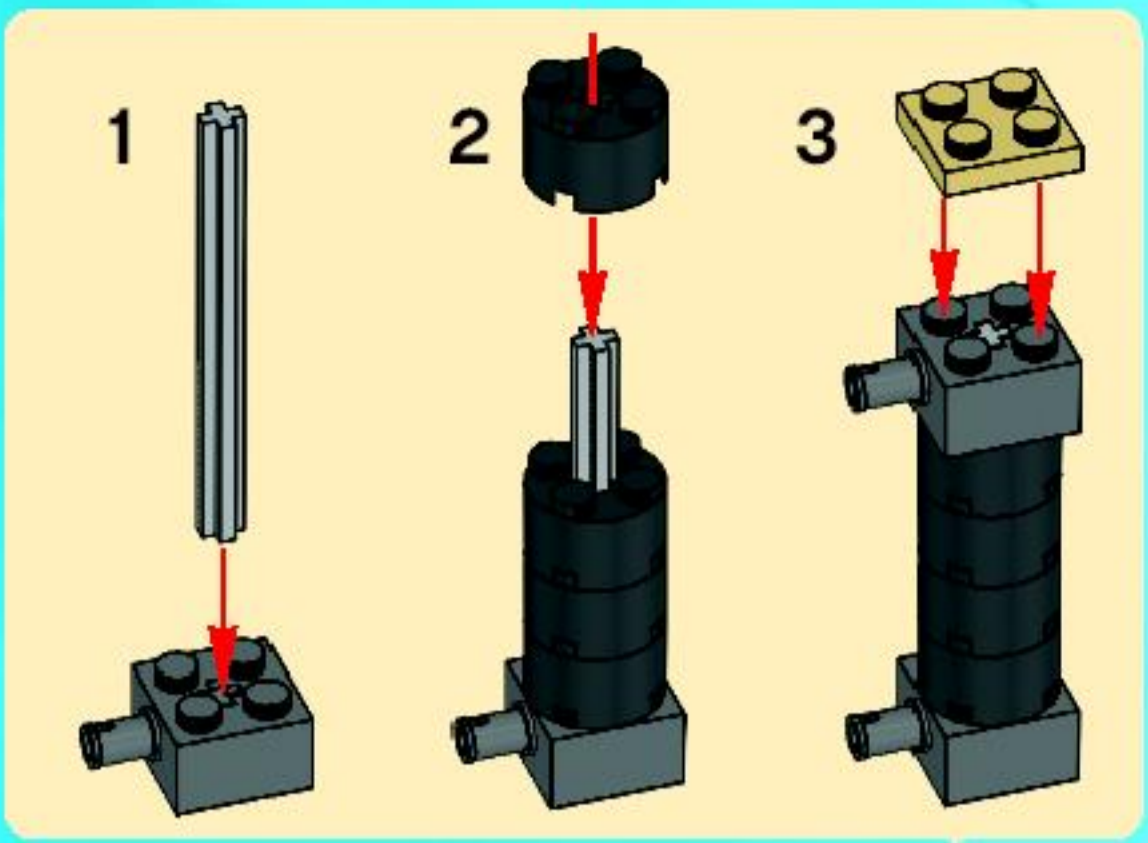



1x



1x



1x

29

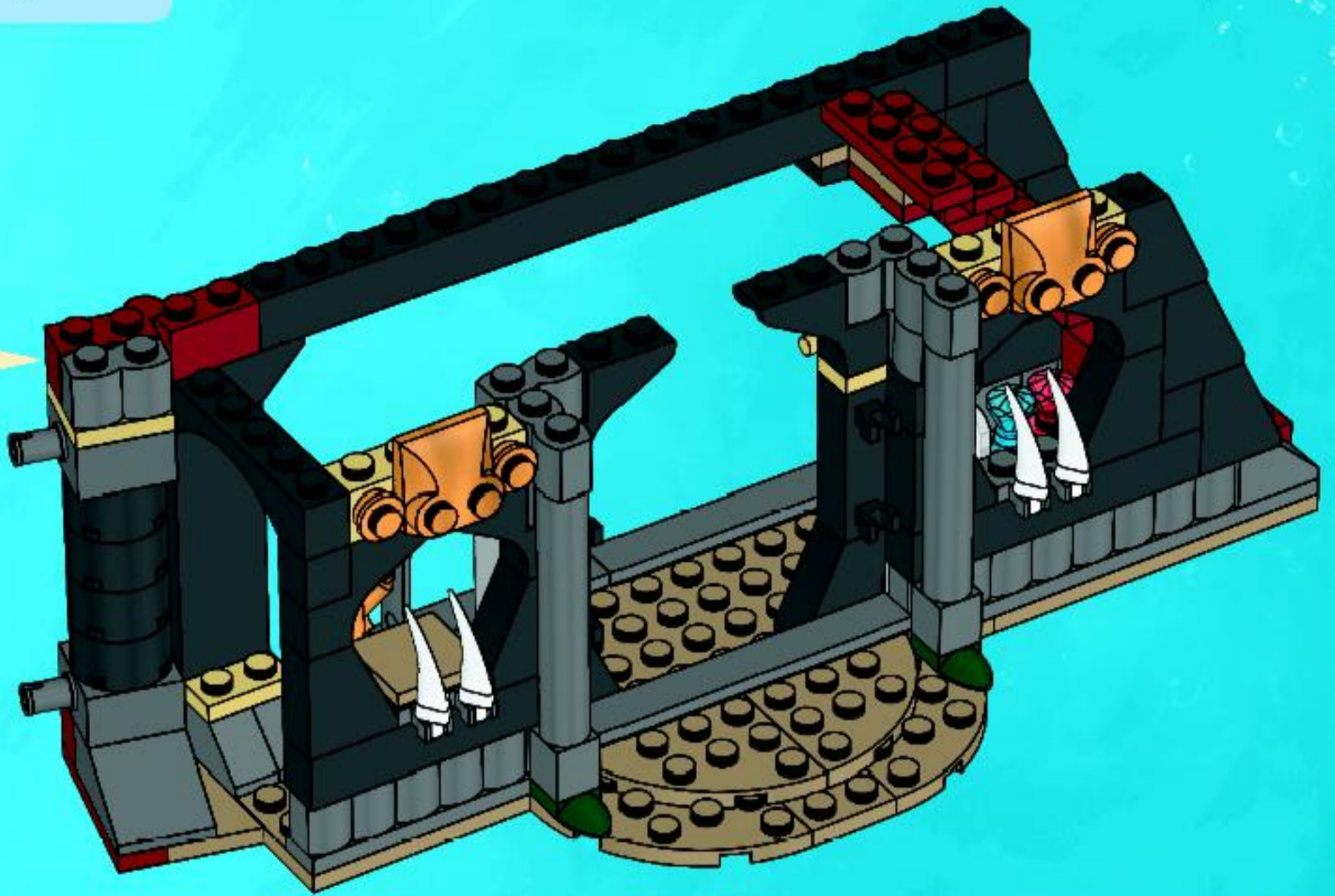
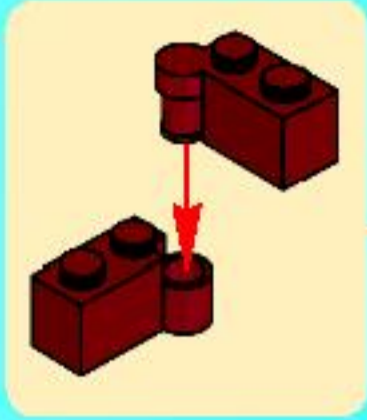

1x



2x

30

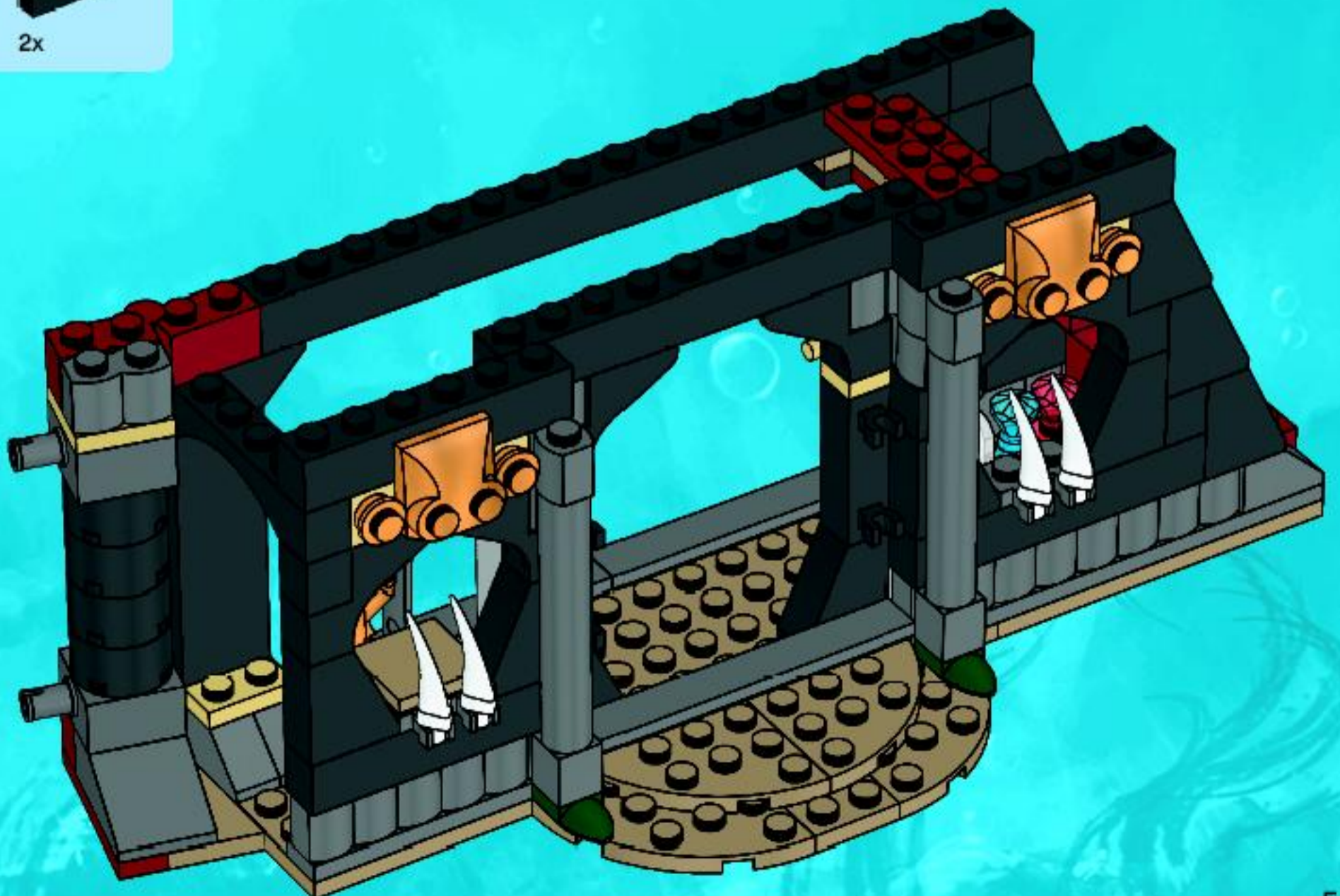



9

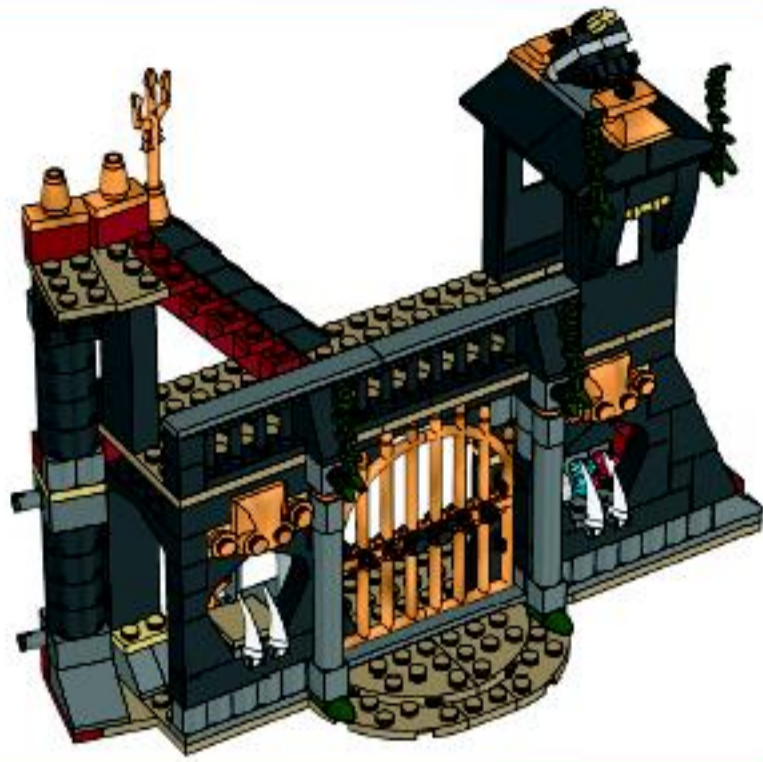

2x

31

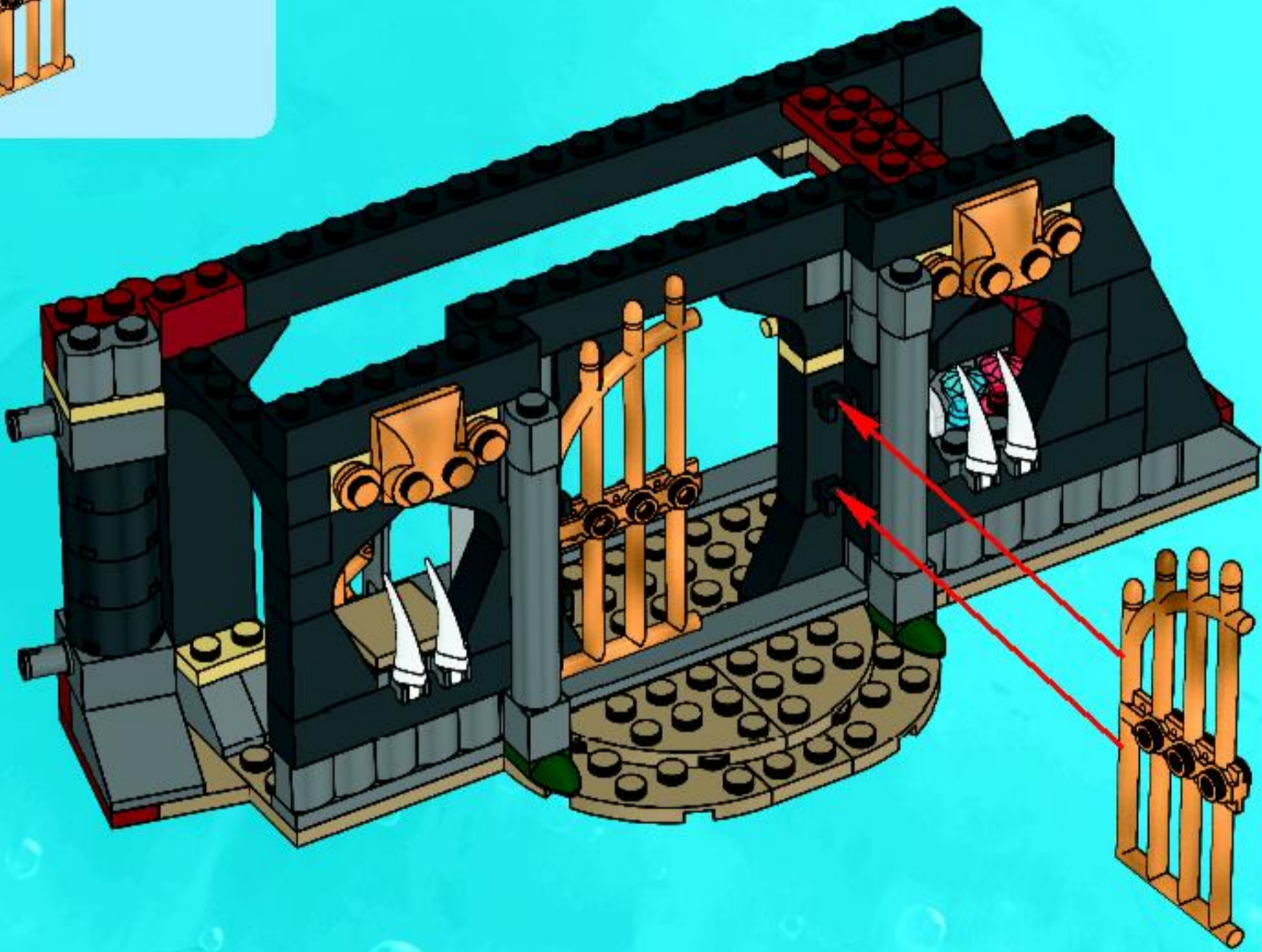

●
2x

●
2x

32

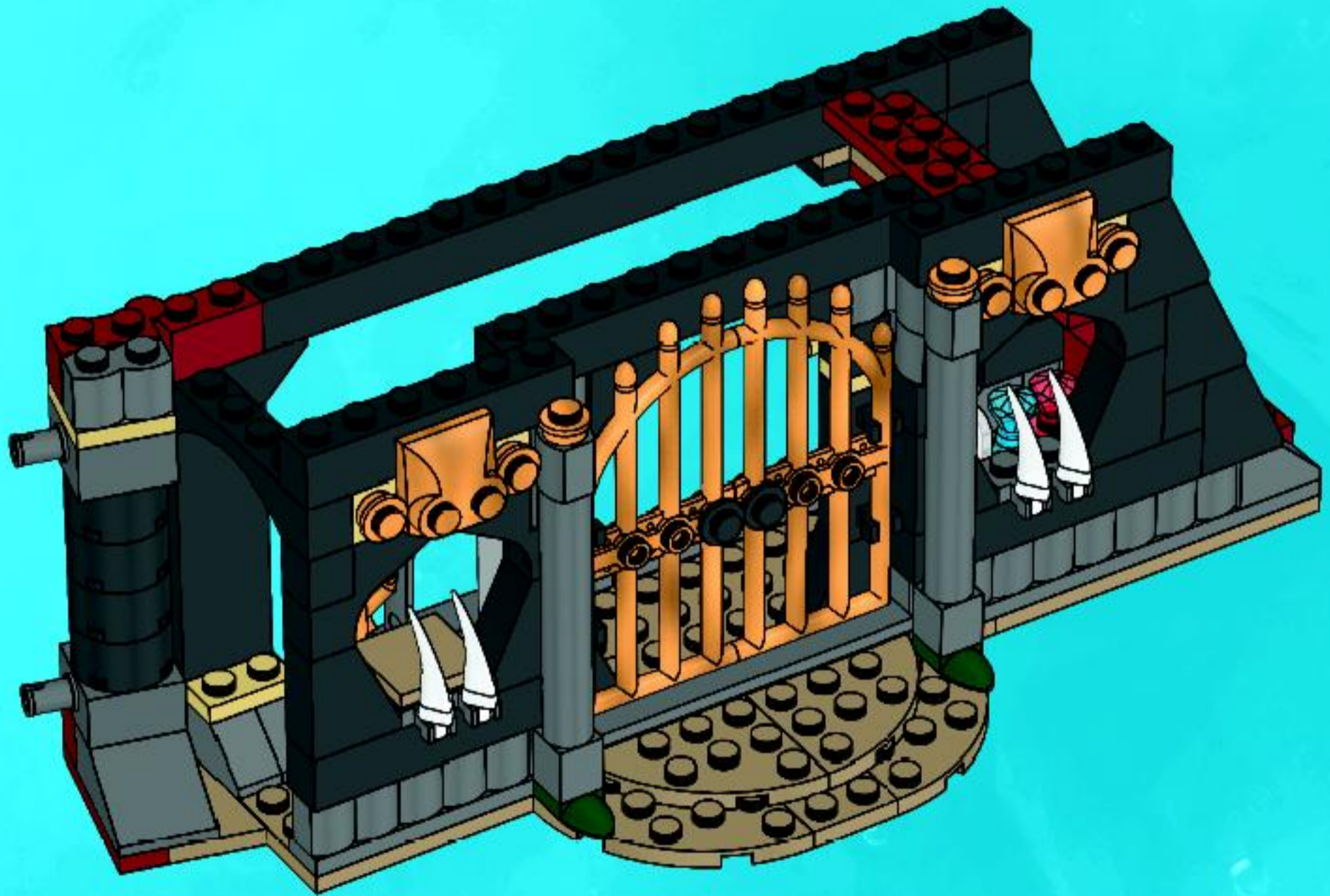



33



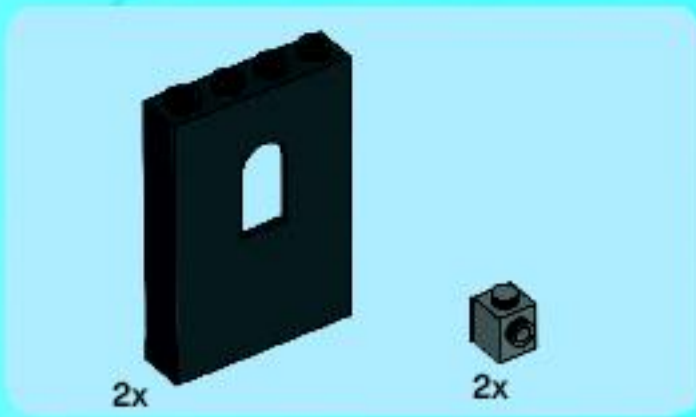

34



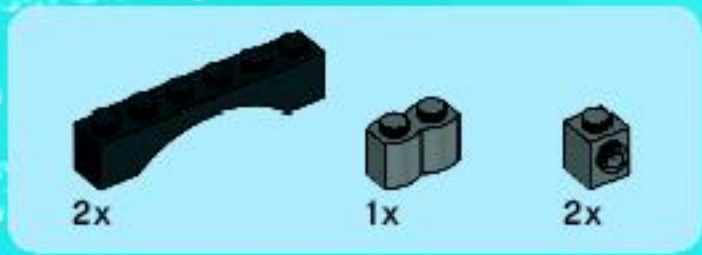

35

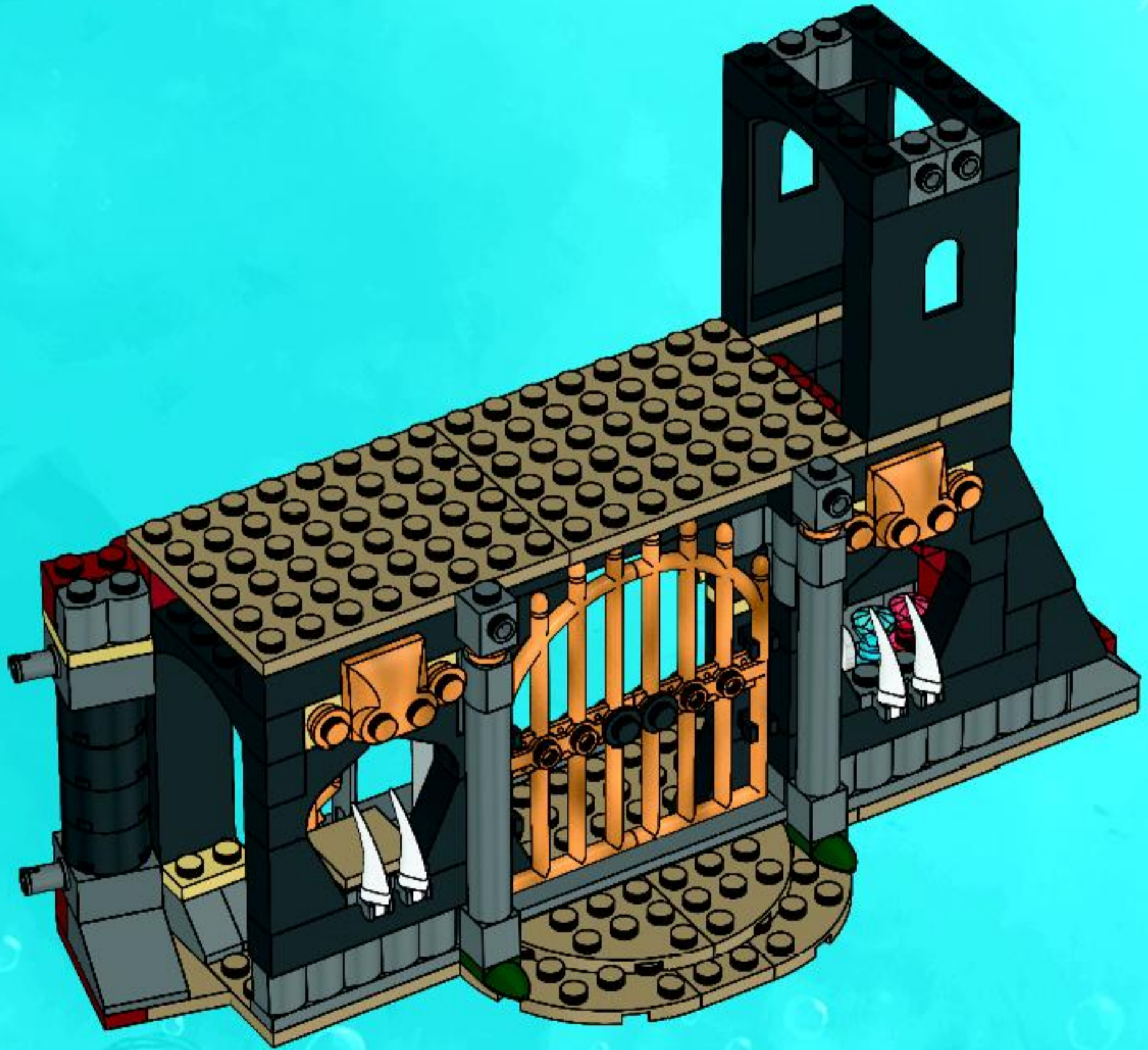

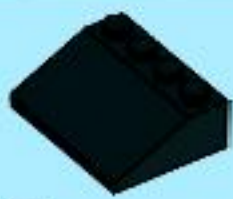

2x



2x

36



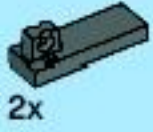

2x



2x



2x

37

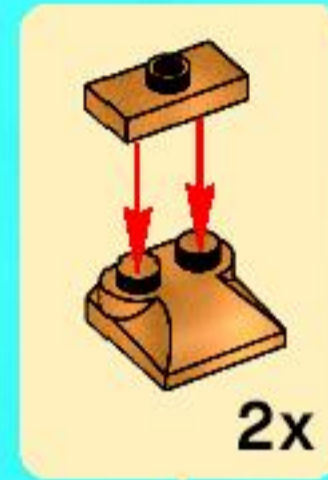

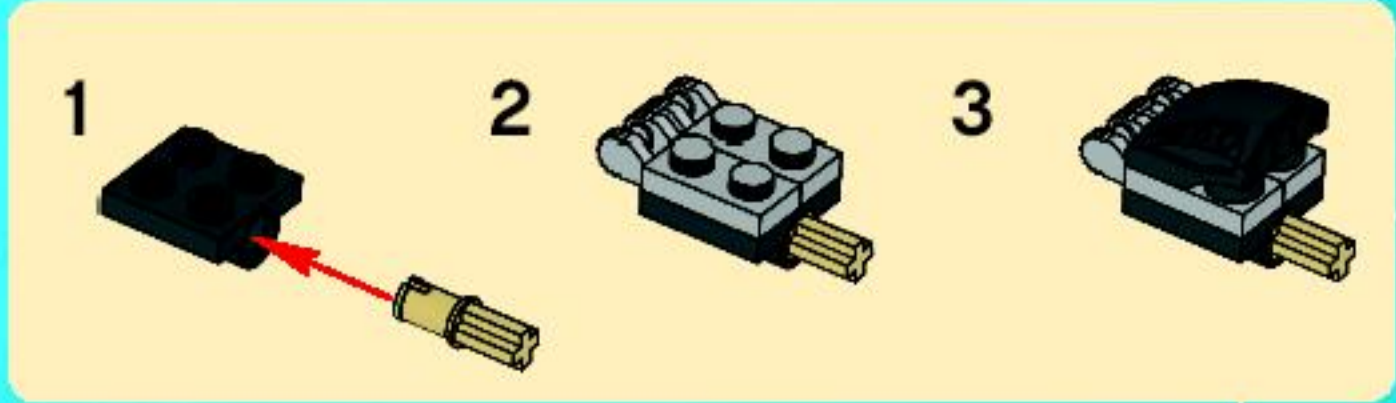
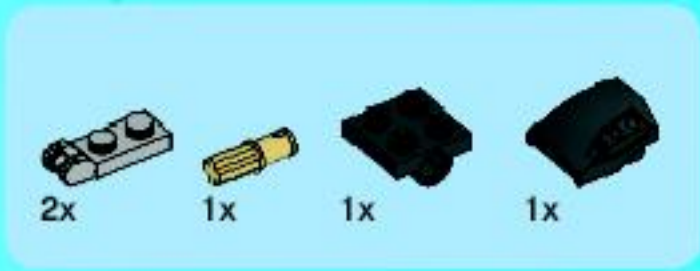

38





1x



4x

39

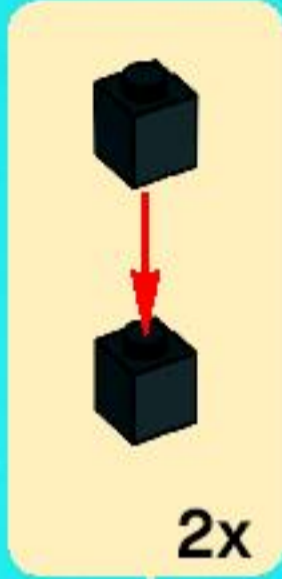

2x

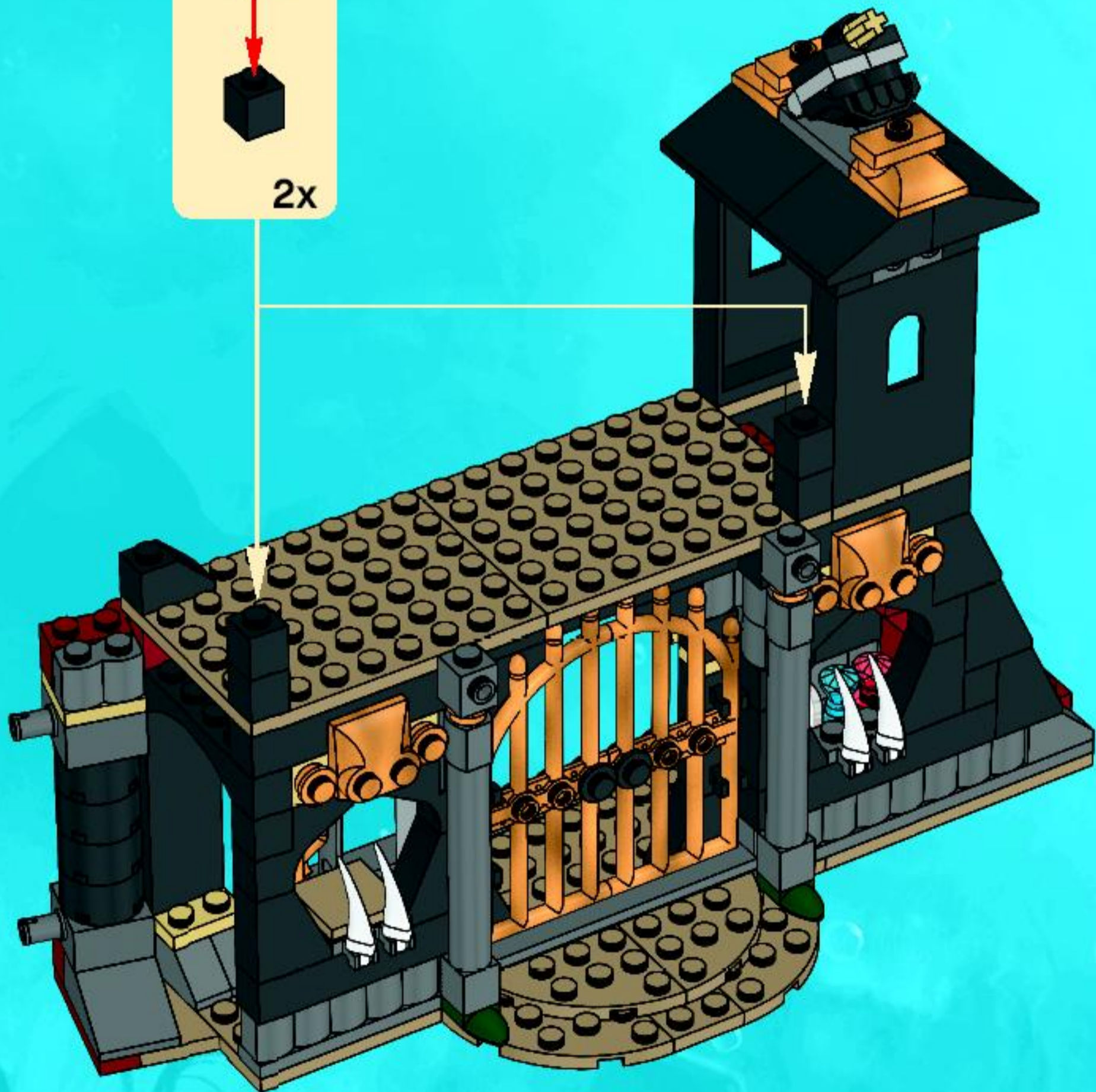

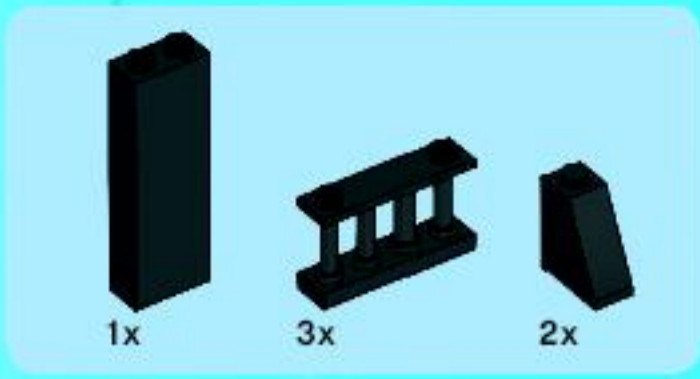

40



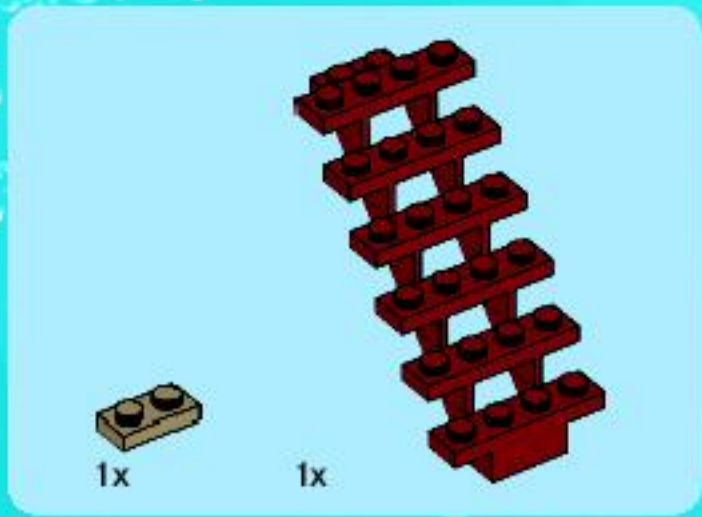

41

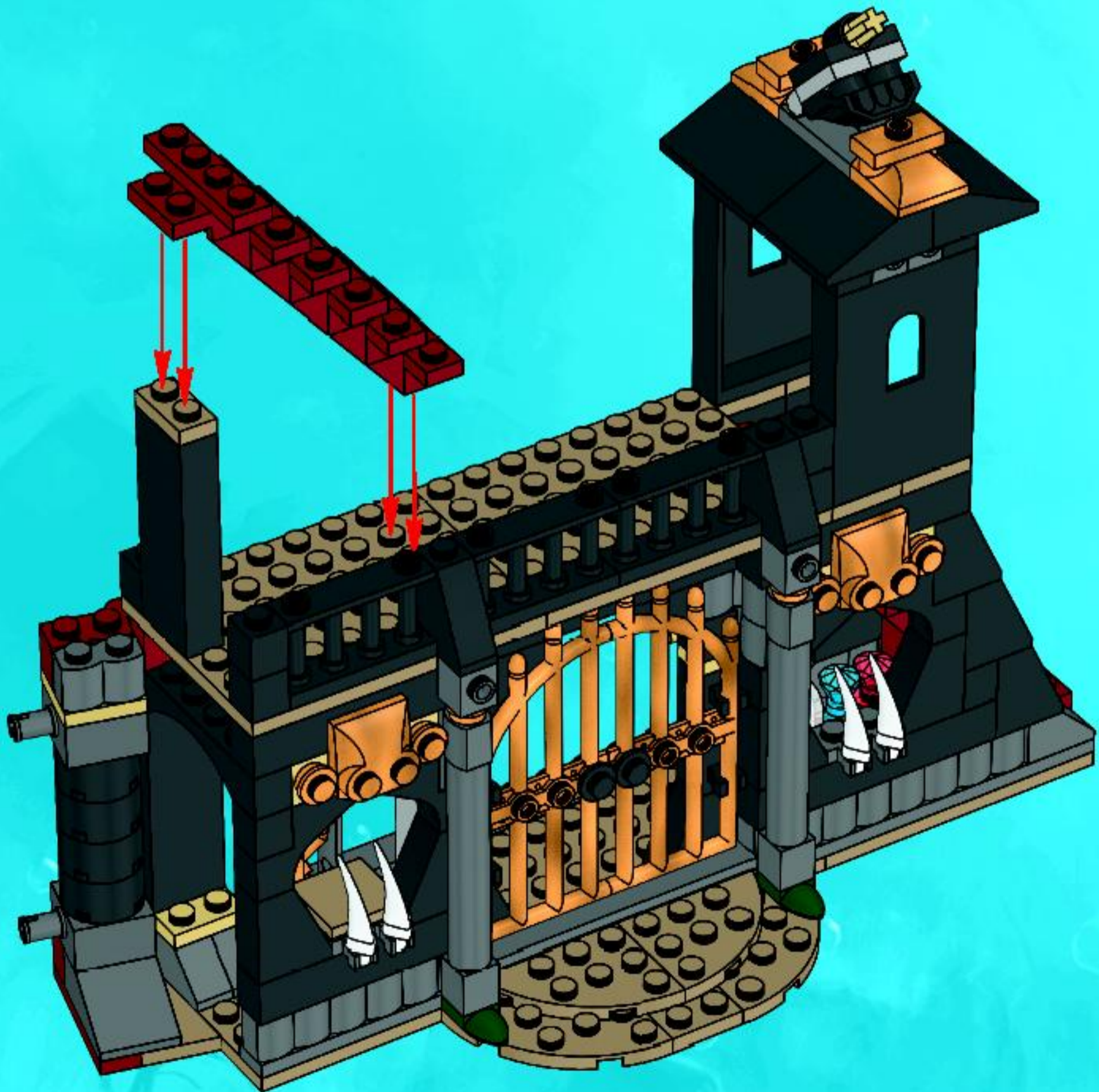



6x

42

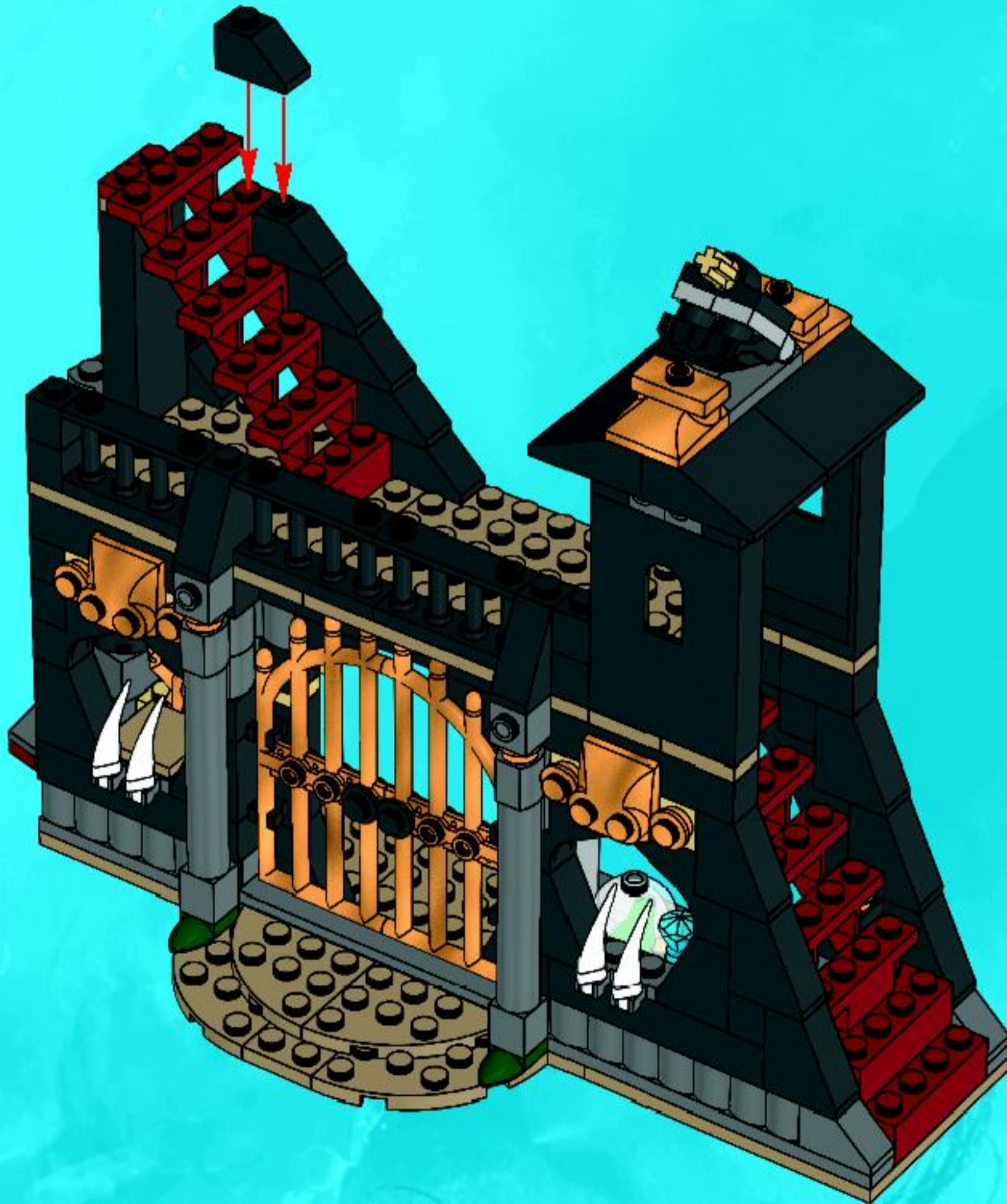

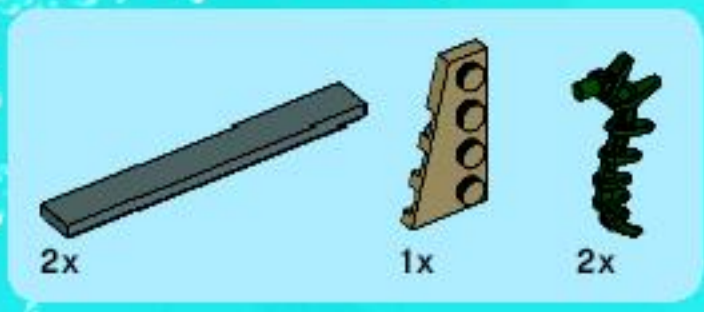

43





44

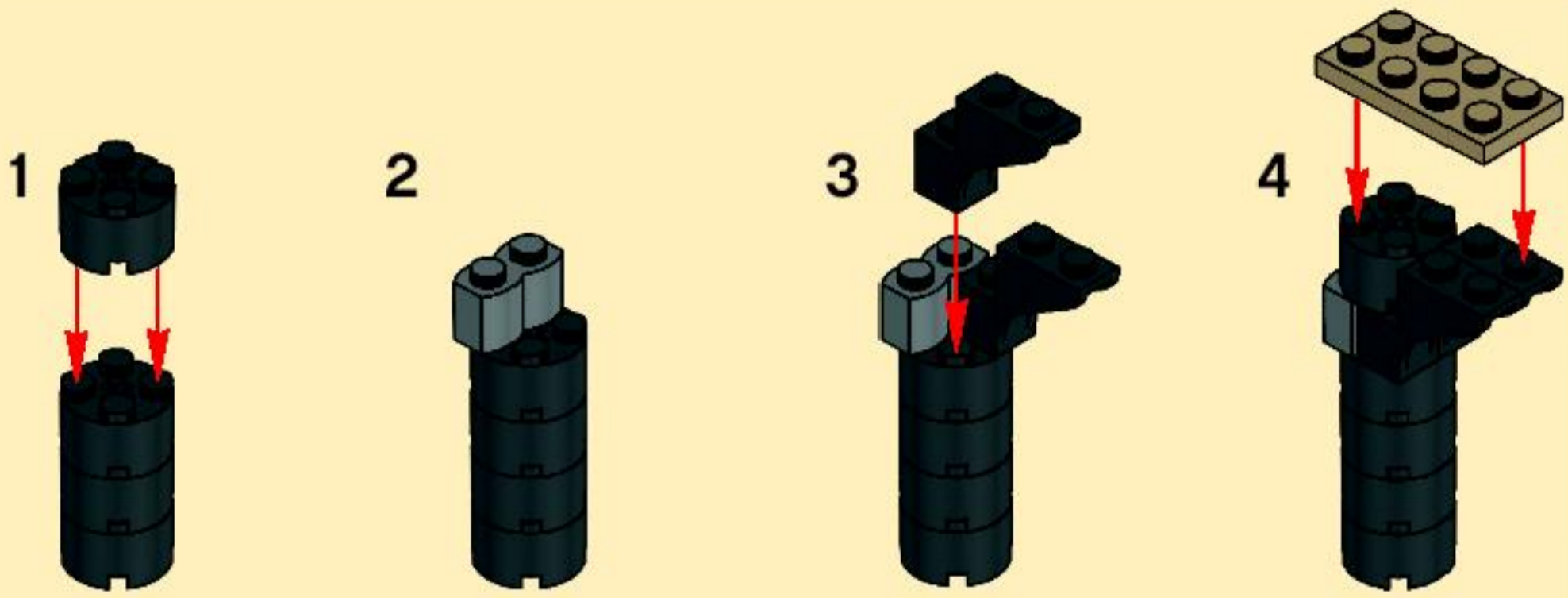



1x



1x



1x

45

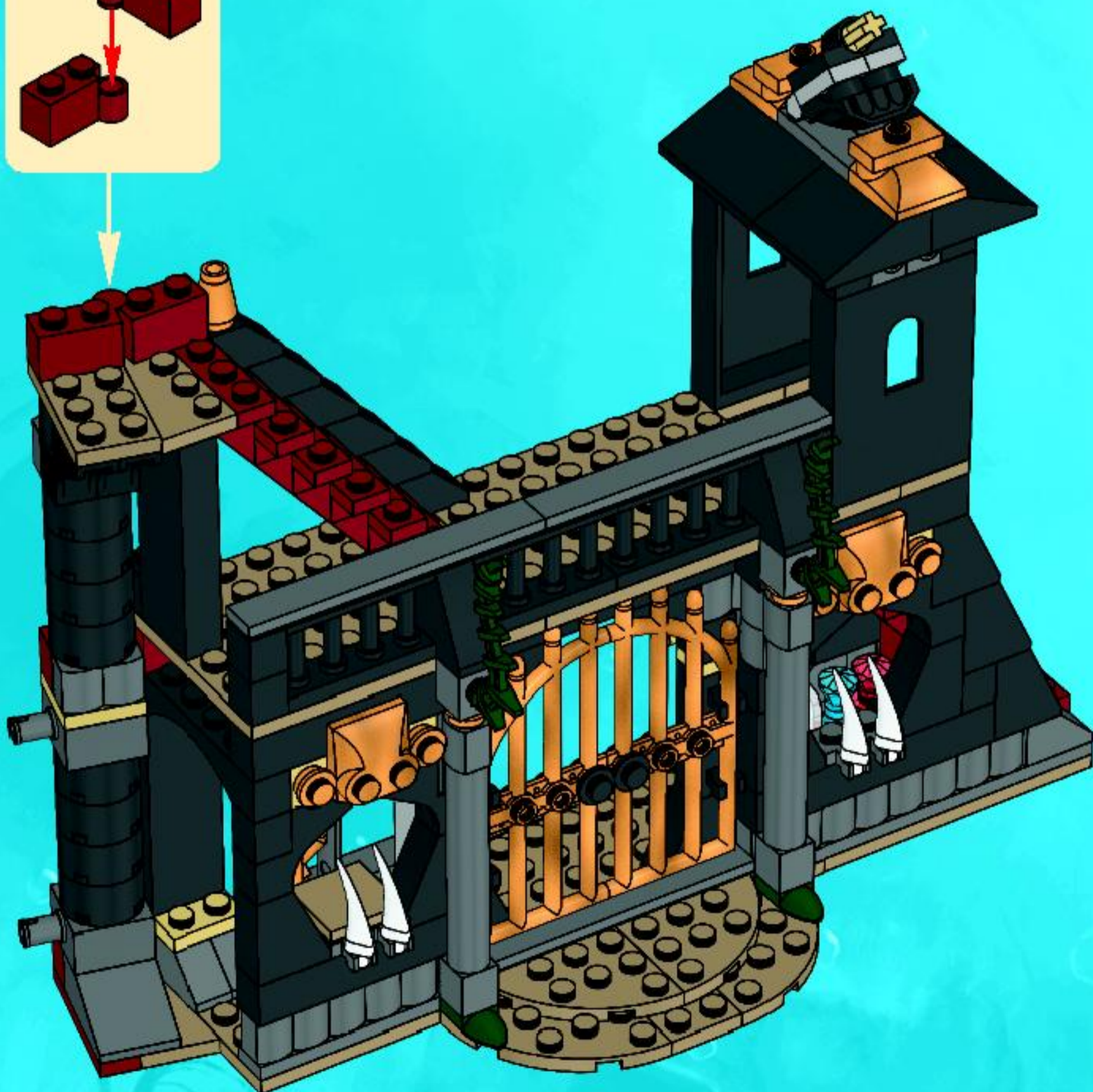
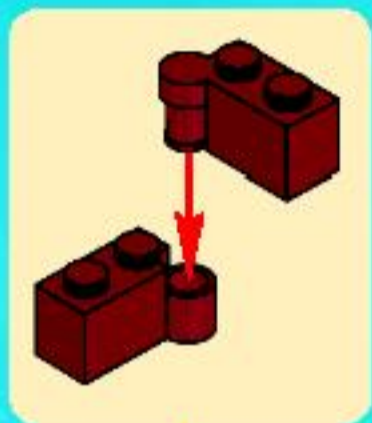



2x

46





2x



1x

47

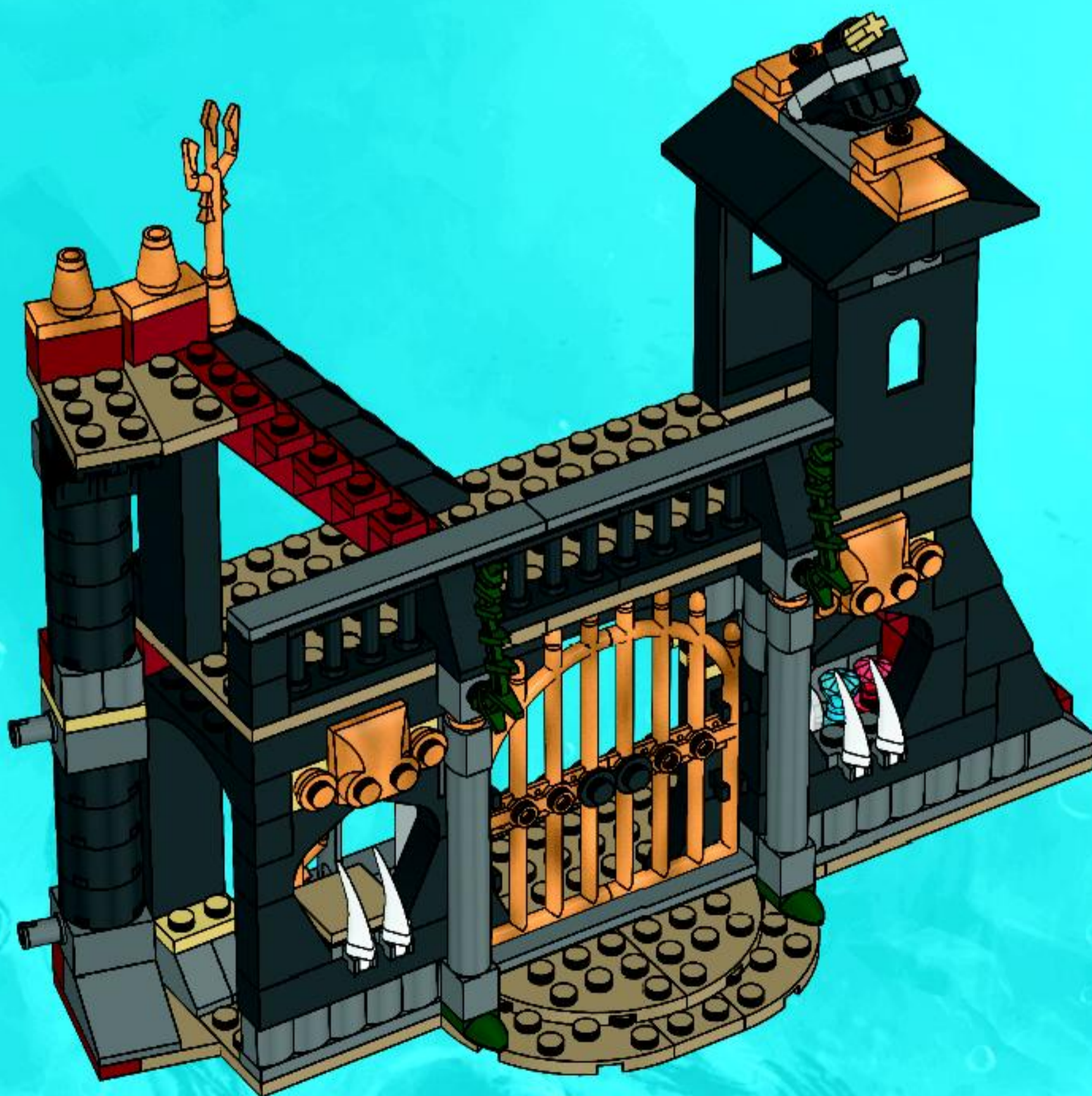

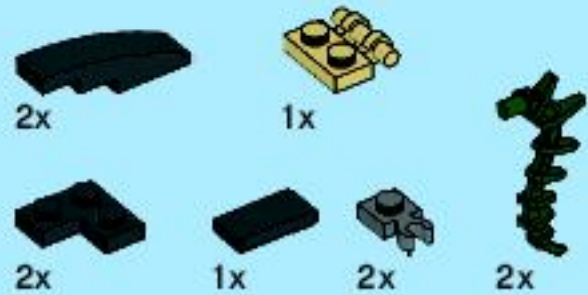

48

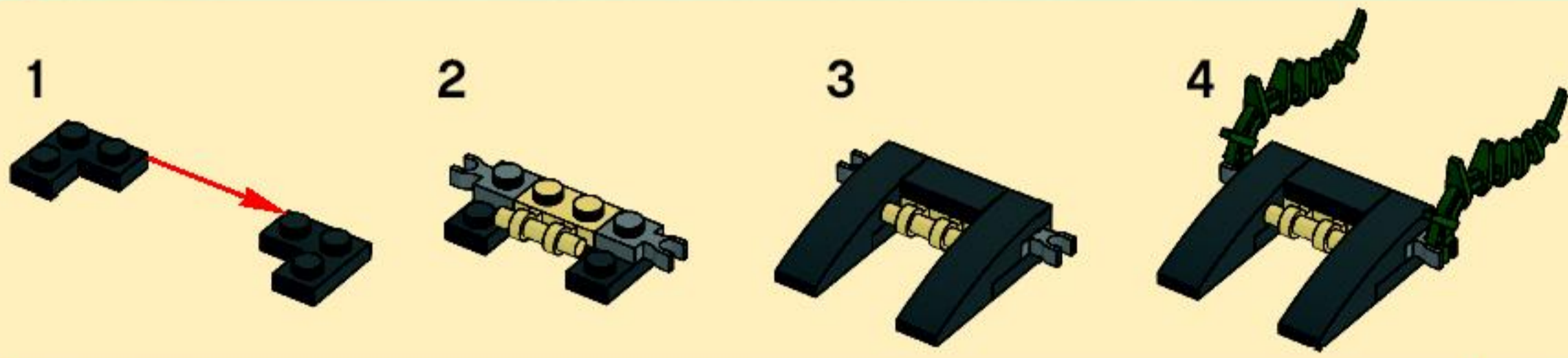

49





50







8058



8075



8077



8058



8075



8077



8078



8078



8076

8076





6x
4581277



1x
4567459



1x
4563475



1x
4570659



2x
4211197



2x
4211186



4x
4211362



6x
4211389



4x
4533772



2x
4552348

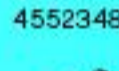

2x
4211865

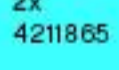

7x
4211639

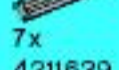

1x
4518282

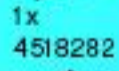

4x
4233493

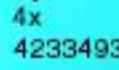

1x
4211440

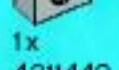

4x
4211466



1x
4211442



2x
4556157



2x
4211494

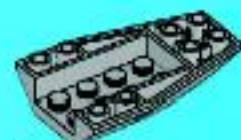

2x
4180464



1x
4211397



10x
4211429

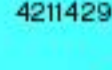

2x
4211356

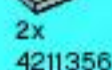

1x
4243797



1x
4211404



2x
4594238

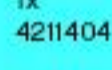

4x
4251163

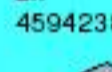

2x
4211805

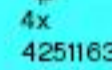

7x
4211632

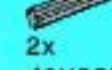

4x
4211804



4x
4211419



4x
4211419



1x
4282789



1x
4282786



1x
4282786



2x
4594243



1x
4567457



1x
4563652



1x
4570535



2x
4535930



1x
4211060



10x
4211109



18x
4558955



1x
4210875



42x
4211095



6x
4211087



4x
4211046



8x
4268139



4x
4180811



4x
4582257



6x
4211111



8x
4504378



4x
4552203



22x
4211135



2x
4211045



2x
4211106



4x
4246896



1x
4210782

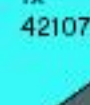

1x
4210637

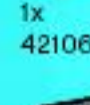

2x
4210906



1x
4210873



1x
4210771



1x
4210772

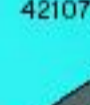

2x
4180486

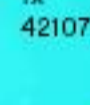

1x
4161210

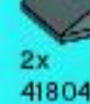

4x
4210882



9x
4581225

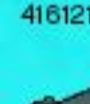

4x
4215387



1x
4210788



7x
4210688



1x
4508553



4x
4514559



2x
4210851



1x
4161224



2x
4211094



2x
4211001



1x
4211053



2x
4211065



6x
4211056

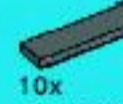

10x
4211008



2x
4257526



24x
4587212



4x
4521187



2x
4561036



3x
4568036



3x
4570036



3x
4563473

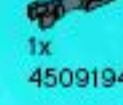

1x
4509194



2x
4582820



5x
4563480



2x
4585622



14x
4523157



6x
4563483



13x
4529247



1x
4570651



1x
4584099



8x
4519970



3x
4570738



2x
4585621



26x
4523159



4x
4566967



1x
4541394



1x
4541393



1x
4505990



8x
4286597



Customer Service

Kundenservice

Service Consommateurs

Servicio Al Consumidor

www.lego.com/service or dial



: 00800 5346 5555

: 1-800-422-5346



Atlantis.LEGO.com





WIN!

Go to www.nielsen.com/LEGO to fill out a survey for a chance to win a cool LEGO® Product. No purchase necessary. Open to all residents where not prohibited.

 www.LEGO.com



www.nielsen.com/LEGO

GEWINNE!

Nimm an der Umfrage auf www.nielsen.com/LEGO teil und hab die Chance ein cooles LEGO® Produkt zu gewinnen!

Die Teilnahme am Gewinnspiel führt zu keinerlei Kaufverpflichtungen. Teilnahme in allen nicht aus geschlossenen Ländern möglich.

WIN!

Ga naar www.nielsen.com/LEGO, vul een enquêteformulier in en maak kans op een cool LEGO® product.

Geen aankoopverplichting. Iedereen mag deelnemen, uitgezonderd ingezetenden van landen waar een enquêteverbod geldt.

GAGNE!

Visite www.nielsen.com/LEGO pour répondre à un questionnaire et avoir une chance de gagner un produit LEGO® très cool!

Aucune obligation d'achat. Ouvert à tous les résidents des pays autorisés.

当てよう!

www.nielsen.com/LEGOにアクセスして、アンケートにご記入ください。当選者にはレゴ製品を差し上げます。

お買い上げの必要はありません。禁止されていない限り、すべての年齢にご利用いただけます。