



# ATLANTIS

8076



1

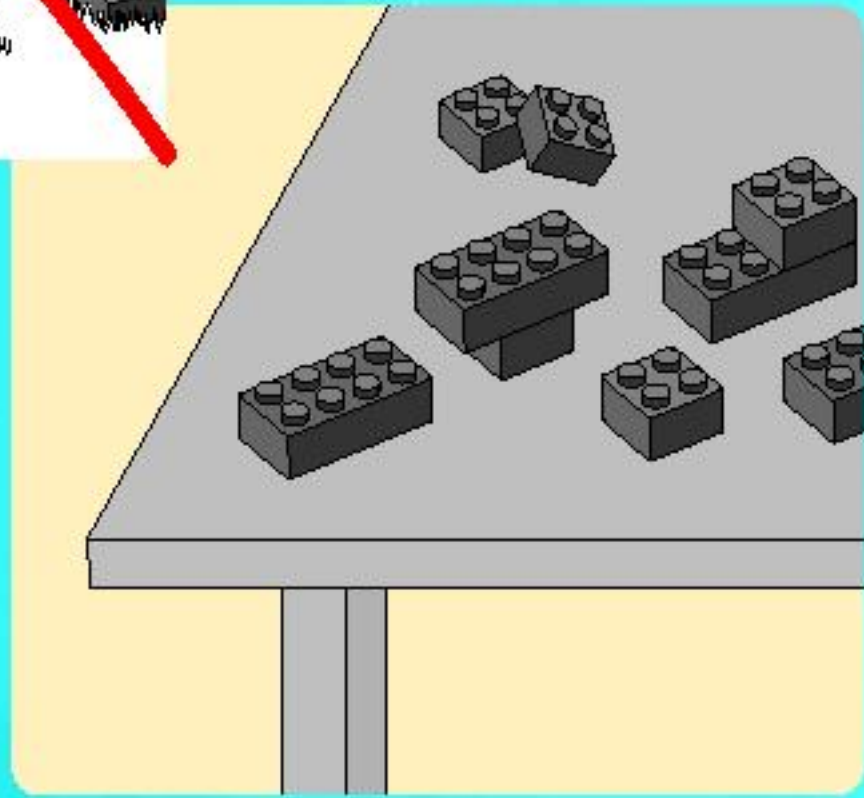
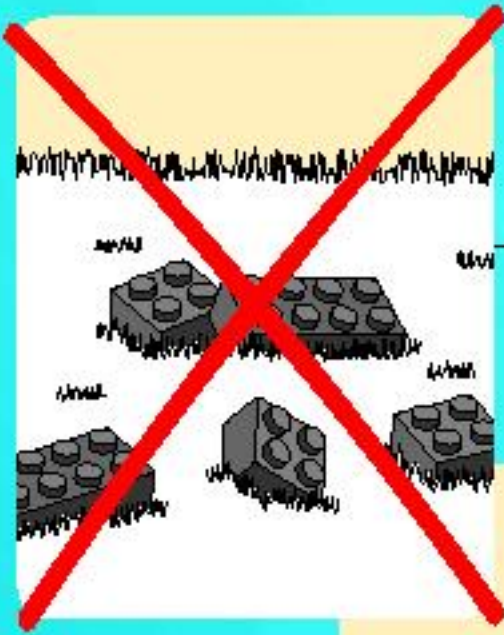

2

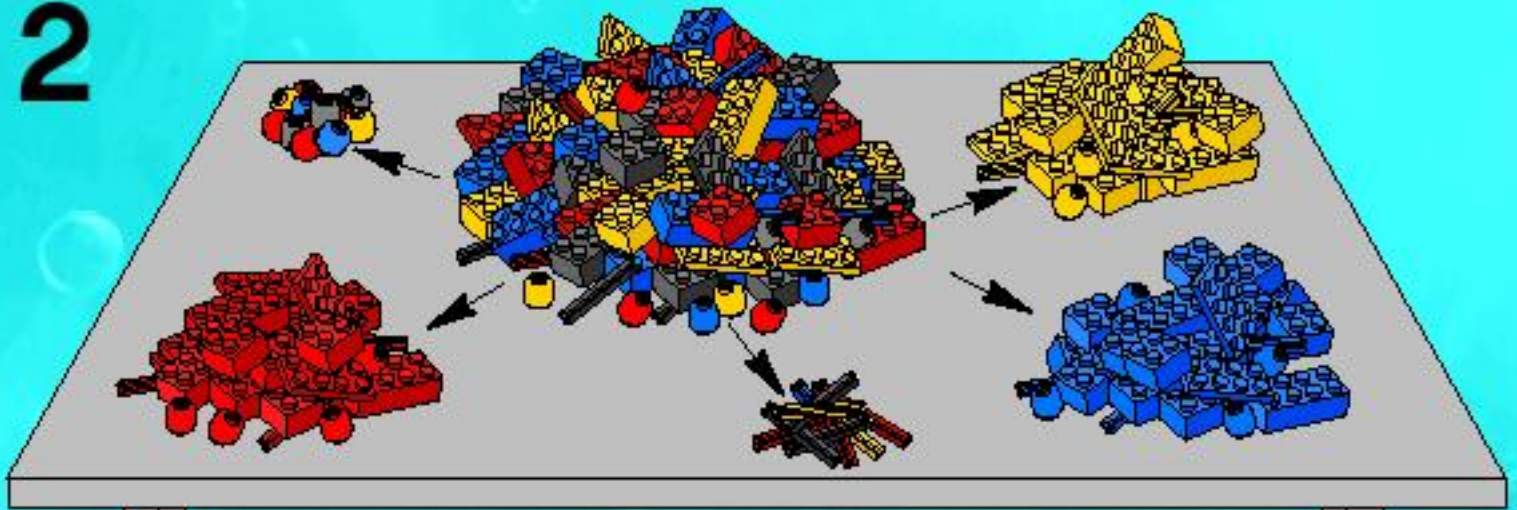

2



3

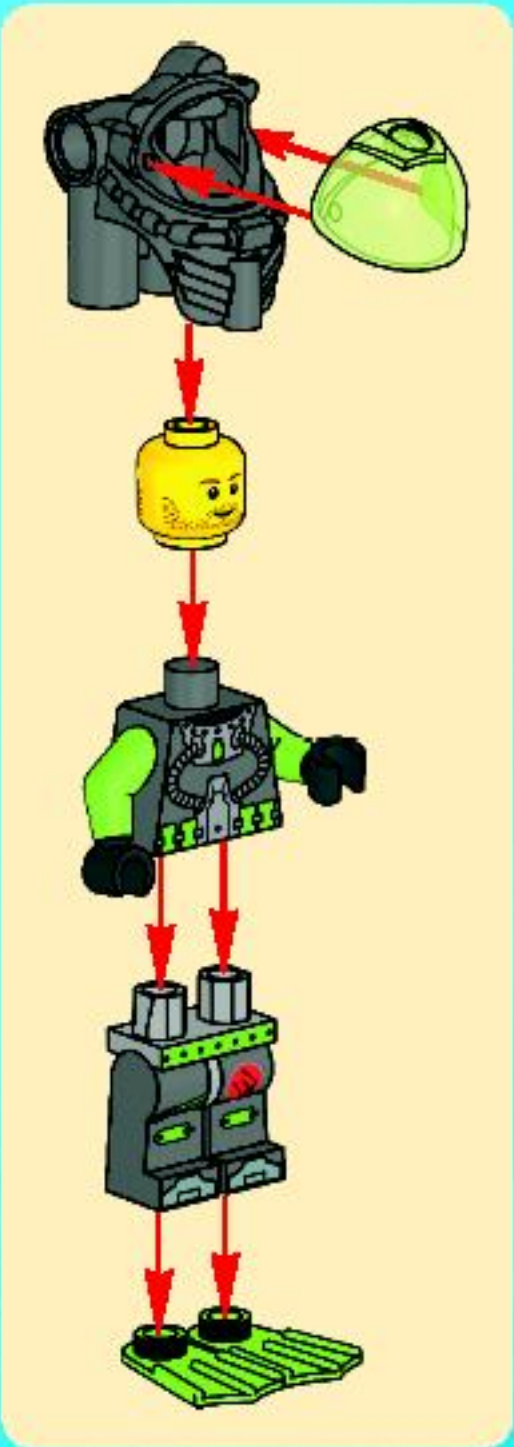



1x

1

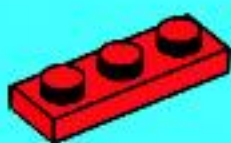

1x



1x

2





1x



1x

# 3



2x

# 4





1x

5

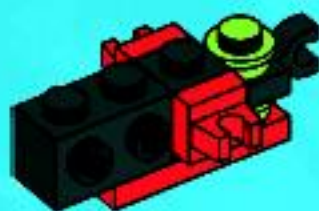

1x

6



1x



1x

7





1x

8

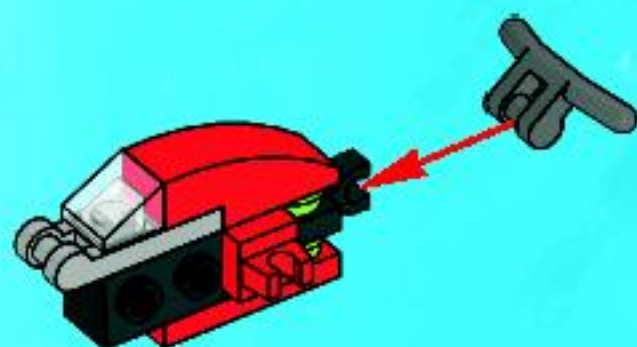

1x



1x

9

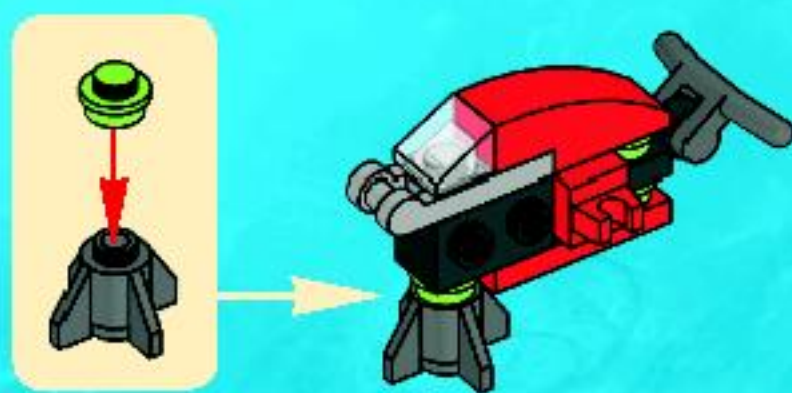



10



11







1x



2x

# 12



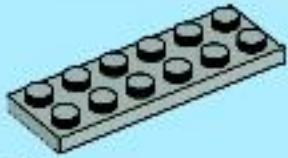

1x

**1**





2

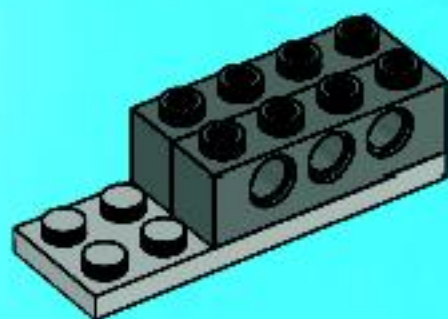

3

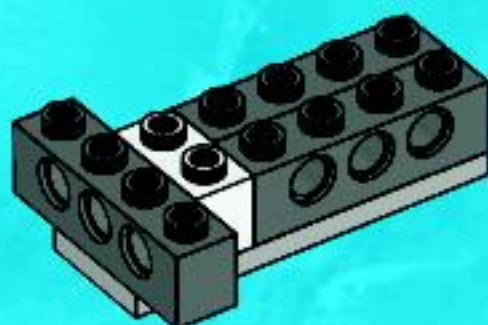



2x



1x

# 4

1



2

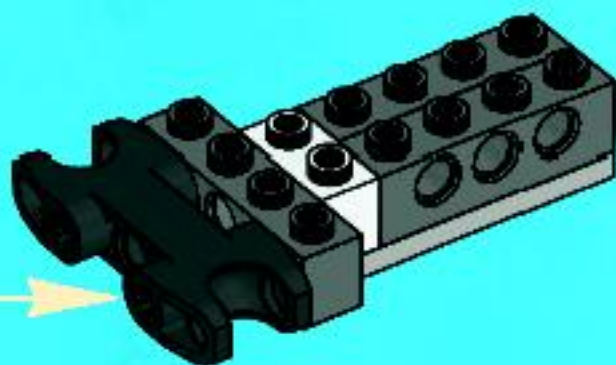
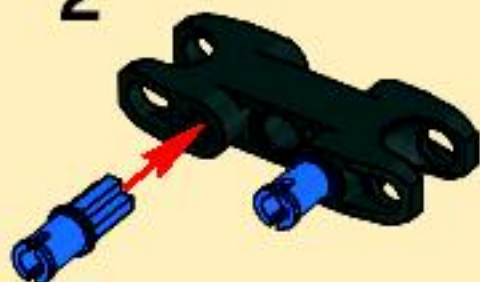

1x

# 5

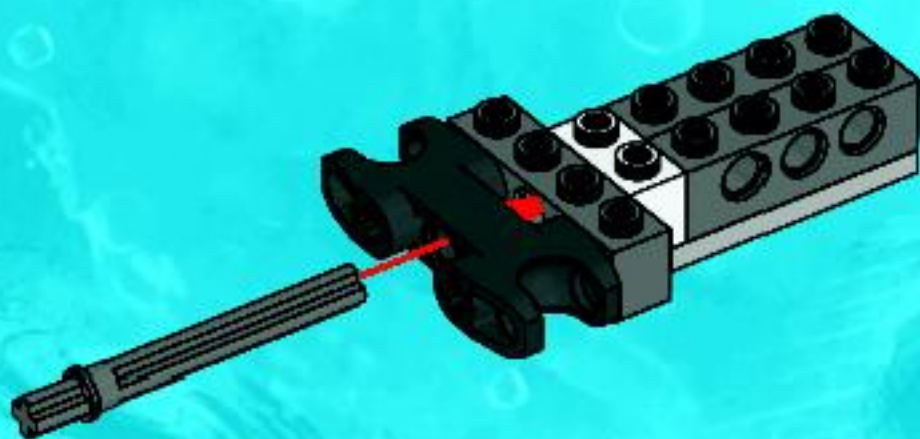



1x

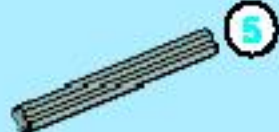

1x

1

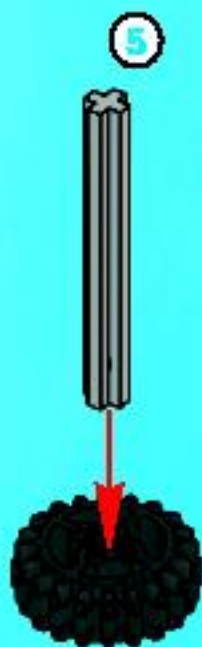

1x

2

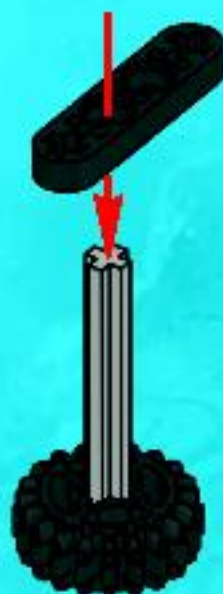



2x

3



1x

3

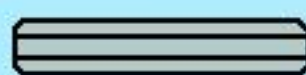

3

1:1

4





1x

5



1x



1x

6



# 7



# 8

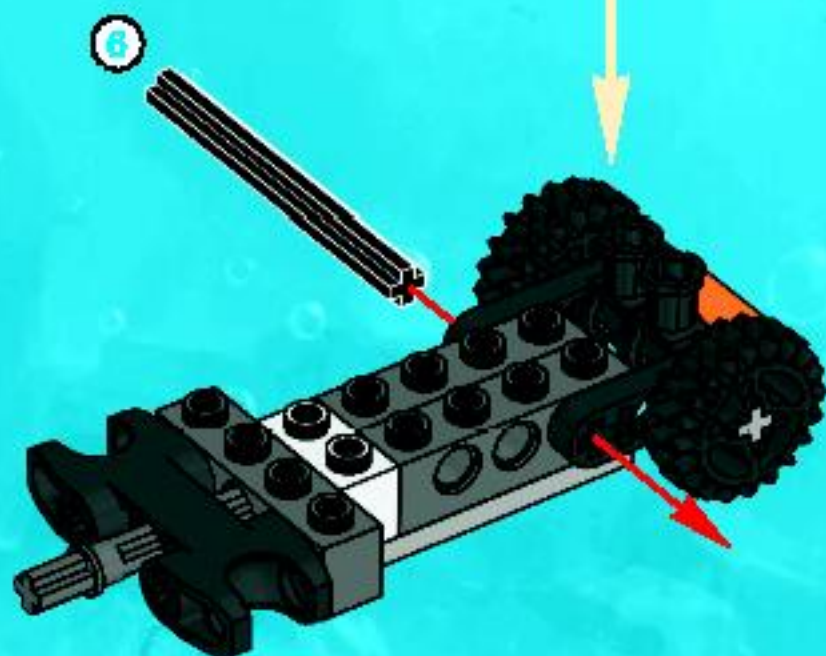

1:1



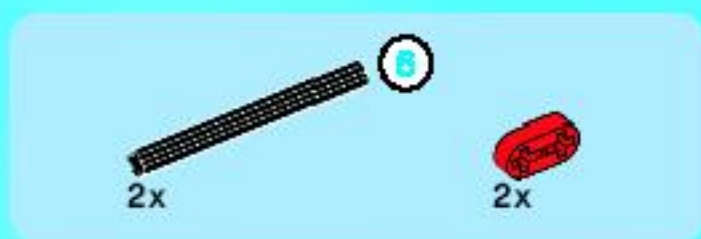

9

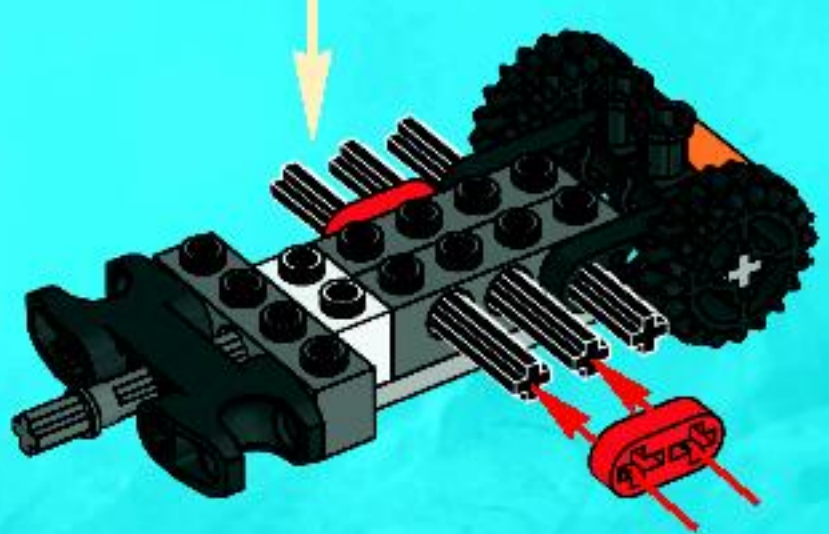
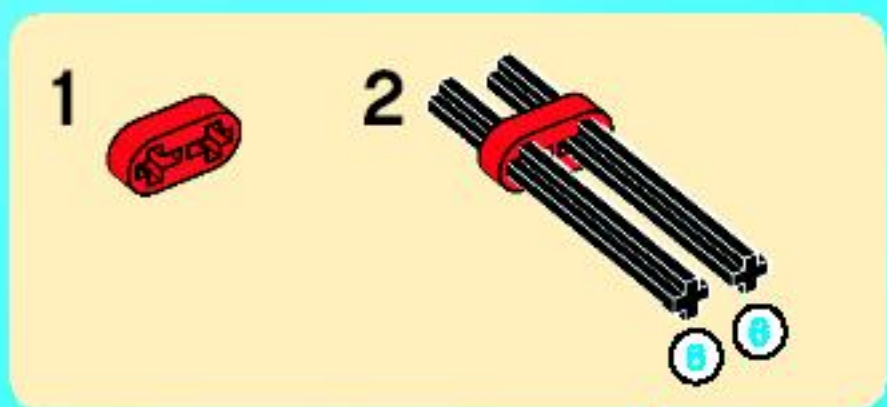



2x

# 10

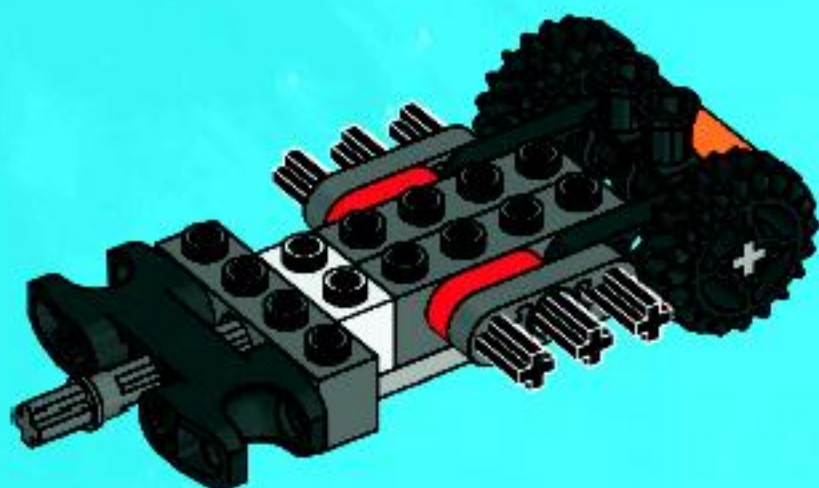

2x

# 11

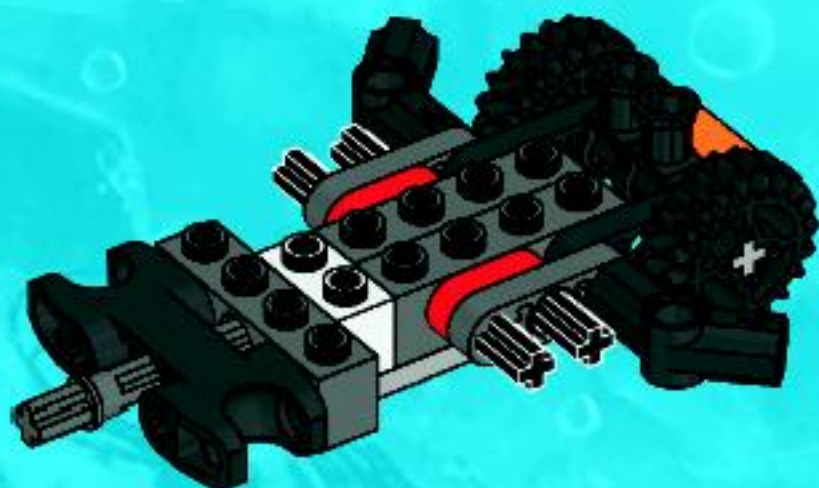



2x

# 12

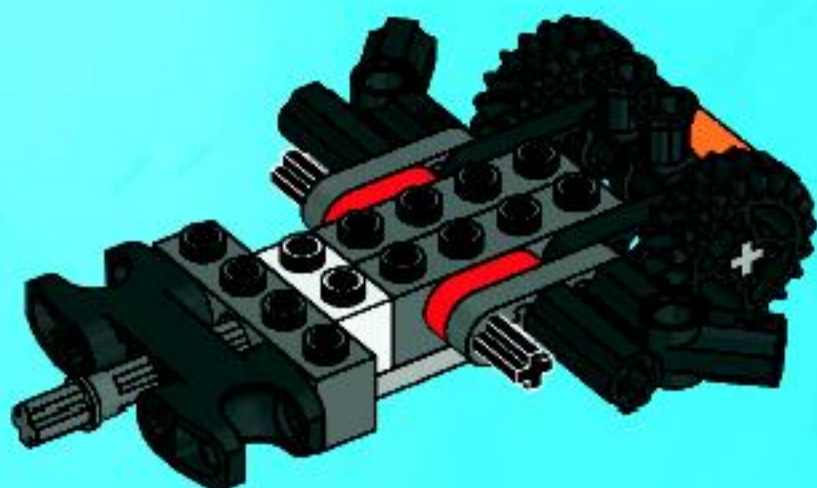

2x

# 13

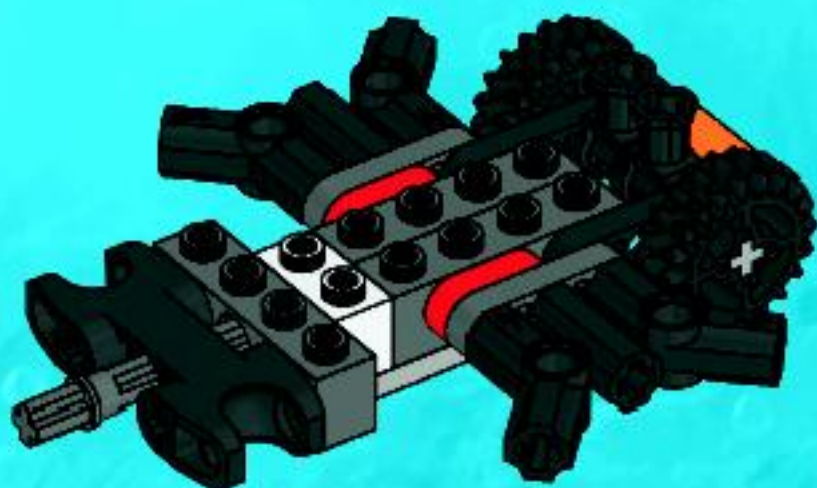

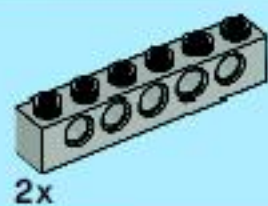

2x

# 14

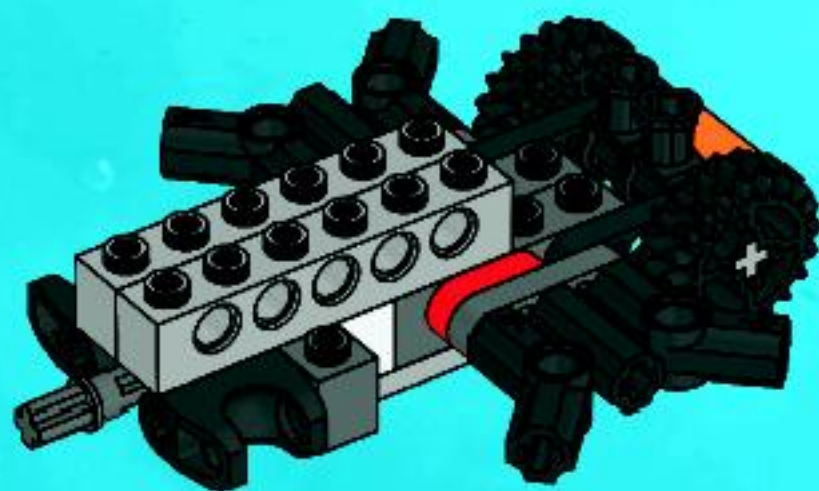



2x



2x

# 15

1

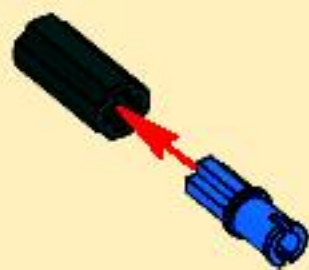

2x

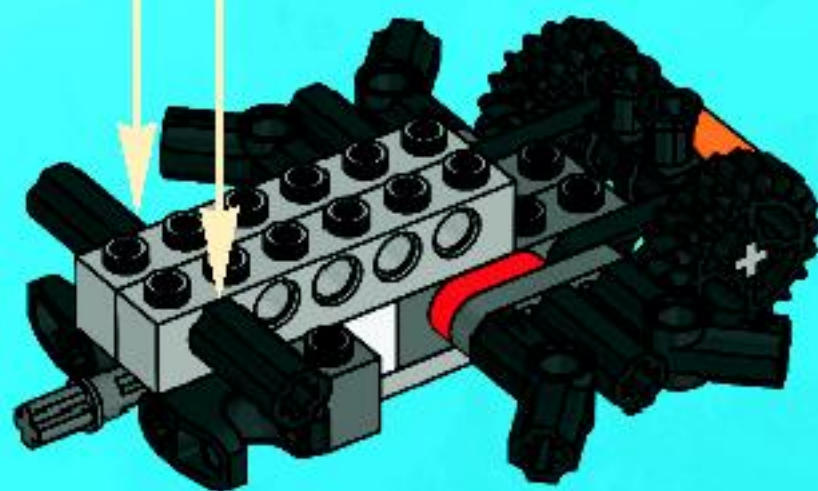



6x



6x

# 16

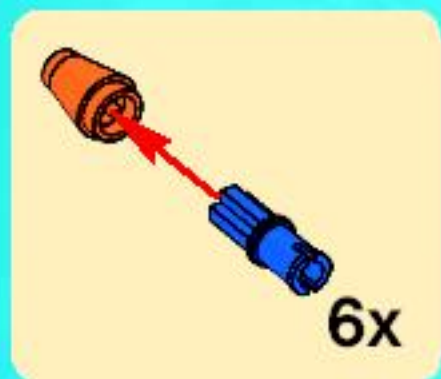



4x



2x

# 17

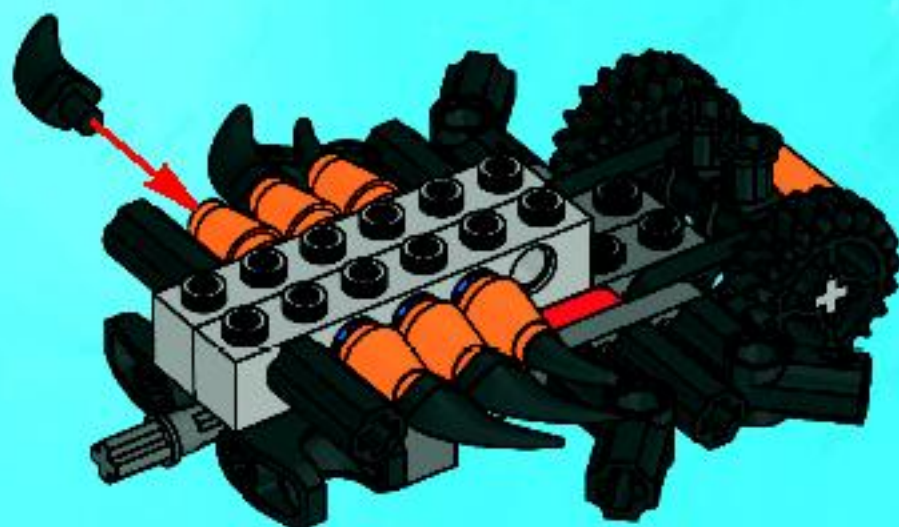

1x

# 18

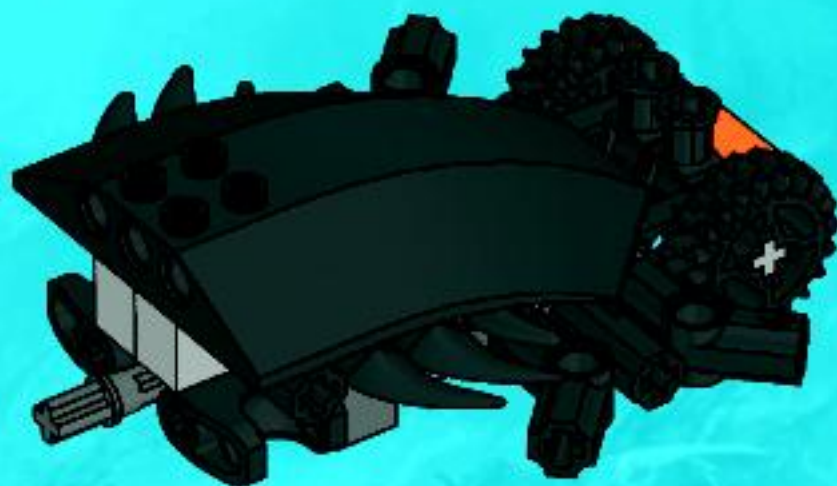

19







1x



2x



1x

# 20

1



2

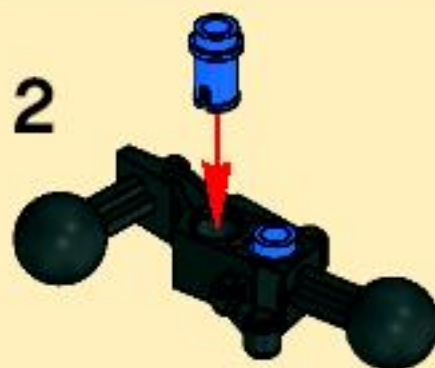

3

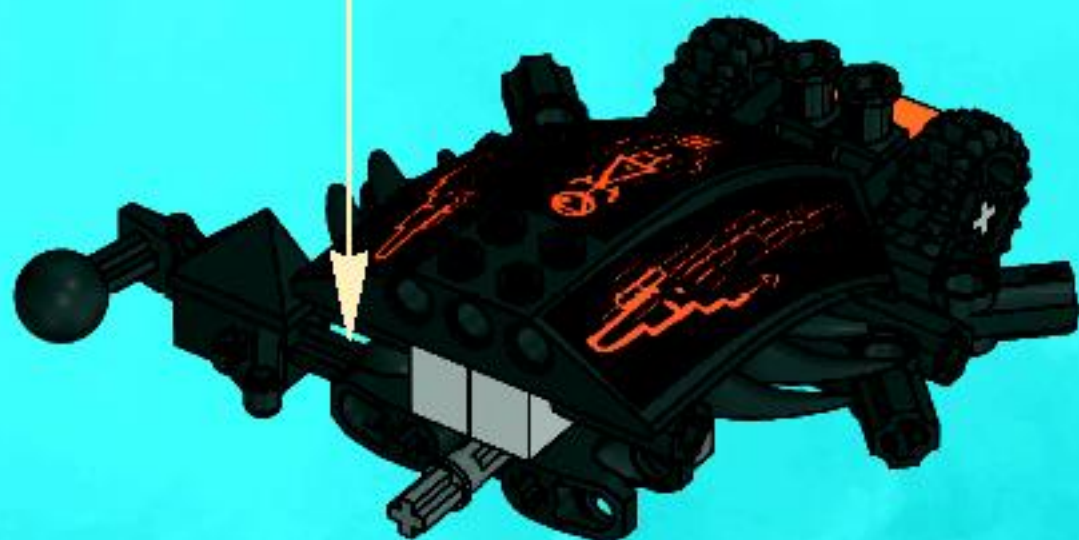



# 21

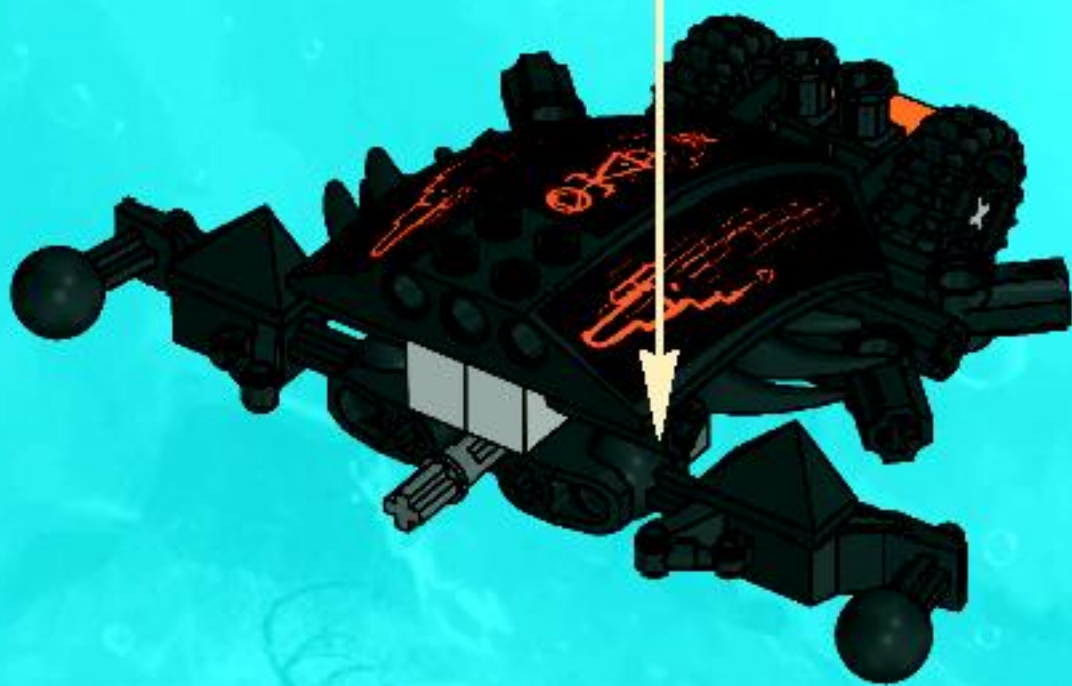
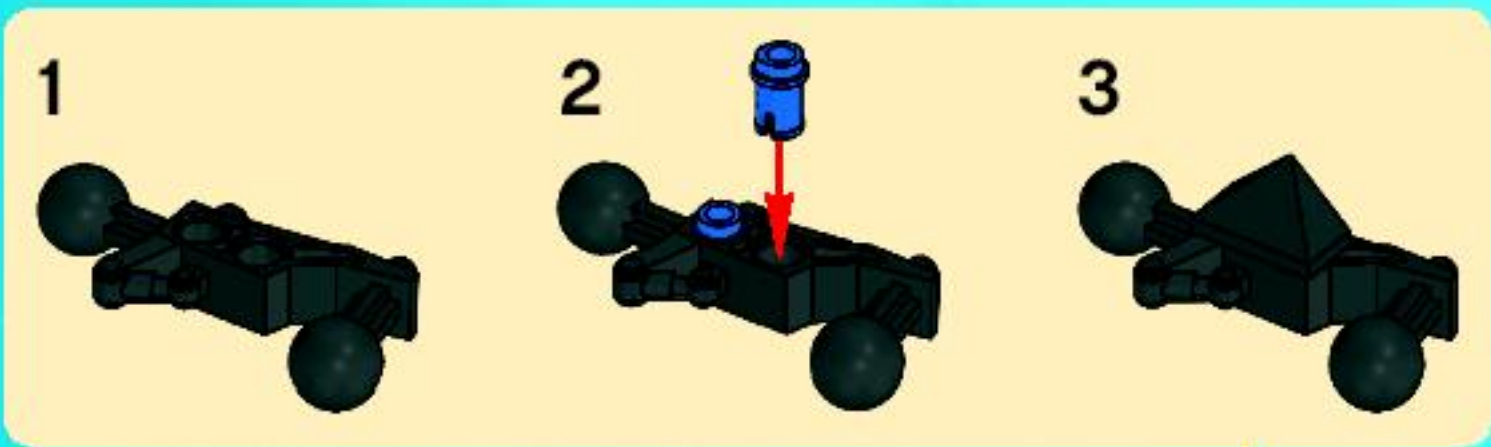



1x



1x

1

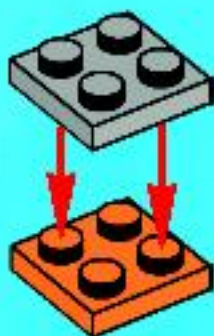

1x

2





1x

3



1x

4





1x



1x



1x



1x

5

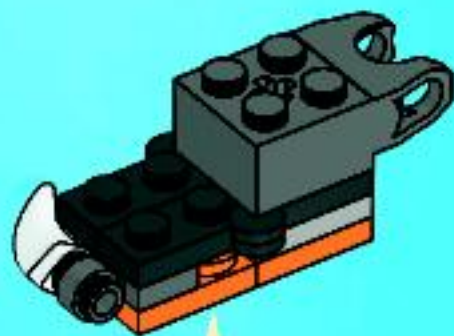

1



2



3



1x

6





1x

7



1x

8





1x

9



2x

10





1x



1x



1x



1x

# 11

1

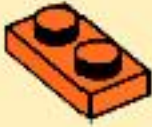

2



3





12

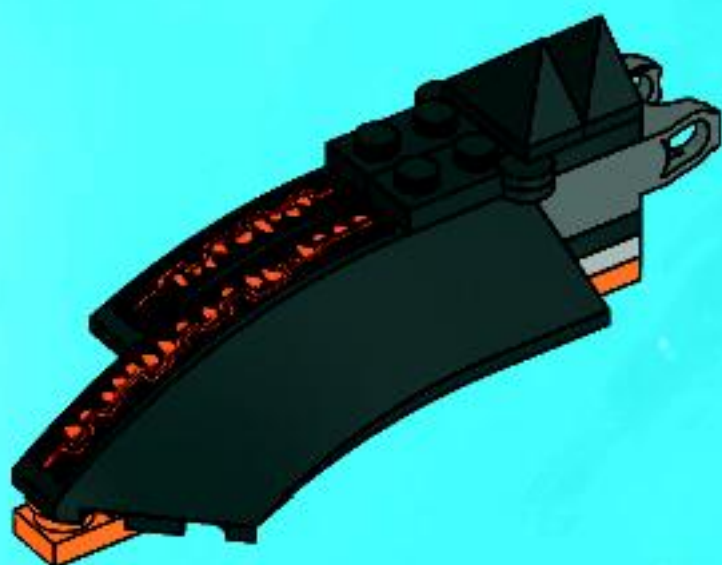

13





1x



1x

1

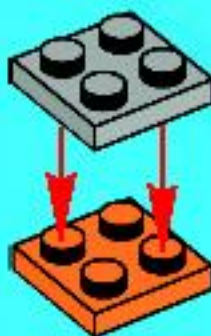

1x

2





1x

3



1x

4





1x



1x



1x



1x

5



1



2



3



1x

6

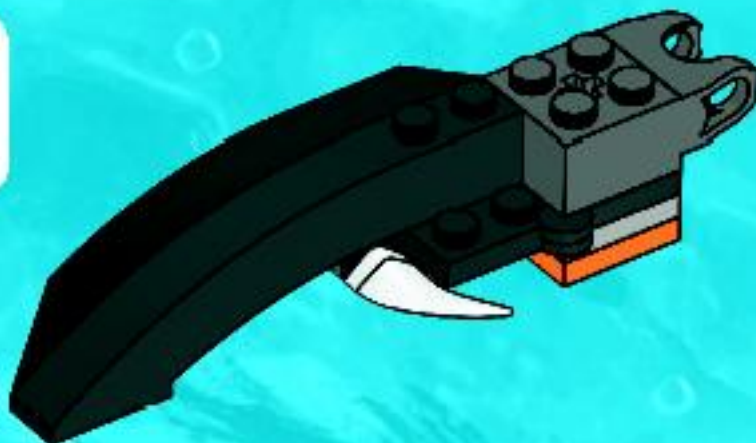



1x

7

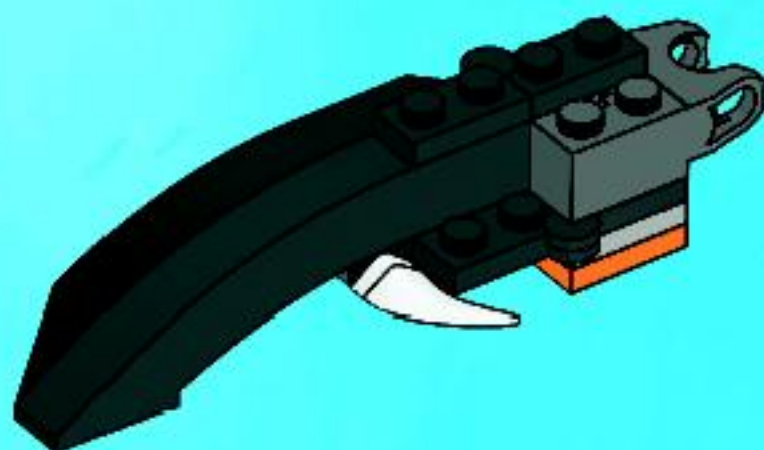

1x

8

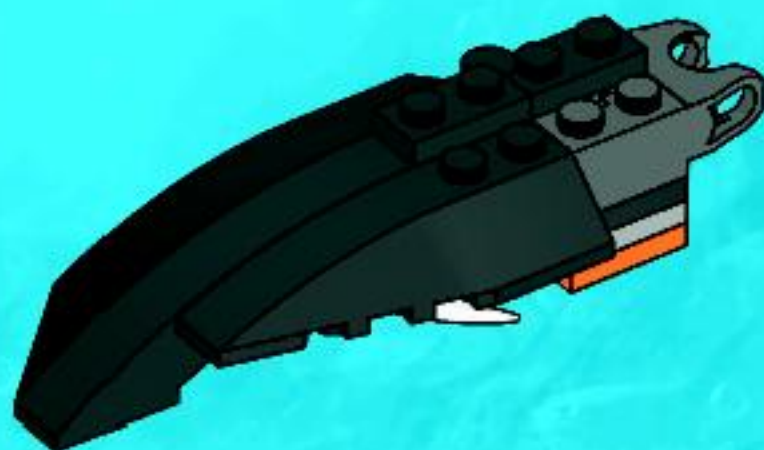



1x

9



2x

10





1x



1x



1x



1x

# 11

1



2



3

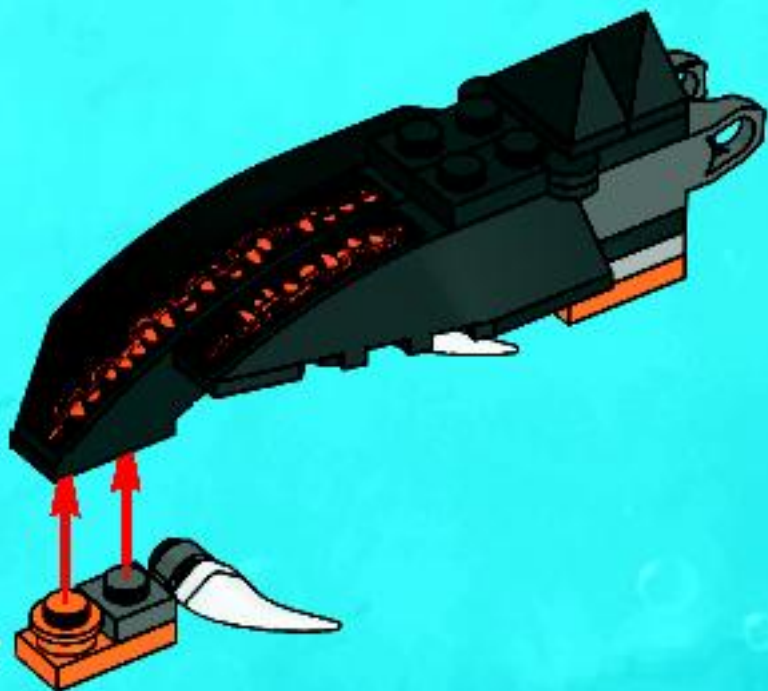

12







1x

1



2x

2

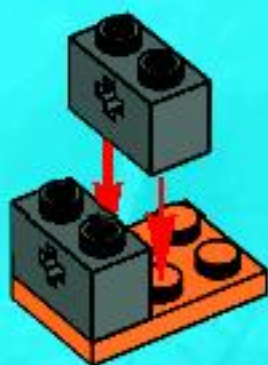



1x

3

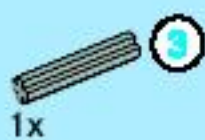

1x

4

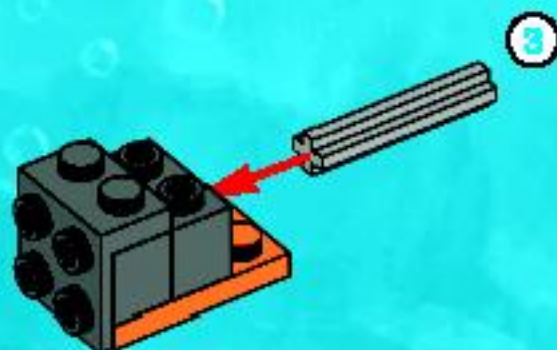

3

1:1



5

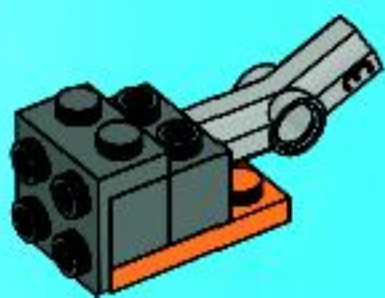

6

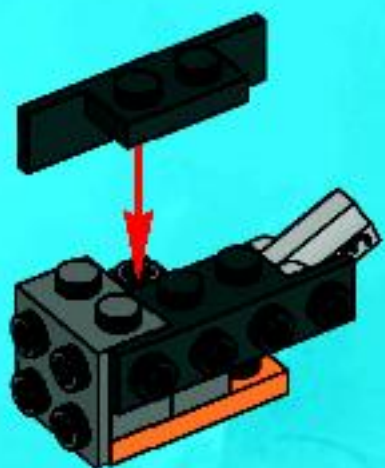



1x

7

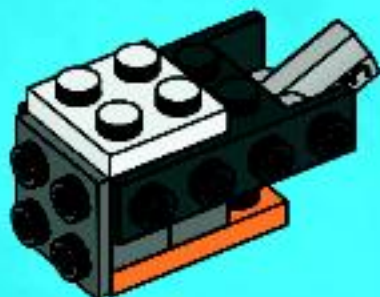

6x

8

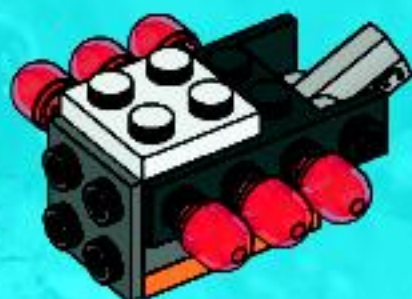



2x



2x



2x

1



2



2x

9

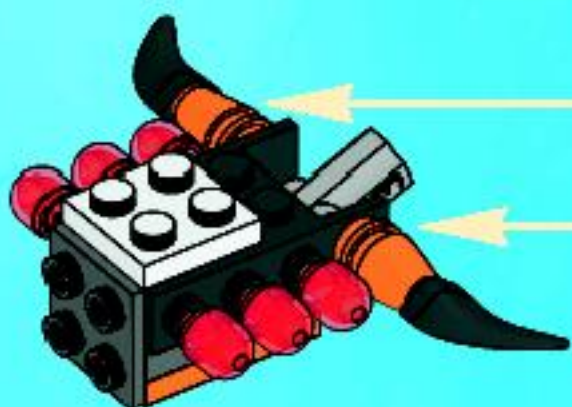

1x

10





2x



2x



1x

# 11

1



2



3





1x



3x



1x



1x



6x



6x

# 12

1



2



3



4



5



6



7

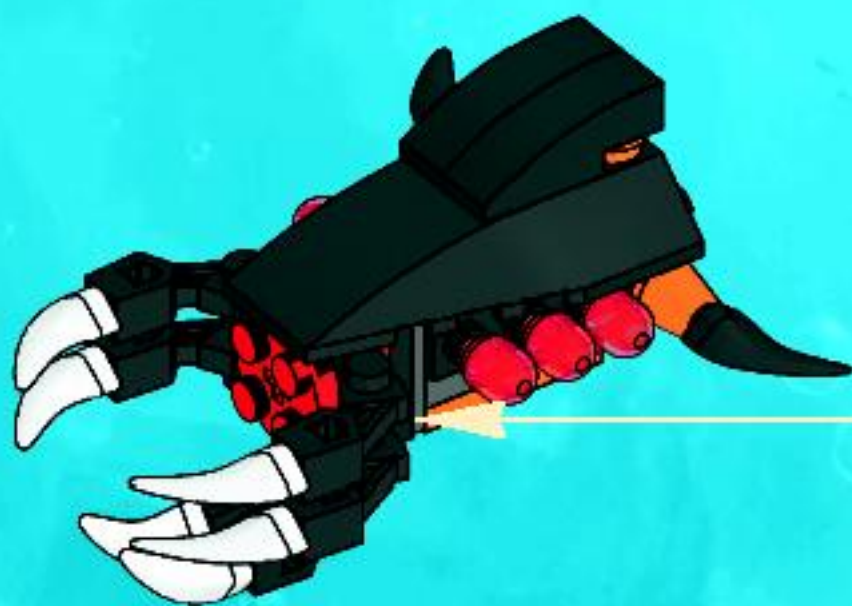



8





1x

1



2x



2x

2





2x

3



2x



1x

4





2x

5

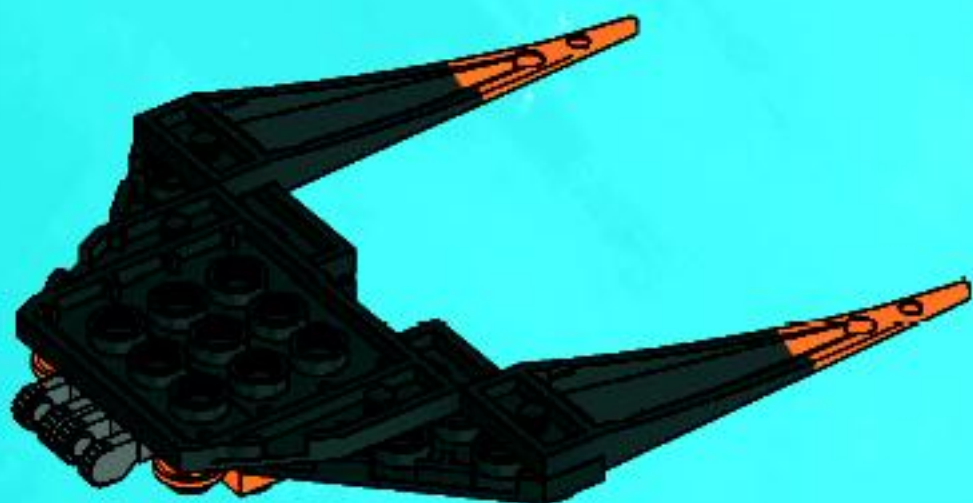

4x

6

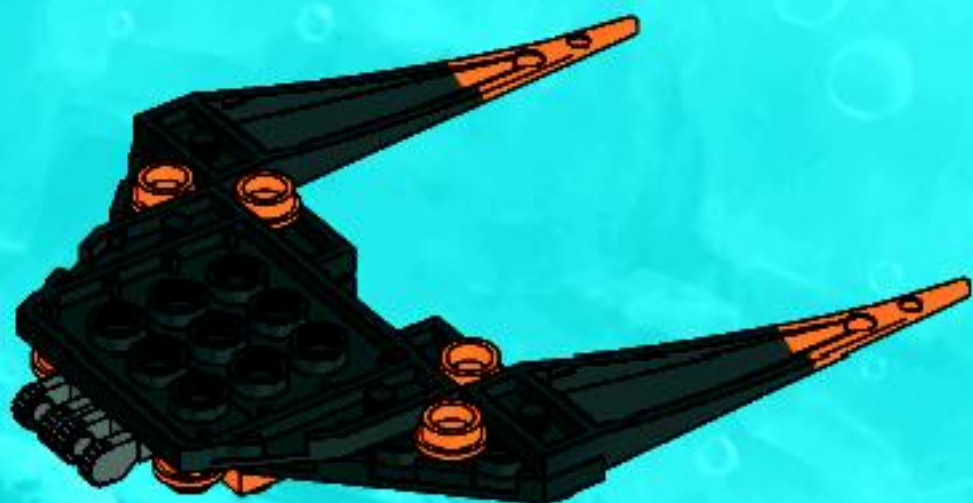



2x

7



2x

8

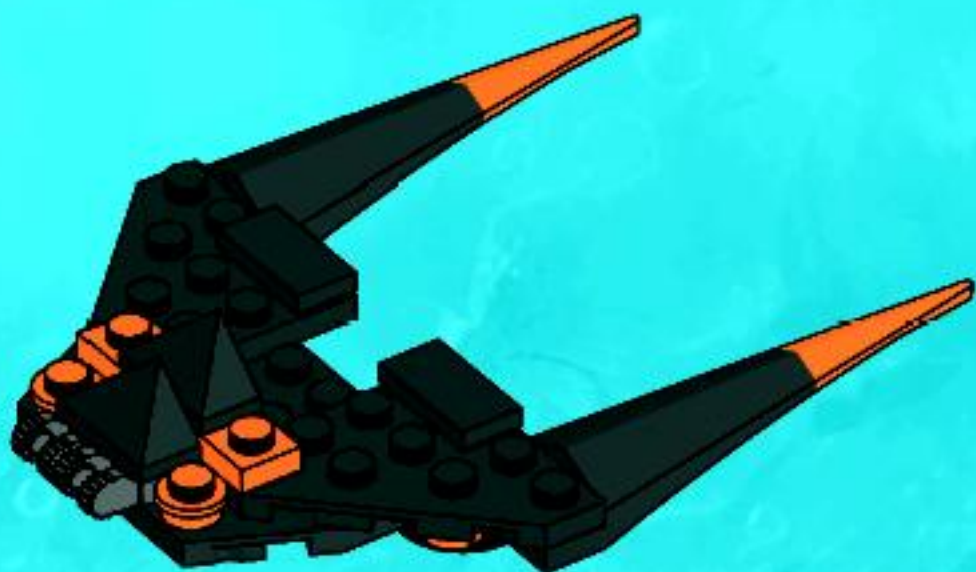



8x



4x



4x

# 9

1



2



3



4x

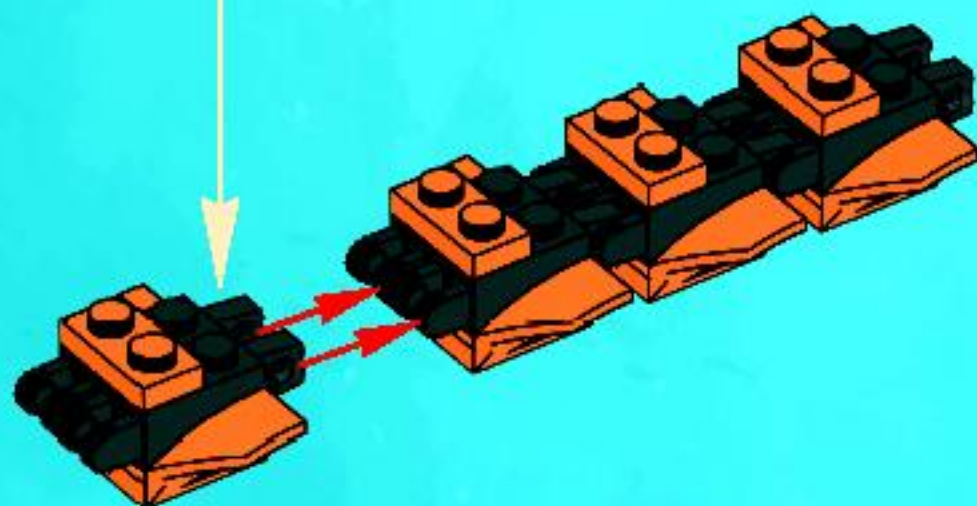

8x

# 10

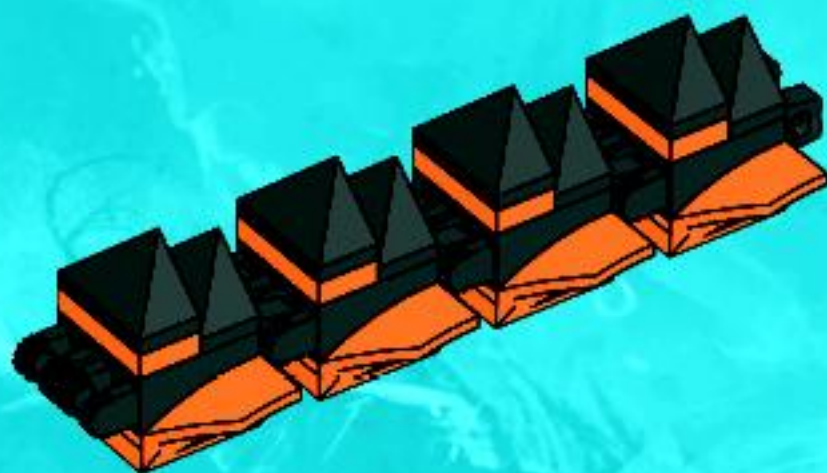

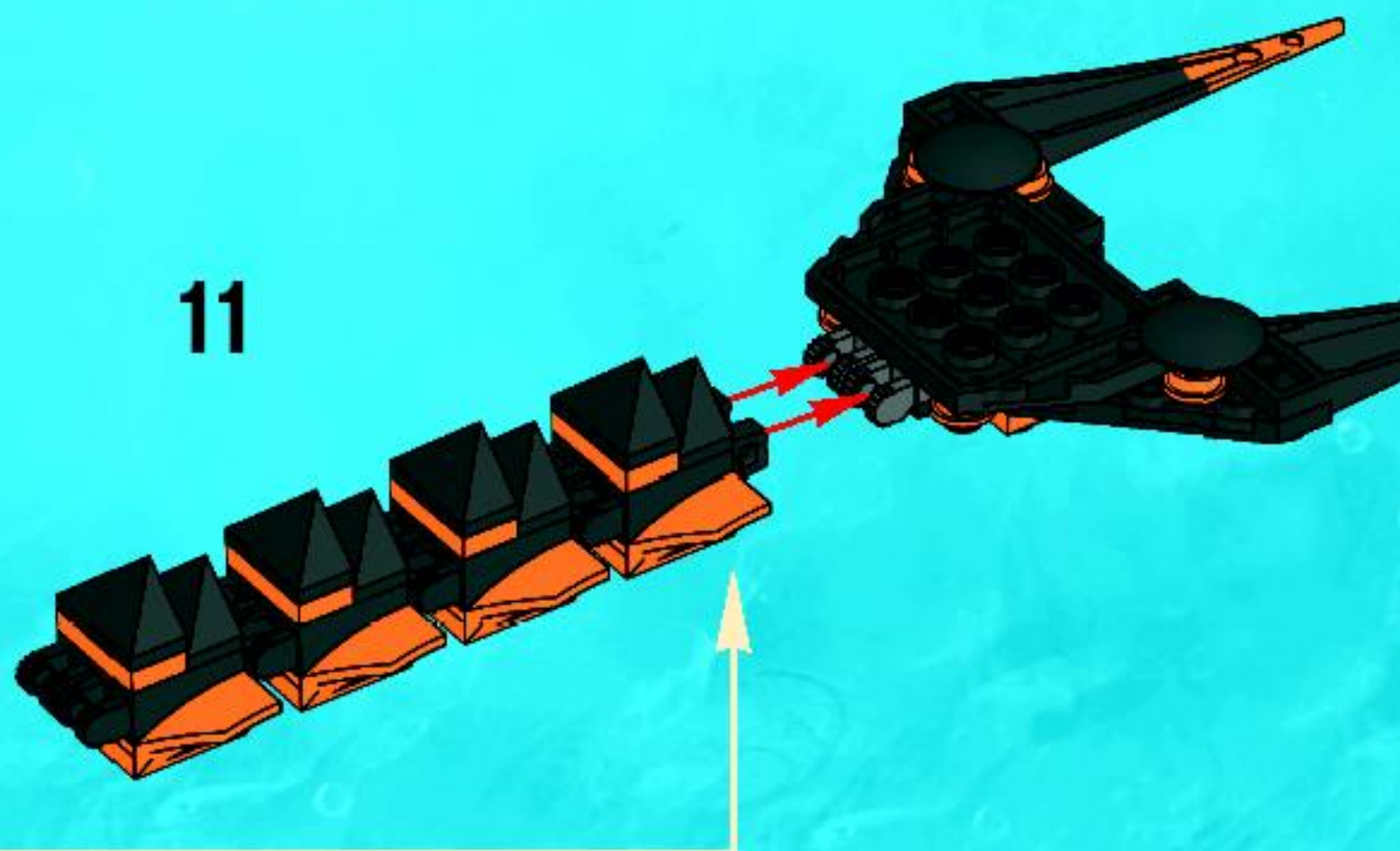
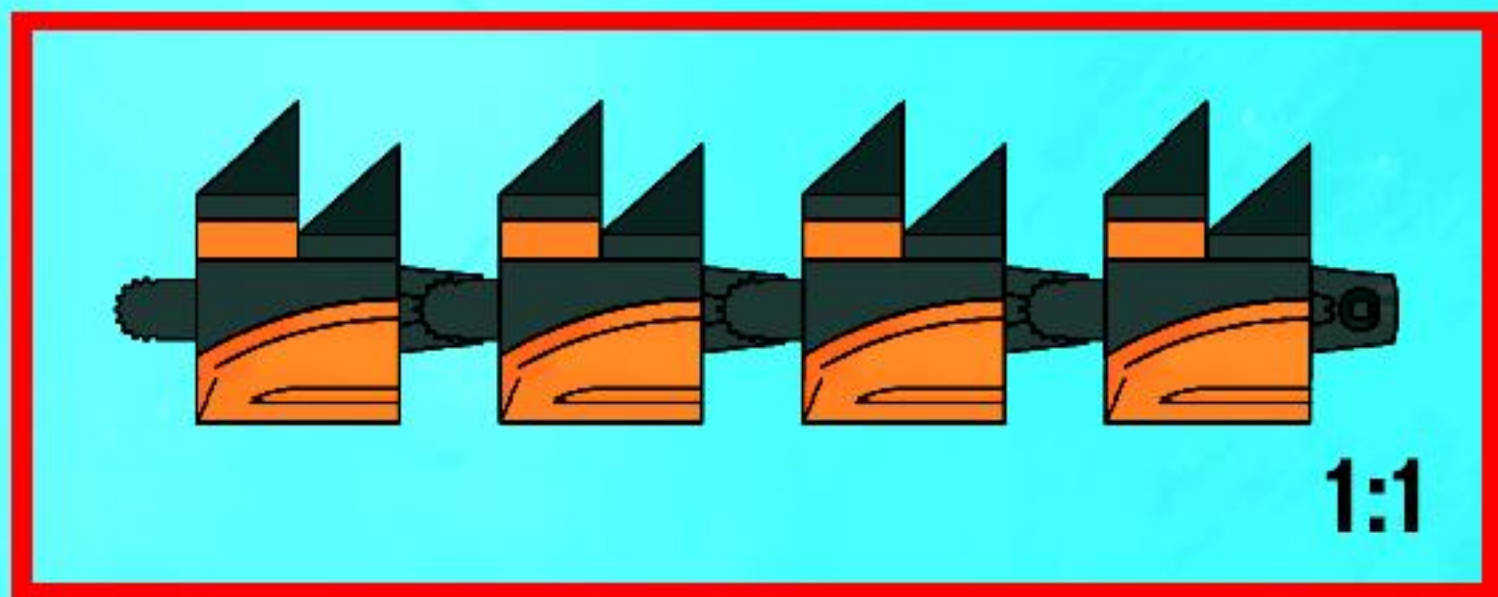



2x

12

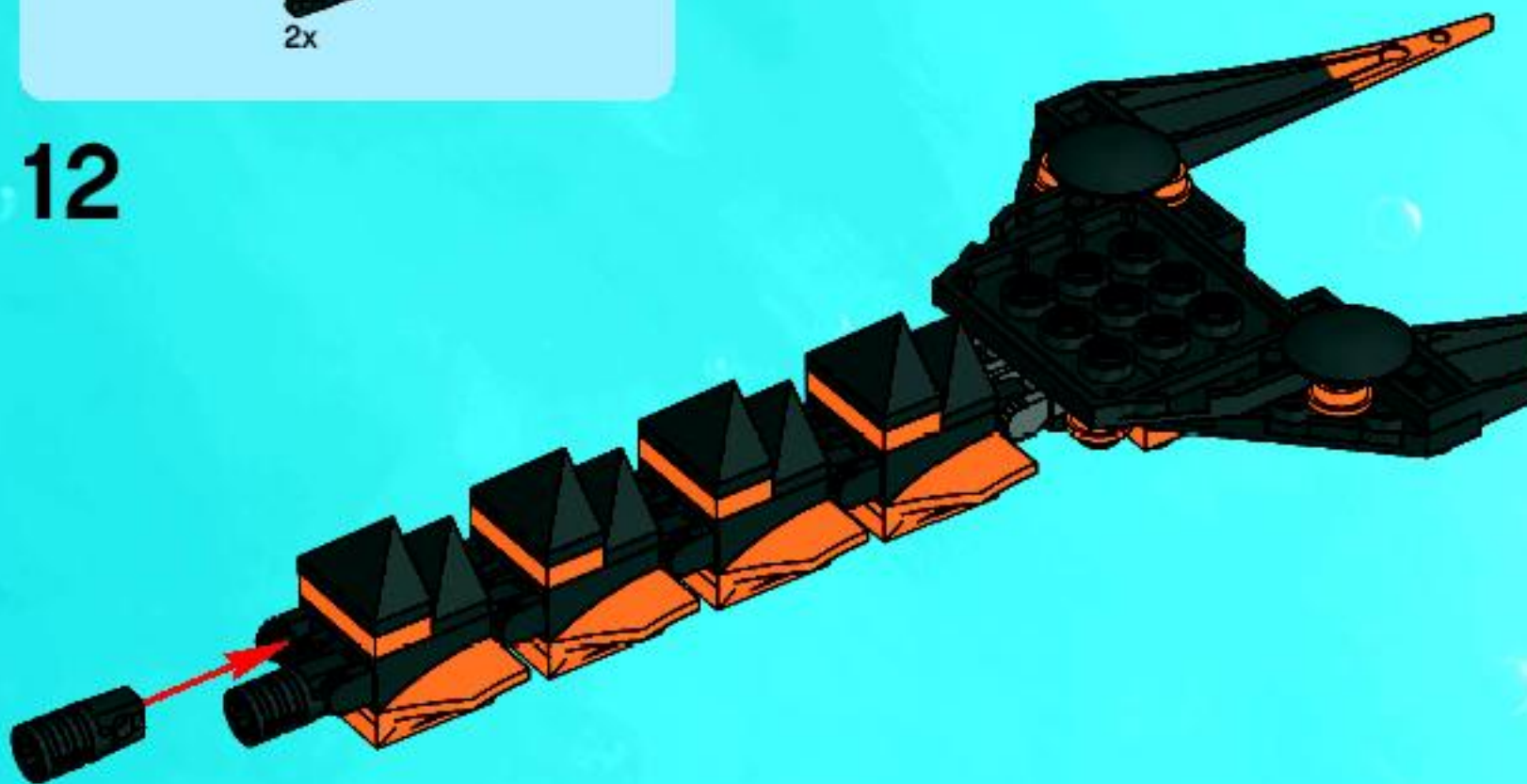

2x

13





14





2x



2x



2x



4x

# 15



2x





2x



6x



2x



2x



2x

# 16

1



2



3



4



5



6



2x





6x



4x



2x



2x

# 17

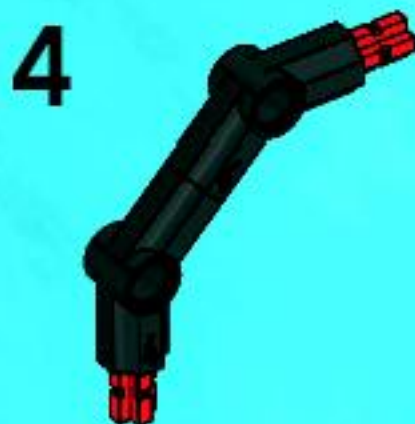

2x







**FREE! GRATIS! GRATUIT!**



**club**  
MAGAZINE™

**www.LEGOclub.com**



**00800 5346 5555\***



**1-866-534-6258 • 1-877-518-5346**

US & Canada only

Canada seulement

\* Free phone. Mobile charges may apply. \* Numéro sans frais. Des frais peuvent s'appliquer avec les téléphones cellulaires.  
\* Gebührenfrei. Kosten für Anrufe aus Mobilfunknetzen können anfallen. \* Gratis telefonnummer vinnr Postcode. \* Det er ett gratis nummer, når du ringer fra Posttelefon. \* Jedaz gratis, nárdu ringerz Priu en Post telefon.



VISIT THE WORLD'S  
BIGGEST LEGO® SHOP!

**www.LEGOshop.com**



# ATLANTIS



8077





8078



8076





# ATLANTIS

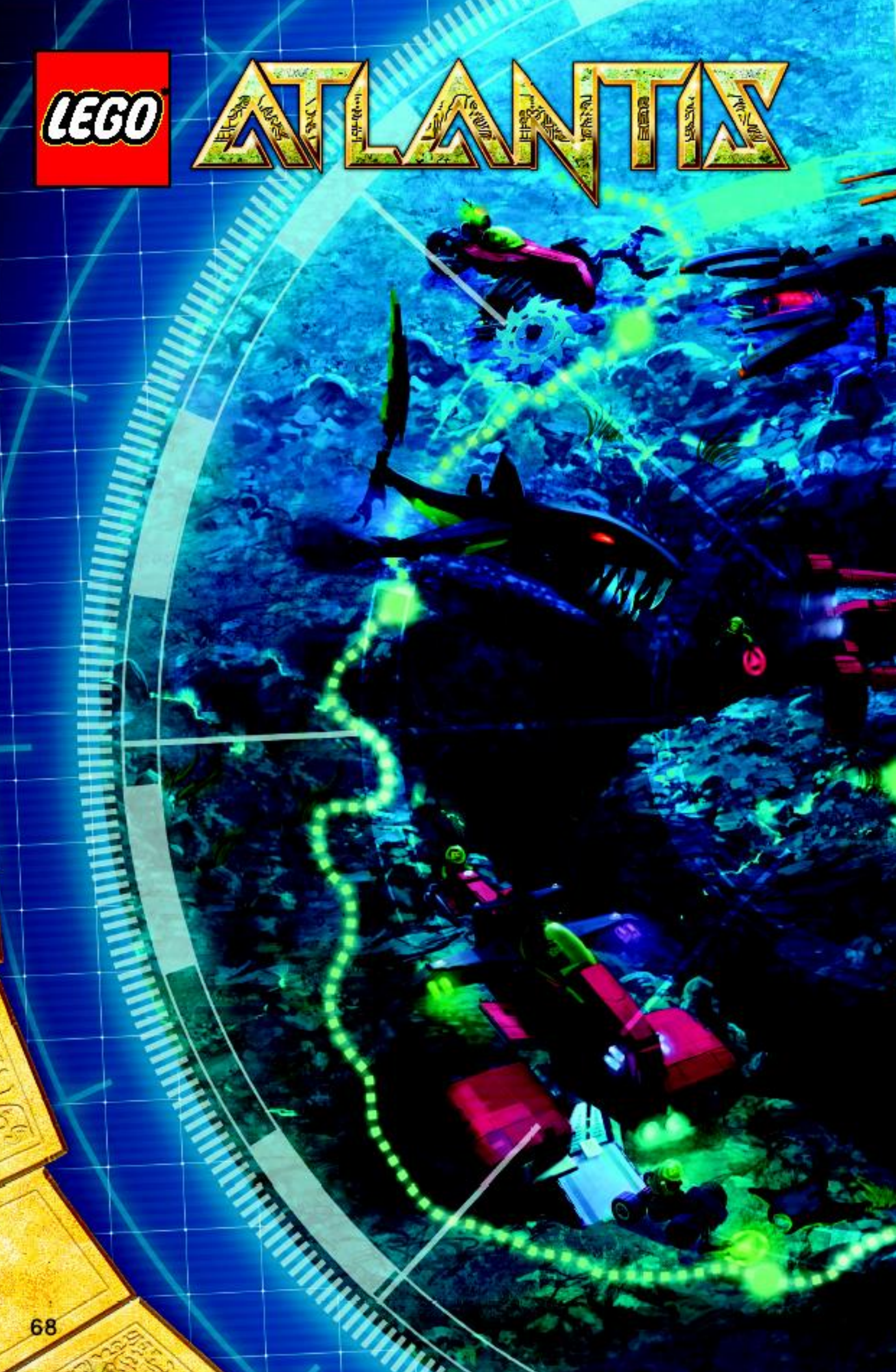

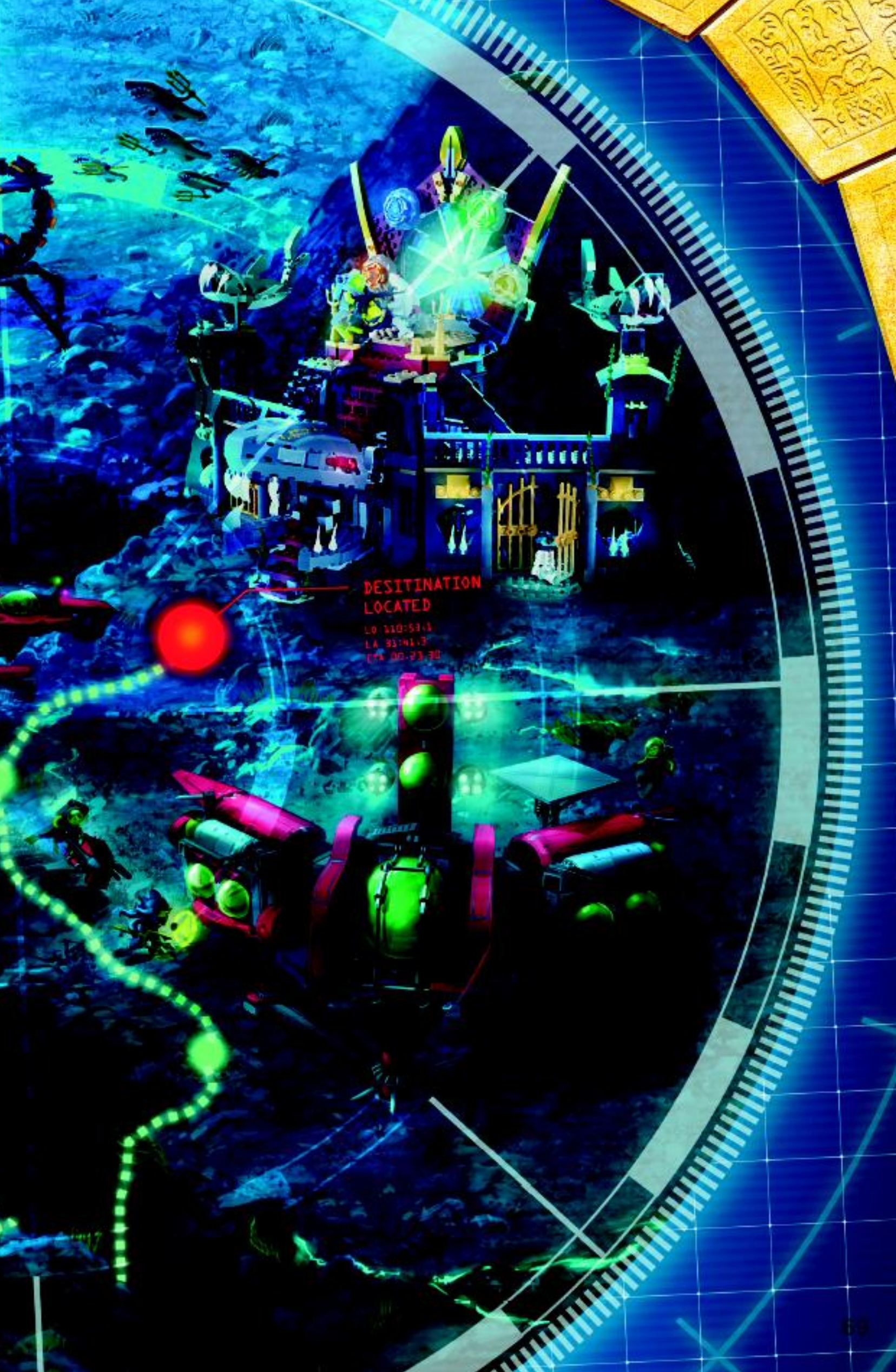

DESTINATION  
LOCATED

LO 310-53.3  
LA 33141.3  
ETA 00-23-30



1x  
4233486



1x  
302201



10x  
4566256



1x  
4251162



2x  
302321



1x  
362321



2x  
255521



1x  
403221



2x  
4186678



18x  
4142865



4x  
4143005



10x  
4206482



1x  
4570014



1x  
4214559



1x  
4253815



2x  
4251161



2x  
4278359



2x  
4107081



6x  
4512363



2x  
4177430



6x  
4294996



1x  
4223247



2x  
4287672



2x  
306926



1x  
302226



1x  
4517925



3x  
4225201



8x  
4167106



16x  
304826



2x  
4282746



8x  
74011



2x  
4158848



2x  
4142236



12x  
4121610



12x  
4563477



2x  
4568385



3x  
370626



1x  
4598407



2x  
4528179



2x  
4582471



2x  
4160025



8x  
4177932



2x  
4159007



1x  
4125278



1x  
4118782

14x  
4518029

14x  
4157103

1x  
4538144

4x  
4582819

2x  
4211466

1x  
4211639

2x  
4211815

1x  
4211452

2x  
4211397

1x  
4515369

1x  
4211552

3x  
4183133

1x  
4569900

6x  
4497943

2x  
4210935

2x  
4524353

3x  
4213607

4x  
4210828

1x  
4277928

2x  
4210884

1x  
4568036

1x  
4570036

1x  
4563473

1x  
4212352

1x  
4261908

2x  
4582820

2x  
4223767

1x  
4508553

1x  
4570738

1x  
4570651

1x  
4244362

1x  
4129572

1x  
4160108

1x  
4160130

1x  
4570510

1x  
4286970

1x  
4286971

1x  
4506636



Customer Service  
Kundenservice  
Service Consommateurs  
Servicio Al Consumidor

[www.lego.com/service](http://www.lego.com/service) or dial

													: 00800 5346 5555		
													: 1-800-422-5346		



# WIN!

Go to [www.nielsen.com/LEGO](http://www.nielsen.com/LEGO)  
to fill out a survey for a chance  
to win a cool LEGO® Product.  
No purchase necessary.  
Open to all residents where not prohibited.



## [www.nielsen.com/LEGO](http://www.nielsen.com/LEGO)

### GEWINNE!

Nimm an der Umfrage auf [www.nielsen.com/](http://www.nielsen.com/) LEGO teil und hab die Chance ein cooles LEGO® Produkt zu gewinnen!

Die Teilnahme am Gewinnspiel führt zu keinerlei Kaufverpflichtungen. Teilnahme in allen nicht ausgeschlossenen Ländern möglich.

### WIN!

Ga naar [www.nielsen.com/LEGO](http://www.nielsen.com/LEGO), vul een enquêteformulier in en maak kans op een cool LEGO® product.

Geen aankoopverplichting.  
Iedereen mag deelnemen, uitgezonderd ingezetenden van landen waar een enquêteverbod geldt.

### GAGNE!

Visite [www.nielsen.com/LEGO](http://www.nielsen.com/LEGO) pour répondre à un questionnaire et avoir une chance de gagner un produit LEGO® très cool!

Aucune obligation d'achat.  
Ouvert à tous les résidents des pays autorisés.

### 当てよう!

[www.nielsen.com/LEGO](http://www.nielsen.com/LEGO) にアクセスして、アンケートにご記入ください。当選者にはレゴ製品を差し上げます。

お買い上げの必要はありません。購止されていない限り、すべての年齢にご利用いただけます。