



# ATLANTIS

8061





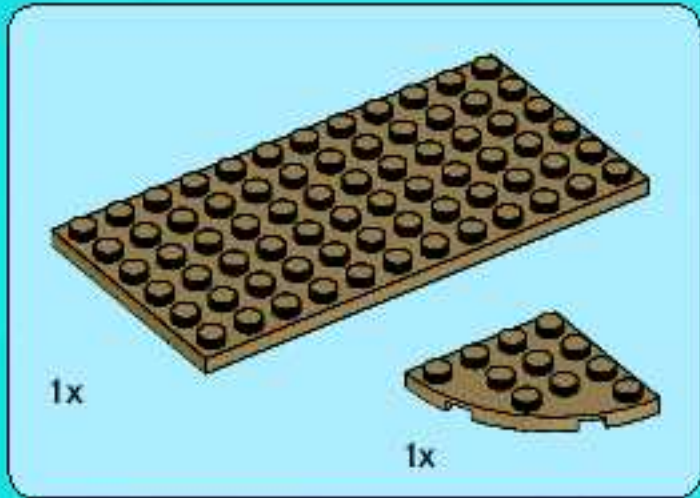
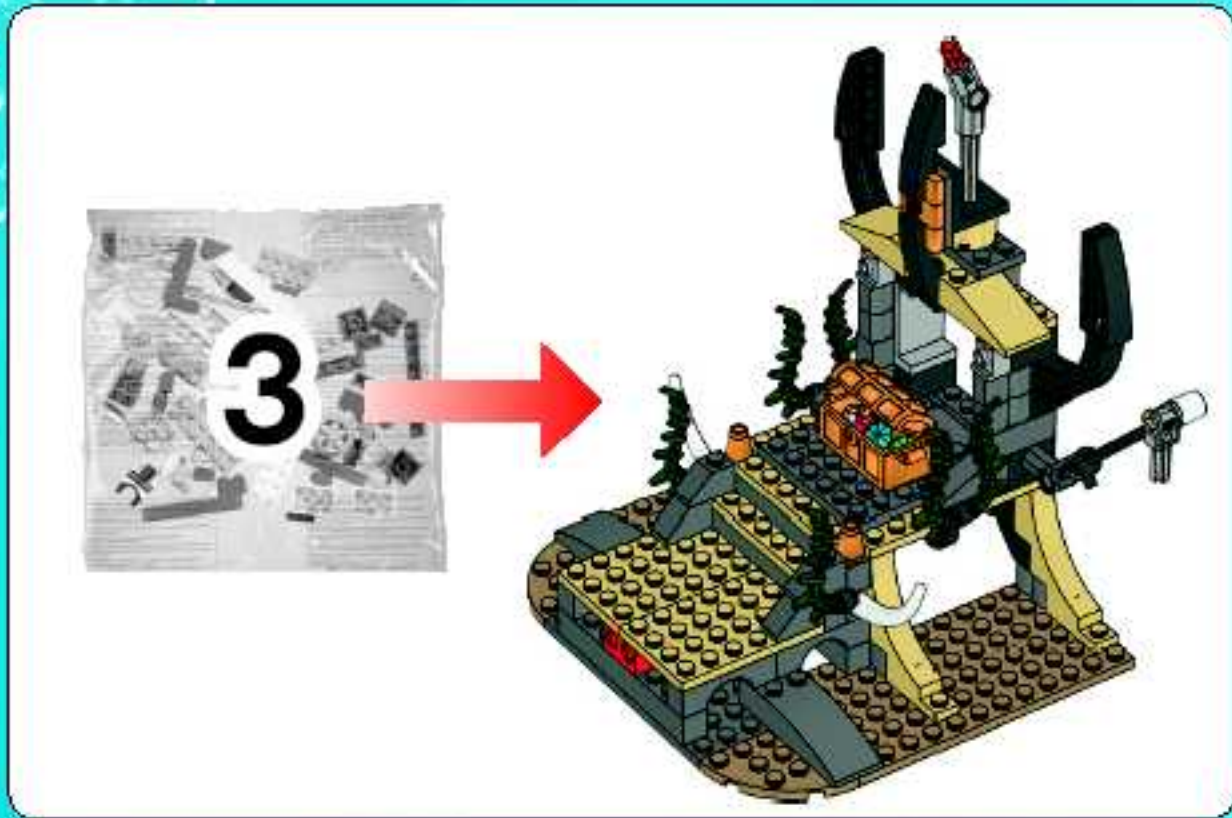

1

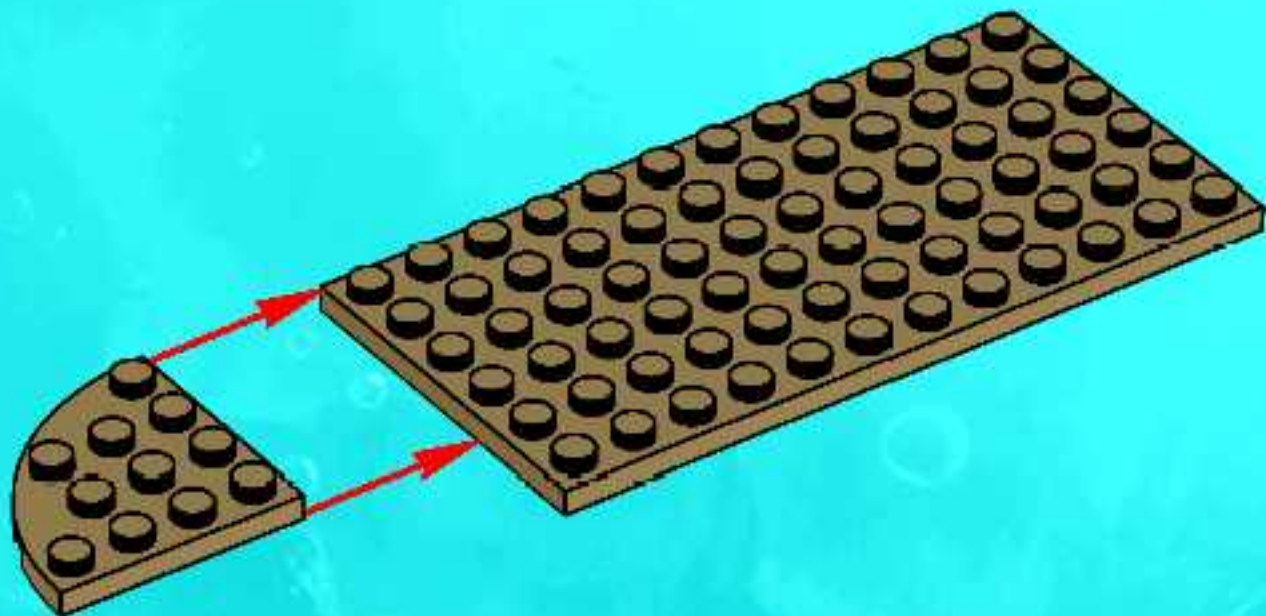



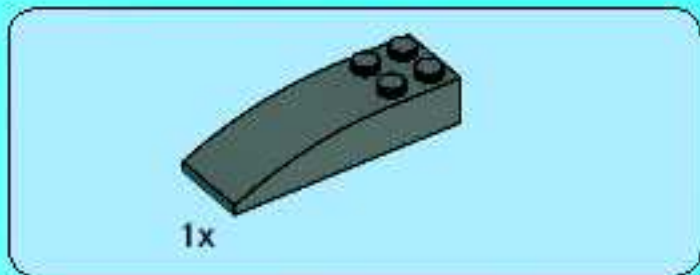

2

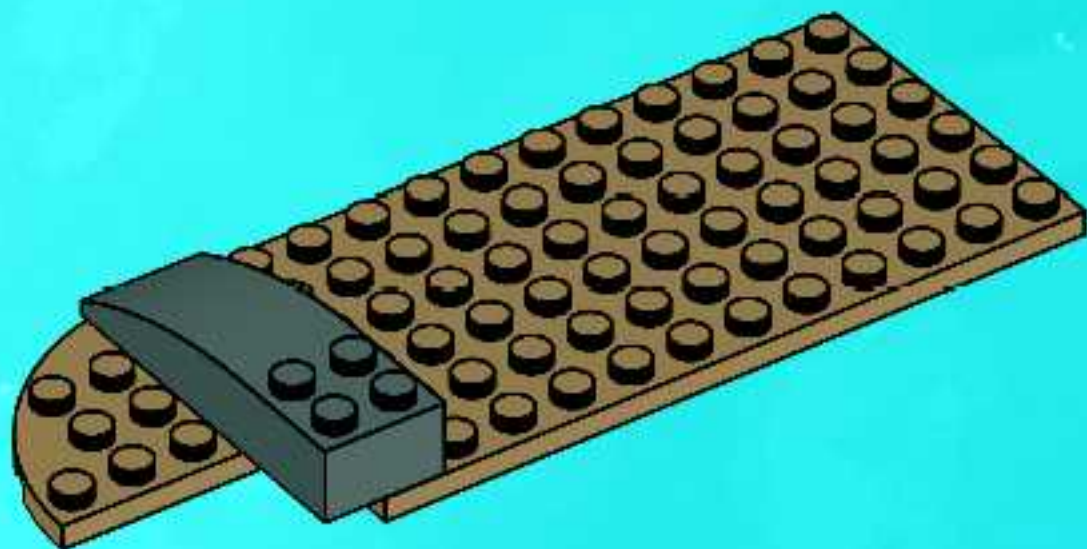

3

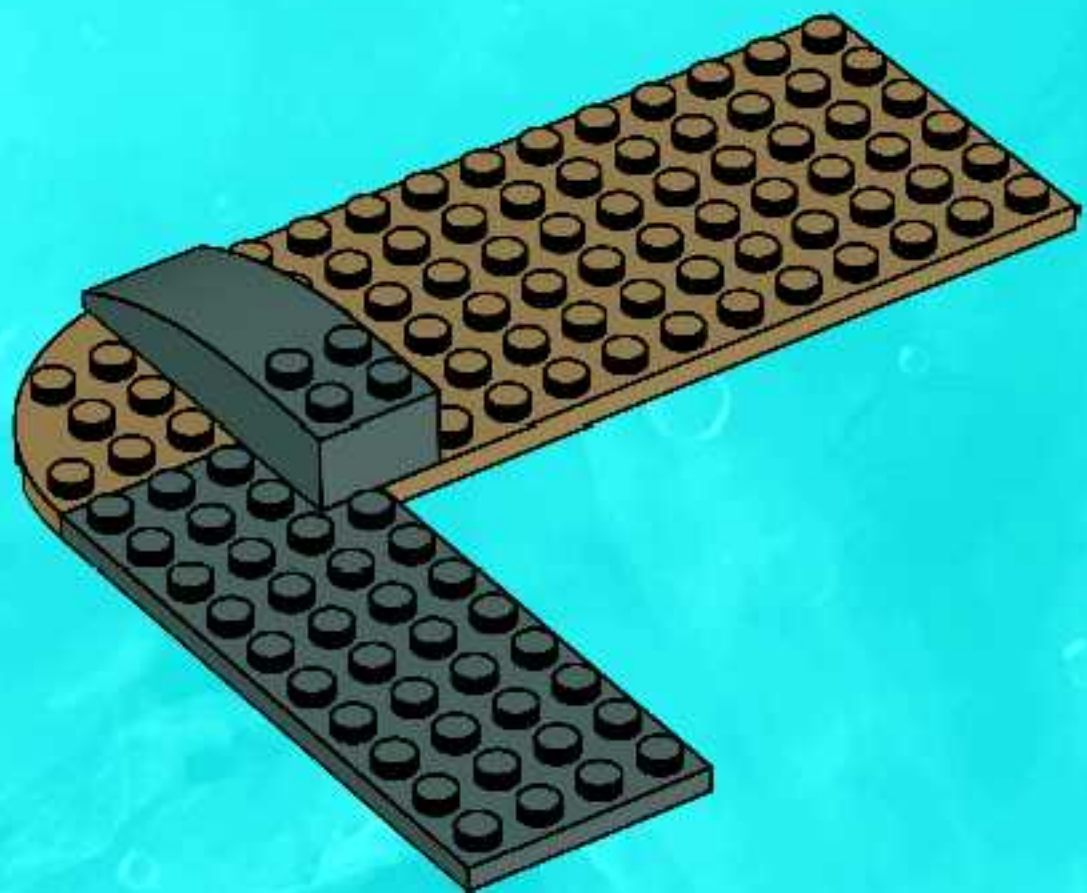



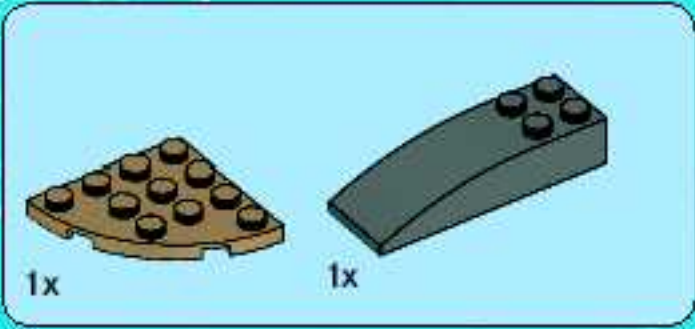

4

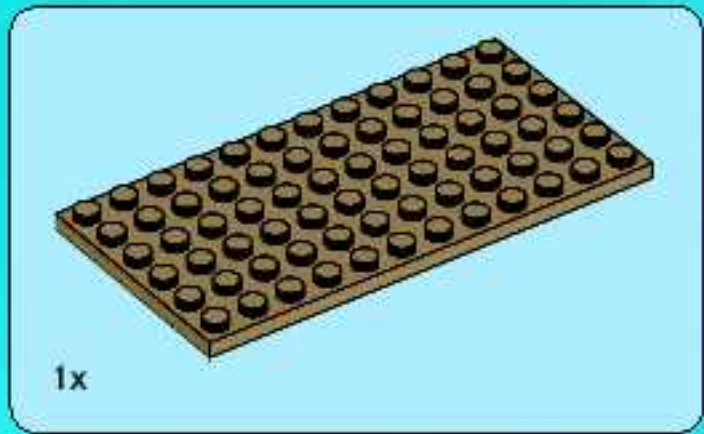
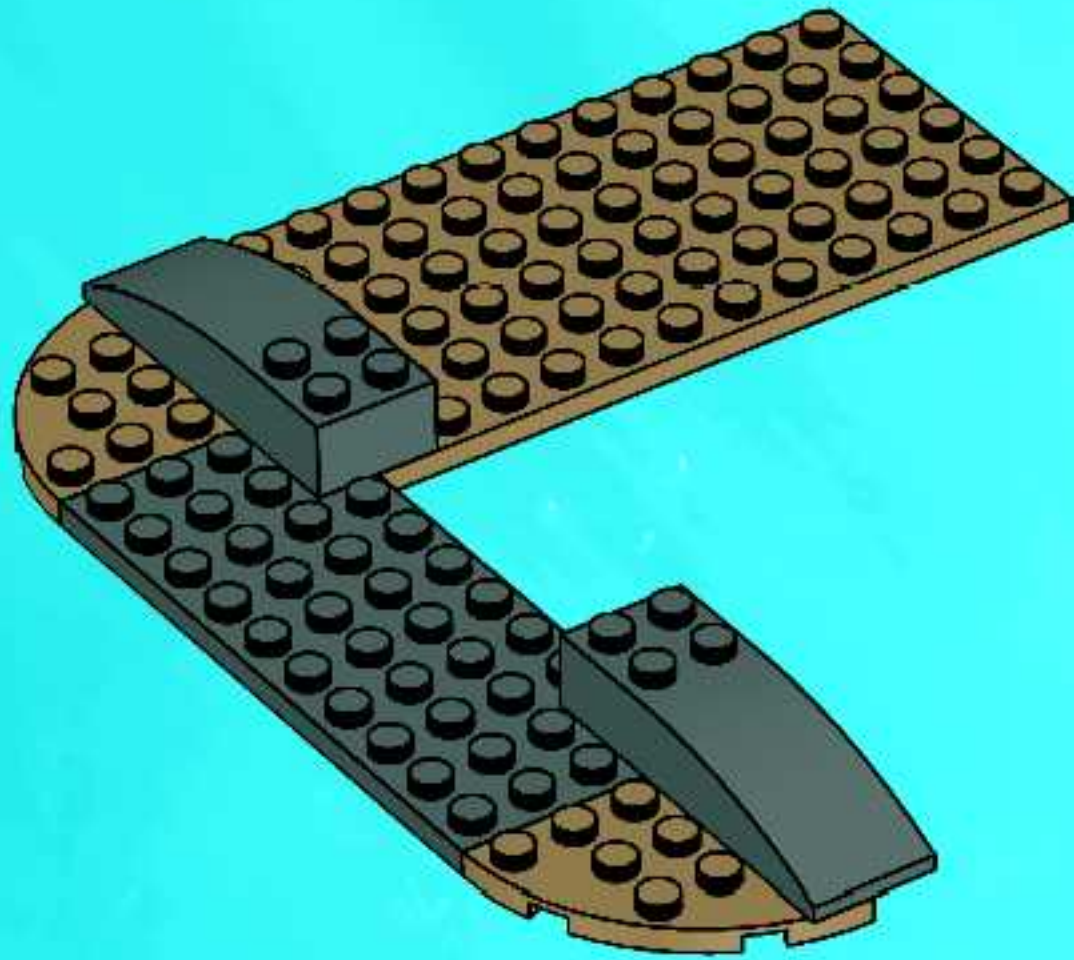

5

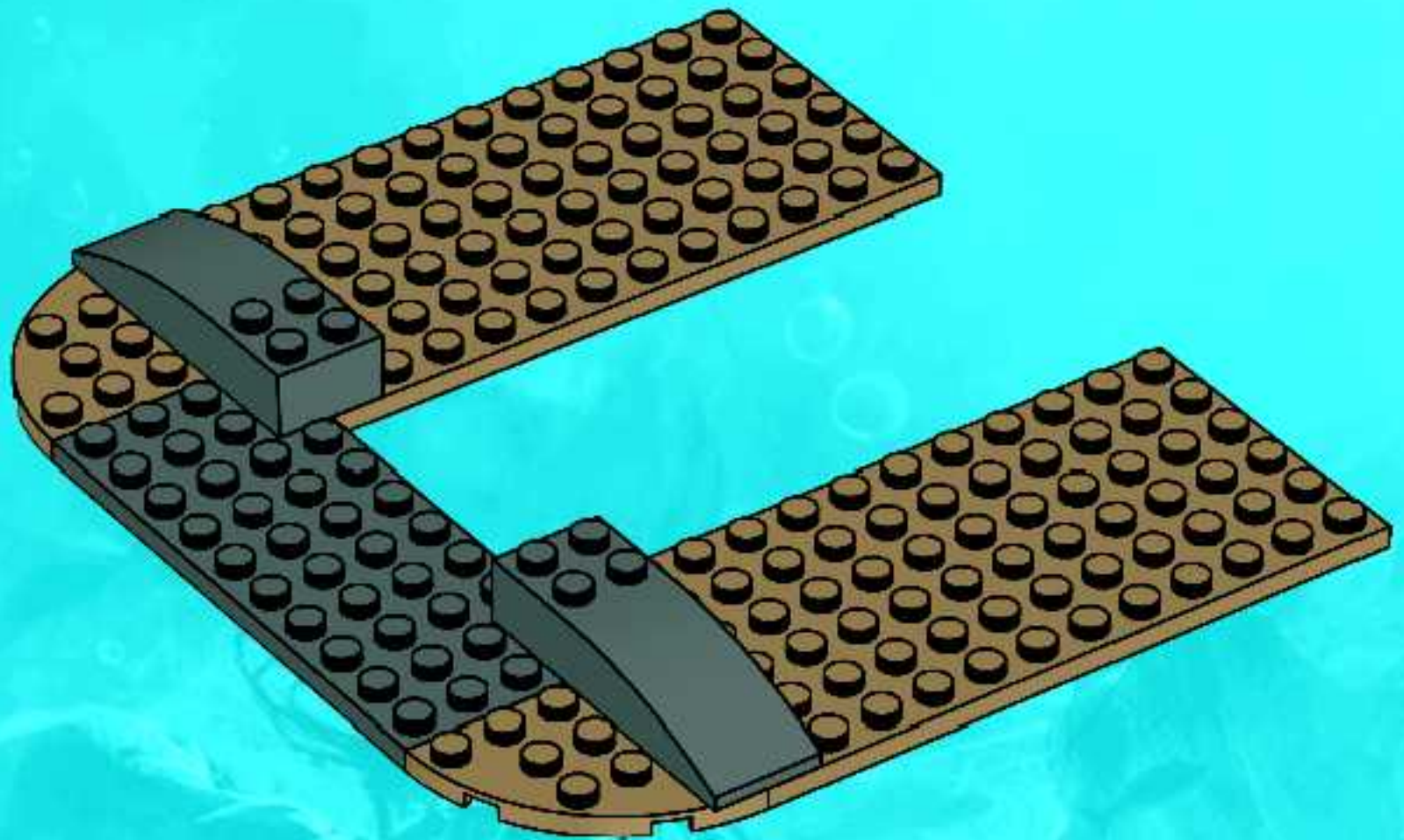



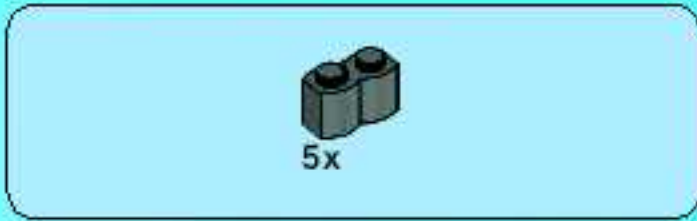

6

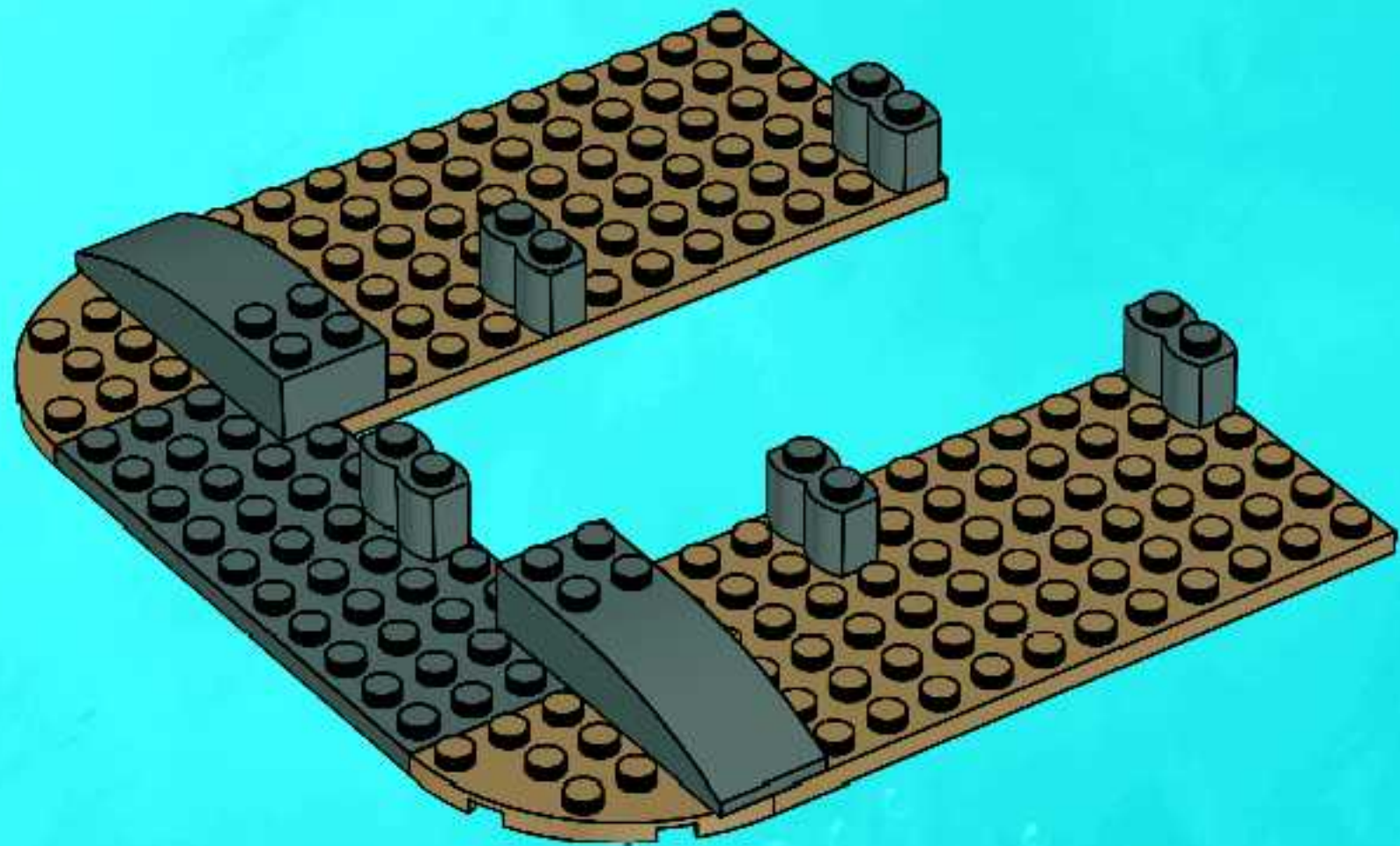



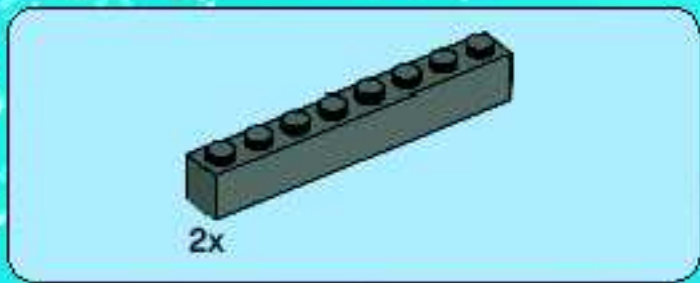

7

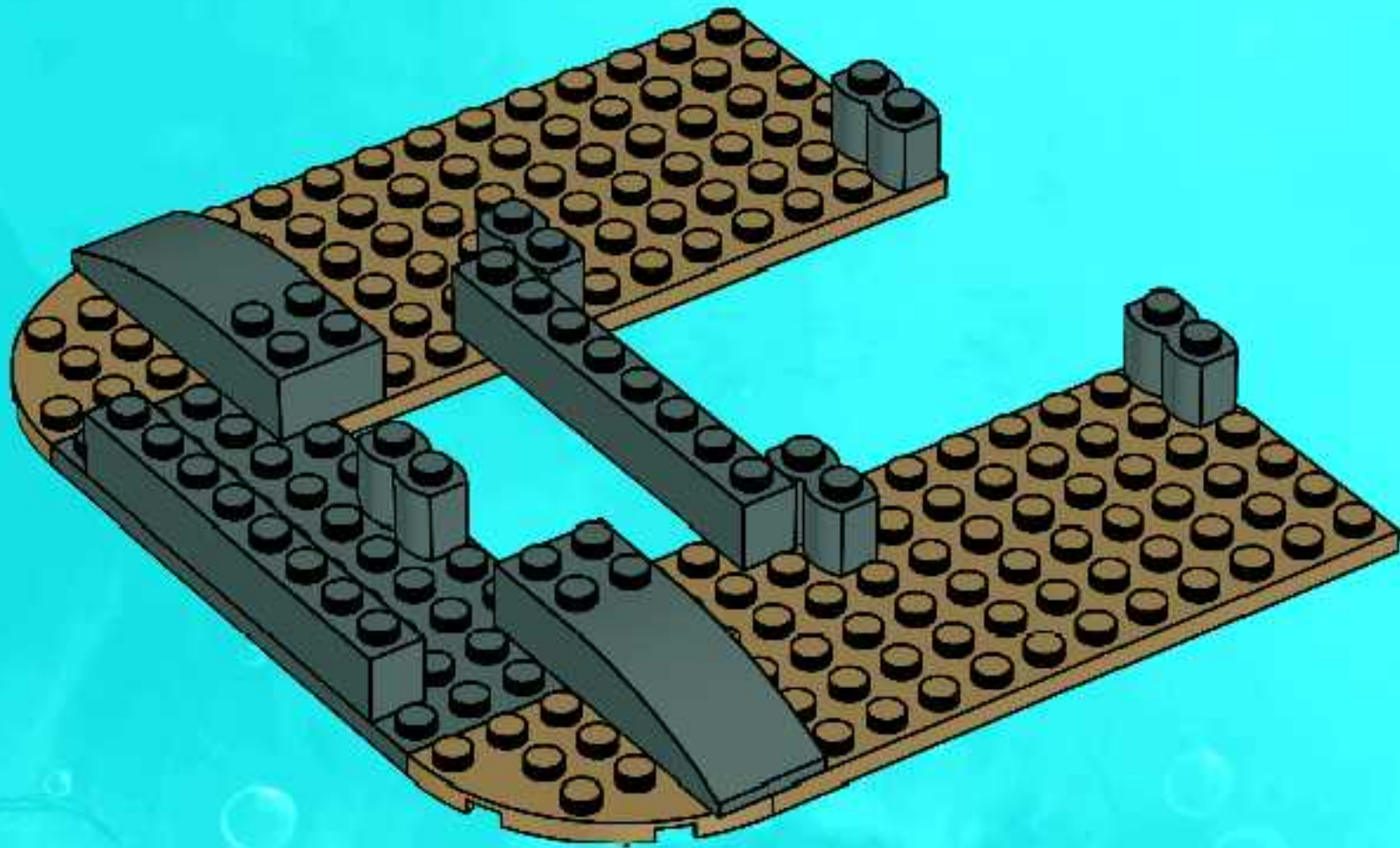





8

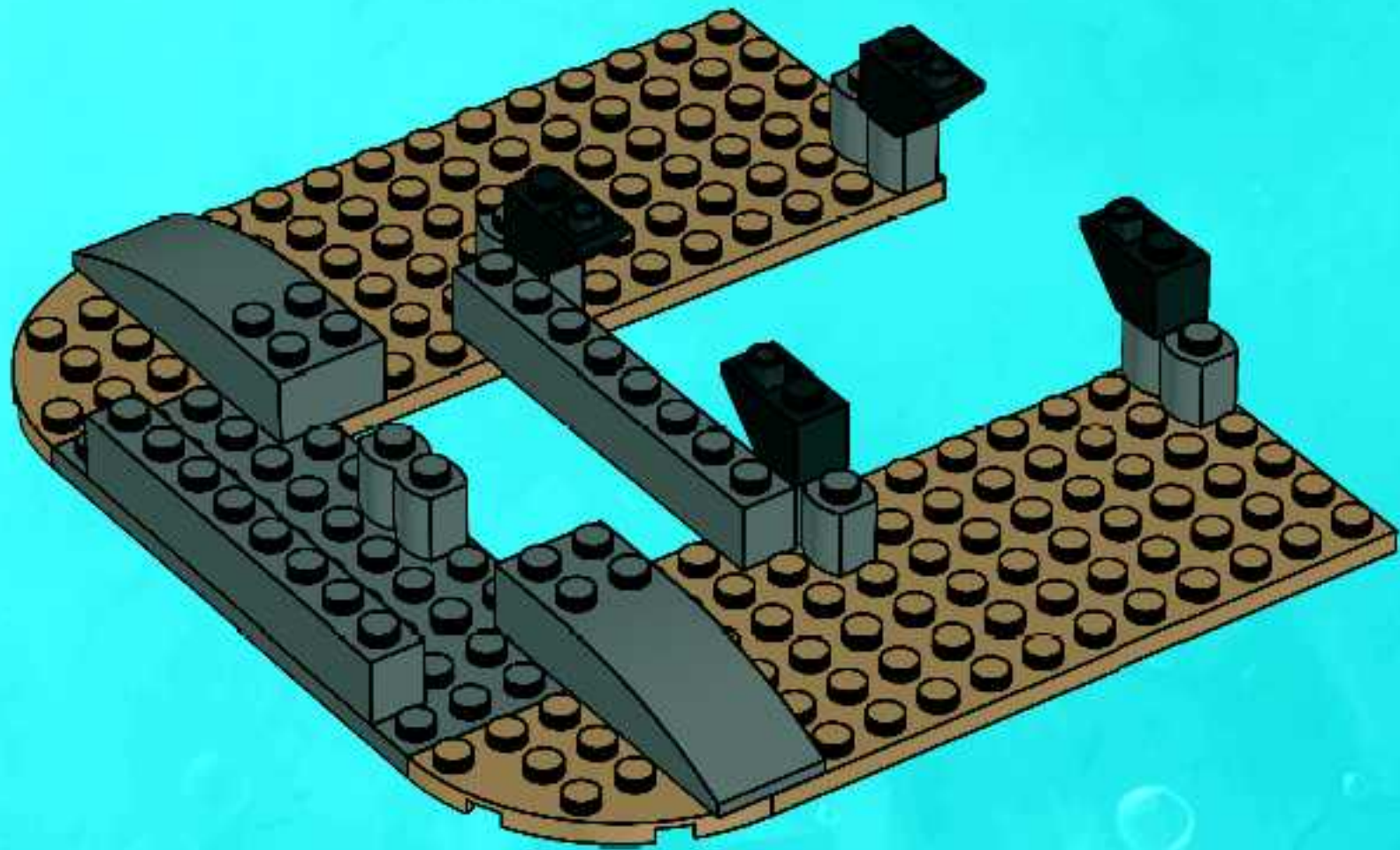





1x



2x

9

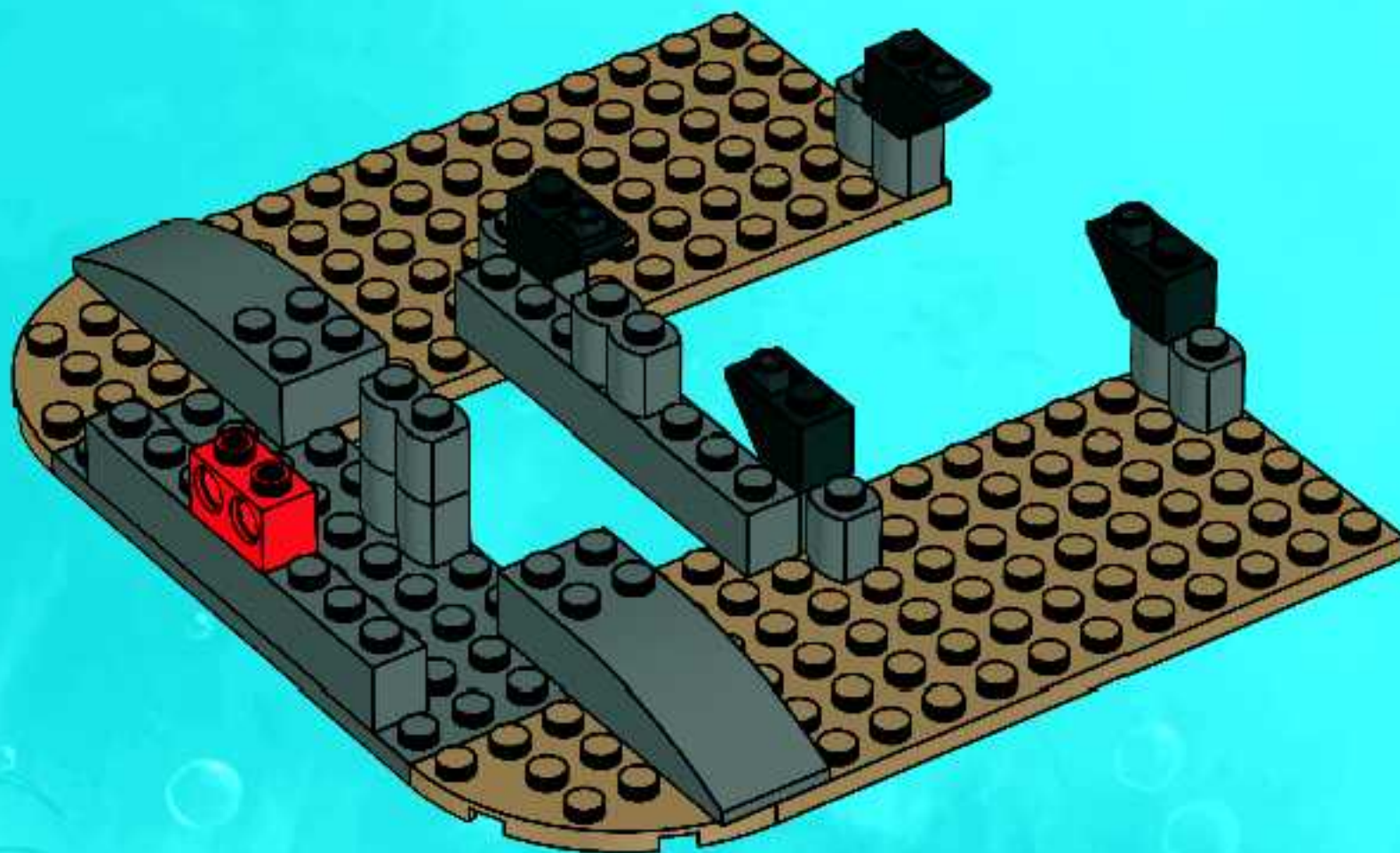



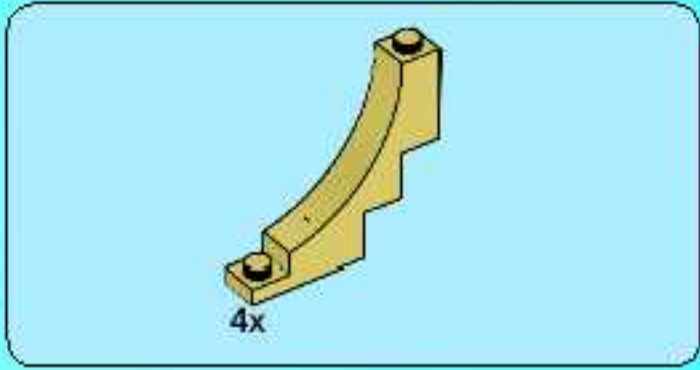

10

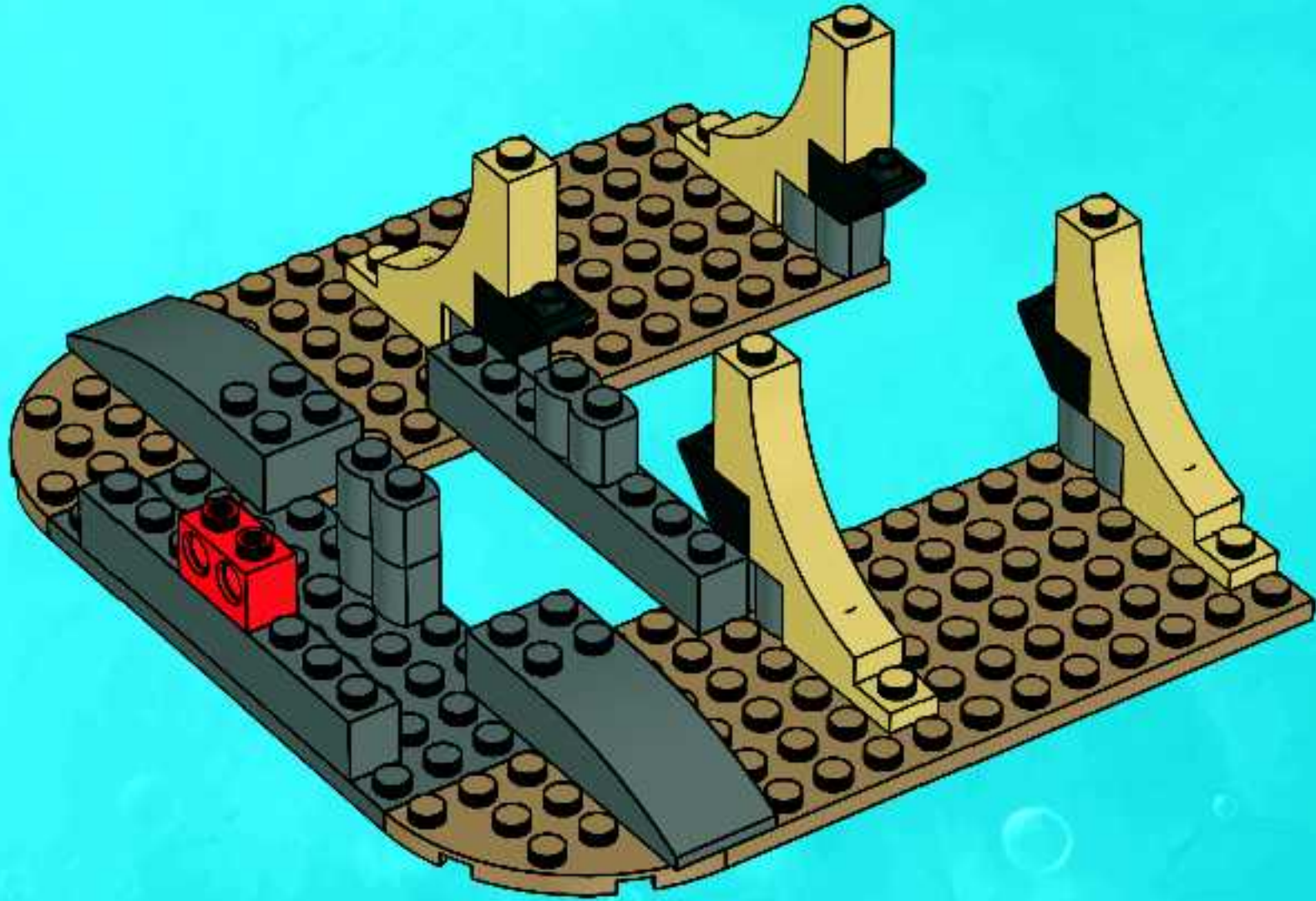





4x

11

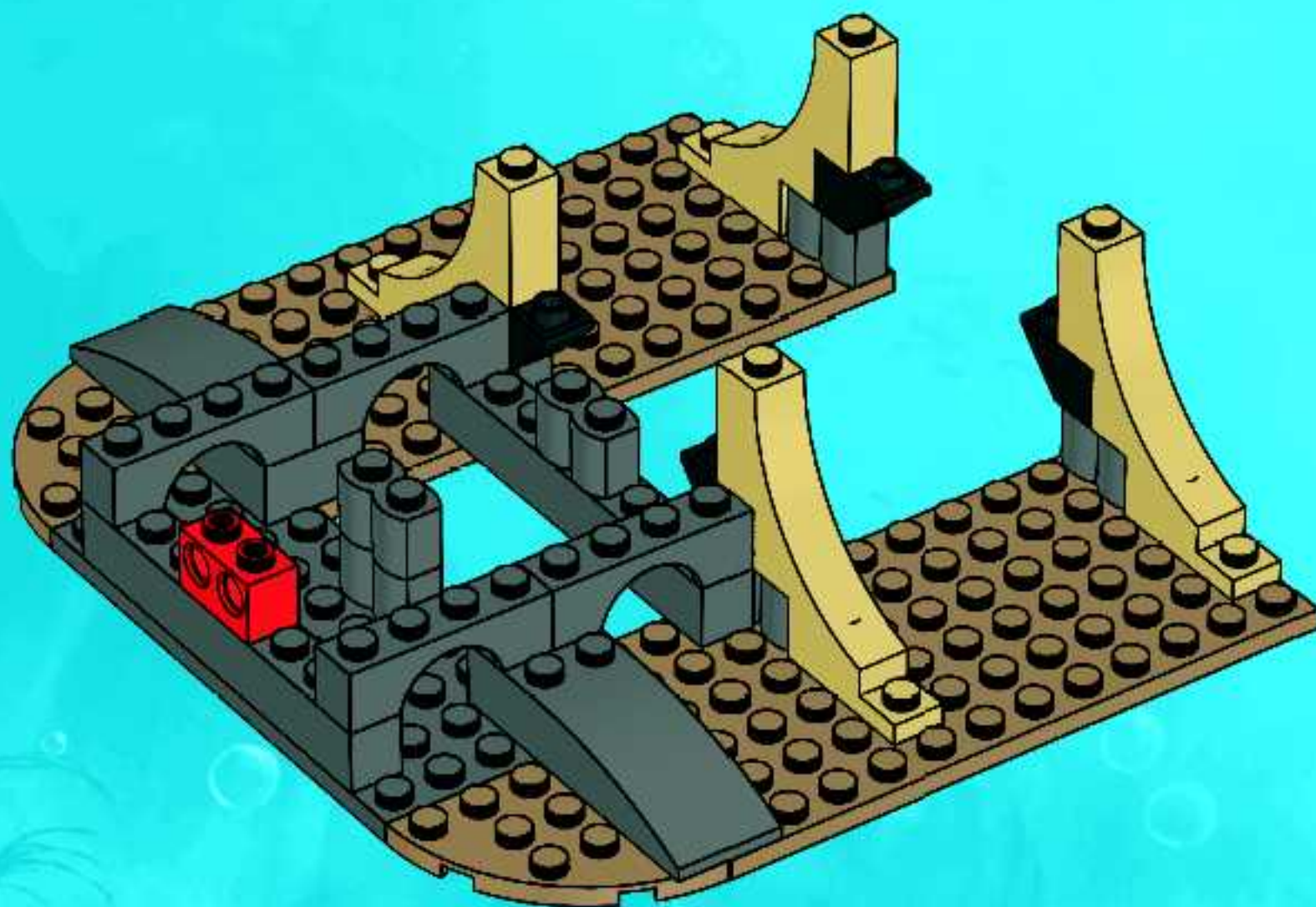





12

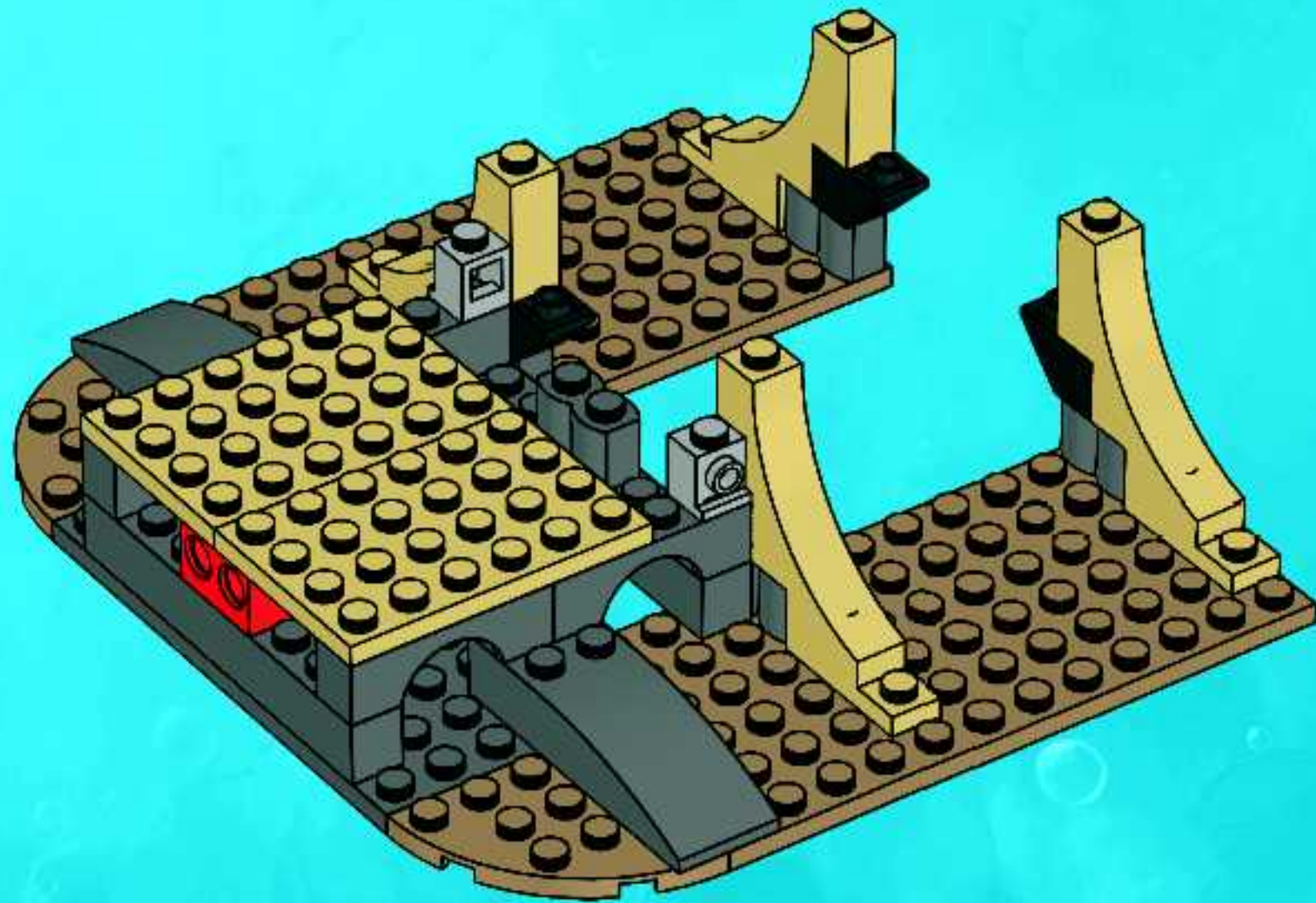



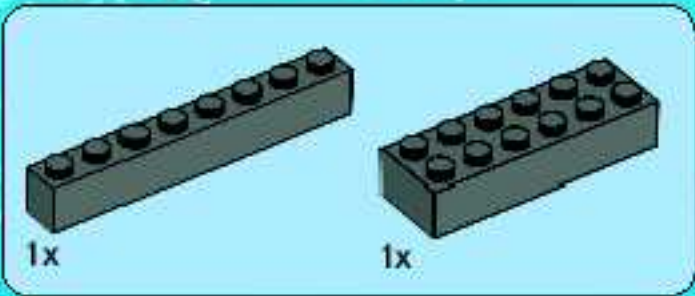

13

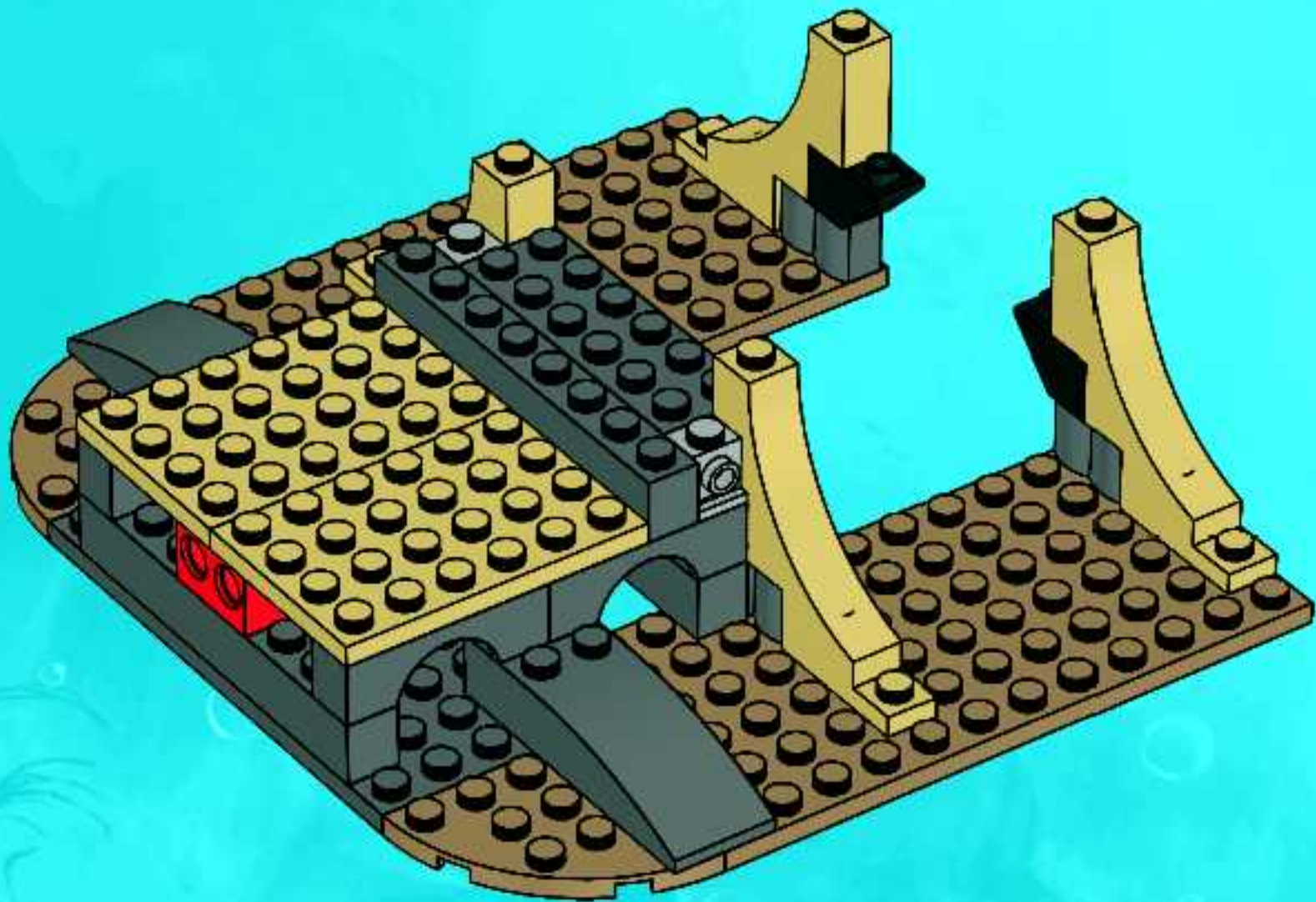



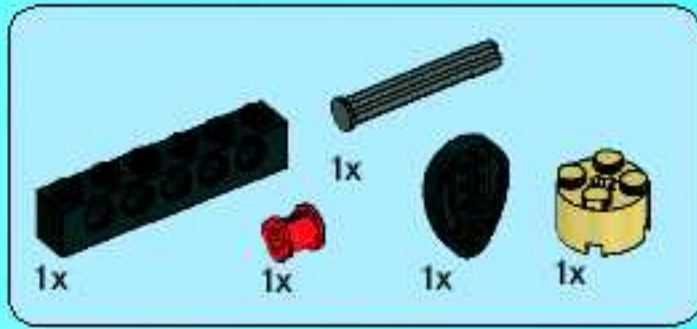

14

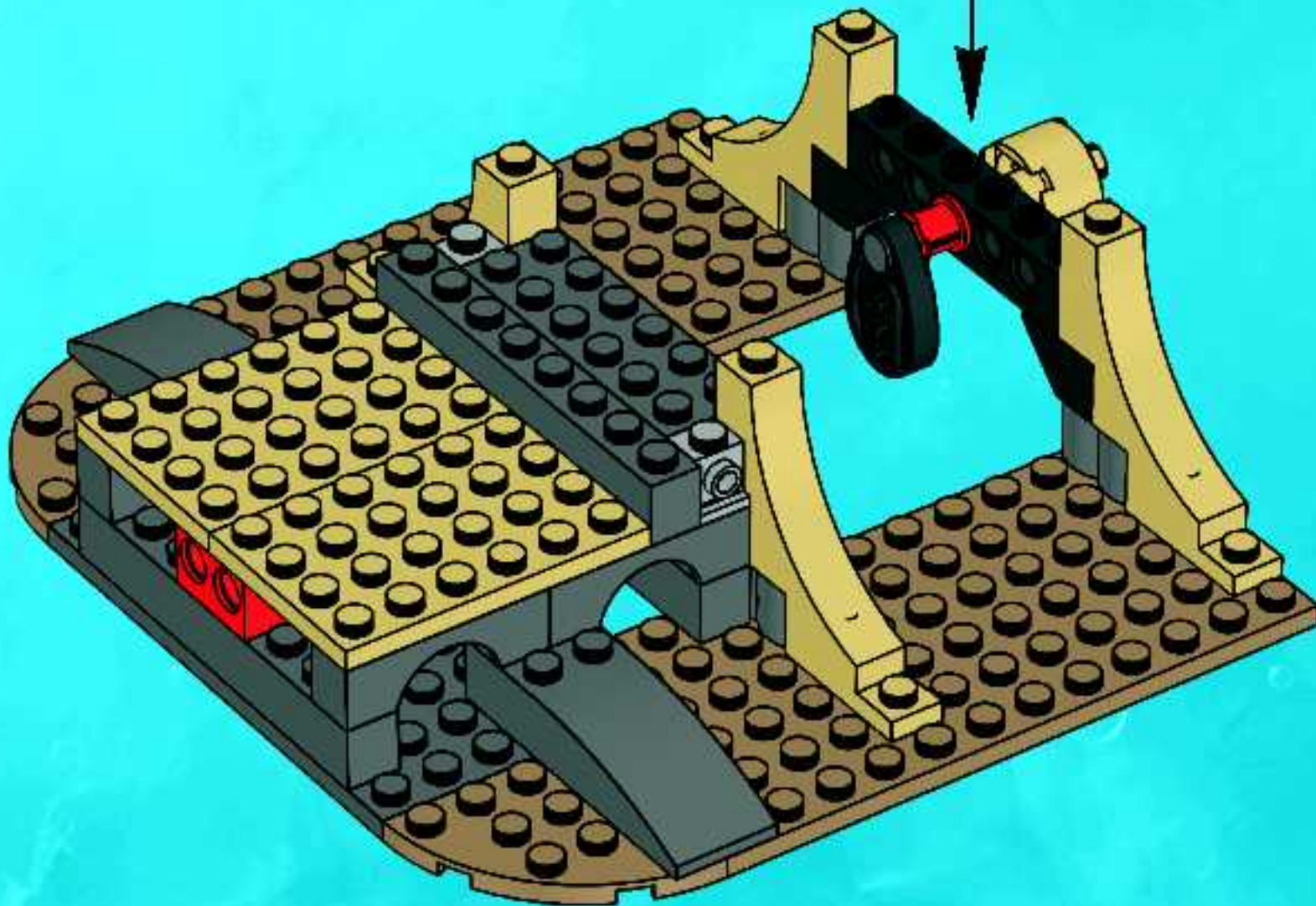
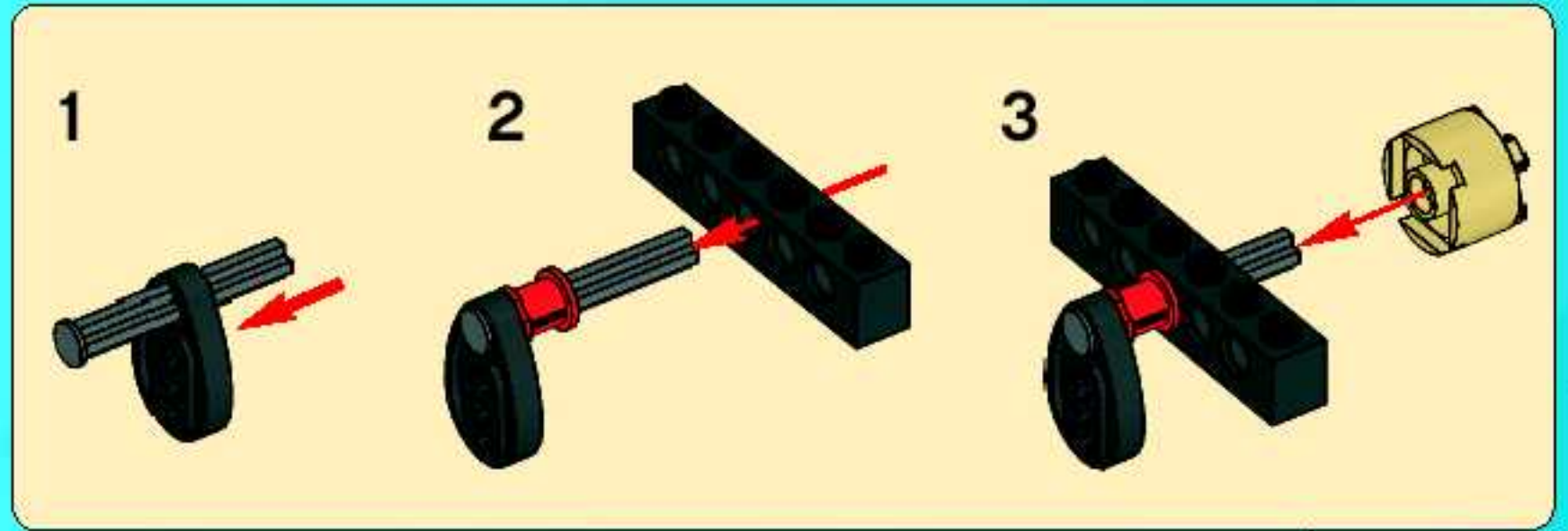





4x



1x

# 15

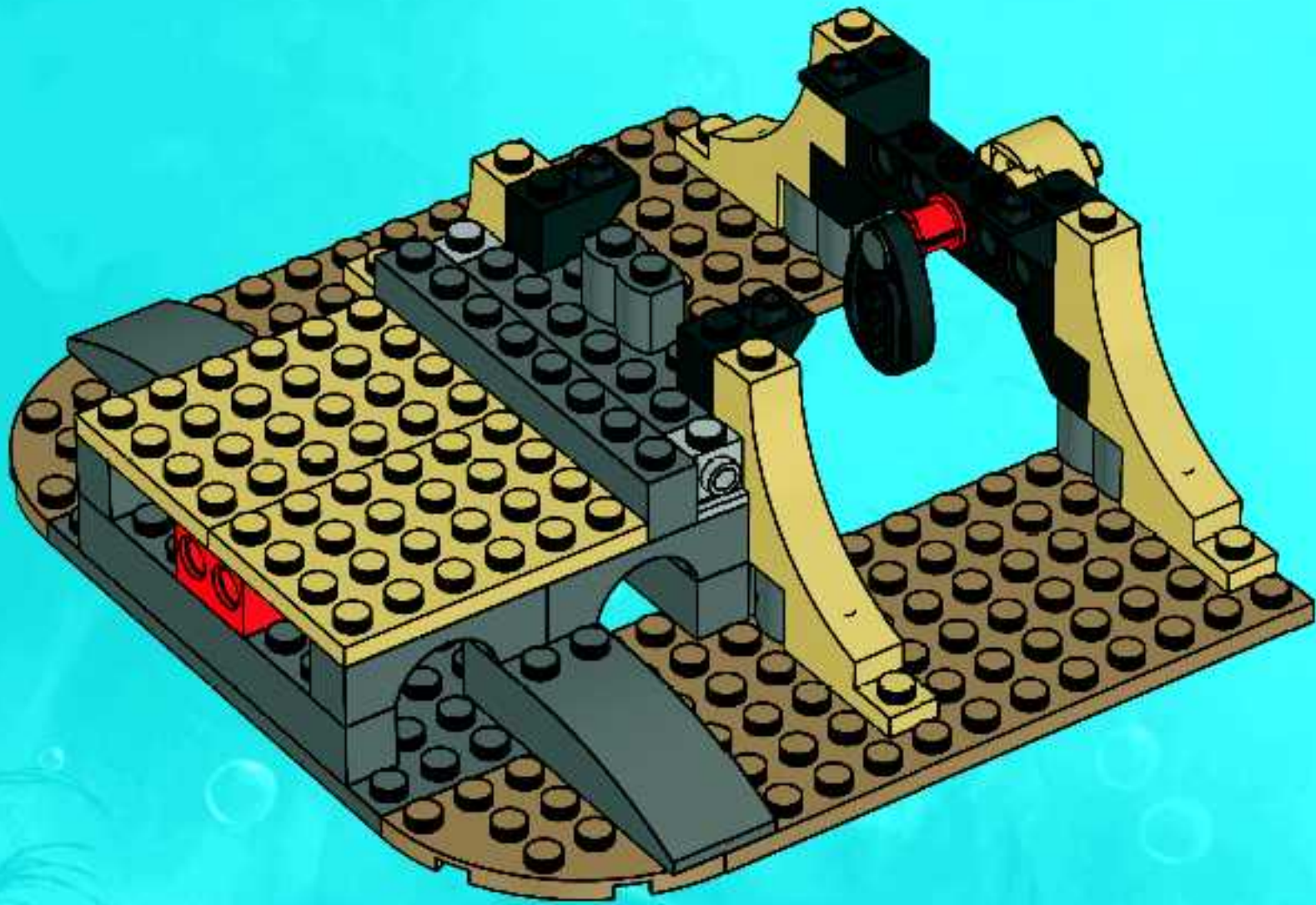



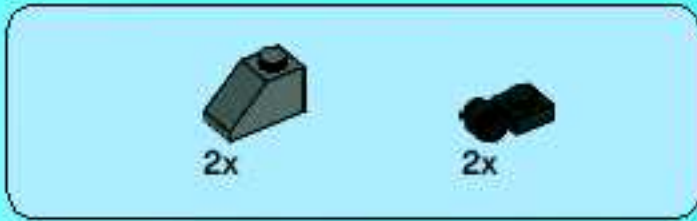

16

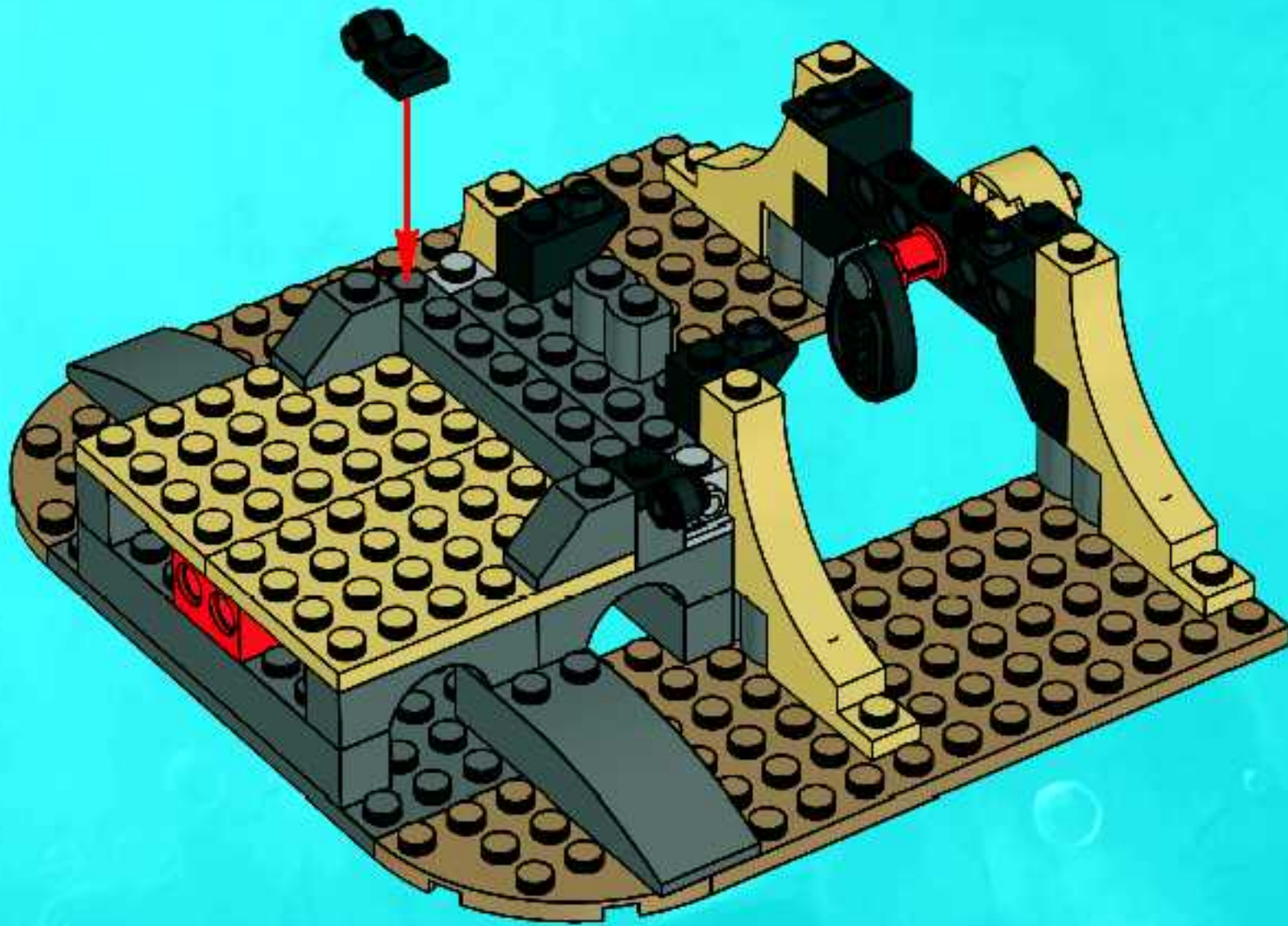



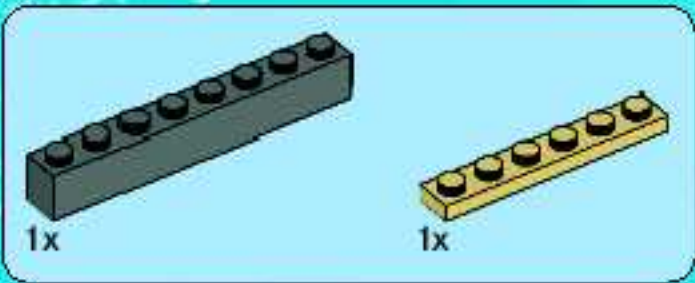

17

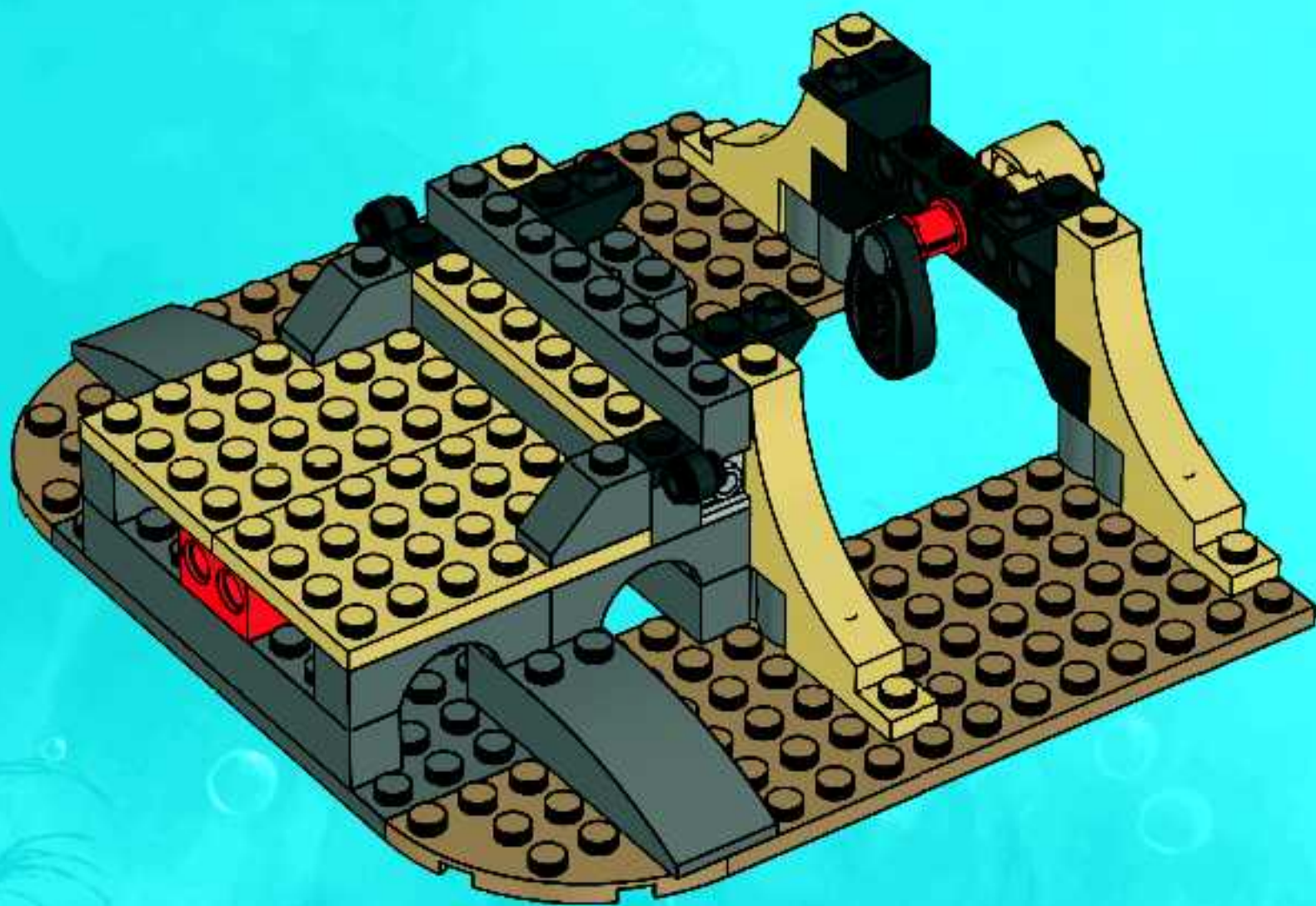





18

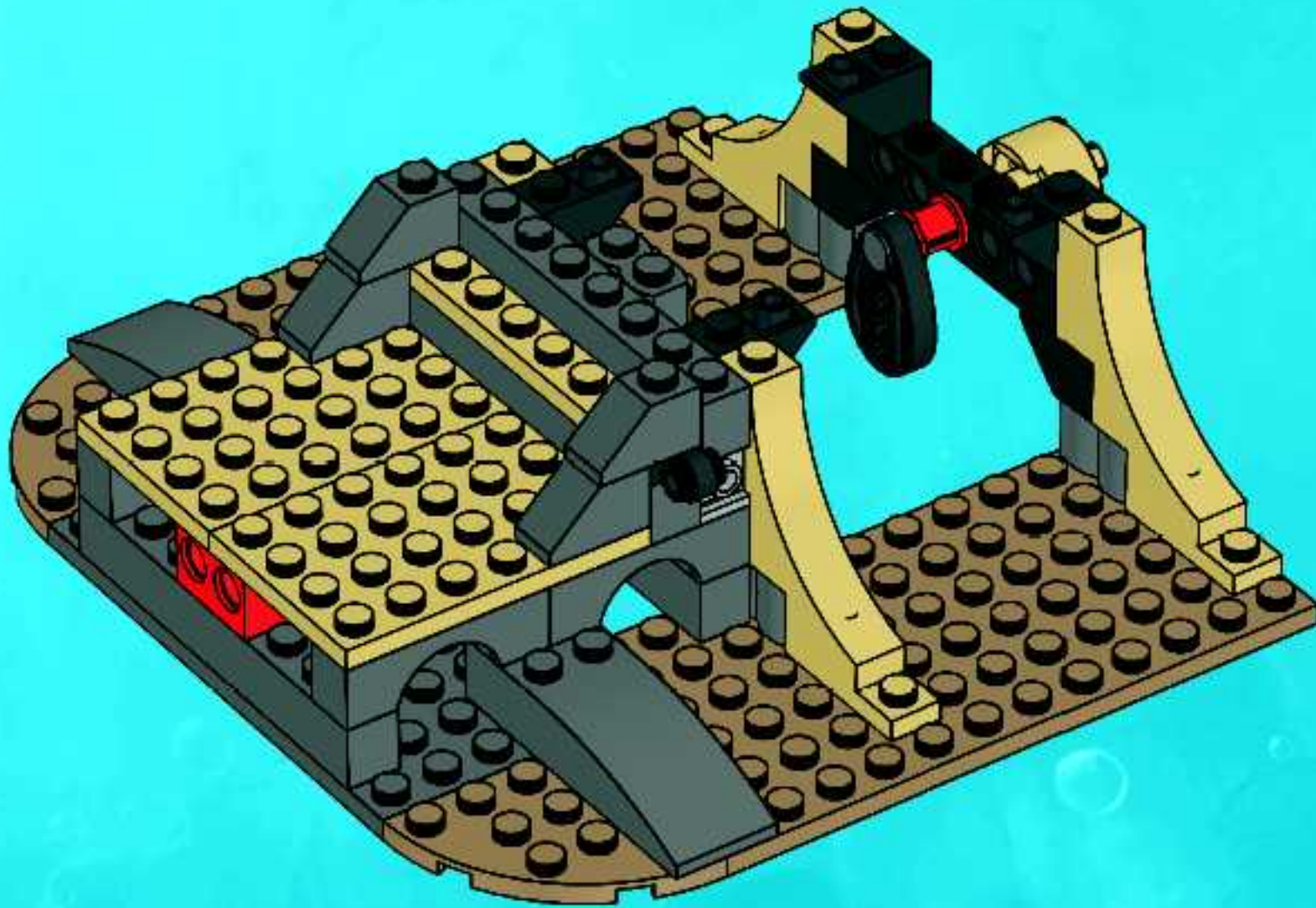



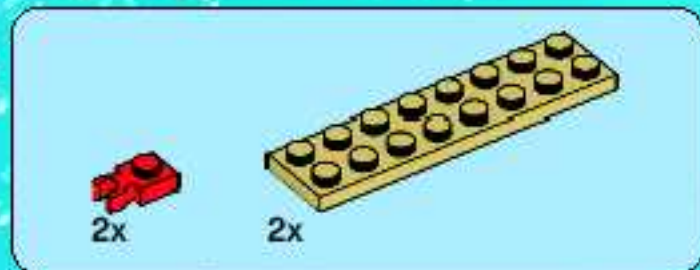

19

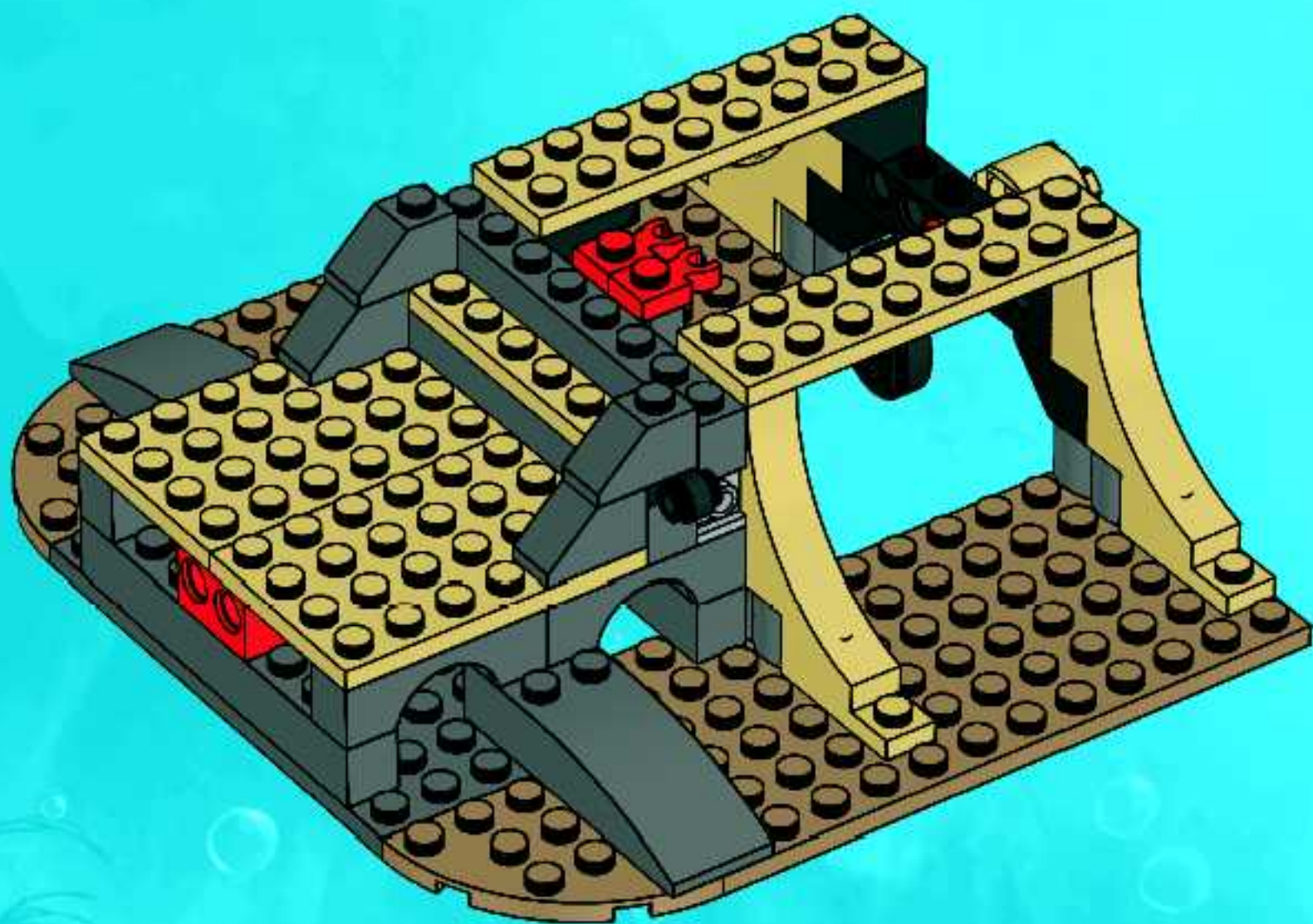



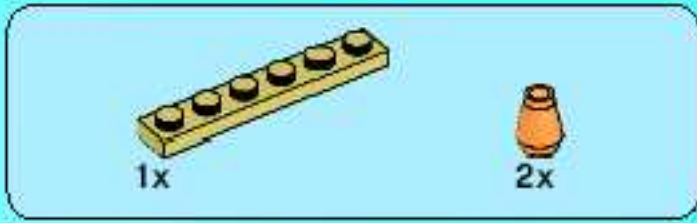

20

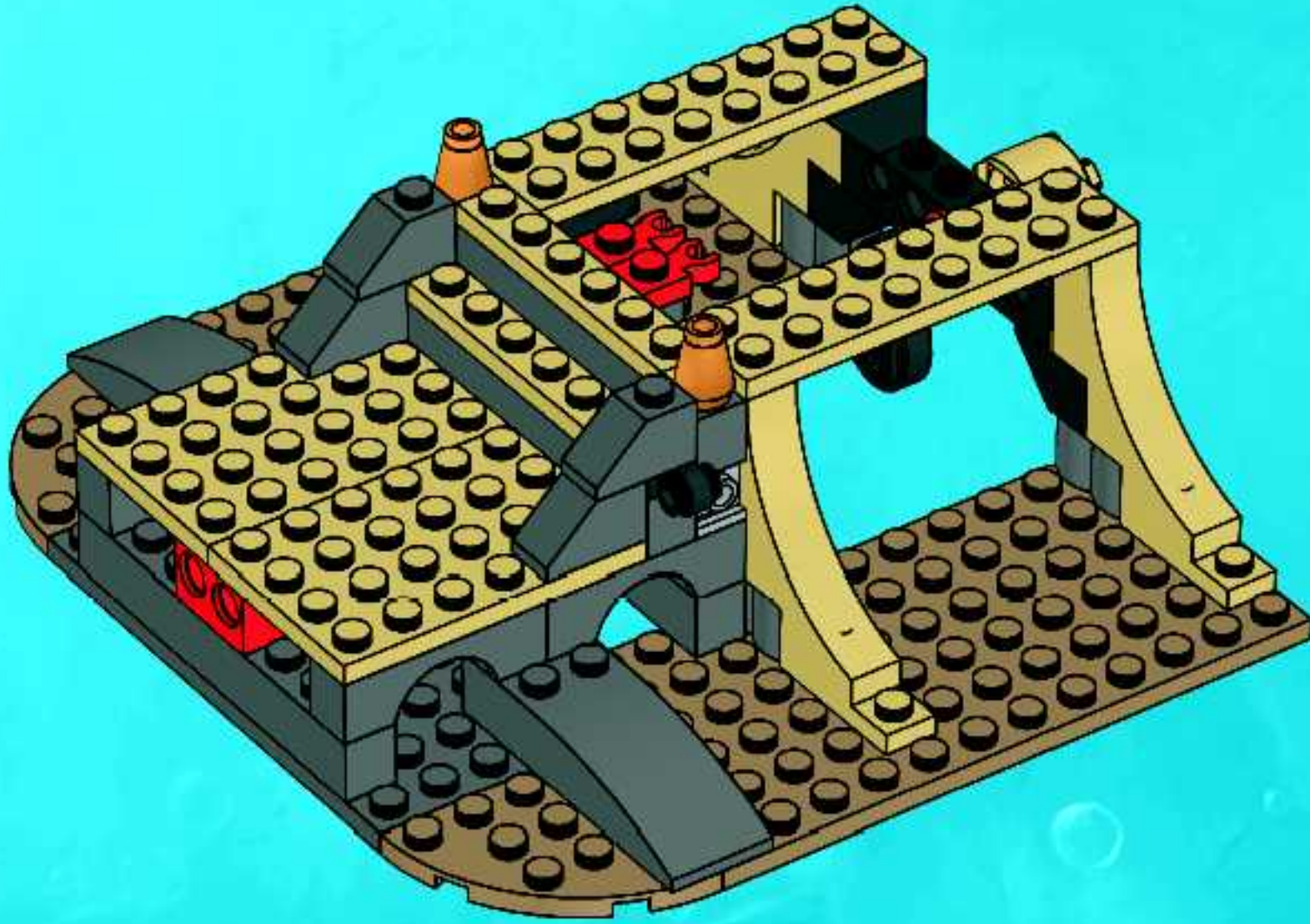





21

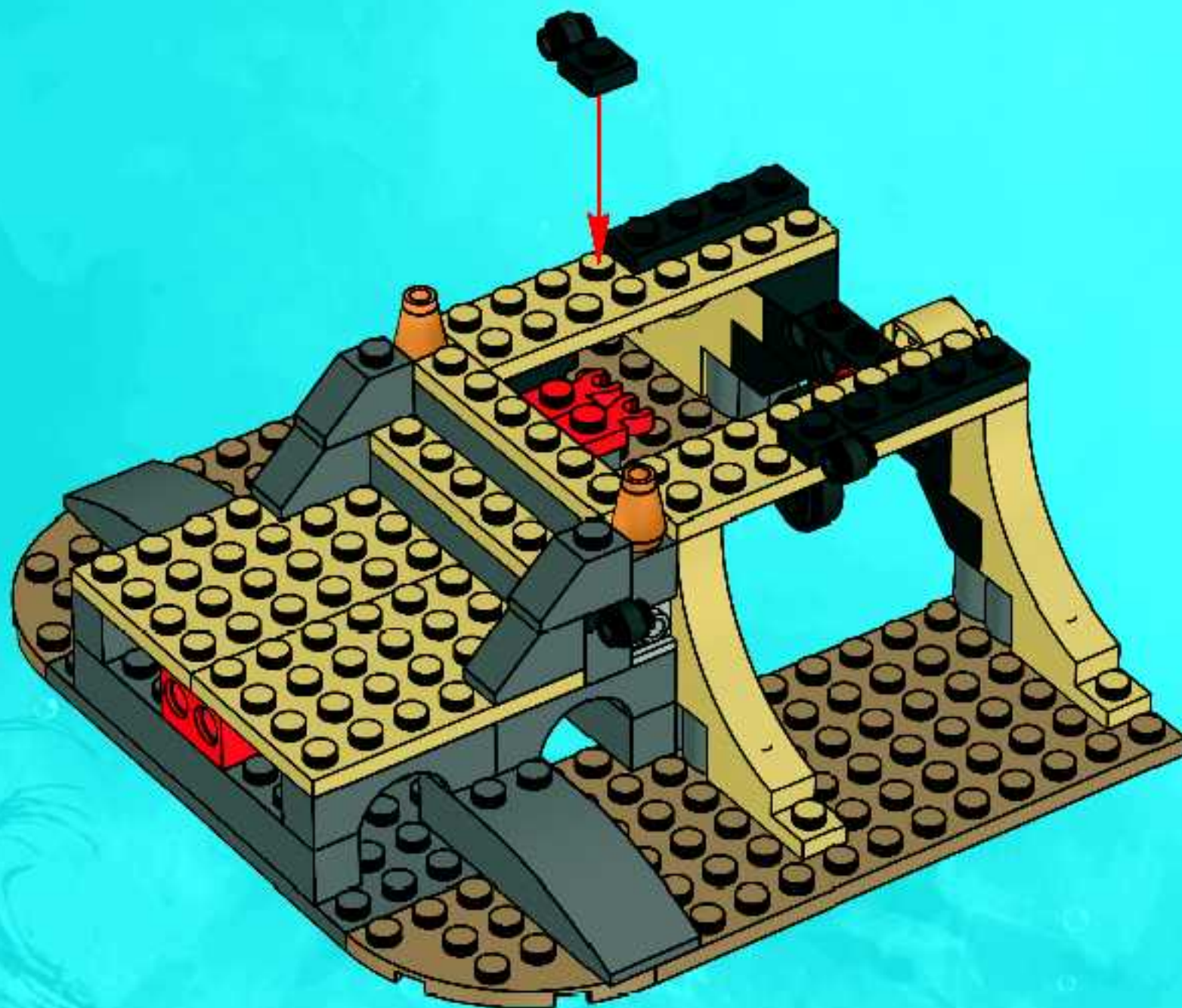



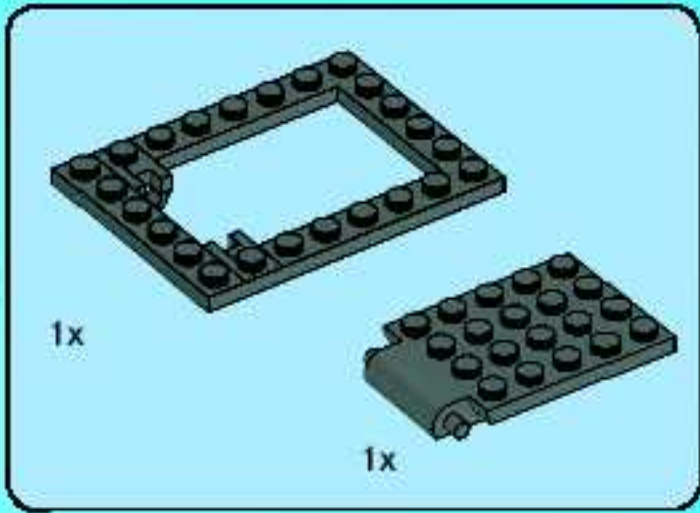

**22**

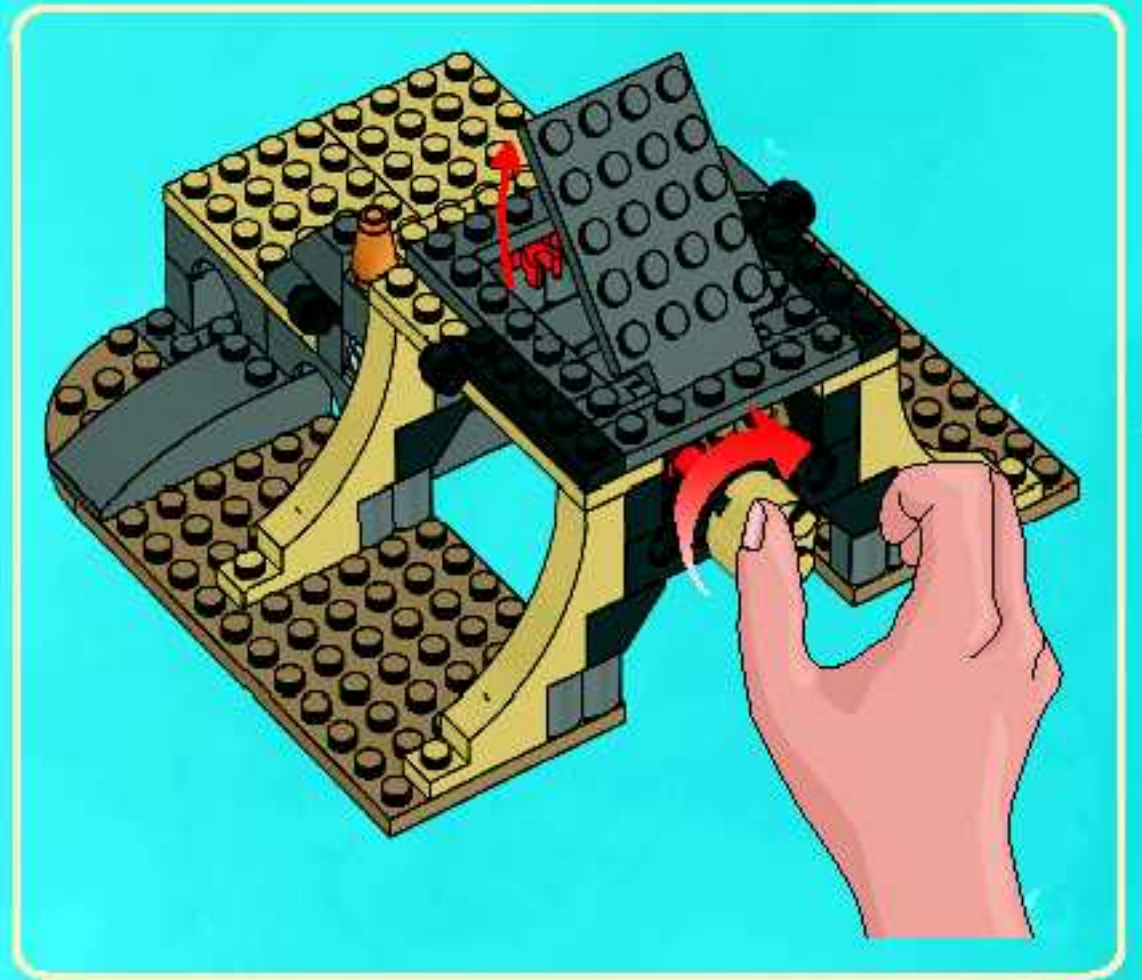
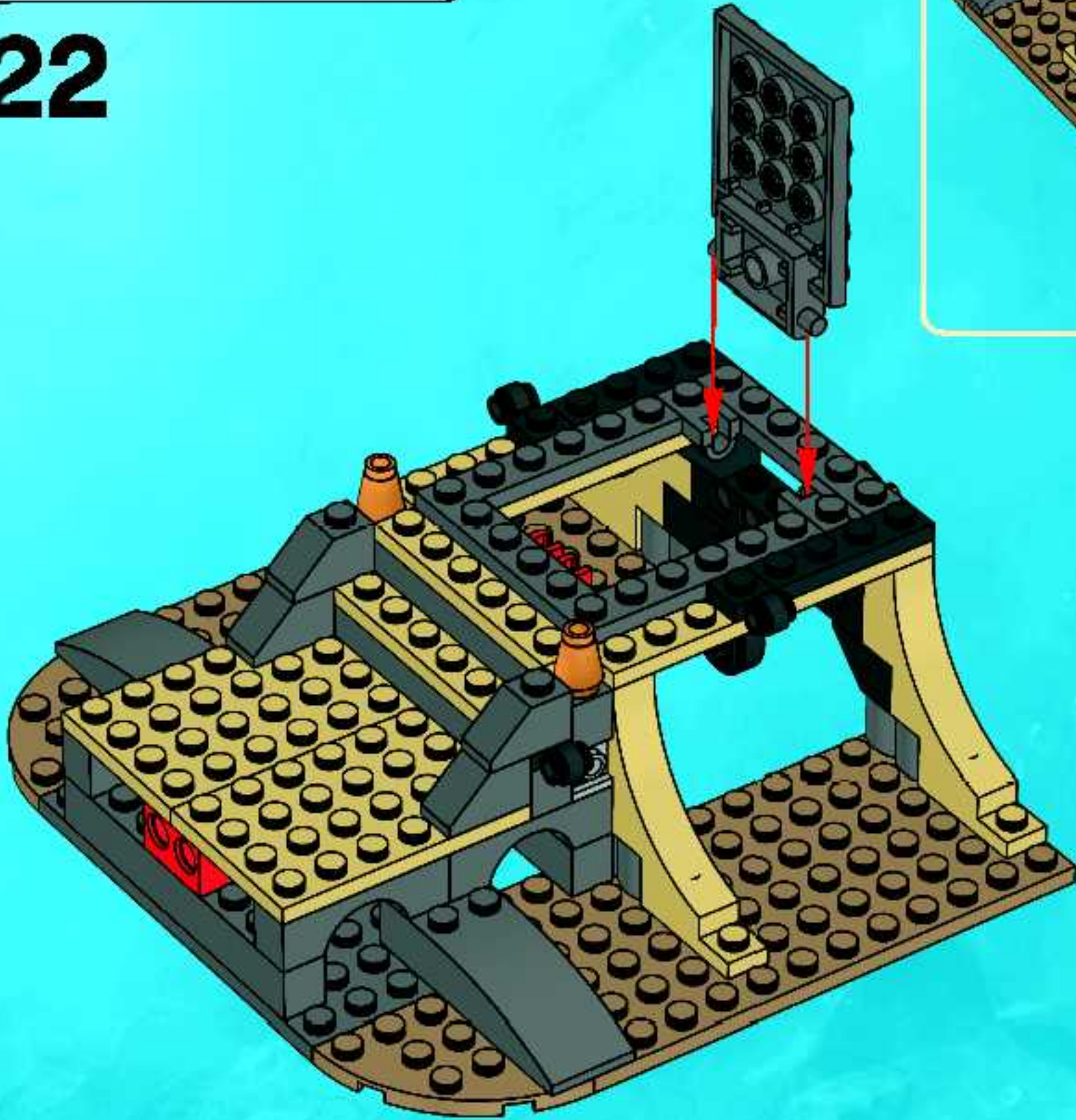







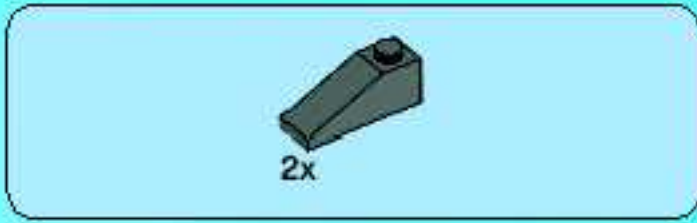

24

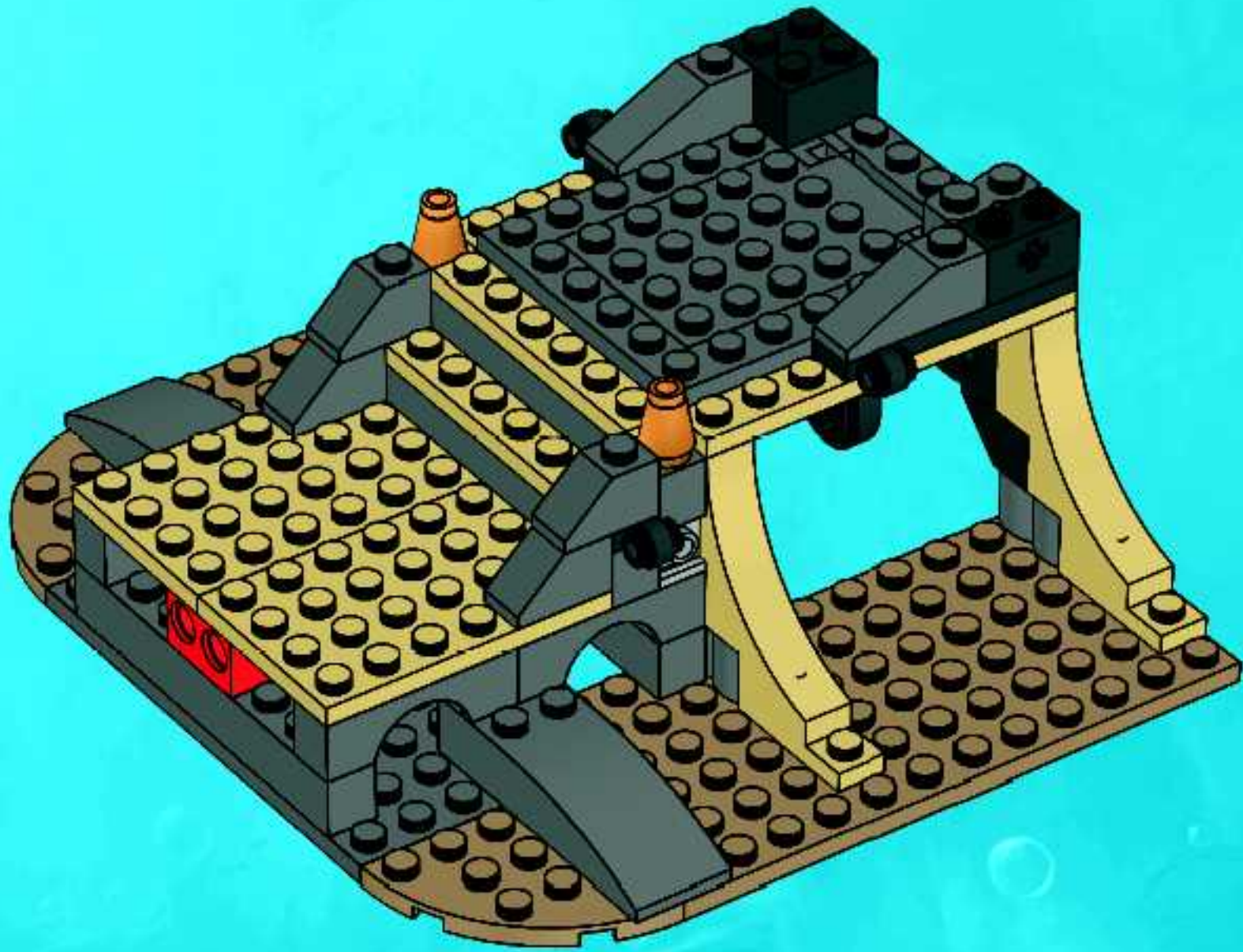





2x

25

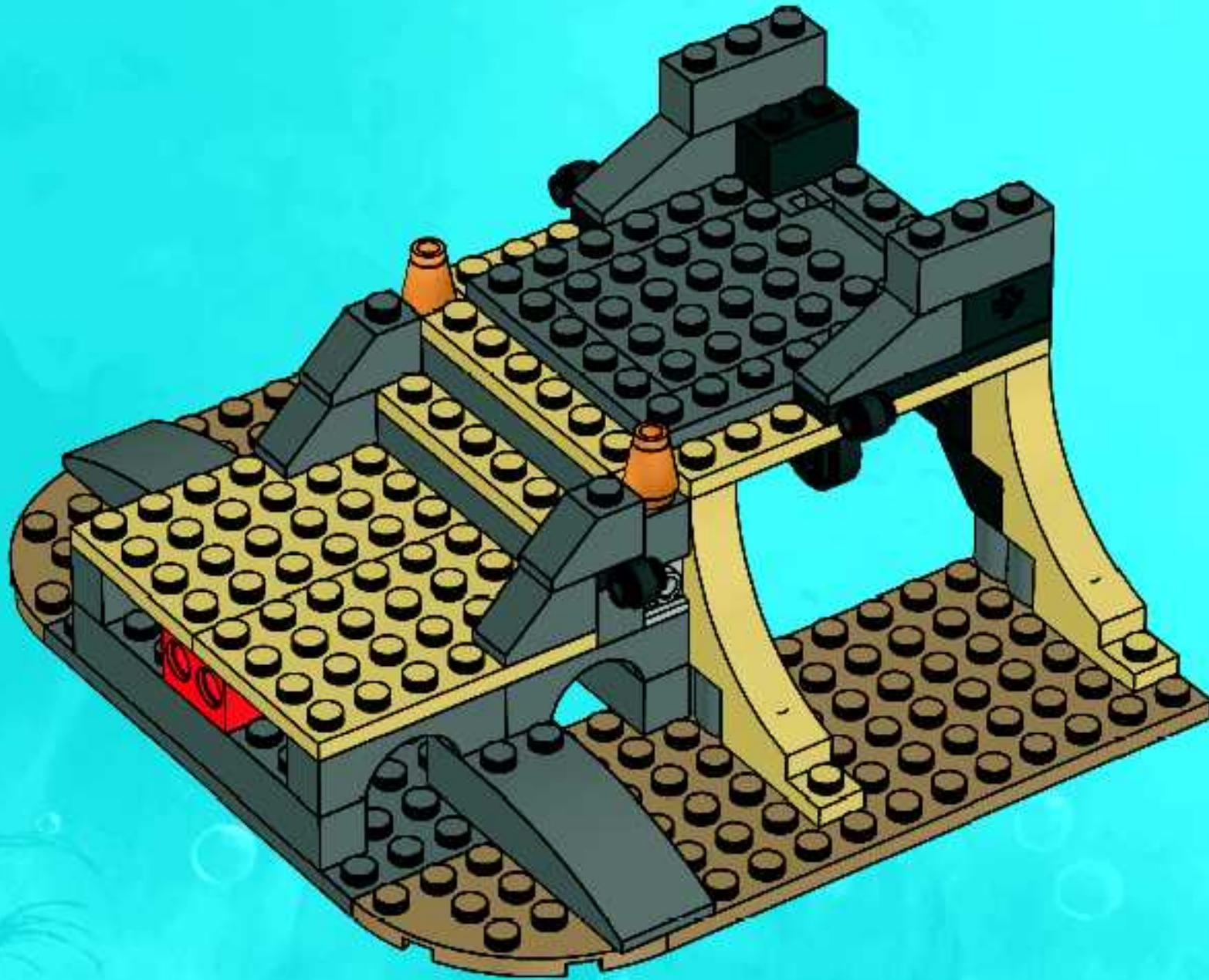





2x



2x

# 26

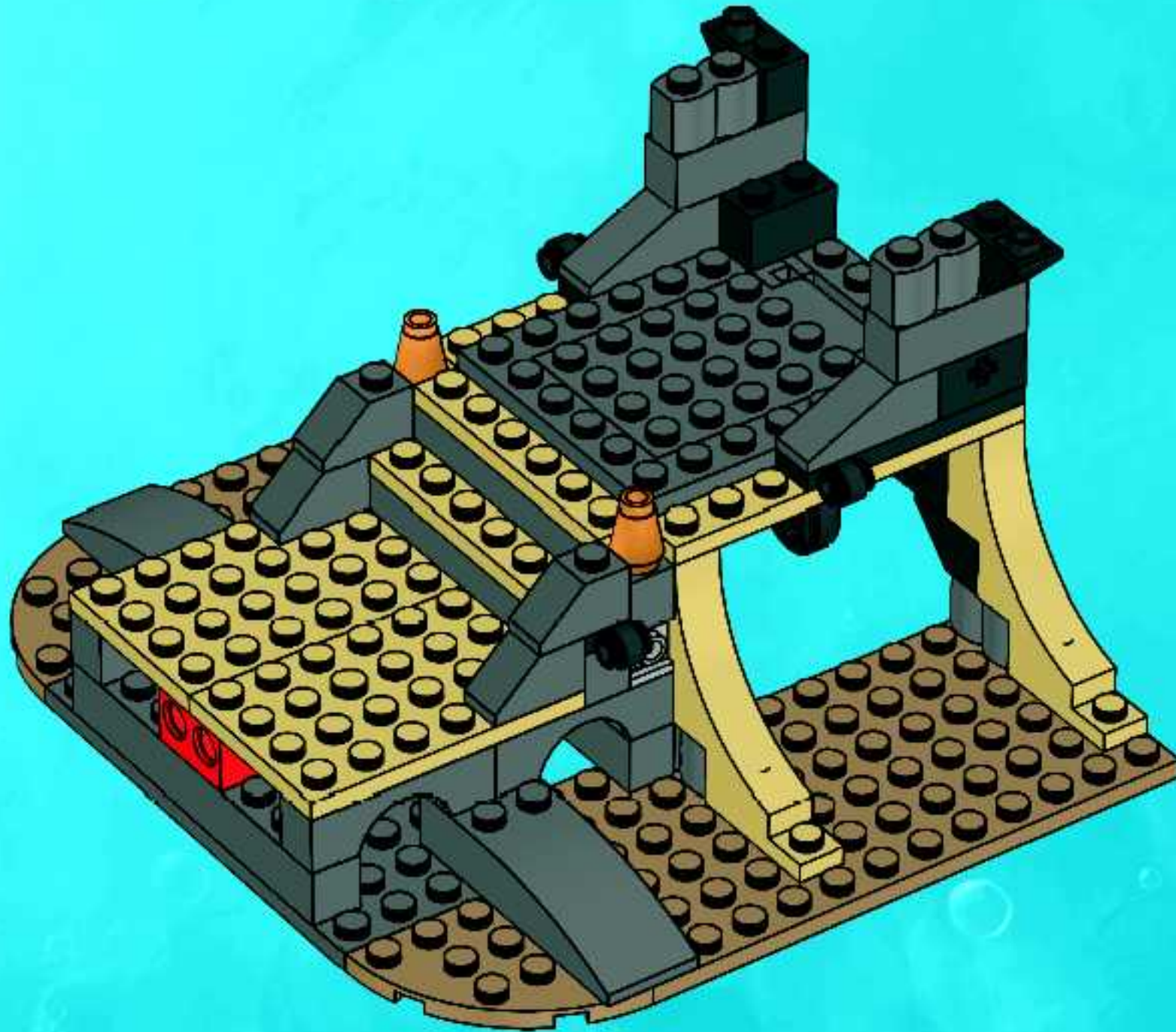





2x



2x

# 27

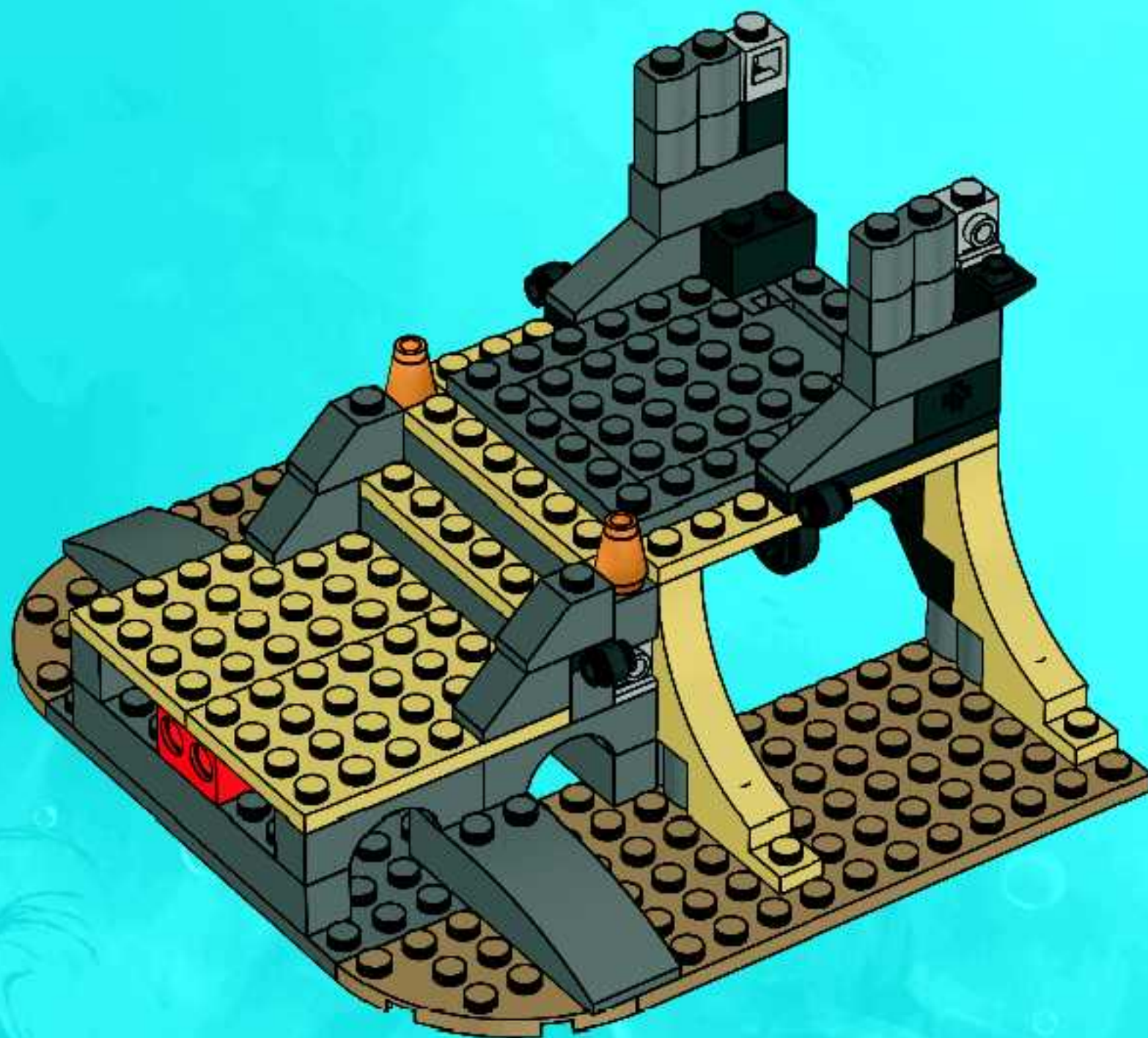



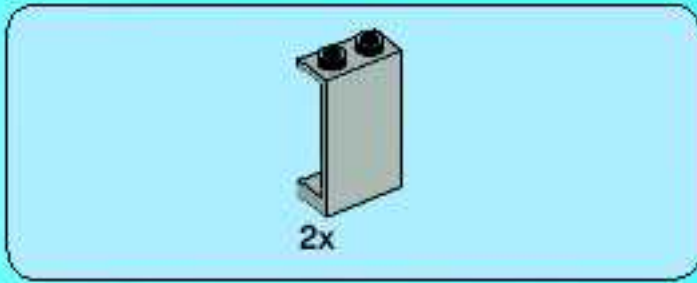

28

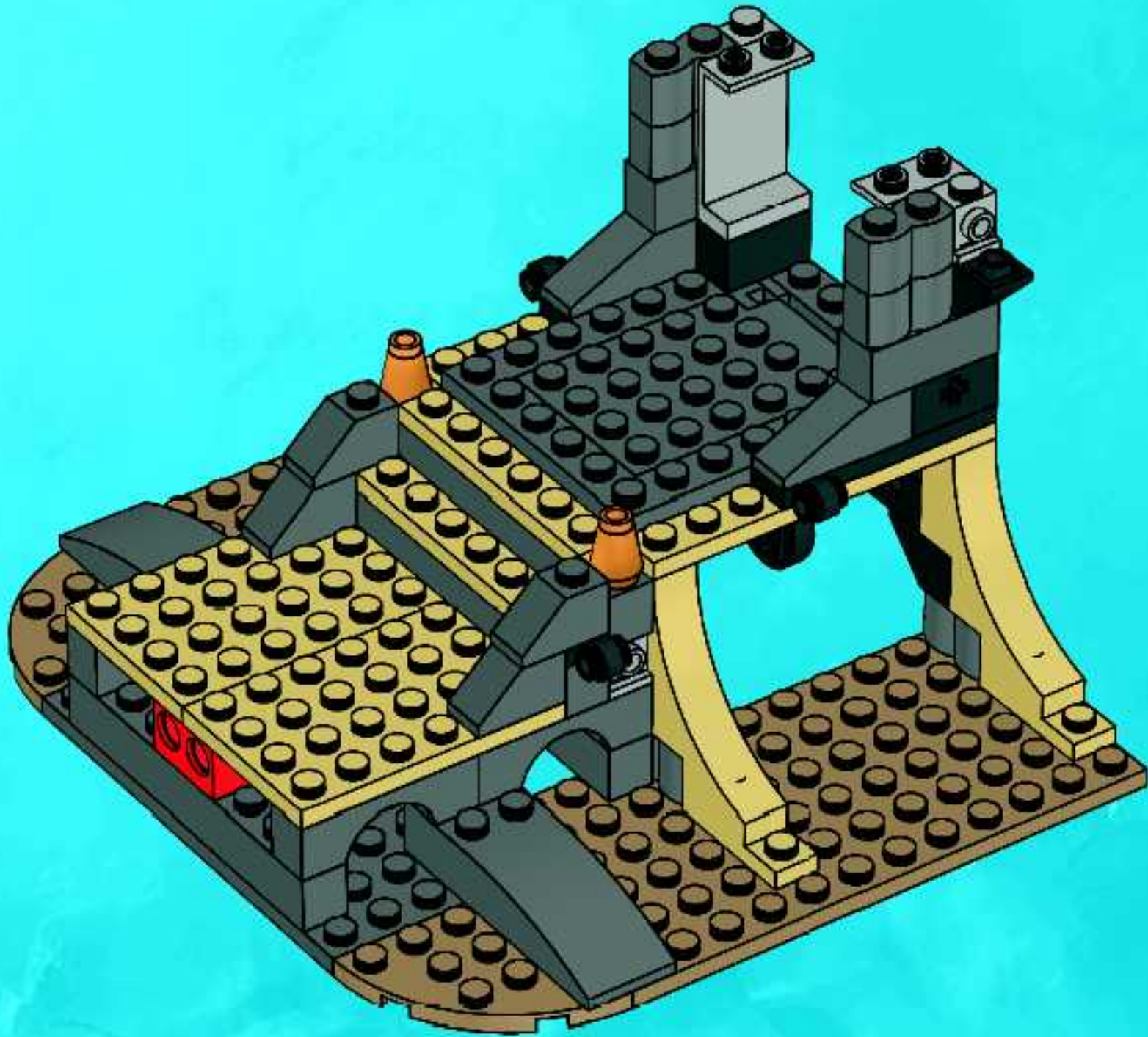



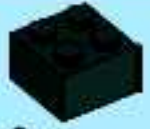

2x



2x

# 29

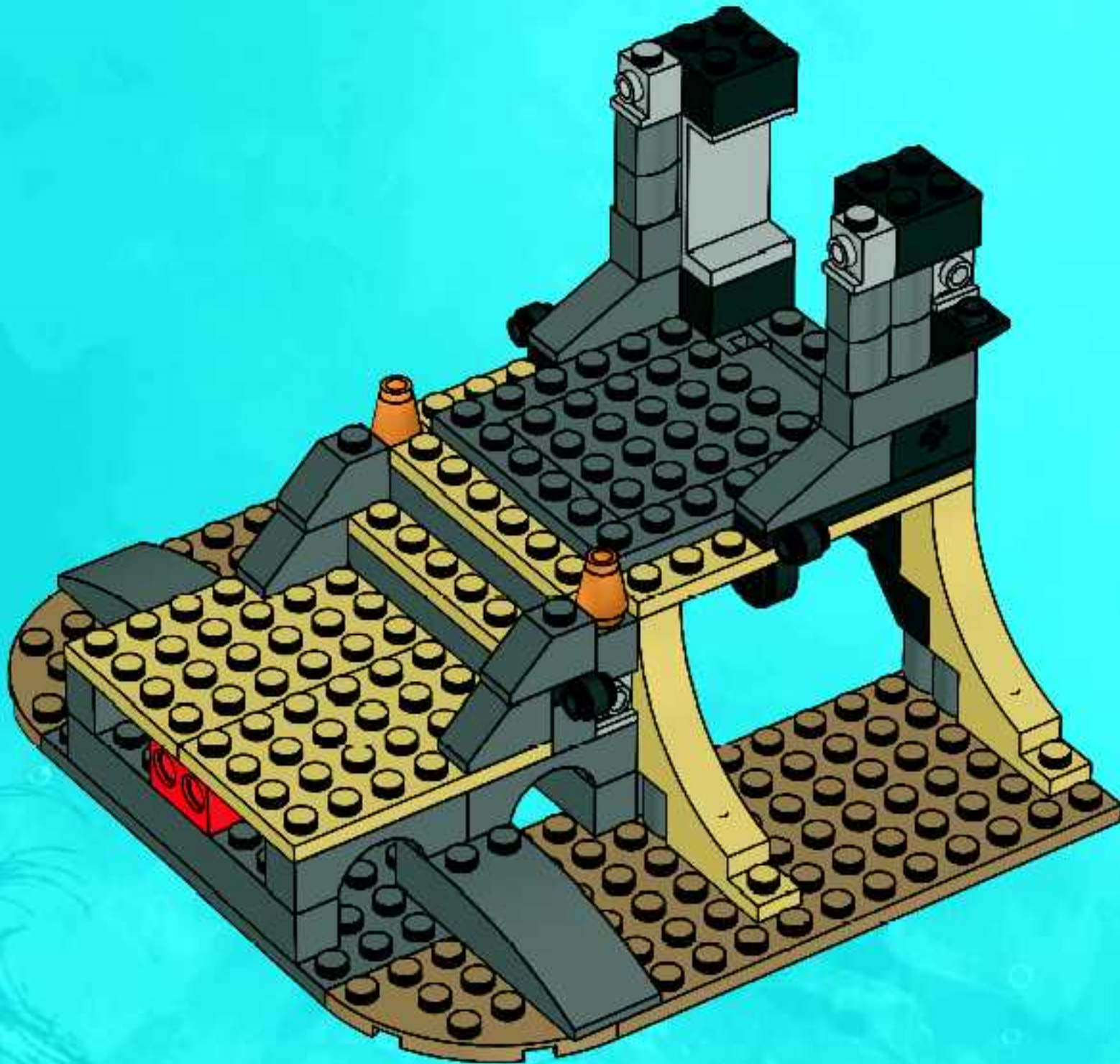



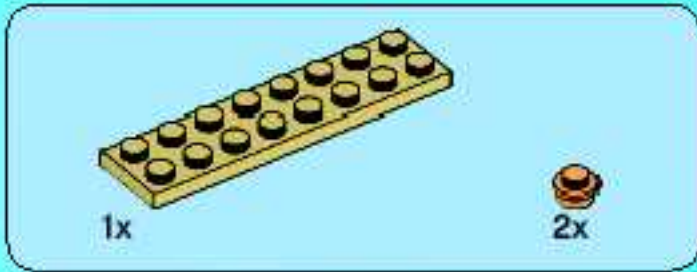

30

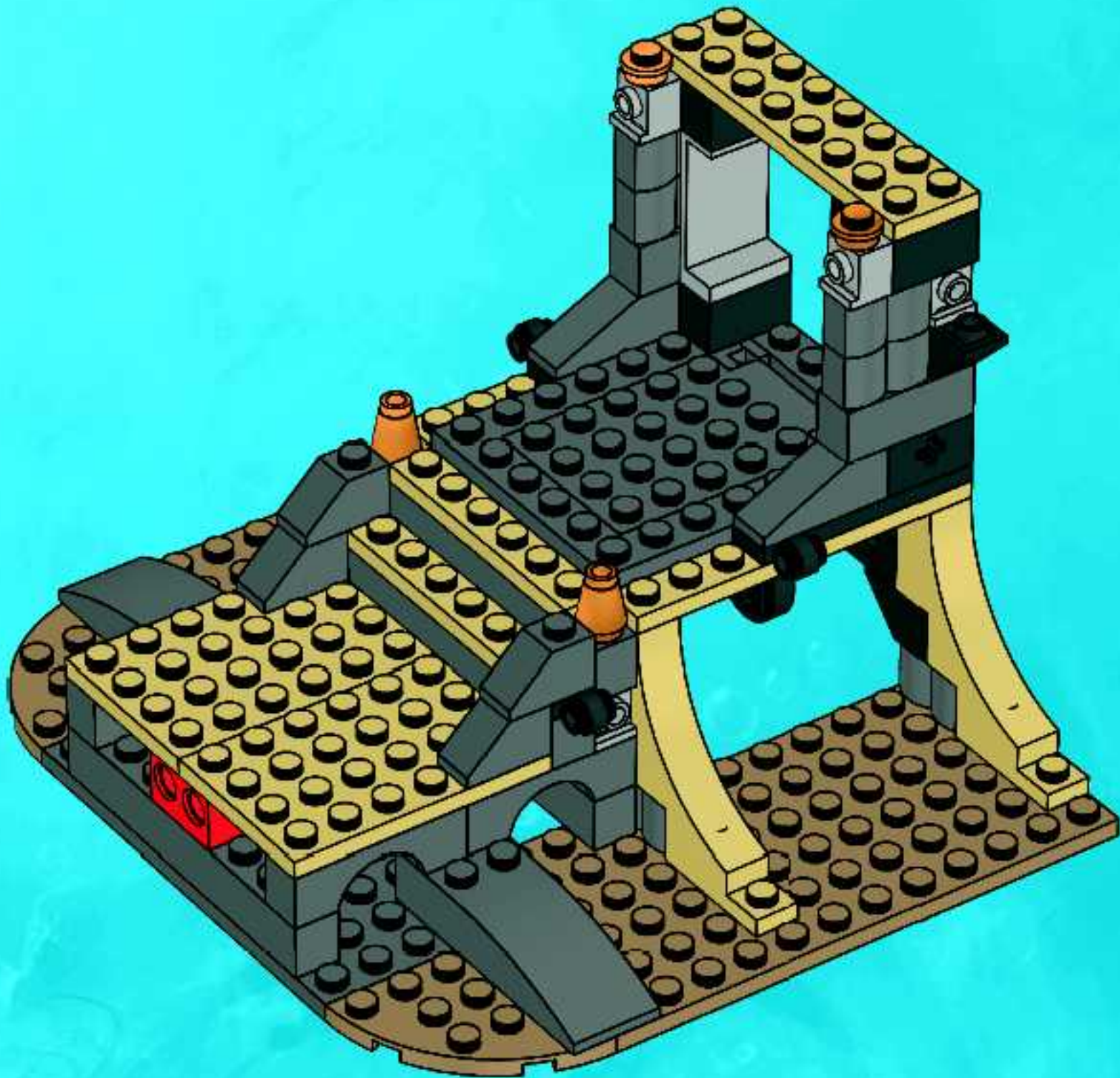





1x



2x

# 31

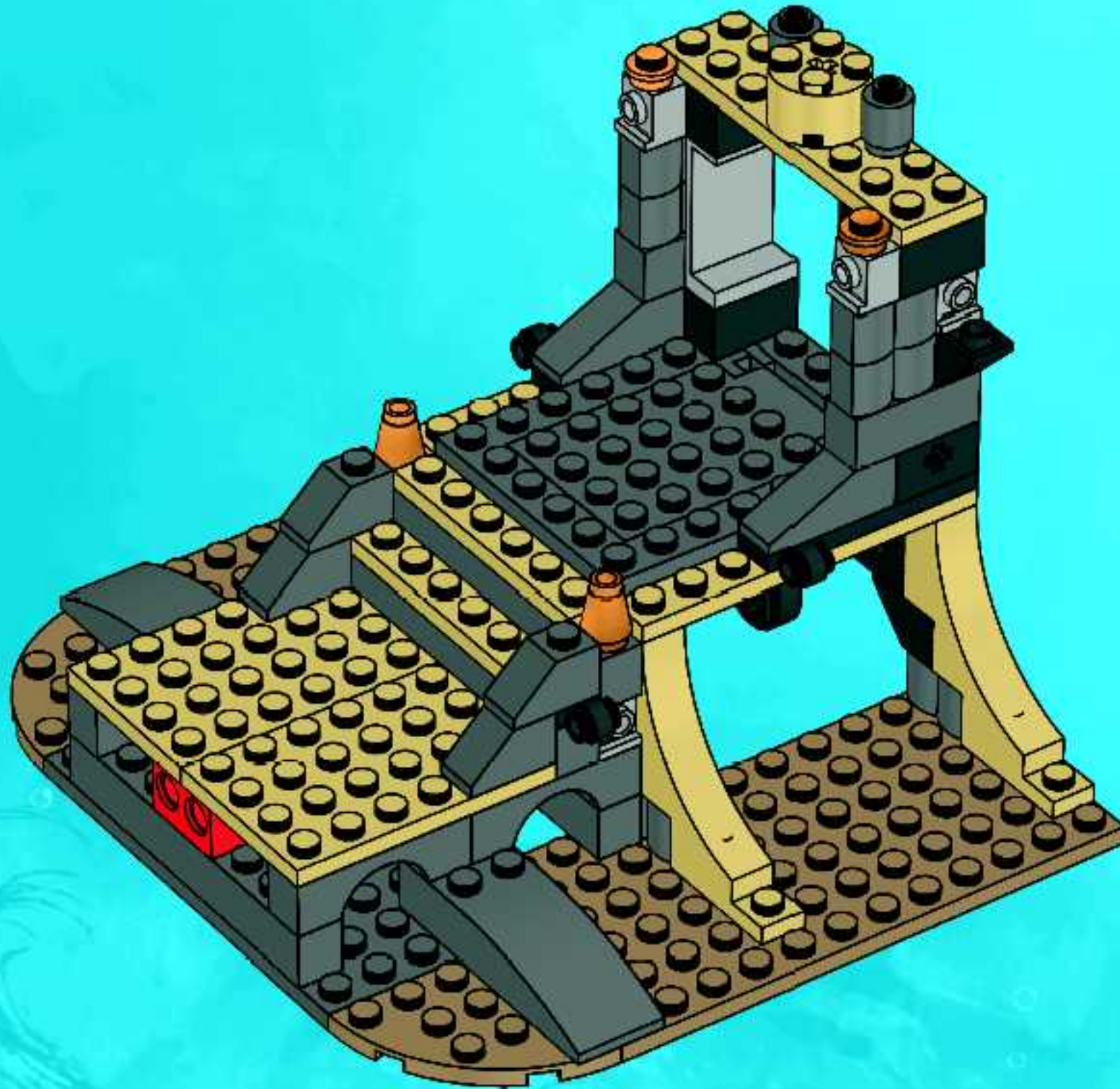



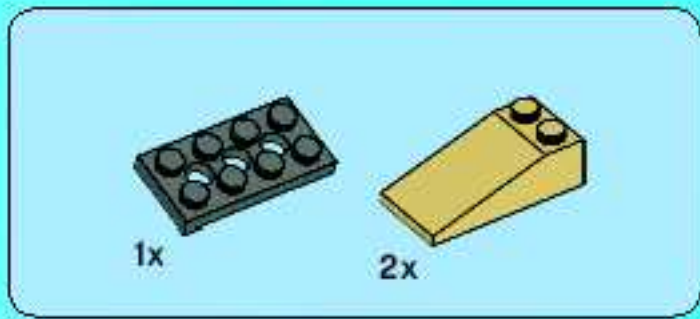

32

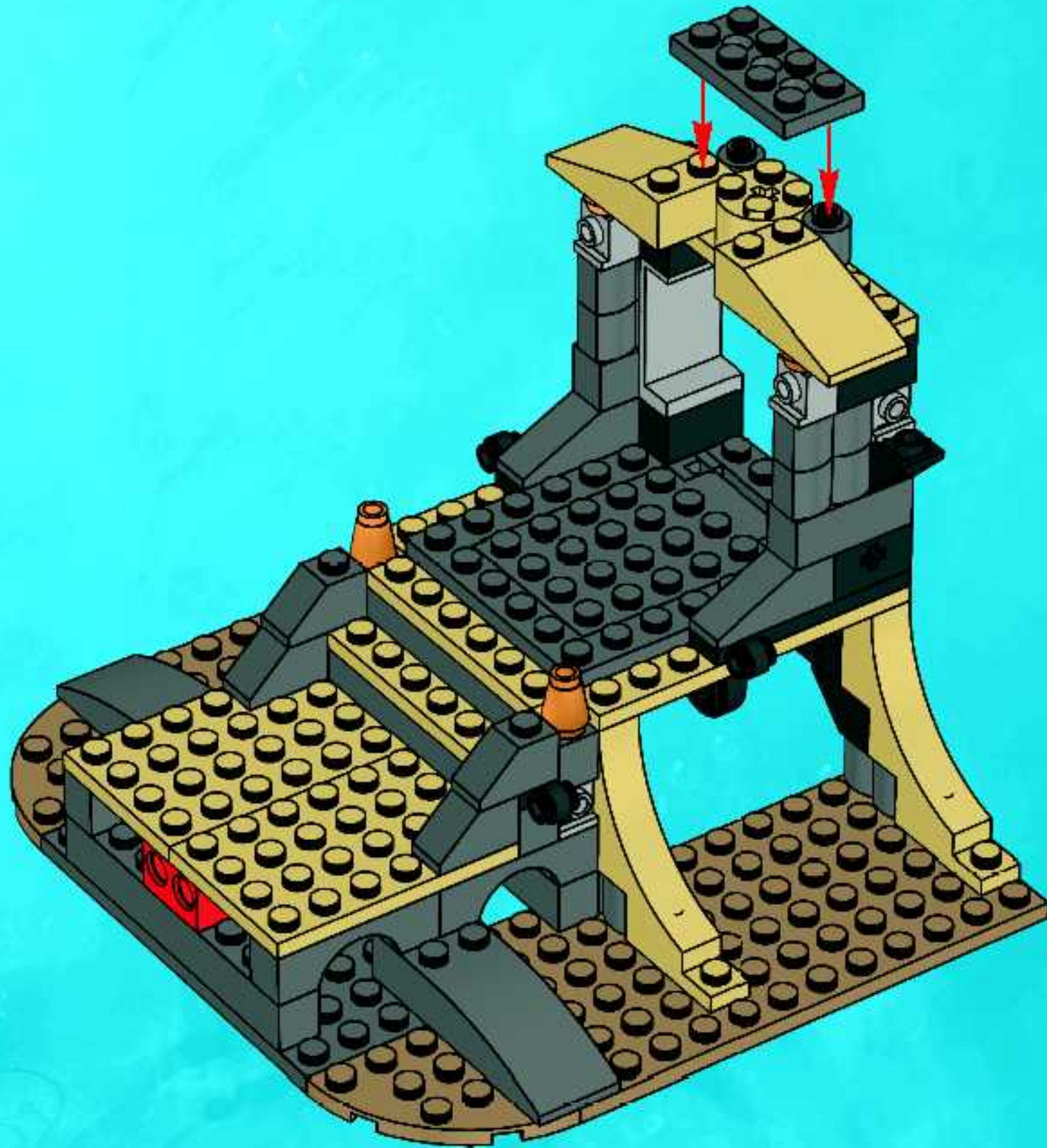





1x



1x

# 33

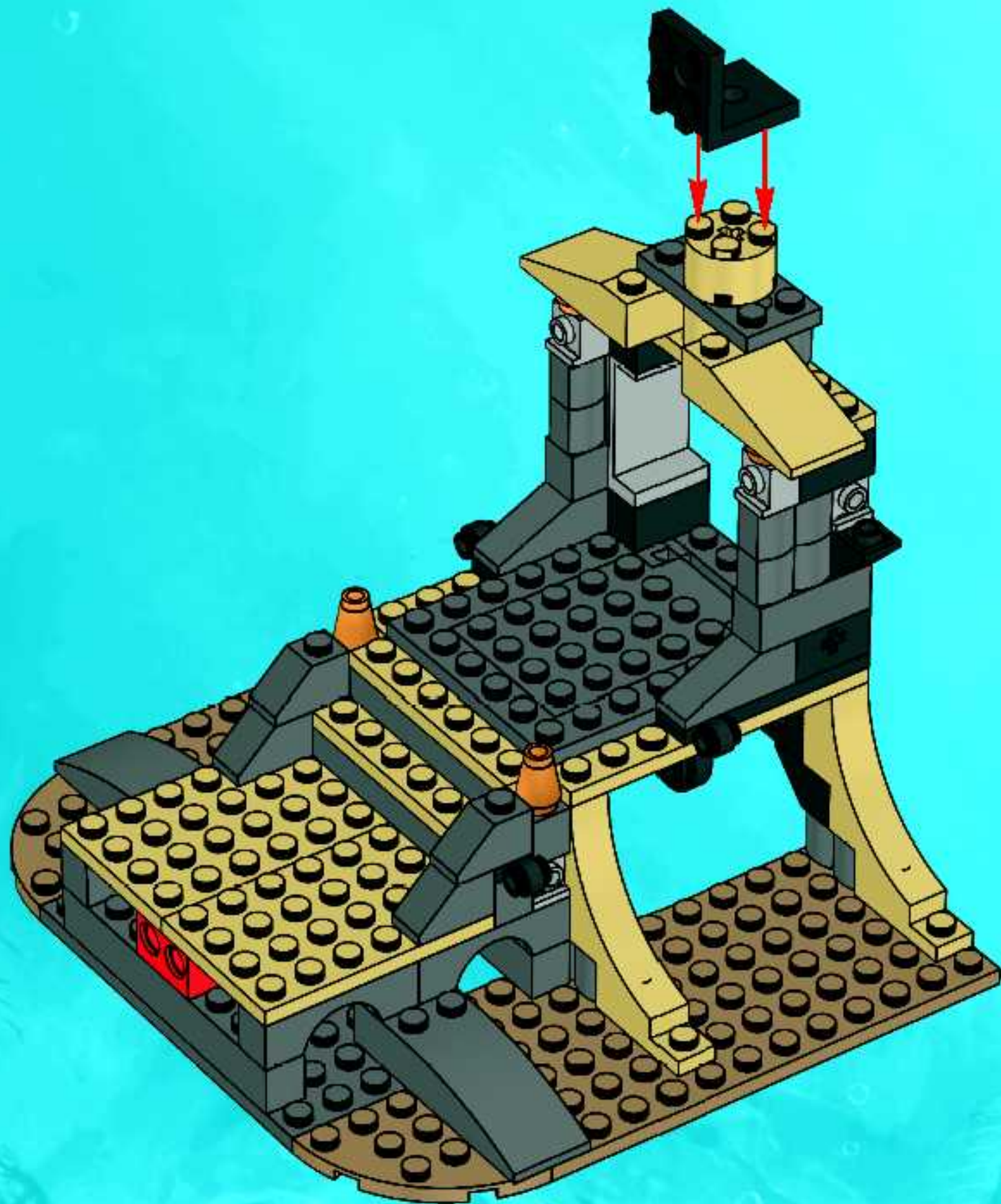



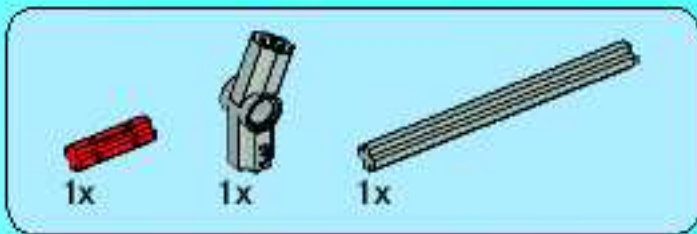

34

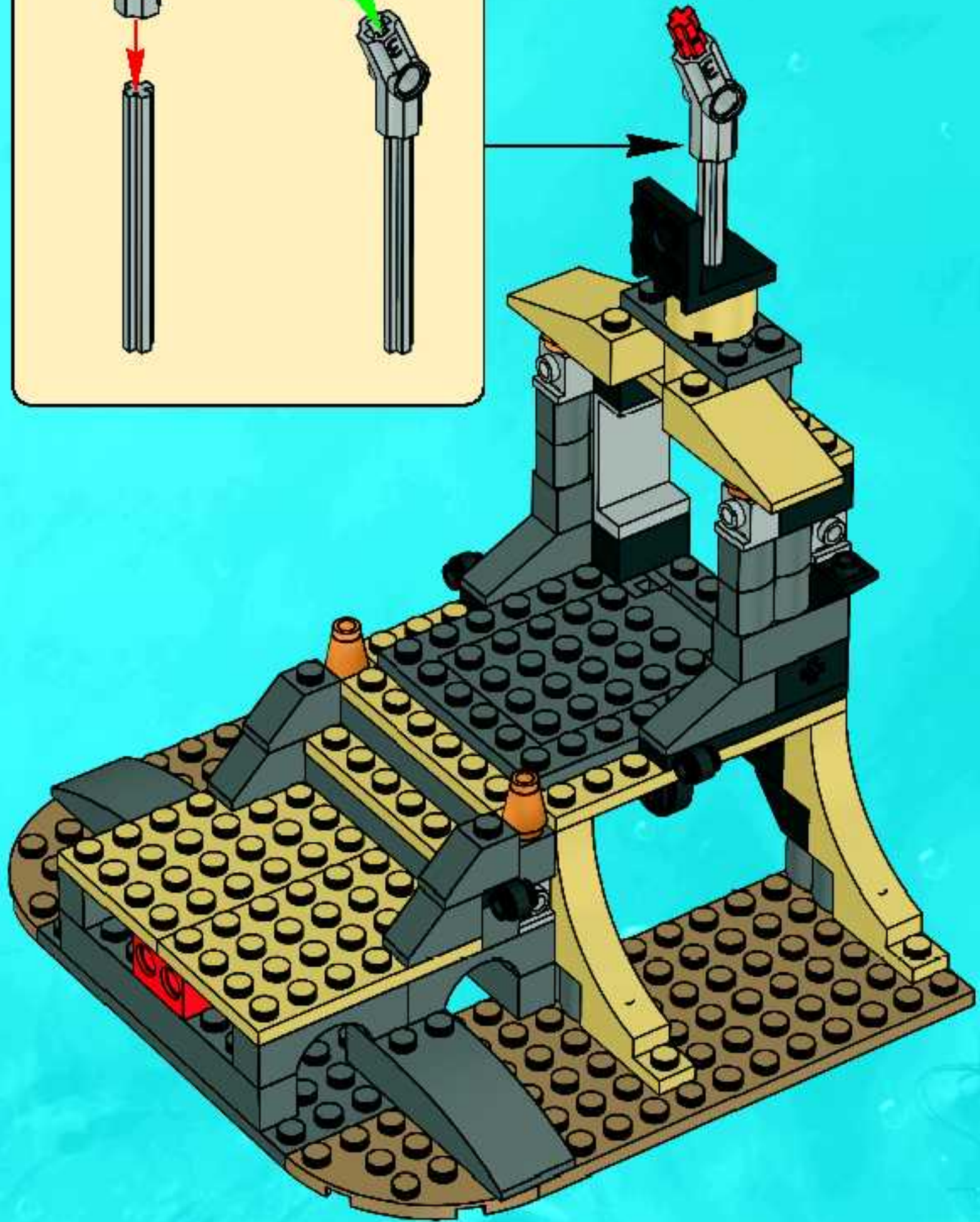
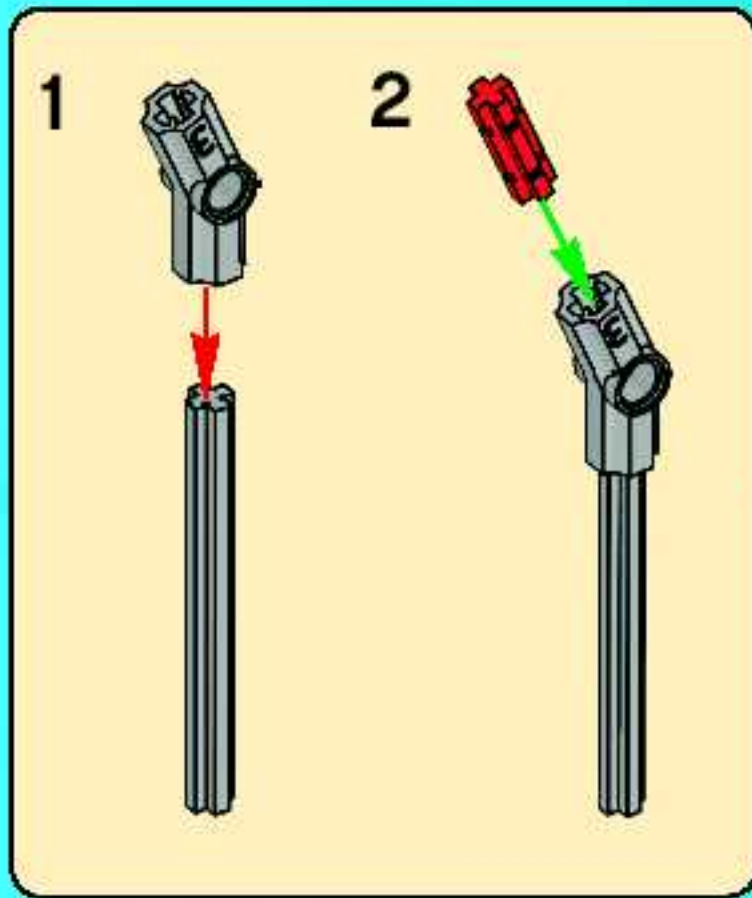





1x



2x



3x

# 35

1



2

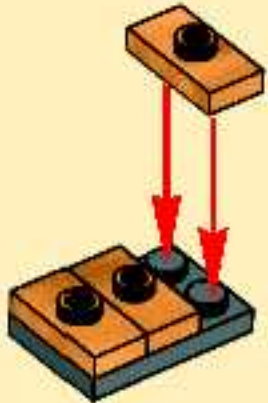

3

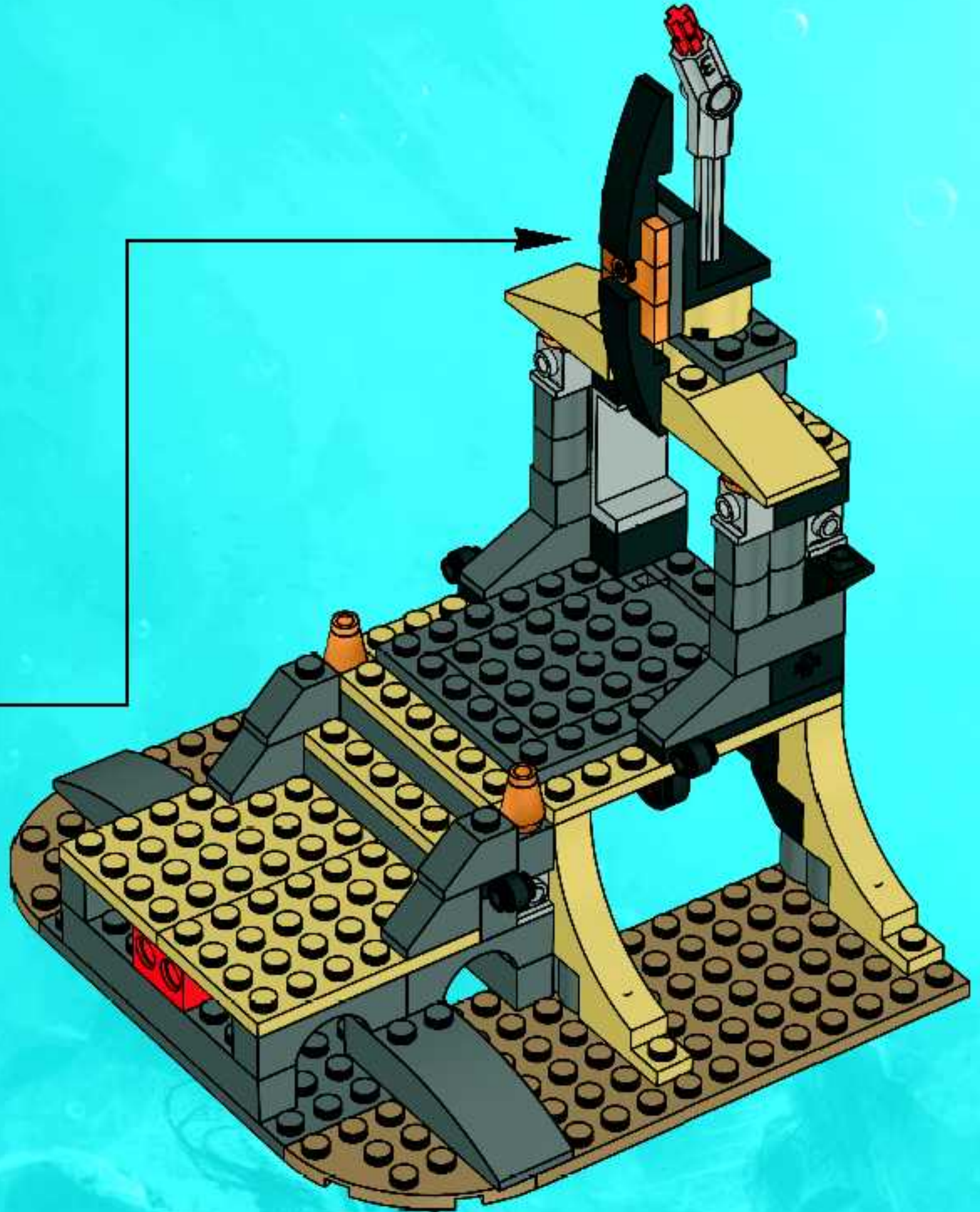
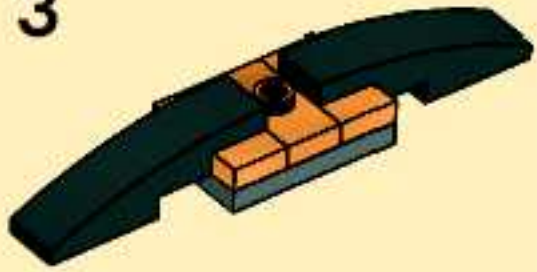



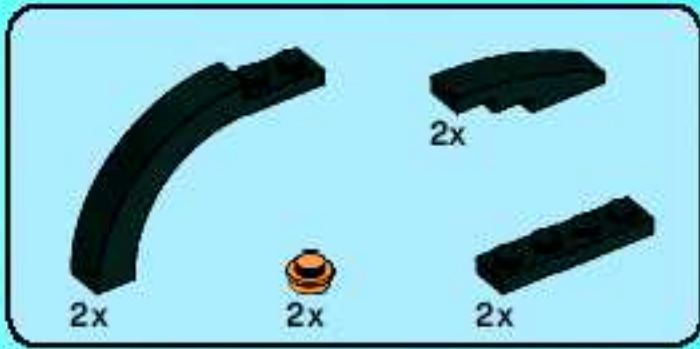

36

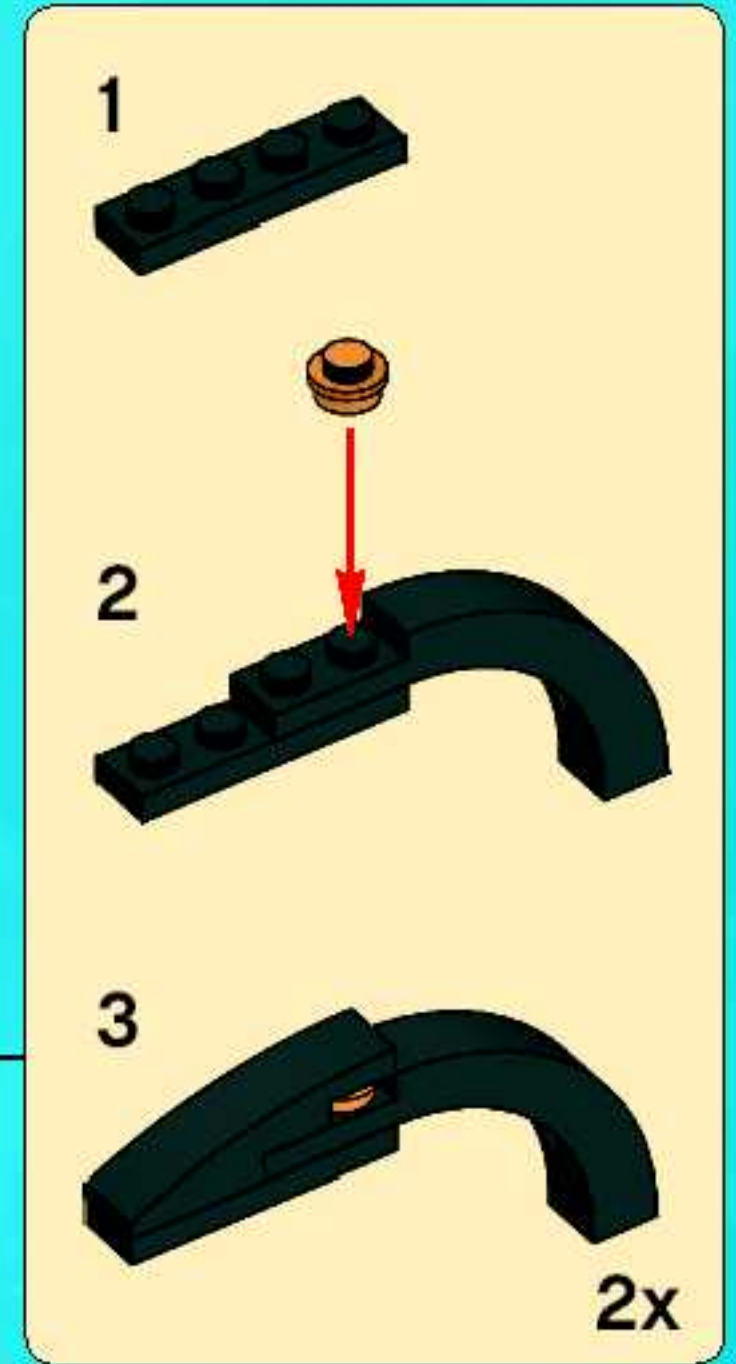
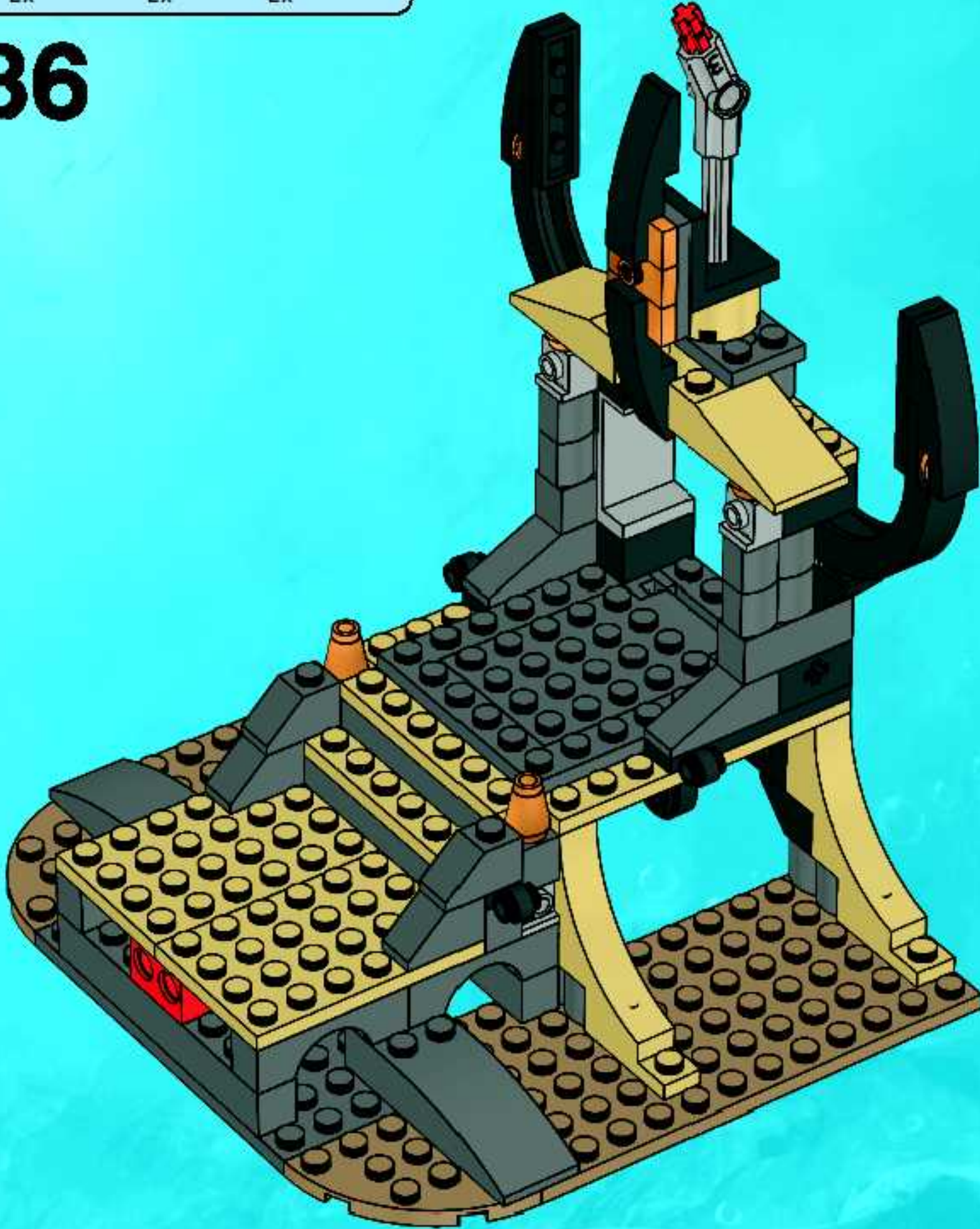



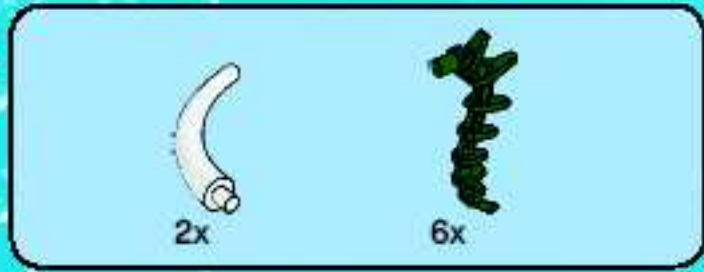

37





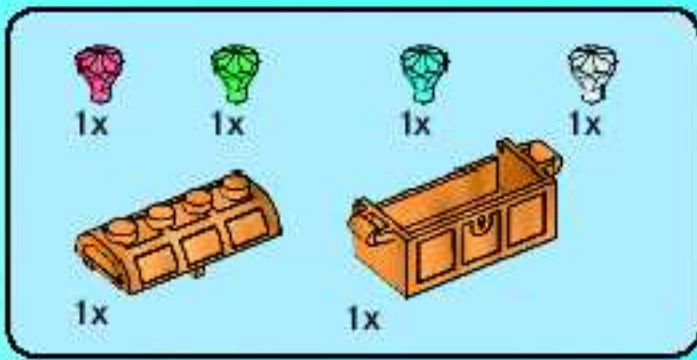

# 38

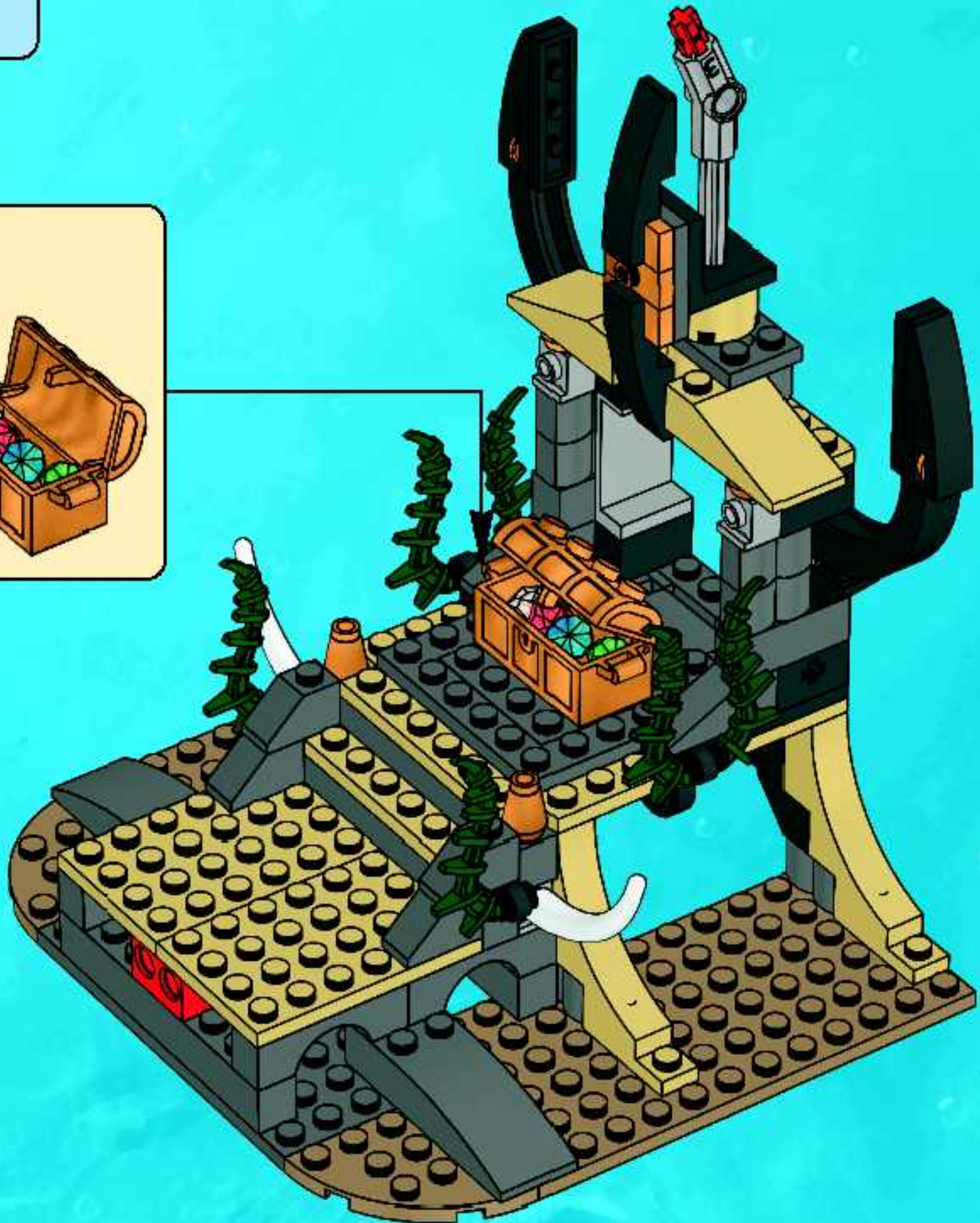
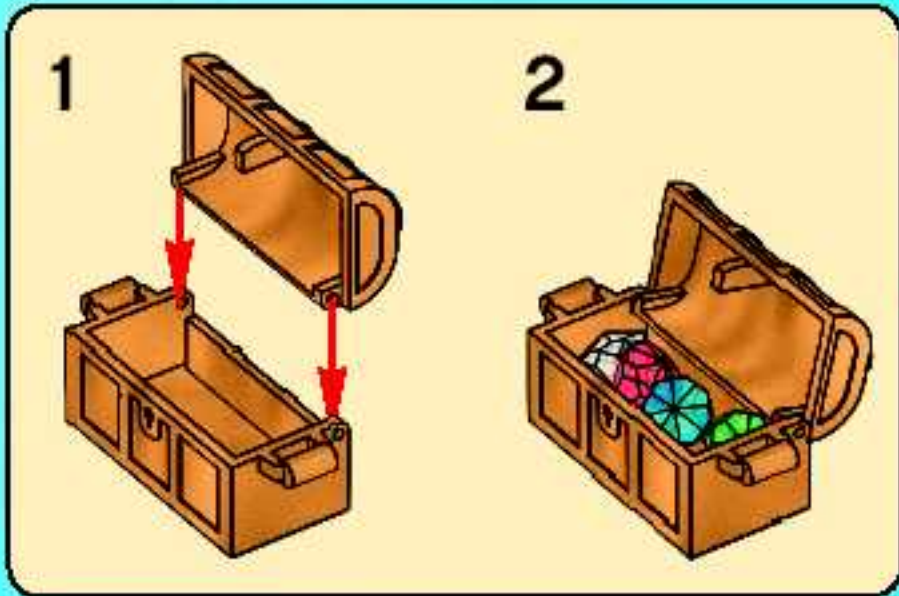



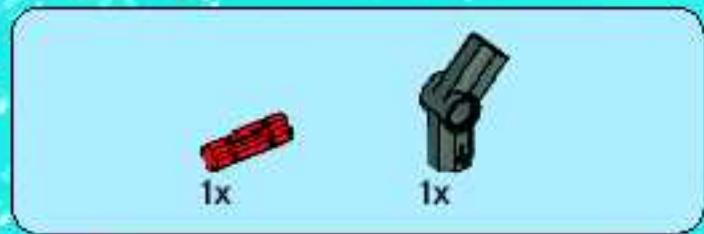

1

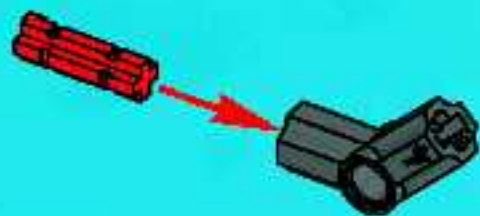

2



3

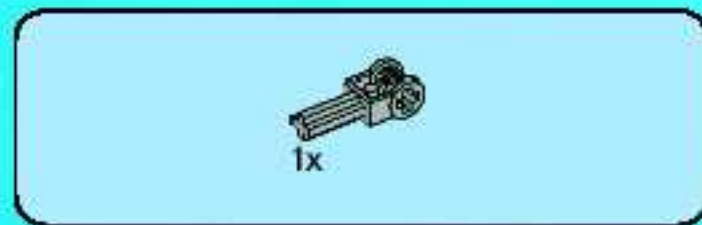
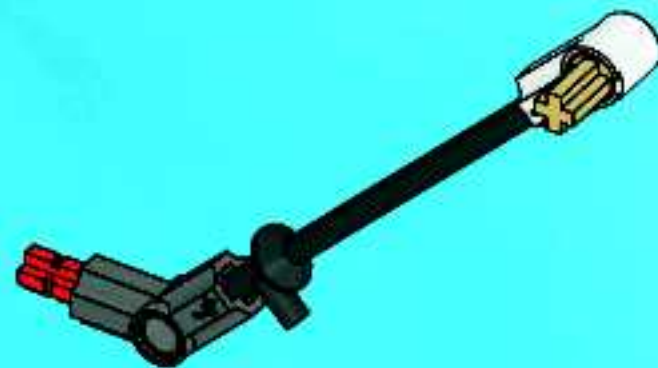

4





39

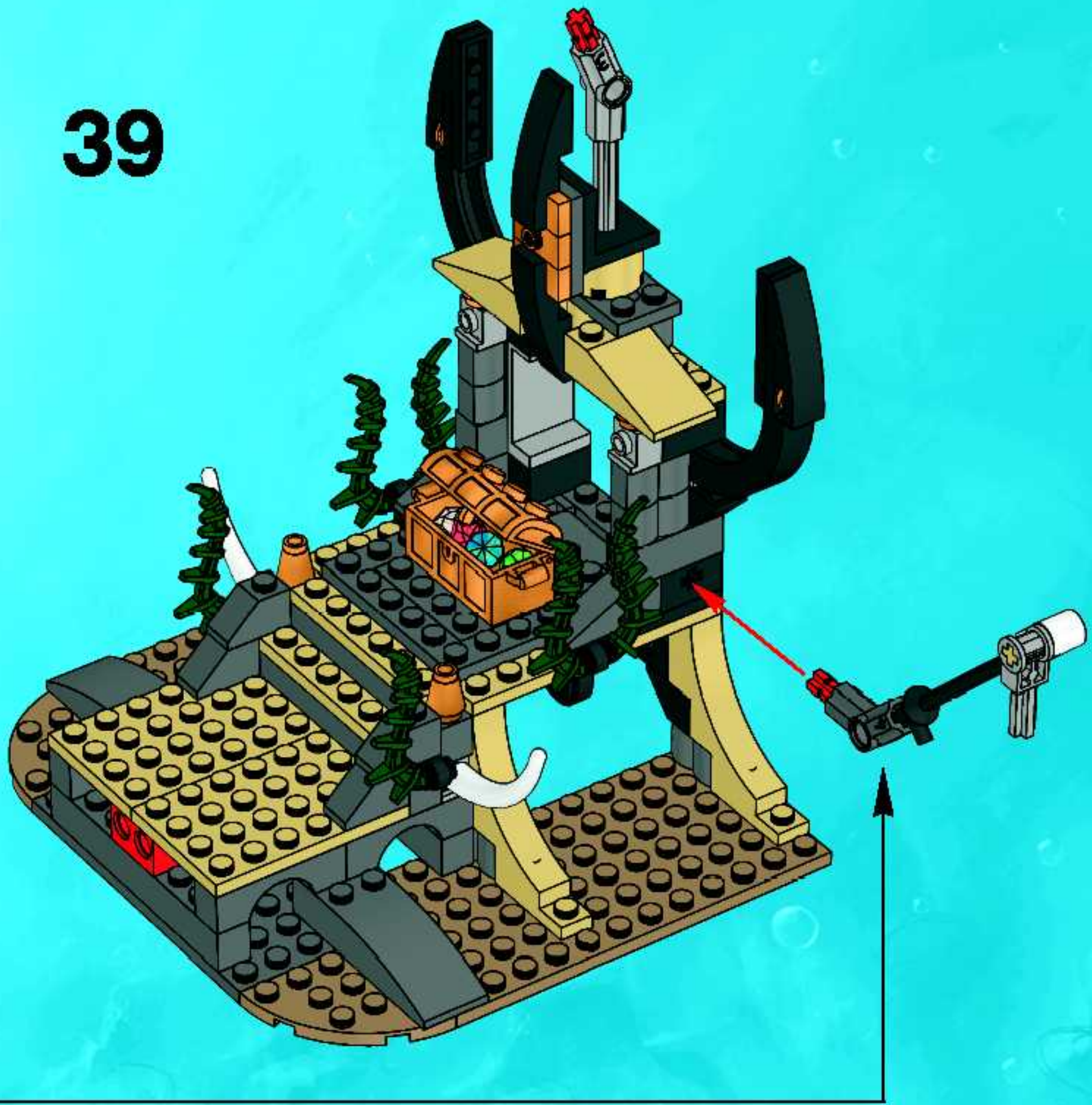



40

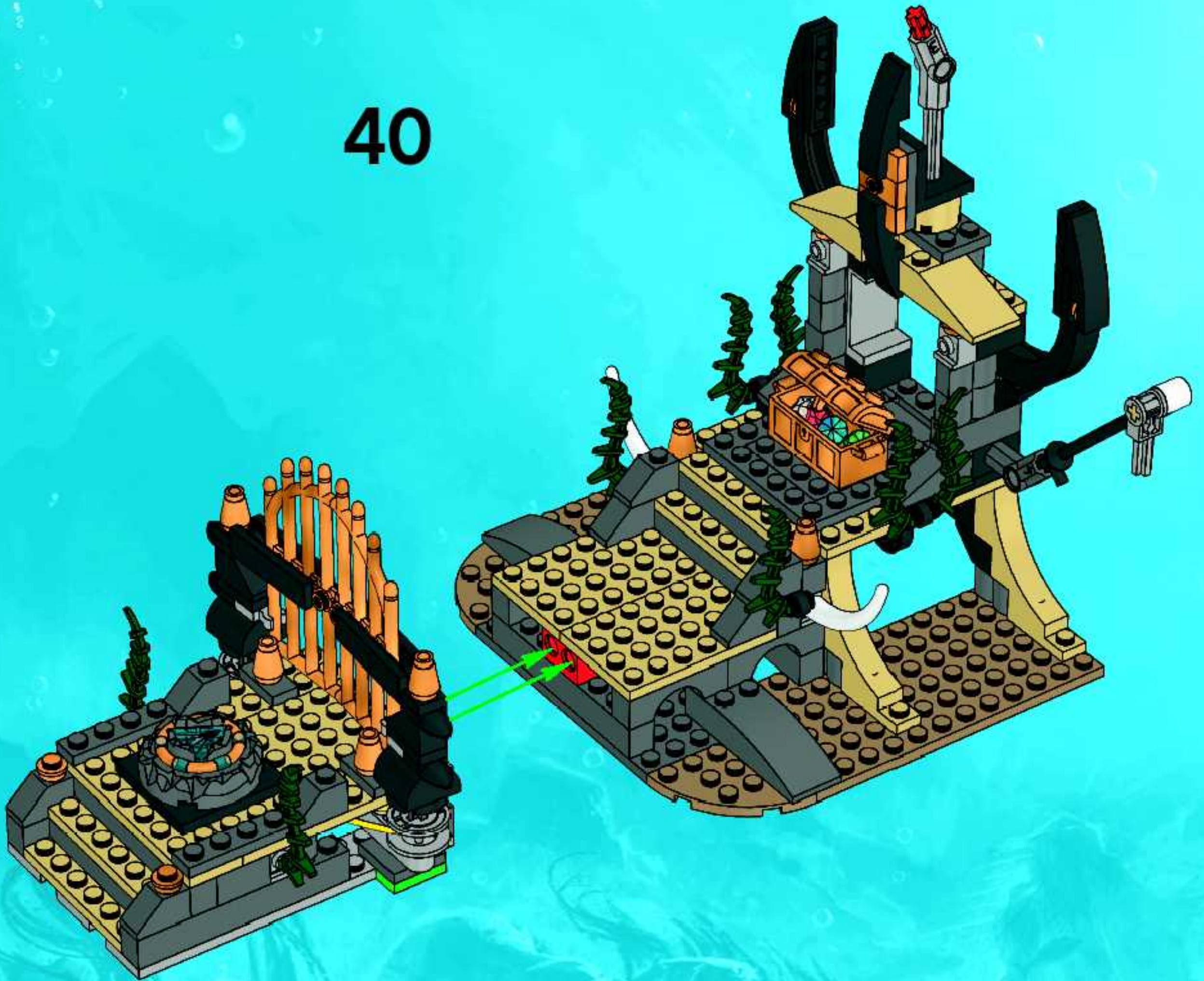



41

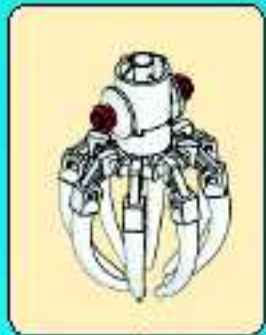



42

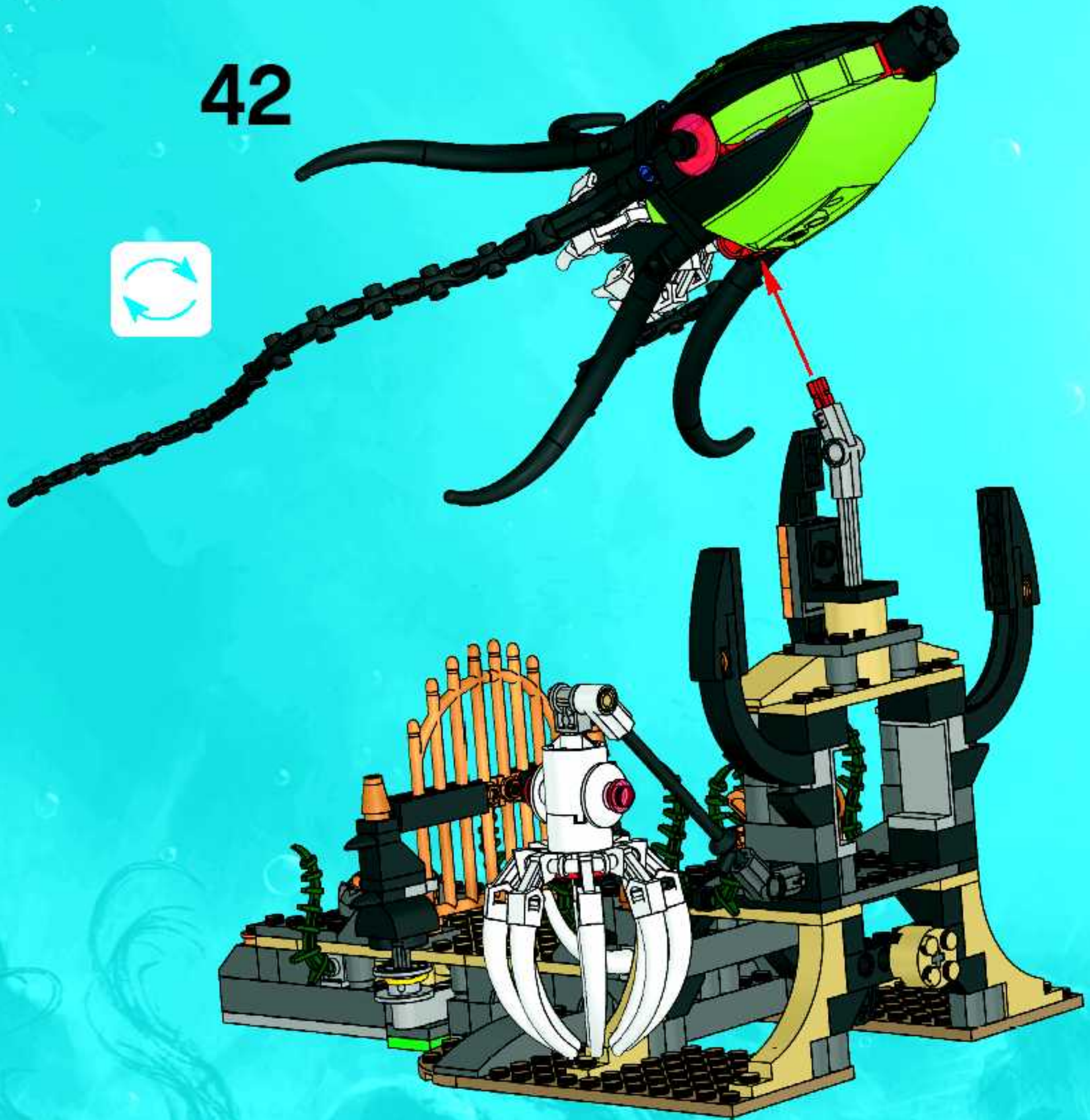











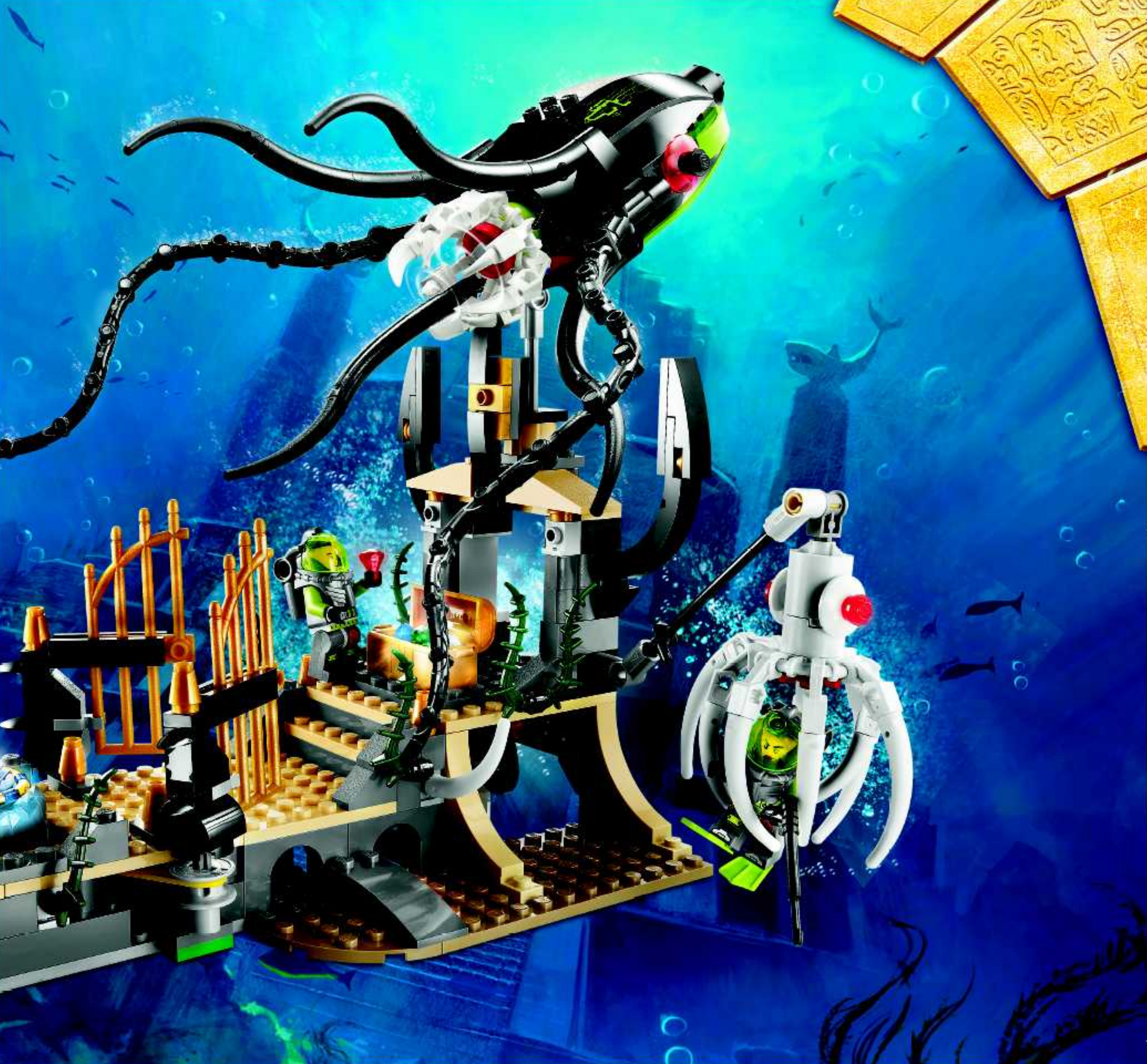



8060



8061



8075







8056



8057



8058



8059







# ATLANTIS

8056



8058



8057



8059





8061



8075







8056



8057



8058



8059



8060



8061



8075



ATLANTIS.LEGO.COM



ATLANTIS





2x  
4266897



2x  
4570451



8x  
4294148



1x  
4570532



1x  
4563475



1x  
4567459



1x  
4563657



10x  
4211476



1x  
4211660



1x  
4211466



3x  
4211360



2x  
4211479

52



2x  
4585429



3x  
4521532



1x  
4156151



4x  
4211483



1x  
4211552



1x  
4211815



1x  
4211536



1x  
4211805



2x  
4211104



2x  
4210875



8x  
4211099



13x  
4211095



8x  
4211135



4x  
4211000



2x  
4211045



4x  
4210999



2x  
4210873



1x  
4211043



2x  
4211001



1x  
4211122



2x  
4211119



5x  
4211129



1x  
4227398



6x  
4211090

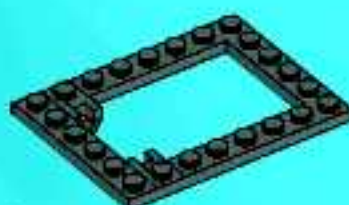

1x  
4210784



1x  
4211077



2x  
4570036



2x  
4563473



1x  
4289542



1x  
4563480



2x  
4568036



1x  
4210688



4x  
4560177



2x  
4568967



3x  
4523157



6x  
4529247



6x  
4523159



1x  
4541394



1x  
4541393



1x  
4563483



1x  
4527943



2x  
4504372



2x  
4537925



2x  
4537928



1x  
4563327



1x  
614301



2x  
4569900



2x  
302328



1x  
4248937



2x  
3005741



2x  
4142995



1x  
4113954

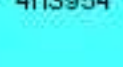

1x  
4119483

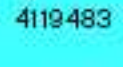

1x  
4570660

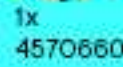

1x  
4113955



2x  
4570738



1x  
614301





1x  
4194010

3x  
4114001

2x  
4544151

1x  
4160108

4x  
4508453

1x  
370726

2x  
3003301

6x  
4113988

1x  
4570014

1x  
4160130

4x  
4492779

2x  
4107082

2x  
474001

1x  
4158867

1x  
4549621

1x  
4161281

4x  
4563474

2x  
614126

16x  
4296948

1x  
4186017

1x  
4233487

1x  
4506636

4x  
4273590

4x  
4121715

4x  
4568387

2x  
4558886

1x  
614326

2x  
302326



4x  
4566256

3x  
370021

1x  
4500978

4x  
243126

1x  
4517986

4x  
4522034

10x  
4508454

1x  
4179355

2x  
3200026

4x  
371026



1x  
4512363

1x  
4118981

2x  
408521



6x  
408126



2x  
403226

5x  
4125220

2x  
403221

10x  
366526



2x  
4121966



2x  
4530709

1x  
4128598

2x  
4200023

1x  
395626

4x  
4570498

2x  
4227155



3x  
300326

2x  
4505942

4x  
4124067

8x  
4206482

1x  
4161266

1x  
384926



Customer Service  
Kundenservice  
Service Consommateurs  
Servicio Al Consumidor

[www.lego.com/service](http://www.lego.com/service) or dial



: 00800 5346 5555

: 1-800-422-5346



FREE! GRATIS! GRATUIT!



www.LEGOclub.com



00800 5346 5555\*        

  1-866-534-6258 • 1-877-518-5346

US & Canada only

Canada seulement



VISIT THE WORLD'S  
BIGGEST LEGO® SHOP!

[www.LEGOshop.com](http://www.LEGOshop.com)

\* Prephone. Mobile charges may apply. \* Numéro sans frais. Les frais peuvent s'appliquer avec les téléphones cellulaires. \* Gebührenfrei. Kosten für Anrufe aus Mobilfunknetzen können anfallen.  
\* gratis telefontummer via Postale Itp. \* Numero gratis numero, altri di pagare Pro Postale Itp. \* Det är gratis, när du ringer från en Postale Itp.









# WIN!

Go to [www.nielsen.com/LEGO](http://www.nielsen.com/LEGO)  
to fill out a survey for a chance  
to win a cool LEGO® Product.  
No purchase necessary.  
Open to all residents where not prohibited.

 [www.LEGO.com](http://www.LEGO.com)



## [www.nielsen.com/LEGO](http://www.nielsen.com/LEGO)

### GEWINNE! WIN!

Nimm an der Umfrage auf  
[www.nielsen.com/](http://www.nielsen.com/)  
LEGO teil und hab die Chance ein cooles  
LEGO® Produkt zu gewinnen!

Die Teilnahme am Gewinnspiel führt zu keinerlei  
Kaufverpflichtungen. Teilnahme in allen nicht  
ausgeschlossenen Ländern möglich.

Ga naar [www.nielsen.com/LEGO](http://www.nielsen.com/LEGO),  
vul een enquêteformulier in en  
maak kans op een  
cool LEGO® product.

Geen aankoopverplichting.  
Iedereen mag deelnemen, uitgezonderd  
ingezonden  
van landen waar een enquêteverbod geldt.

### GAGNE! 当てよう!

Visite [www.nielsen.com/LEGO](http://www.nielsen.com/LEGO)  
pour répondre à un questionnaire  
et avoir une chance de gagner  
un produit LEGO® très cool!

Aucune obligation d'achat.  
Ouvert à tous les résidents des pays  
autorisés.

[www.nielsen.com/LEGO](http://www.nielsen.com/LEGO)にアクセスして、アンケ  
ートにご記入ください。当選者にはレゴ製品を  
差し上げます。

お買い上げの必要はありません。

禁止されていない限り、すべての年齢にご利用いただけます。