

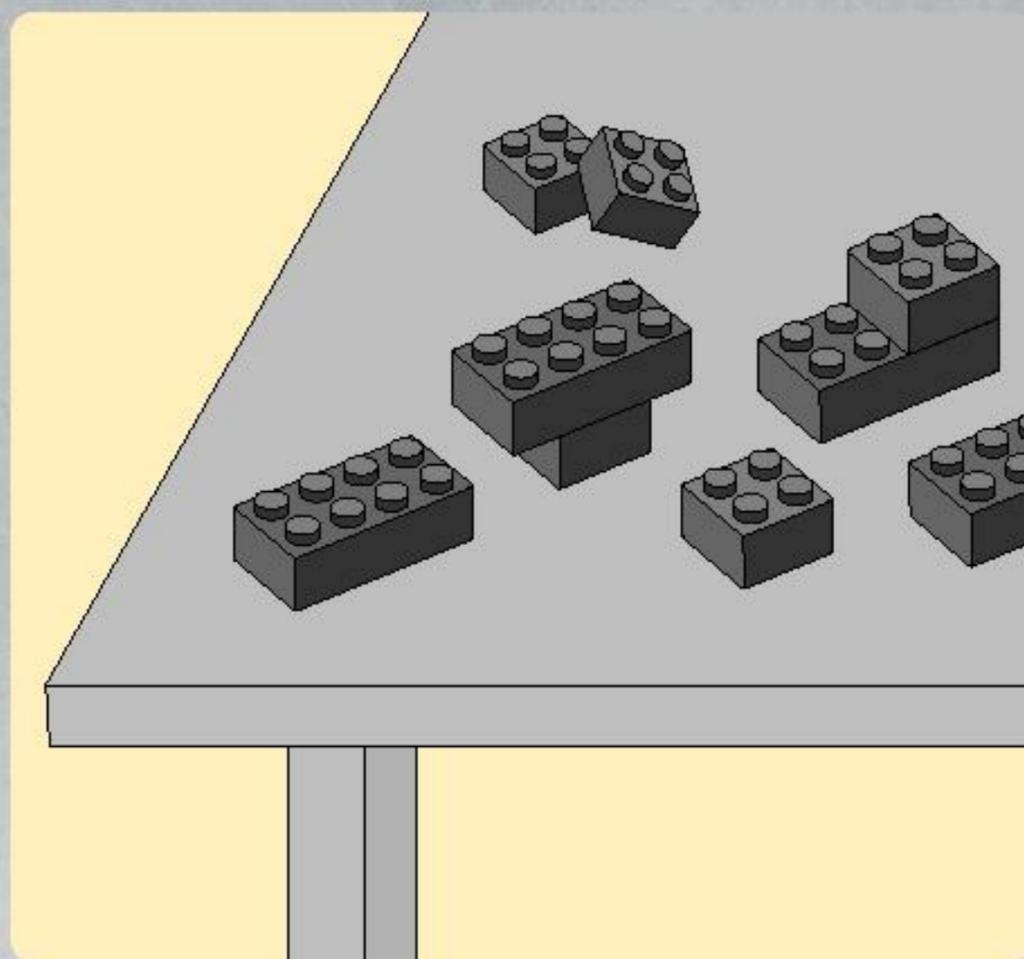

1

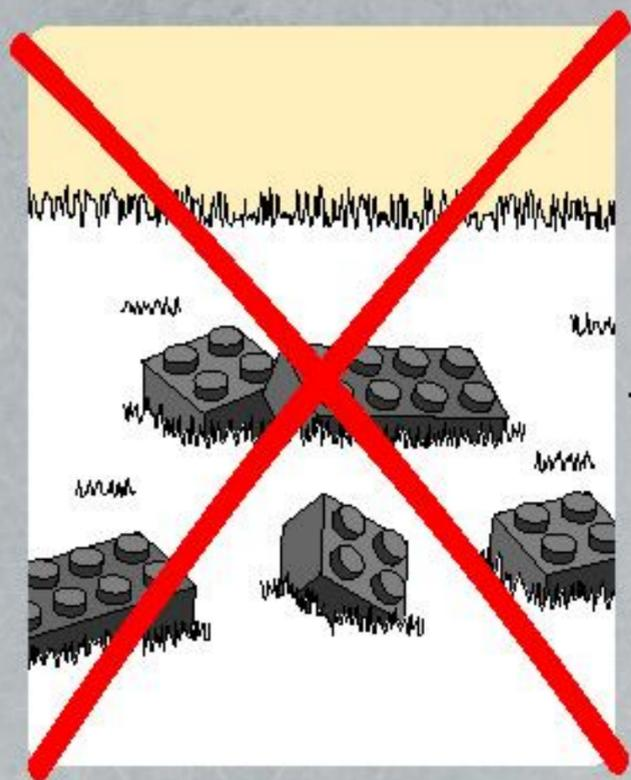

2



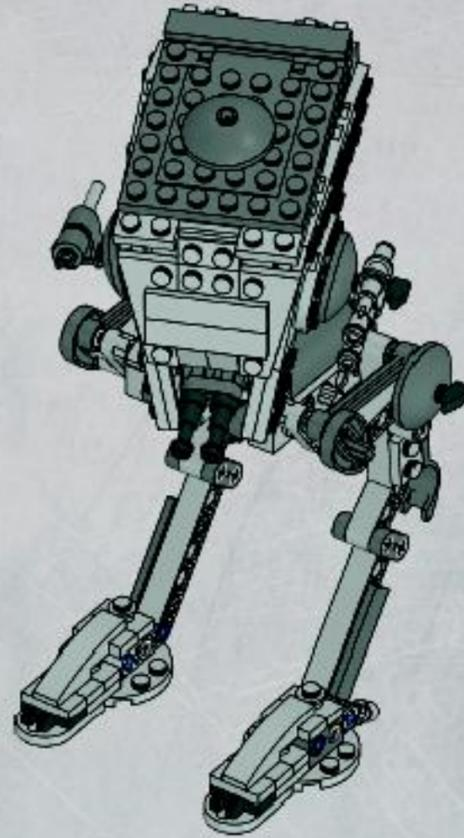
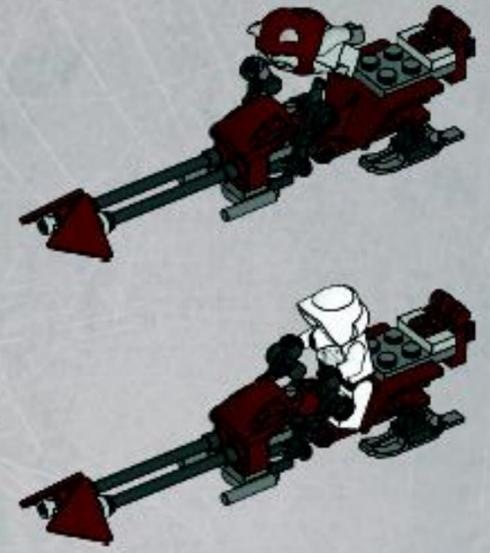
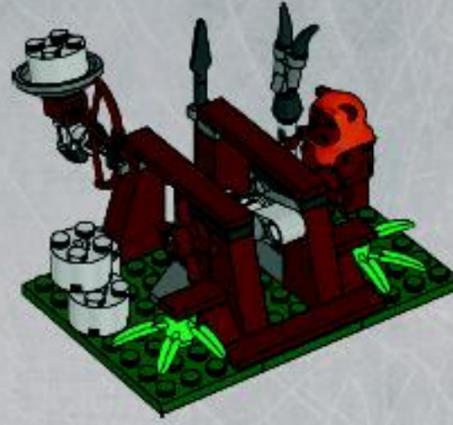
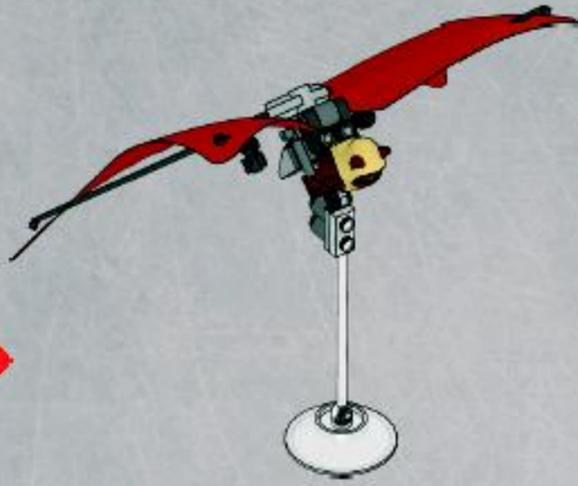

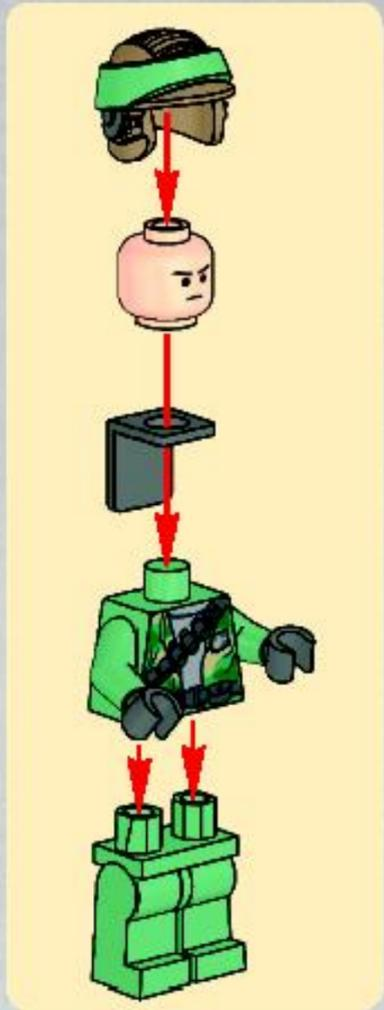
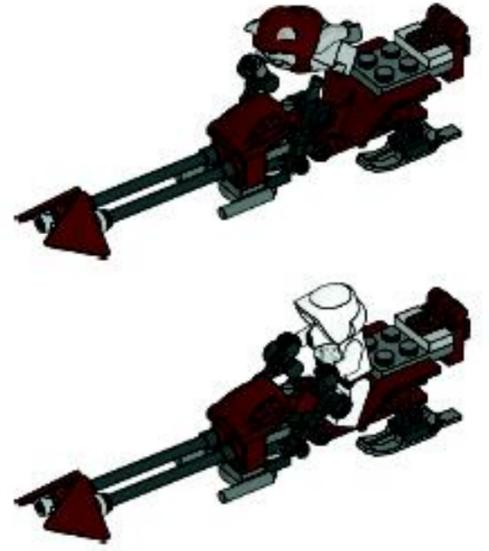
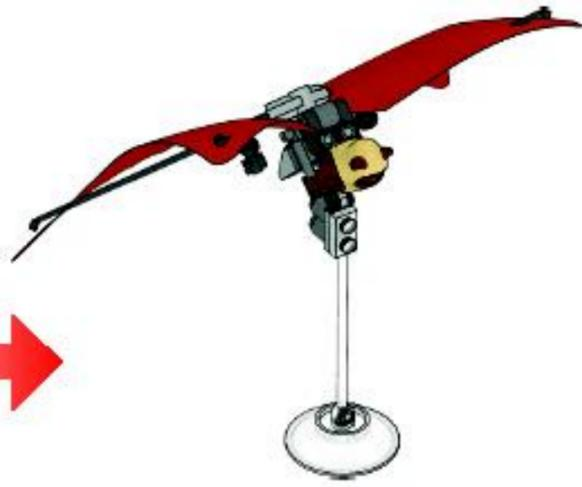

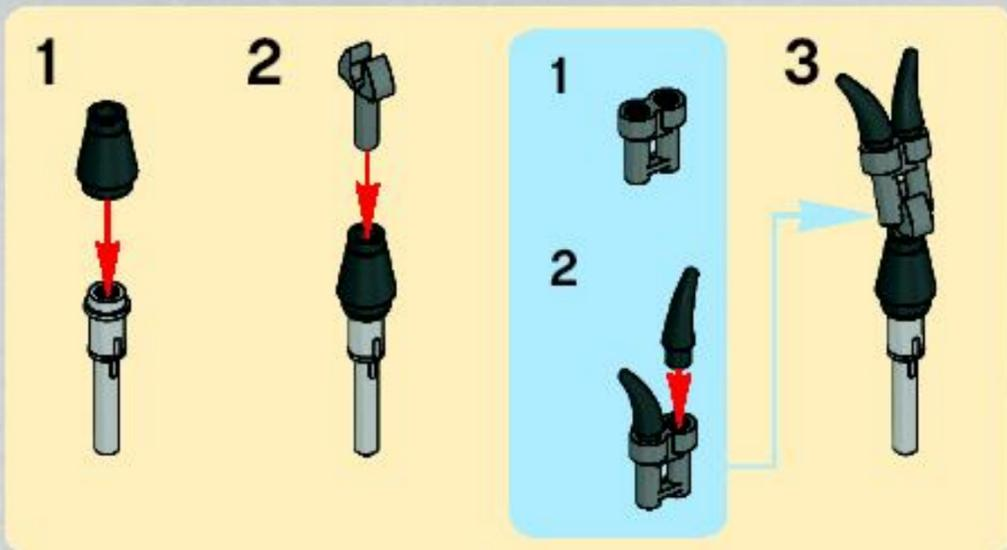
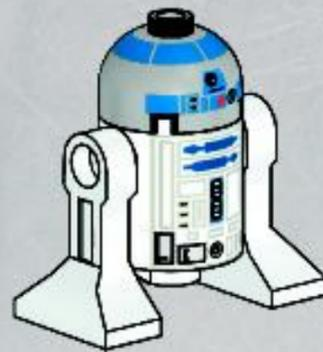
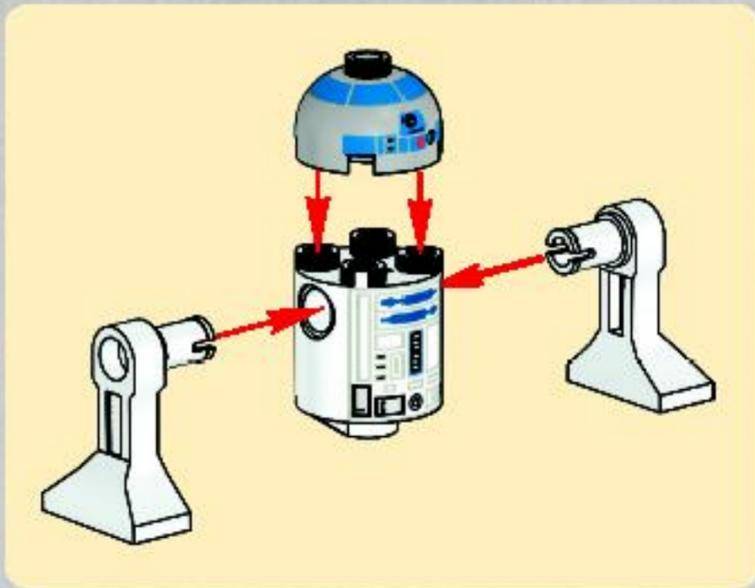

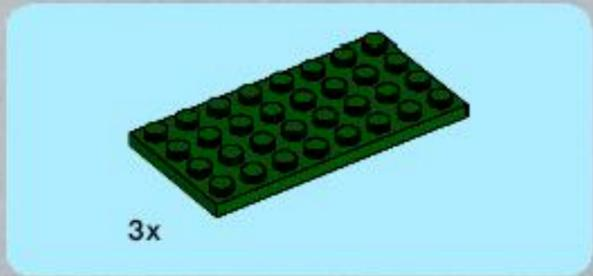
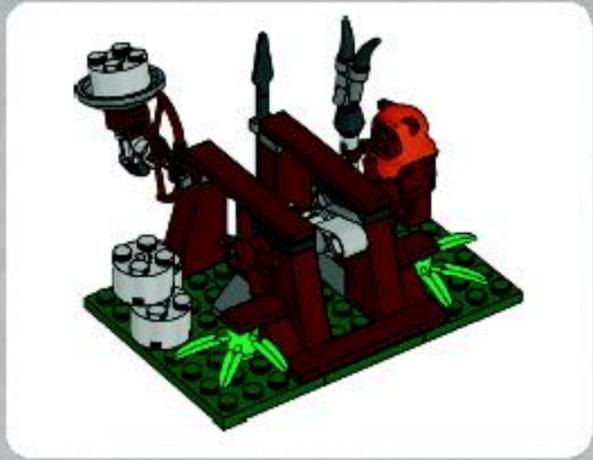

1

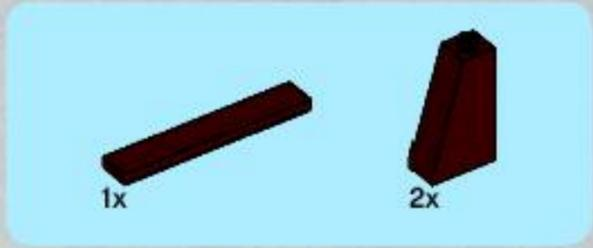
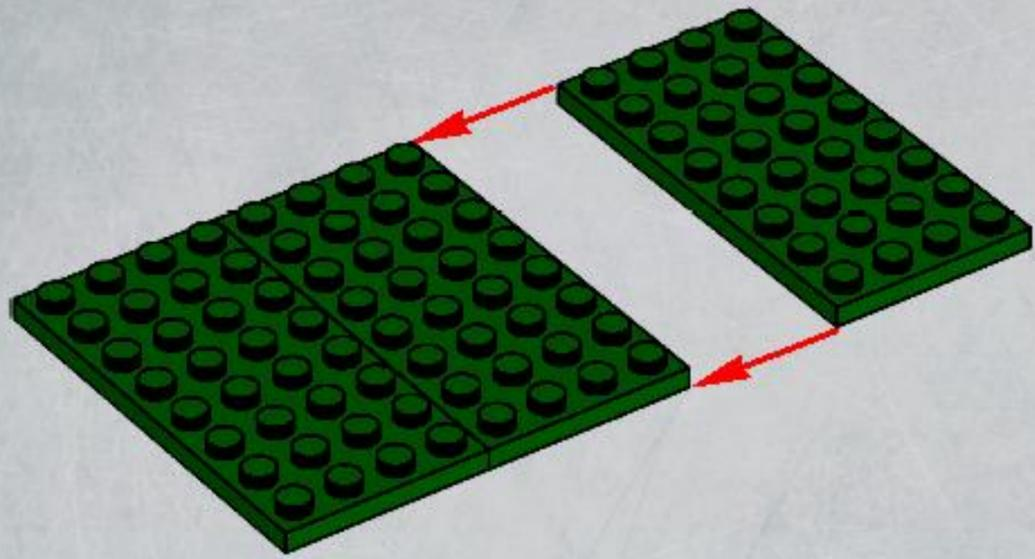

2

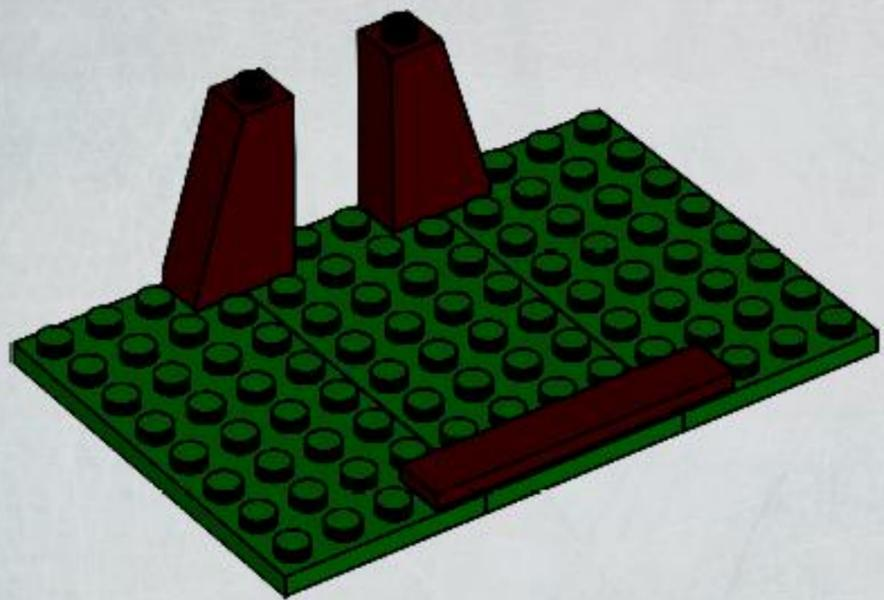



2x



2x

# 3

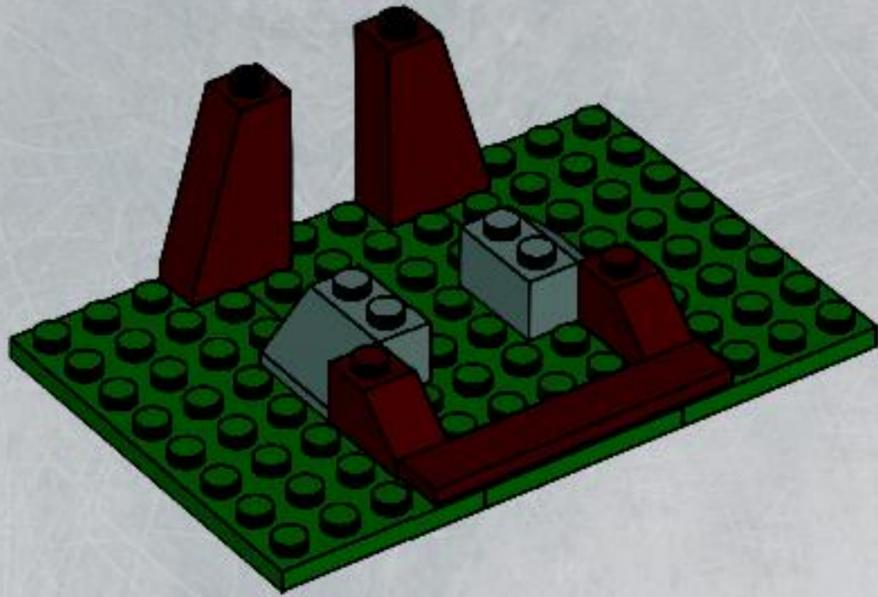

2x



2x



1x

# 5

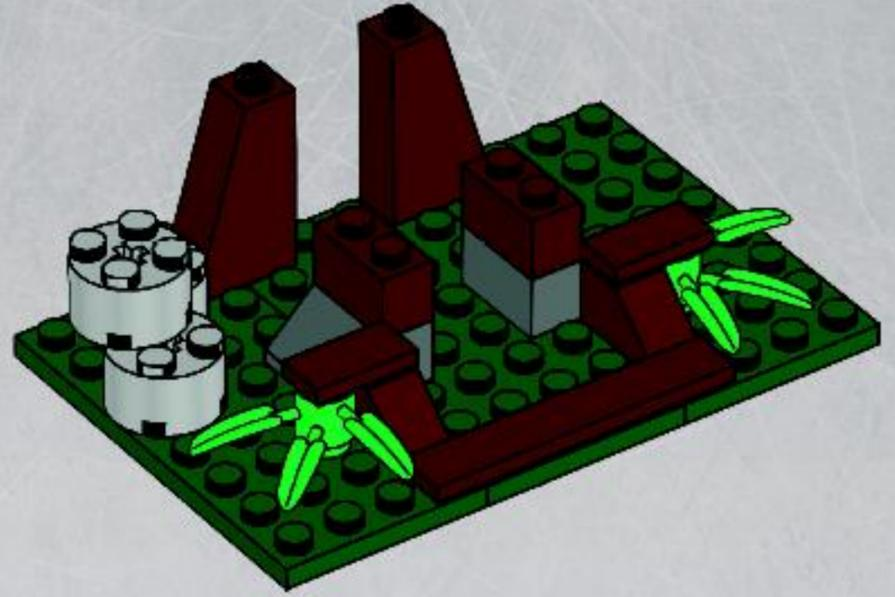

2x



2x

# 4

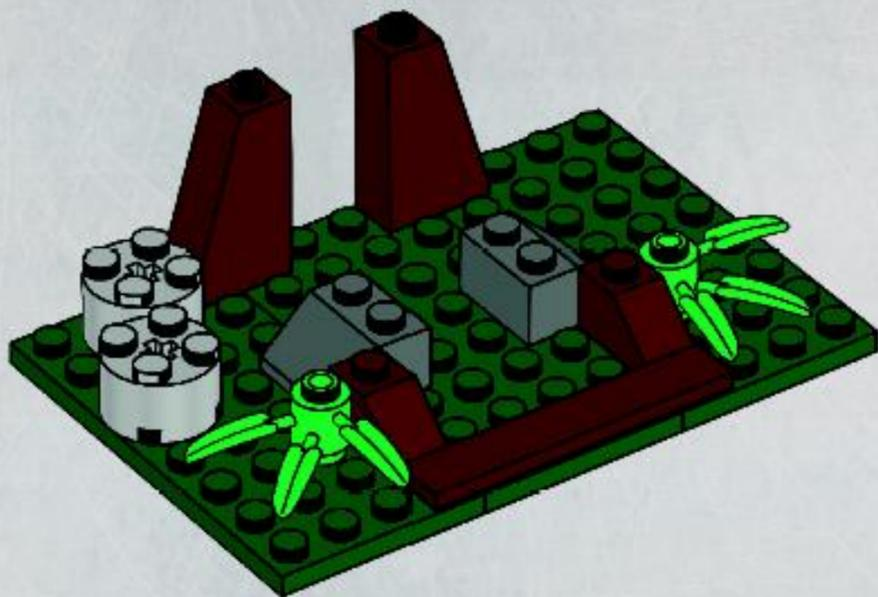

2x

# 6

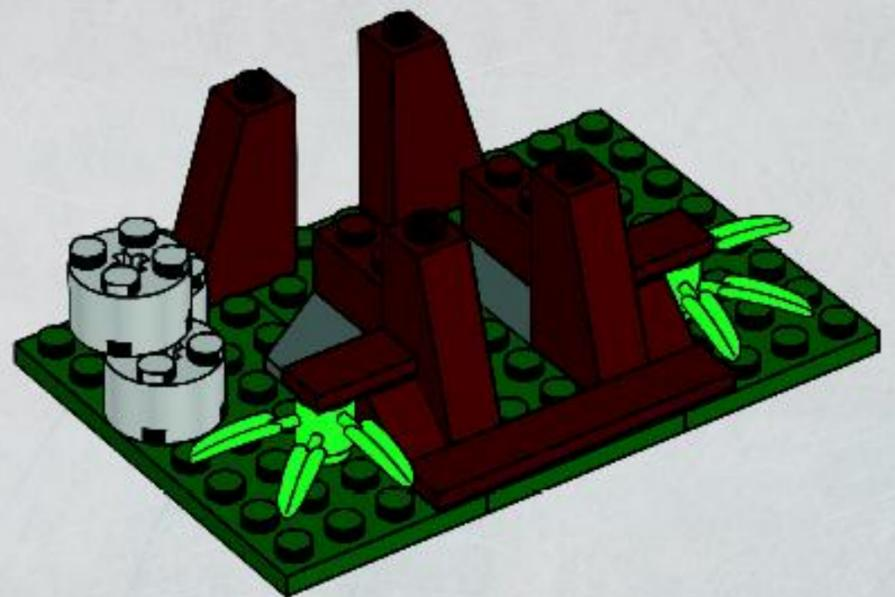





6

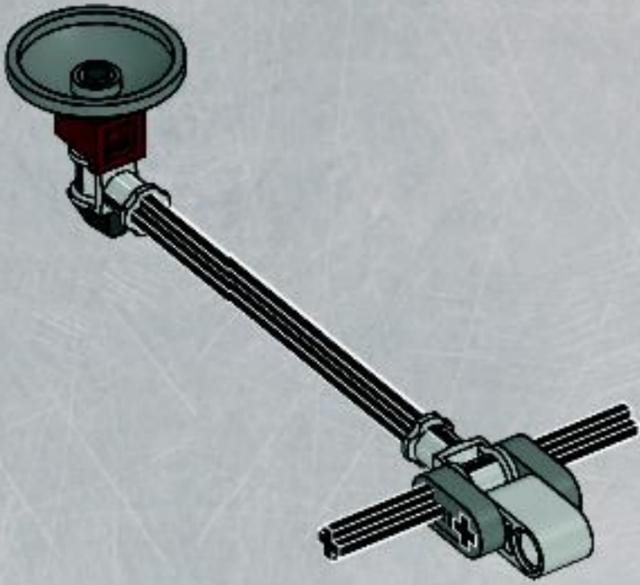

7

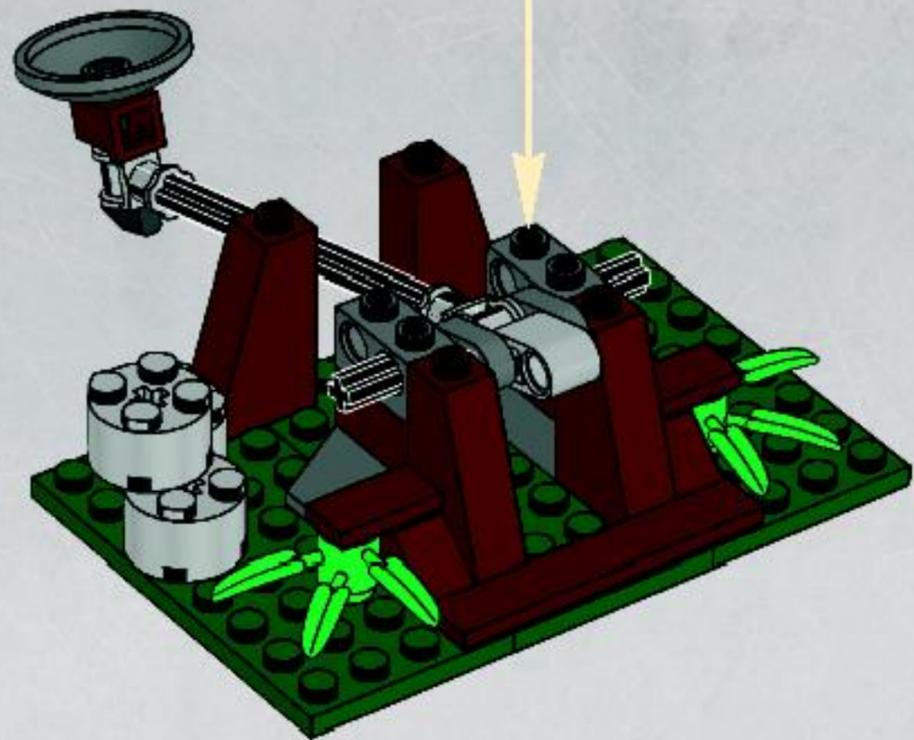
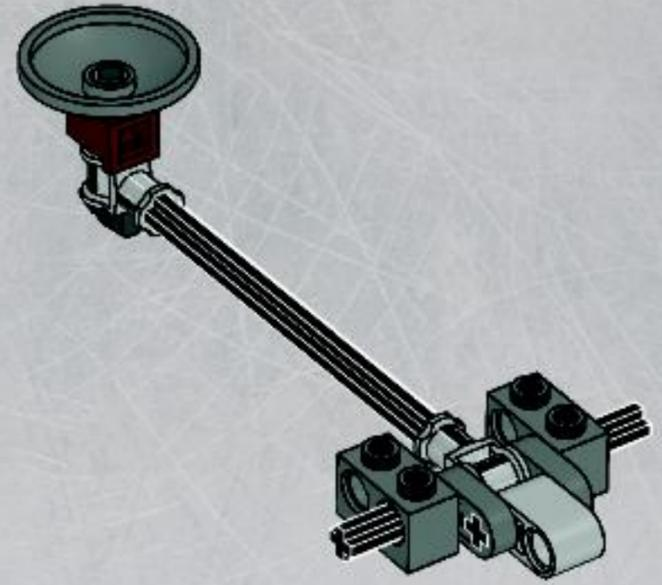



8

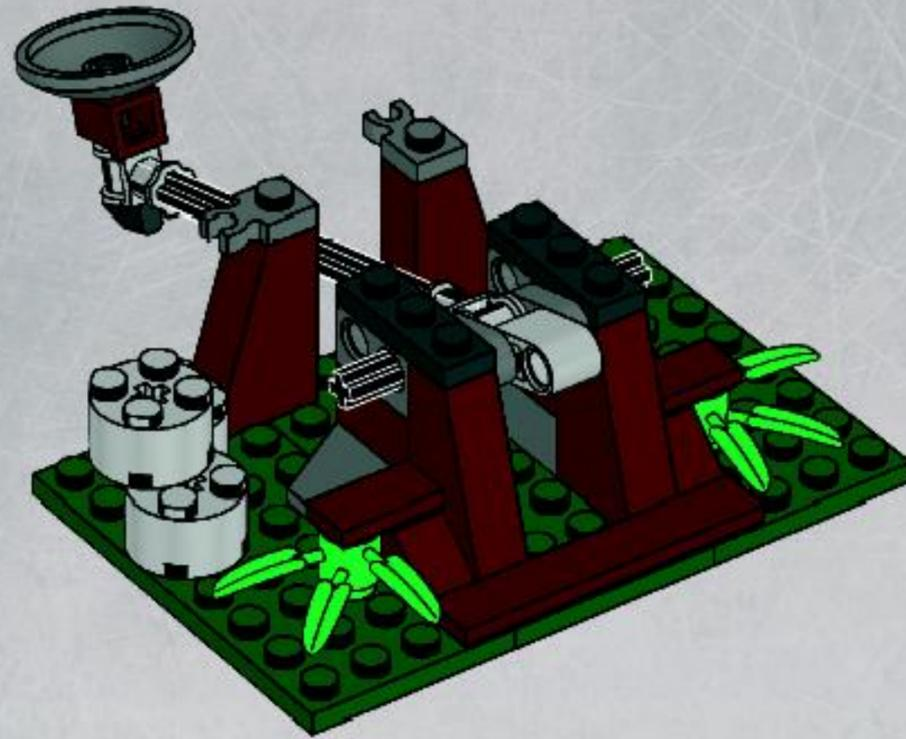

9

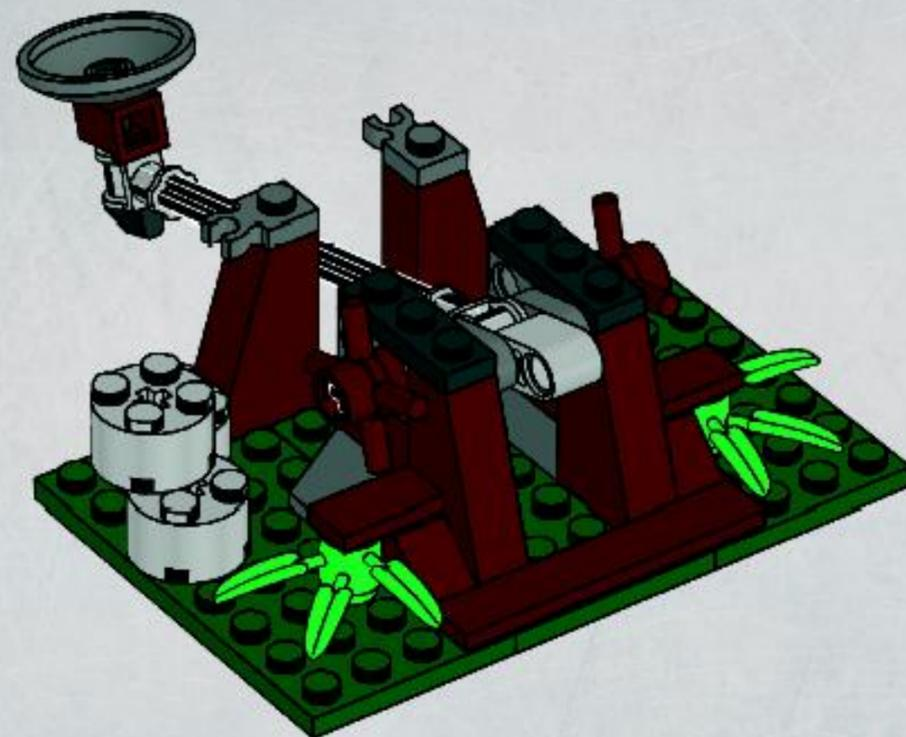



2x

# 10

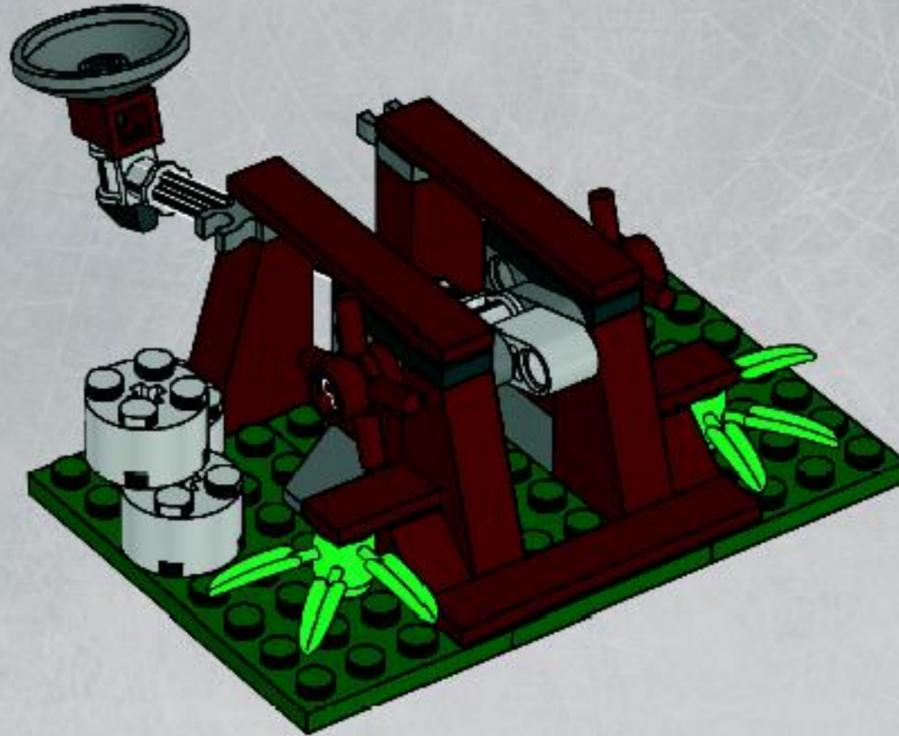

1x



1x

# 11

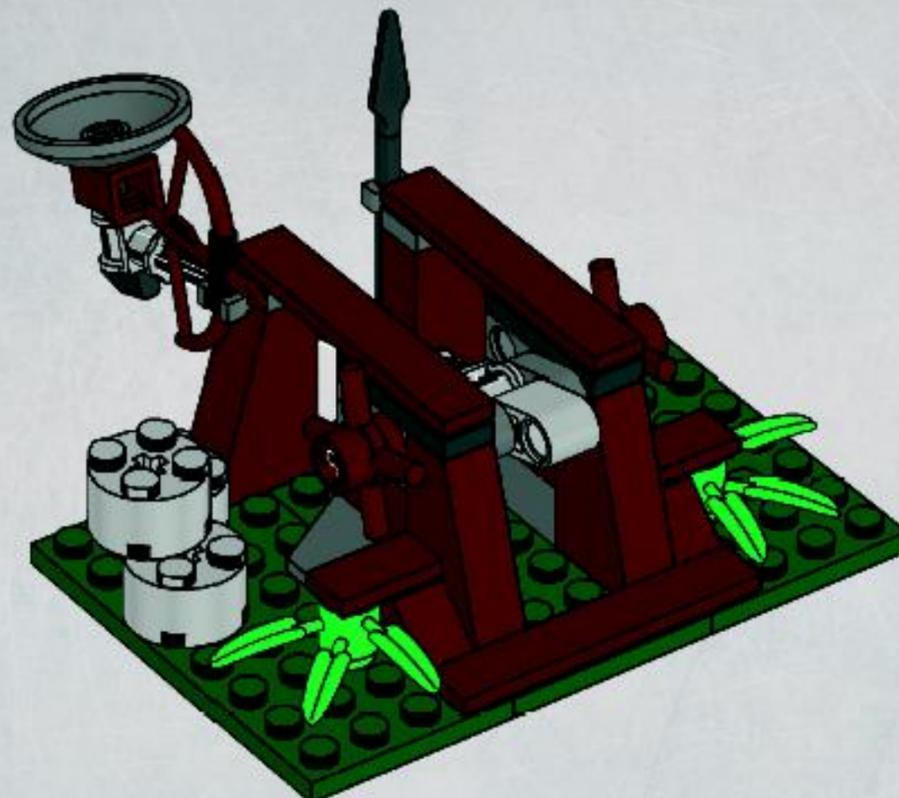



1x

# 12

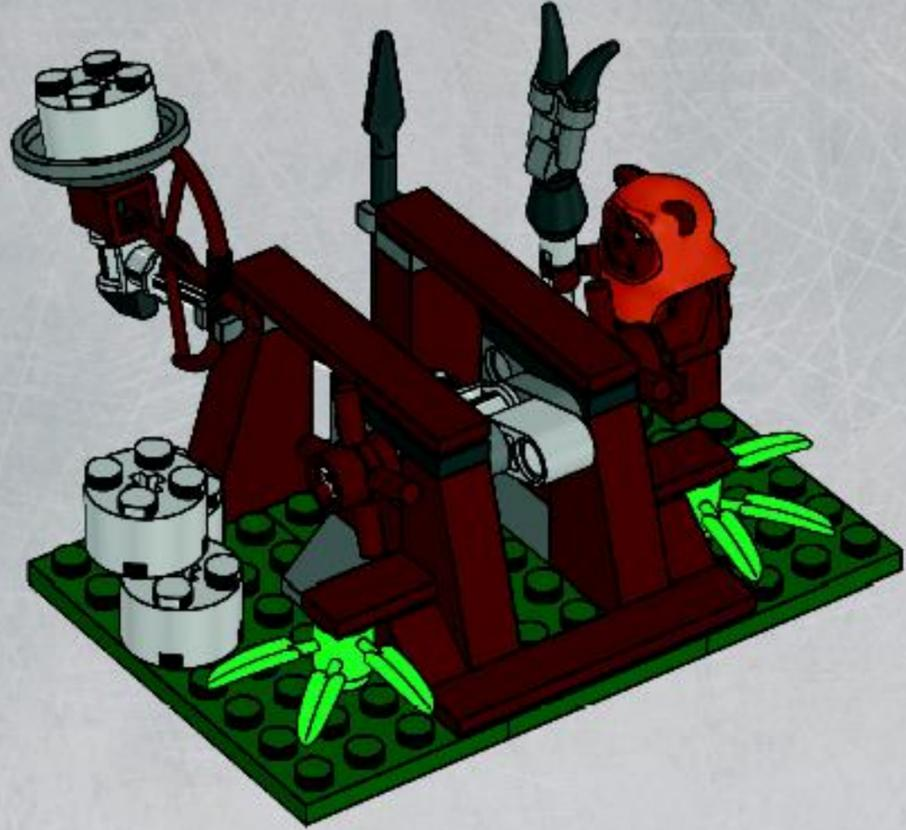

# 13

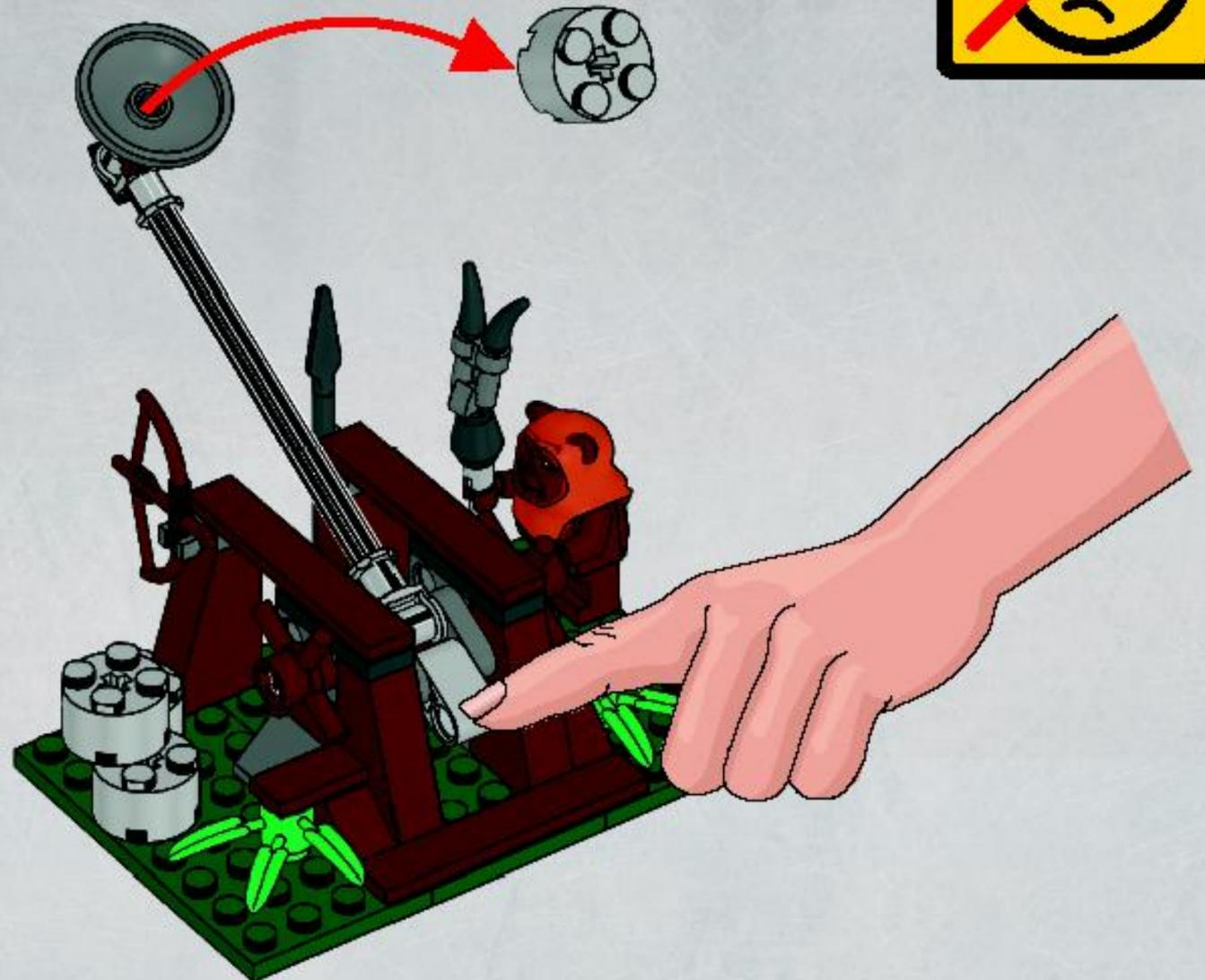

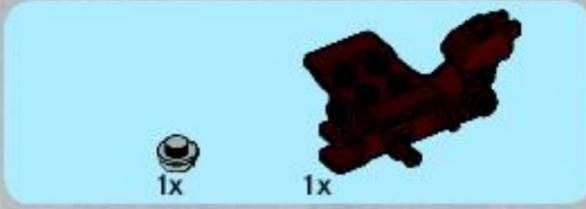
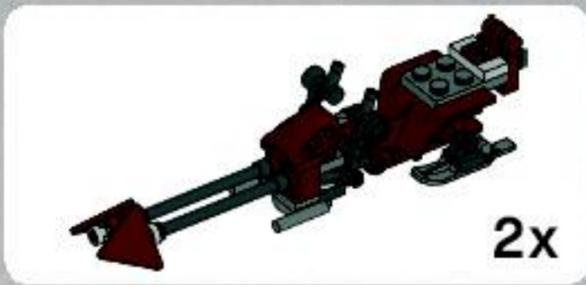

1



2

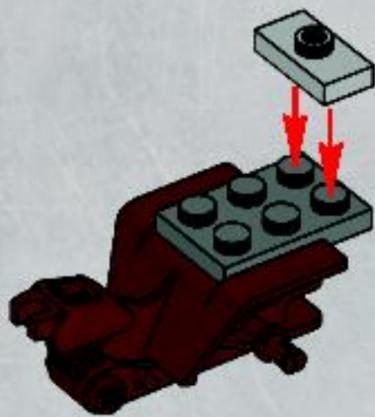

3

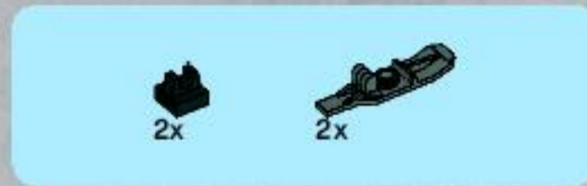

4

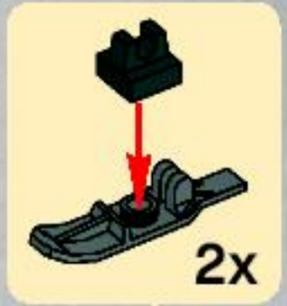

5

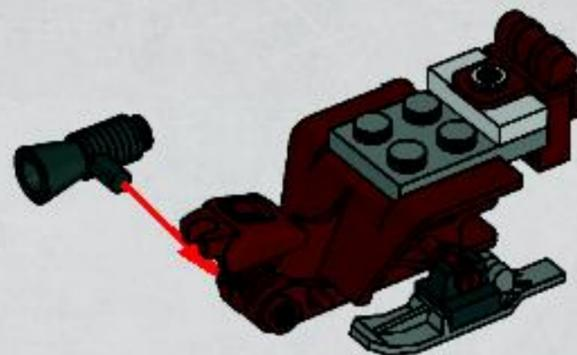

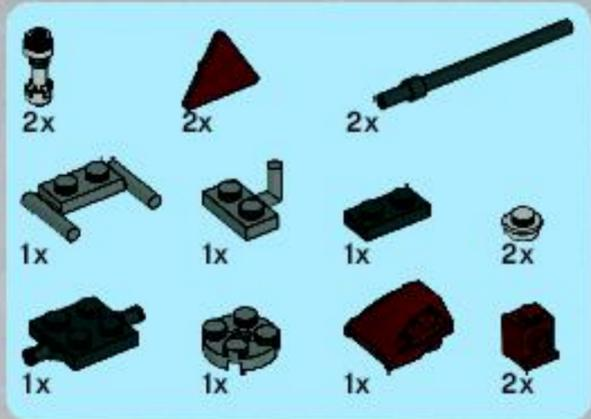

6

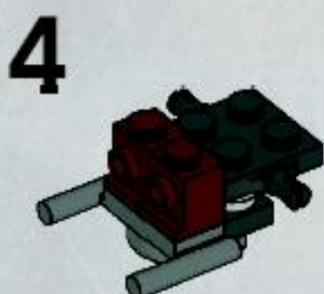
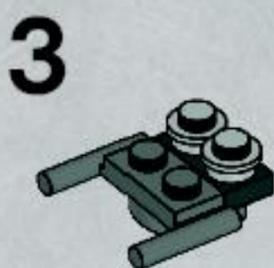

5

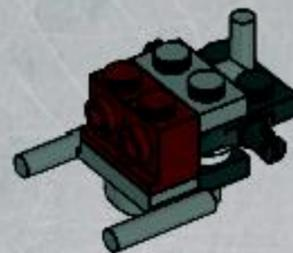

6

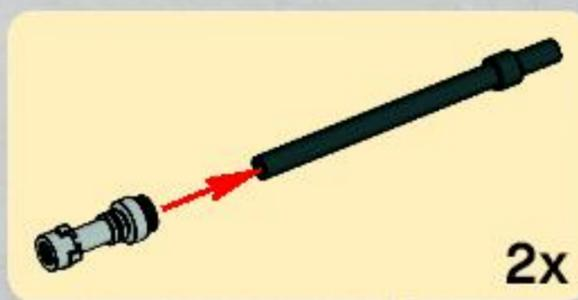
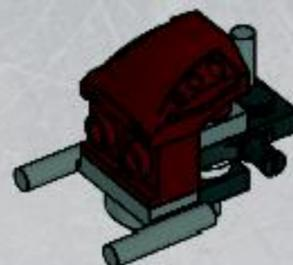

7

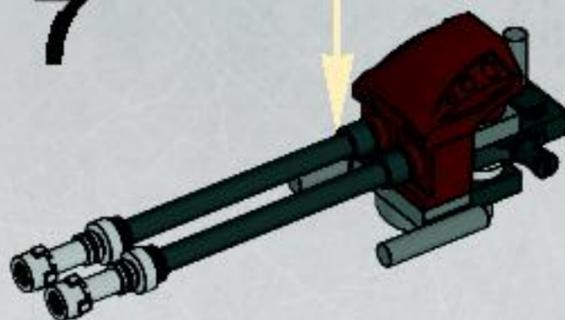

8

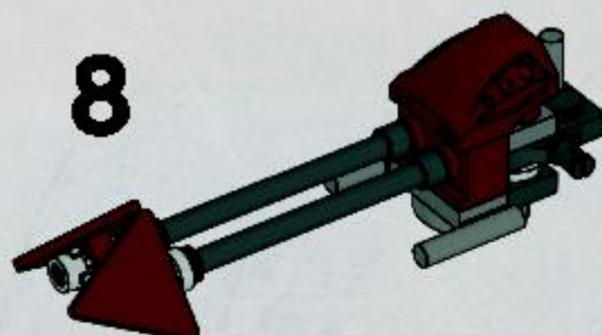

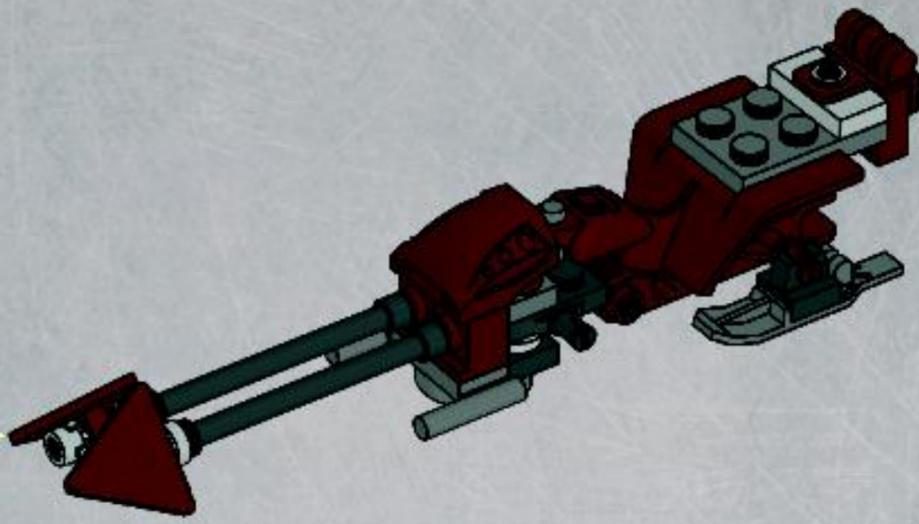

7

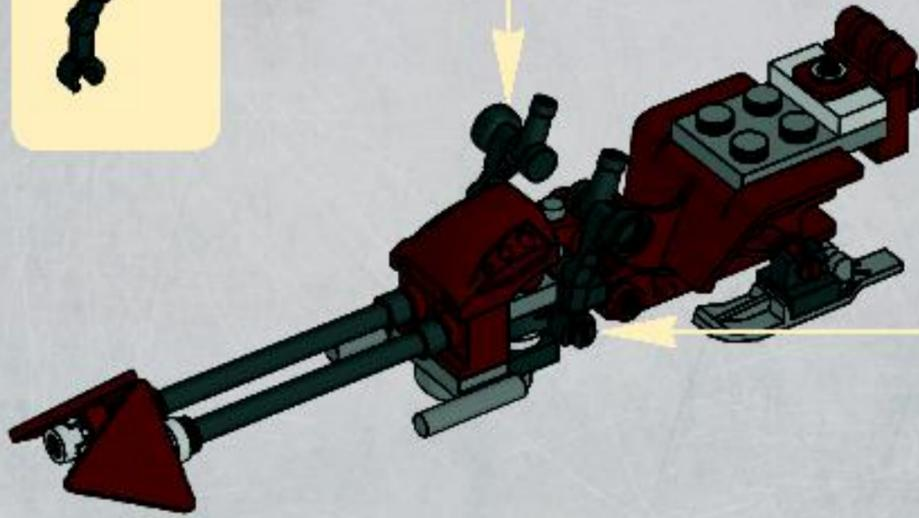

2x

8

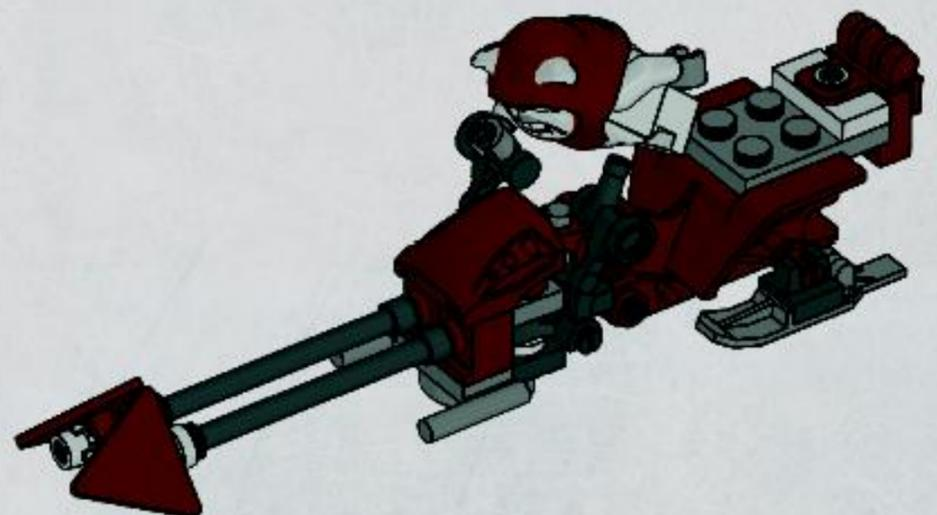
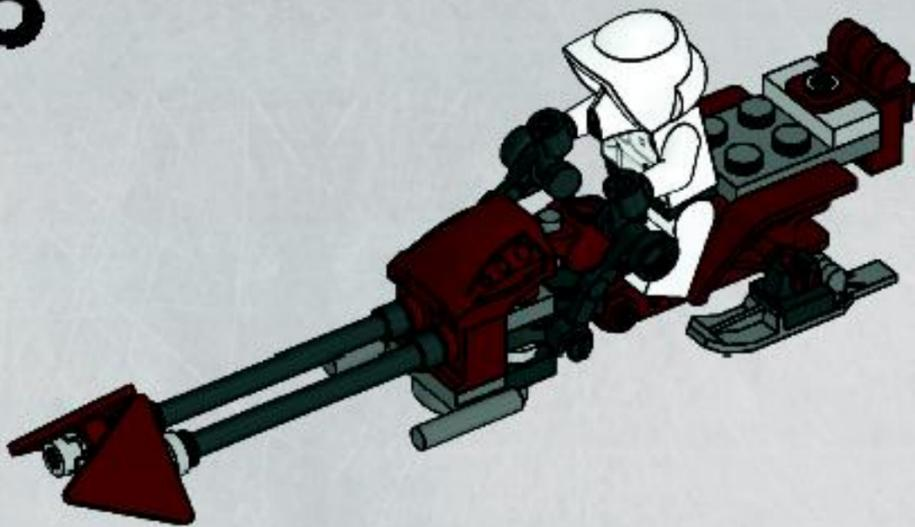



1x

1



2x

2



1x

3



1x



1x



1x

4

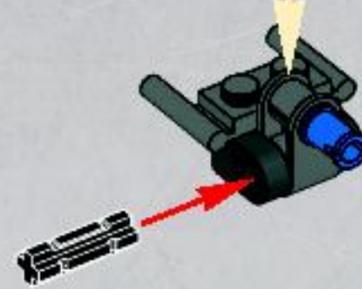
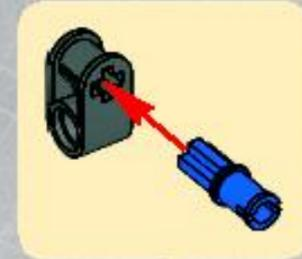

2x

5

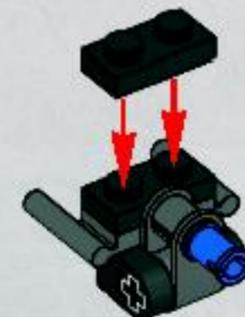





1x



1x

# 6

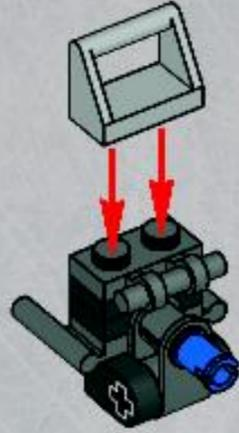

1x

# 7

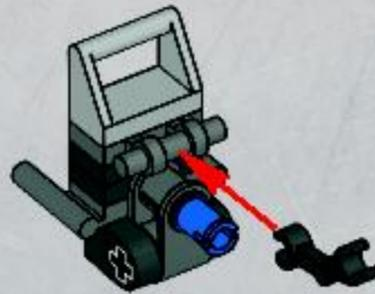

1x

# 8

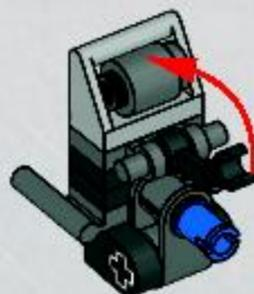

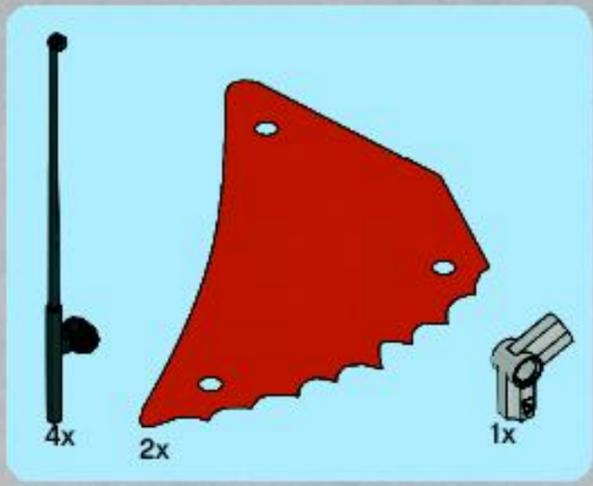

9

1

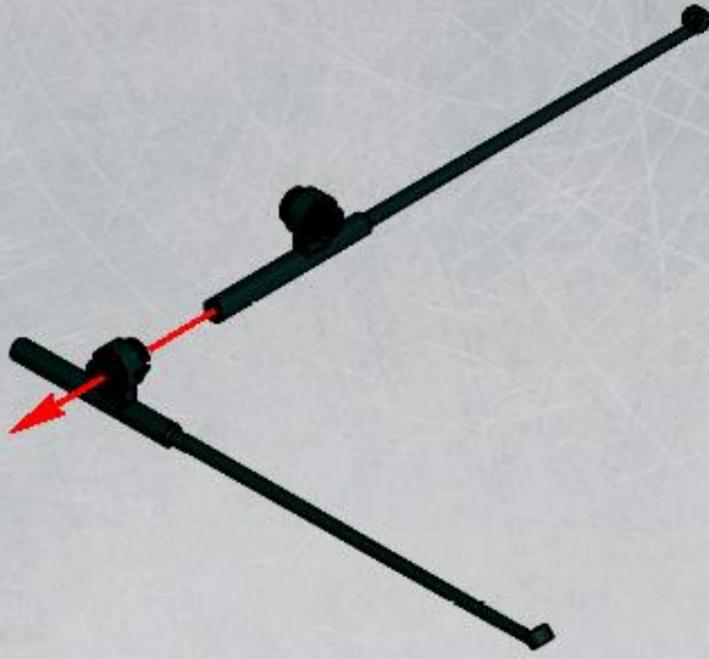

2



3

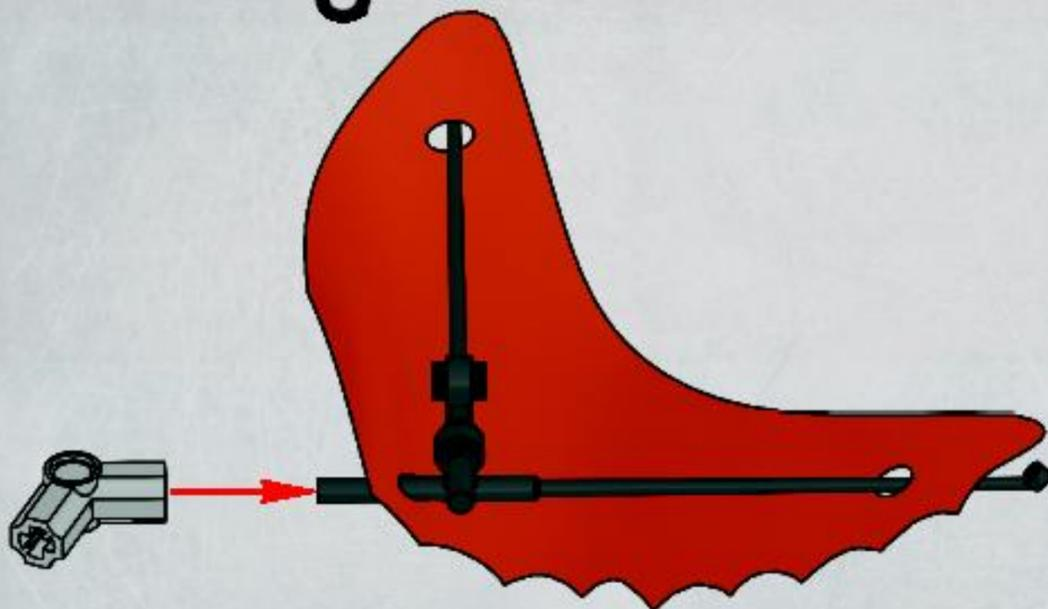

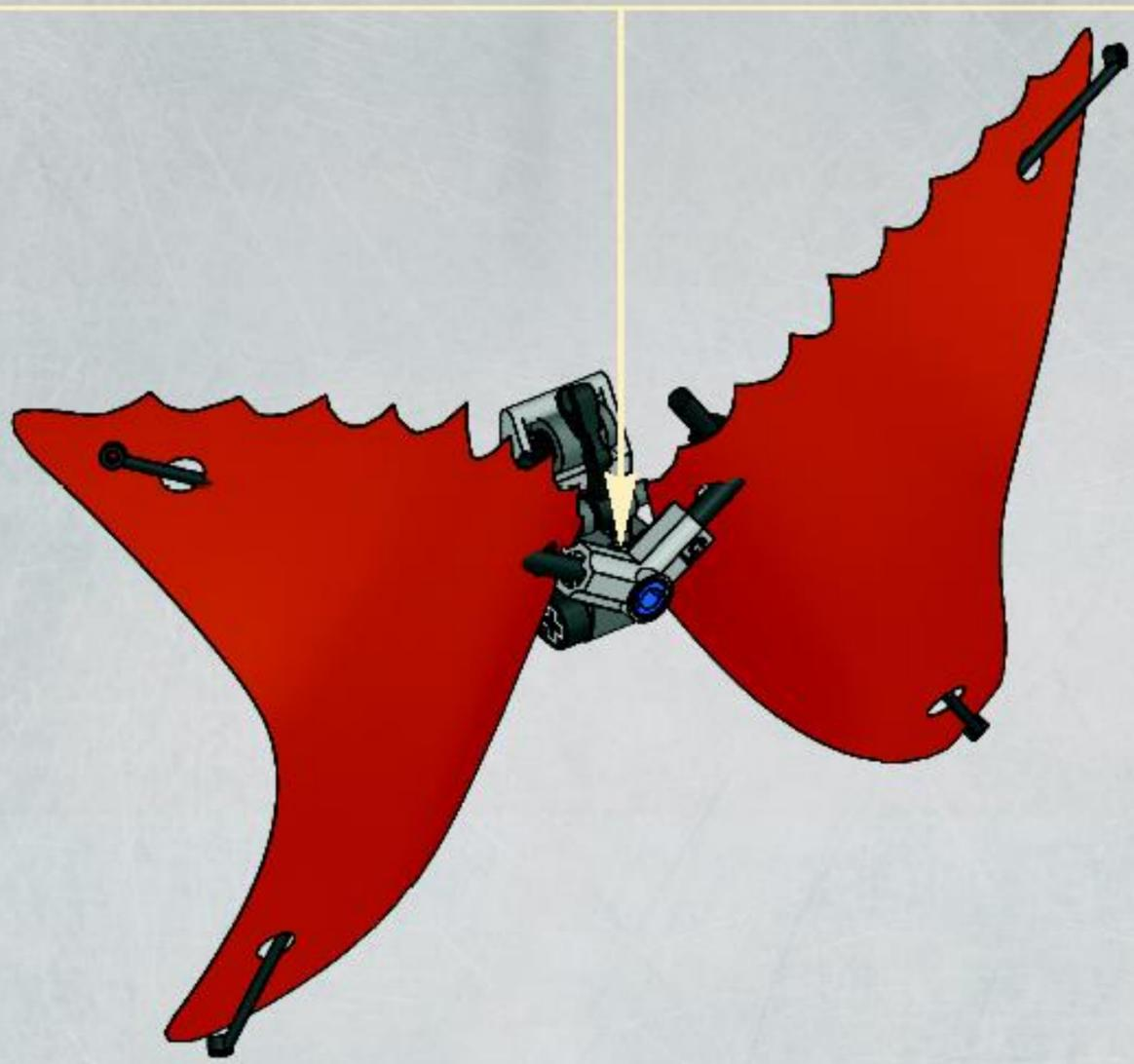
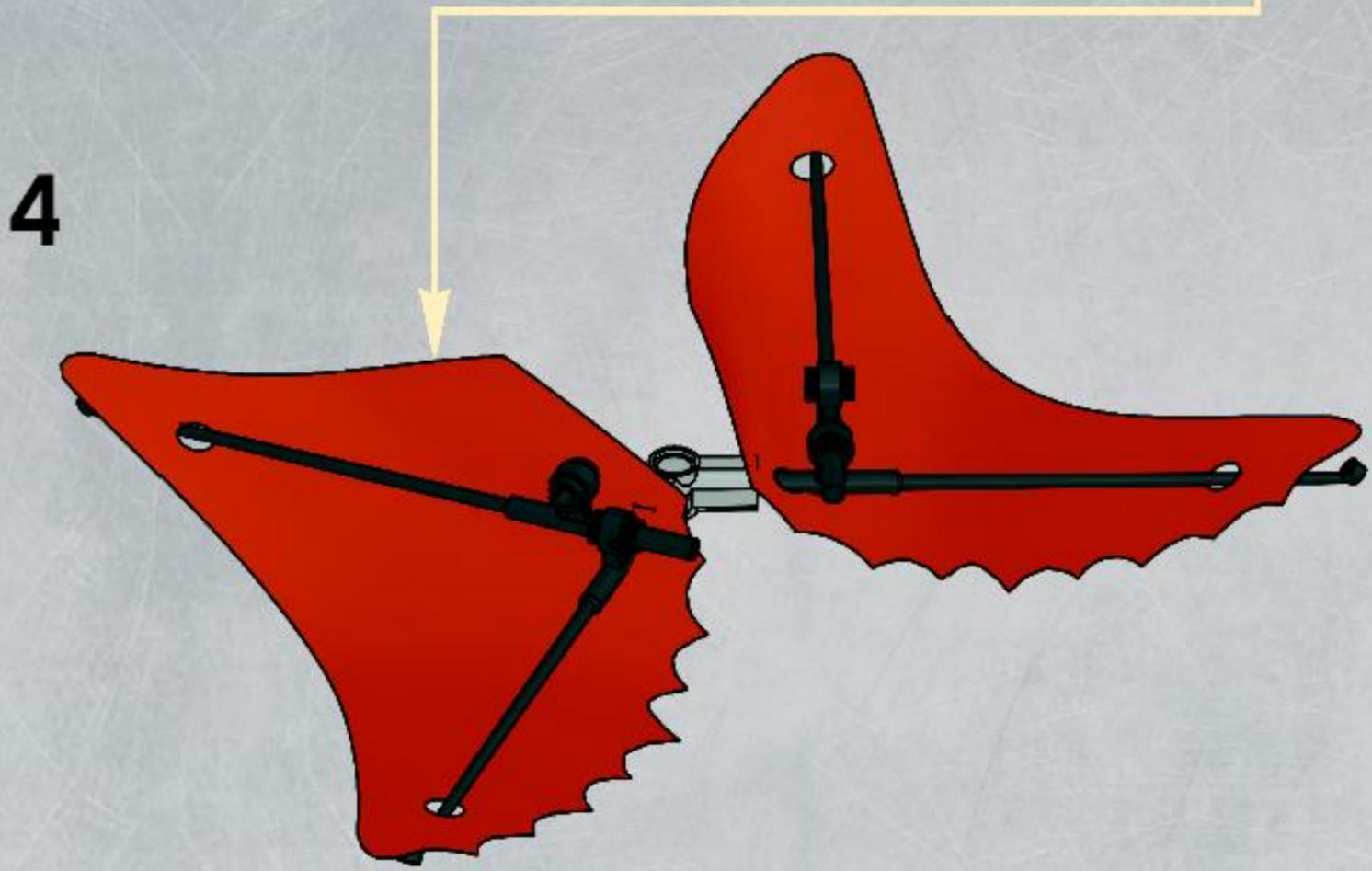
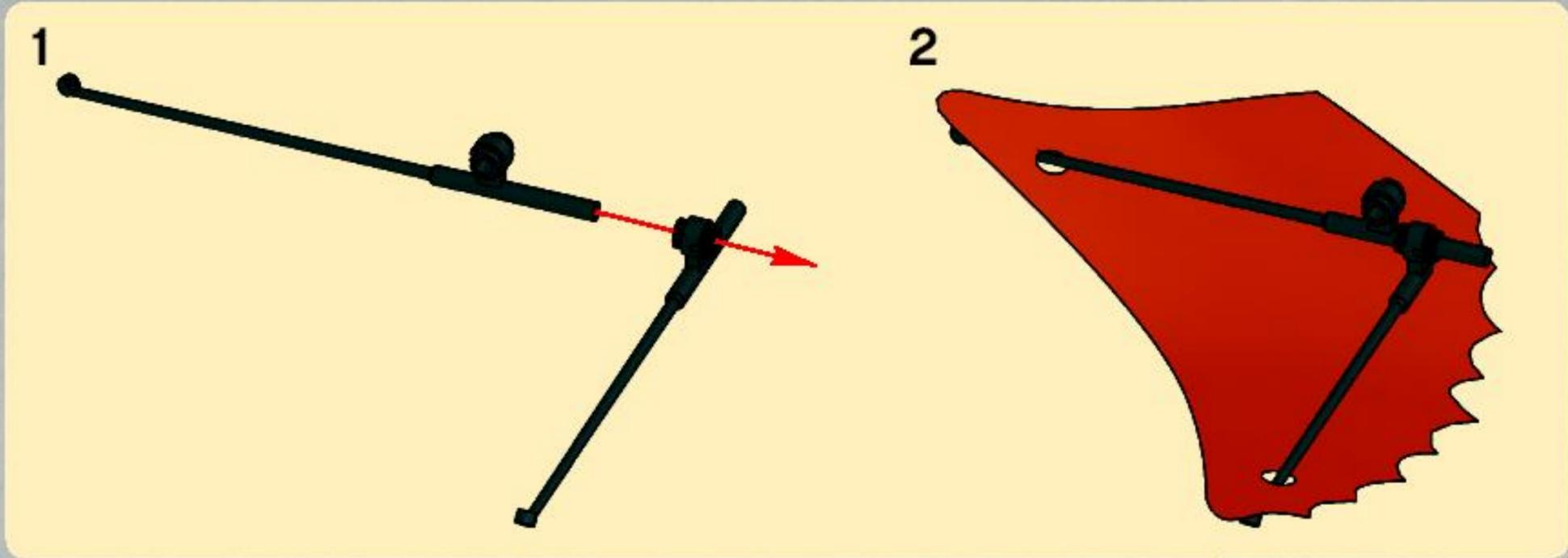



1x

# 10

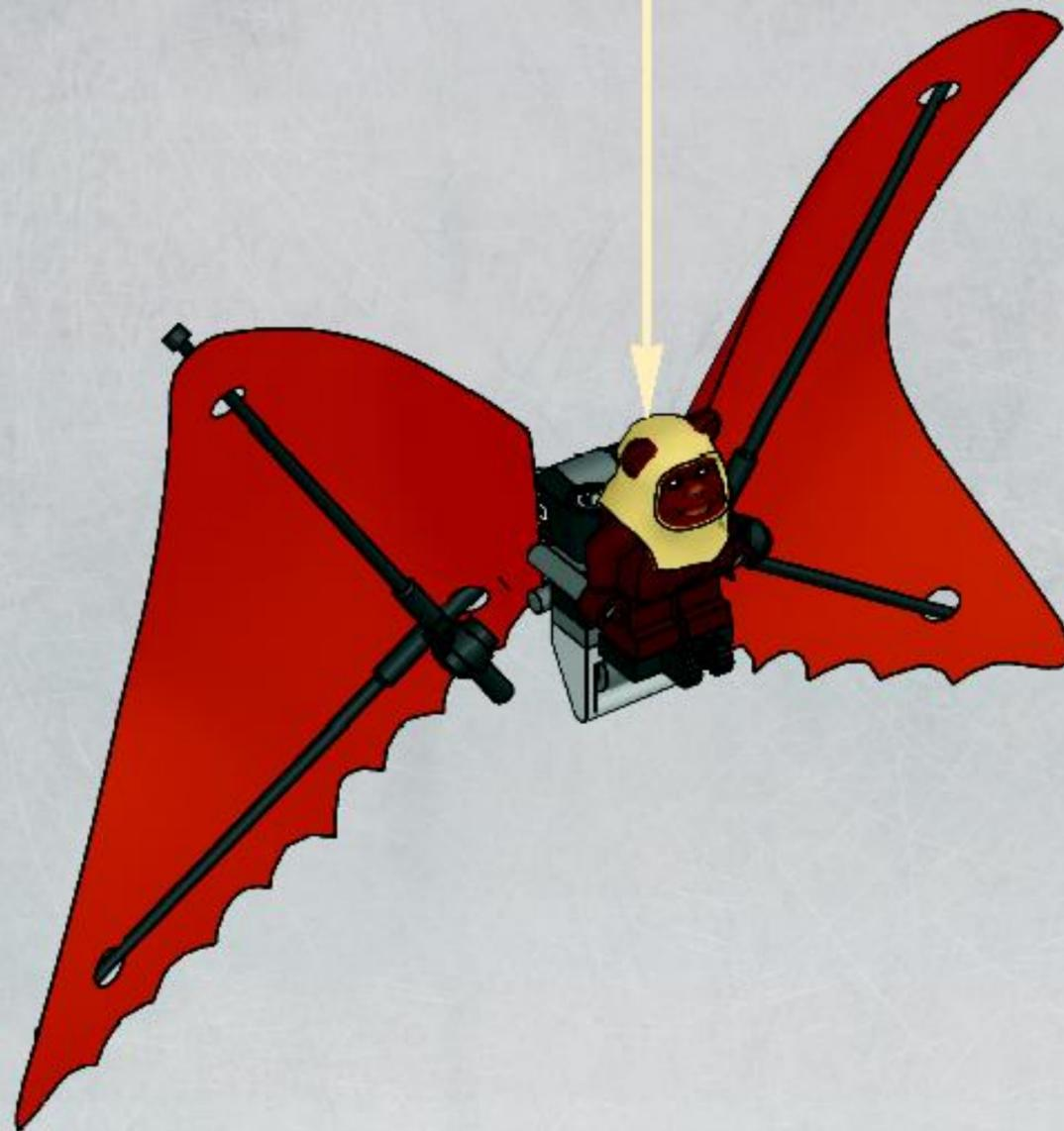

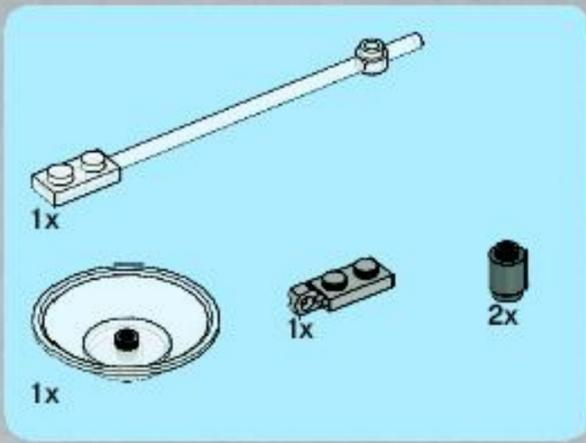

# 11

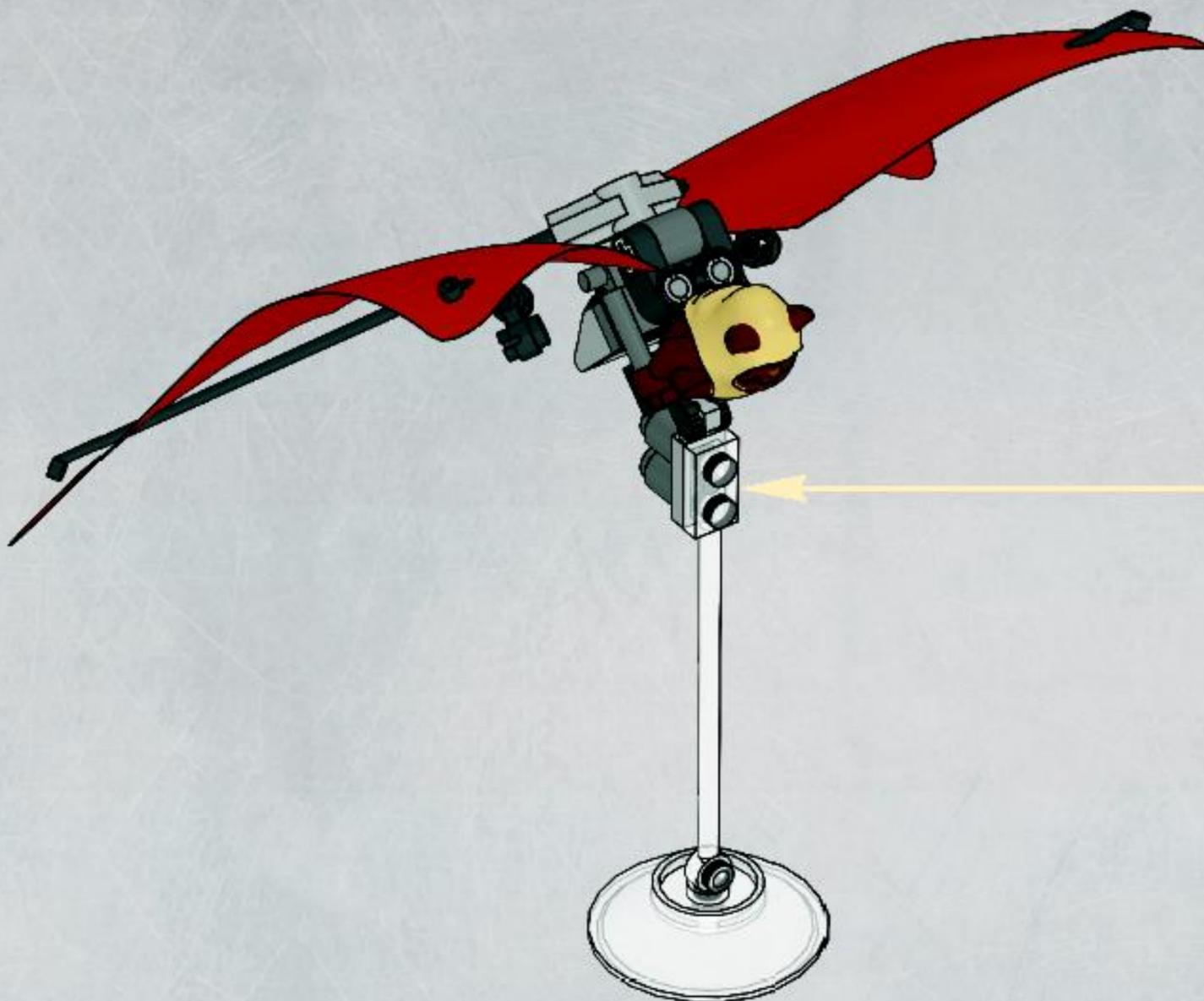
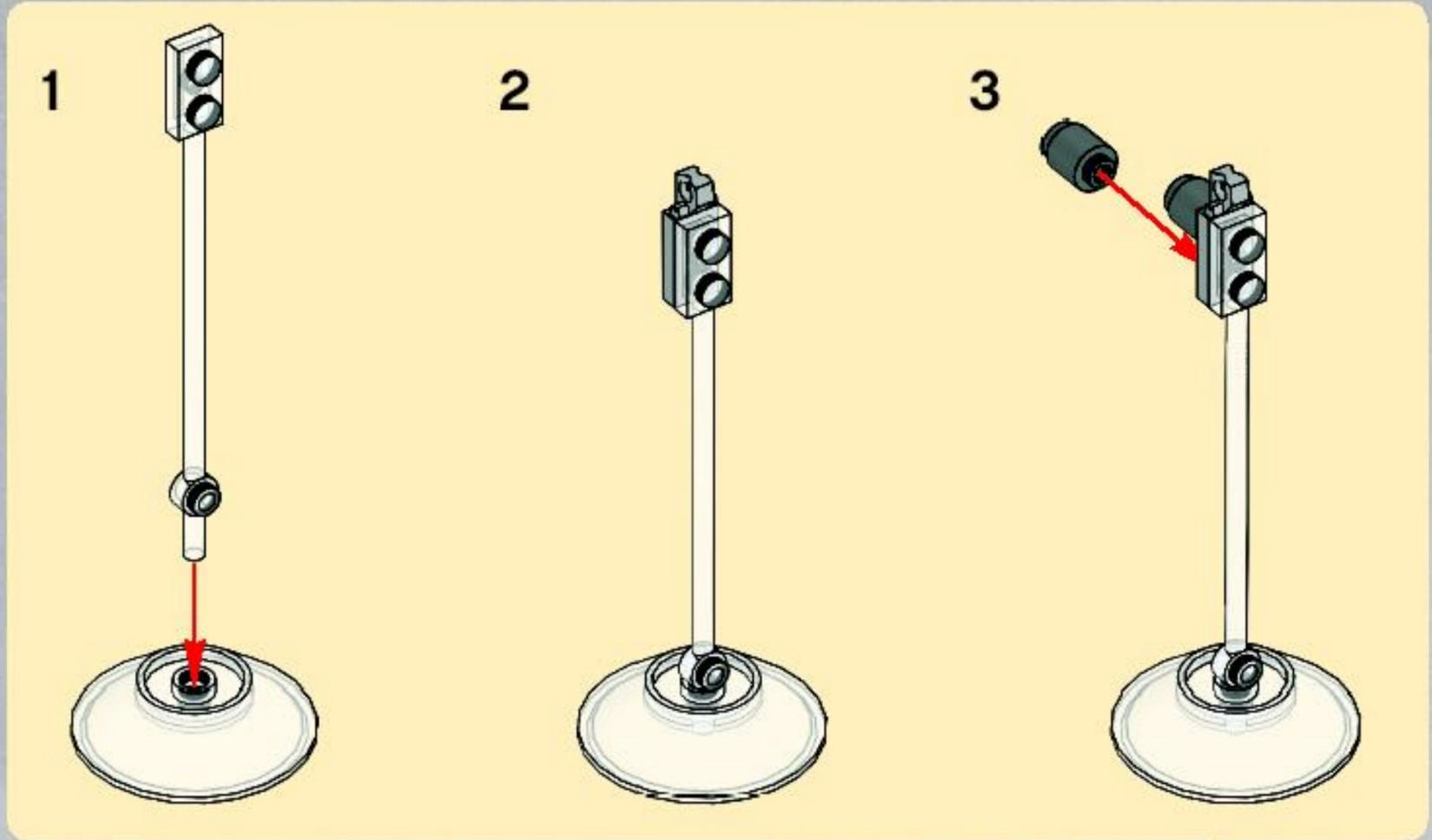

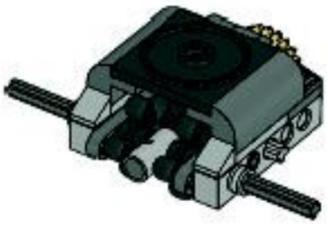
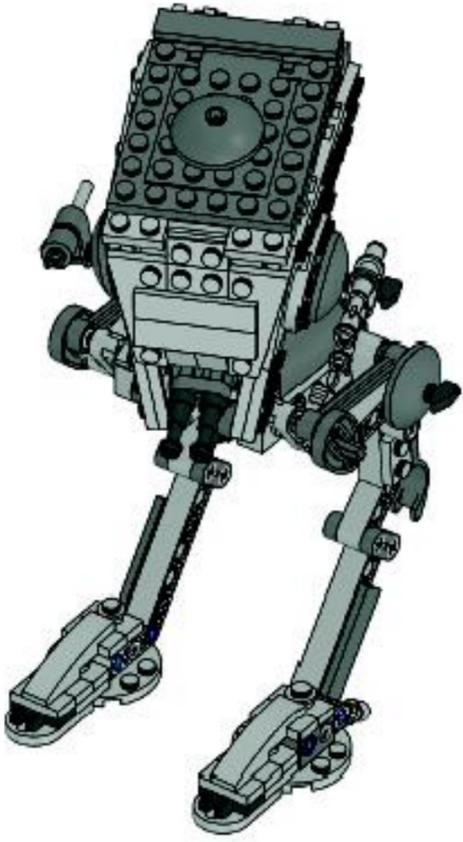

1

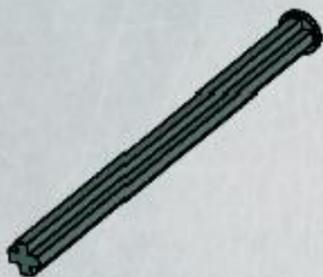

2

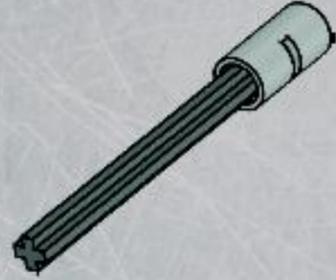

3

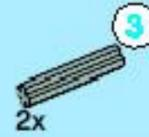
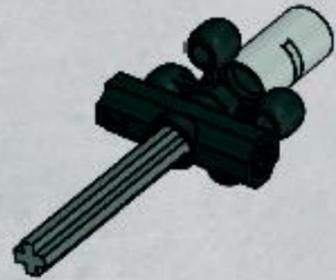

4

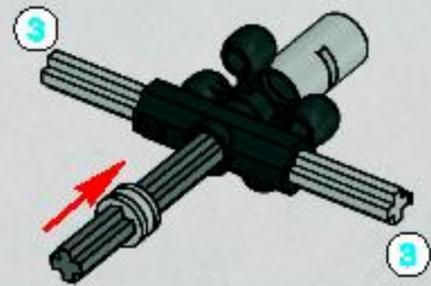



5

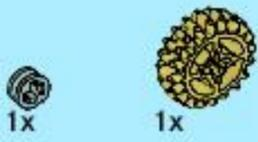
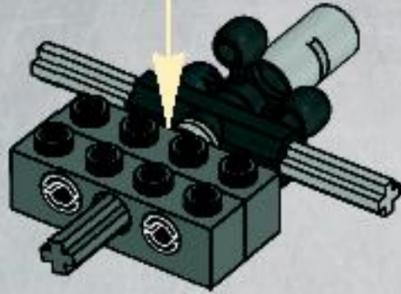
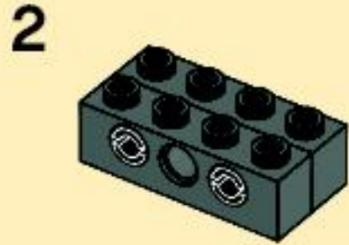
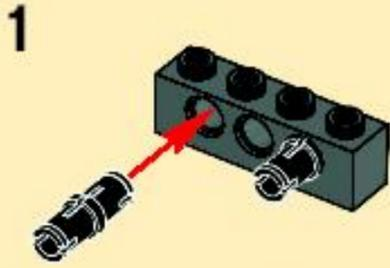

6

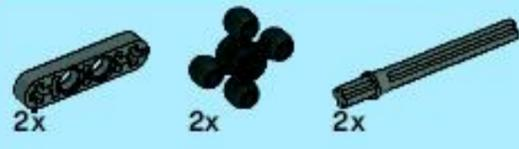
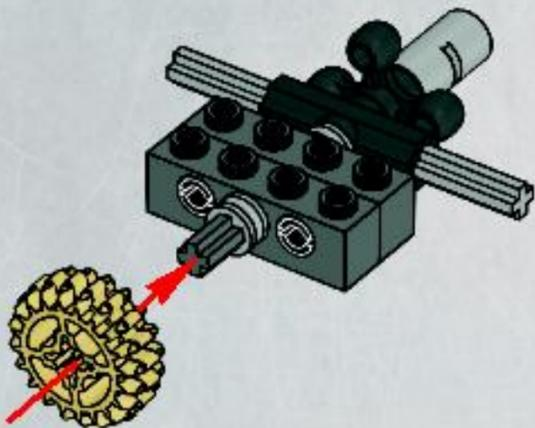

7

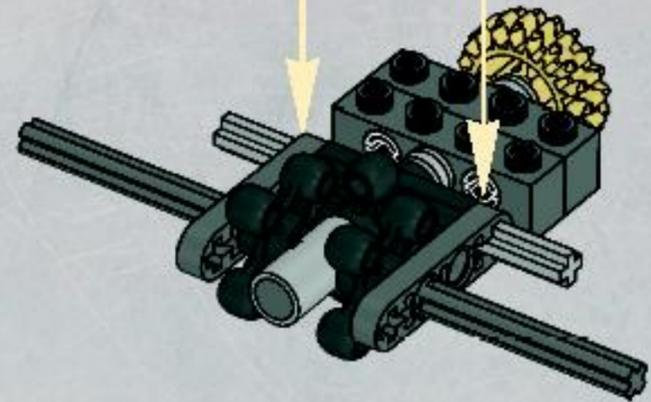
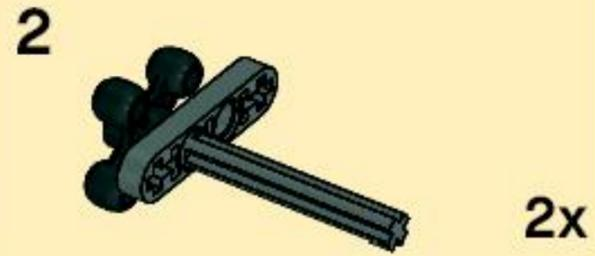
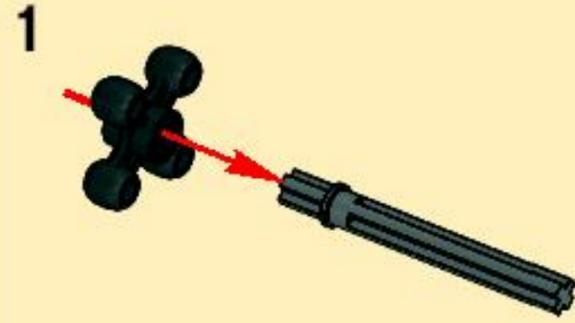



8

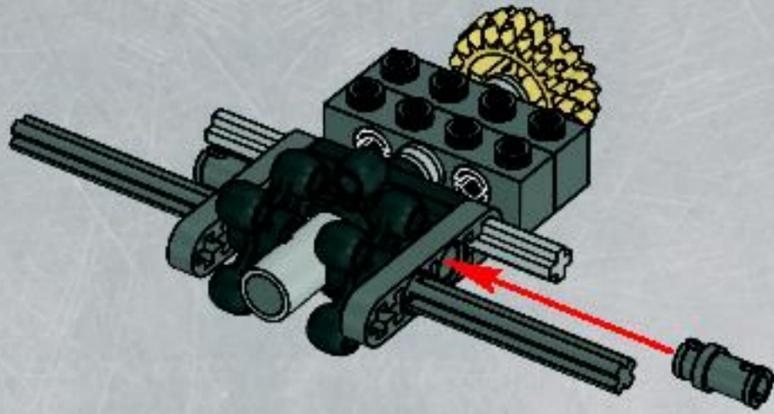

10

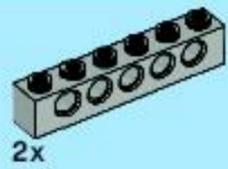
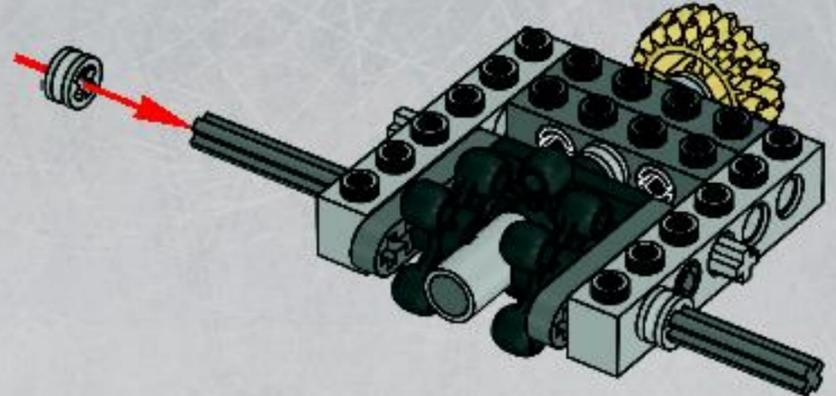

9

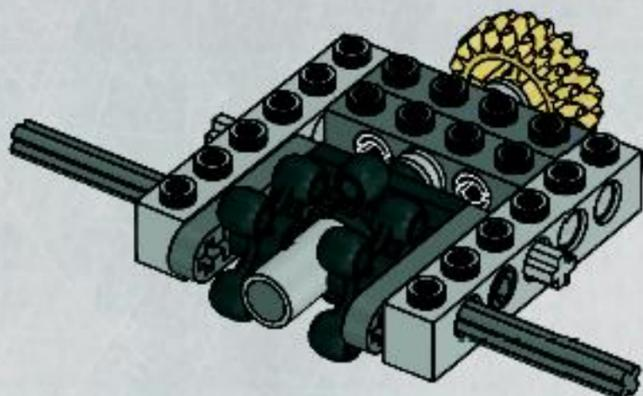

11

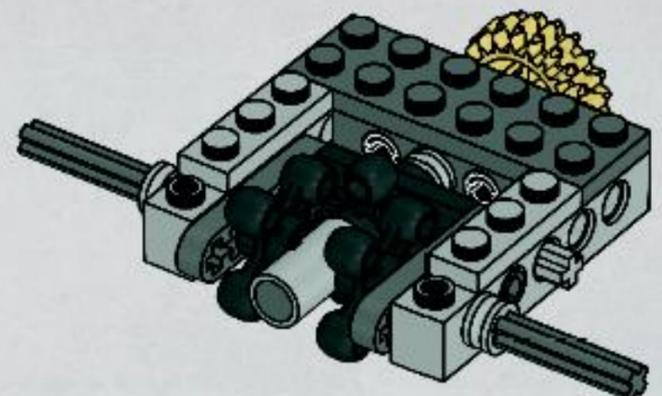





2x

# 12

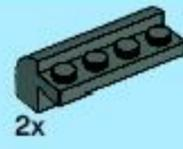
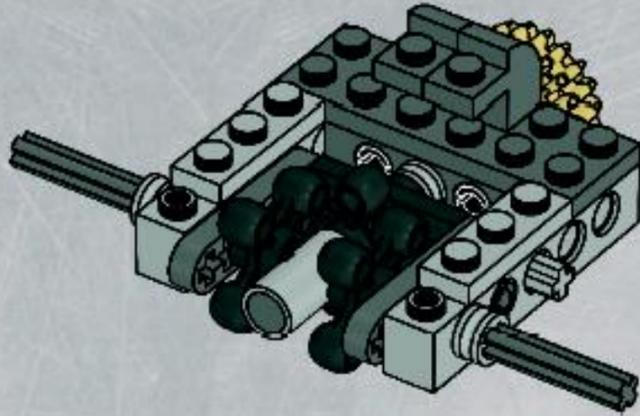

2x



2x

# 14

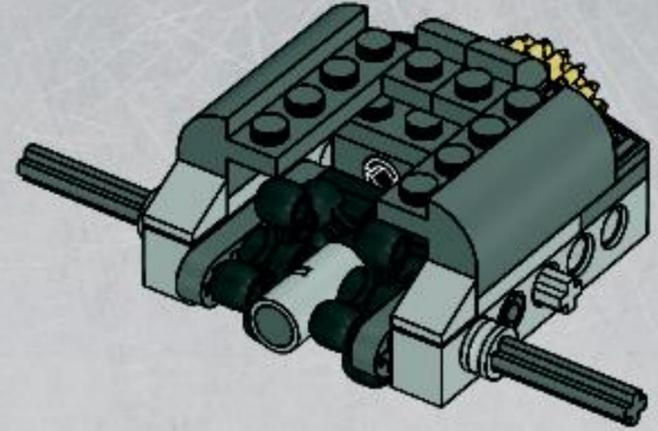

2x

# 13

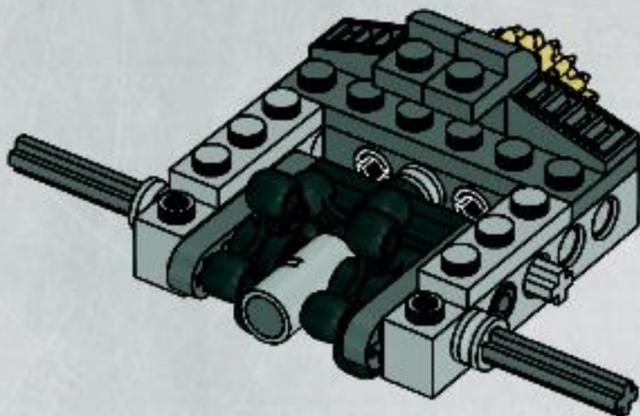

1x

# 15

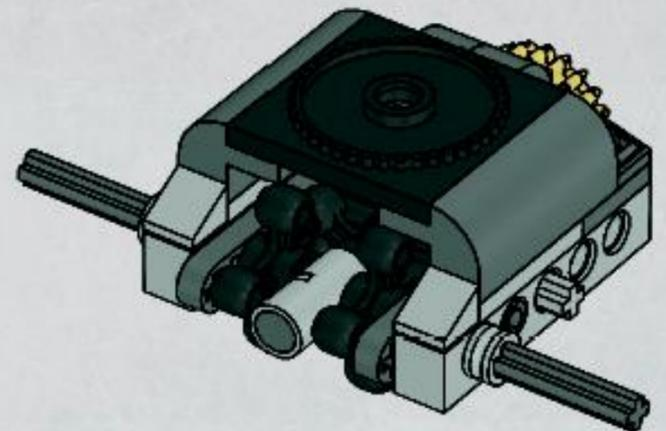

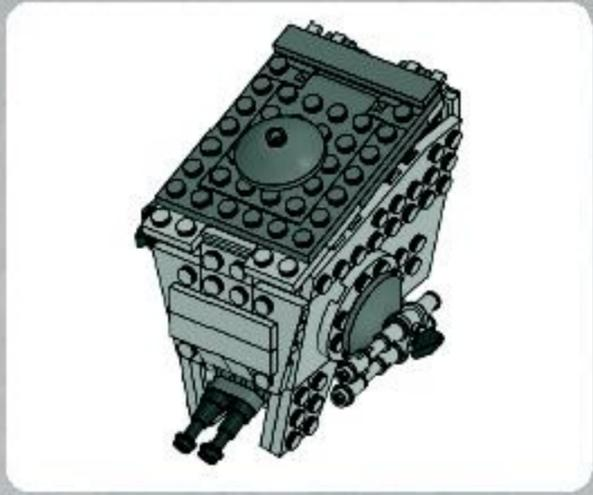

1



2

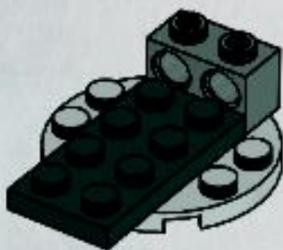

3

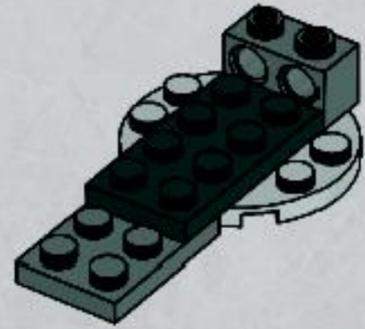

4

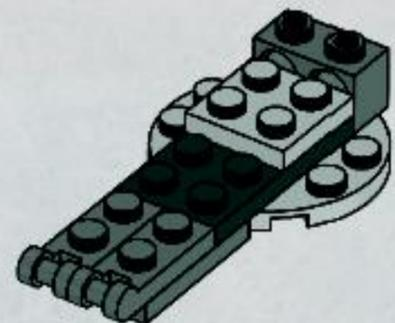



4x

5

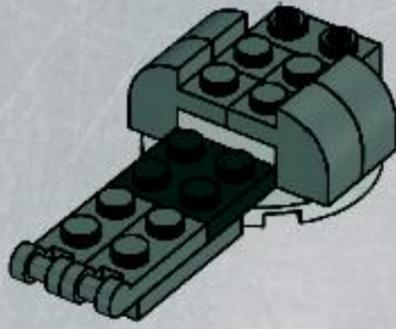

1x



1x



2x

7

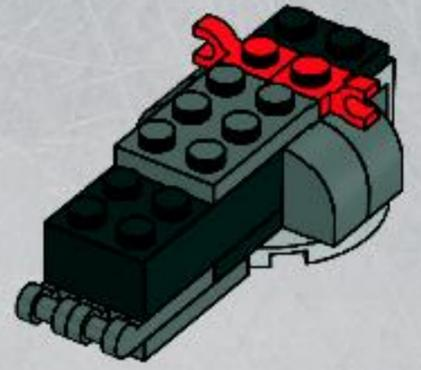

1x



1x



1x

6

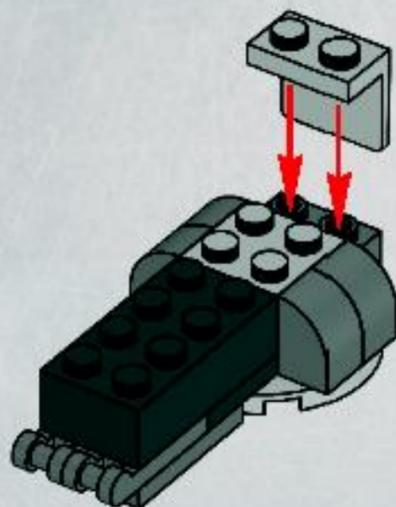

2x



2x

8

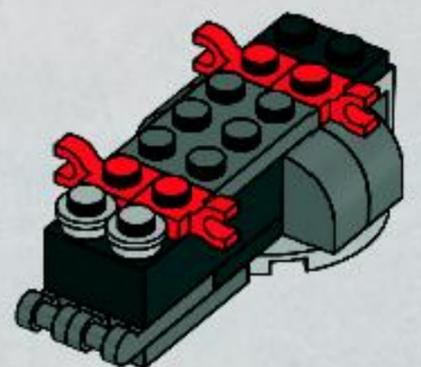



1x



1x

# 9

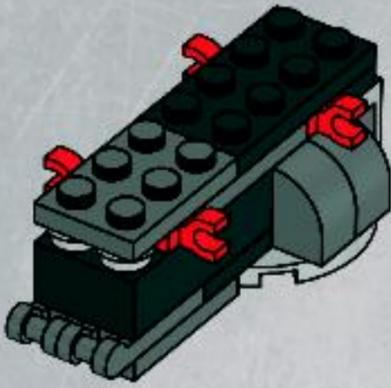

1x



1x

# 11

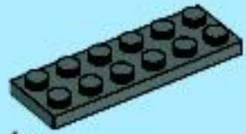
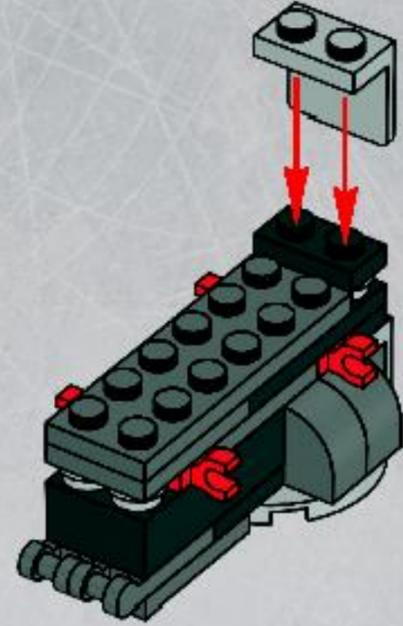

1x



2x

# 10

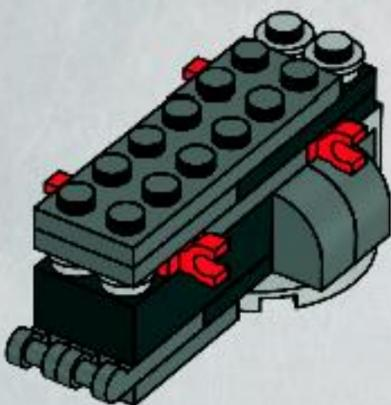

1x



1x

# 12

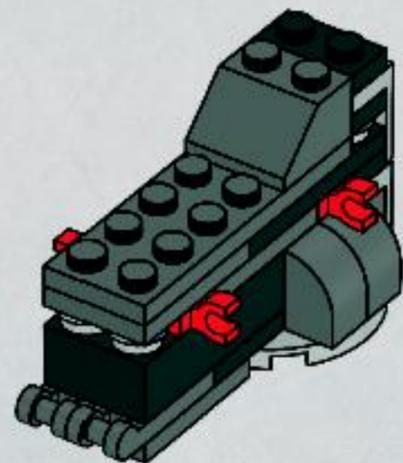

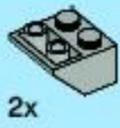

2x

# 13

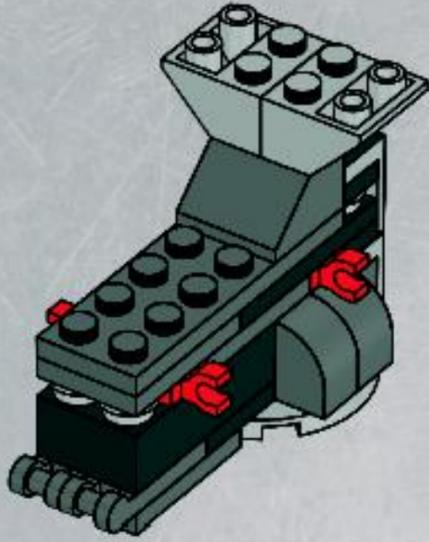

1x



1x

# 15

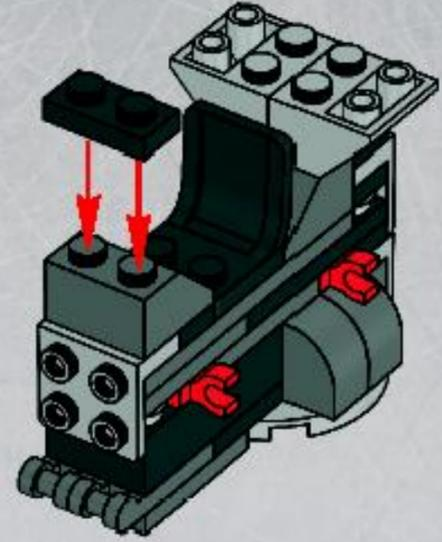

1x



1x



1x

# 14

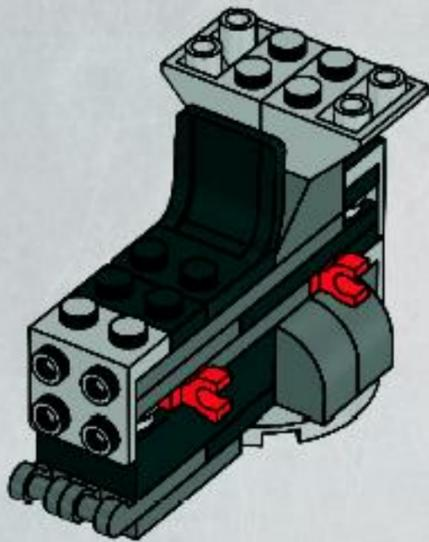

2x



1x

# 16

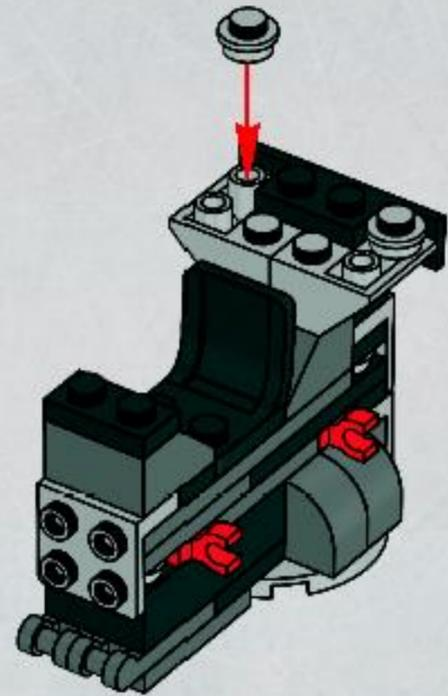

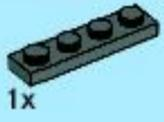

1x

# 17

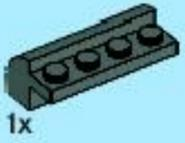
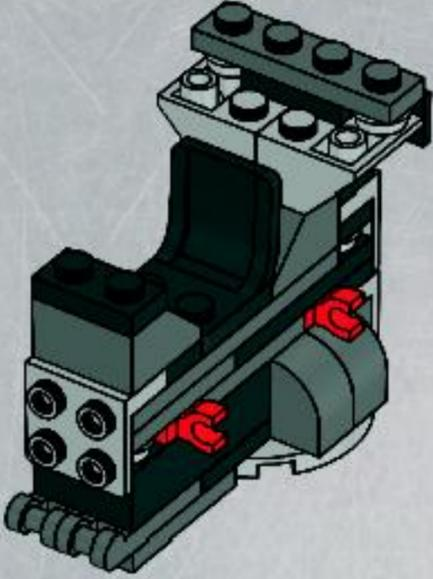

1x

# 18

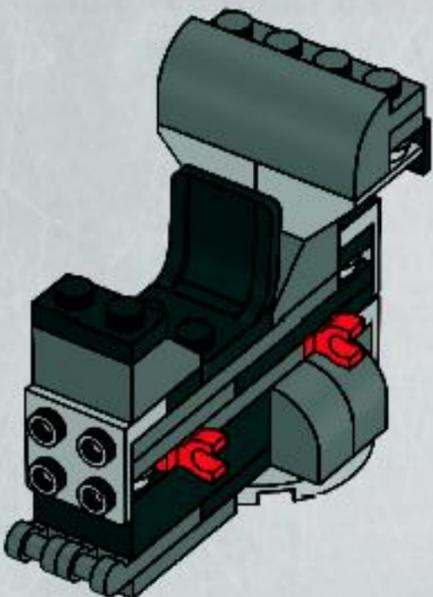

4x

# 19

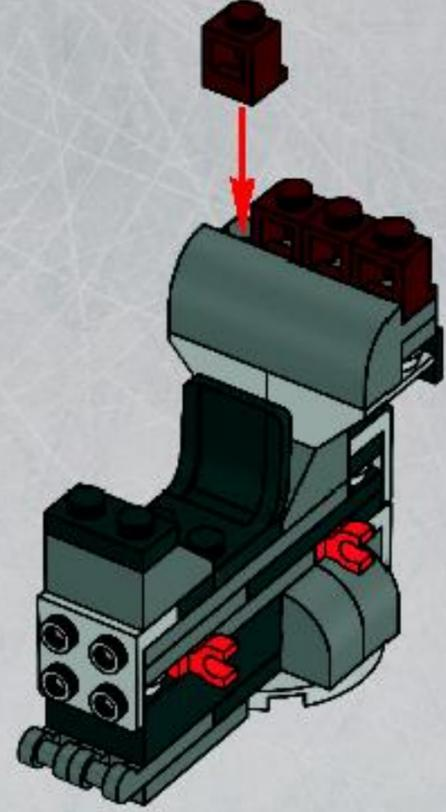

1x



2x

# 20





21

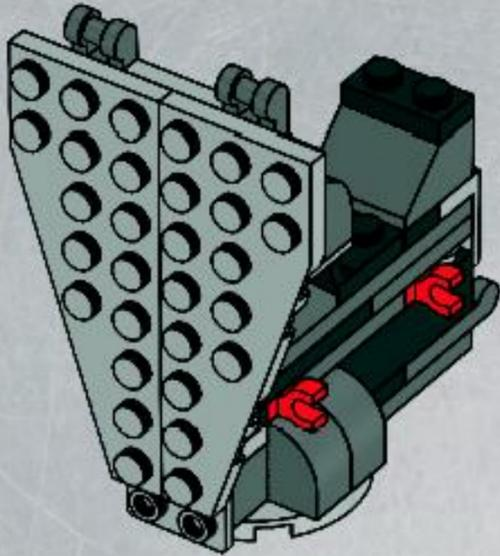

22

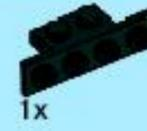
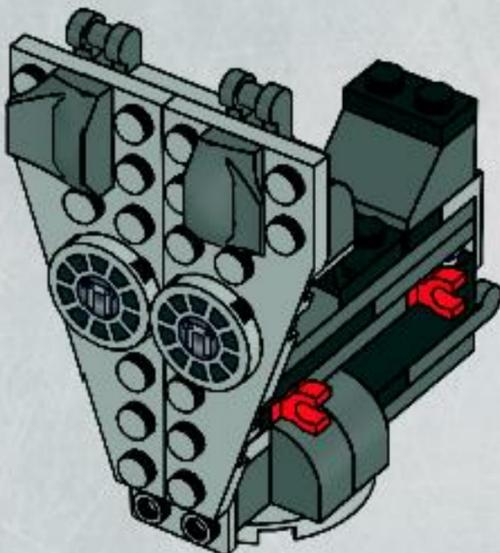

23

1

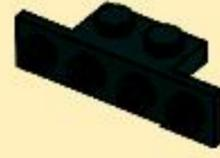

2

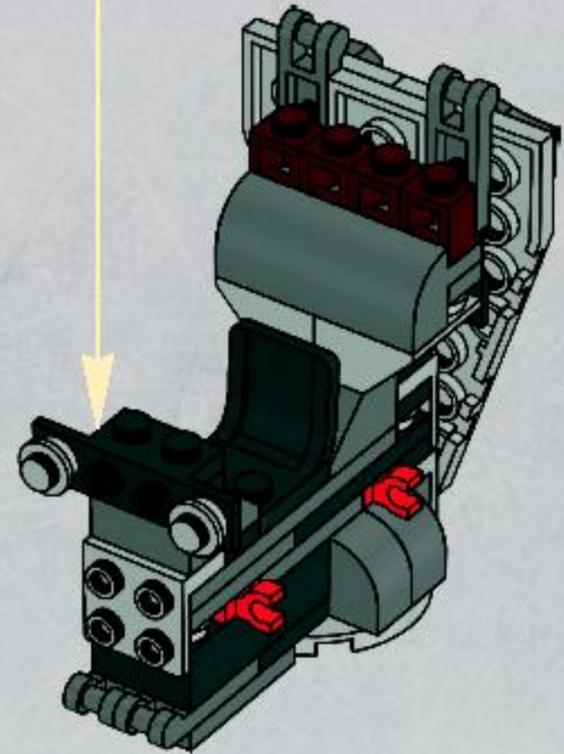
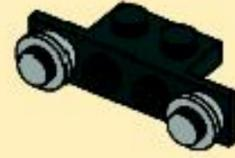



1x



2x

# 24

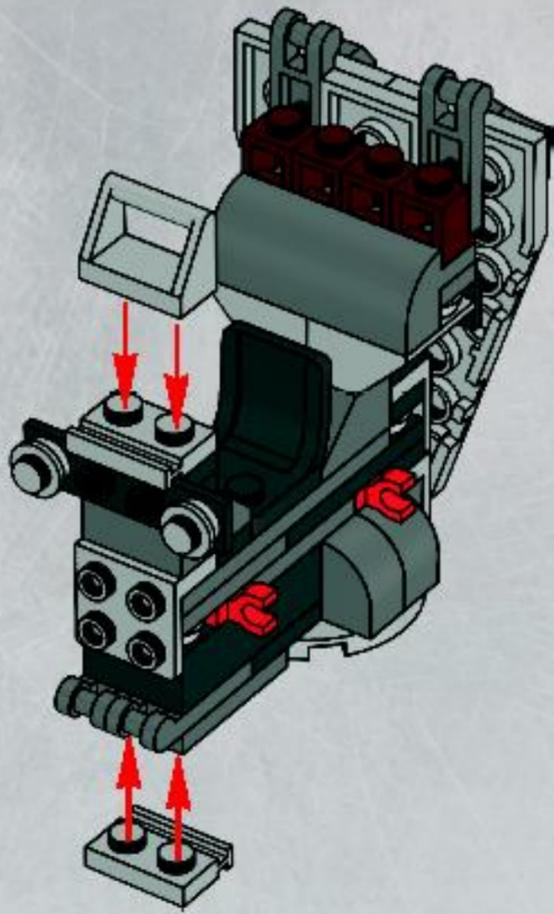

1x



2x



2x

# 25

1



2

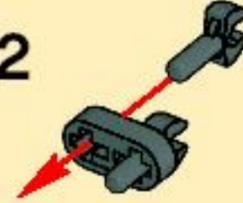

3

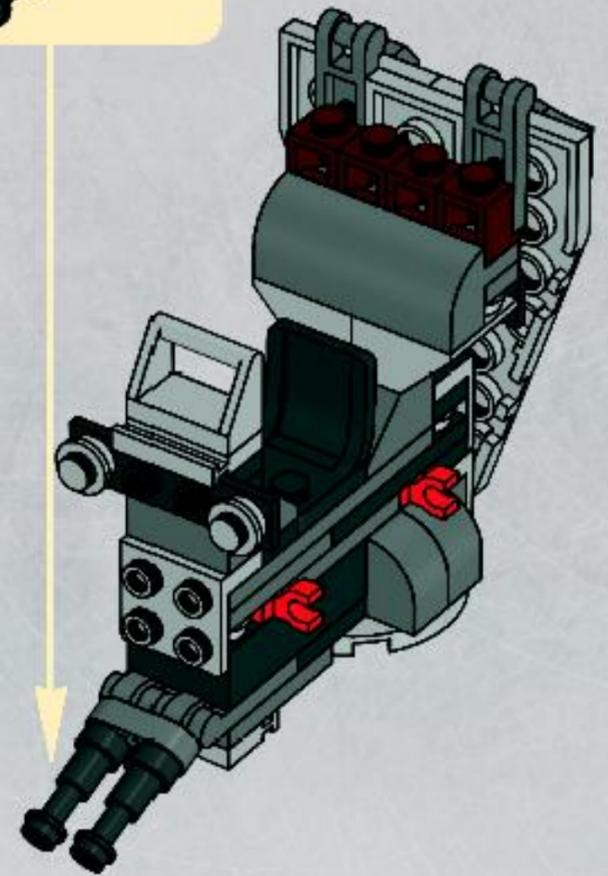



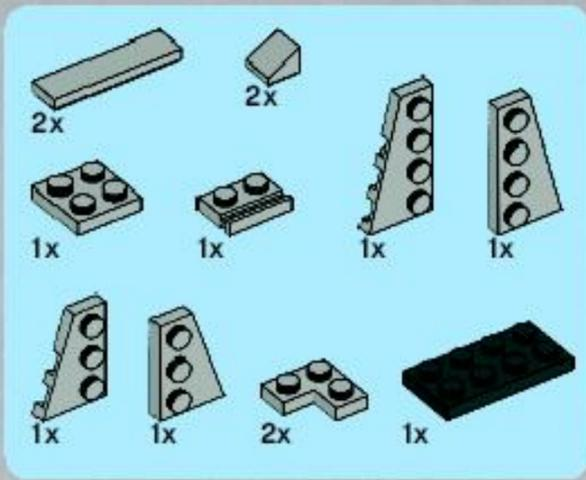

# 26

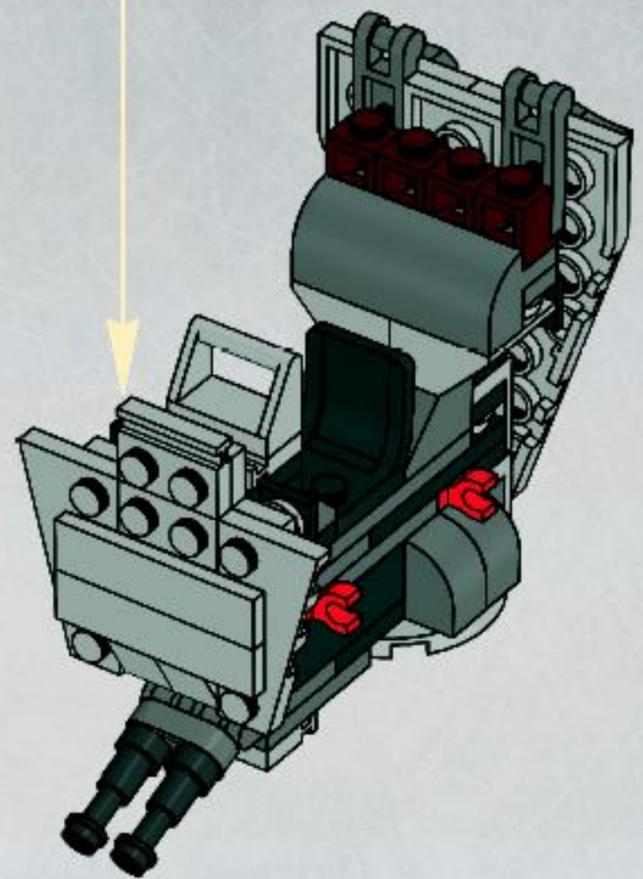
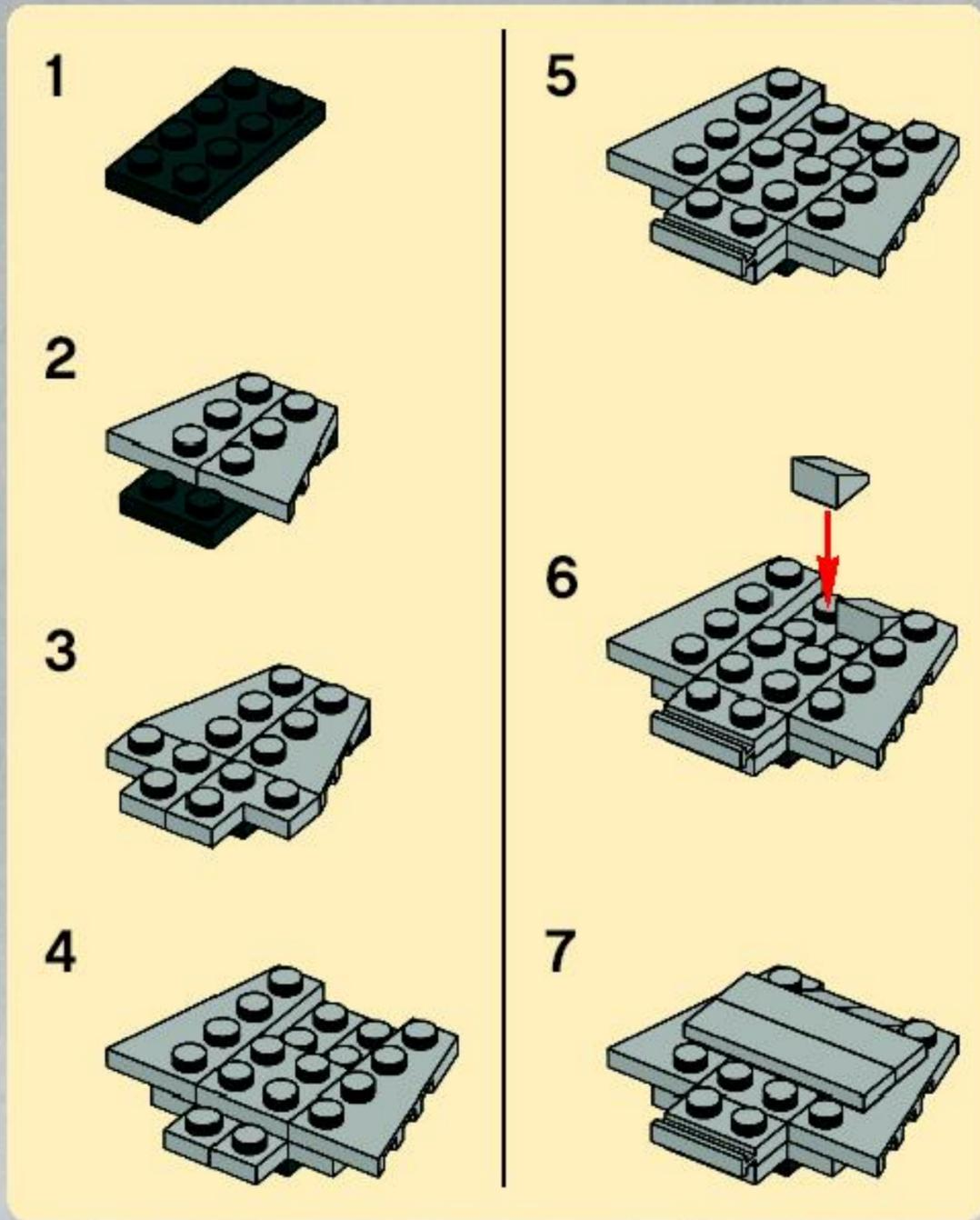

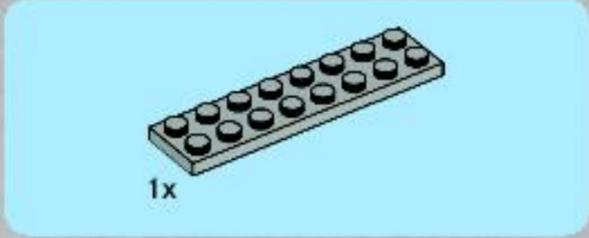
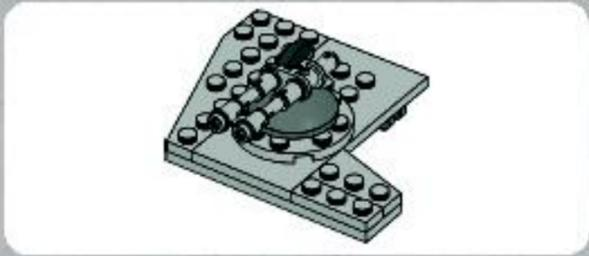

1

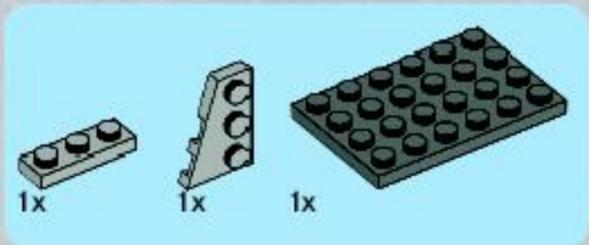
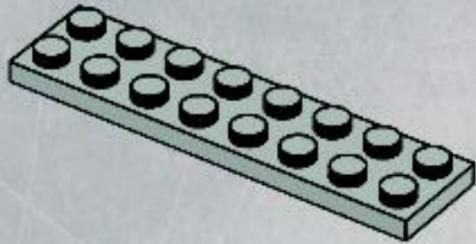

2

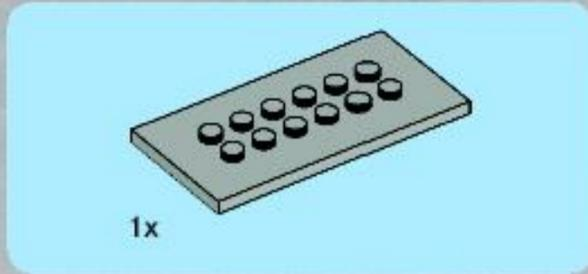
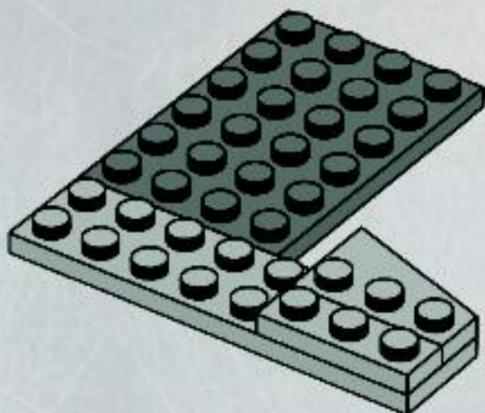

3

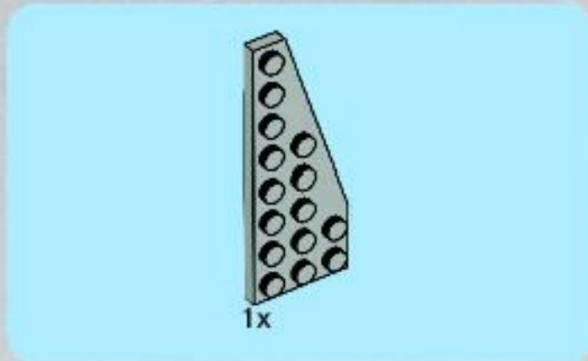
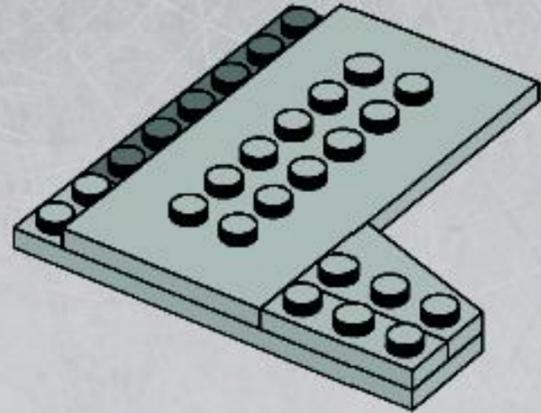

4

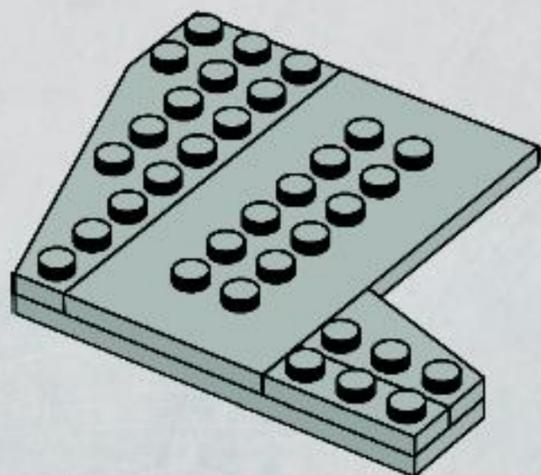



5

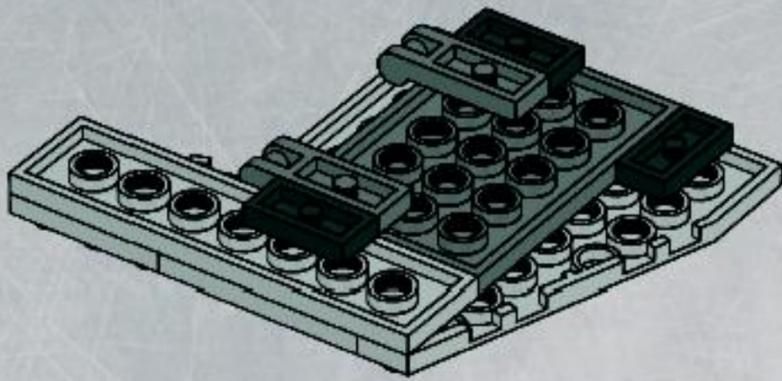

7

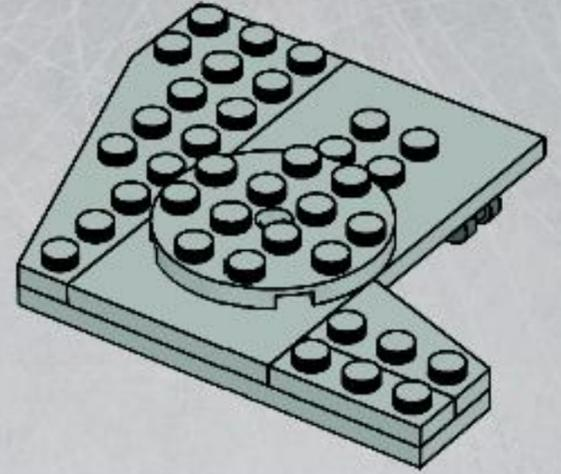

6

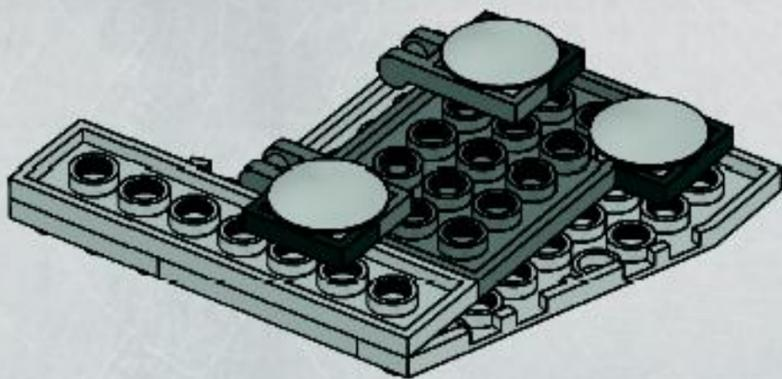

8

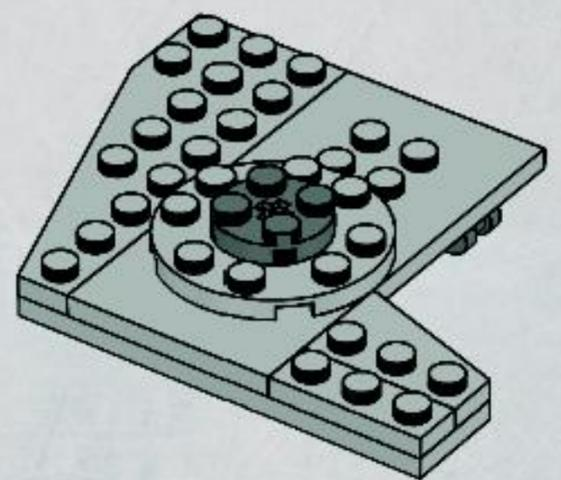

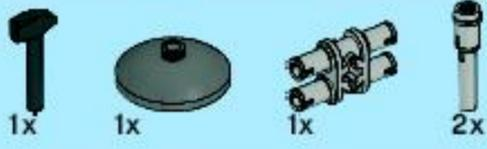

9

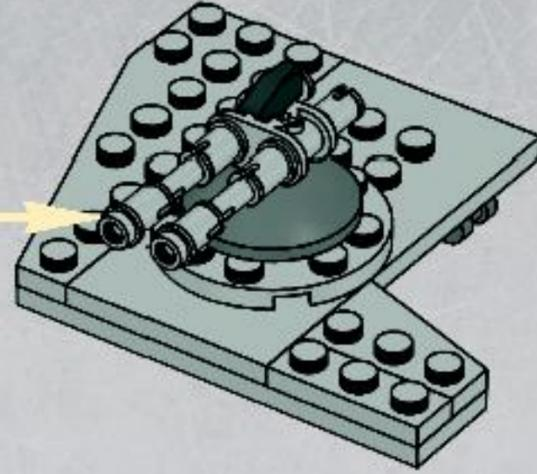
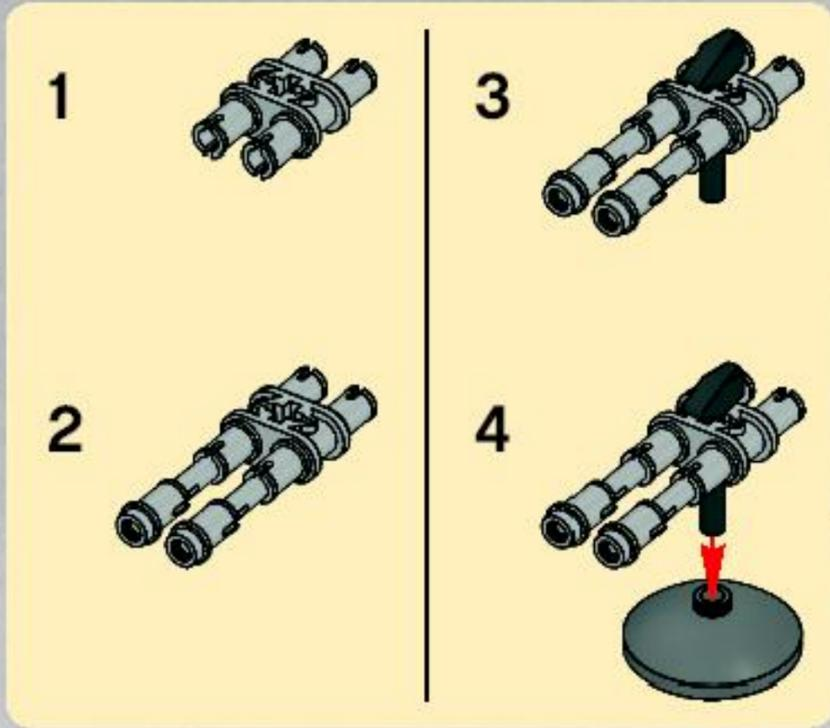

10

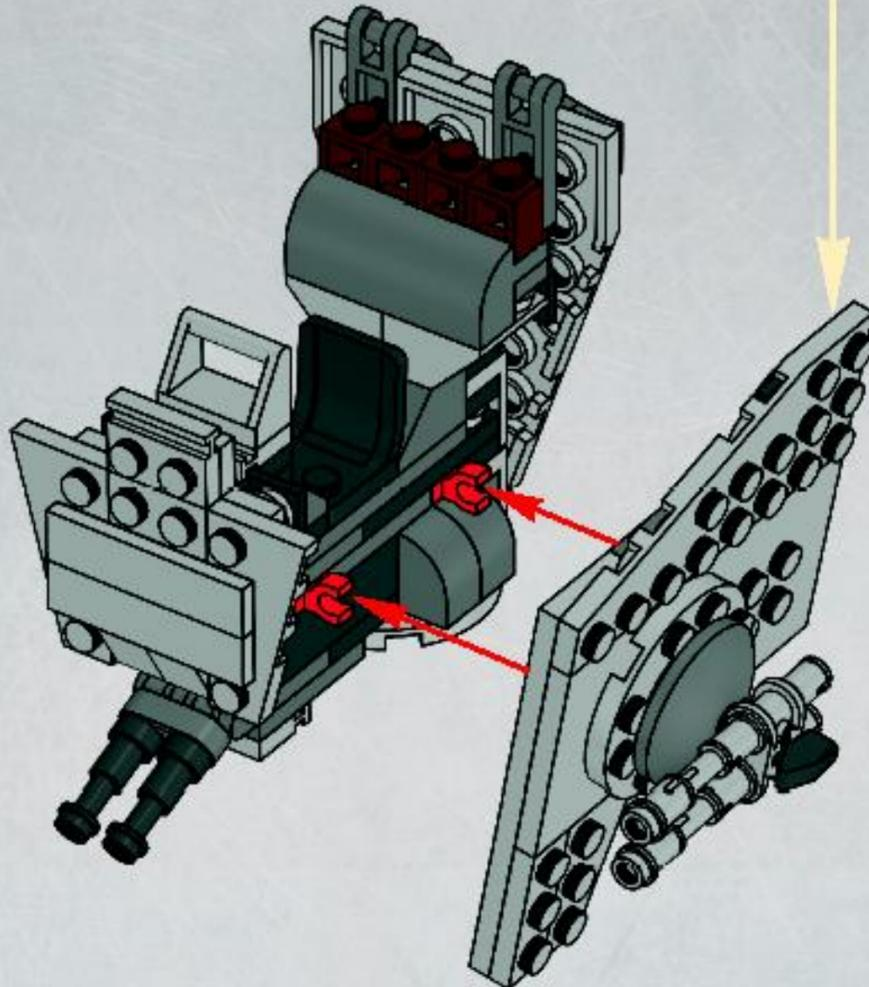

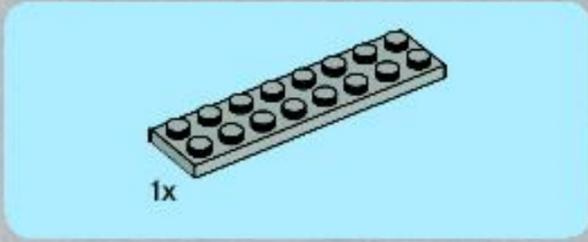
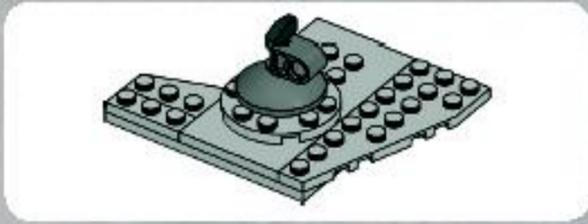

1

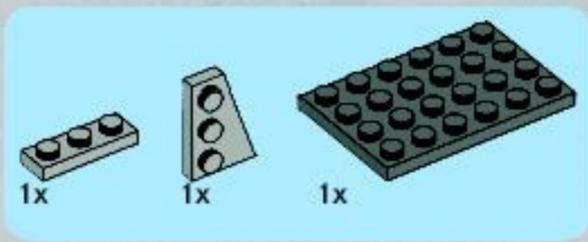
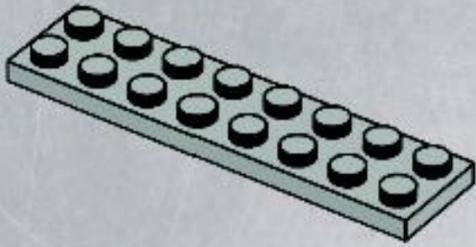

2

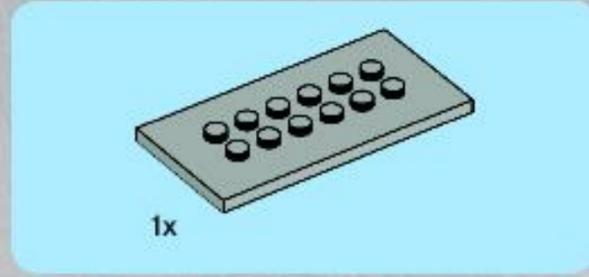
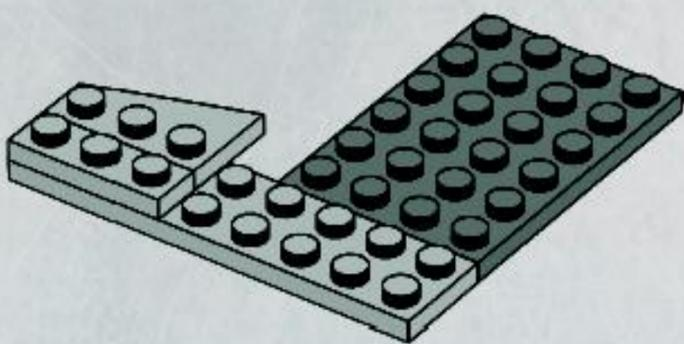

3

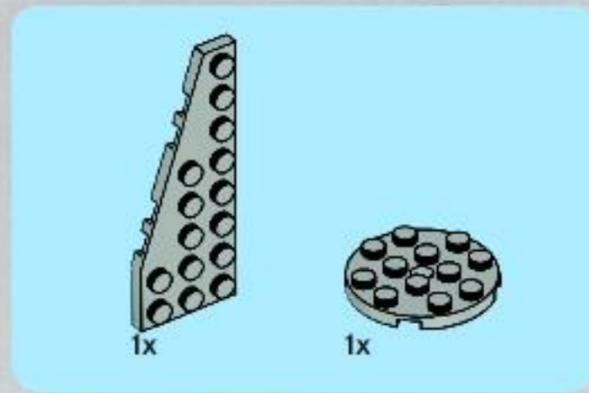
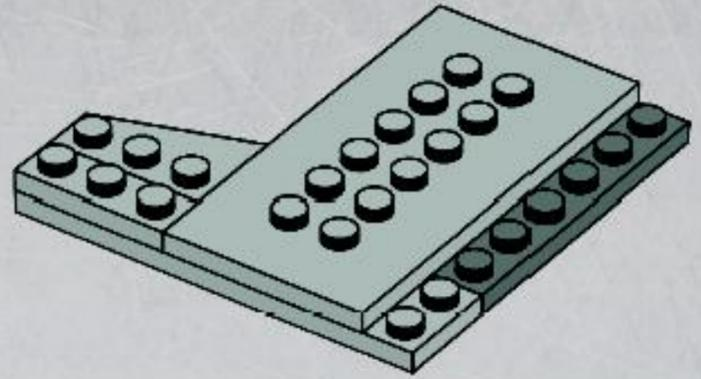

4

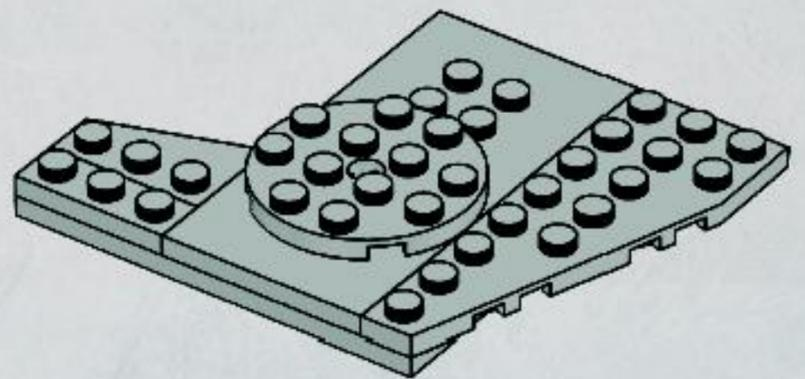



5

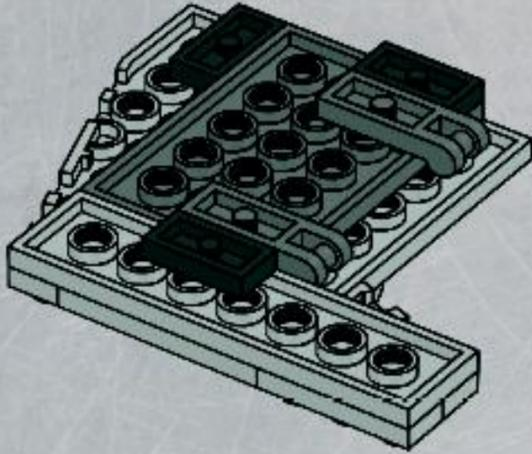

6

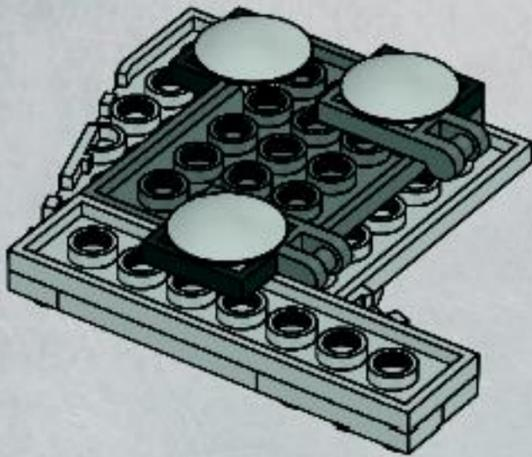

7

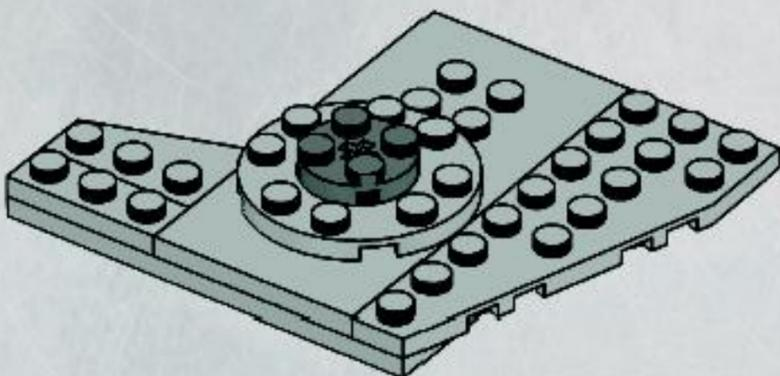

8

1

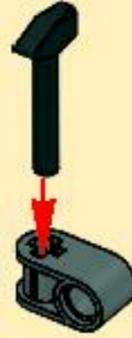

2

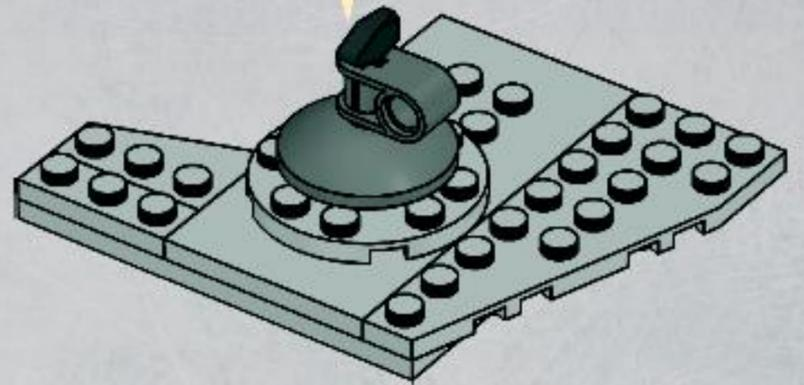

9

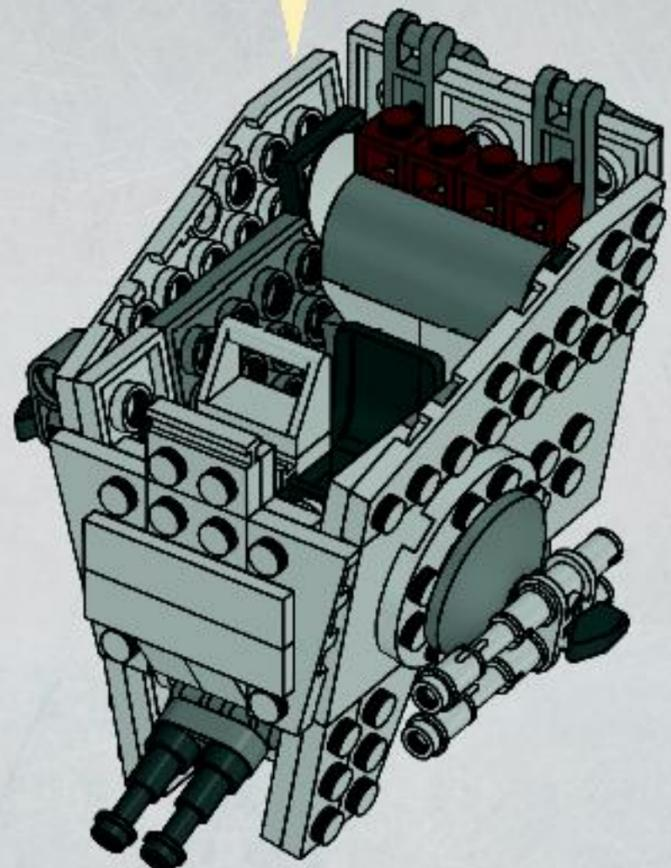



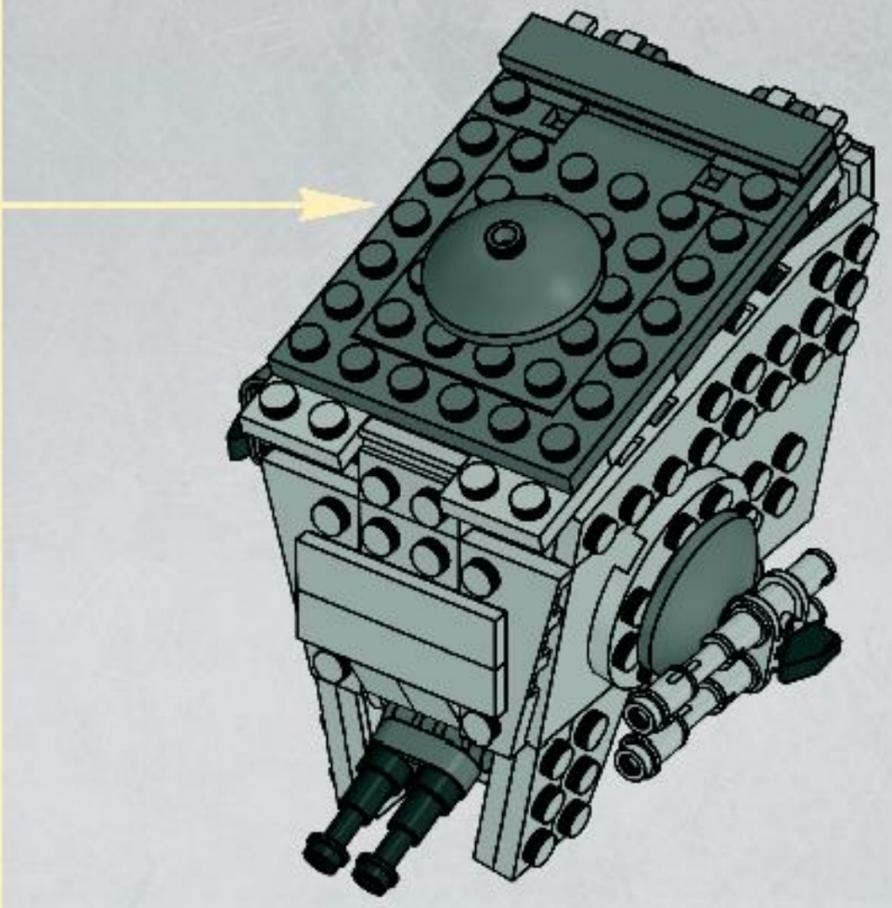
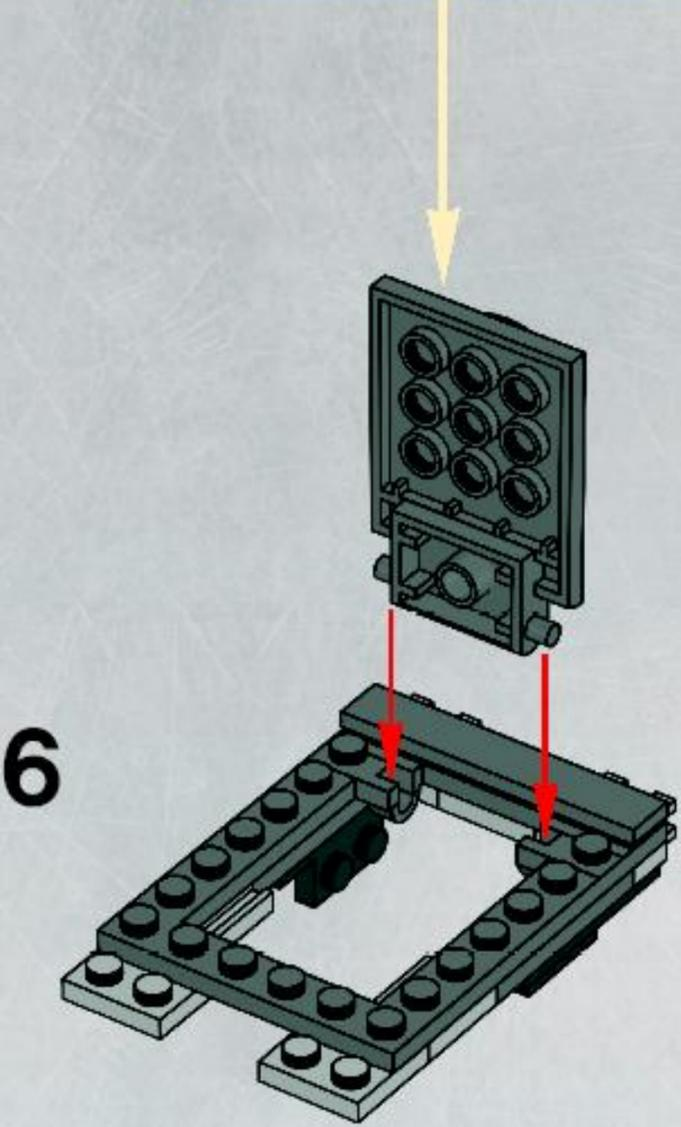
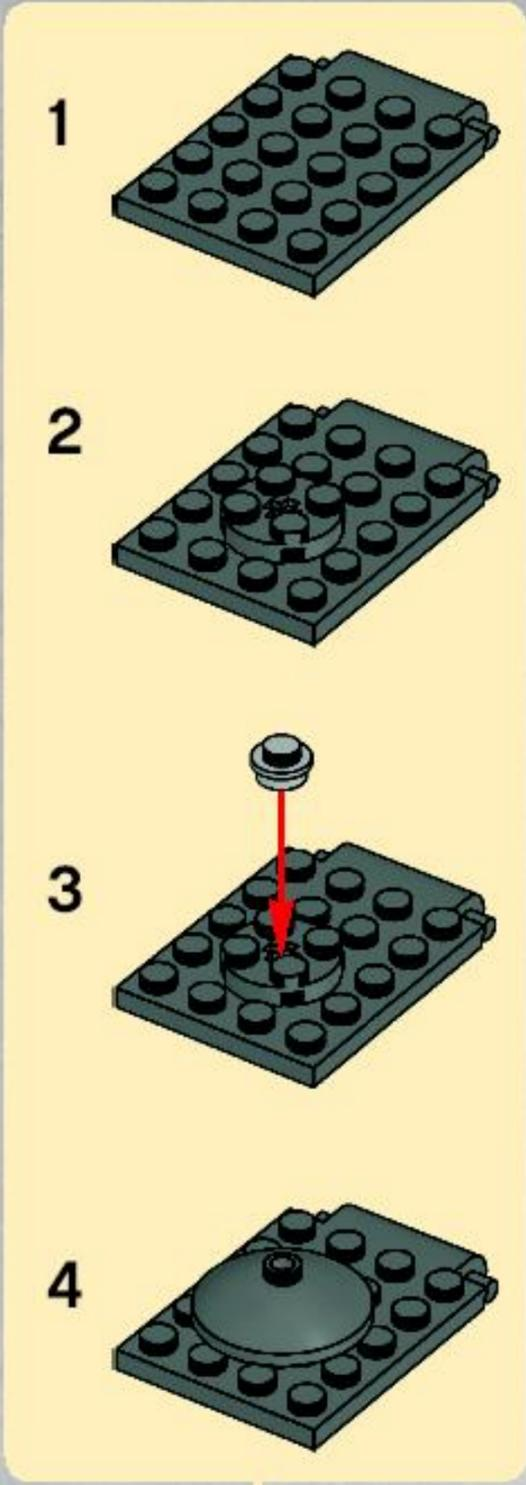



11

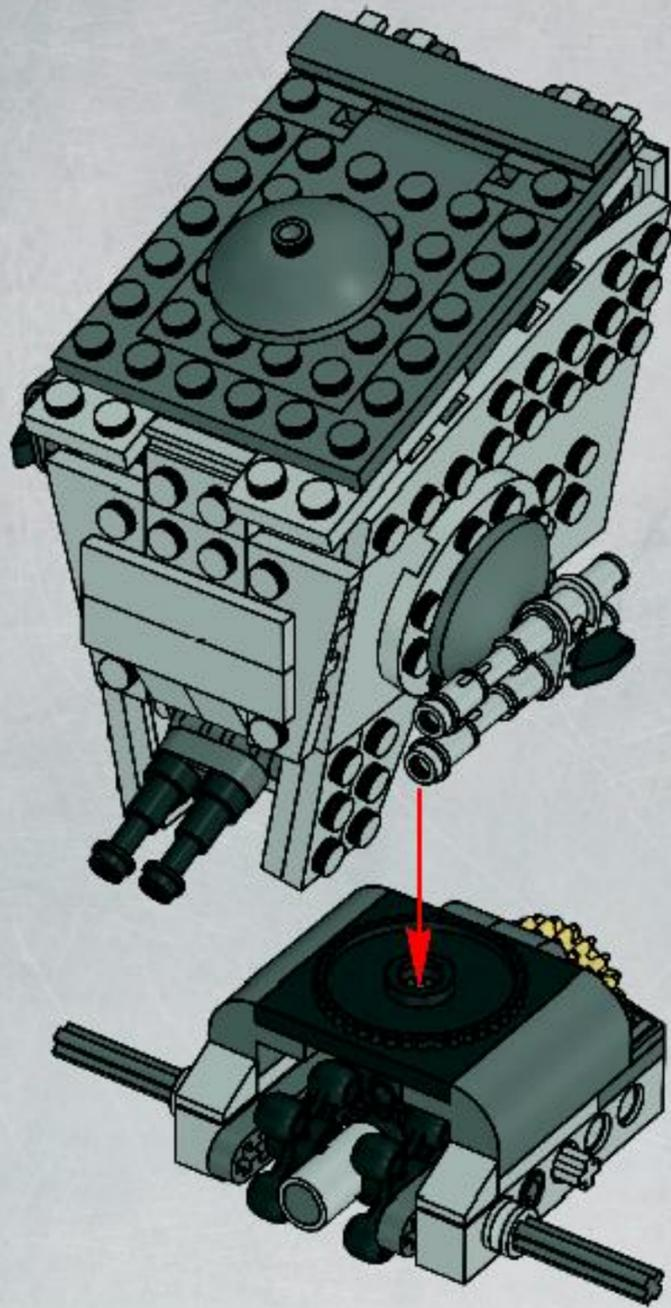

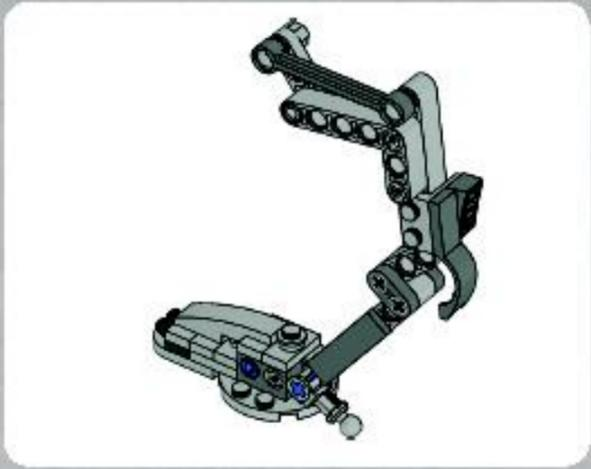

1

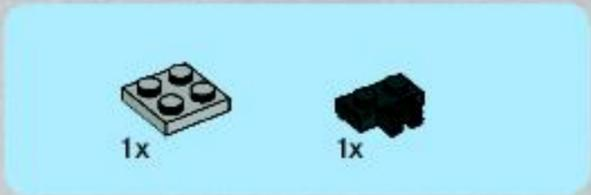
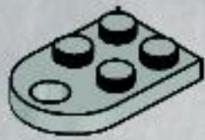

2

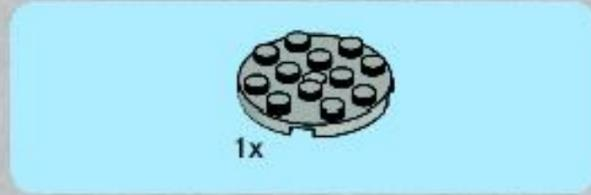

3

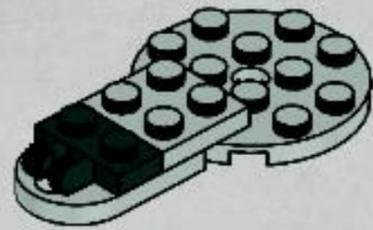

4

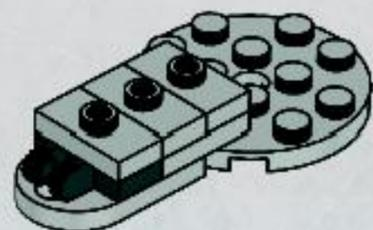

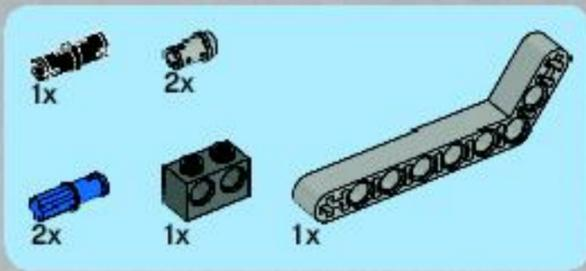

5

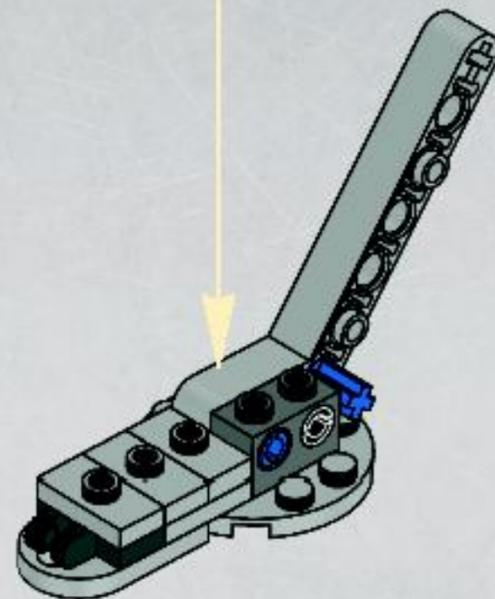
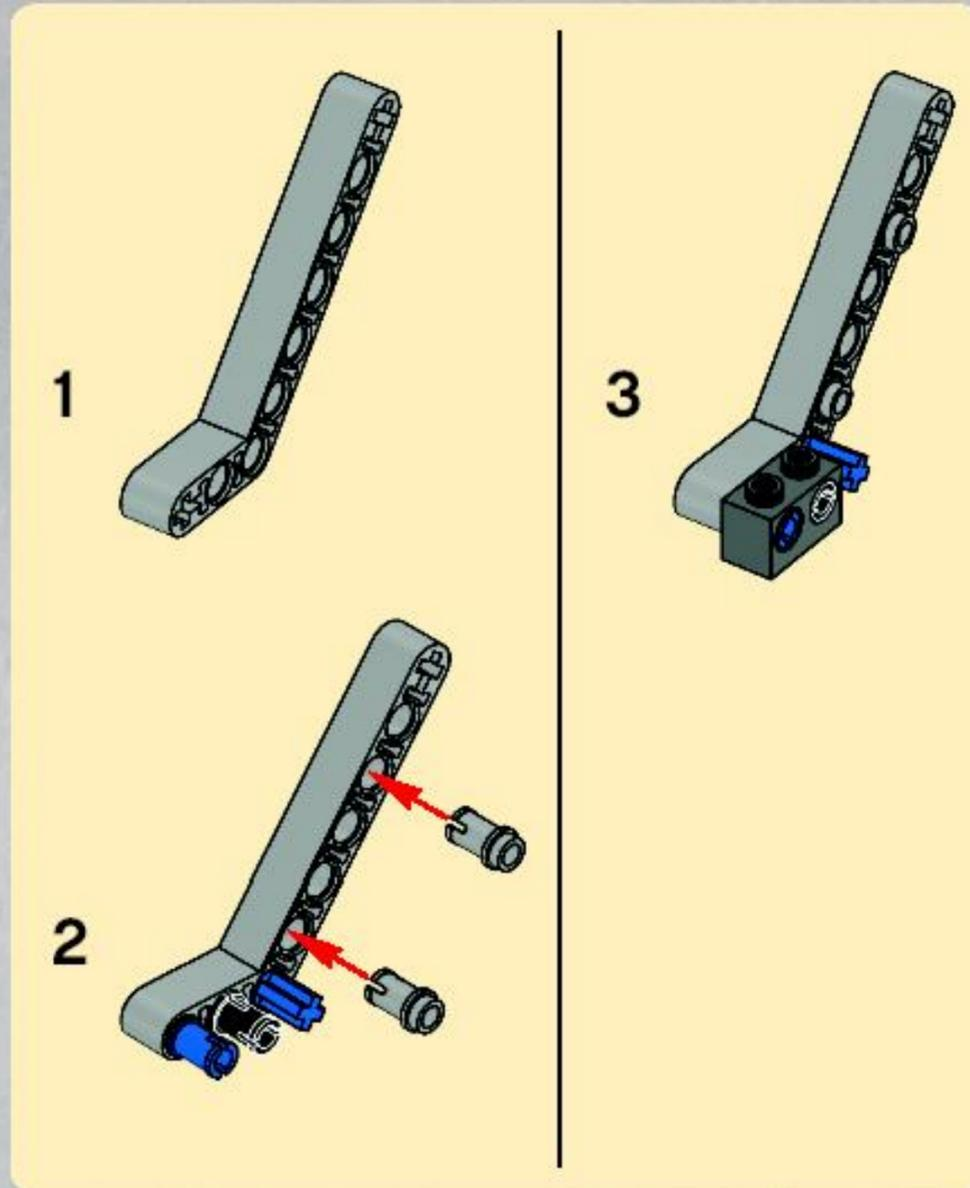



2x



1x

6

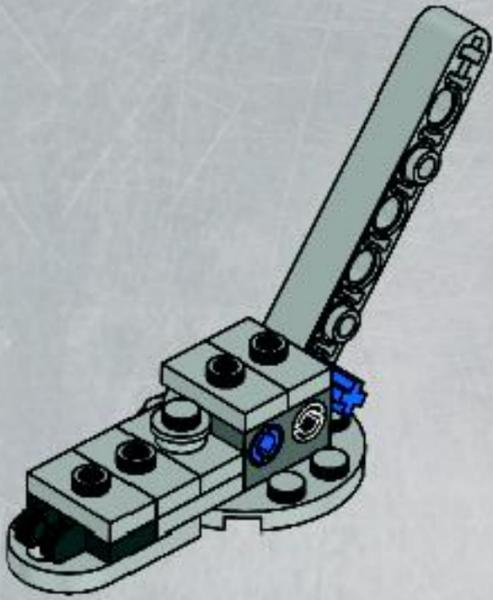

1x



1x

8

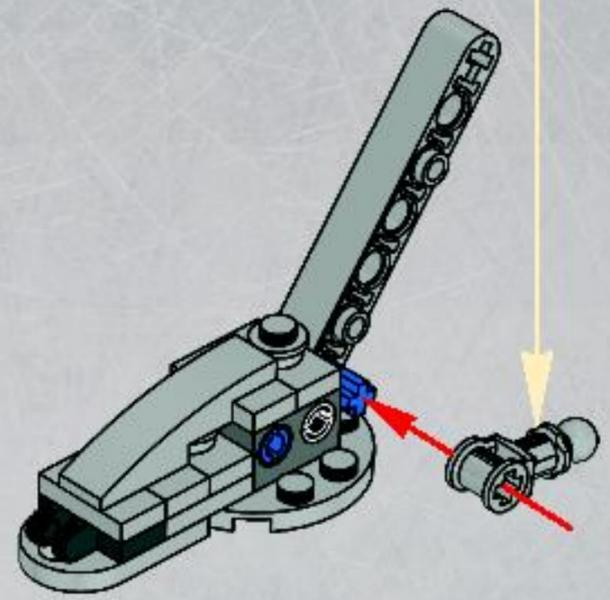
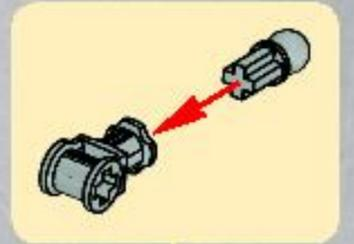

1x



1x

7

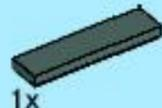
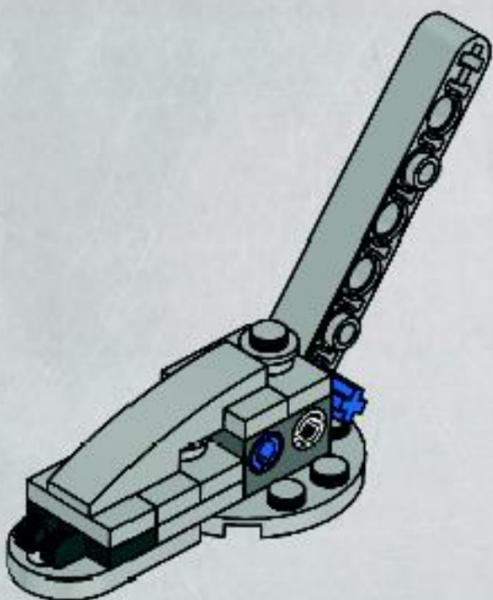

1x



1x

9

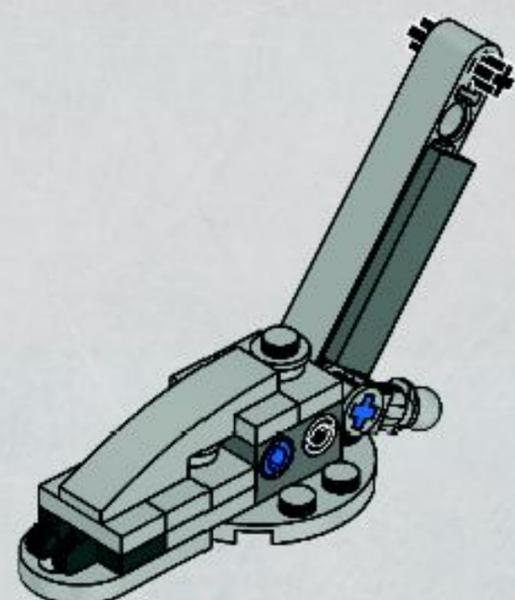



1x

1x

# 10

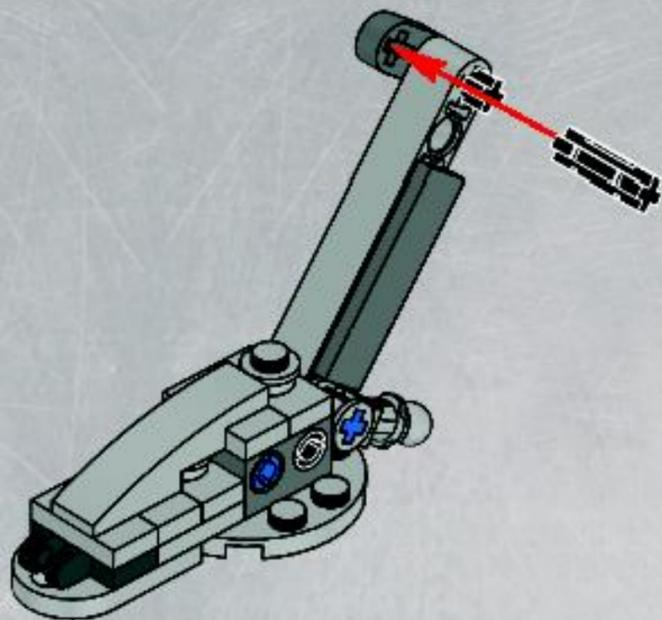

2x

2x

# 12

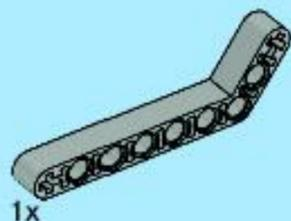
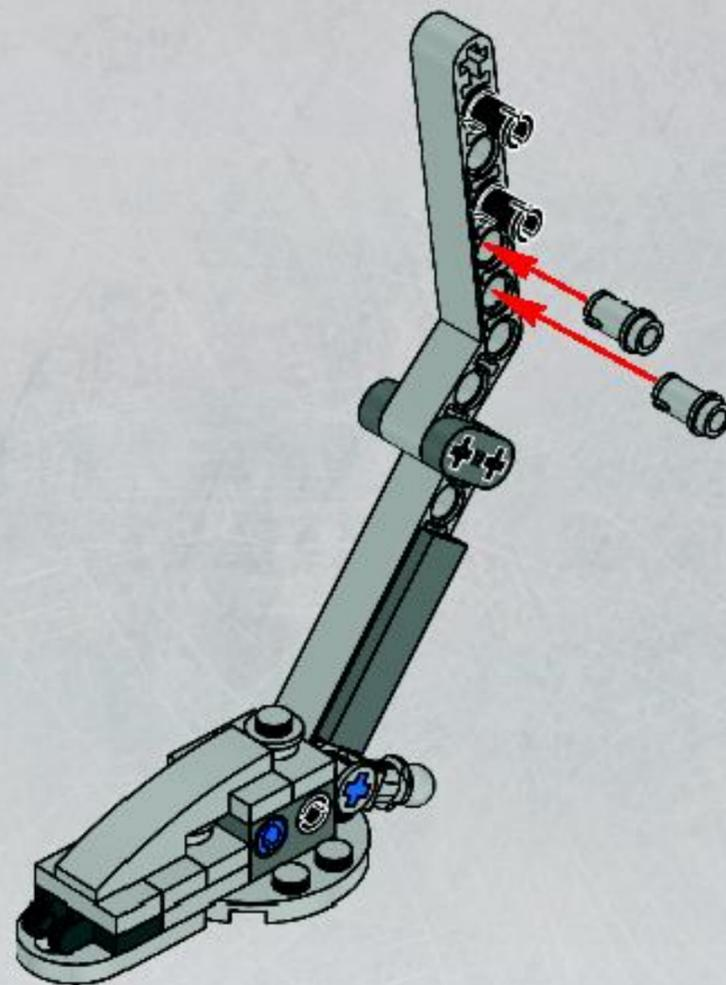

1x

1x

# 11

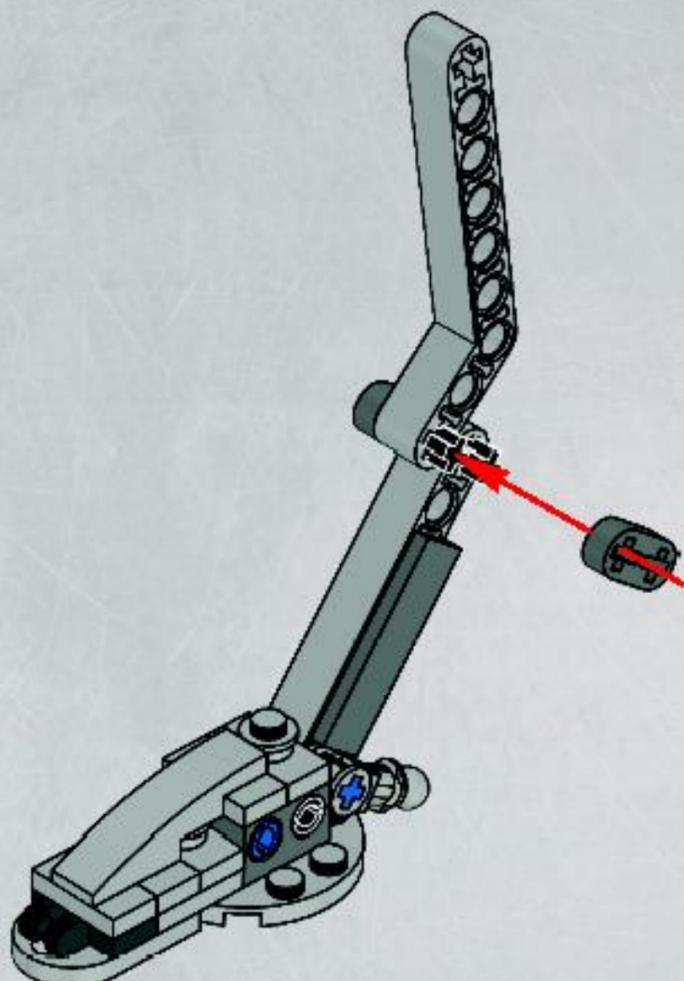



1x



1x



1x

# 13

1



2

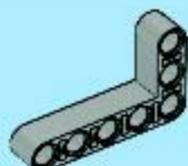
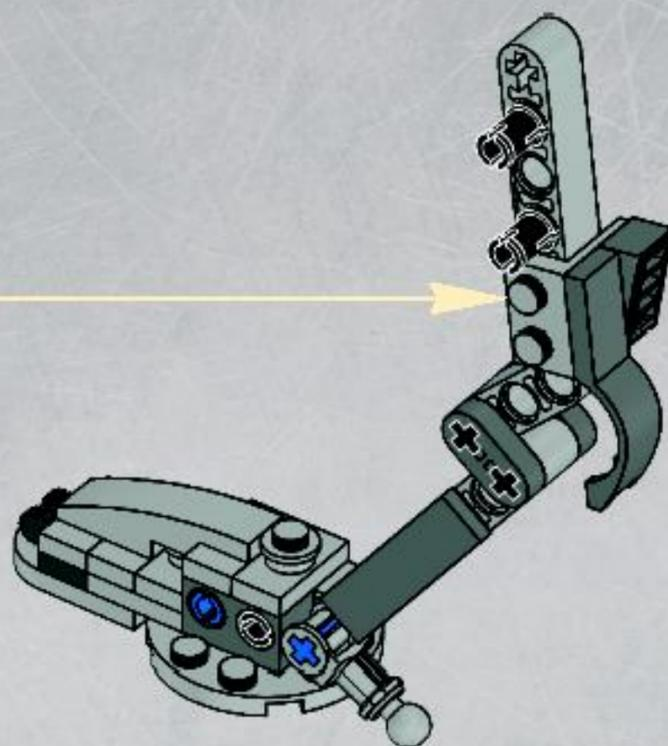

1x

# 14

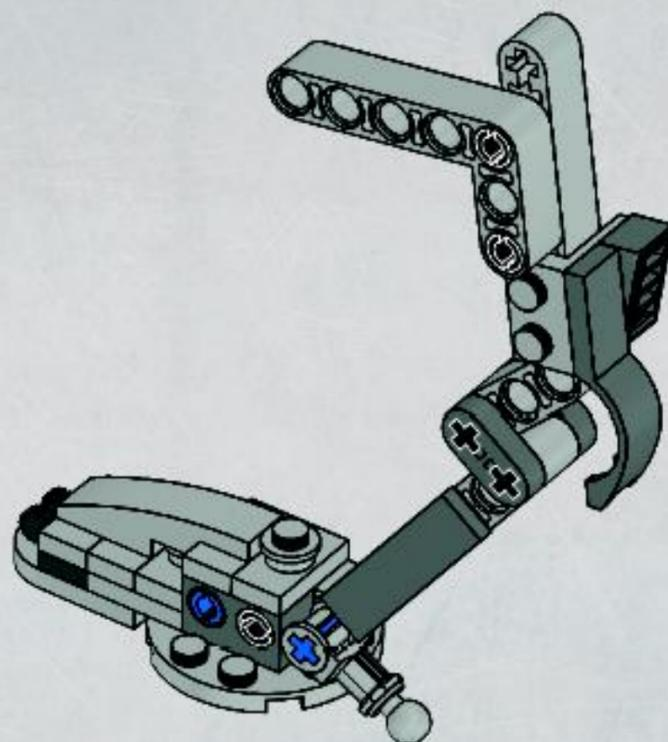



1x

# 15

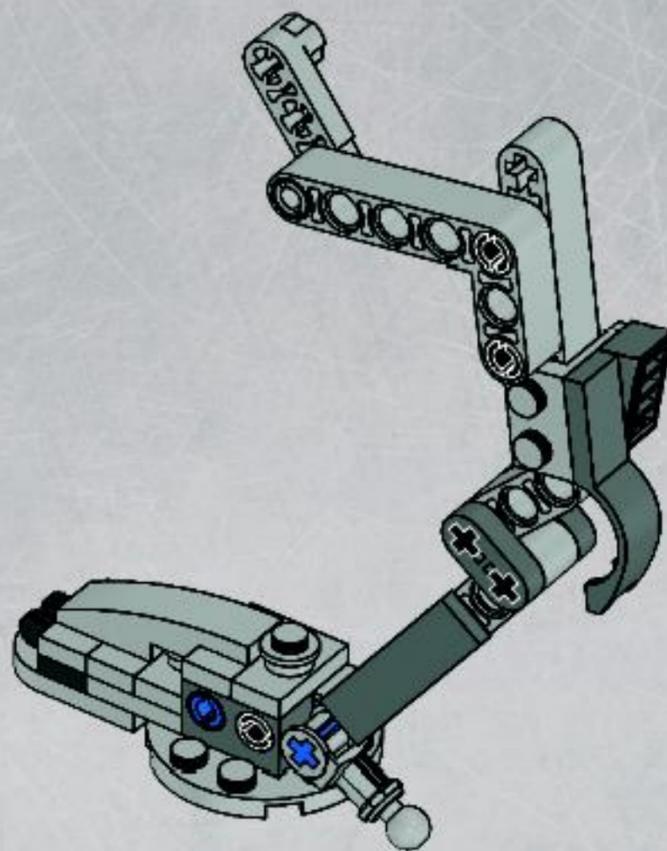

2x

# 16

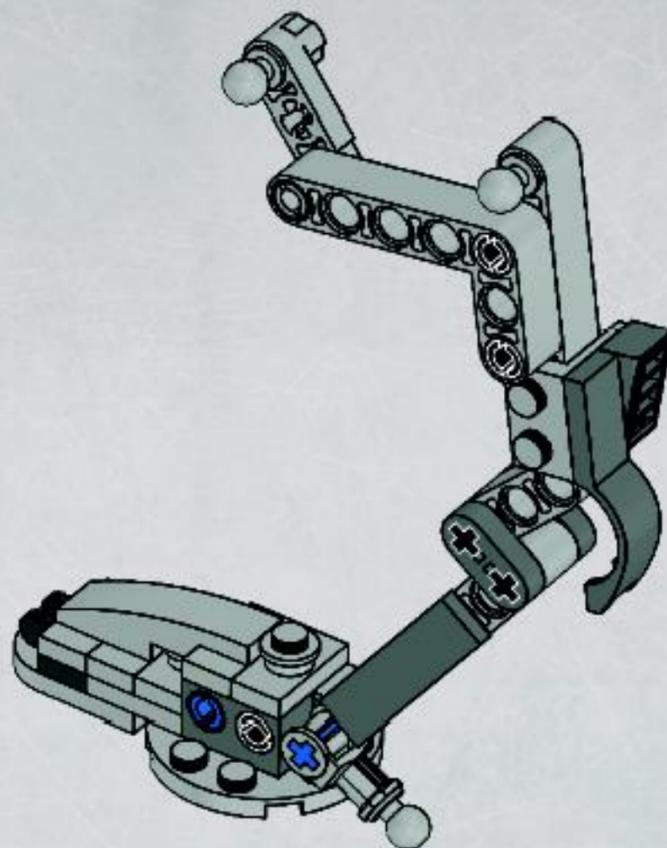

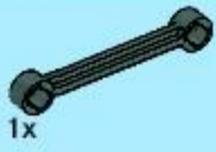

1x

# 17

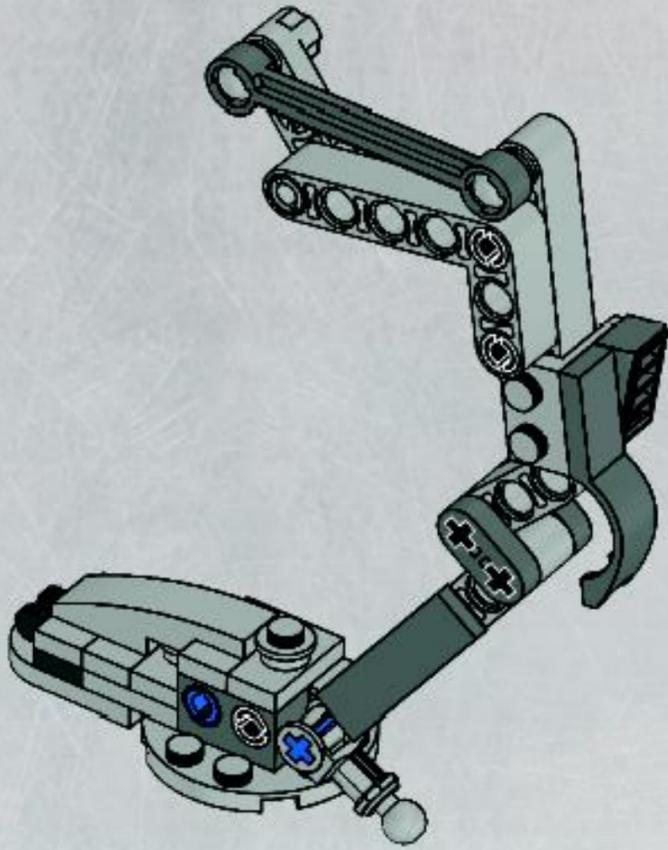

# 18

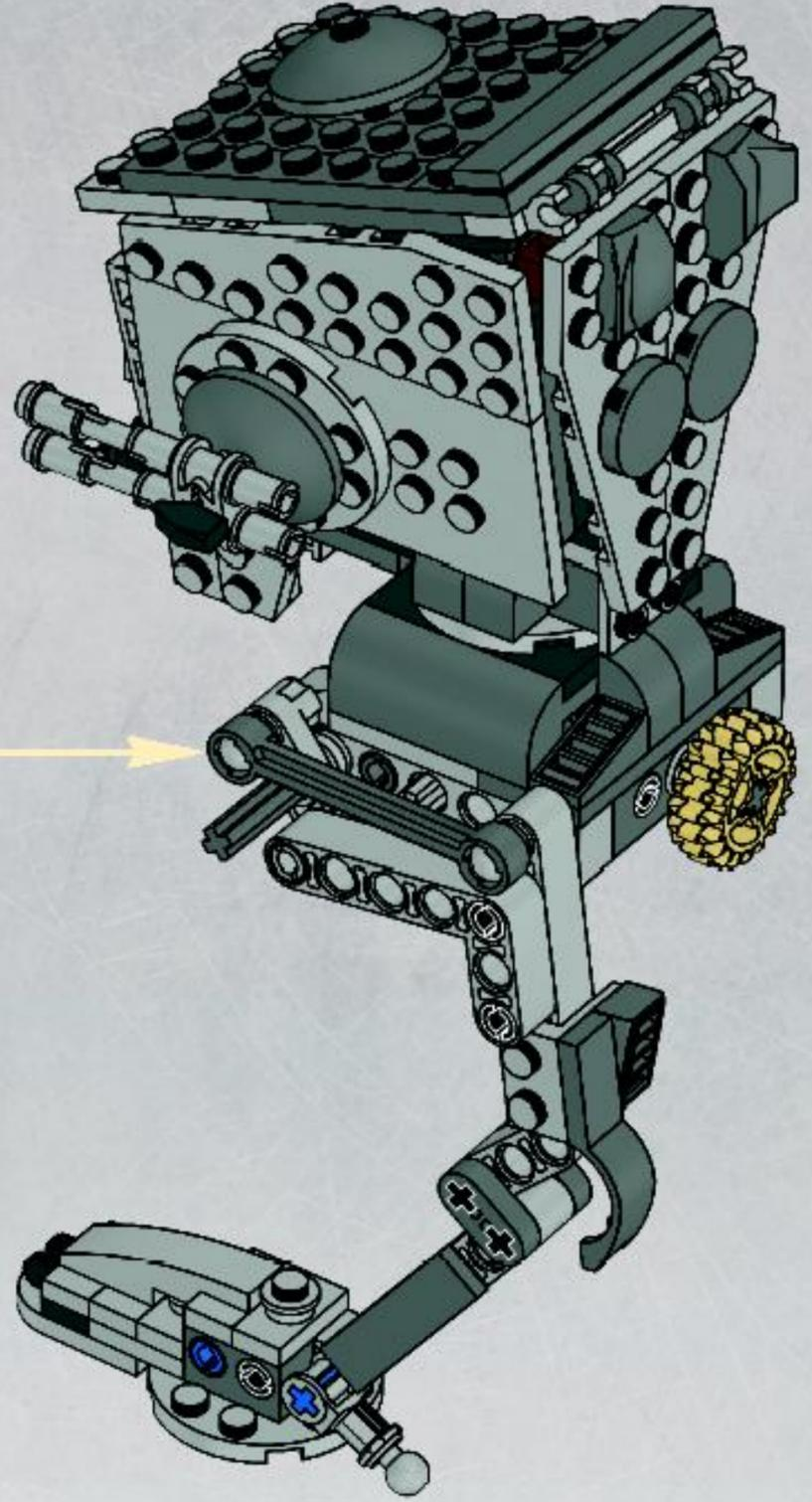





1

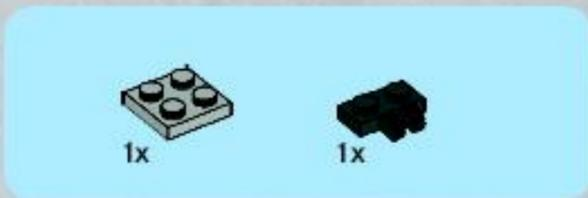

2

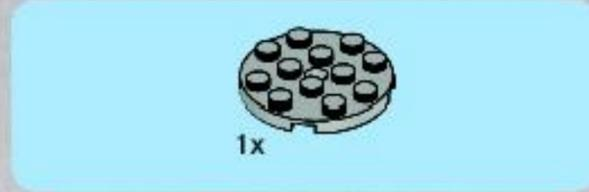

3

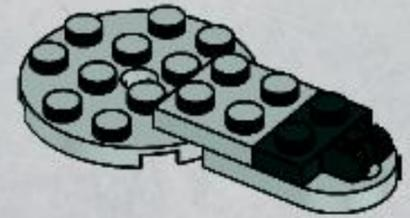

4

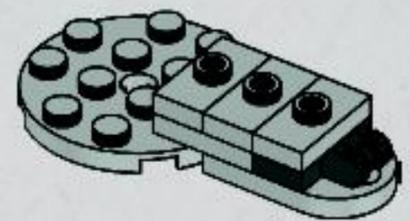

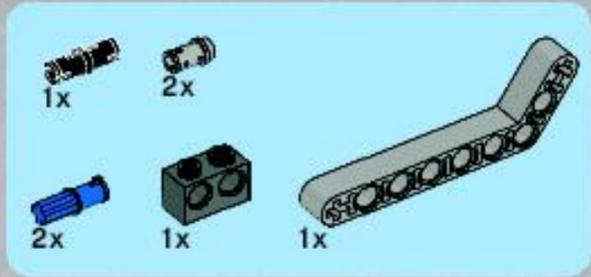

5

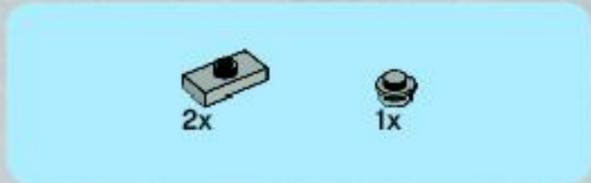
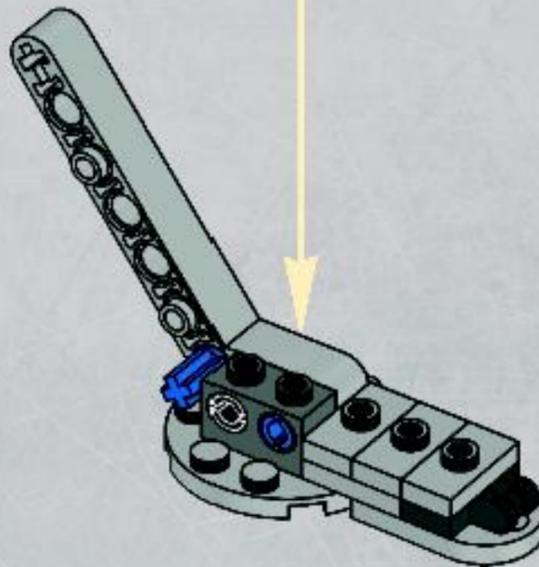
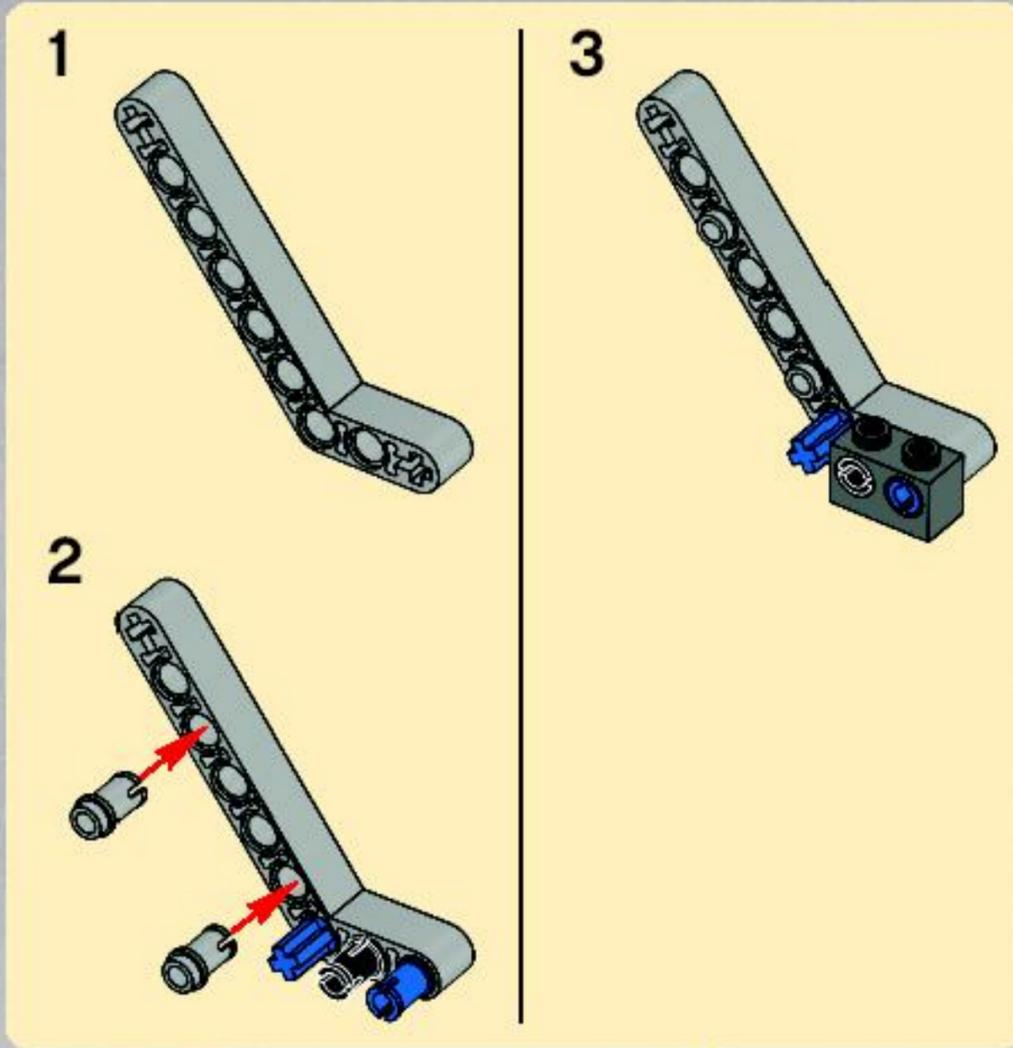

6

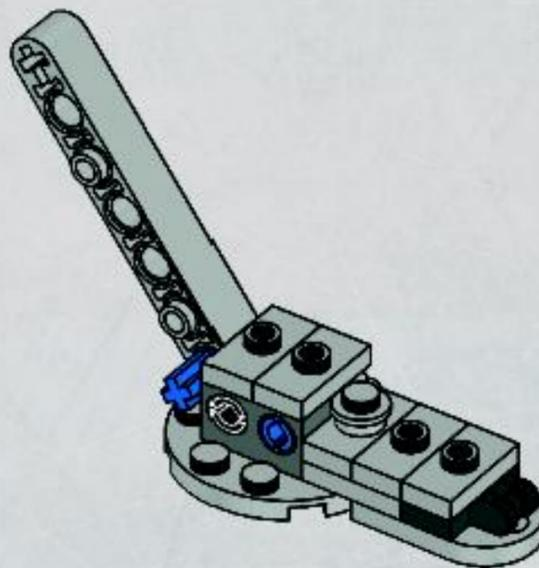

1x

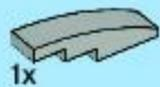

1x

# 7

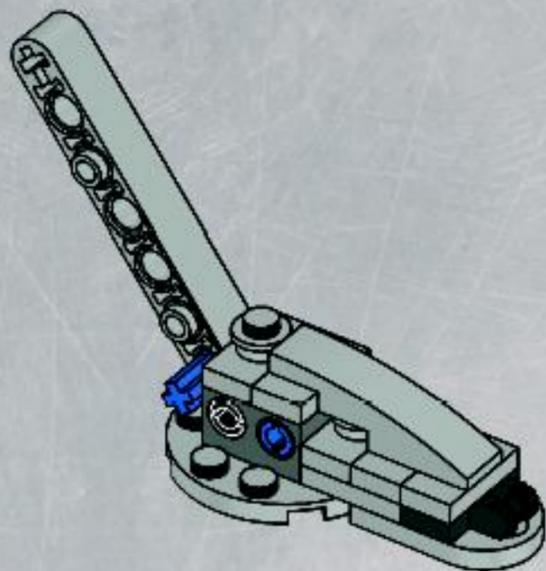

1x



1x

# 9



1x



1x

# 8

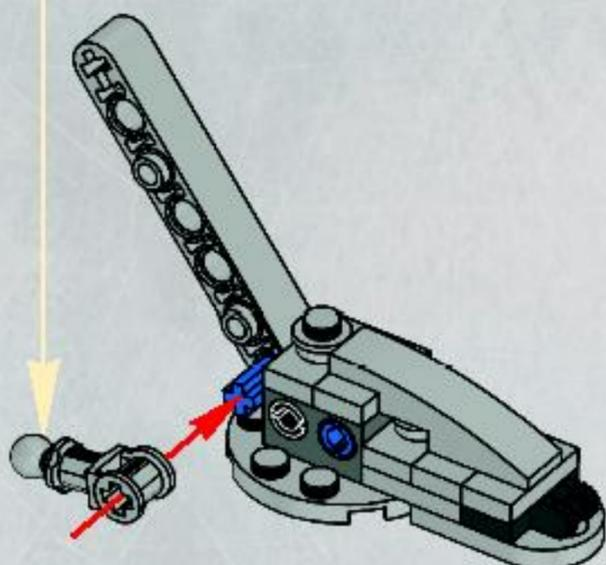
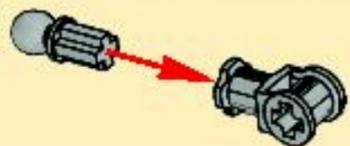

1x



1x

# 10

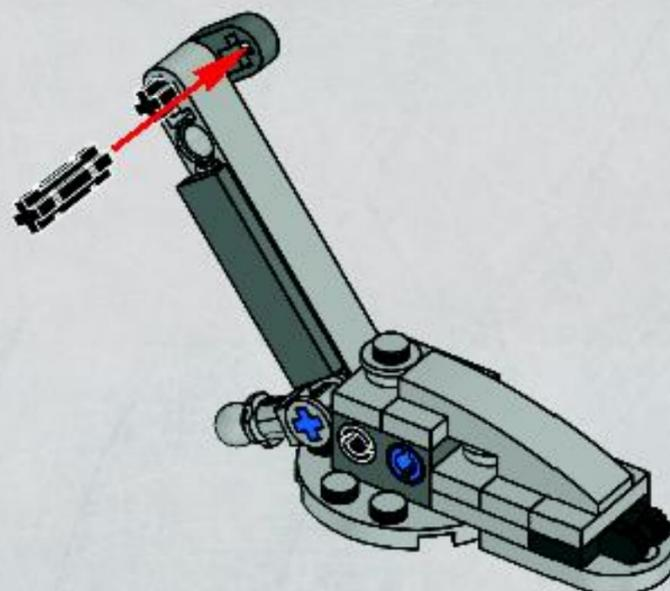

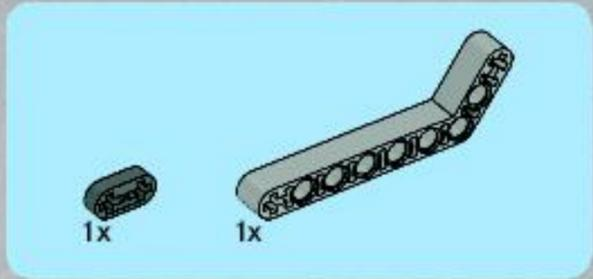

11

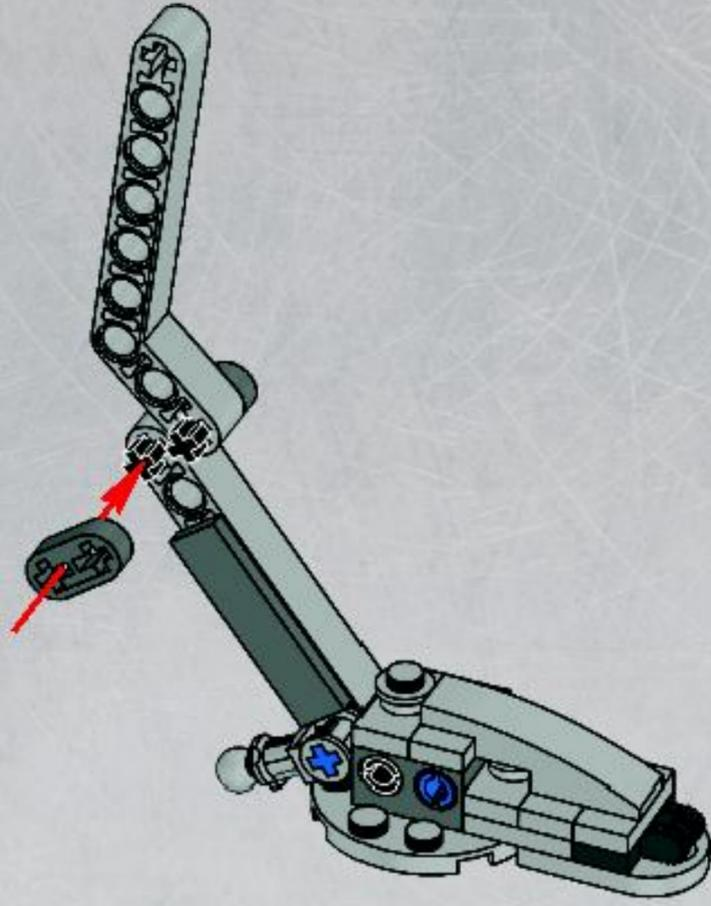

12

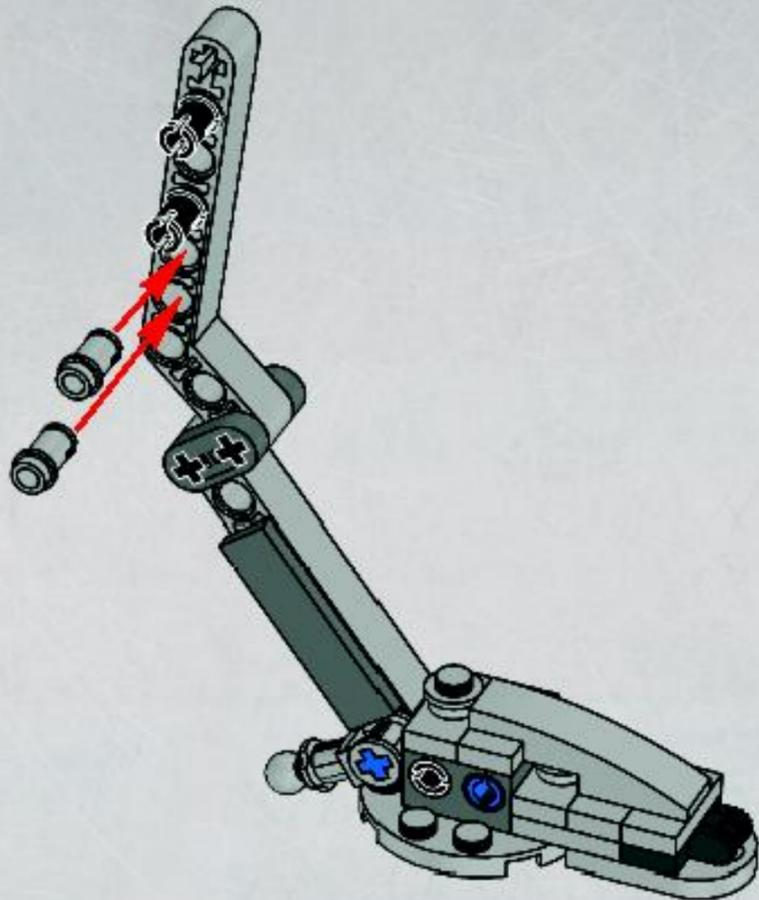



1x

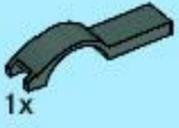

1x



1x

# 13

1



2

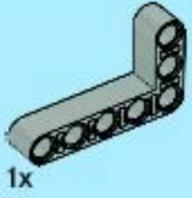
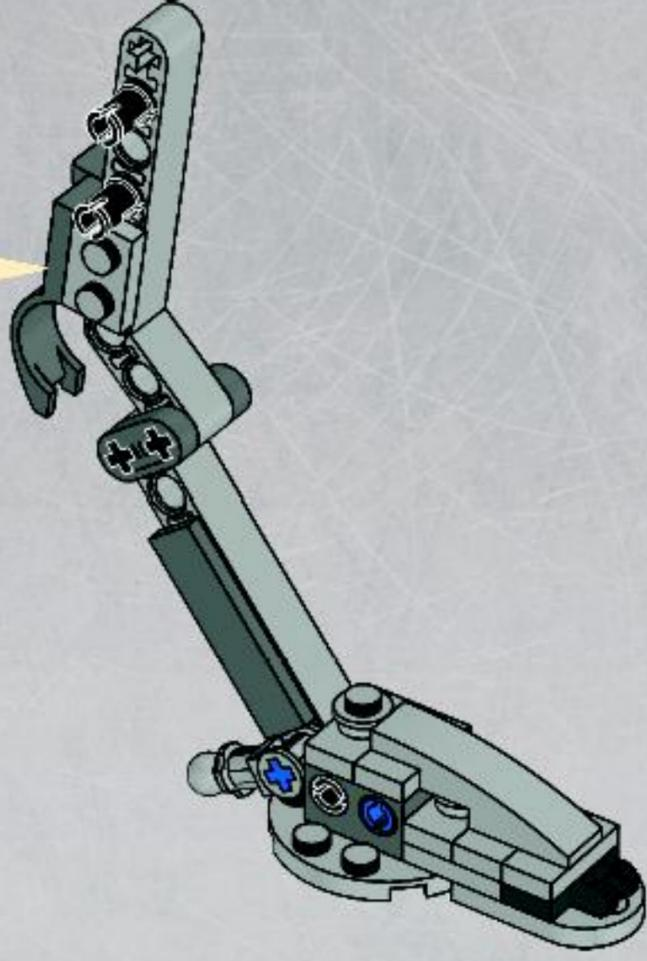
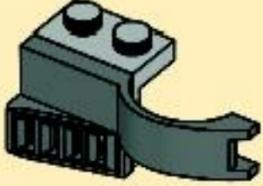

1x

# 14

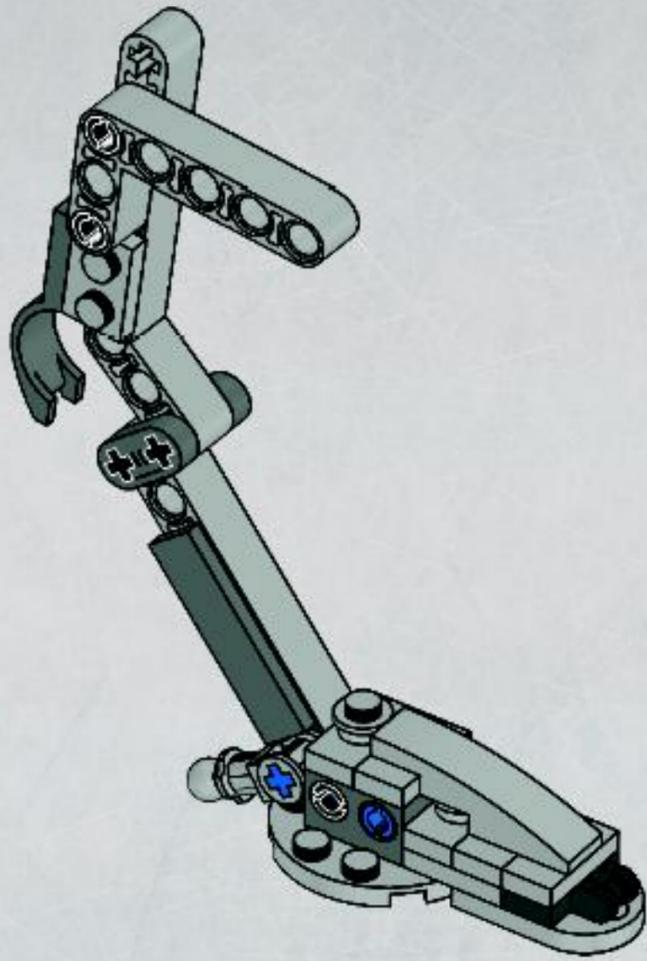



1x

# 15

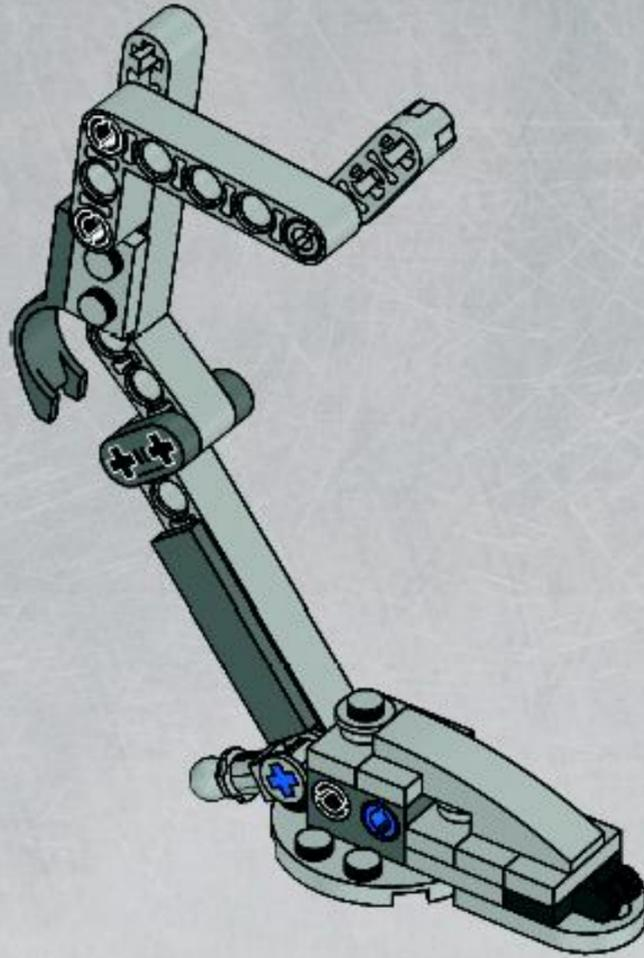

2x

# 16

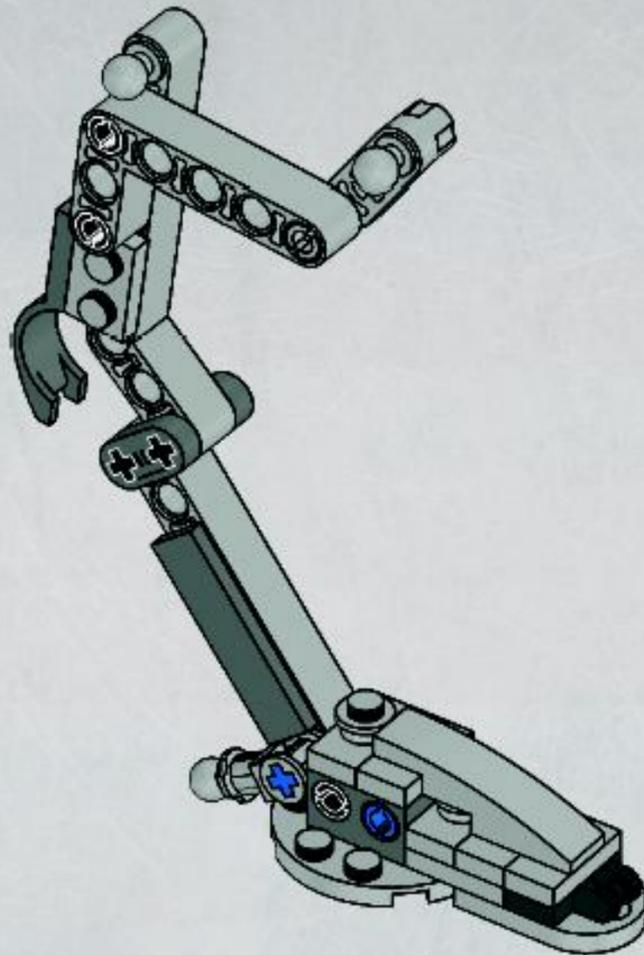



1x

17

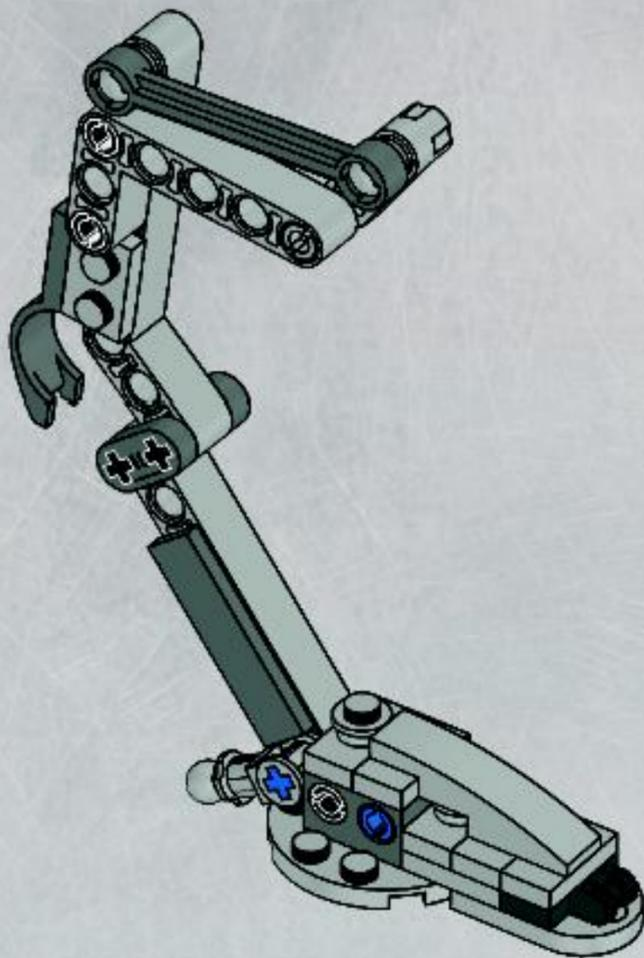

18

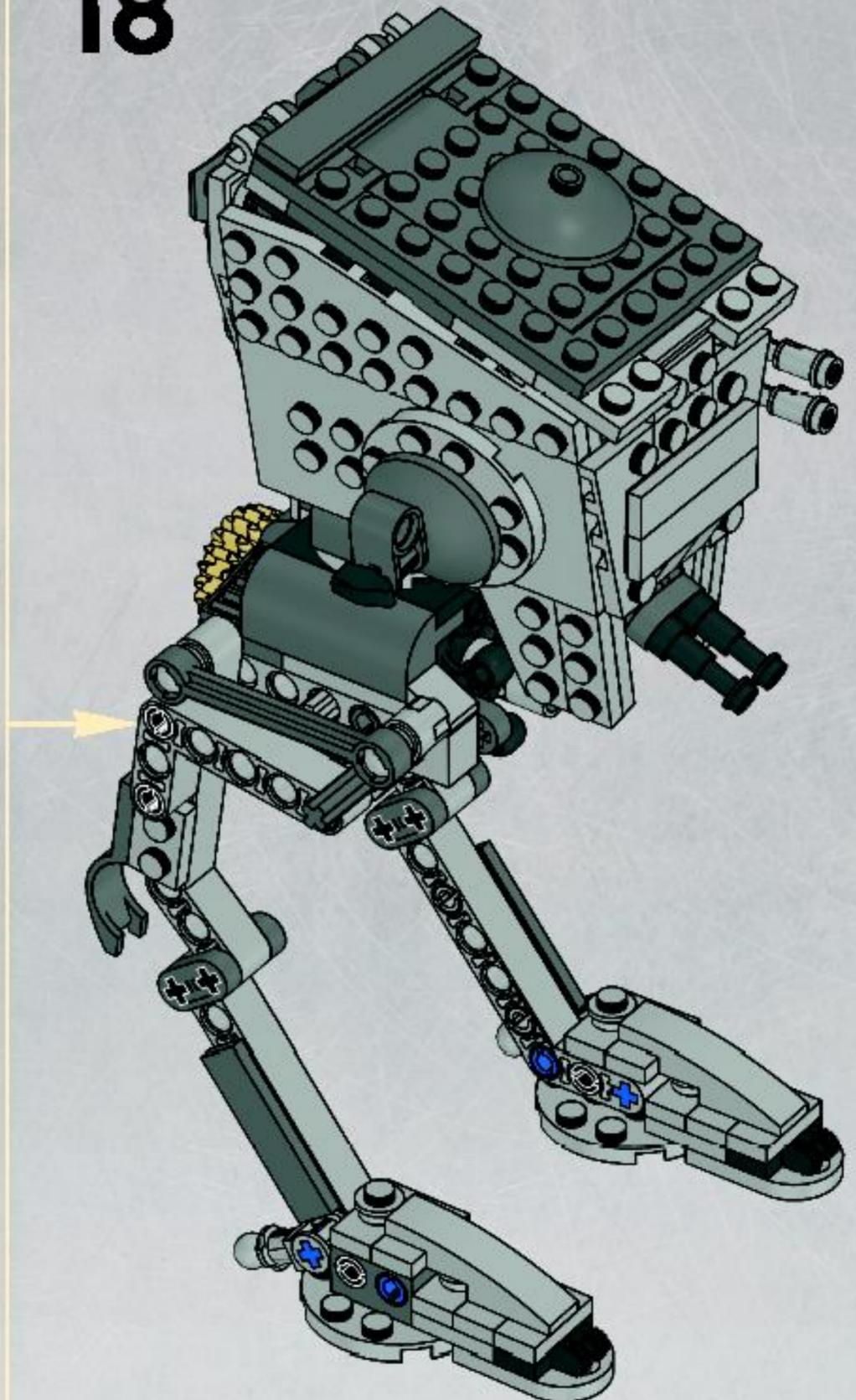



2x

# 19

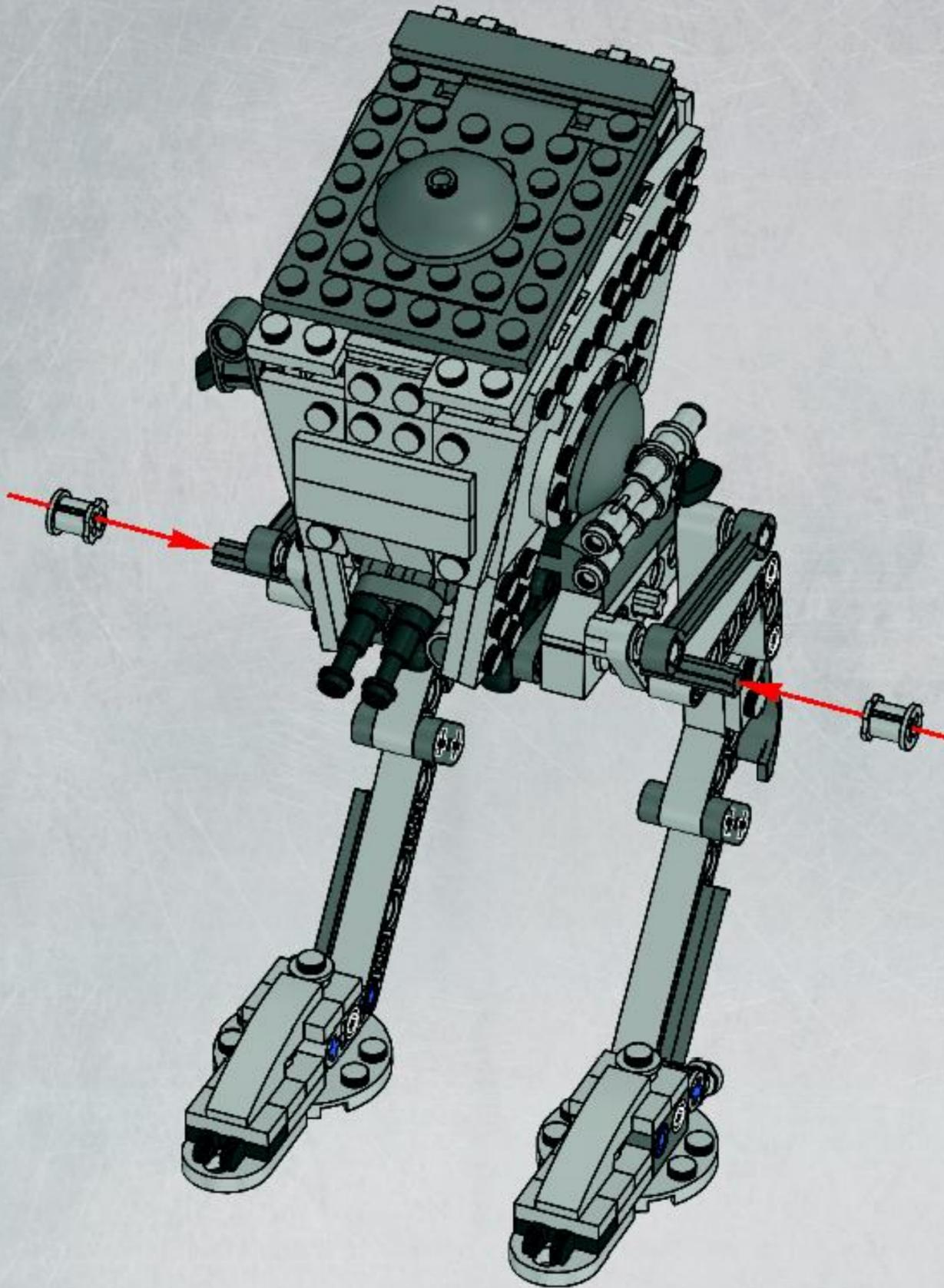





2x



2x

# 20

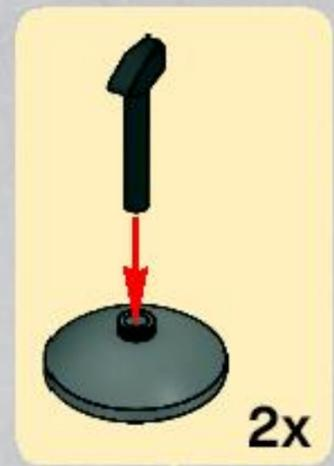
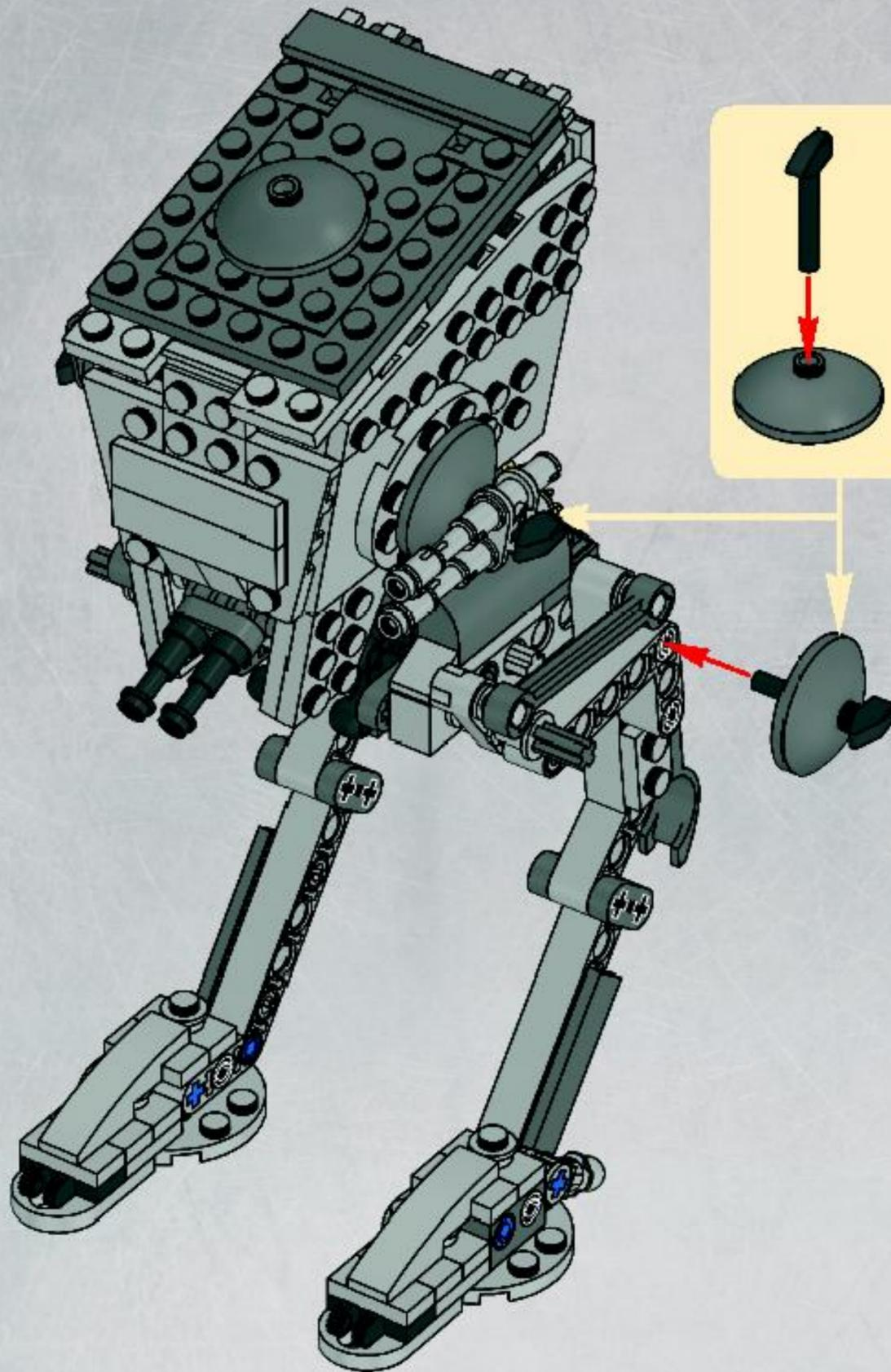



2x

# 21

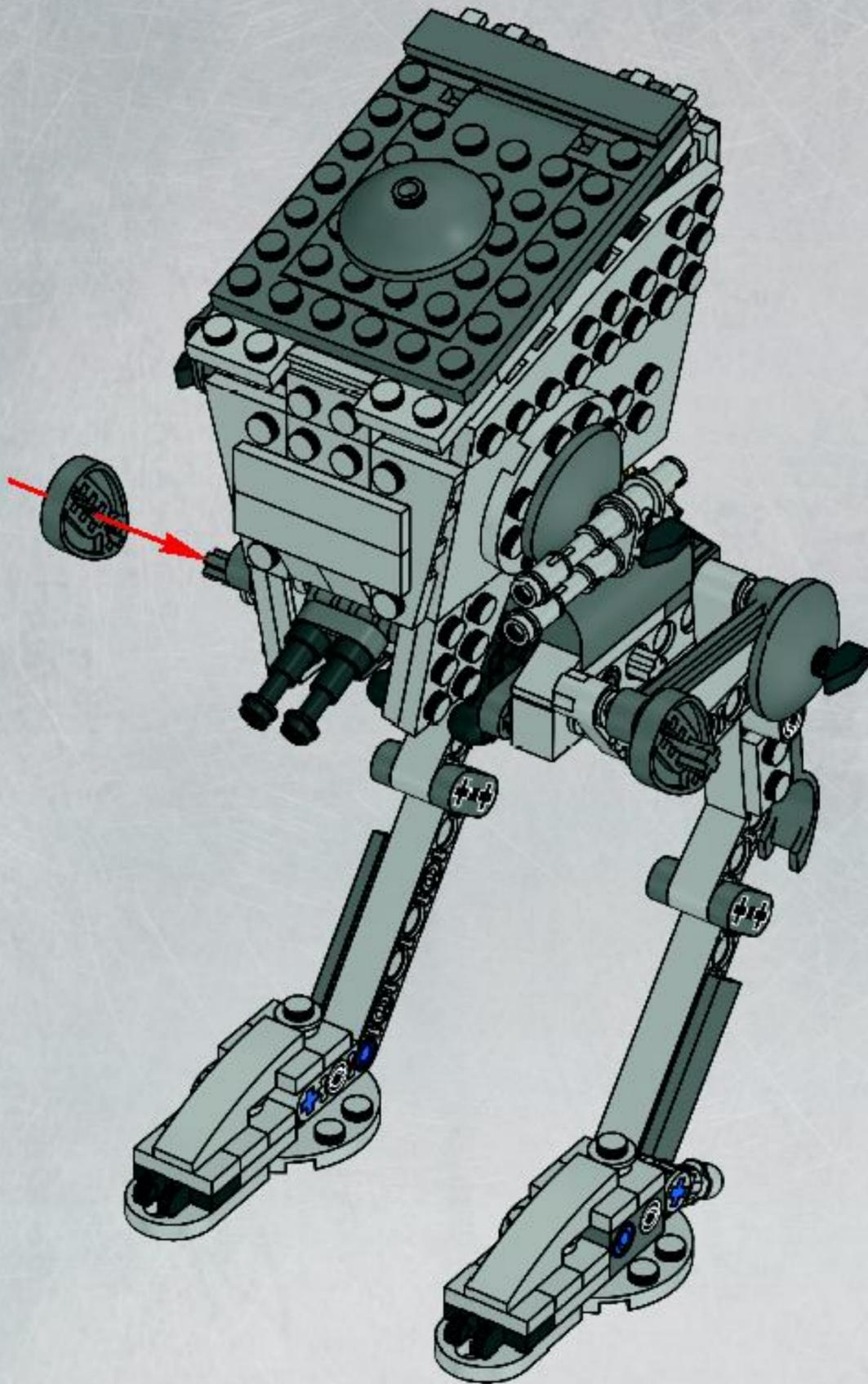



1x



1x

# 22

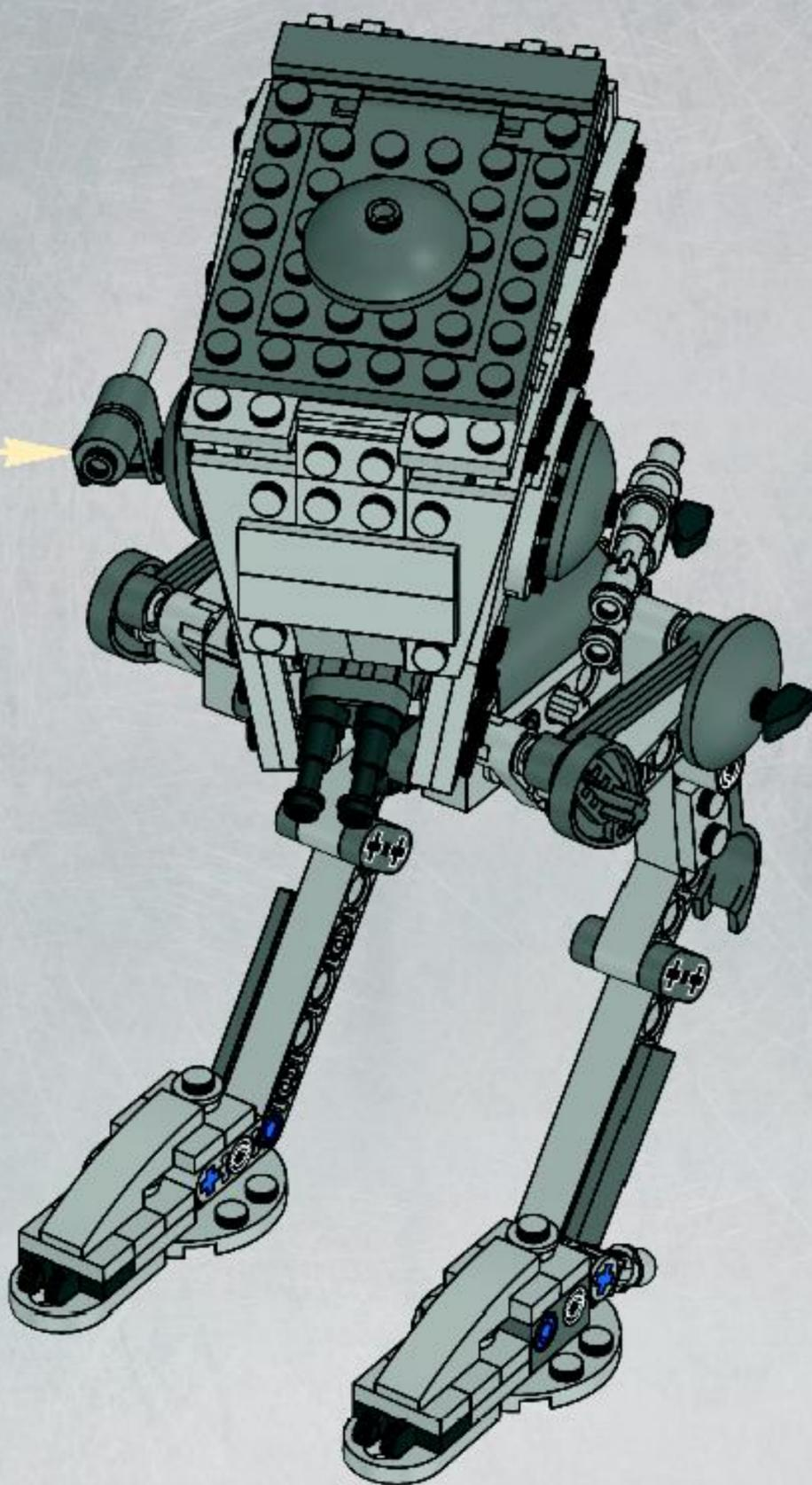
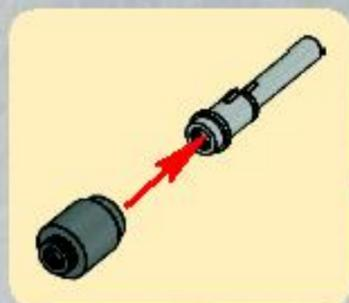



23

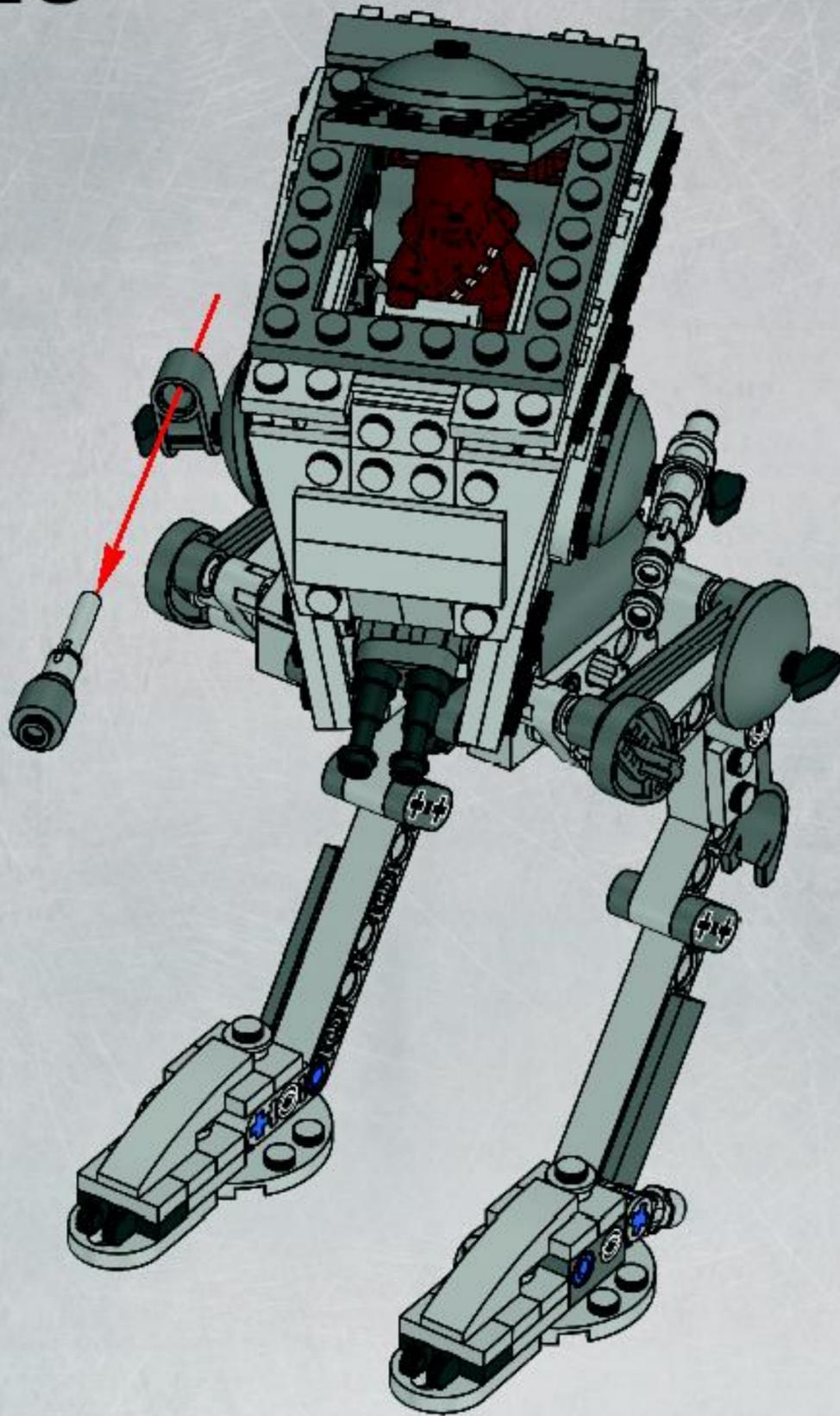

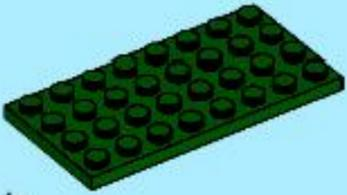

1x

1

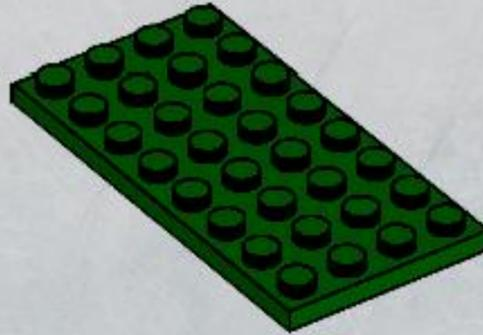

1x



1x

2

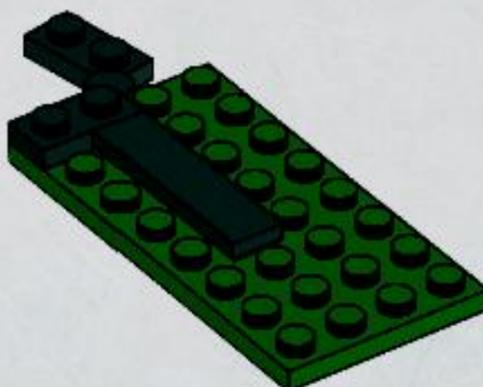

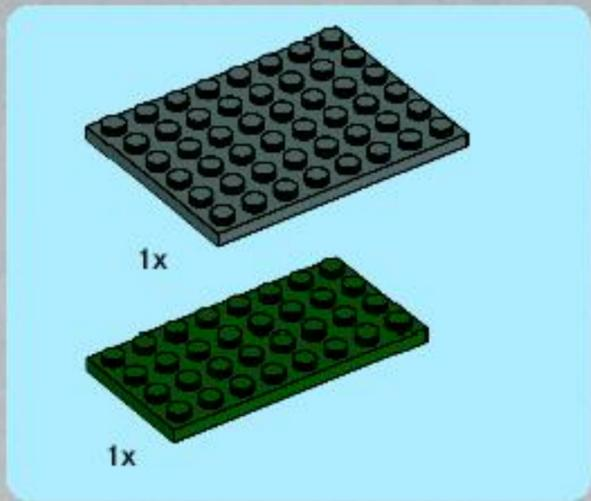

3

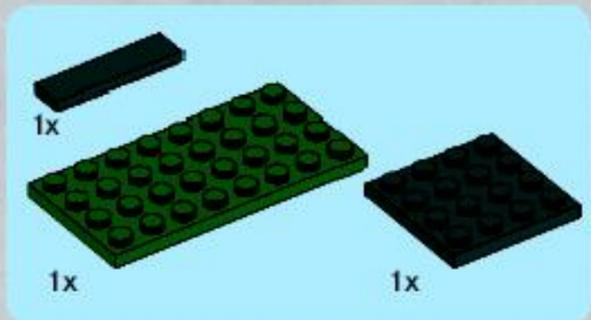
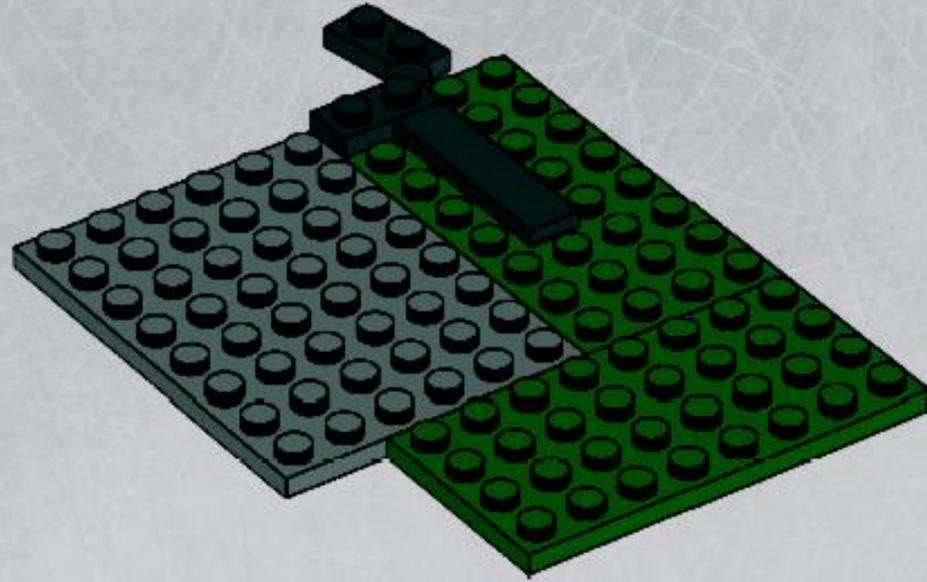

4

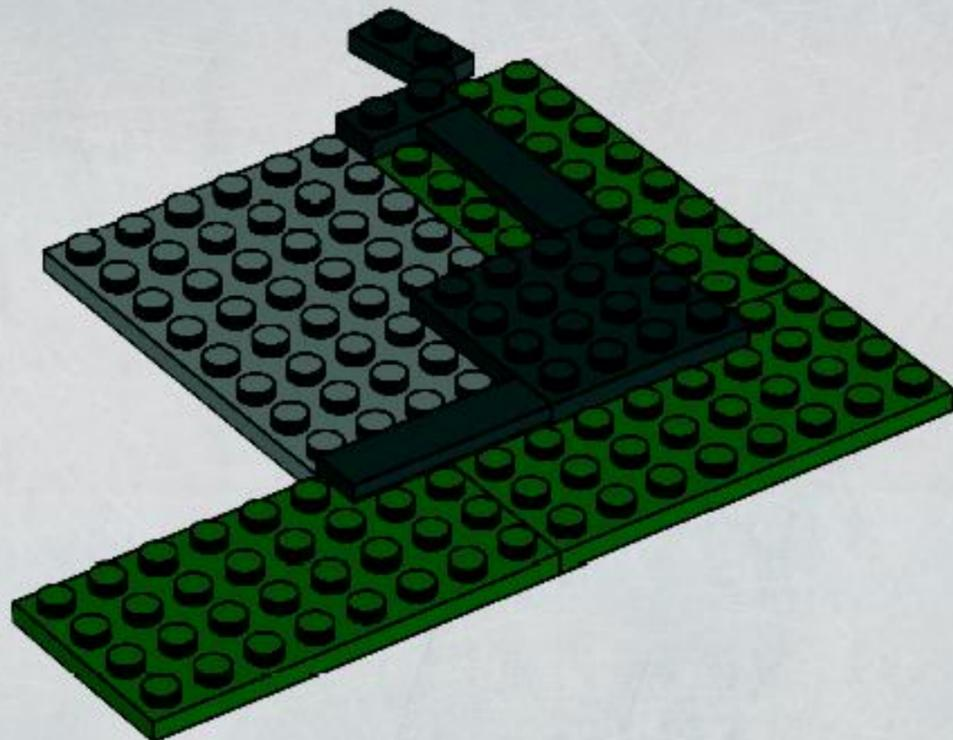

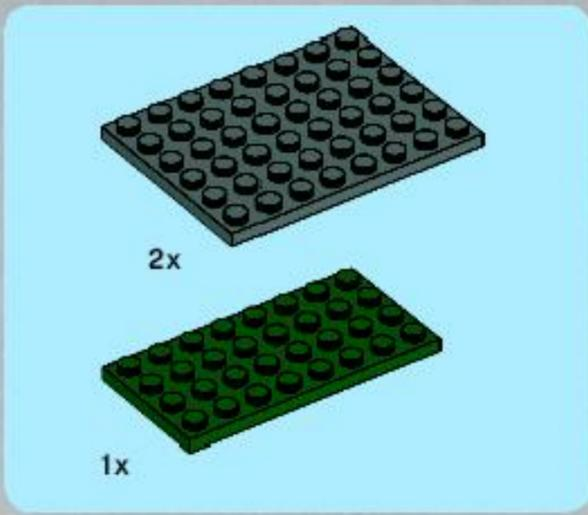

5

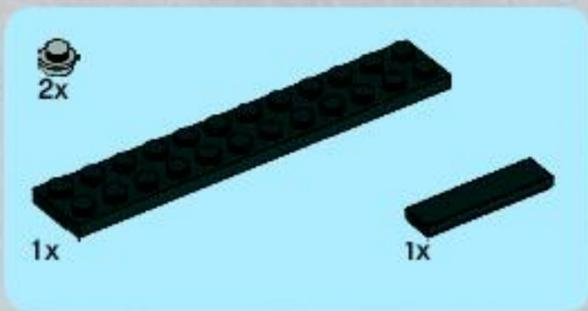
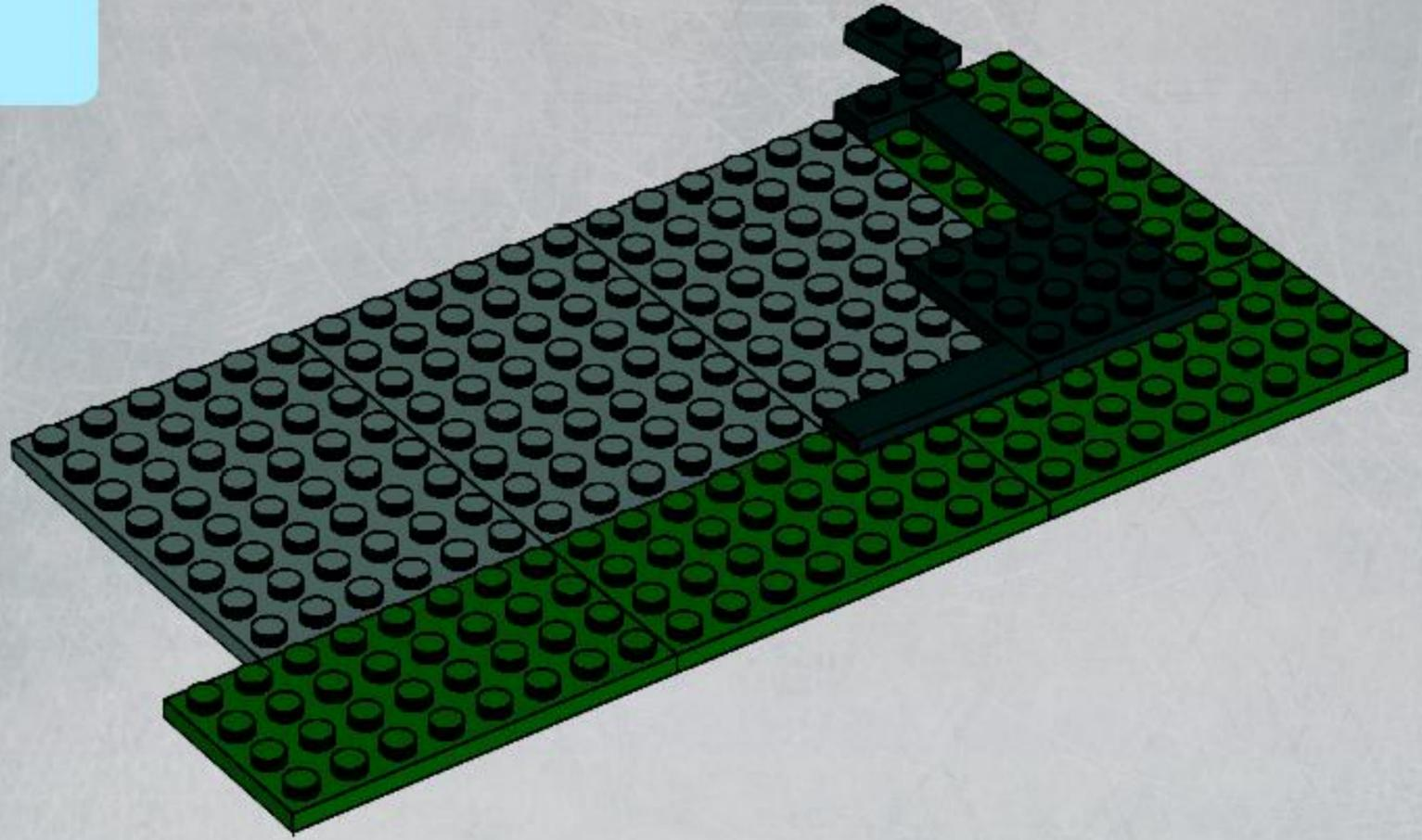

6

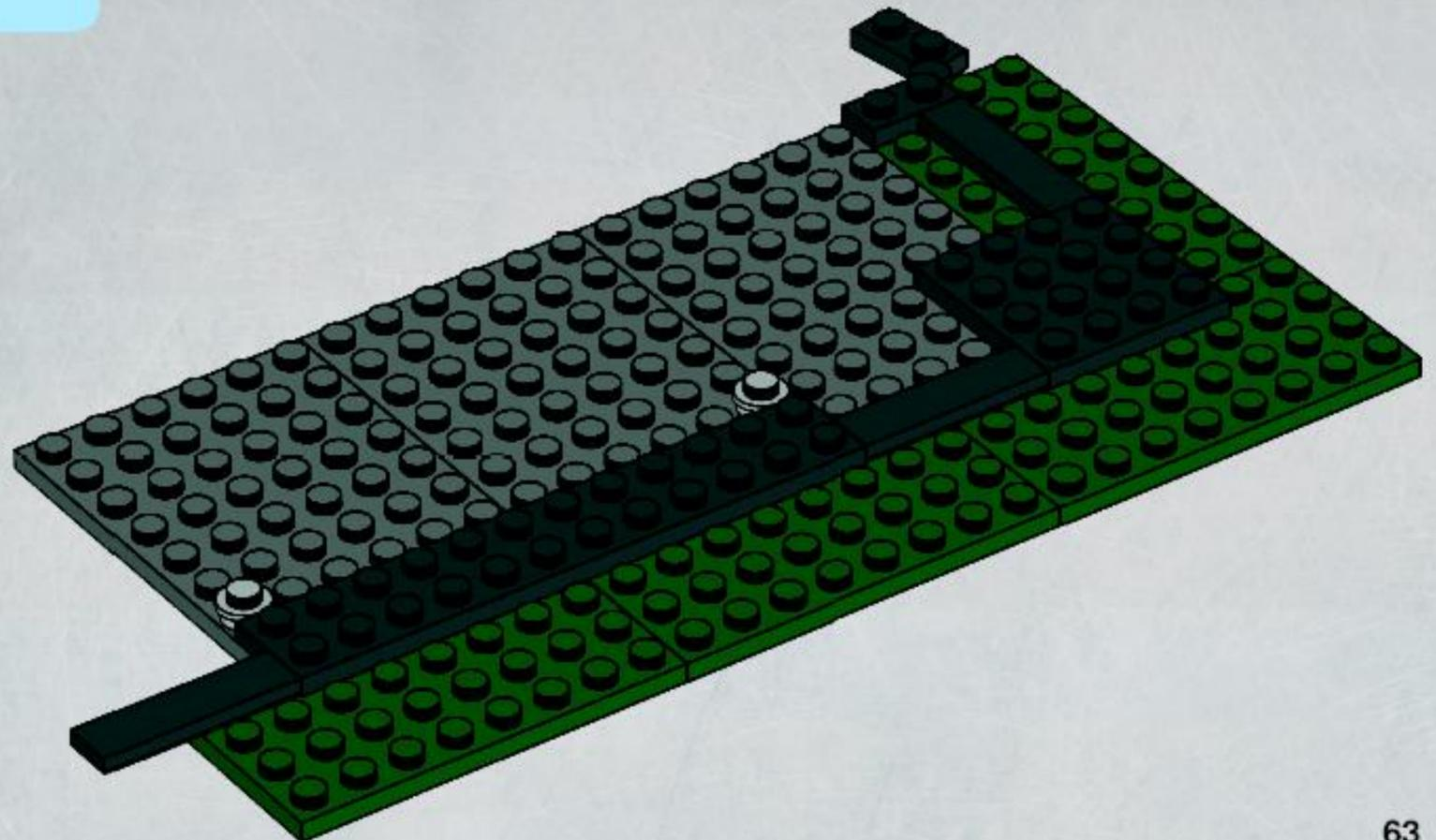

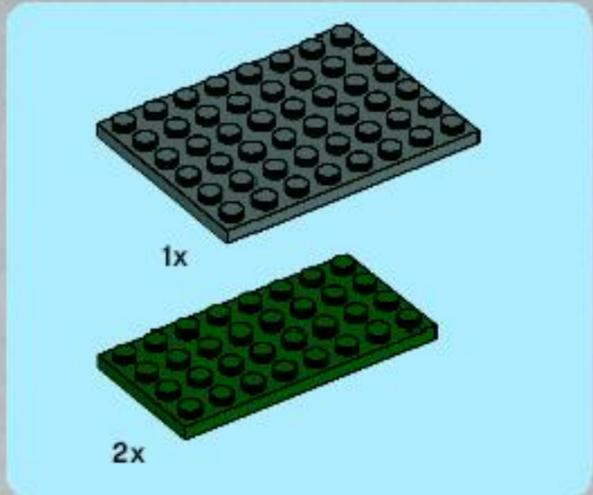

7

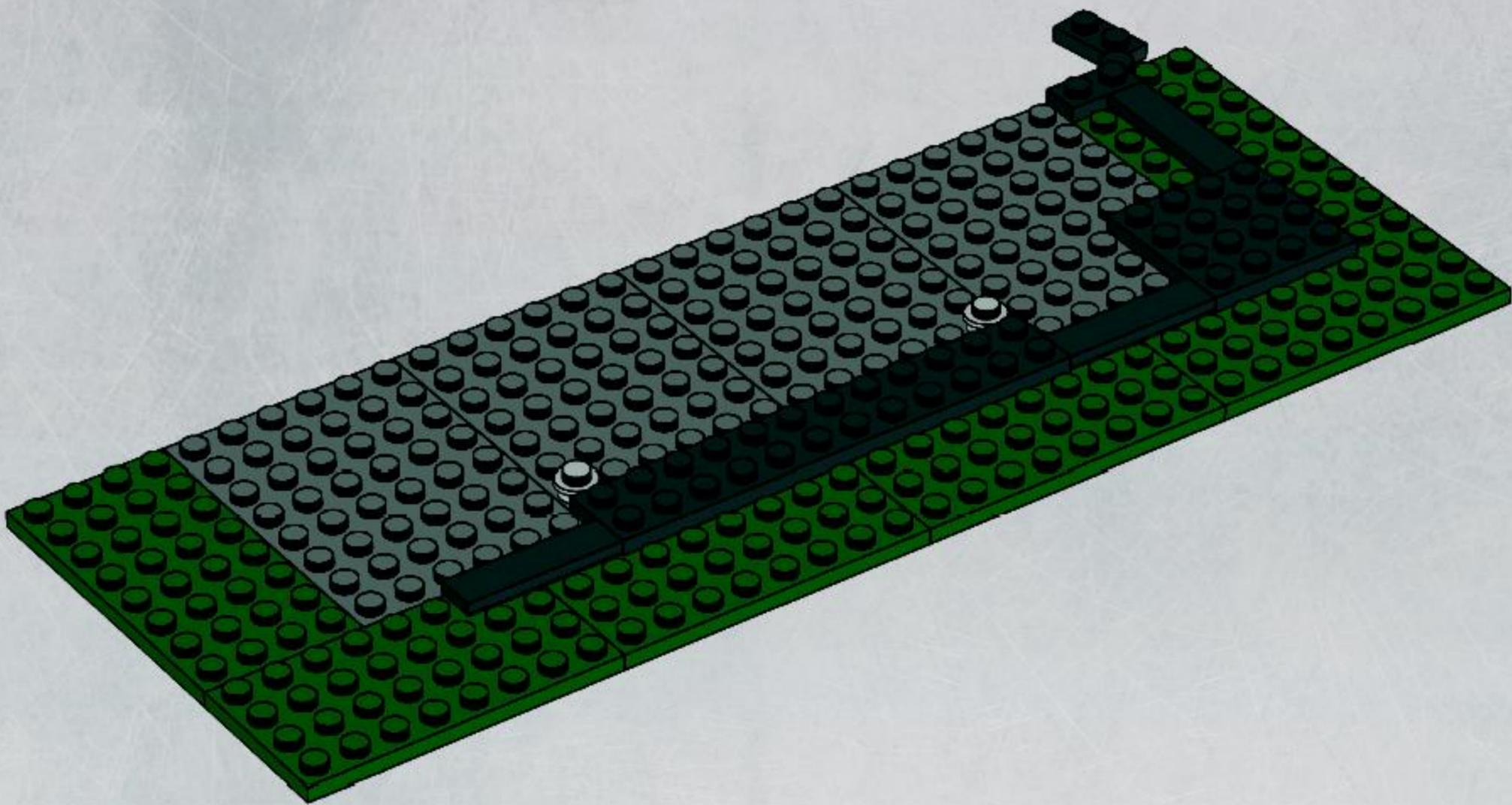



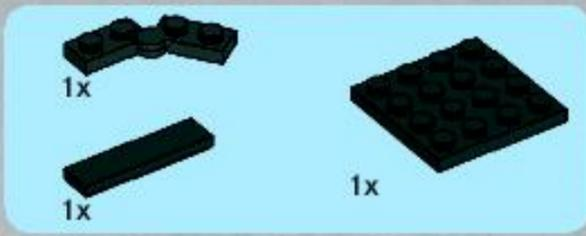

8

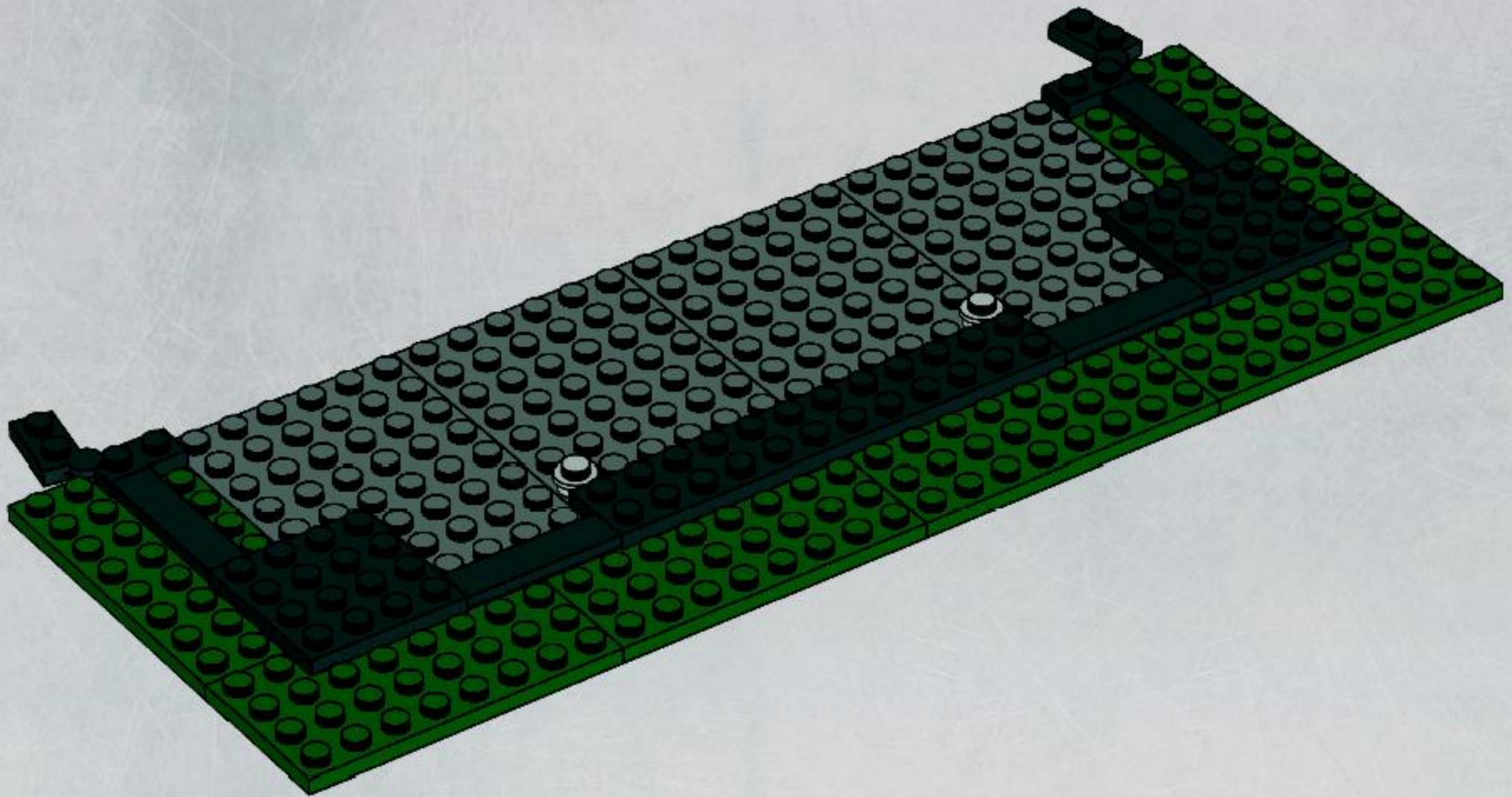

2x 2x 2x 2x

# 9

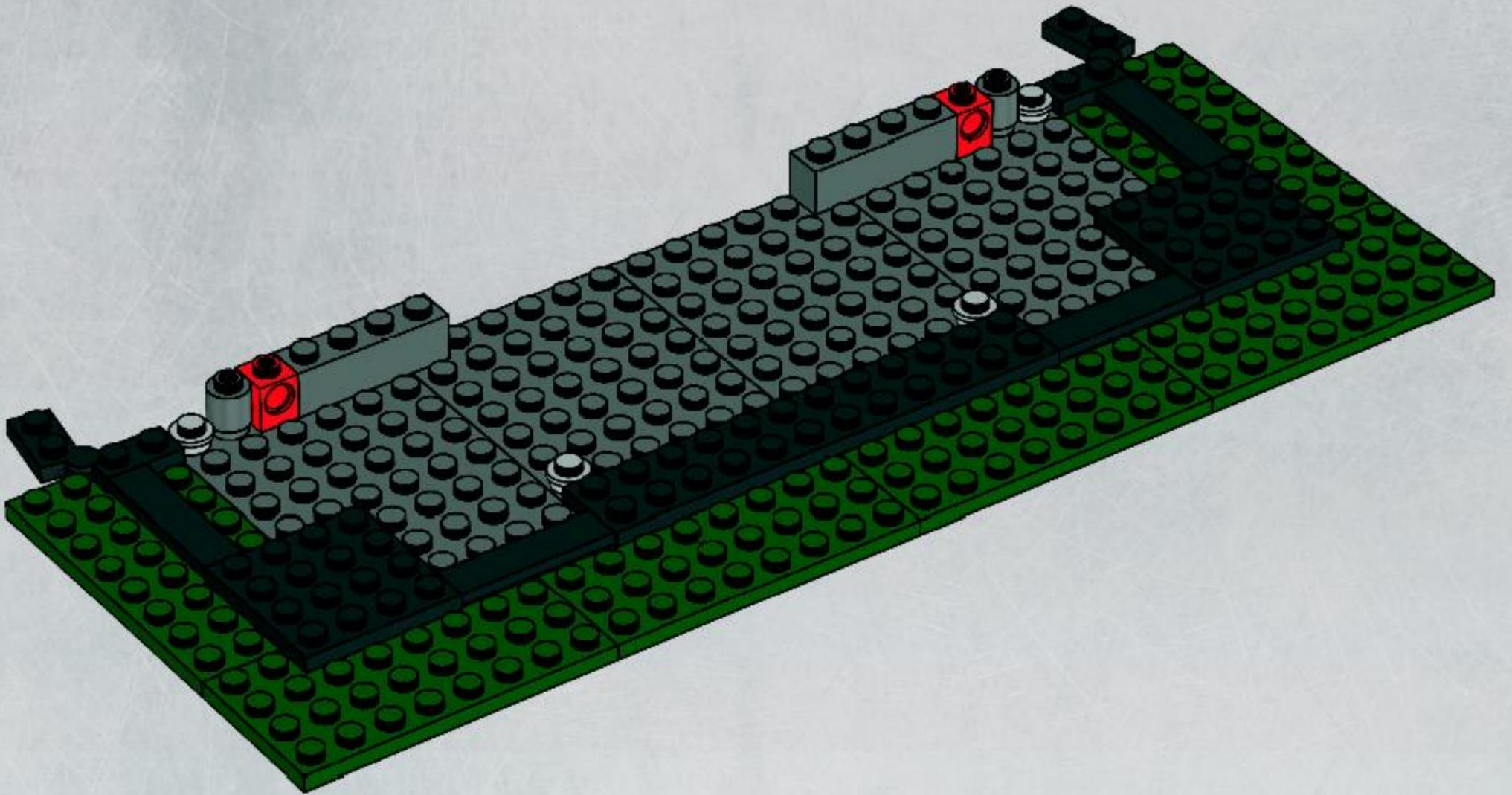

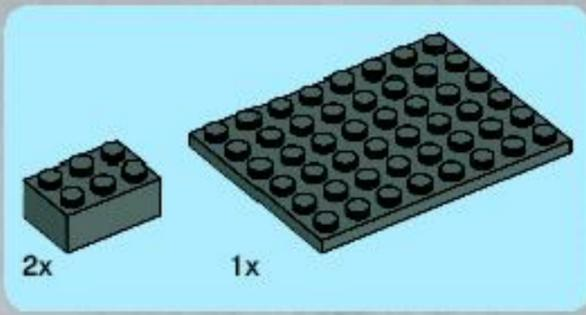

# 10

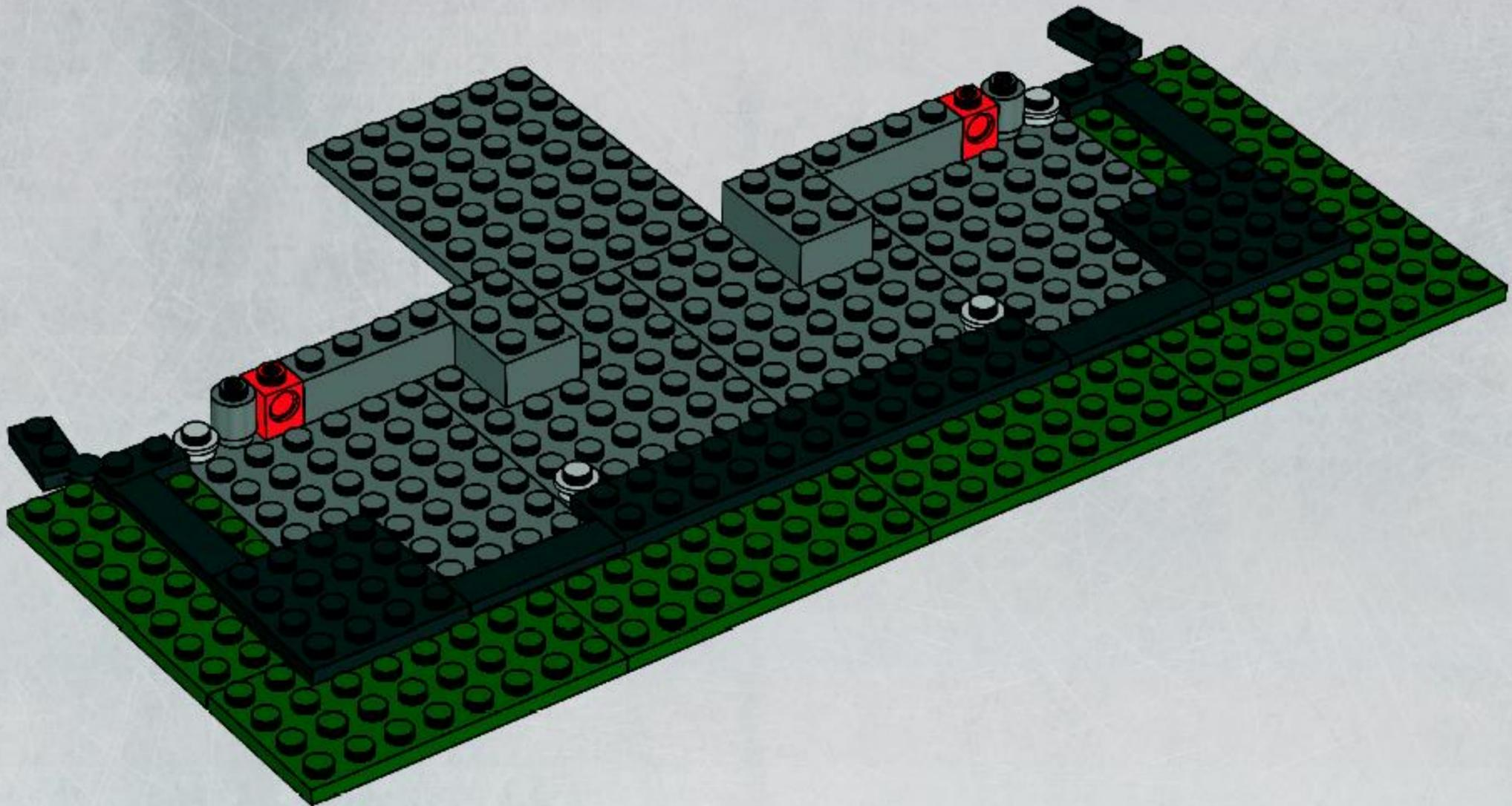



2x

11

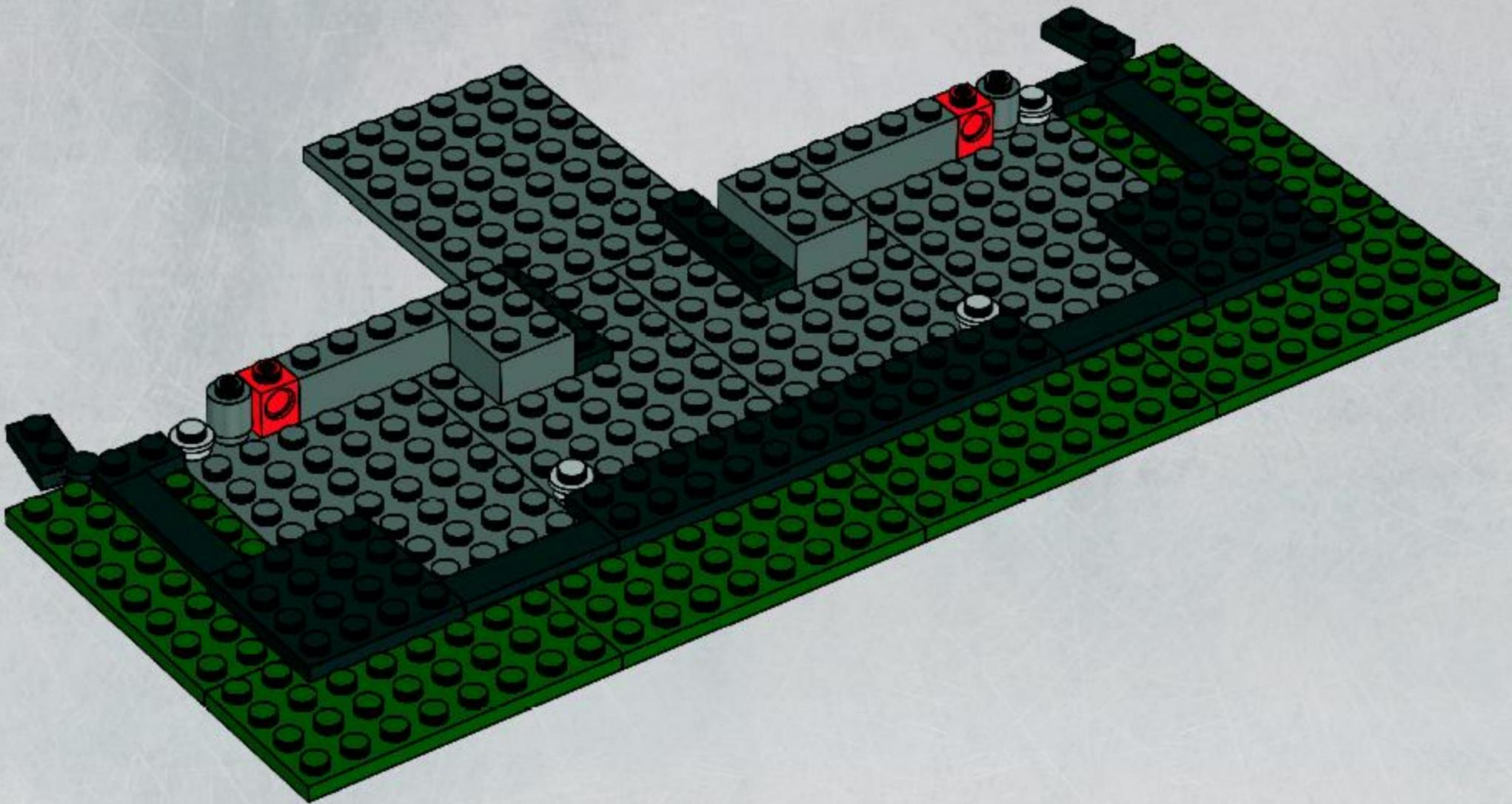

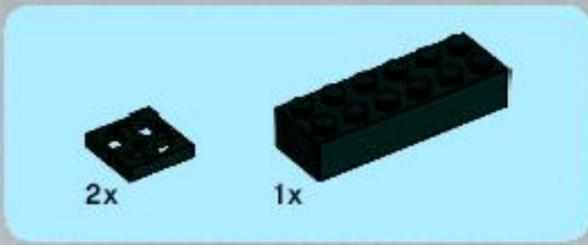

12

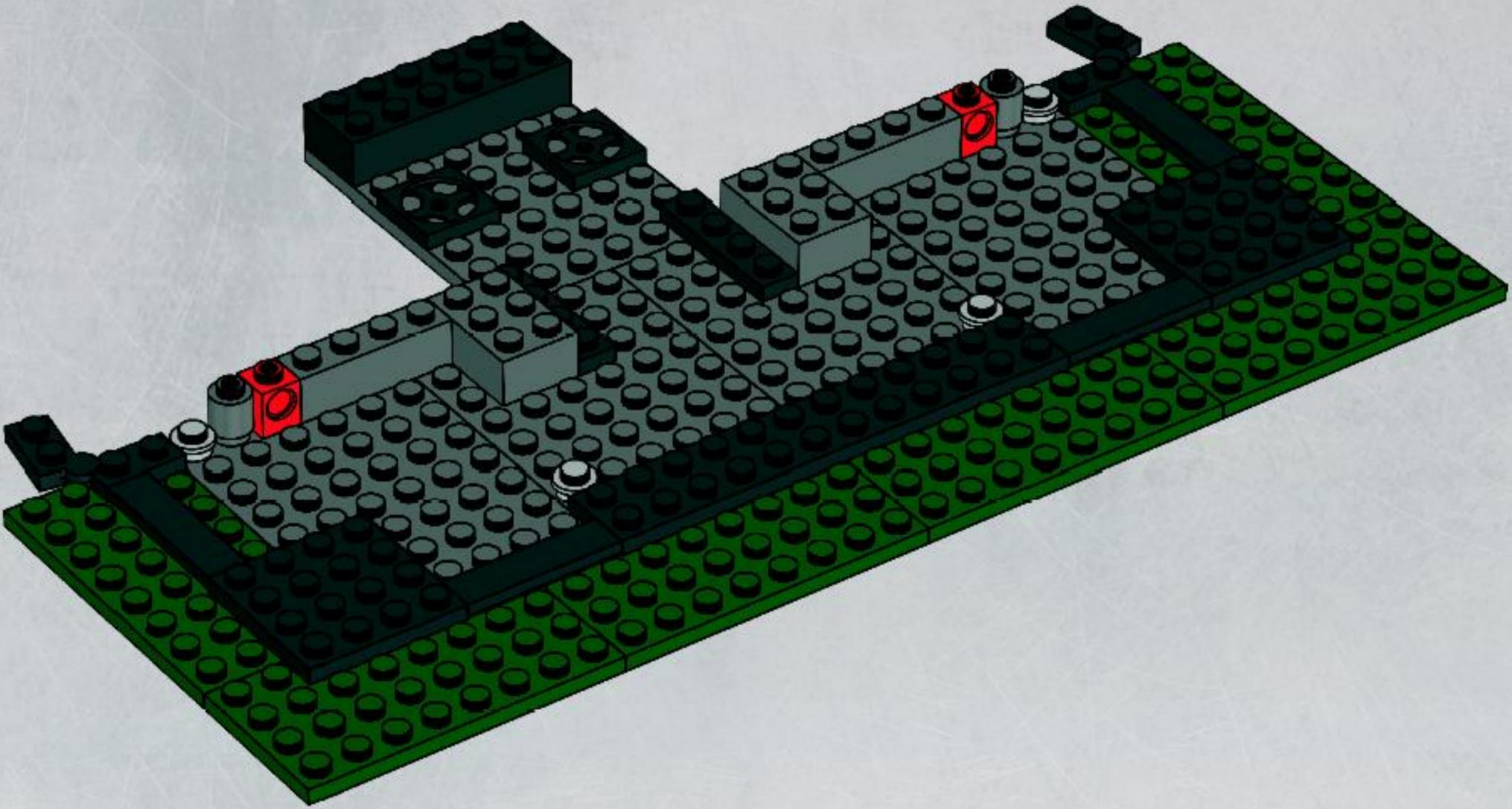



# 13

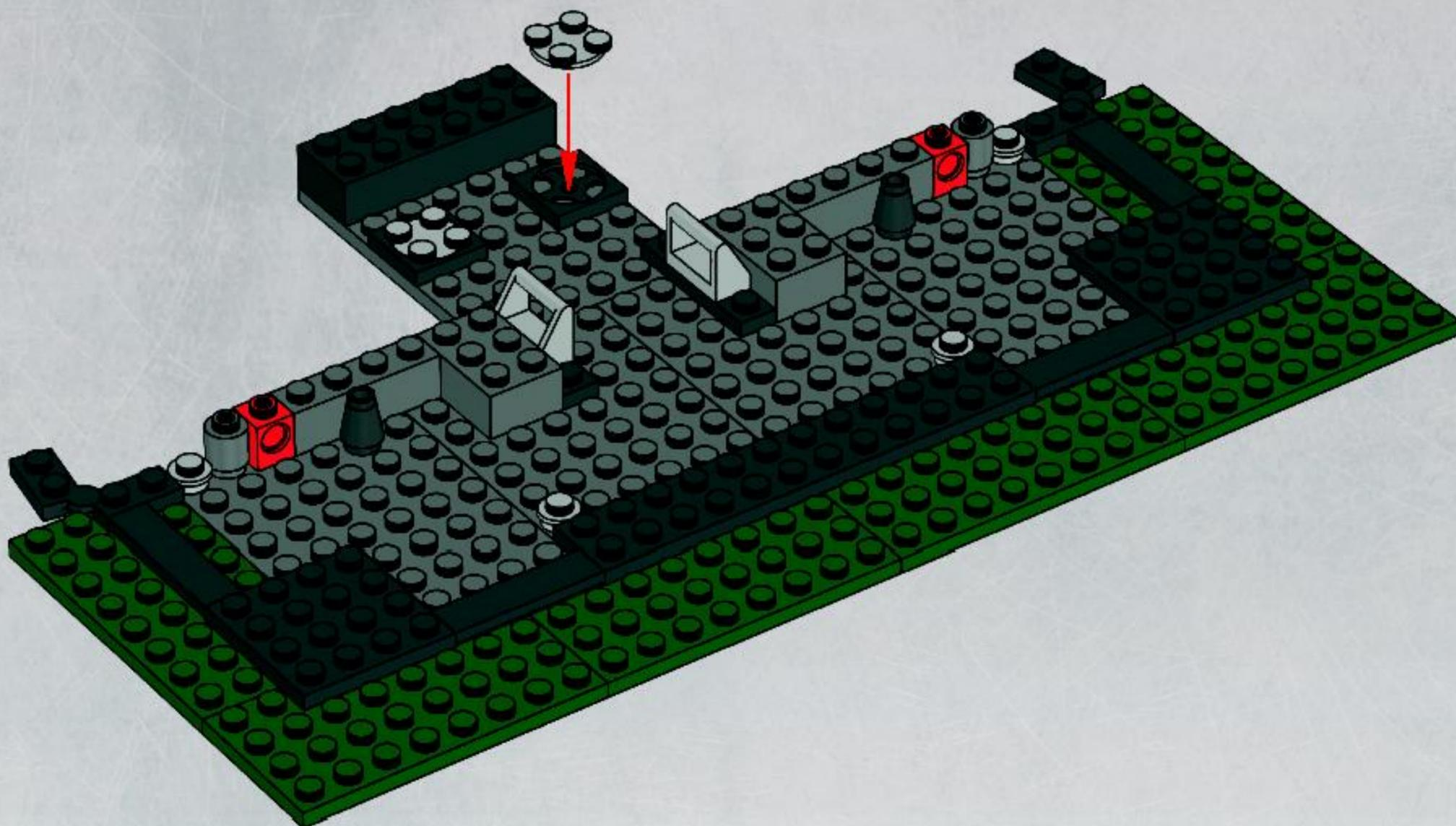









2x

# 16

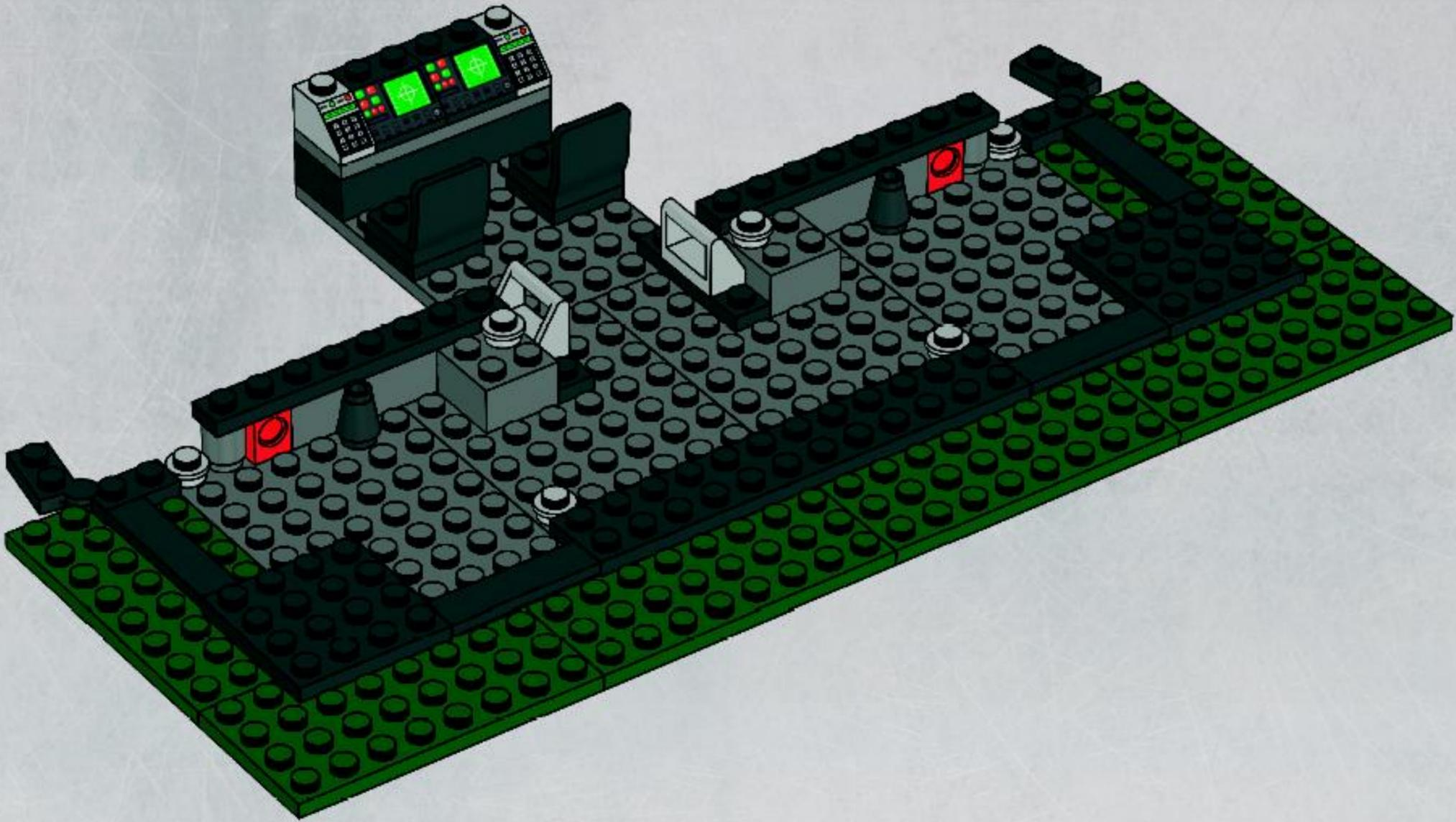







2x



2x

# 19

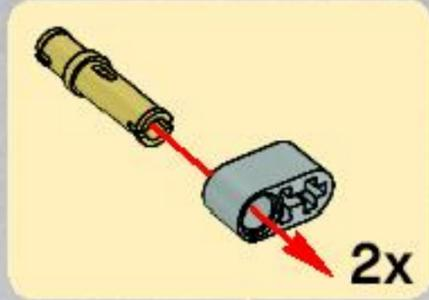

2x

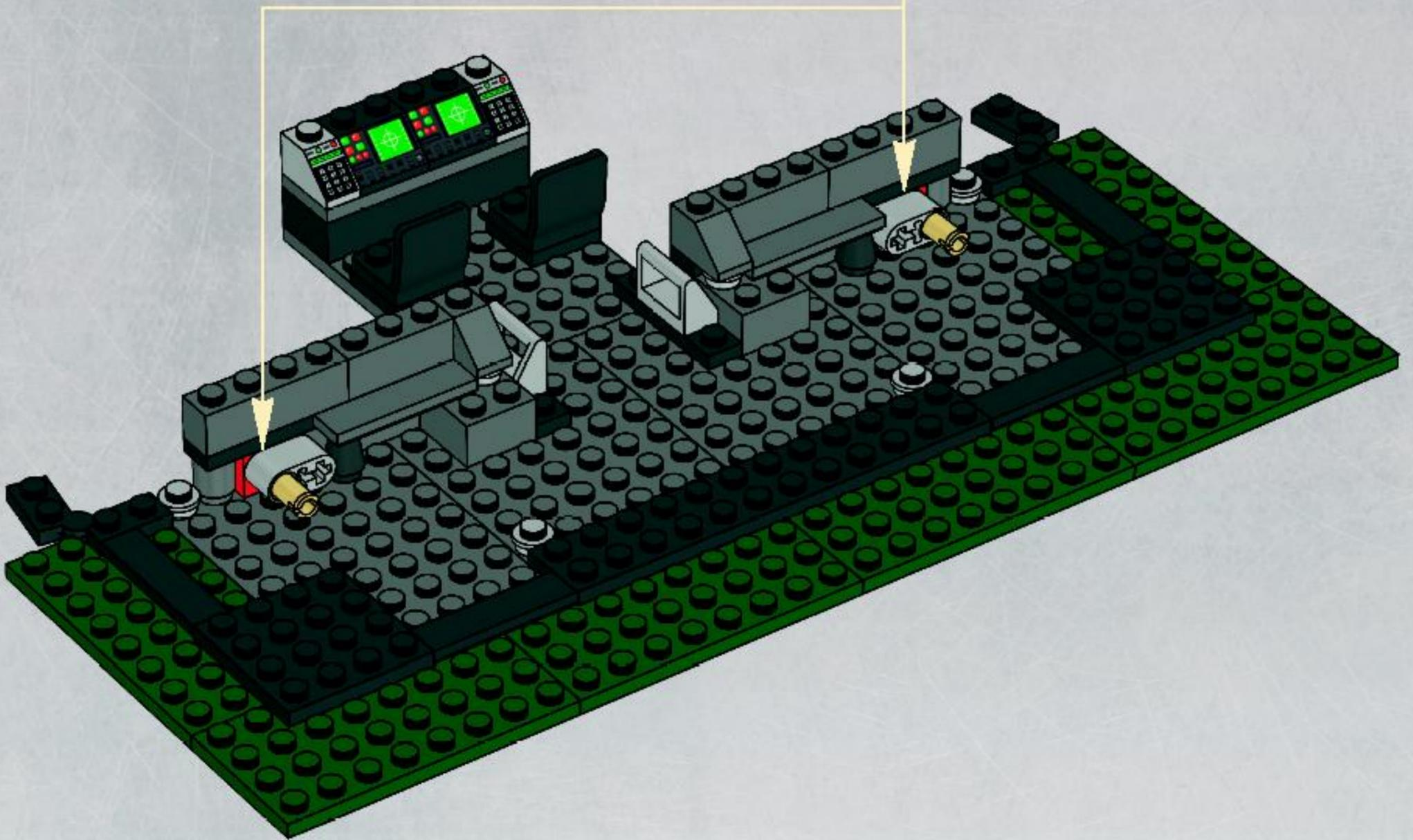

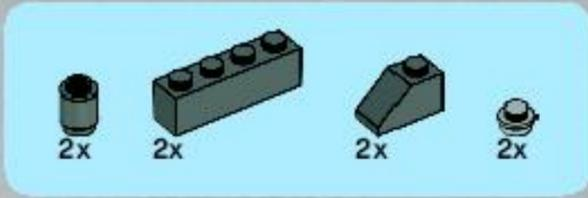

# 20

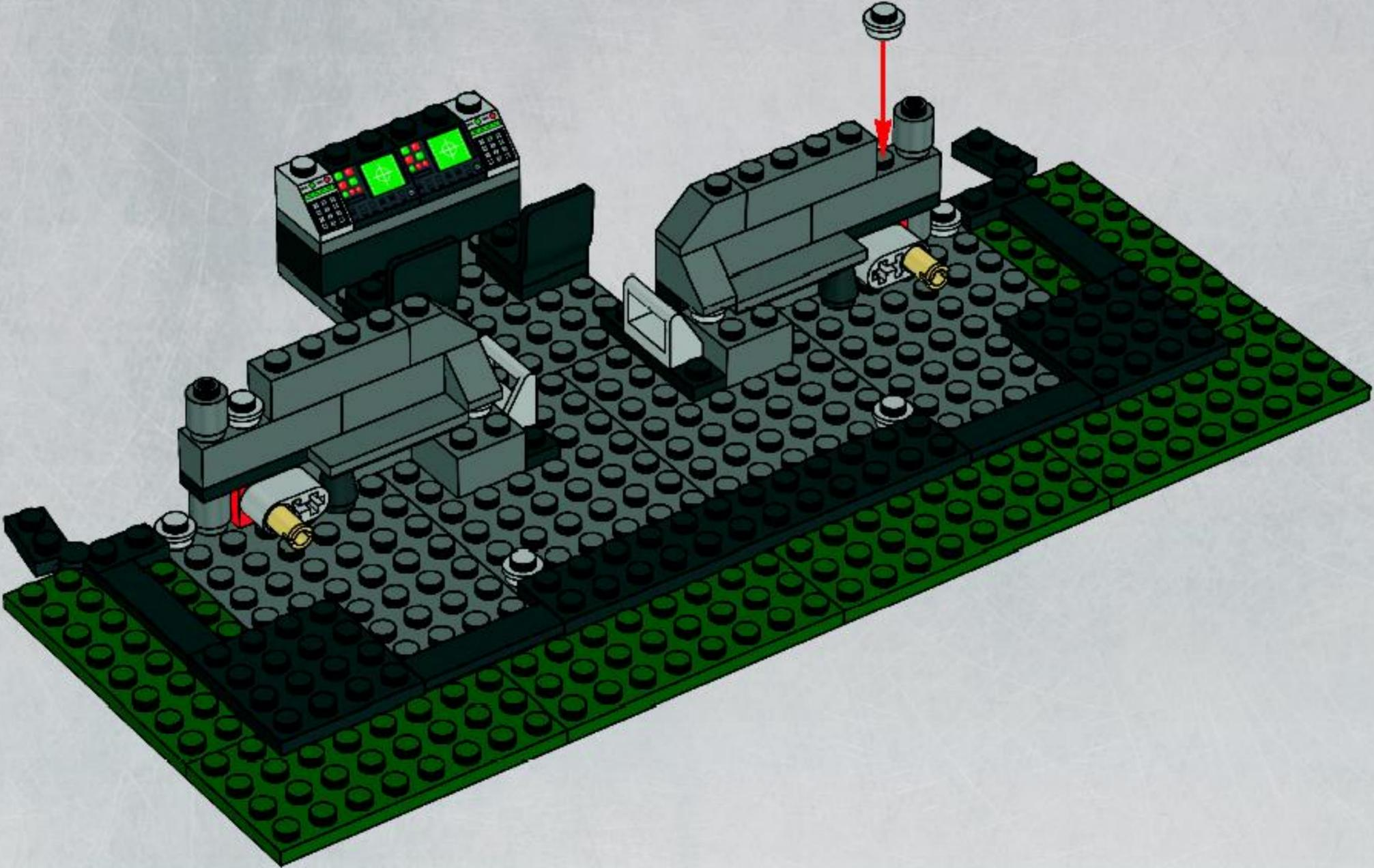

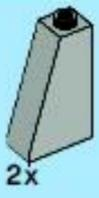

2x

# 21

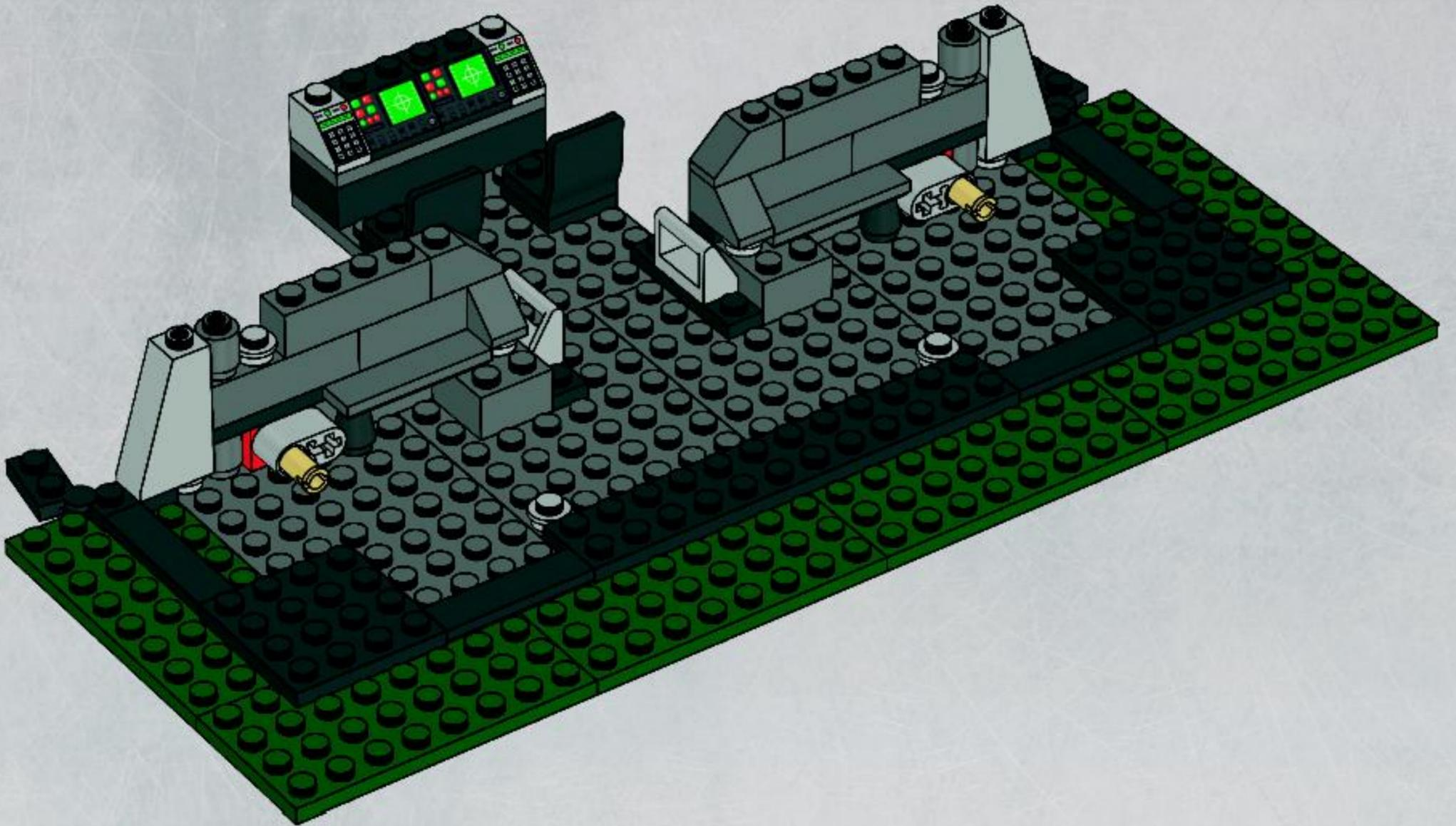



4x



2x



2x

# 22

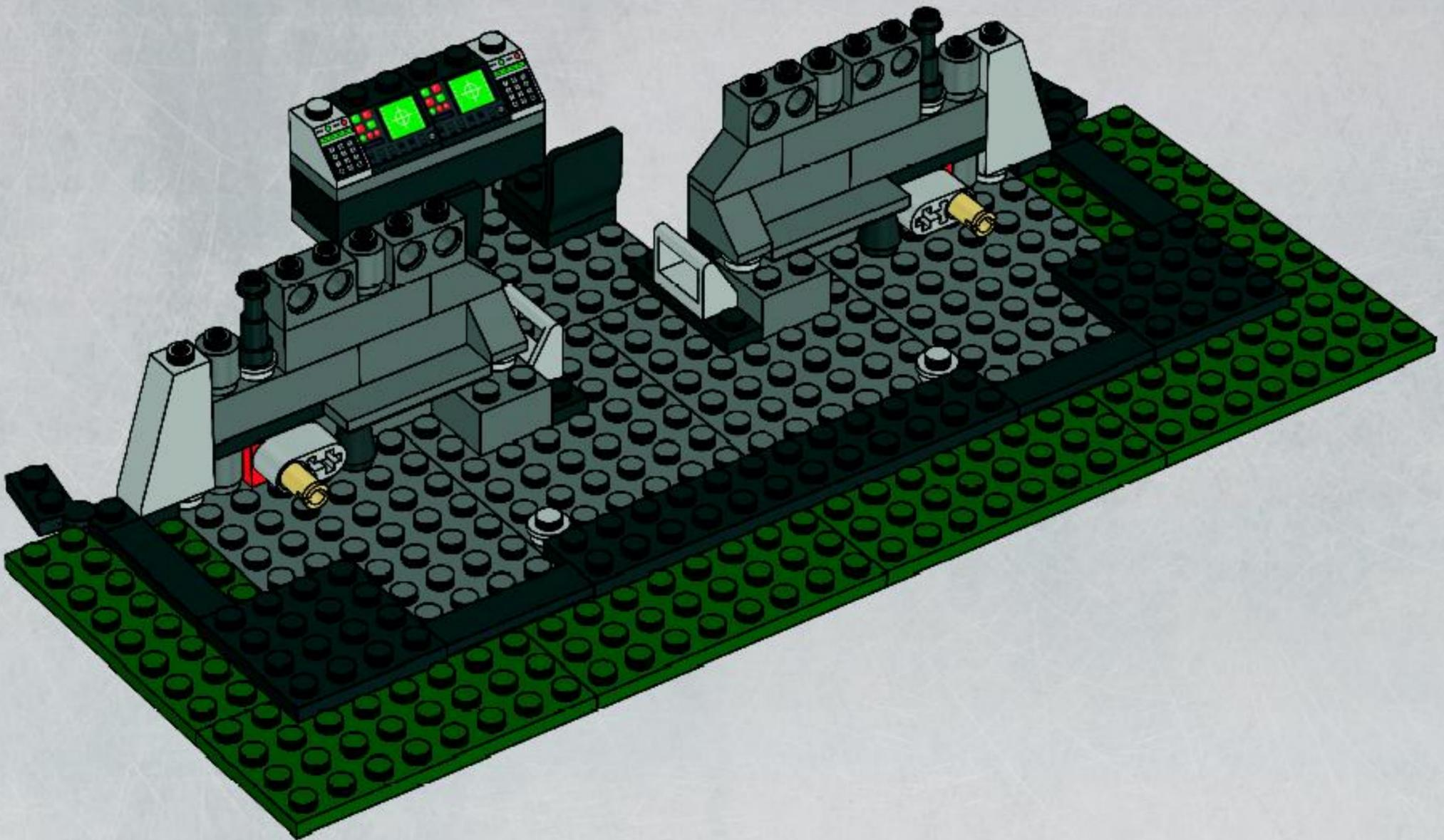

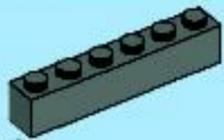

4x

# 23

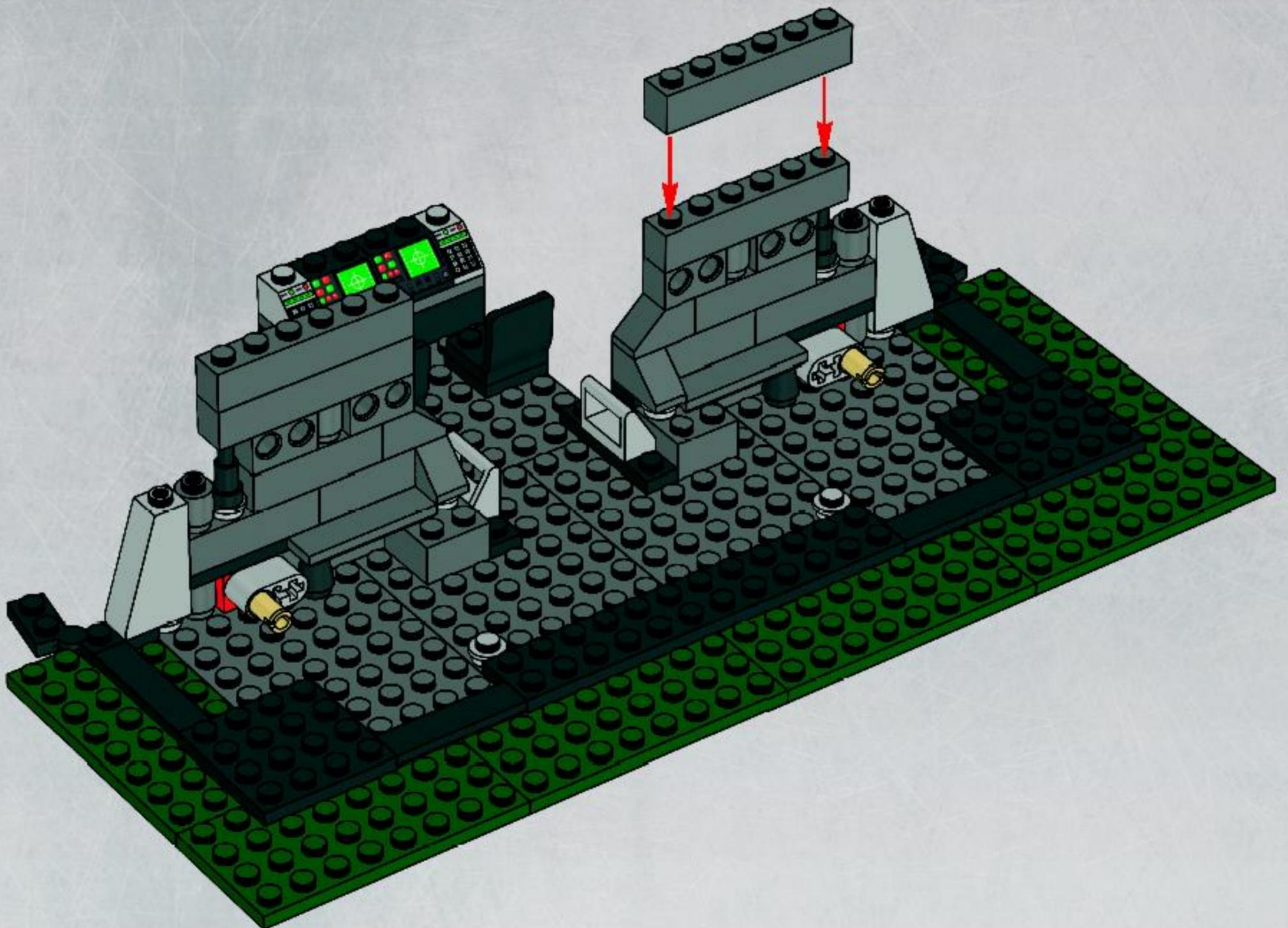



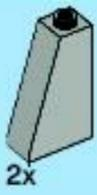

24

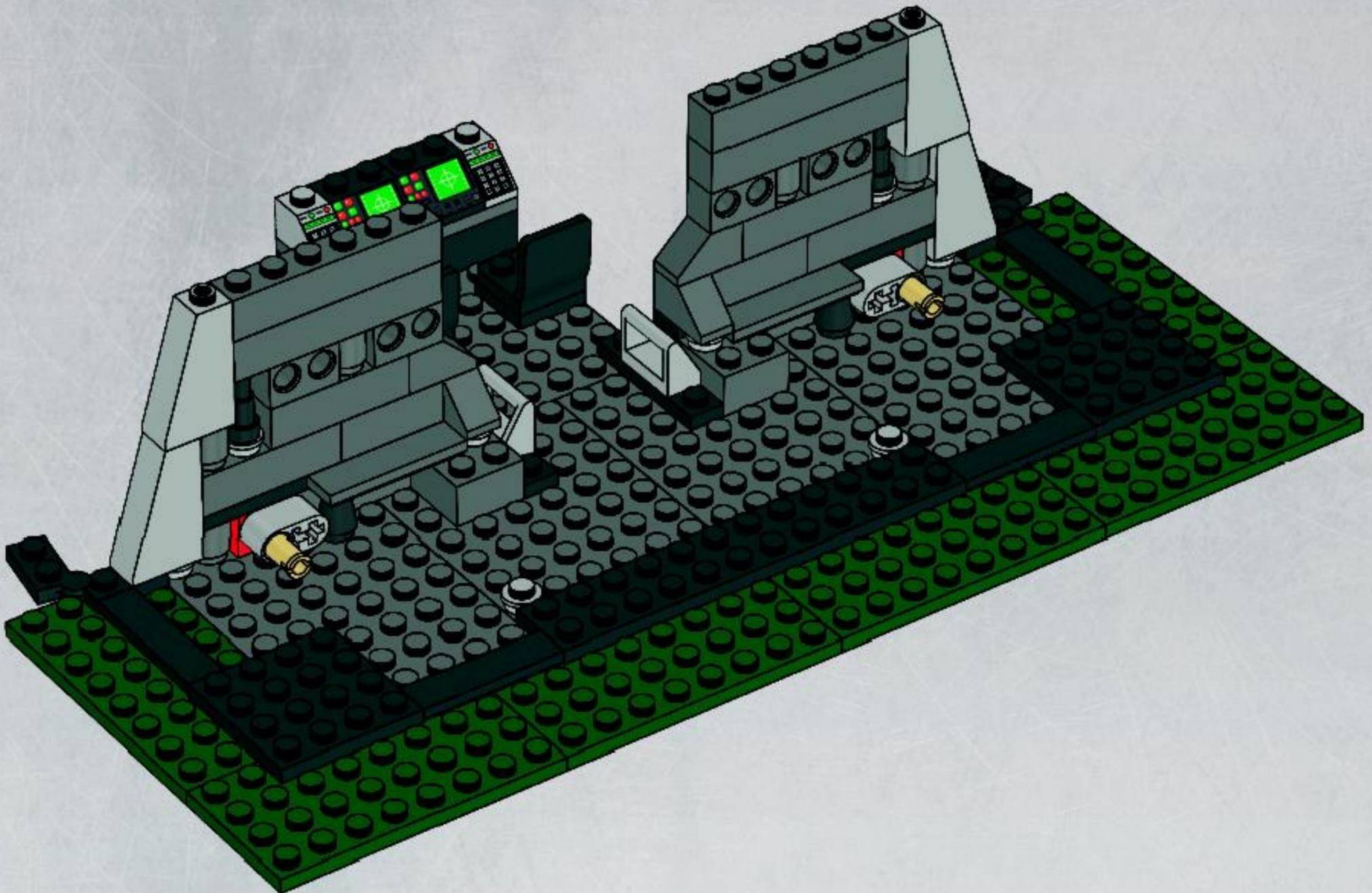



# 25

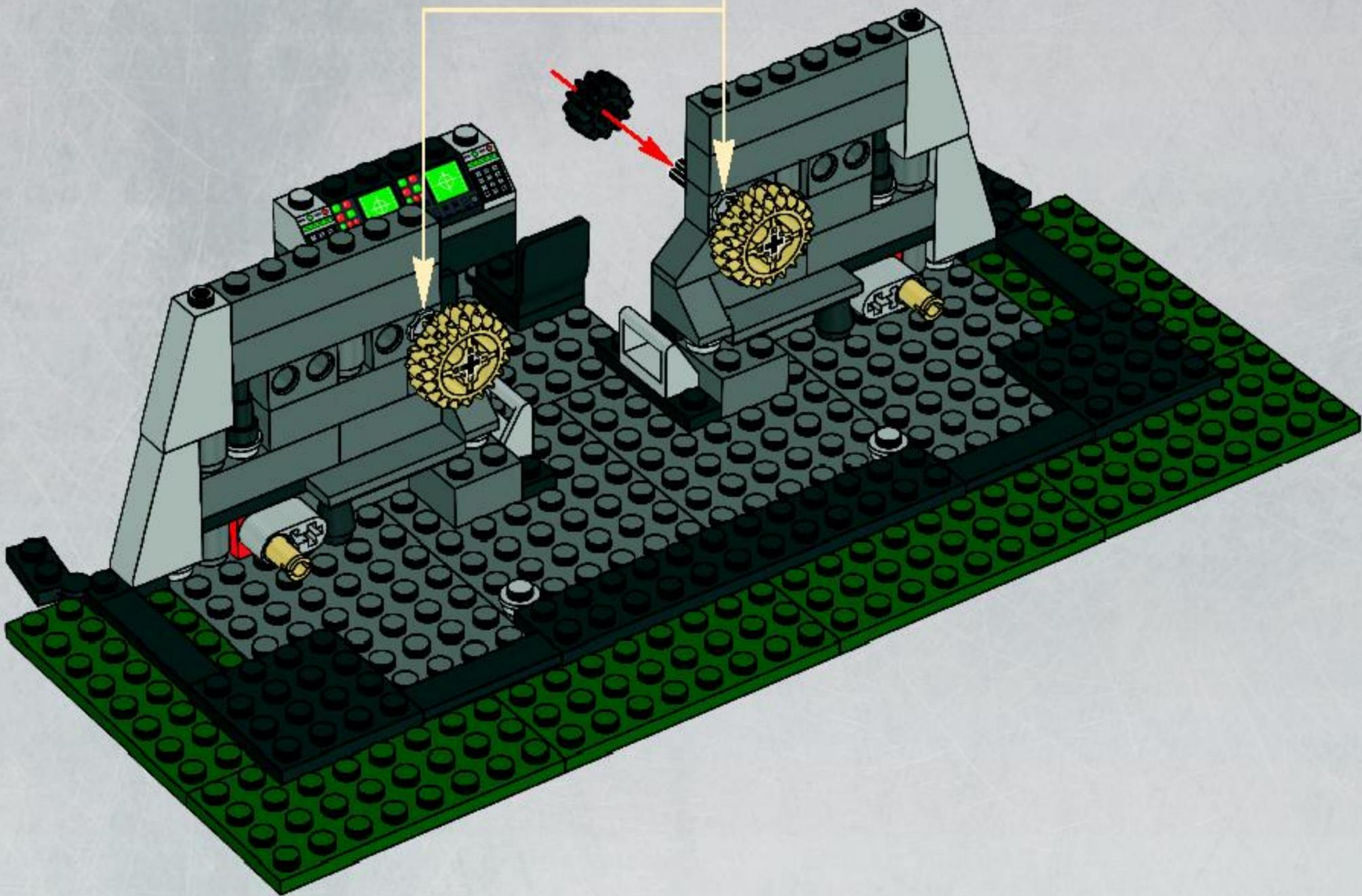
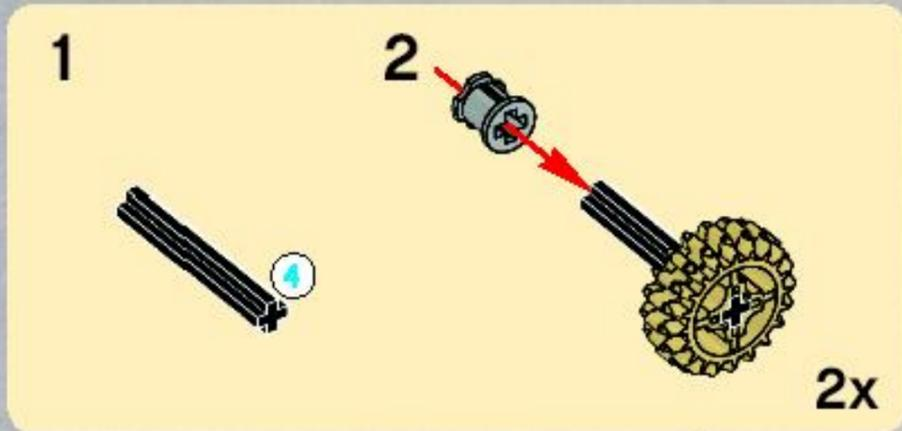

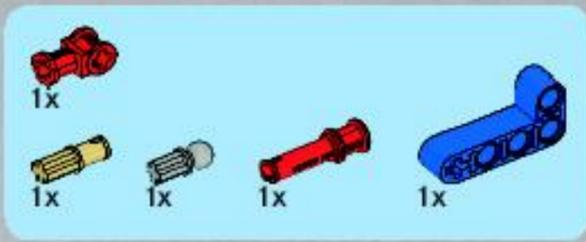

# 26

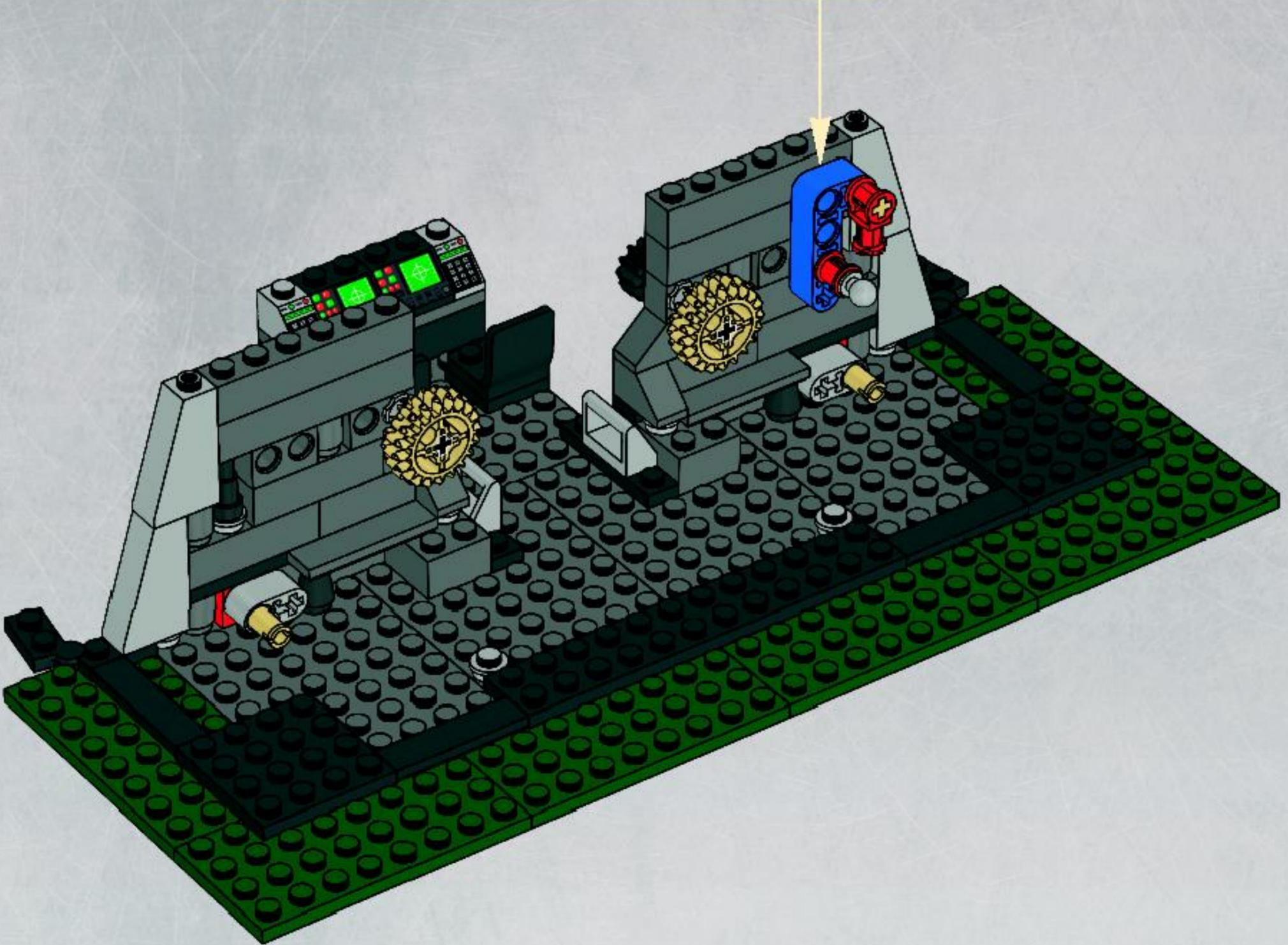
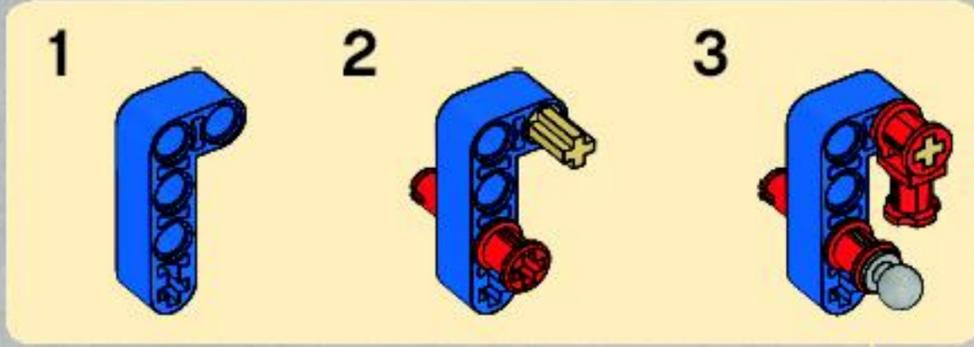

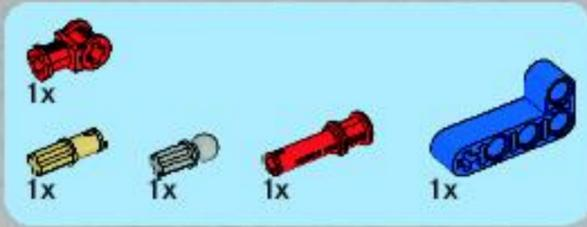

# 27

