

nickelodeon

LEGO

# TEENAGE MUTANT NINJA TURTLES



79121



**WARNING:** CHOKING HAZARD.  
Toy contains small parts and a small ball.  
Not for children under 3 years.



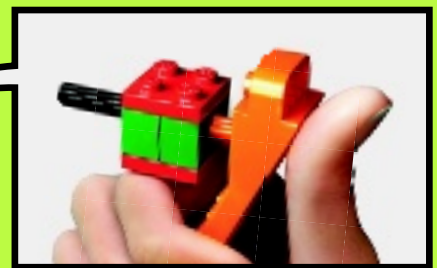

[LEGO.com/brickseparator](https://LEGO.com/brickseparator)

IMPORTANT: Never modify the elements or use other projectiles than provided with this toy.  
IMPORTANT : Ne jamais modifier les éléments ni utiliser d'autres projectiles que ceux fournis avec ce jouet.  
IMPORTANTE: No modifique los elementos ni utilice otros proyectiles diferentes a los suministrados junto con este juguete.



**AVERTISSEMENT : RISQUE D'ÉTOUFFEMENT.**  
Le jouet contient des petites pièces ainsi qu'une petite boule.  
Il ne convient pas aux enfants de moins de 3 ans.



**ADVERTENCIA: PELIGRO DE ASFIXIA.**  
Juguete que contiene partes pequeñas y una pelota pequeña.  
No recomendado para niños menores de 3 años.

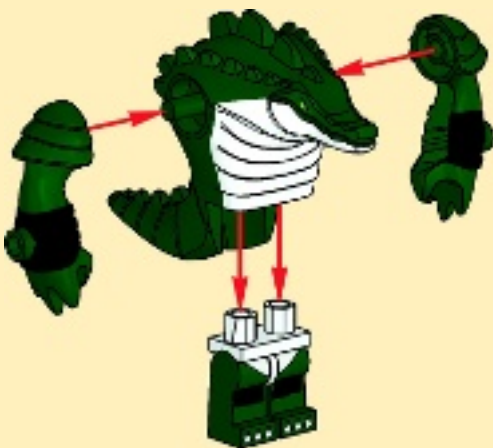
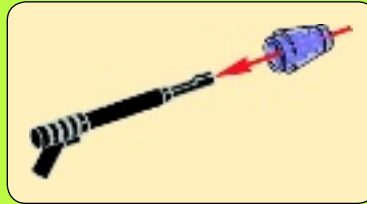
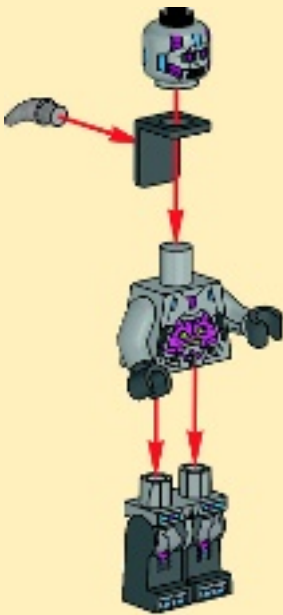



1x

# 1



2x

# 2

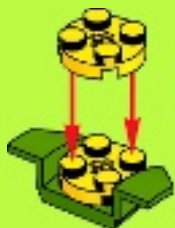

1x

# 3



1x



1x



1x



1x

# 4

1



2



1x

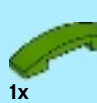

1x



1x



1x

# 5

1

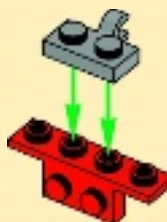

2

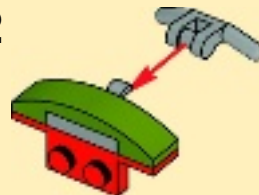



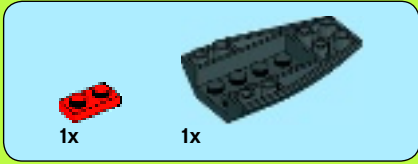

1

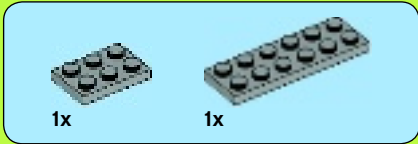

2



3

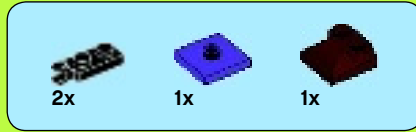

4

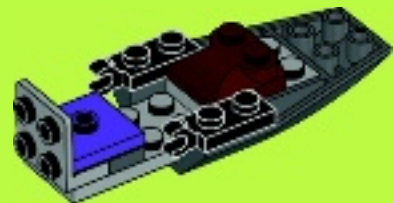



5

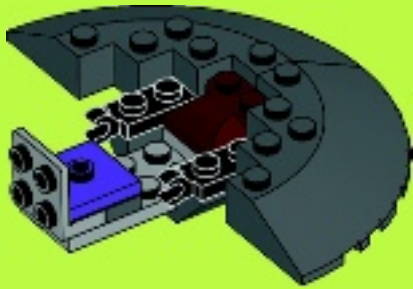

6

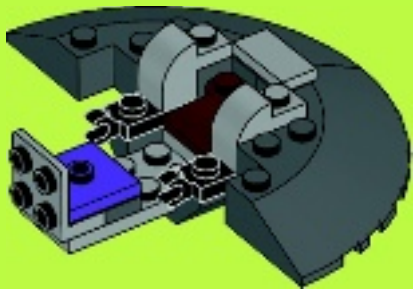

7

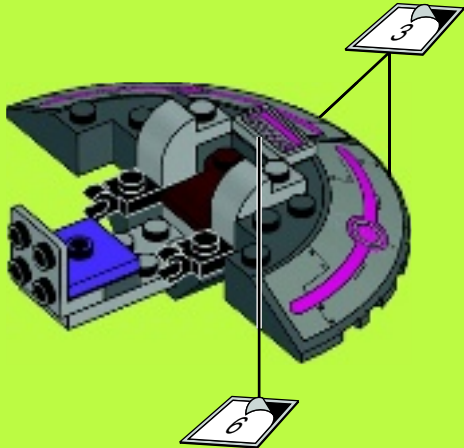

8

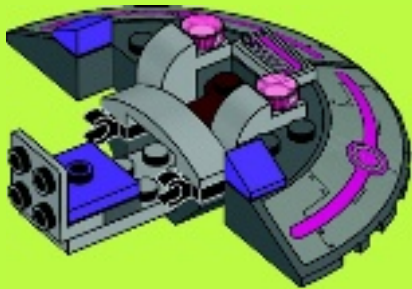



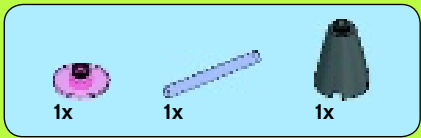

9

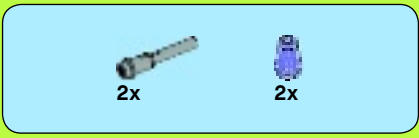
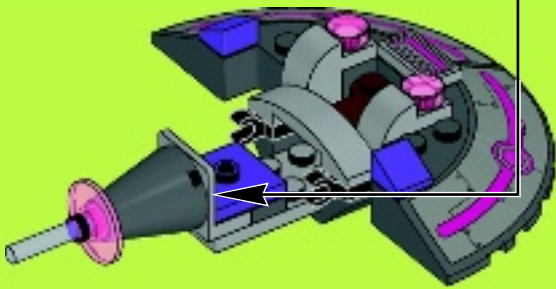

11

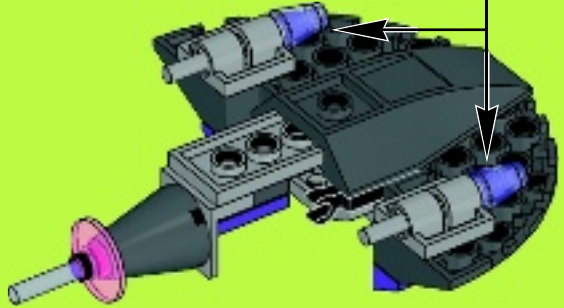
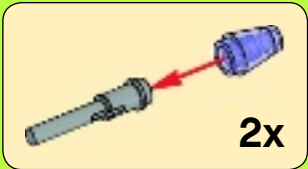

10

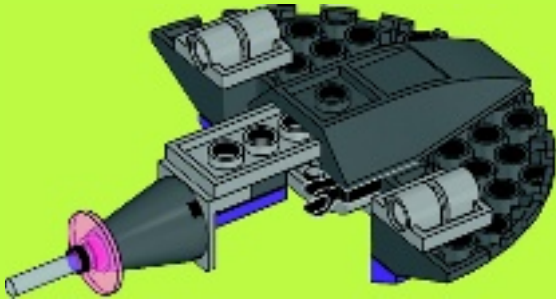

12

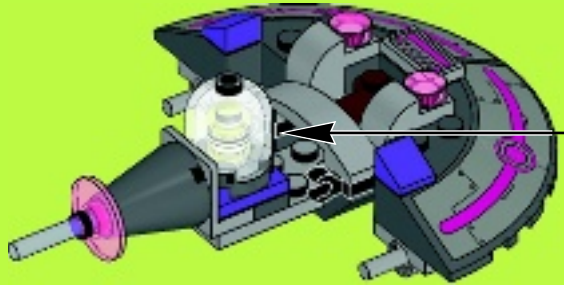
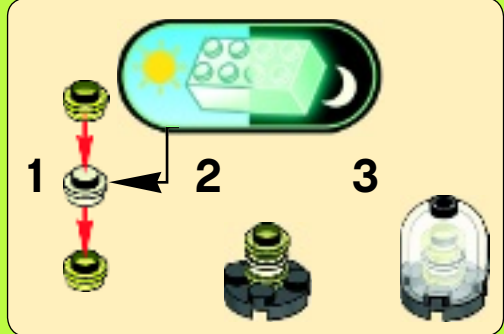

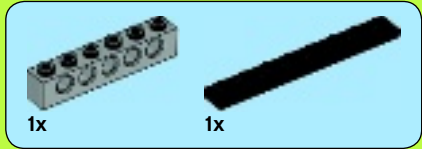
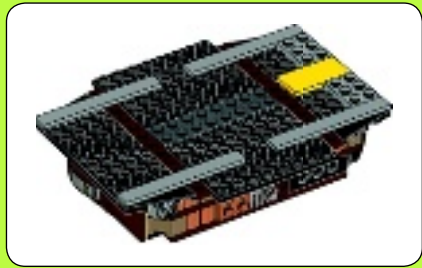
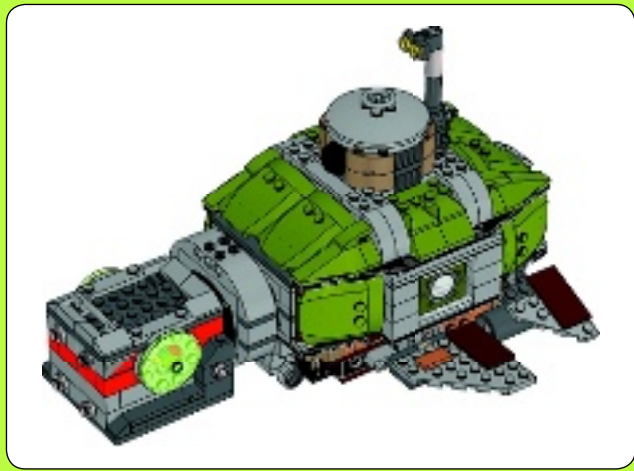

1

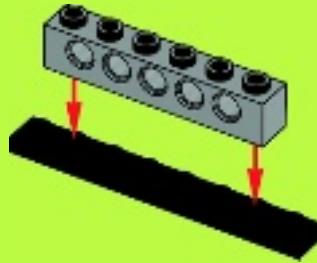

2

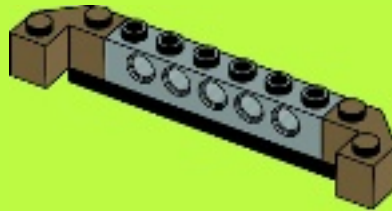





3

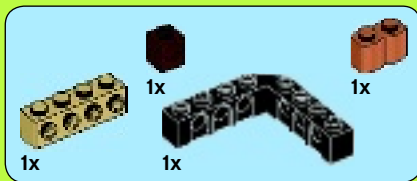
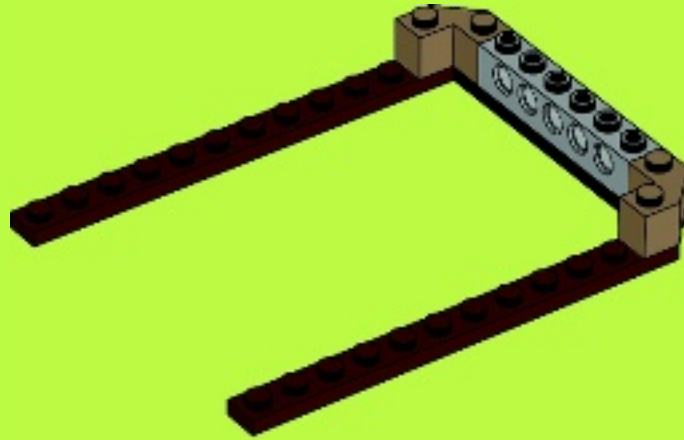

4

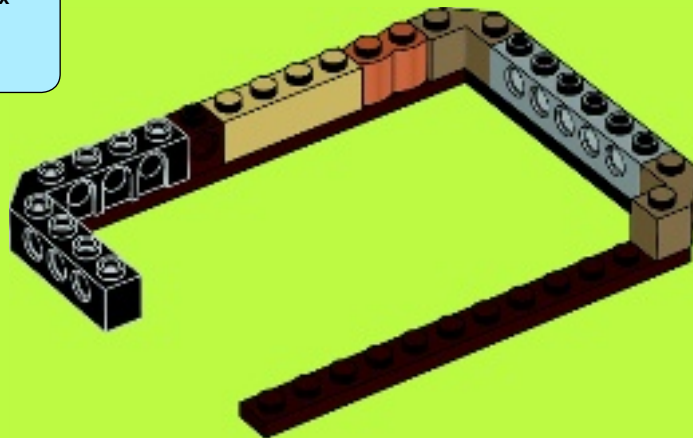

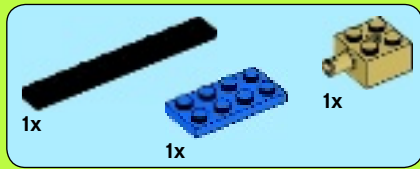

5

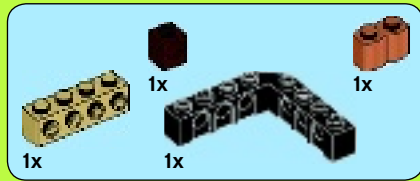
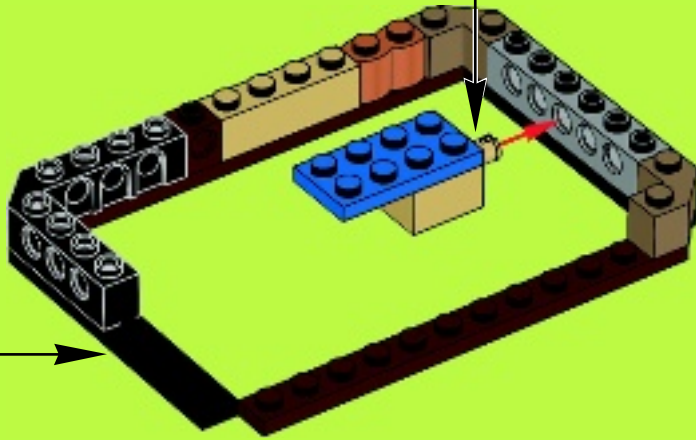
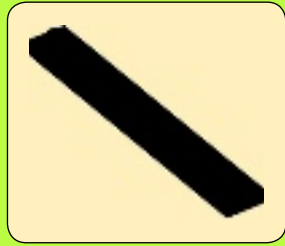

6

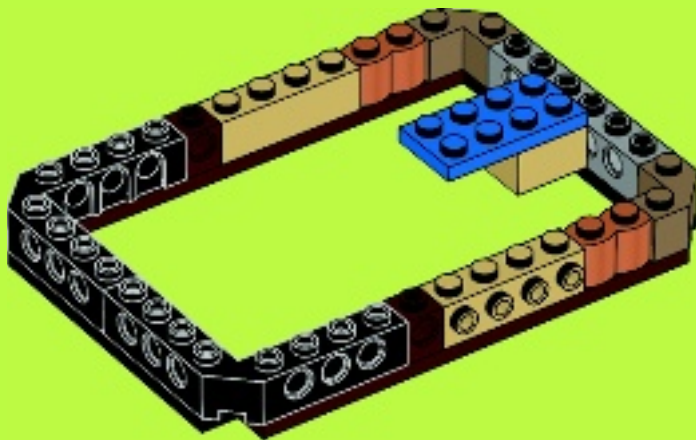





2x



2x

# 7

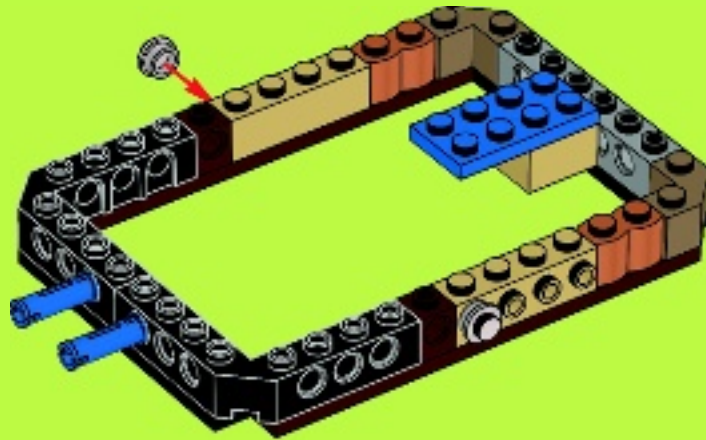

2x



3x



1x

# 8

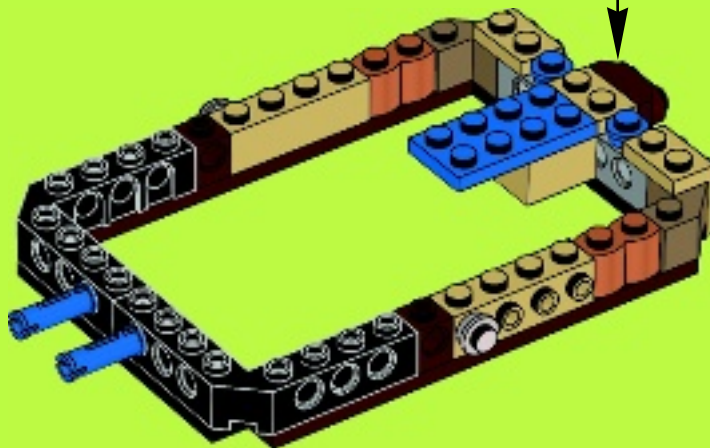
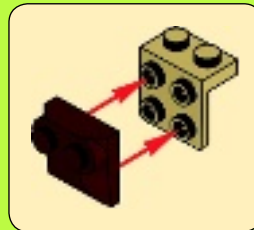

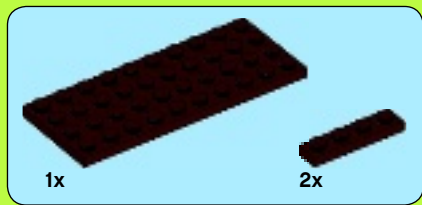

9

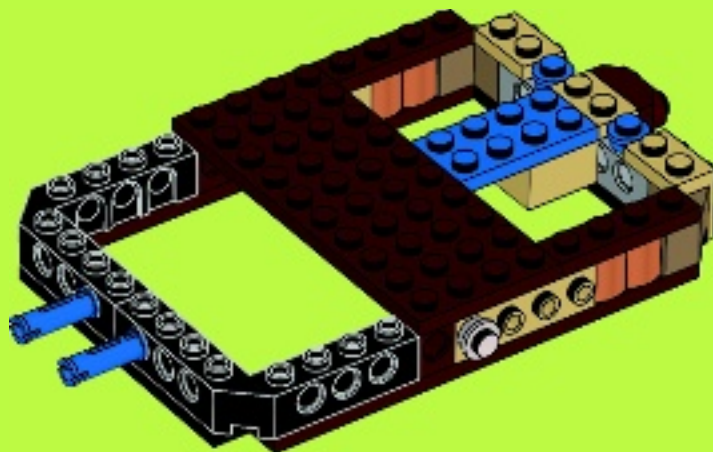

10

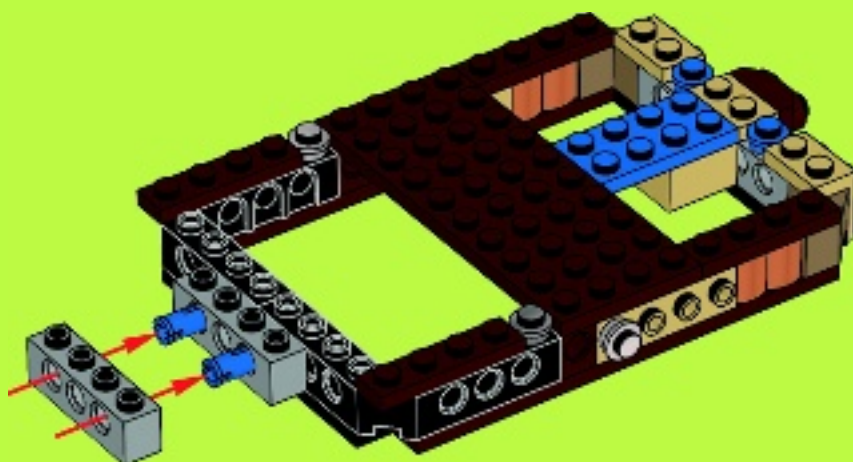

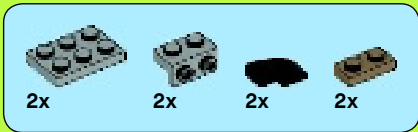

# 11

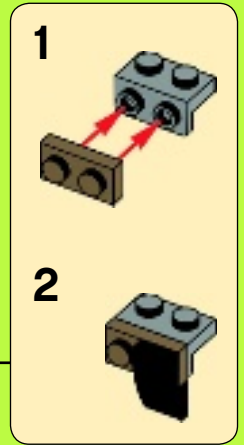
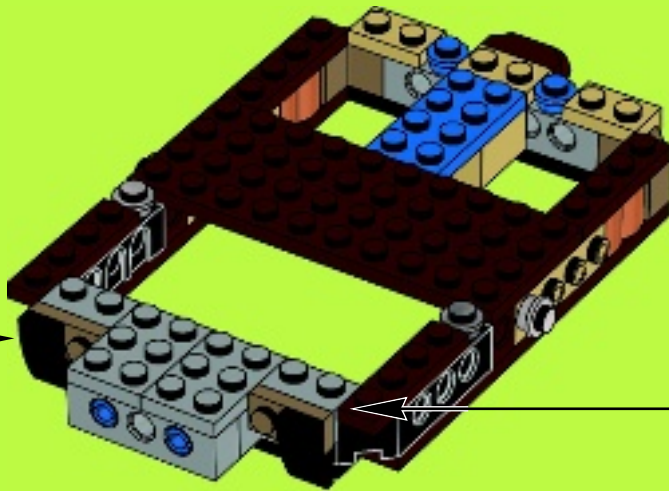
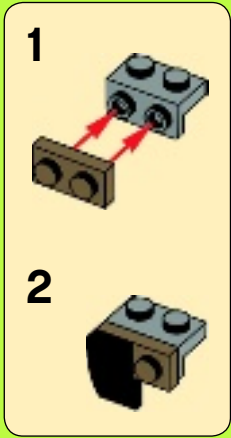

# 12

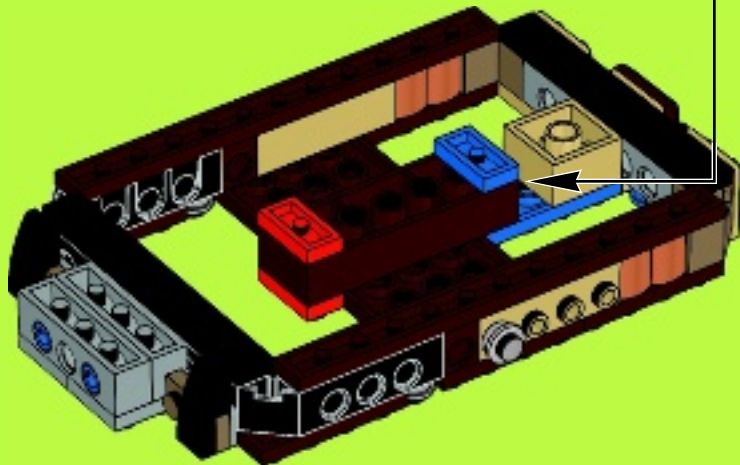

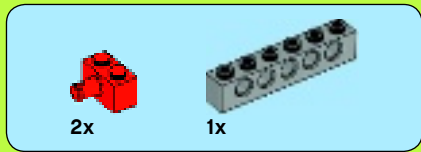

# 13

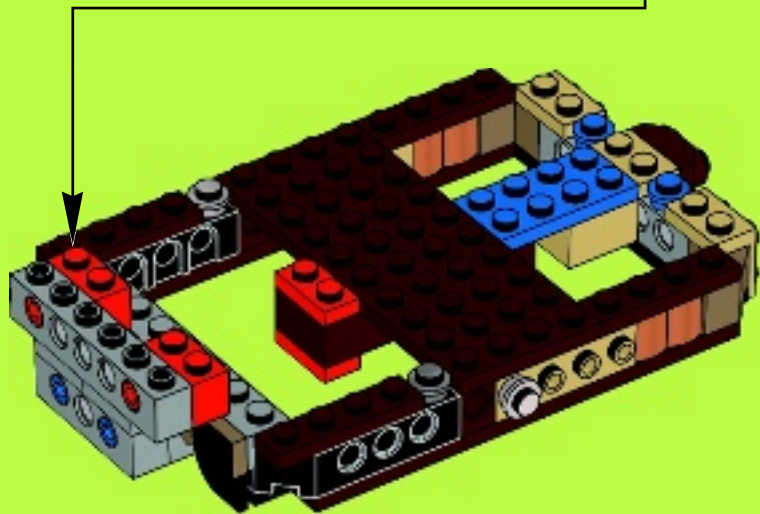
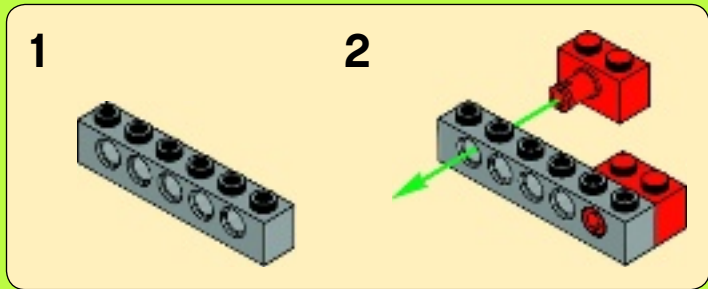

# 14

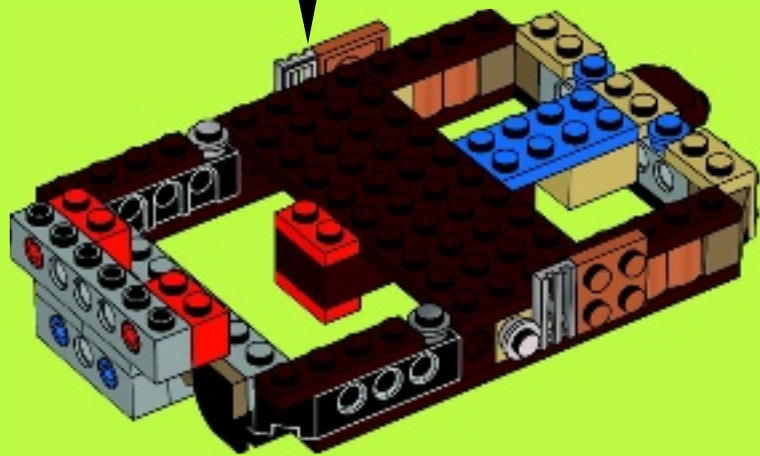



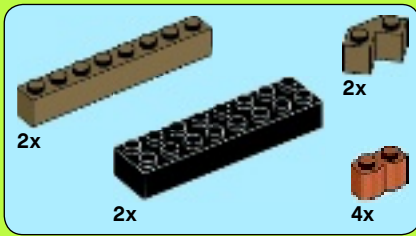

# 15

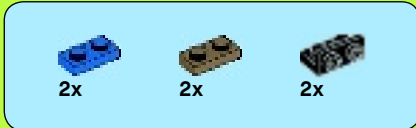
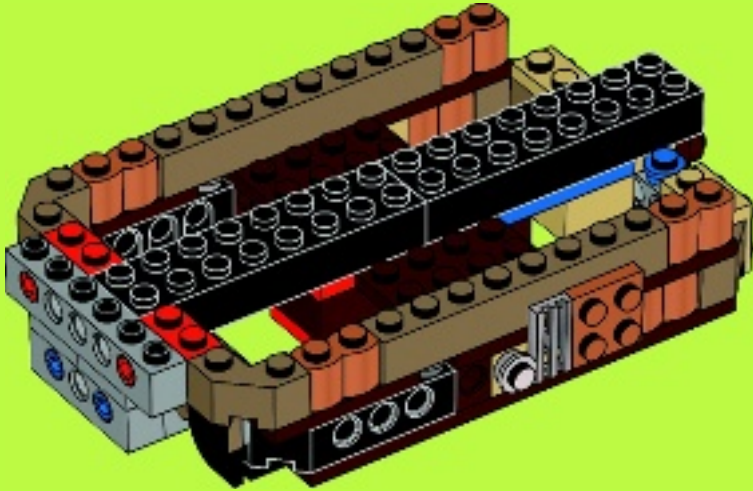

# 16

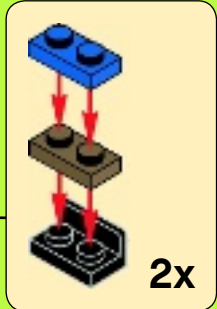
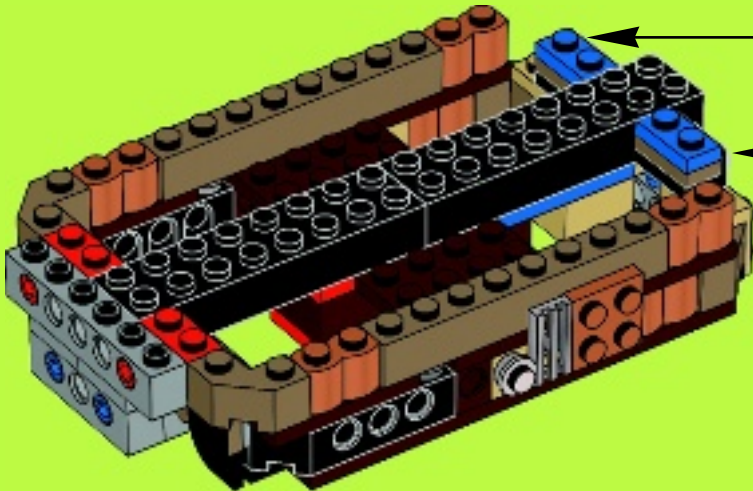

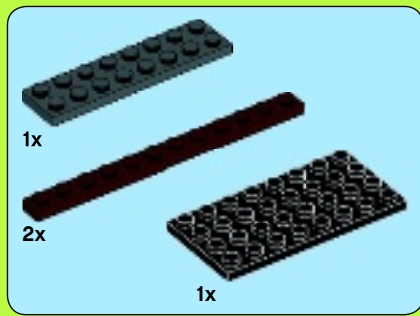

17

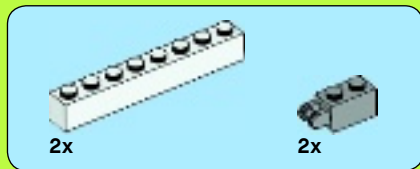
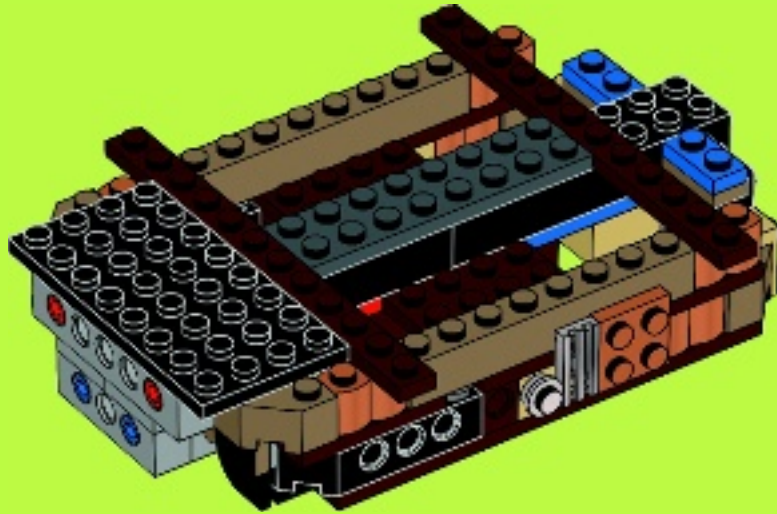

18

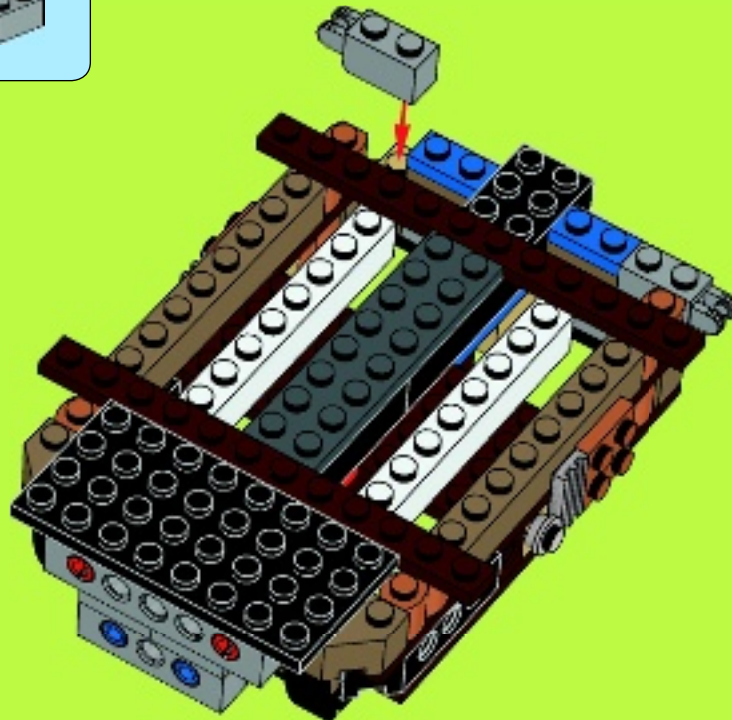

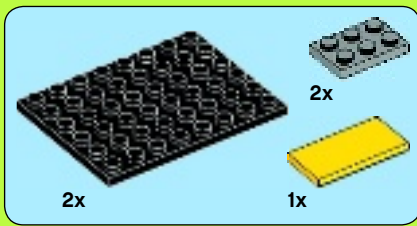

19

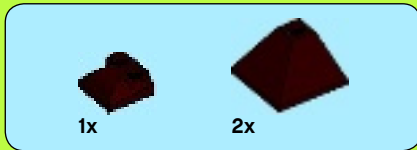
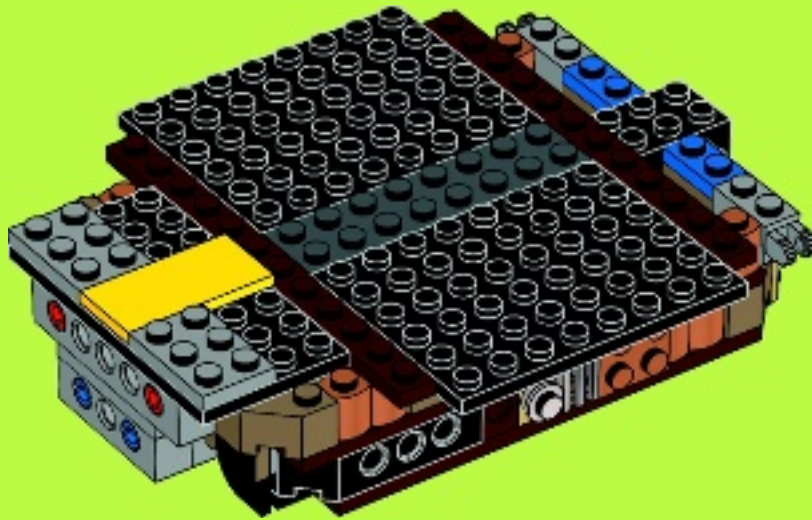

20







# 21

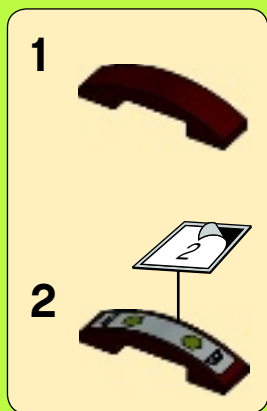

# 22

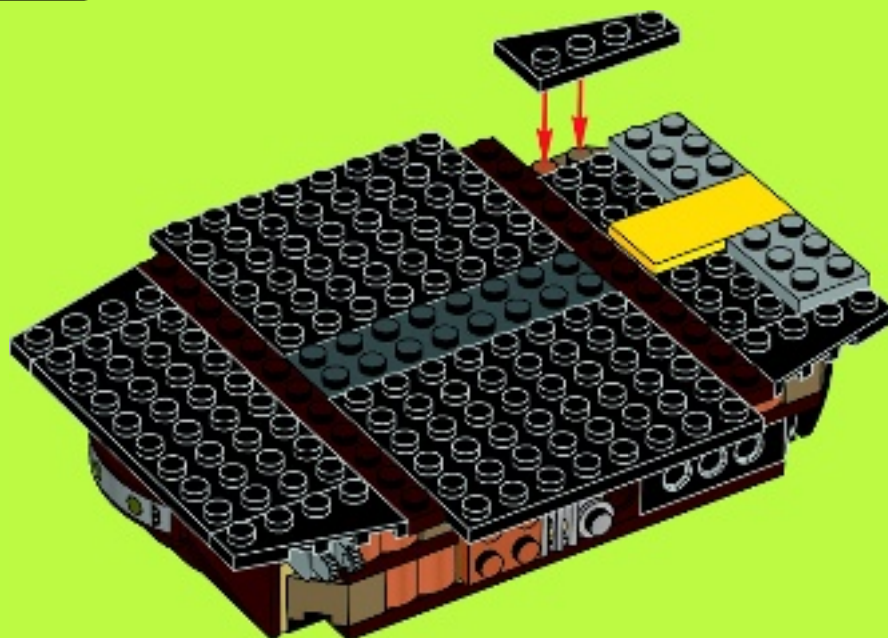





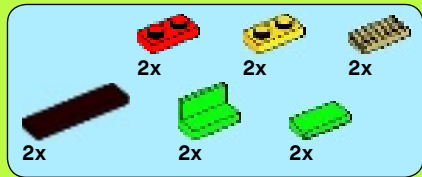

25

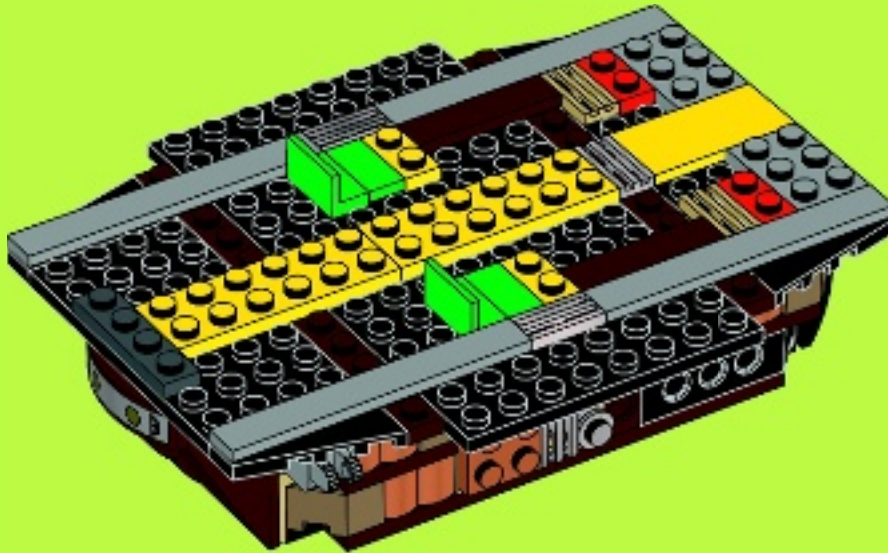

26

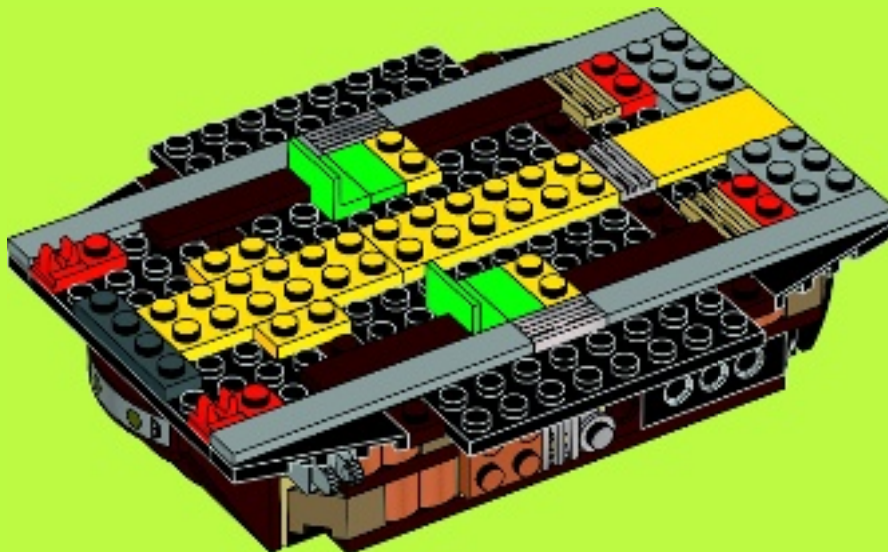



# 27

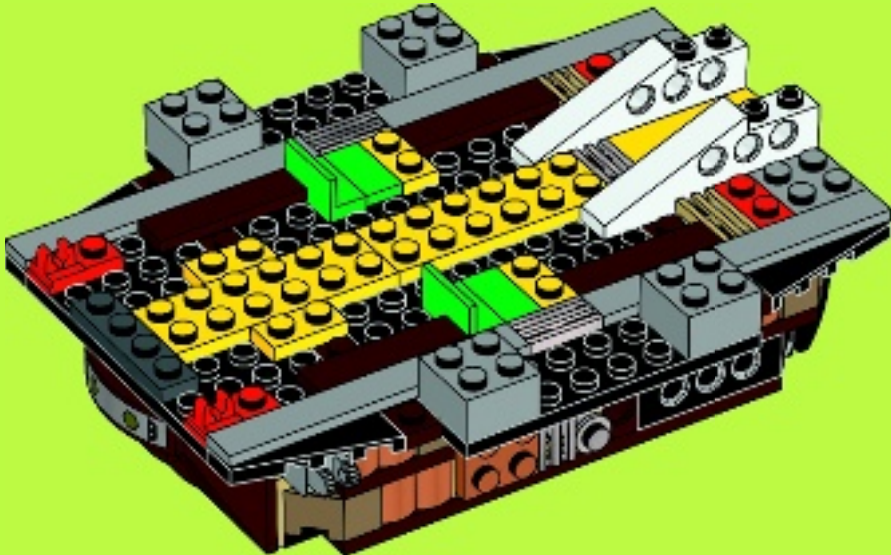

# 28

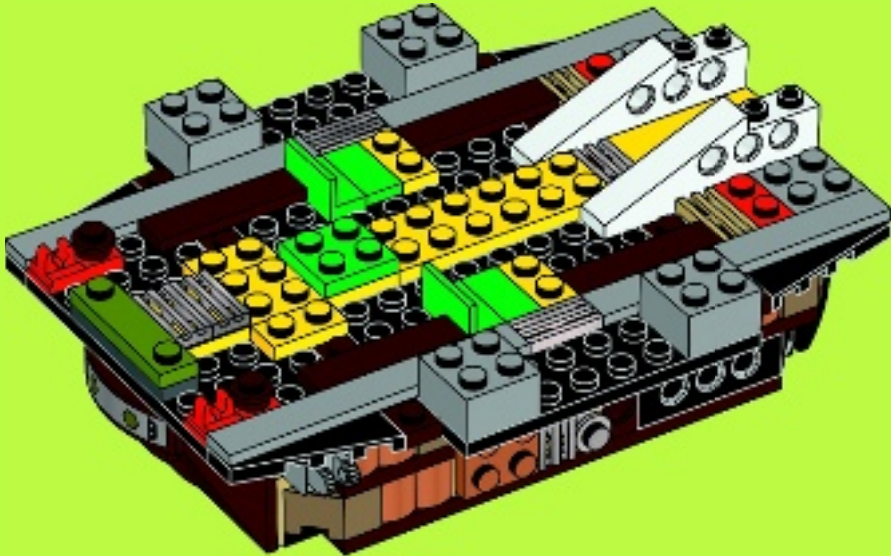



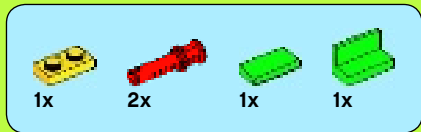

# 29

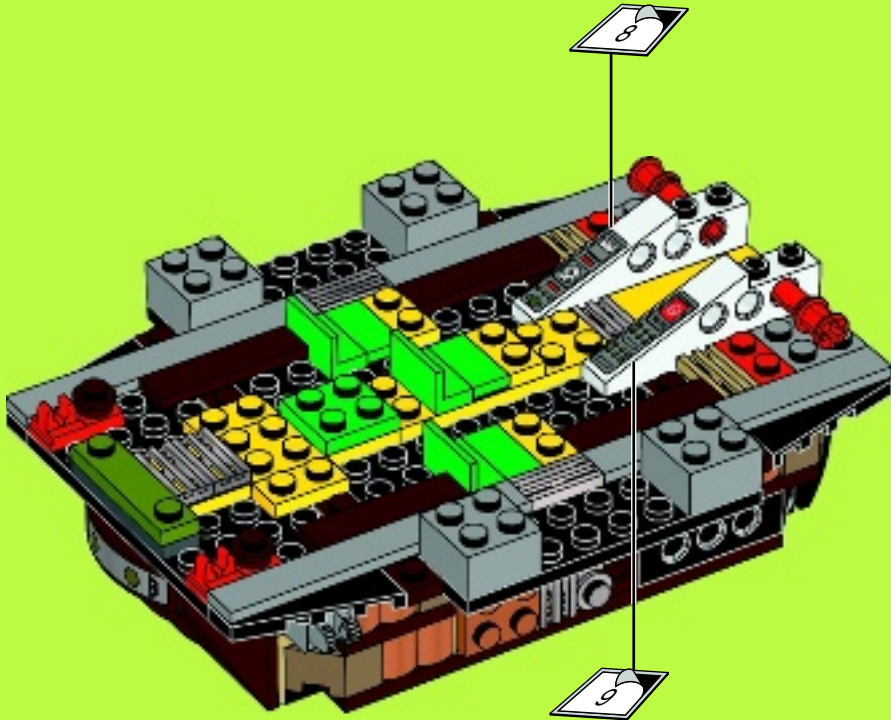

# 30

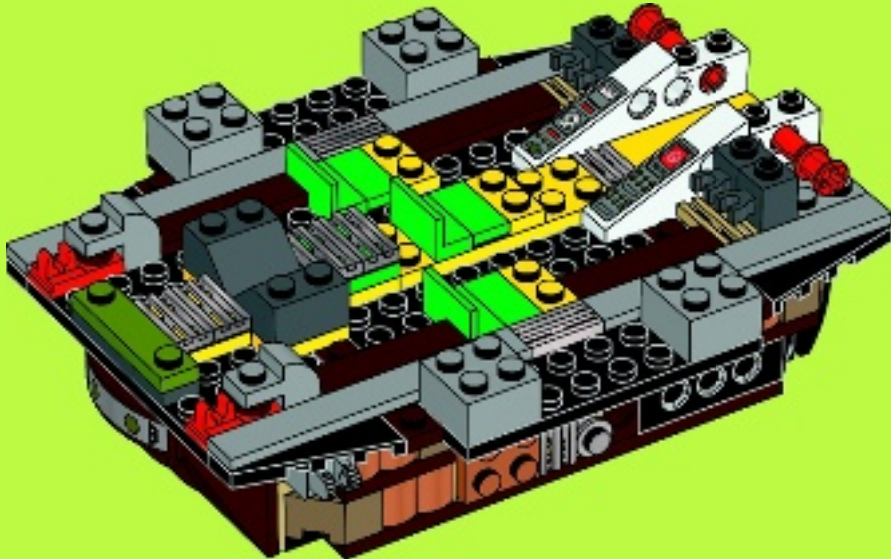



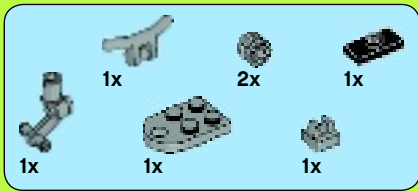

# 31

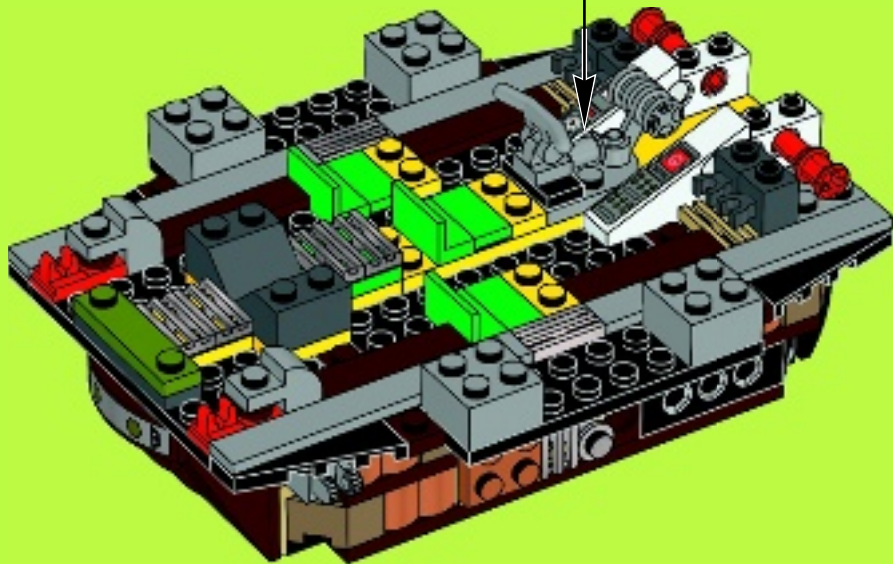
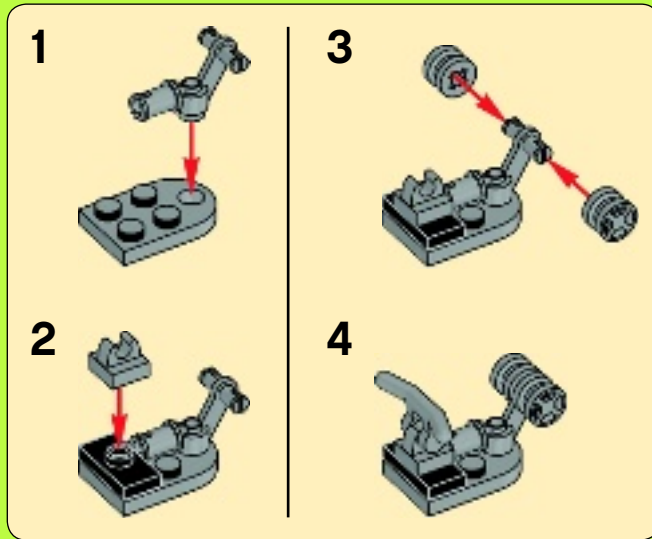

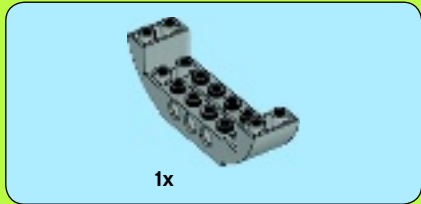

1

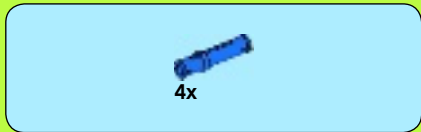
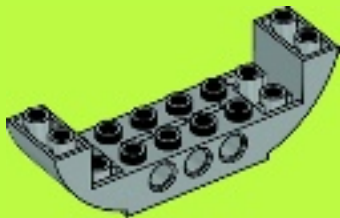

2

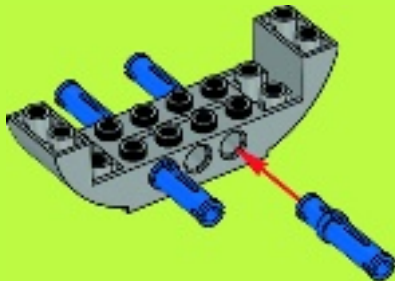

3

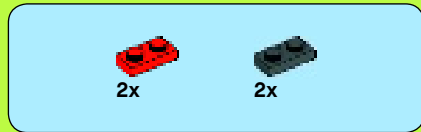
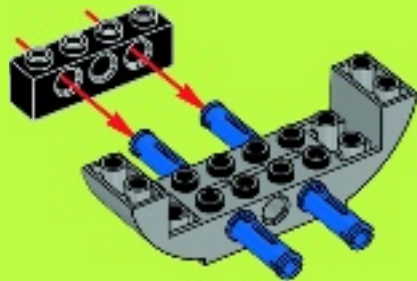

4





5



6



7

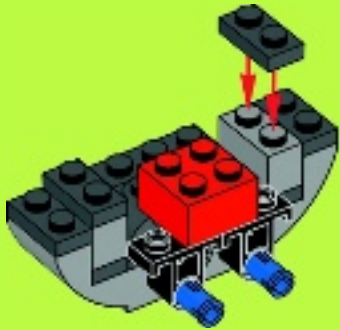

8

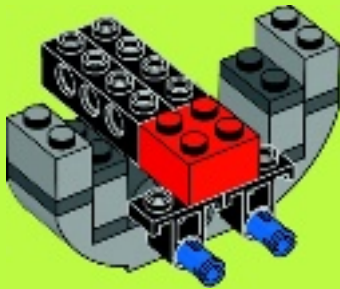



4x

# 9

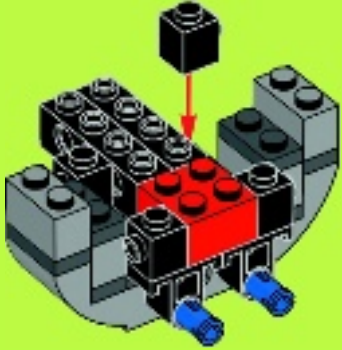

2x



2x



2x

# 10

1



2

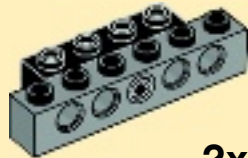

2x

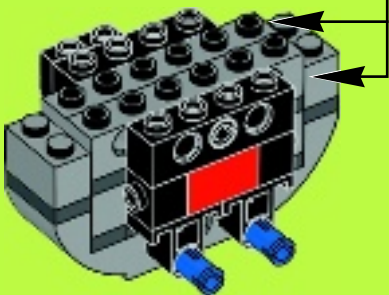

2x



2x

# 11

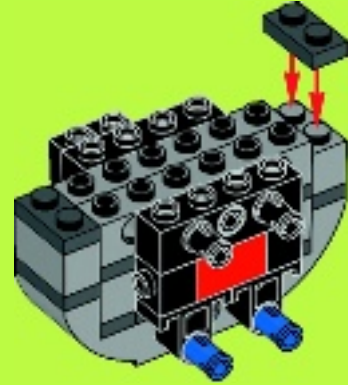

6x



6x

# 12

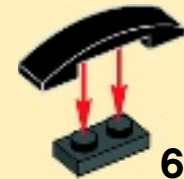

6x

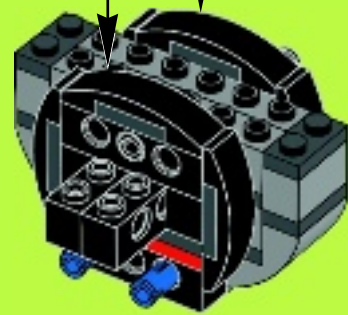



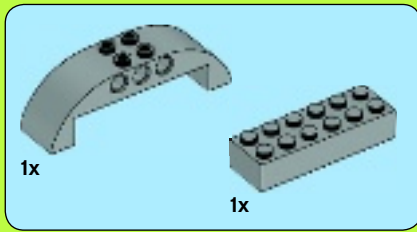

13

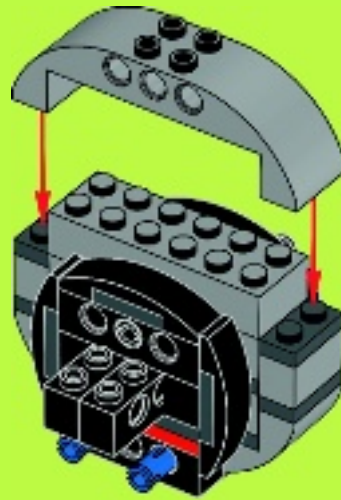

32

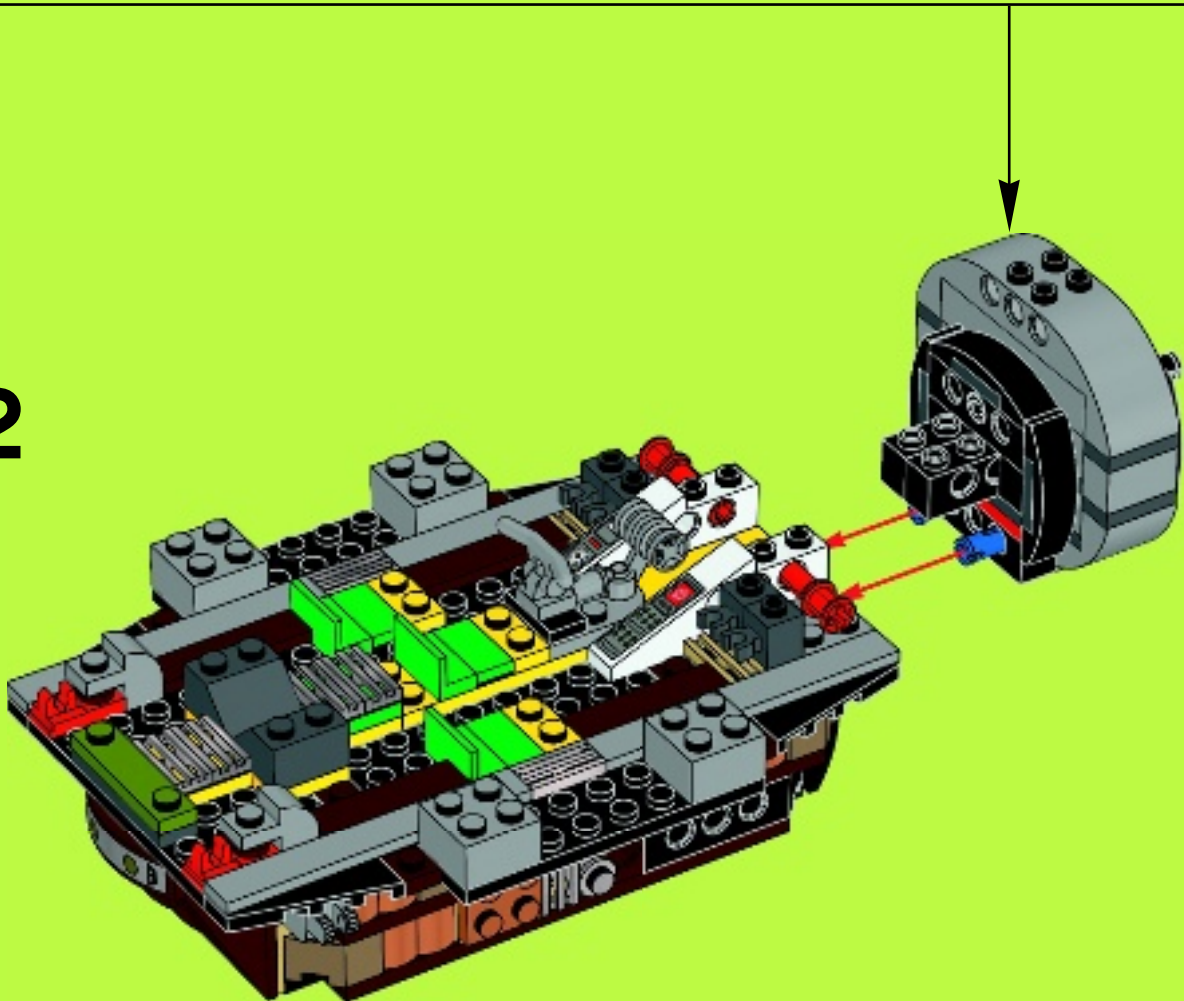



2x



2x



4x

# 33

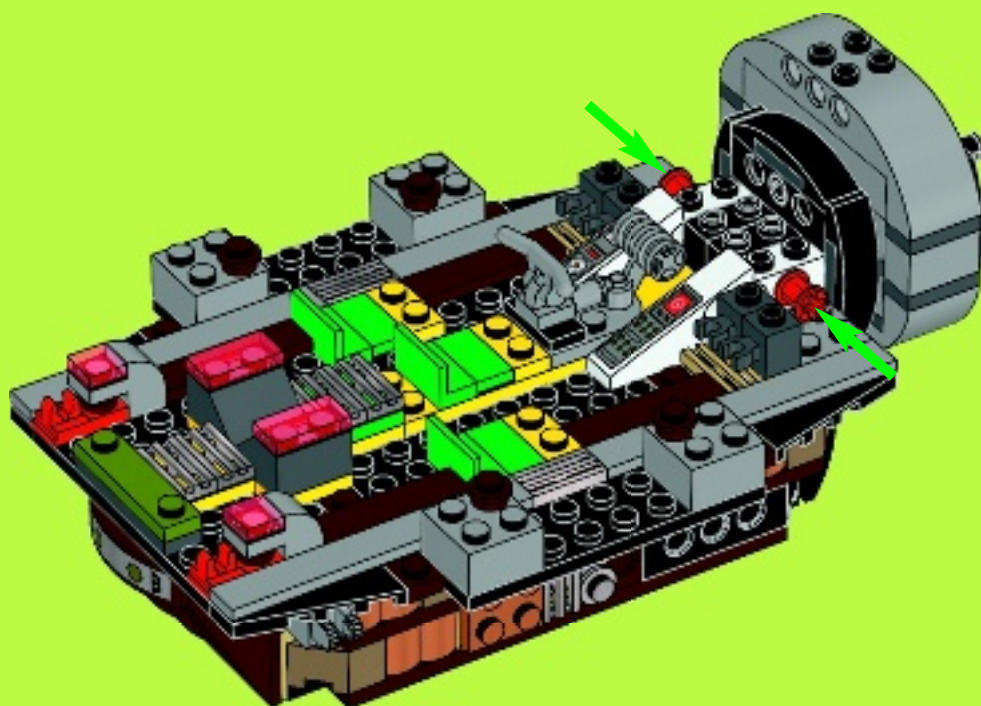



6x

# 34

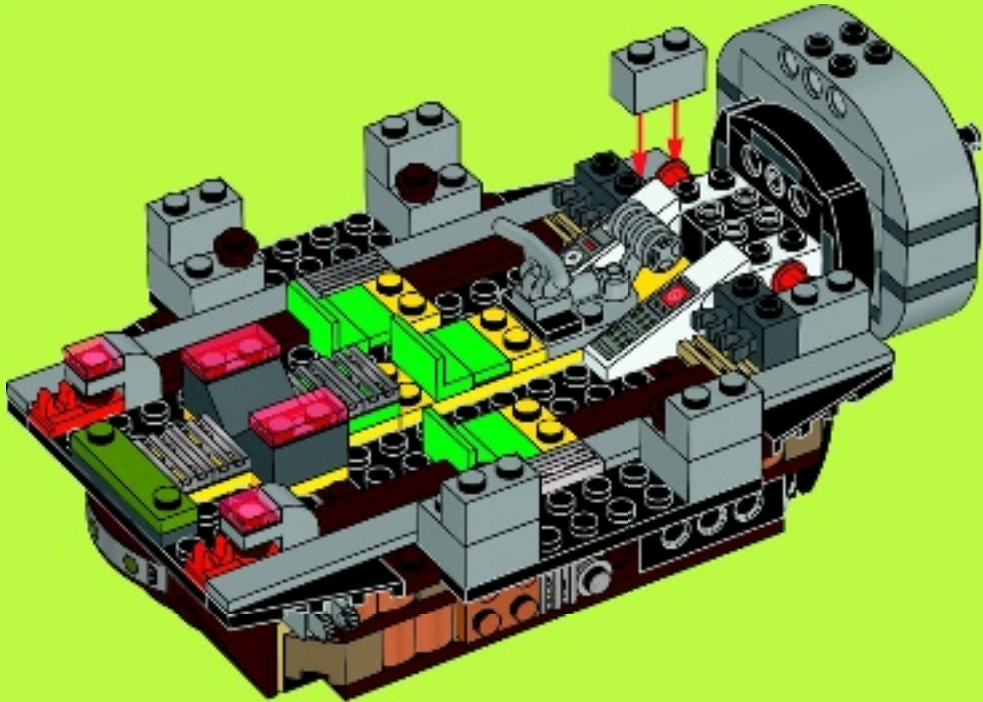

4x



8x

# 35

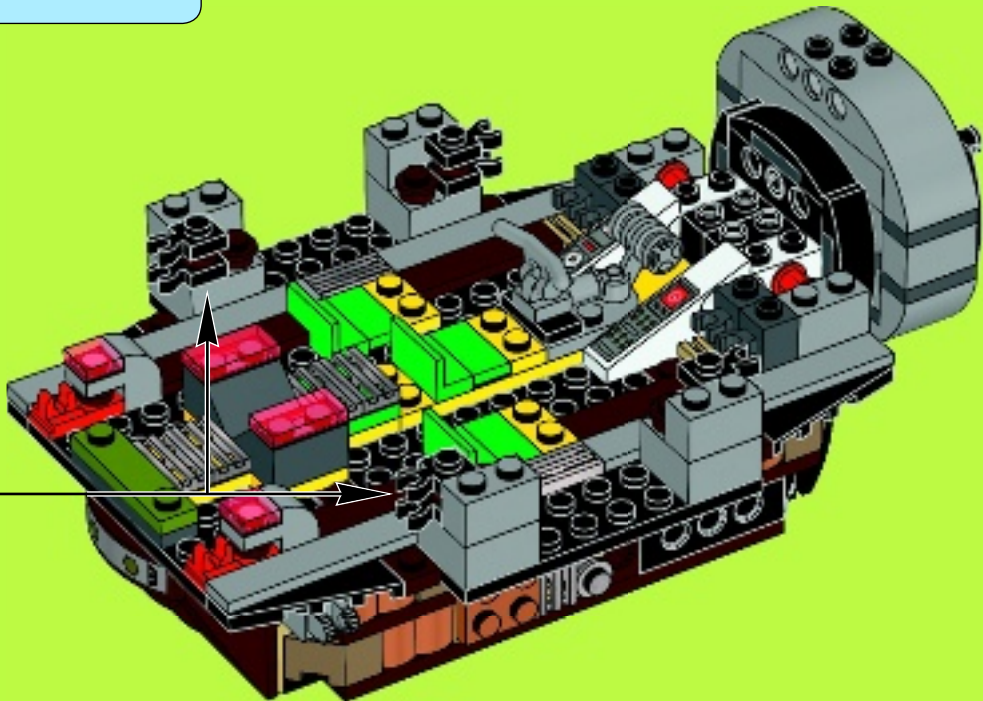

4x



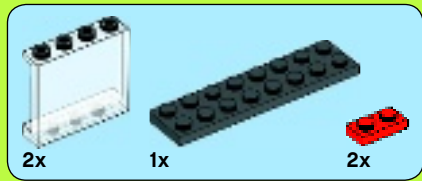

# 36

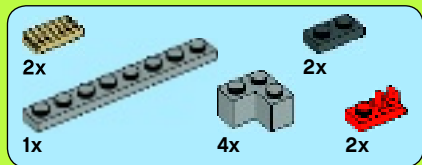
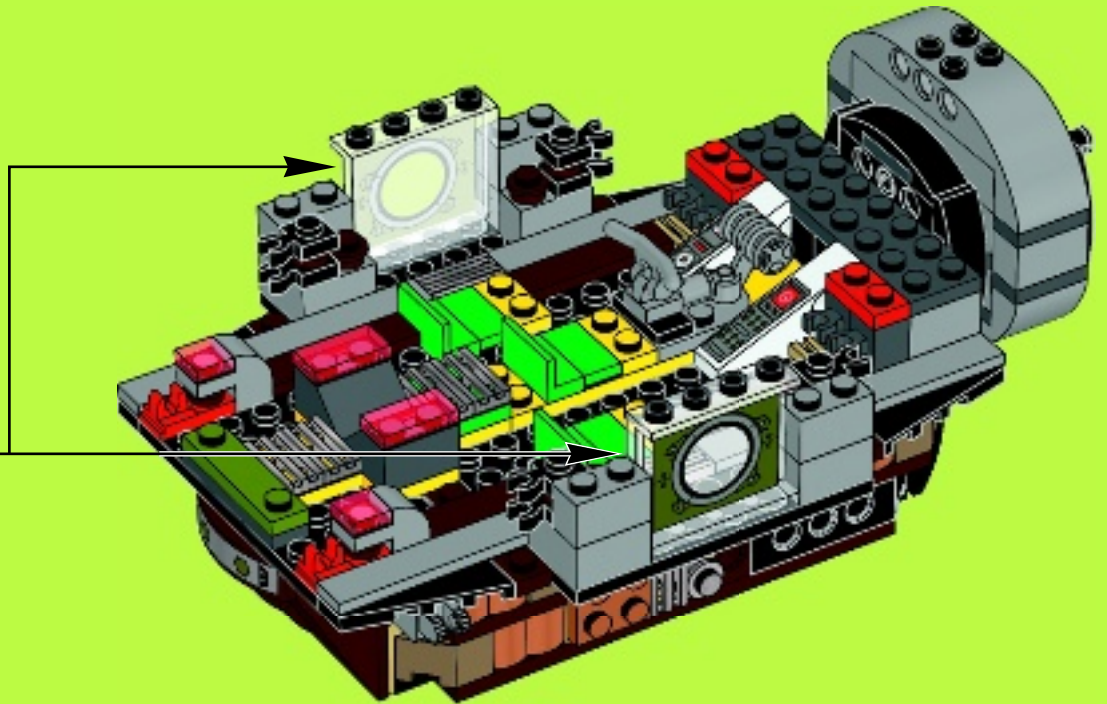
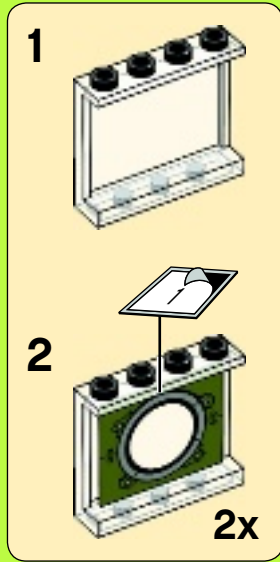

# 37

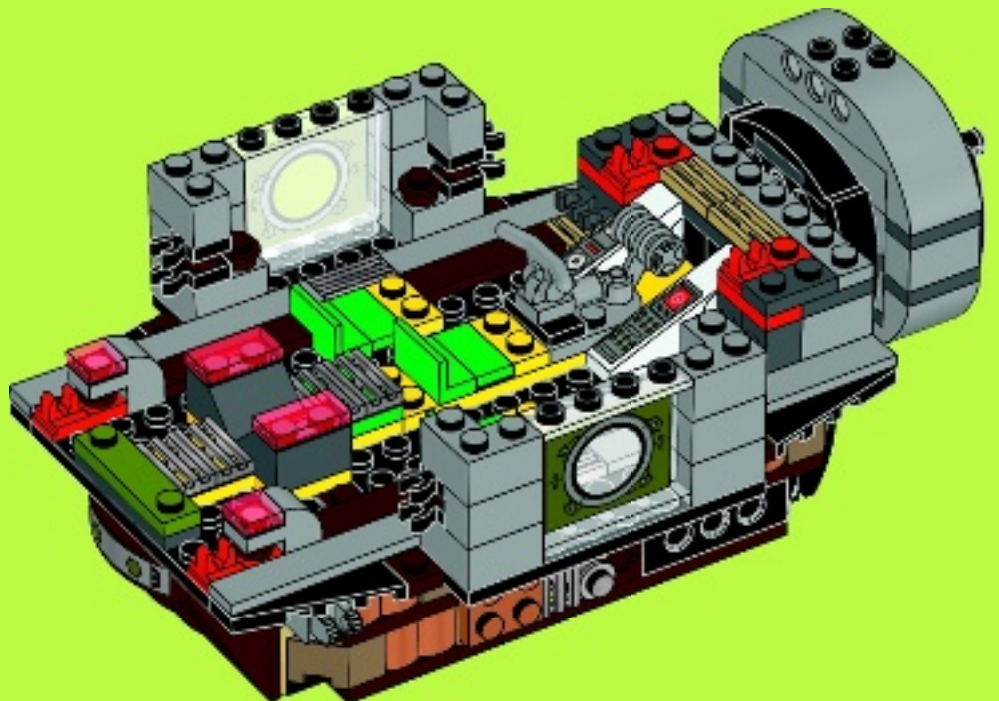



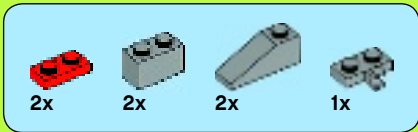

# 38

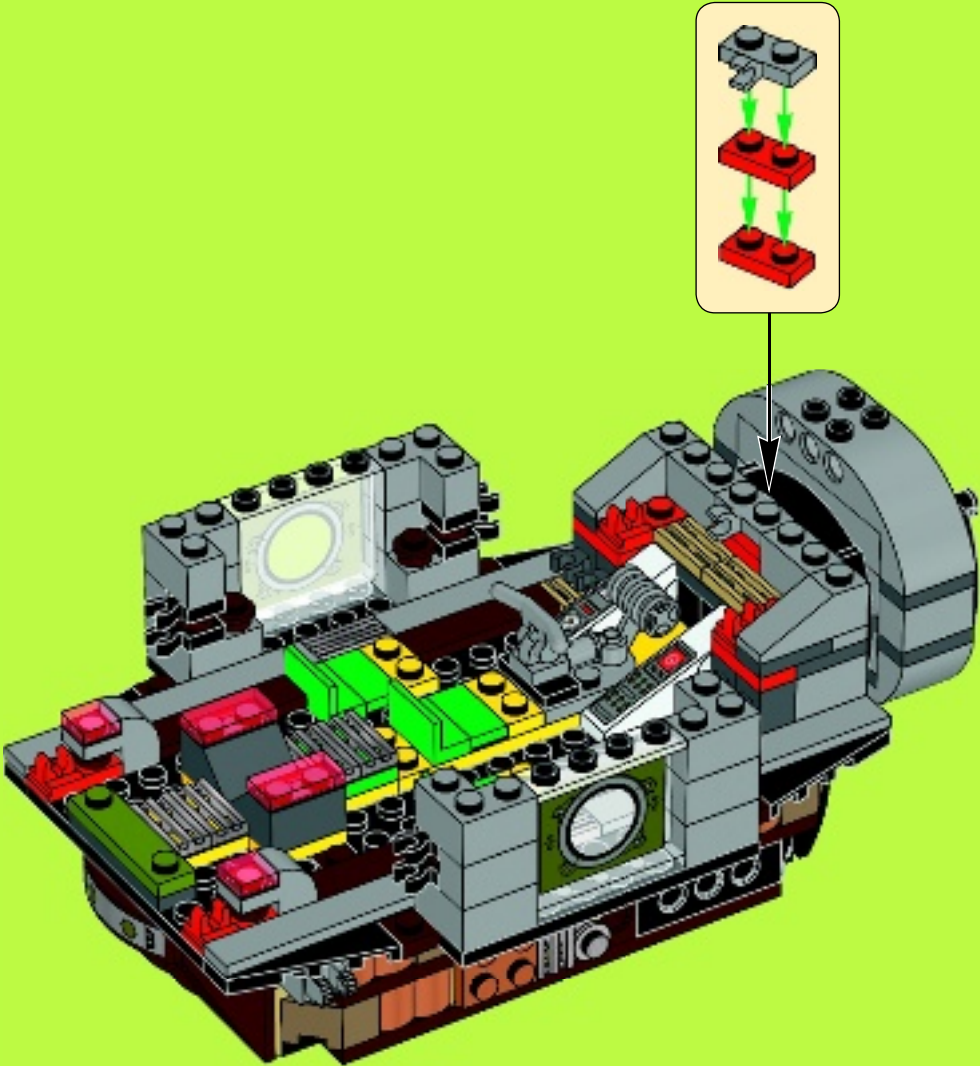

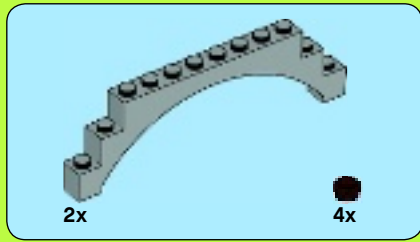

# 39

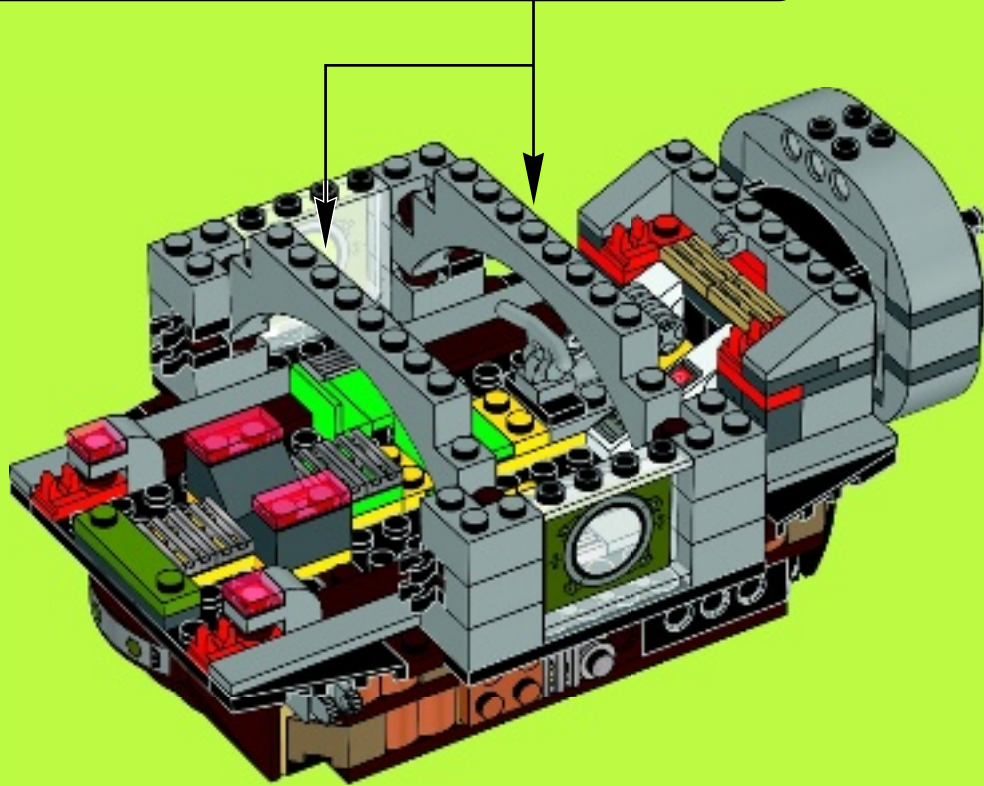
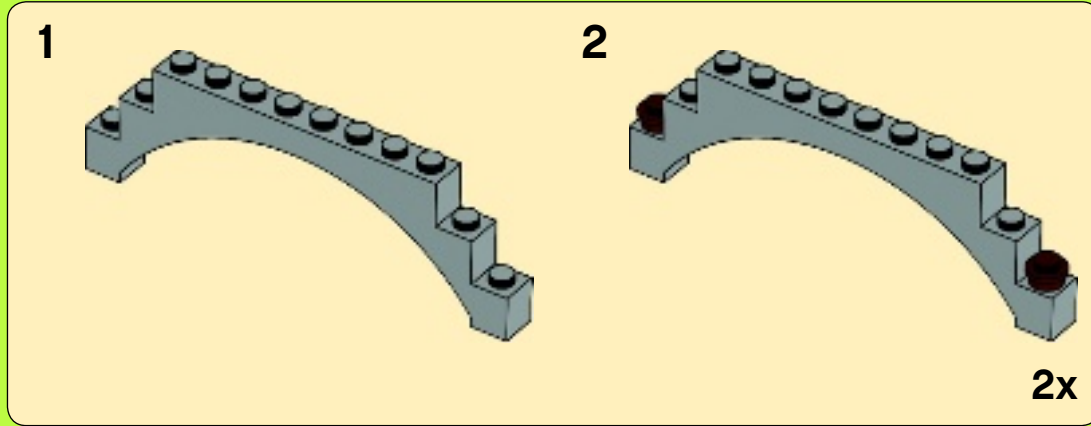

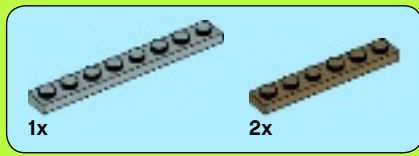

40

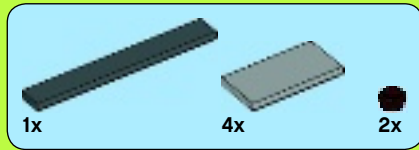
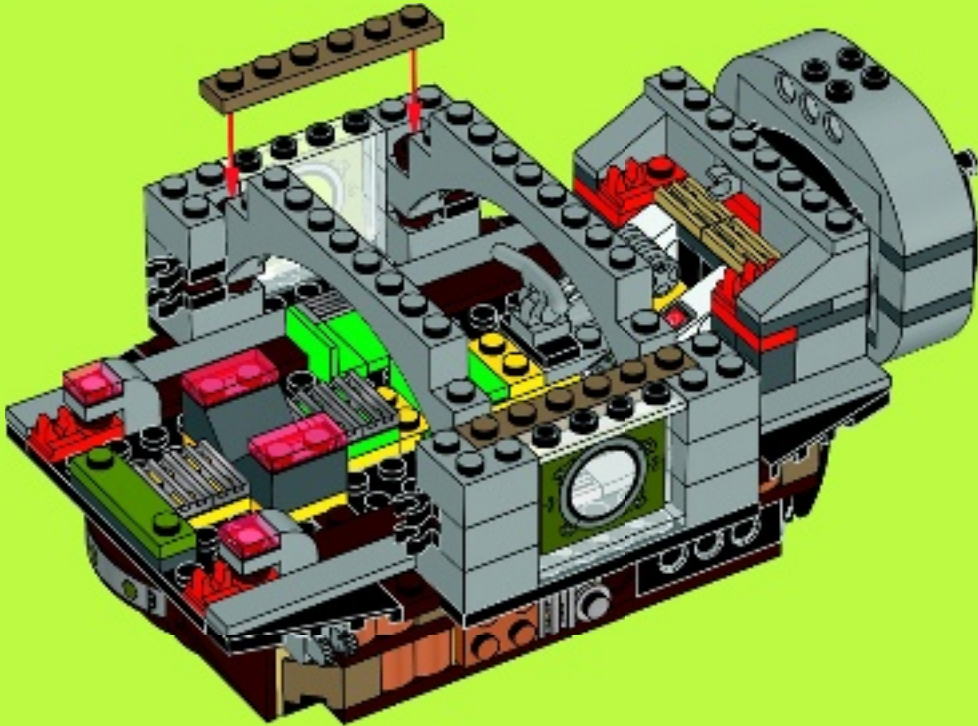

41

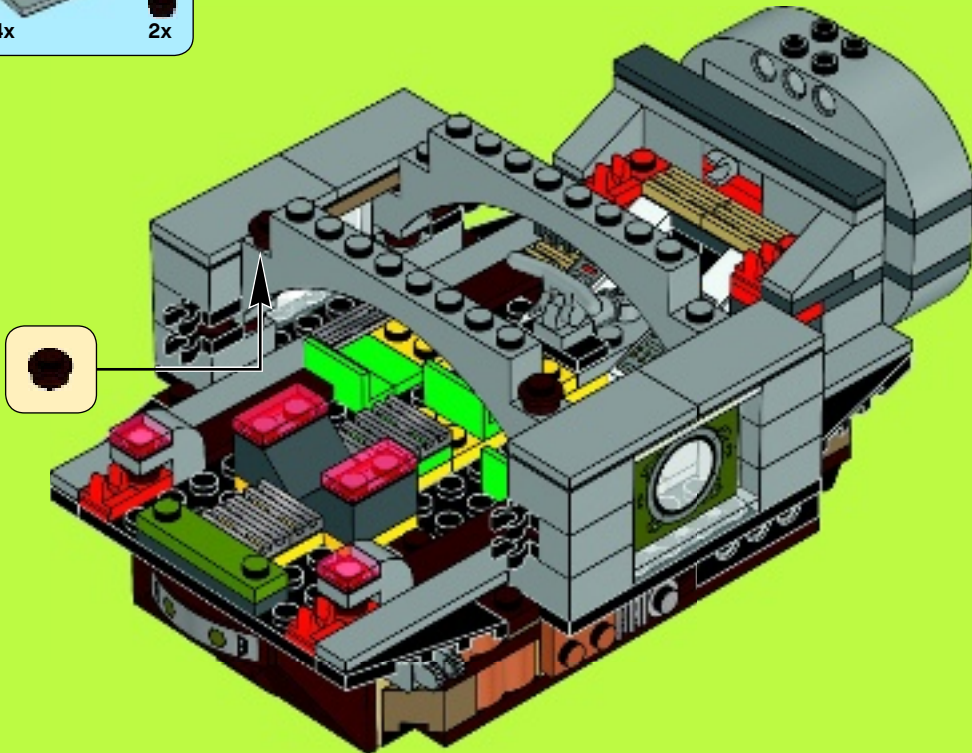

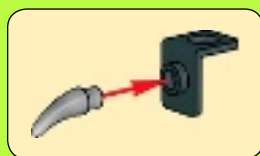
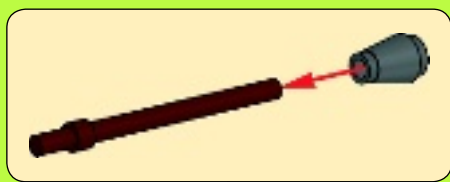
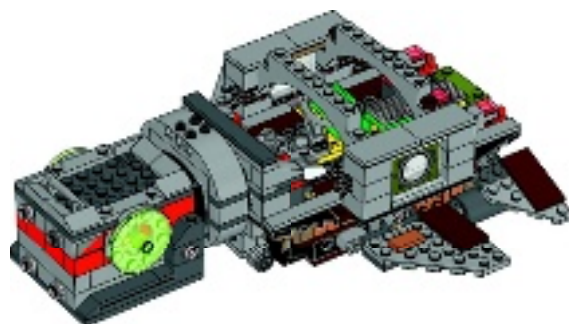



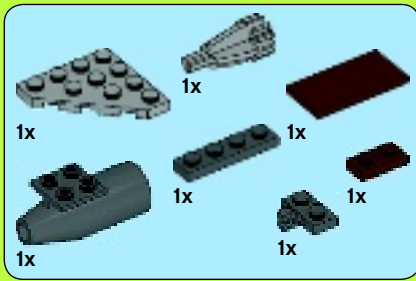

# 42

1

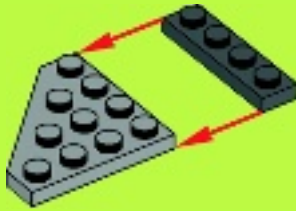

2

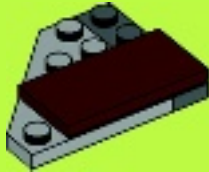

3



4

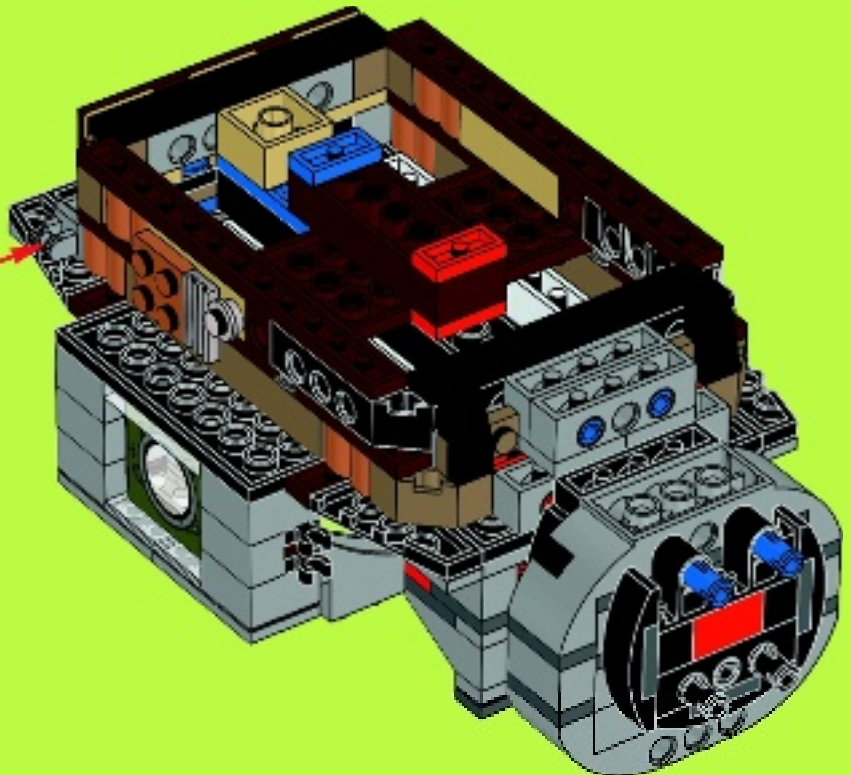
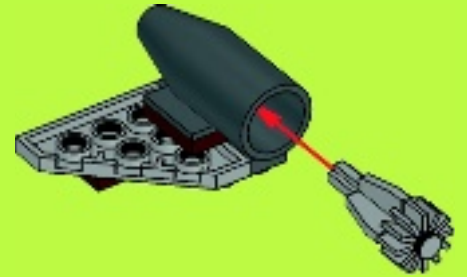

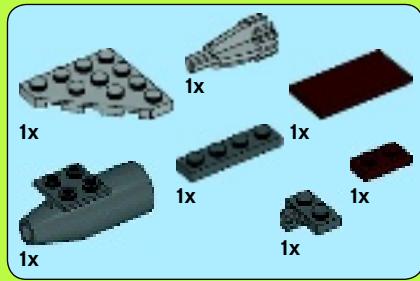

**43**

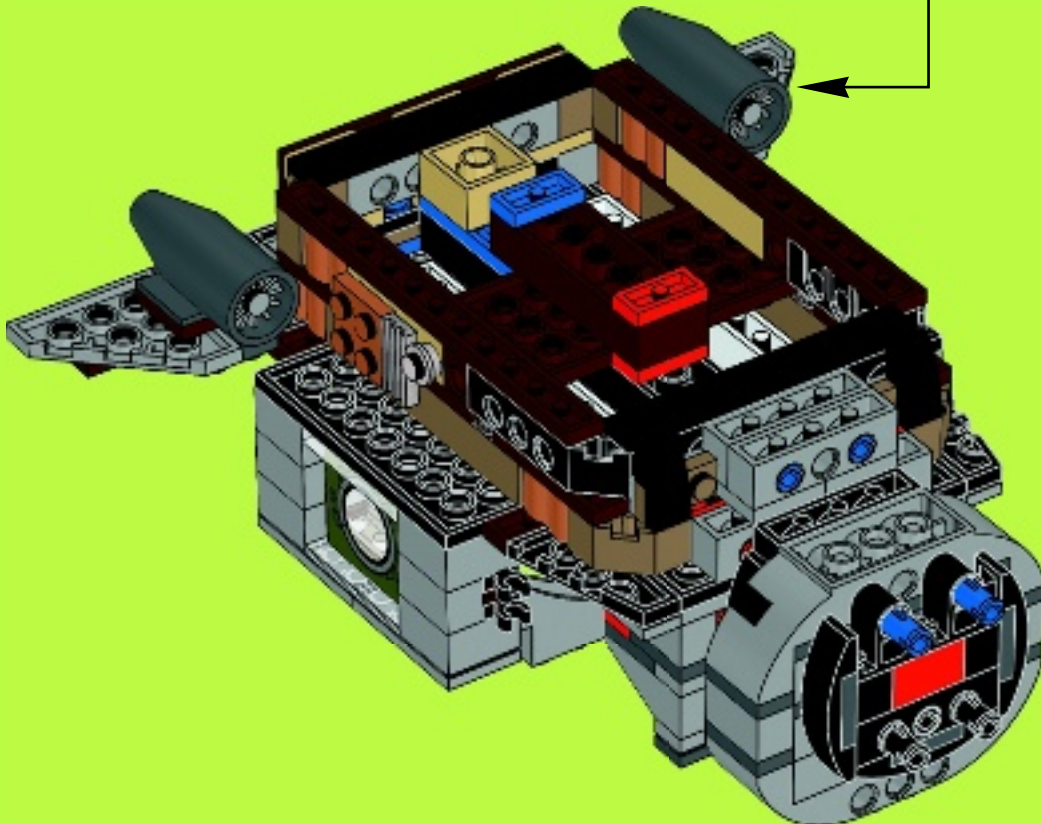
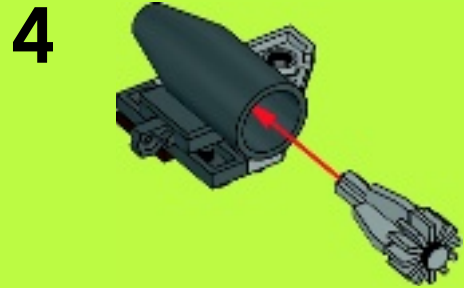
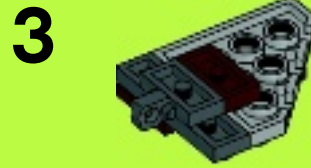
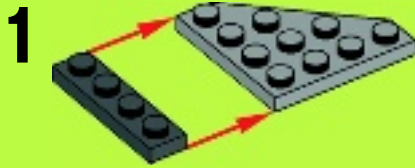



# 44

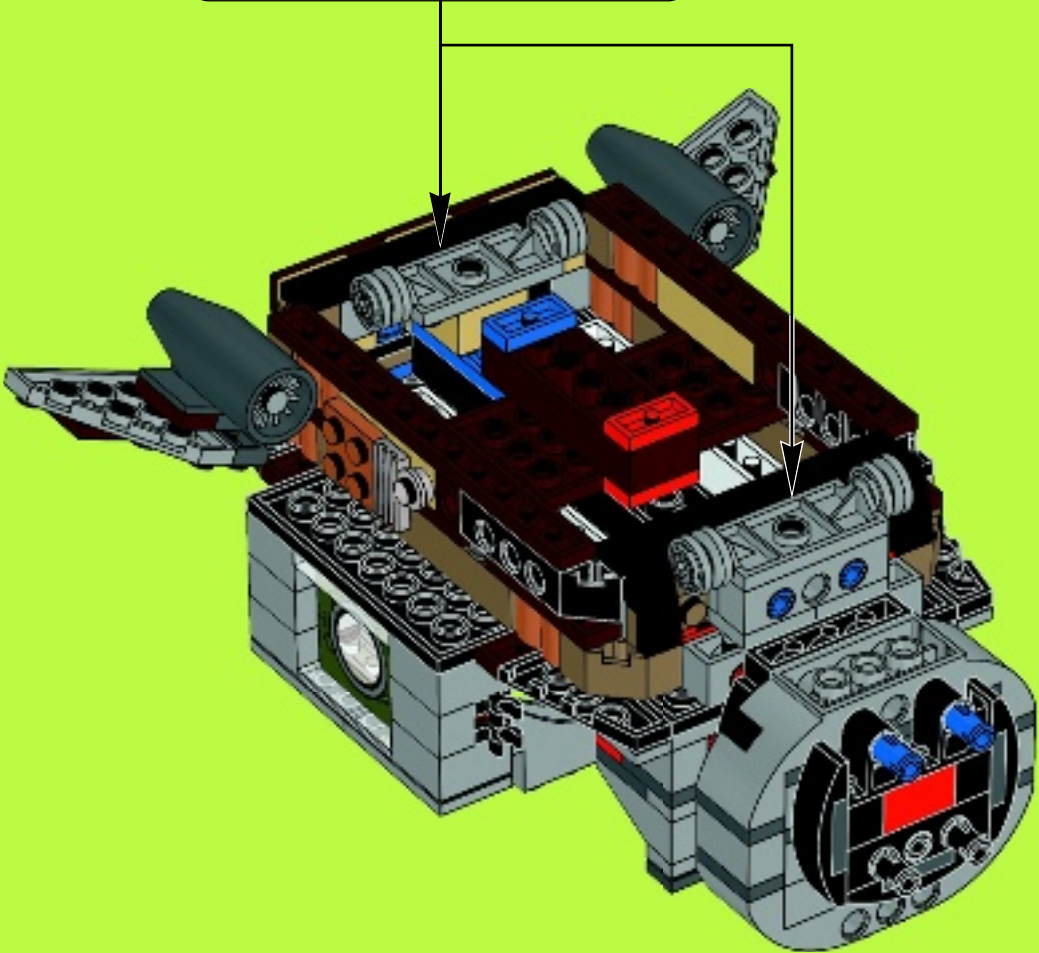
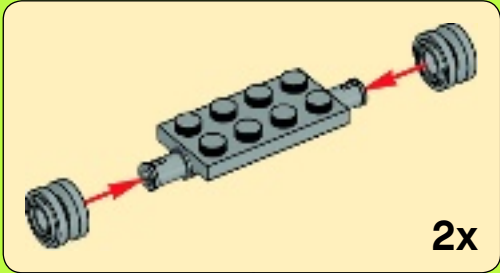

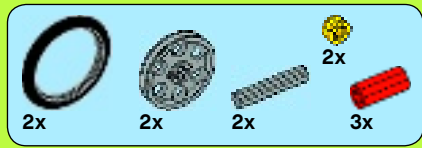

# 45

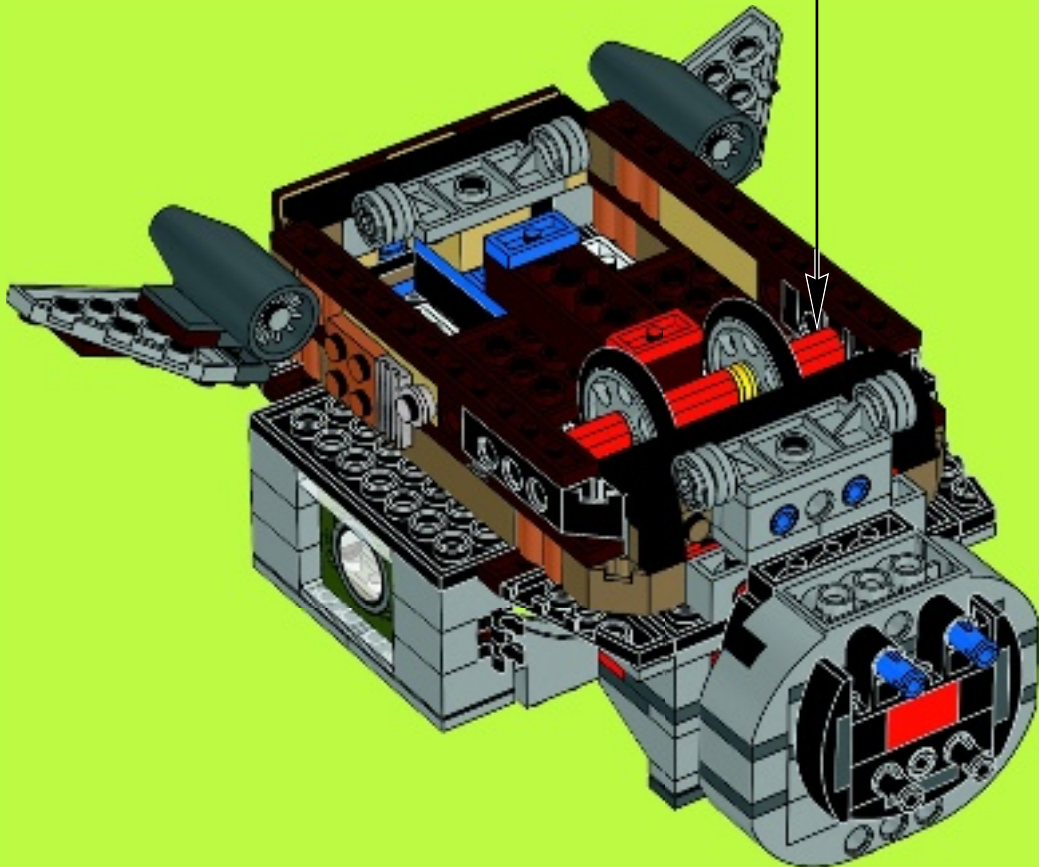
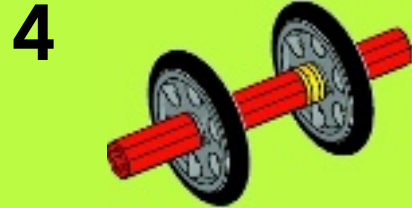
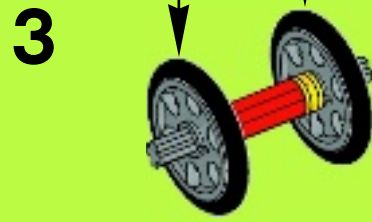
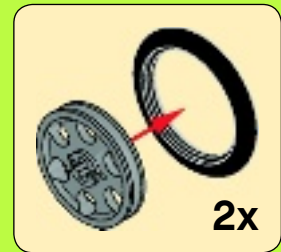
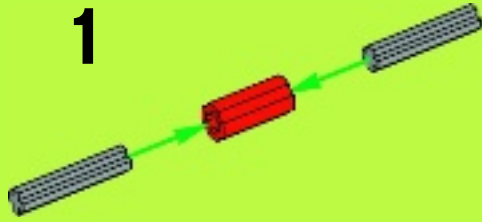





46

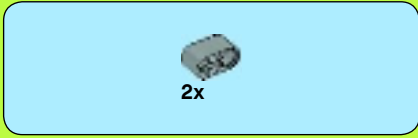
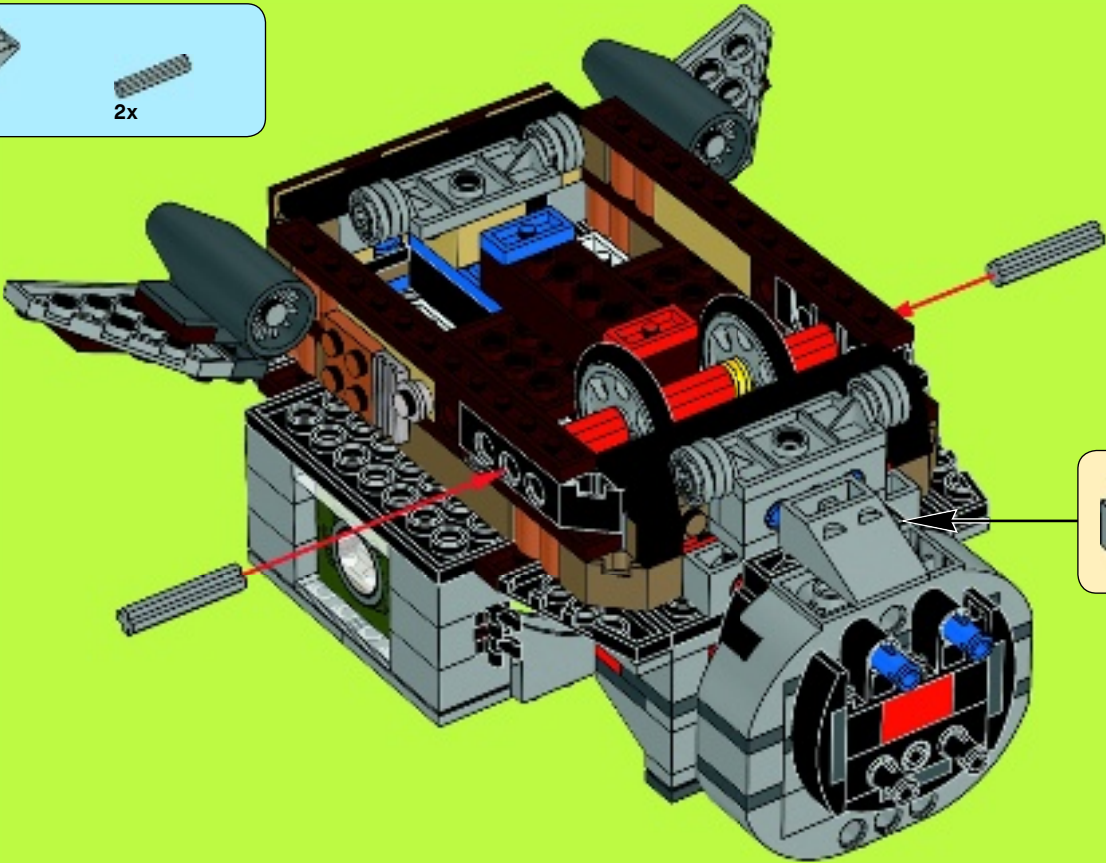

47

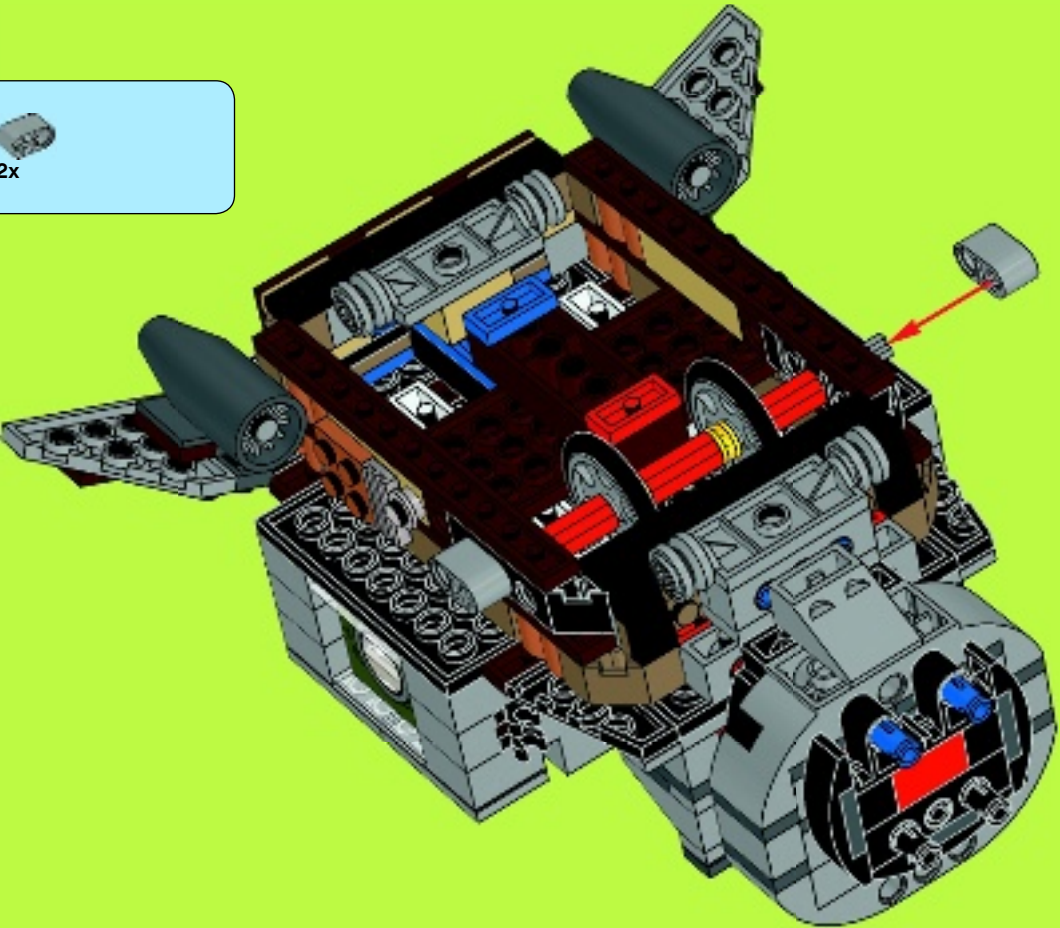

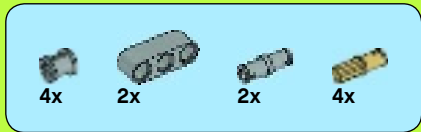

# 48

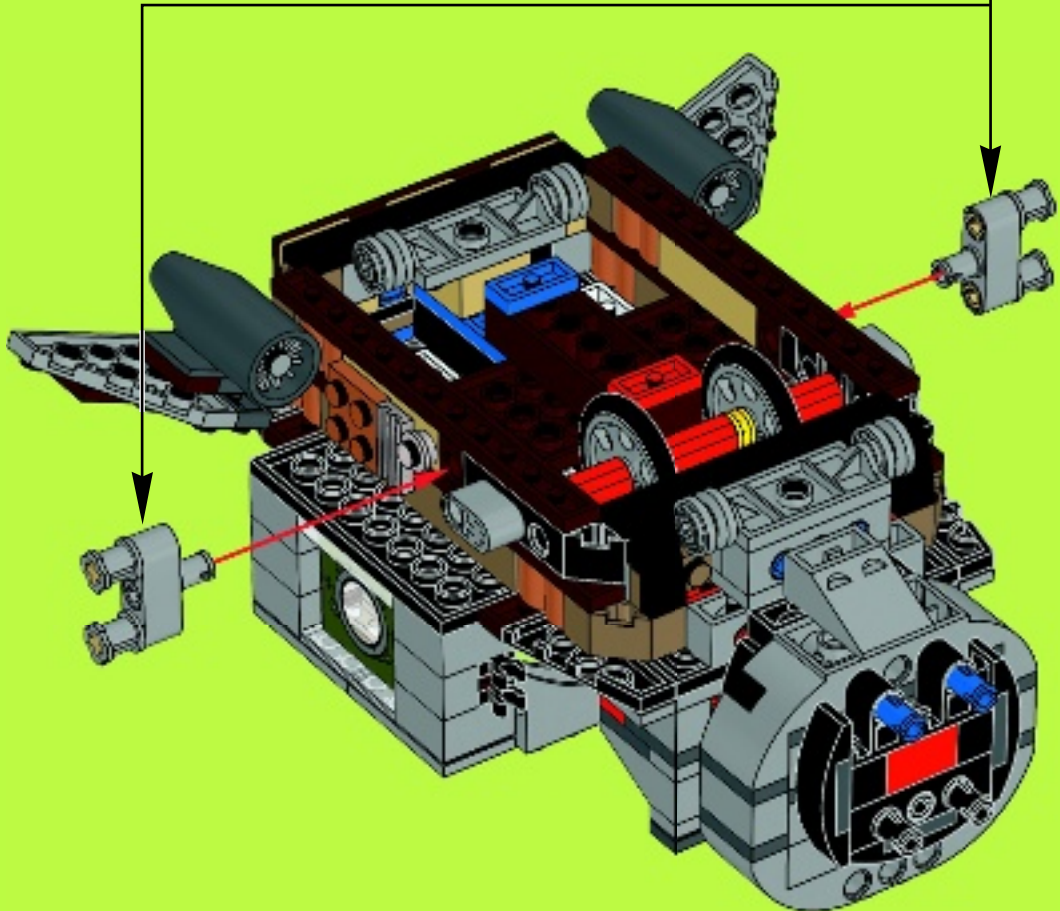
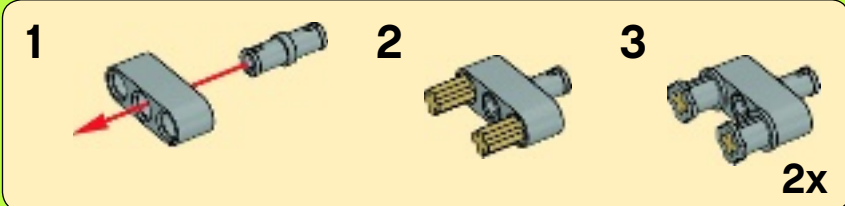



1

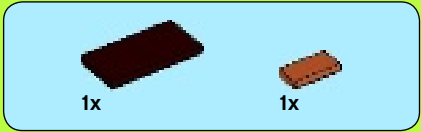

2



3



4





1x

5

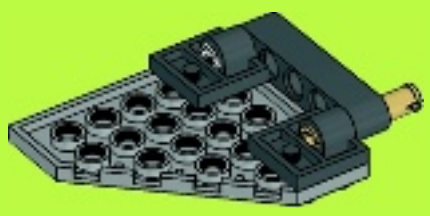

49

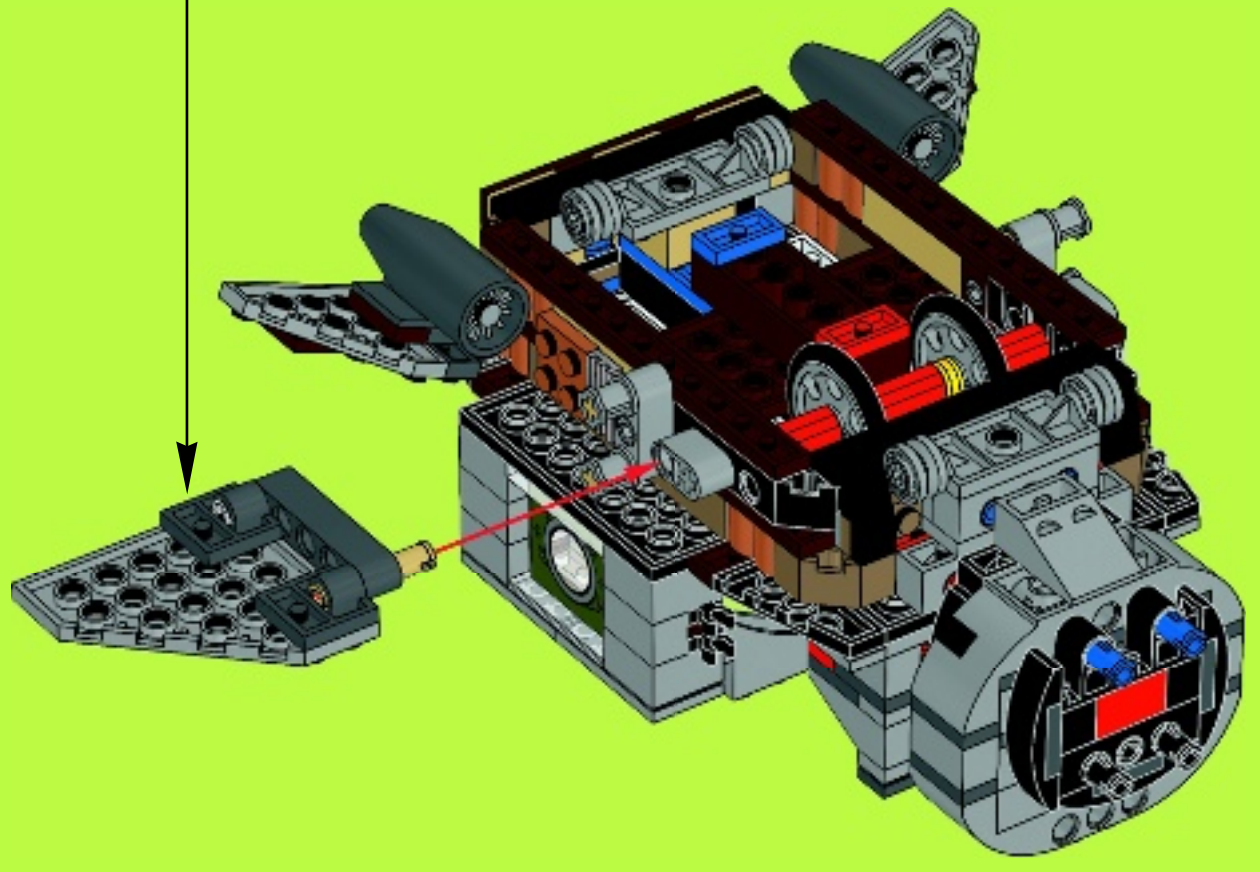





1

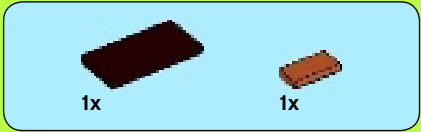
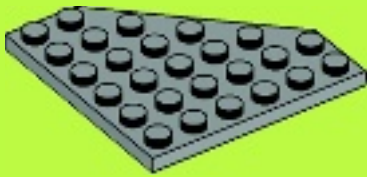

2



3

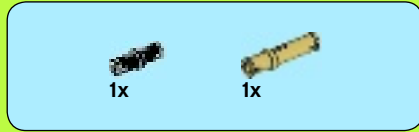

4





1x

5



50

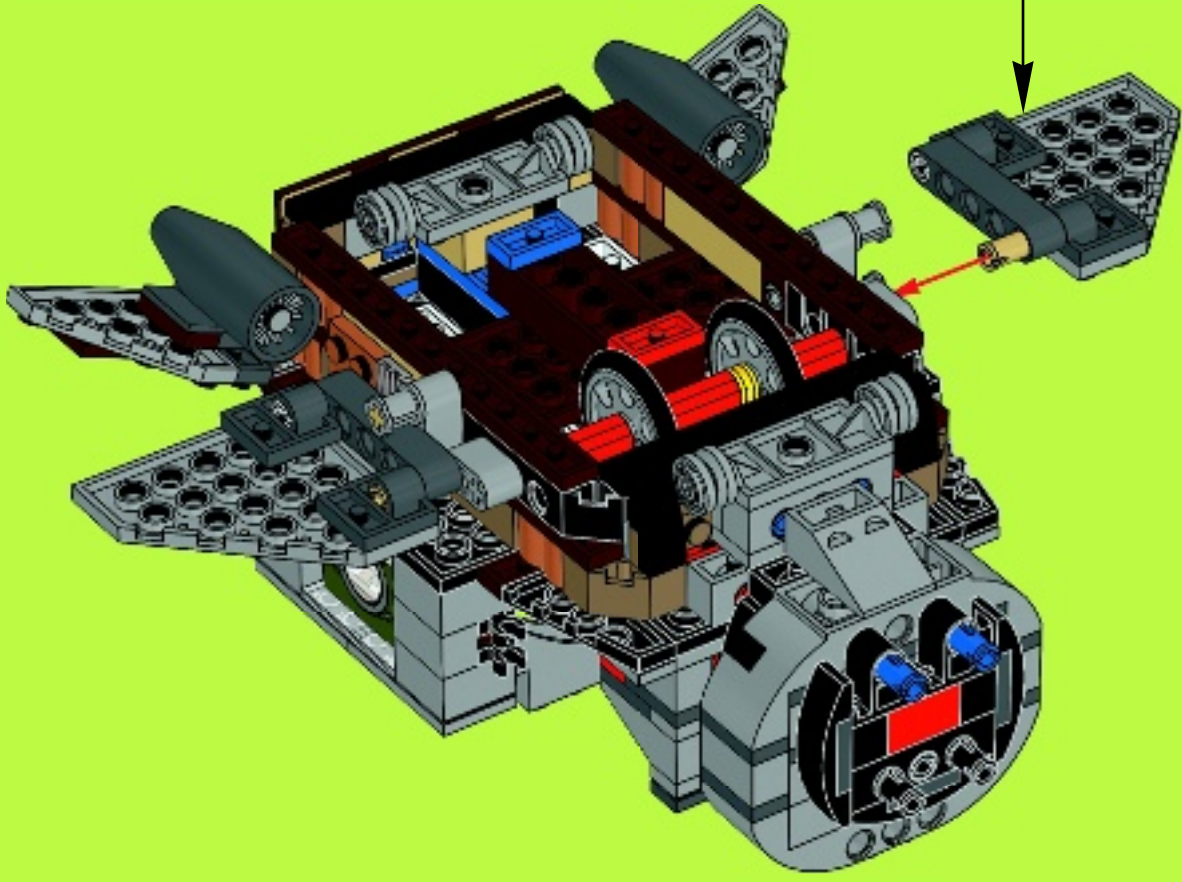

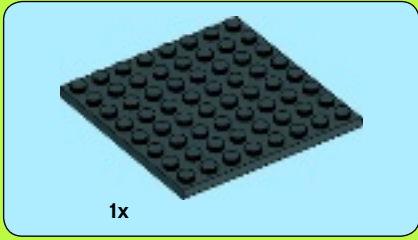

1x

1



1x

2x

2



1x

2x

2x

1x

3

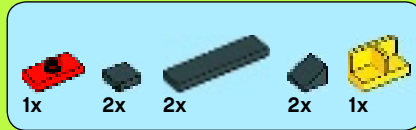
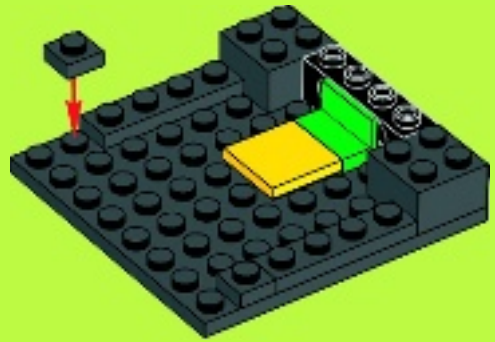

1x

2x

2x

2x

1x

4

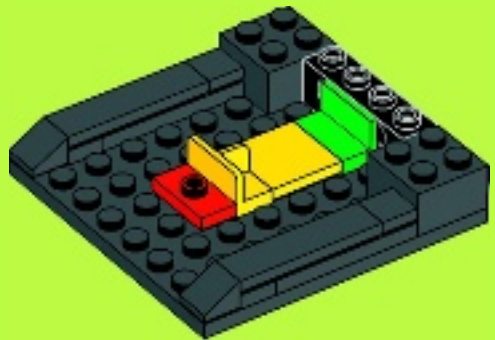

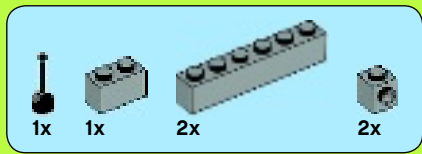

5

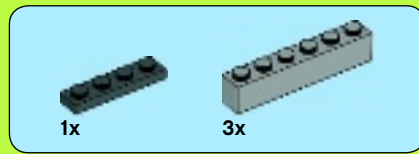
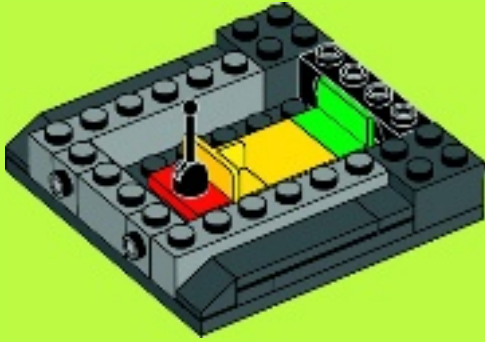

7

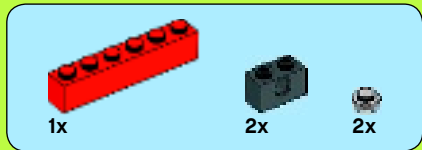
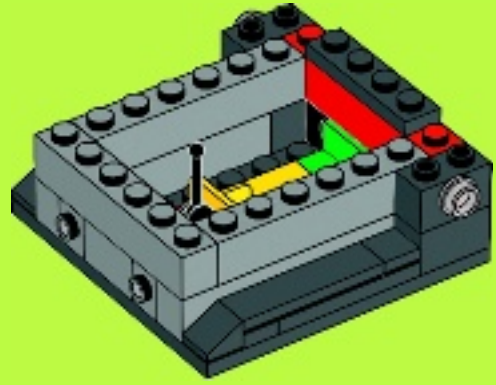

6

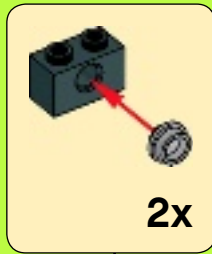
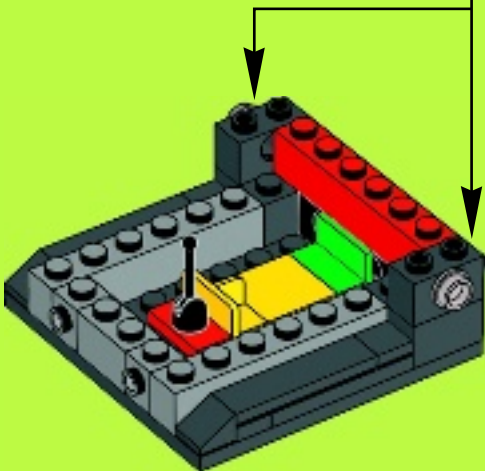

8

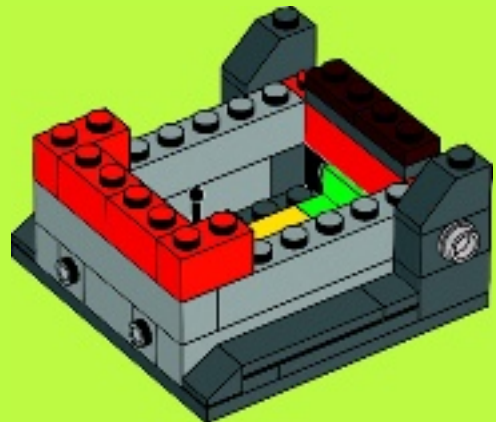





9

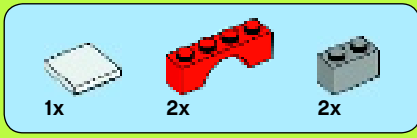
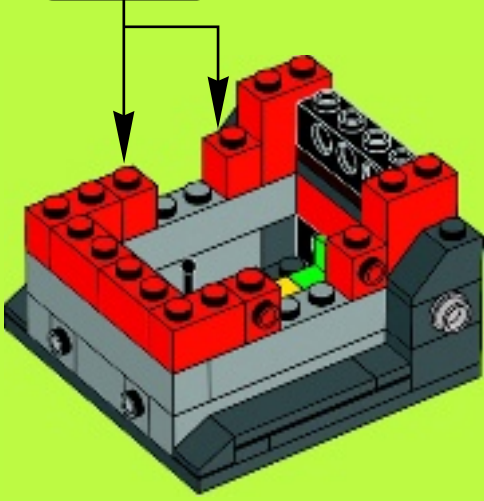

11

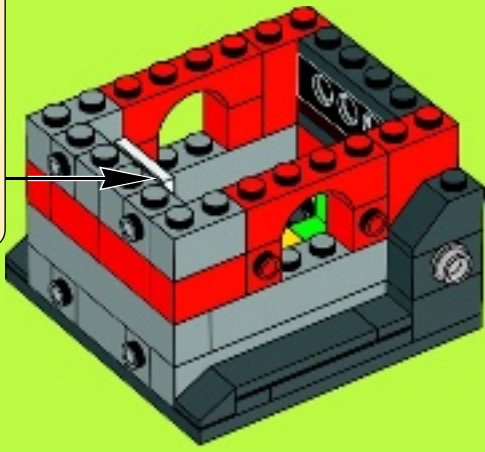
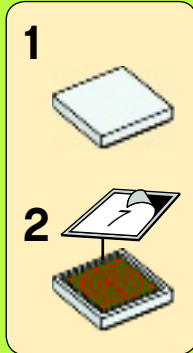

10

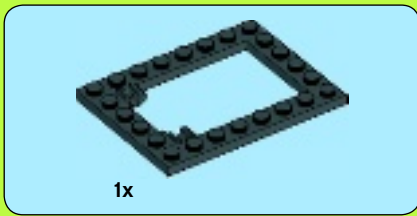
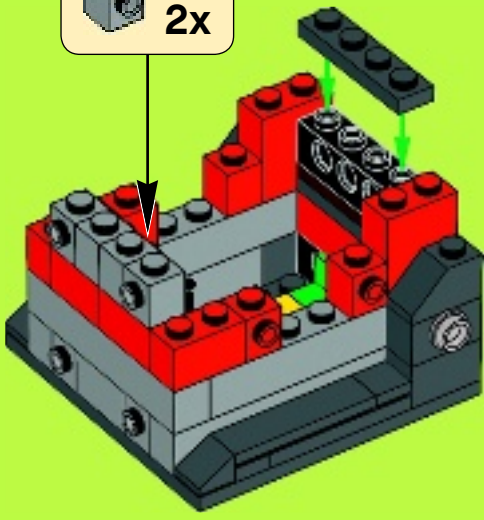

12

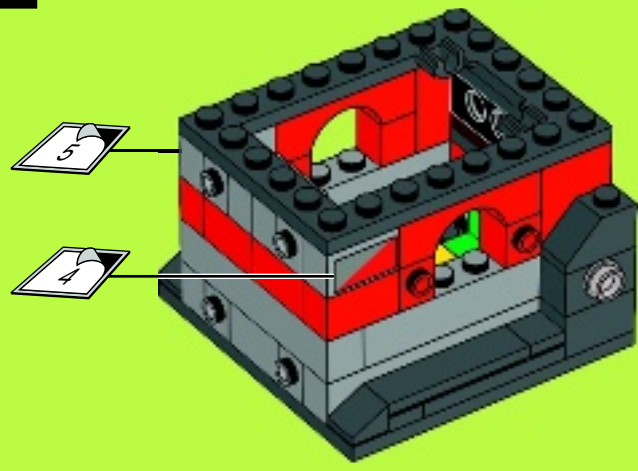



4x



4x

# 13

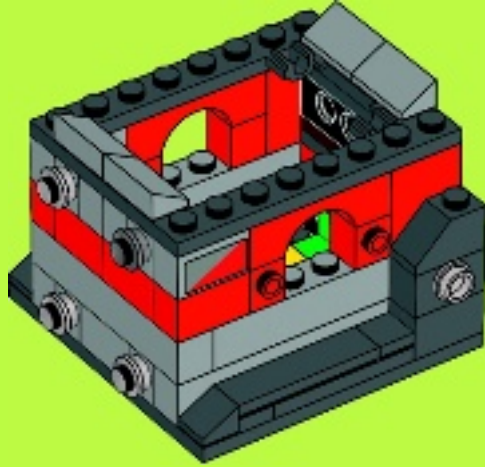

4x



2x

# 14

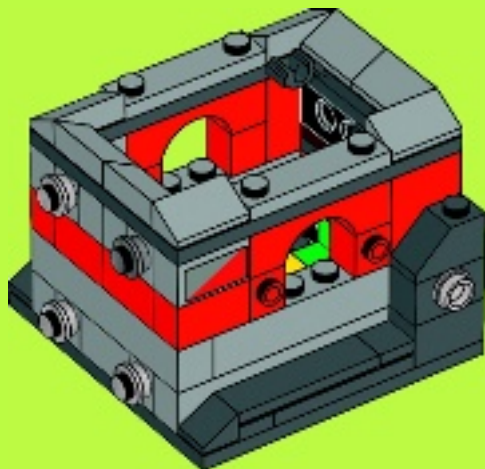



# 15

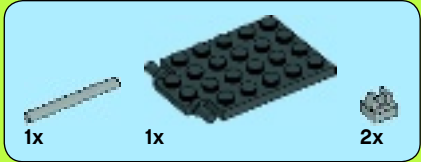
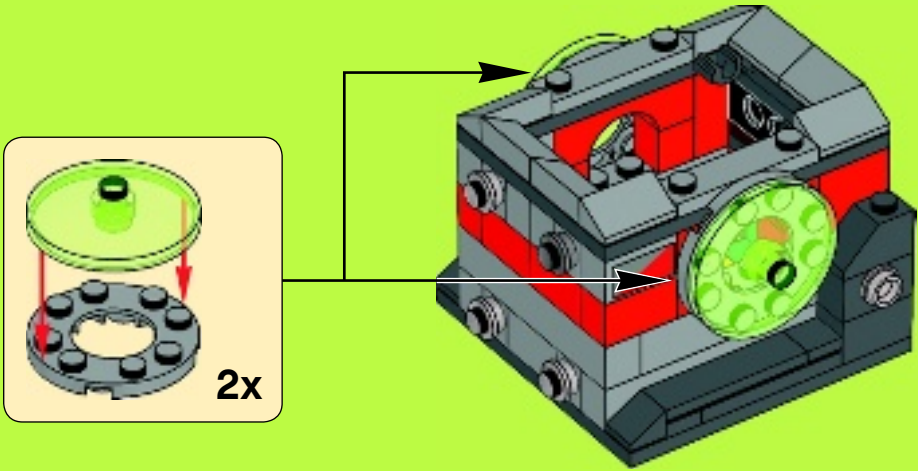

# 16

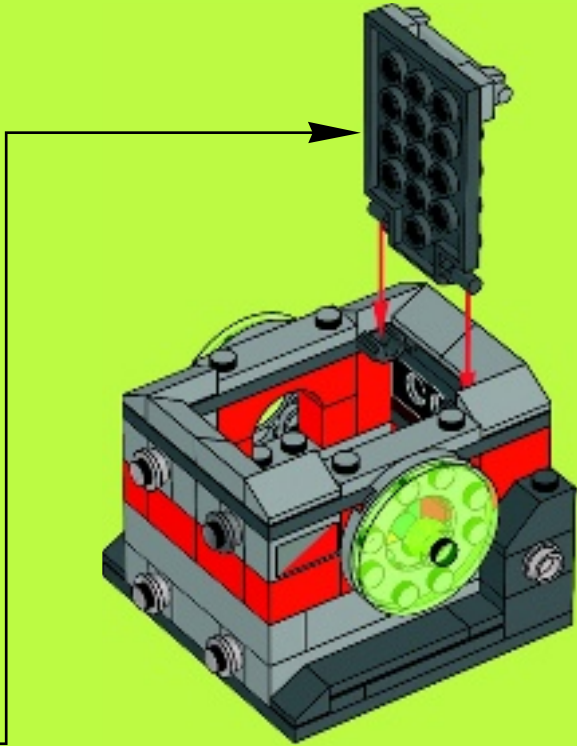
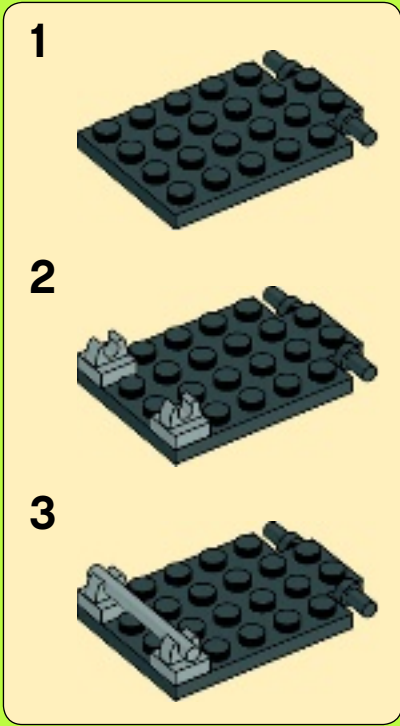

51

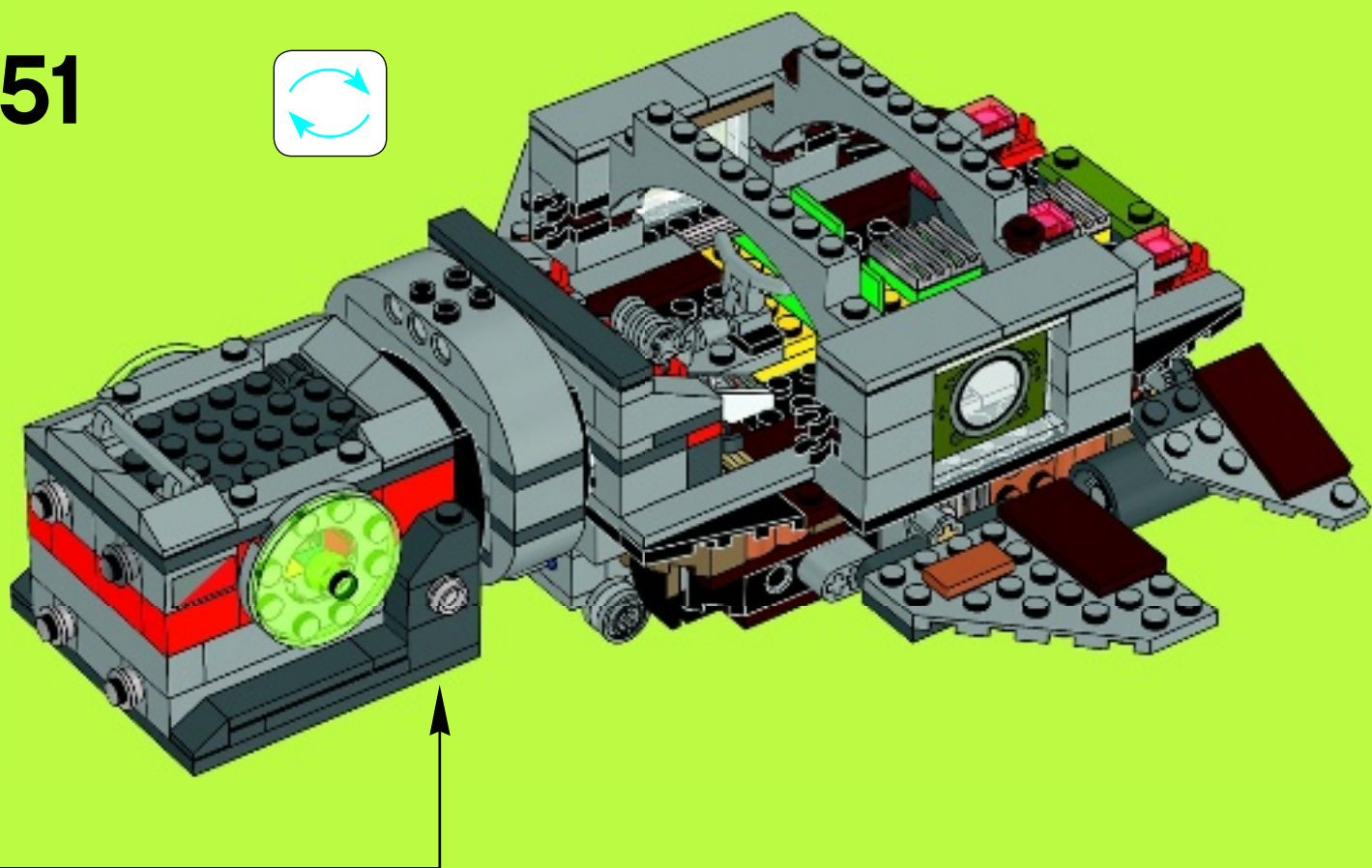



52

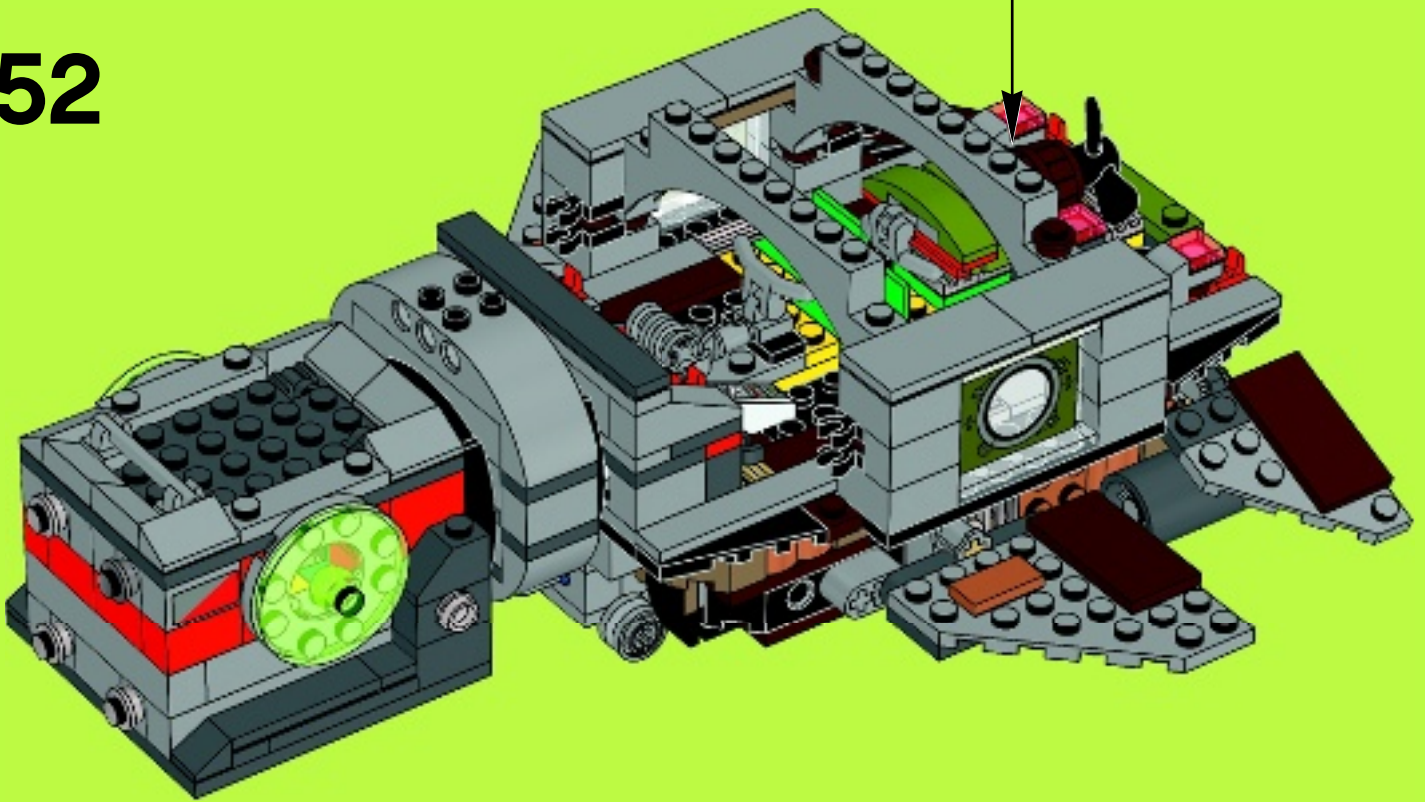
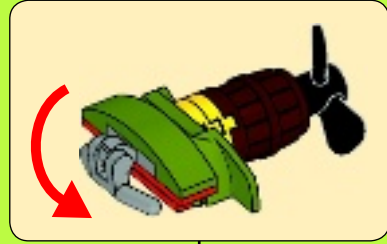

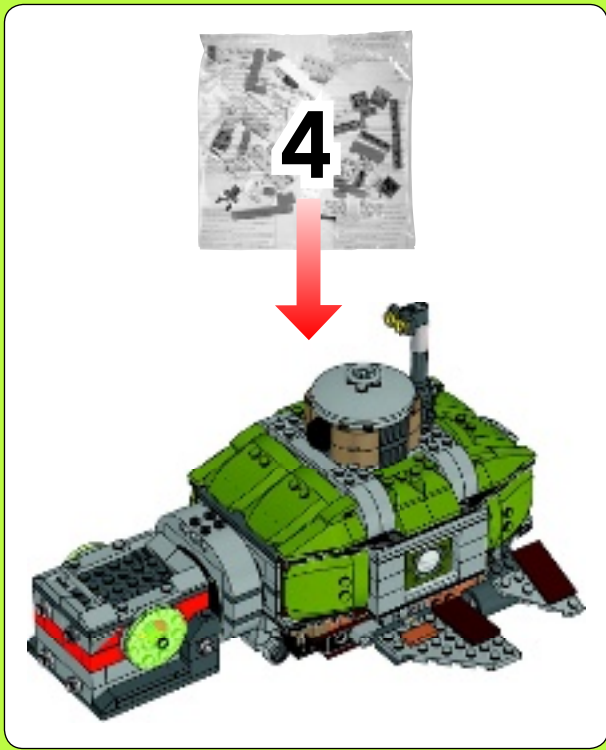

1

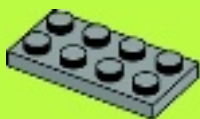

2

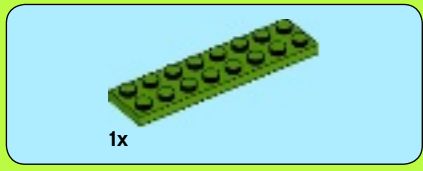
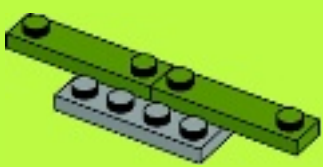

3

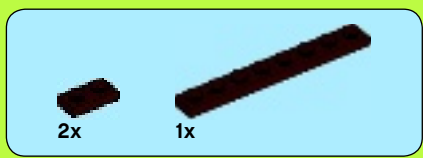
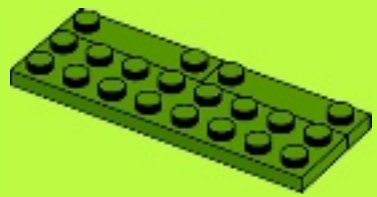

4

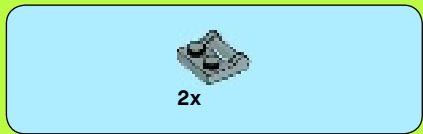
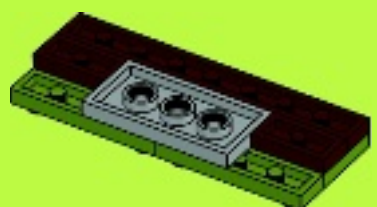

5

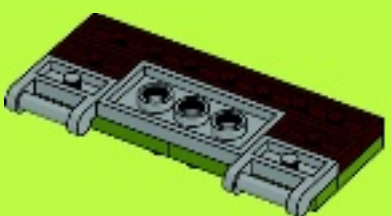



2x

6

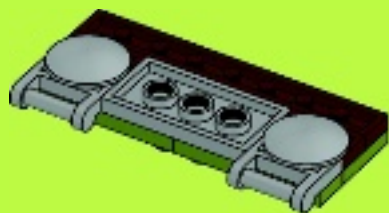

1x



1x

7

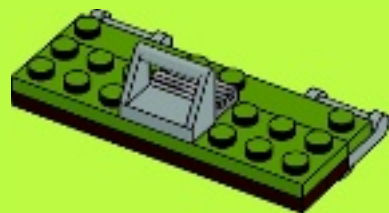

53

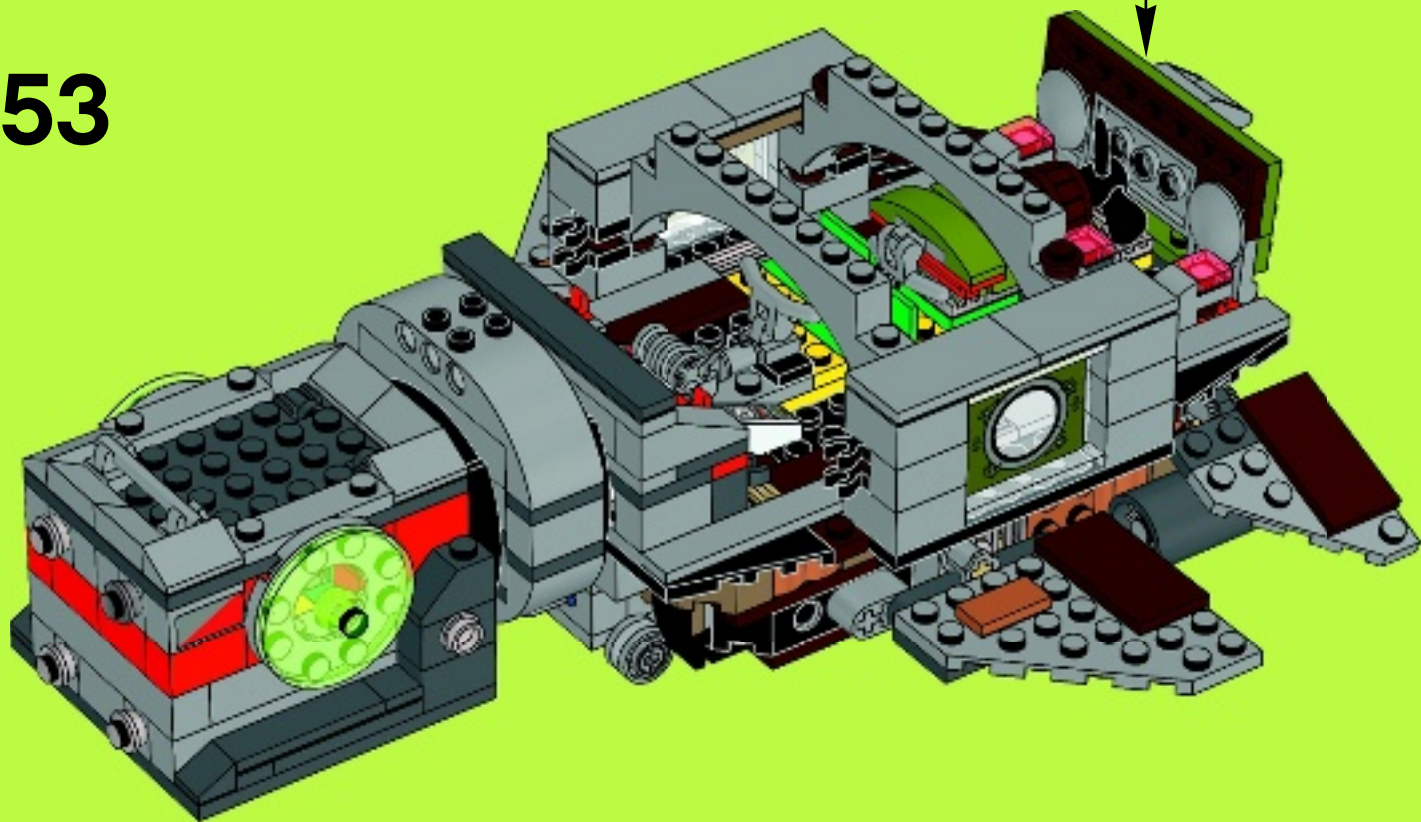



1

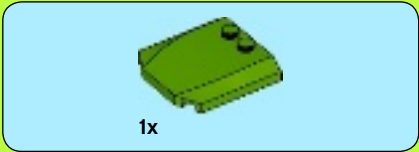

2

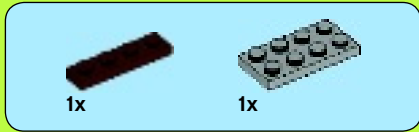
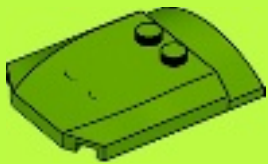

3

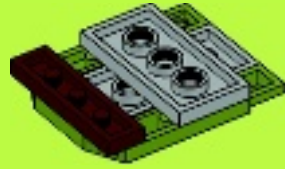

4

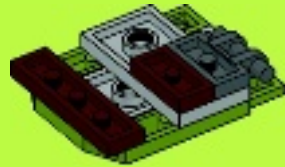





1x

5



2x

54

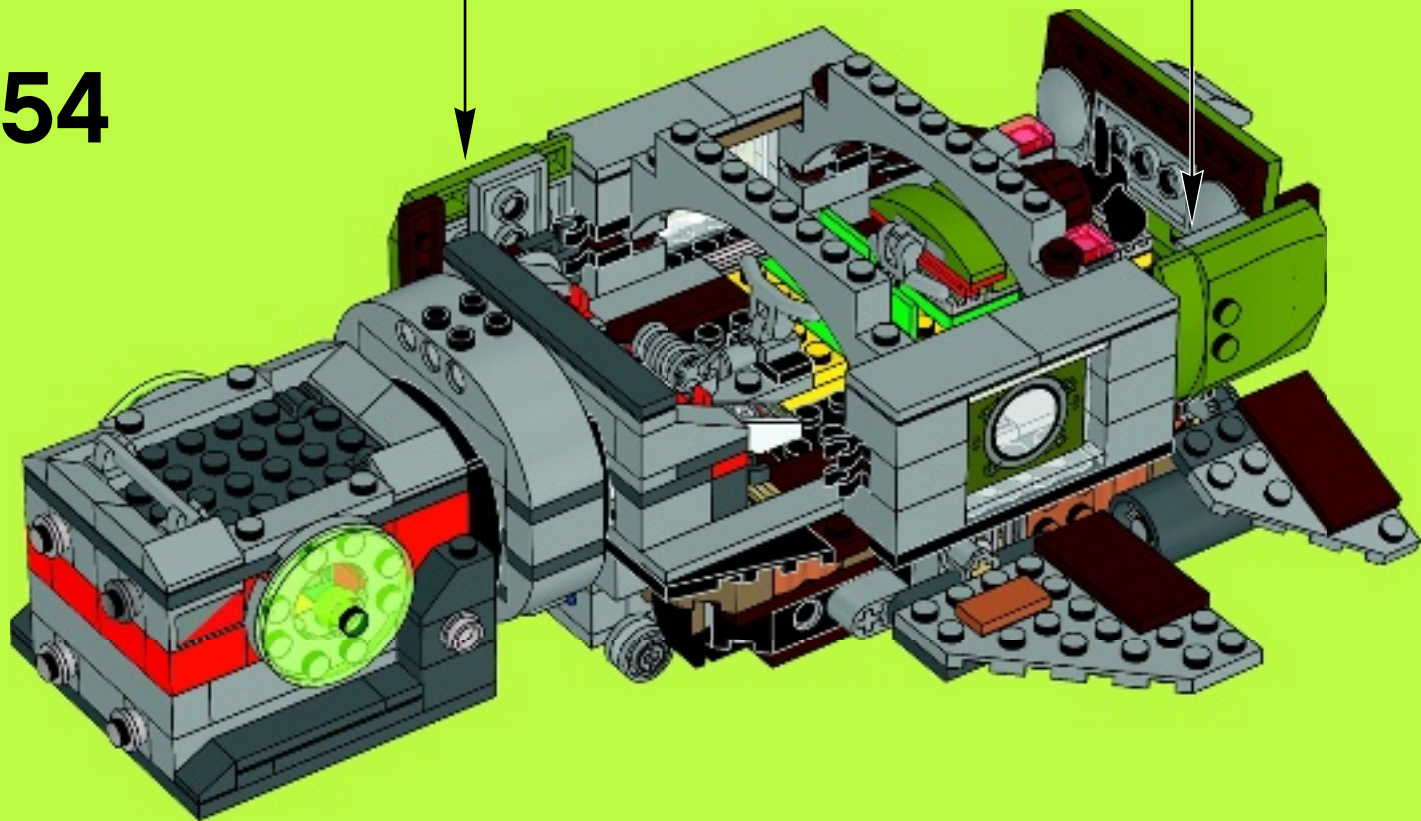



1

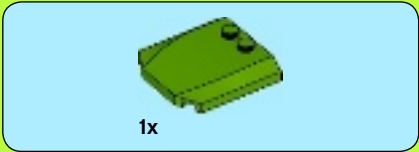

2

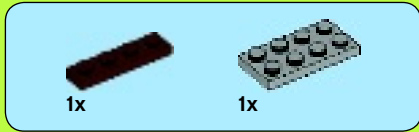
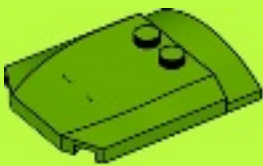

3

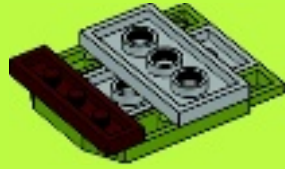

4

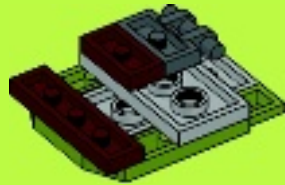



1x

5



2x

55

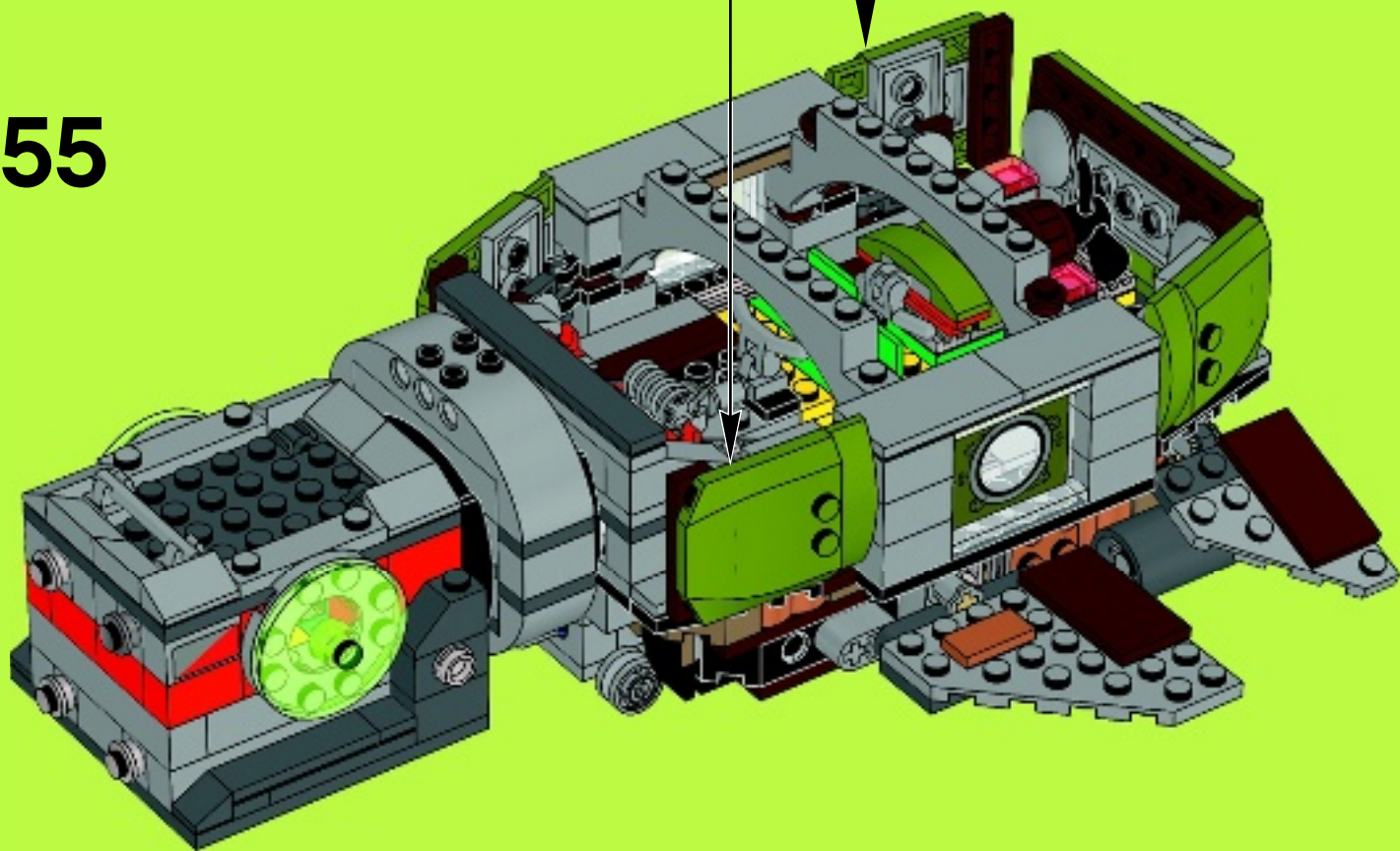

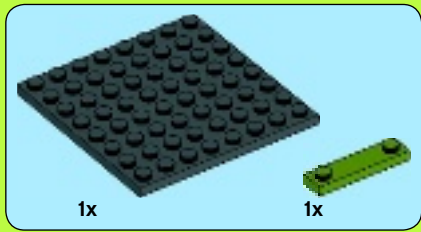

1

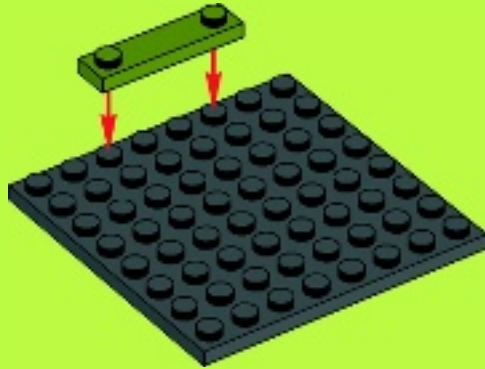

2

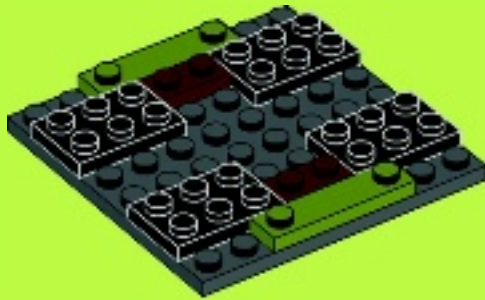

3

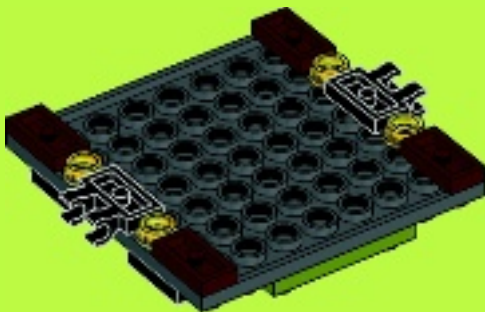





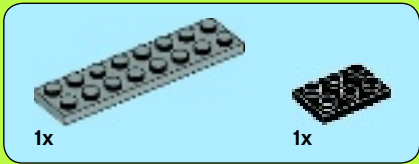
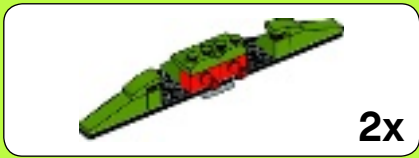

1

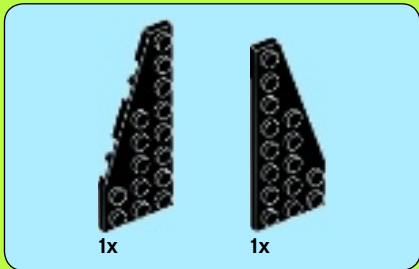
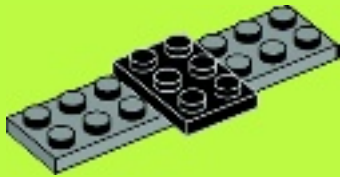

2

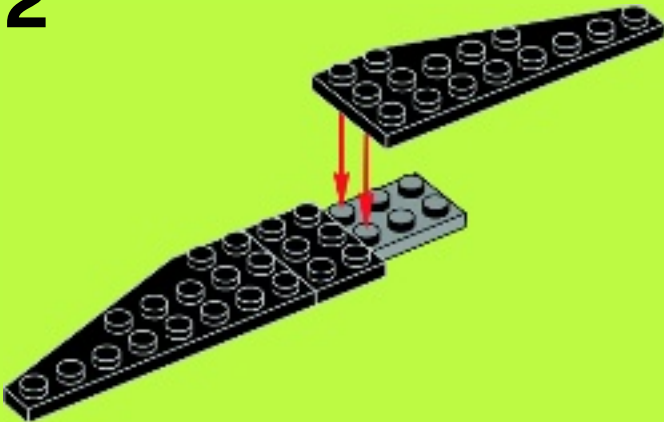

3

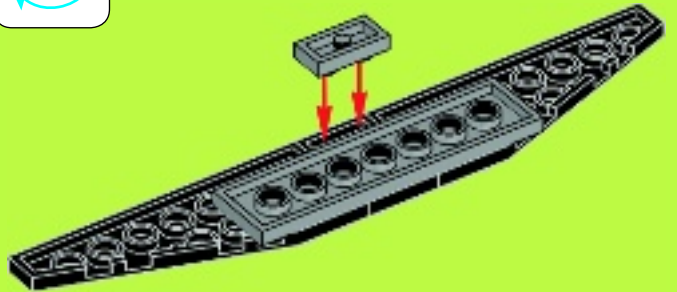

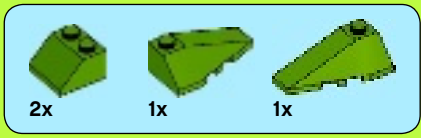

4

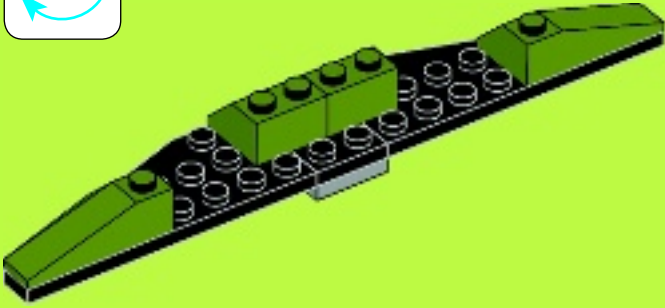

5

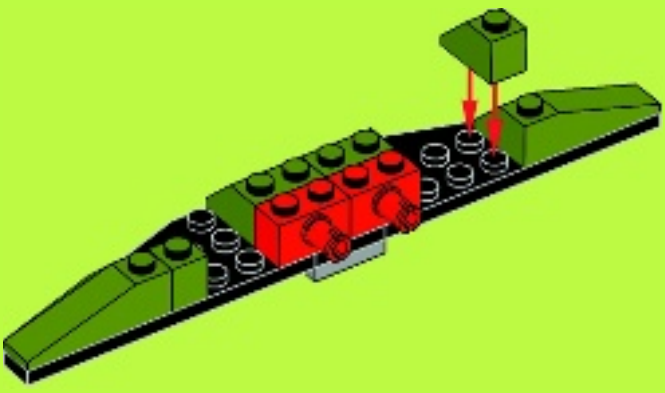

6



7

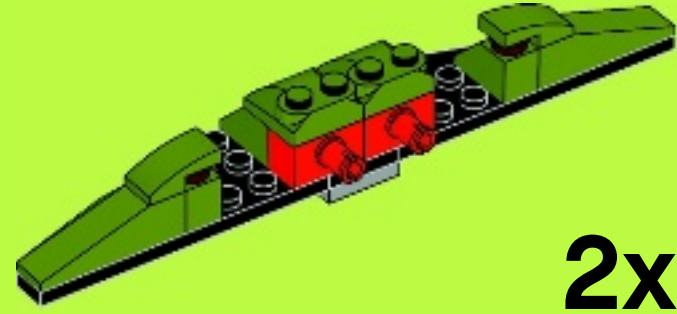

2x

7

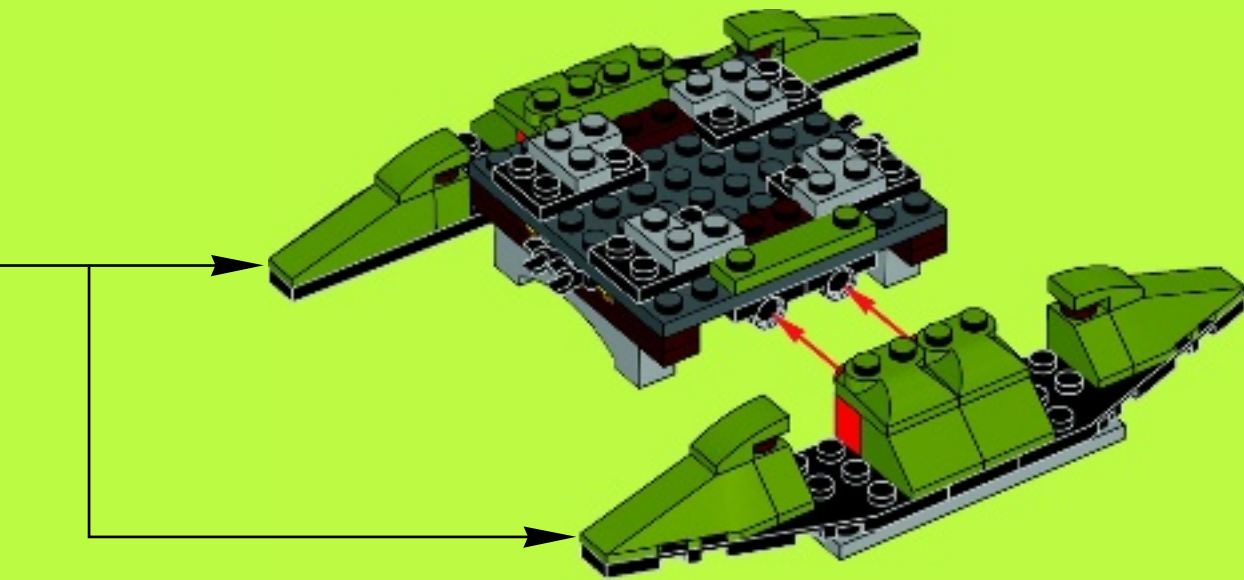



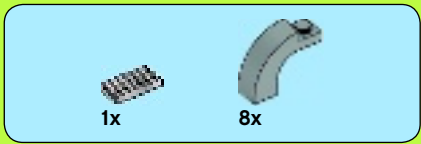

8

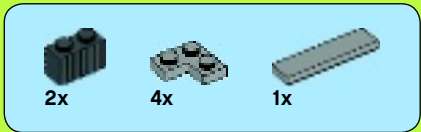
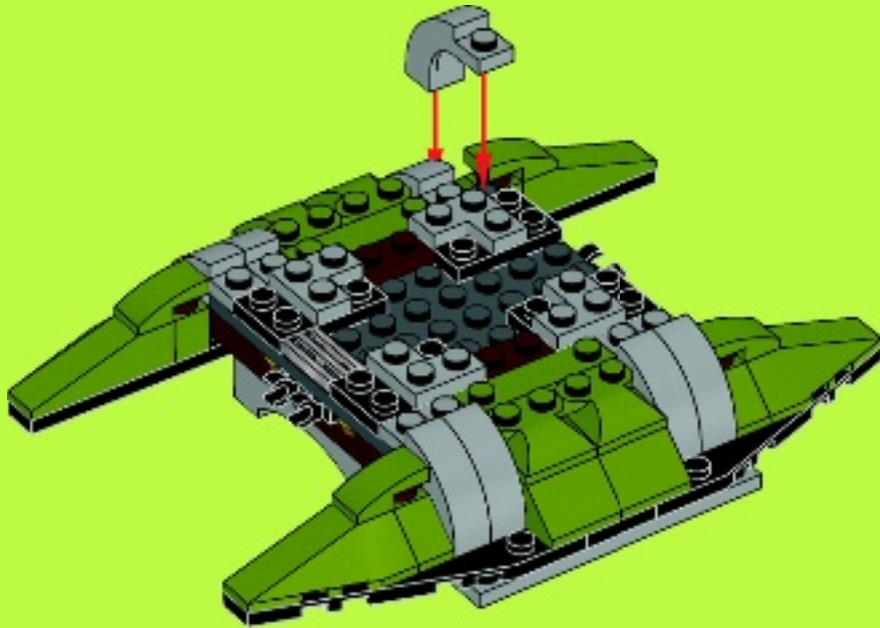

9

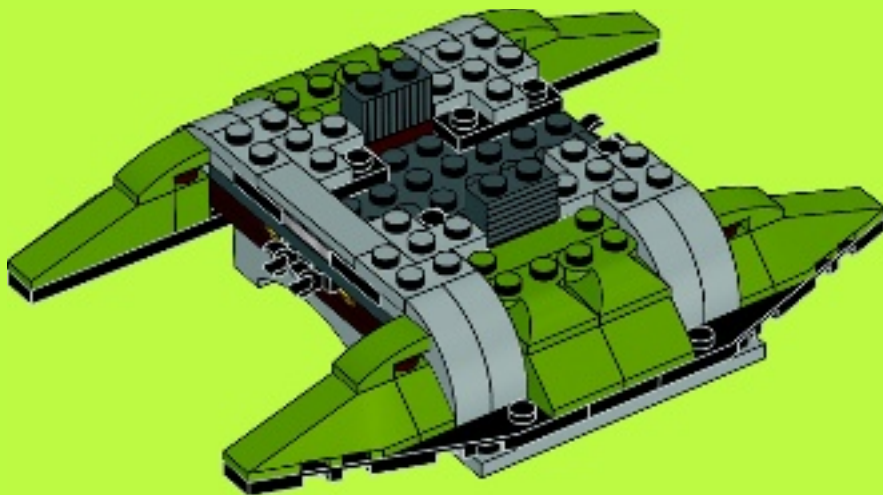

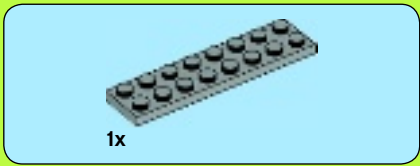

1

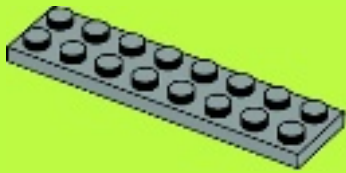

2

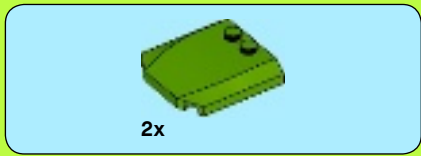
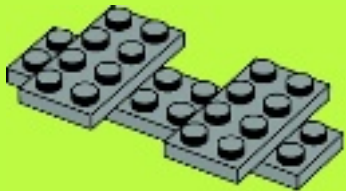

3

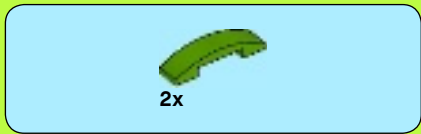
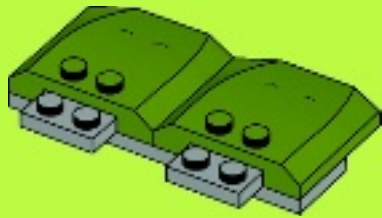

4

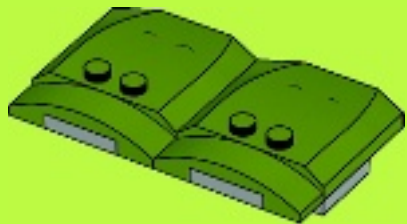



5

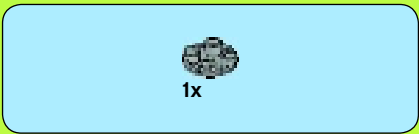
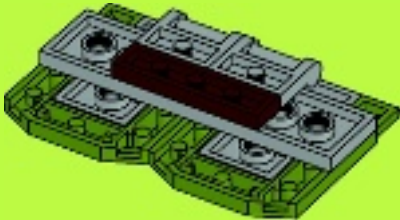

6

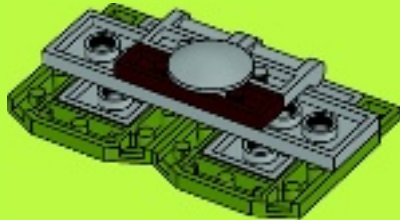

2x

10

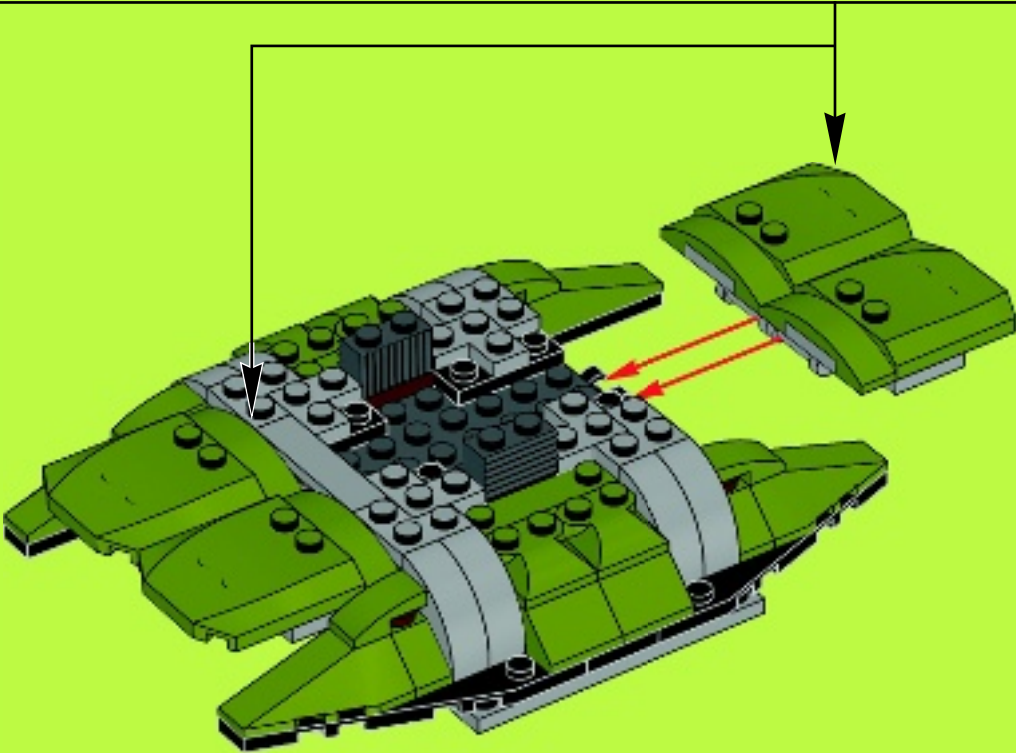

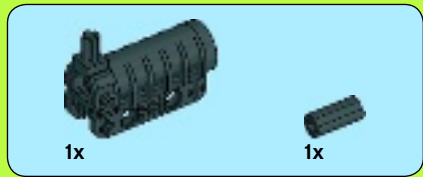

1

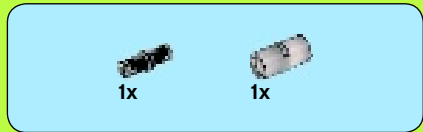

3

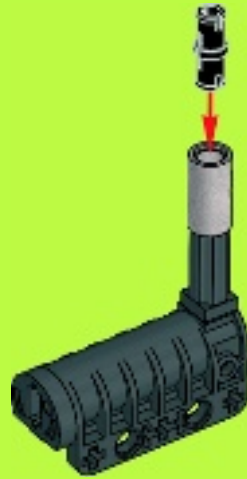

2



4

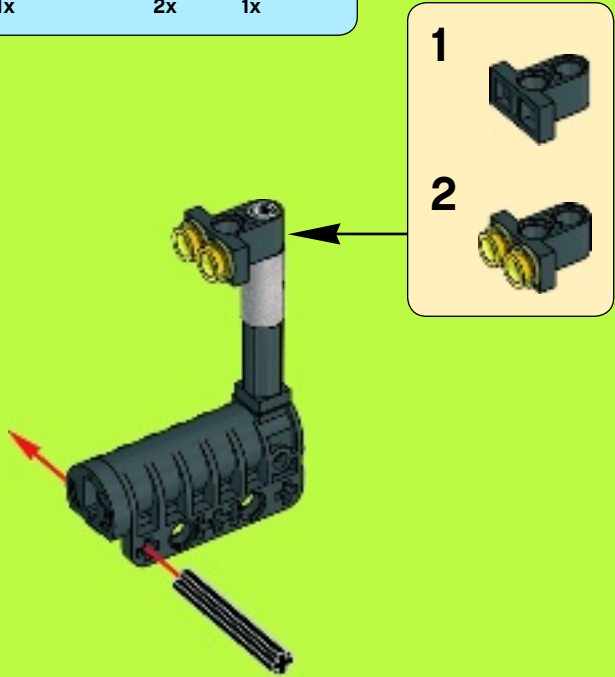





5

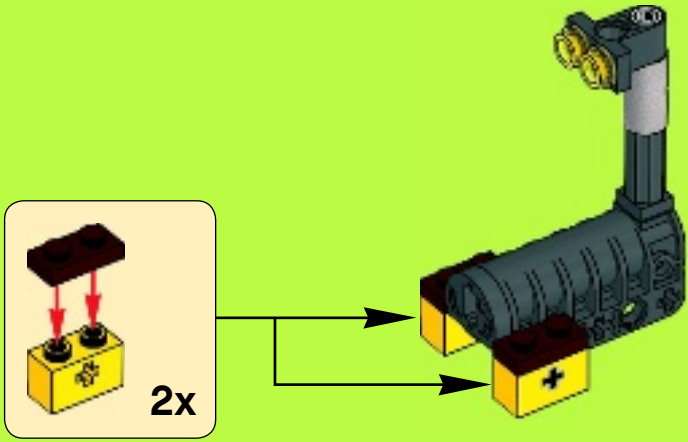

11

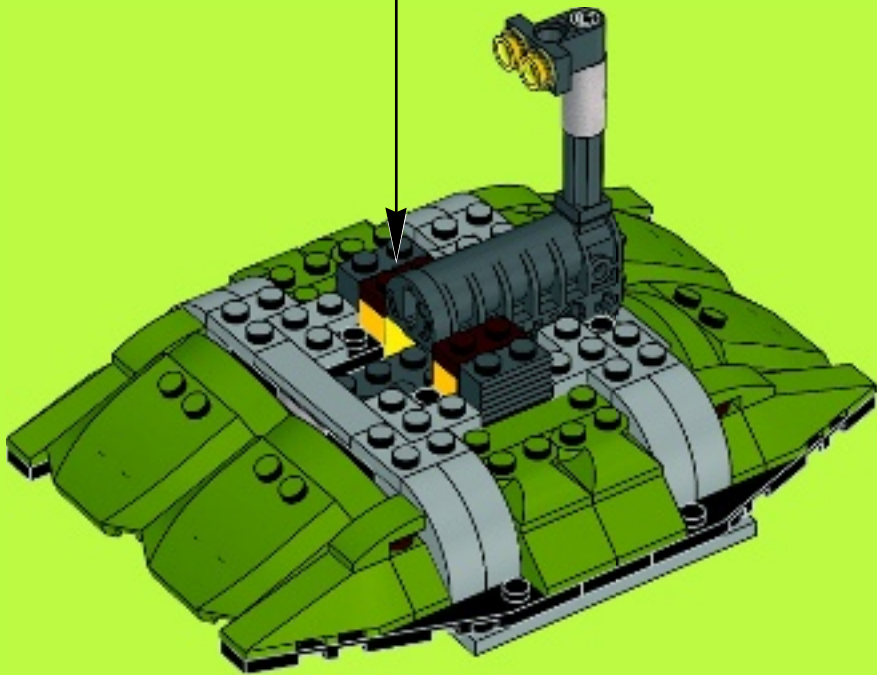



2x



4x

# 12



2x

# 13

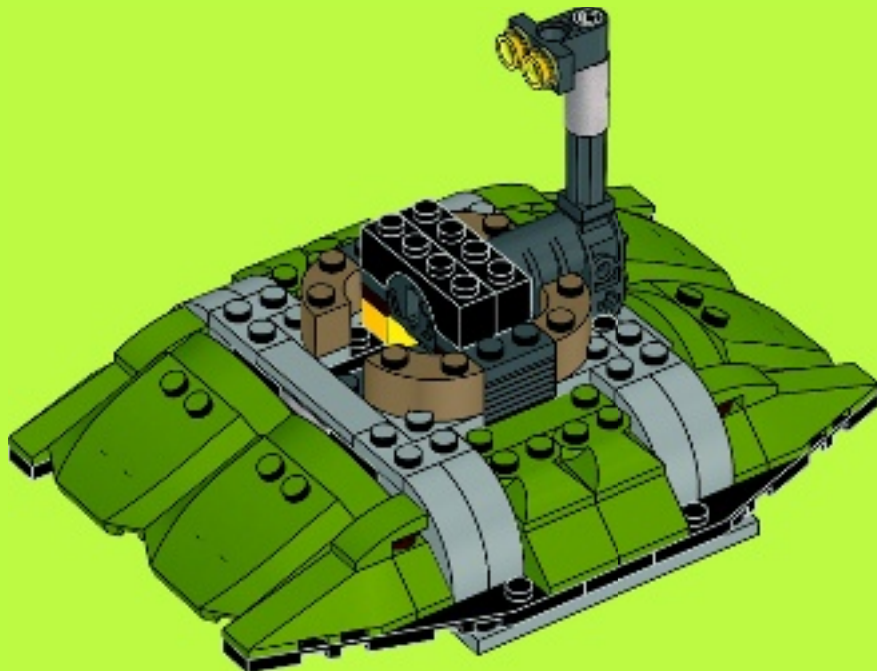



2x



4x

# 14

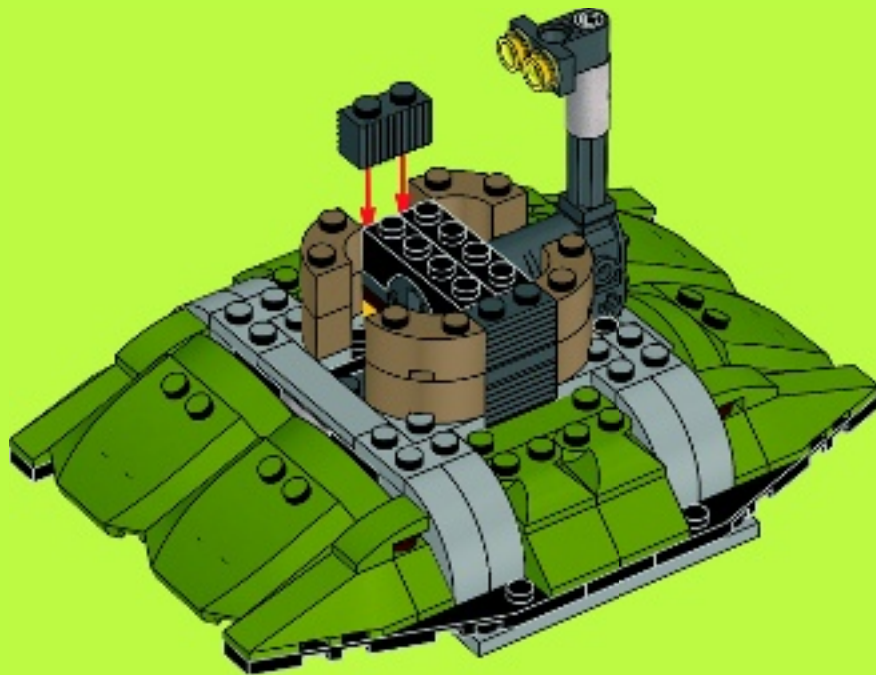

1x

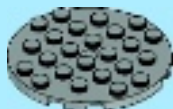

1x

# 15

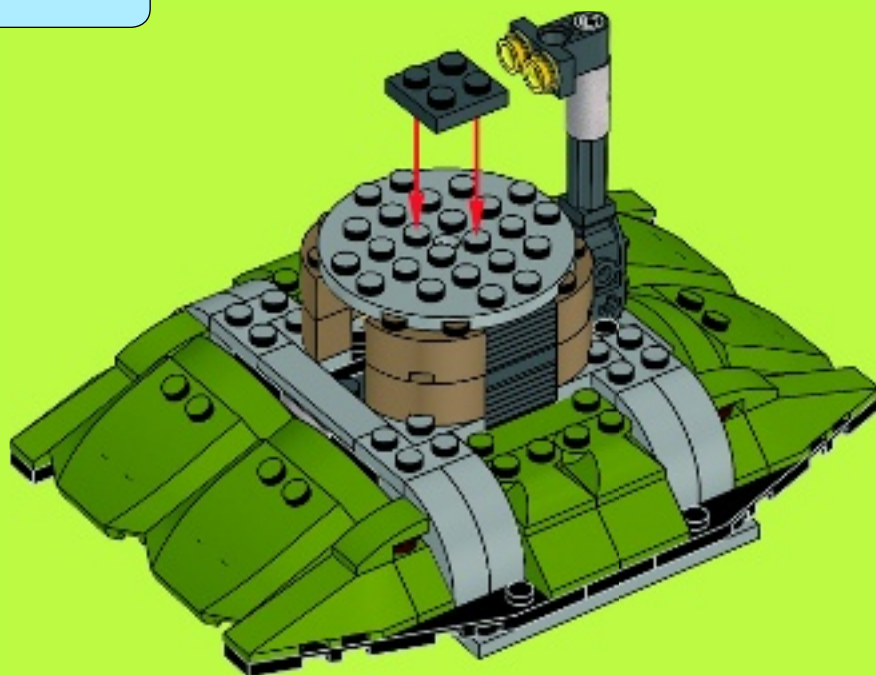



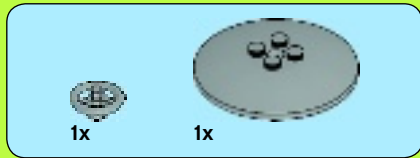

16

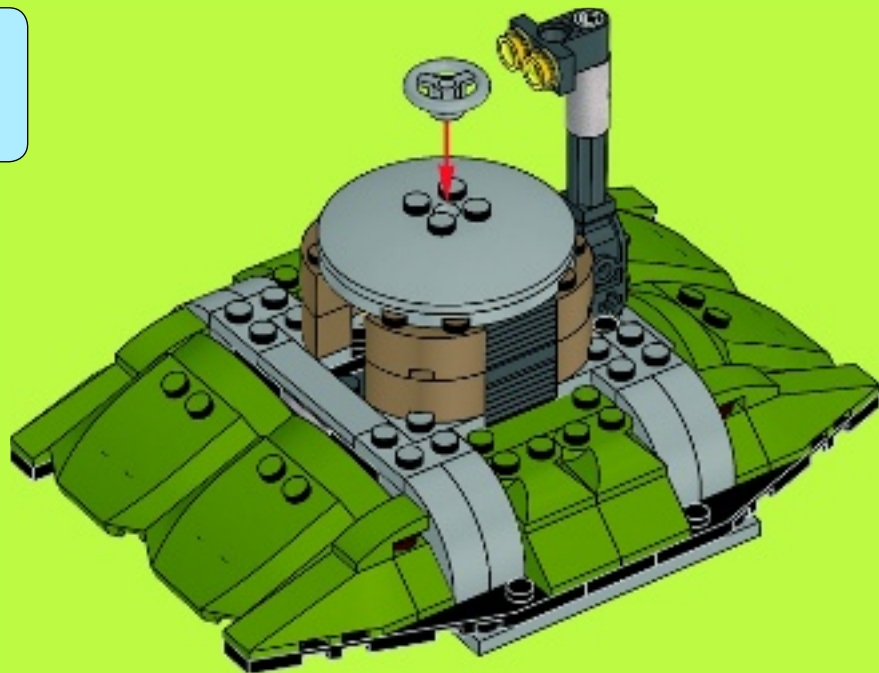

56





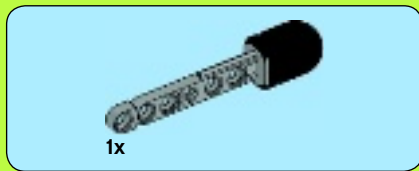

57





58

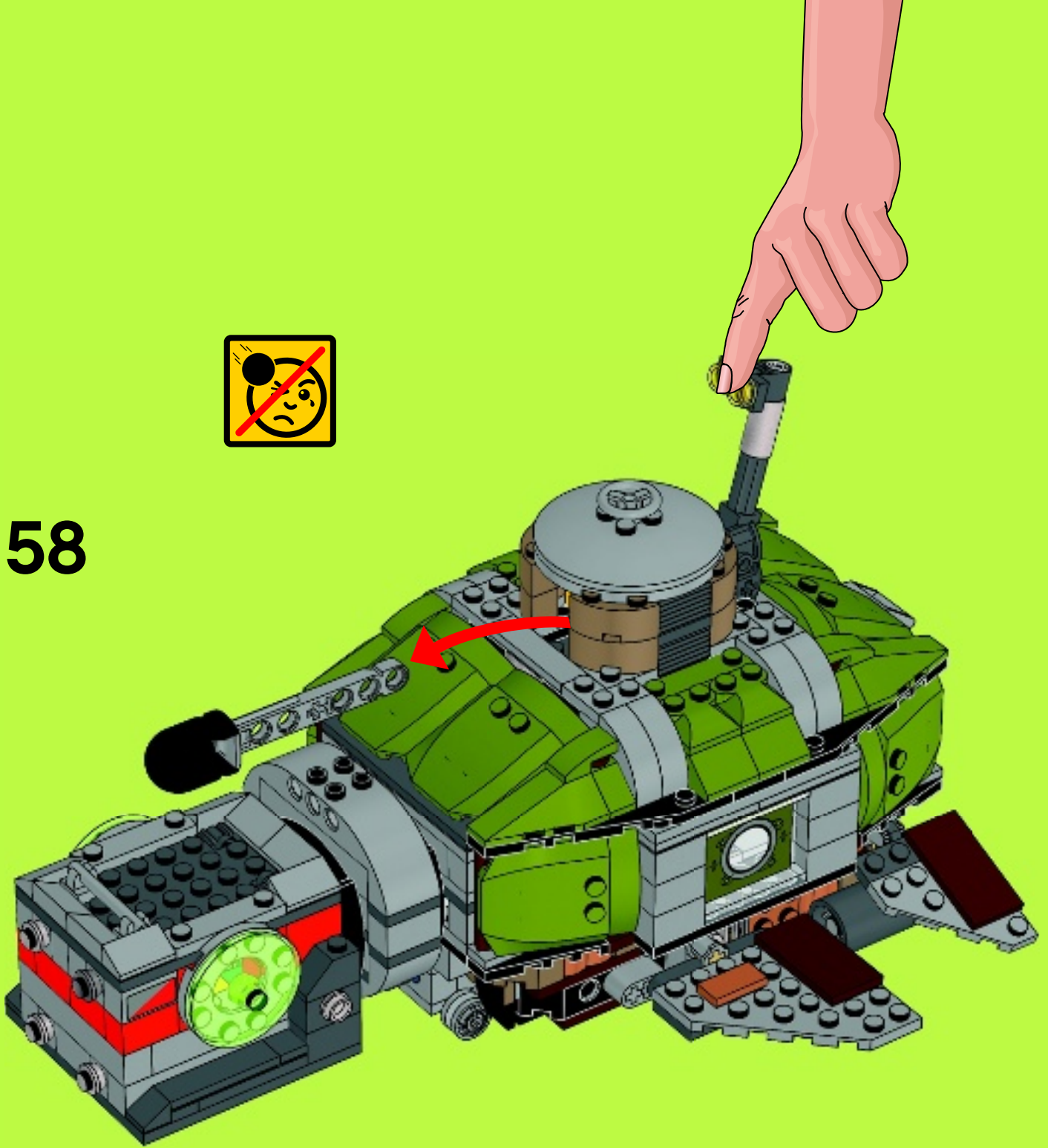

59







2x 300801  
2x 4528417  
1x 306801  
2x 4201062  
1x 4185273  
4x 4124456  
3x 6048857  
5x 4666579  
2x 4514554  
2x 4143832  
4x 300421  
1x 300321  
1x 300921  
4x 4558886  
6x 245821  
2x 365921  
11x 302321  
1x 379421

4x 4597713  
1x 6089576  
1x 4142865  
3x 4513174  
2x 4140806  
3x 302323  
1x 302023  
2x 614123  
1x 4206482  
6x 4514553  
2x 4233484  
5x 302324  
1x 306824  
1x 4560181  
2x 379524  
2x 403224  
1x 4621603  
2x 4239601  
2x 6037390  
4x 4558954  
7x 370126

2x 4529549  
6x 4613153  
2x 365926  
1x 379426  
6x 302126  
2x 303526  
2x 303626  
8x 4550017  
2x 4144023  
2x 6020193  
2x 4556158  
2x 4535739  
4x 6061032  
2x 4161332  
2x 4160869  
2x 4251394

2x 4251393  
1x 73587  
2x 6043130  
1x 604126  
2x 6028041  
7x 4121715  
1x 370526  
3x 306928  
1x 302228  
4x 4522673  
1x 6077751  
1x 6077754  
1x 6076596  
1x 4113949  
2x 4594686  
2x 3003941  
2x 4189801

6x 3005744  
4x 4567340  
1x 4544069  
2x 3005749  
2x 6024124  
4x 6020847  
8x 6001826  
4x 4528604  
2x 6015424  
2x 6023062  
1x 6070010  
1x 6076787  
2x 6069997  
1x 4216615  
2x 4620075  
2x 6073014

1x 4658005  
18x 4211150  
4x 4211194  
10x 4211190  
4x 4579690  
3x 4216945  
4x 6055145  
1x 4225715  
20x 4216581  
1x 4211147  
1x 4538724  
3x 6058134  
1x 4531751  
1x 6025366  
1x 6077748  
1x 6076613  
4x 6064670  
4x 6016474

2x 6064659  
2x 6064662  
4x 6031787  
9x 6016482  
5x 6024727  
1x 6073988  
1x 6016462  
8x 6024696  
4x 6073984  
11x 4619636  
10x 4633691  
2x 4612900  
2x 4612901  
1x 6054858  
2x 6046943  
2x 4519946  
2x 6070270  
6x 4651231  
2x 6021997  
2x 6056383





2x 4211694  
2x 4211441  
4x 4211466  
8x 4568637  
2x 4211488  
1x 4211570  
4x 4211519  
8x 4625619  
1x 4622803  
2x 4618874  
1x 6070267  
1x 6070266  
15x 4211388  
4x 4211387  
4x 4211349  
5x 4211393  
1x 4211795

2x 6061061  
2x 4211398  
1x 4211414  
8x 4211353  
5x 4211396  
1x 4211356  
2x 4599498  
4x 4560183  
14x 4211395  
1x 4211452  
4x 4211481  
2x 4211425  
4x 4211406  
3x 6030711  
2x 6028812  
1x 4211357  
1x 4654580  
2x 4654582

6x 4244627  
2x 4211376  
1x 4211419  
10x 4278273  
2x 6028015  
2x 4160560  
1x 6015349  
1x 4211796  
2x 4211520  
1x 4211628  
2x 6073751  
2x 6072953  
2x 4211506  
1x 4519013  
2x 4211572  
1x 4211701  
2x 4258308  
2x 4211825  
2x 4520320

2x 4211655  
2x 6004888  
2x 4494222  
4x 4211622  
4x 4211758  
2x 4211807  
6x 4558953  
4x 4211815  
1x 4299625  
1x 4654448  
2x 6053876  
1x 4129859  
4x 4210636  
2x 4211060  
4x 4580437  
1x 4529240  
1x 6022161  
2x 4622338  
2x 4211111

2x 4504378  
2x 4211135  
2x 4211054  
1x 4636417  
2x 4210719  
2x 4210848  
17x 4211063  
3x 4211094  
8x 4211001  
2x 4211053  
1x 4211008  
2x 4210997  
2x 4210892  
1x 4210763  
4x 4210660  
4x 6047417

2x 4210802  
1x 4595710  
1x 4595708  
1x 4211042  
2x 6073755  
2x 4210469  
2x 4579639  
2x 4218696  
2x 4210686  
1x 4516546  
1x 6064131  
2x 4567509  
1x 4659770  
1x 6009086











[LEGO.com/turtles](http://LEGO.com/turtles)



**79118**



**79119**



**79120**



**79121**







# WIN!

Go to [LEGO.com/productfeedback](http://LEGO.com/productfeedback) to fill out a survey for a chance to win a cool LEGO® Product. No purchase necessary. Open to all residents where not prohibited.



## LEGO.com/productfeedback

### GEWINNE!

Nimm an der Umfrage auf [LEGO.com/productfeedback](http://LEGO.com/productfeedback) teil und hab die Chance ein cooles LEGO® Produkt zu gewinnen!

Die Teilnahme am Gewinnspiel führt zu keinerlei Kaufverpflichtungen. Teilnahme in allen nicht ausgeschlossenen Ländern möglich.

### WIN!

Ga naar [LEGO.com/productfeedback](http://LEGO.com/productfeedback), vul een enquêteformulier in en maak kans op een cool LEGO® product.

Geen aankoopverplichting. Ledereen mag deelnemen, uitgezonderd ingezetenden van landen waar een enquêteverbod geldt.

### GAGNE!

Visite [LEGO.com/productfeedback](http://LEGO.com/productfeedback) pour répondre à un questionnaire et avoir une chance de gagner un produit LEGO® très cool!

Aucune obligation d'achat. Ouvert à tous les résidents des pays autorisés.

### 当てよう!

[LEGO.com/productfeedback](http://LEGO.com/productfeedback)にアクセスして、アンケートにご記入ください。当選者にはレゴ®製品を差し上げます。

お買い上げの必要はありません。禁止されていない限り、すべての皆様にご利用いただけます。

