

nickelodeon

LEGO

# NINJA TURTLES



79117



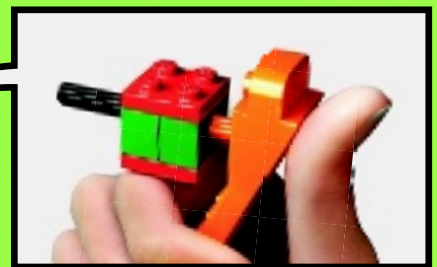
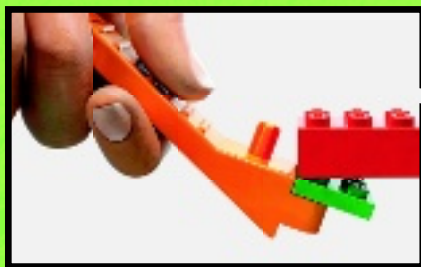

[LEGO.com/brickseparator](http://LEGO.com/brickseparator)



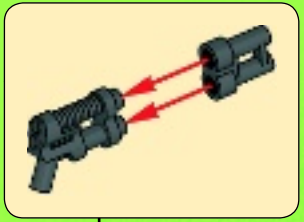
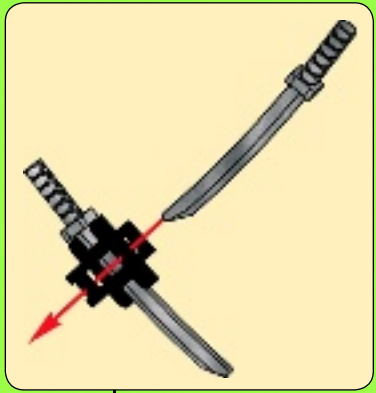
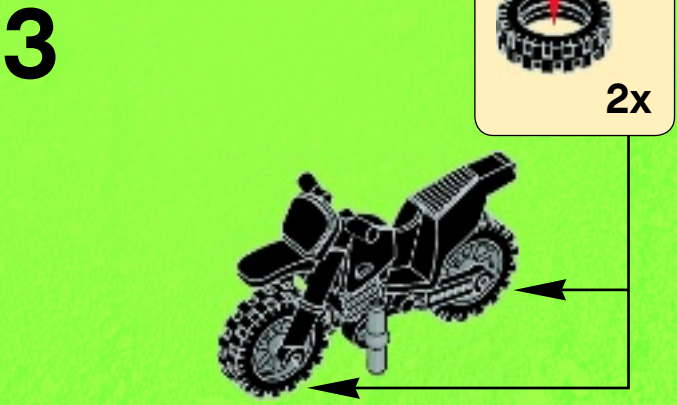
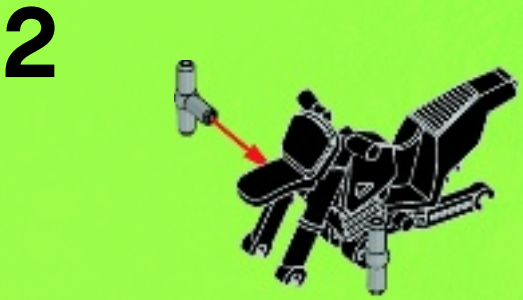
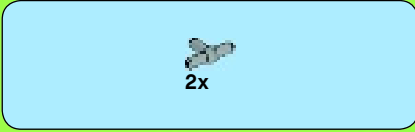
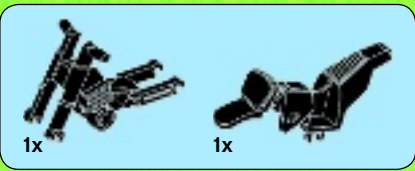
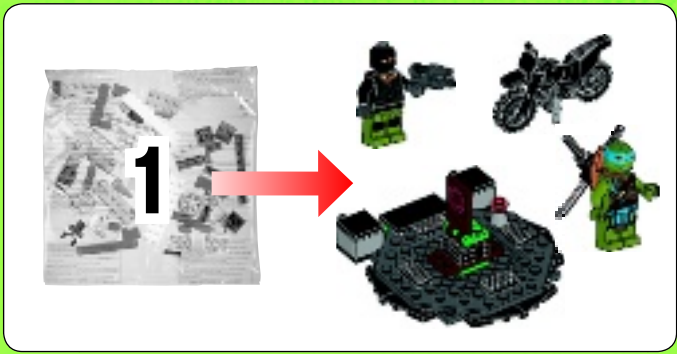

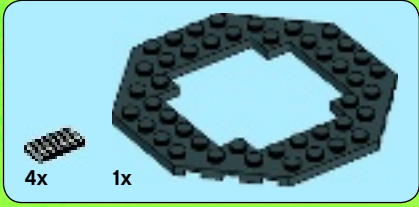
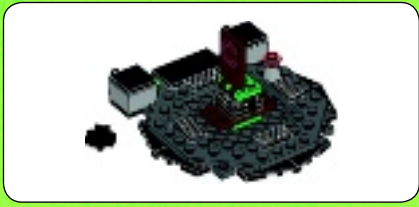

1

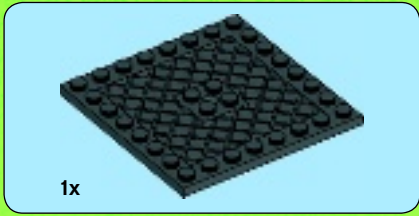
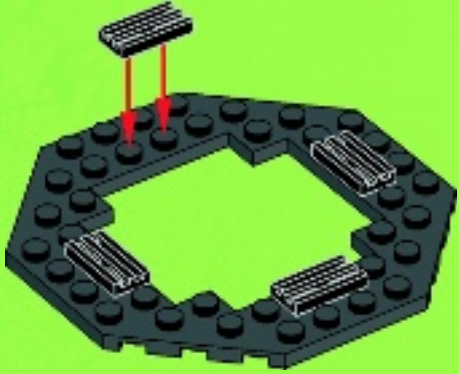

2



3

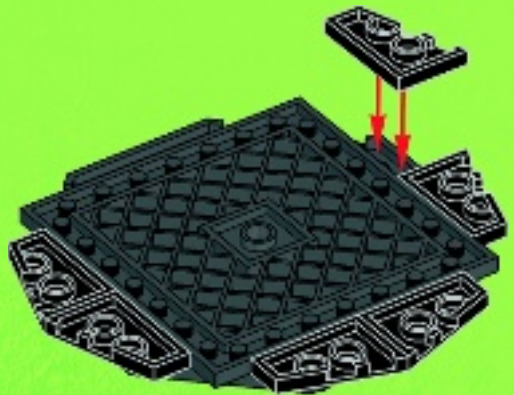

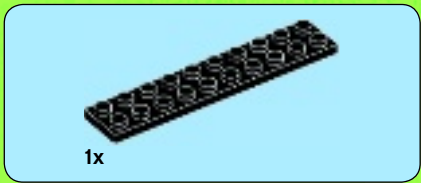

4

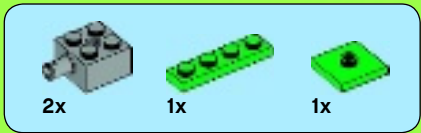

5

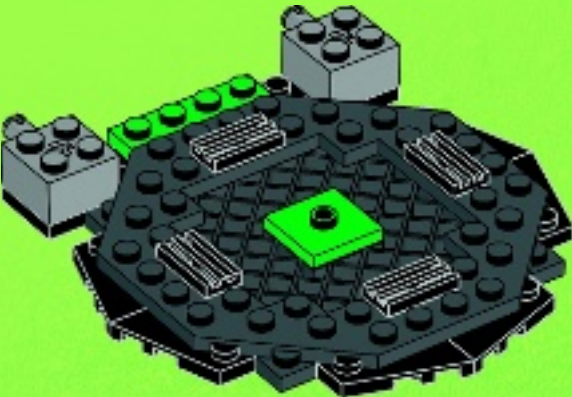

6

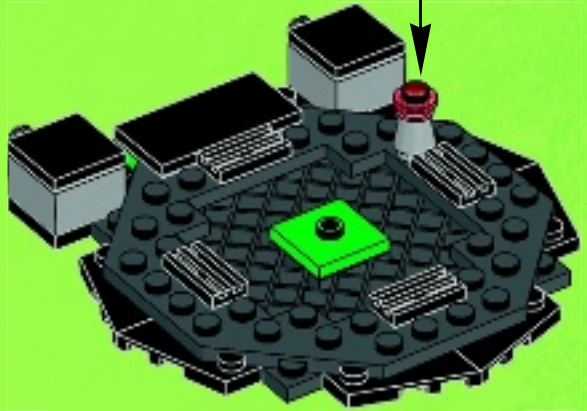

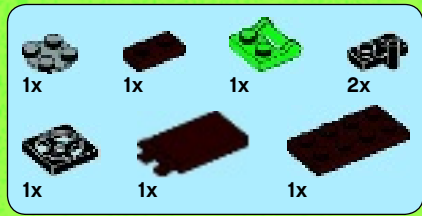

# 7

1



2



3



4

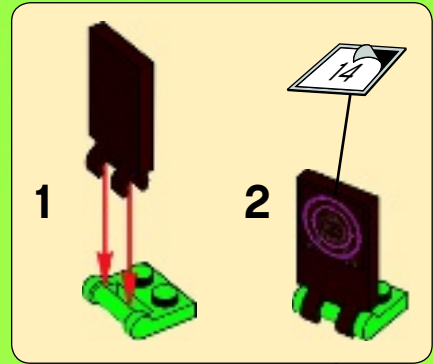

5

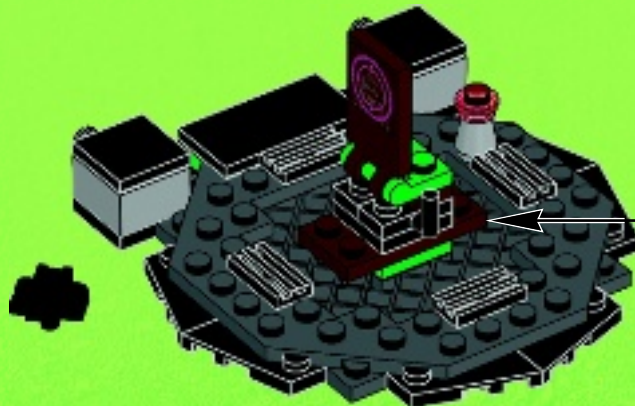

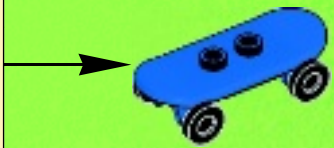
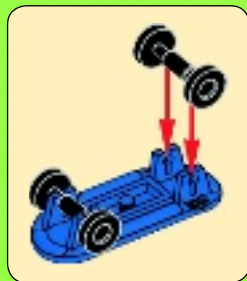
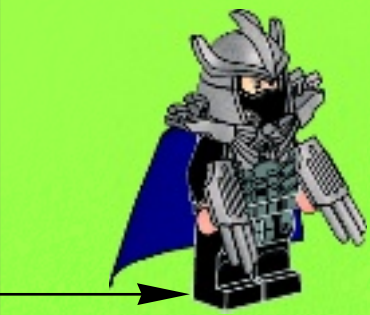
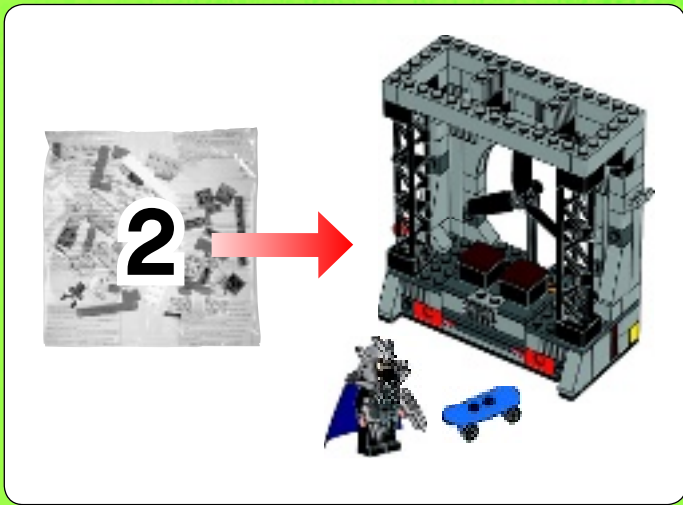

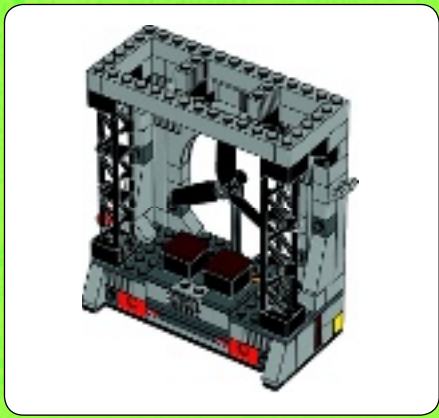

1

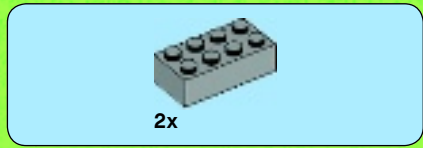

2

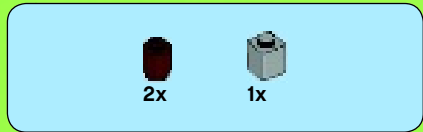
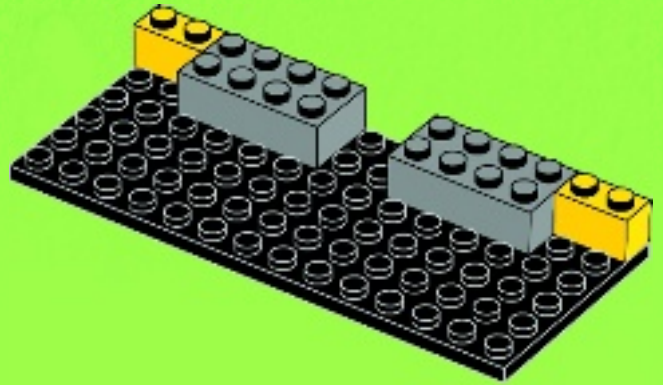

3

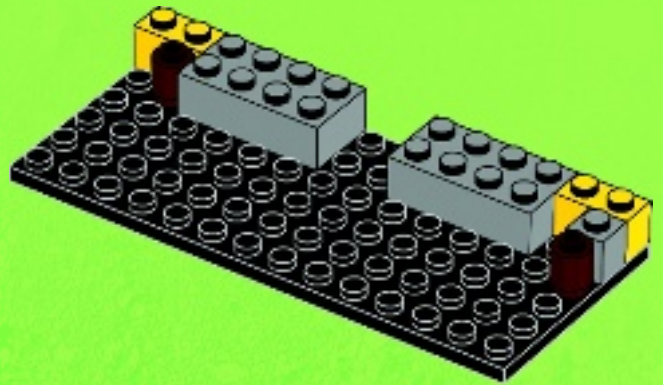



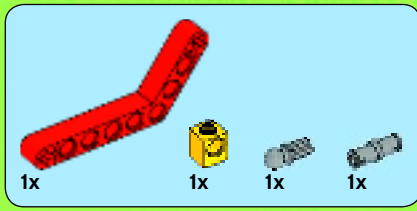

4

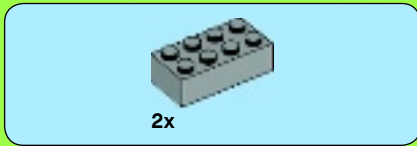
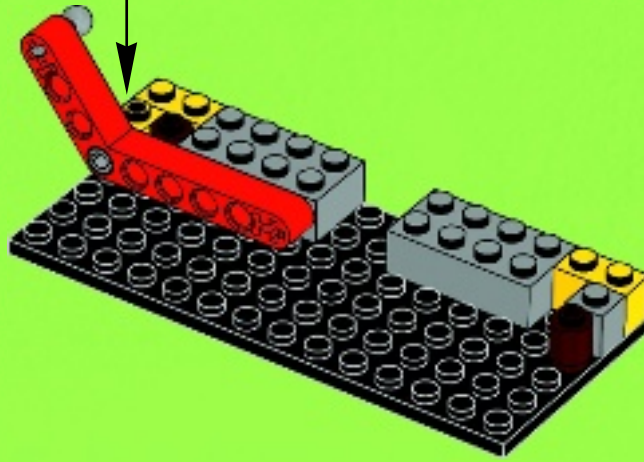
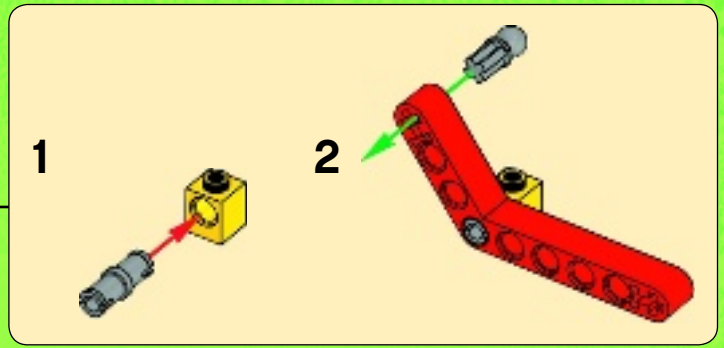

5

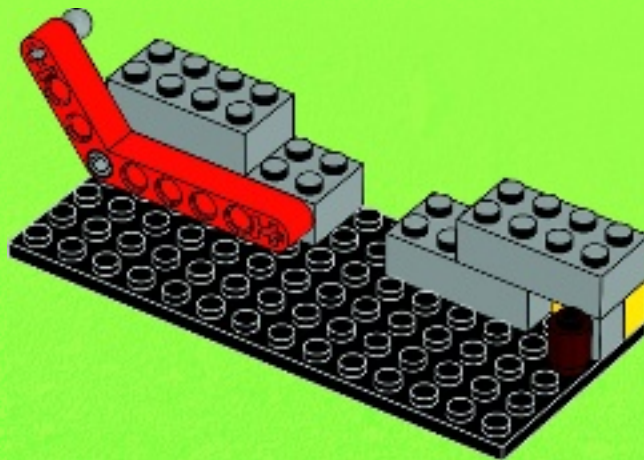



2x



1x

# 6

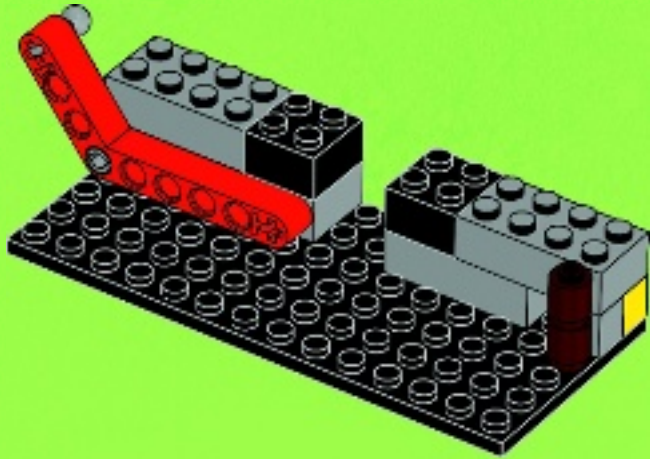

2x

# 7

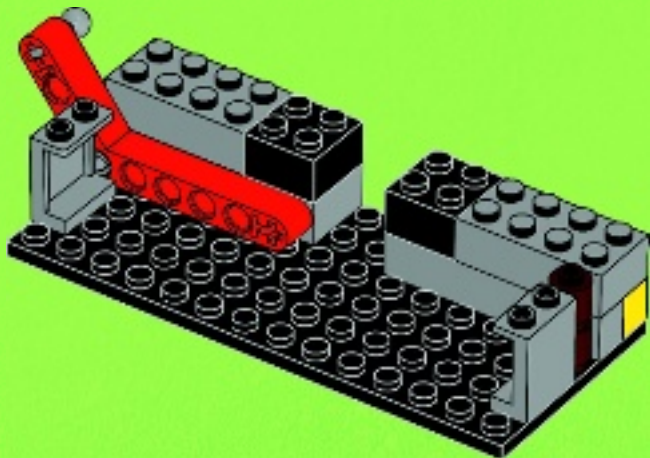

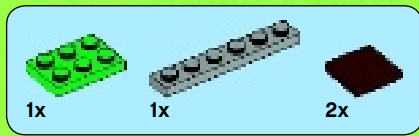

8

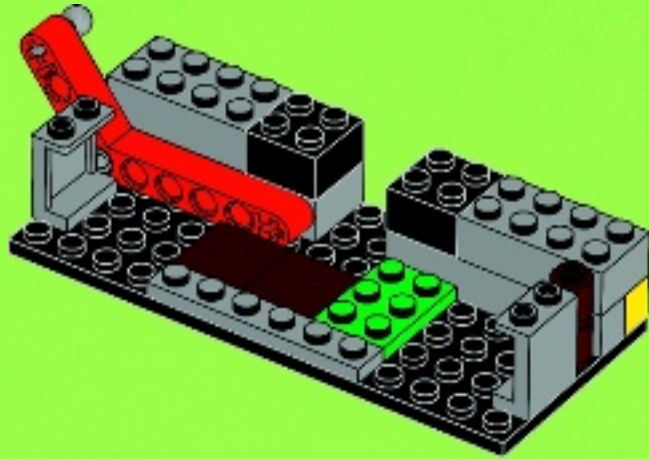

9

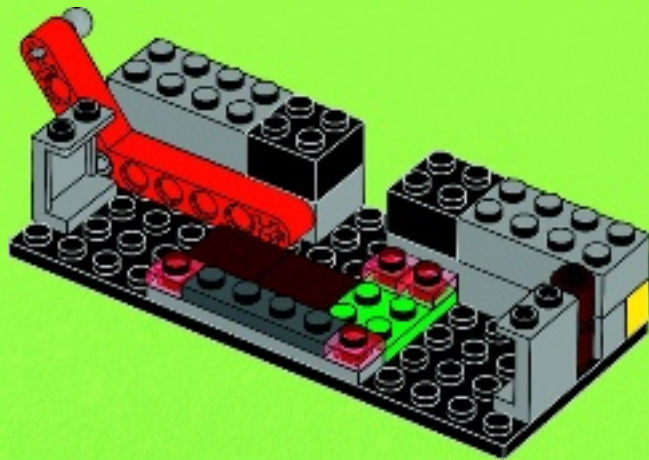



# 10

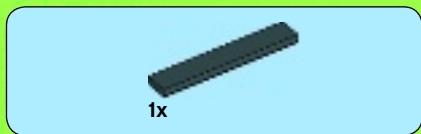
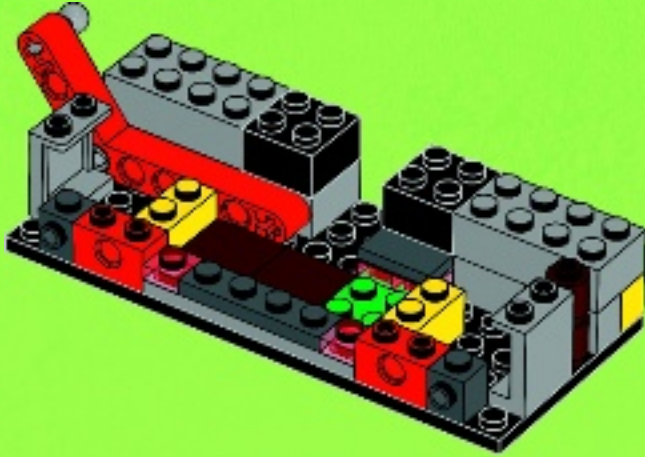

# 11

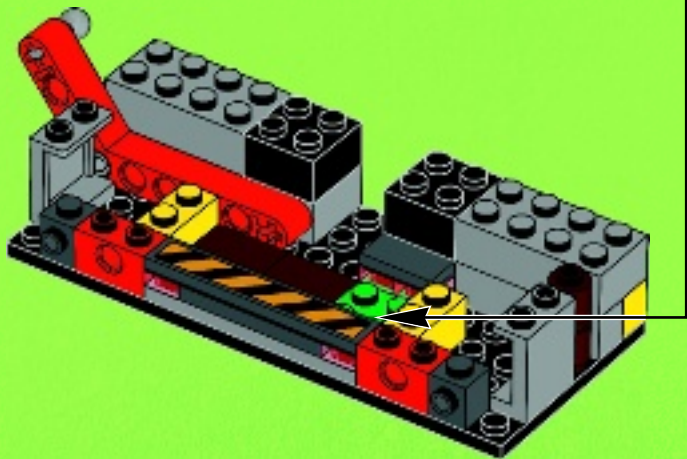



2x



2x

# 12

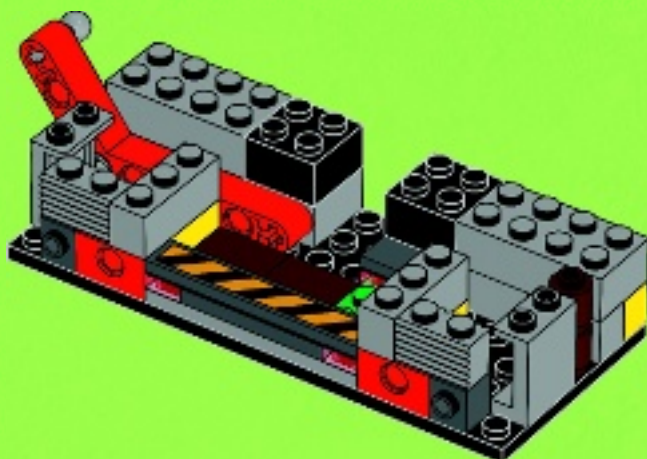

2x



2x

# 13

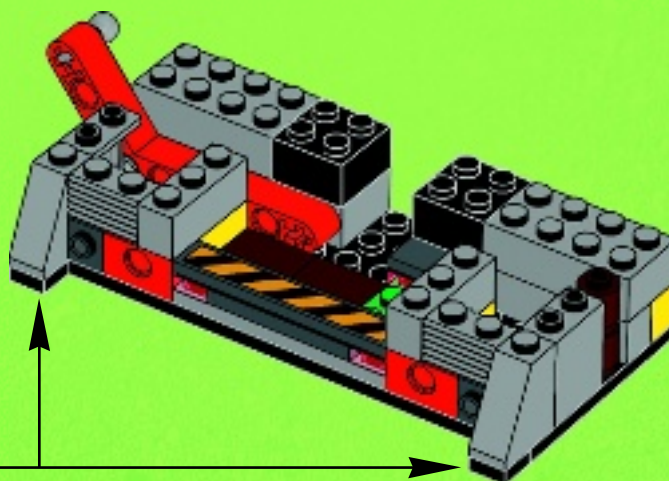
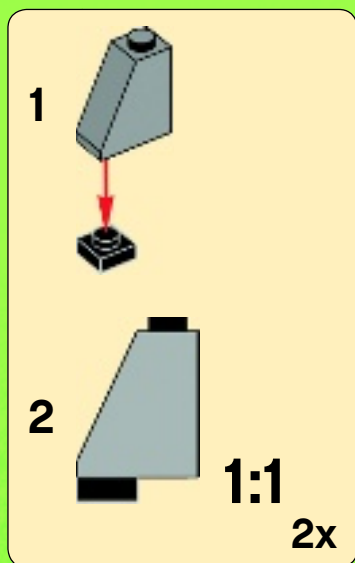



# 14

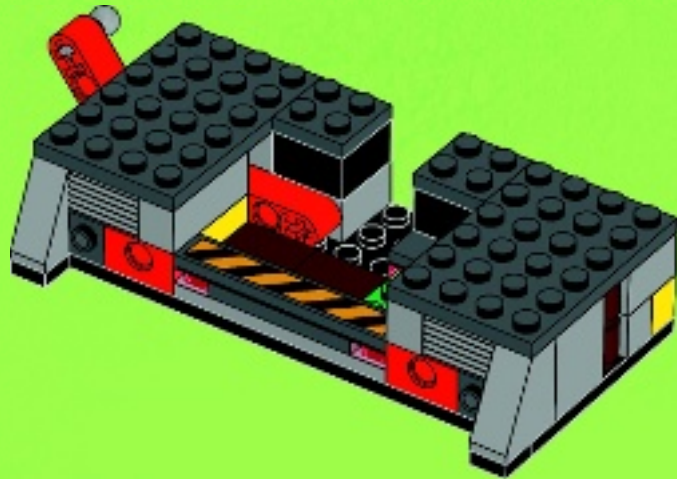

# 15

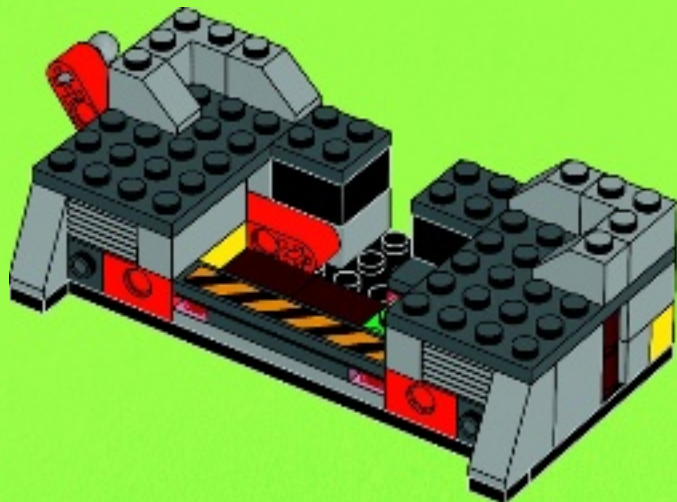

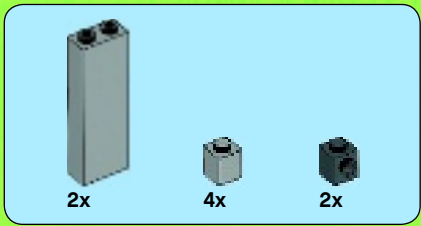

16

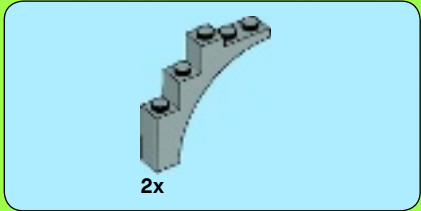
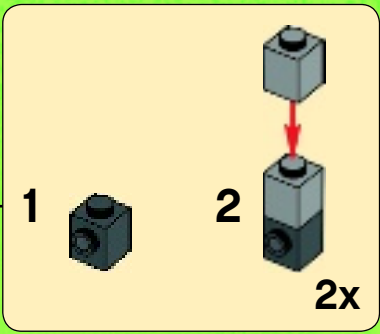
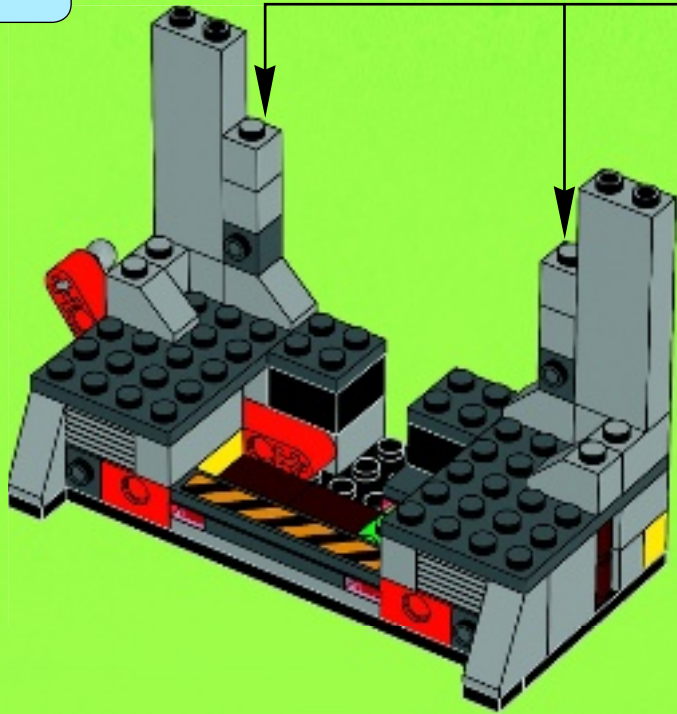

17

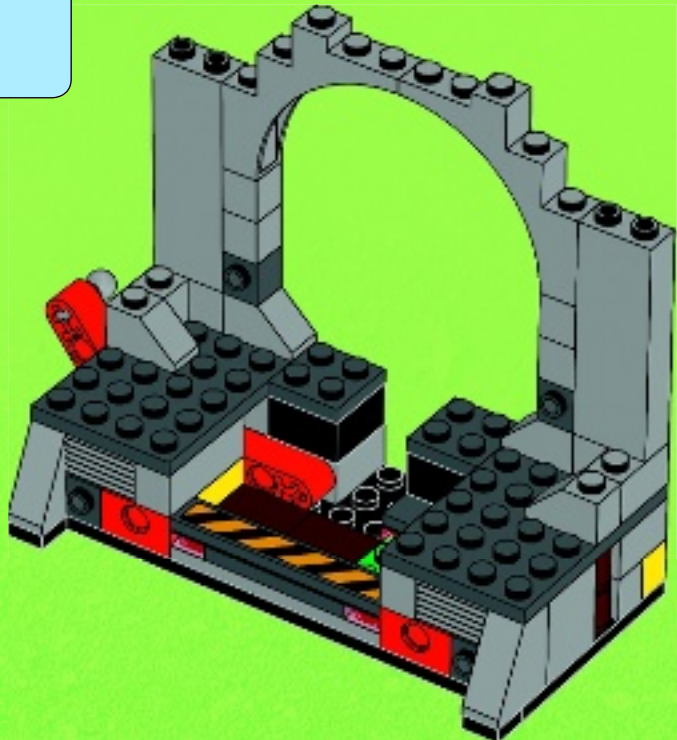

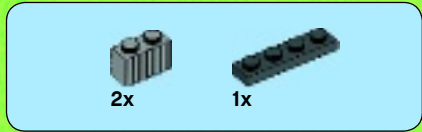

# 18

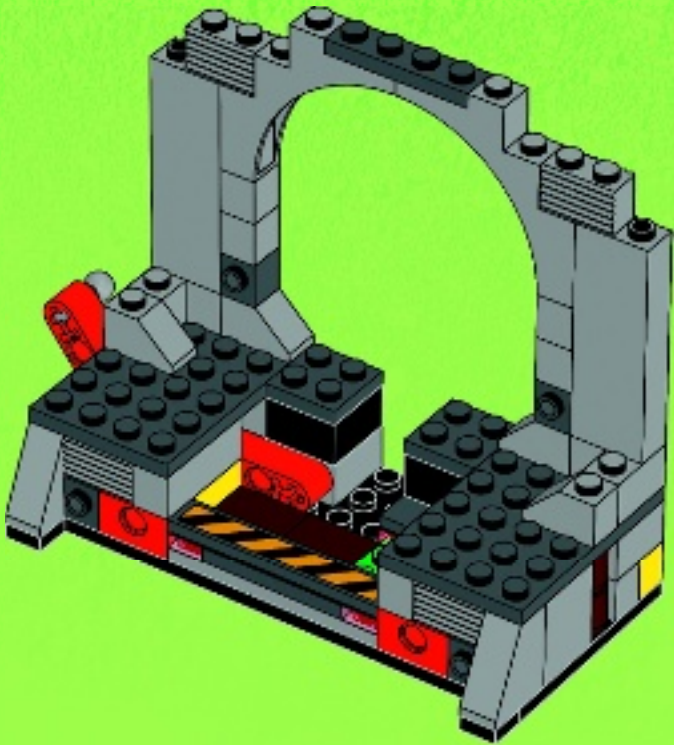

# 19

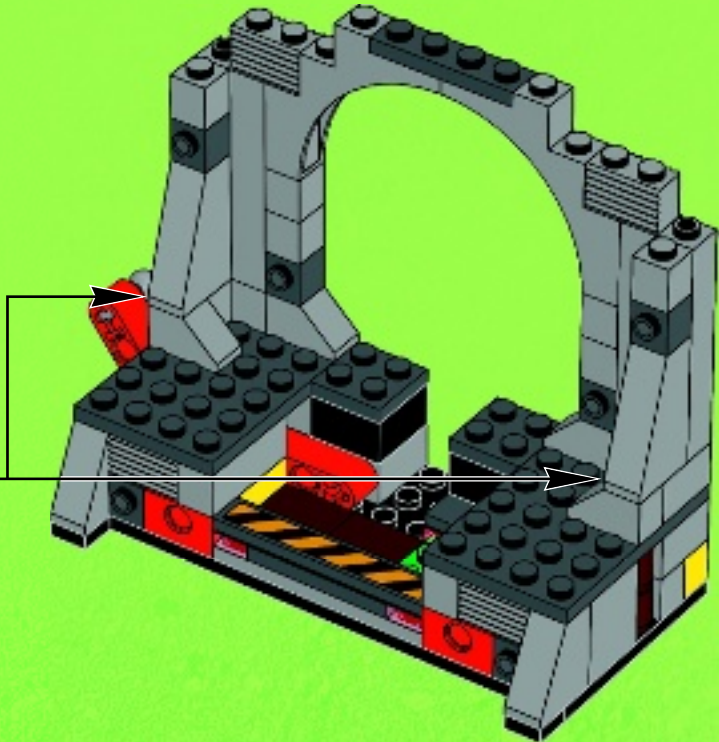
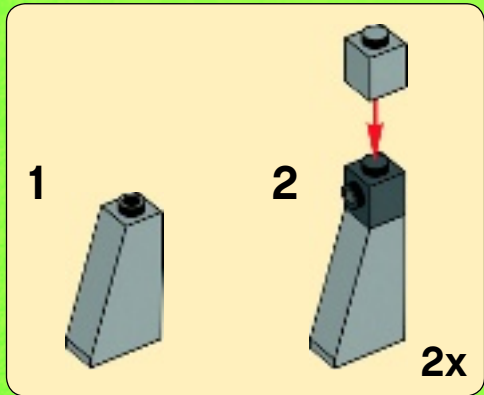





2x

# 20

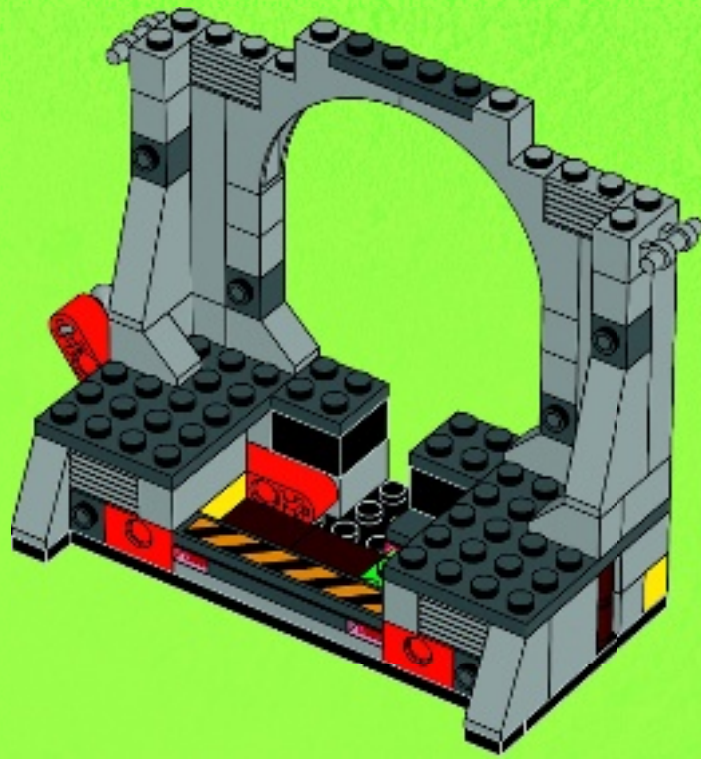

2x



2x

# 21

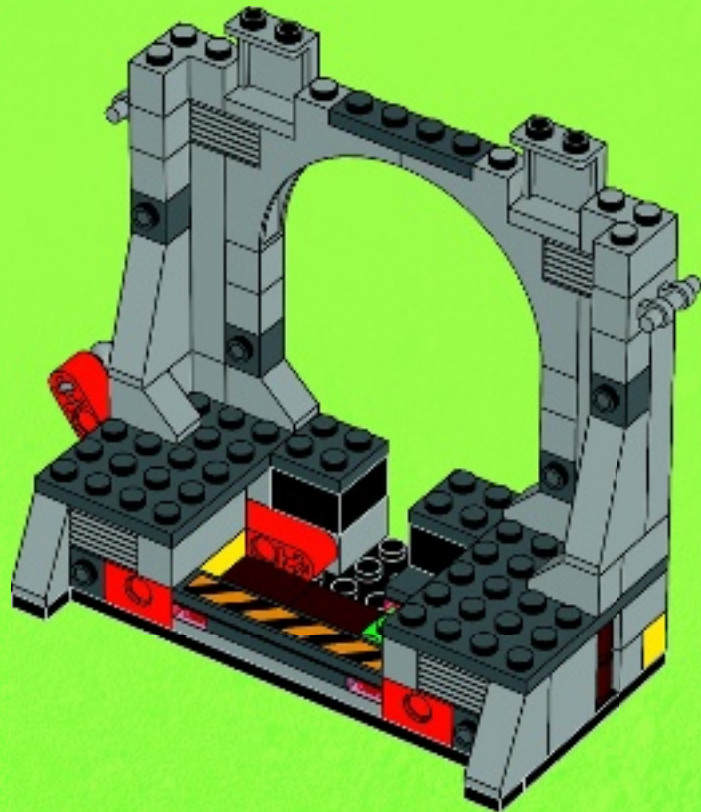



2x



2x

# 22

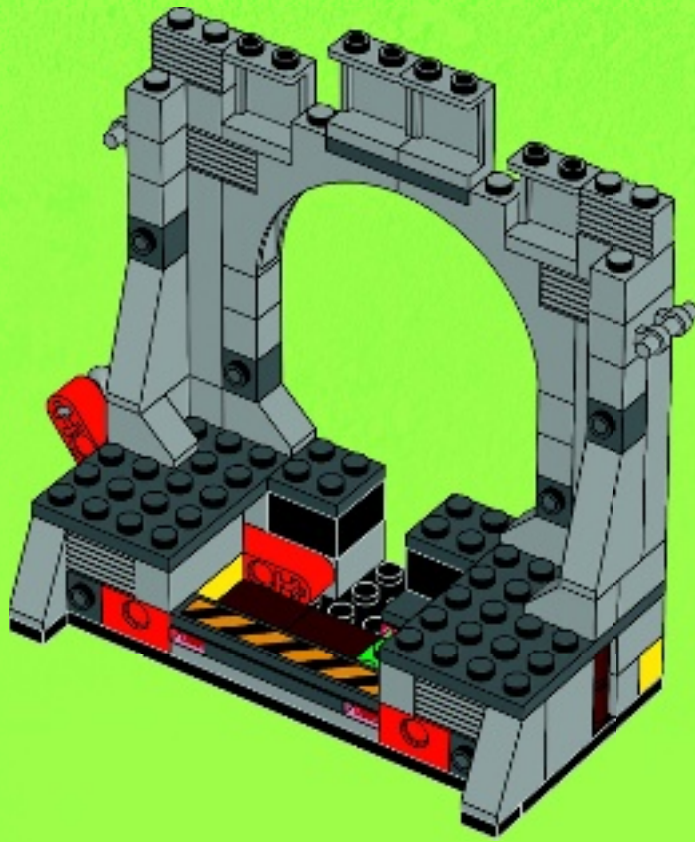

4x

# 23

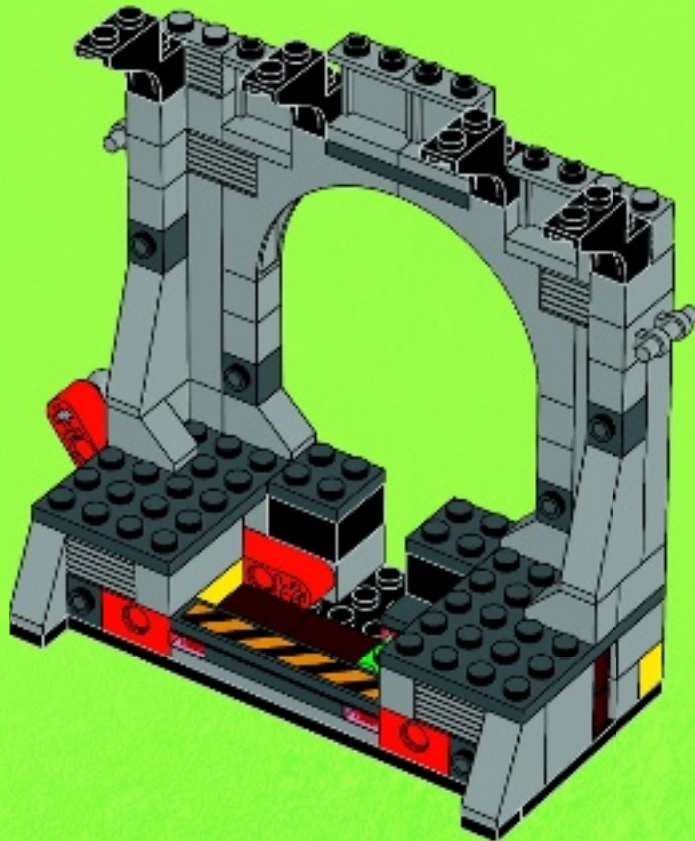



2x



2x

# 24

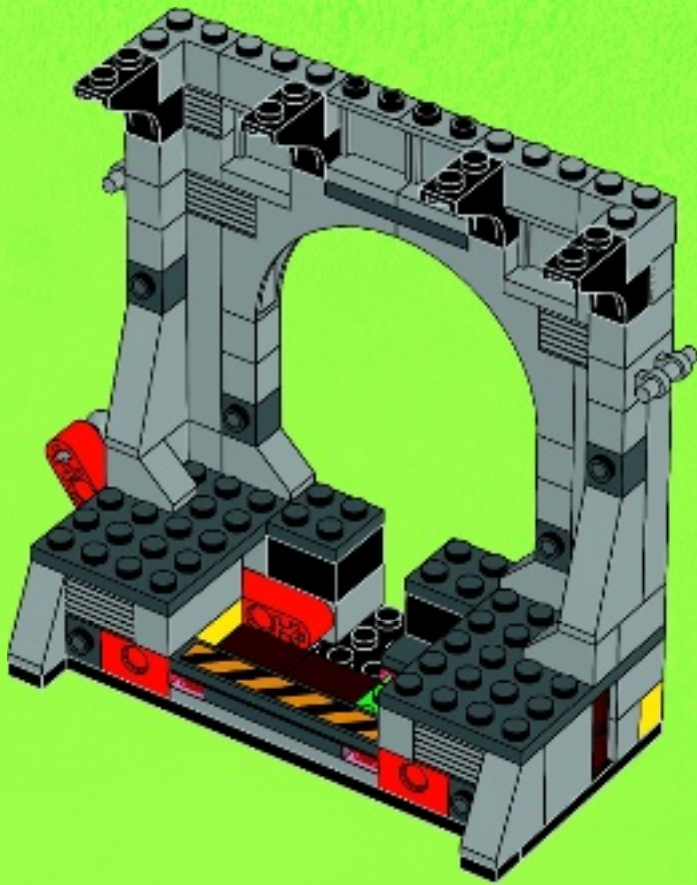

2x

# 25

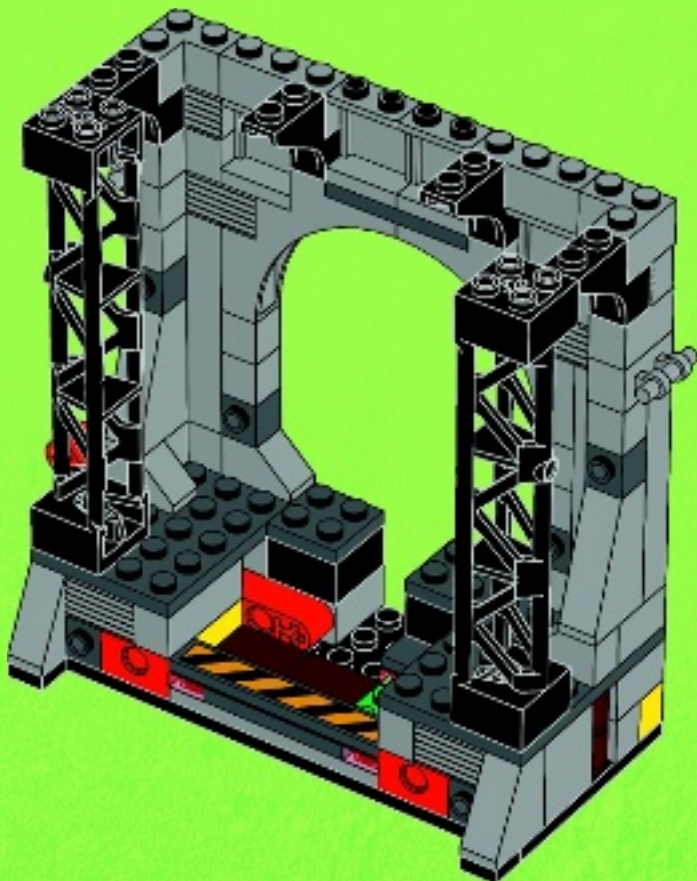

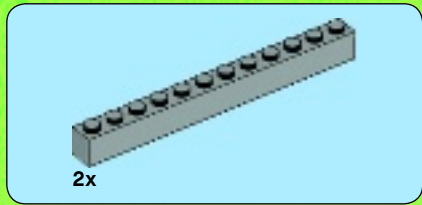

26

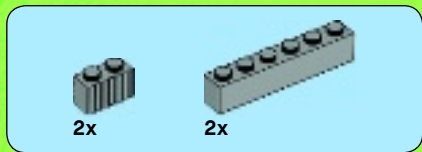
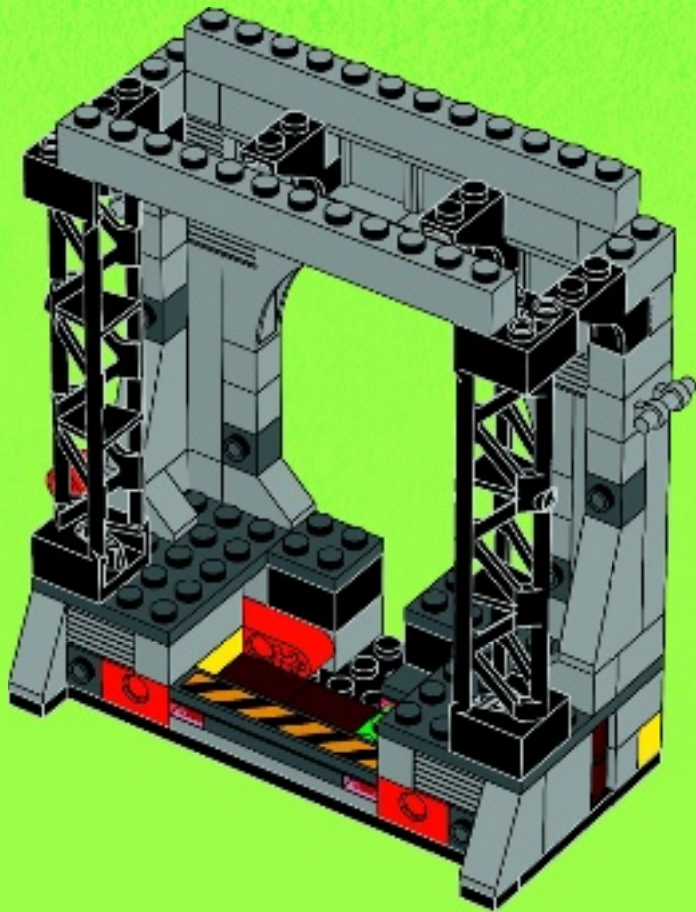

27

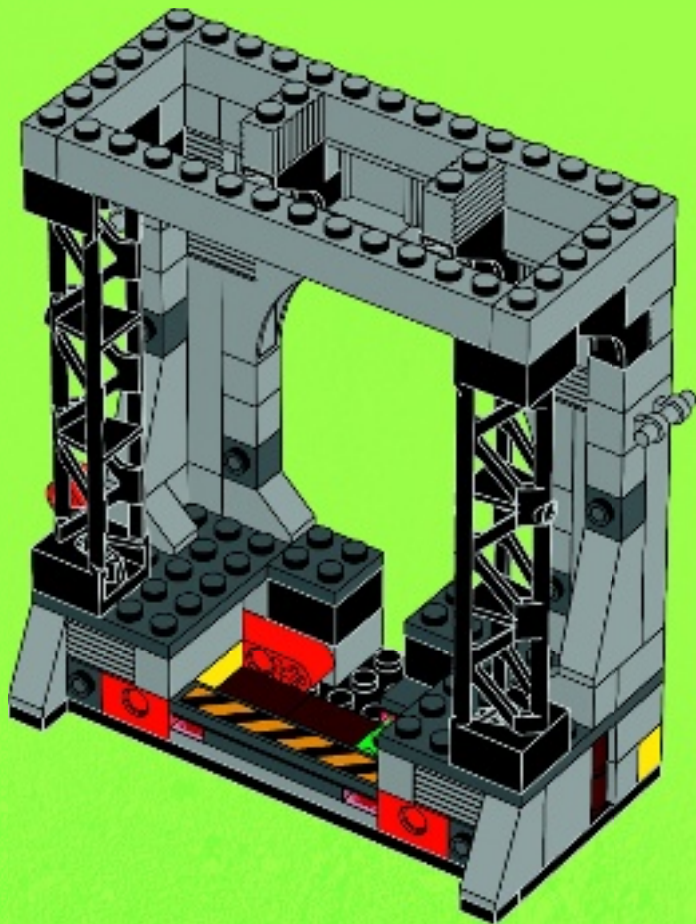

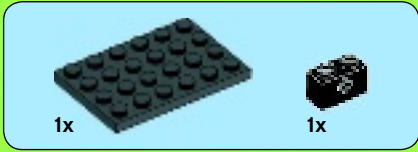

1

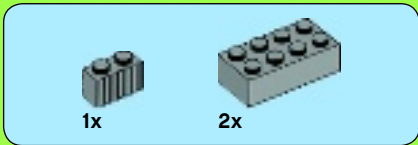

2

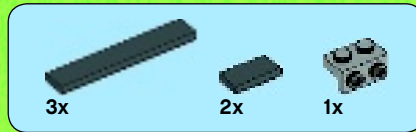

3

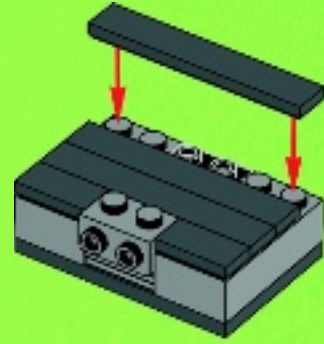

4

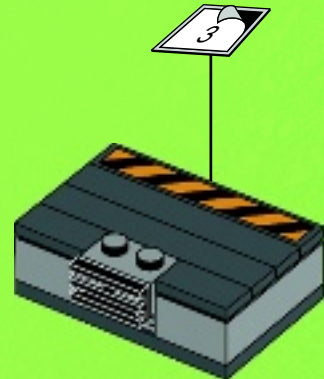

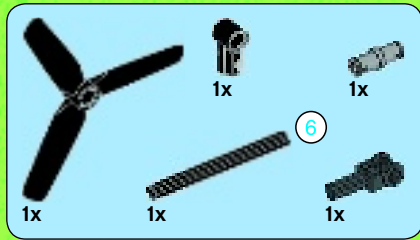

5

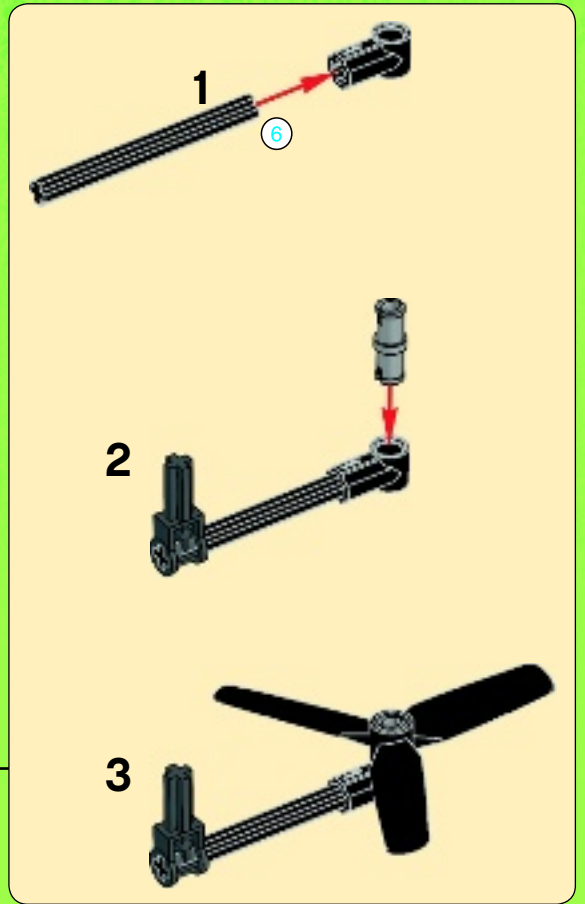
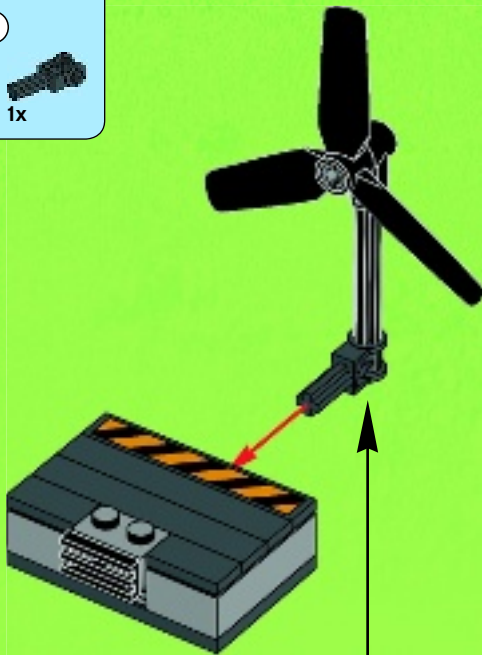

28

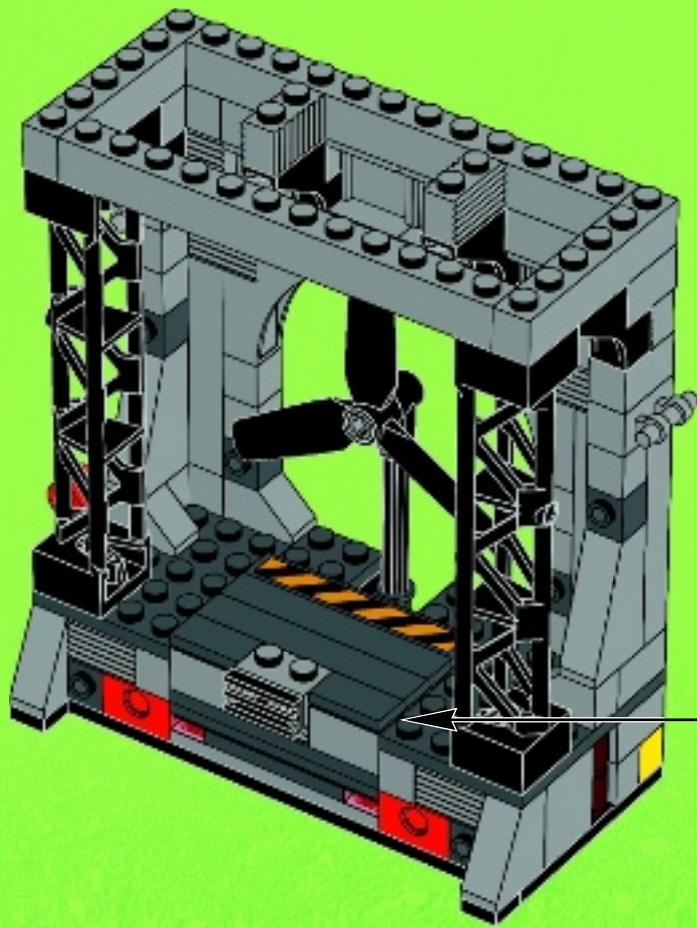



2x



2x

# 29

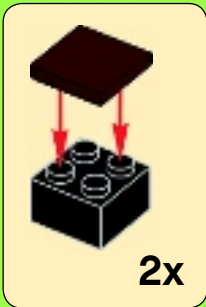
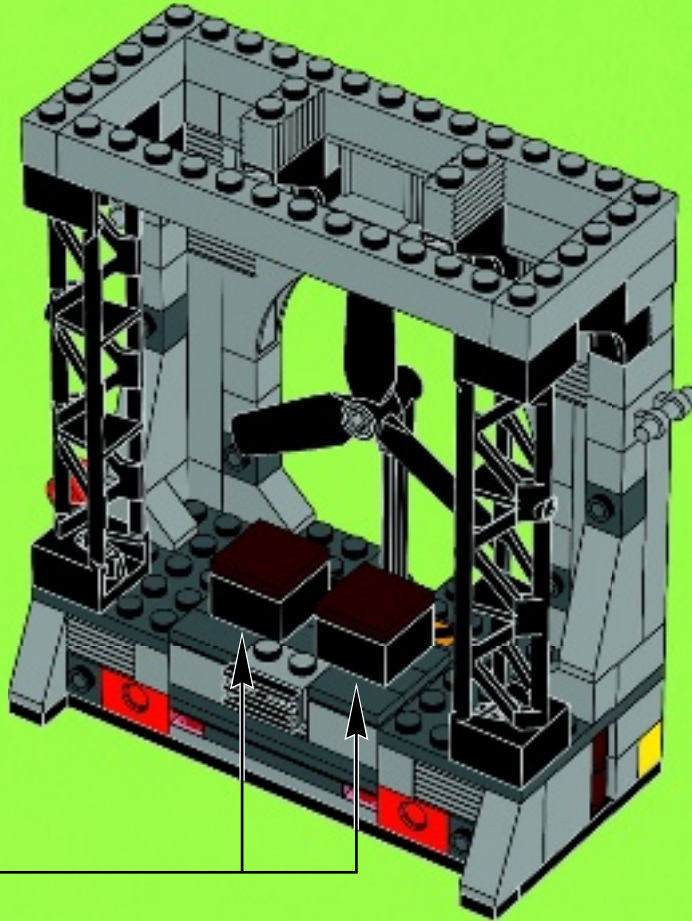

2x

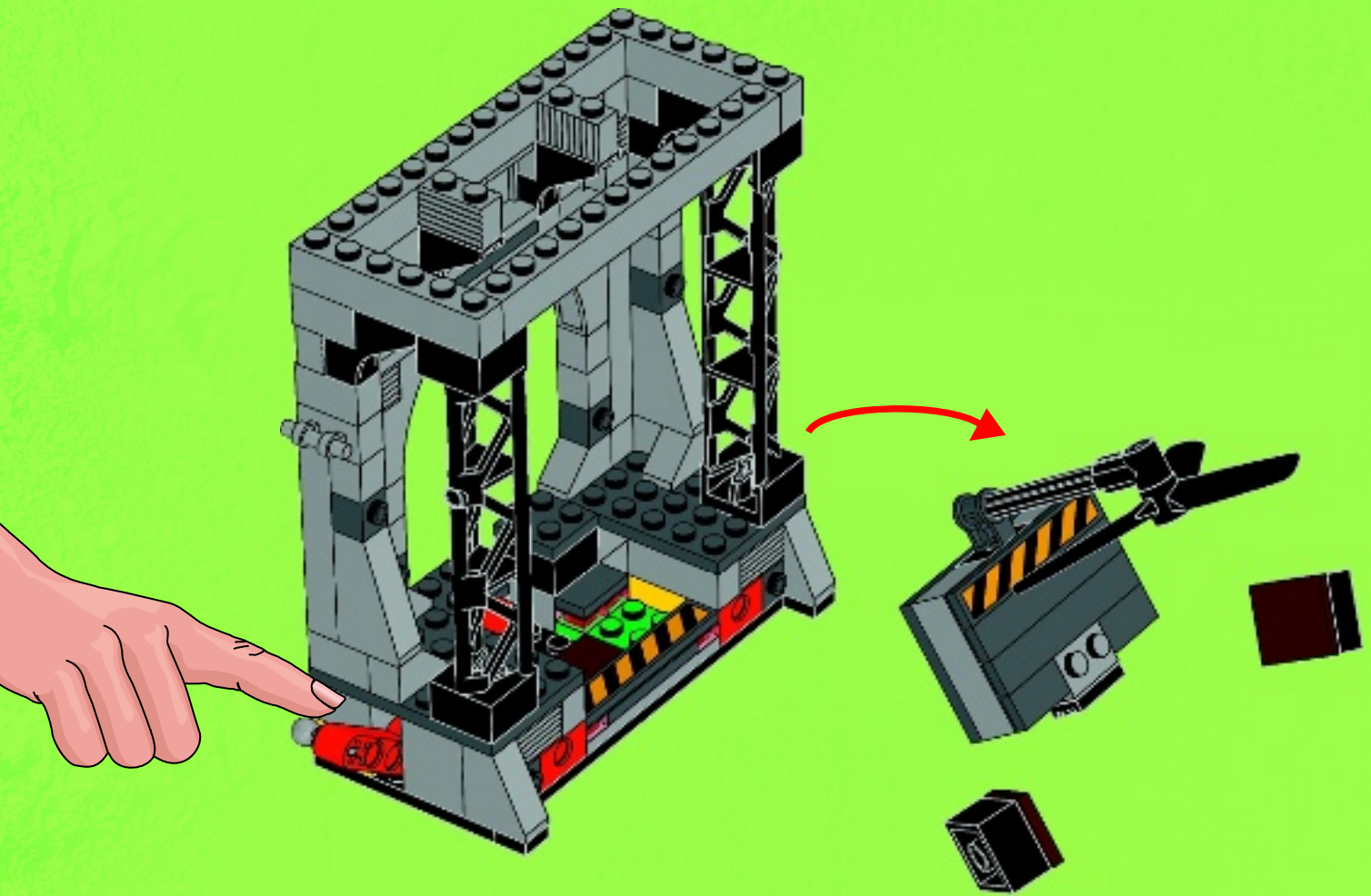





3

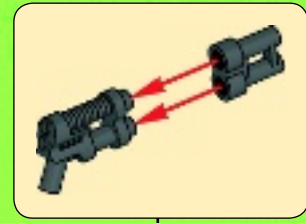
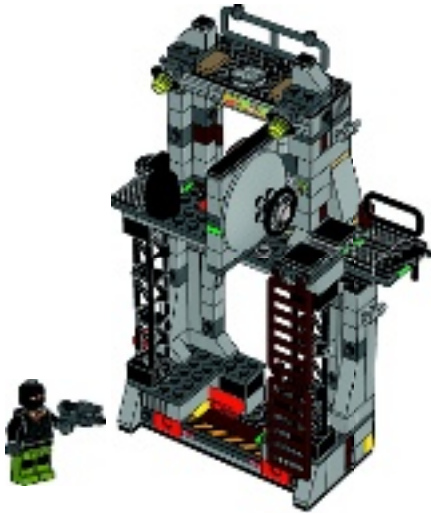

2x

2x

30

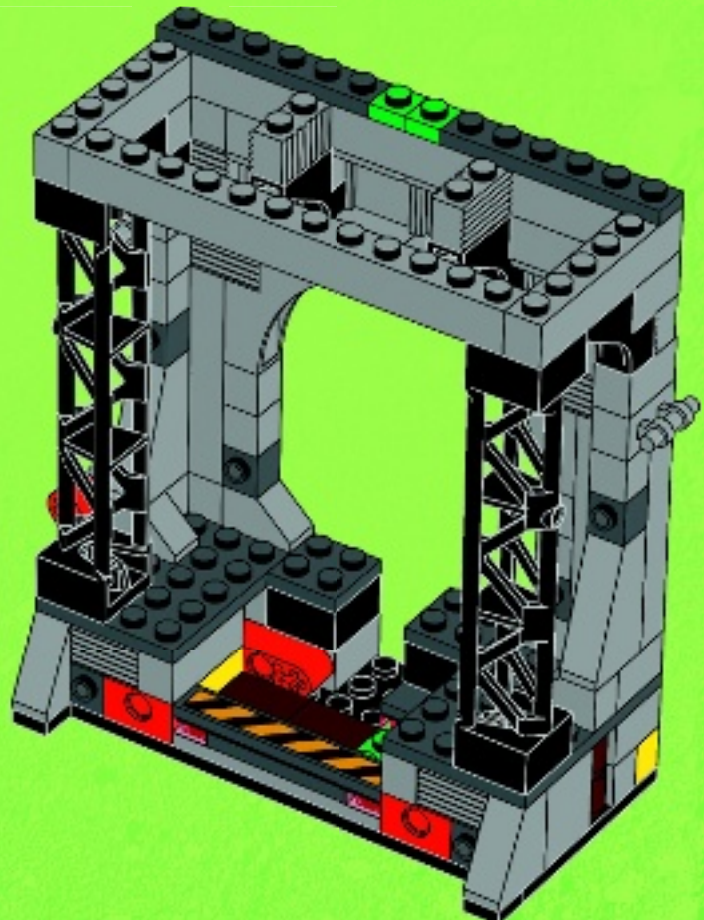

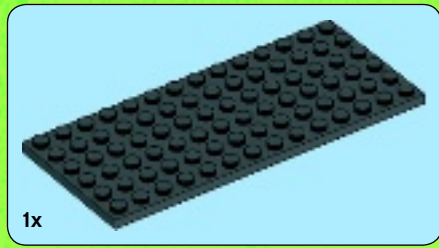

31

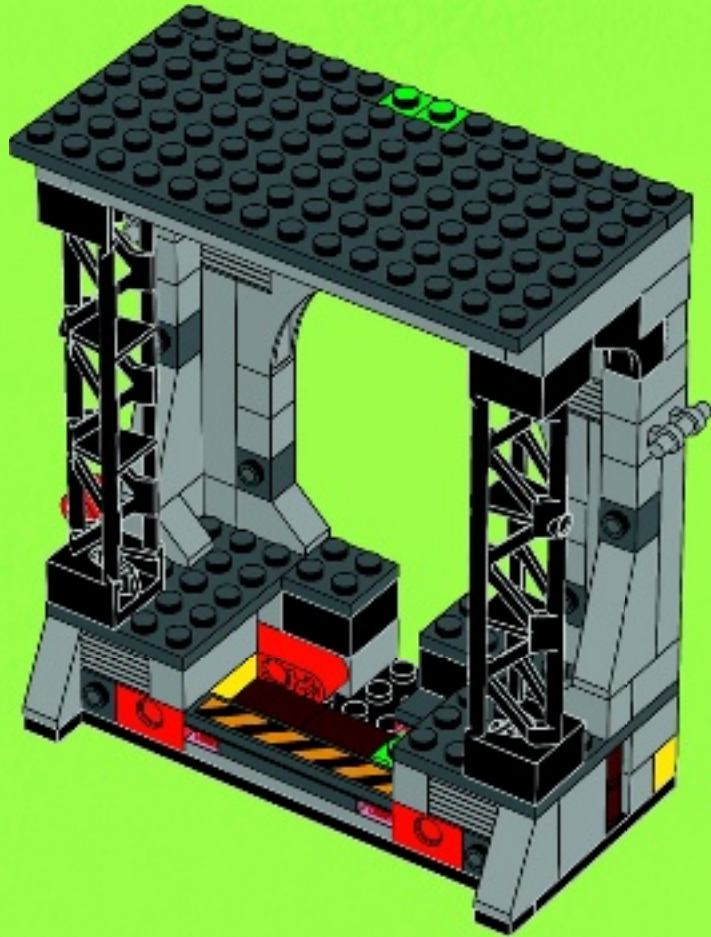



2x



2x



2x

# 32

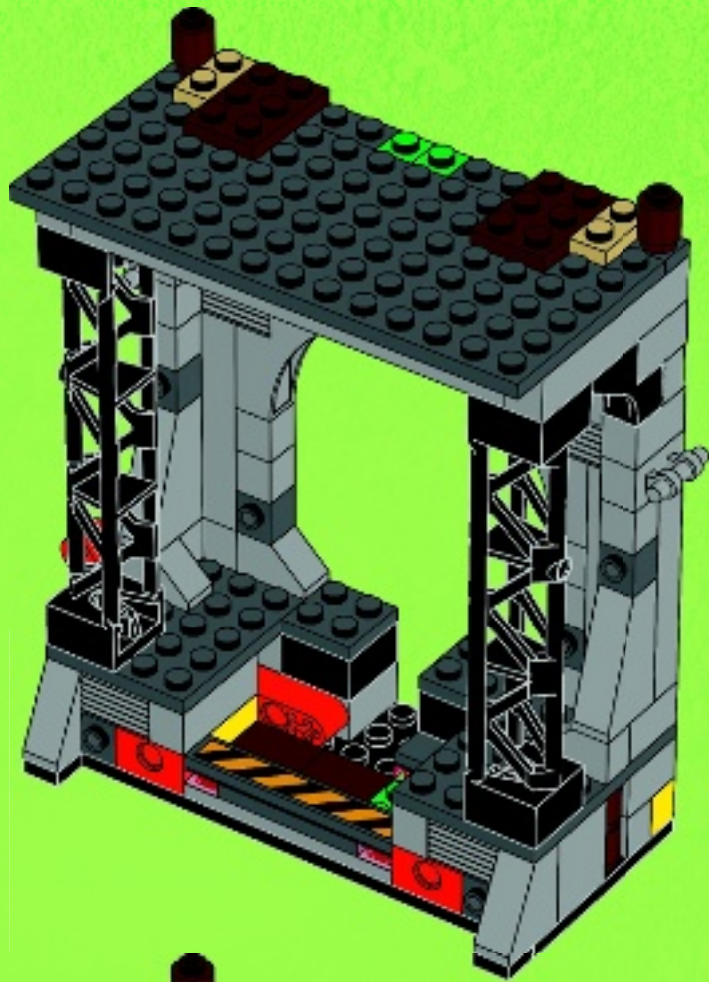

1x



2x

# 33

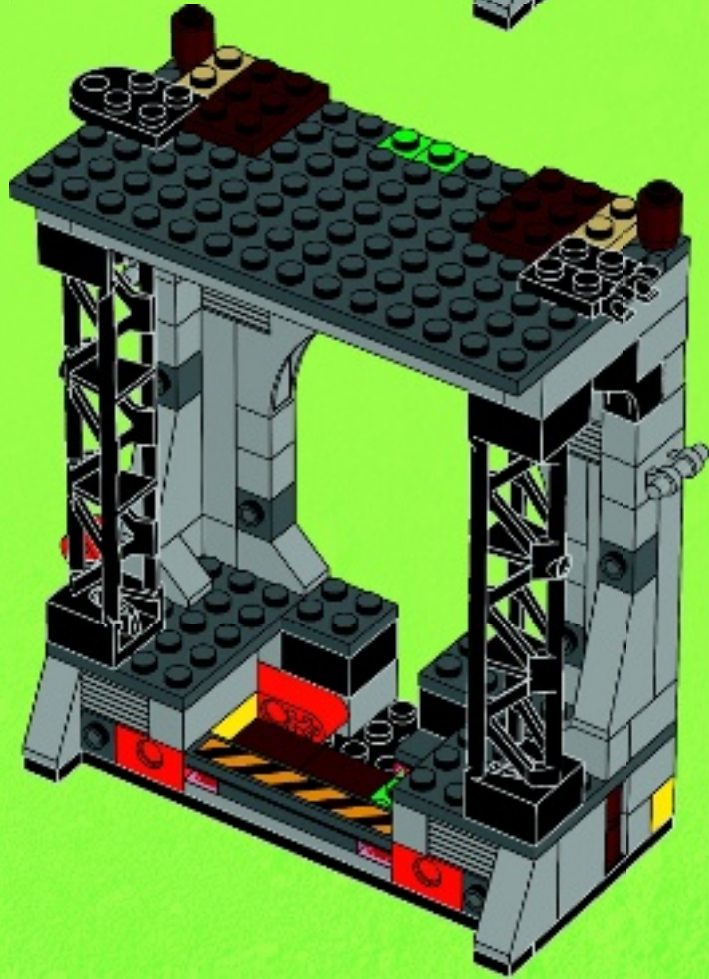



# 34

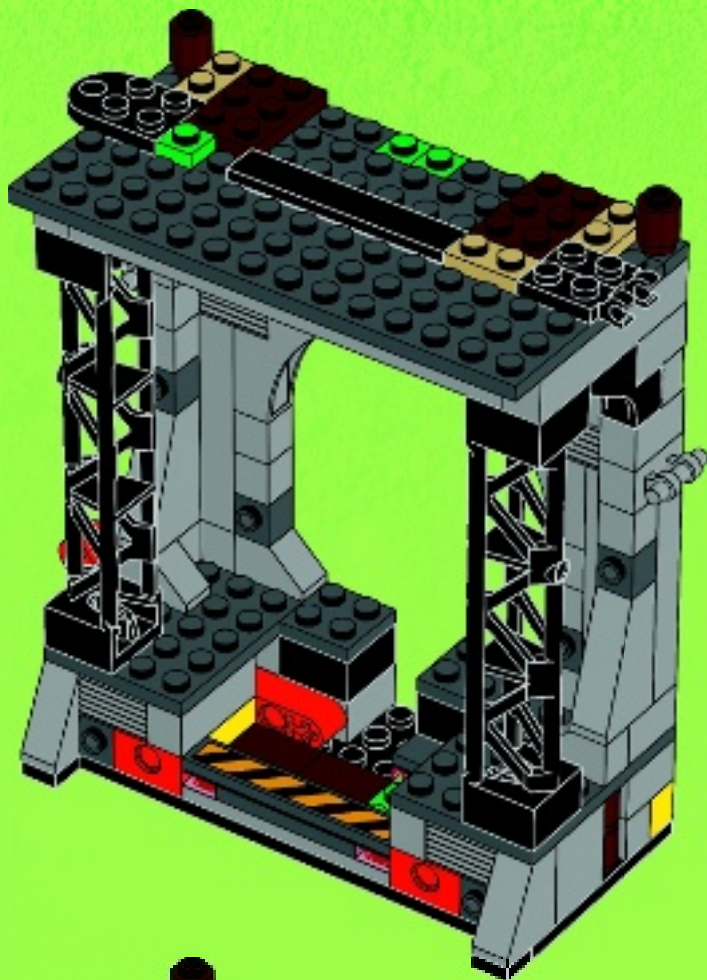

# 35

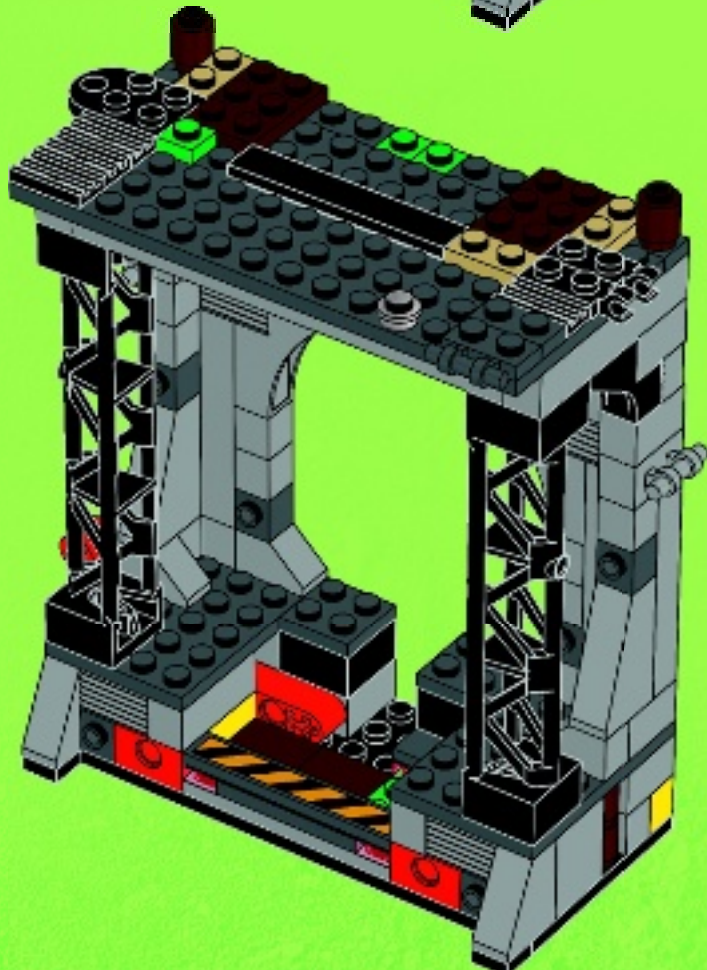

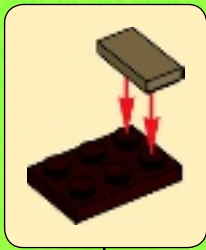
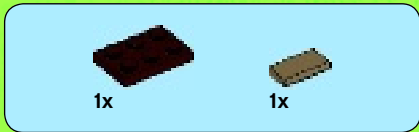

36

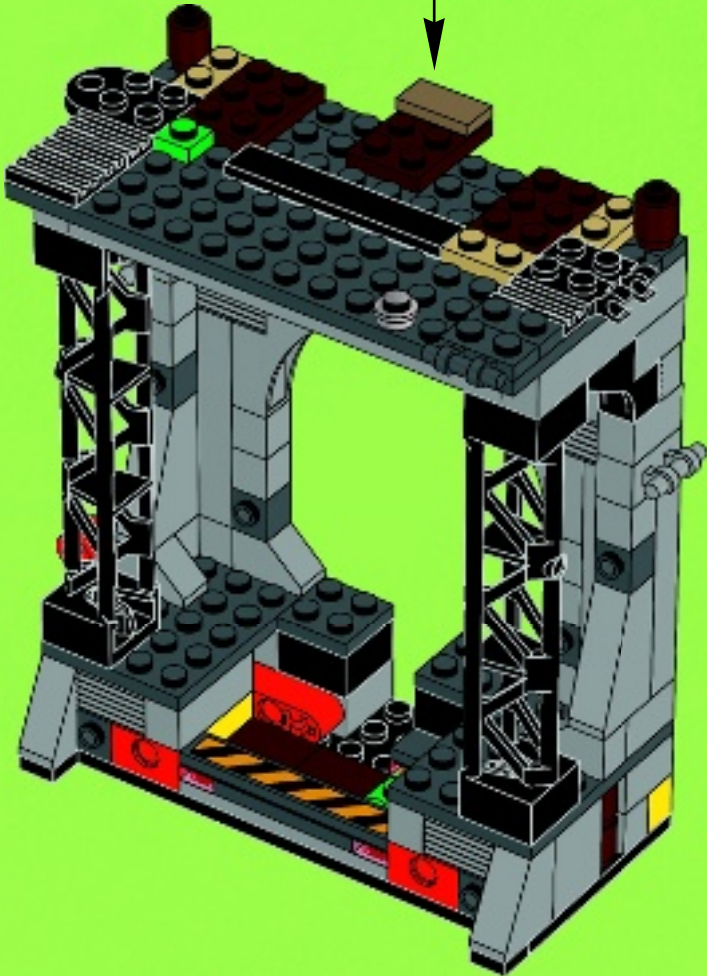



1x



1x

# 1

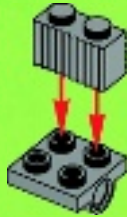

1x



1x

# 2

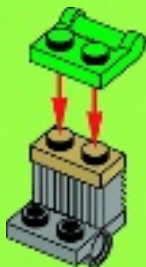

1x



2x



2x

# 3

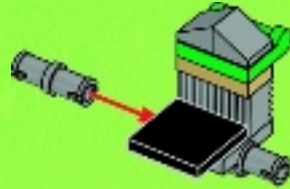

2x



2x



2x



2x



2x

# 4

1



2



3



2x

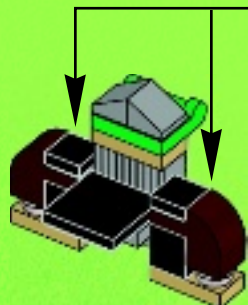

37

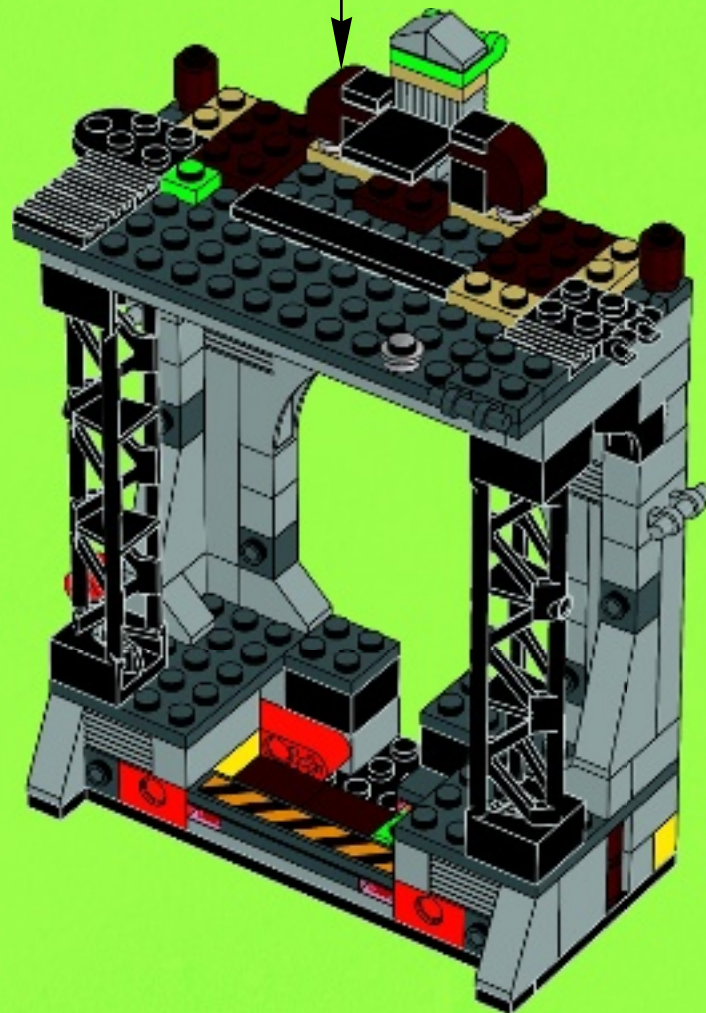



2x

# 38

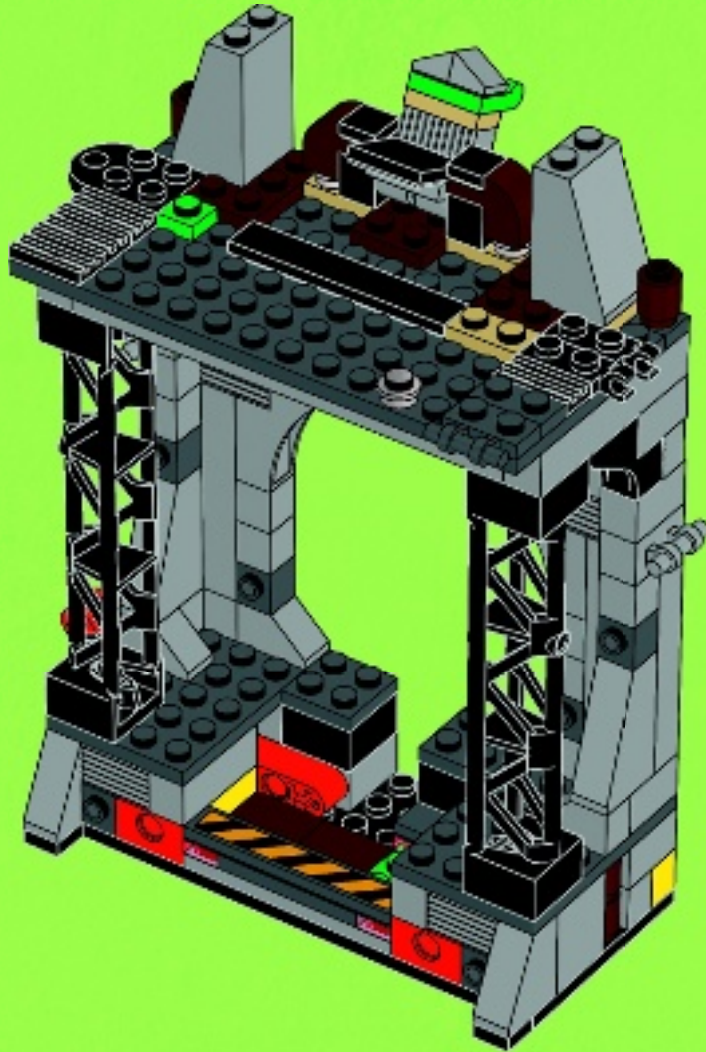





# 39

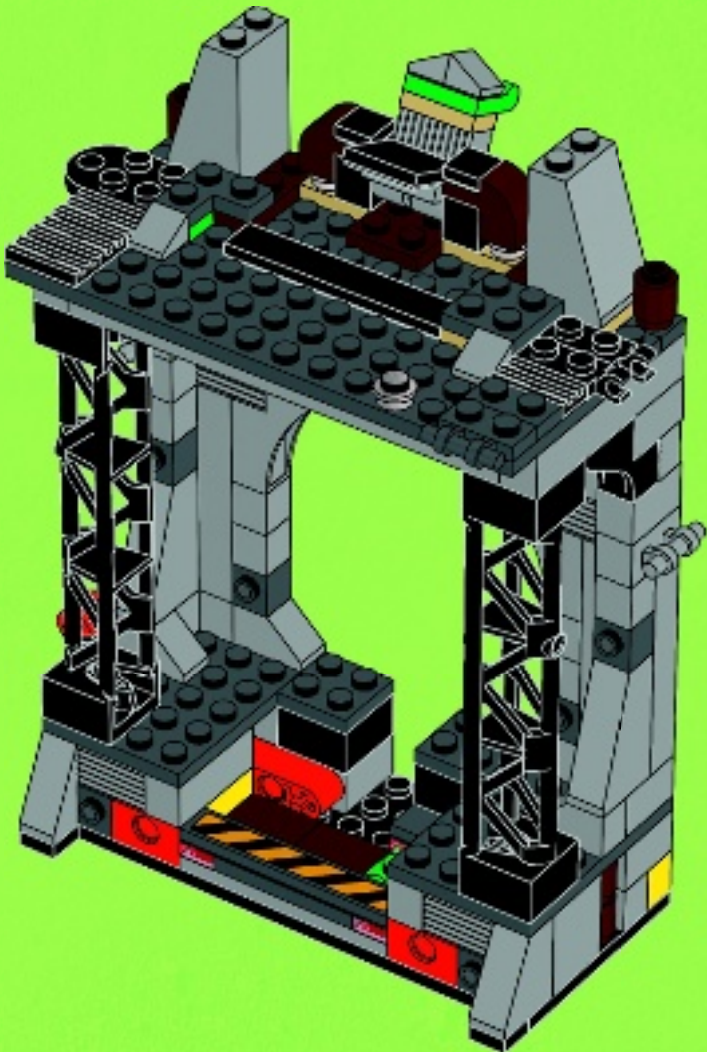



3x



2x

# 40

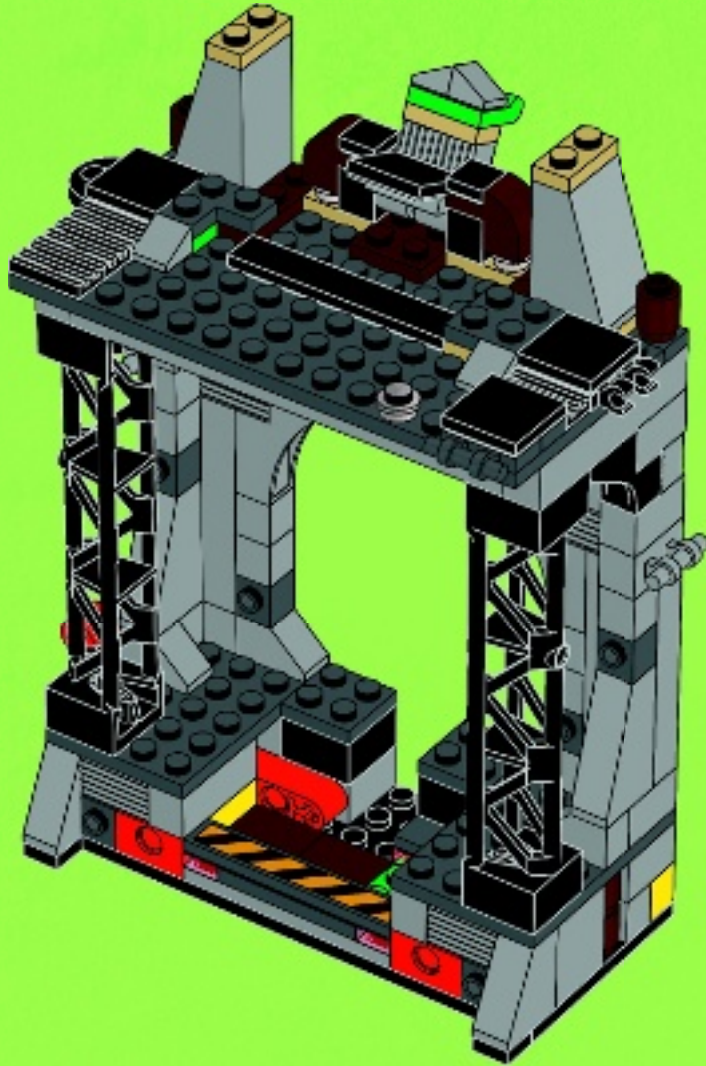



1x



2x

# 41

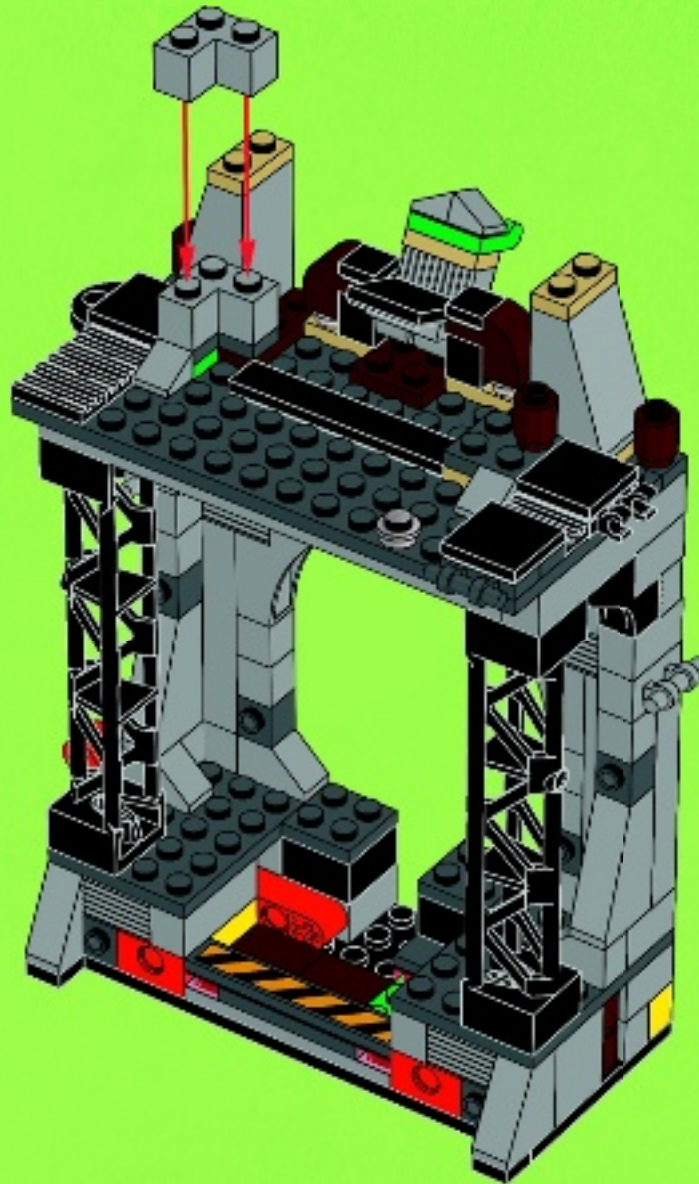



2x



1x

# 42

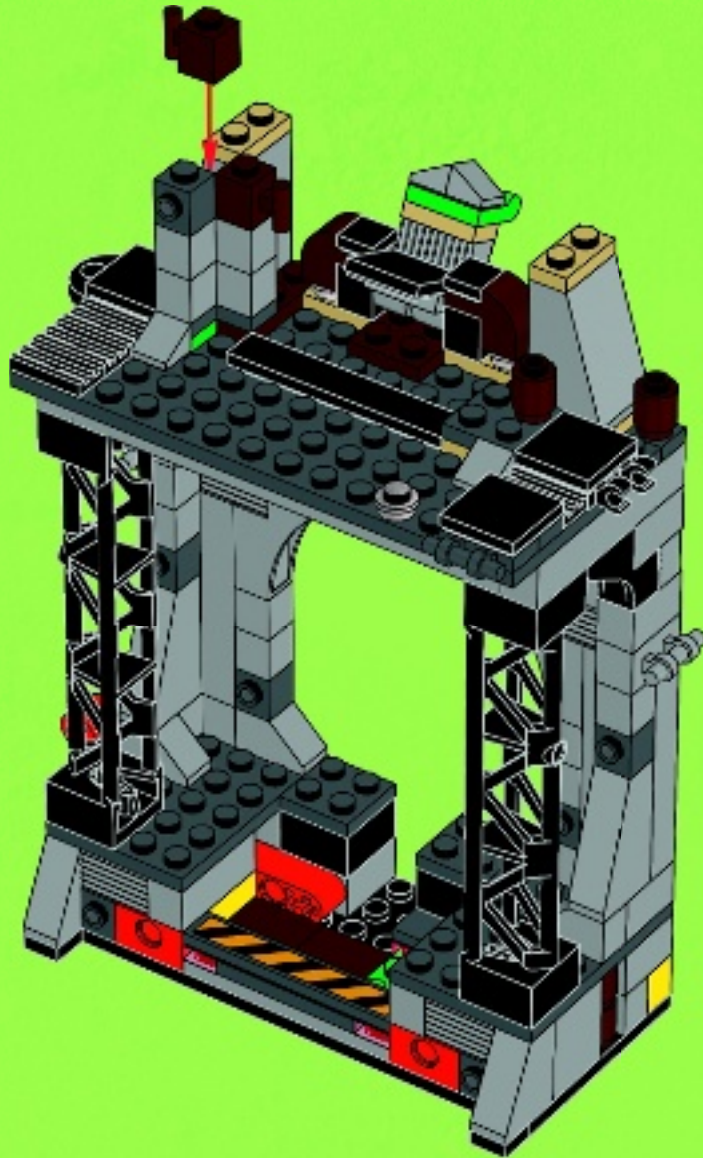



1x



1x

# 43

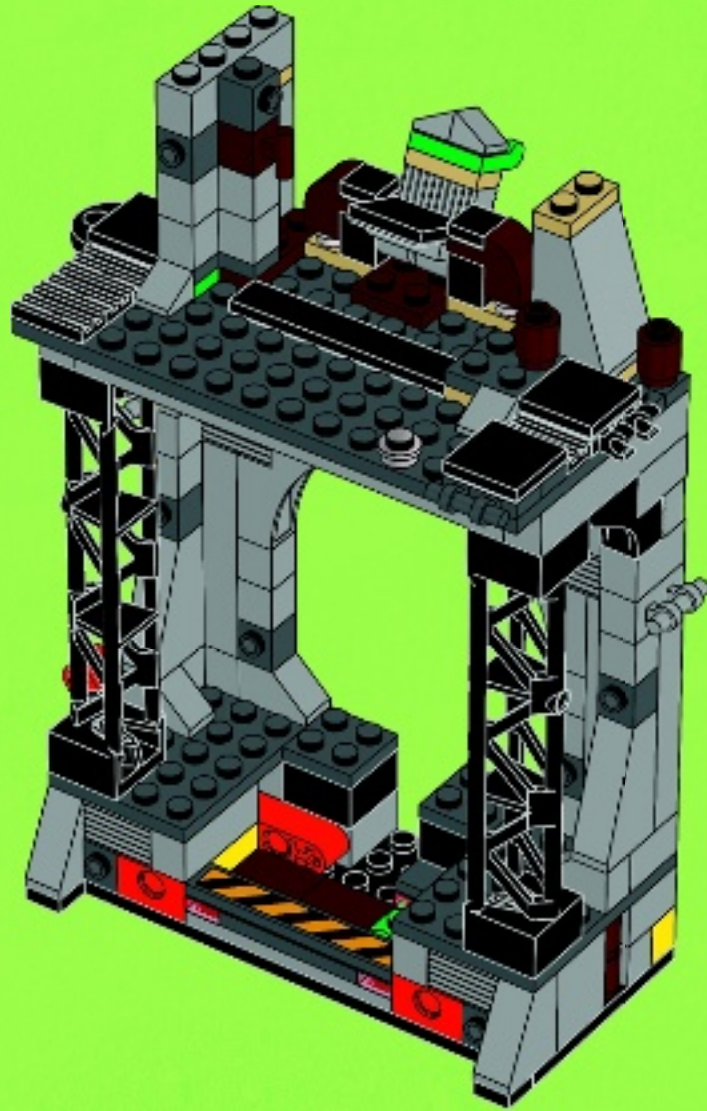



1x



1x

# 44

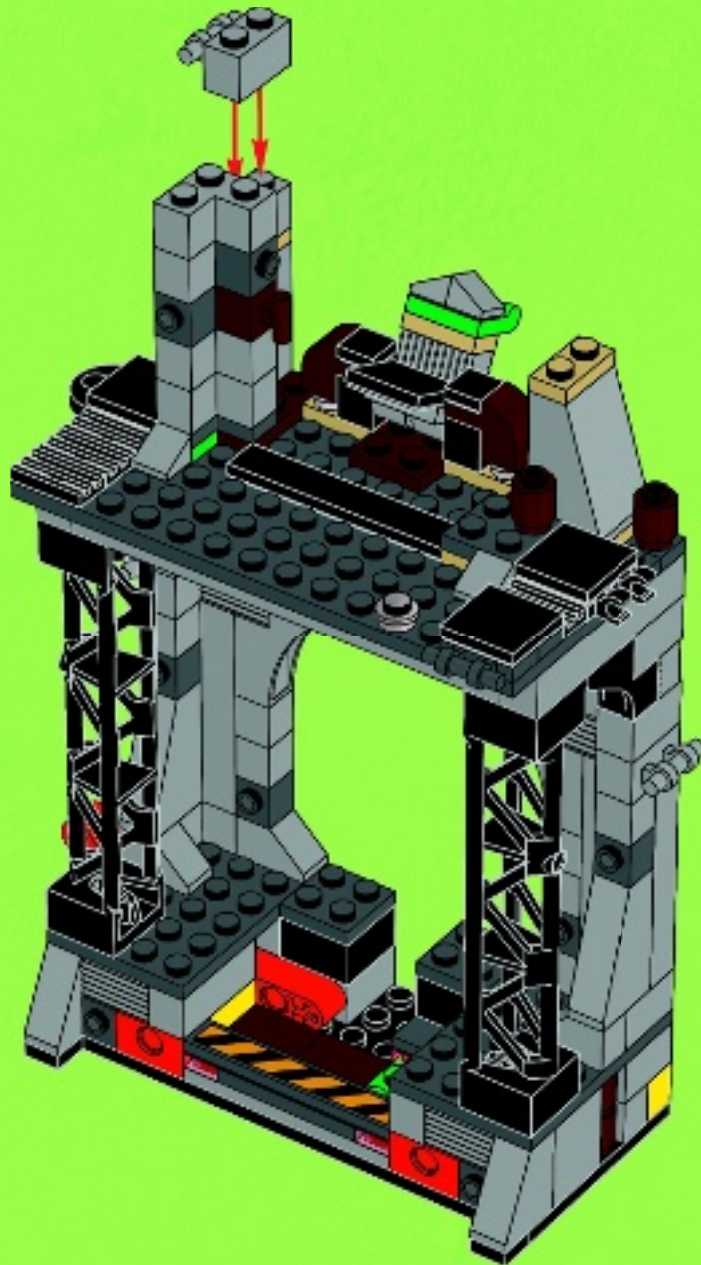



1x

1



1x



1x



1x

2

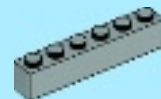
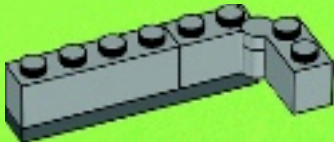
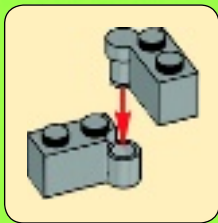

1x

3

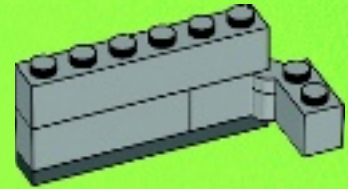

1x



1x

4

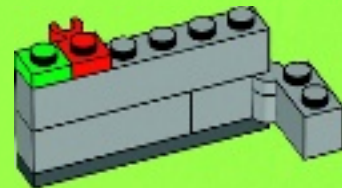

1x



1x



2x

5

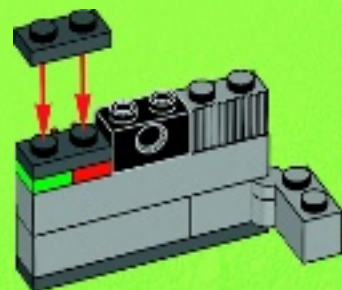

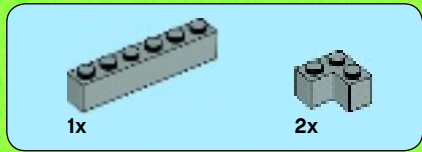

6

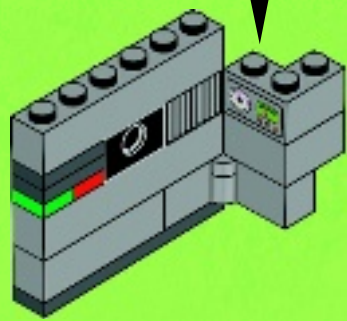
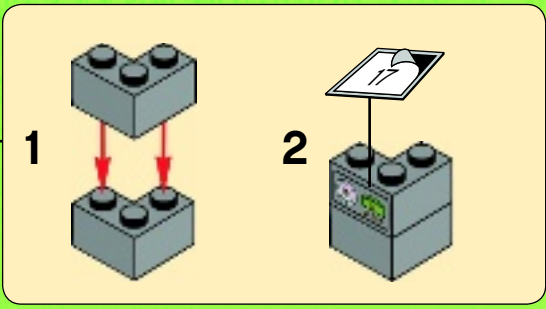

45

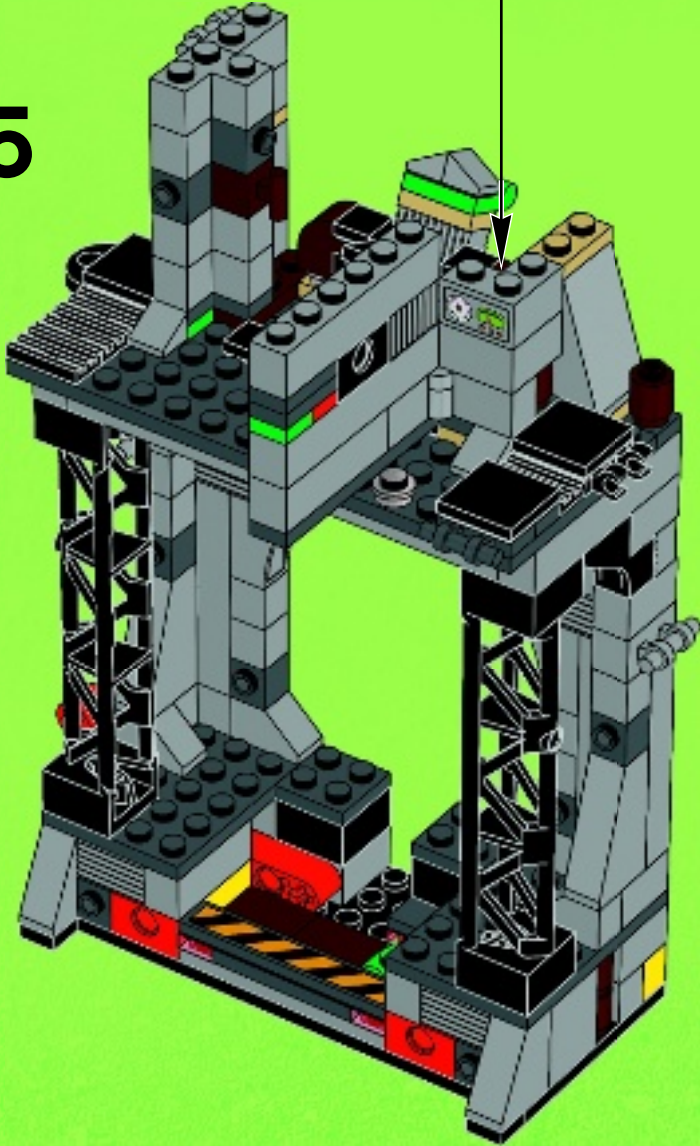





1x



1x

# 46

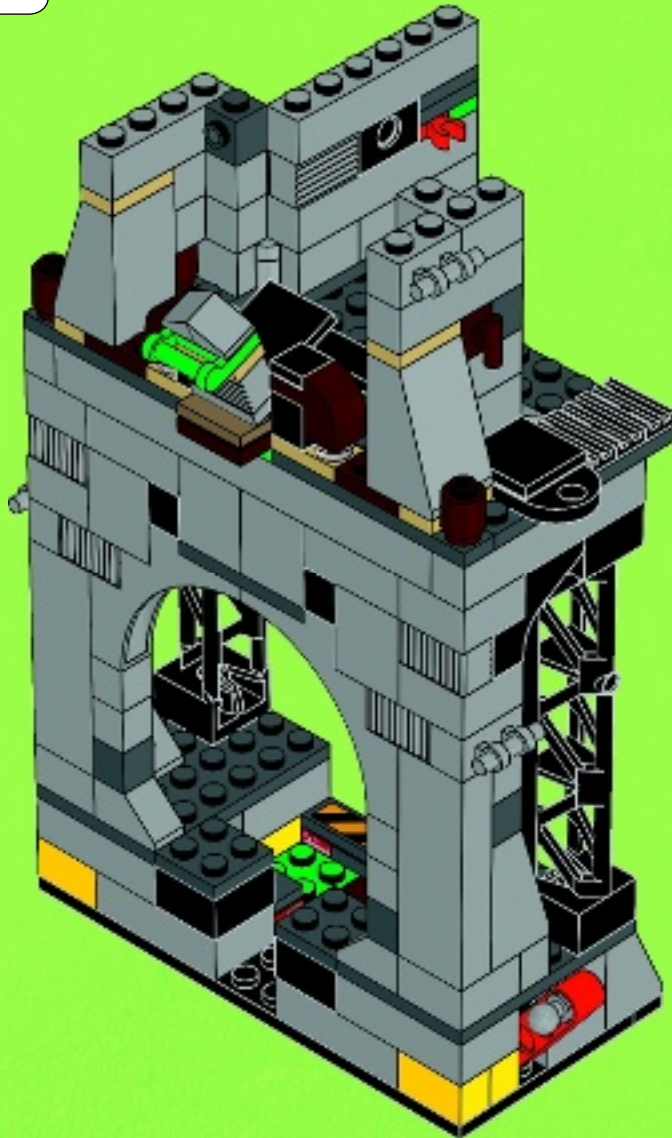



1x



1x

47

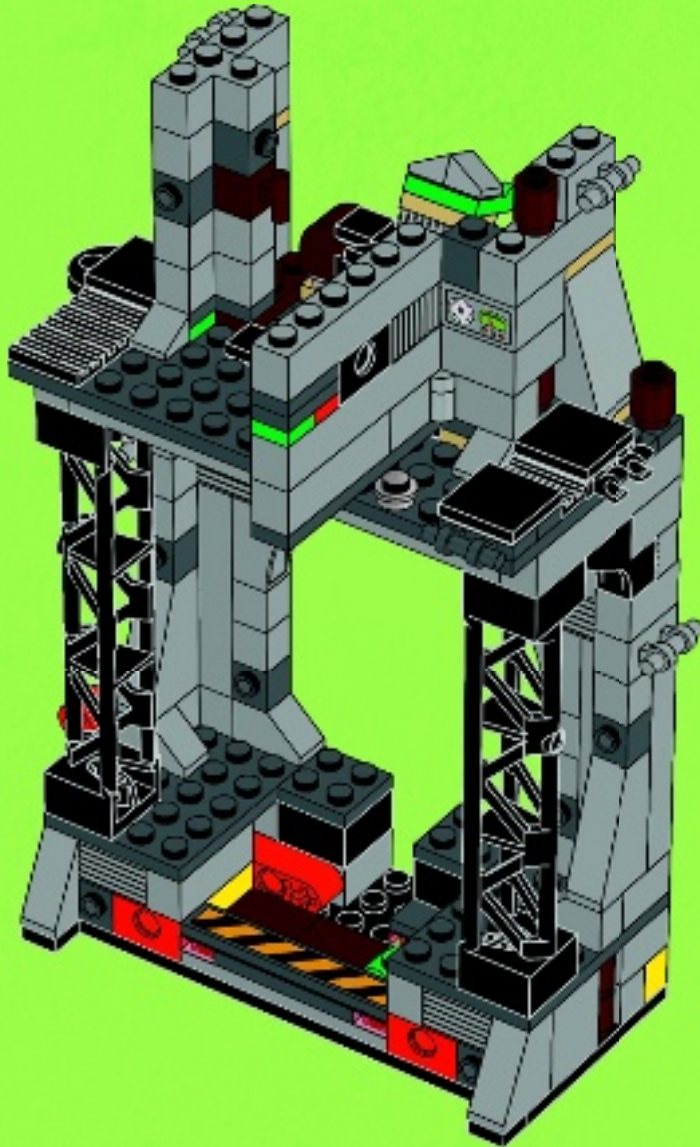

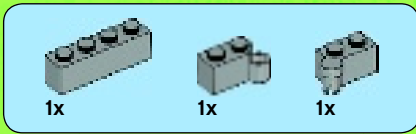

48

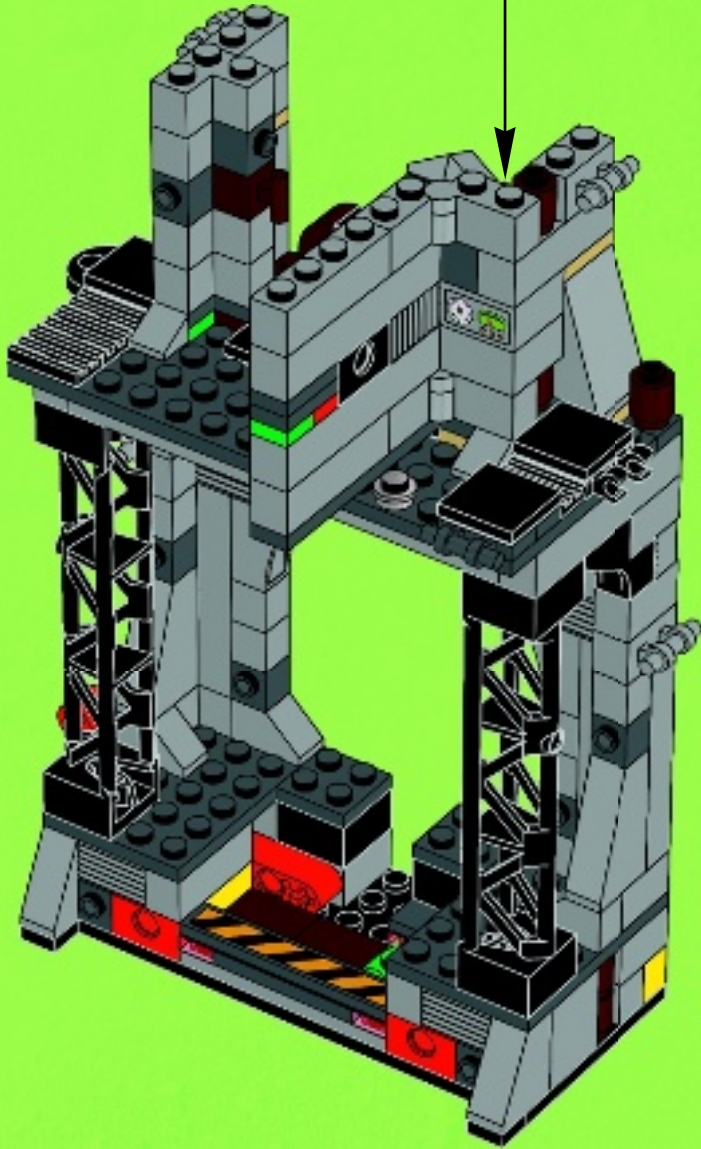
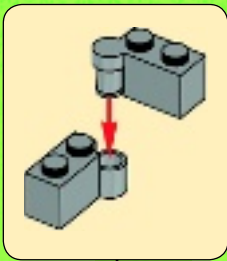



1x



2x

# 49

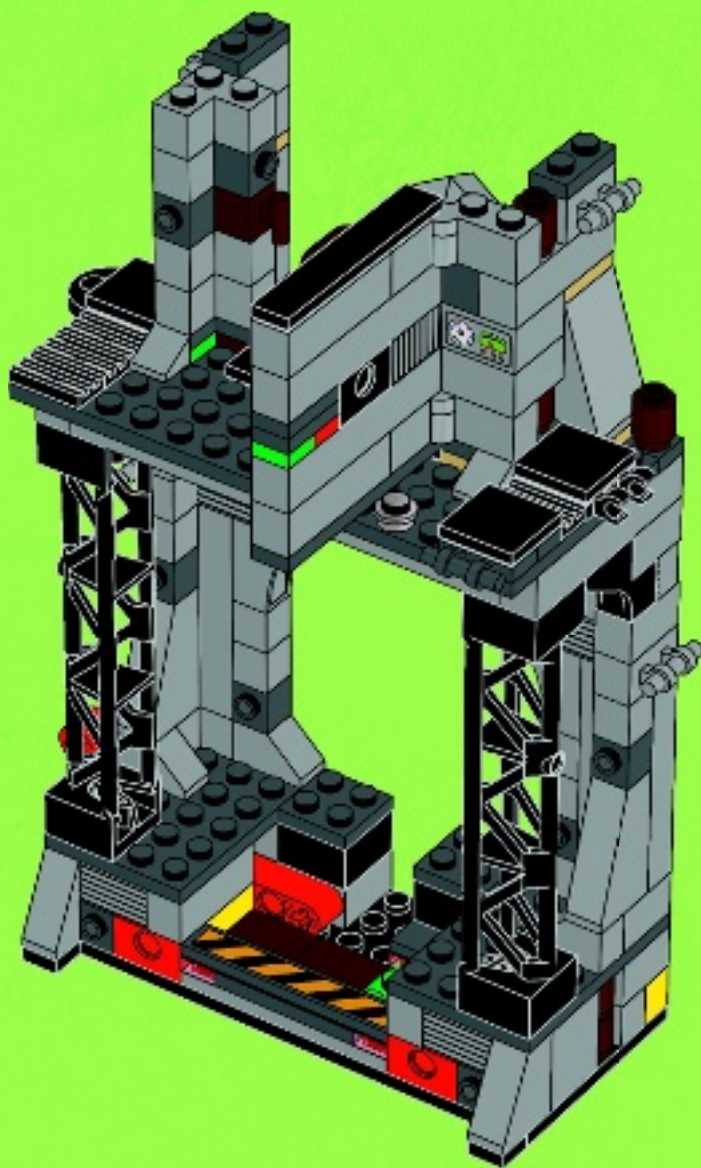



2x

# 50

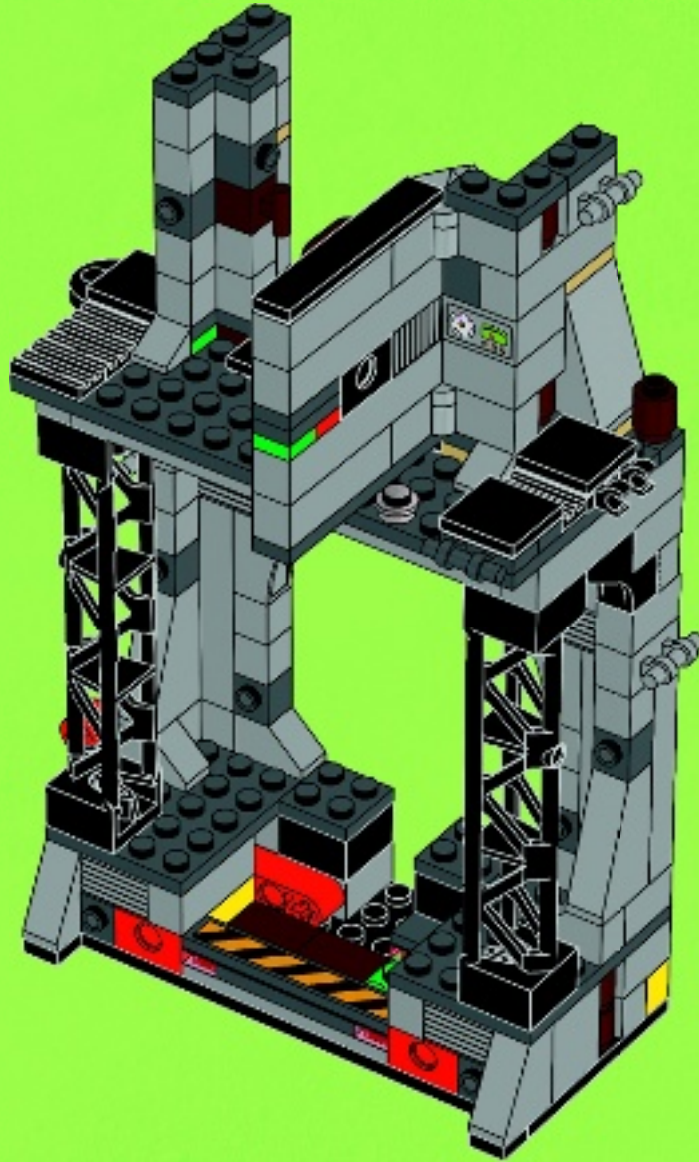



2x



2x

# 51

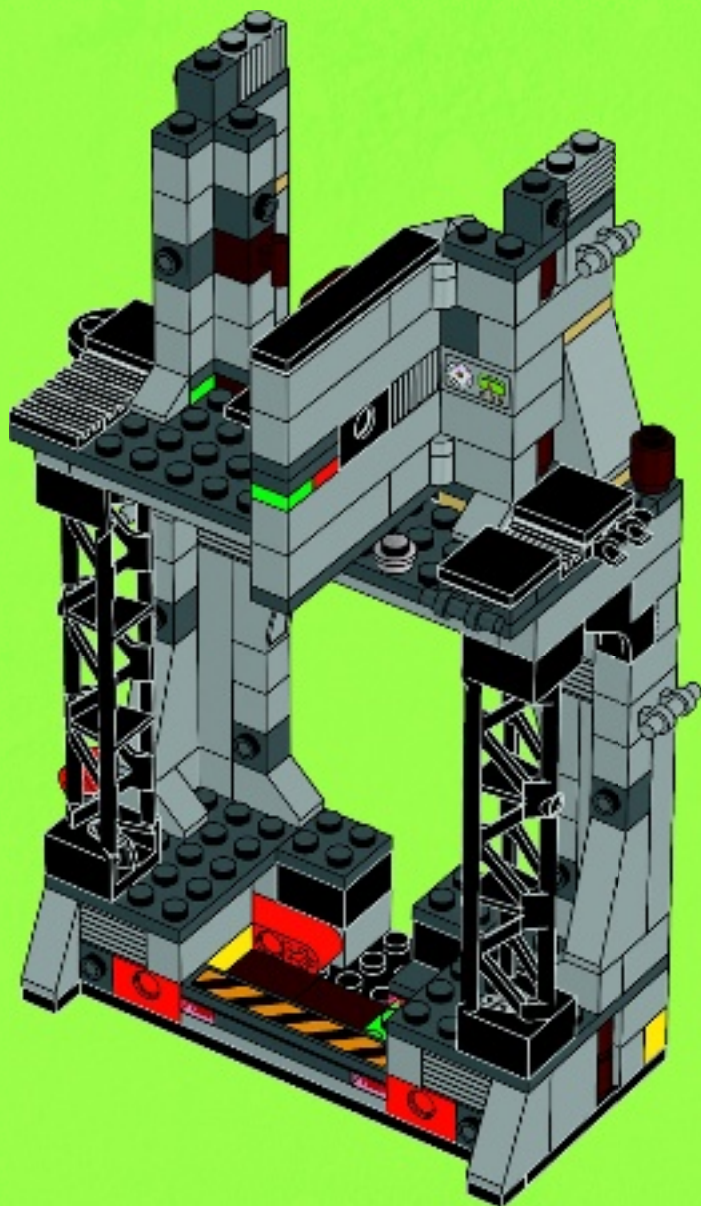

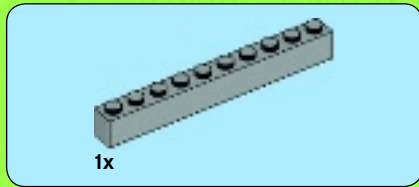

52

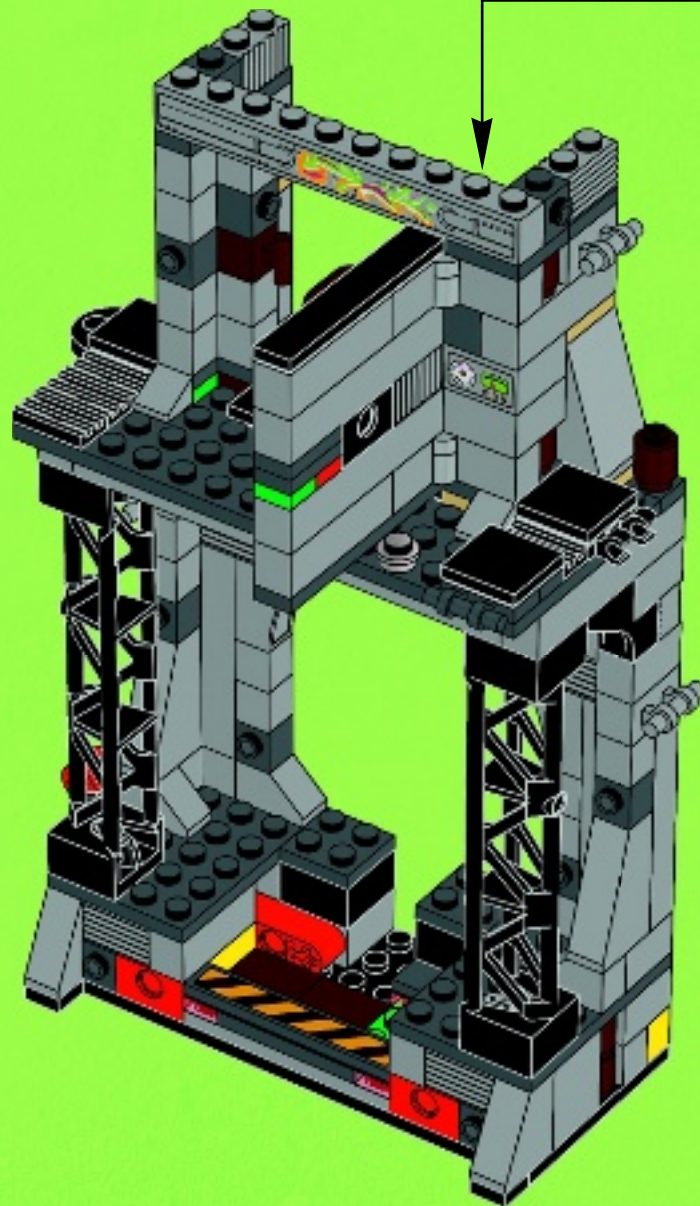
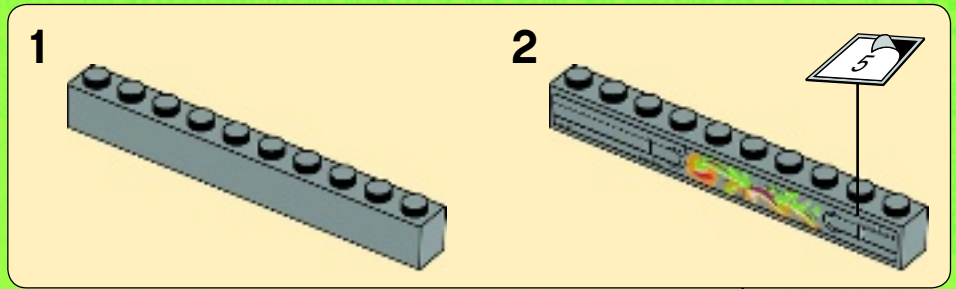



# 53

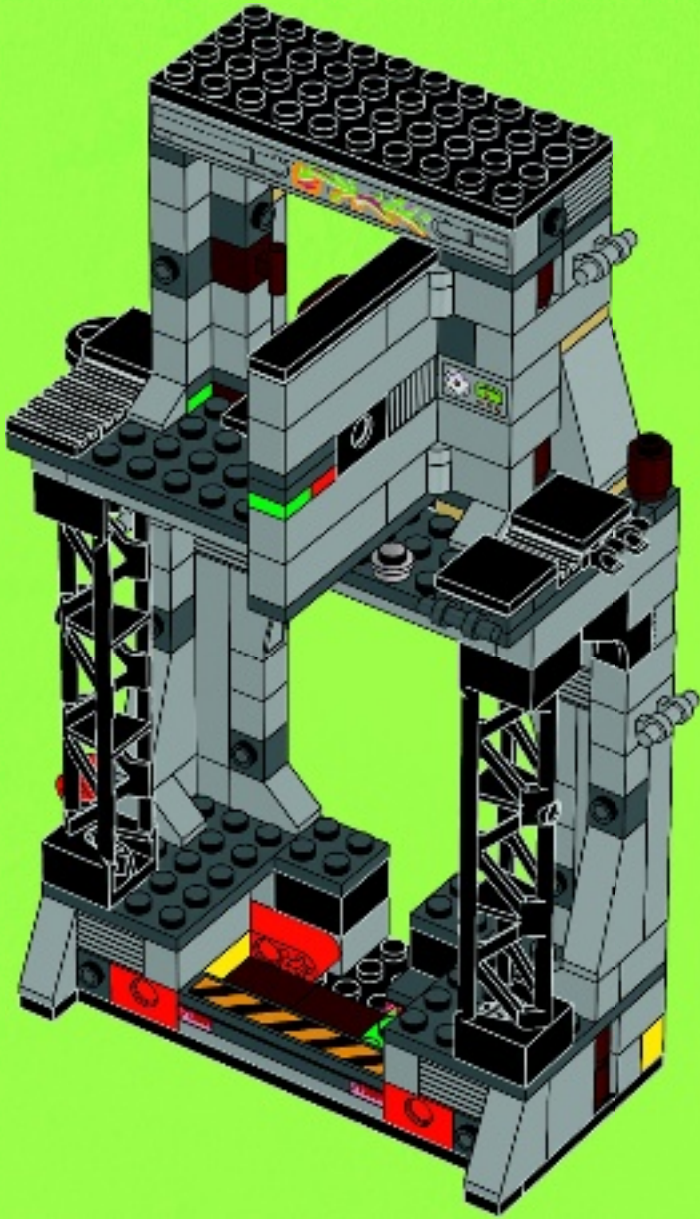



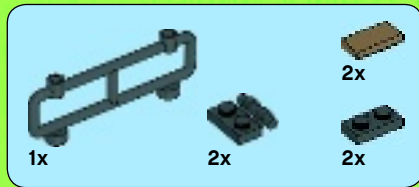

54

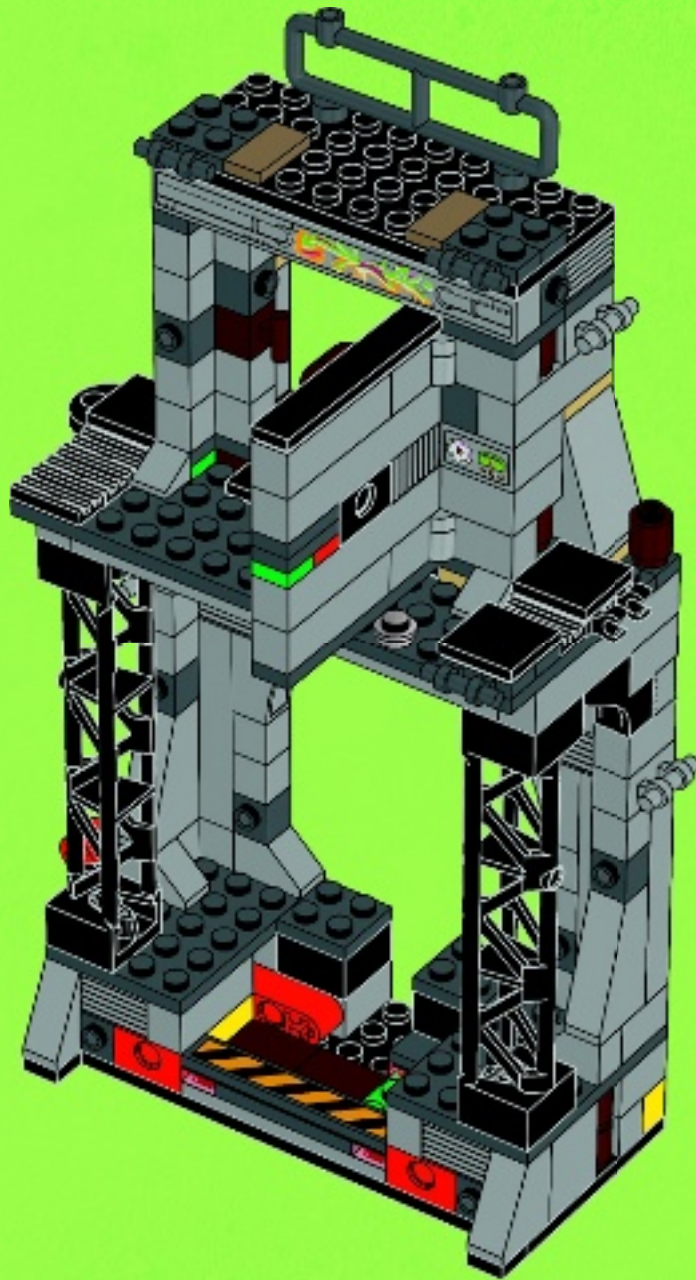



2x



1x

# 55

1



2

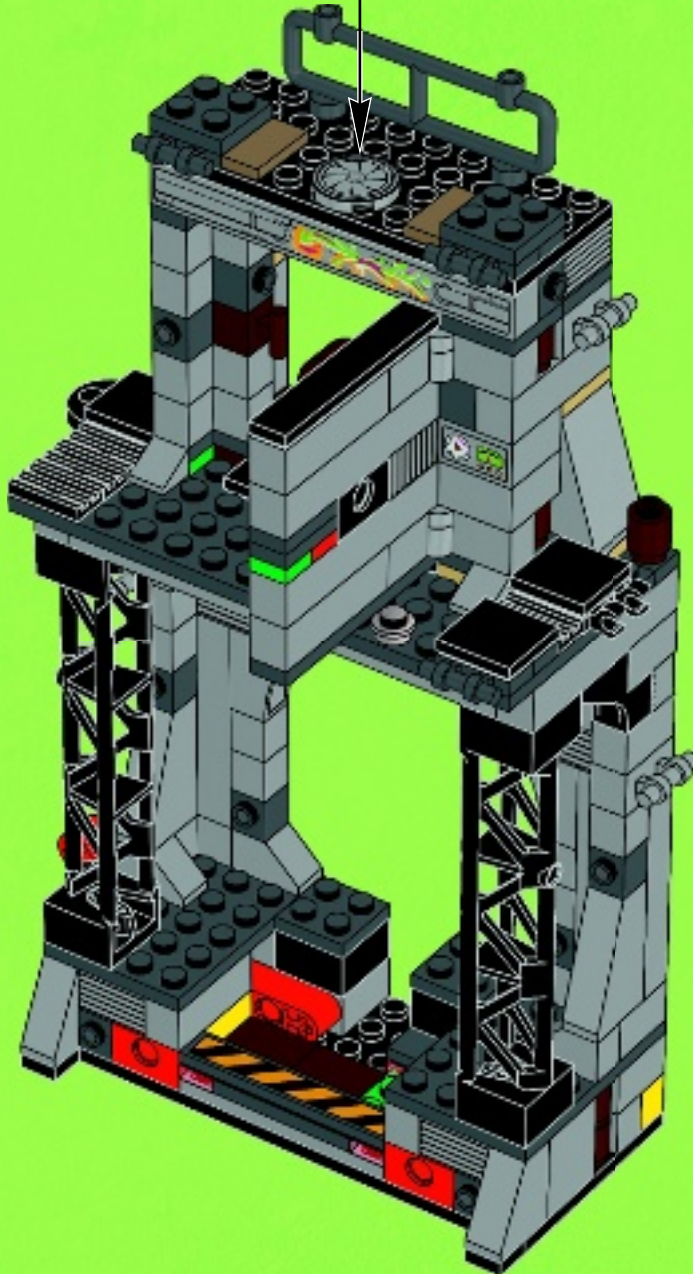
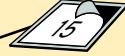



2x 4x 2x

56

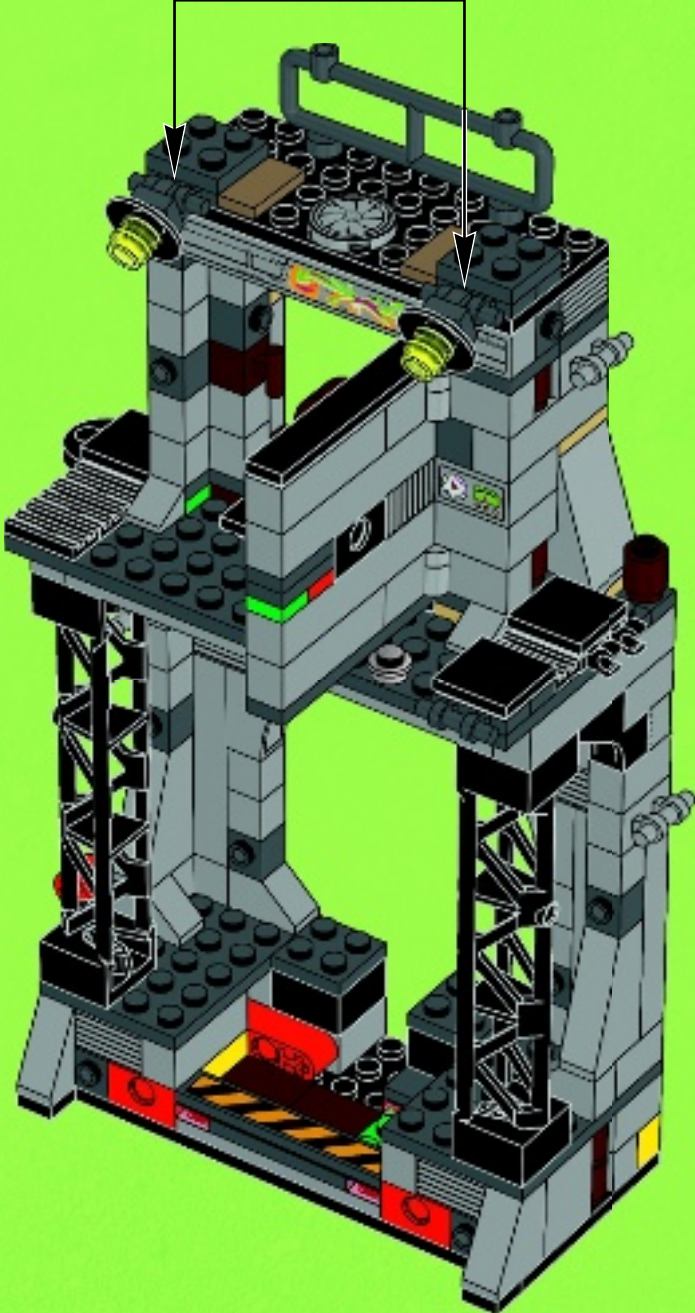
1 2 2x



2x  2x 

 2x

57

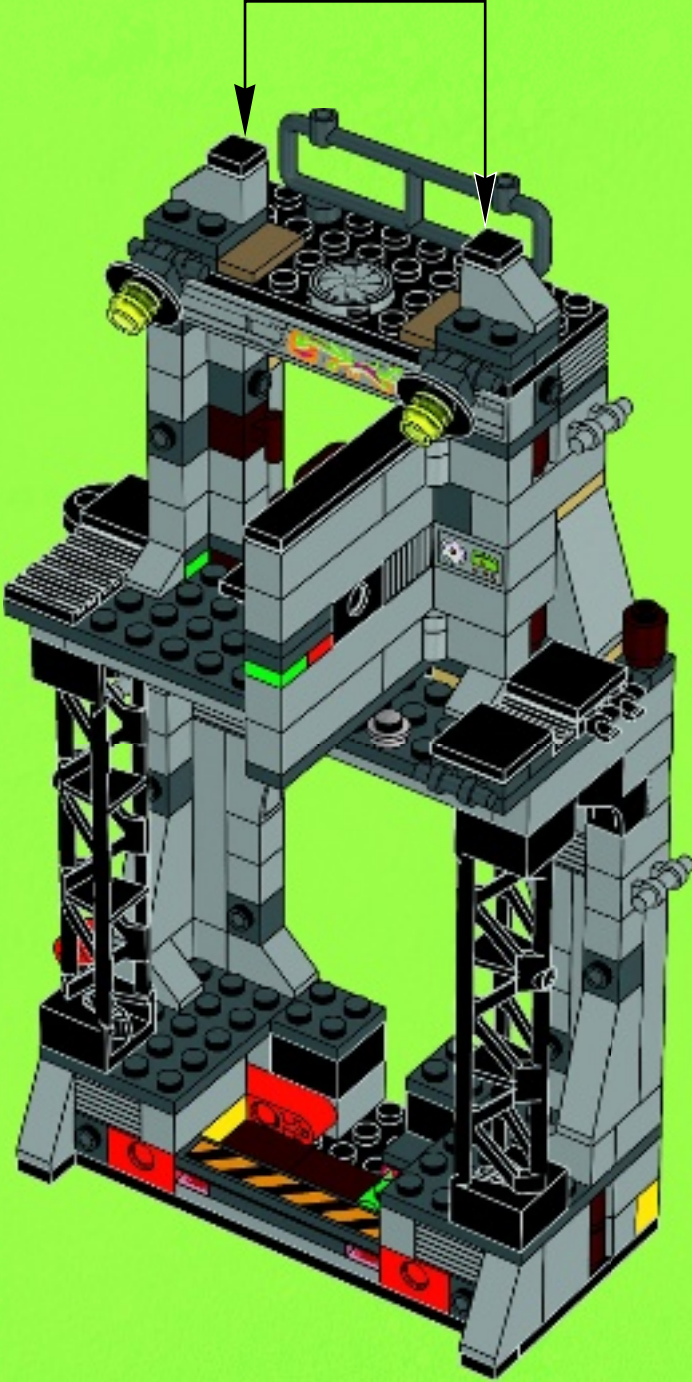

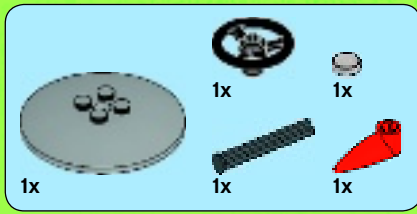

58

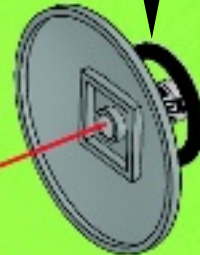
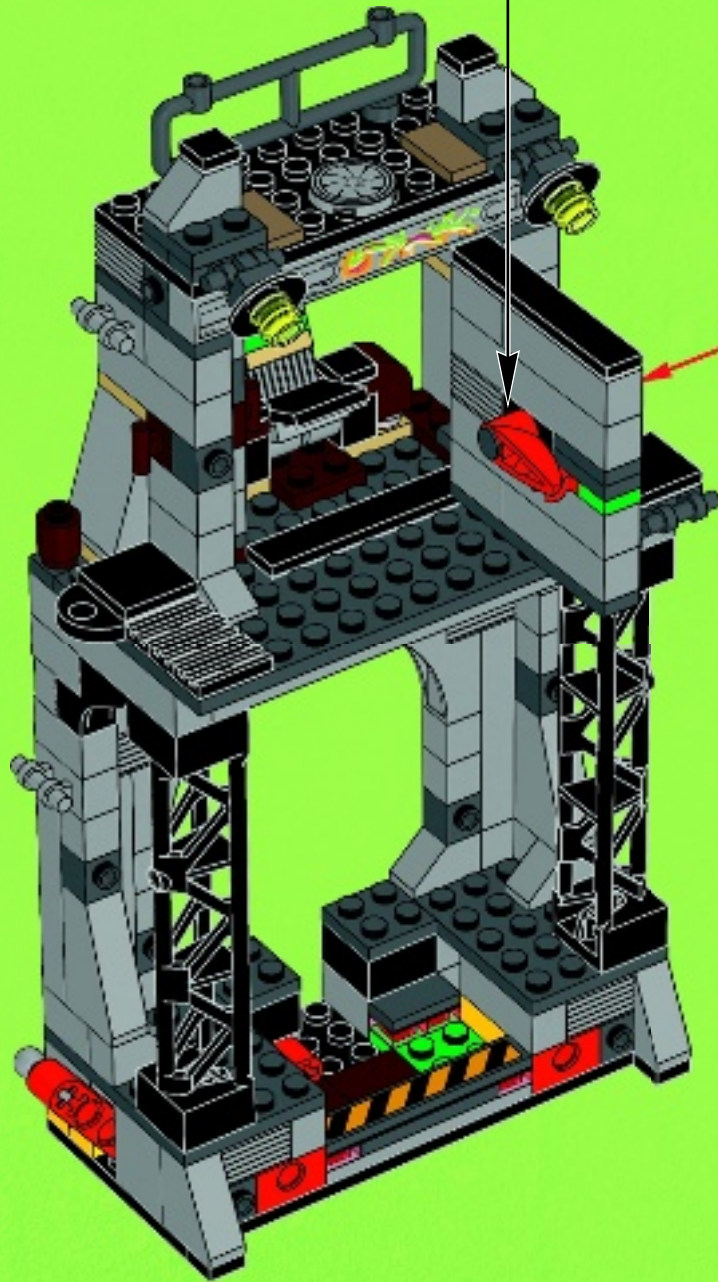
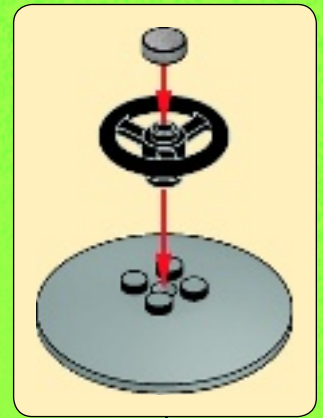
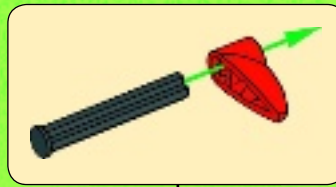

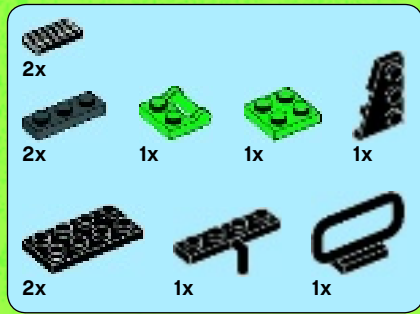

# 59

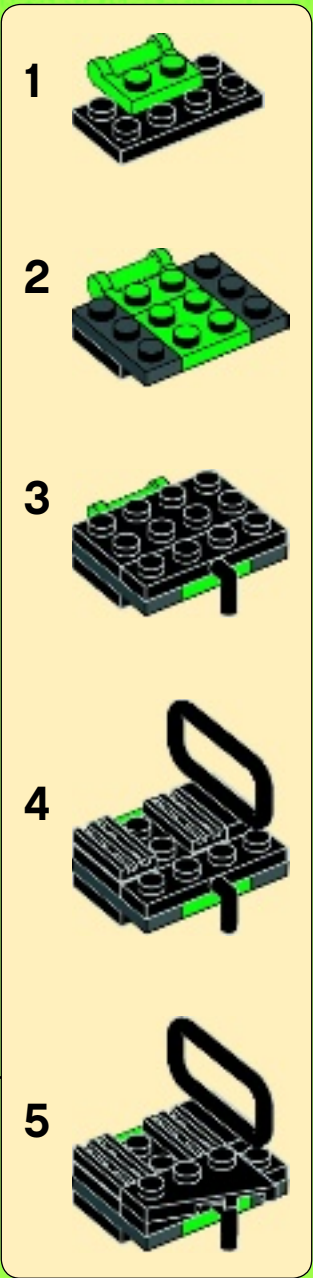
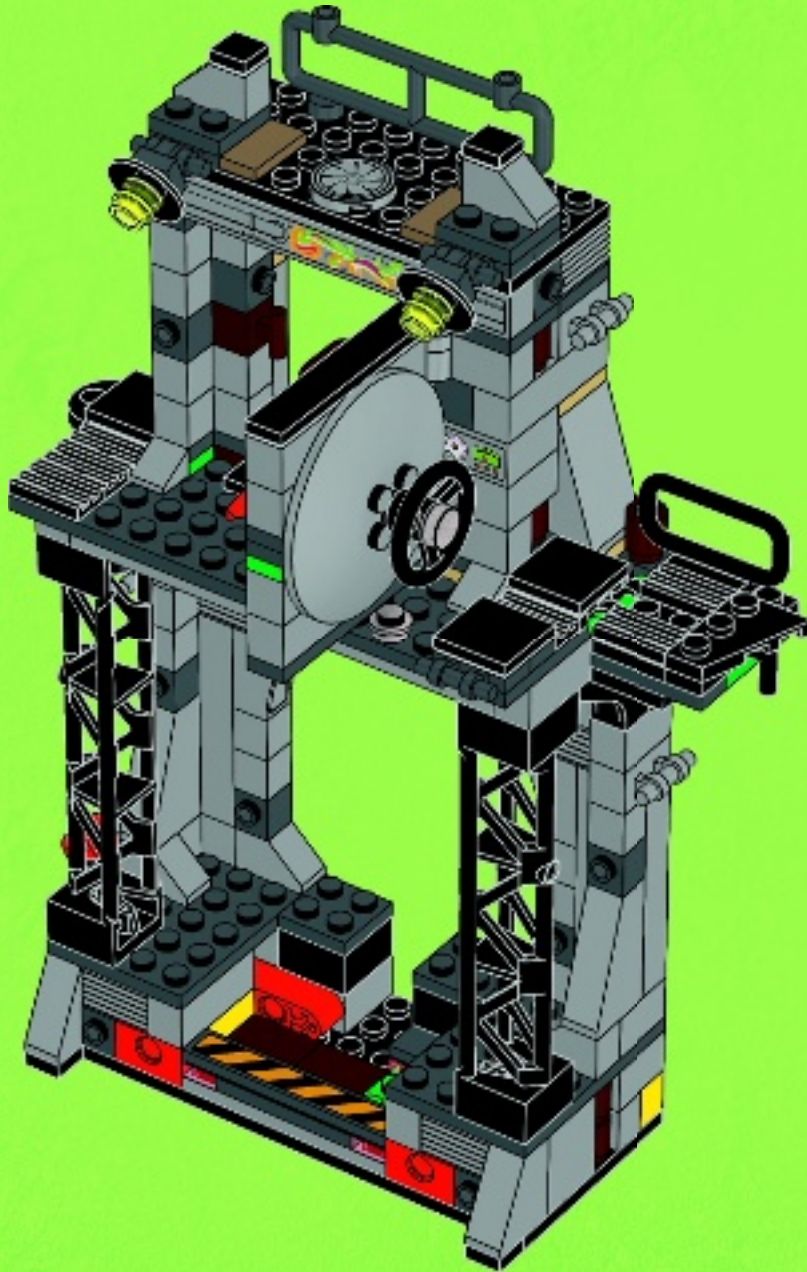

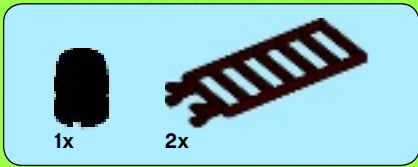

60

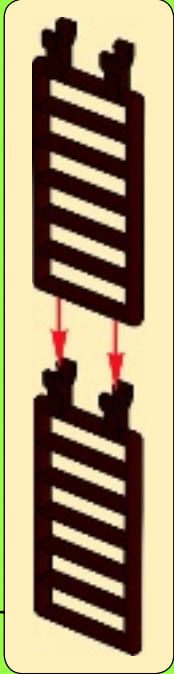
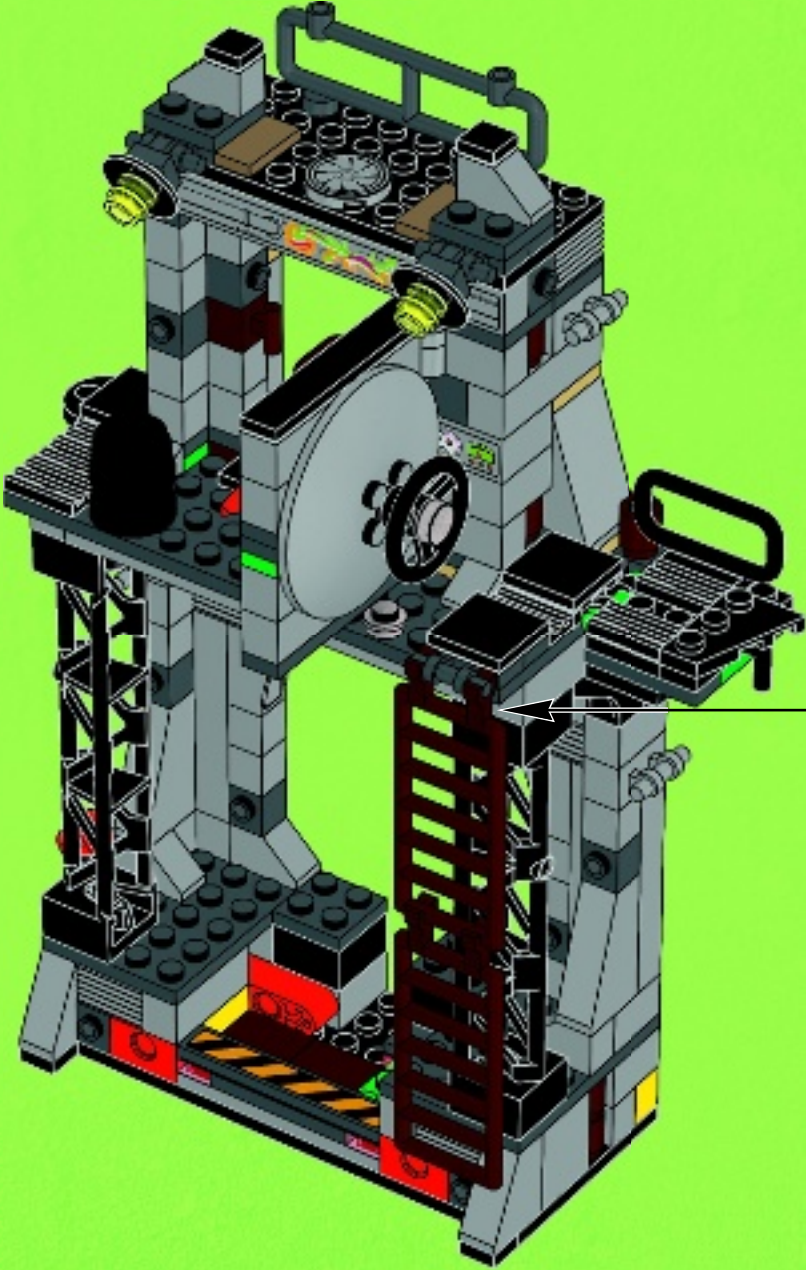



1x

# 61

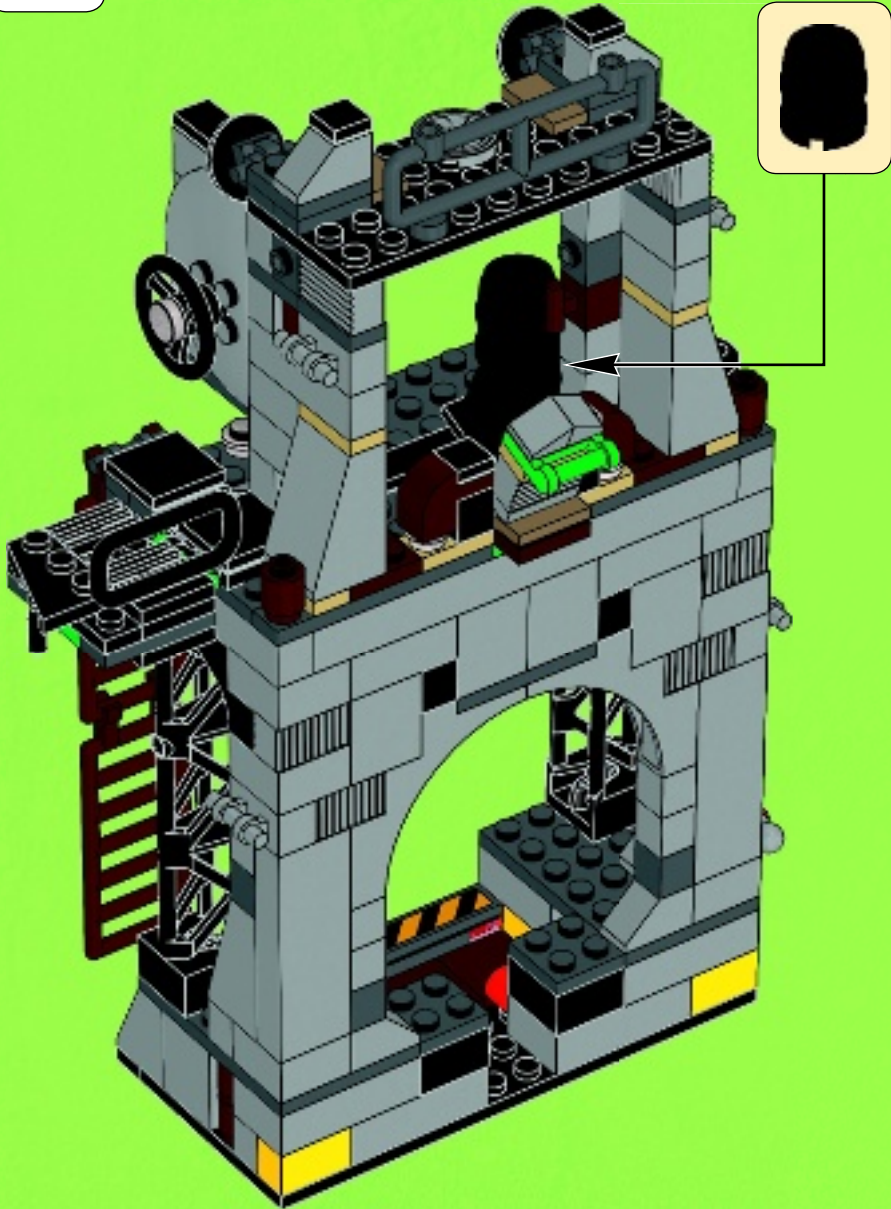



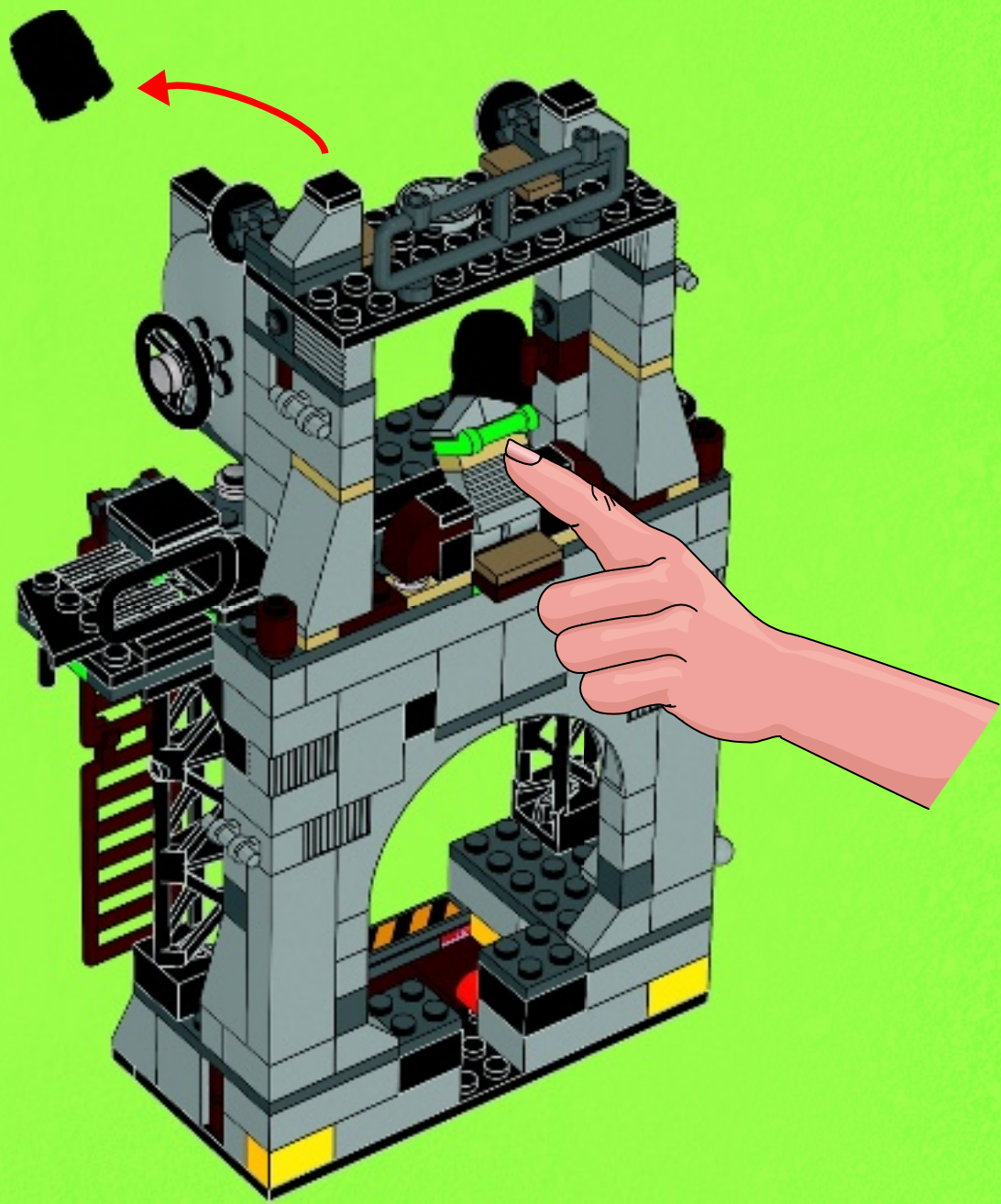

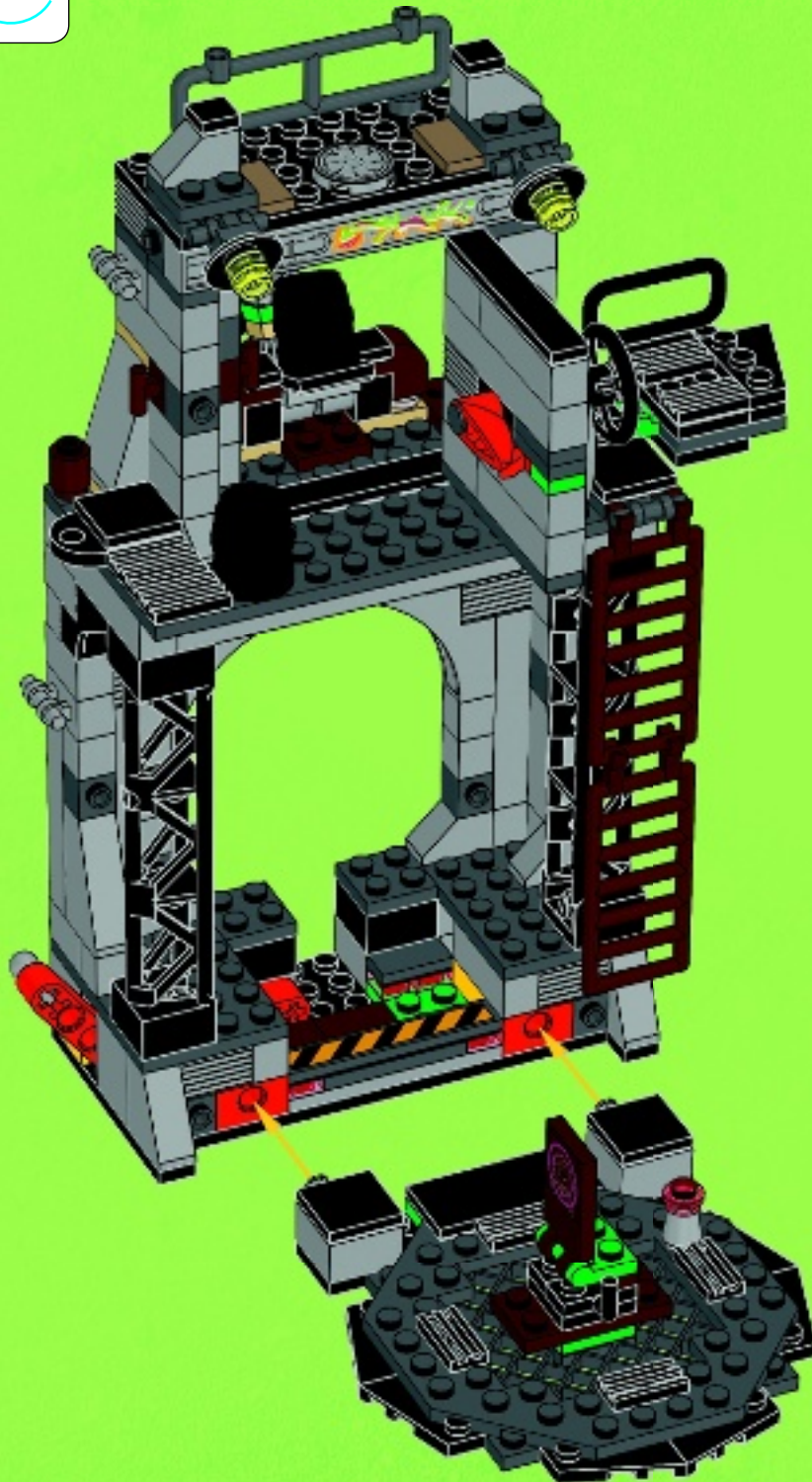

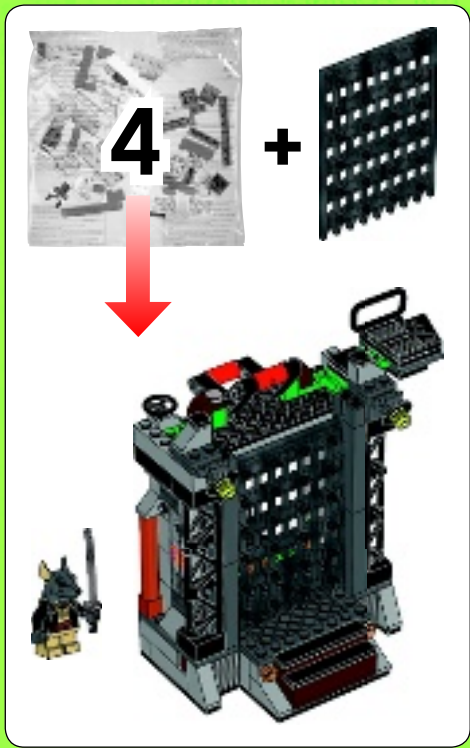

1

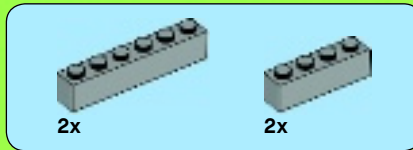

2

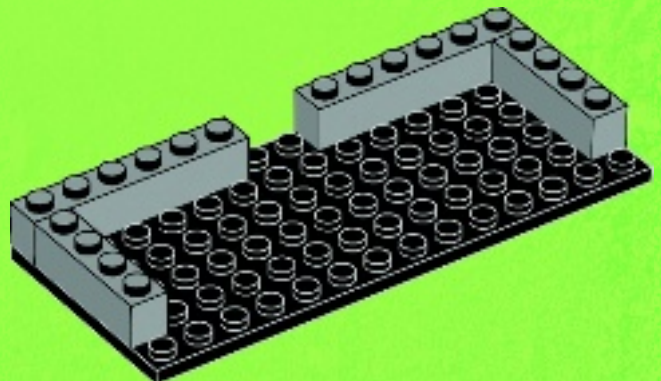

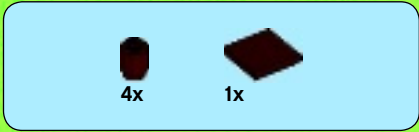

3

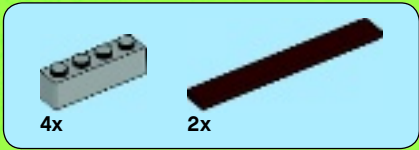
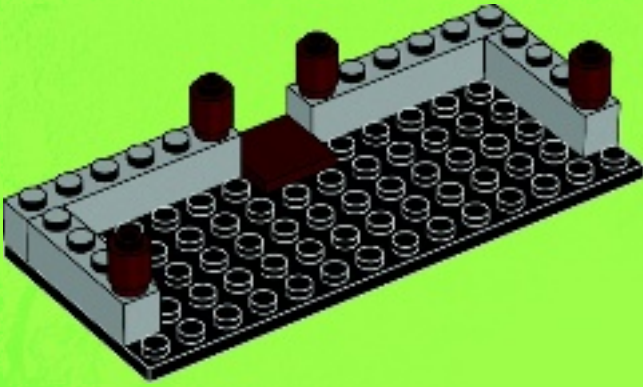

4

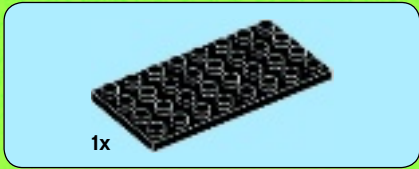
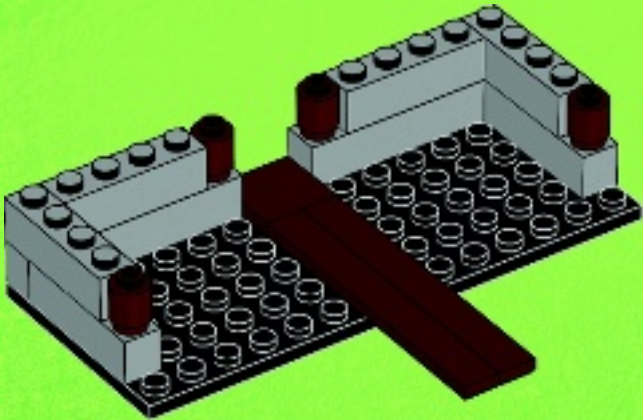

5

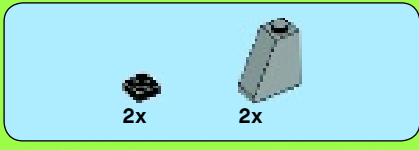
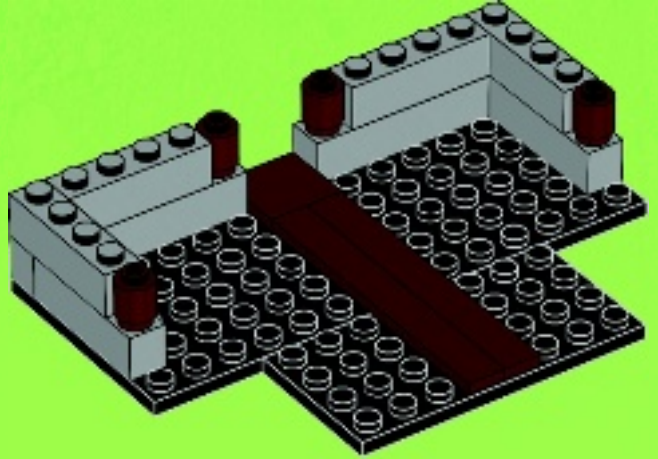

6

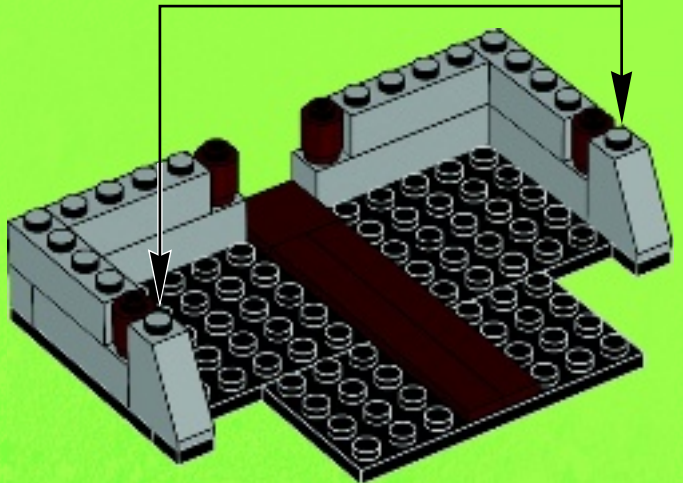
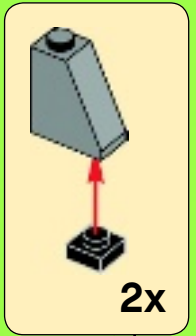

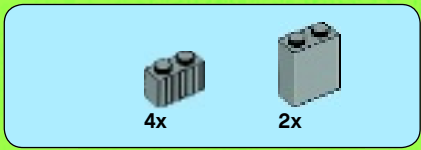

7

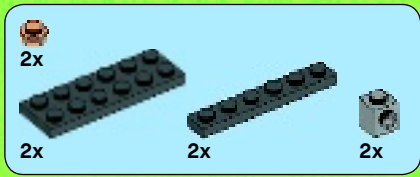
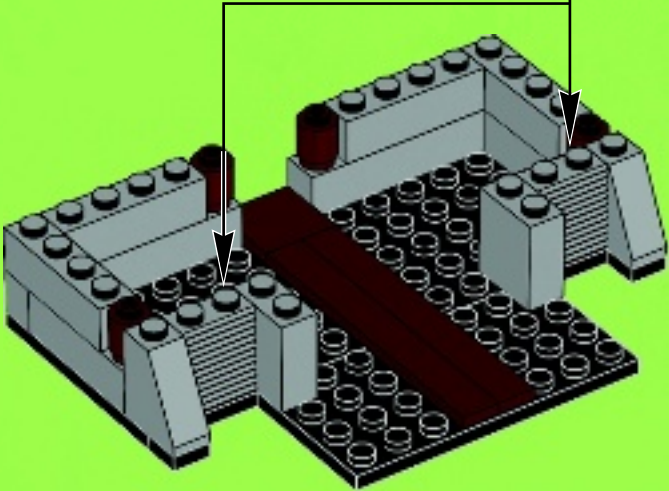
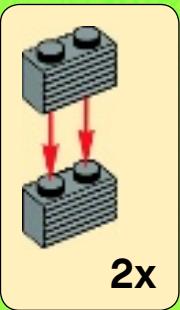

9

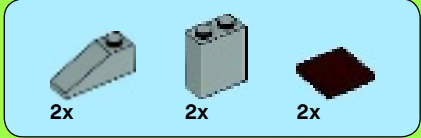
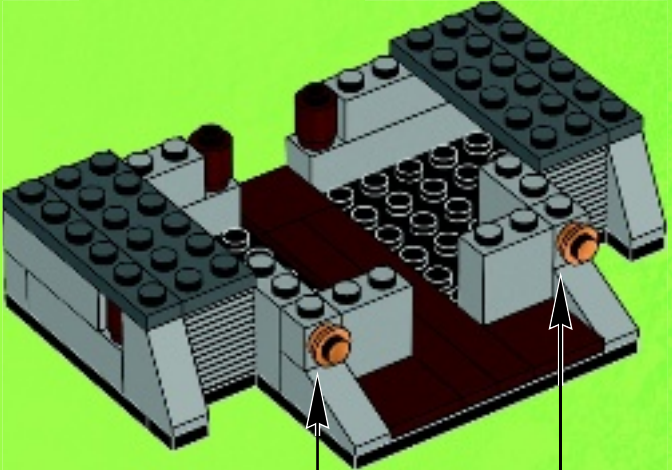

8

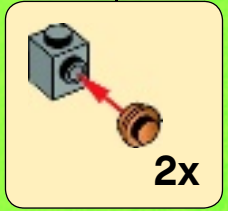
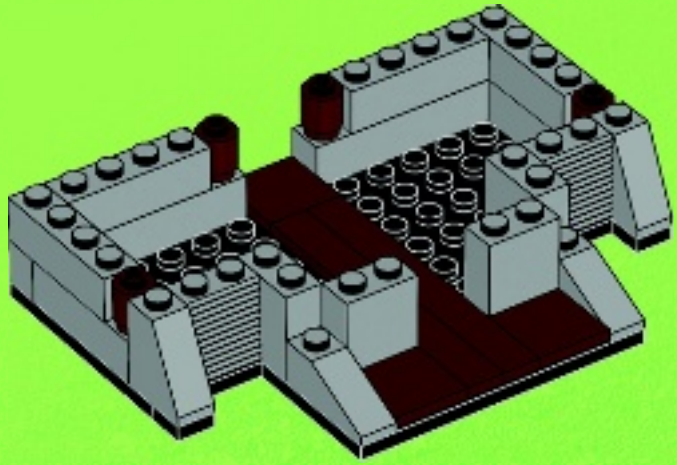

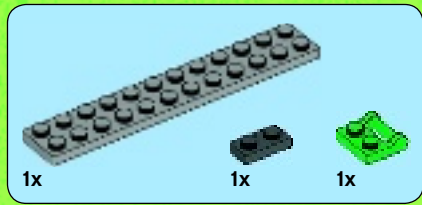

1

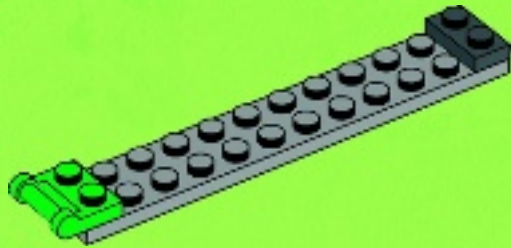

2

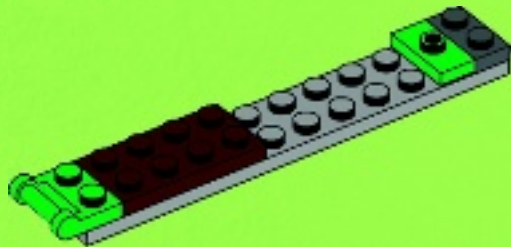

3

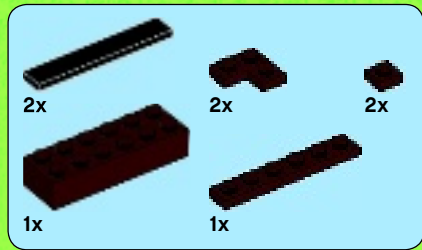
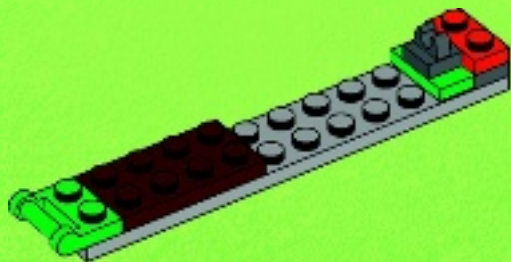

4

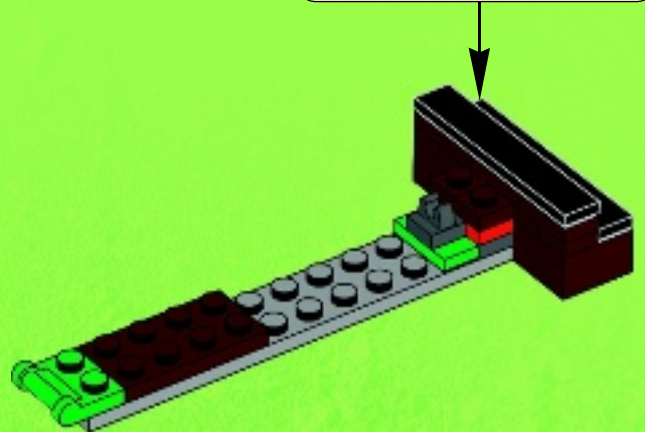
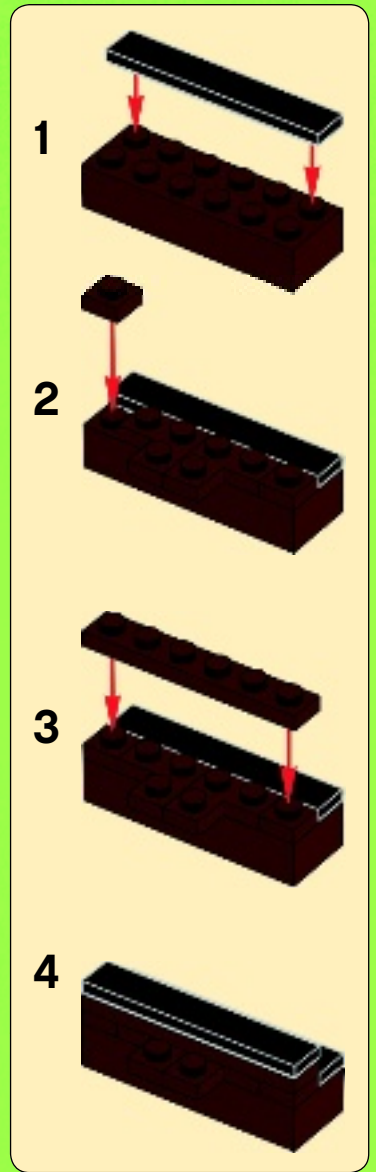



5

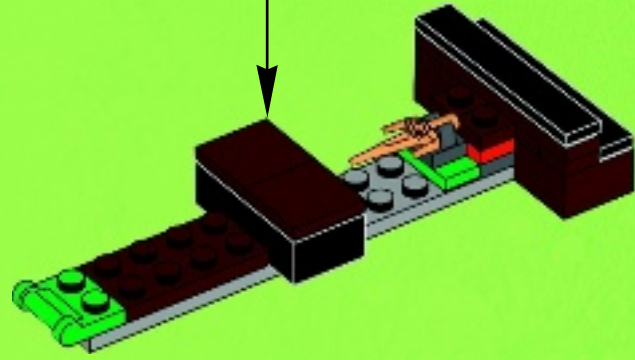
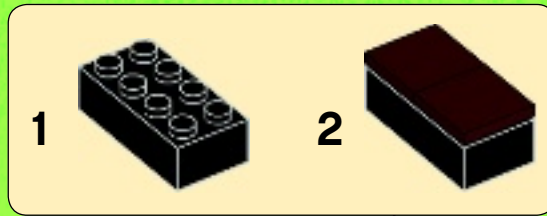

10

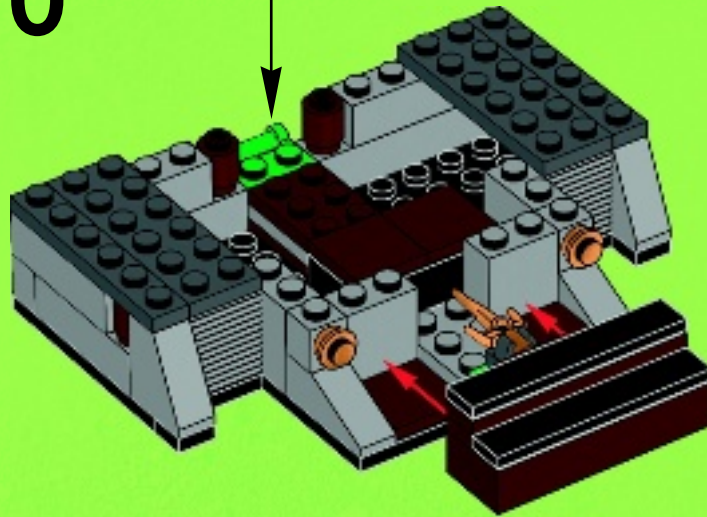



1x

# 11

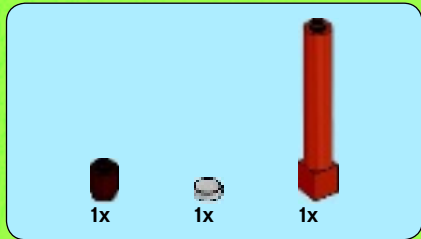
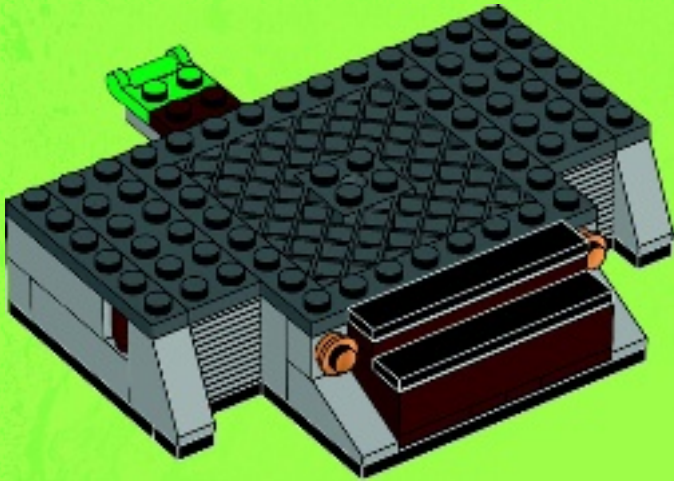

1x

1x

1x

# 12

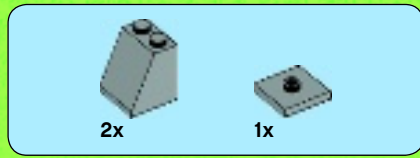
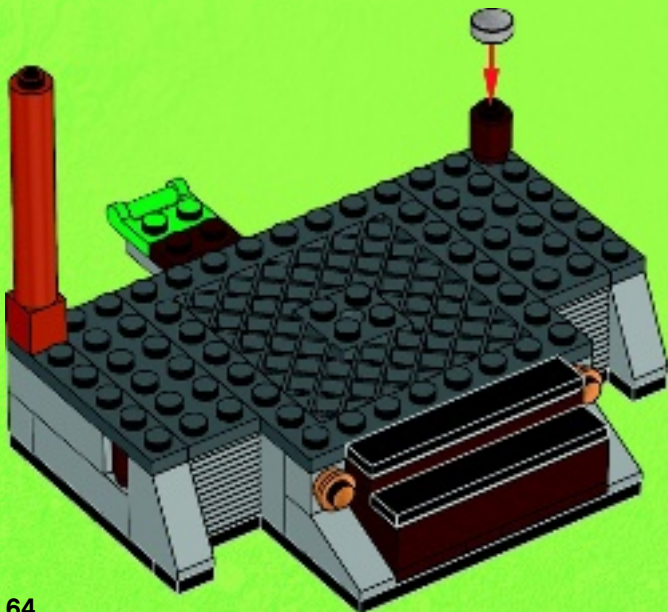

2x

1x

# 13

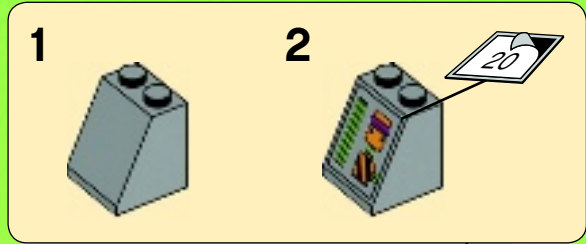

1

2

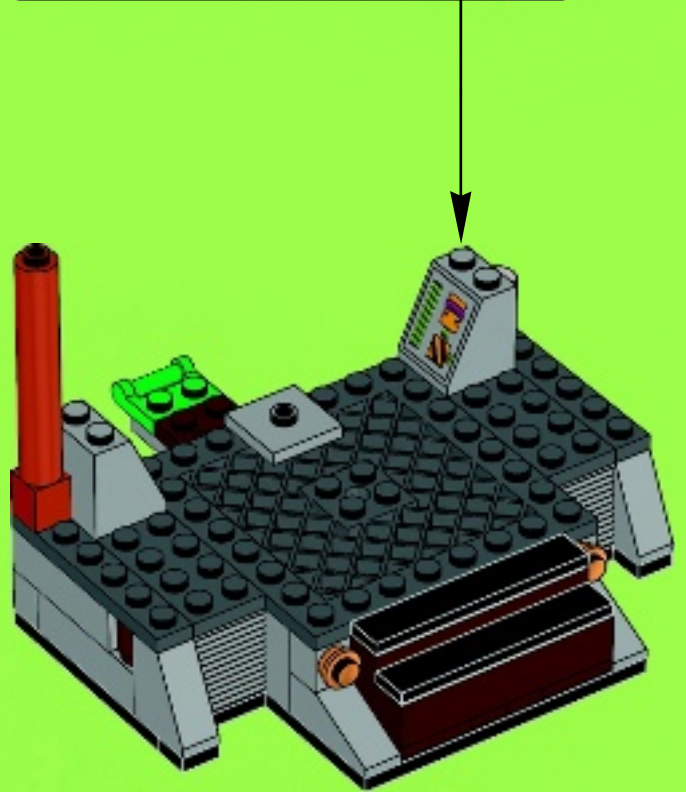





2x

# 14

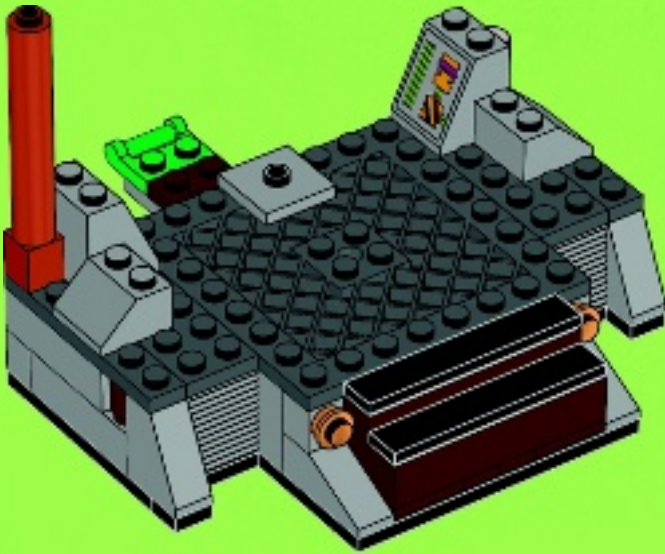

2x



2x

# 15

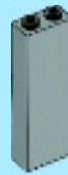

3x



1x



1x

# 16

1



2

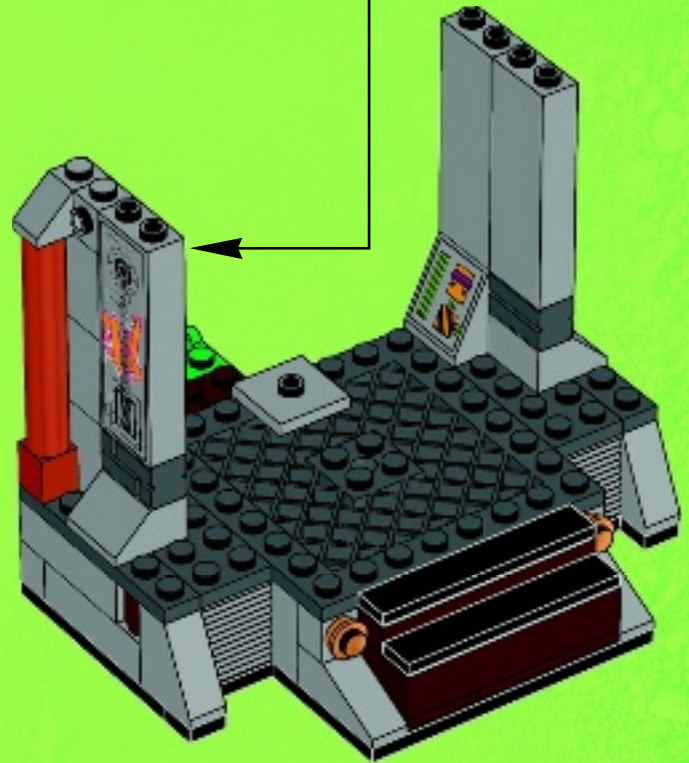

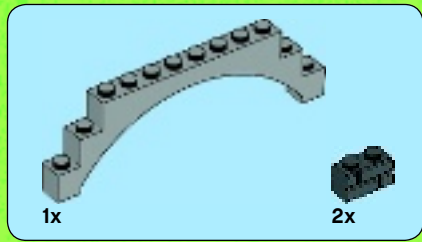

17

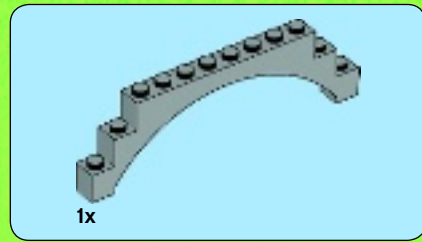
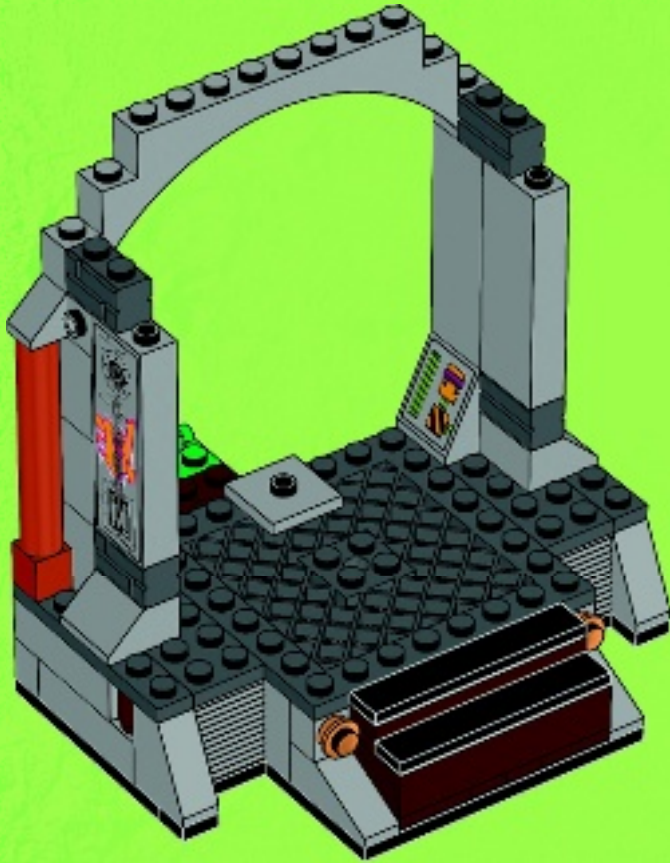

18

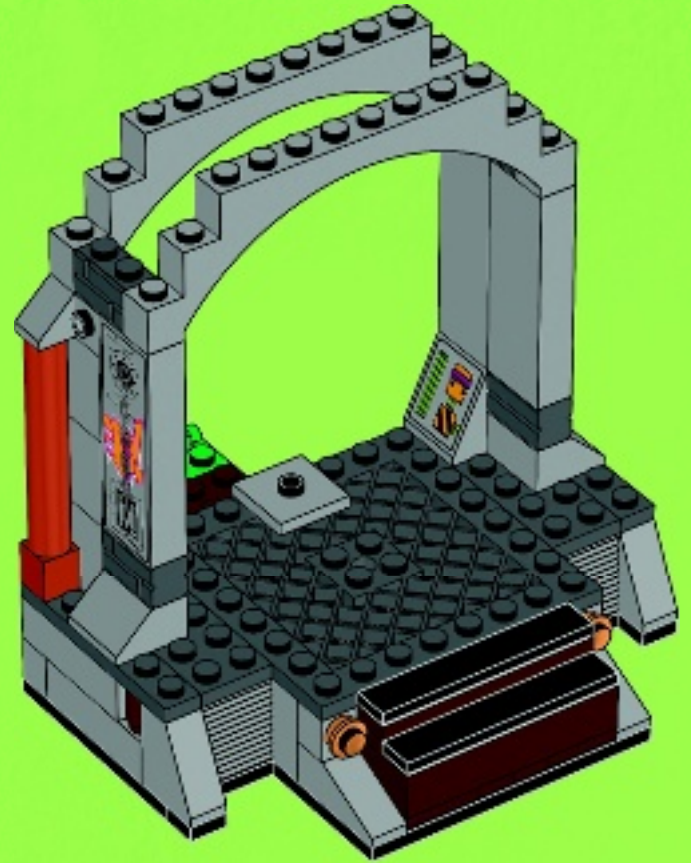



2x



4x

# 19

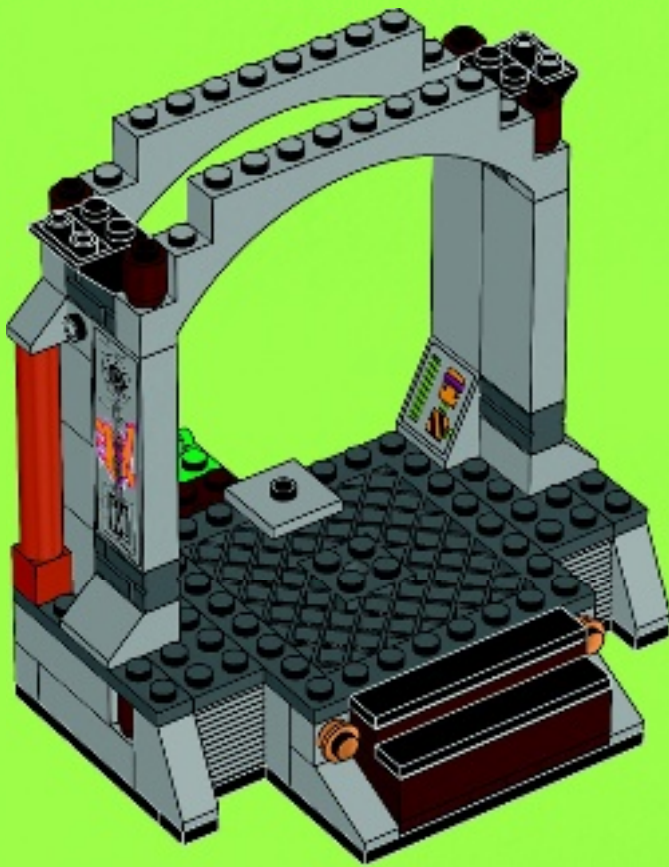

2x



2x

# 20

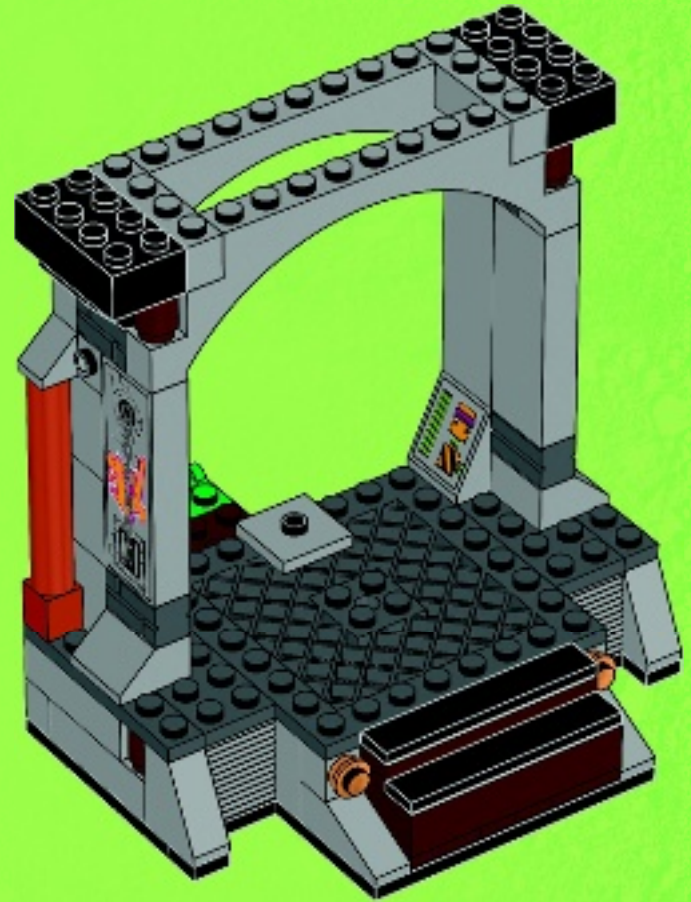

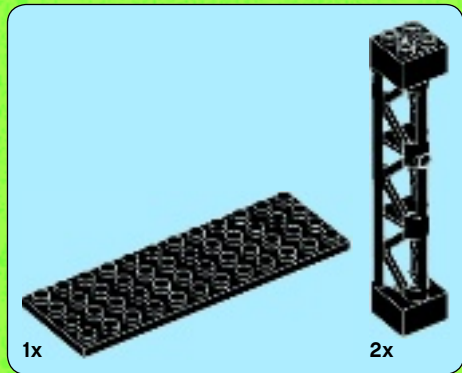

21

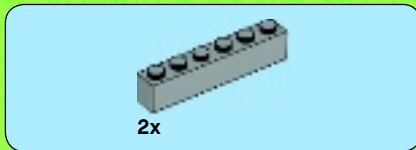
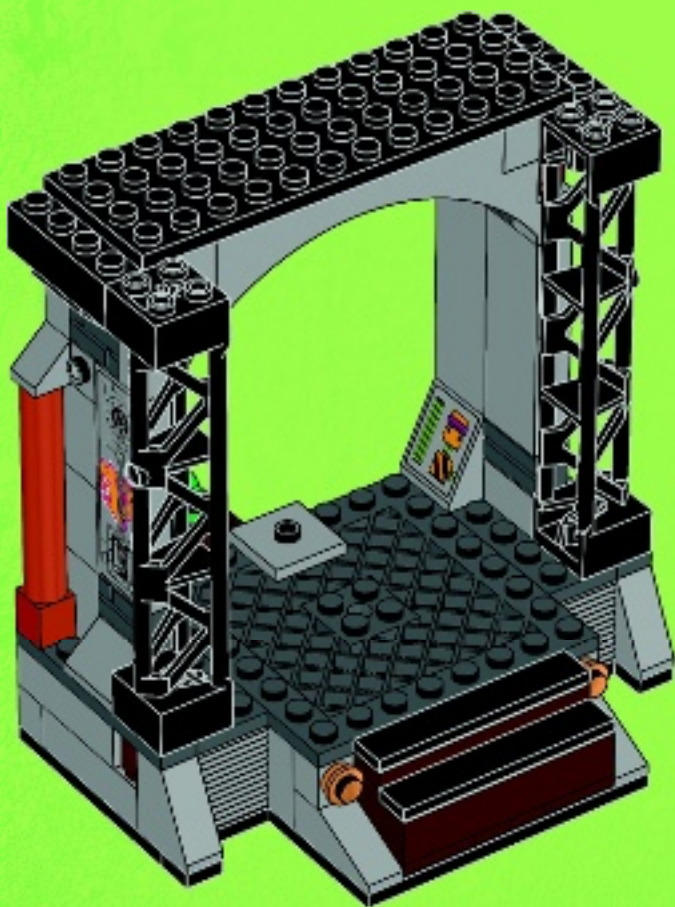

22

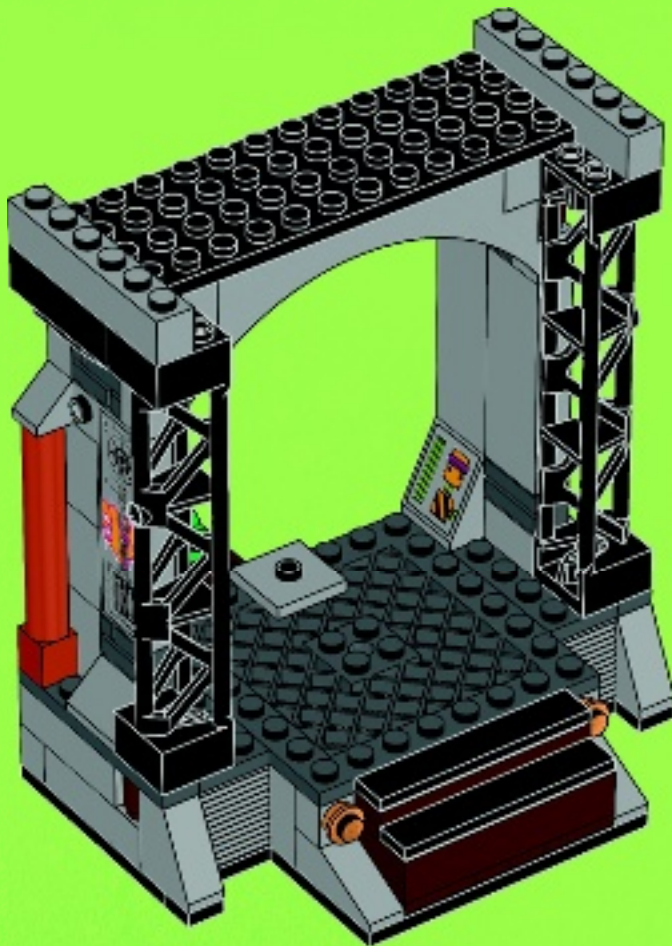



# 23

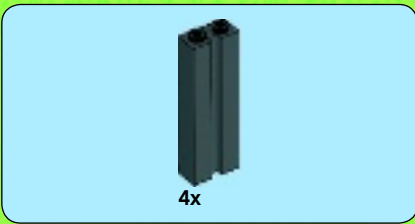
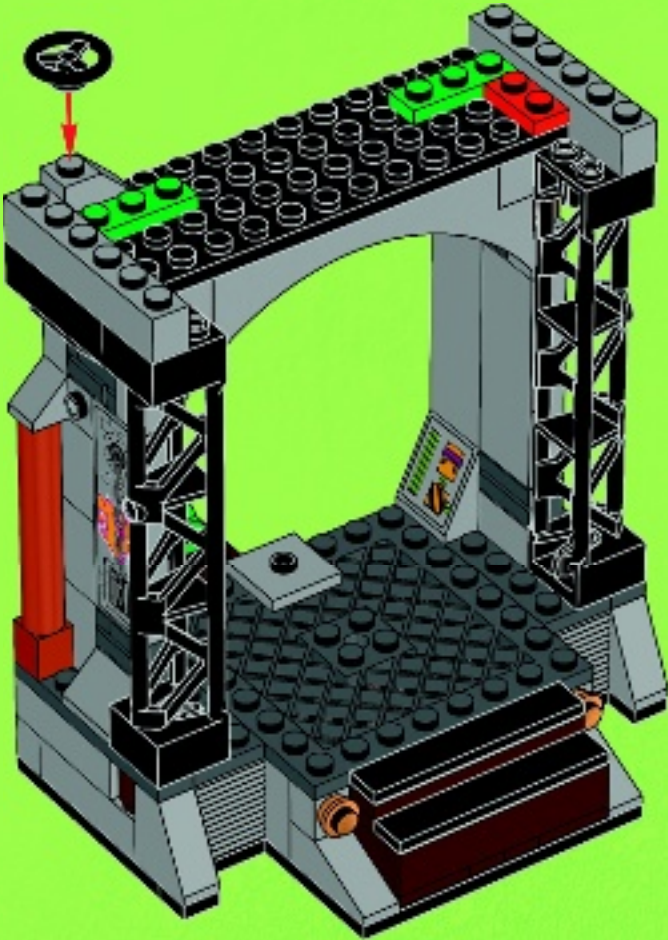

# 24

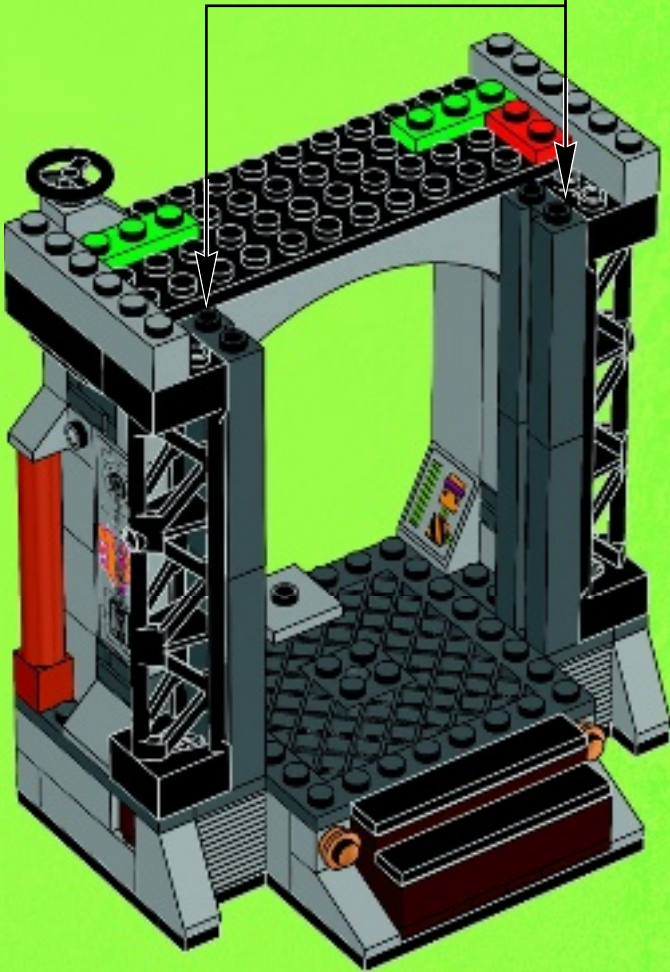
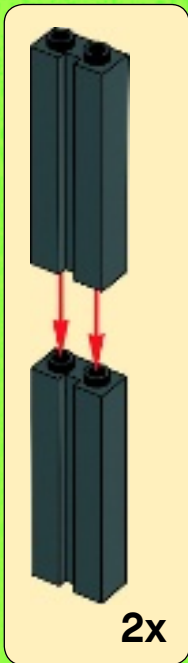

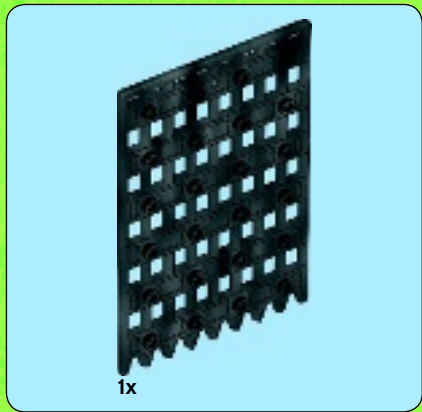

25

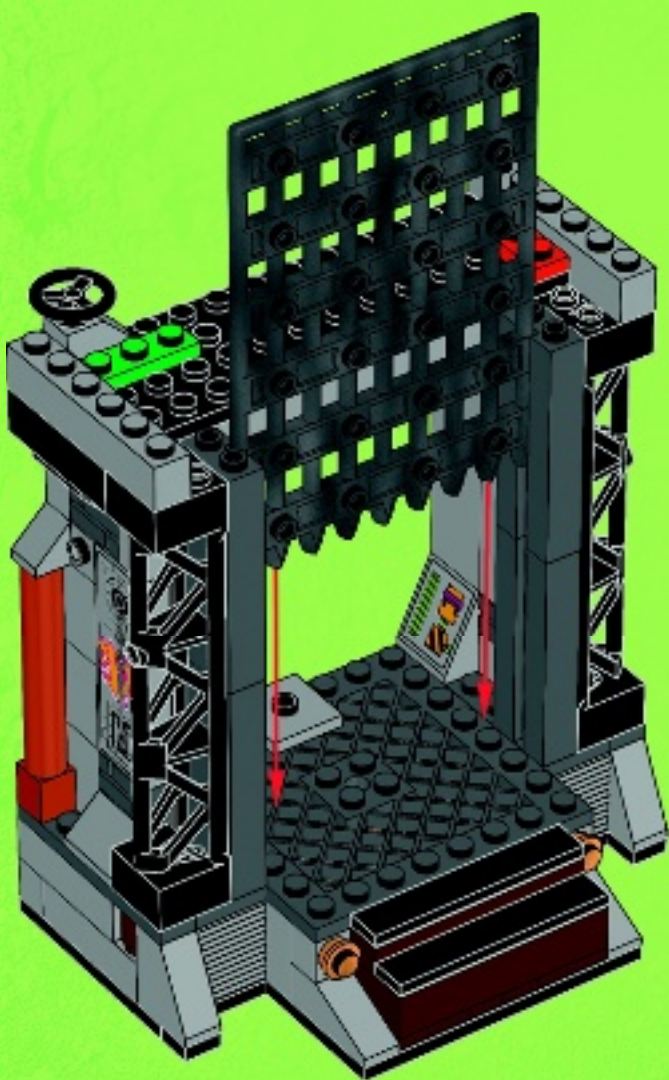

26

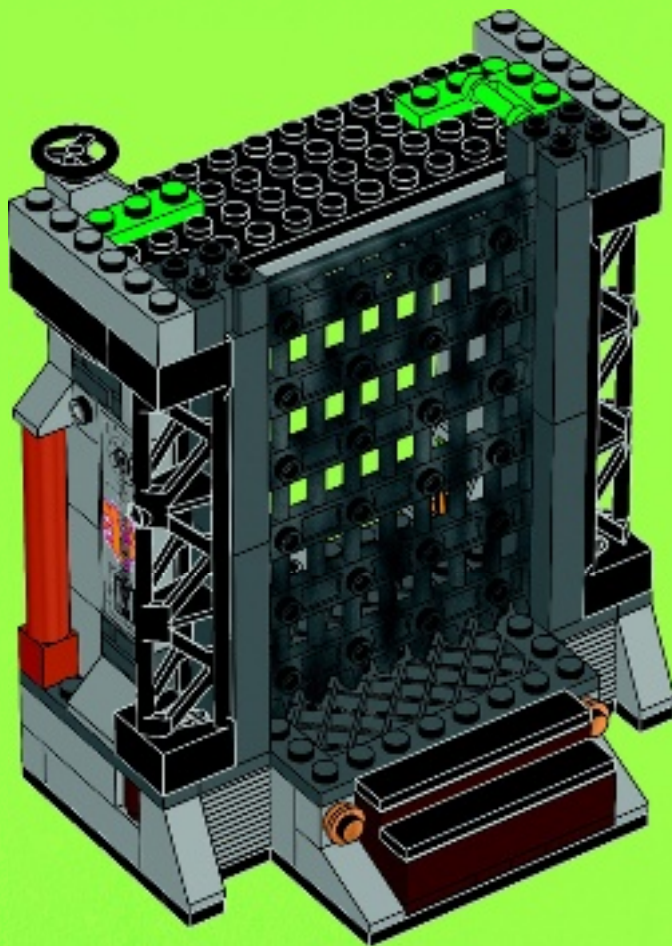

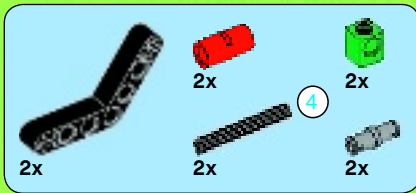

27

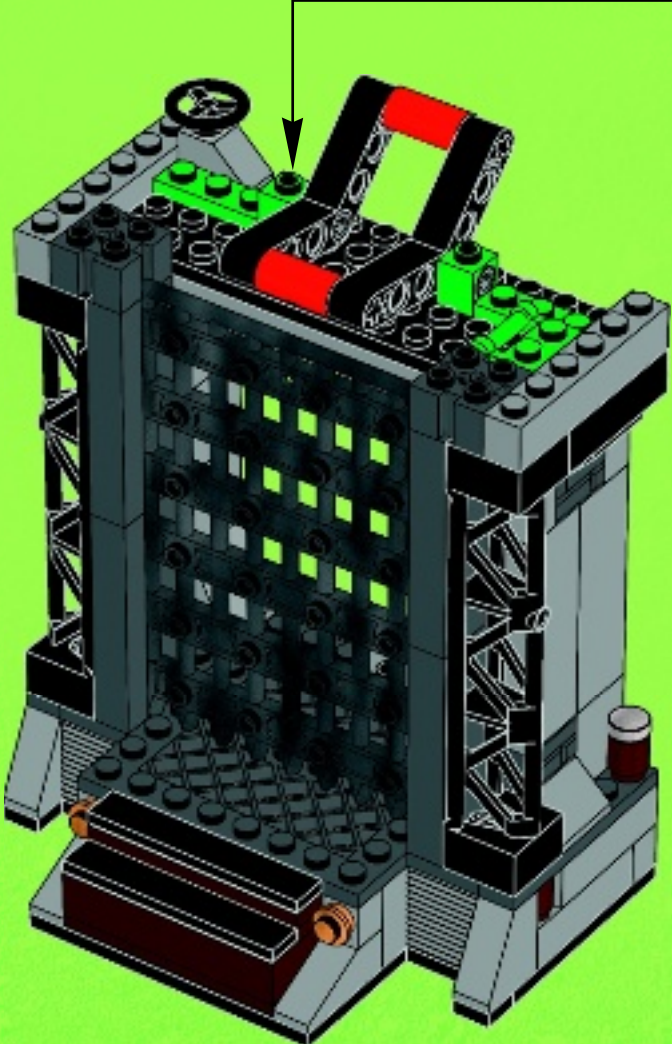
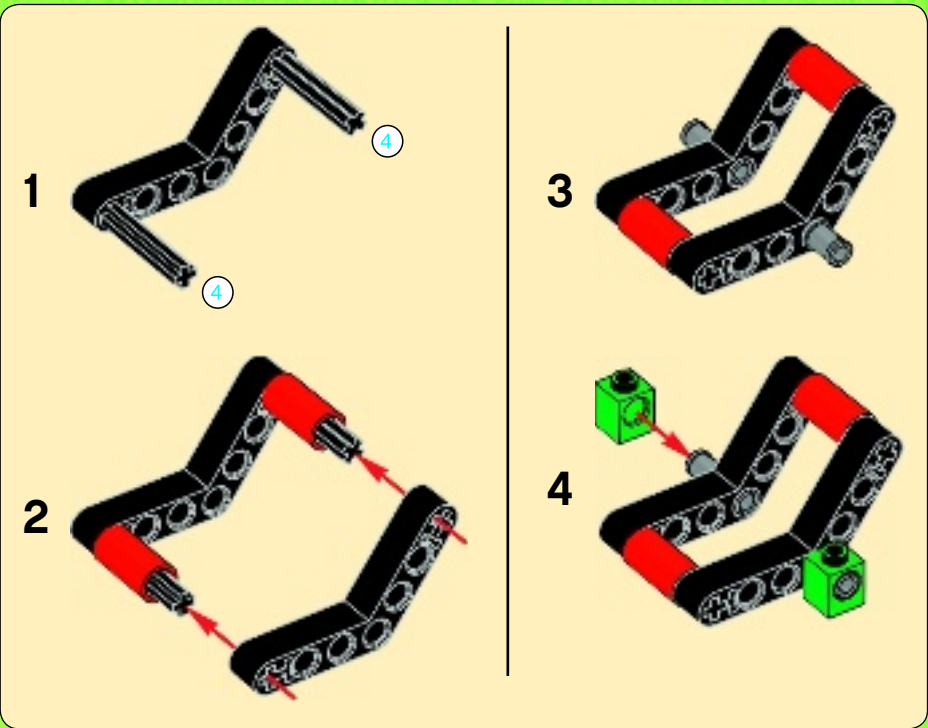

2x

2x

# 28

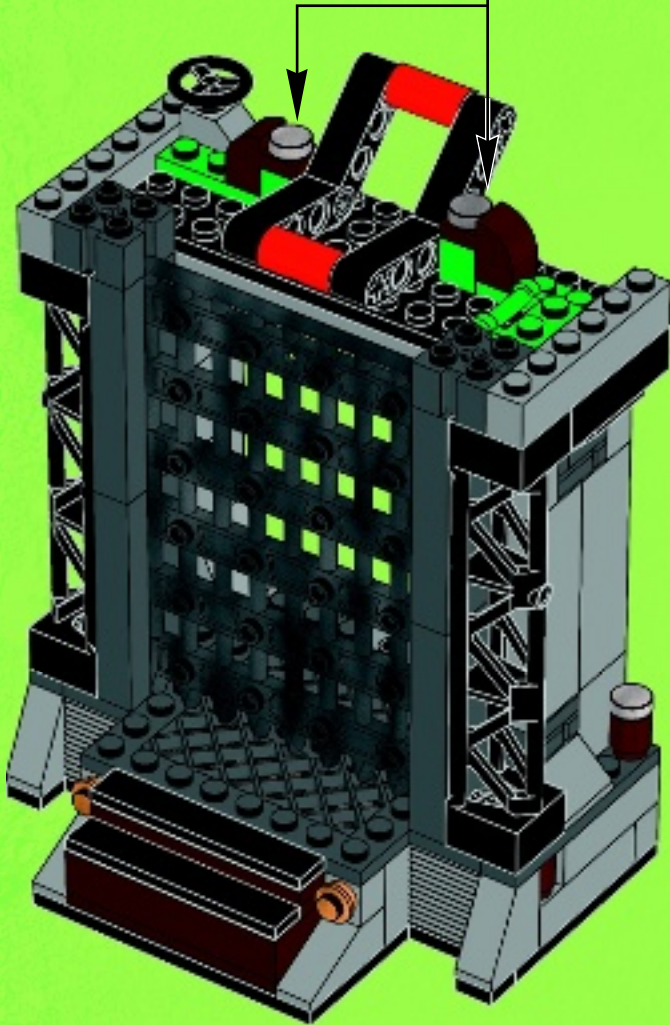

1x

2x

2x

# 29

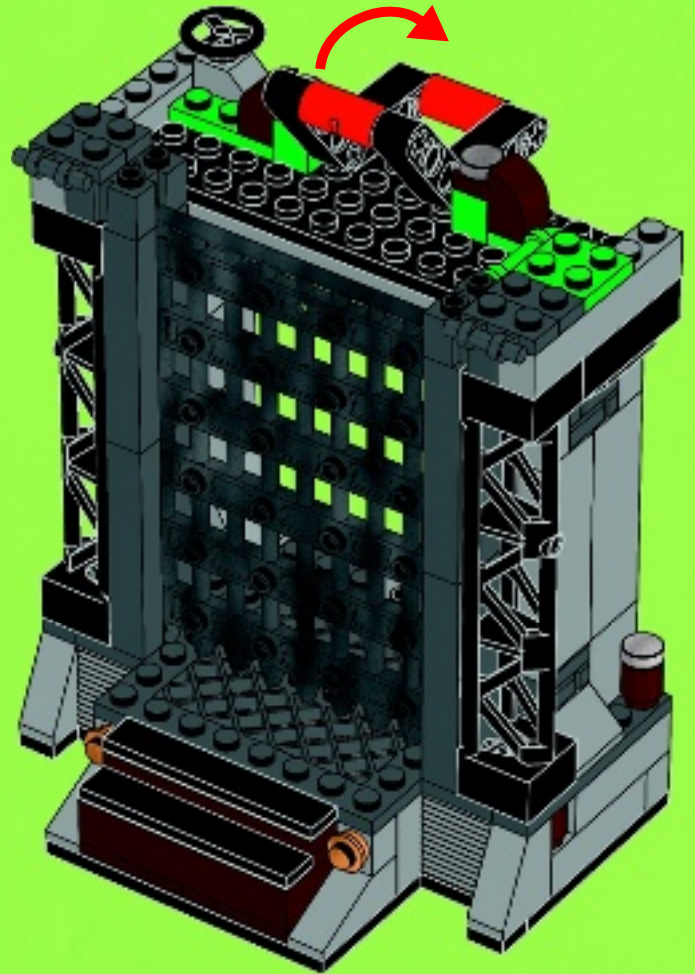





2x



2x

# 30

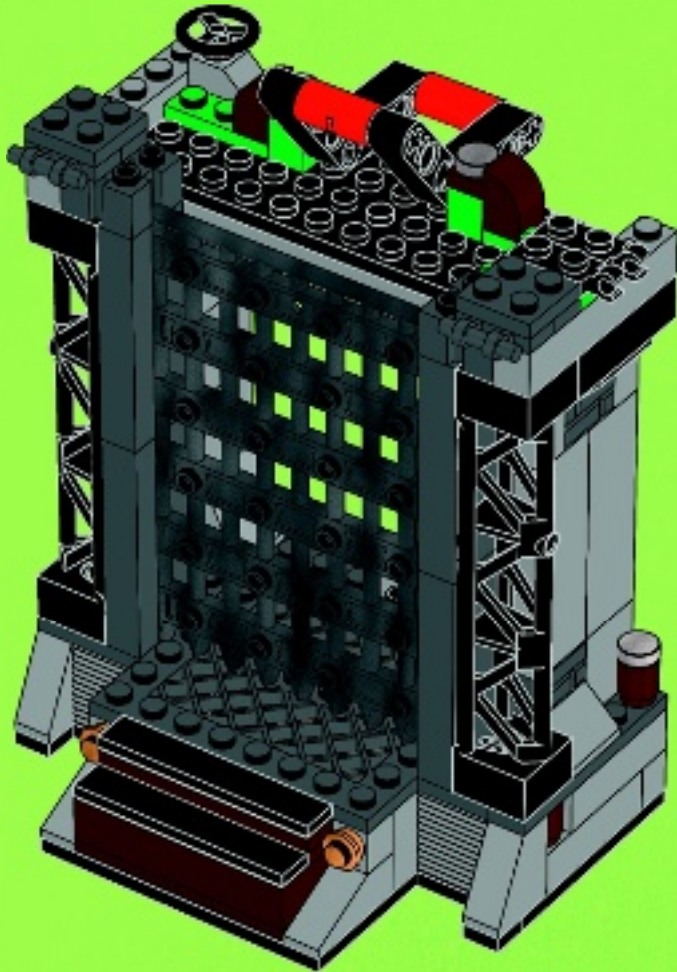

1x



2x



4x



2x

# 31

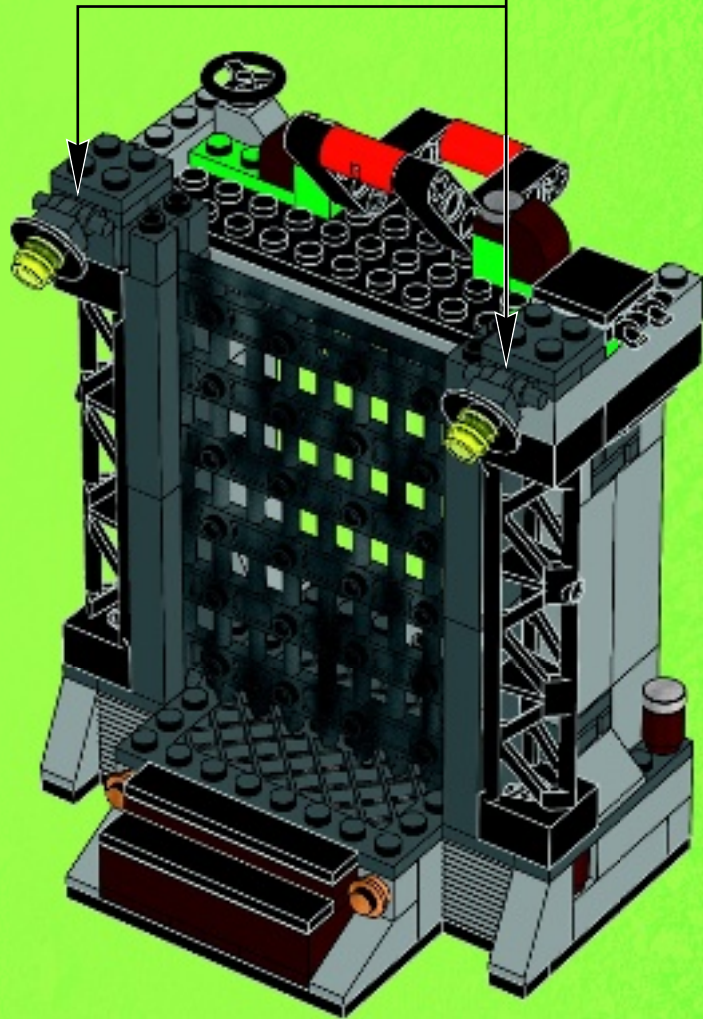
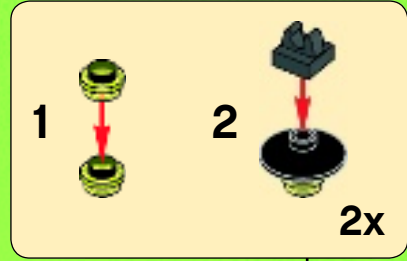



2x



2x

# 32

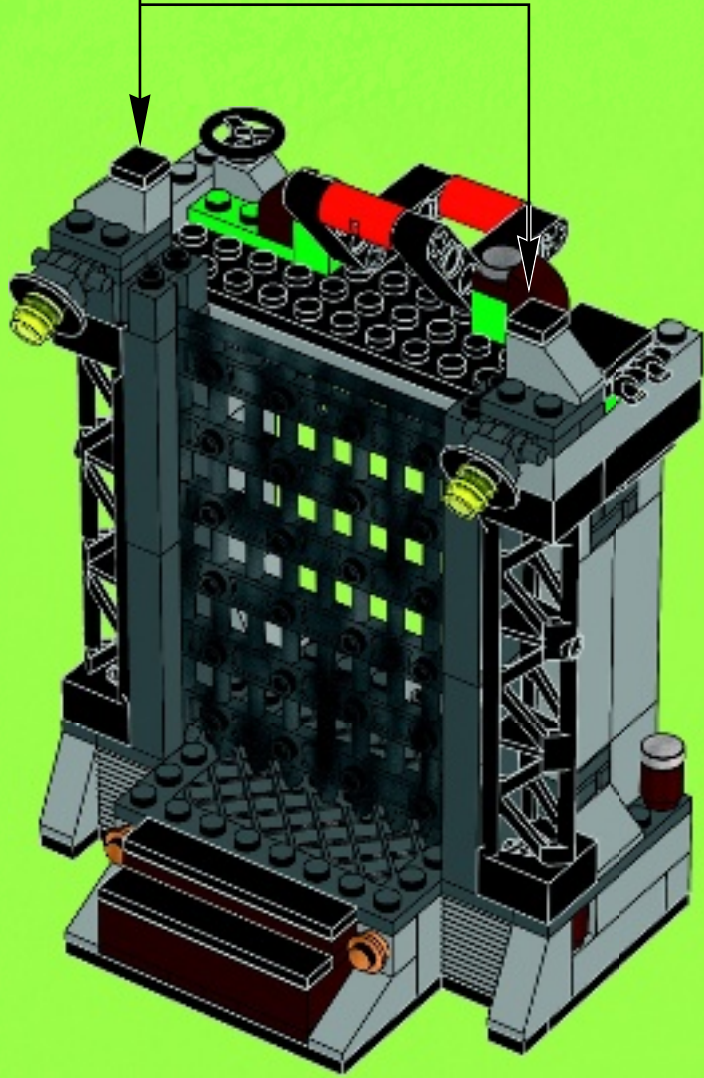
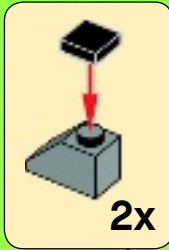

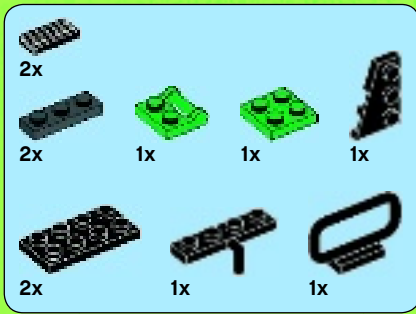

# 33

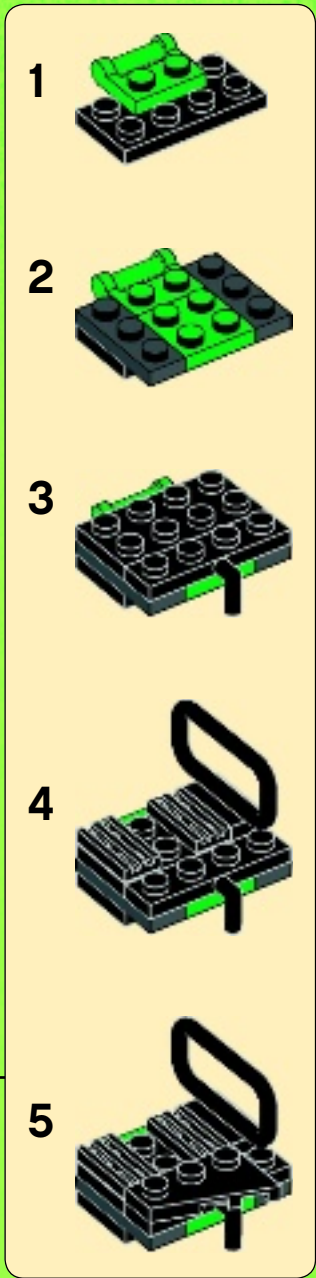
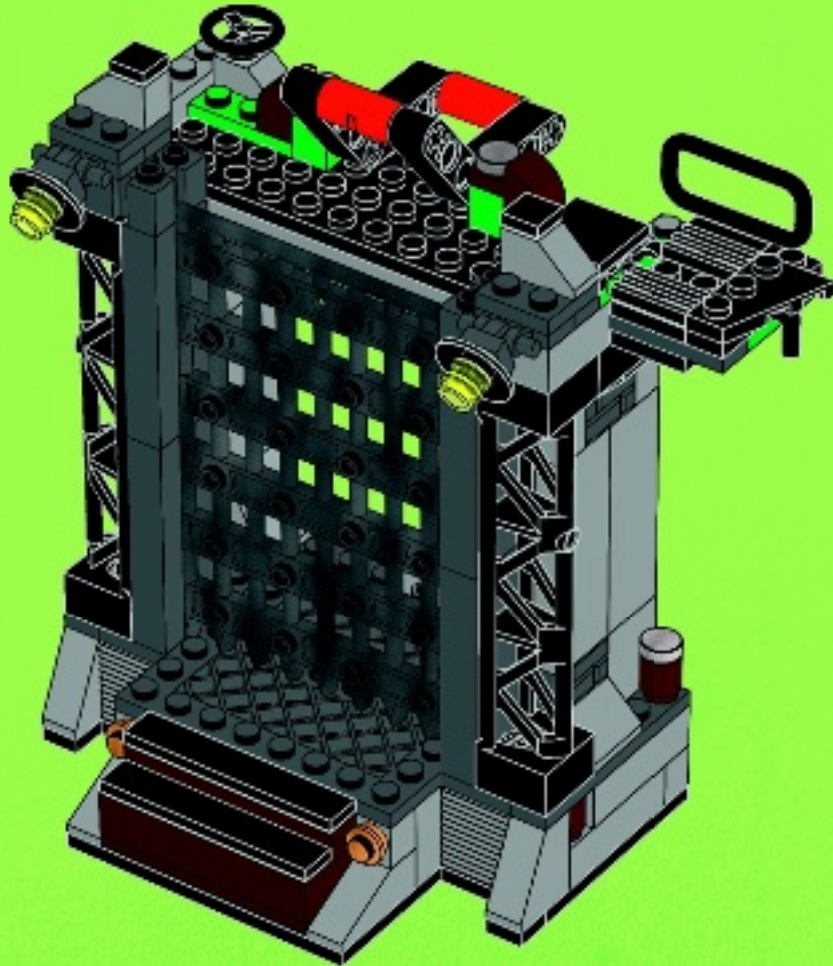

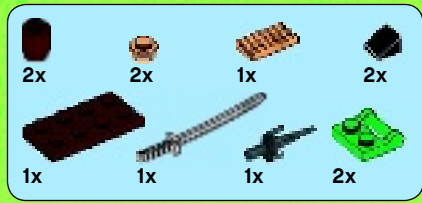

# 34

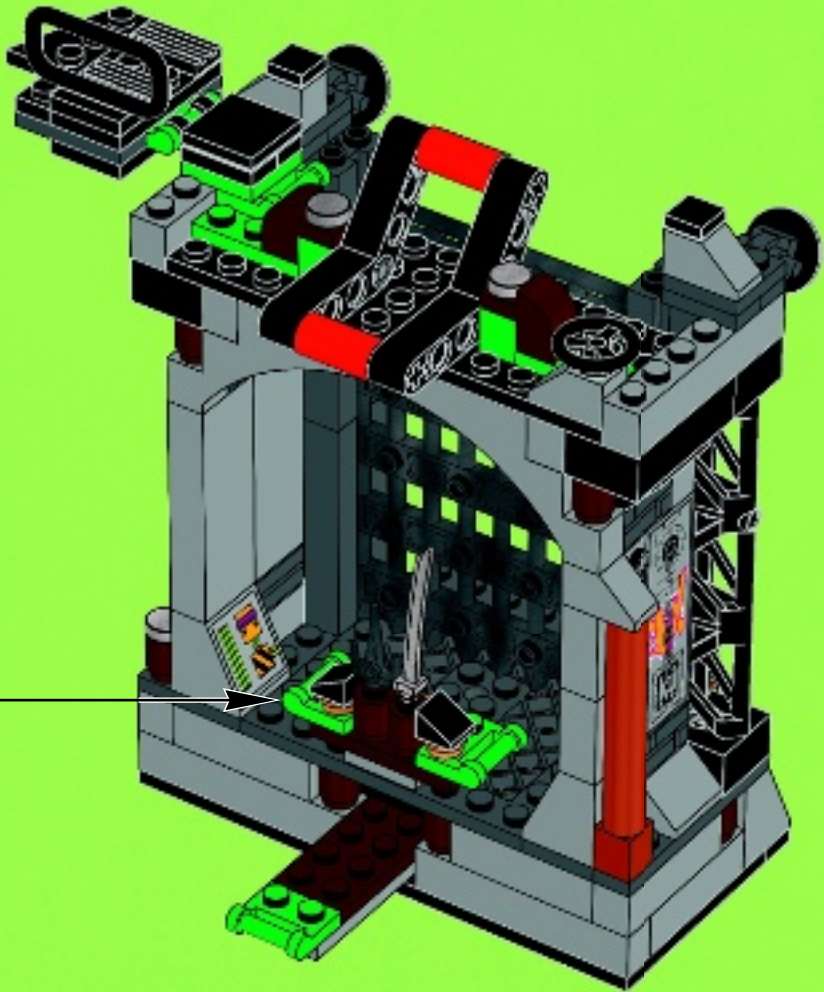
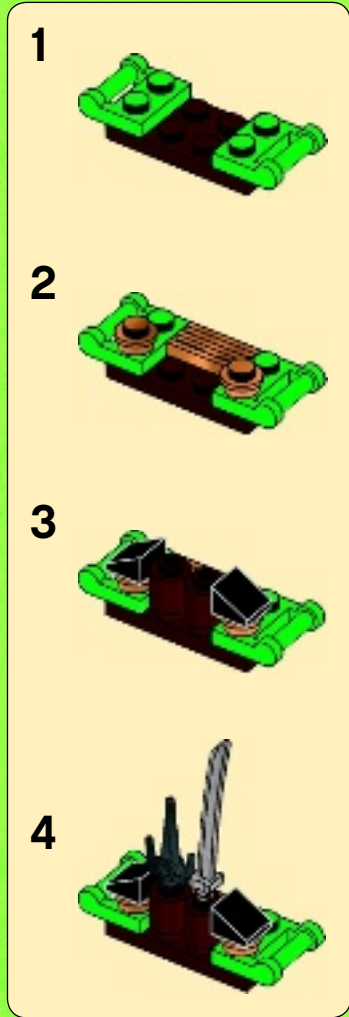

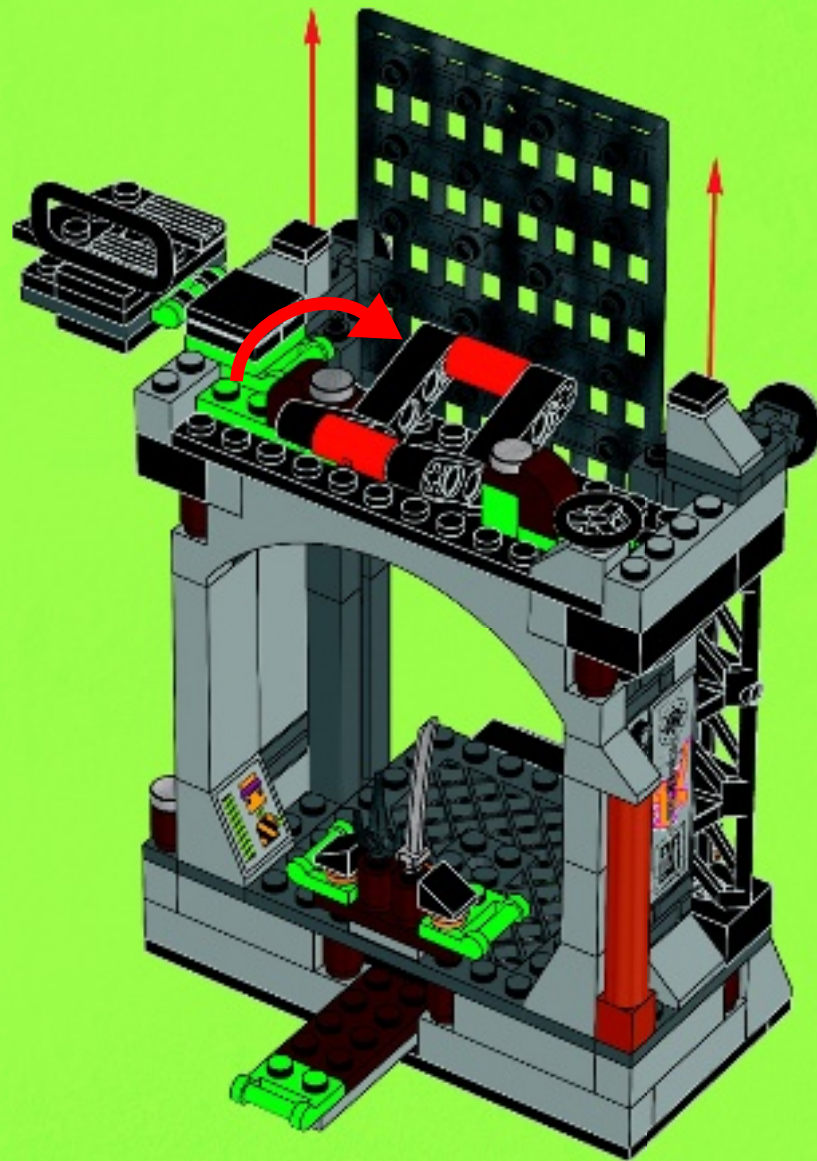

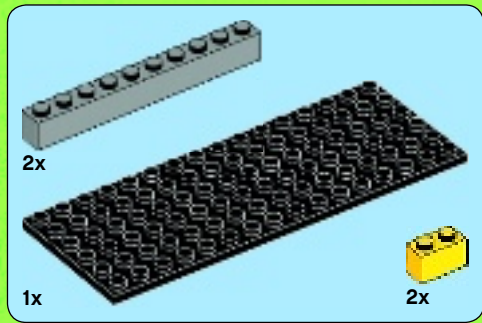
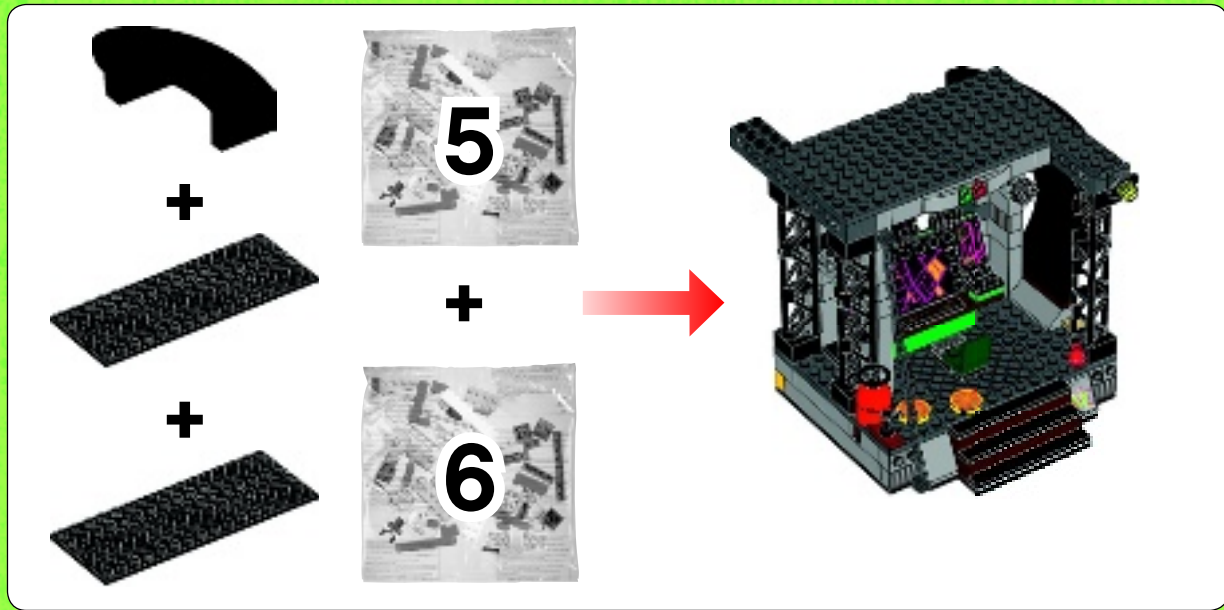

1

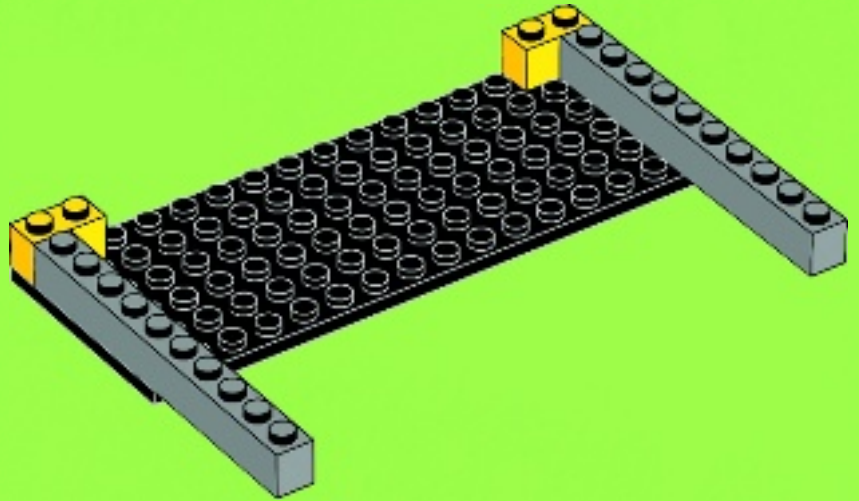

2

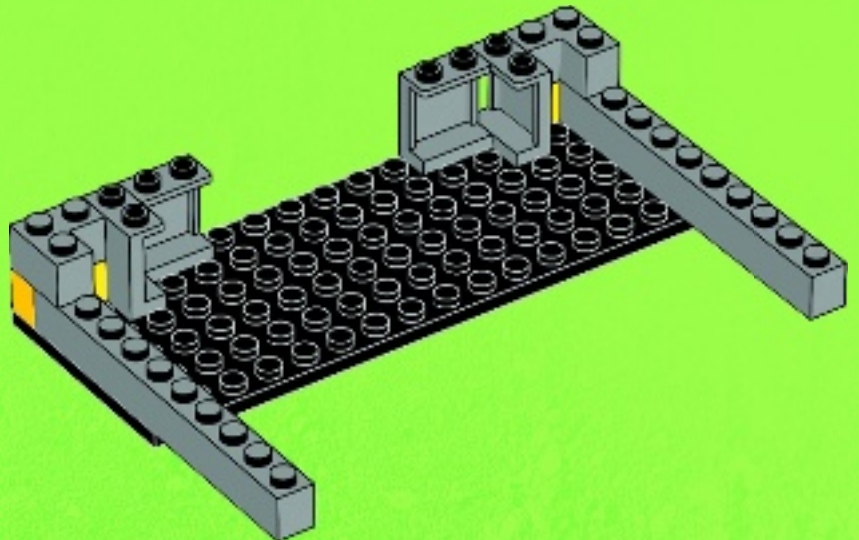

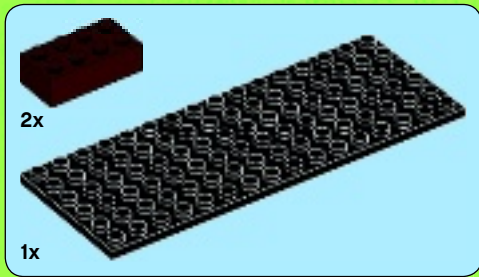

3

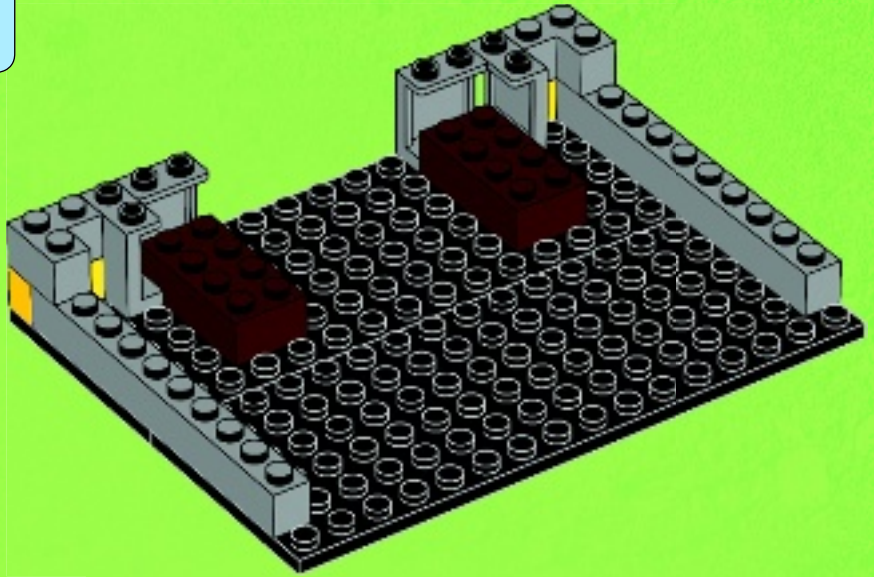

4

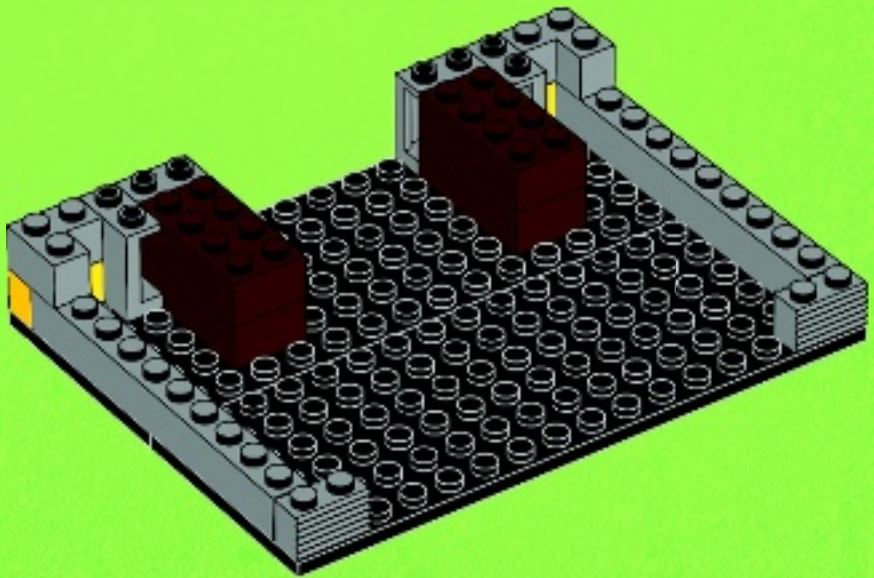



5

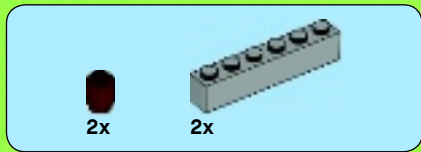
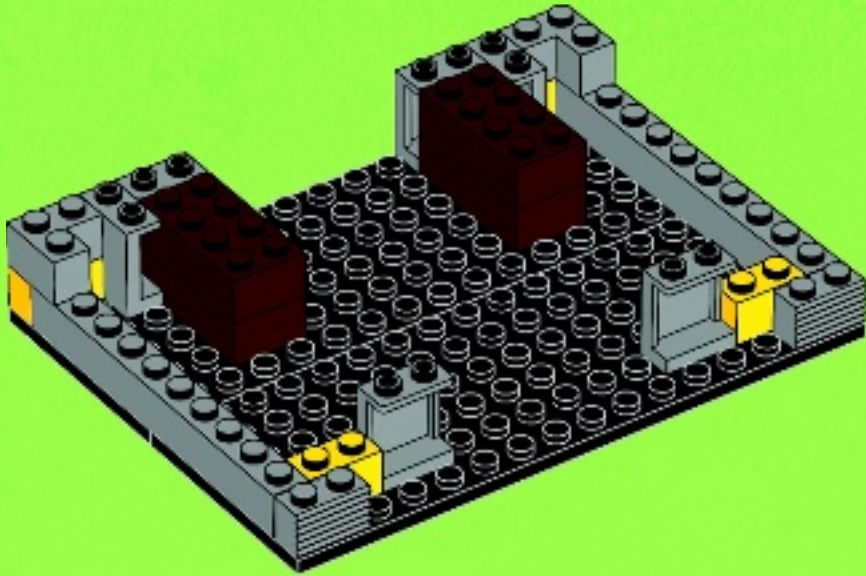

6

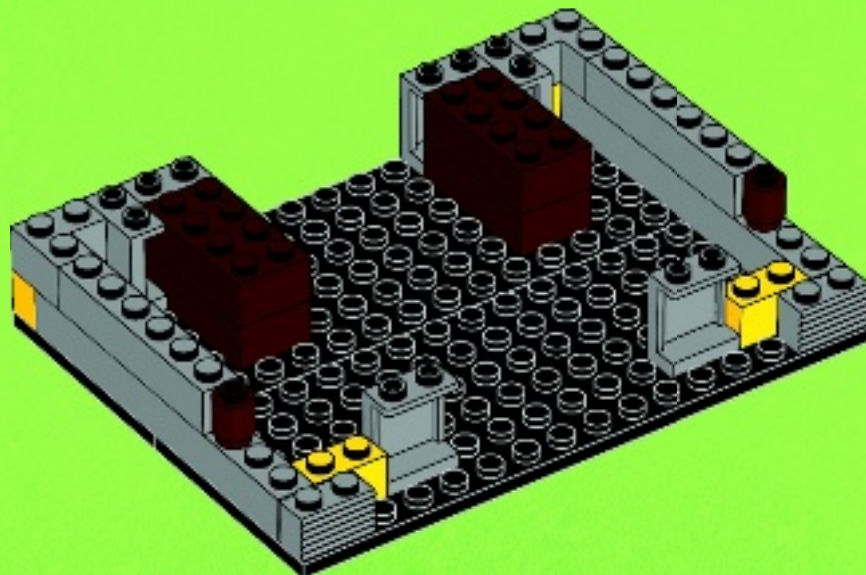





2x



4x

# 7

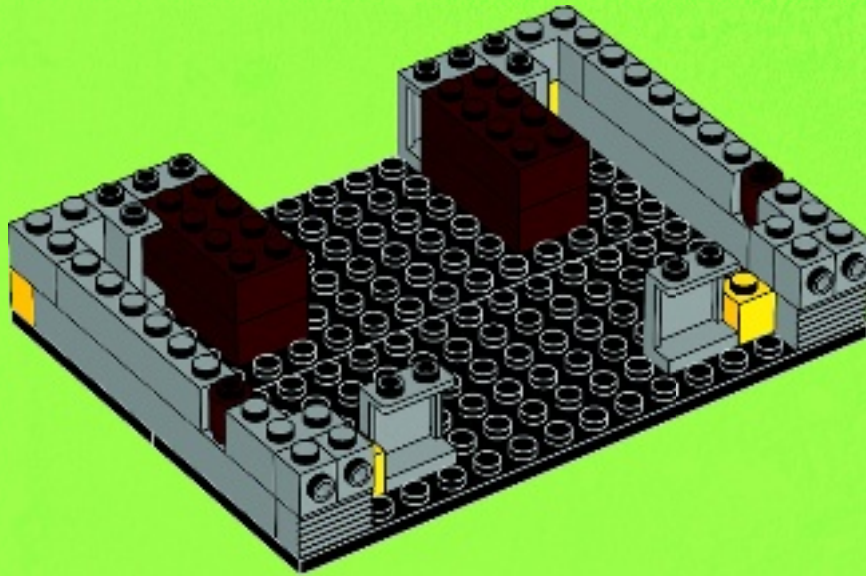

1x



2x

# 8

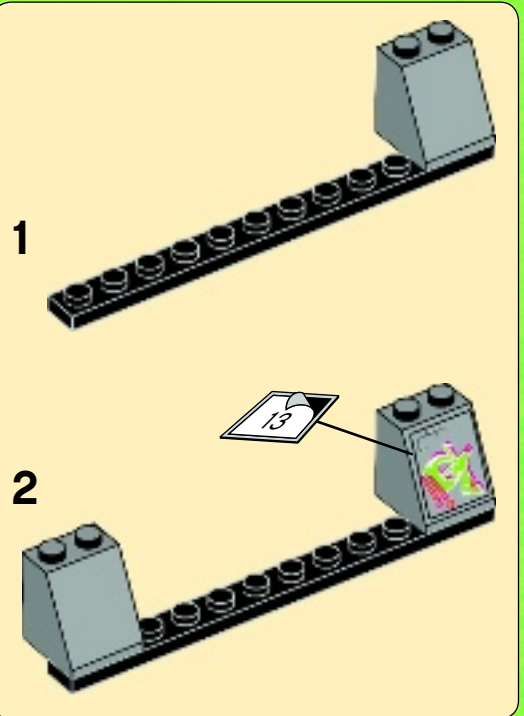
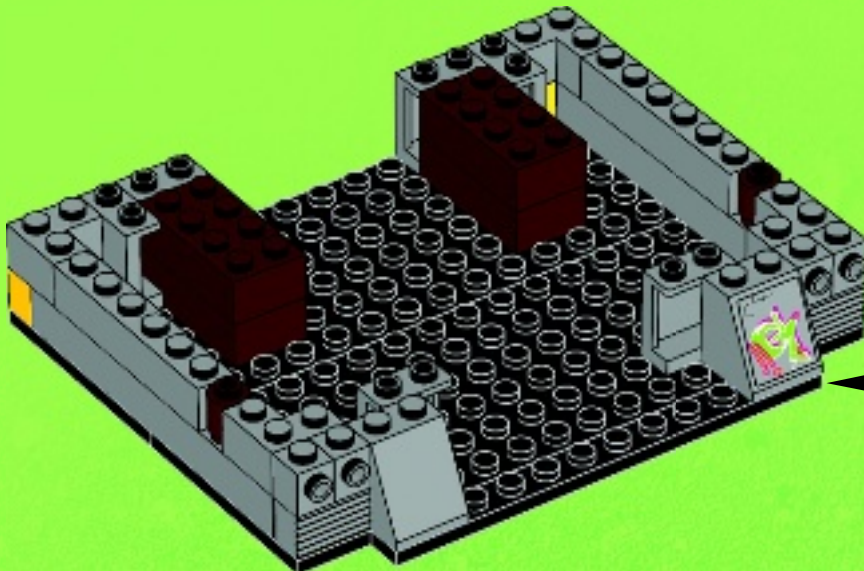

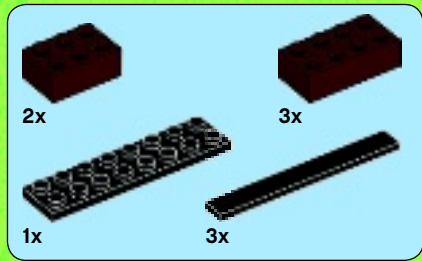

9

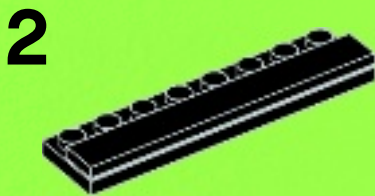

3

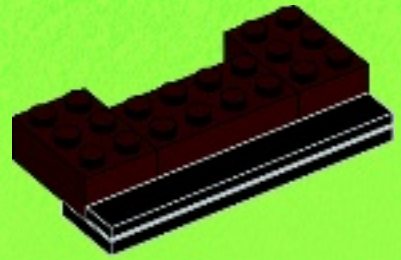

4

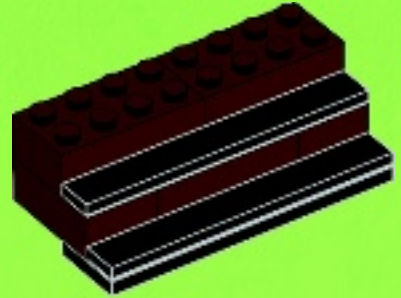

5

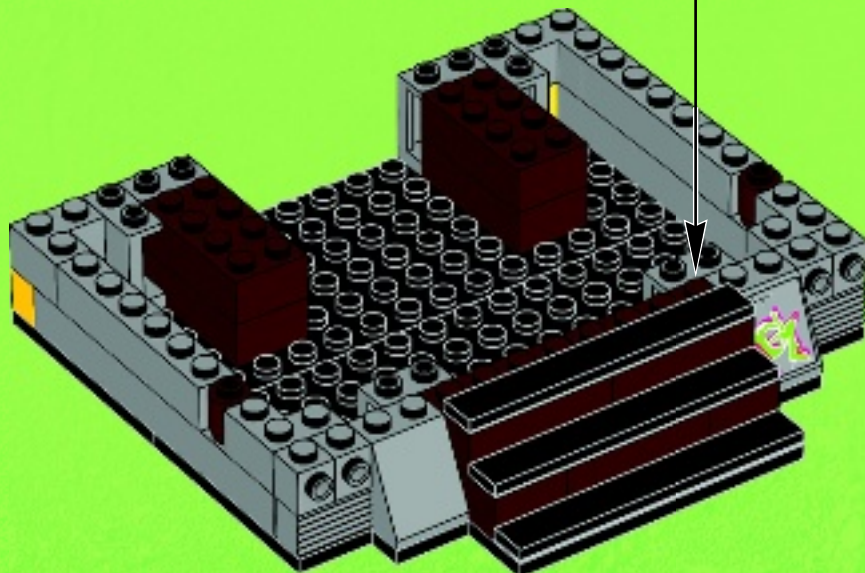
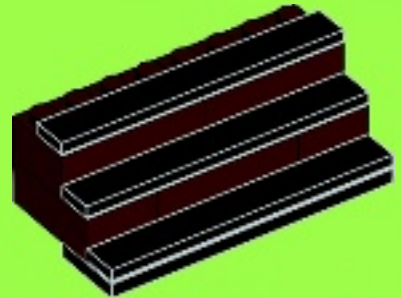

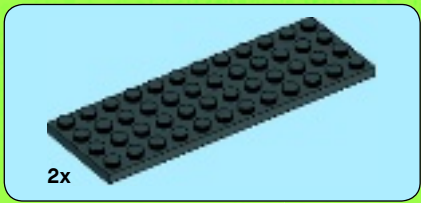

10

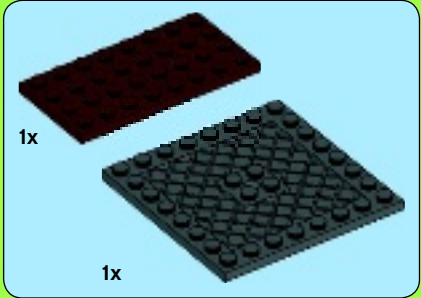
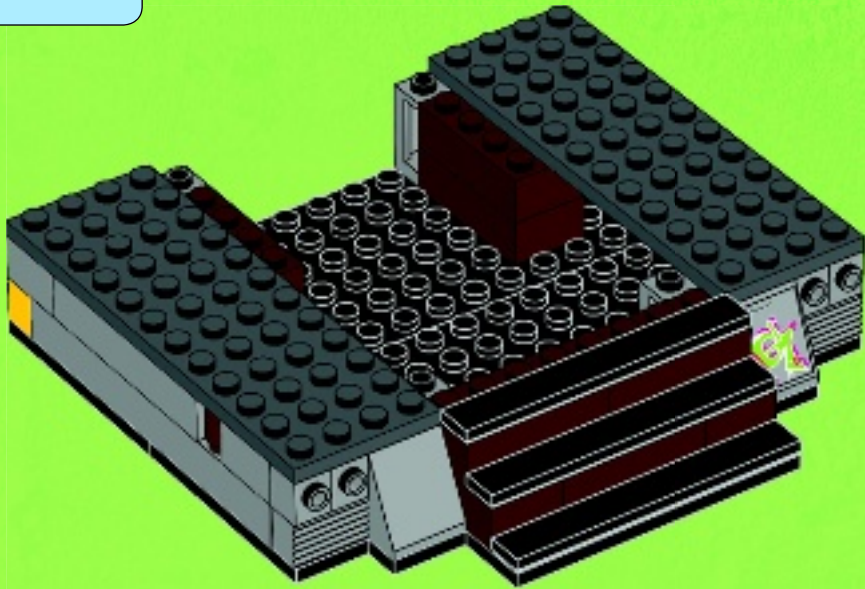

11

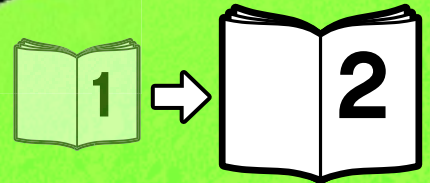
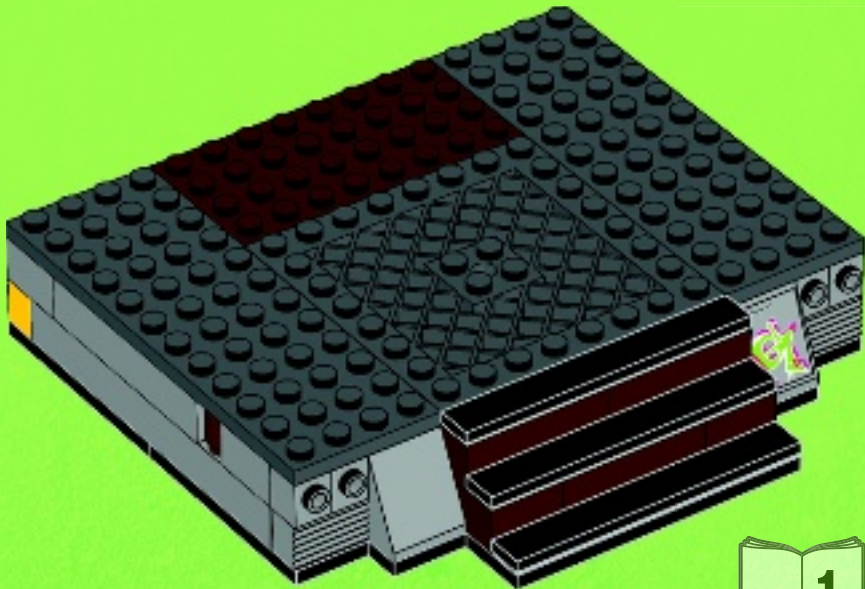



# WIN!

Go to [LEGO.com/productfeedback](http://LEGO.com/productfeedback) to fill out a survey for a chance to win a cool LEGO® Product.

No purchase necessary.

Open to all residents where not prohibited.



## LEGO.com/productfeedback

### GEWINNE!

Nimm an der Umfrage auf [LEGO.com/productfeedback](http://LEGO.com/productfeedback) teil und hab die Chance ein cooles LEGO® Produkt zu gewinnen!

Die Teilnahme am Gewinnspiel führt zu keinerlei Kaufverpflichtungen. Teilnahme in allen nicht ausgeschlossenen Ländern möglich.

### WIN!

Ga naar [LEGO.com/productfeedback](http://LEGO.com/productfeedback), vul een enquêteformulier in en maak kans op een cool LEGO® product.

Geen aankoopverplichting.  
Ledereen mag deelnemen, uitgezonderd ingezetenden van landen waar een enquêteverbod geldt.

### GAGNE!

Visite [LEGO.com/productfeedback](http://LEGO.com/productfeedback) pour répondre à un questionnaire et avoir une chance de gagner un produit LEGO® très cool!

Aucune obligation d'achat.  
Ouvert à tous les résidents des pays autorisés.

### 当てよう!

[LEGO.com/productfeedback](http://LEGO.com/productfeedback)にアクセスして、アンケートにご記入ください。当選者にはレゴ®製品を差し上げます。

お買い上げの必要はありません。

禁止されていない限り、すべての皆様にご利用いただけます。



[LEGO.com](http://LEGO.com)