



# THE LONE RANGER



79111







[LEGO.com/brickseparator](https://www.LEGO.com/brickseparator)

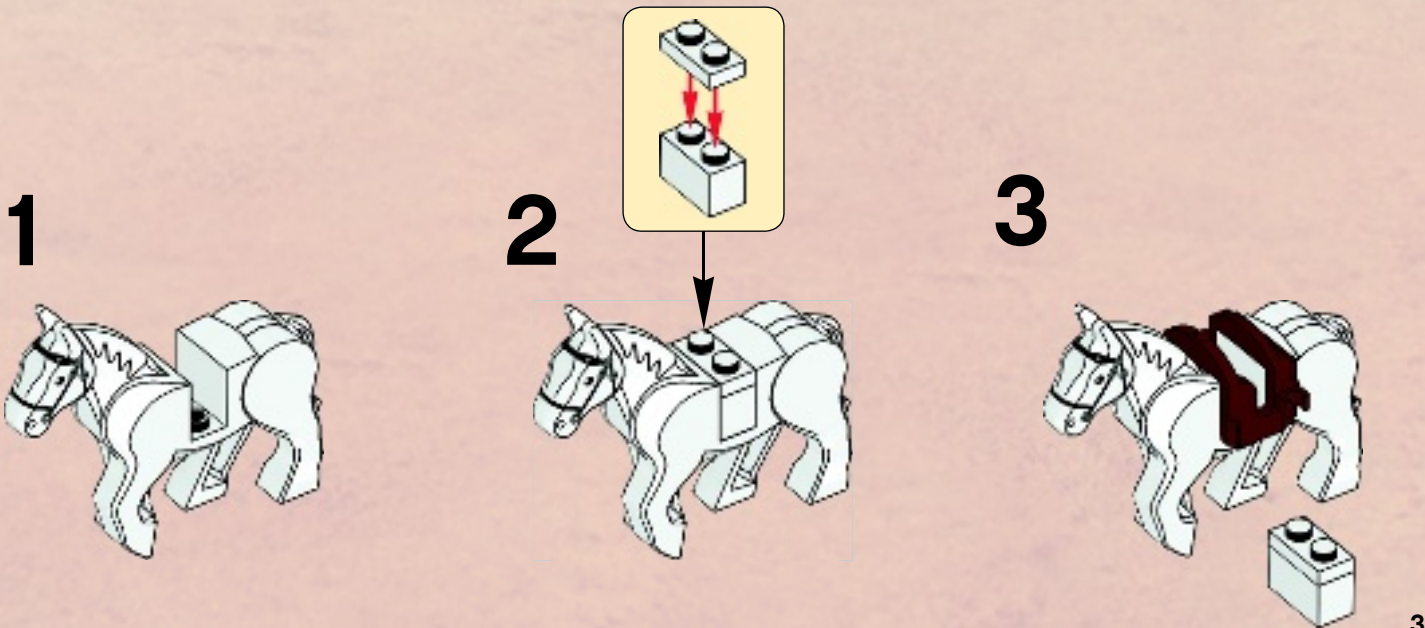
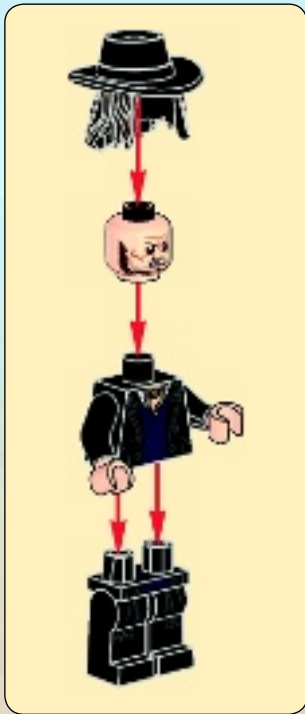
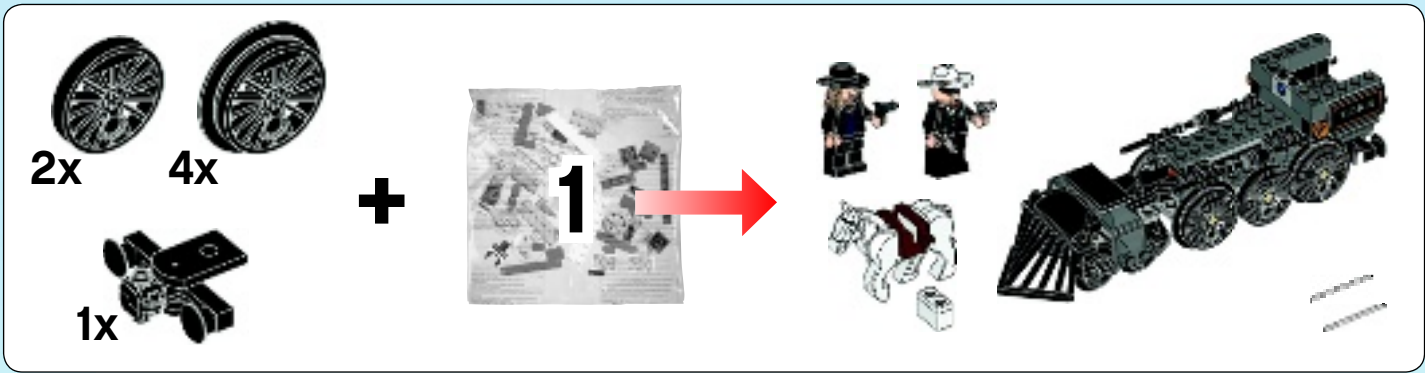

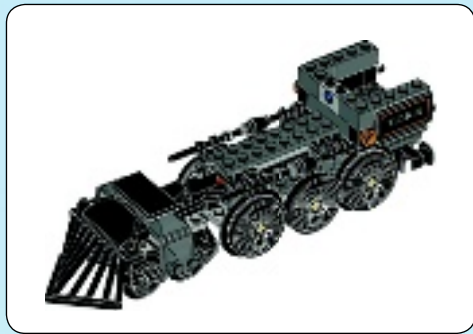

1x

1



2x

2

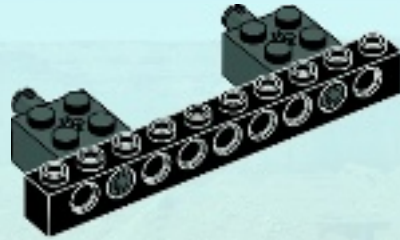

1x

3







4

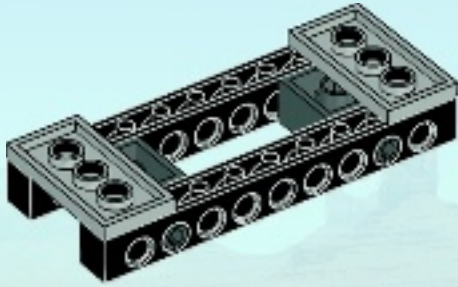

5

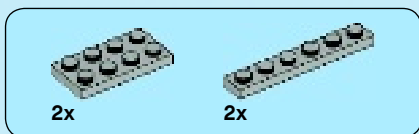
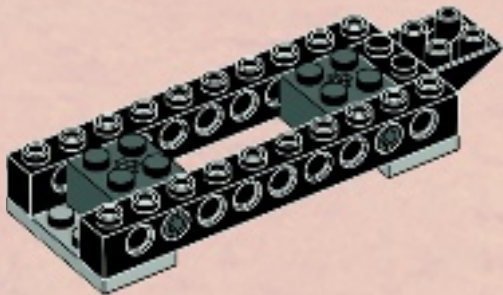

6





6x

7

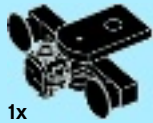
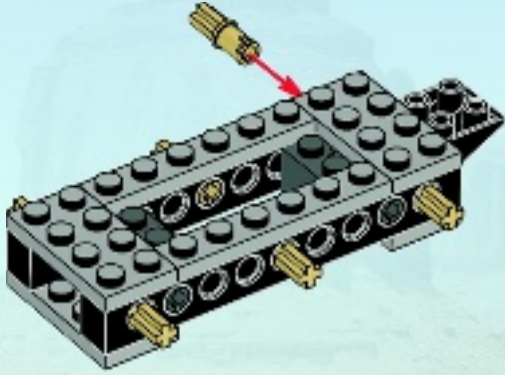

1x

8

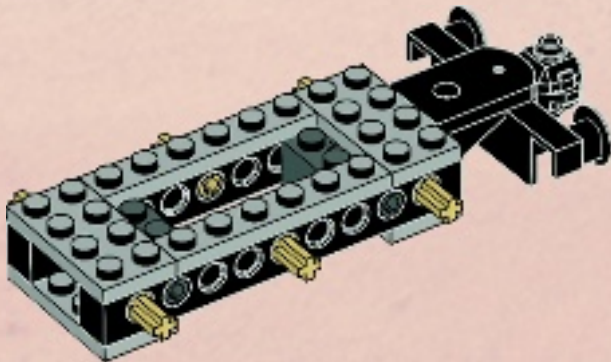

1x

9

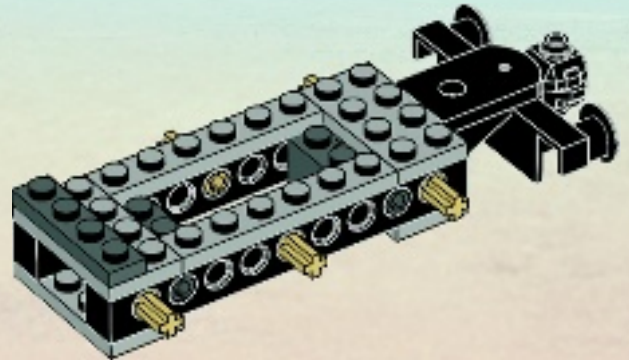



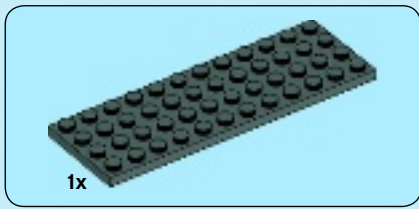

10

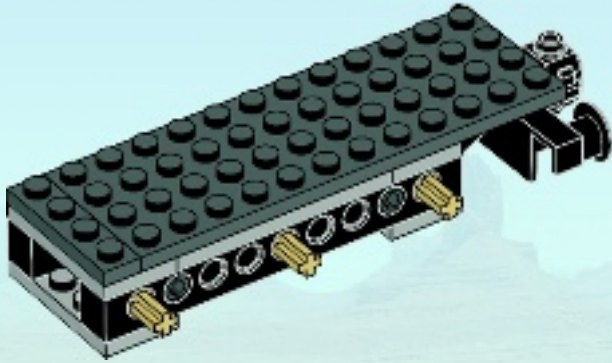

11

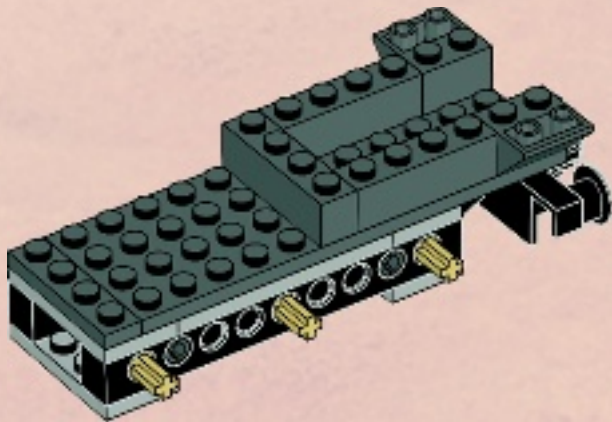

12

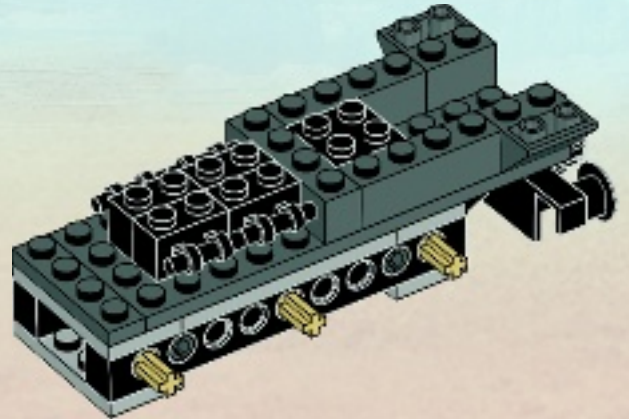



1x



2x

# 13

1

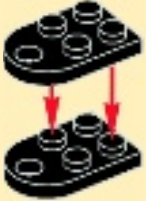

2

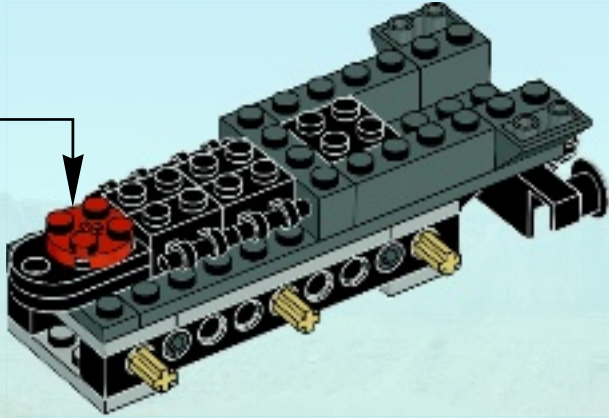

2x

# 14

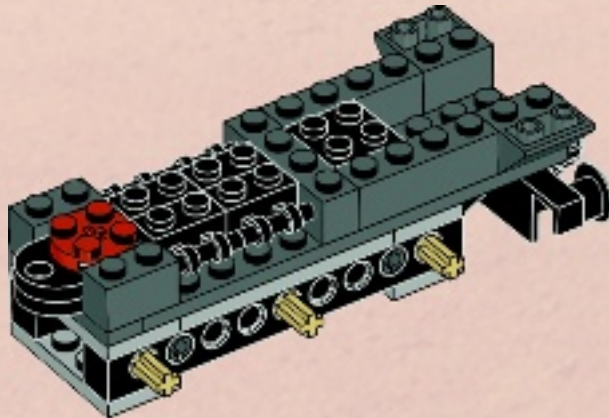



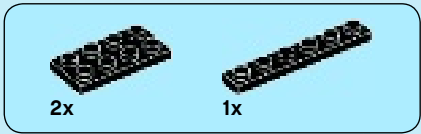

15

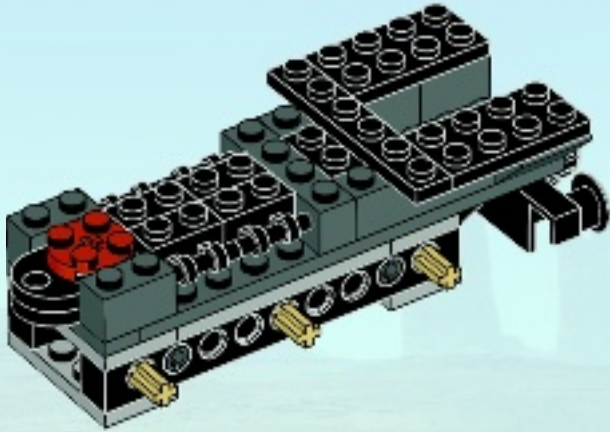

16

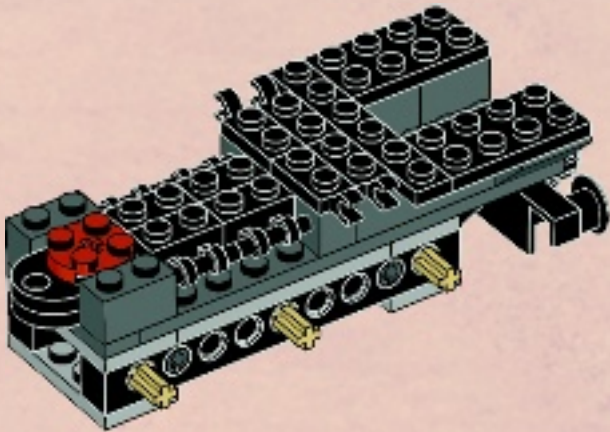

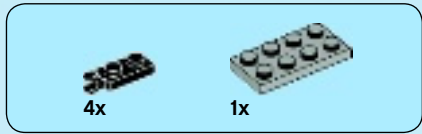

# 17

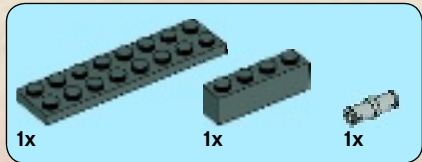
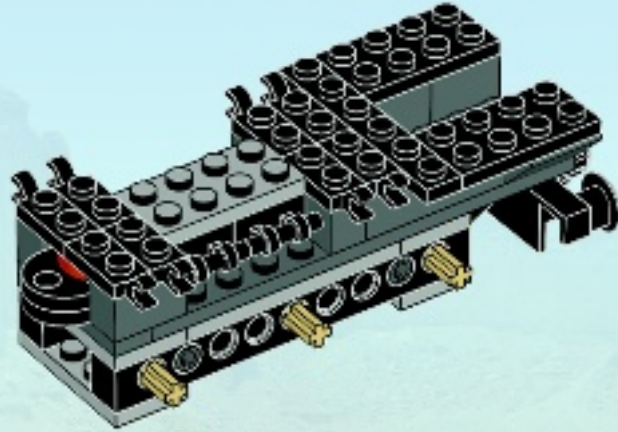

# 18

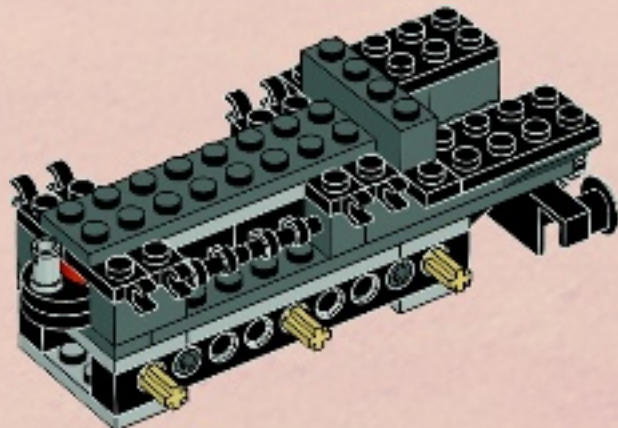





# 19

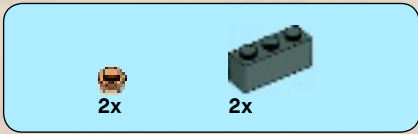
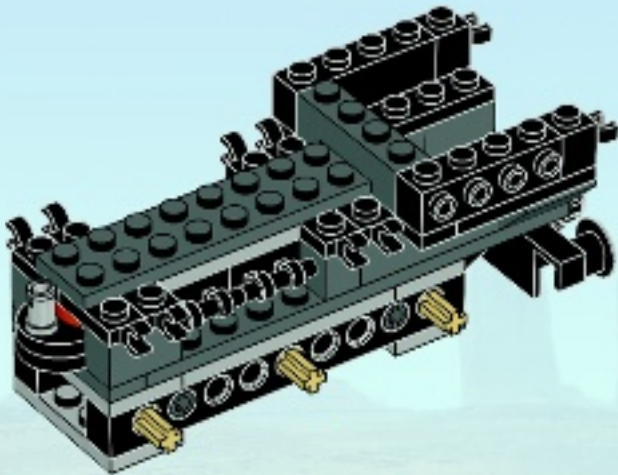

# 20

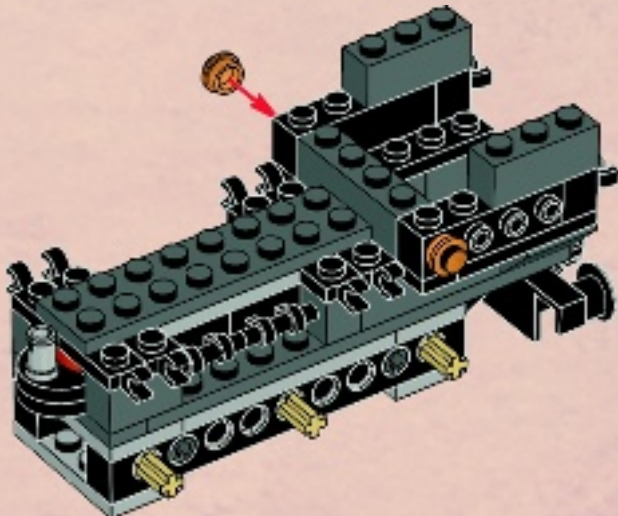

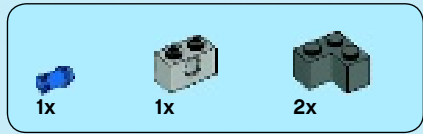

21

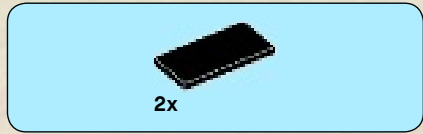
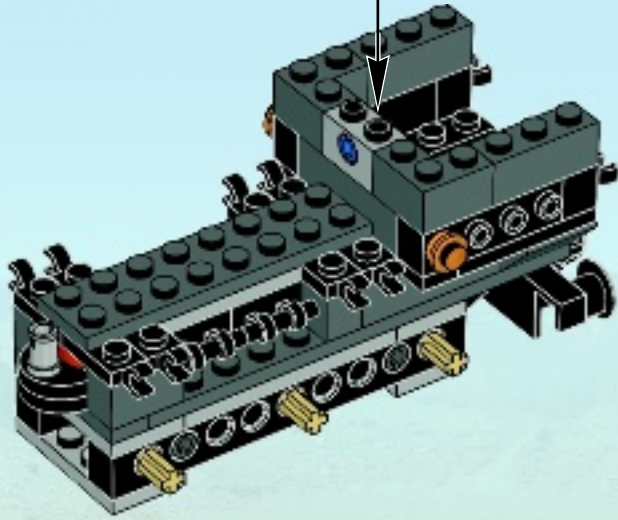
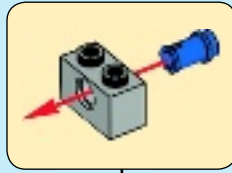

22

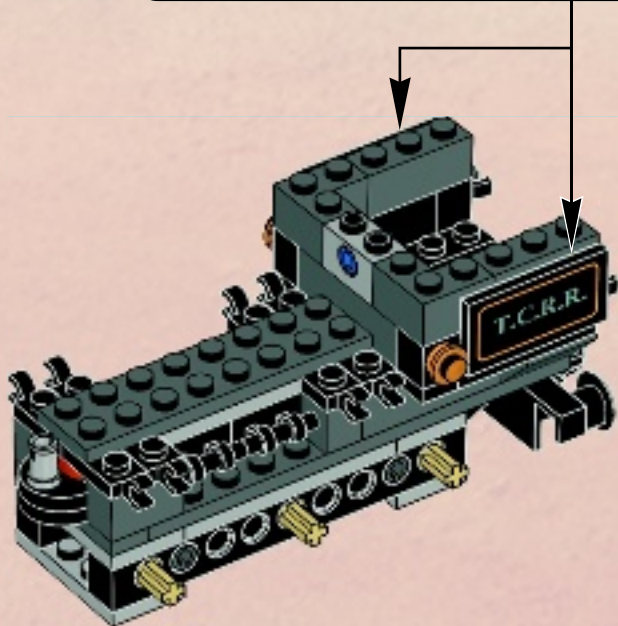
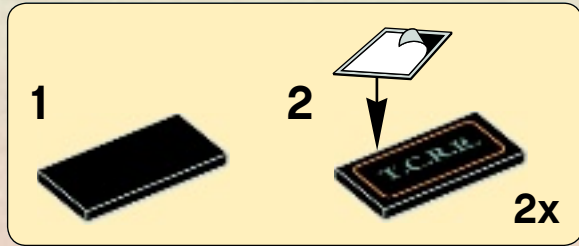





# 23

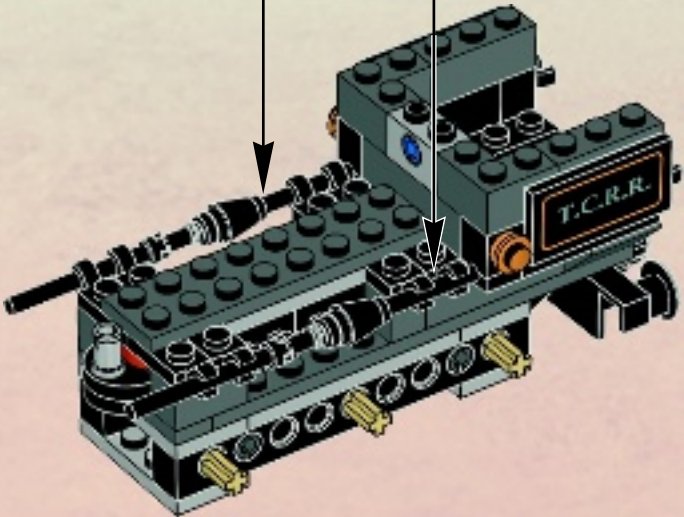
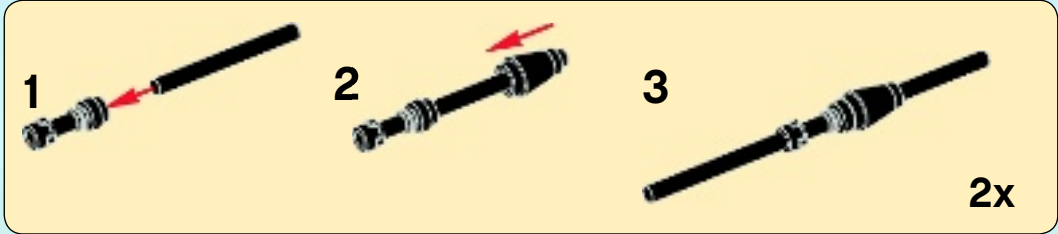



4x

# 24

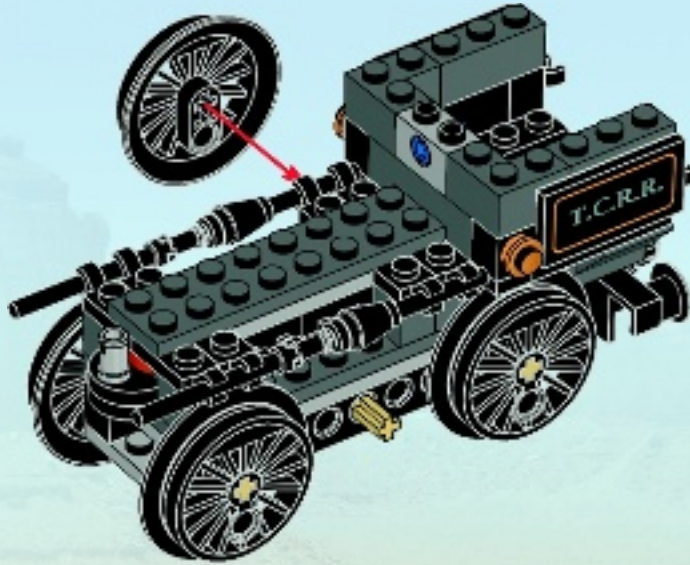

2x

# 25

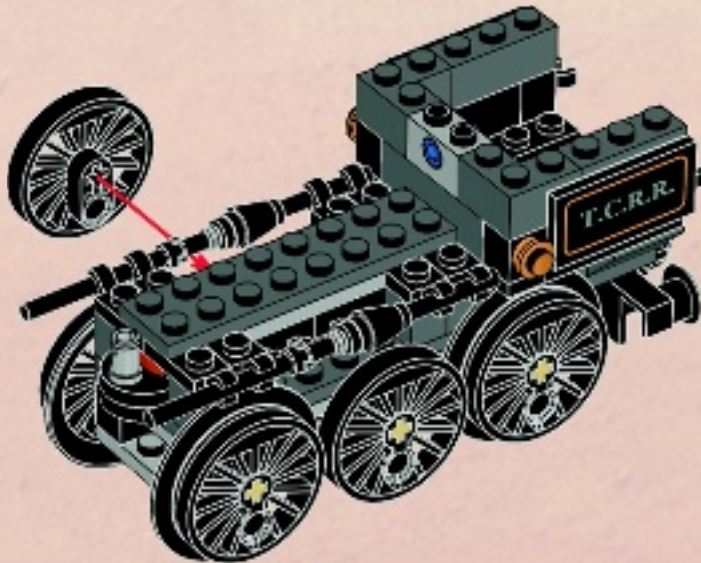



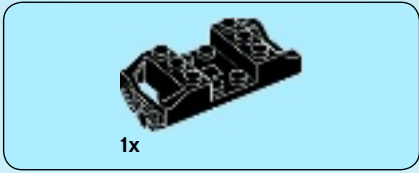

**1**

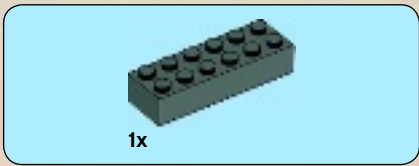

**2**

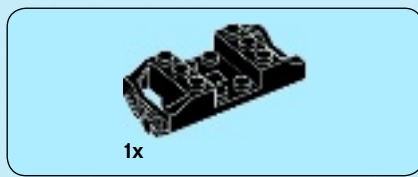

**3**

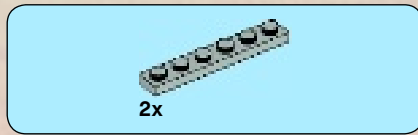

**4**



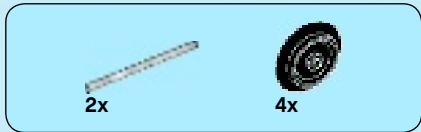

5

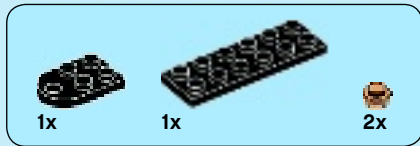
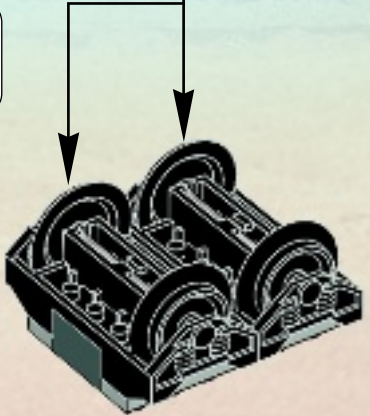
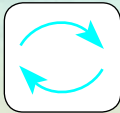
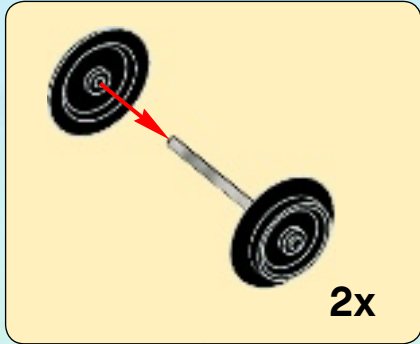

6

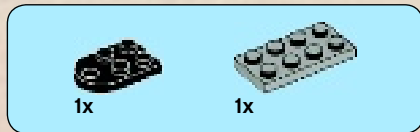
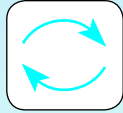

7





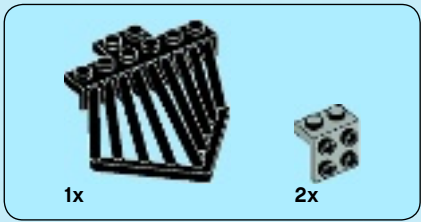

8

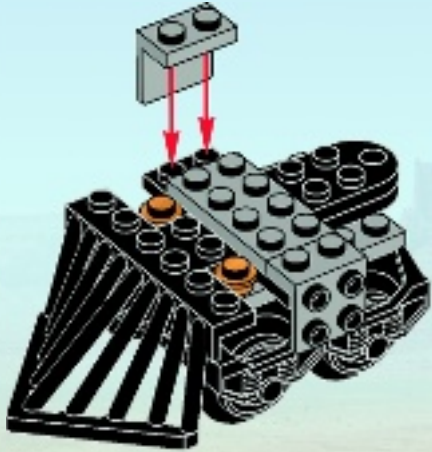

9

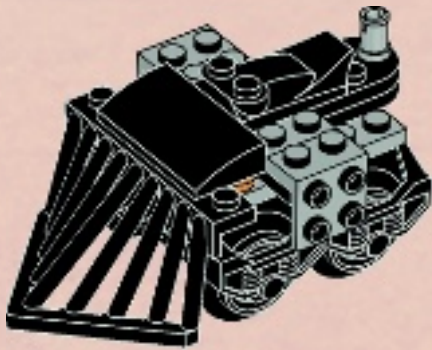

10

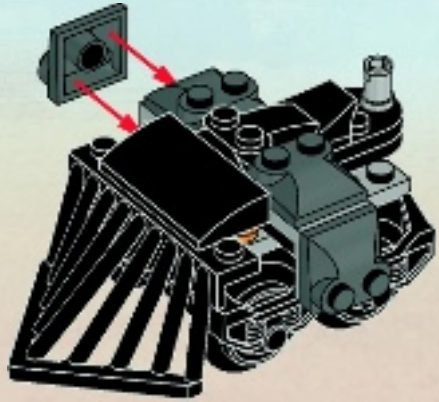



11

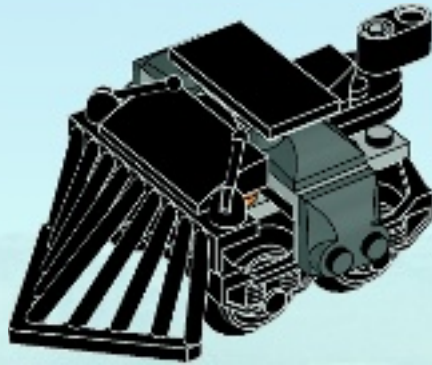

26

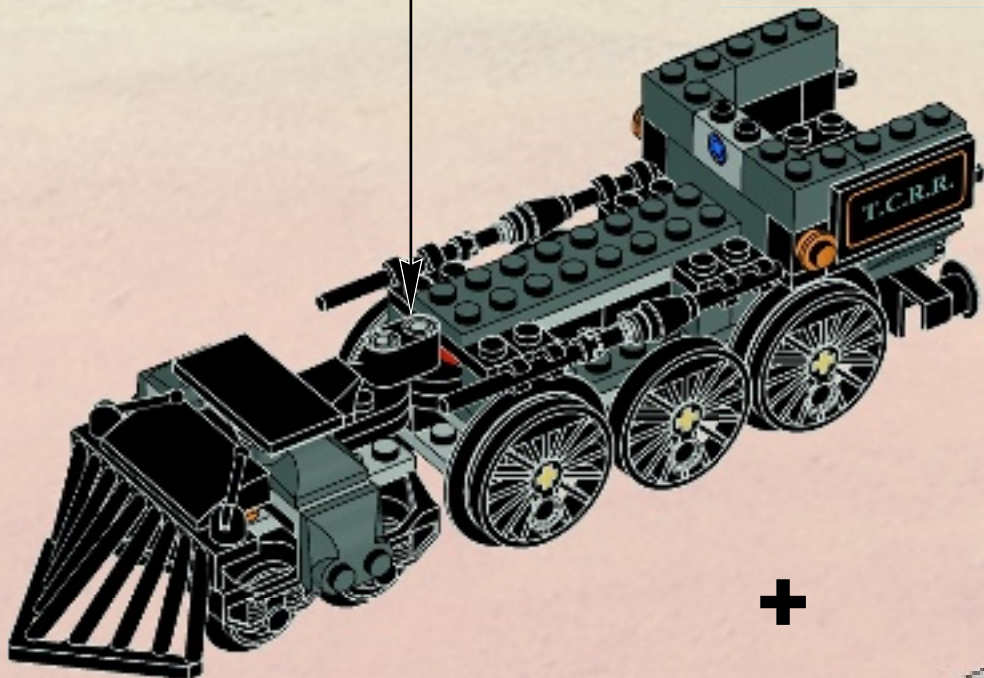

+

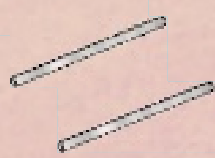



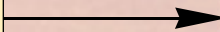
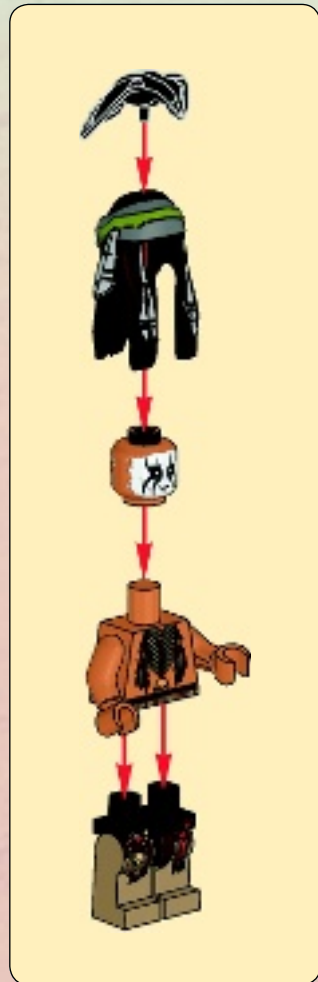

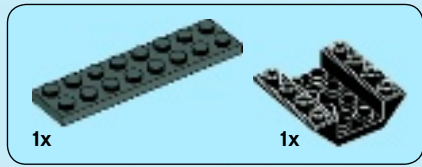

27

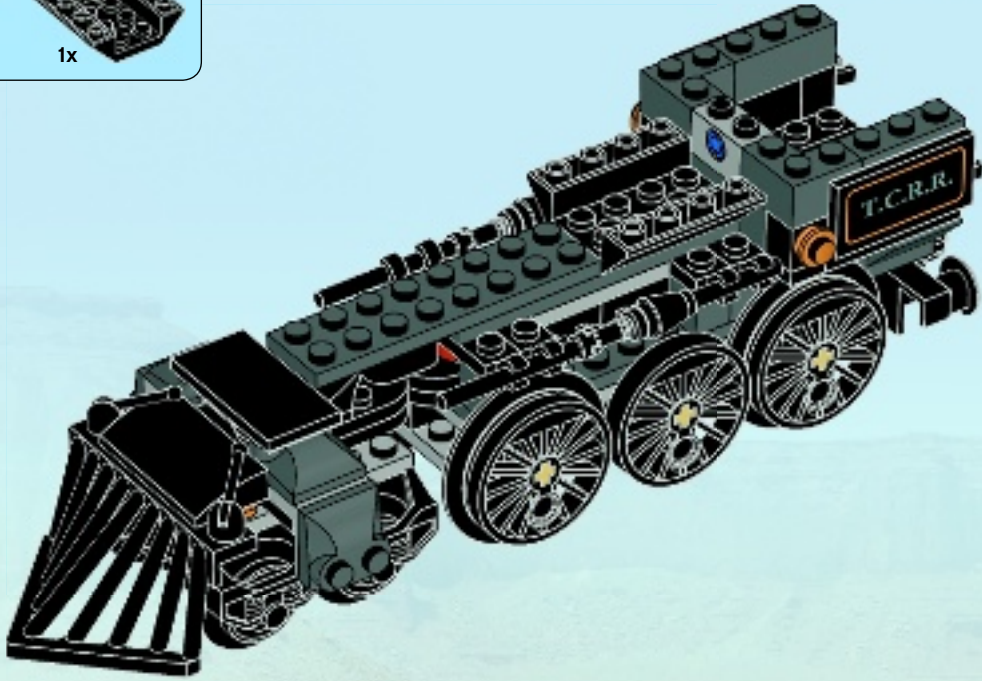

28

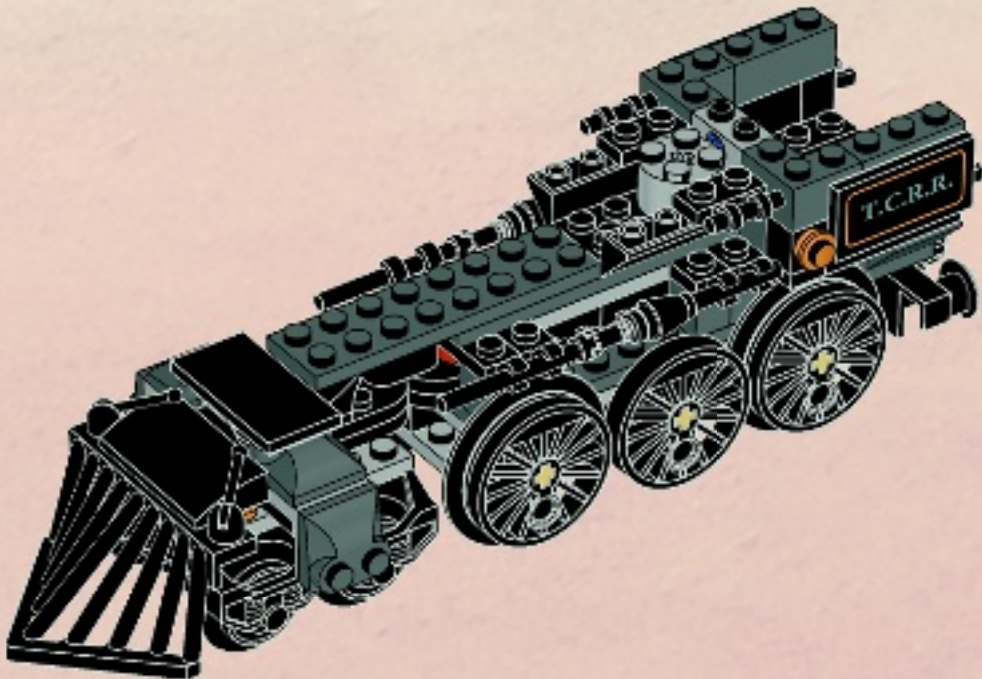





# 29

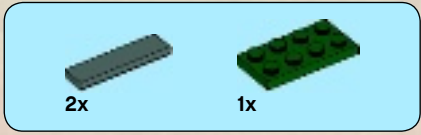
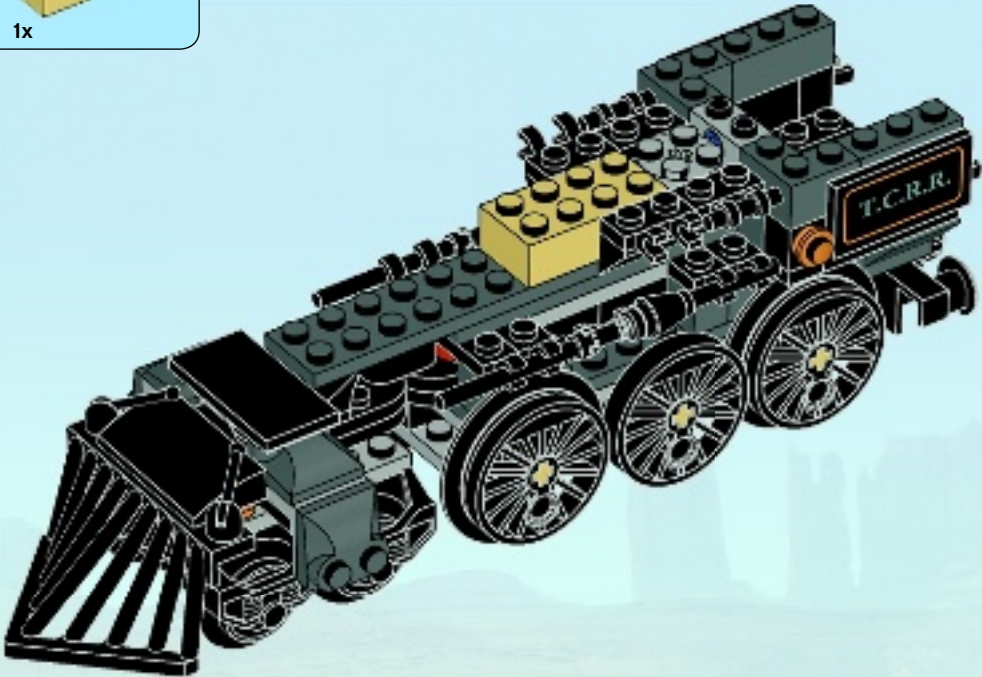

# 30

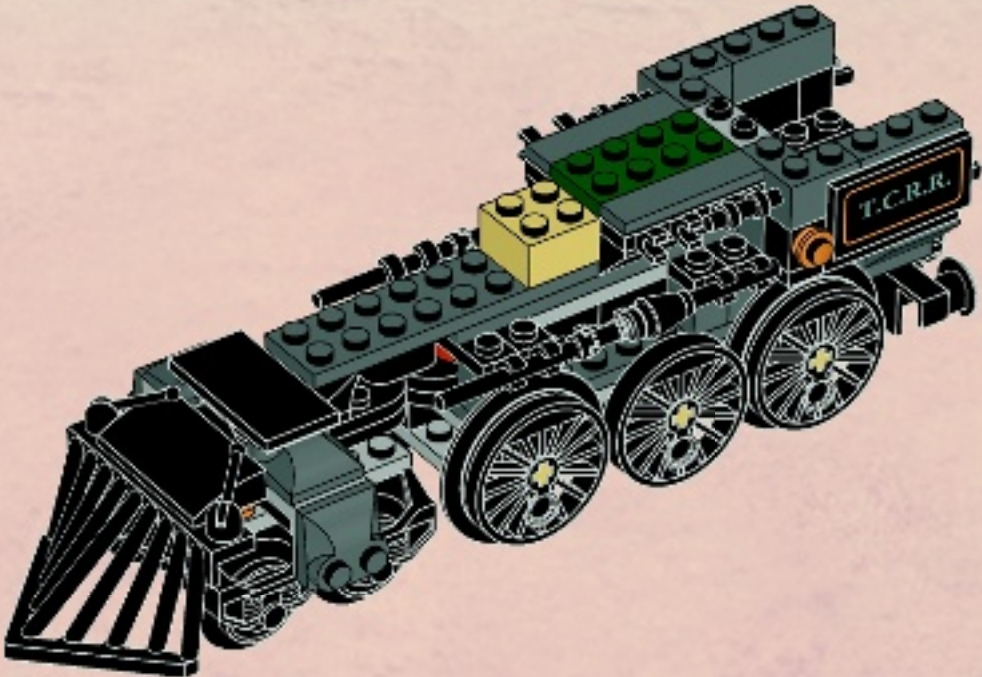





2x



2x

# 31

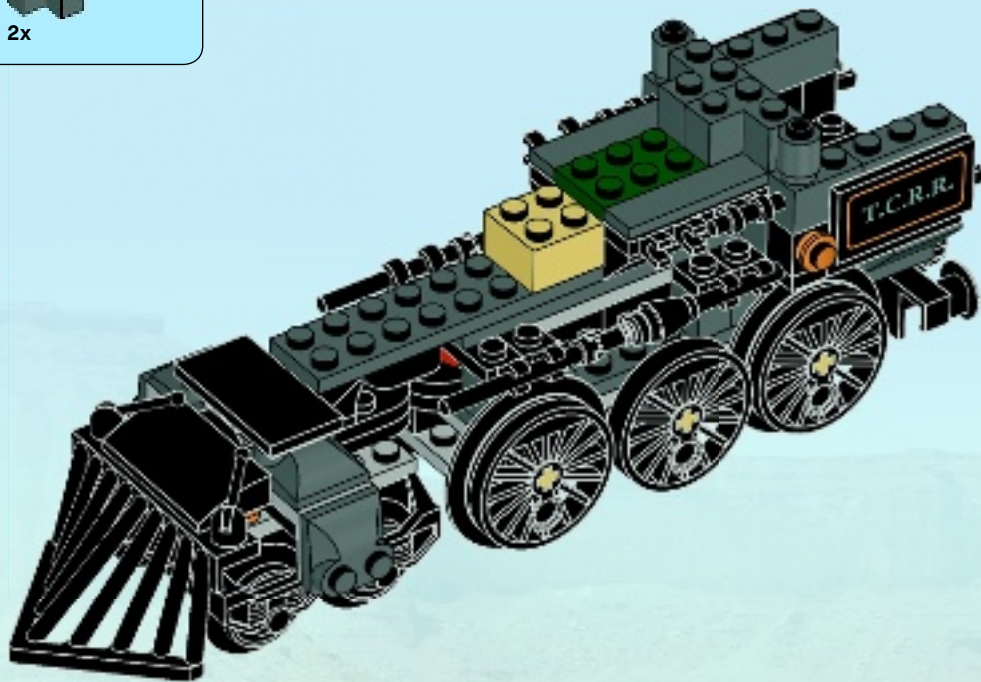

2x



1x

# 32

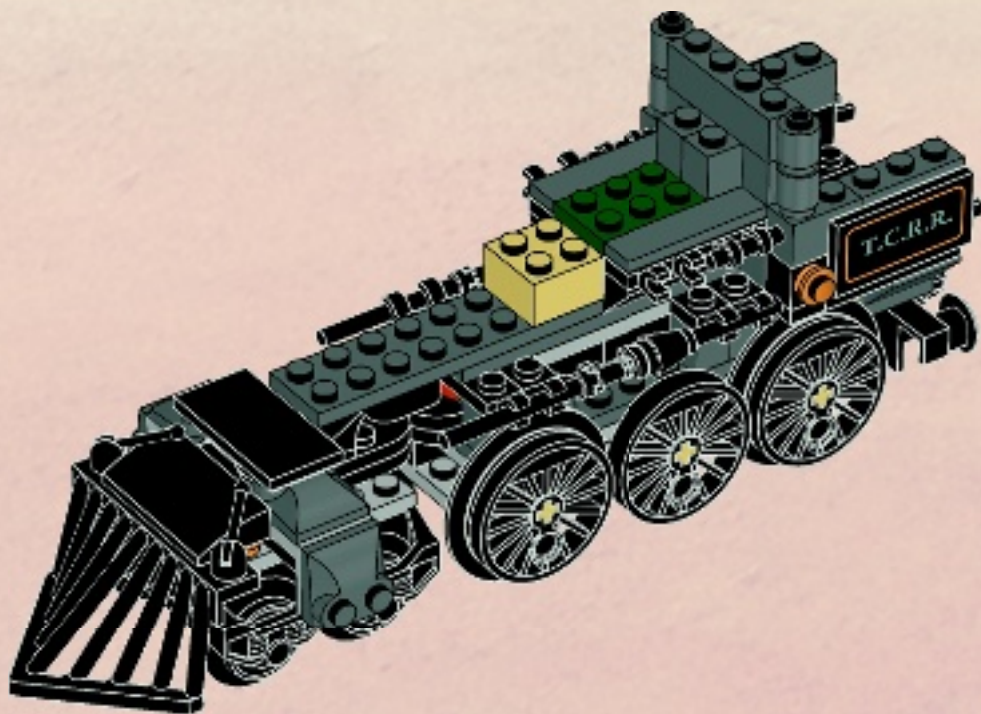



4x

# 33

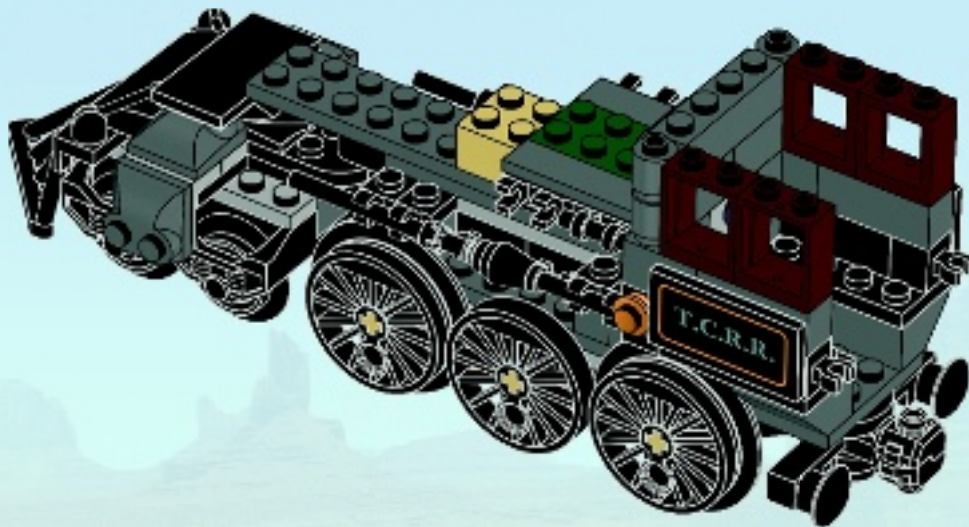

3x



2x



2x

# 34

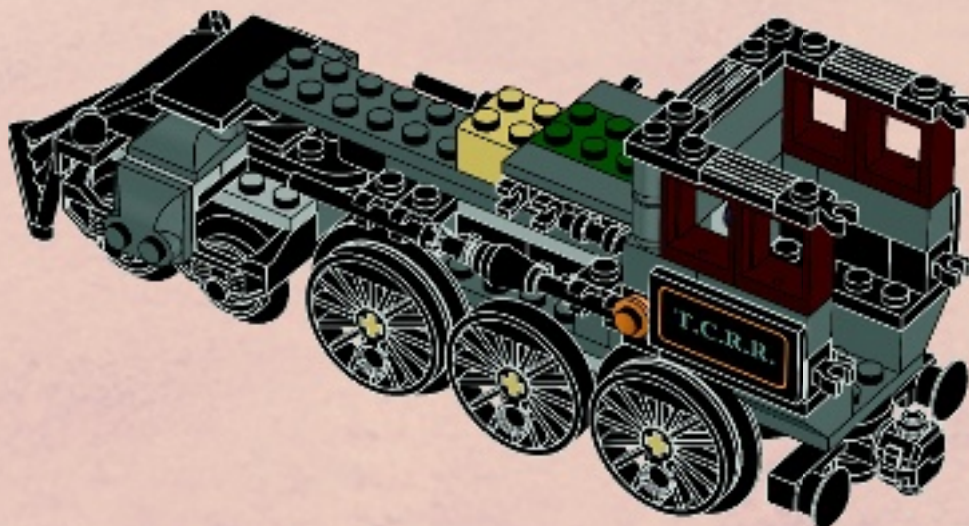



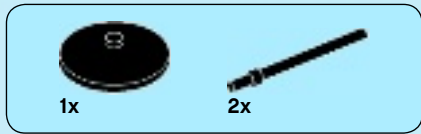

# 35

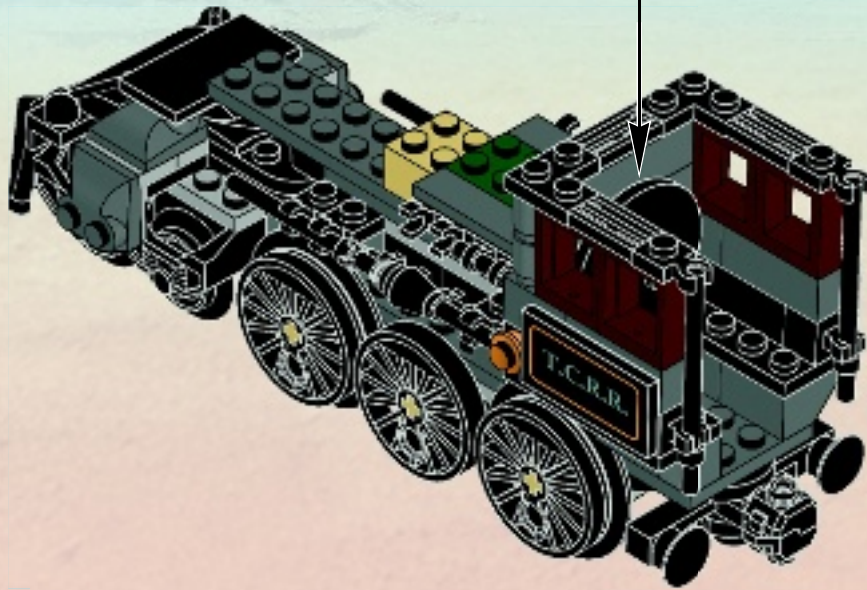
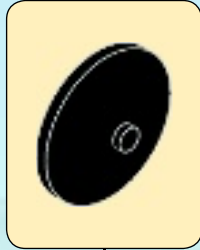



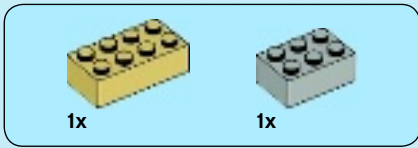

36

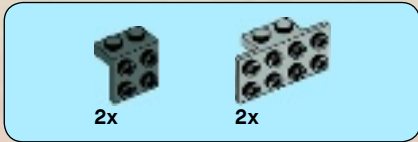
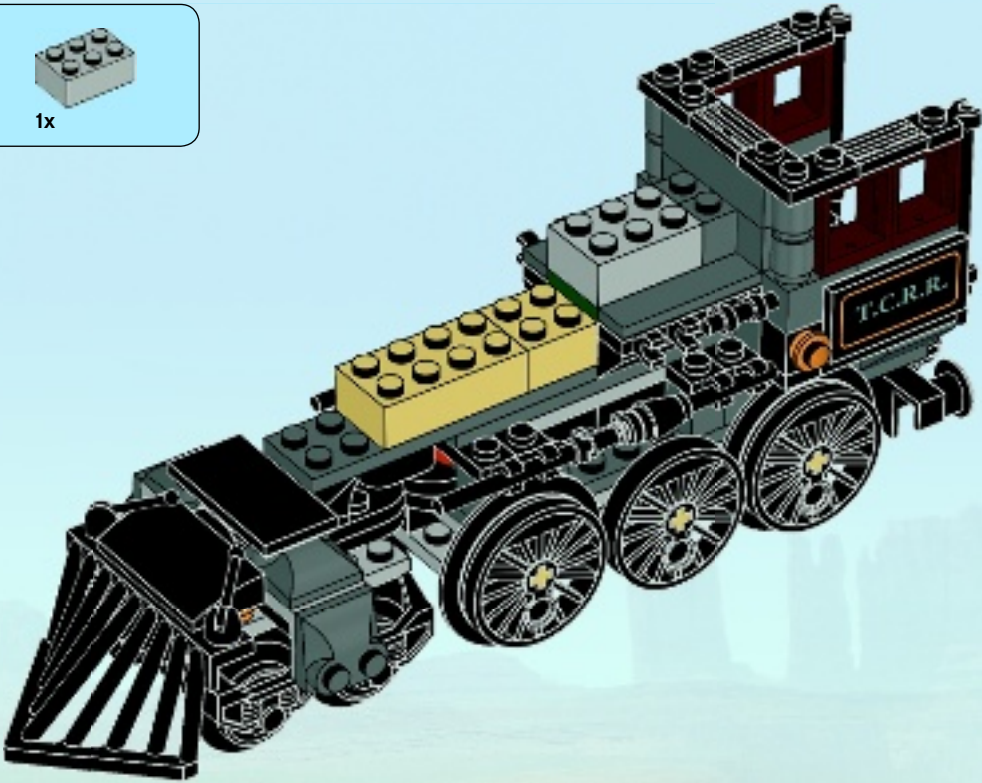

37

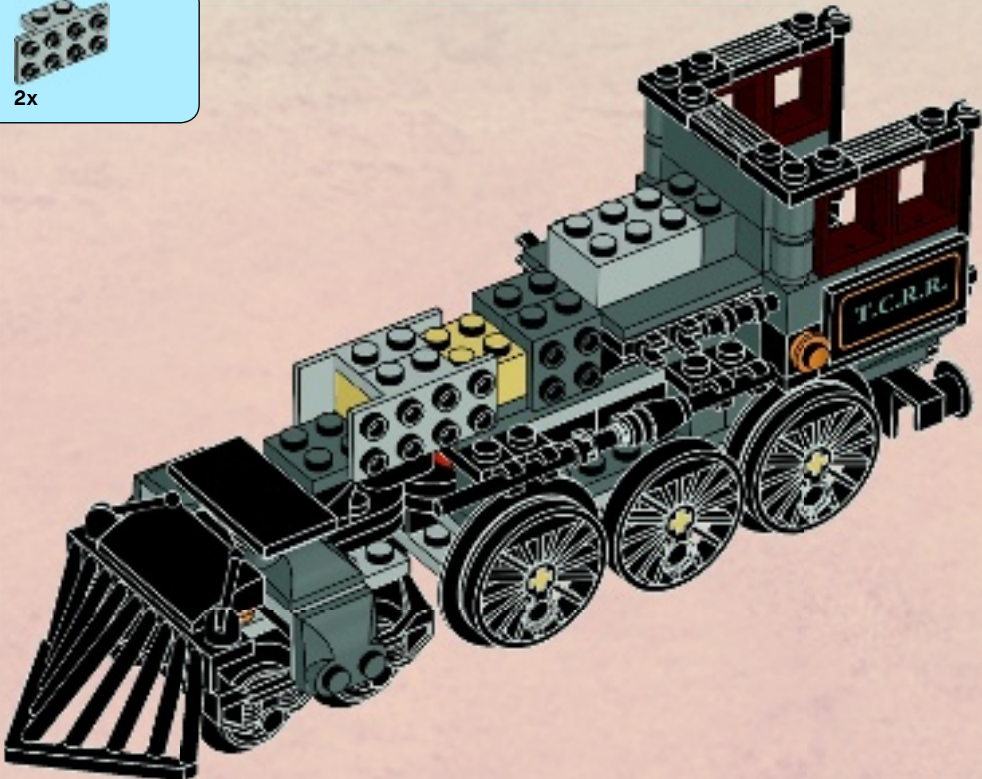

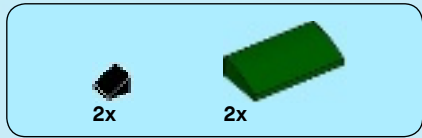

# 38

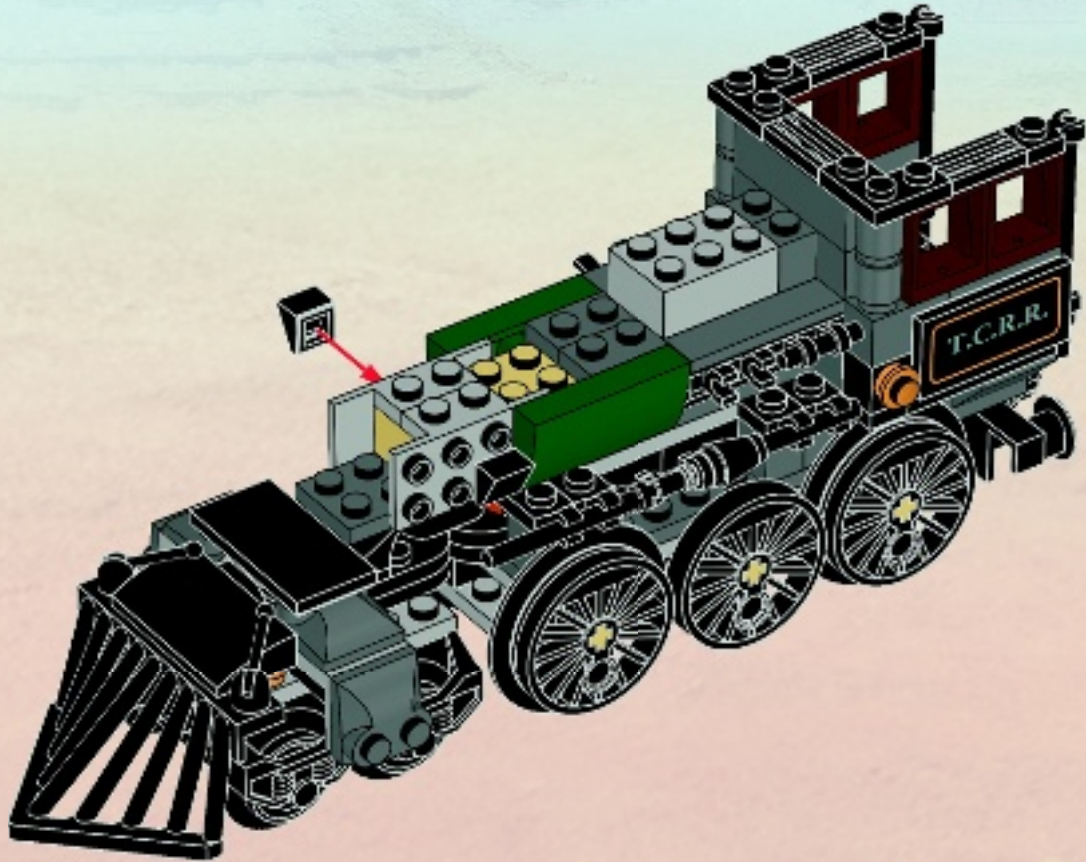





2x



2x

# 39

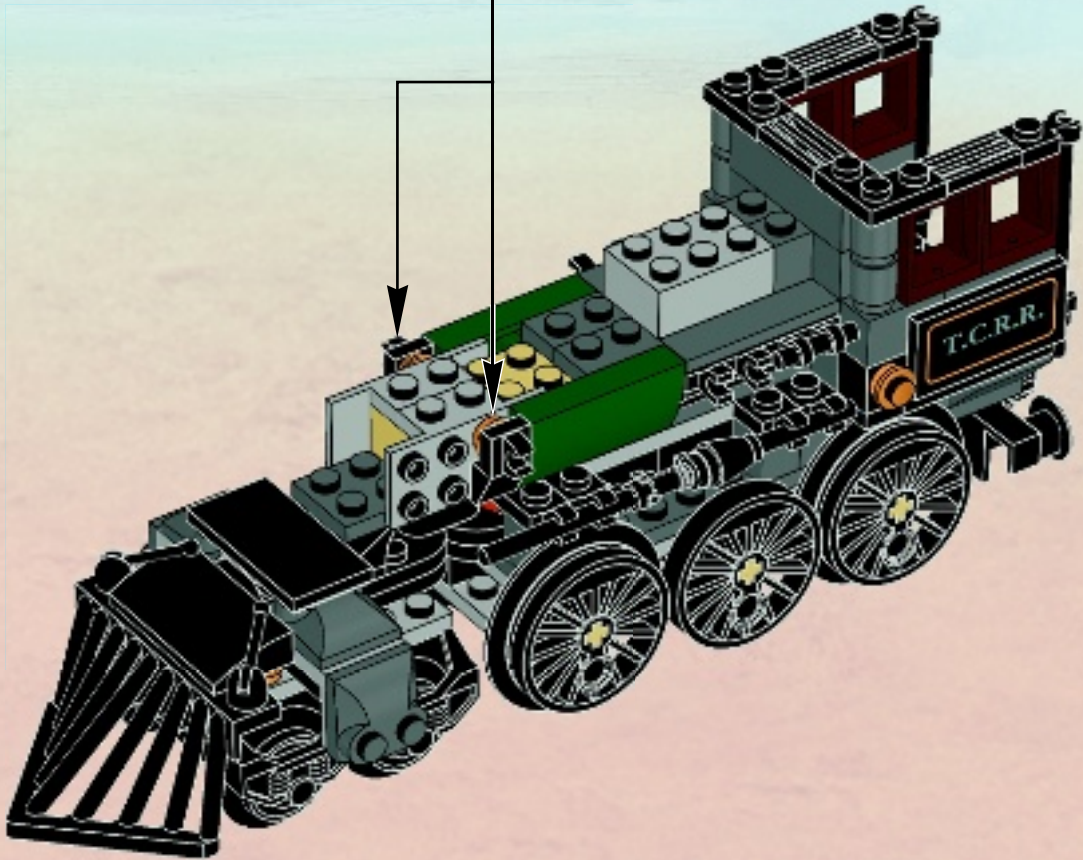
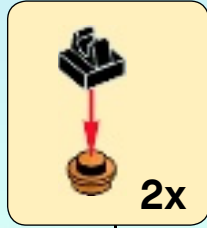





1x

1



1x



1x

2

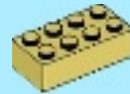

1x

3



1x



1x

4

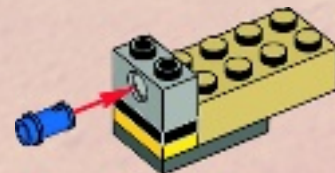



5

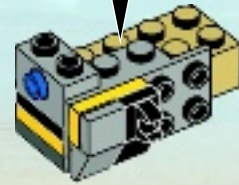
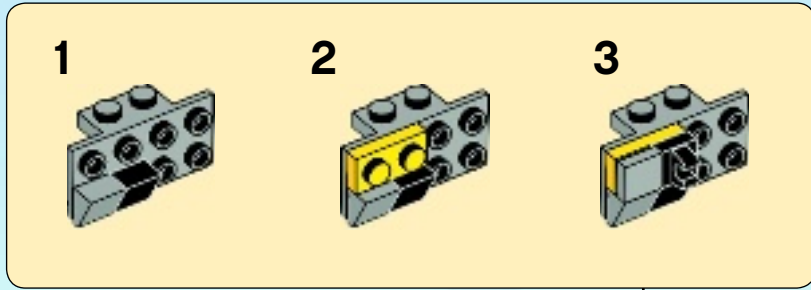

6



7



40

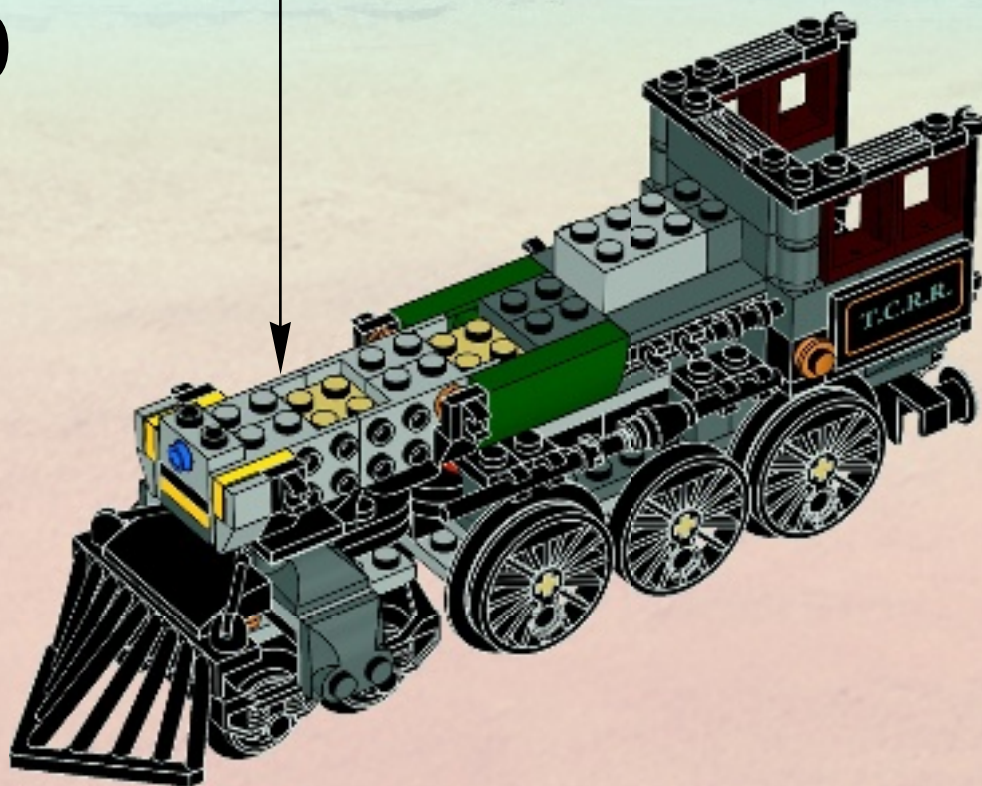



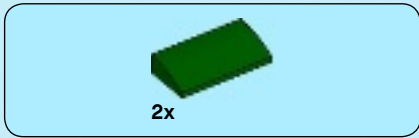

41

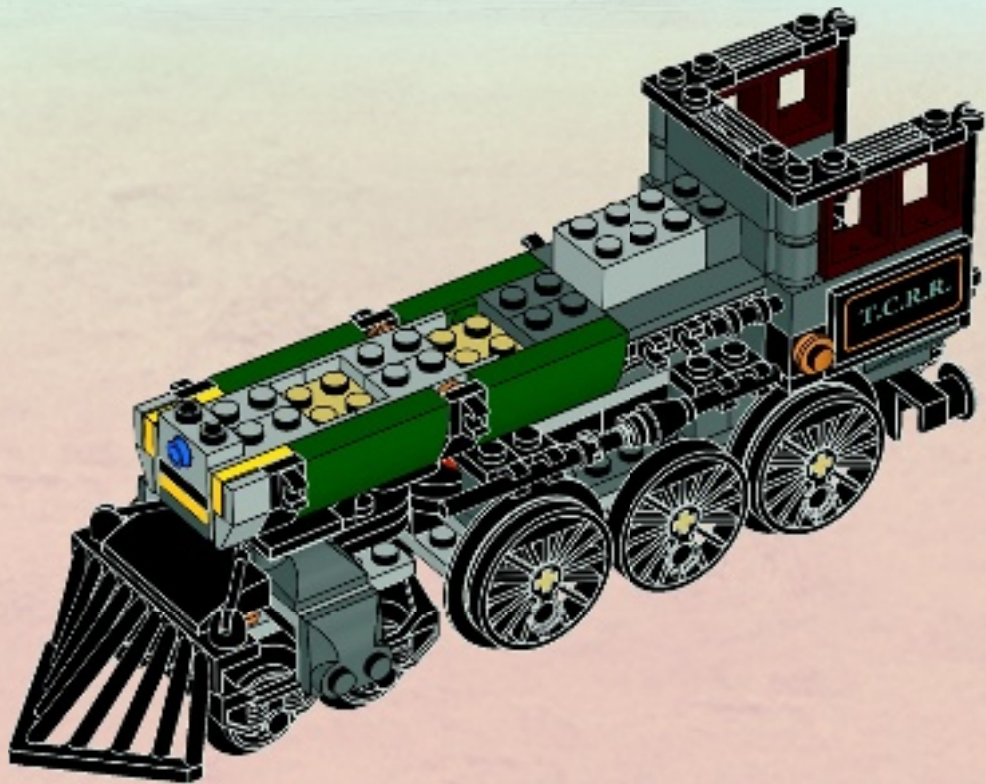



3x

# 42

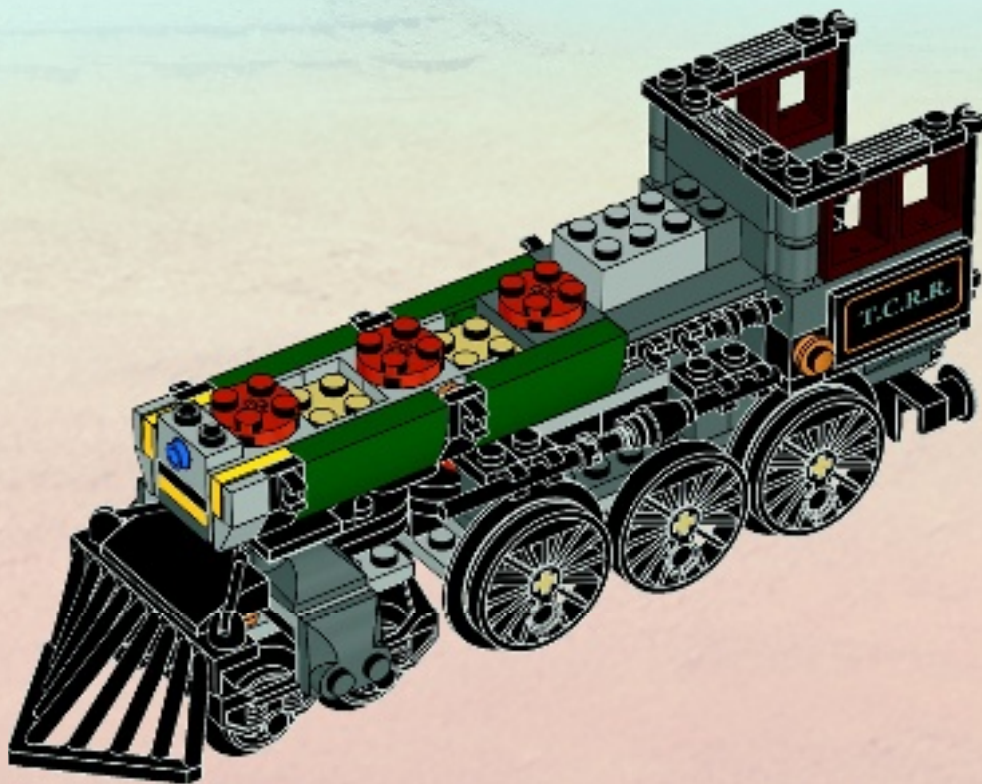

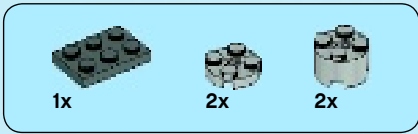

# 43

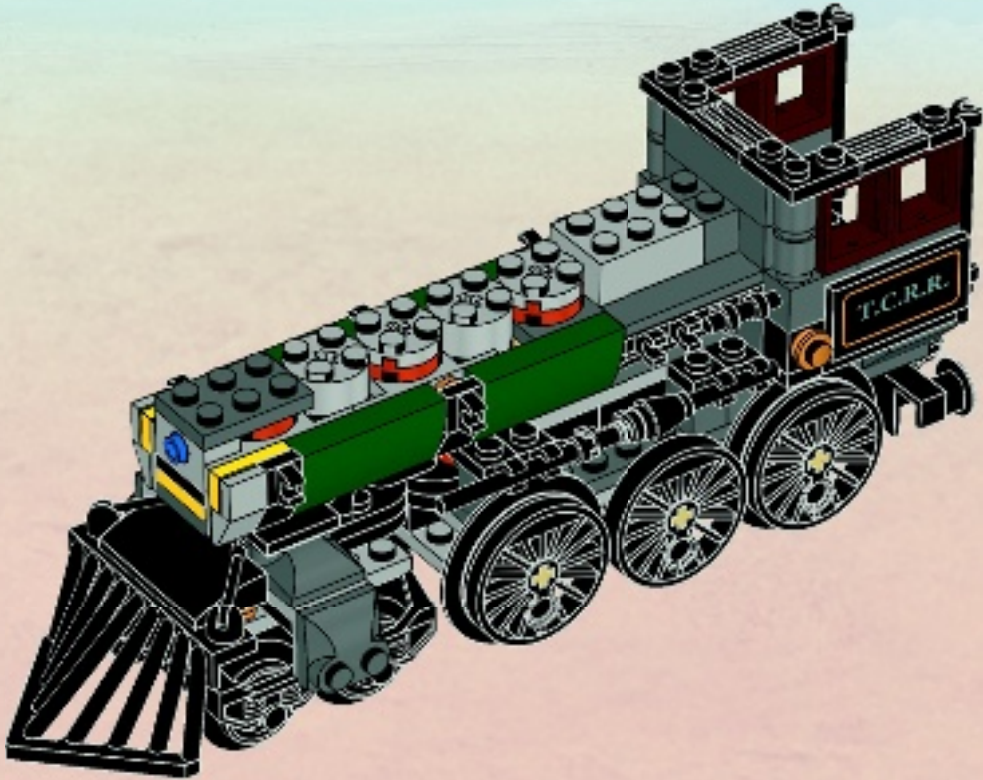





2x



2x

# 44

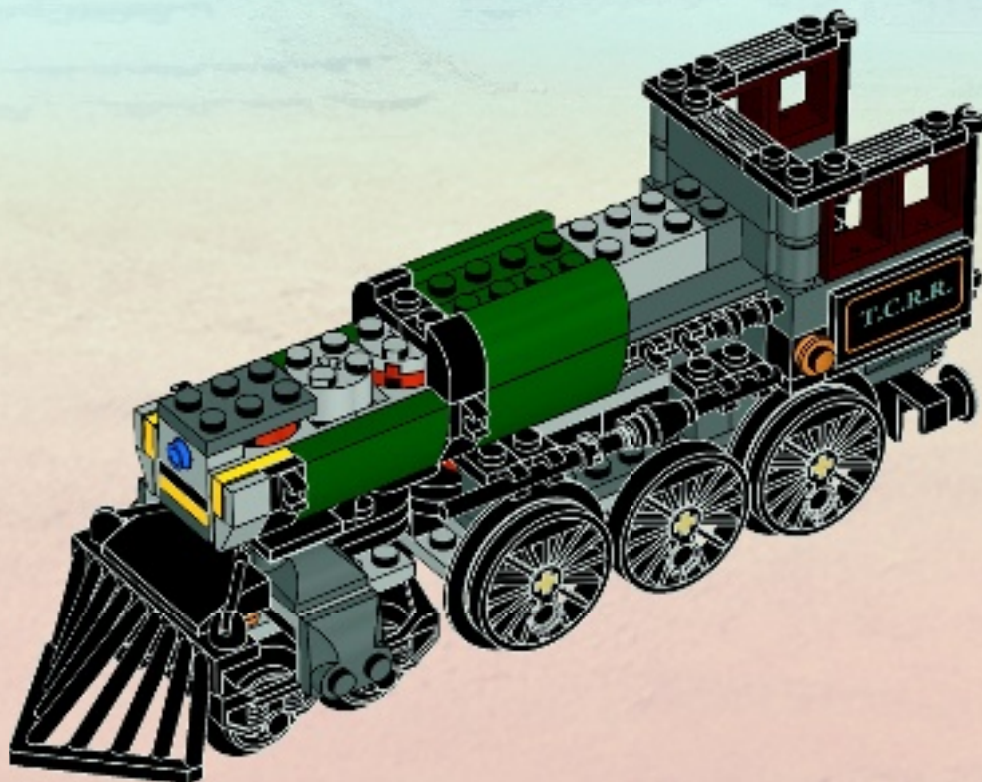



45

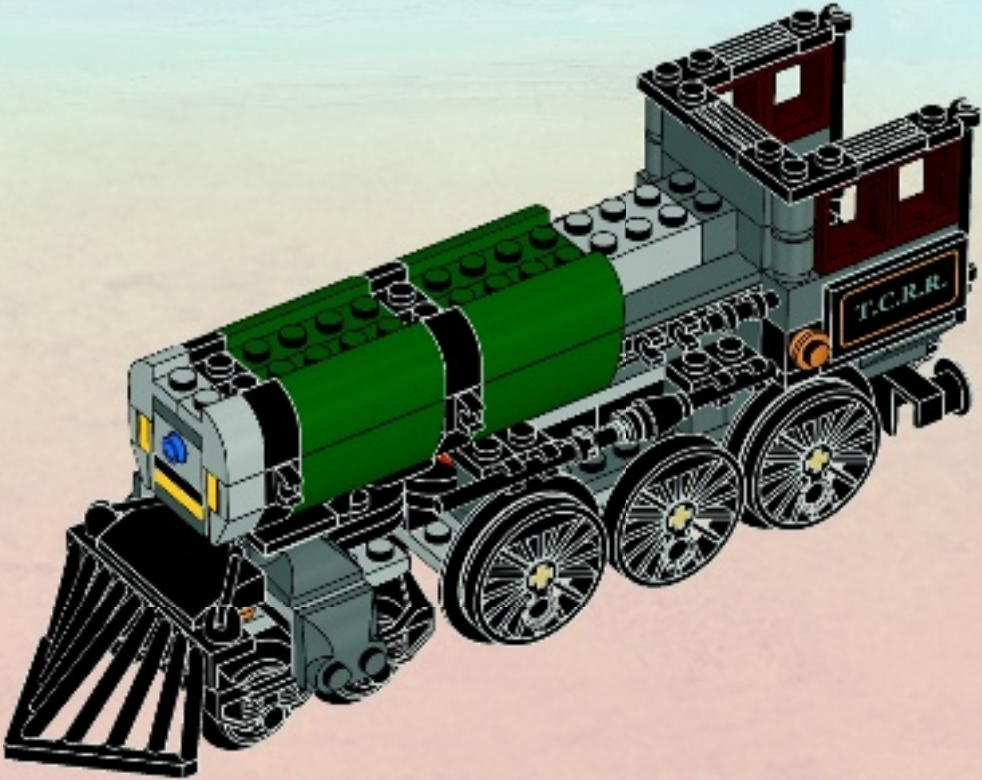

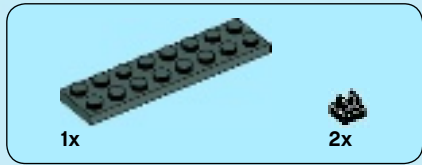

# 46

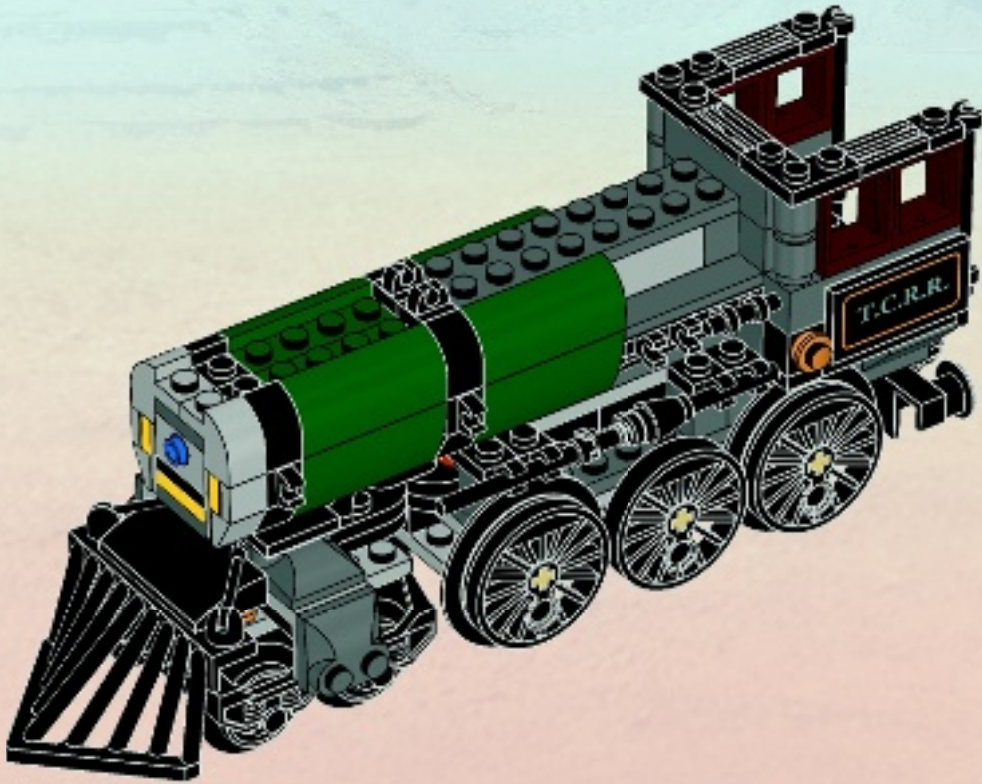





1x



1x

# 47

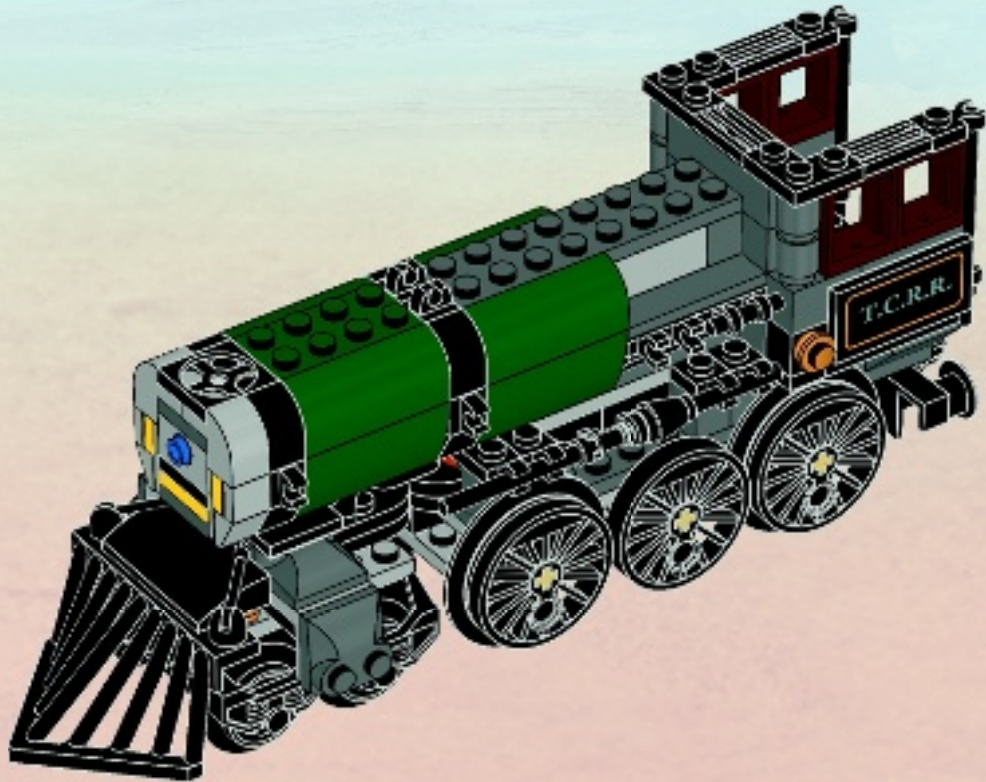



4x

# 48

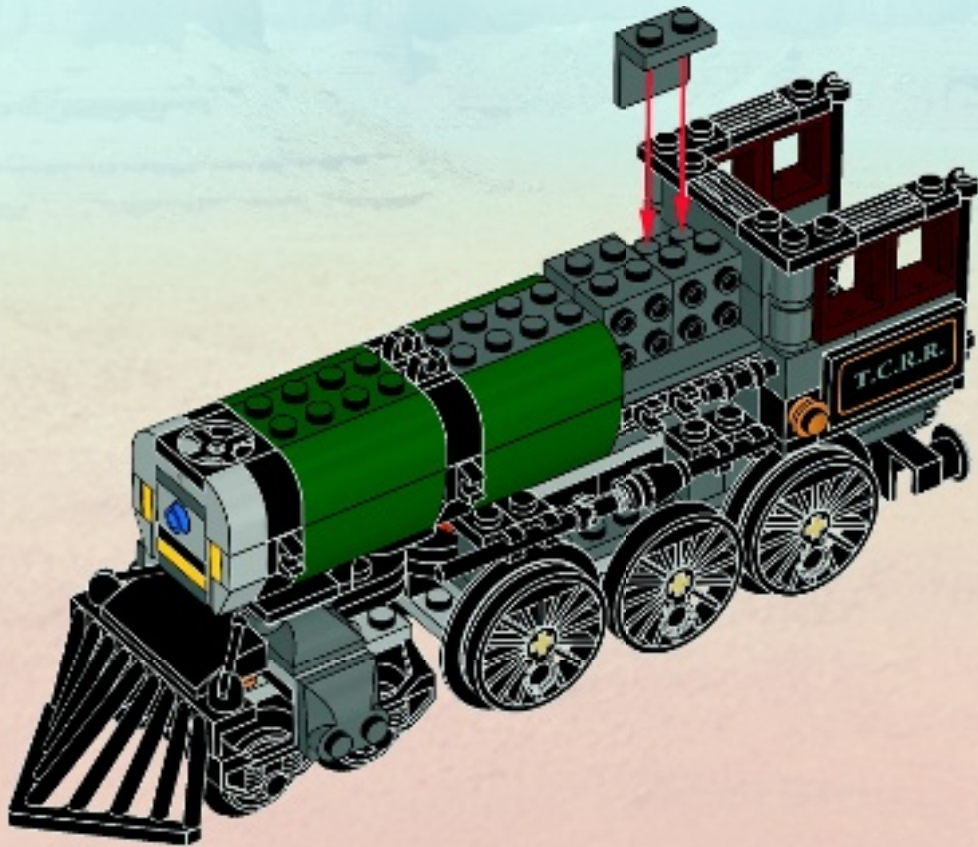



# 49

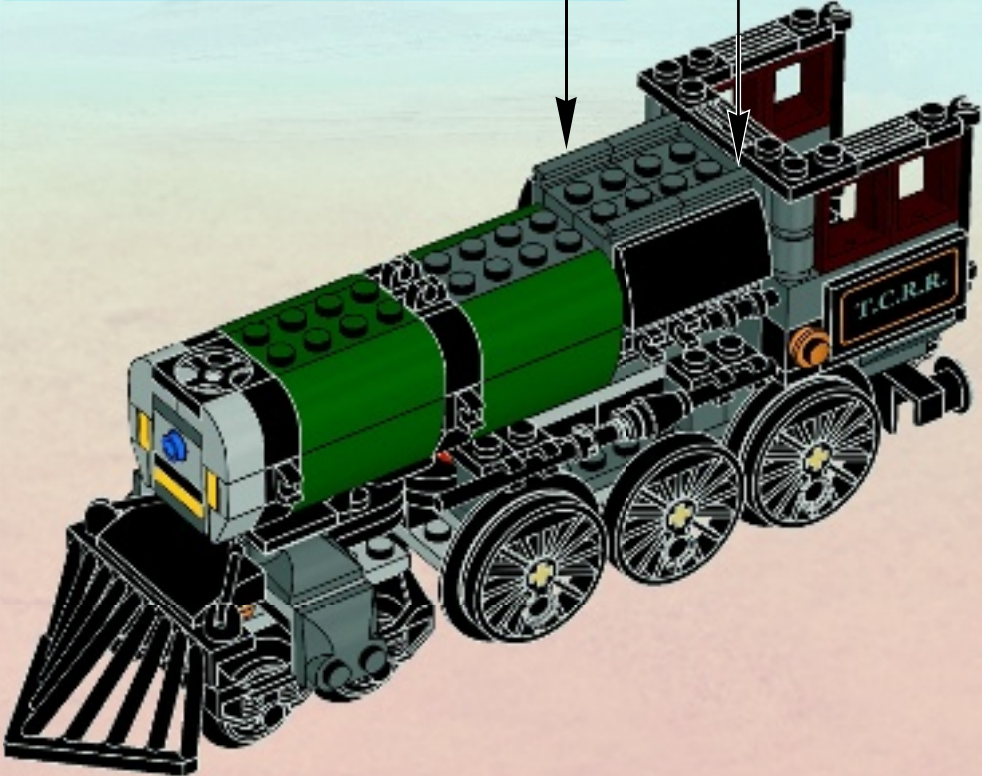



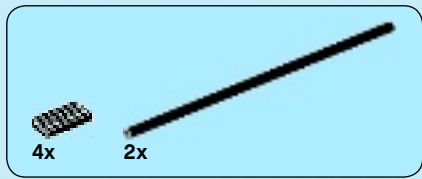

50

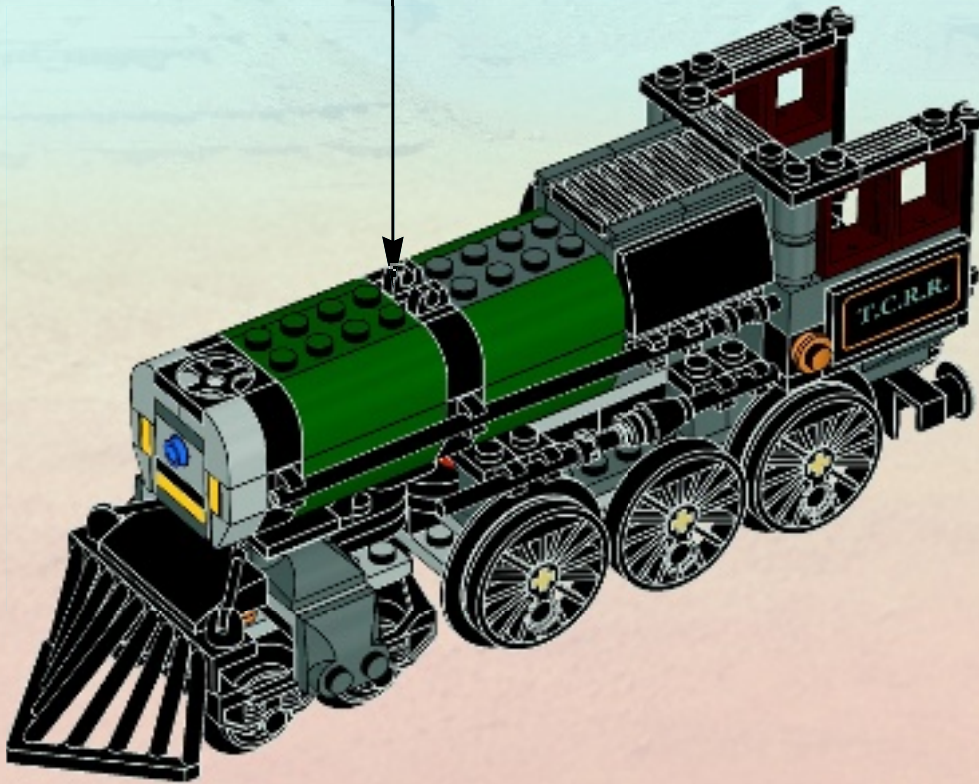
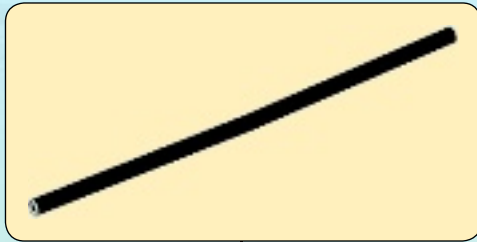



# 51

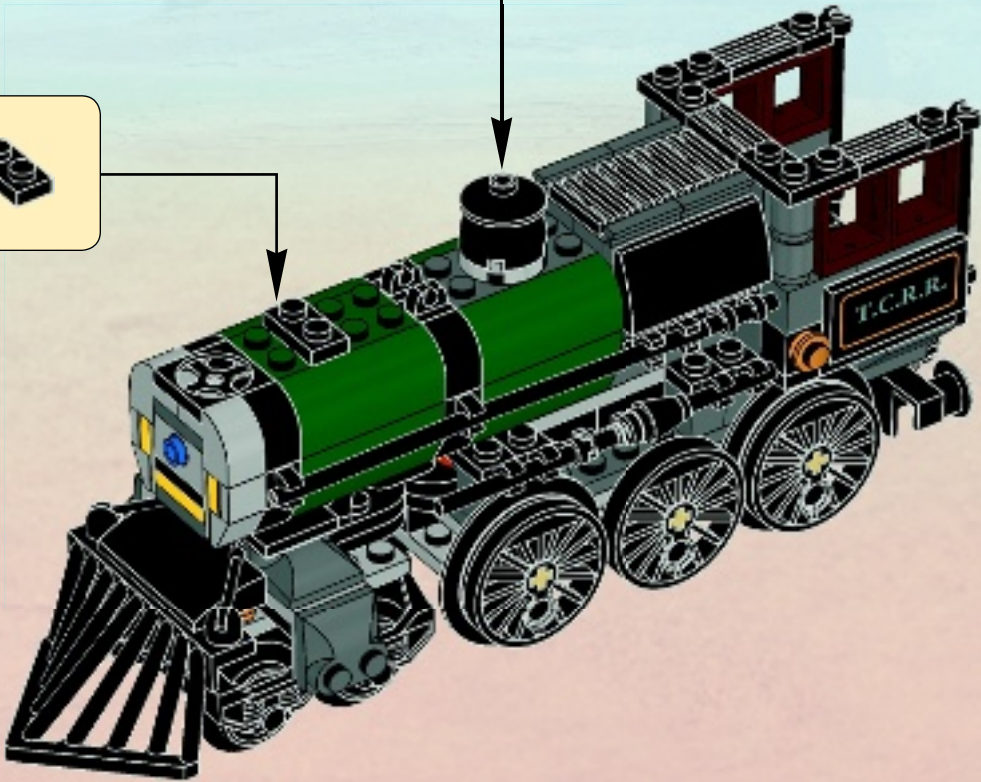
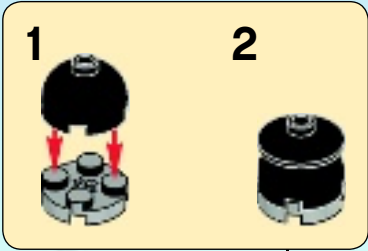

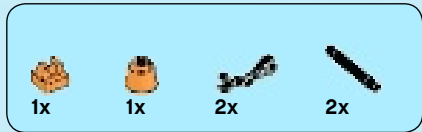

# 52

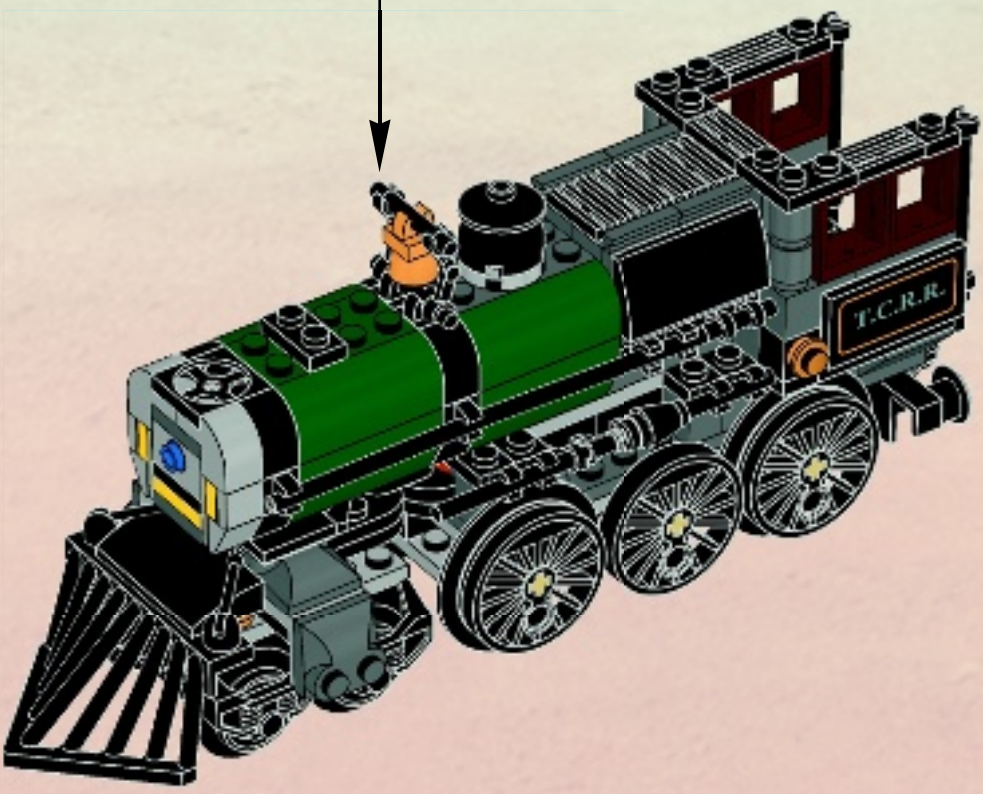
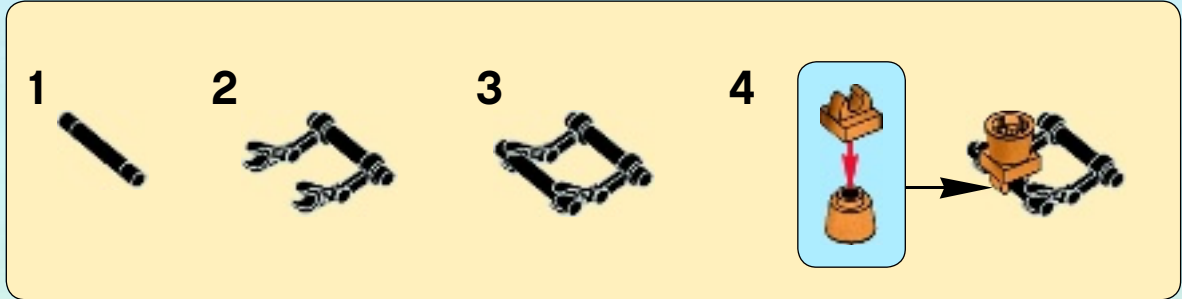



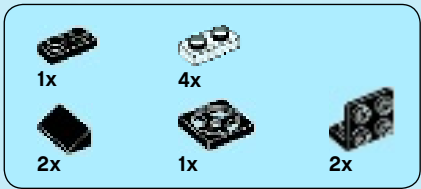

# 53

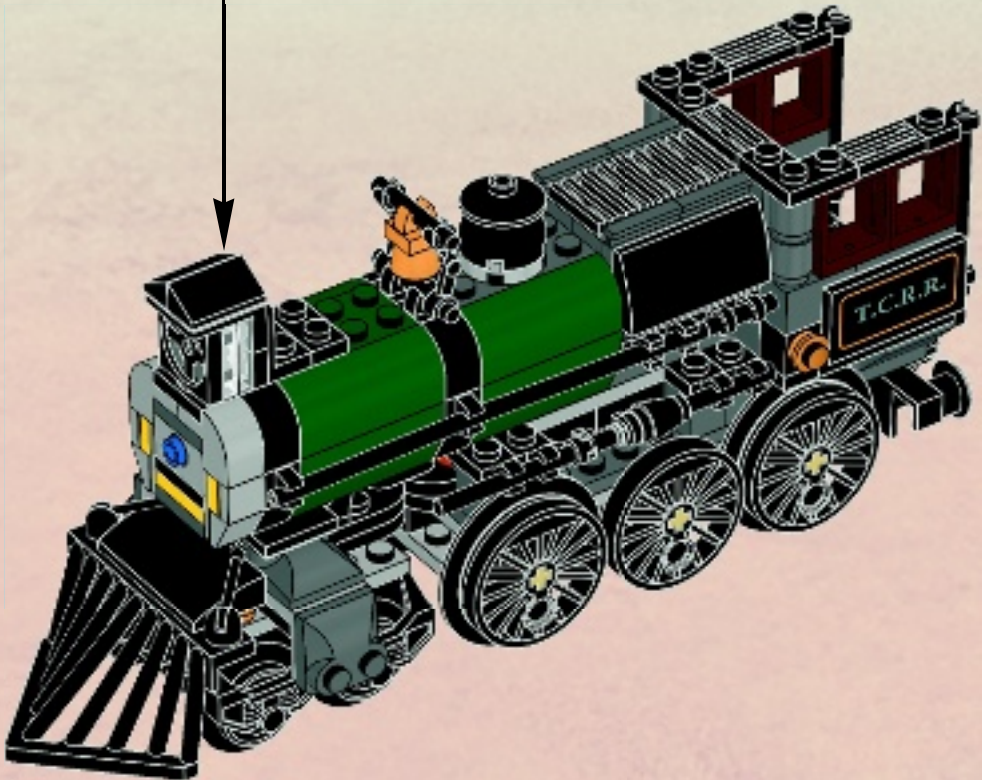
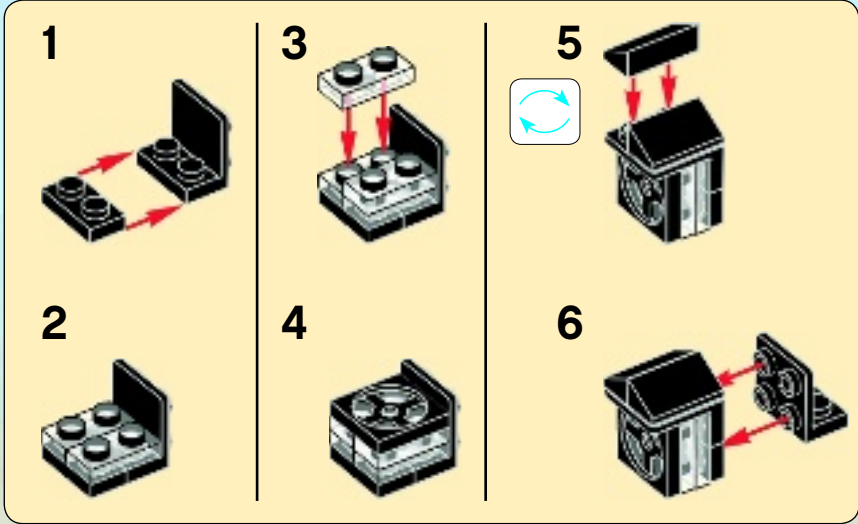

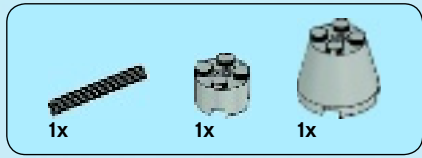

# 54

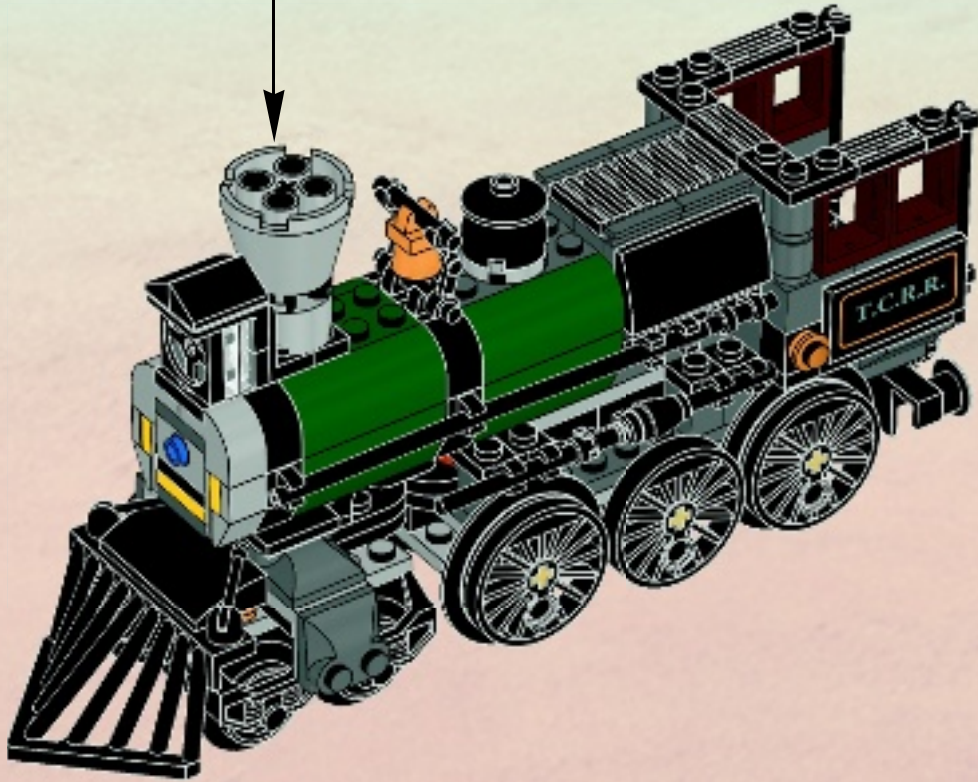
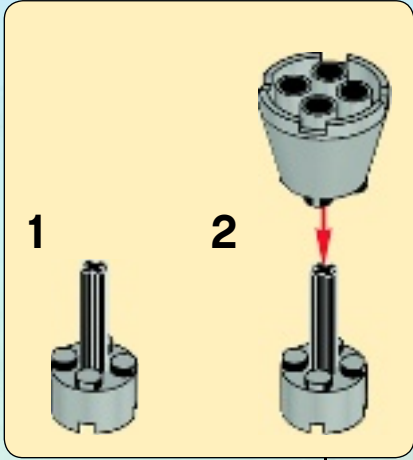

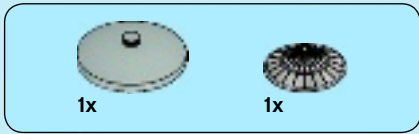



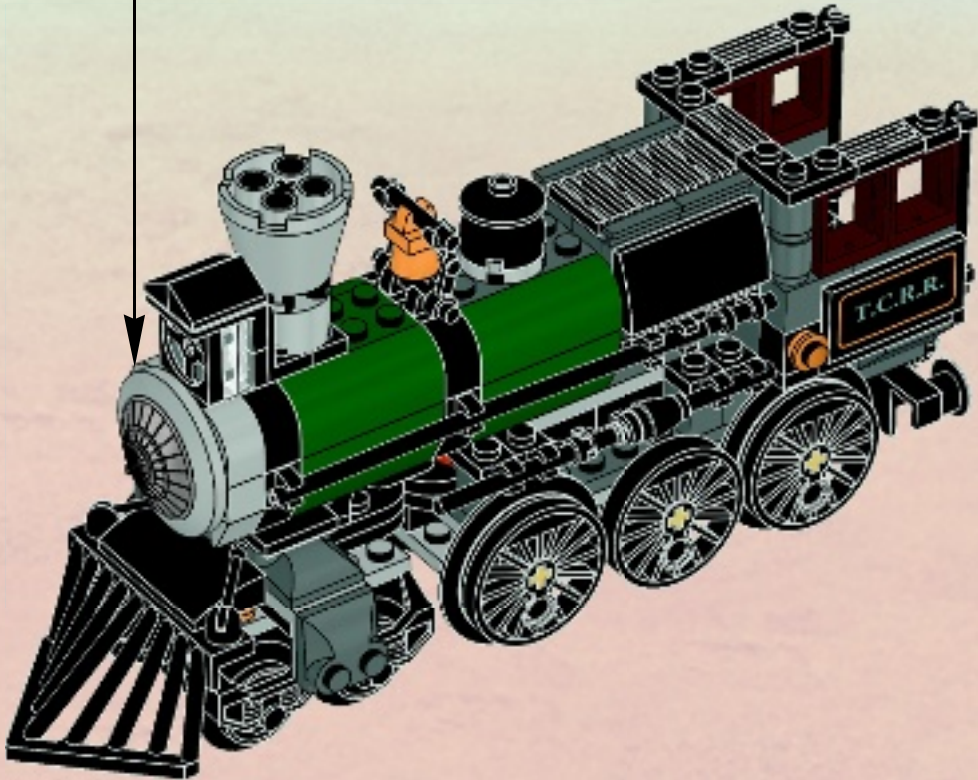
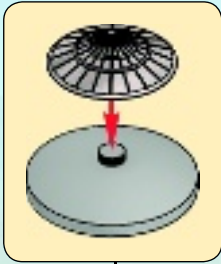



# 55





 2x
  2x
  2x

# 56

1    
 2  2x

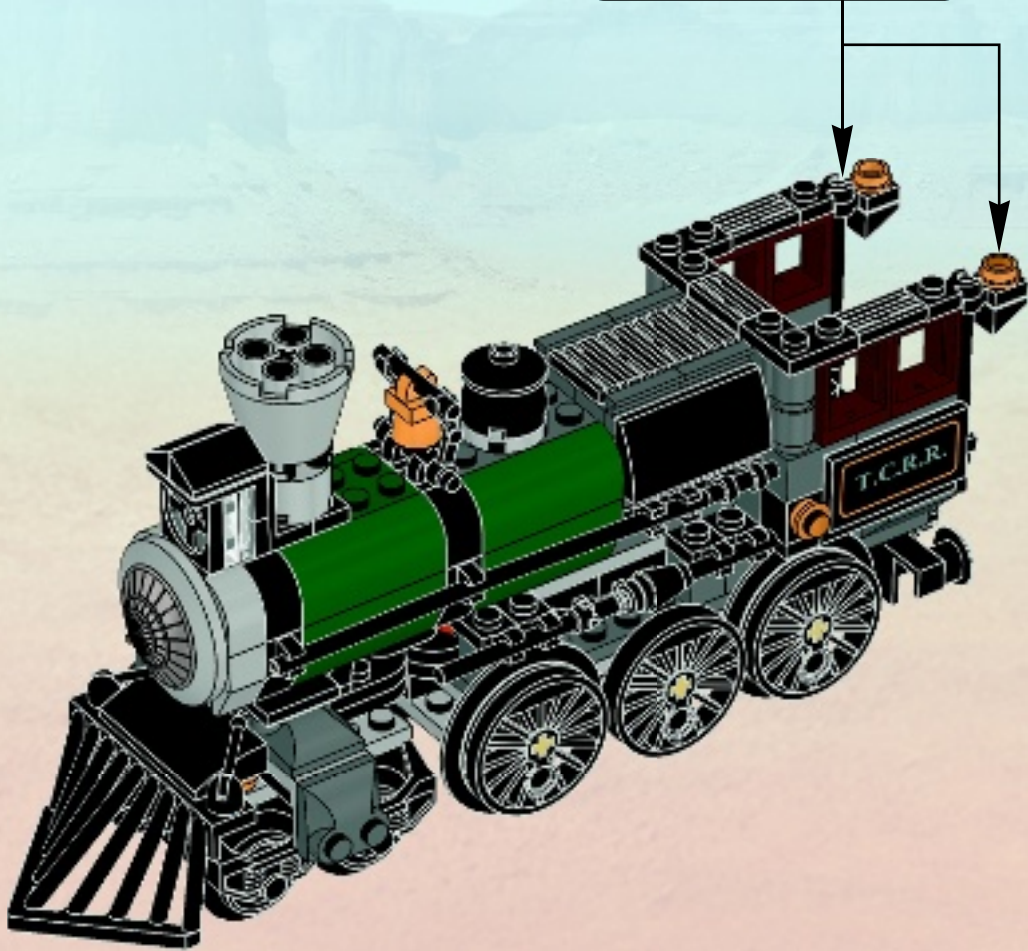

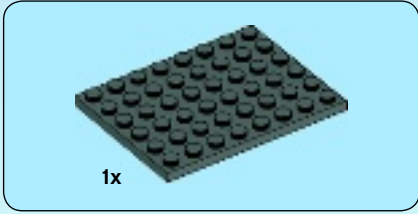

1x

1

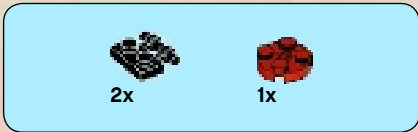

2x

1x

2

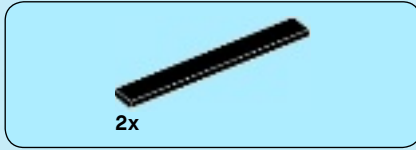

2x

3

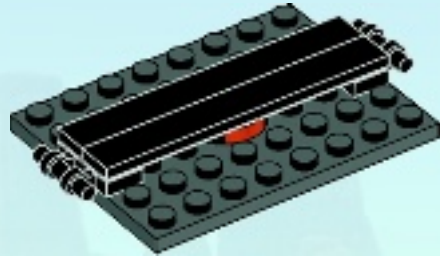

4x

4

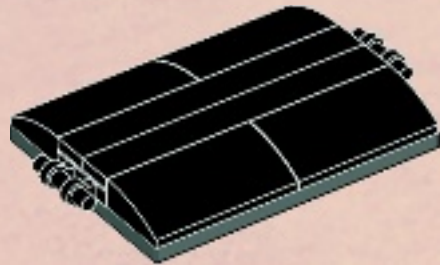



2x



1x

1



2



5

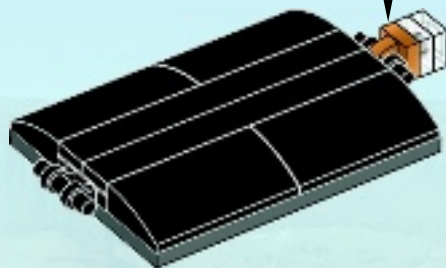

57

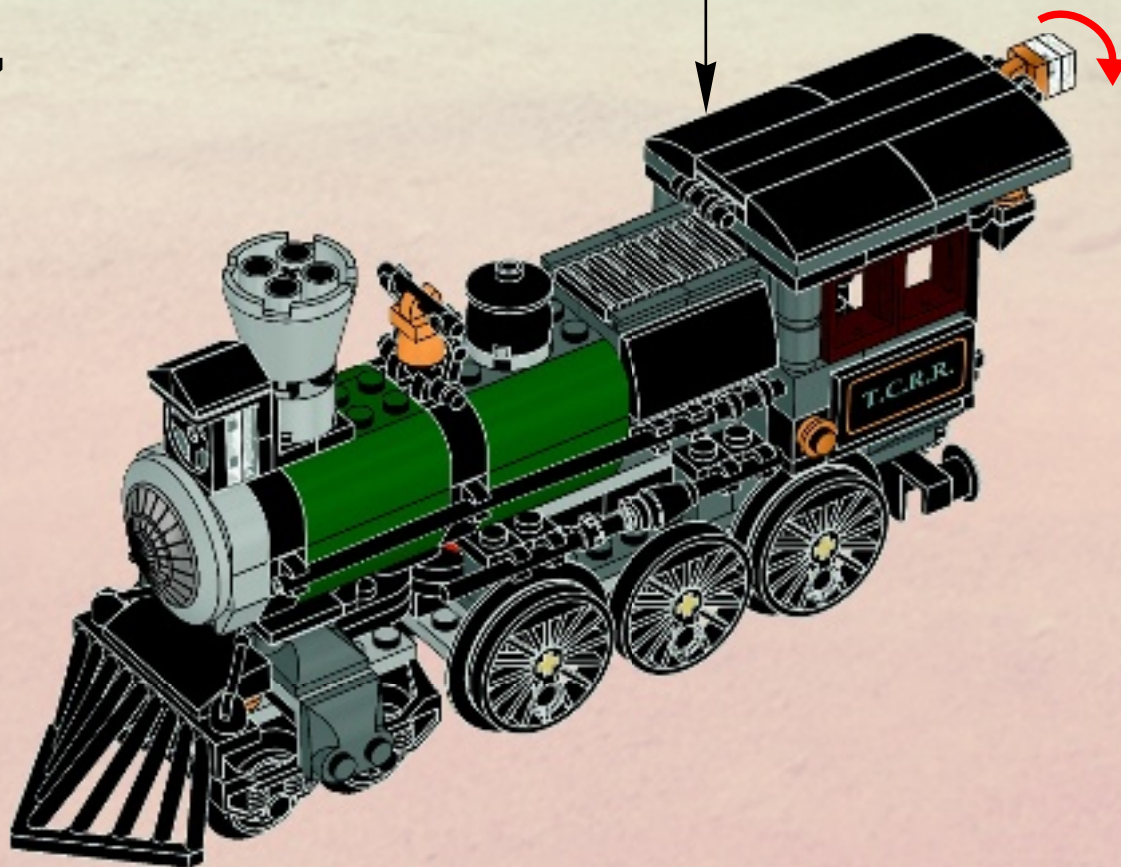



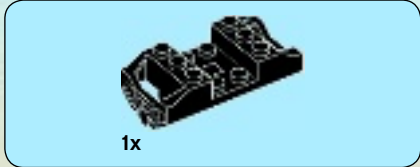
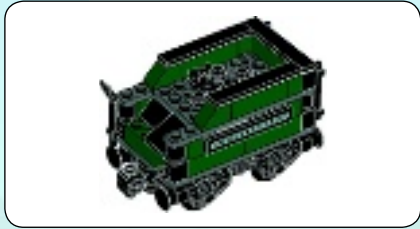
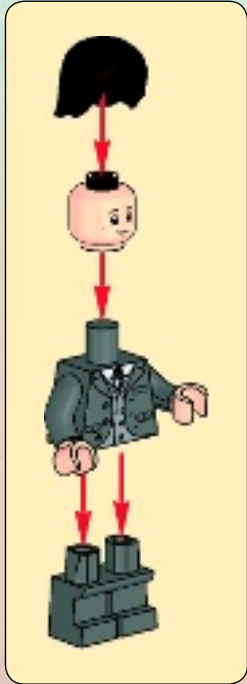
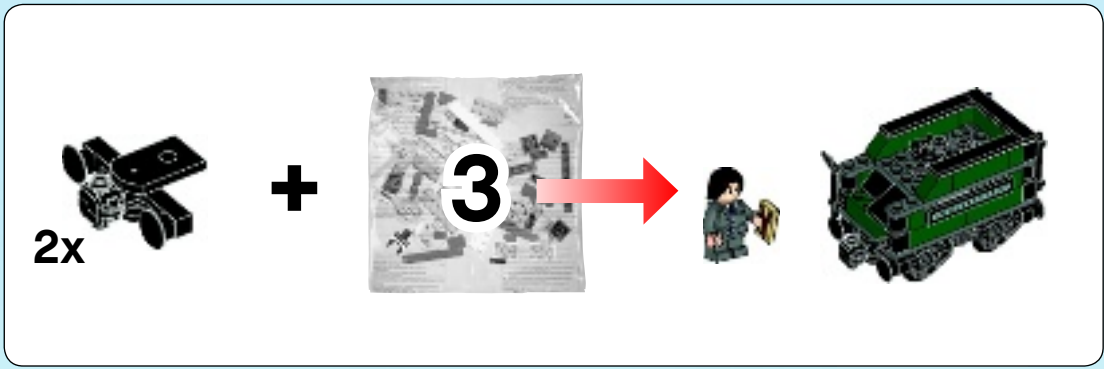

1

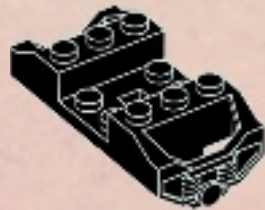

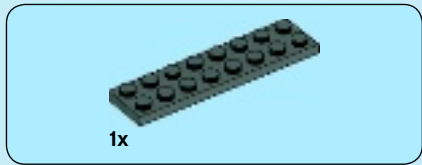

2

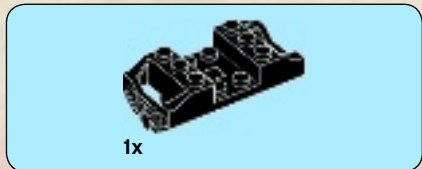
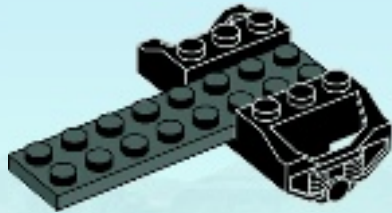

3

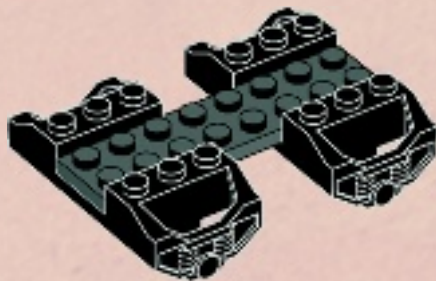

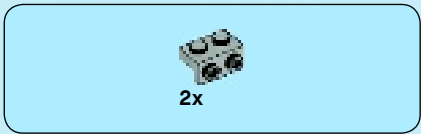

4

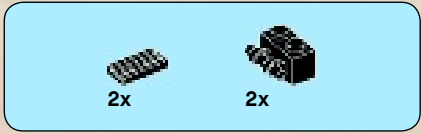

5

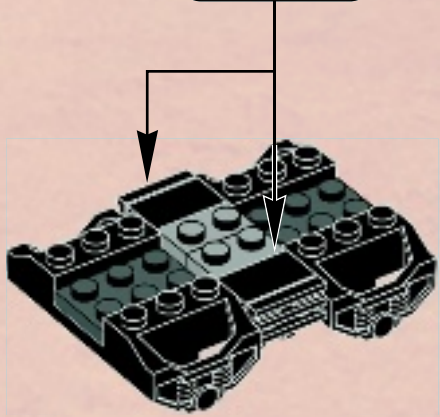
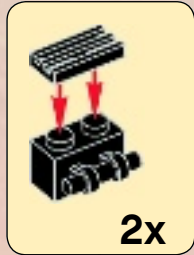





2x

6



1x

7

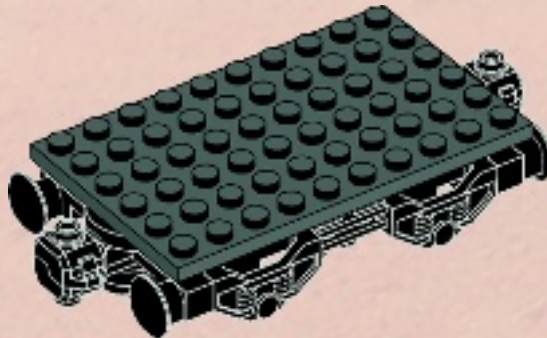

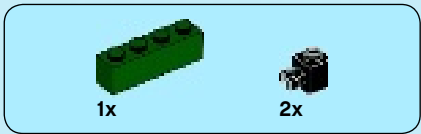

8

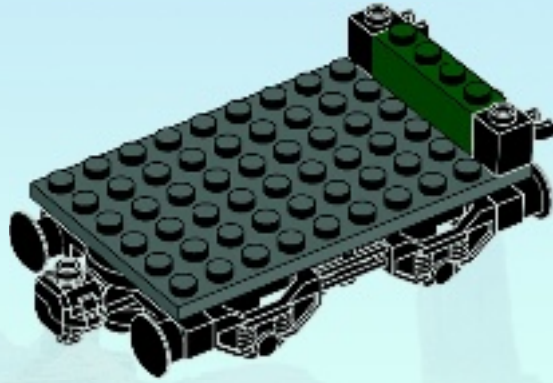

9

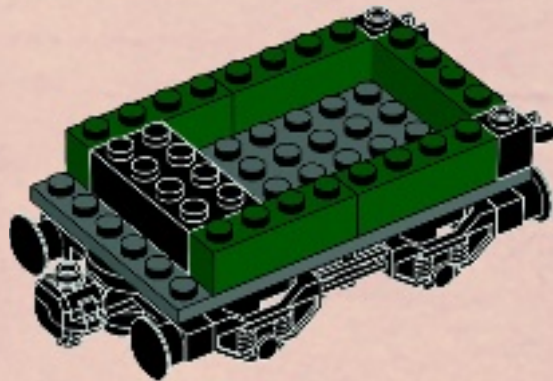

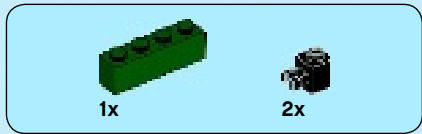

# 10

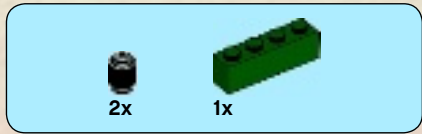
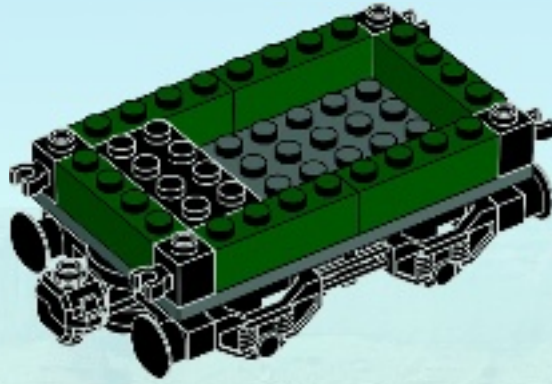

# 11

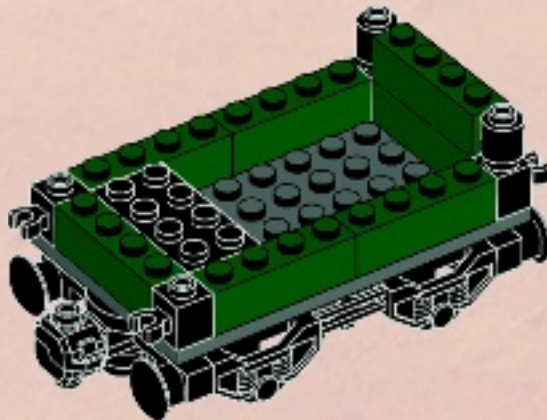





12

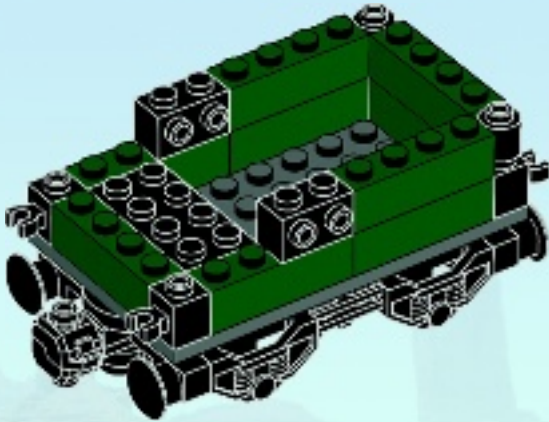

13

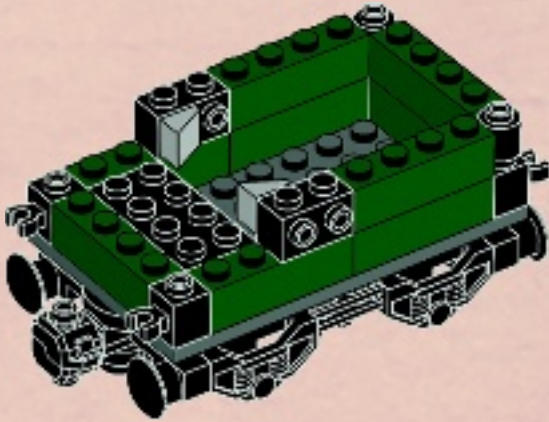

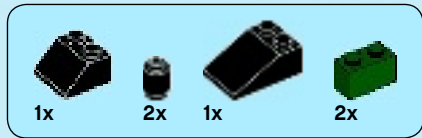

# 14

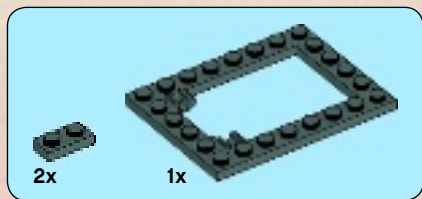
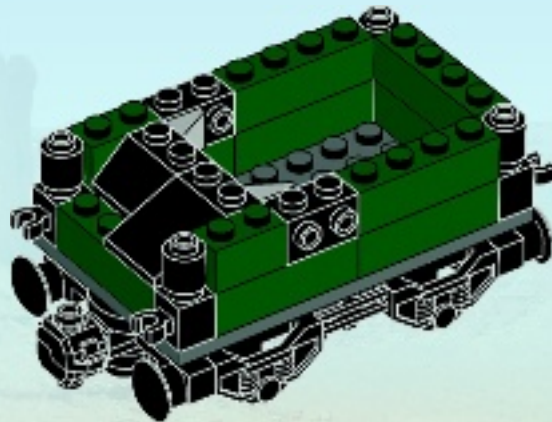

# 15

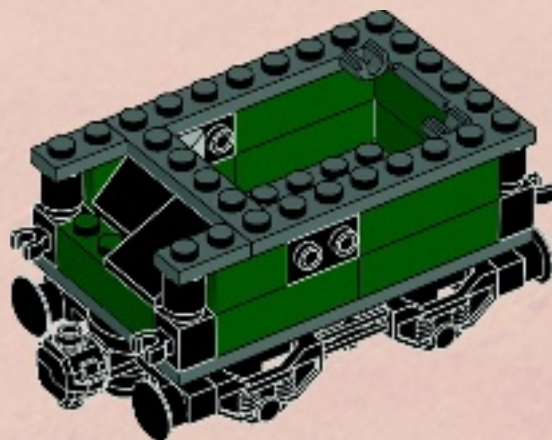

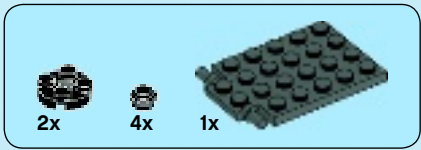

# 16

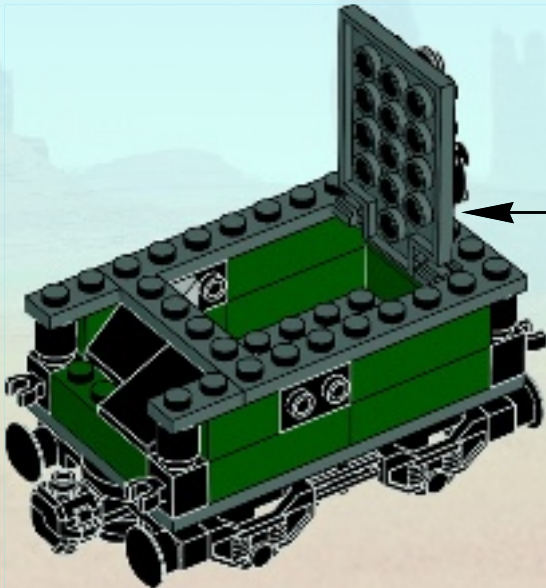
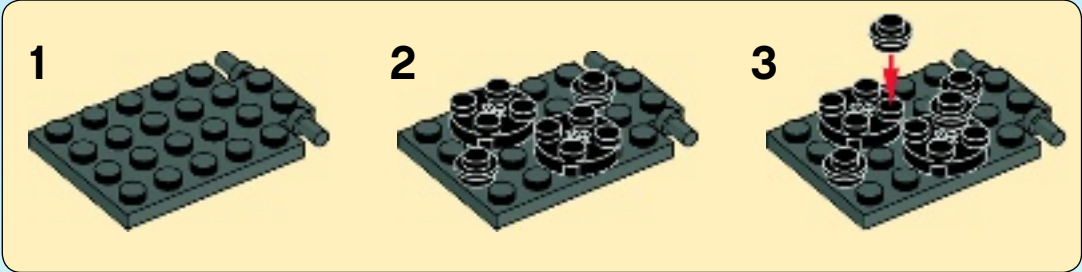

# 17

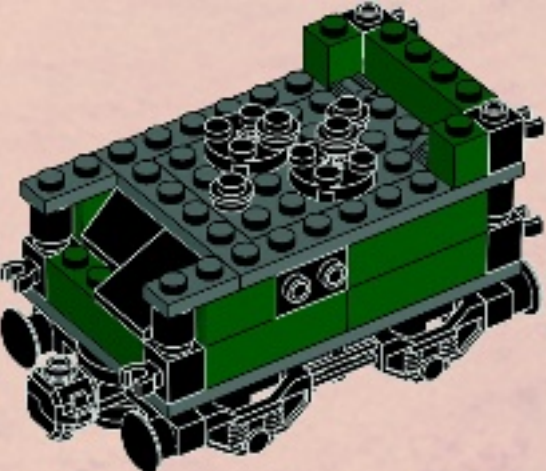



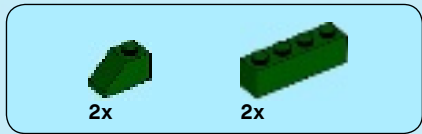

18

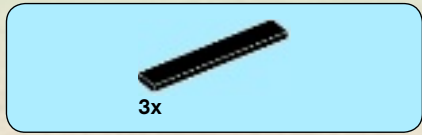
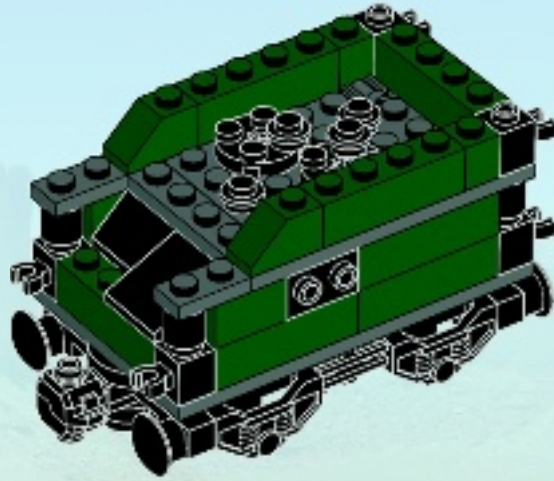

19

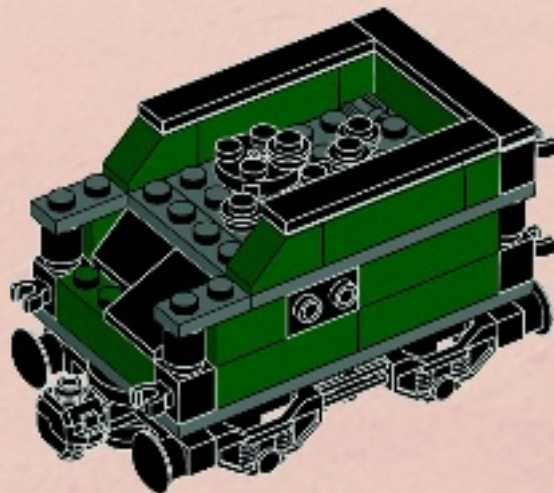

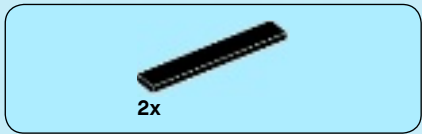

20

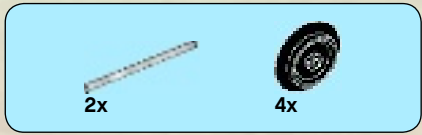
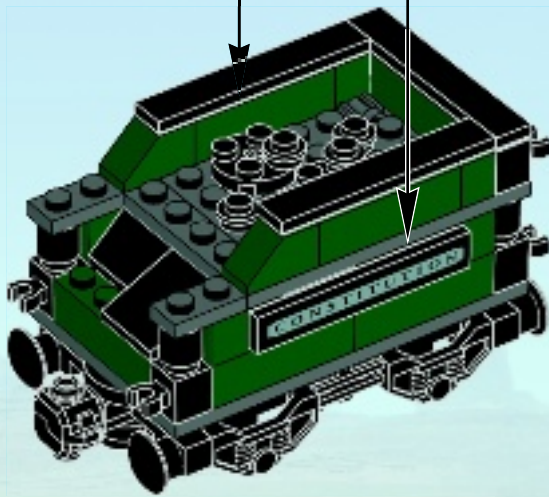
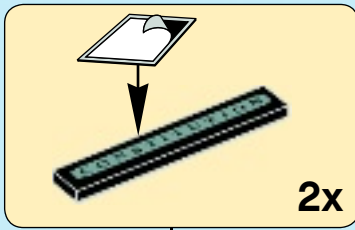

21

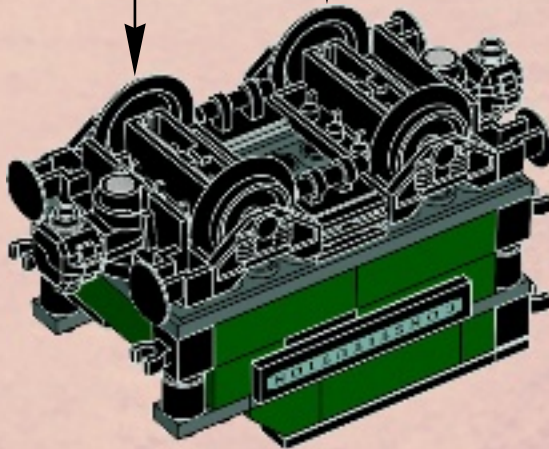
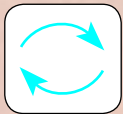
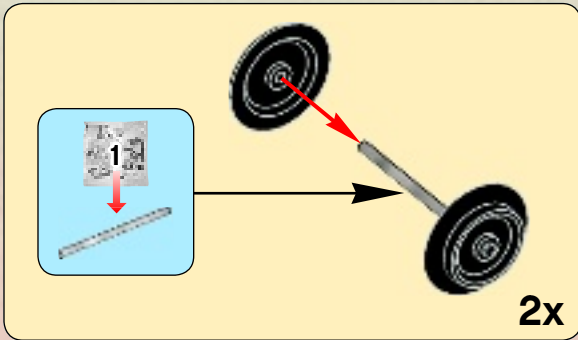



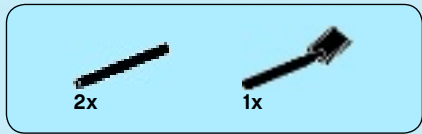

22

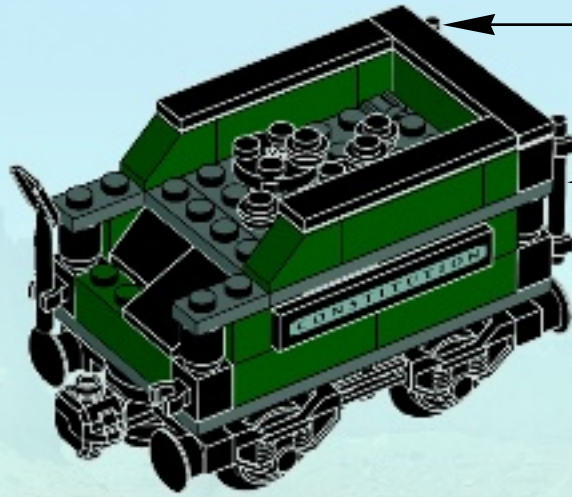
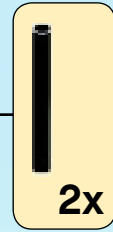
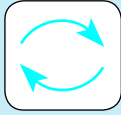

58

