



# THE LONE RANGER



79110







2x

# 75

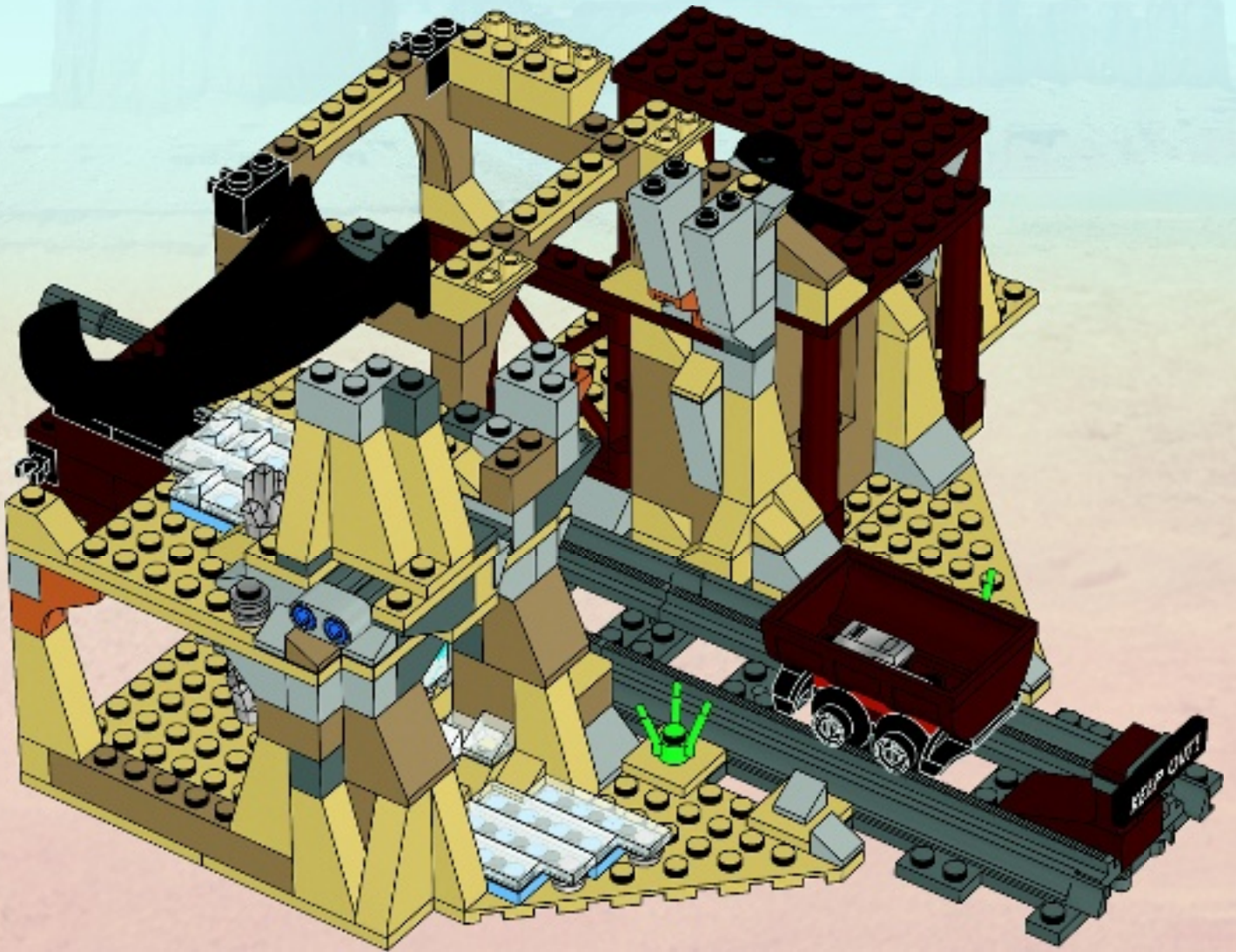
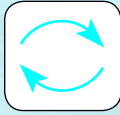



1x

# 76

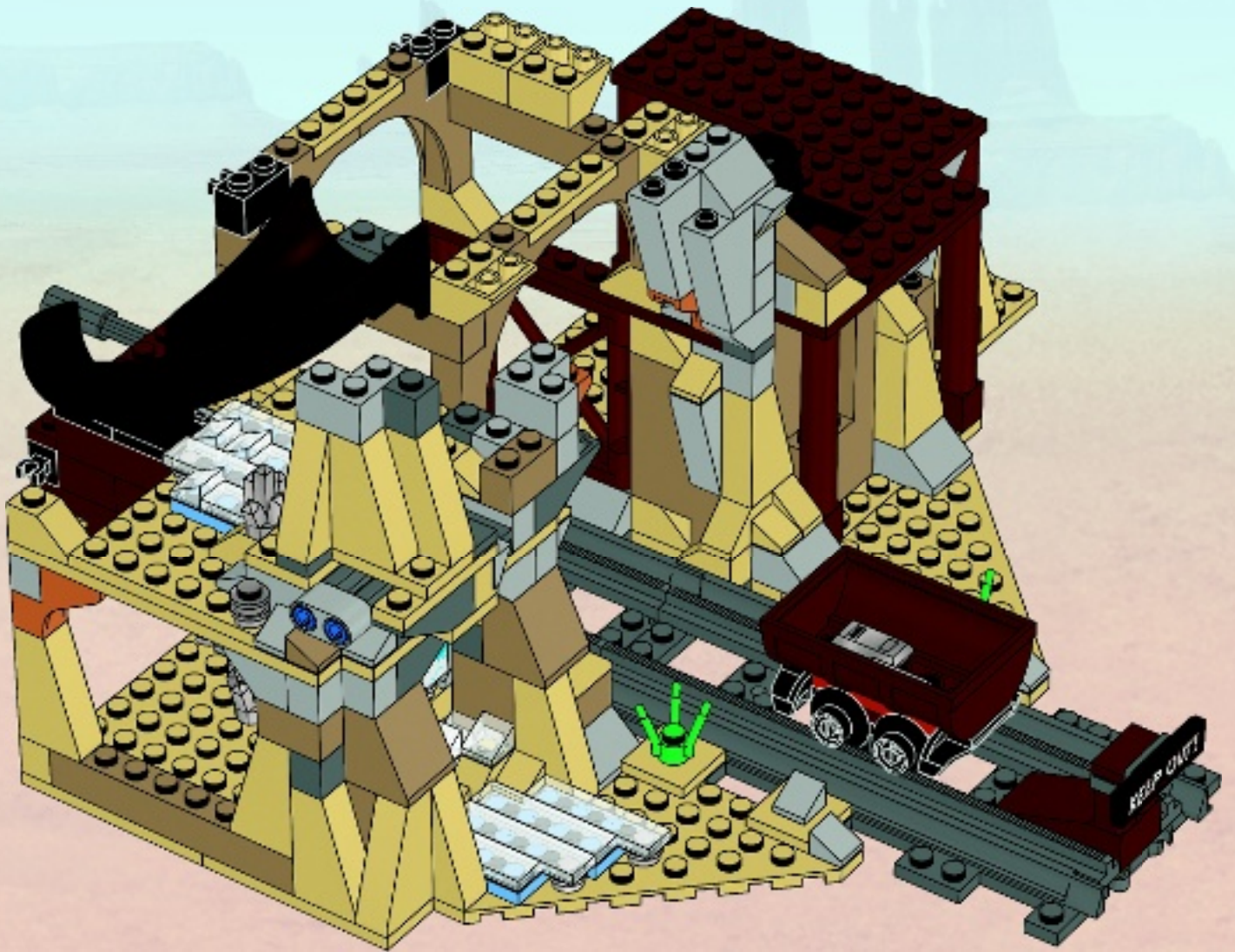





77

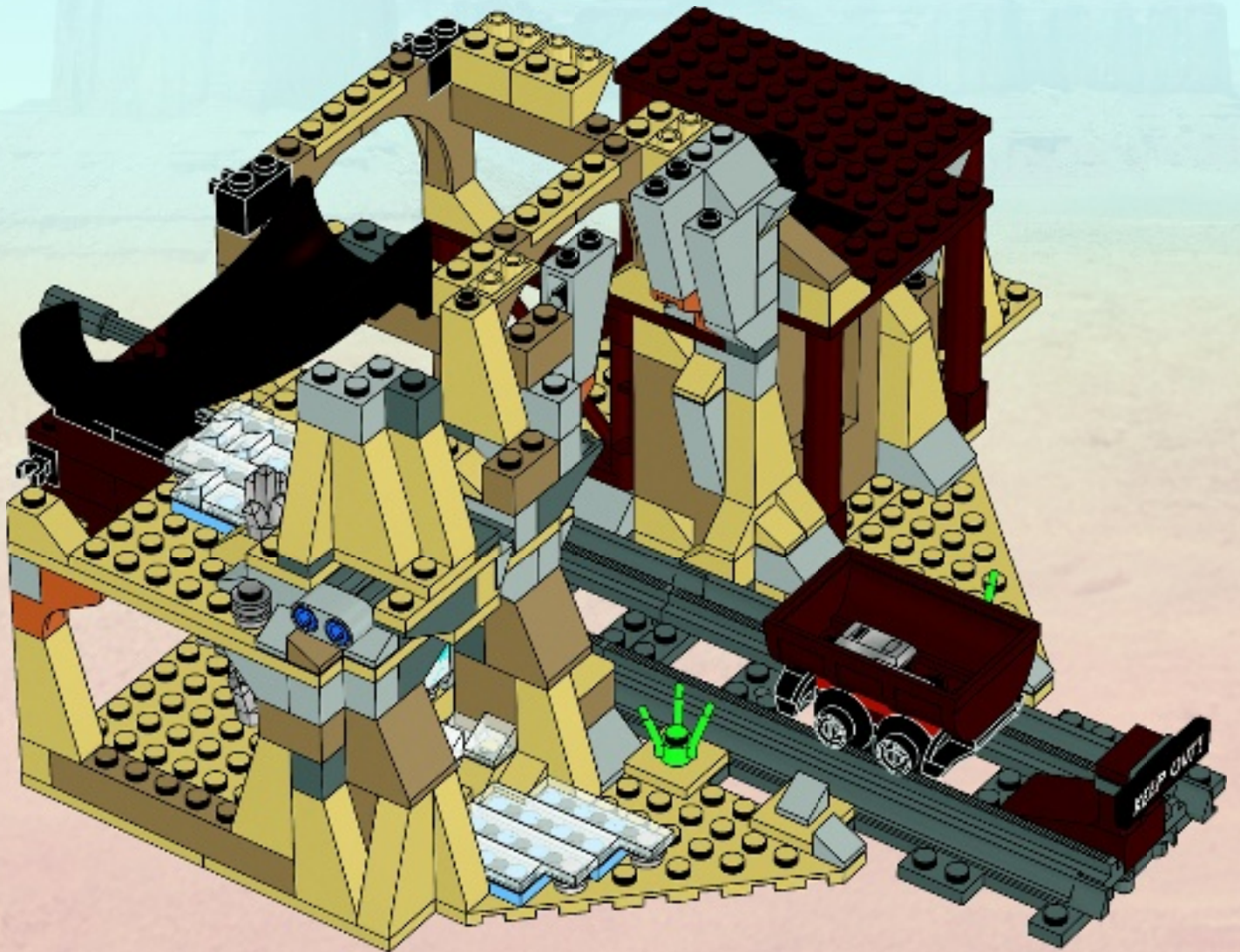



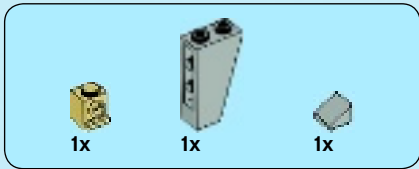

# 78

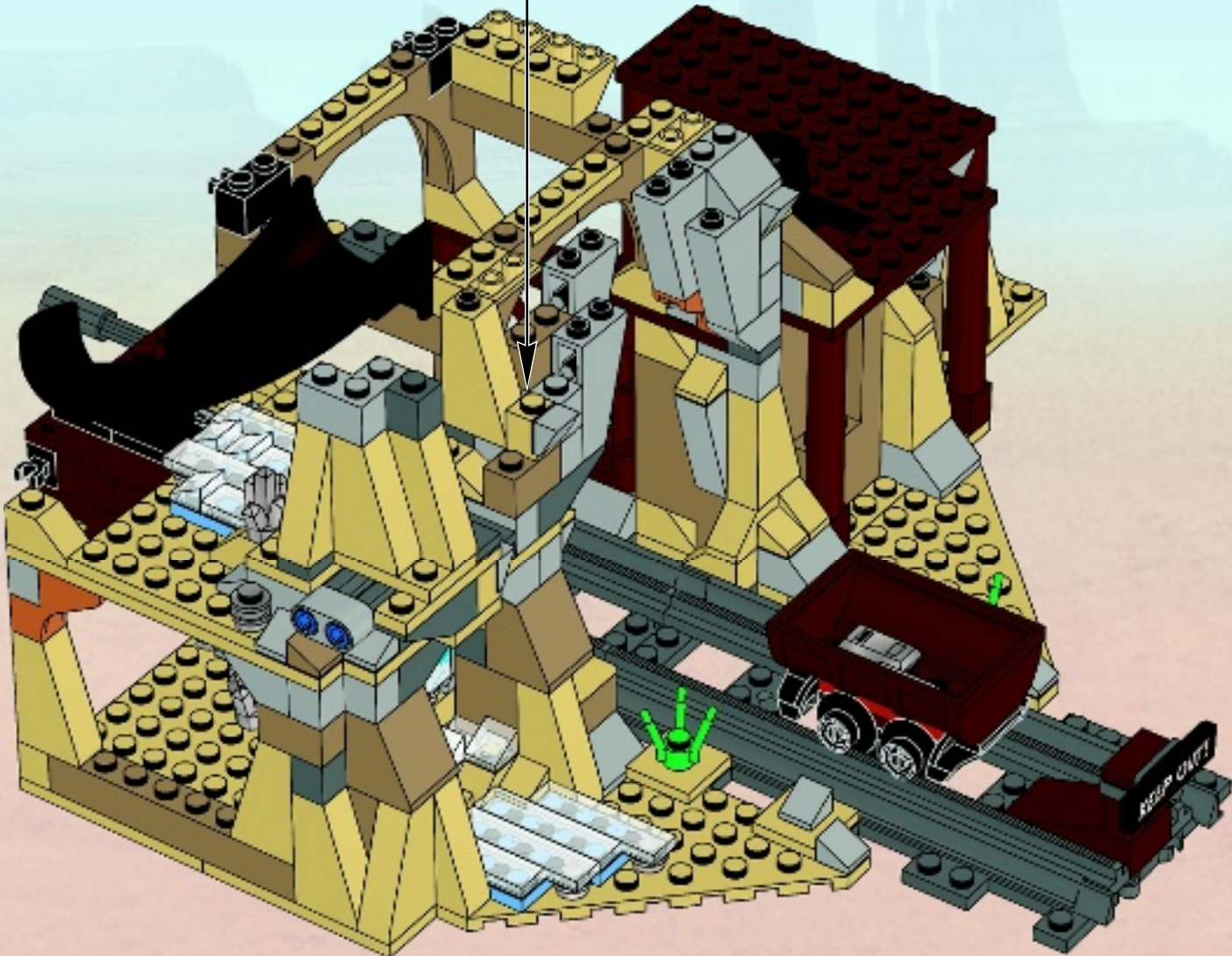
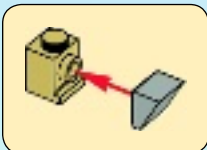





3x

# 79

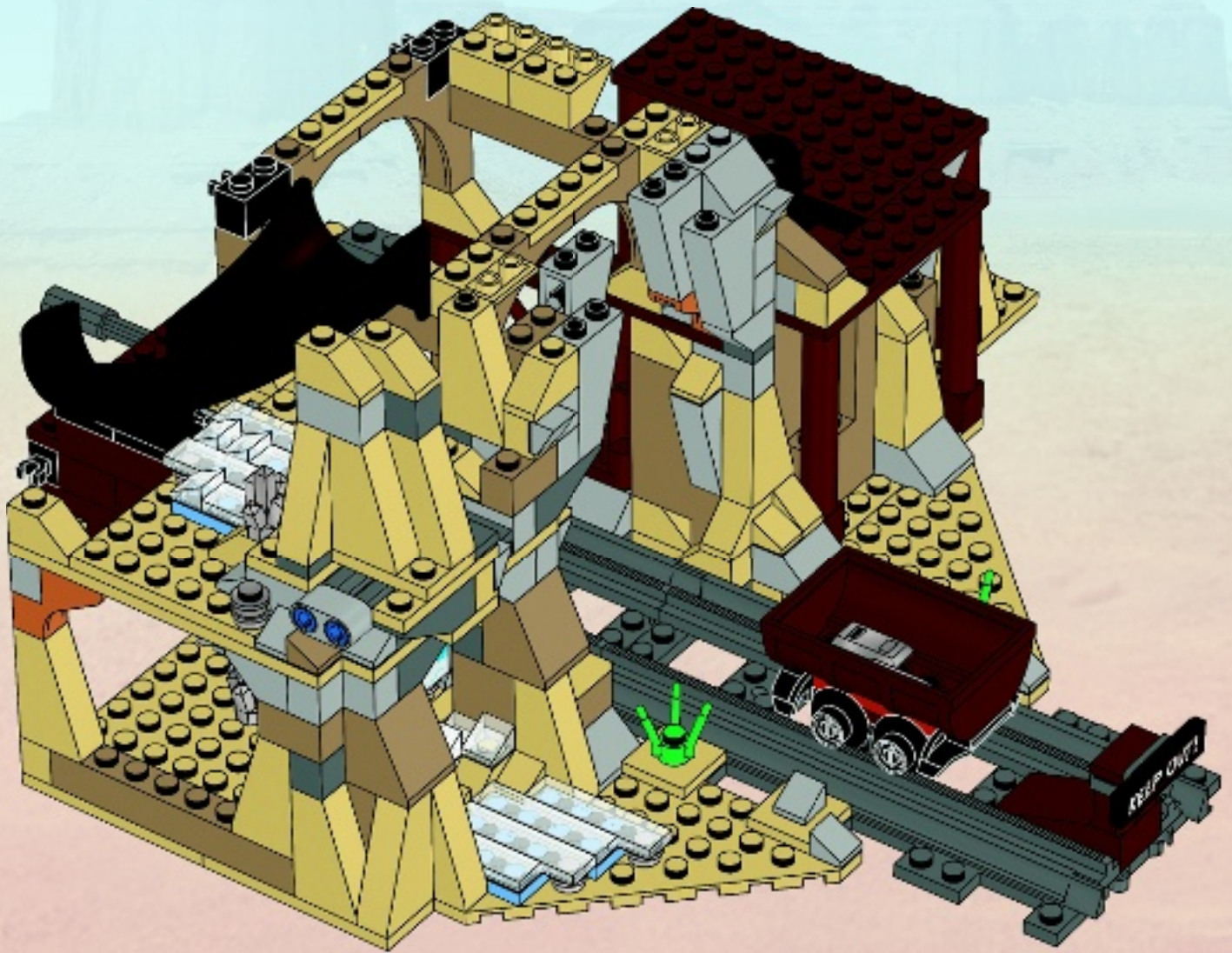





1x

# 80

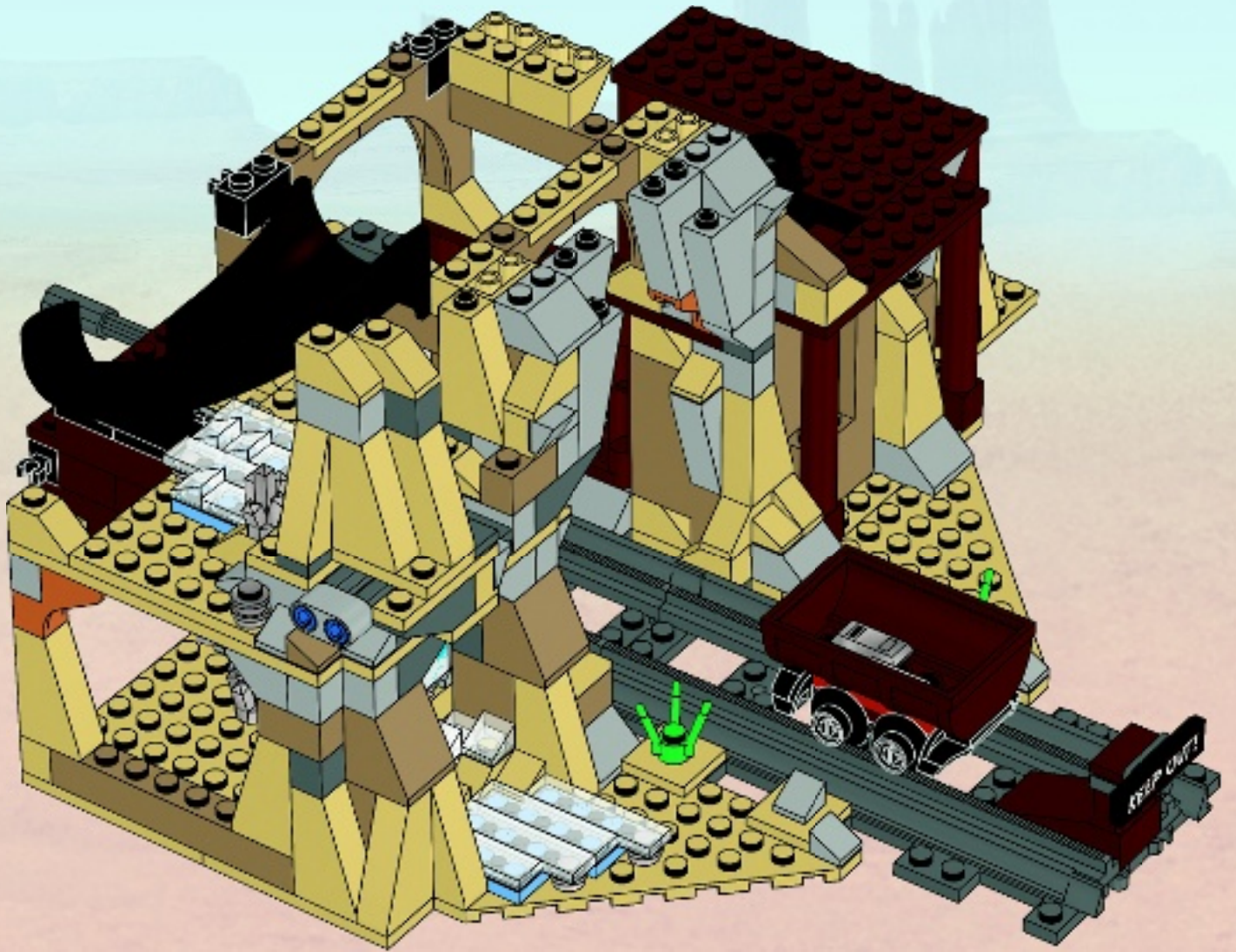



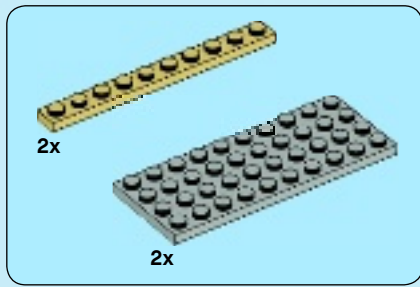

# 81

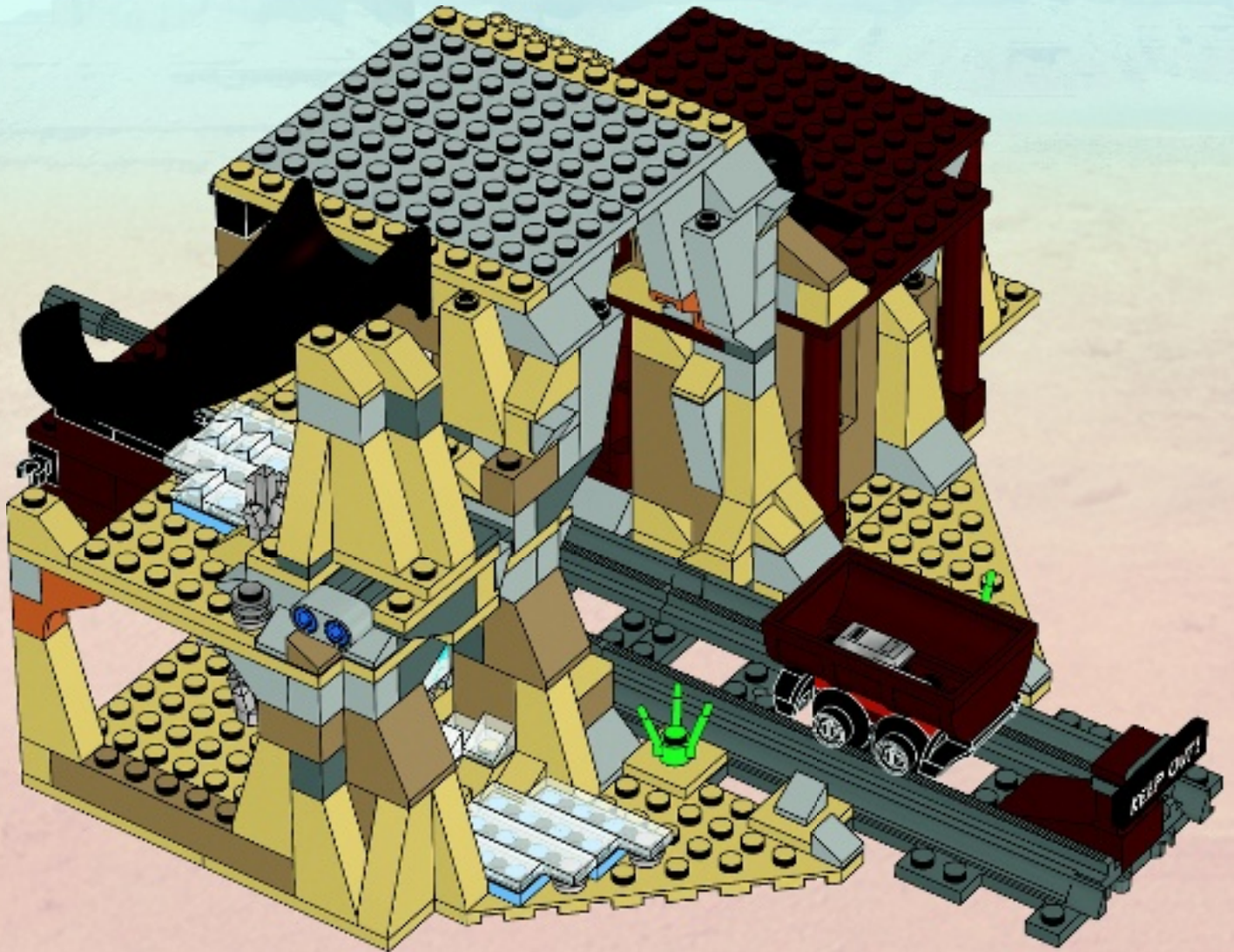

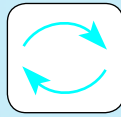
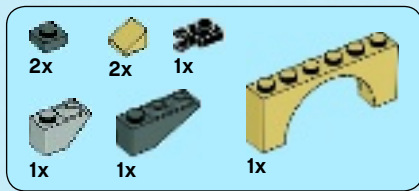



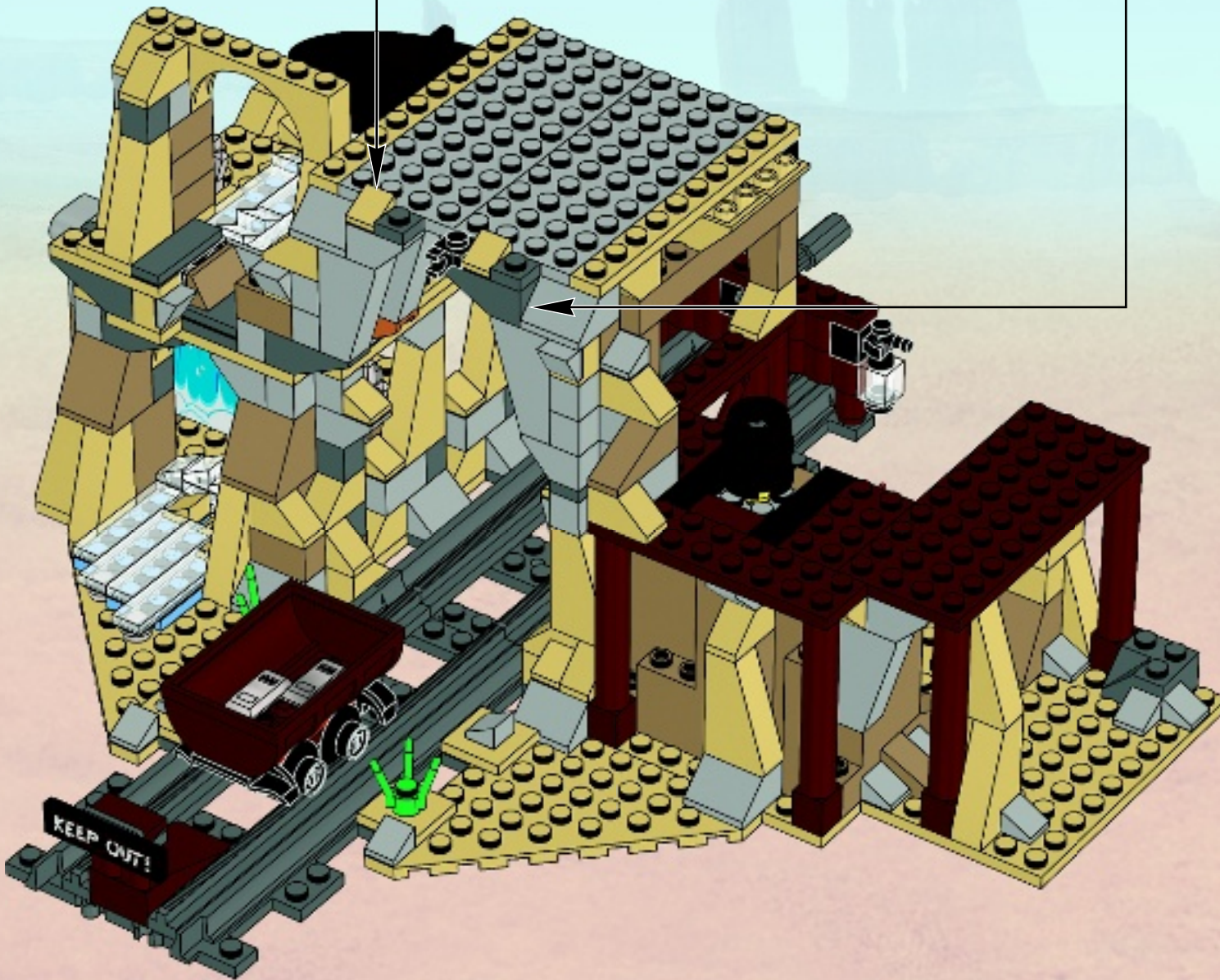
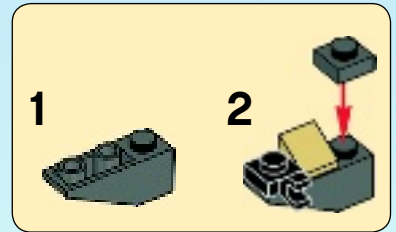
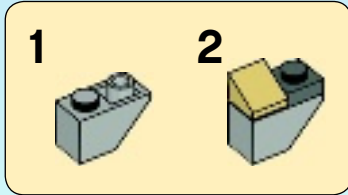

# 82





			
2x	2x	2x	1x

# 83



2x

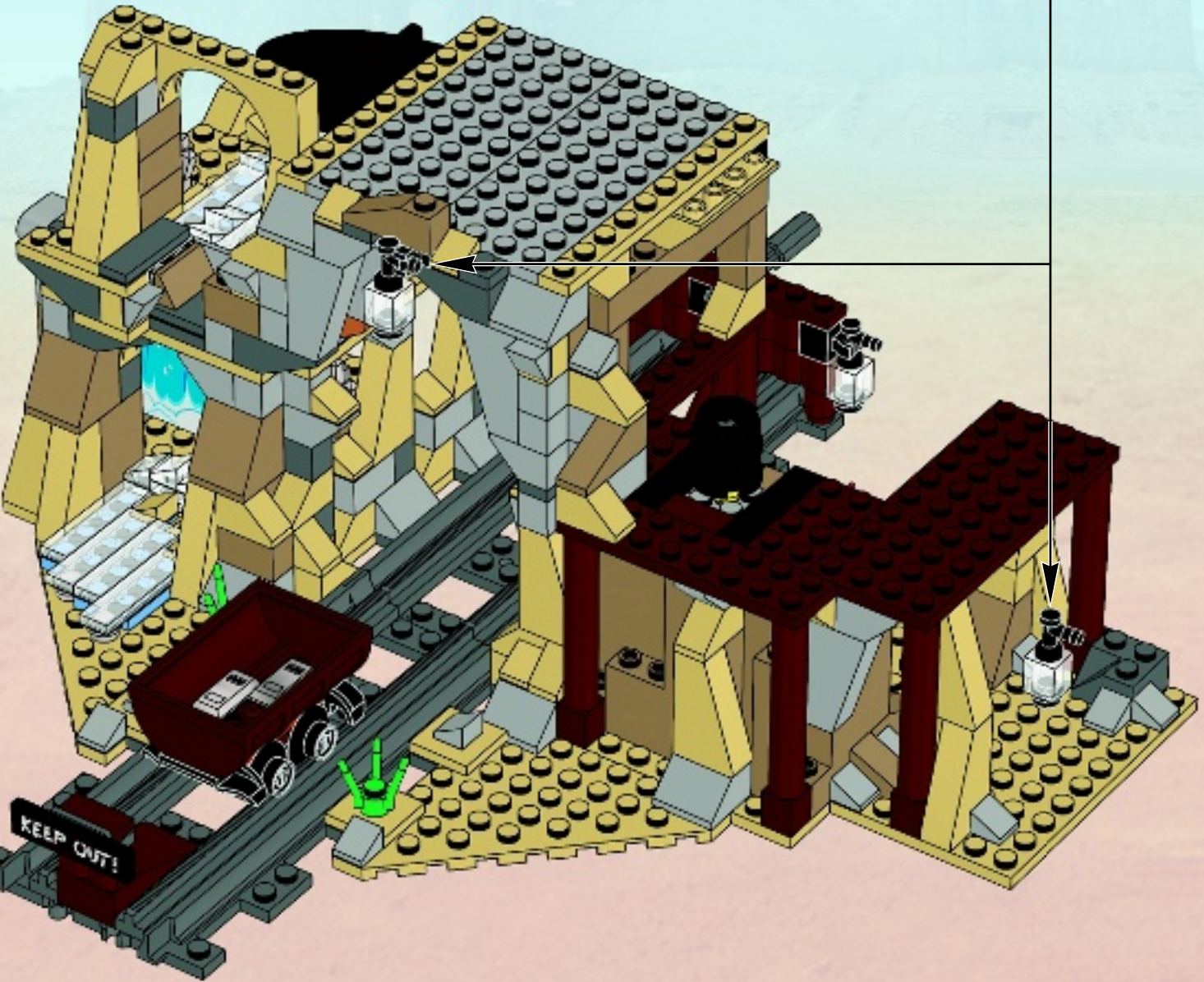

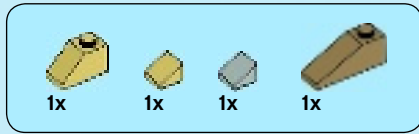

# 84

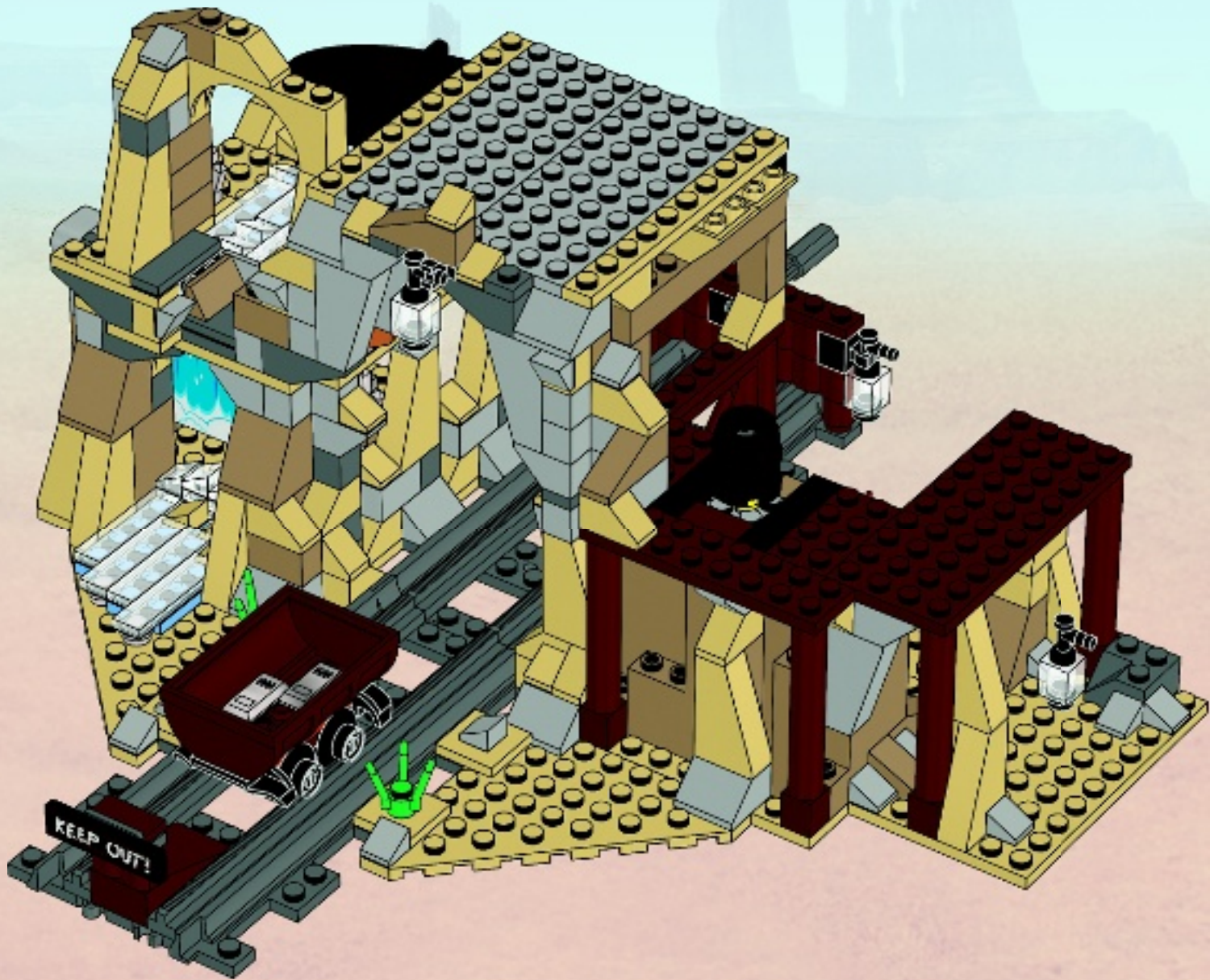





1x



1x

# 85

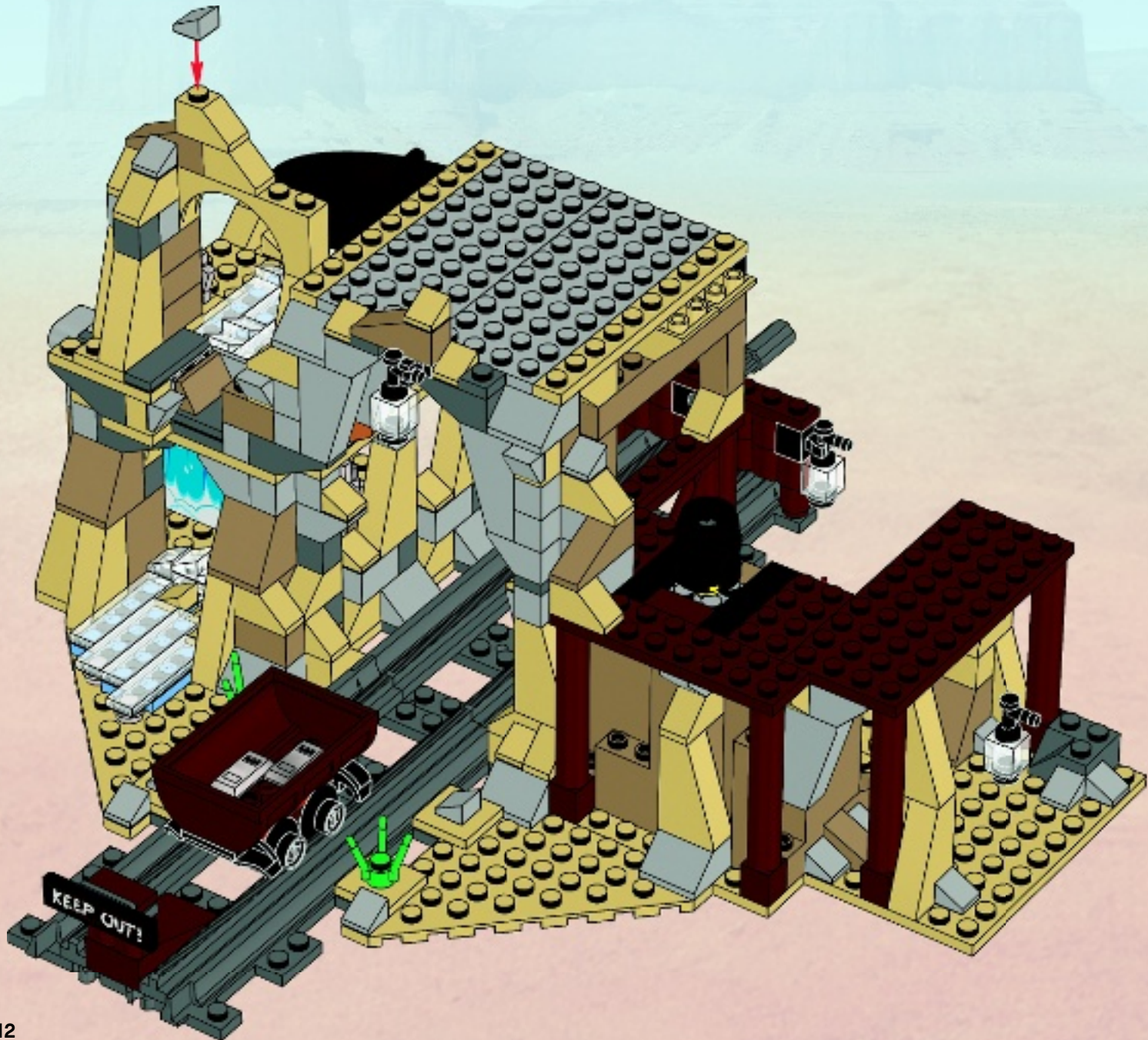







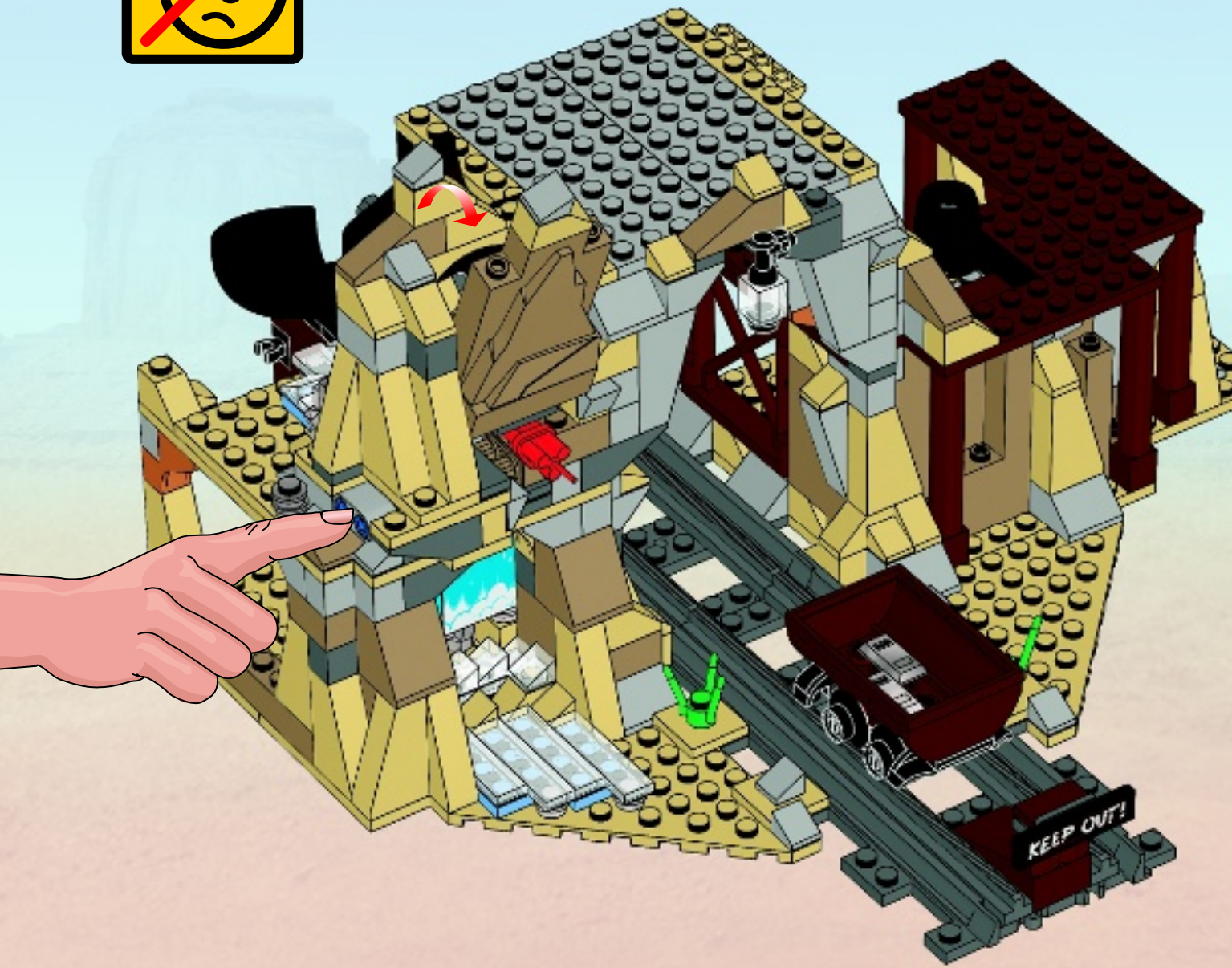

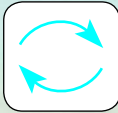
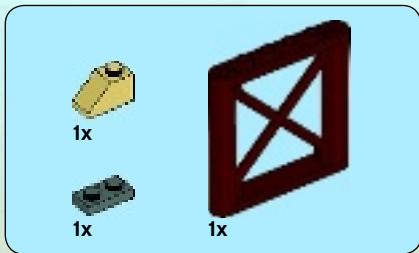
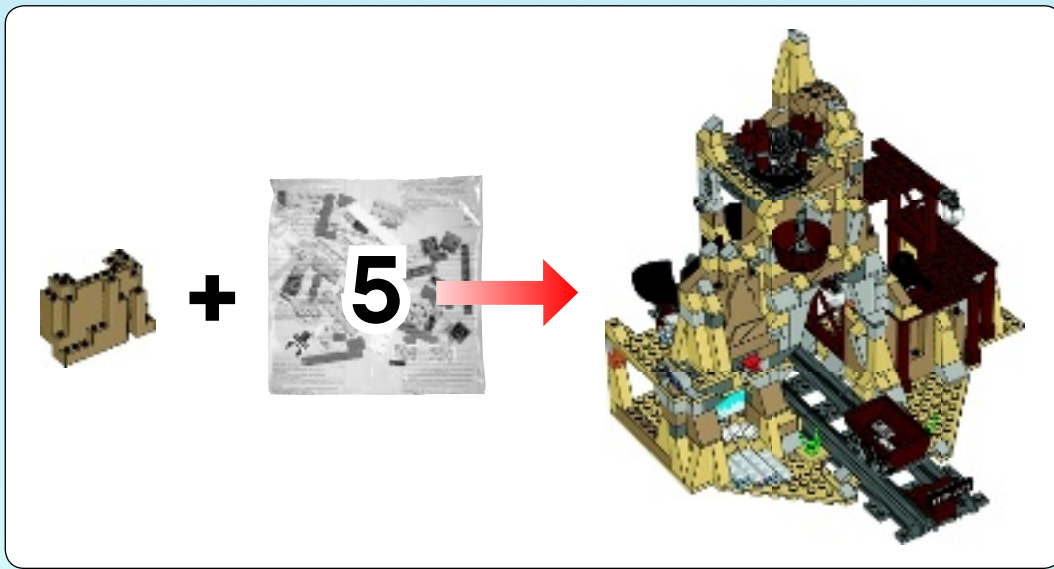

87

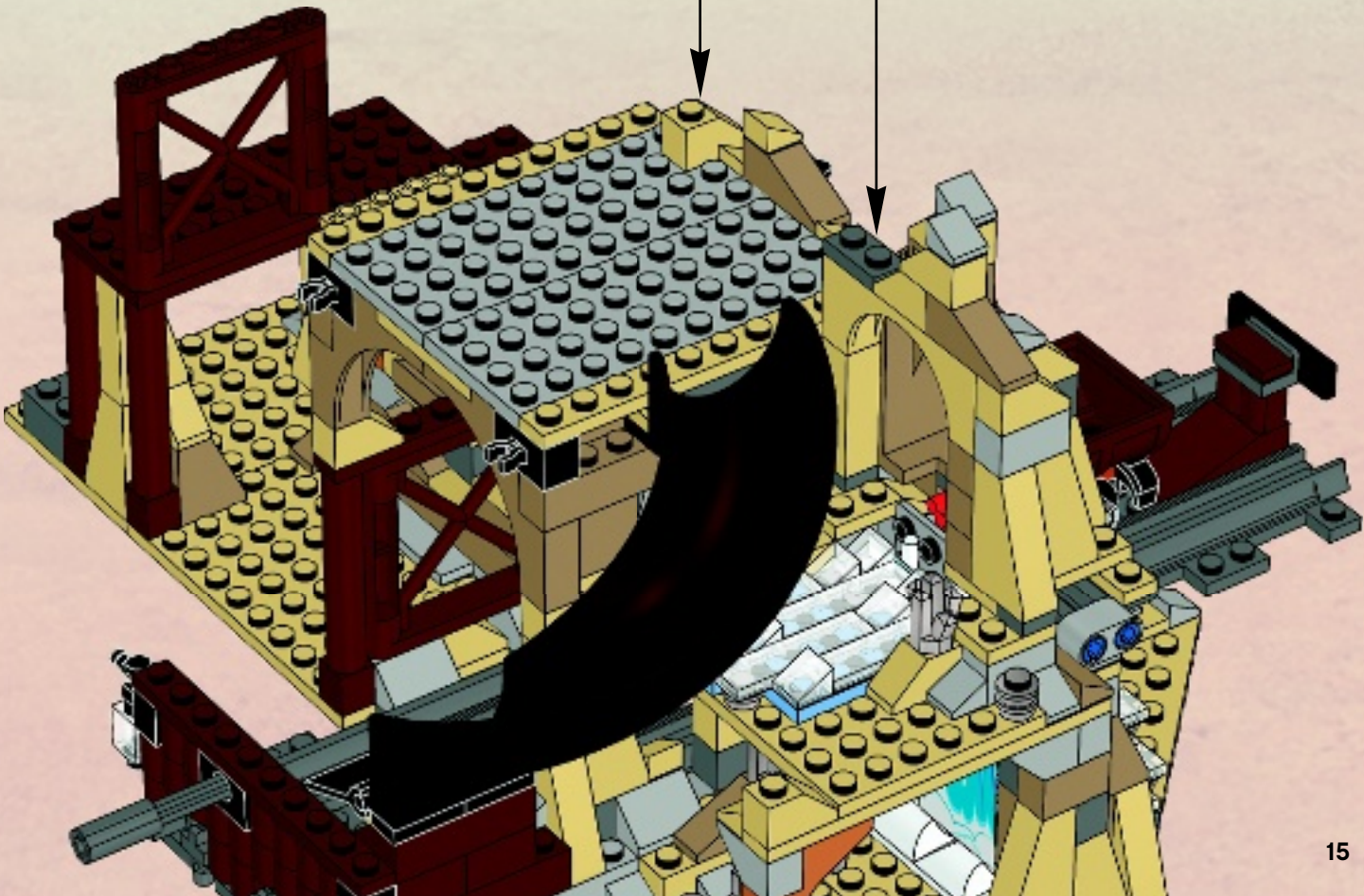



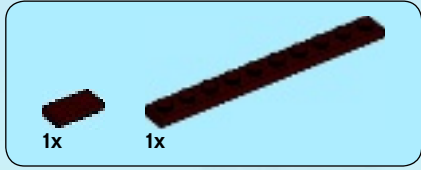
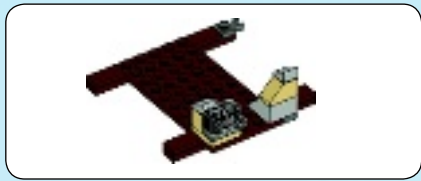

1

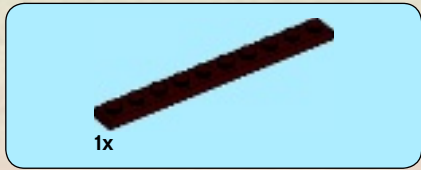

2

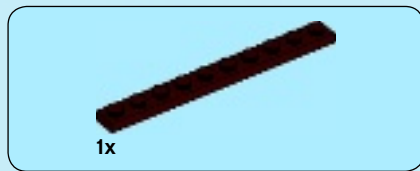
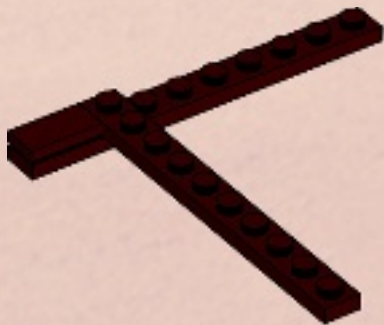

3

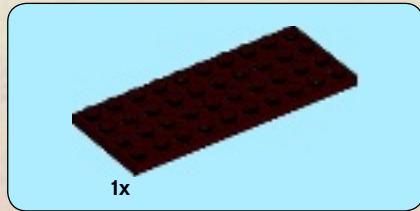
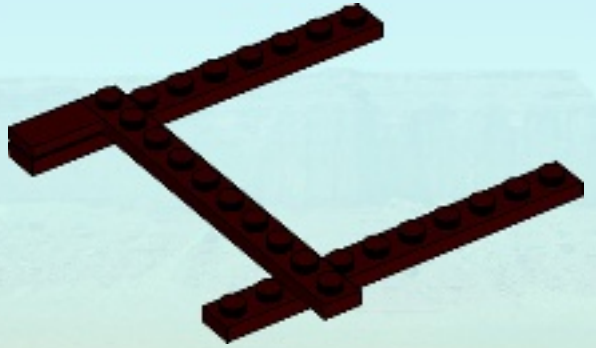

4

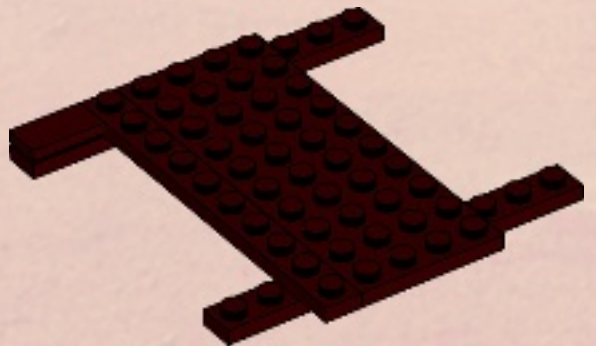

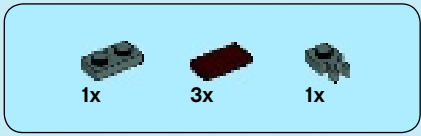

5

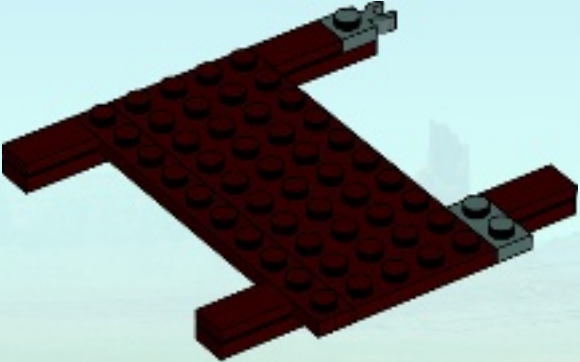

7

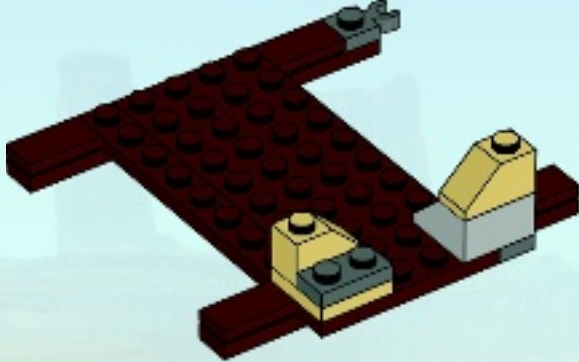

6

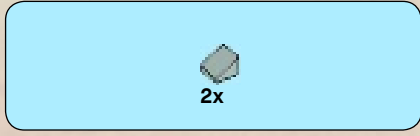
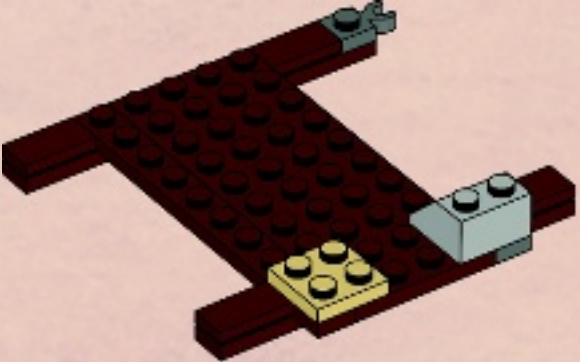

8

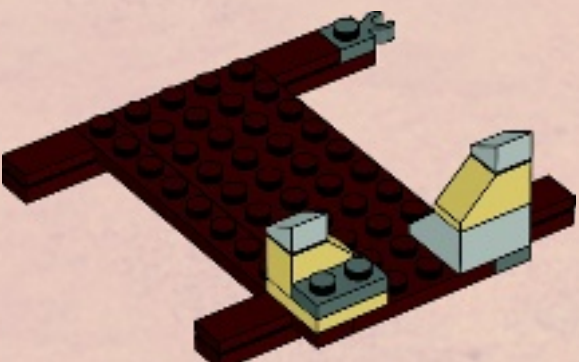







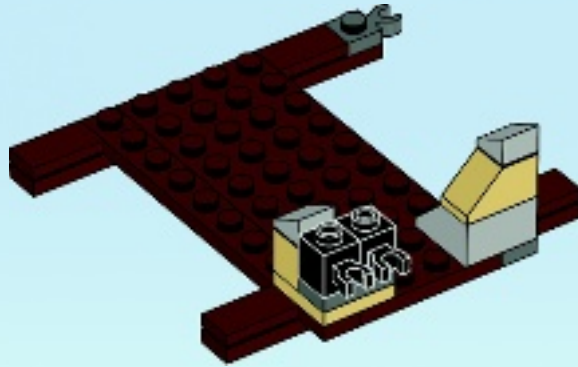

9

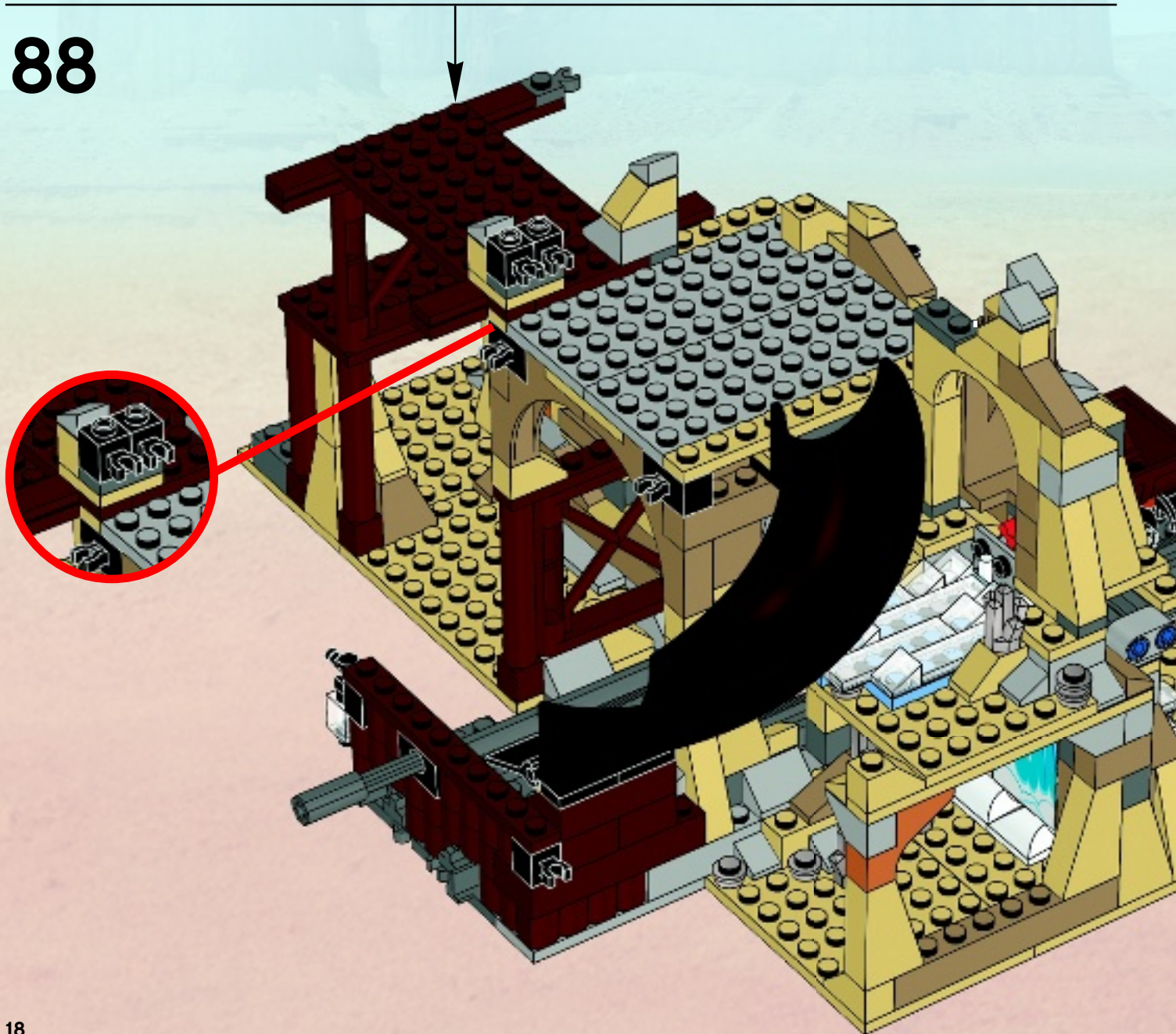

88



- 1x 
- 1x 
- 1x 
- 1x 

# 89

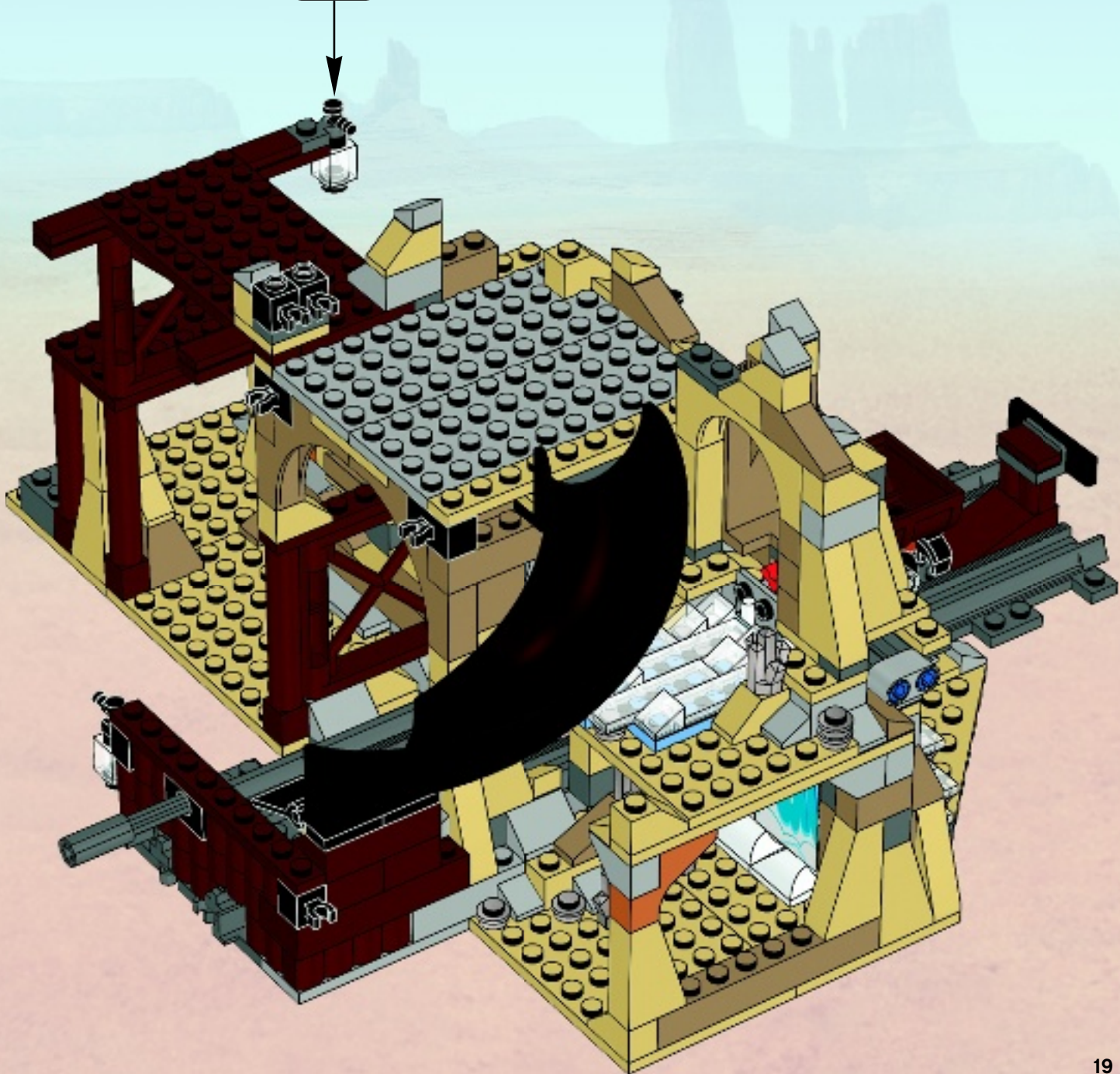
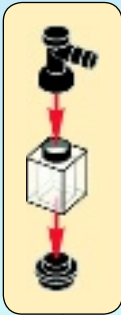





2x

# 90

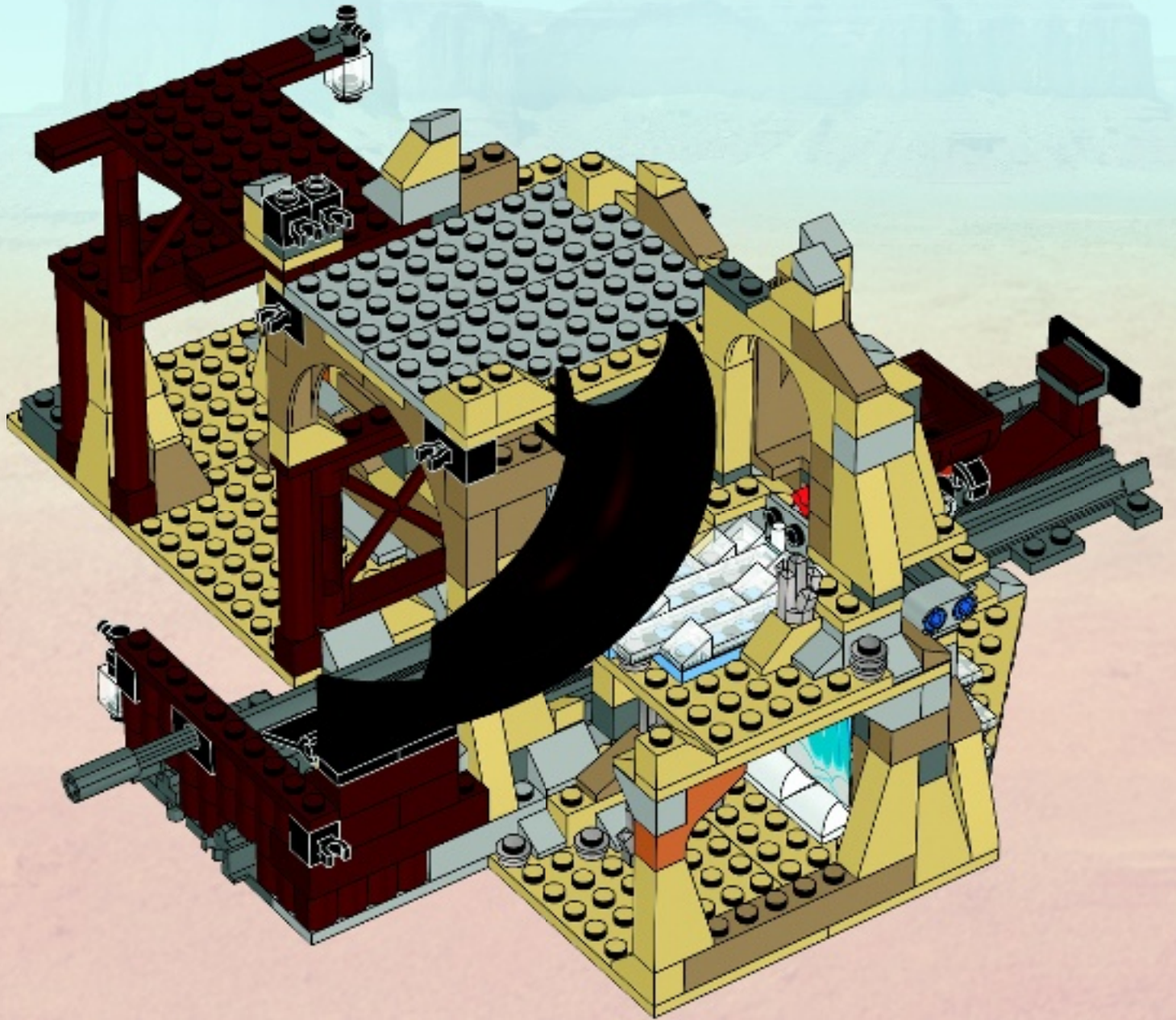



2x

# 91

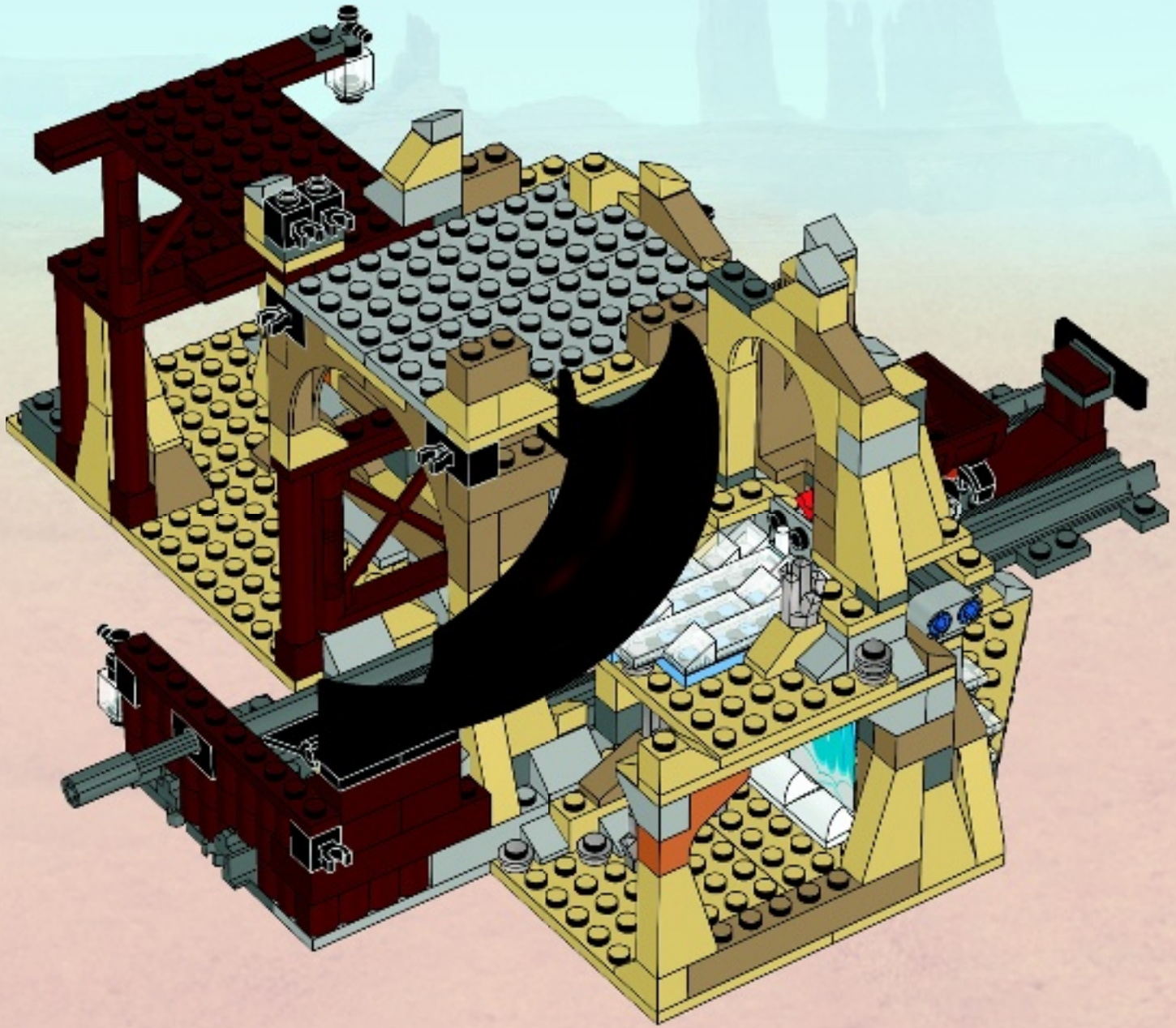



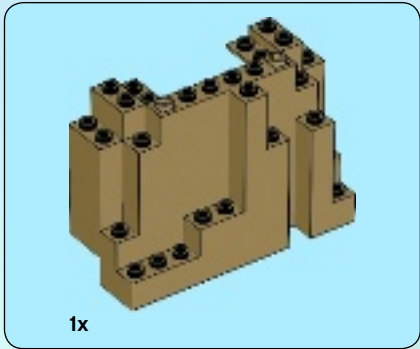
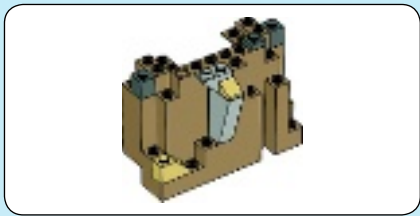

1

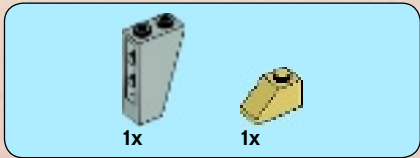
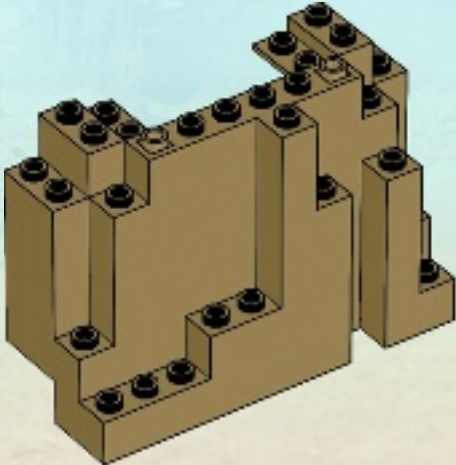

2

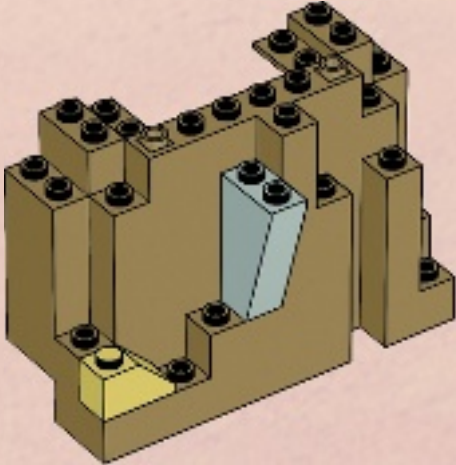



1x



2x

3

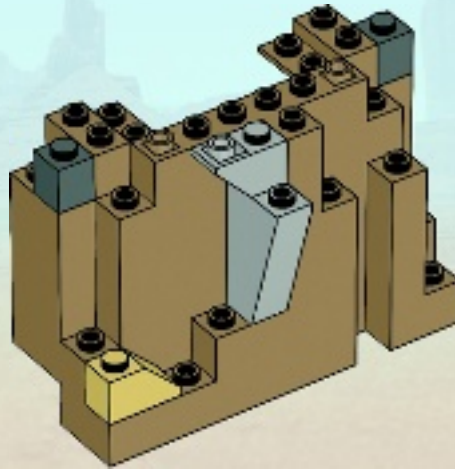

1x



1x

4

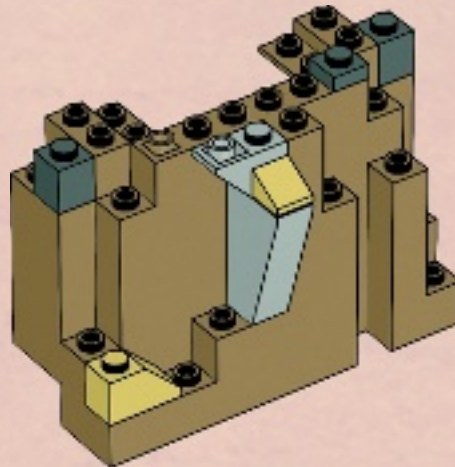



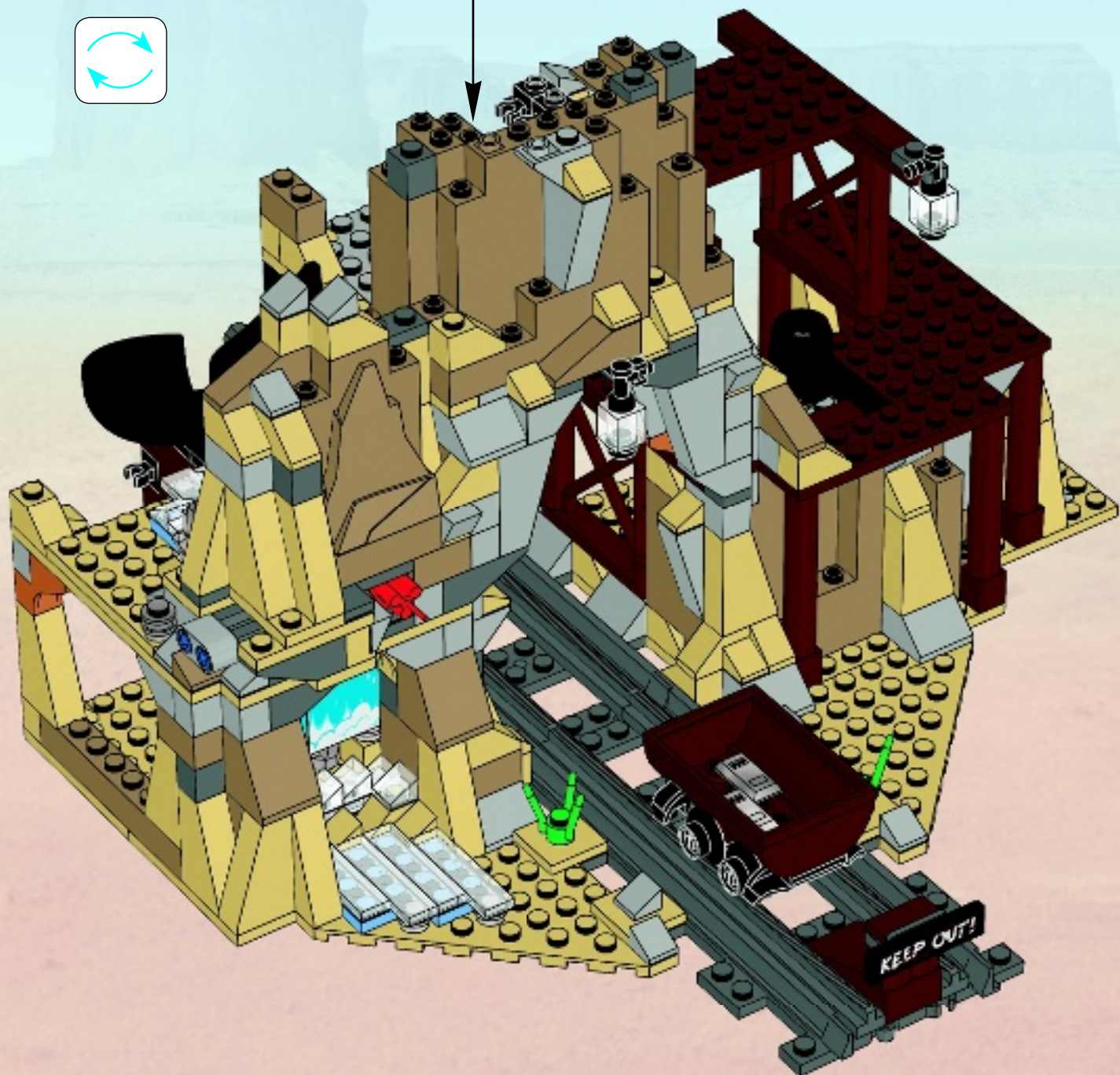
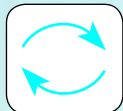



2x



2x

# 93

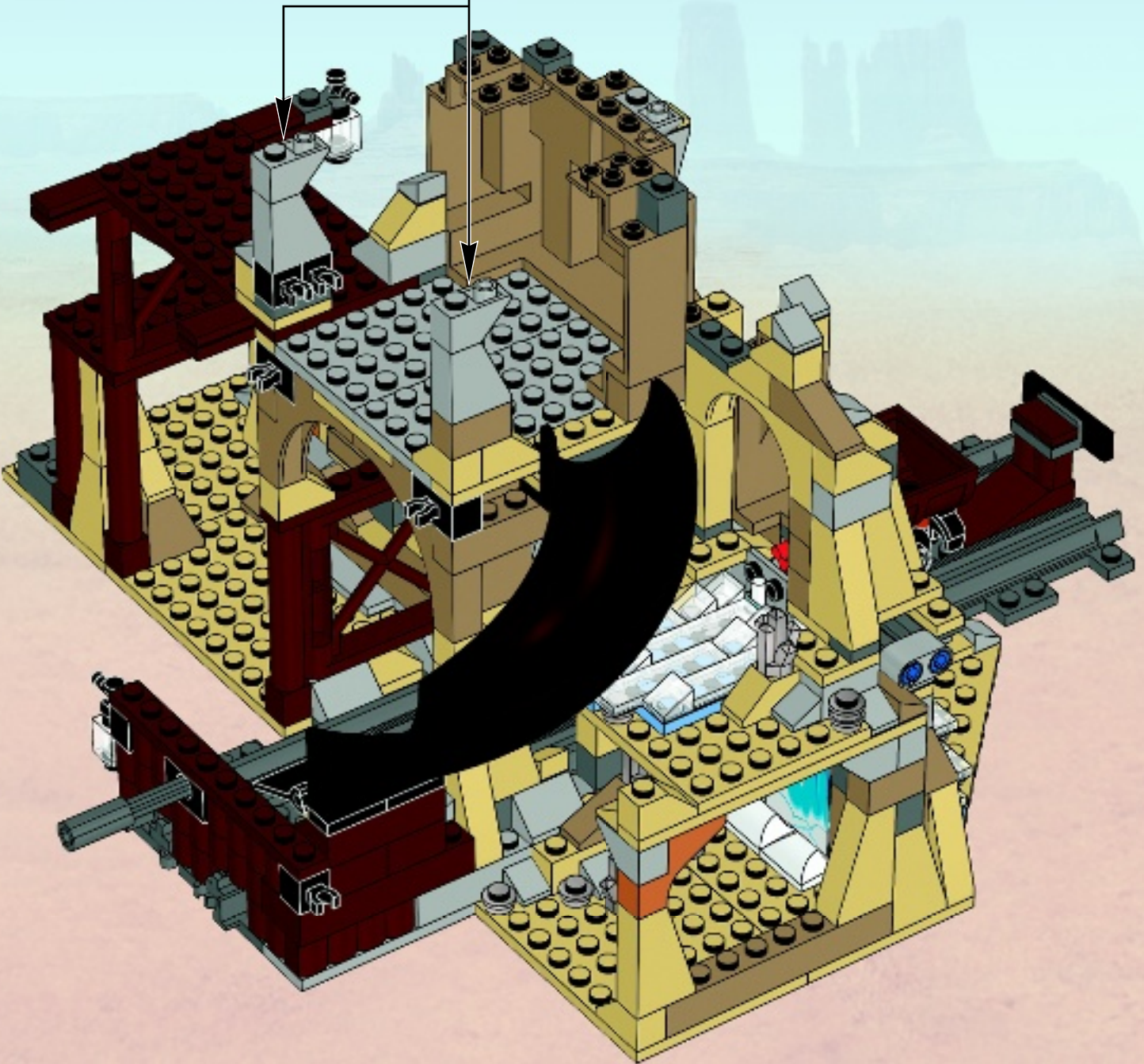
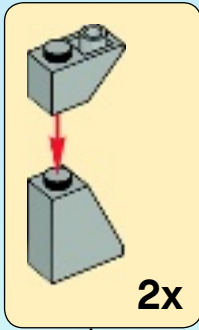
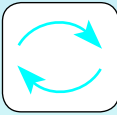



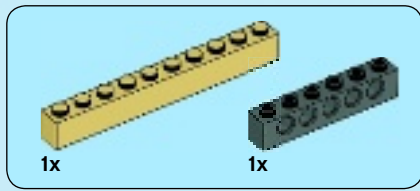

94

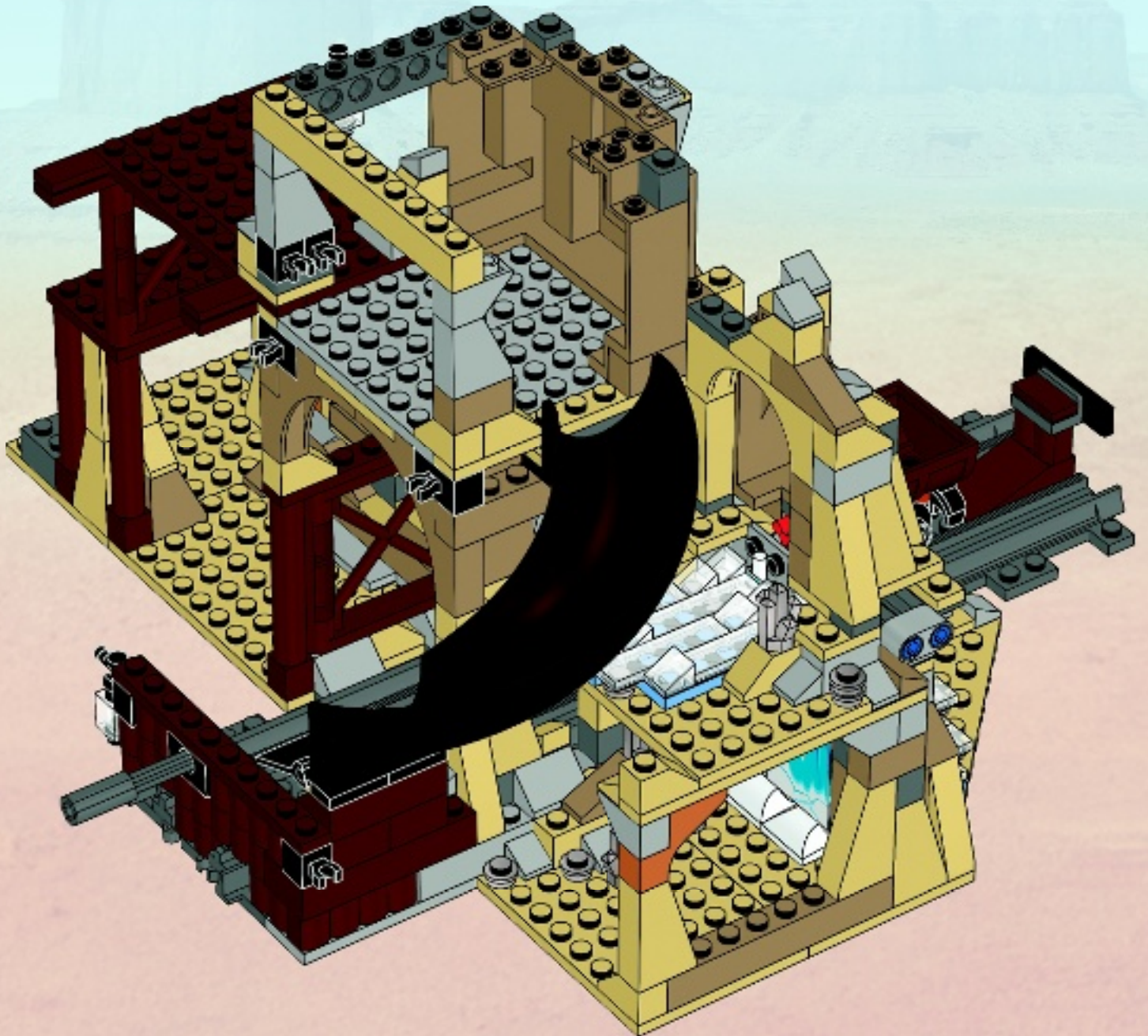

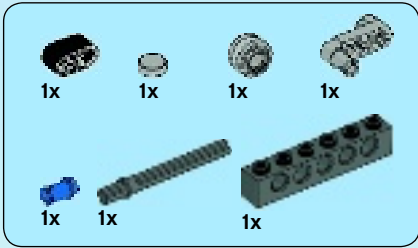

# 95

1

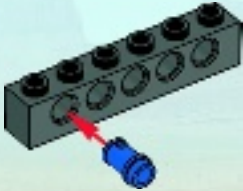

2



3



4

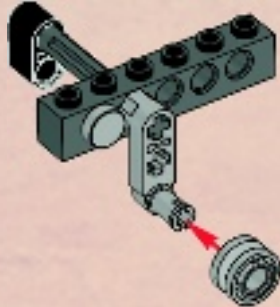



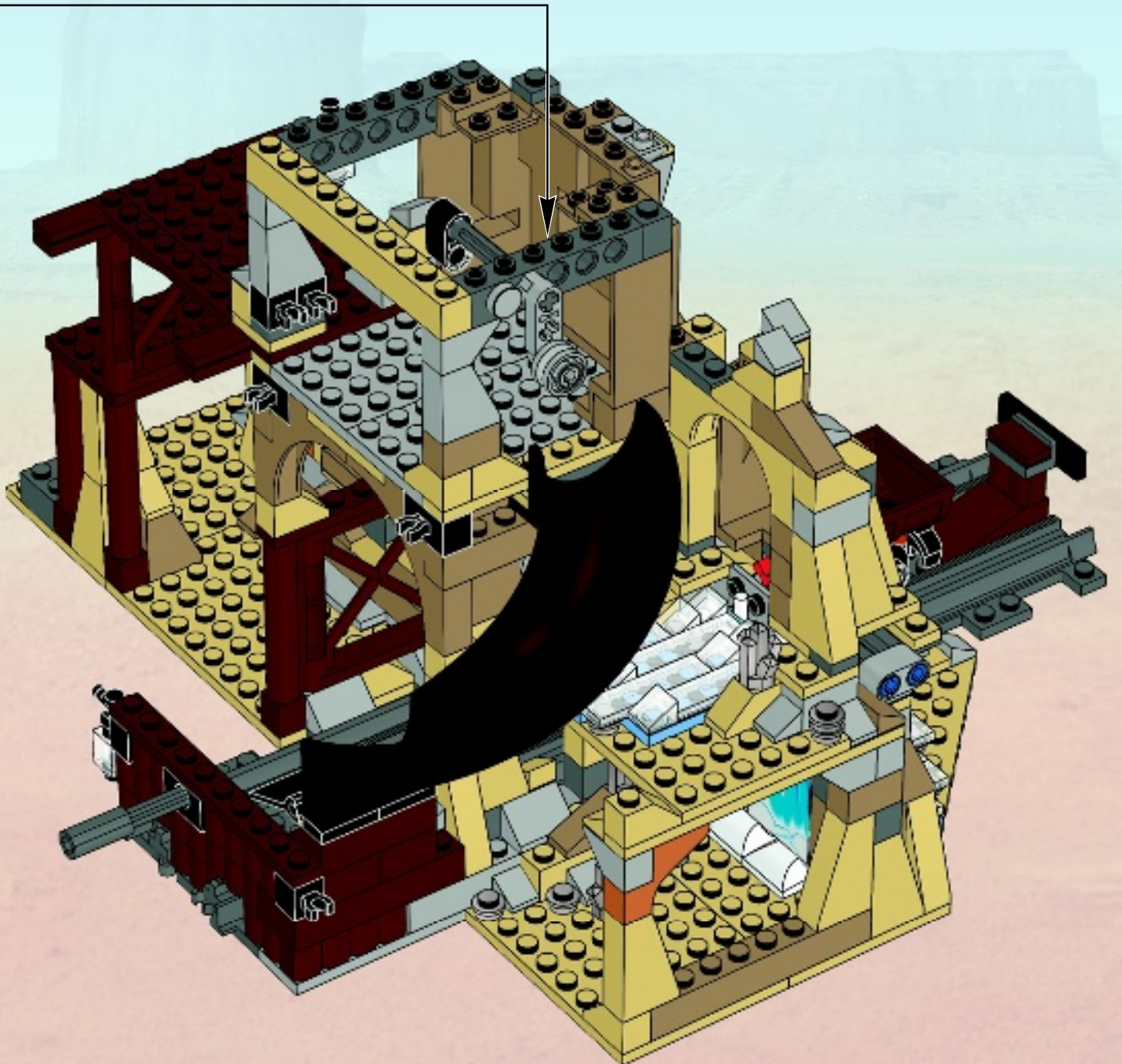



# 96

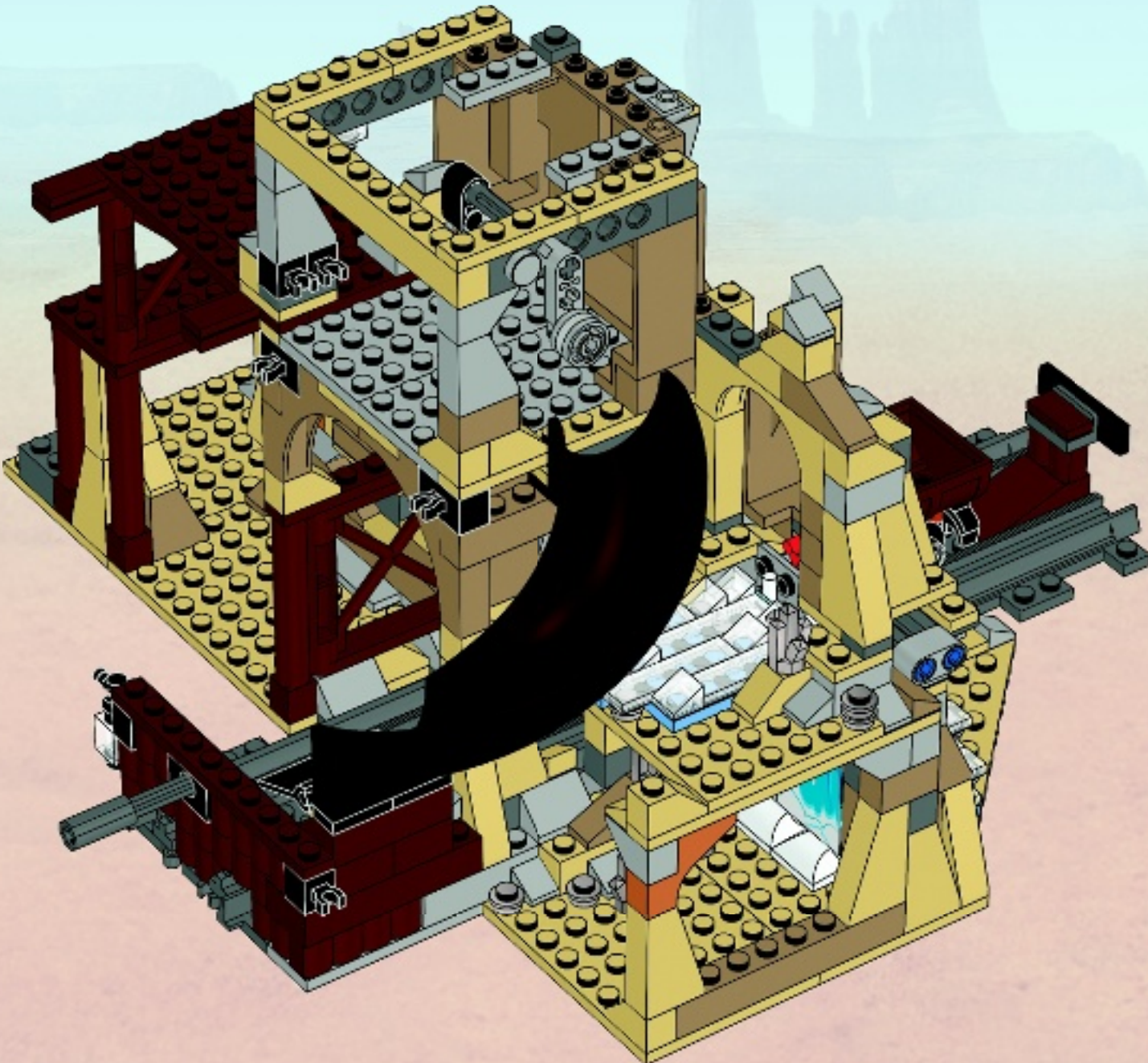



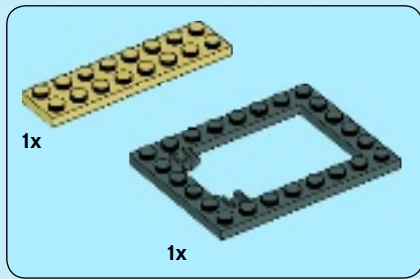

97

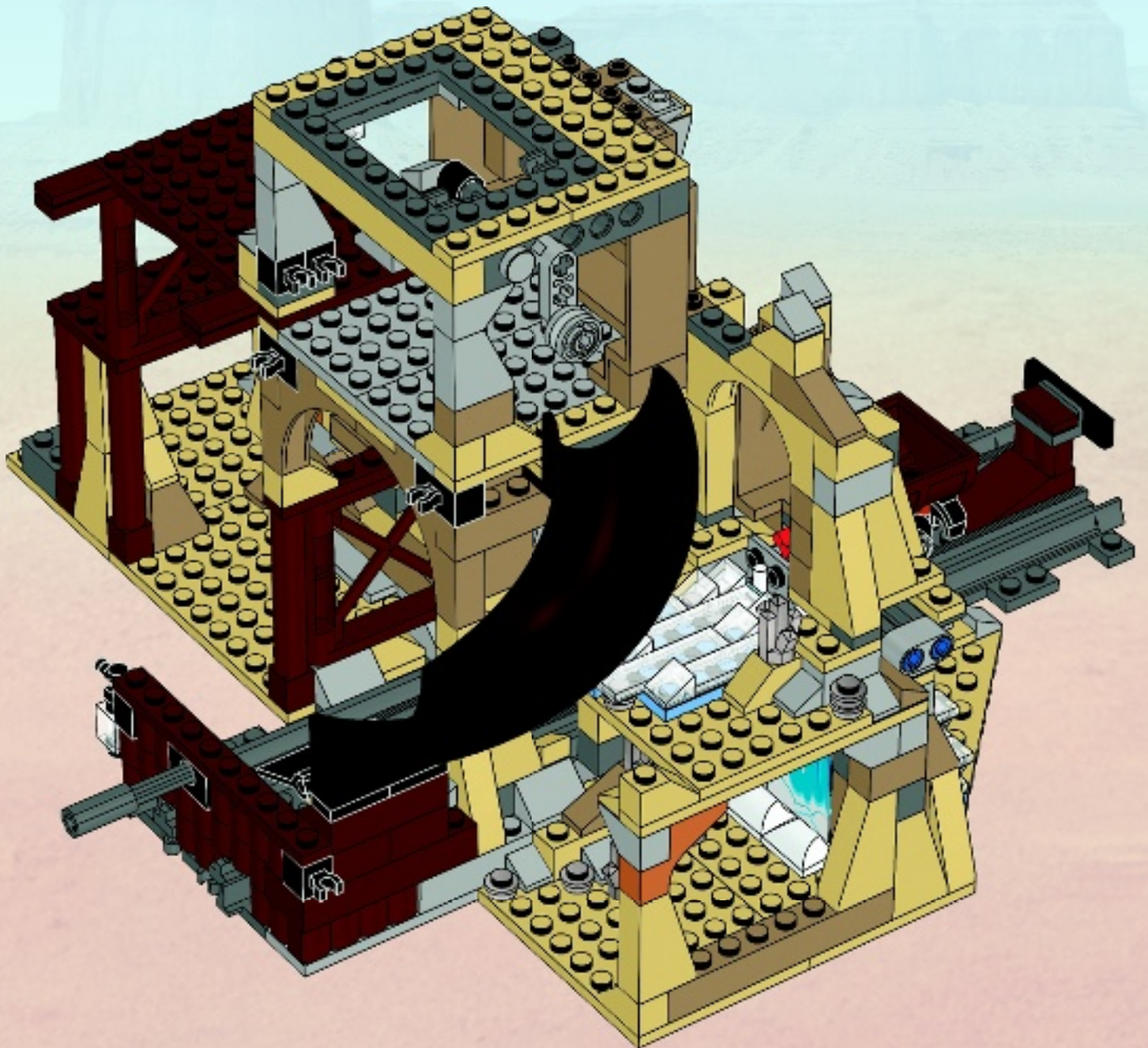

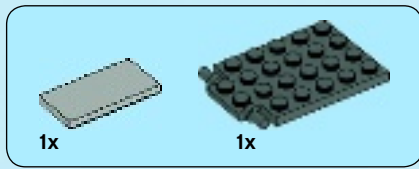

98

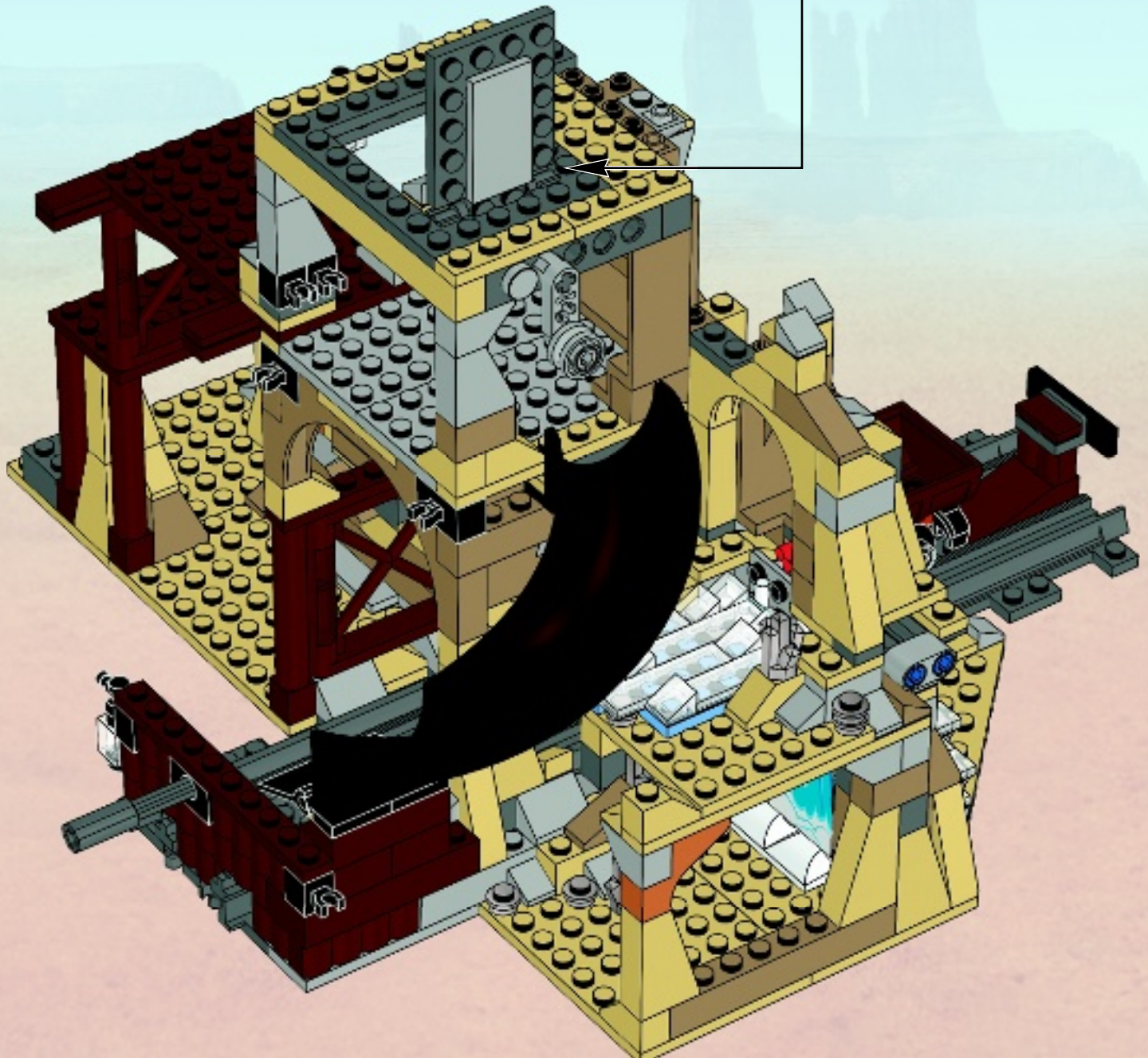
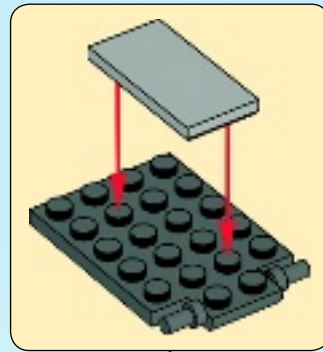



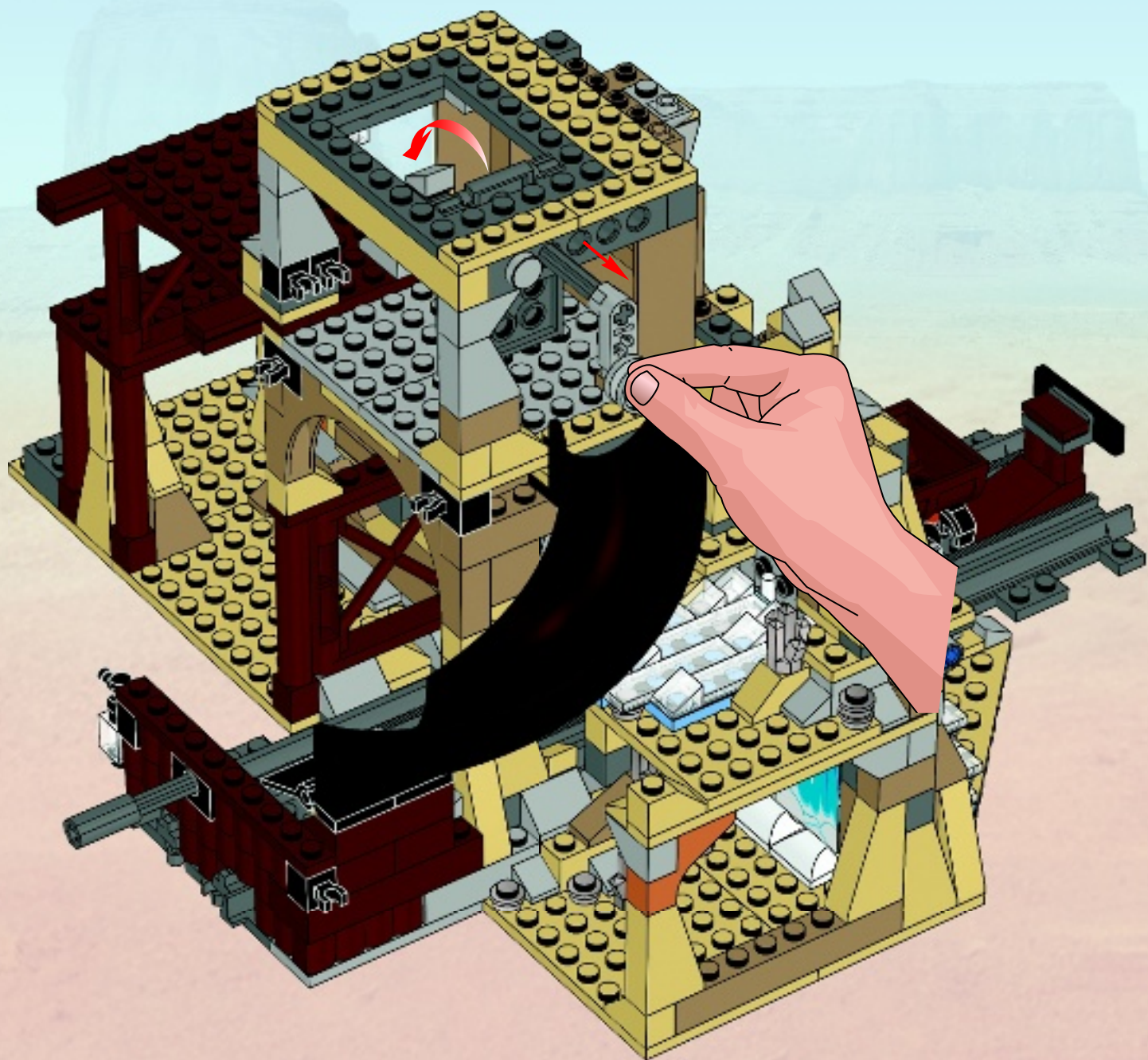



99

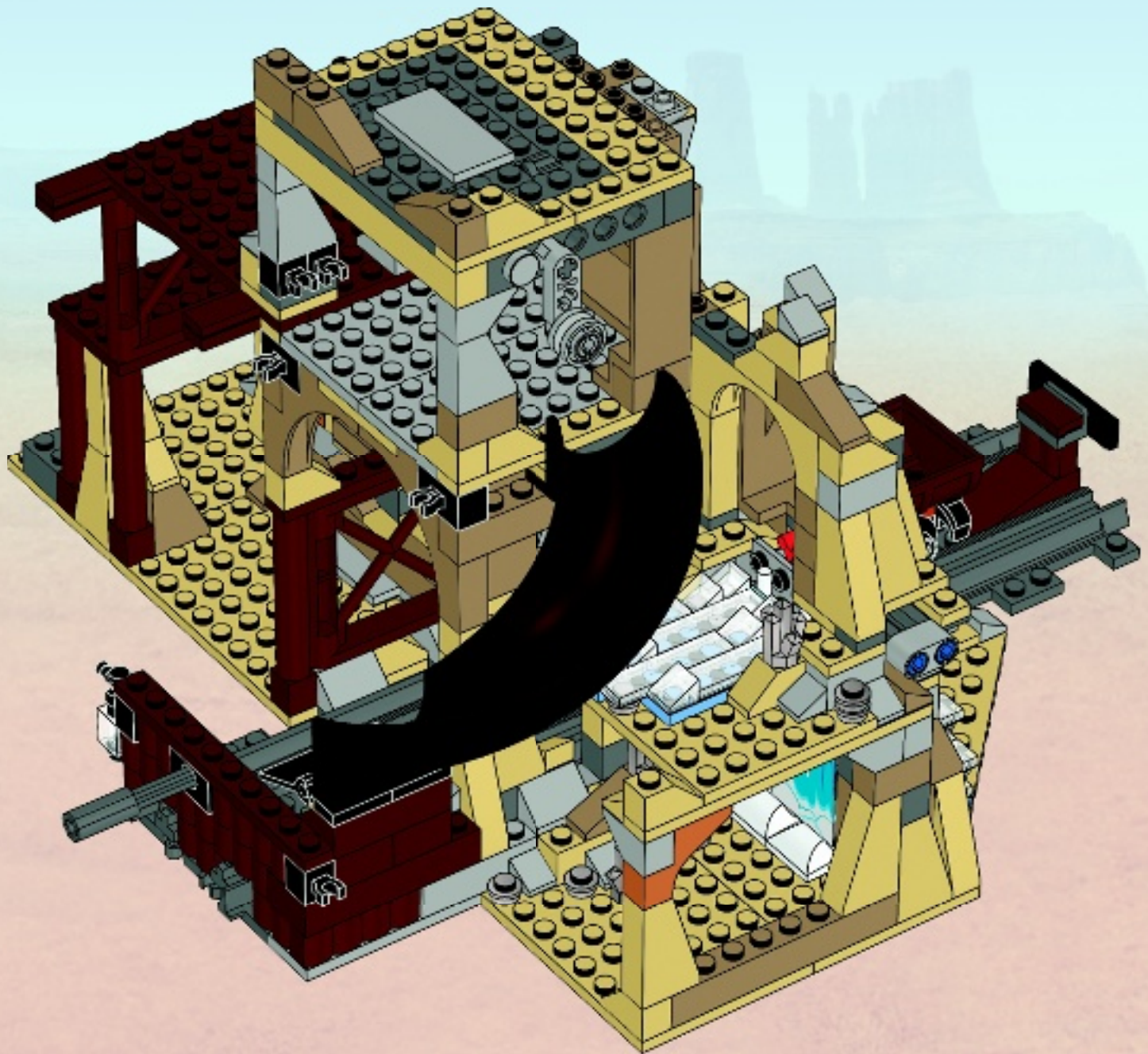



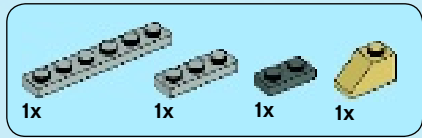

# 100

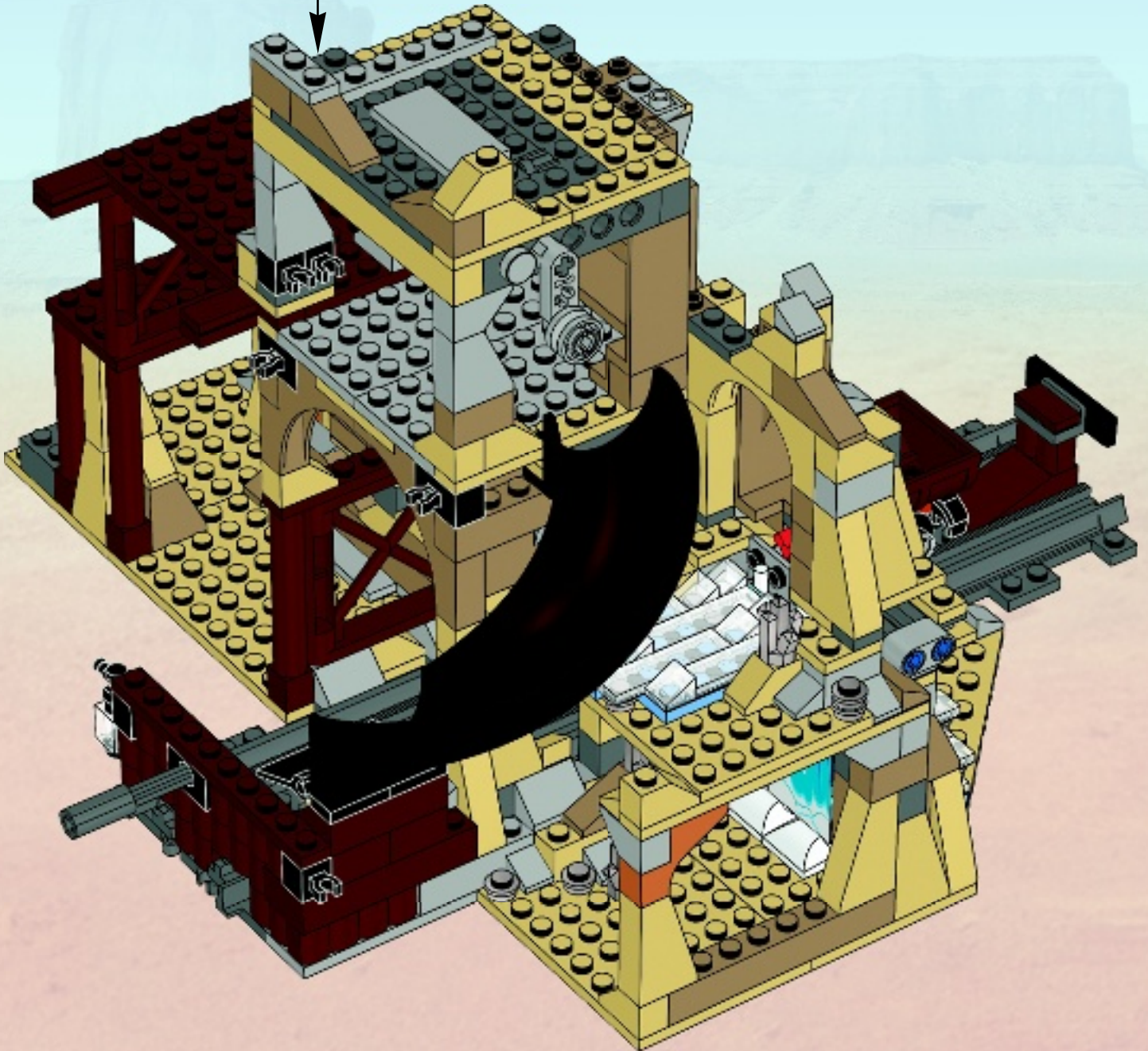

- 1x
- 1x
- 1x
- 1x

# 101

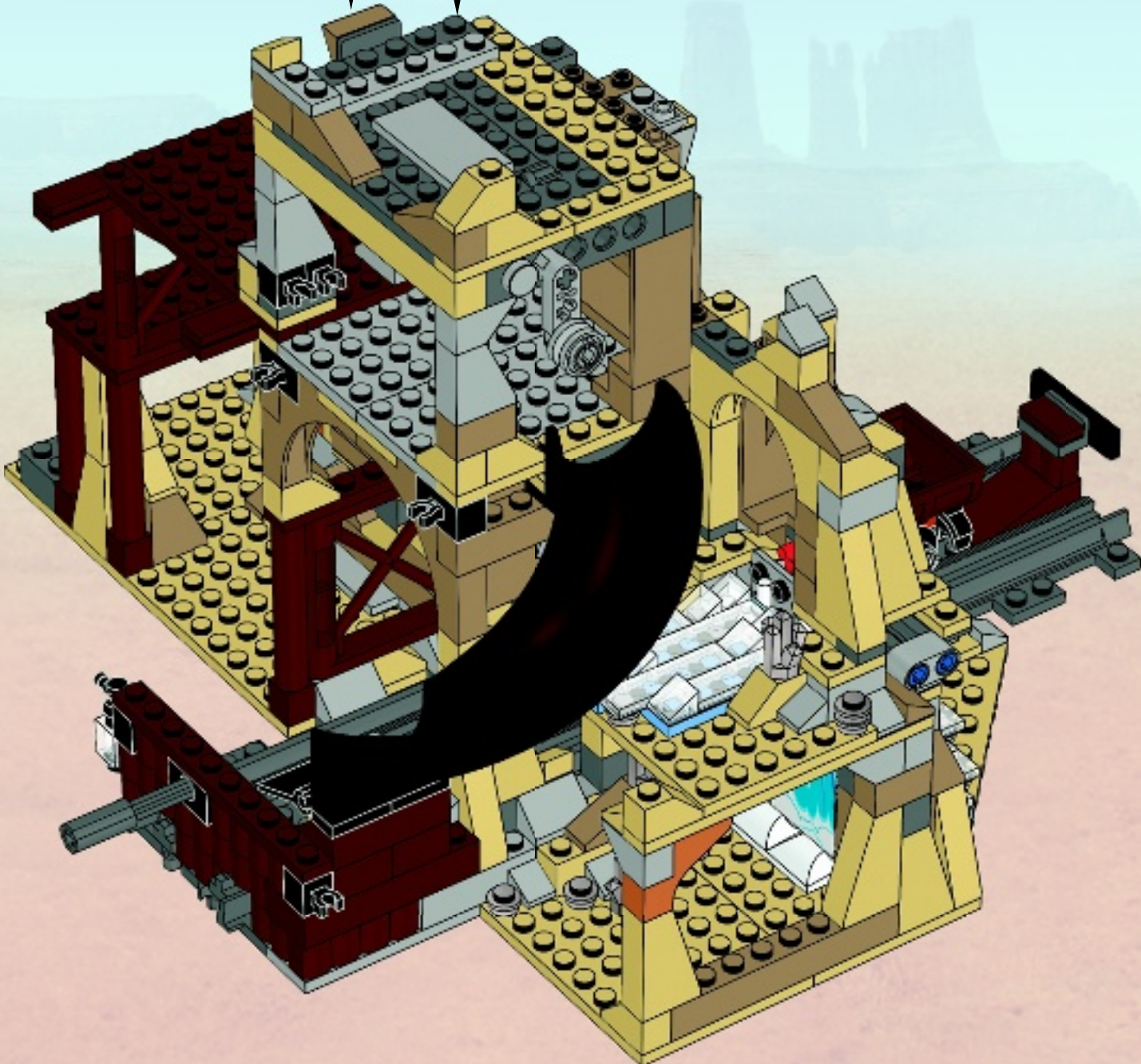
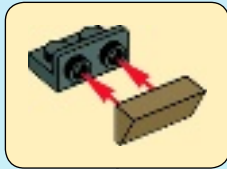



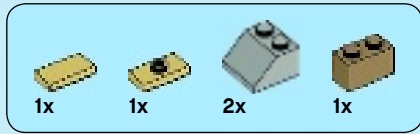

# 102

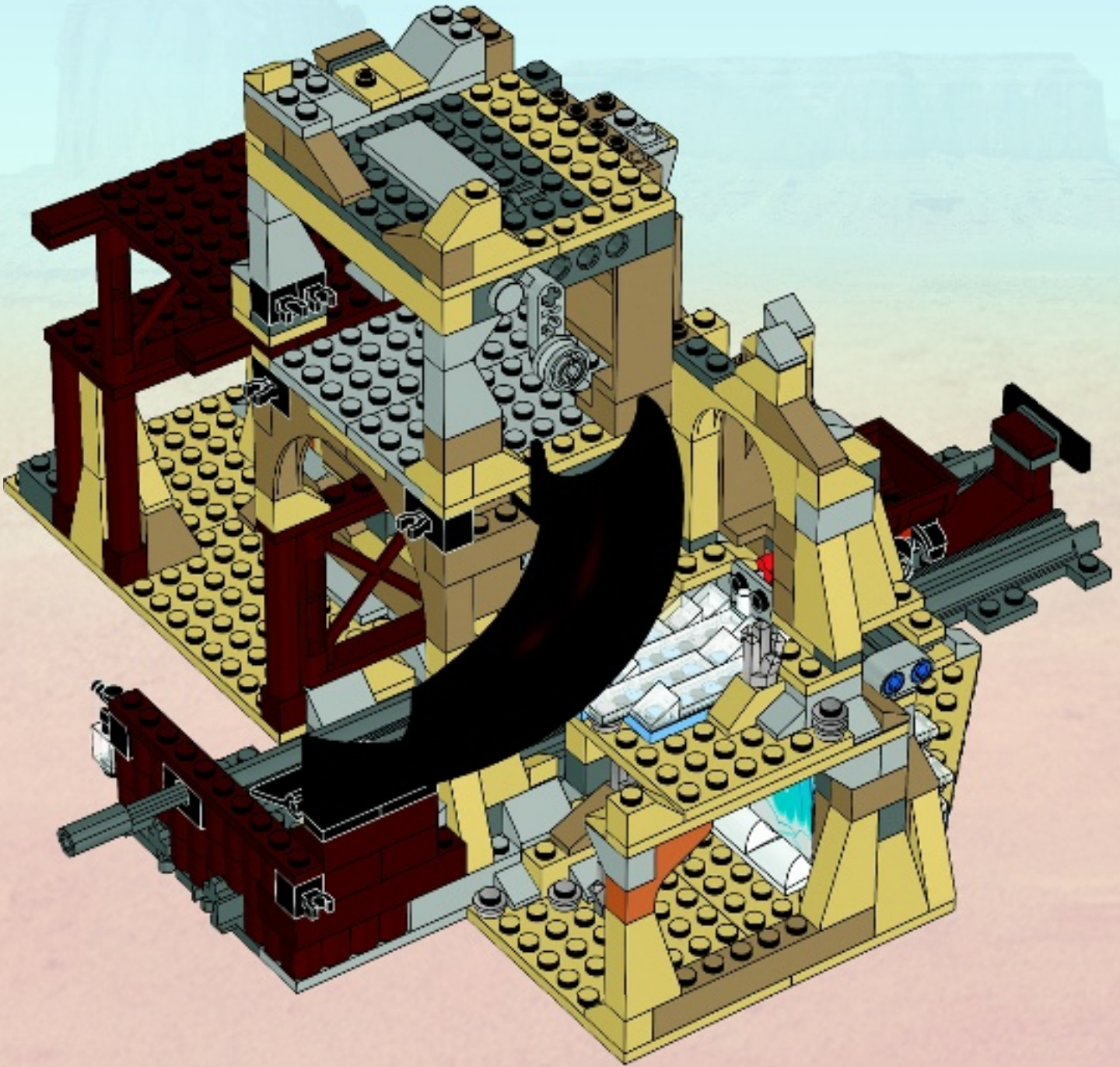

		
2x	1x	1x

# 103

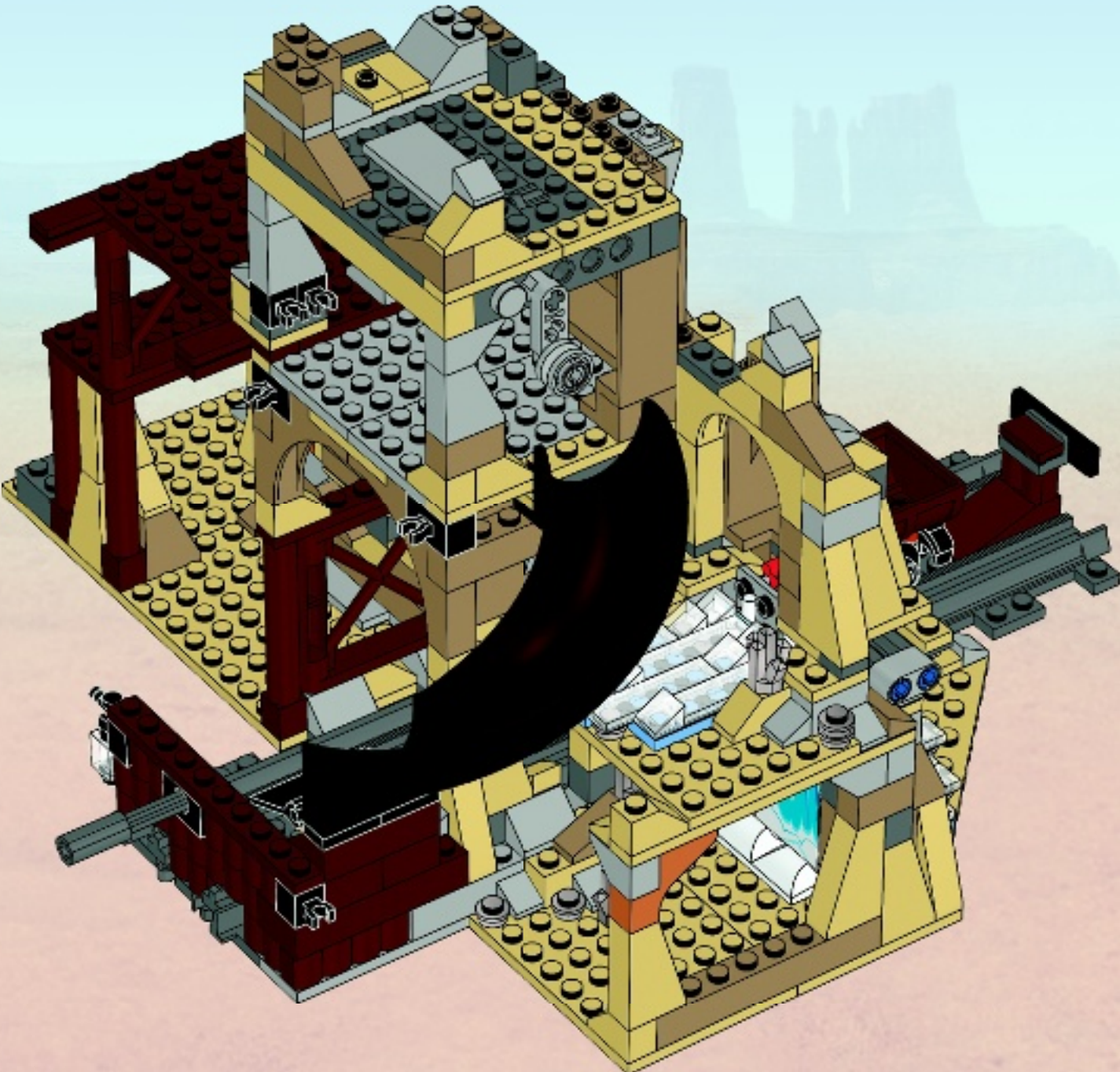





2x

# 104

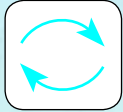





1x



1x

# 105





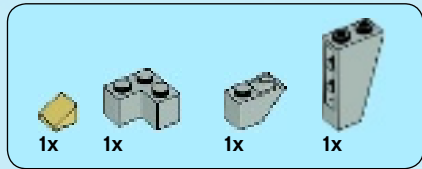

# 106





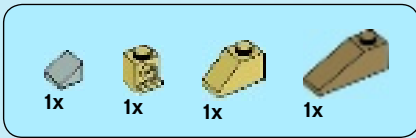

# 107

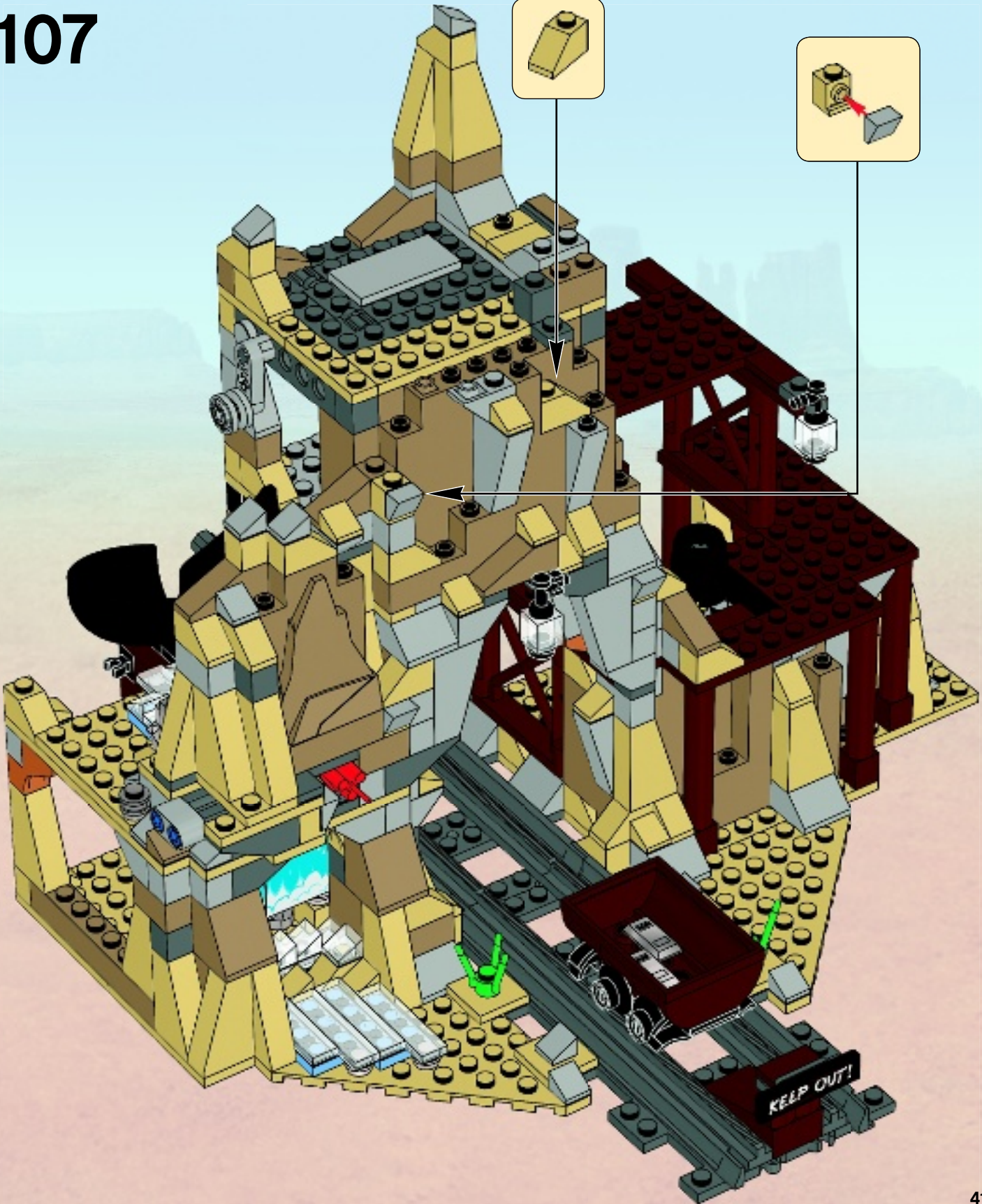
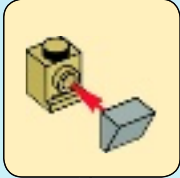
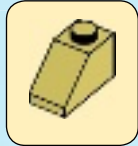





# 108

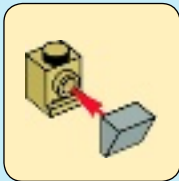





1x



1x

# 109

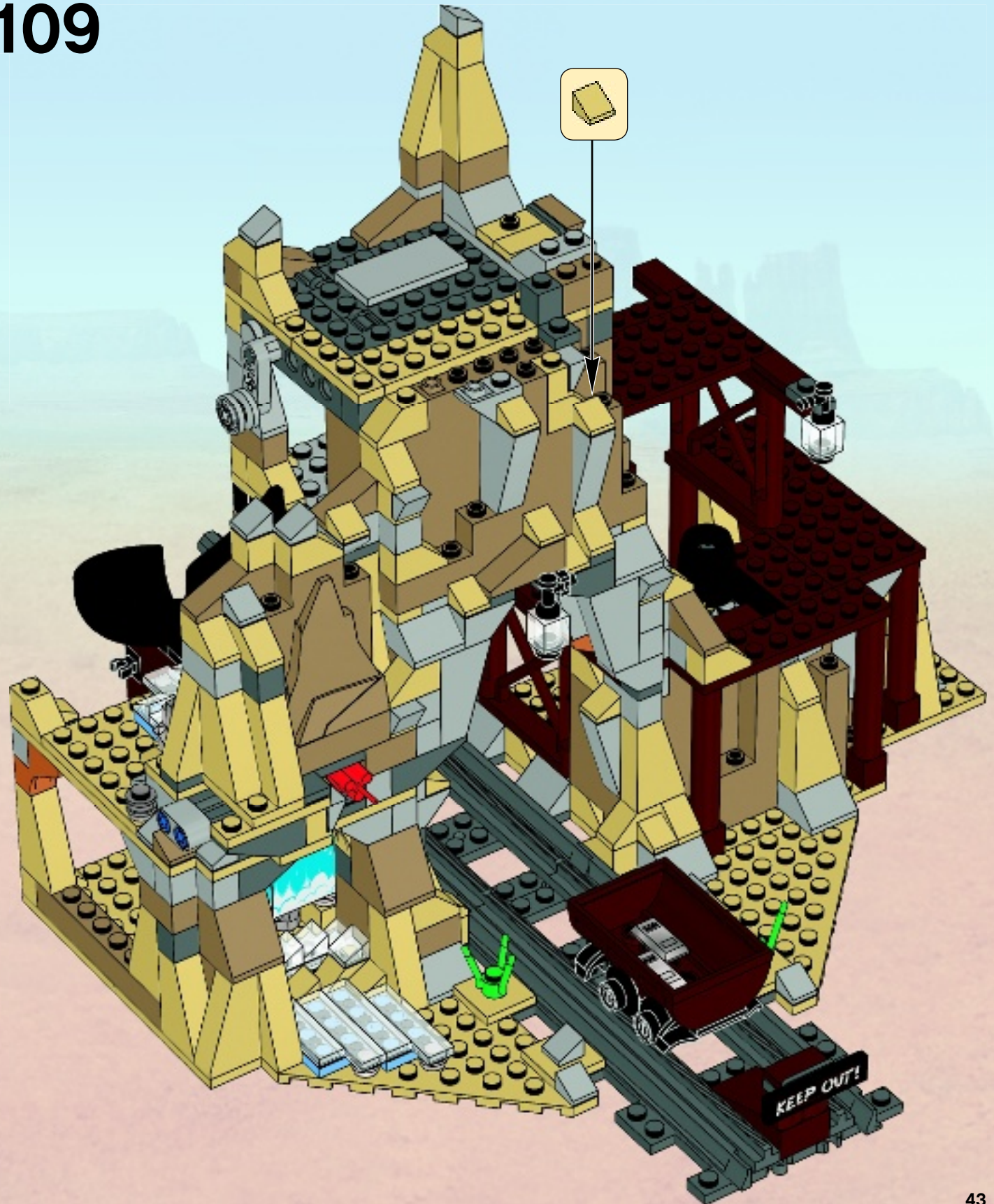





# 110





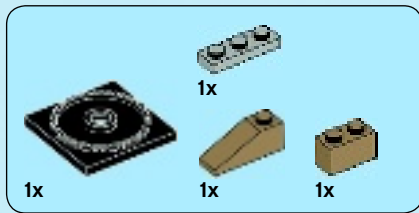

111

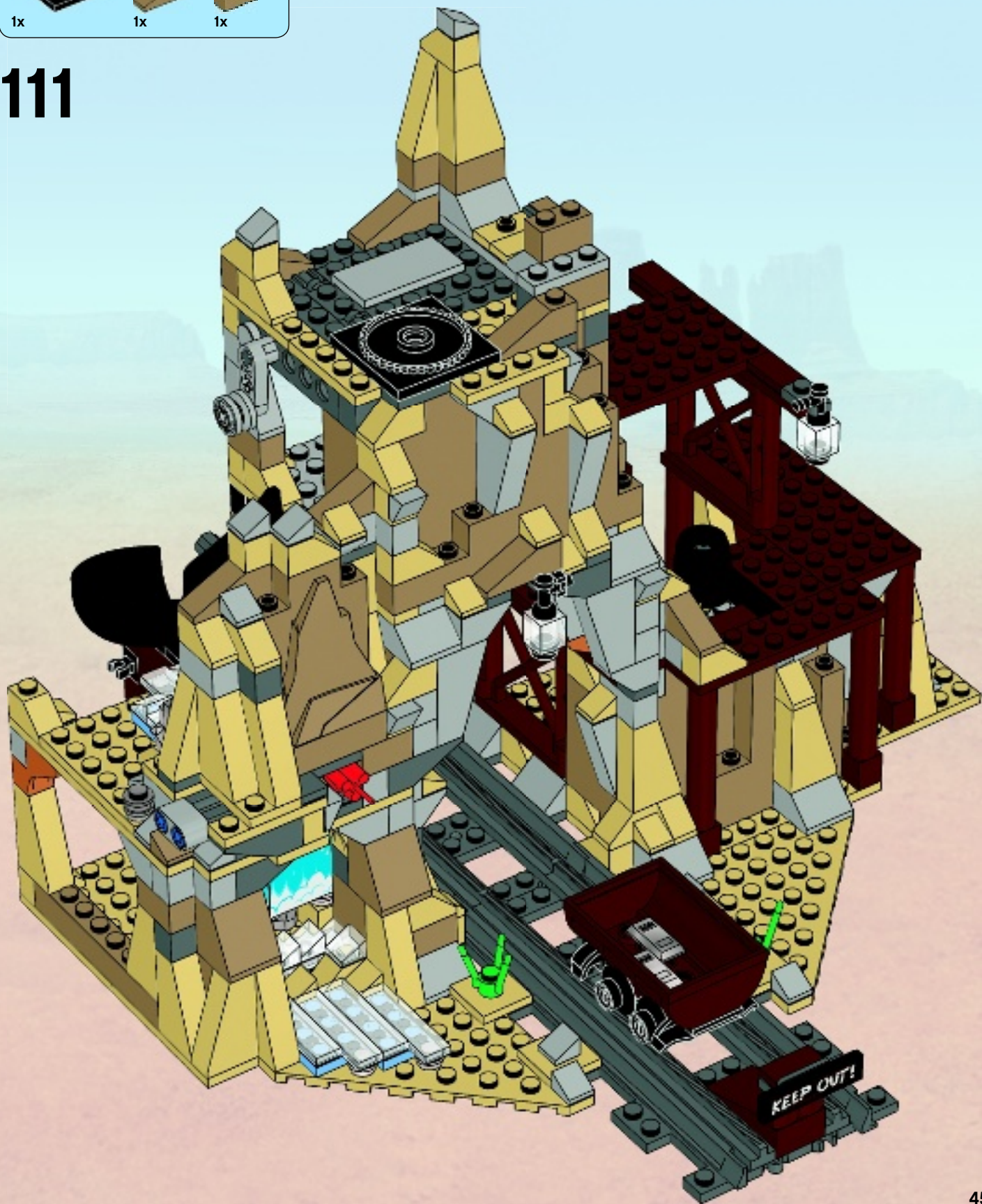



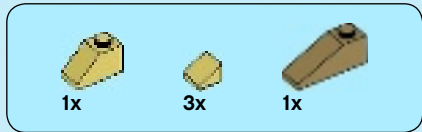

# 112

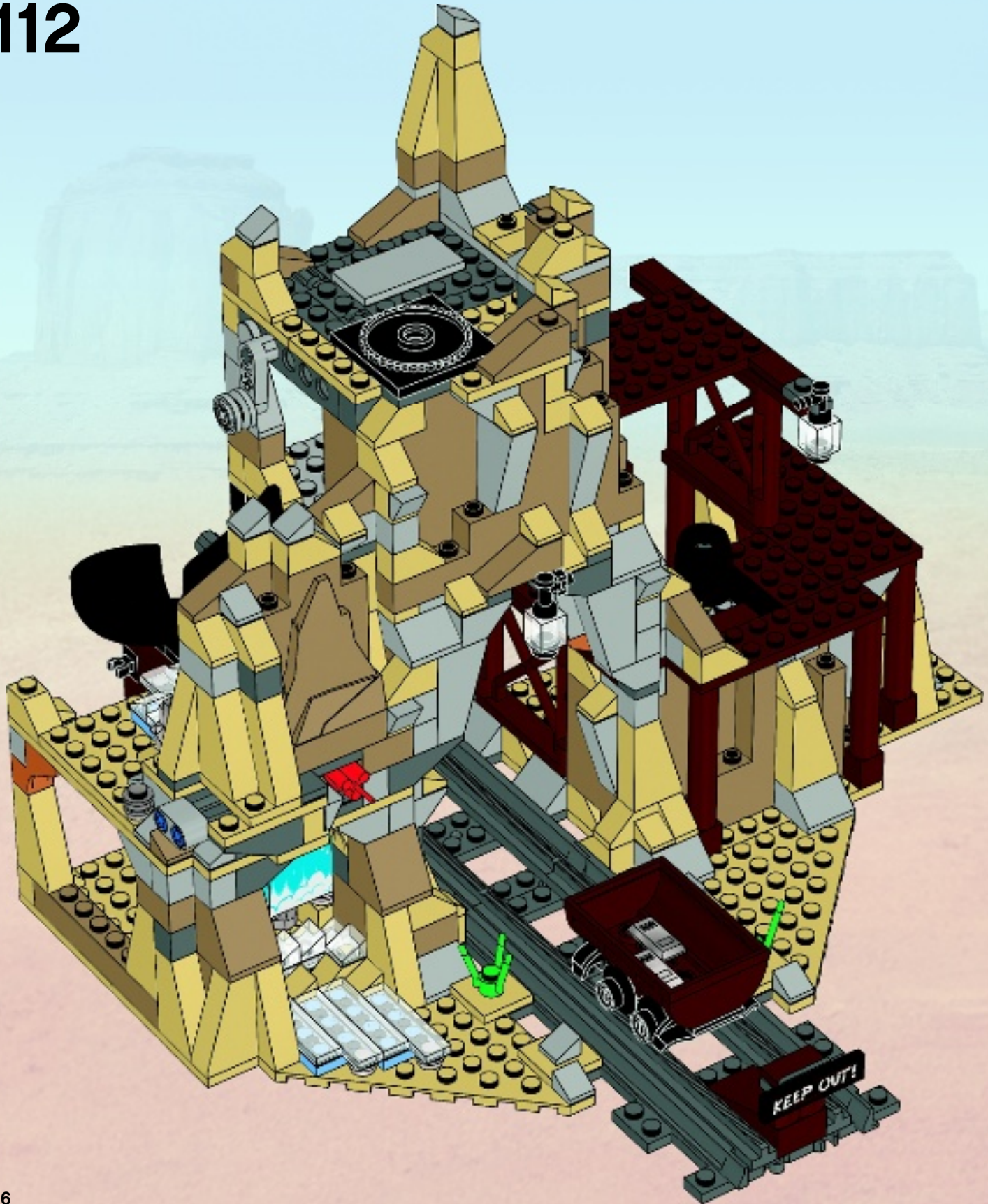



1x 1x 1x

# 113

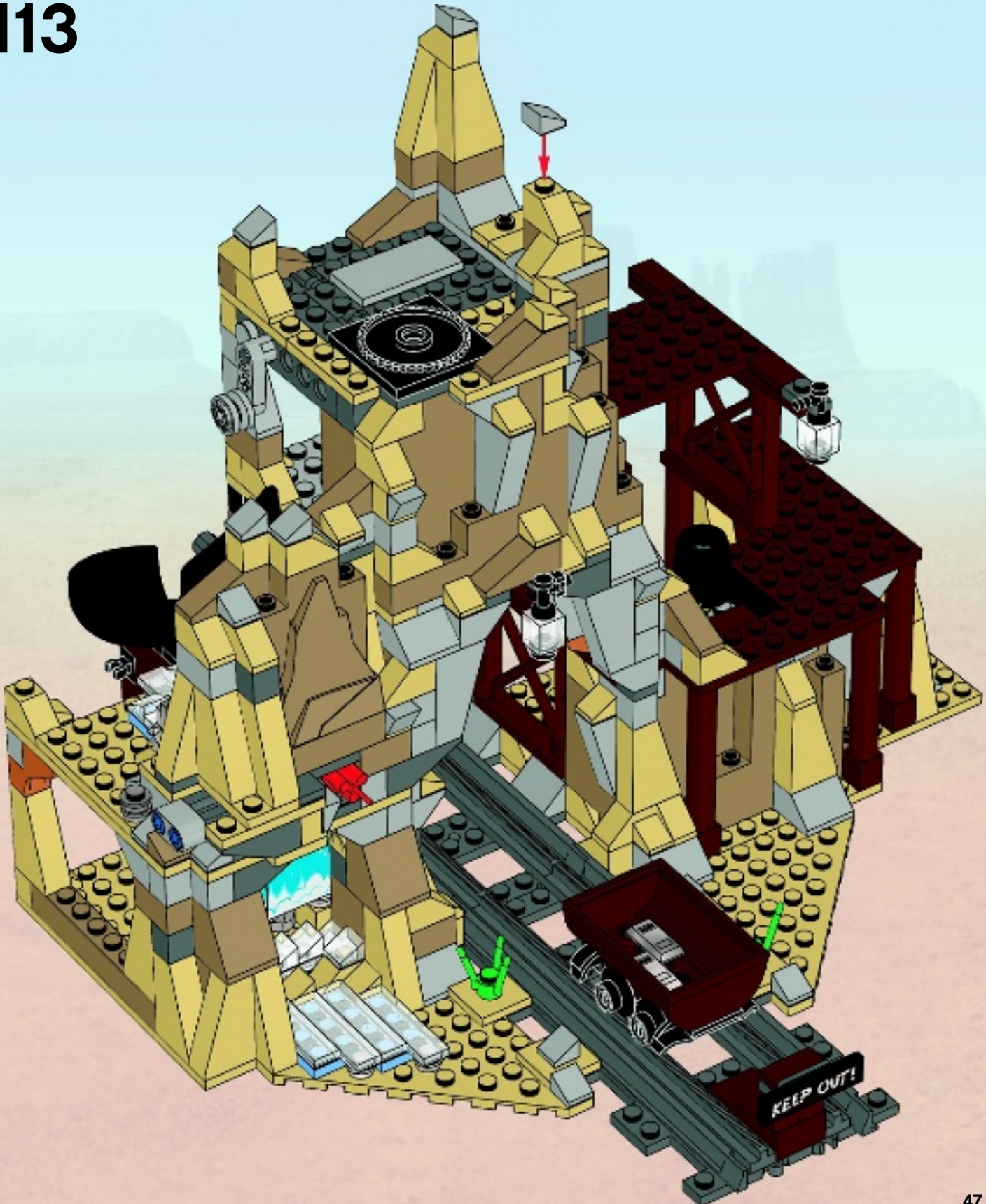



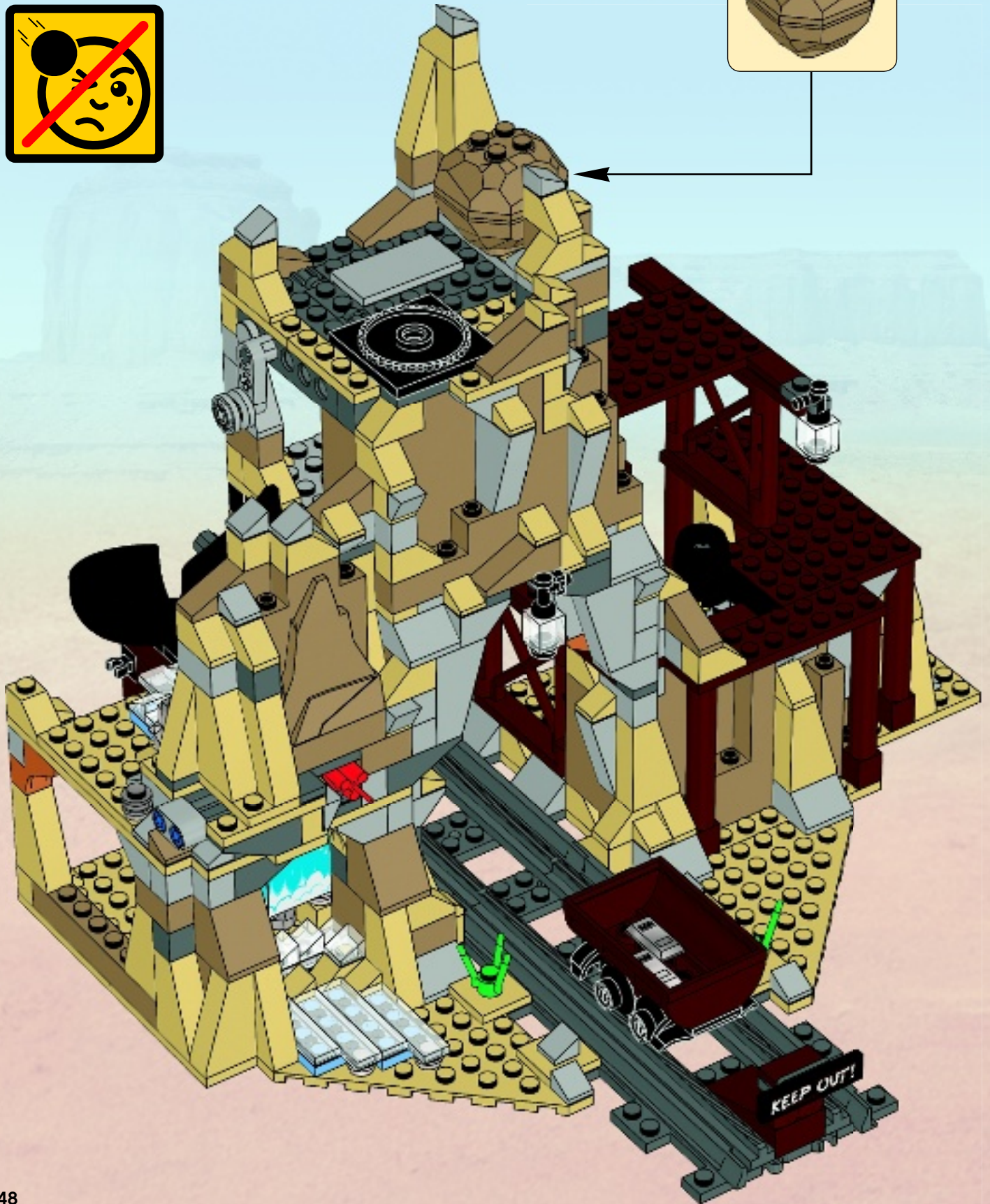



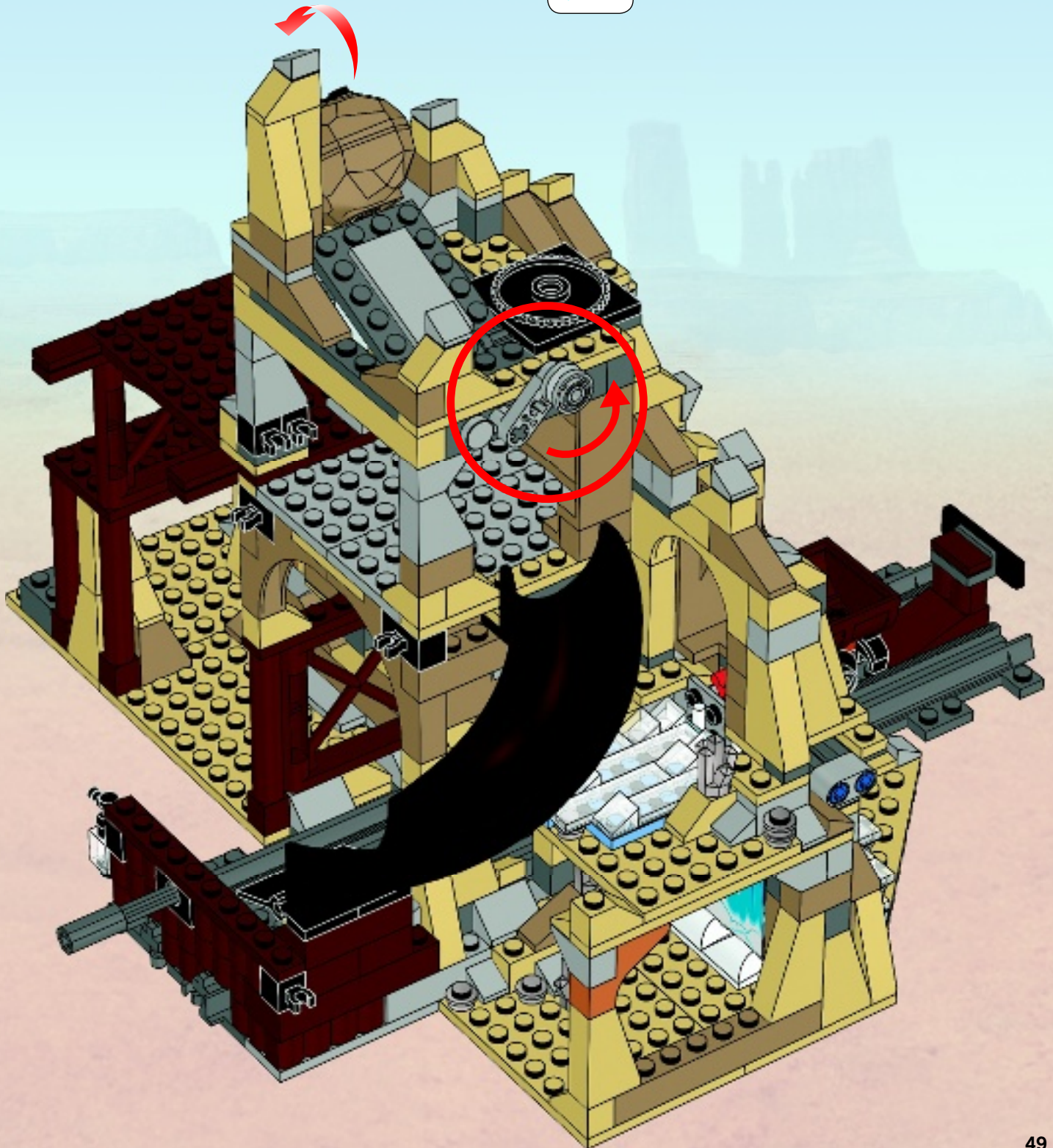
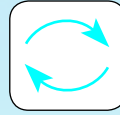



115

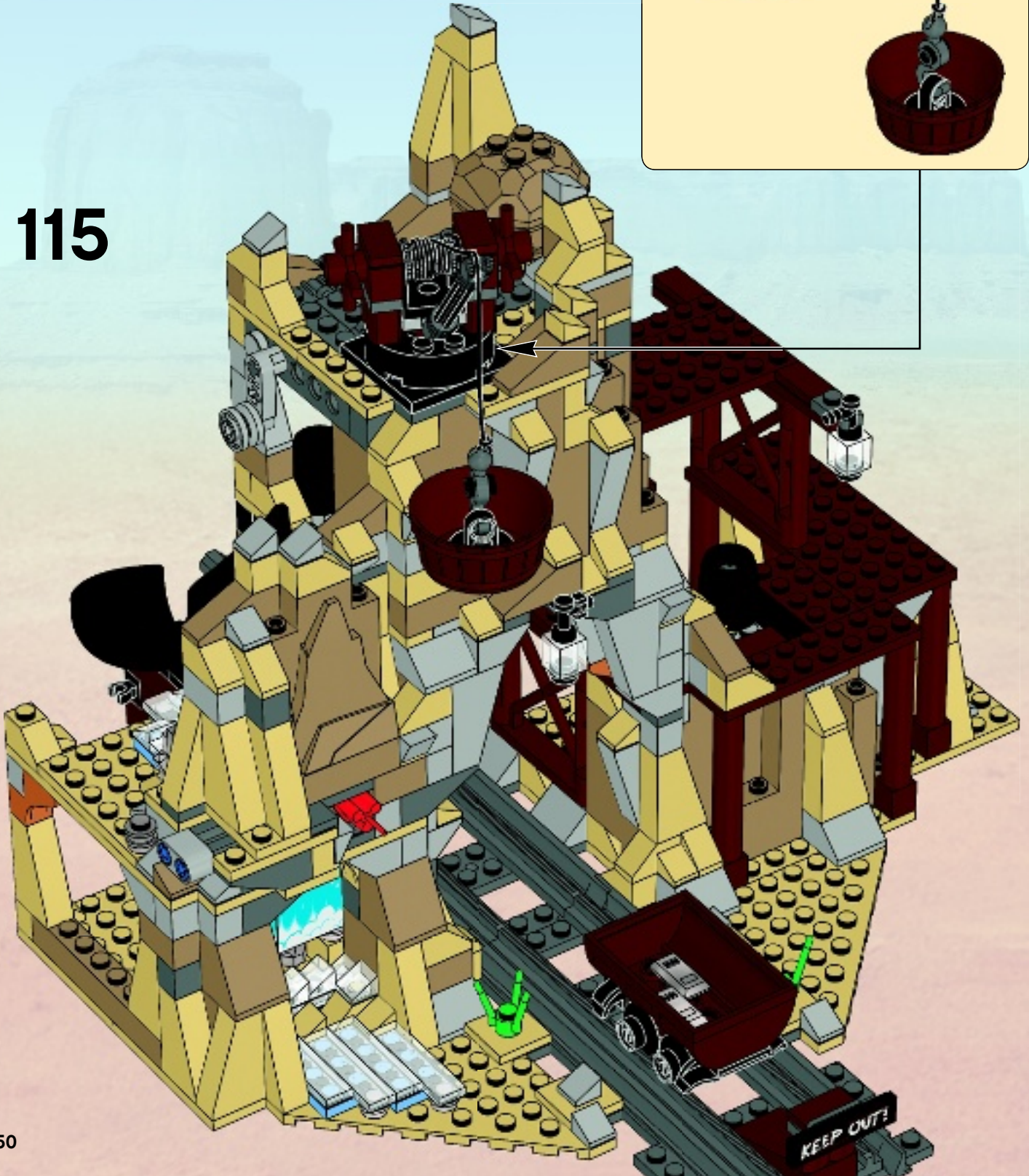
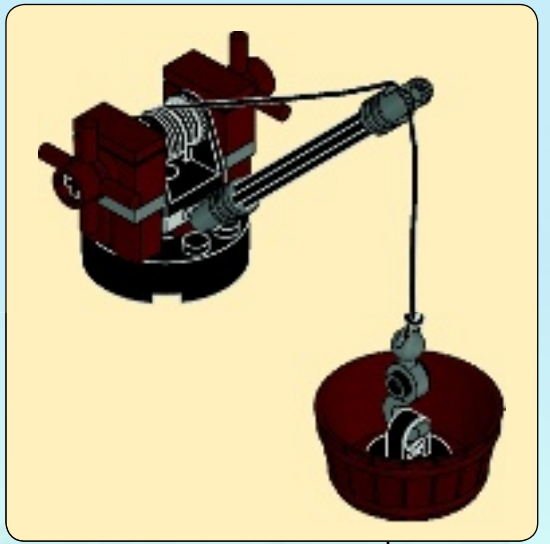



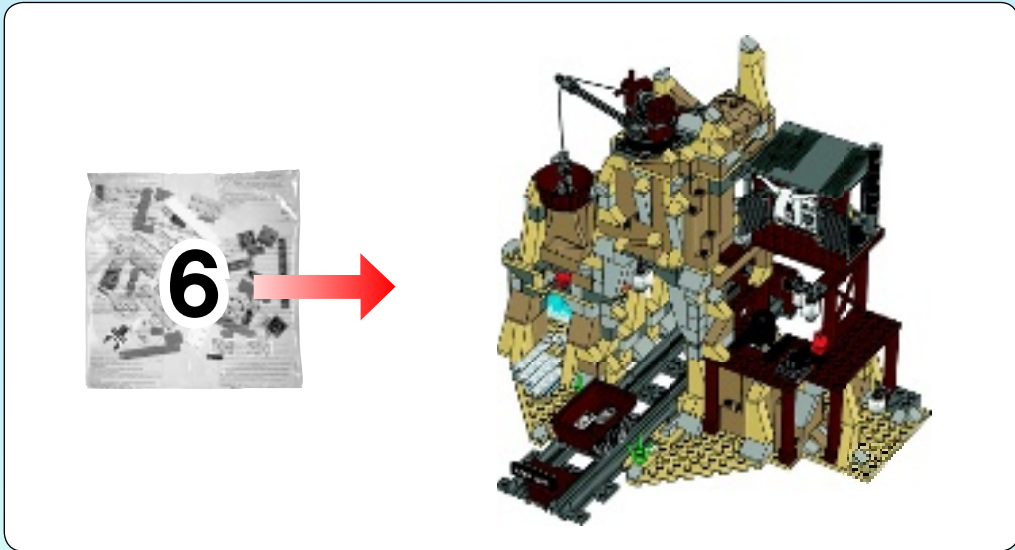

# 116

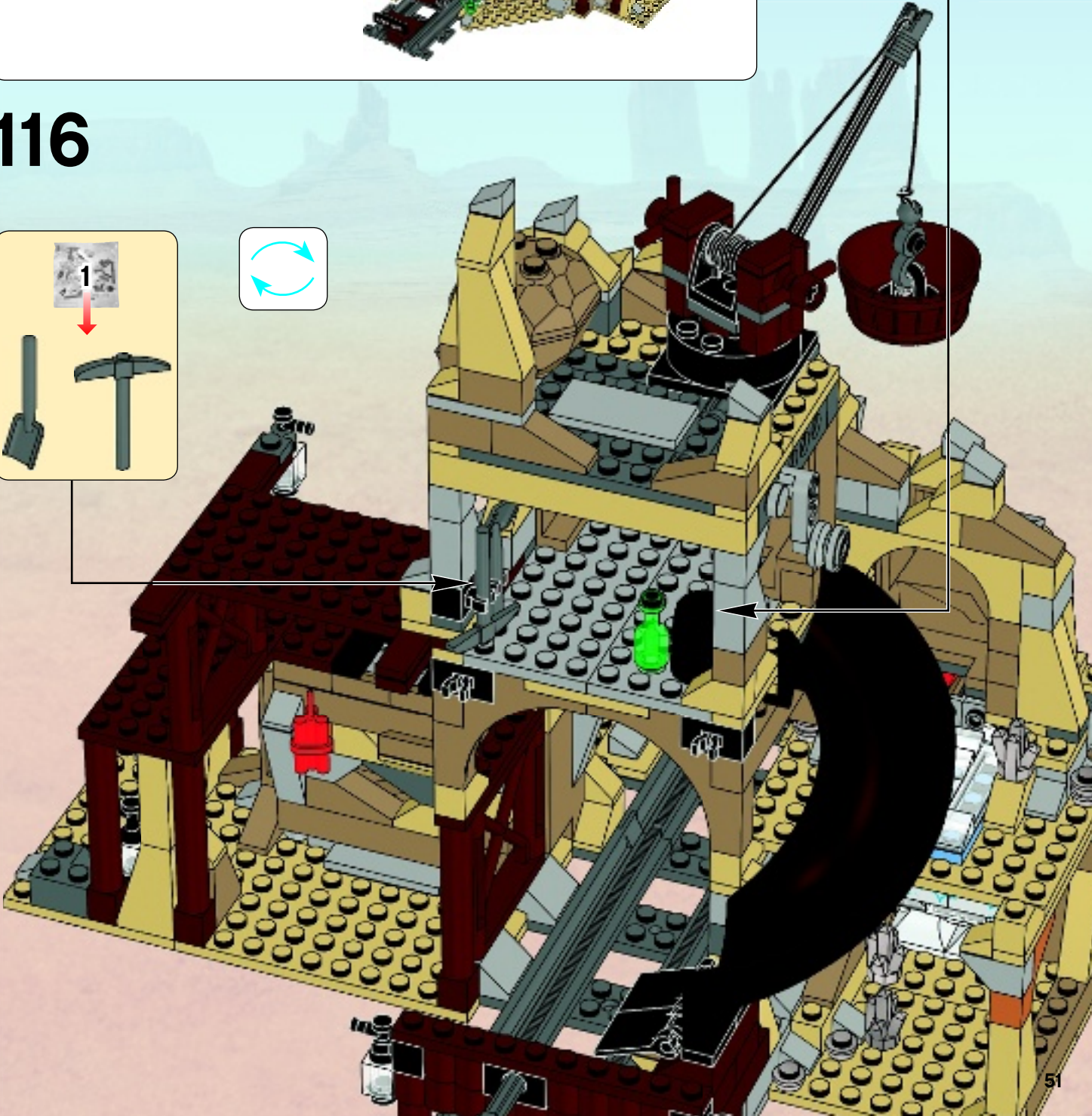
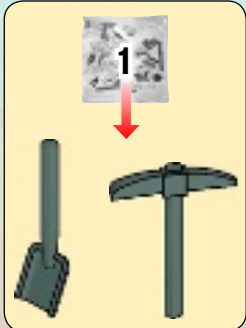







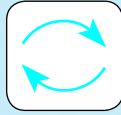

2x

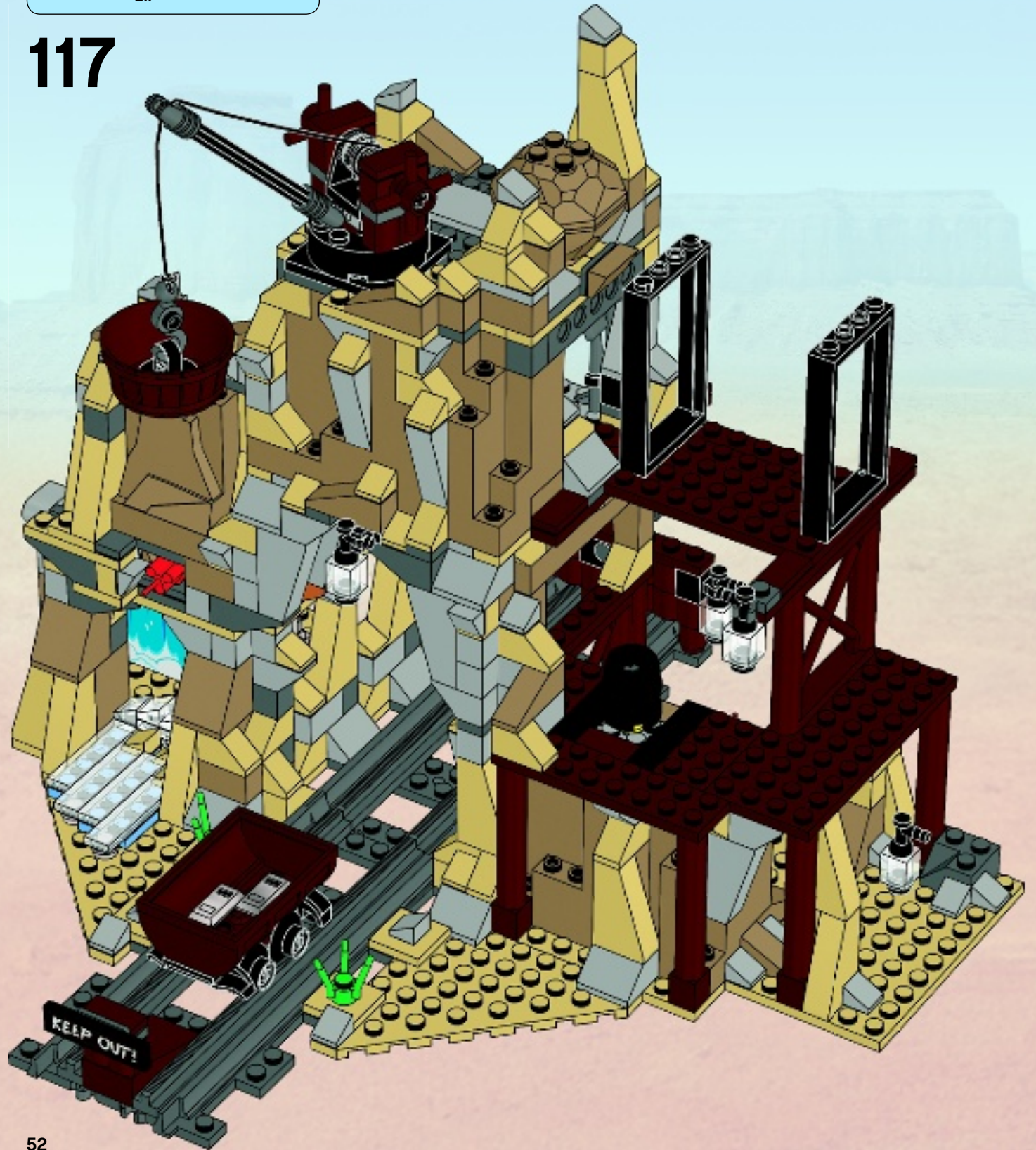

# 117





		
2x	2x	1x

# 118

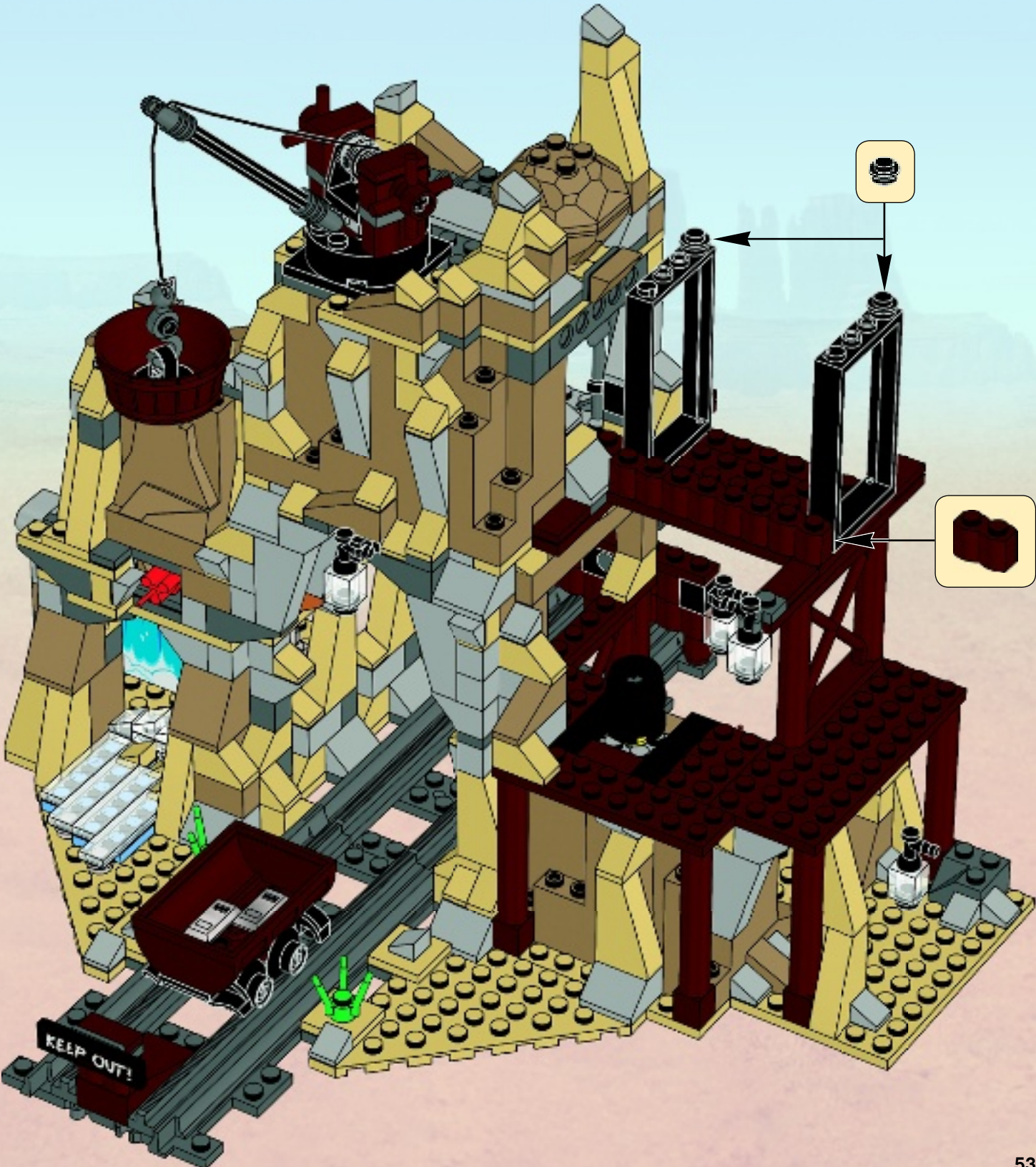



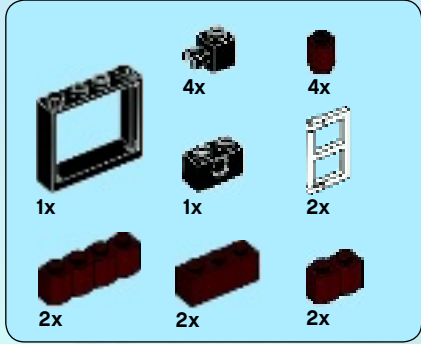

# 119

1

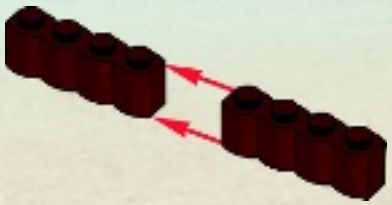

2

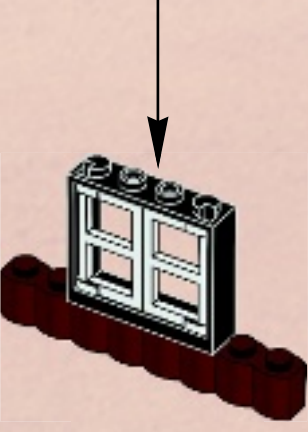
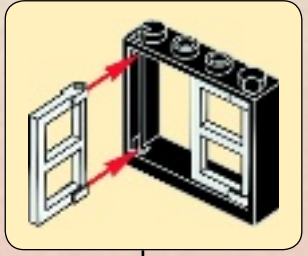

3

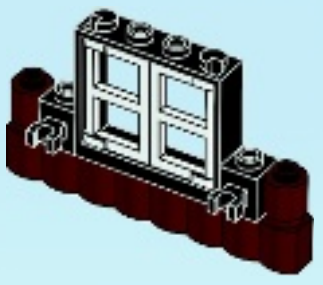

4

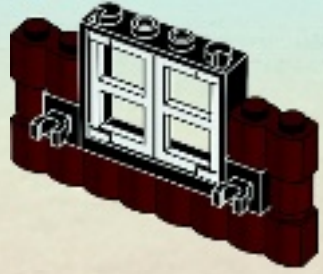

5

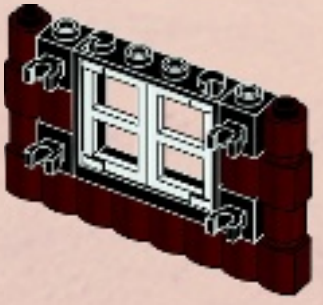

6

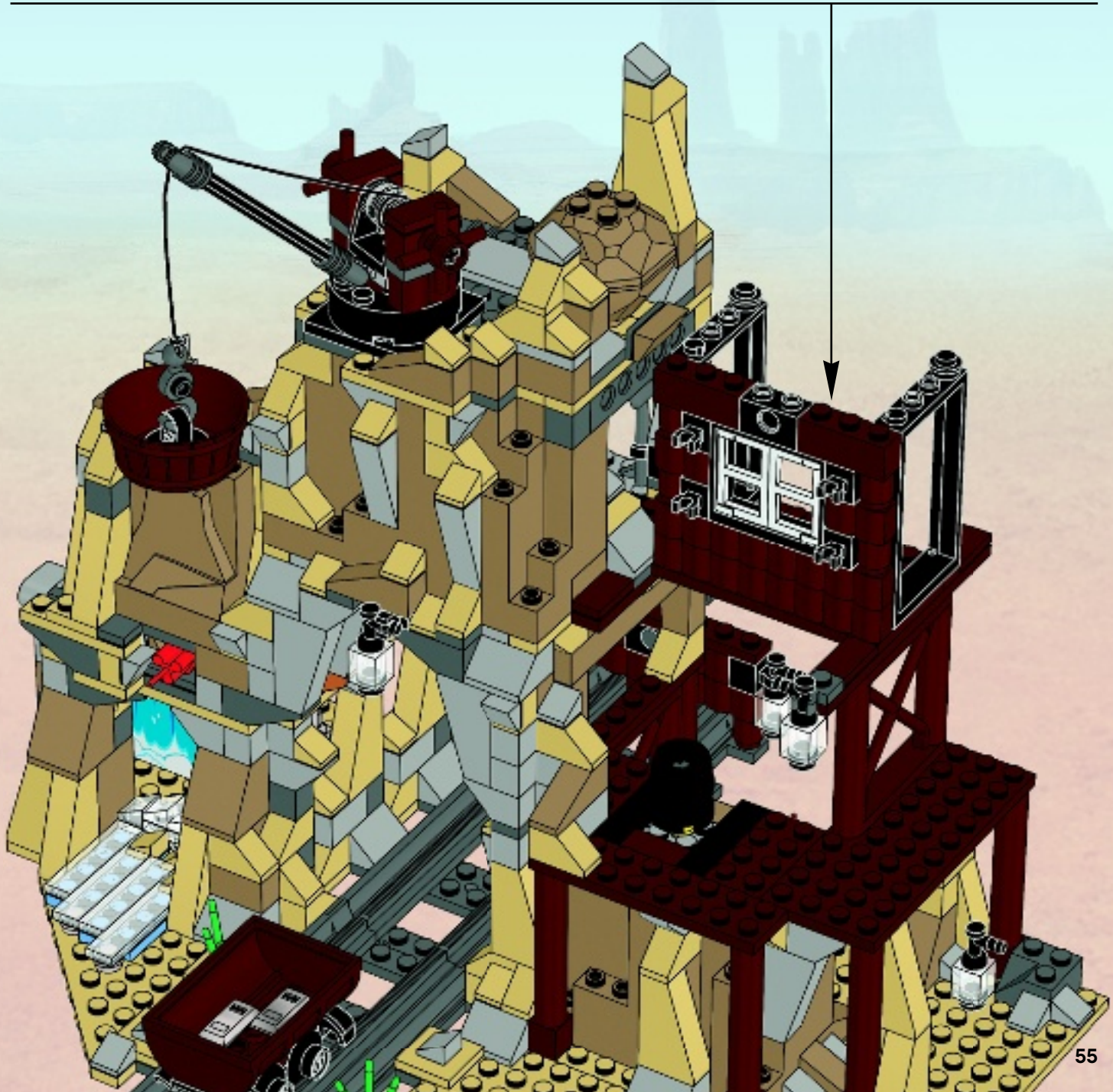
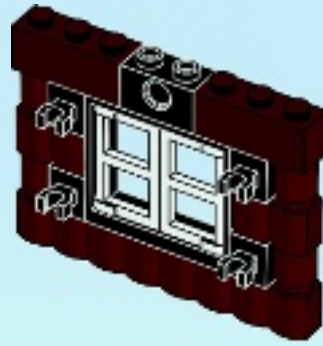



120

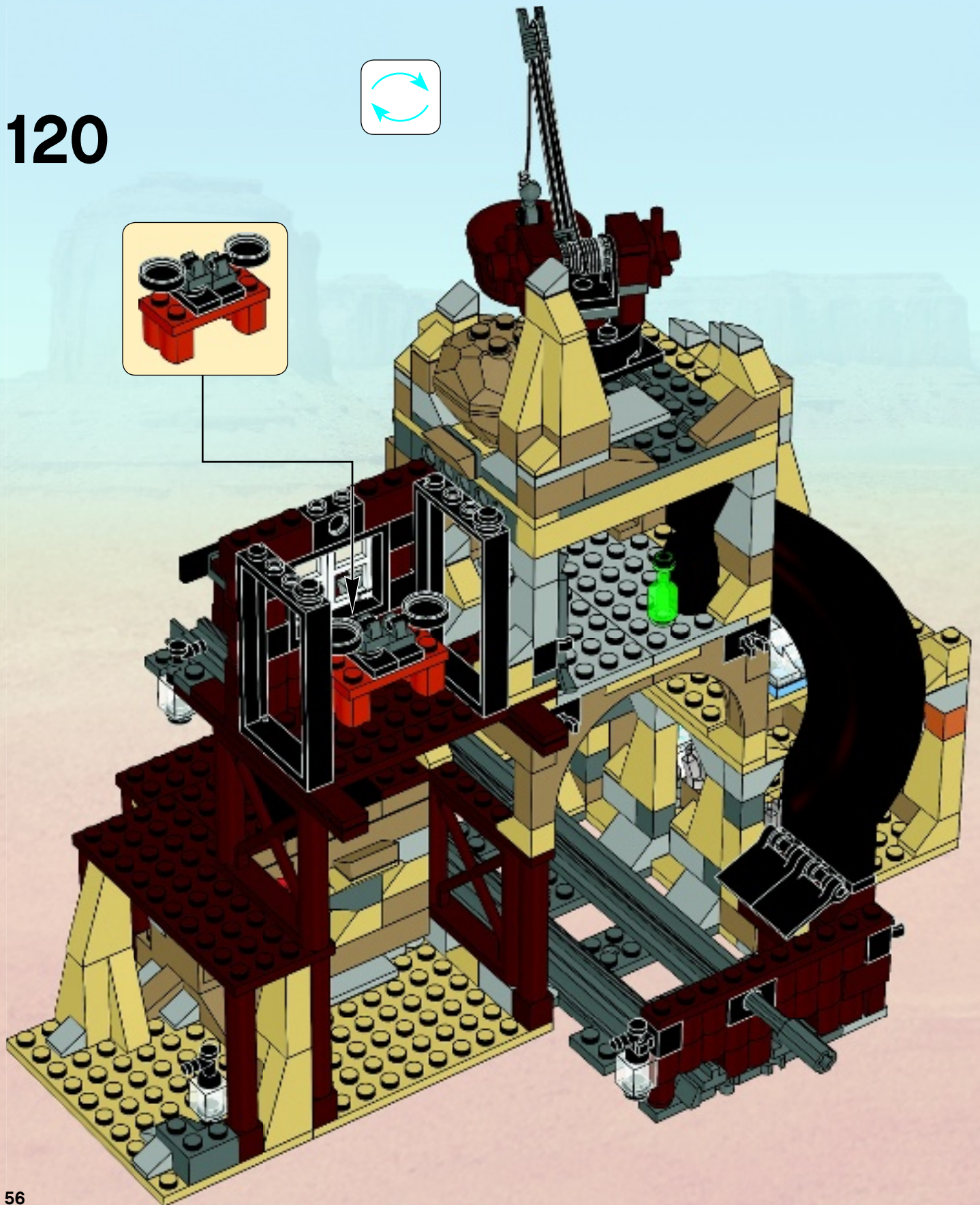
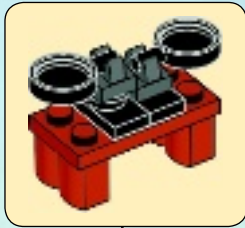
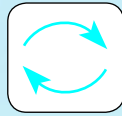



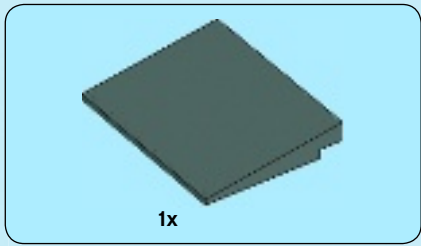

# 121

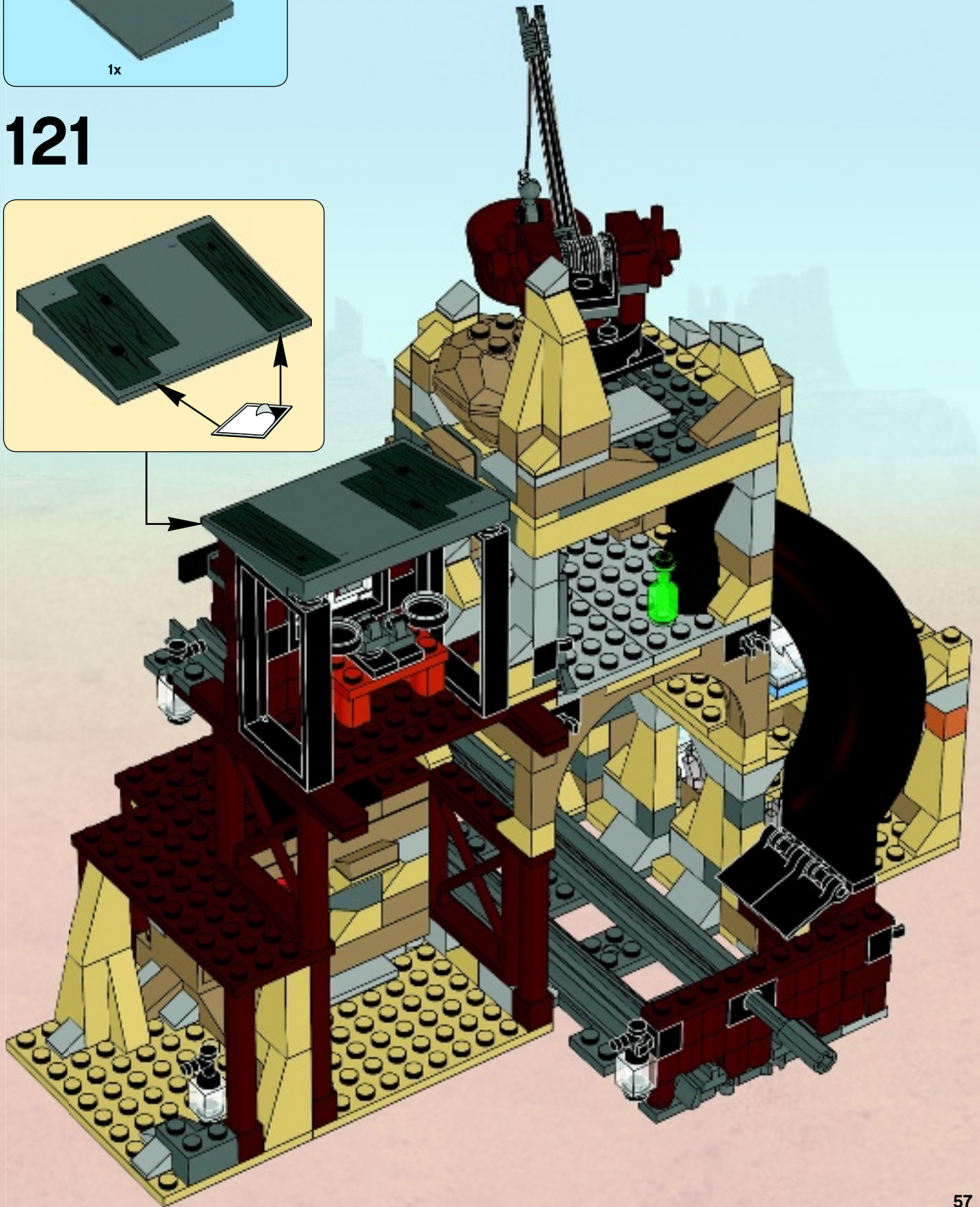
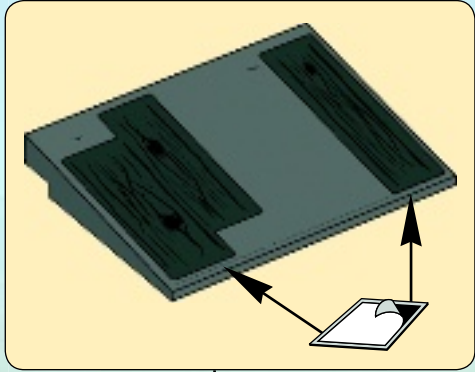





# 122

1



2



3

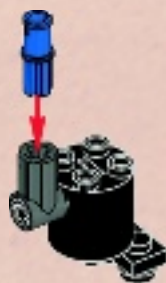

4



5



6

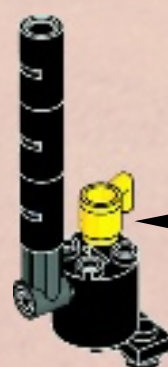

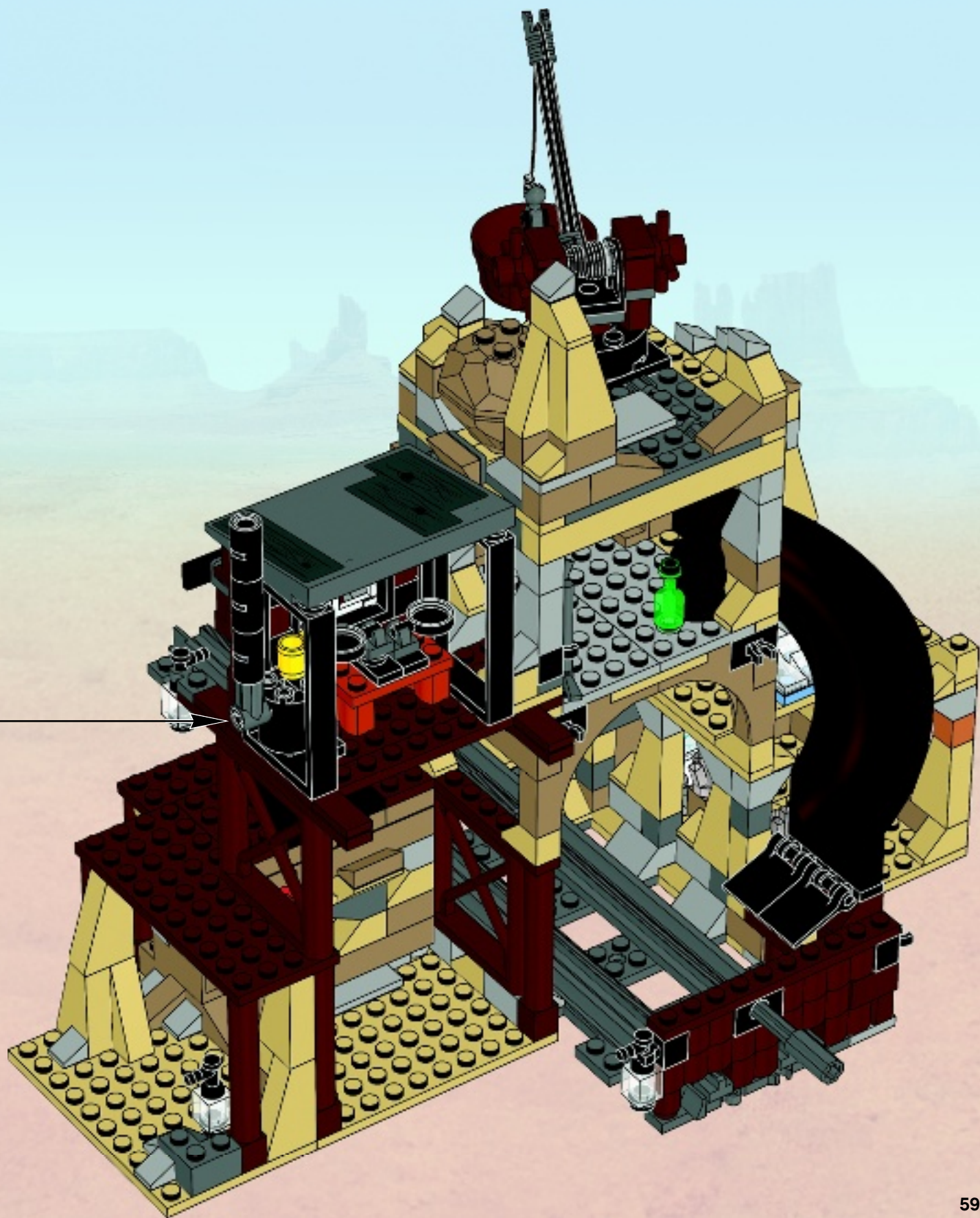



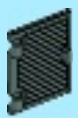

2x

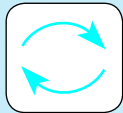

# 123

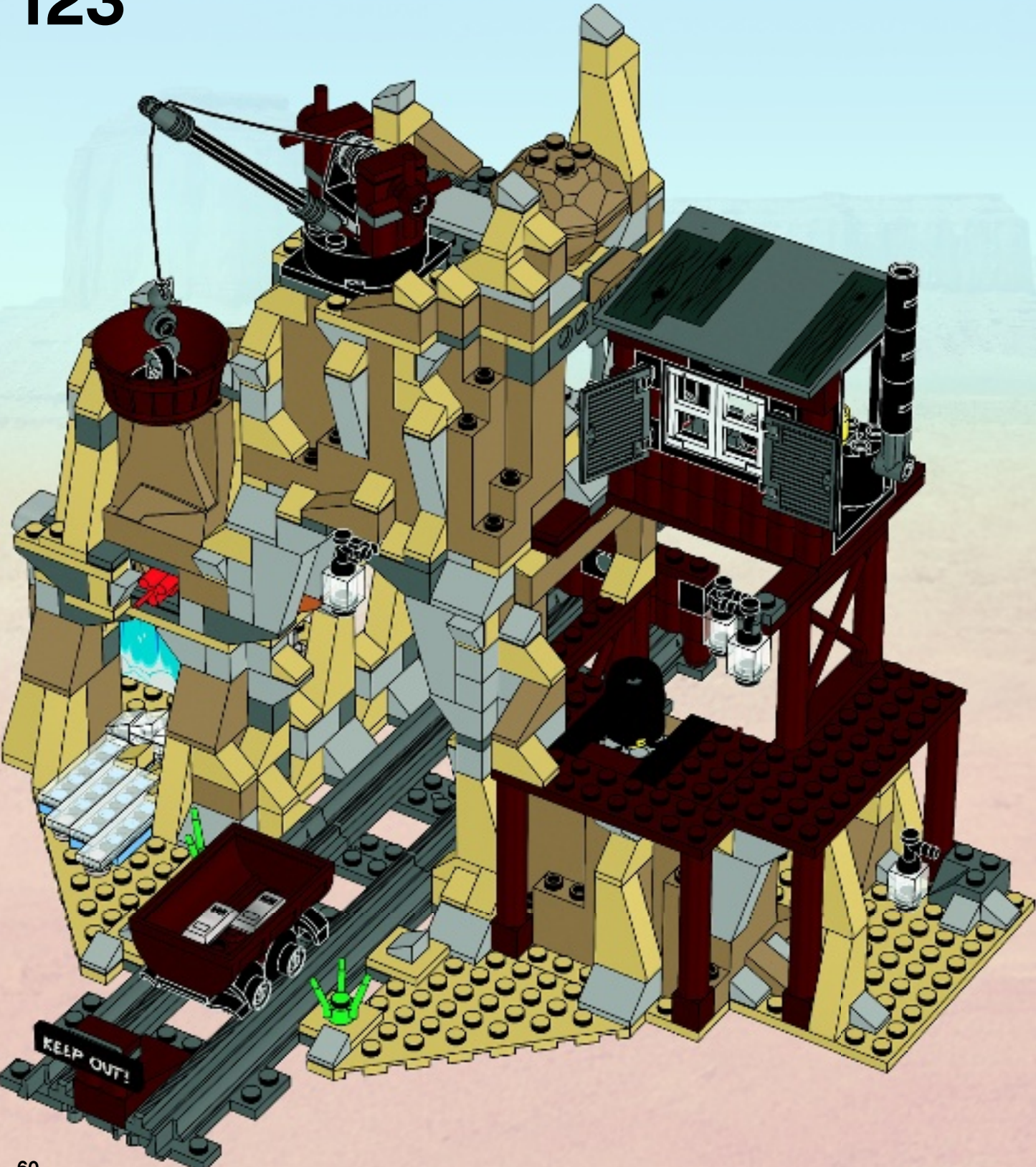



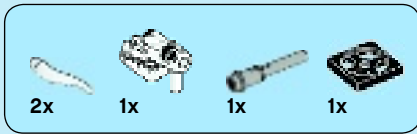

# 124

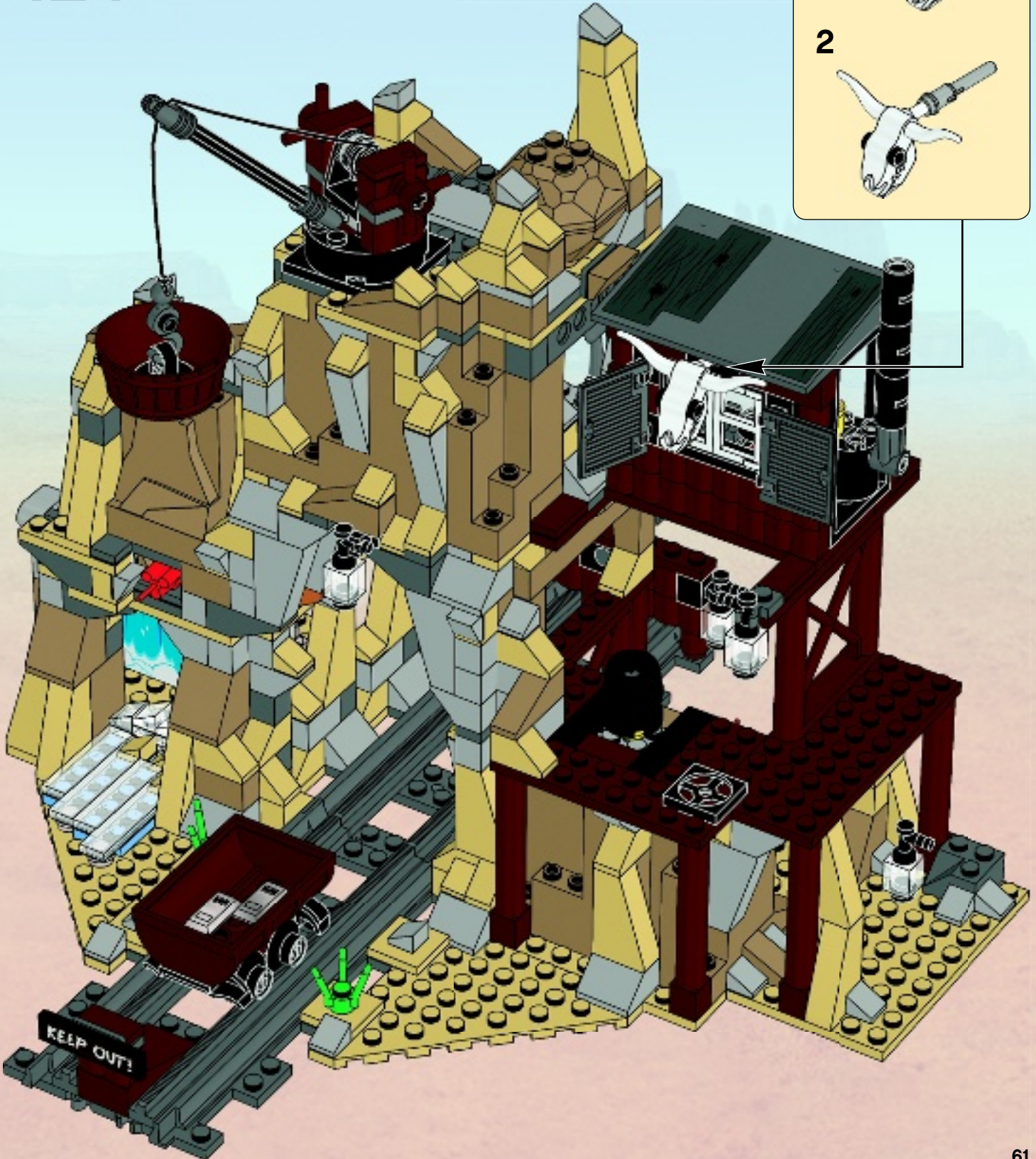
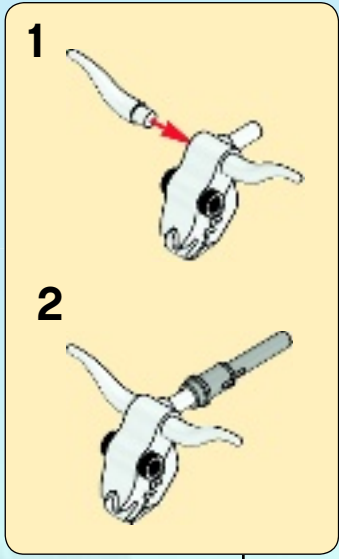



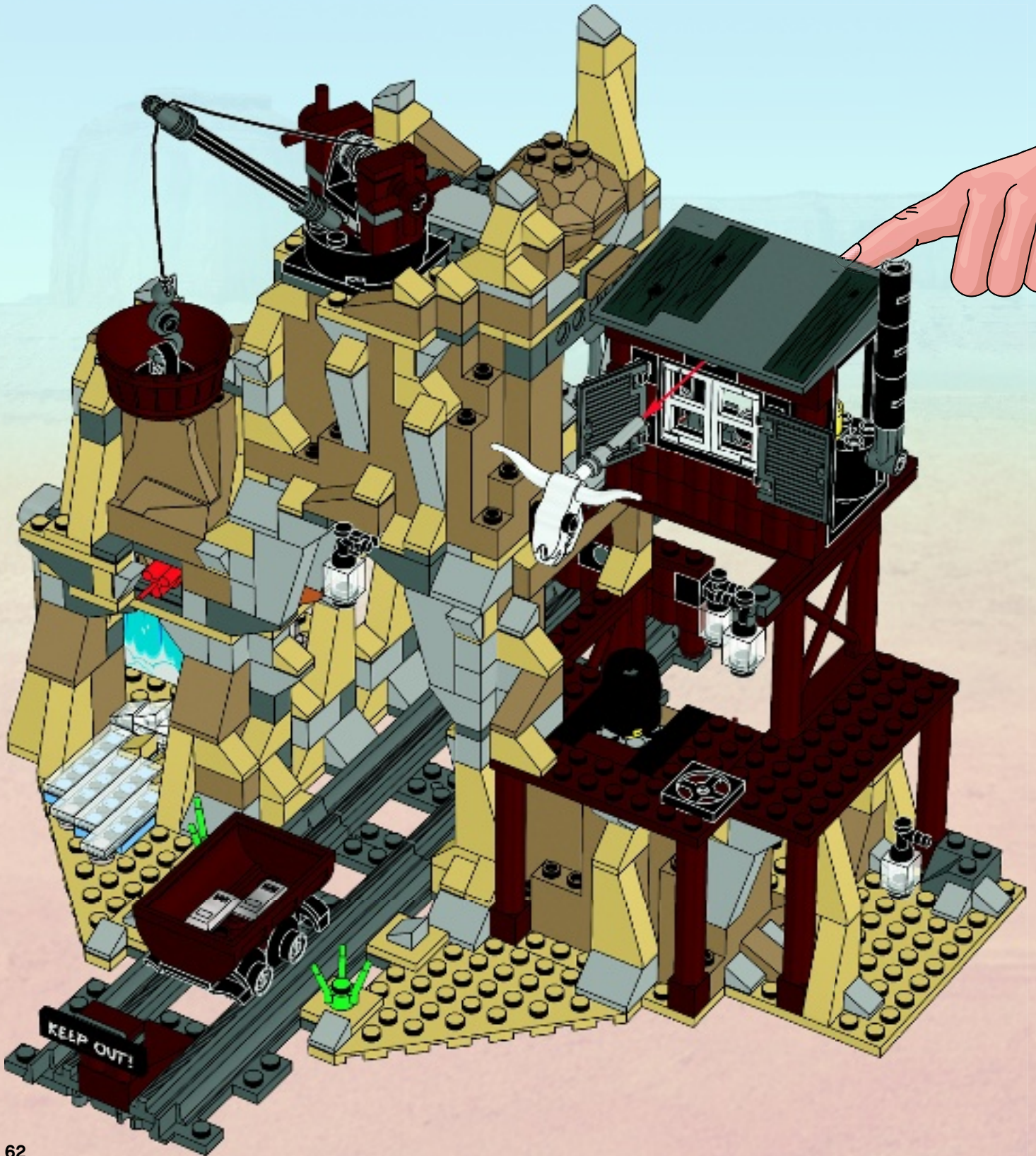





1x

# 125

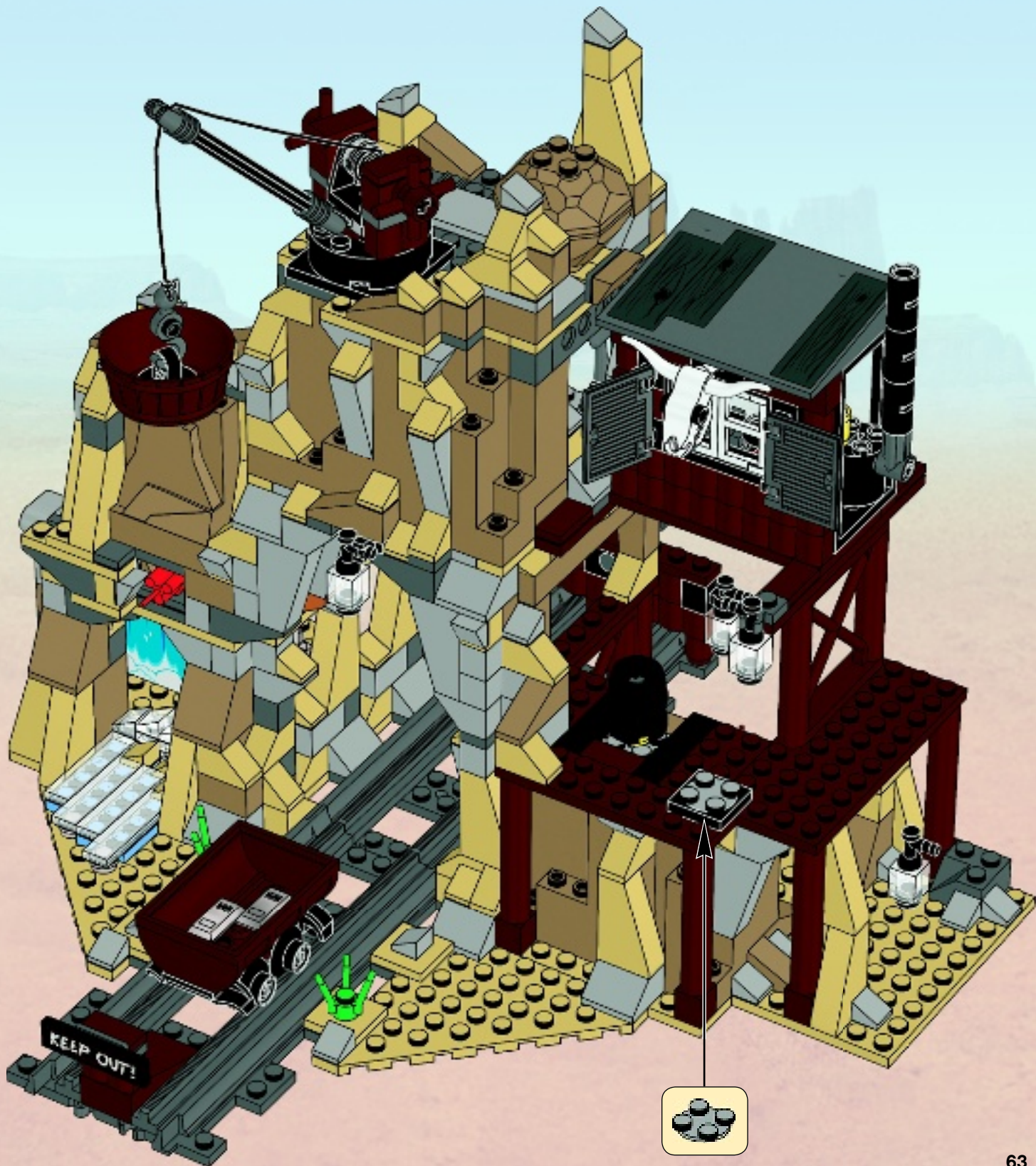





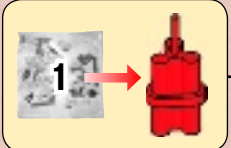
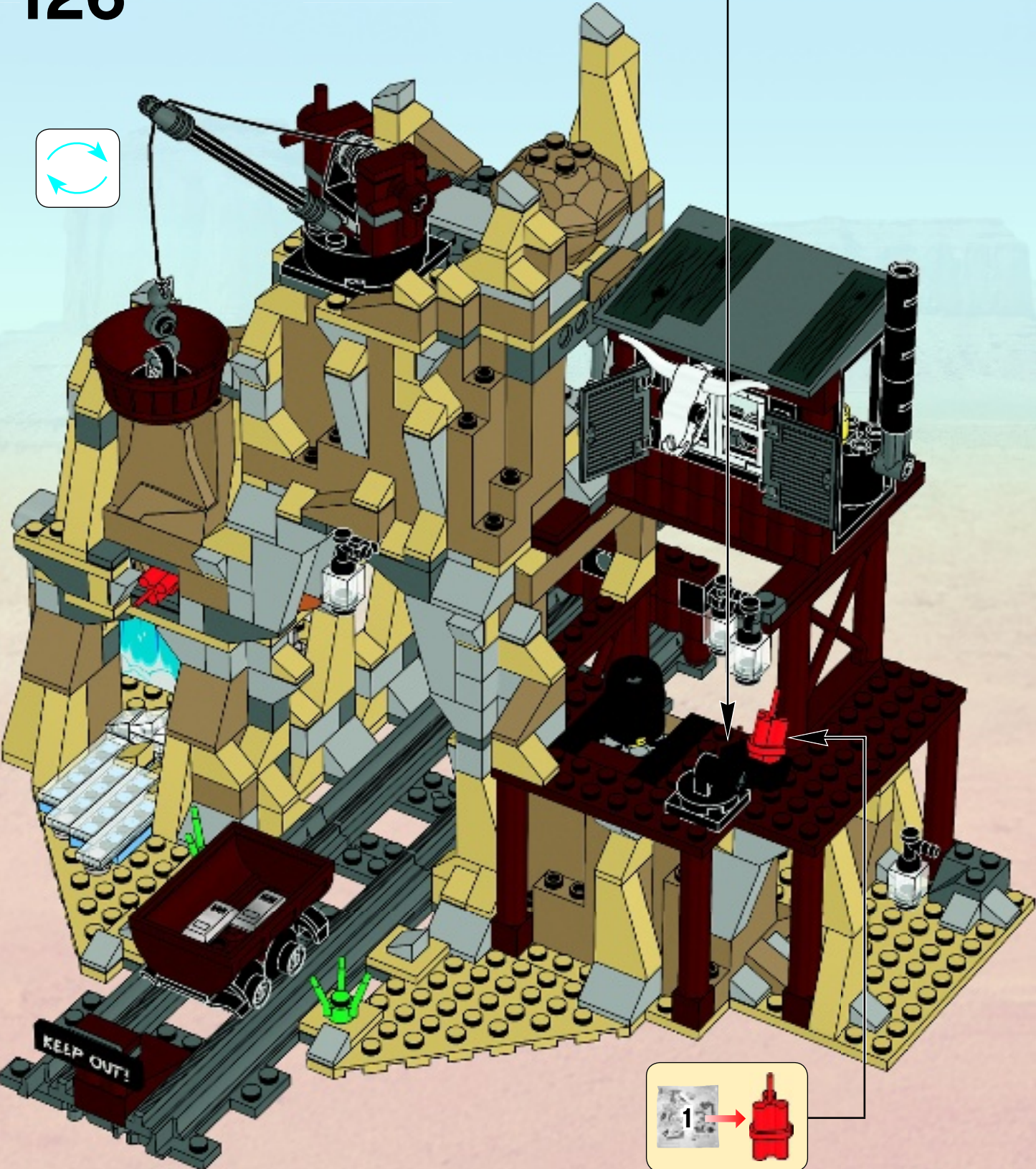
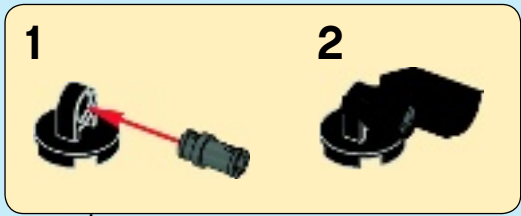
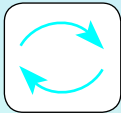

# 126



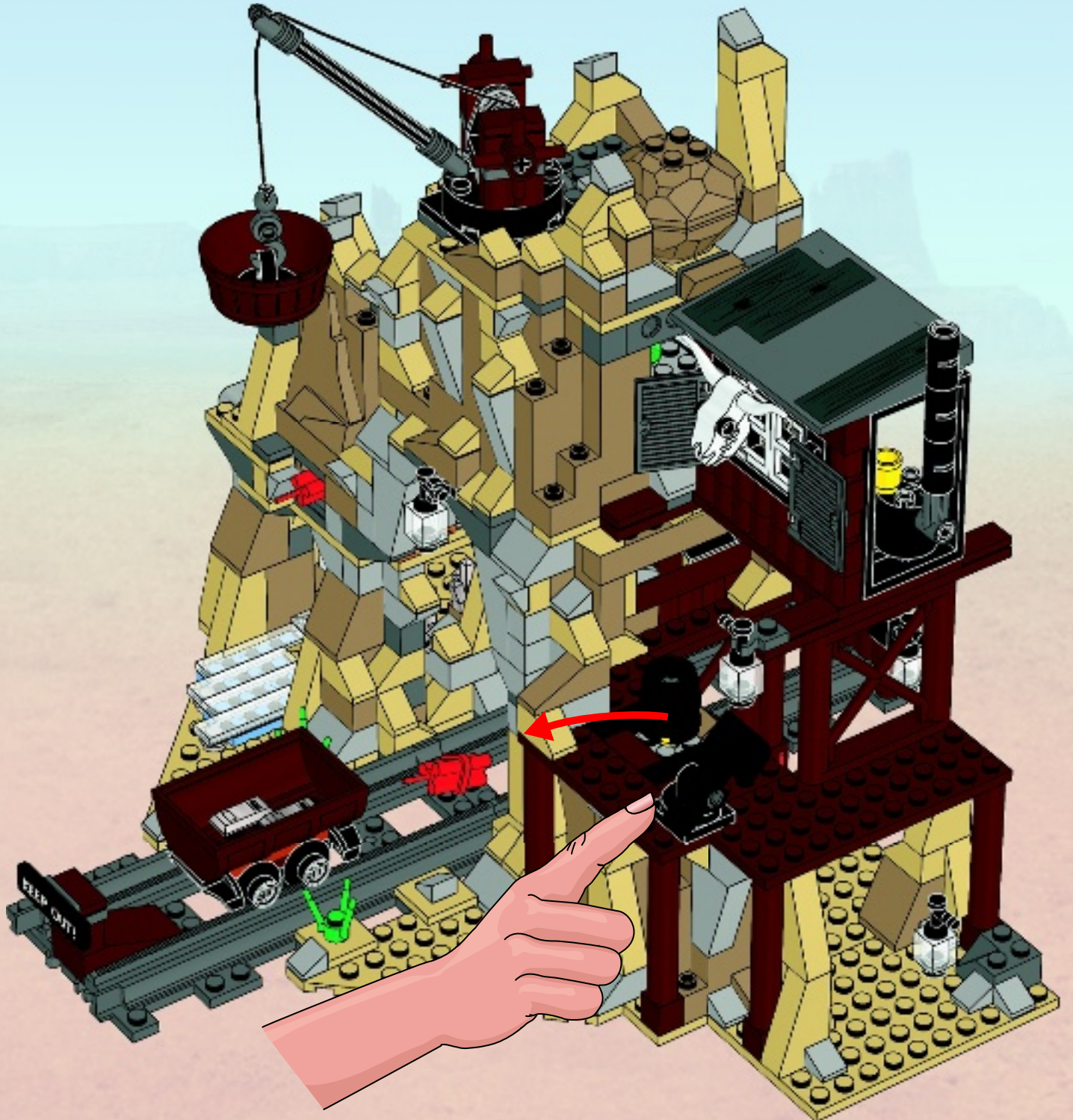





1x  1x 

# 127

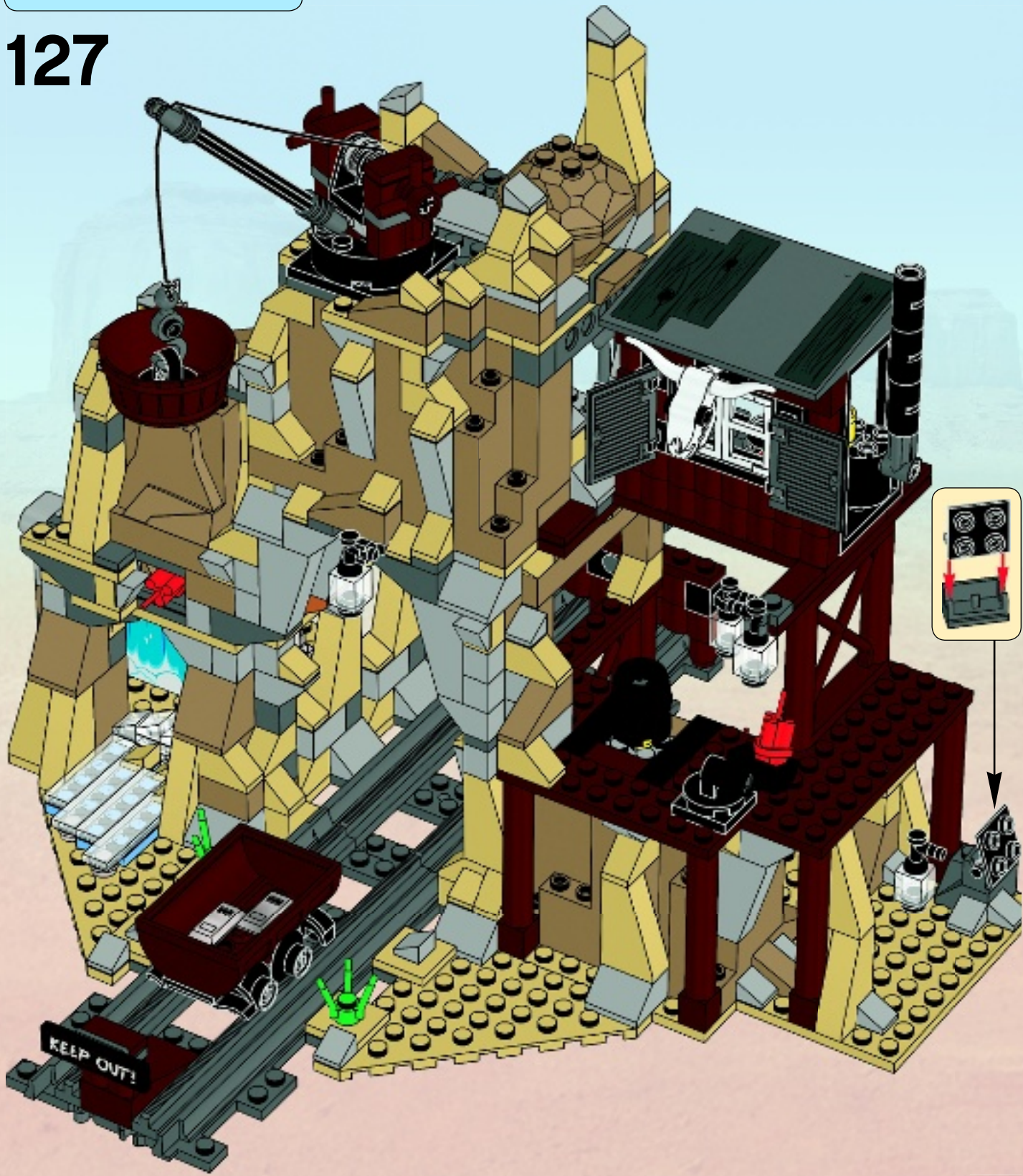



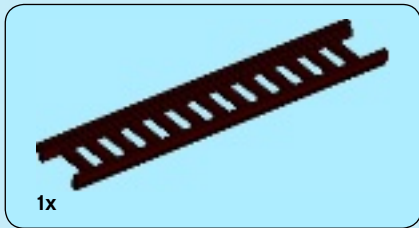

1x

# 128

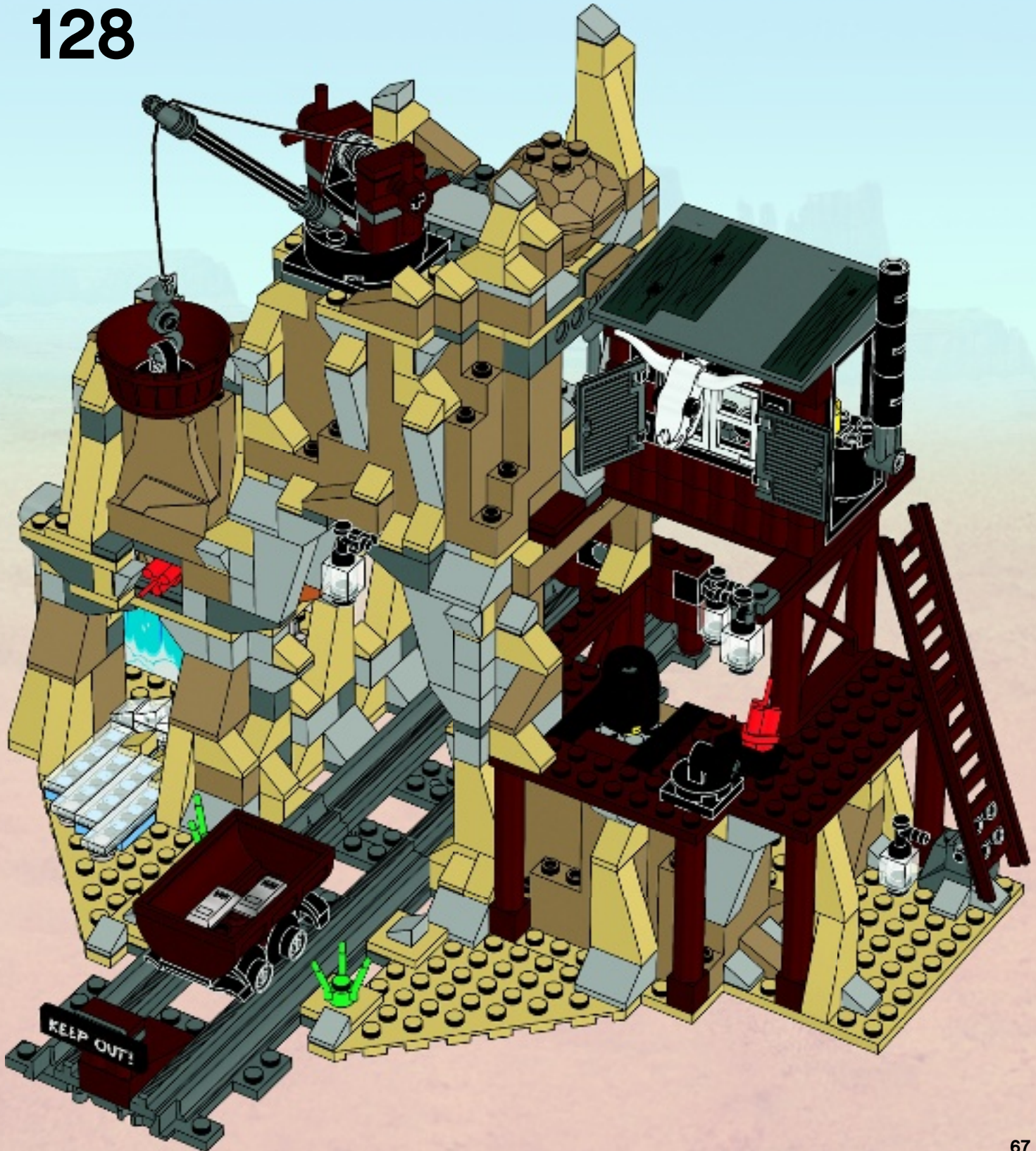





2x  
4611700

2x  
4520842

1x  
6032362

1x  
6032363

2x  
6032360

2x  
4494474

1x  
4114026

4x  
4114084

8x  
4113233

3x  
4114309

2x  
6052783

1x  
4181134

1x  
4166138

2x  
4113988

4x  
4143409

2x  
4626948

6x  
4624185

68

5x  
4118793

21x  
4516055

48x  
4121972

1x  
4155708

4x  
4565387

22x  
4129996

8x  
4118866

1x  
4107623

1x  
6037526

3x  
4538780

1x  
4174747

1x  
4143005

3x  
4206482

1x  
389924

2x  
4239601

8x  
4533771

2x  
4118624

1x  
4194008

1x  
3200026

1x  
4558957

2x  
370026

2x  
379426

1x  
4517925

1x  
4569733

2x  
4140588

9x  
614126

2x  
6010831

1x  
4530589

2x  
4535834

4x  
459926

2x  
6011815

1x  
6042795

1x  
6033775

1x  
6033811

1x  
6042862

1x  
6032332

1x  
6032373

2x  
452826

2x  
460026

4x  
4295370

2x  
4504187

1x  
4124096

1x  
258426

1x  
368026

1x  
4517986

1x  
4297719

1x  
6006140

1x  
4143187

3x  
4121715

3x  
4526982

1x  
370626

1x  
370726

2x  
374128

1x  
6037379

1x  
4167842

8x  
4657537

4x  
4645394

12x  
4244362

4x  
4650970

1x  
6020220

1x  
6037788

1x  
6037792

1x  
6042968

2x  
6031821

19x  
4521914

2x  
4663285

10x  
6015449

3x  
4616593

13x  
6015454

4x  
6024122

5x  
6024124

1x  
6037802

2x  
6037837

2x  
4666352

2x  
4535928

2x  
4211200

2x  
4211220

8x  
4211151

10x  
4211180

8x  
4211181

7x  
4211183

6x  
4520612

2x  
4211252

1x  
4211205

1x  
4225869

2x  
4211186

1x  
4211211

5x  
4223683

2x  
4225715

1x  
4211268

1x  
4211268

- 2x 4211159
- 1x 4541875
- 1x 4216615
- 1x 6043062
- 1x 6042868
- 1x 4507139
- 1x 4211160
- 2x 6002837
- 2x 4252456
- 13x 4211349
- 1x 4211394
- 35x 4521921
- 17x 4211437
- 1x 4211438
- 1x 4211452
- 2x 4211402

- 2x 4515374
- 9x 4216248
- 14x 4211410
- 6x 4211429
- 1x 4211814
- 2x 4654580
- 2x 4560183
- 1x 4211542
- 3x 4650260
- 1x 4211370
- 1x 4540203
- 1x 4520320
- 1x 4211862
- 1x 4563045
- 1x 4211758
- 8x 4211098
- 6x 4210719
- 14x 4211063
- 2x 6030710
- 1x 4587212
- 2x 6000606

- 1x 4210658
- 1x 4211050
- 3x 4516546
- 1x 4212529
- 2x 4210695
- 1x 4211066
- 2x 4211104
- 1x 4210702
- 5x 4211068
- 2x 4211055
- 1x 4568734
- 2x 4210917
- 1x 4654618
- 1x 4595710
- 1x 4595708
- 4x 4638990
- 2x 6037688

- 1x 4211007
- 1x 4211006
- 1x 6035094
- 2x 4560177
- 1x 4508553
- 2x 4552351
- 1x 6042647
- 1x 6032388
- 1x 6033436
- 1x 6042860
- 1x 6033629
- 13x 4249039
- 5x 4519318
- 1x 4654448
- 1x 6038373

- 1x 6037775
- 2x 4536677
- 1x 6042864
- 1x 6038611
- 1x 4568951
- 3x 4536989
- 1x 4569385
- 3x 4568955
- 1x 6043024
- 1x 6043608
- 1x 6043021
- 2x 6034154
- 2x 6034689
- 1x 6035045





Disney **THE LONE RANGER**



[LEGO.com/TheLoneRanger](http://LEGO.com/TheLoneRanger)







# club™

## Free\*! Gratuit!

\* Paid subscription in Australia and New Zealand.  
Abonnement payant en Australie et Nouvelle-Zélande



© 2012 The LEGO Group.

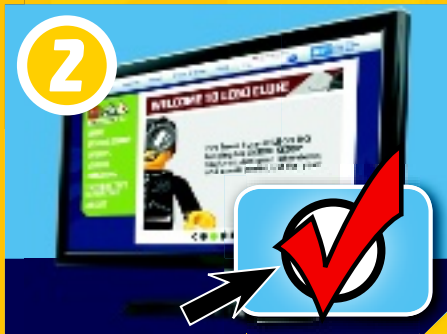

[LEGO.com/club](http://LEGO.com/club)





# WIN!

Go to [www.LEGOsurvey.com/product](http://www.LEGOsurvey.com/product) to fill out a survey for a chance to win a cool LEGO® Product.

No purchase necessary.

Open to all residents where not prohibited.



LEGO.com



## [www.LEGOsurvey.com/product](http://www.LEGOsurvey.com/product)

### GEWINNE!

Nimm an der Umfrage auf [www.LEGOsurvey.com/product](http://www.LEGOsurvey.com/product) teil und hab die Chance ein cooles LEGO® Produkt zu gewinnen!

Die Teilnahme am Gewinnspiel führt zu keinerlei Kaufverpflichtungen. Teilnahme in allen nicht ausgeschlossenen Ländern möglich.

### WIN!

Ga naar [www.LEGOsurvey.com/product](http://www.LEGOsurvey.com/product), vul een enquêteformulier in en maak kans op een cool LEGO® product.

Geen aankoopverplichting. Iedereen mag deelnemen, uitgezonderd ingezetenden van landen waar een enquêteverbod geldt.

### GAGNE!

Visite [www.LEGOsurvey.com/product](http://www.LEGOsurvey.com/product) pour répondre à un questionnaire et avoir une chance de gagner un produit LEGO® très cool!

Aucune obligation d'achat. Ouvert à tous les résidents des pays autorisés.

### 当てよう!

[www.LEGOsurvey.com/product](http://www.LEGOsurvey.com/product) にアクセスして、アンケートにご記入ください。当選者にはレゴ®製品を差し上げます。

お買い上げの必要はありません。禁止されていない限り、すべての皆様にご利用いただけます。

