



nickelodeon.
TEENAGE MUTANT NINJA
TURTLES™



79104



1



2



3



4



LEGO.com/brickseparator

IMPORTANT: Never modify the elements or use other projectiles than provided with this toy.
IMPORTANT : Ne jamais modifier les éléments ni utiliser d'autres projectiles que ceux fournis avec ce jouet.
IMPORTANTE: No modifique los elementos ni utilice otros proyectiles diferentes a los suministrados junto con este juguete.

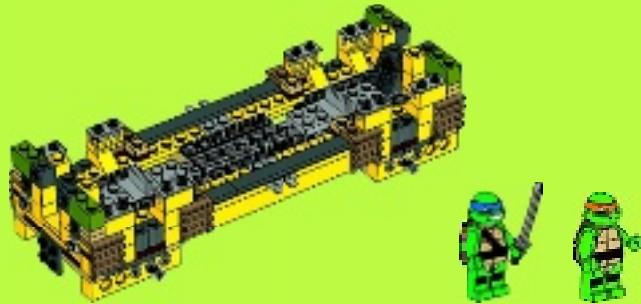

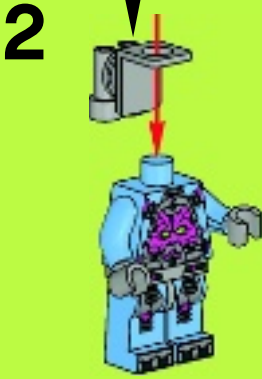
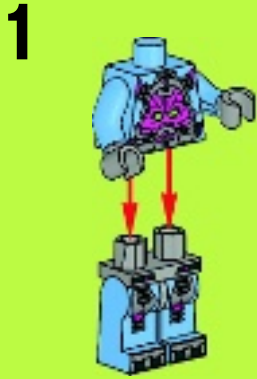
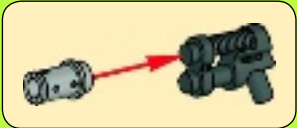
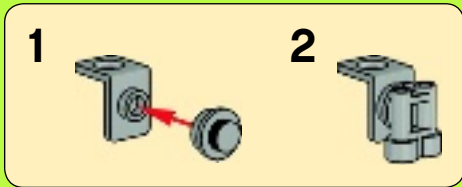
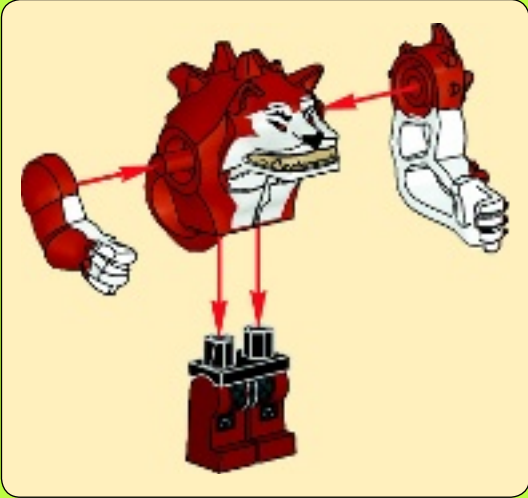

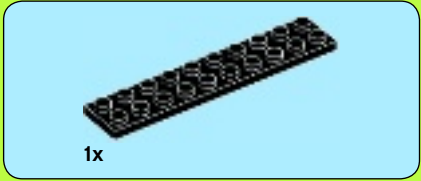

1

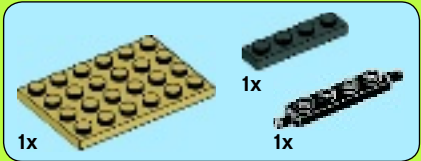

2

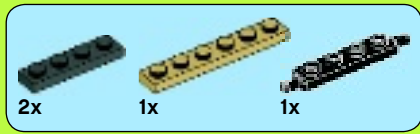

3

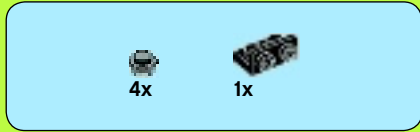

4

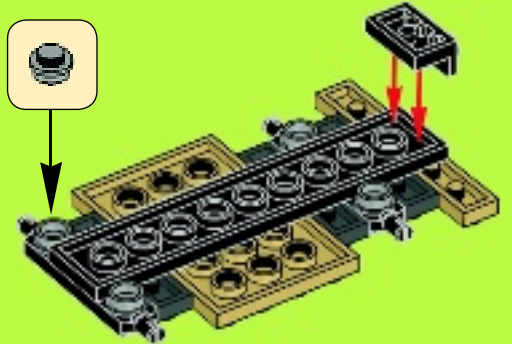

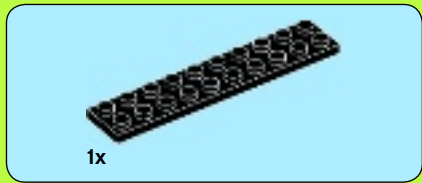

5

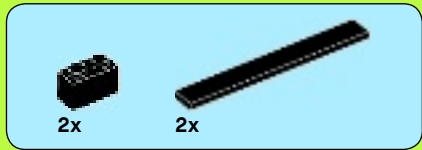
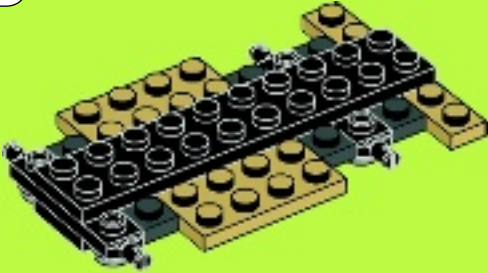

6

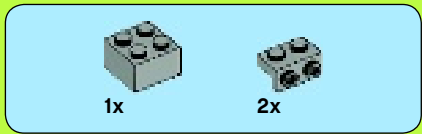
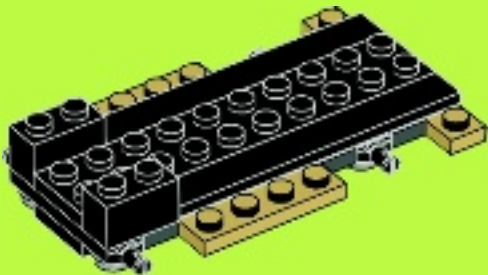

7

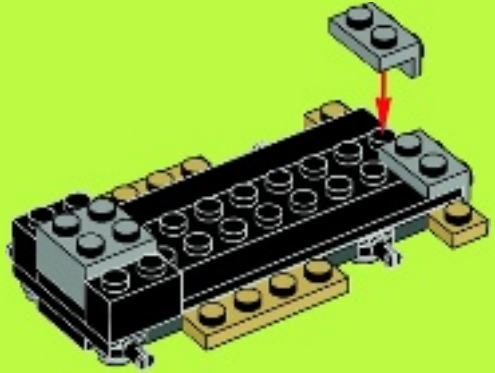

8

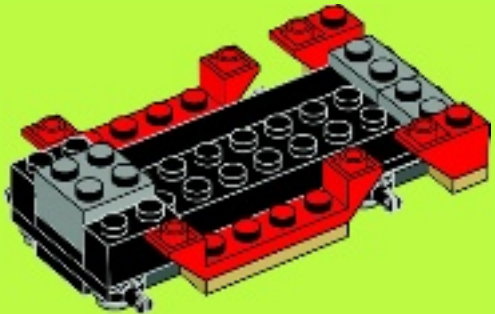



9

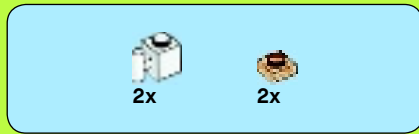
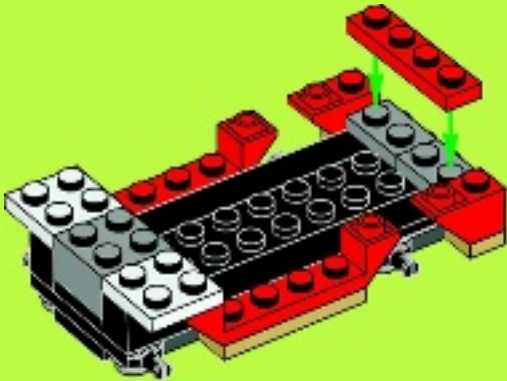

11

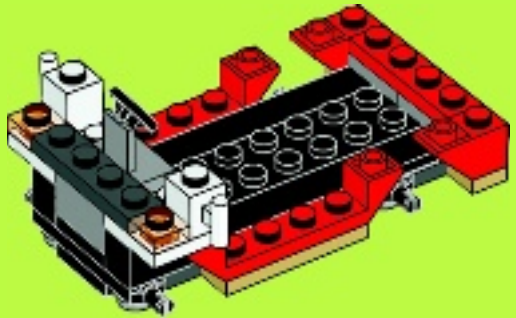

10

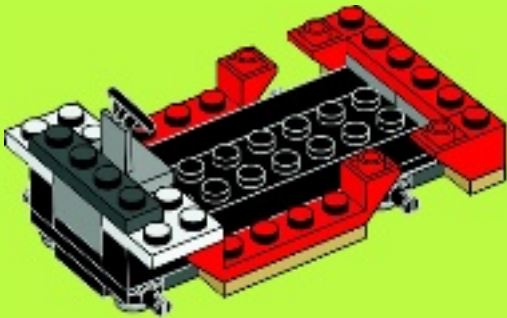

12

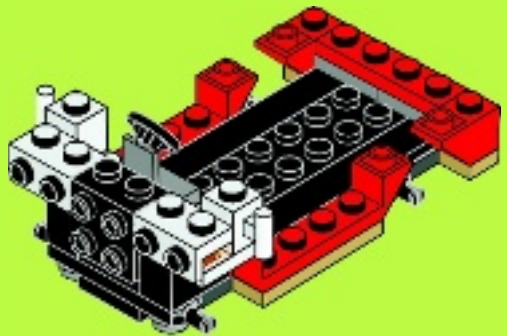



13

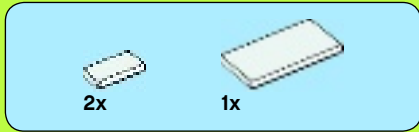
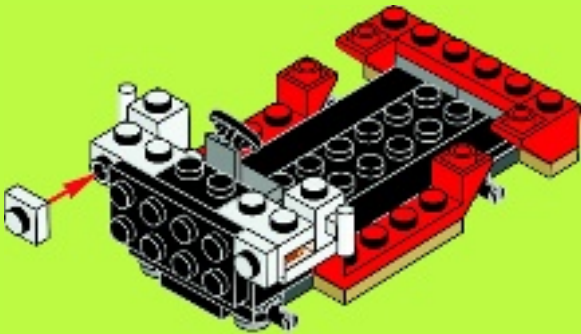

15

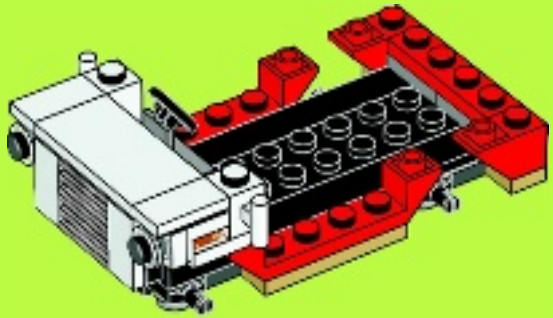

14

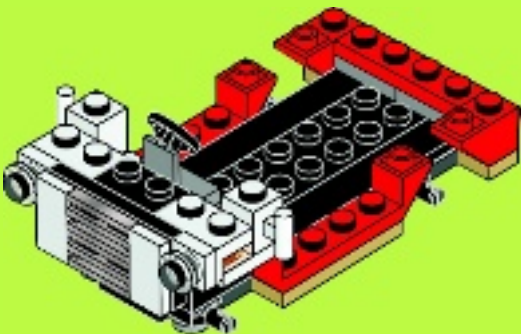

16

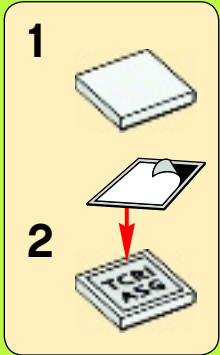



6x

17

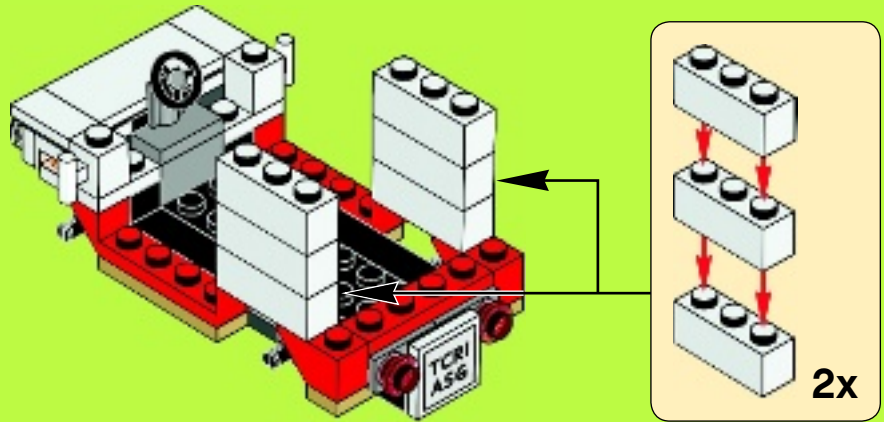

1x



1x

18

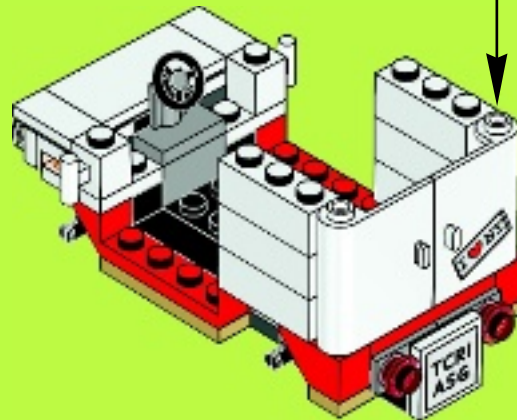
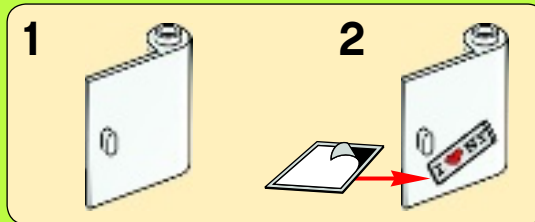



2x

19

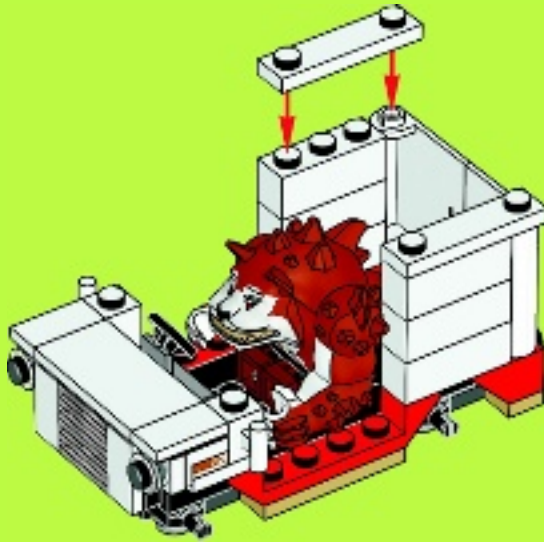

1x



1x

20

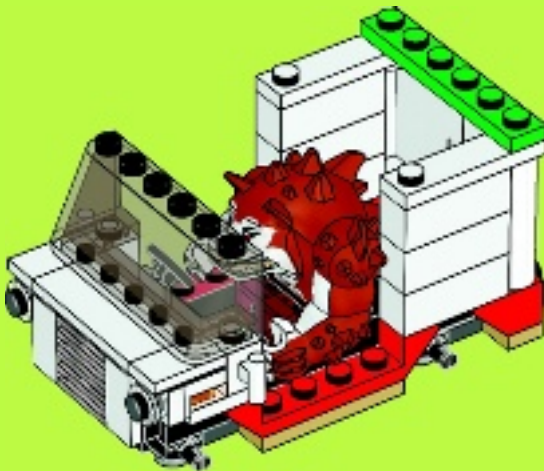

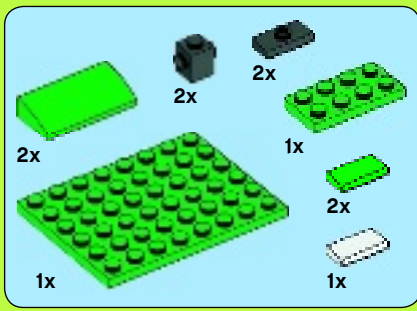

21

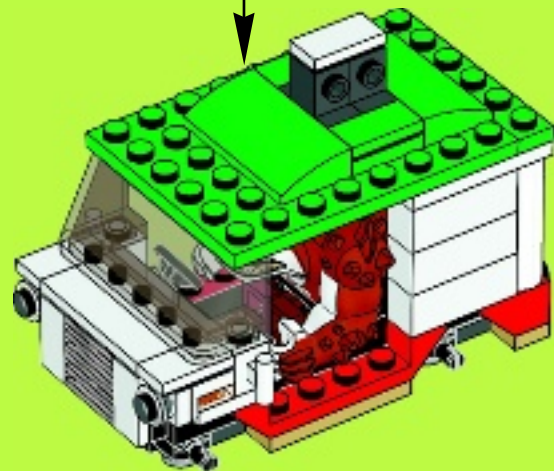
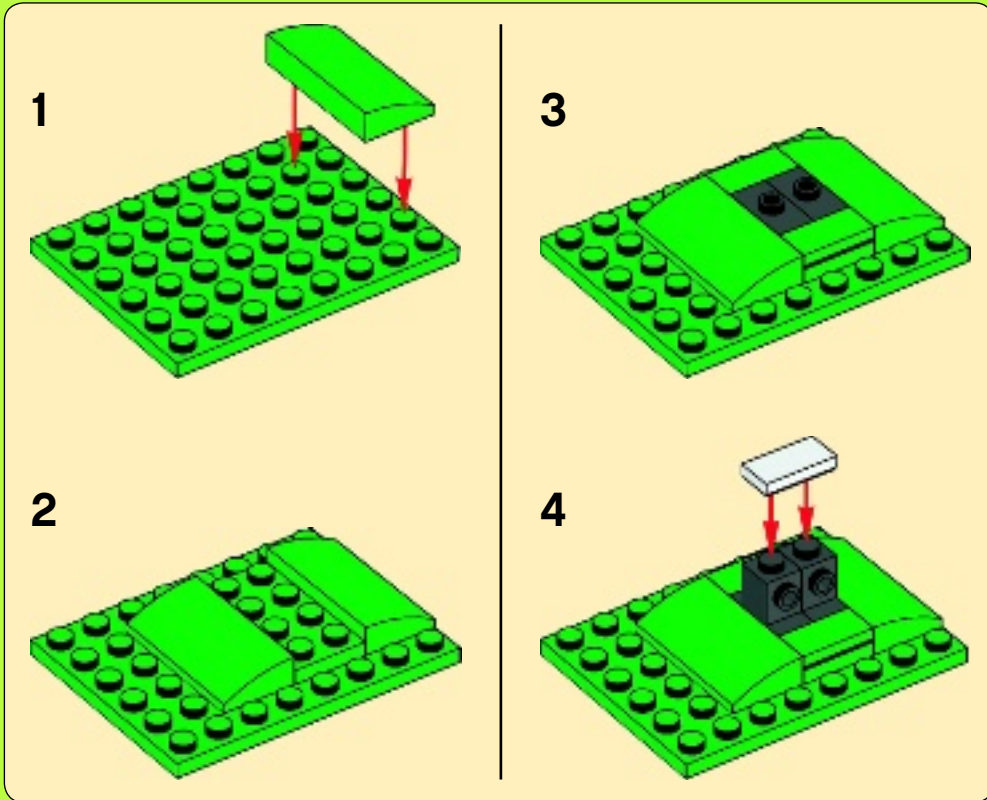

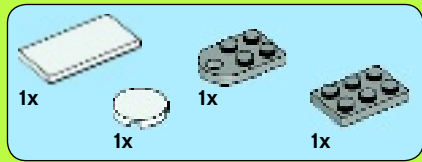

22

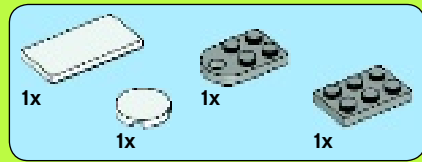
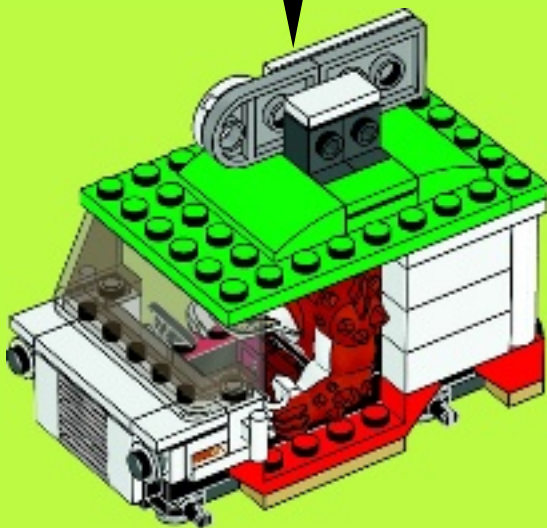
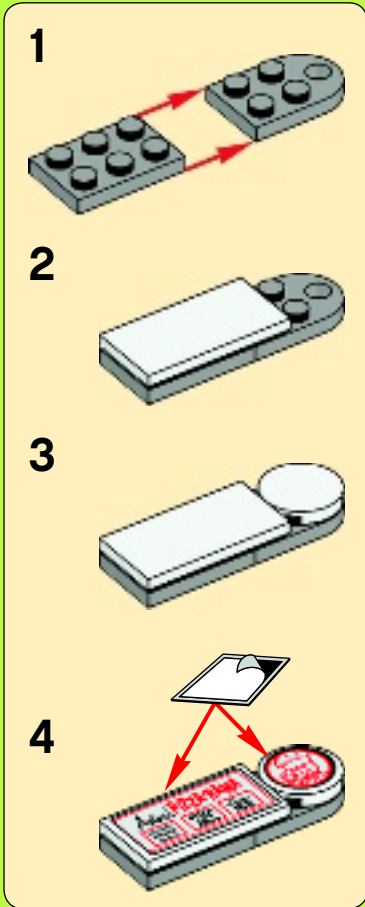

23

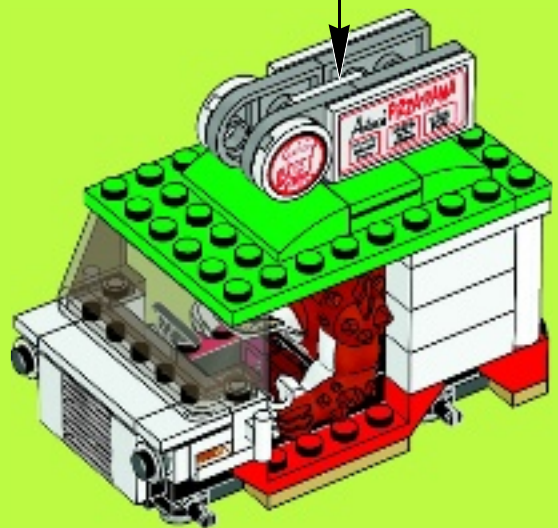
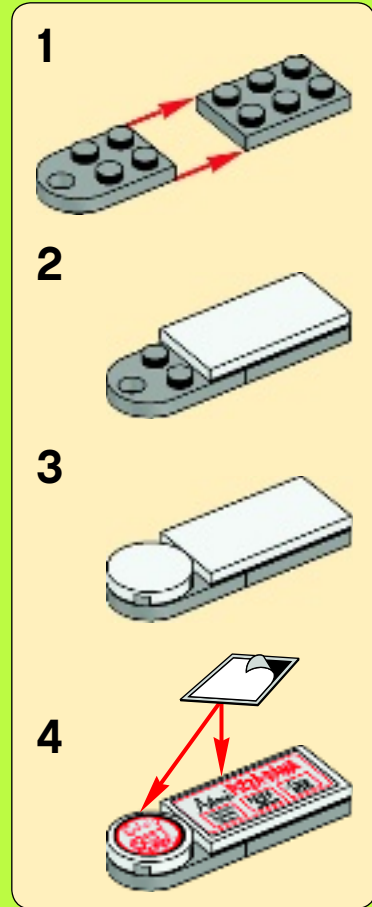



4x



4x

24

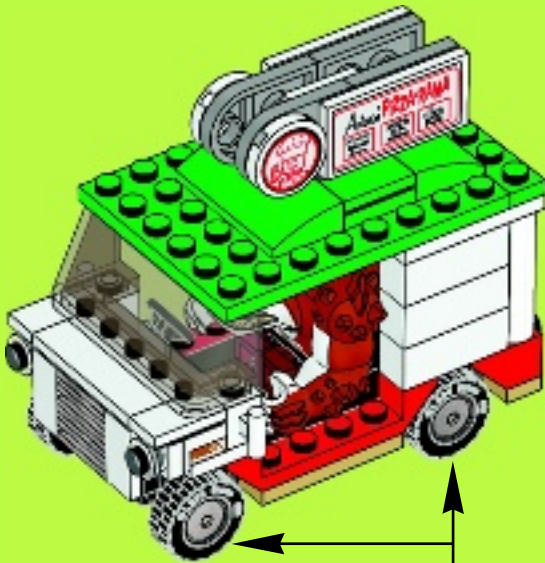

1



2



4x



2x



2x



2x

25

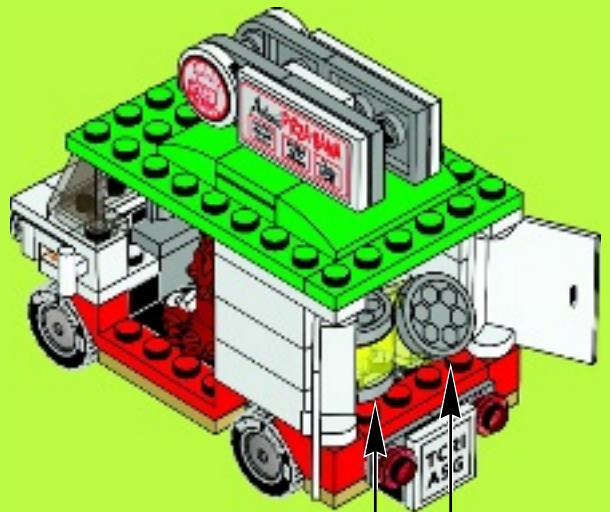

1



2



3



2x

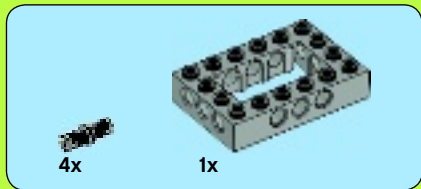
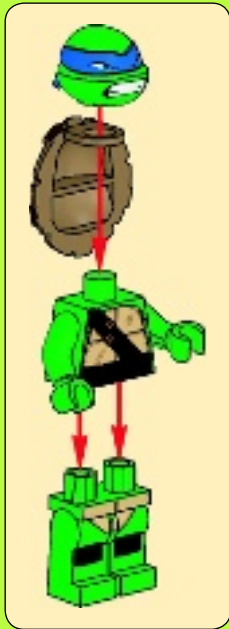

1

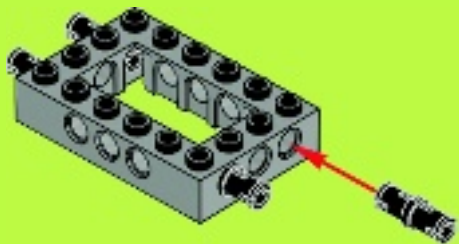

2

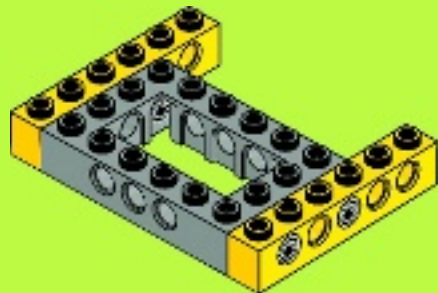



2x

3



1x



2x

4



2x

5

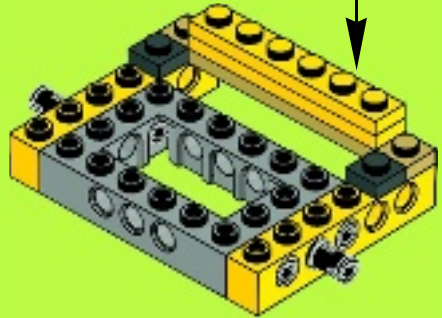
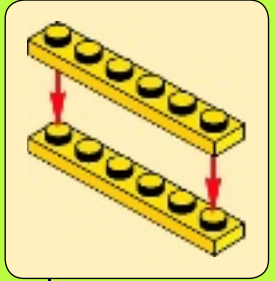

1x



2x

6

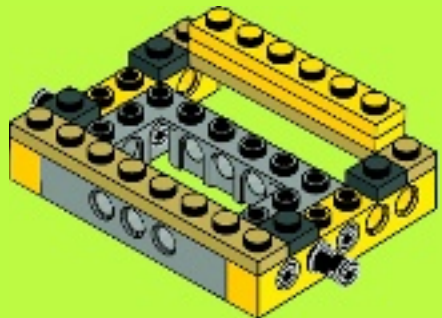

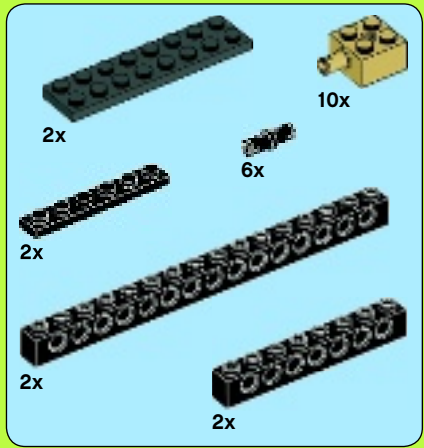
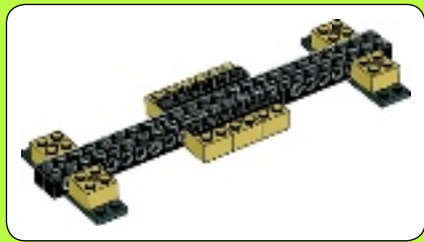

7

1



2



3

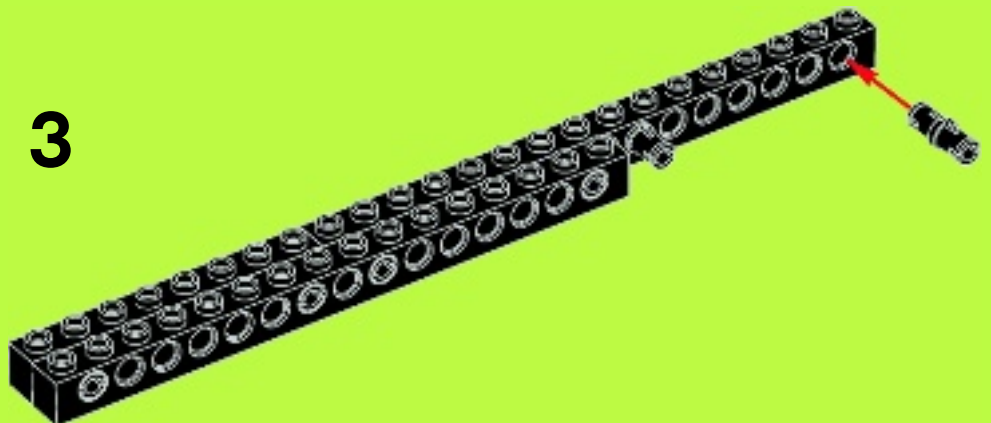

4

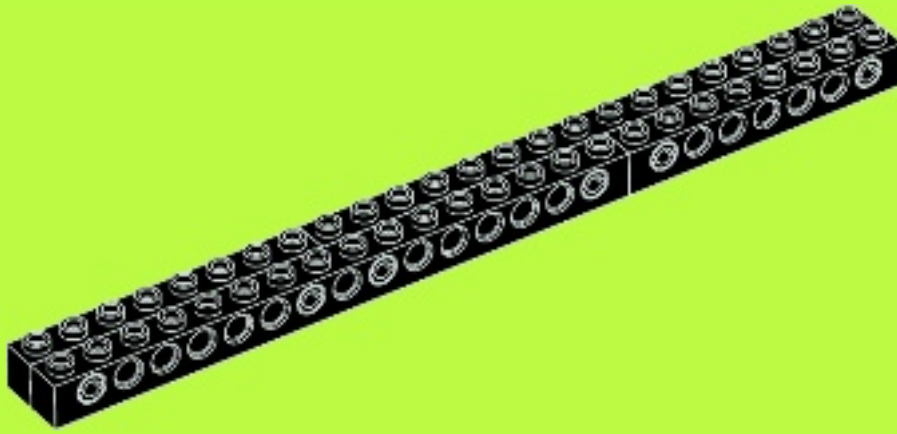

5

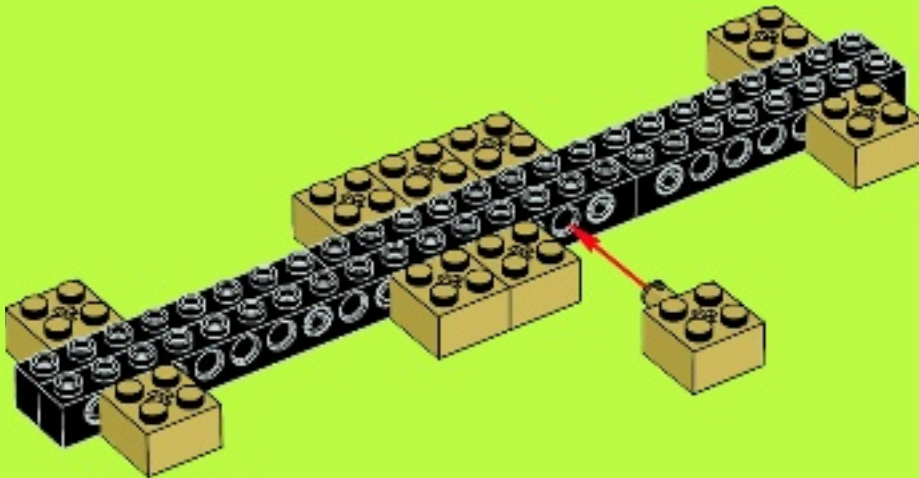

6

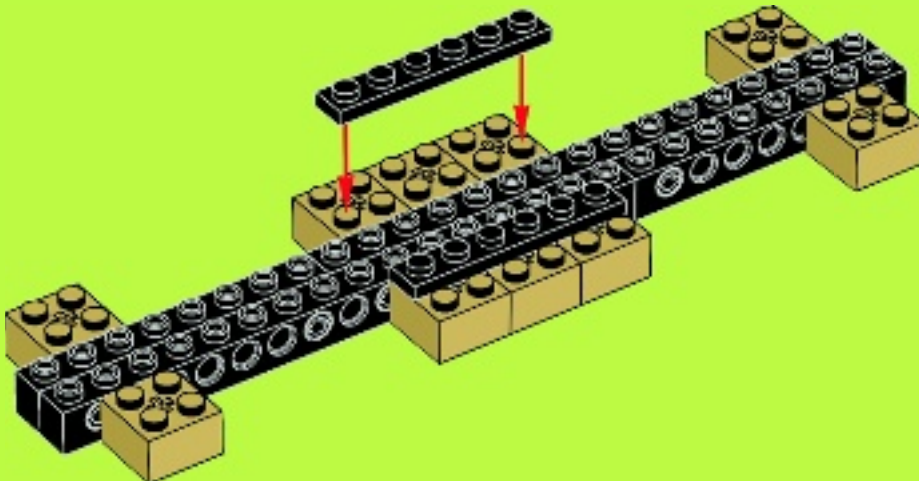

7

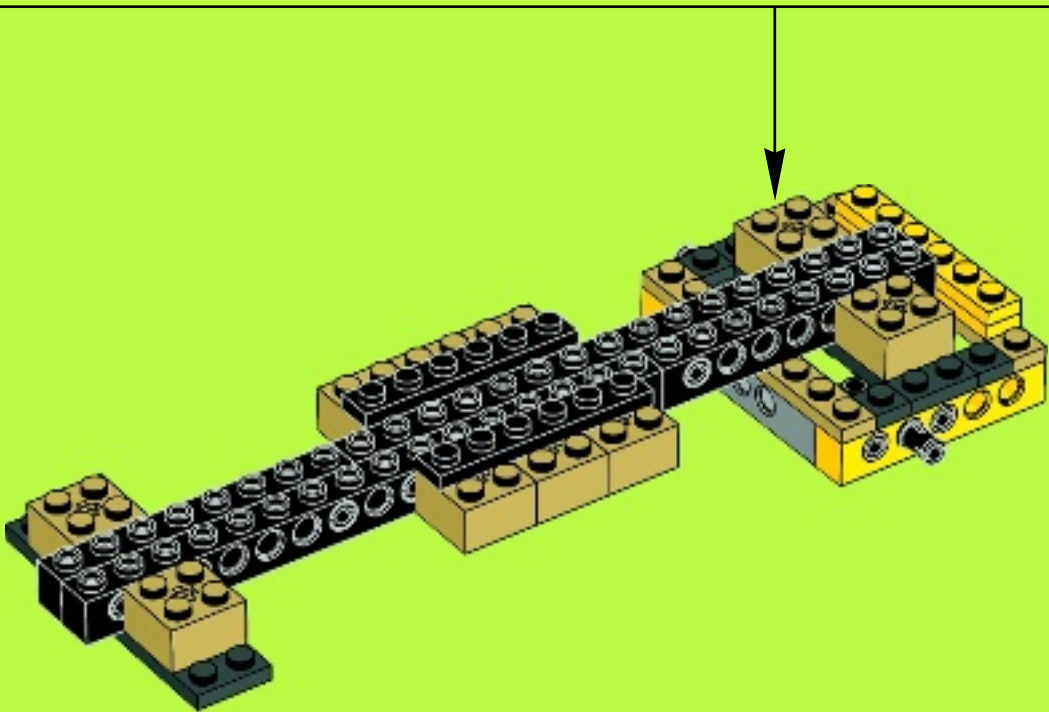
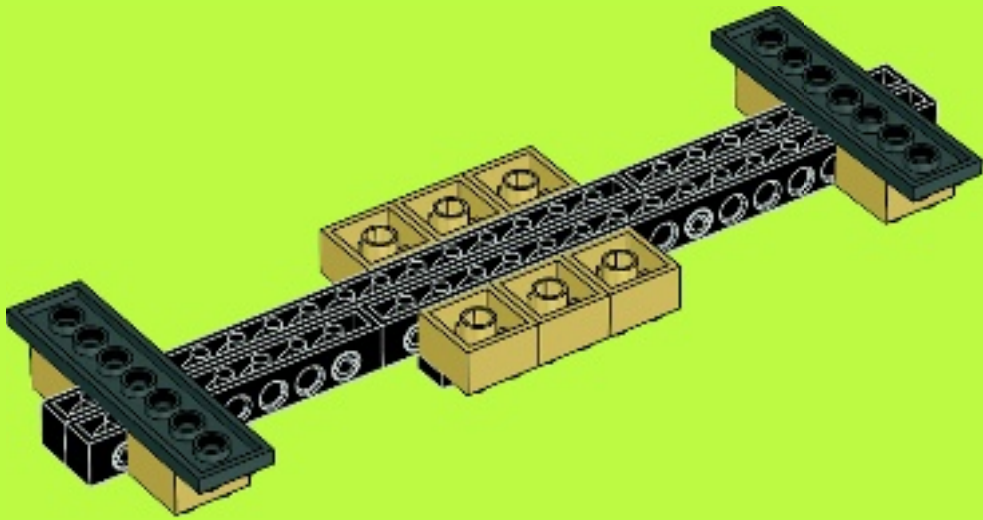

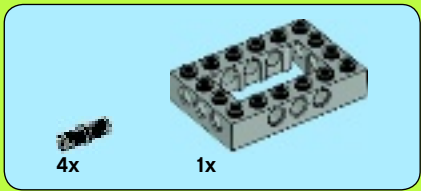

1

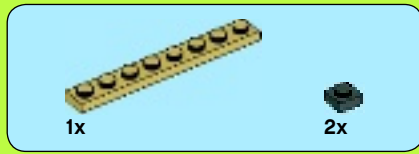
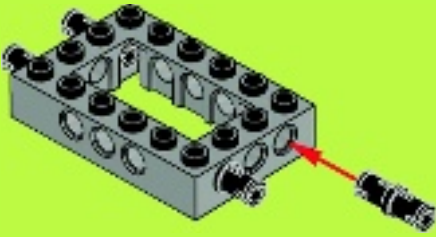

4

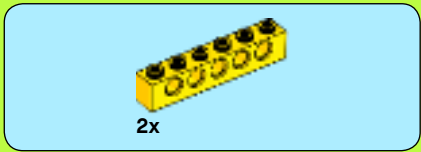
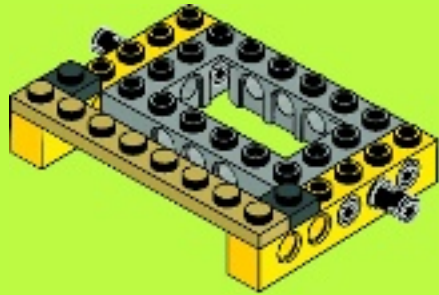

2

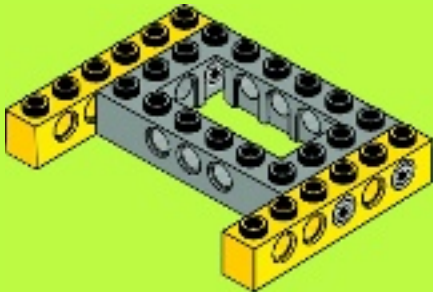

5

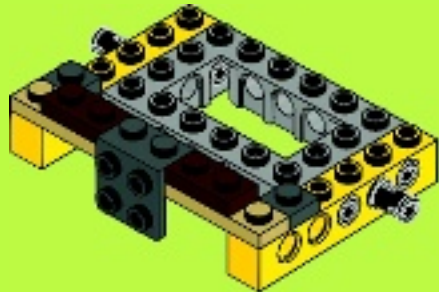

3

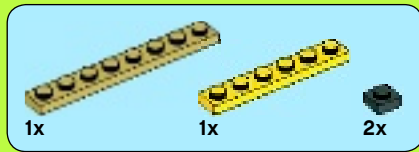
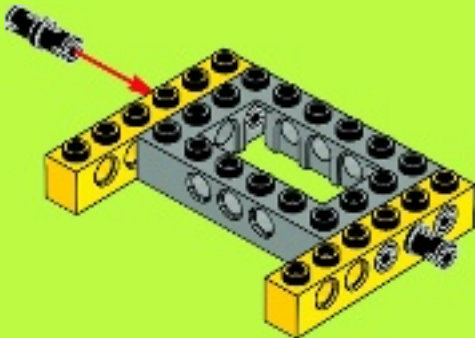

6



8

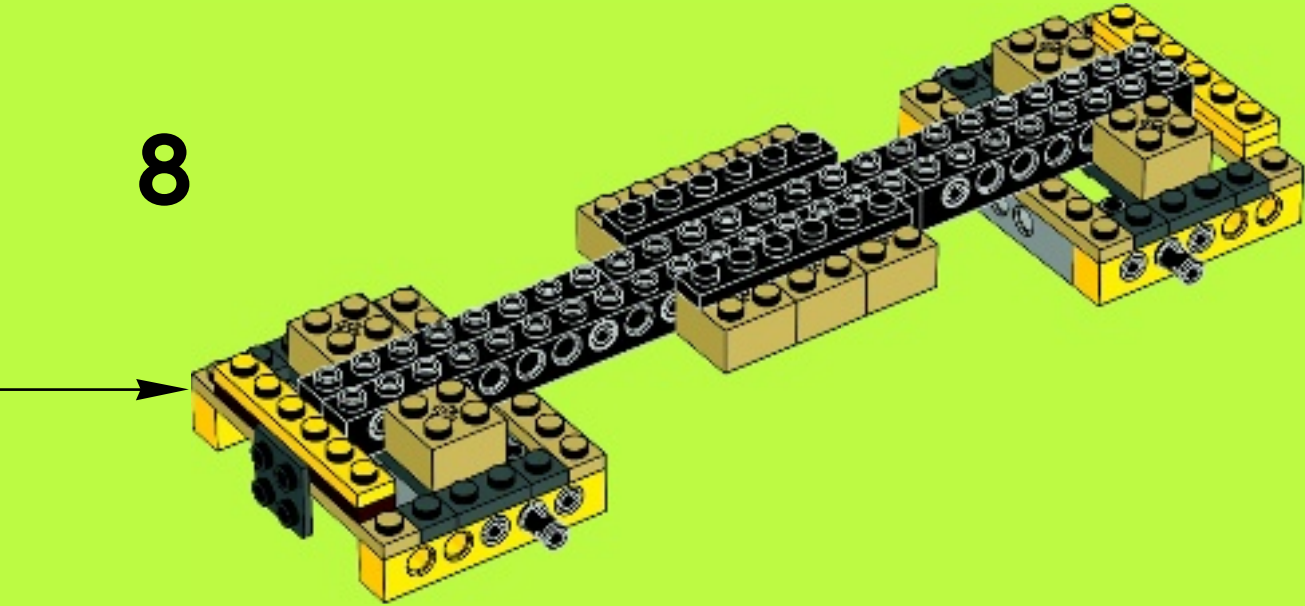

9

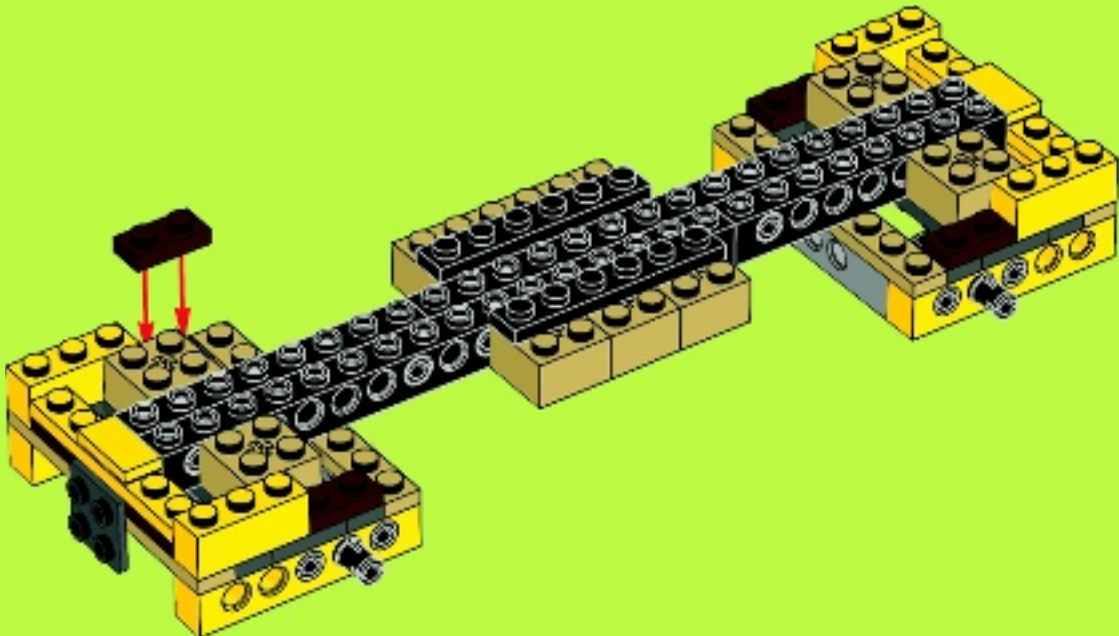



4x



4x

10

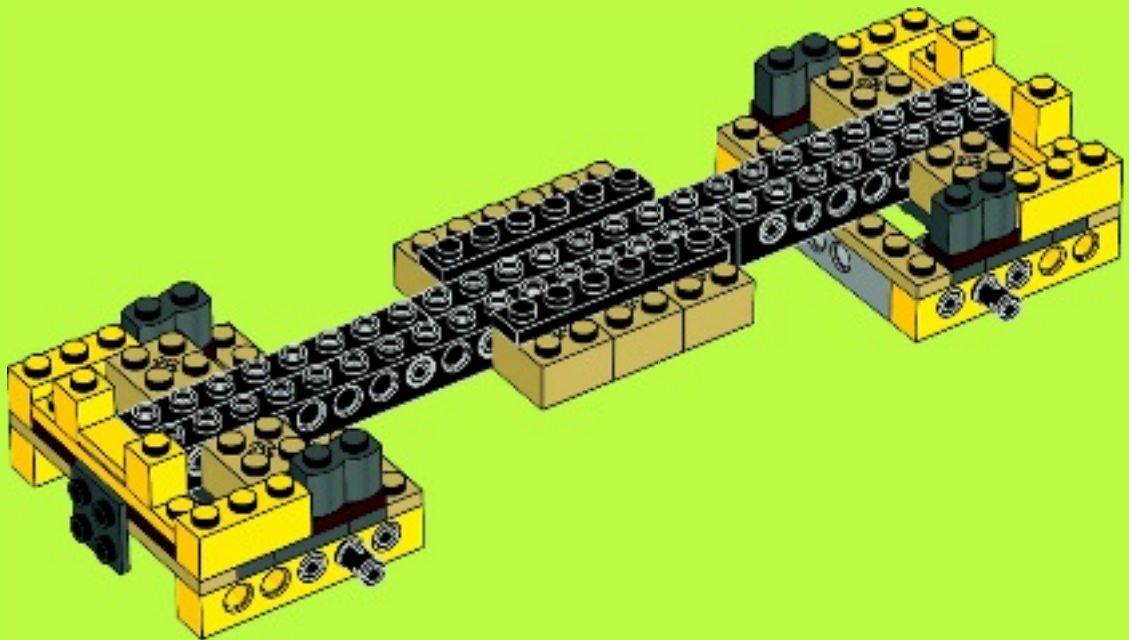

4x



4x

11



2x

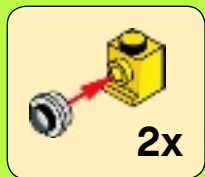

2x

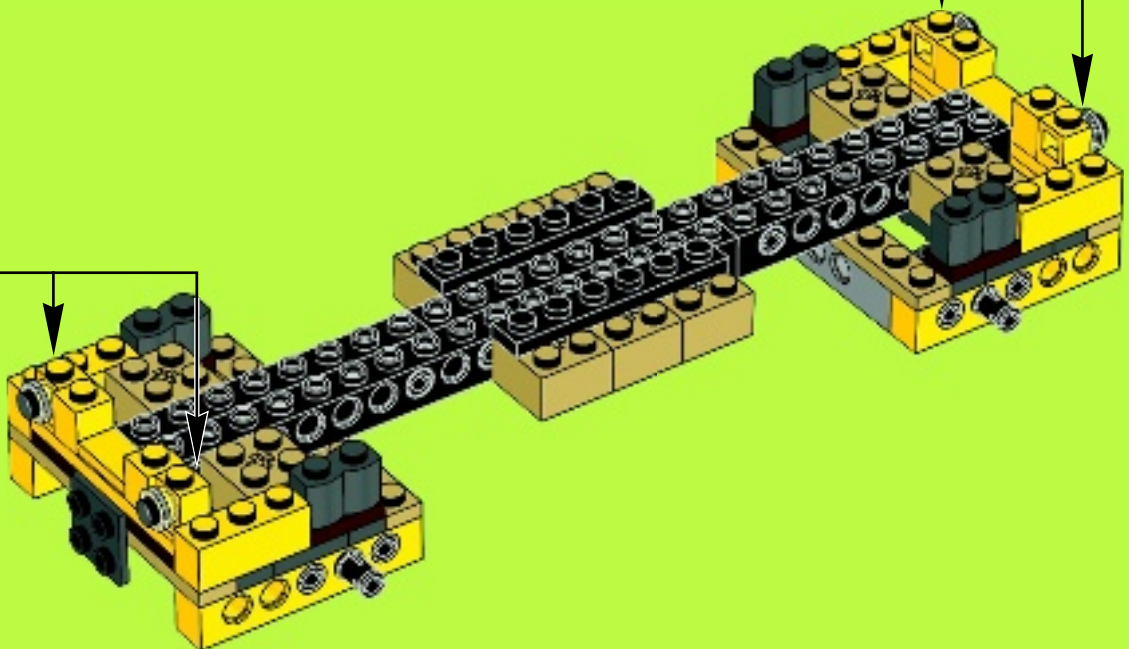



4x

12

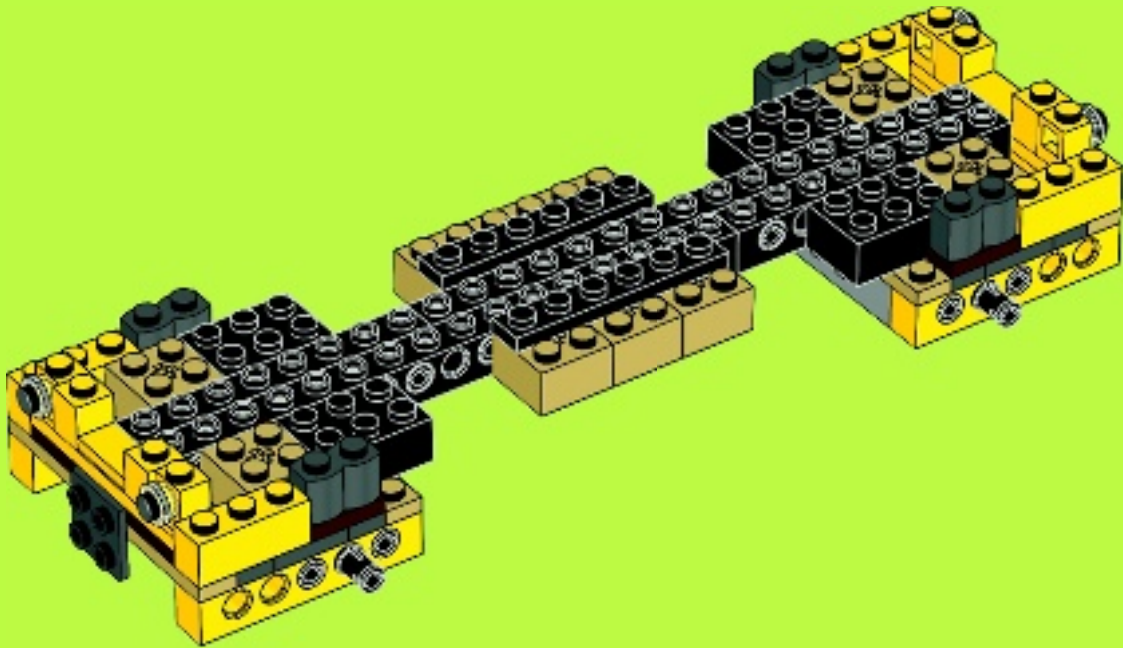

4x



4x

13

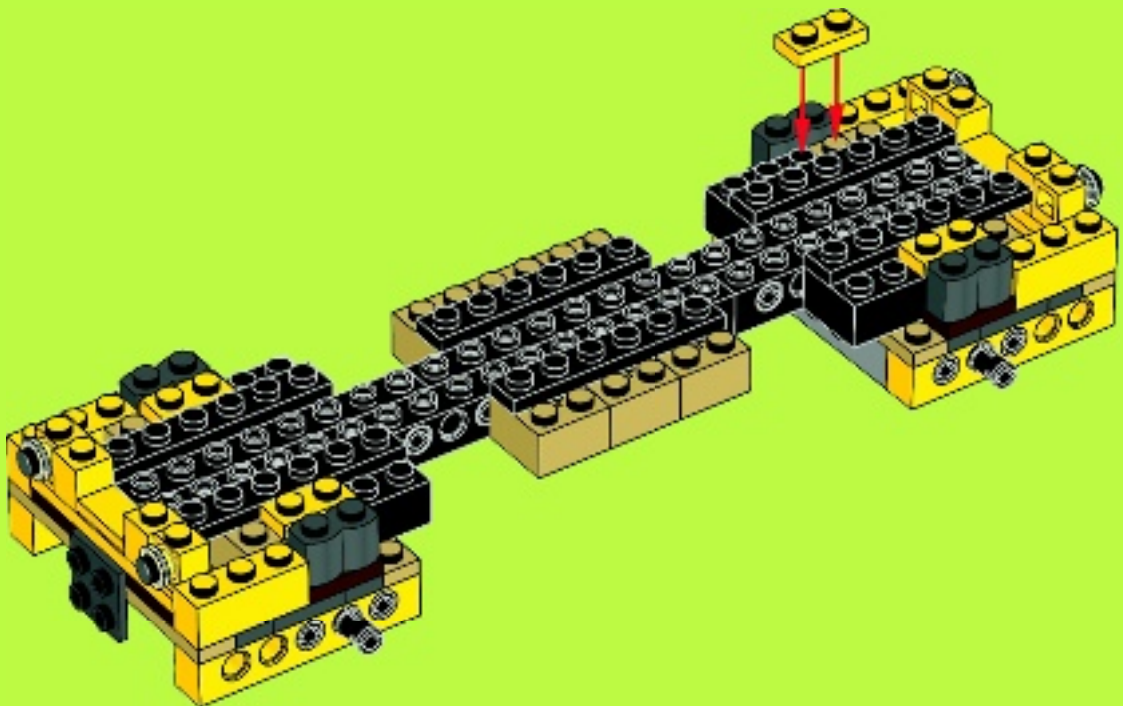



4x

14

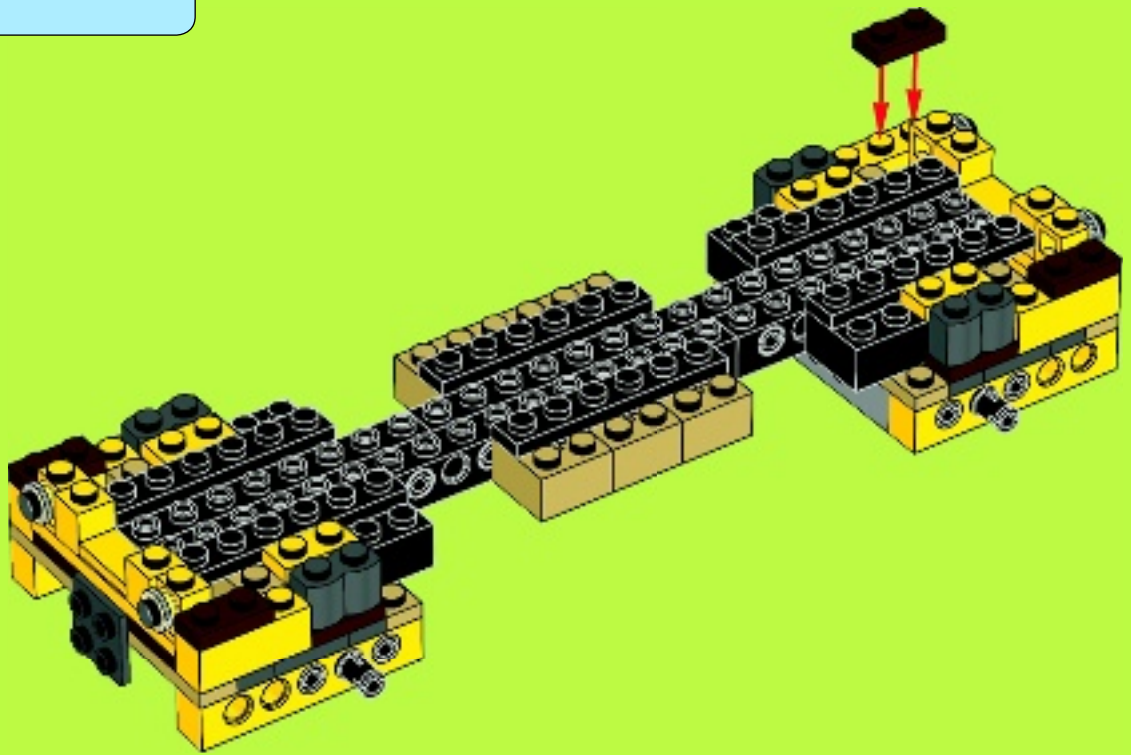

4x



4x

15

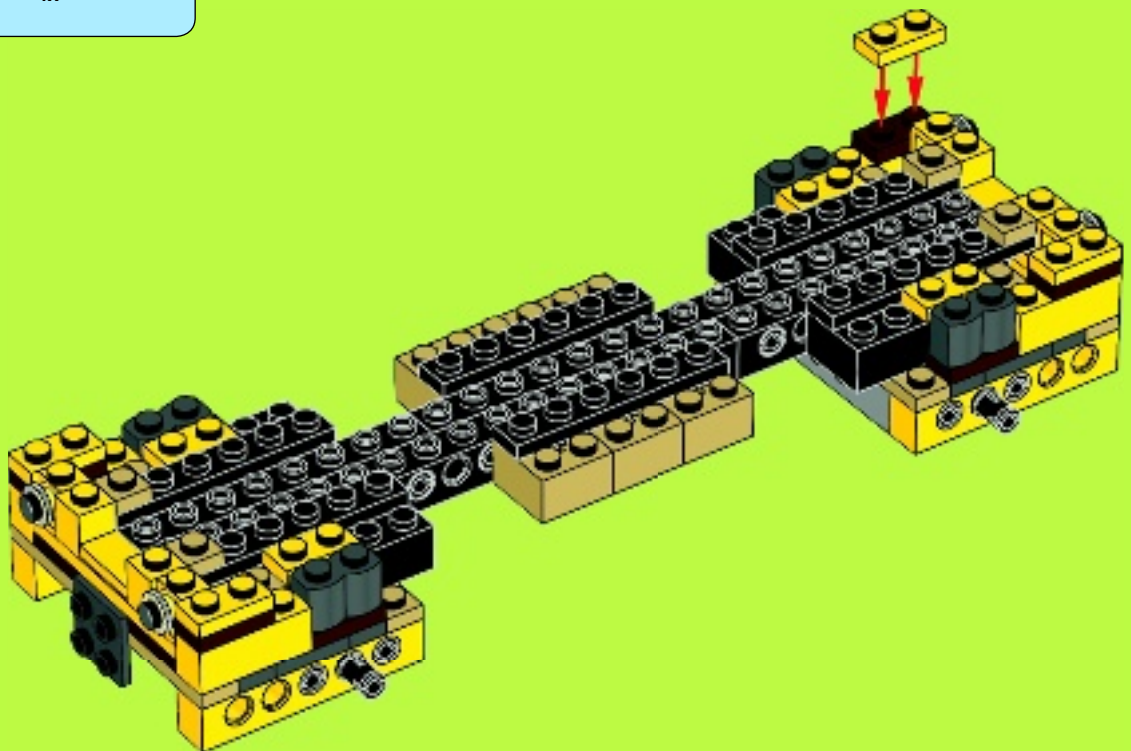

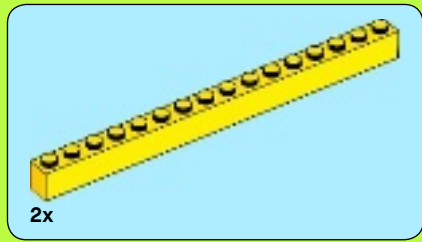

16

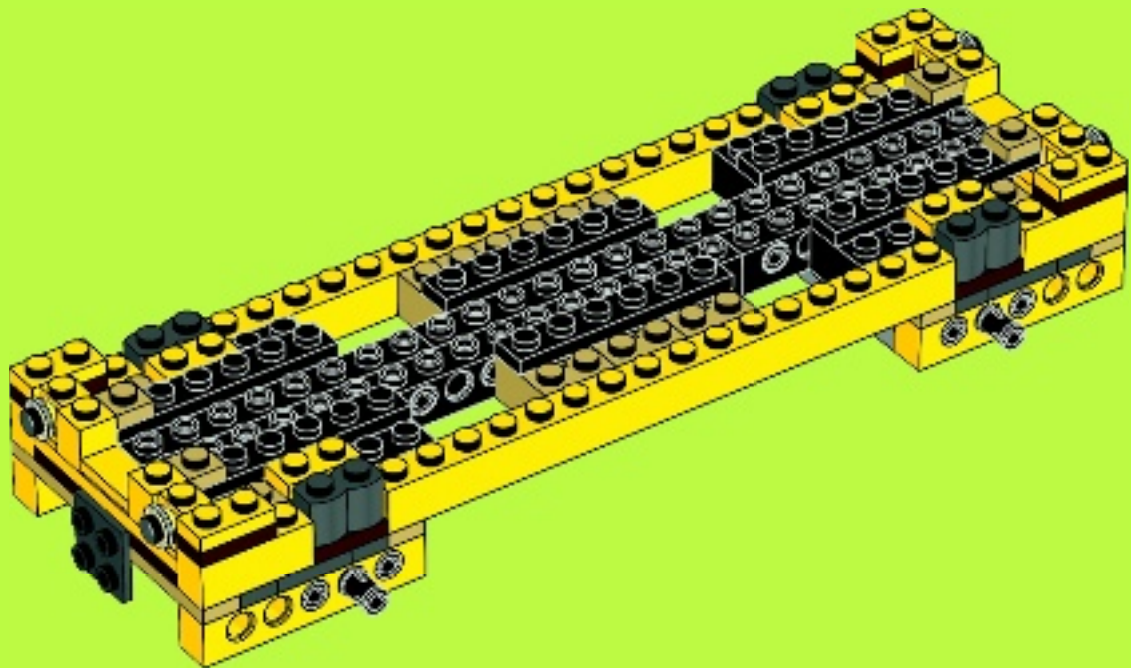



8x



4x

17

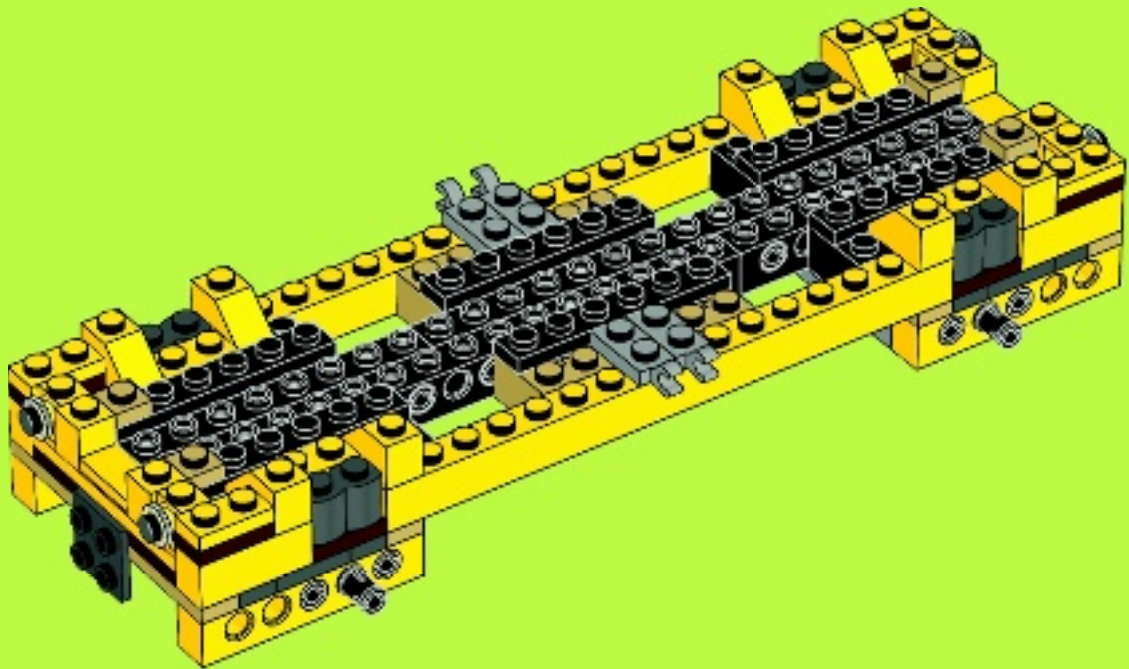

4x

18

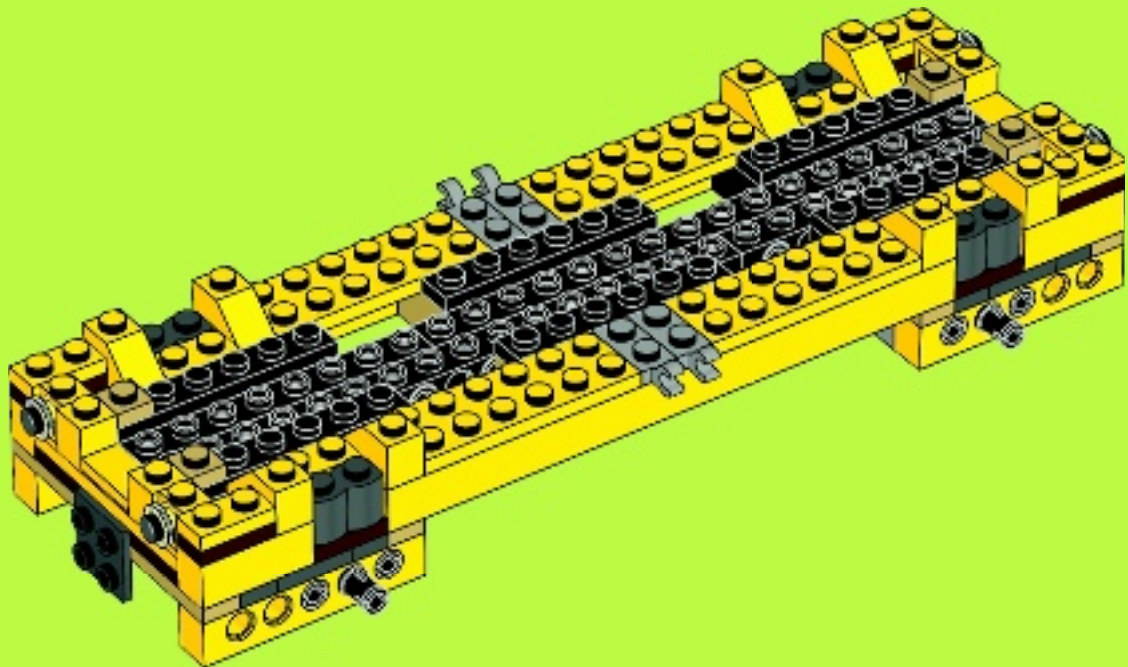

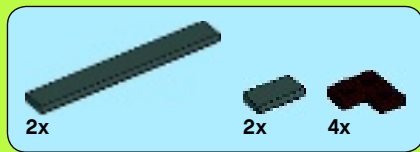

19

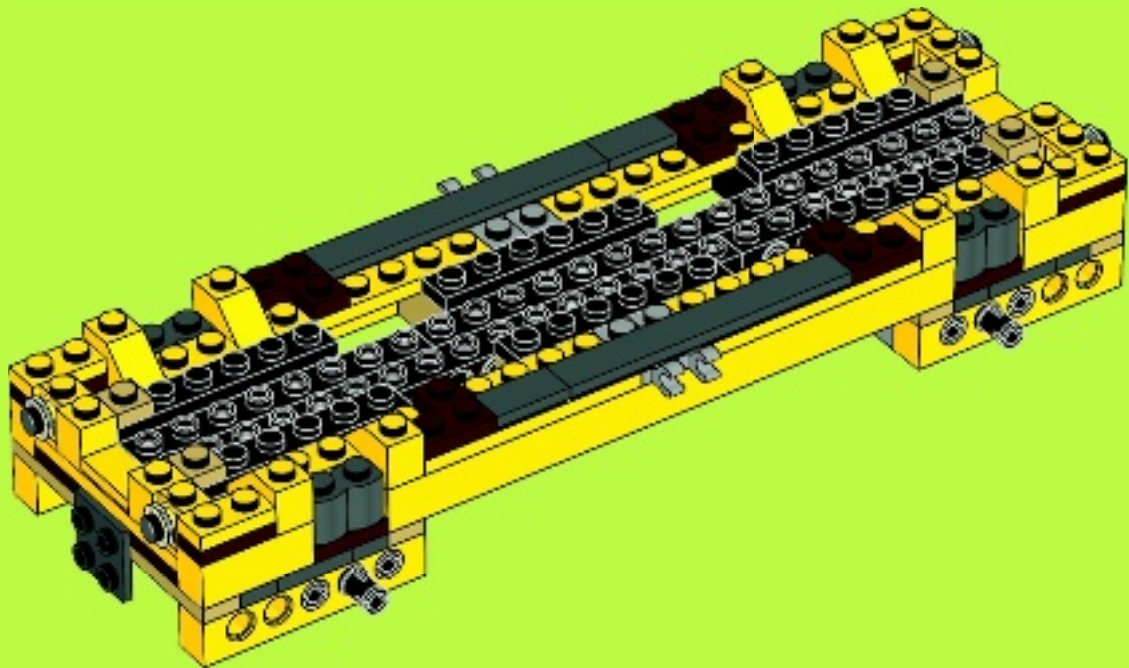



8x

20

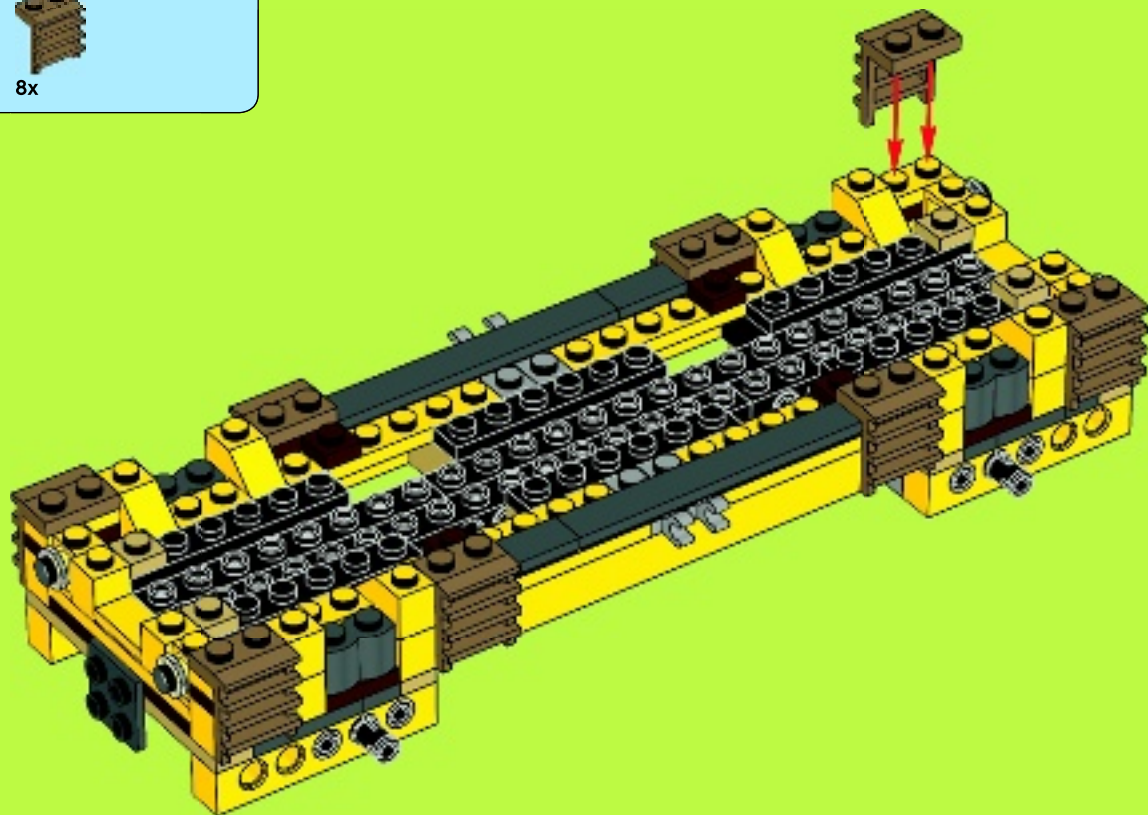

4x

21

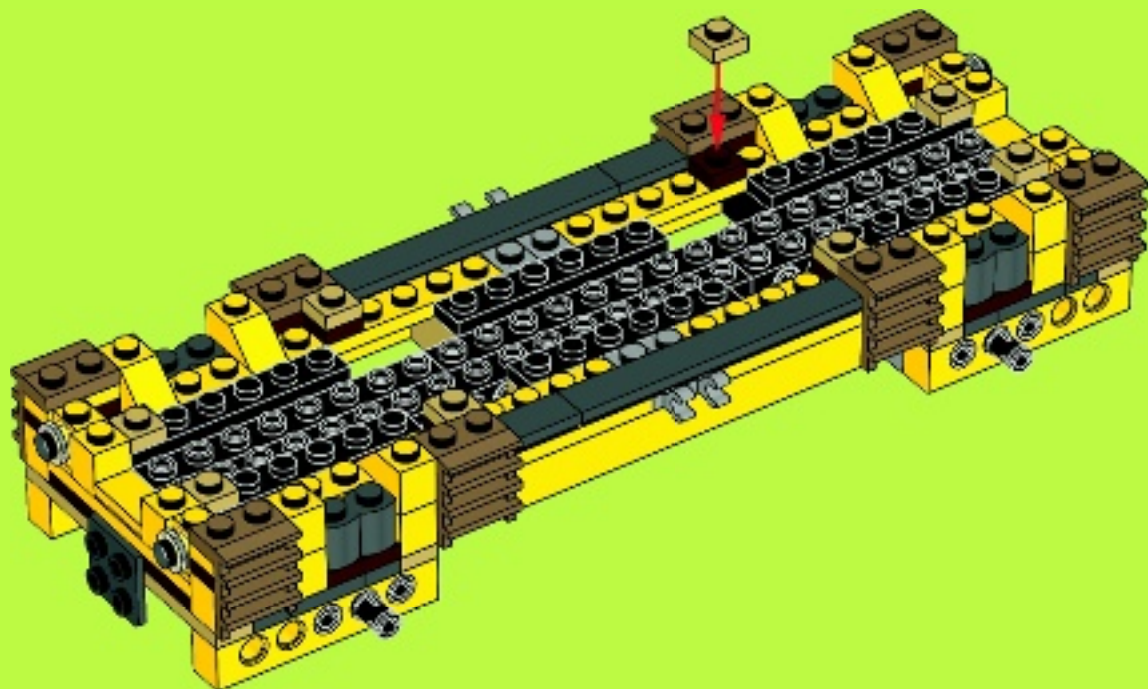

4x 4x

2x

22

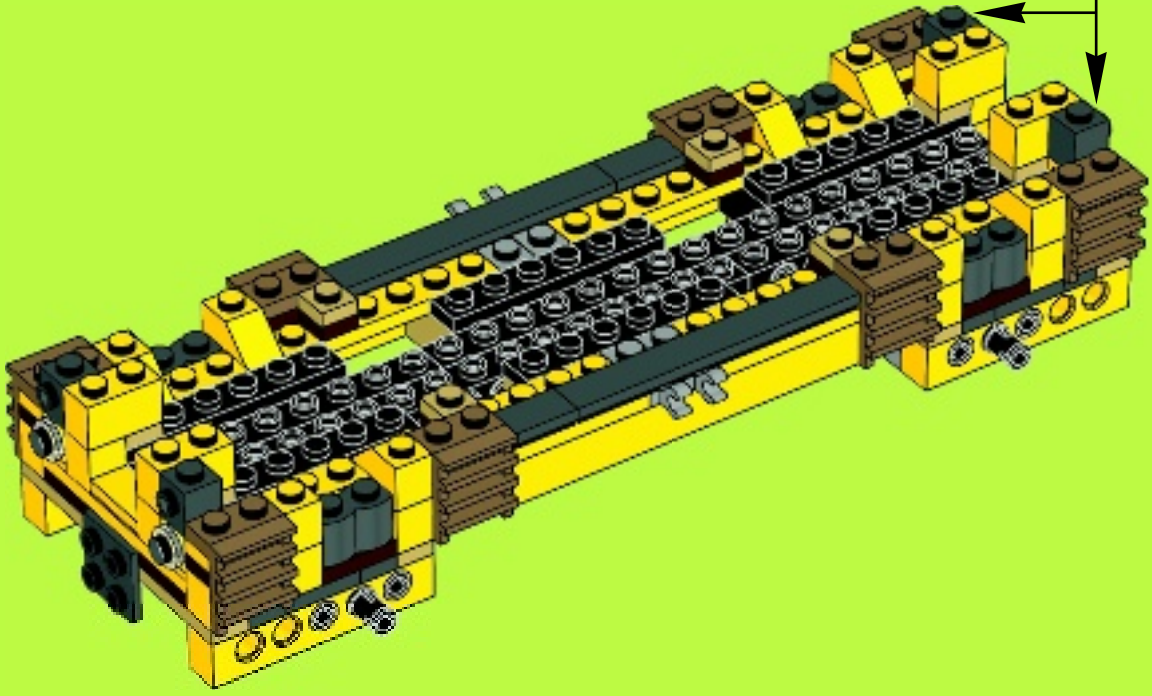

8x

2x

23

2x

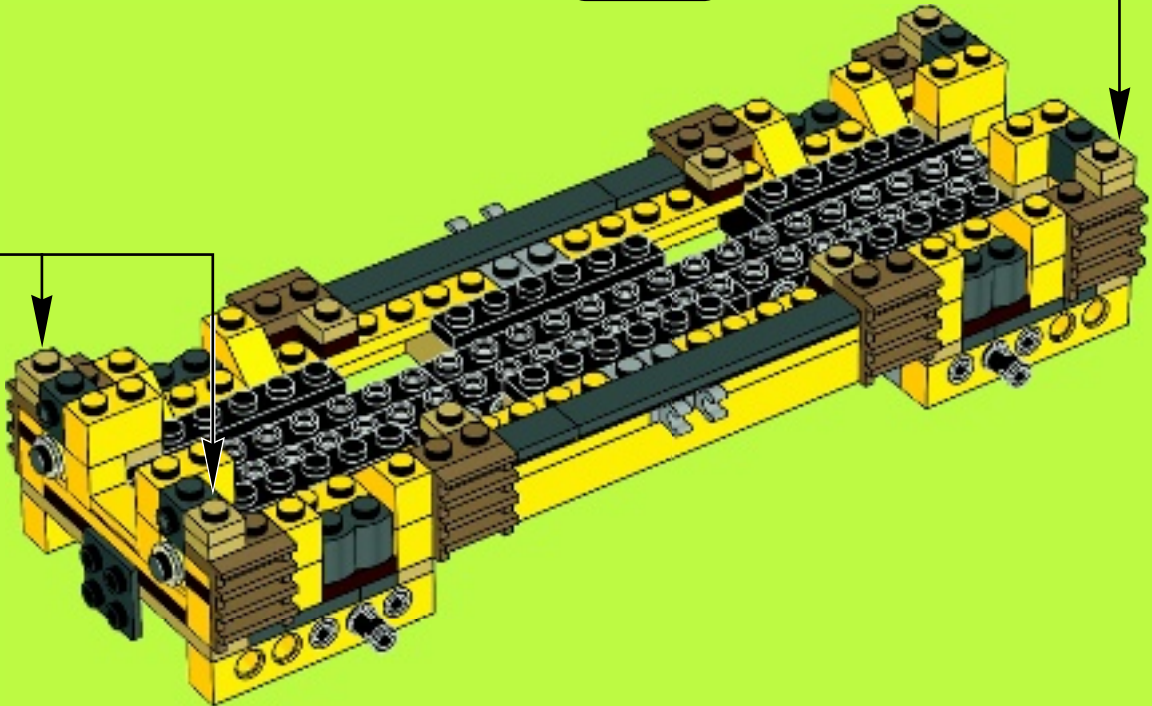

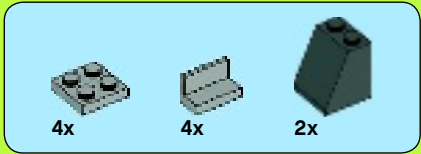

24

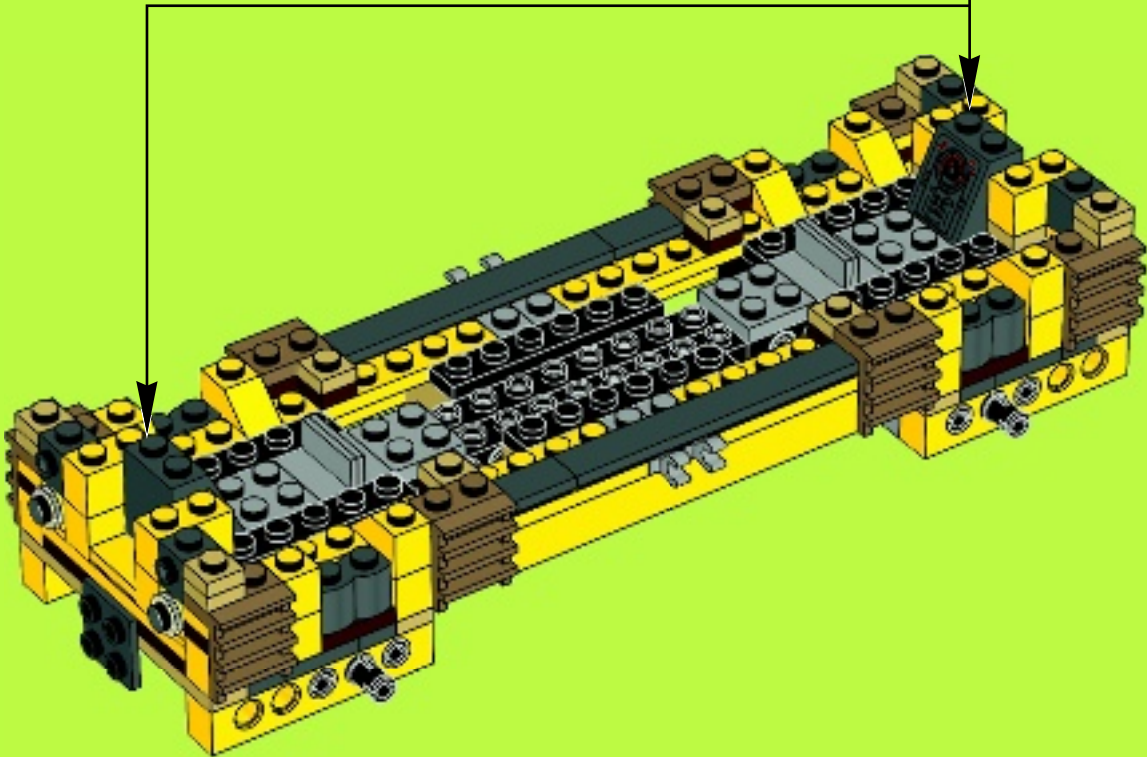
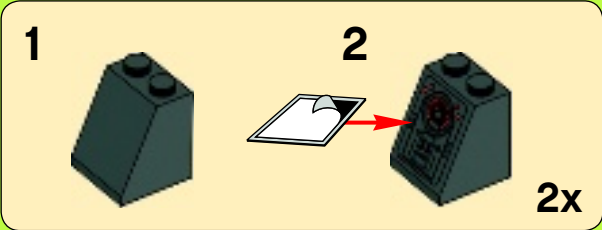

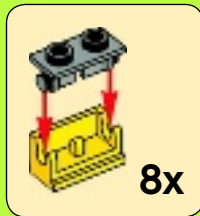

25

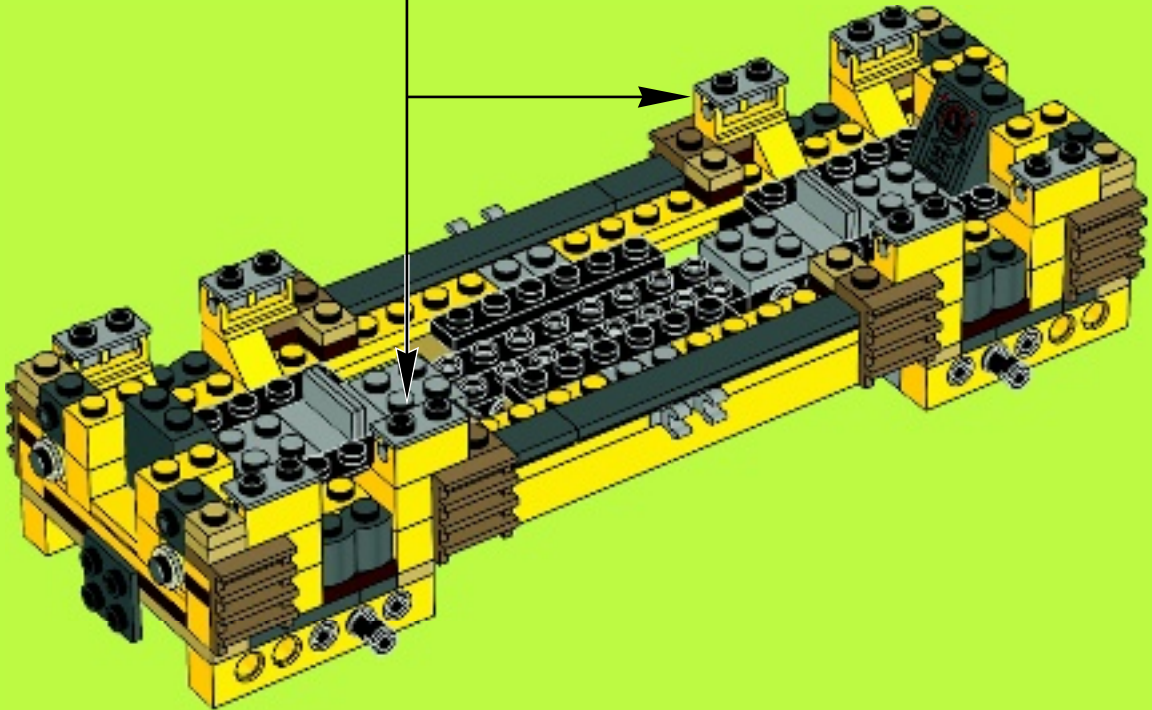

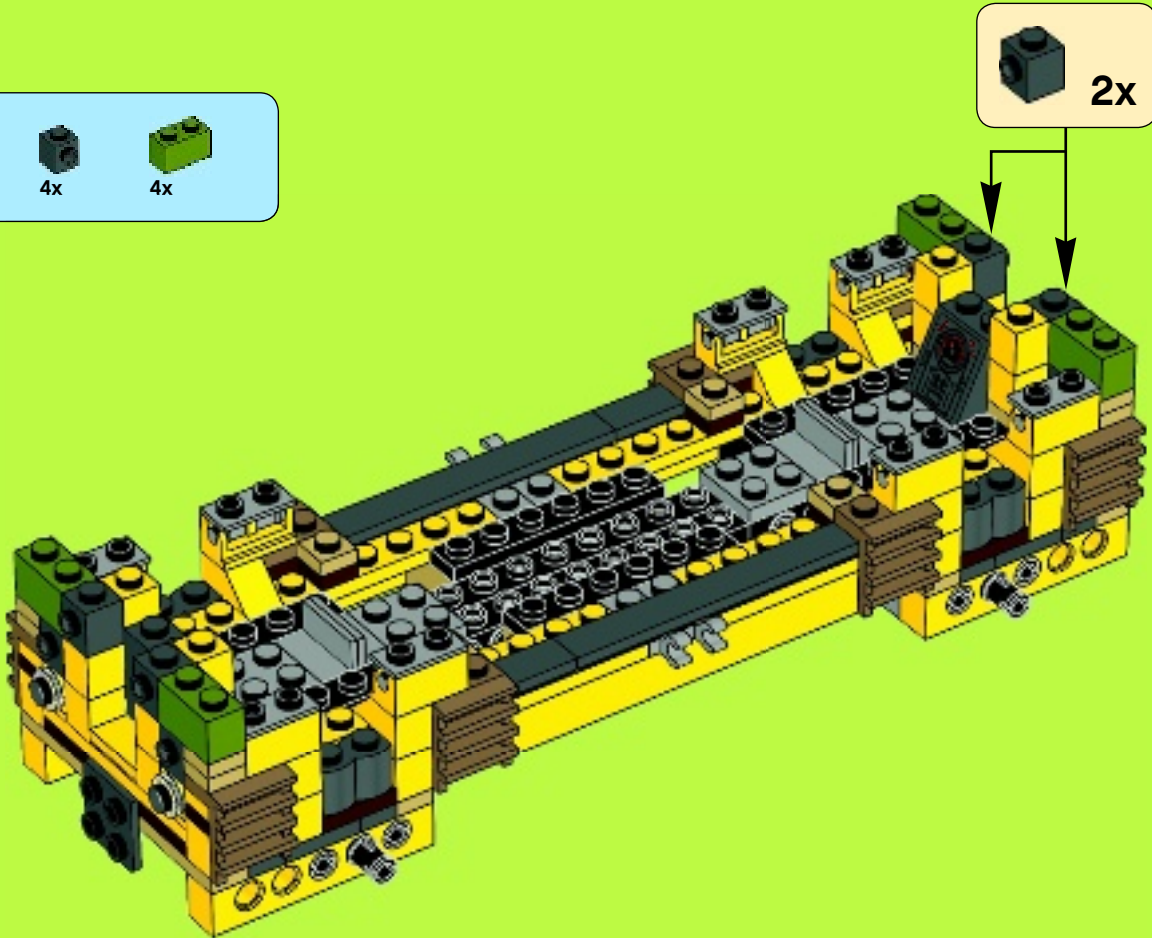

26

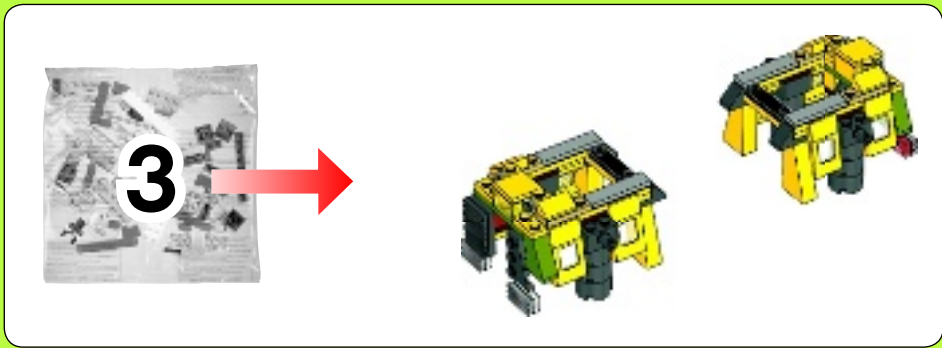

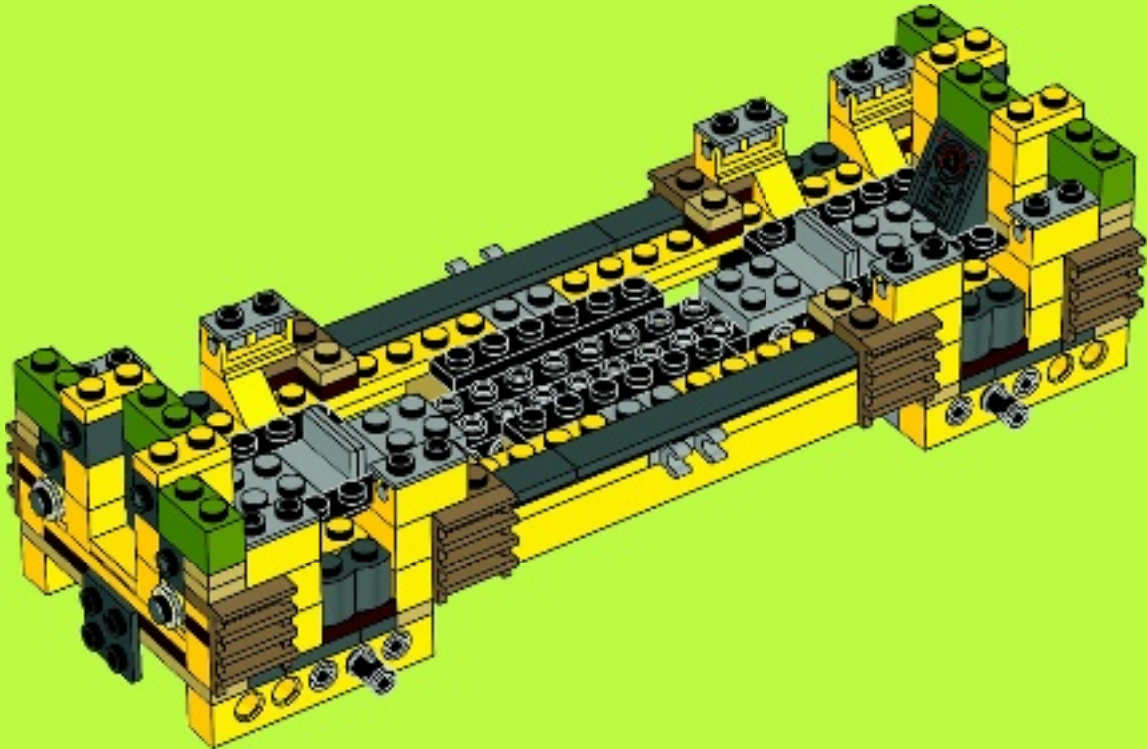

27



2x  4x 

28

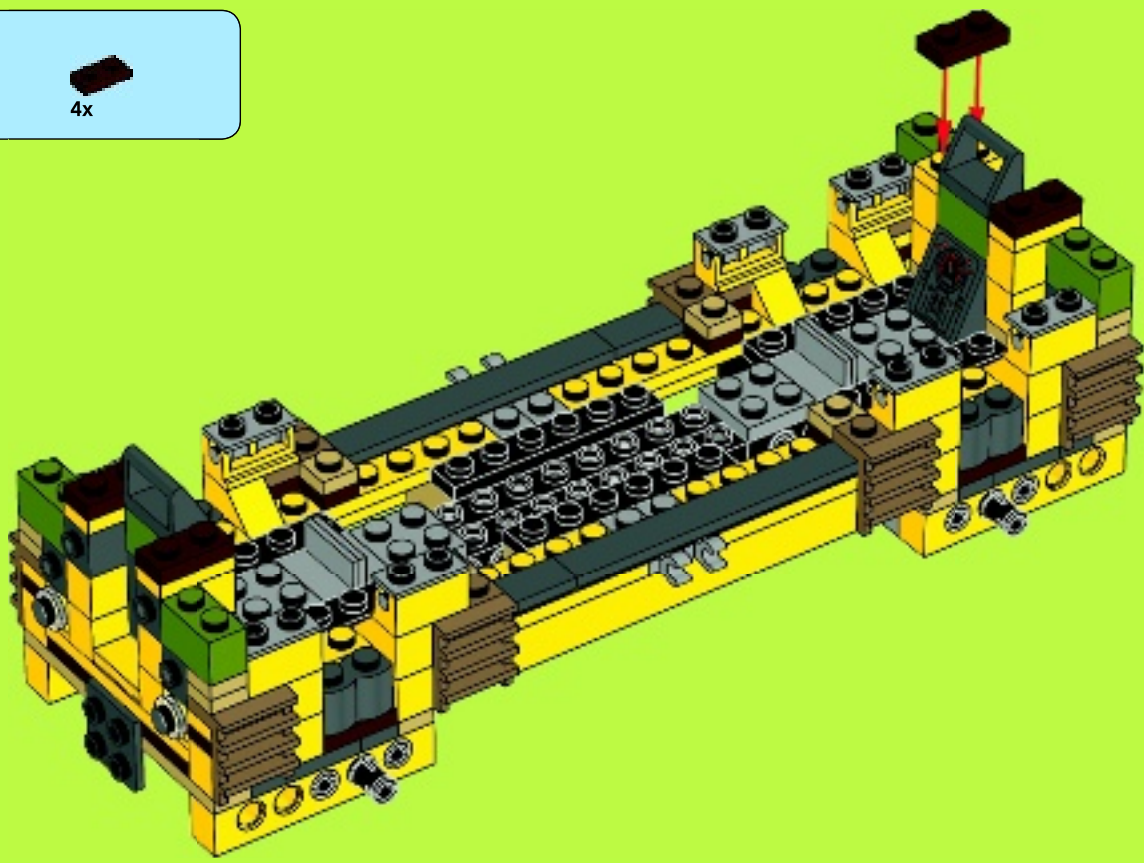

4x  4x 

29

 2x

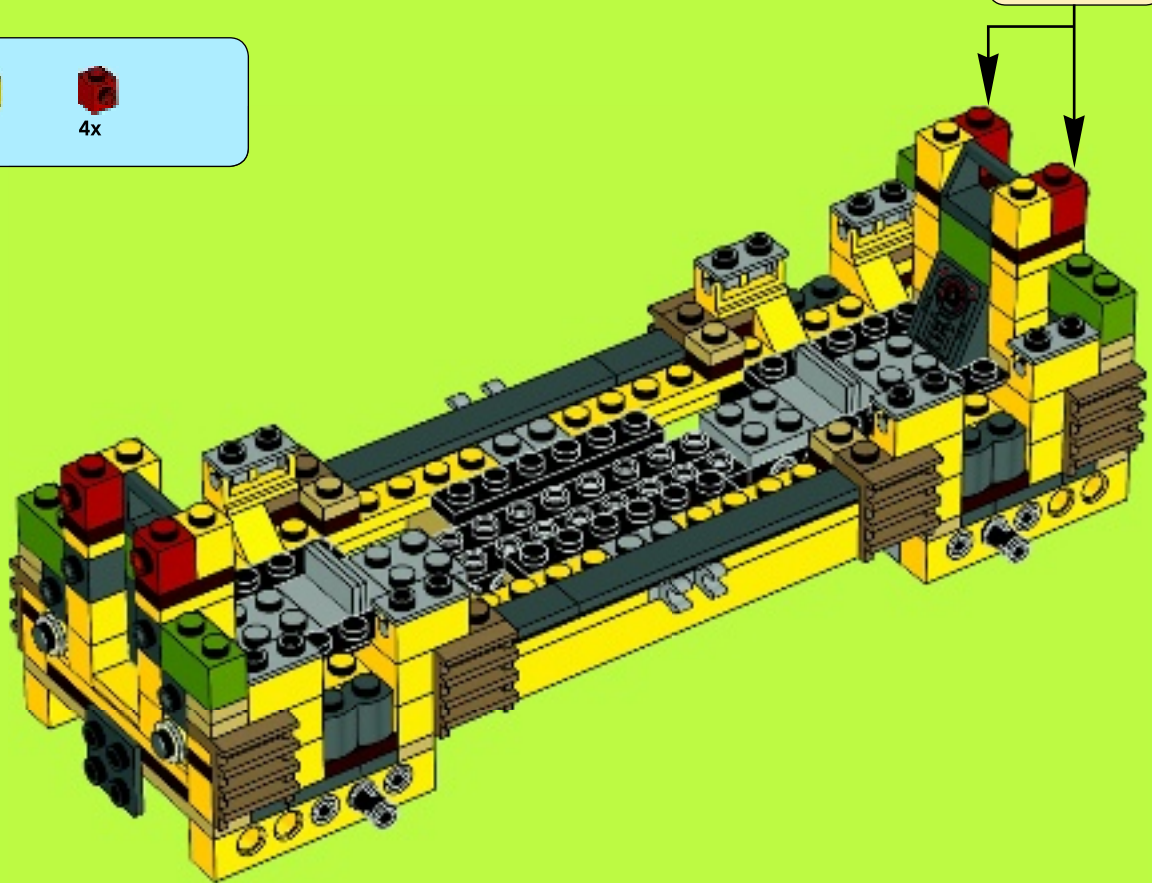



30

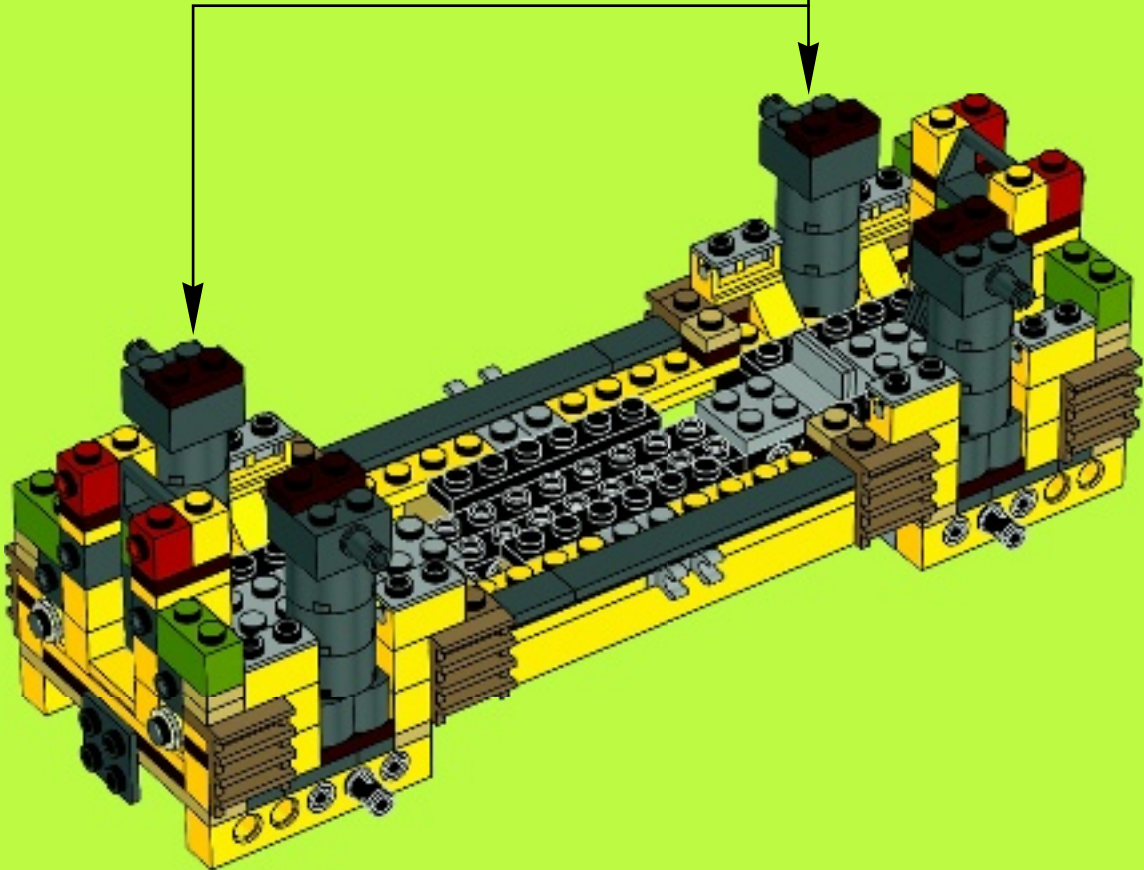
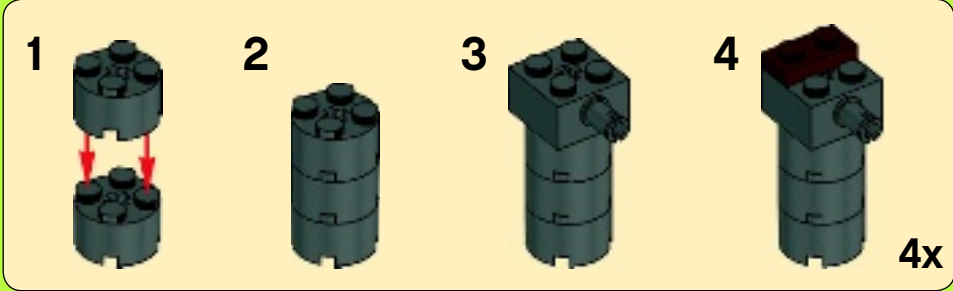



31

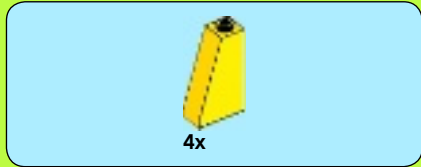
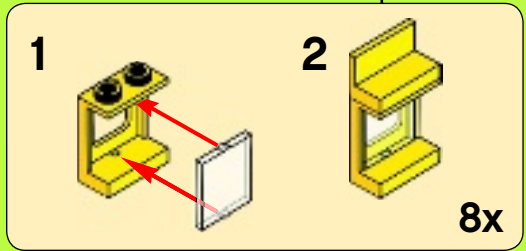
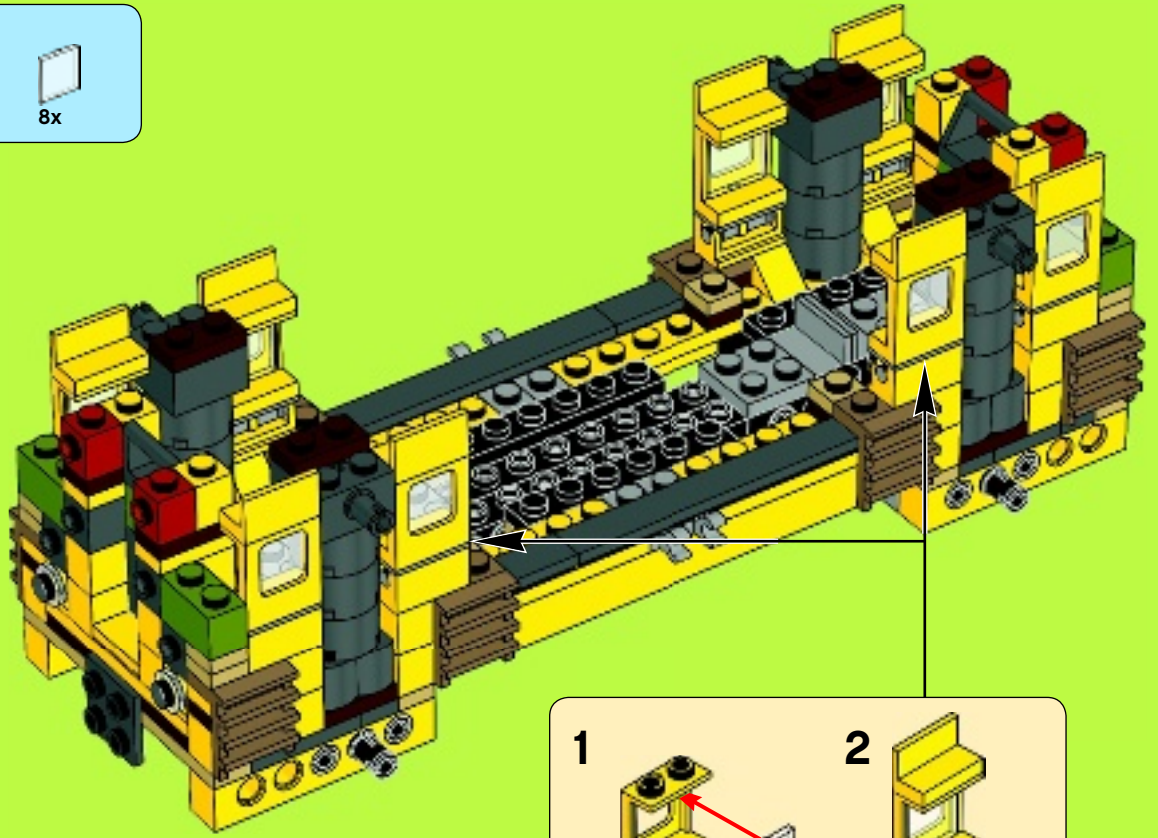

32

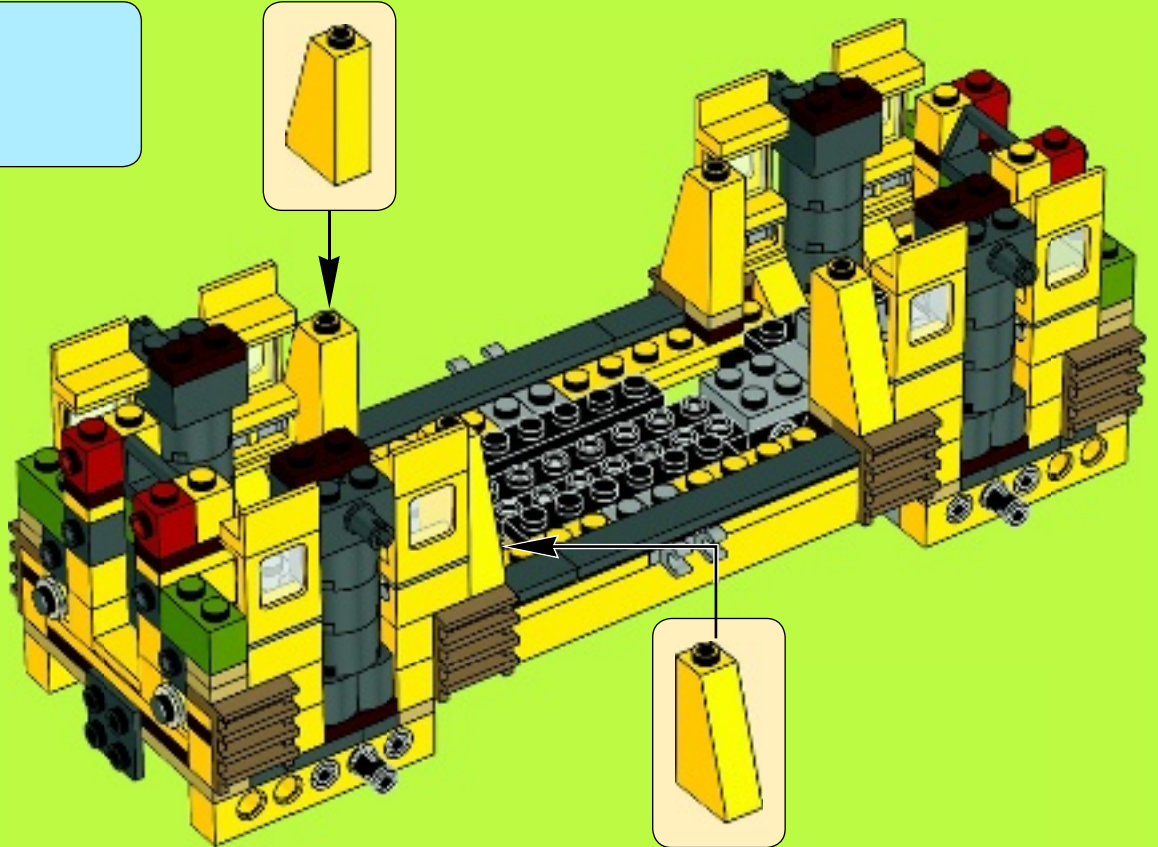



4x



4x

33

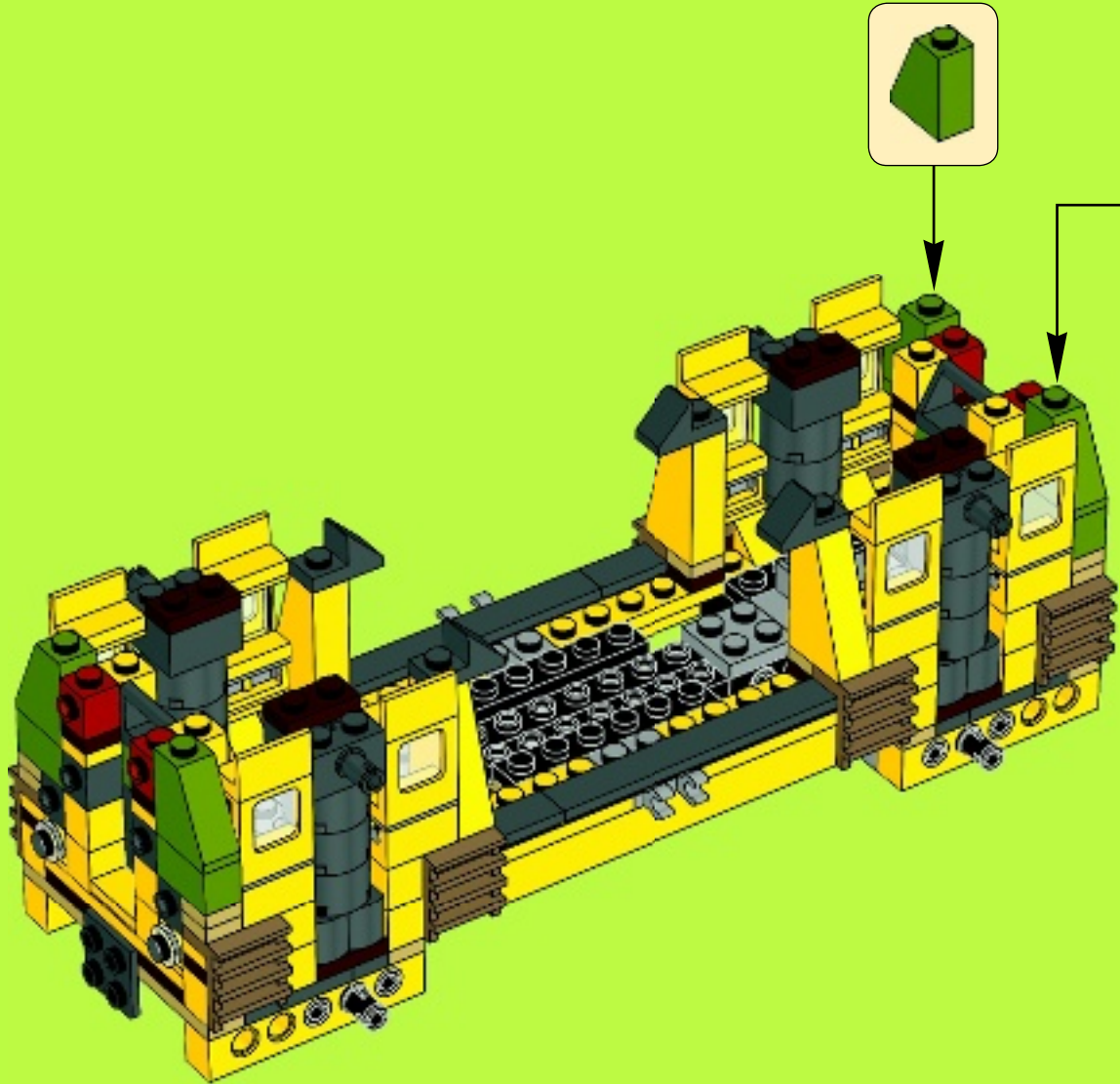



34

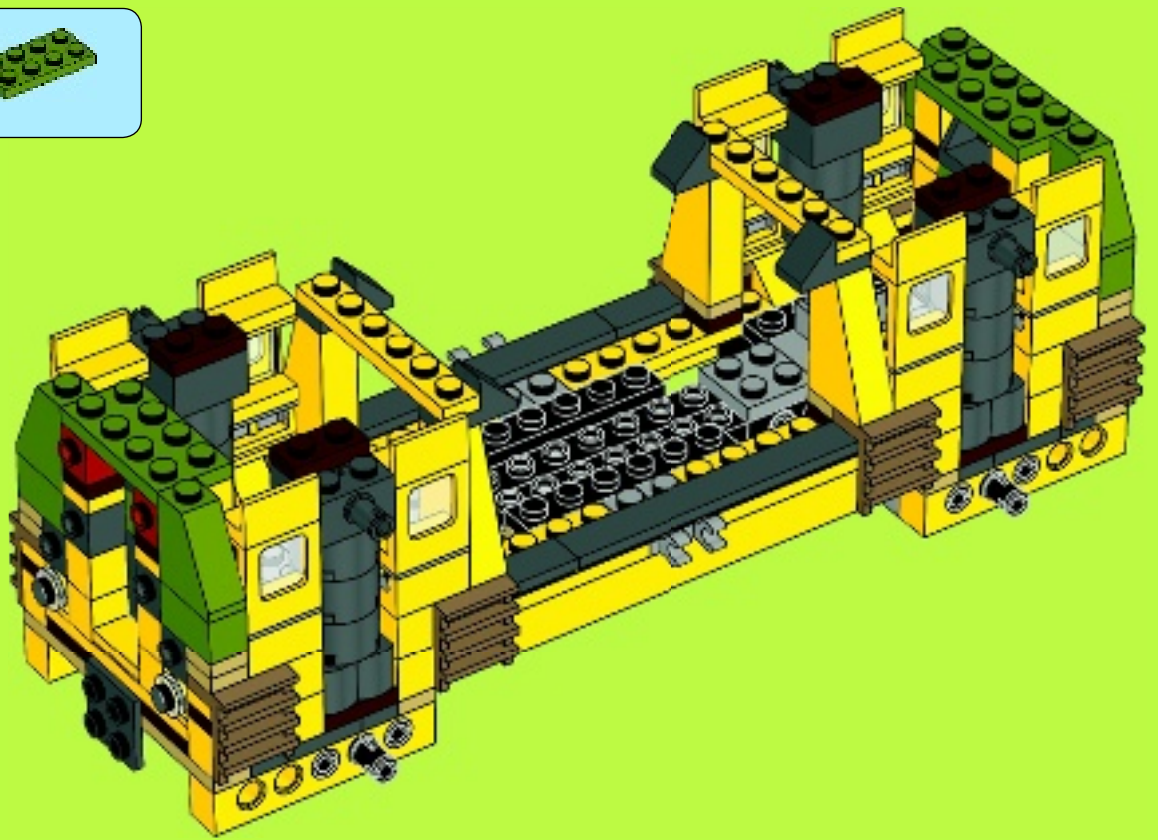

35

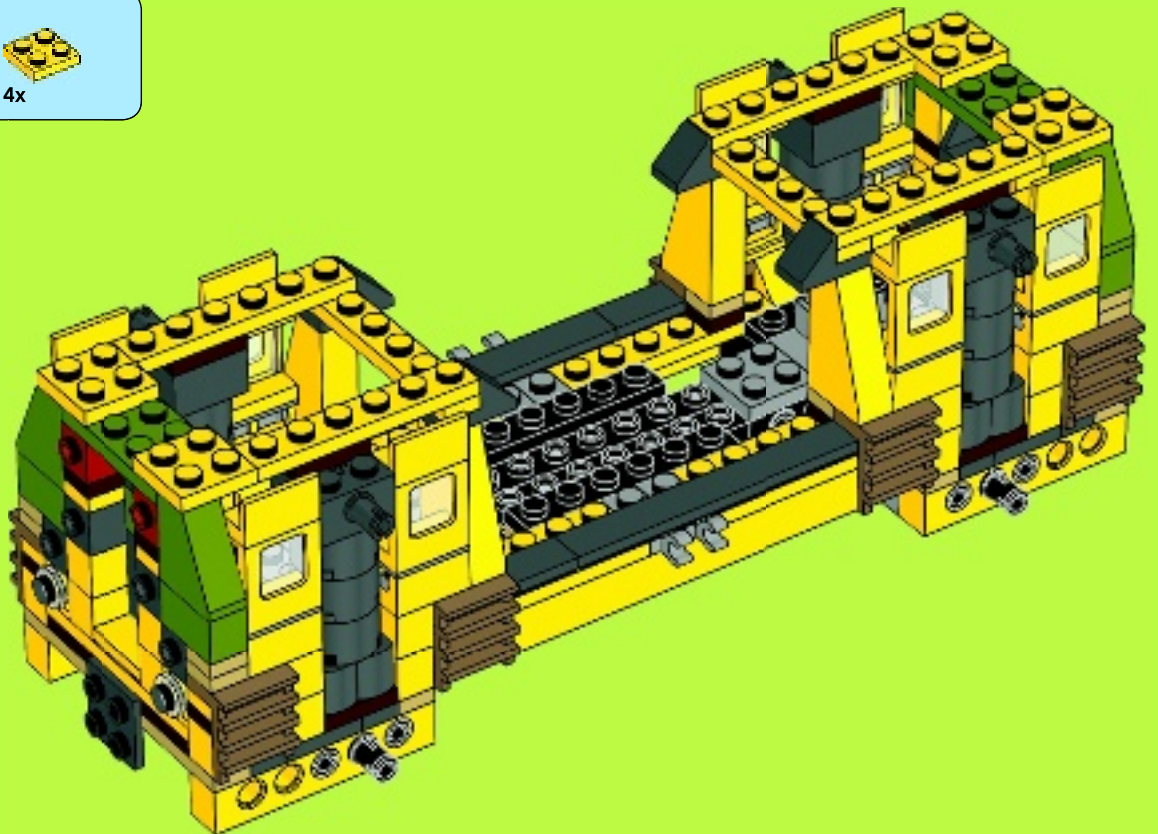



36

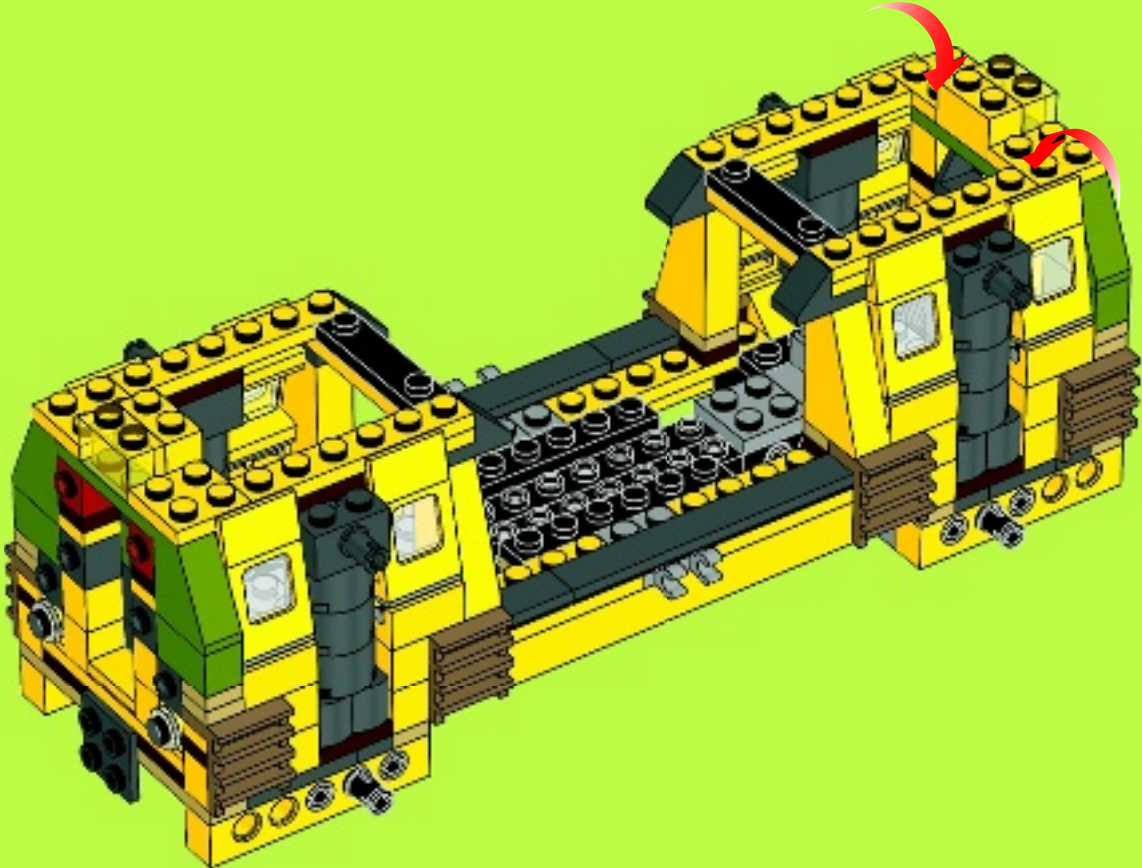



37

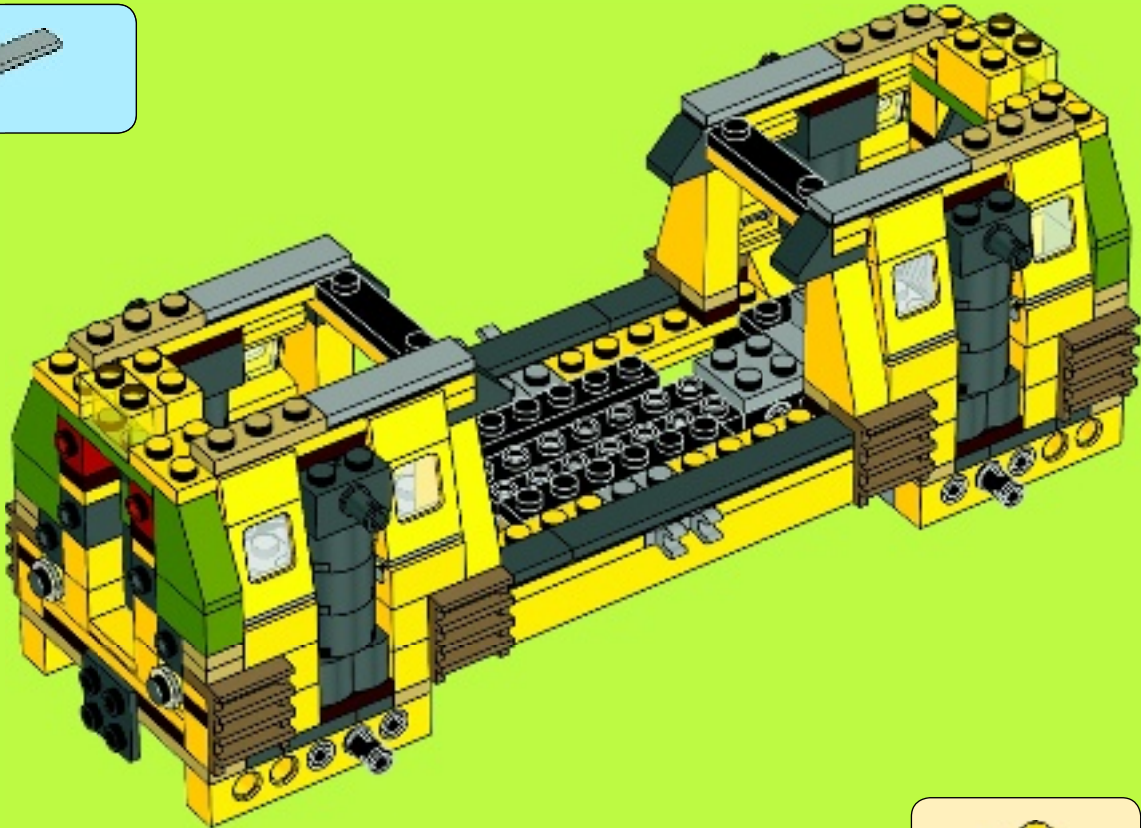

38

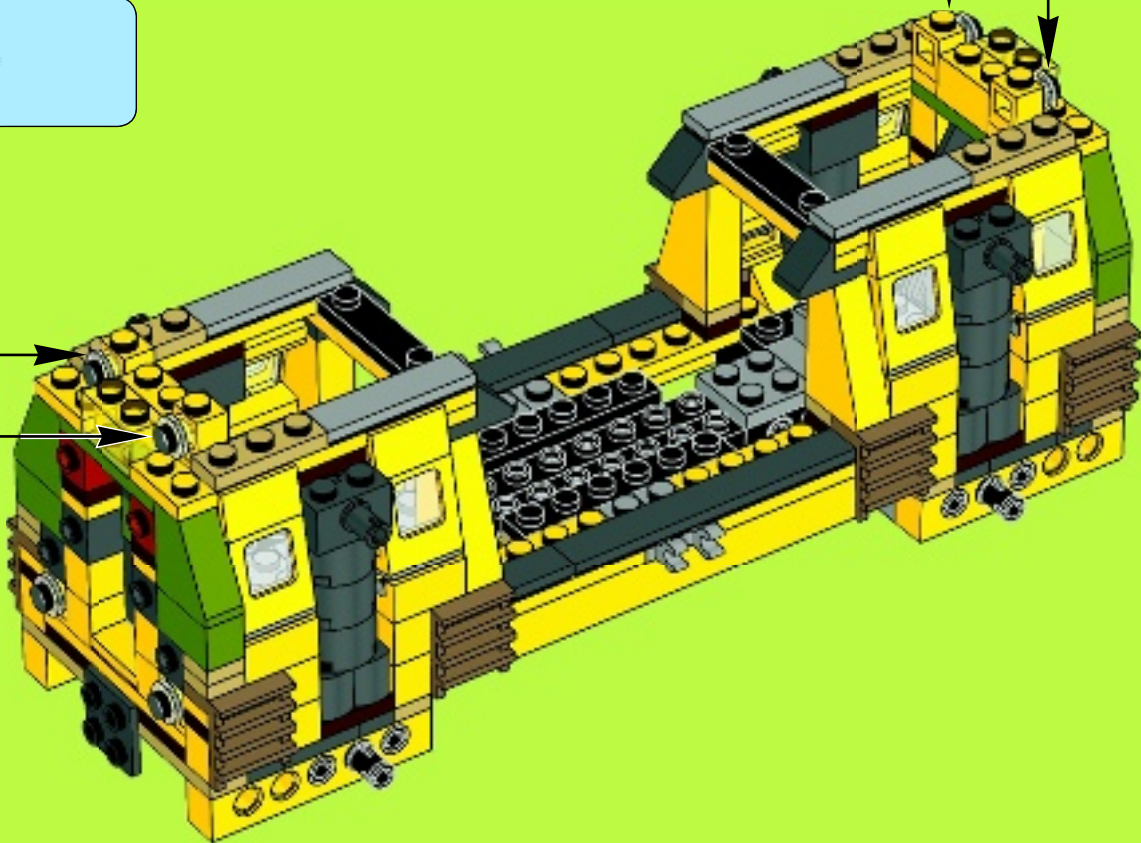
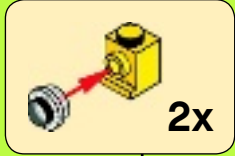



2x



4x

39

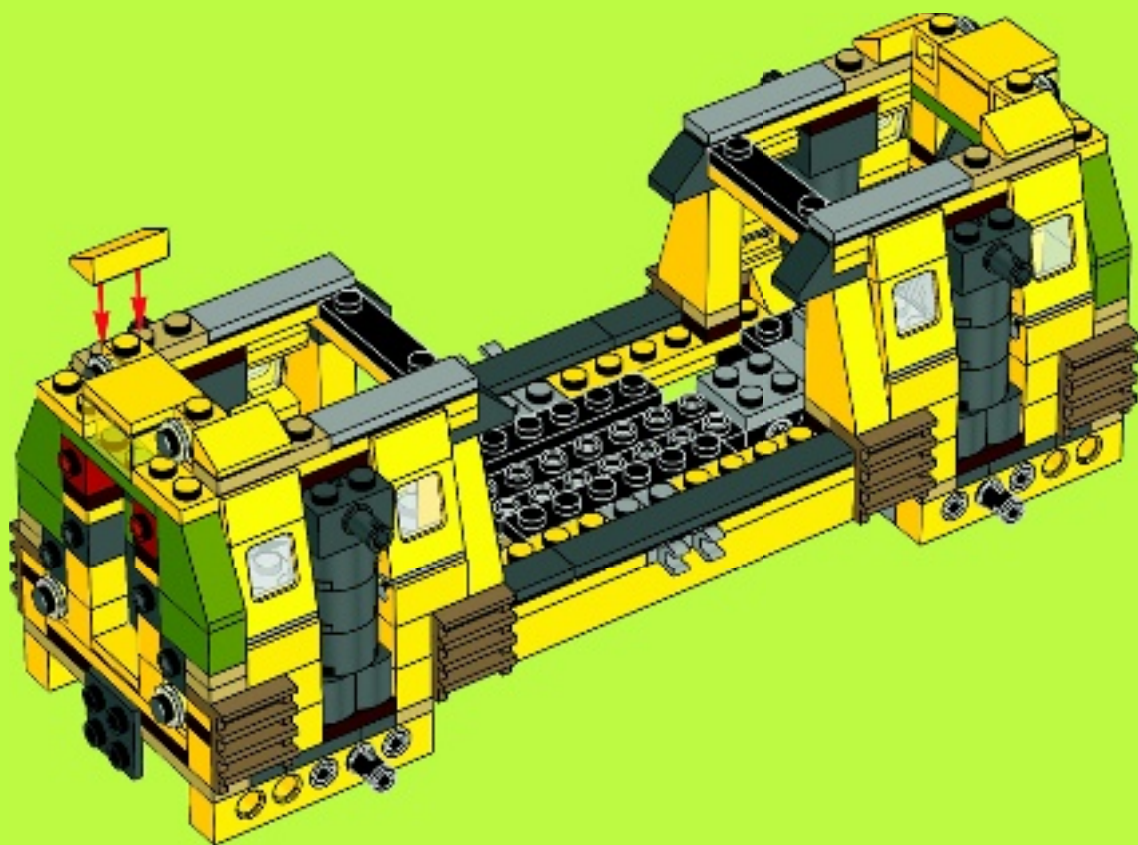

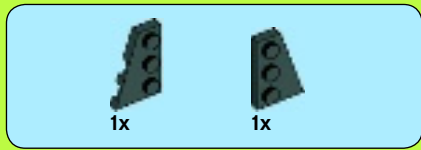

40

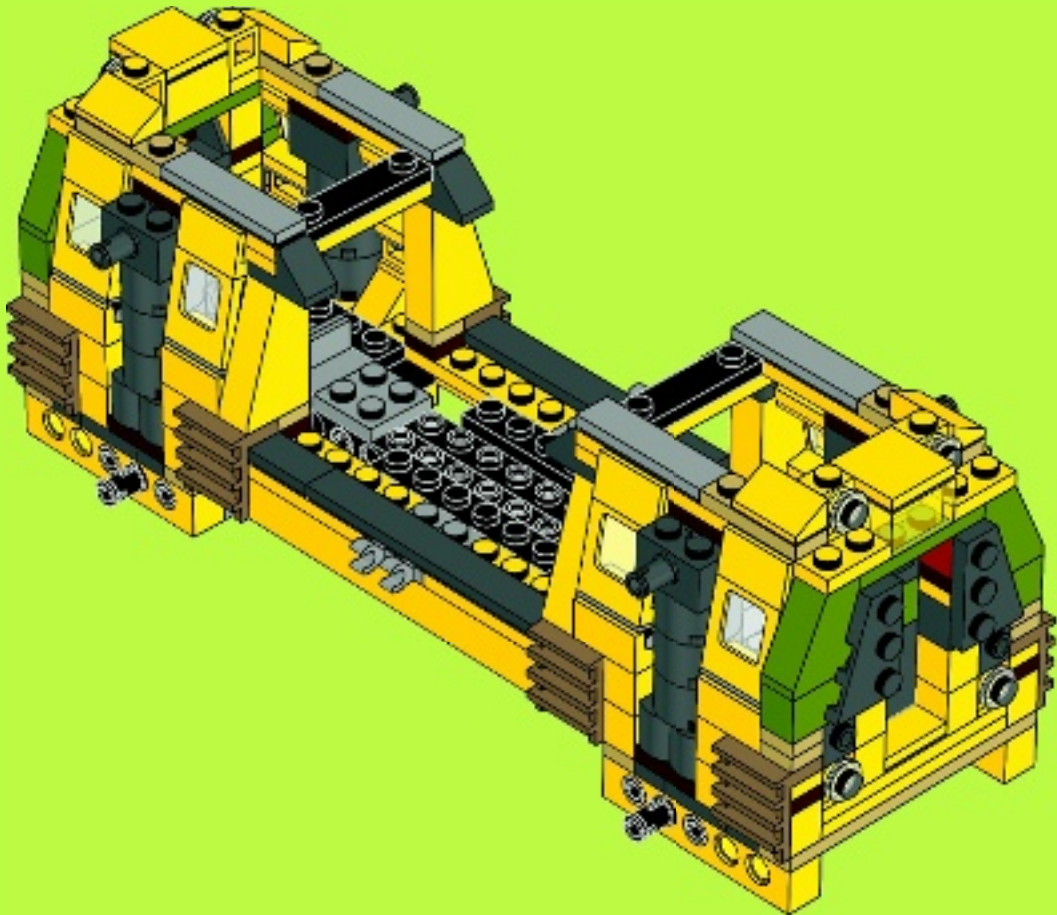



2x



2x

41

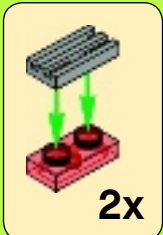
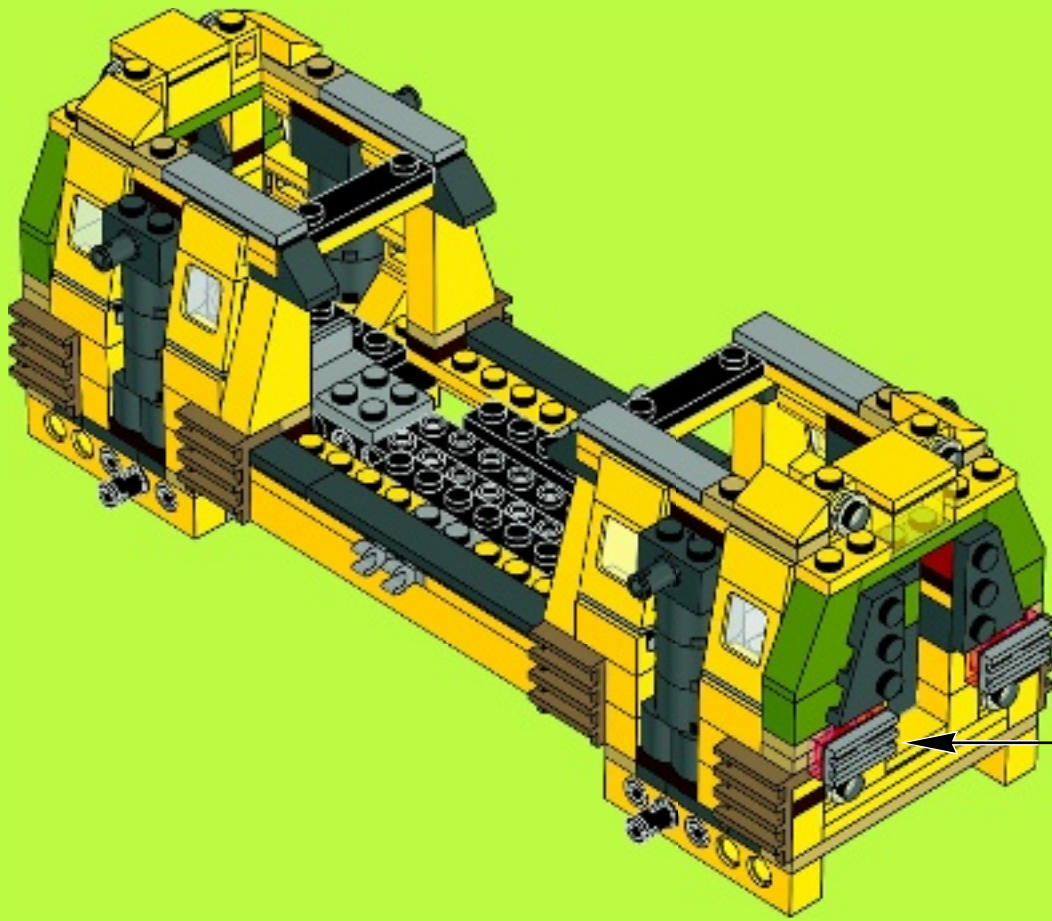

2x

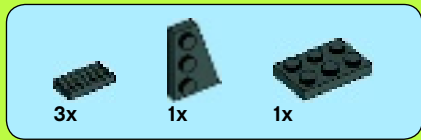

42

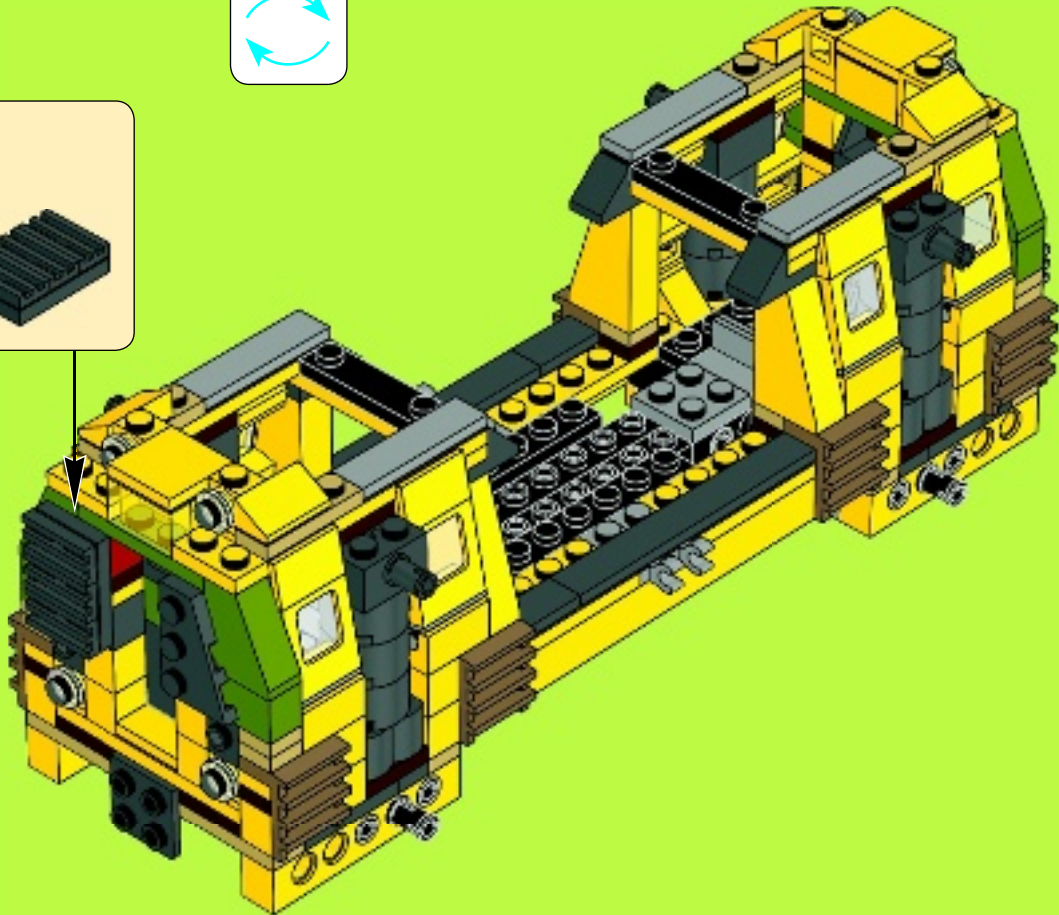
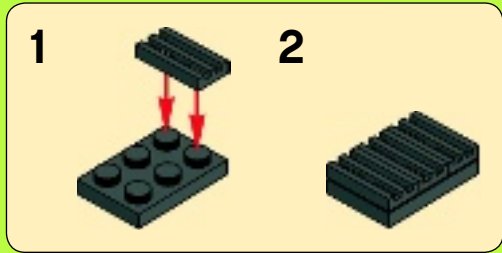



2x



2x

43

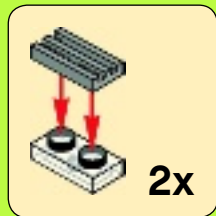

2x

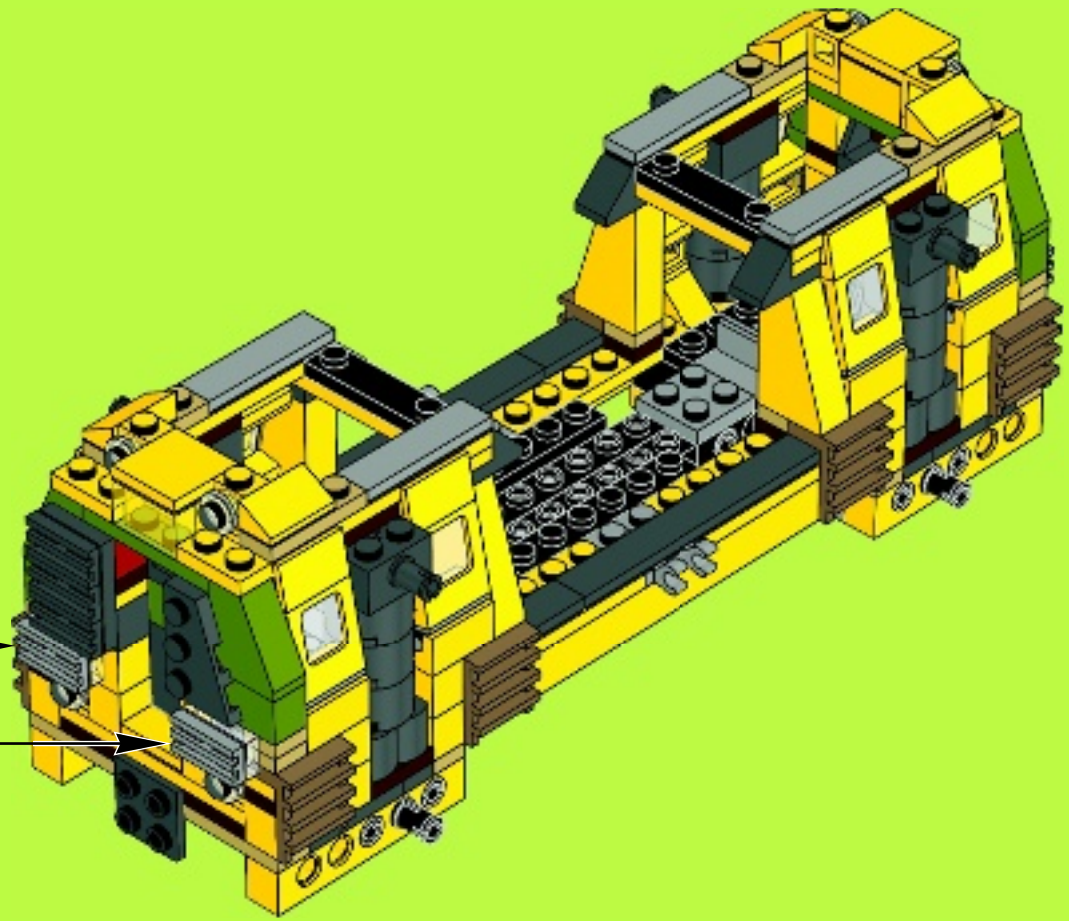

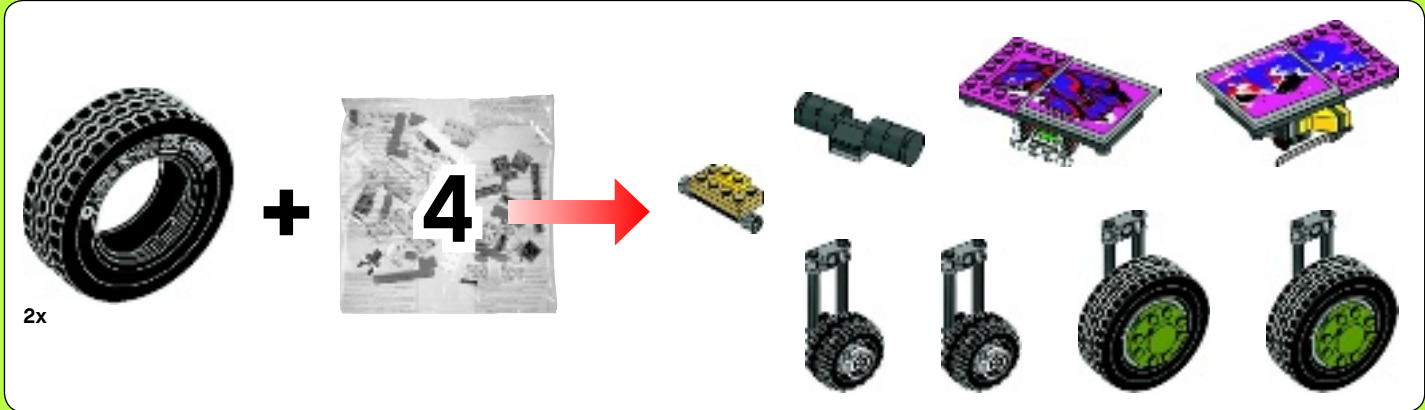

1



2

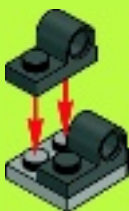

3

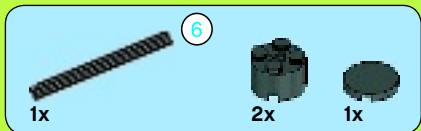

4

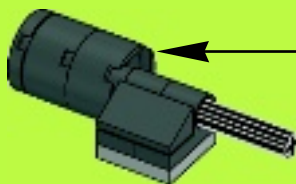
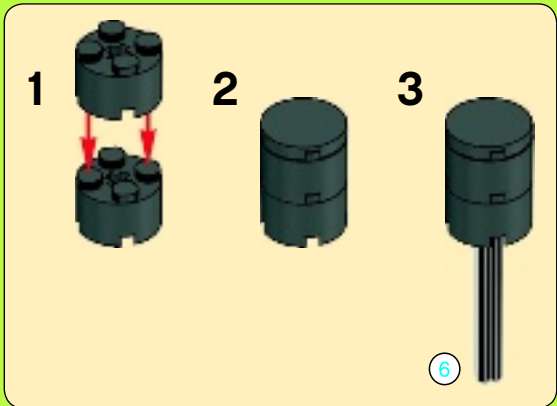



2x



1x

5

1



2

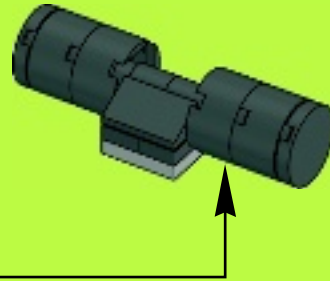

44

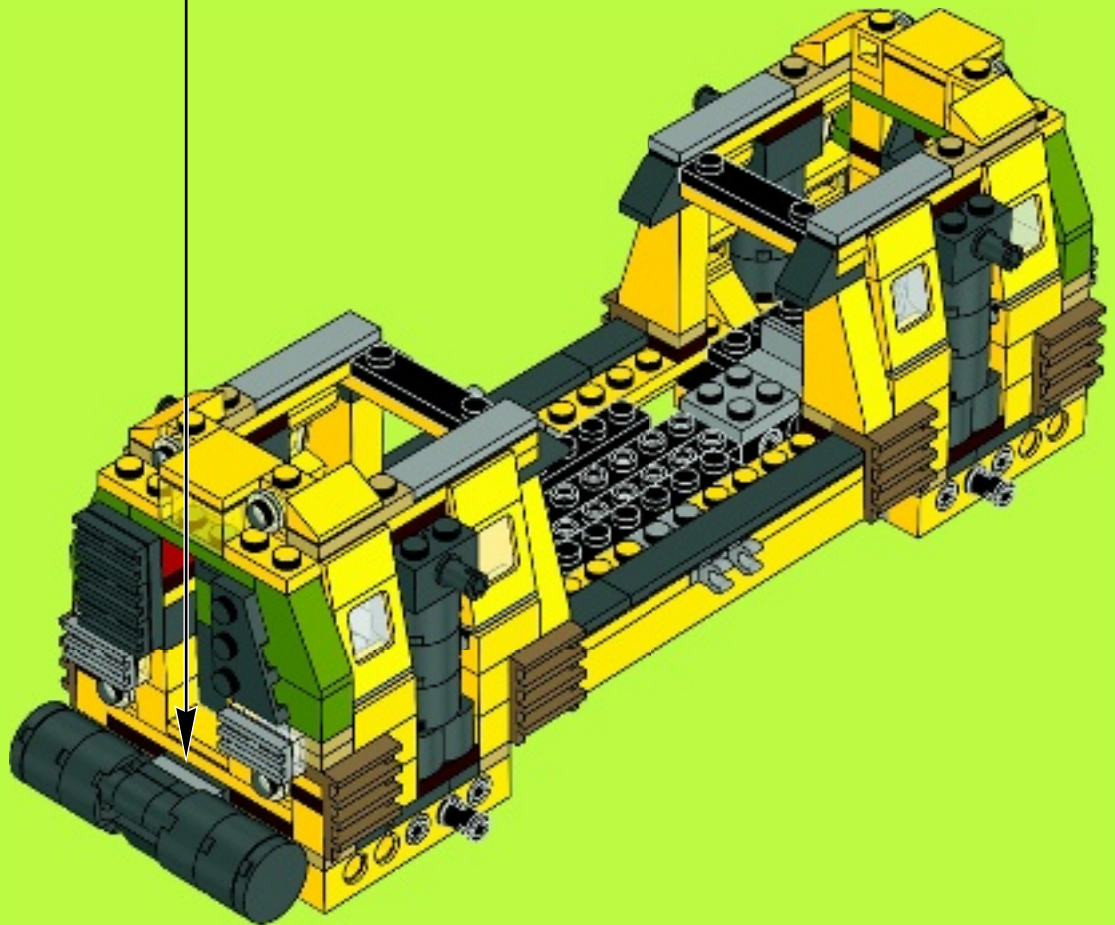



45

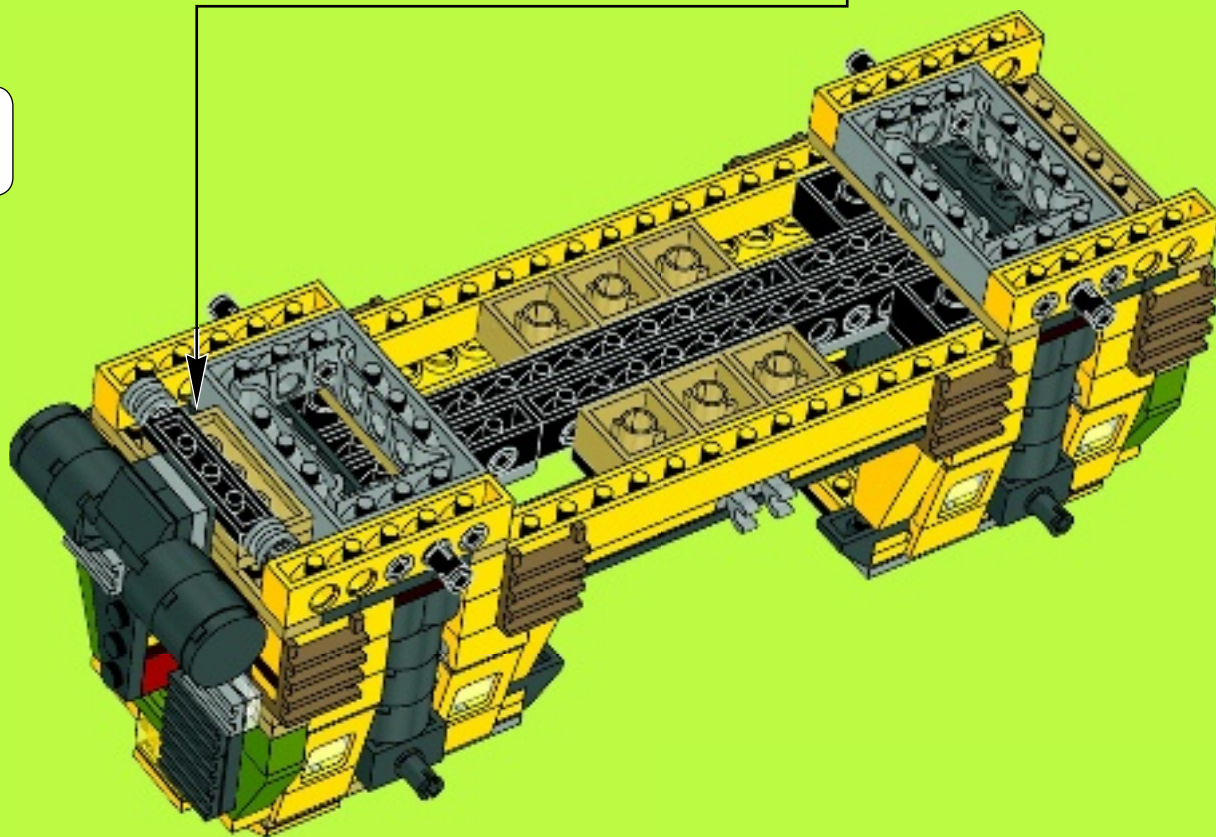
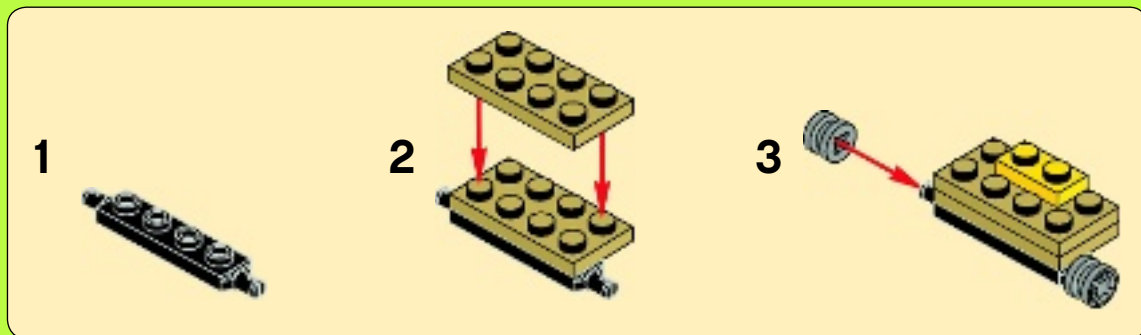

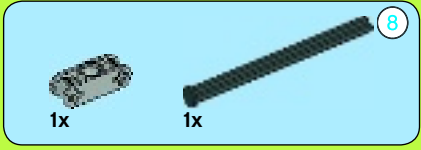

1

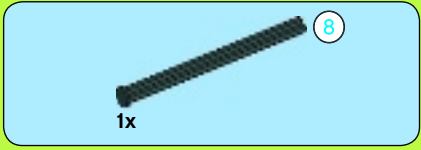

2



3

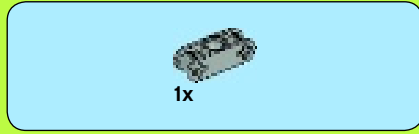

4



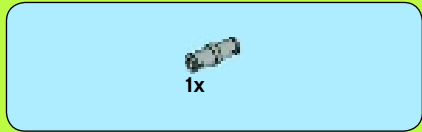

5

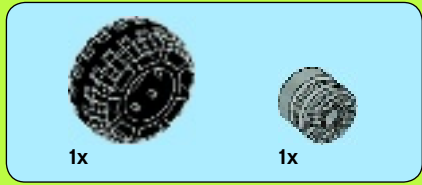
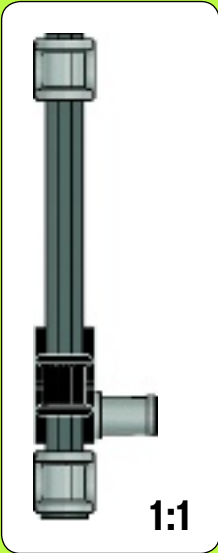

6

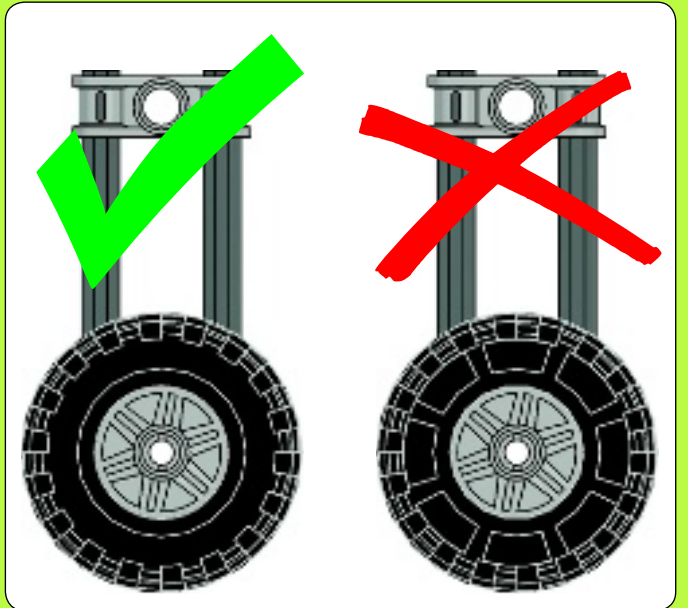



7

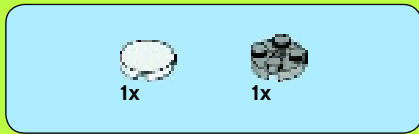

8

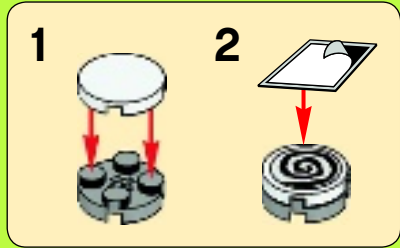

2x

46

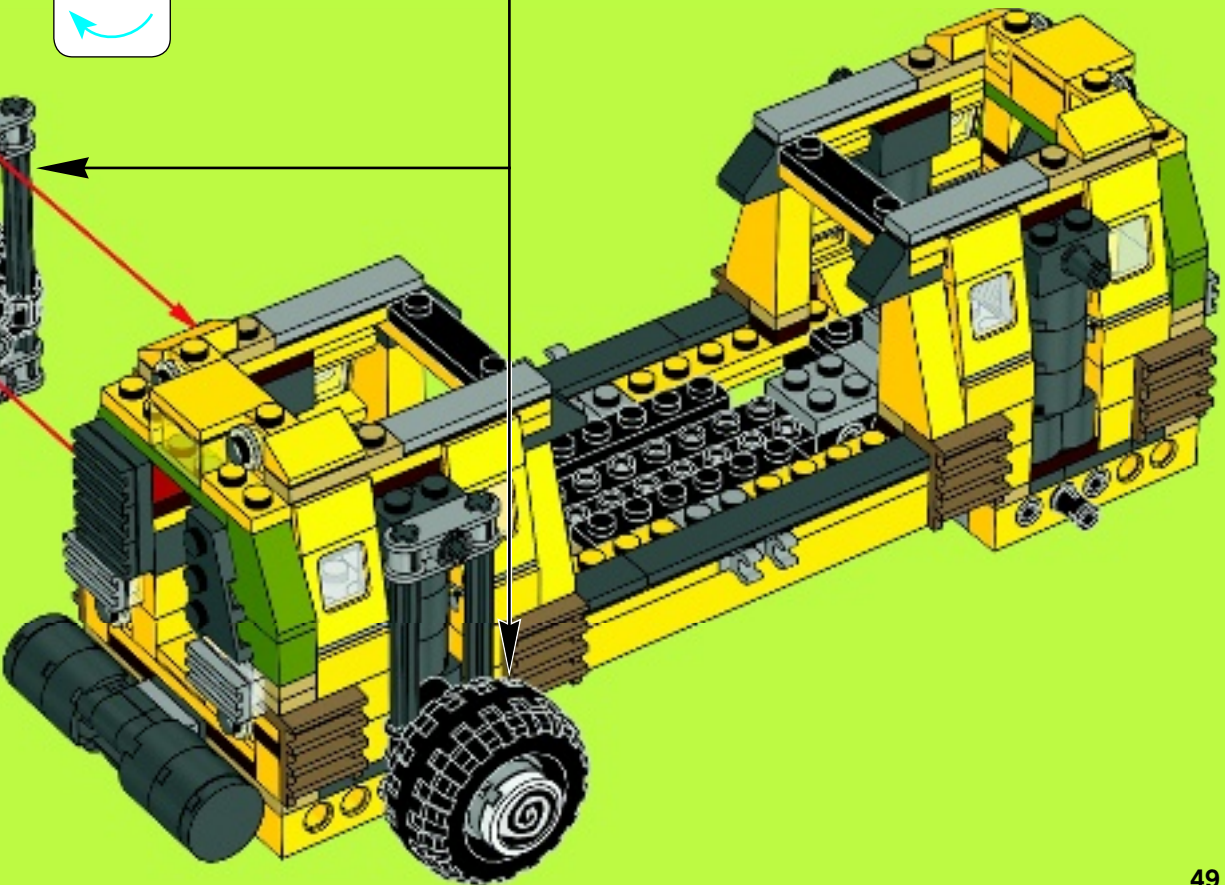

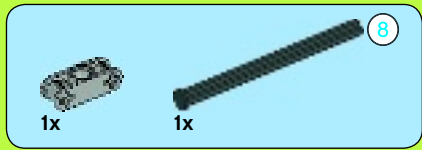

1

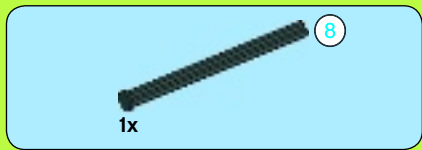
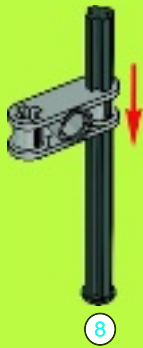

2



3

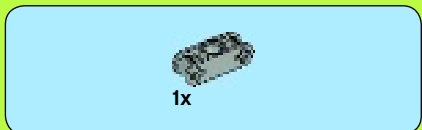

4



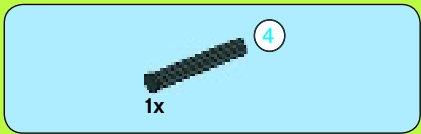

5

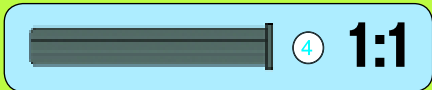
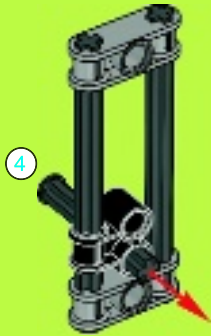

6

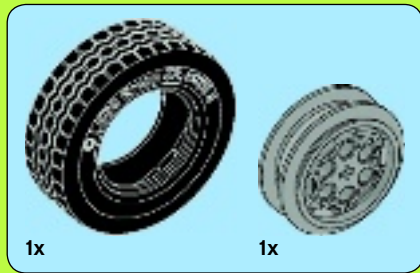
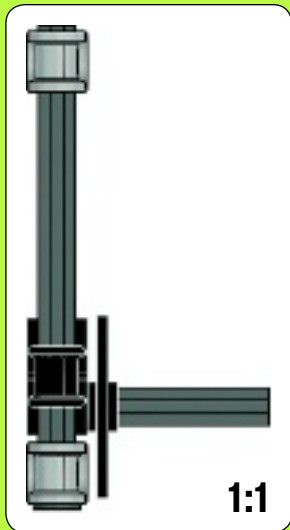

7

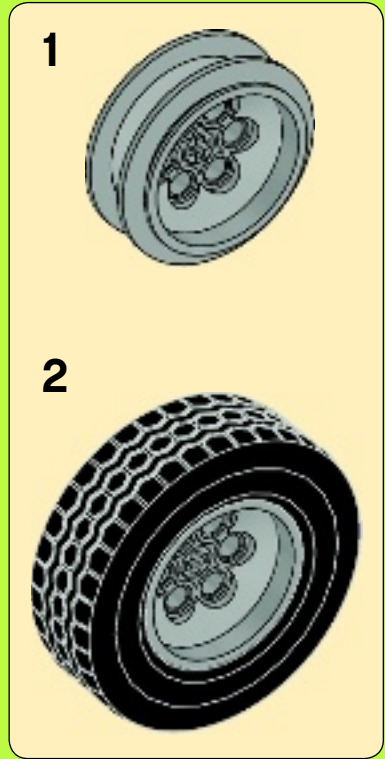



1x

8



1x



1x

9



2x

47

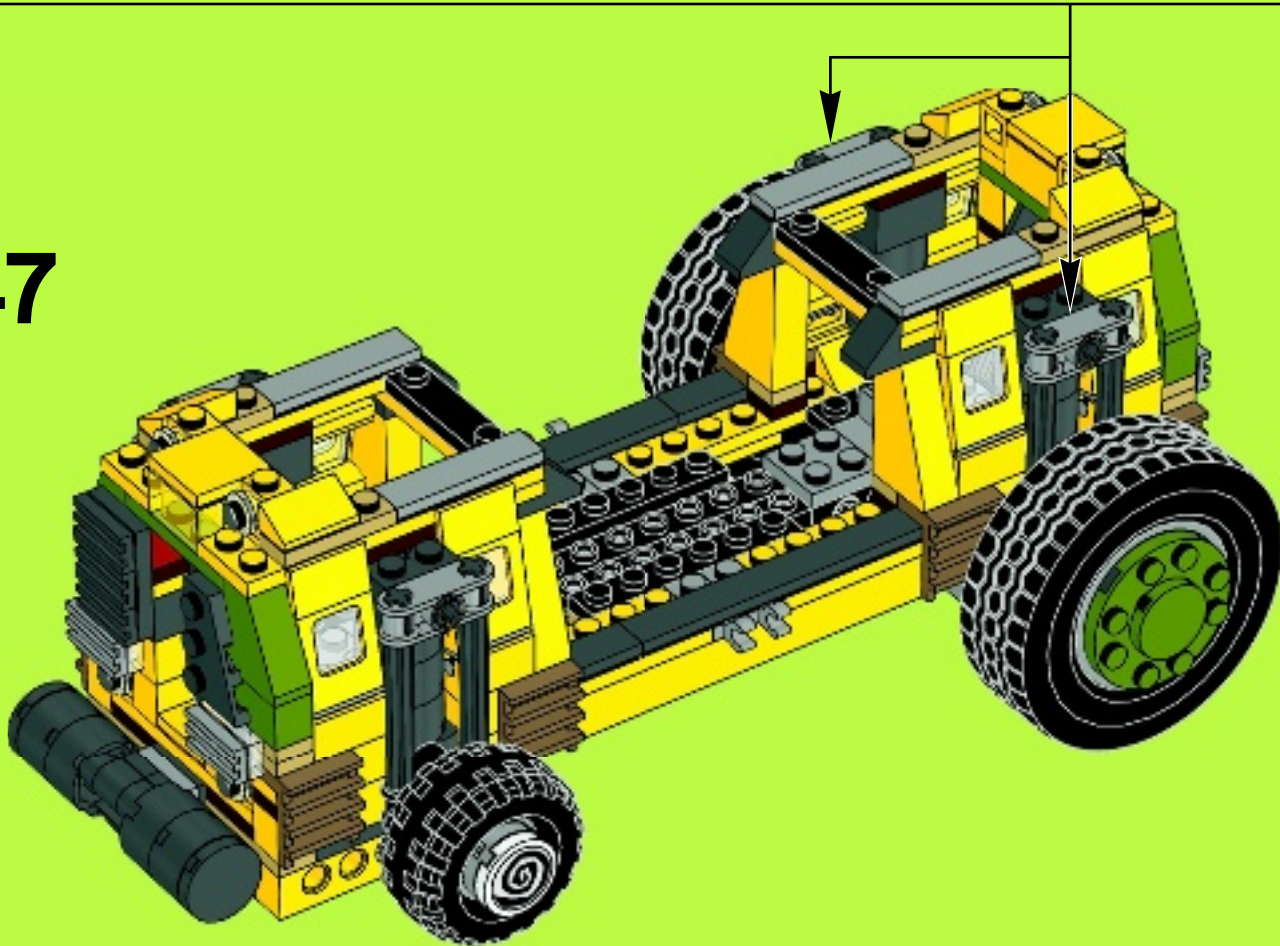



1



2

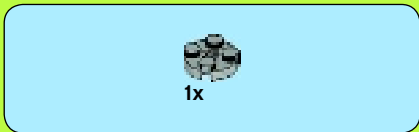

3

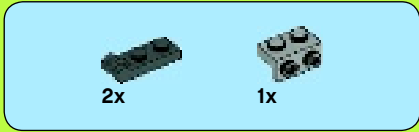

4



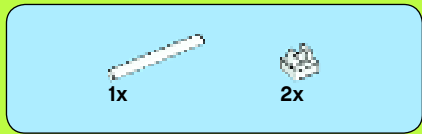

5

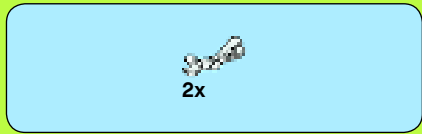

6

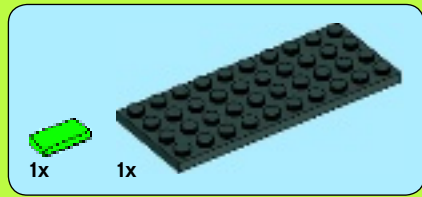

7

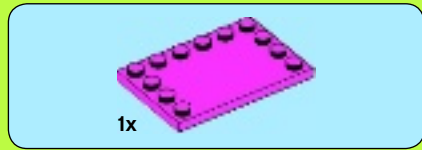
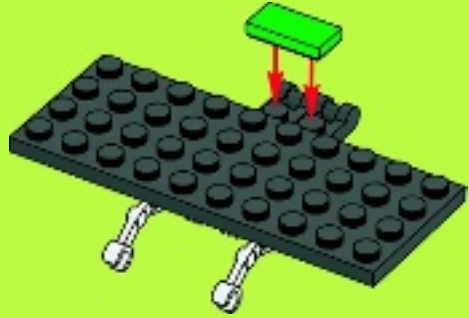

8

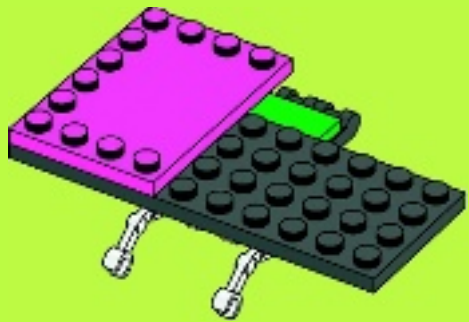

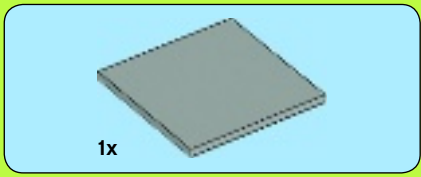

9

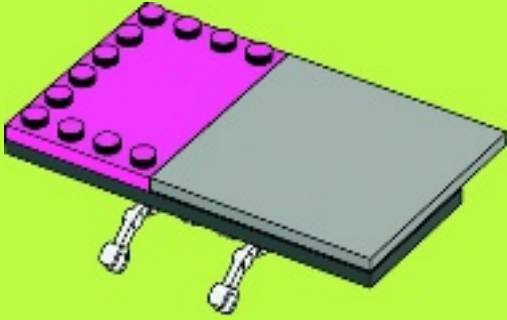

10

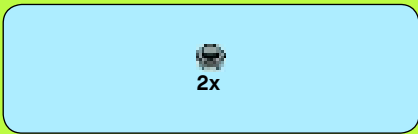
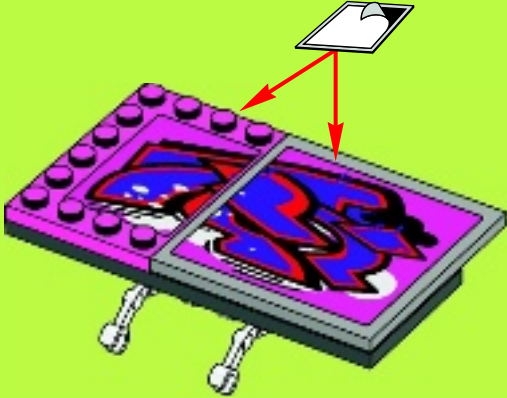

11

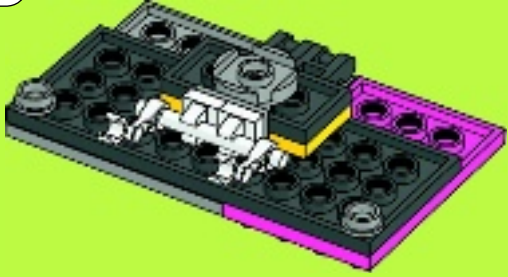



12

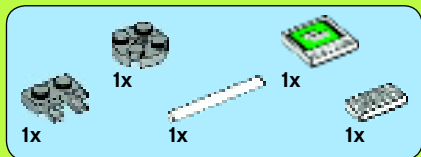
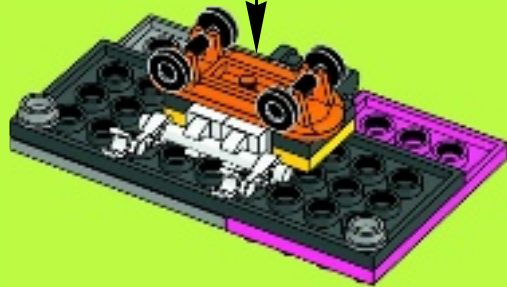

13

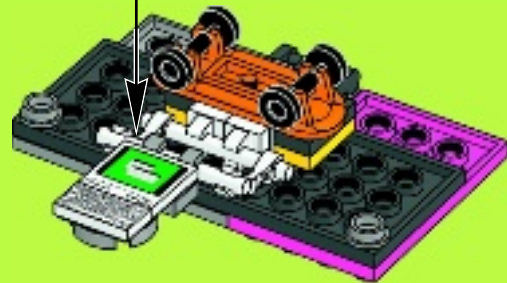
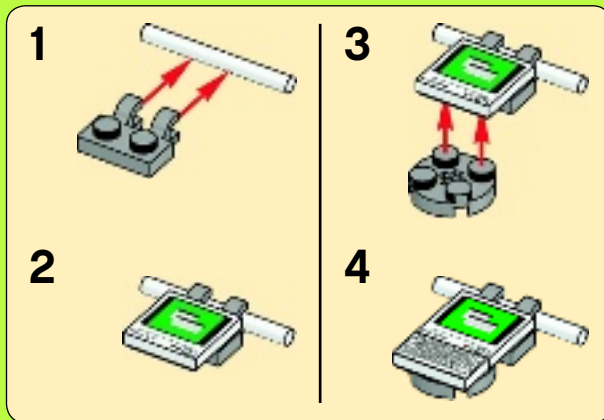

14

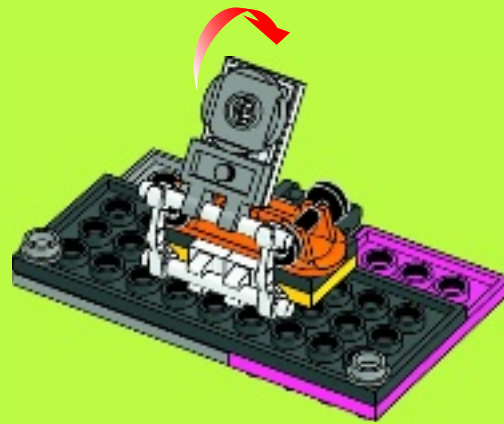

48

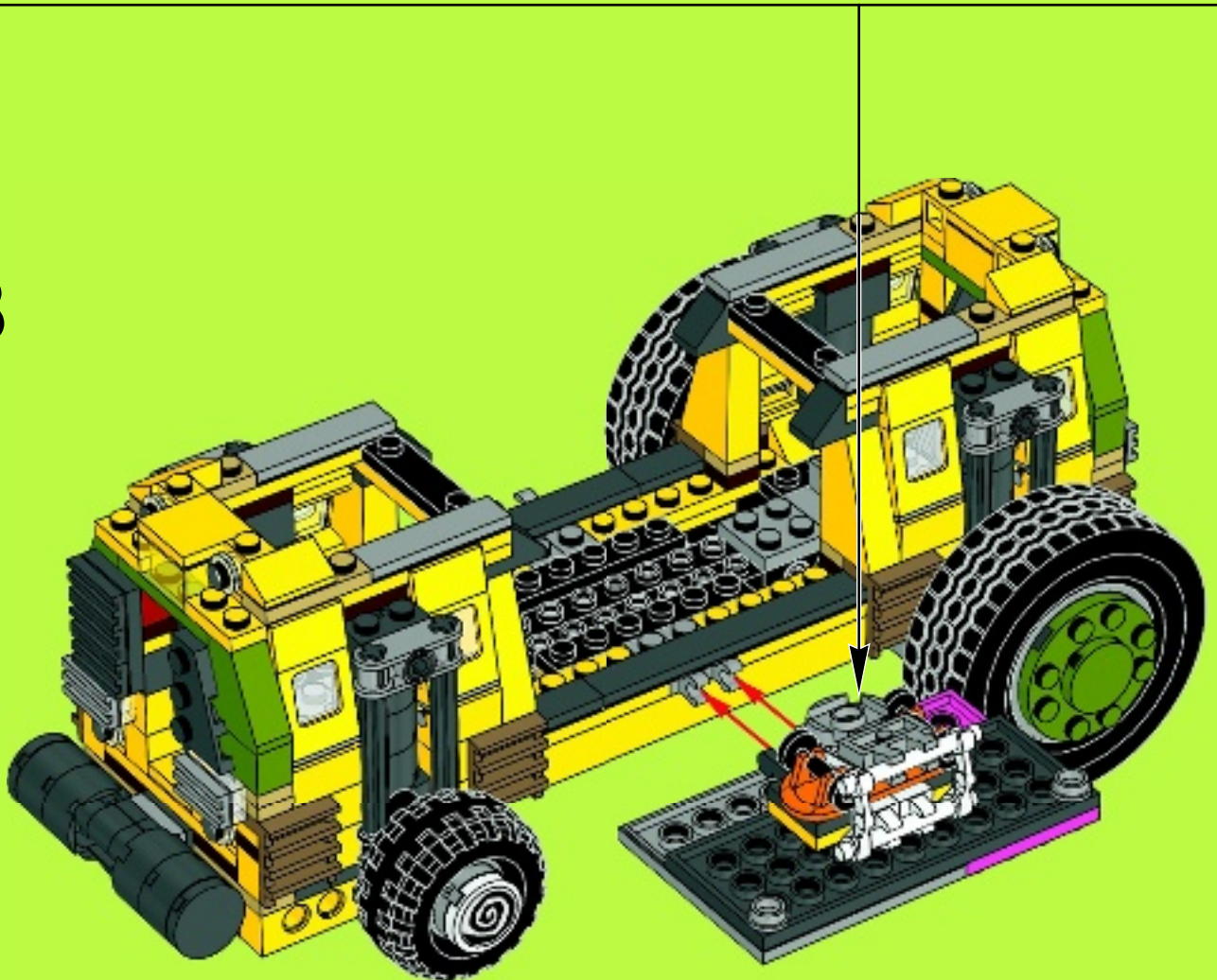



1

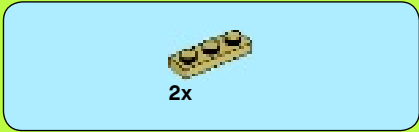

2

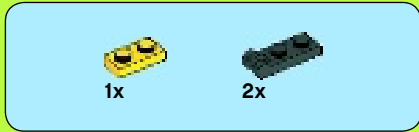

3

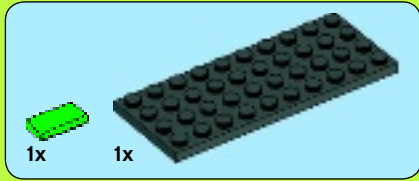

4

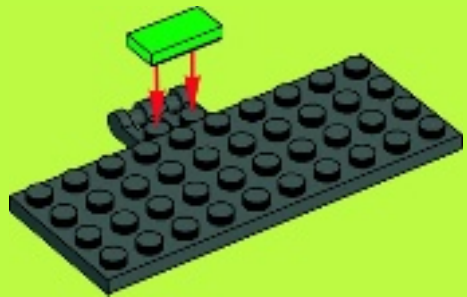

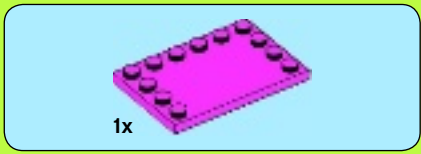

5

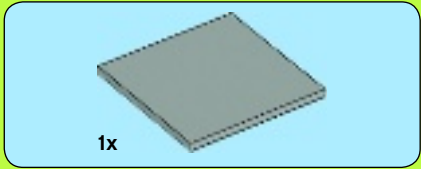
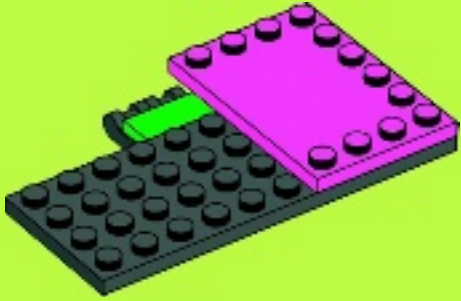

6

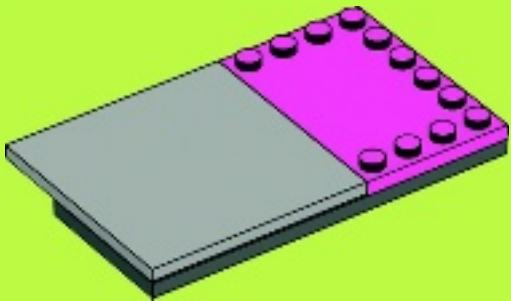

7

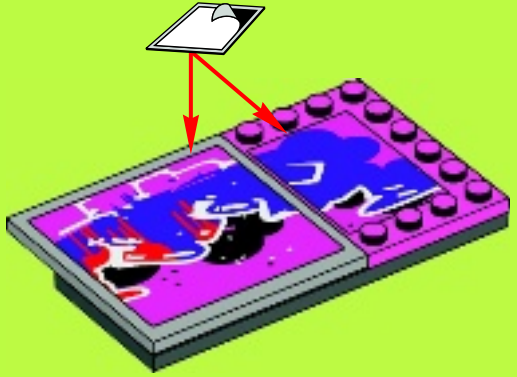

8

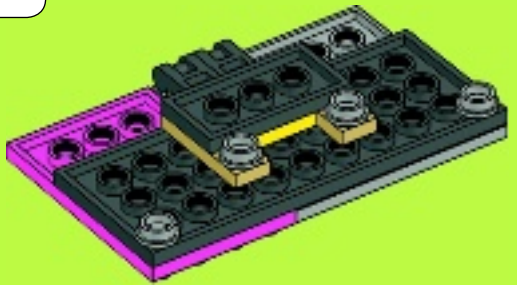
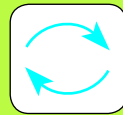

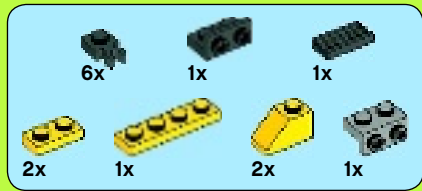

9

1

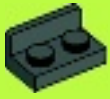

3



5

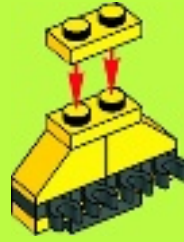

7

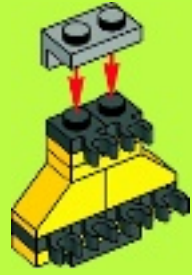

2



4

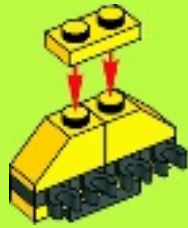

6



8

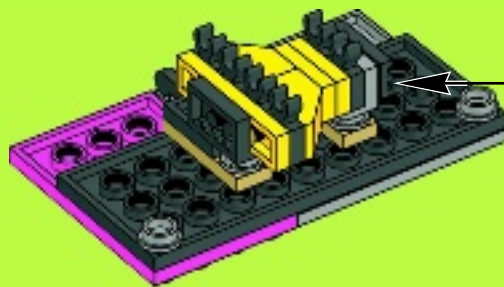
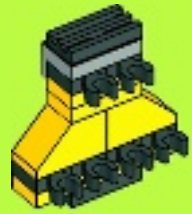



10

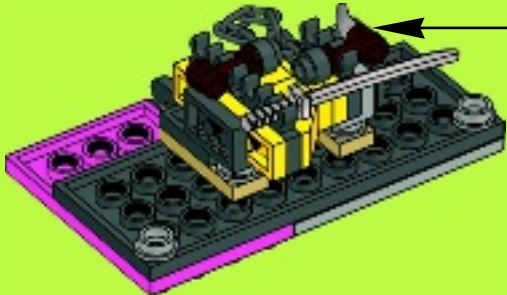
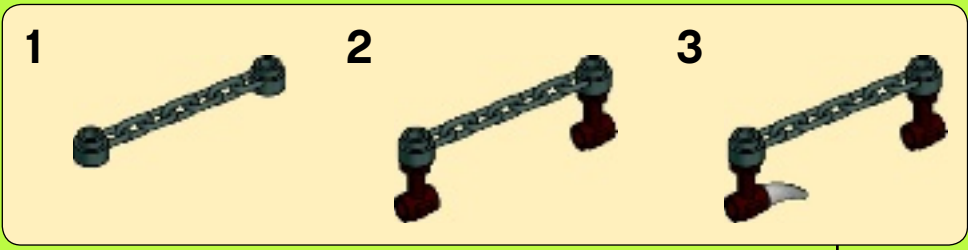

49

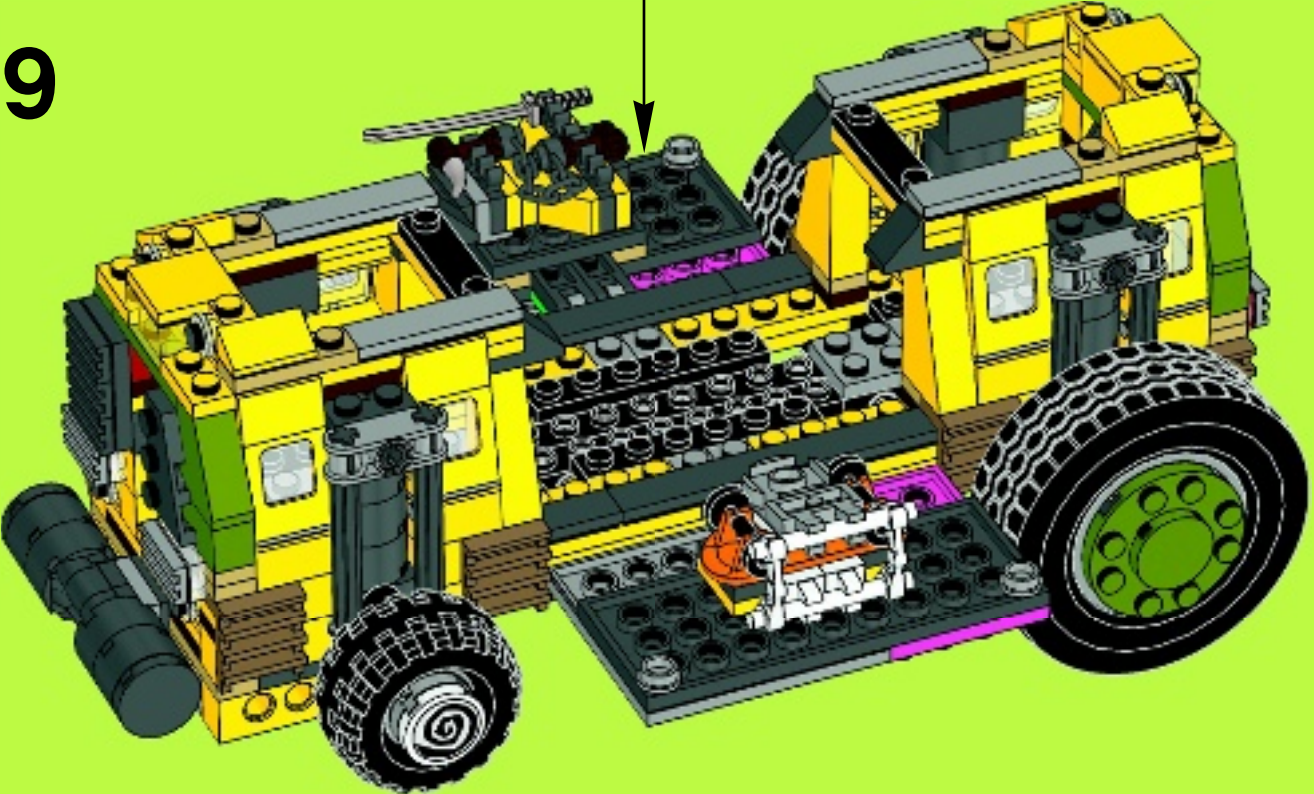



5

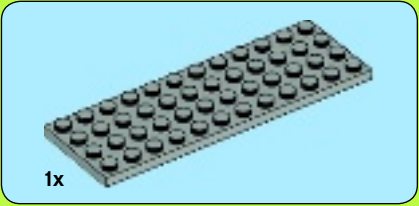

1x

1

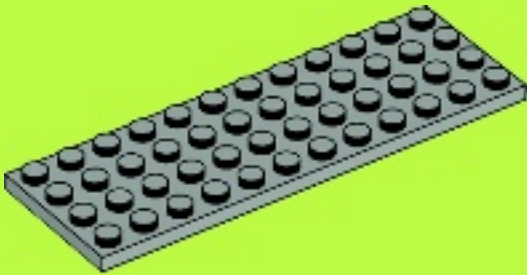

1x

2



2x

3



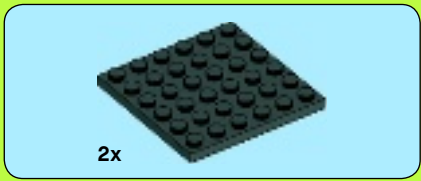

4

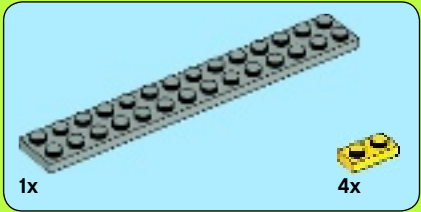
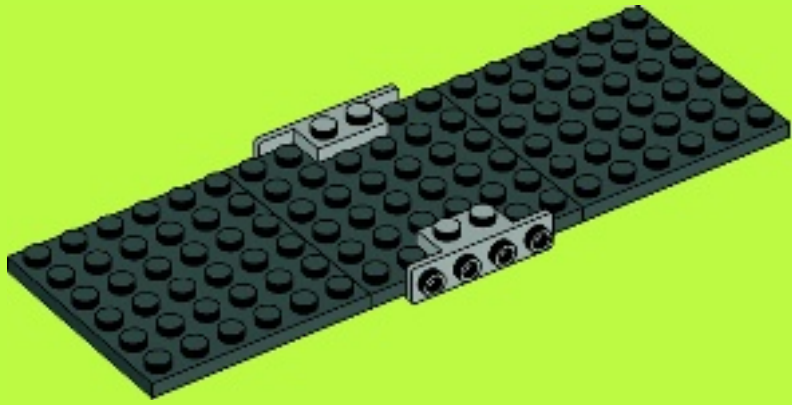

5

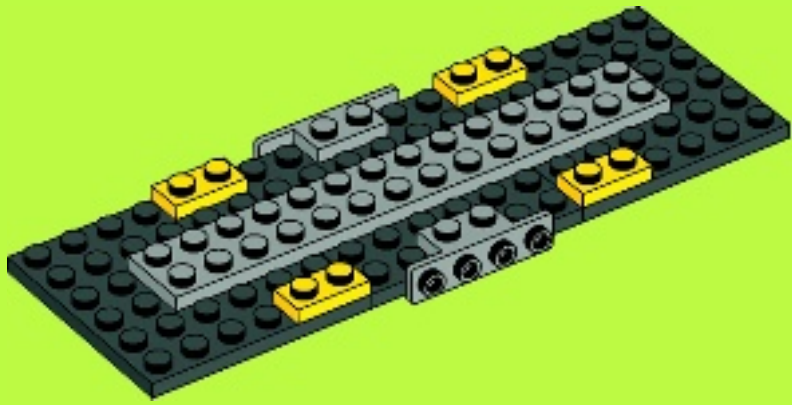



6

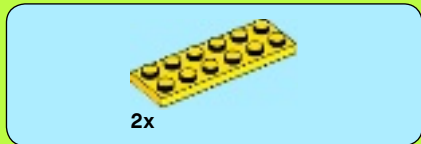
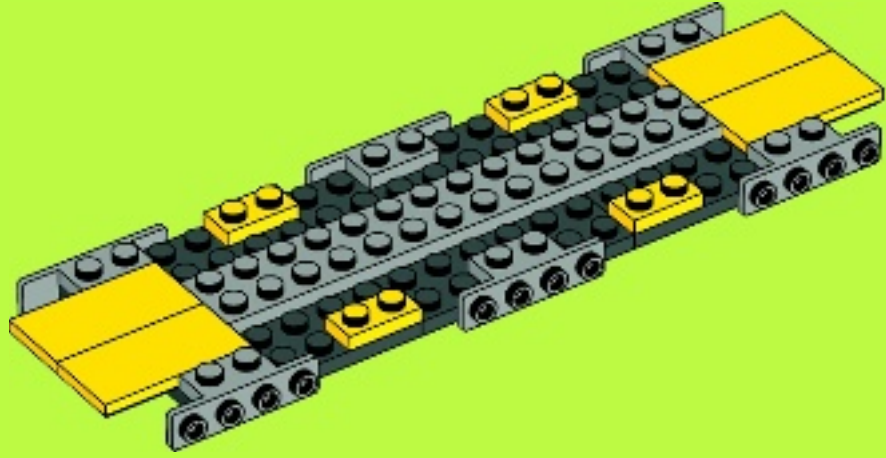

7

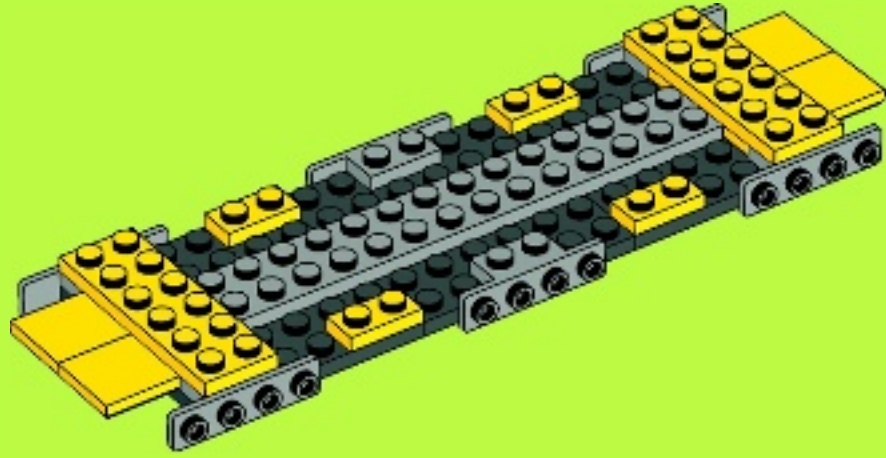

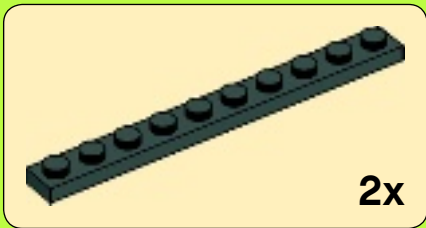
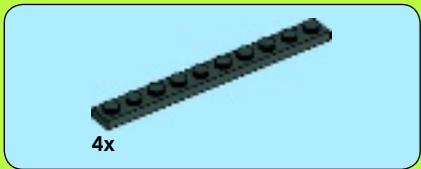

8

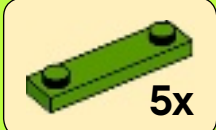
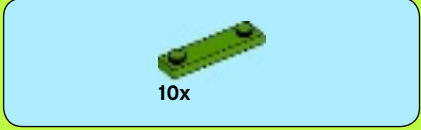
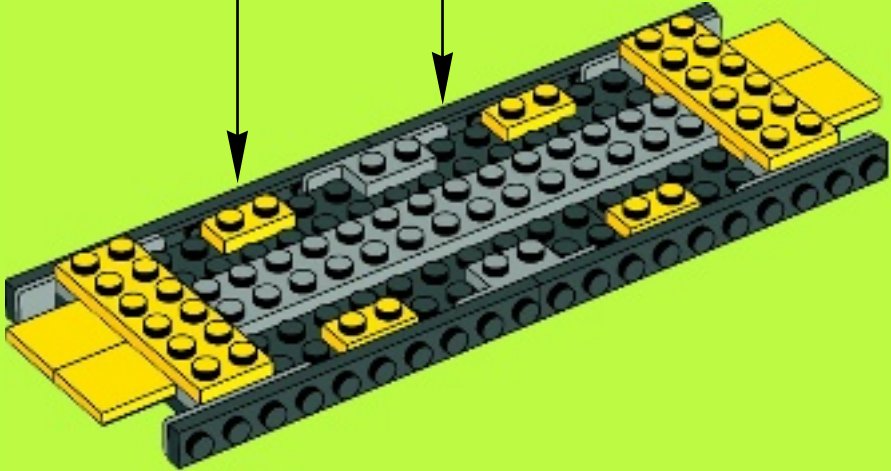

9

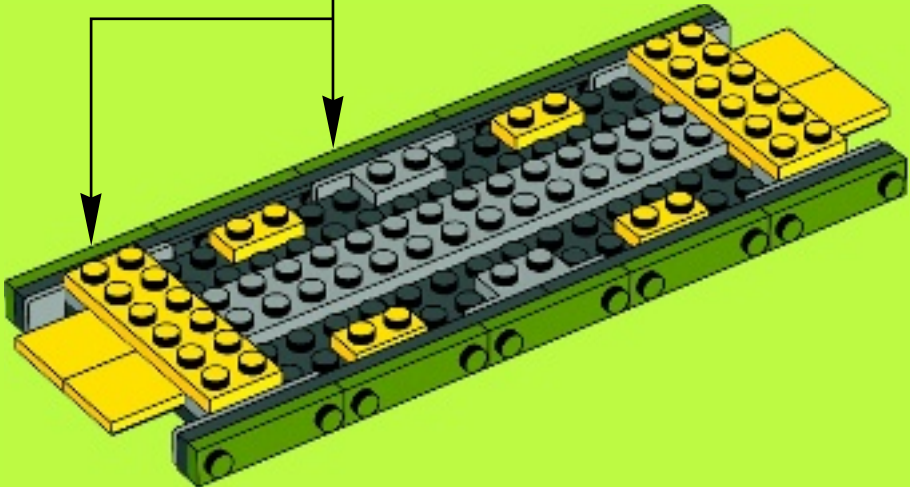

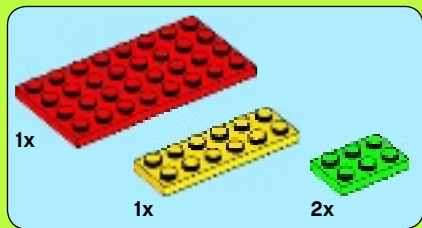

10

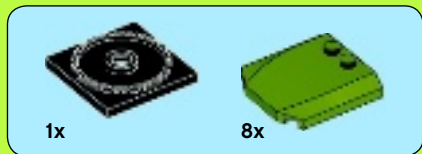
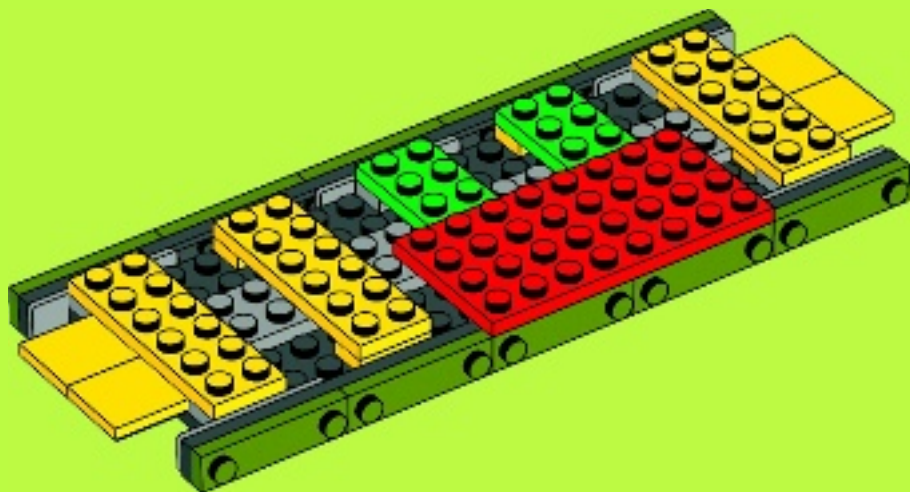

11

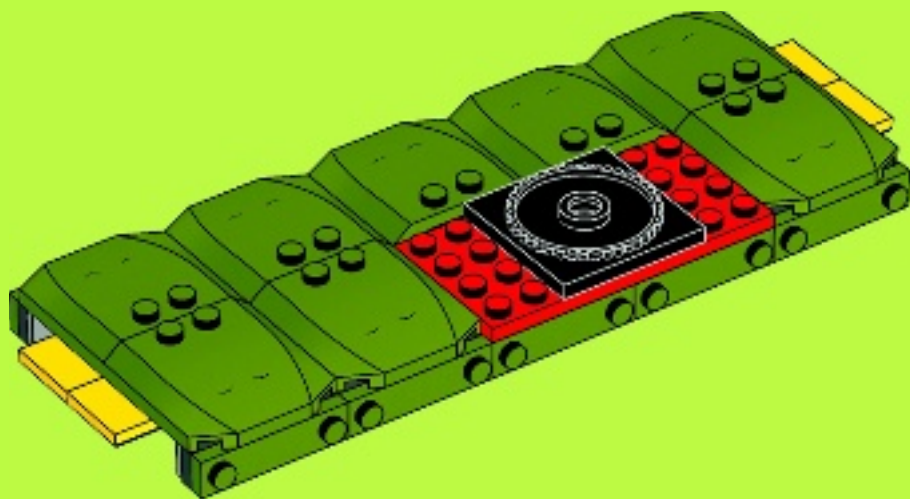

50



51

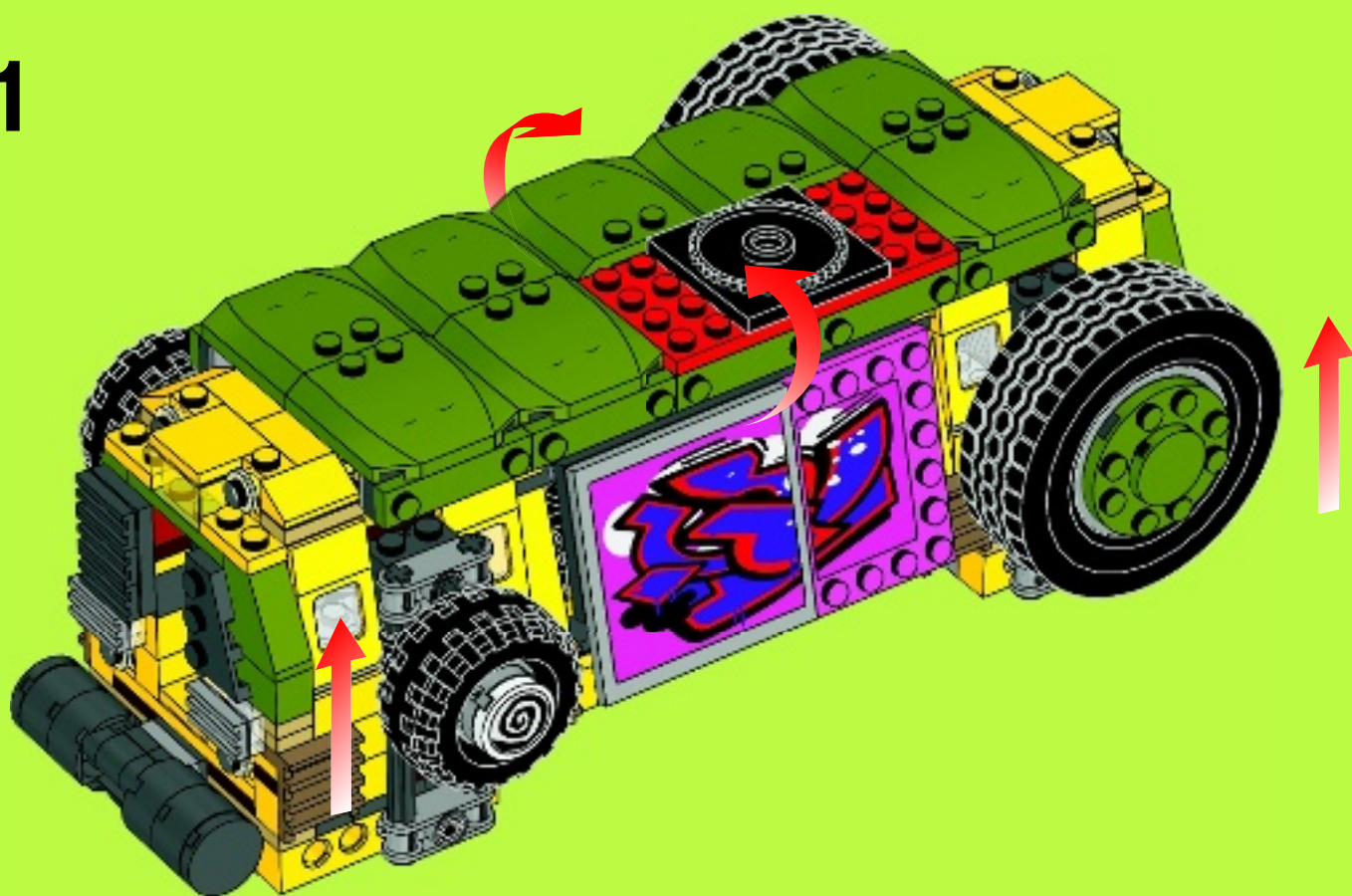

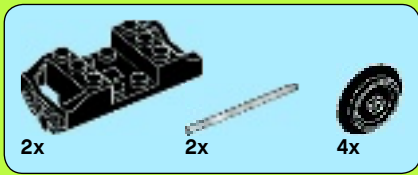

52

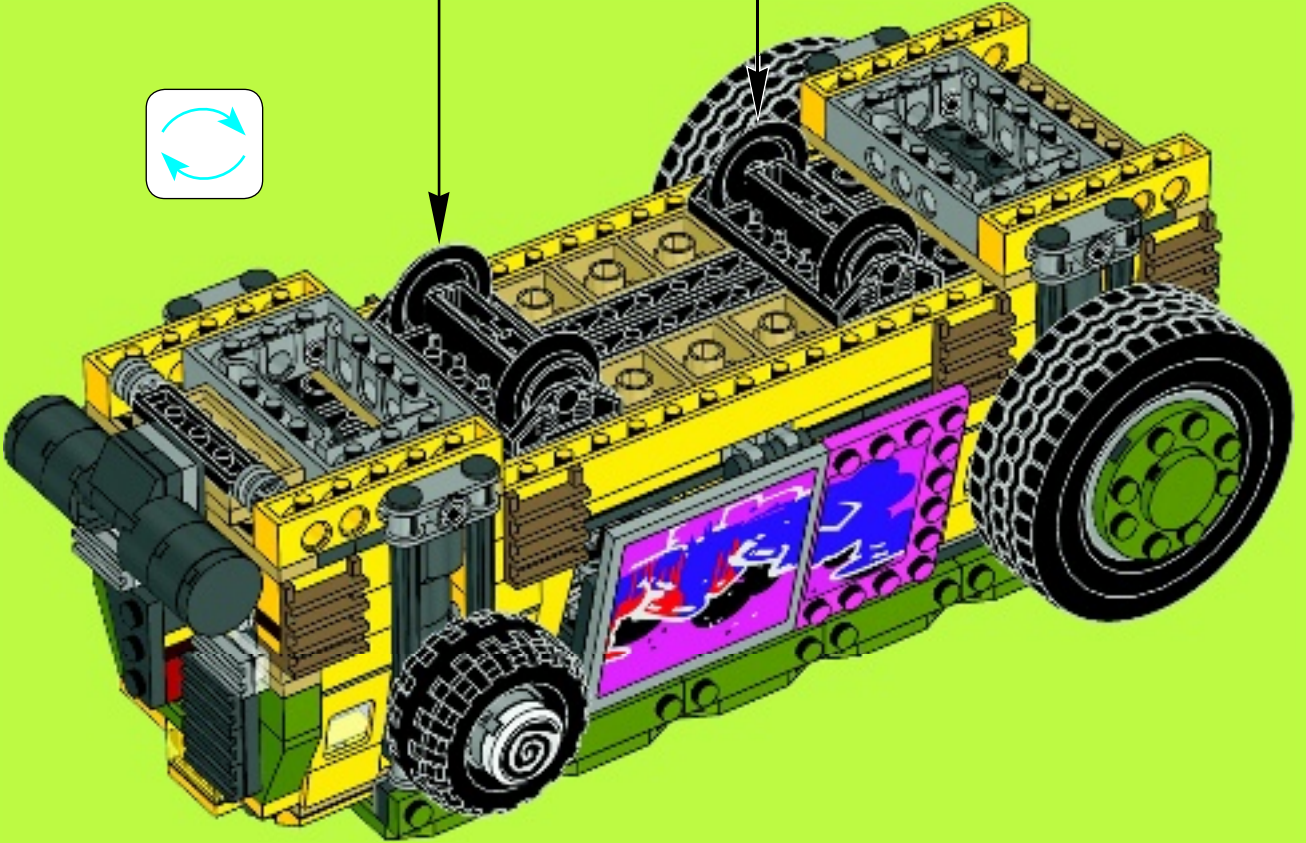
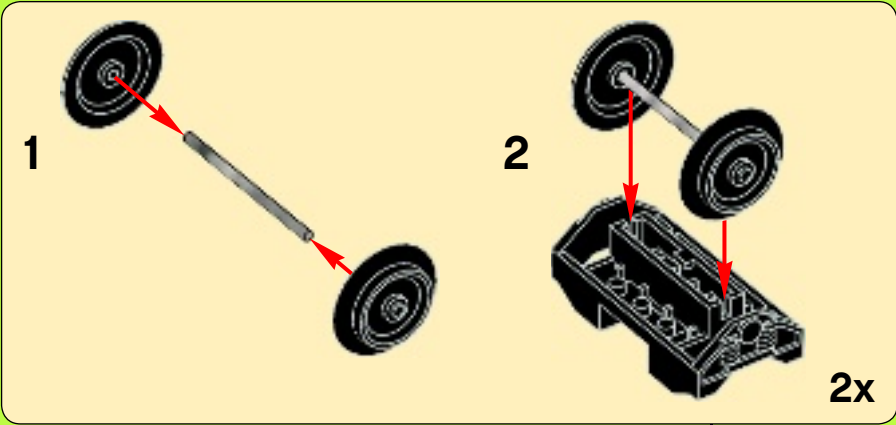

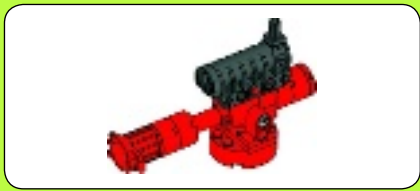

1



2

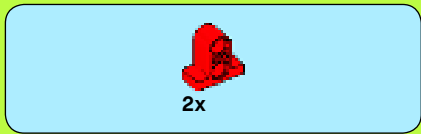

3

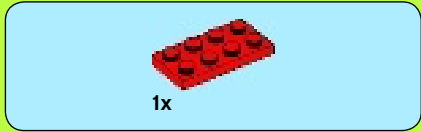
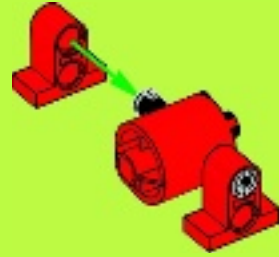

4

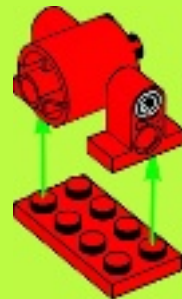



5



7

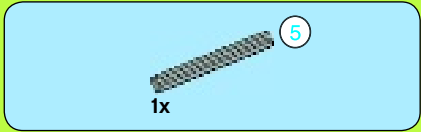
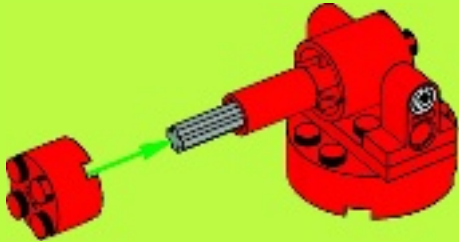

6

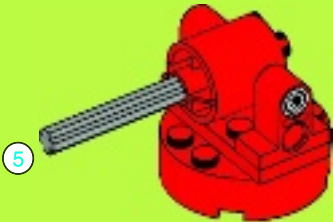

8

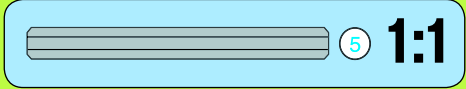
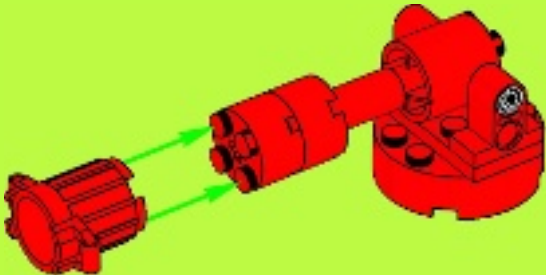

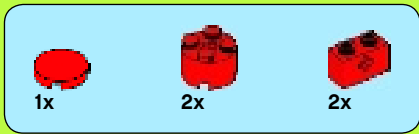

9

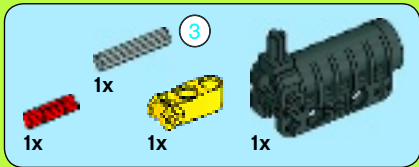
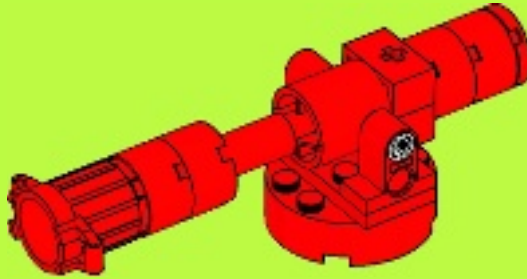
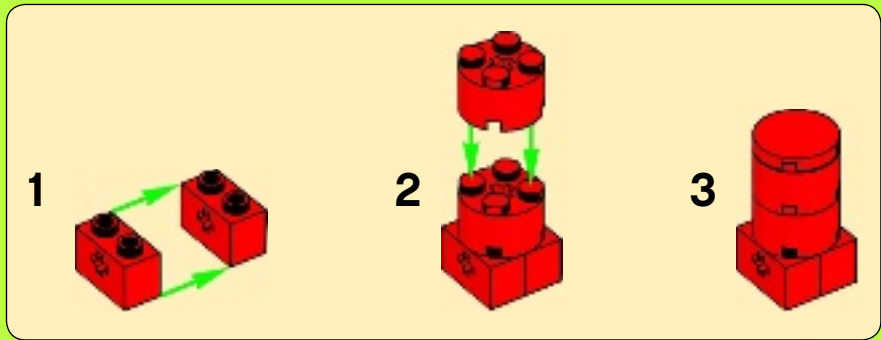

10

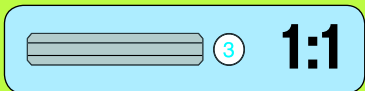
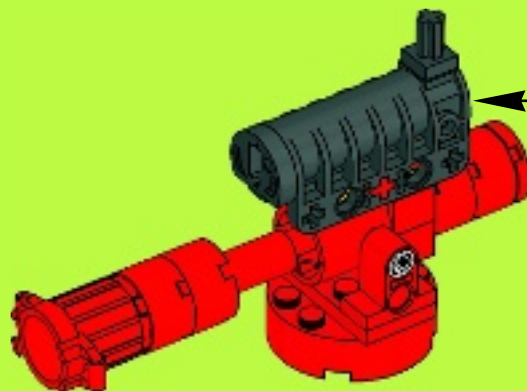
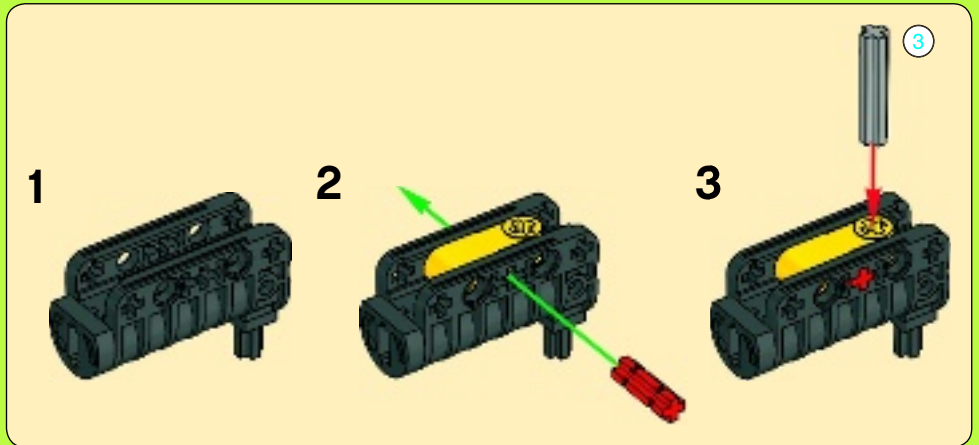

53

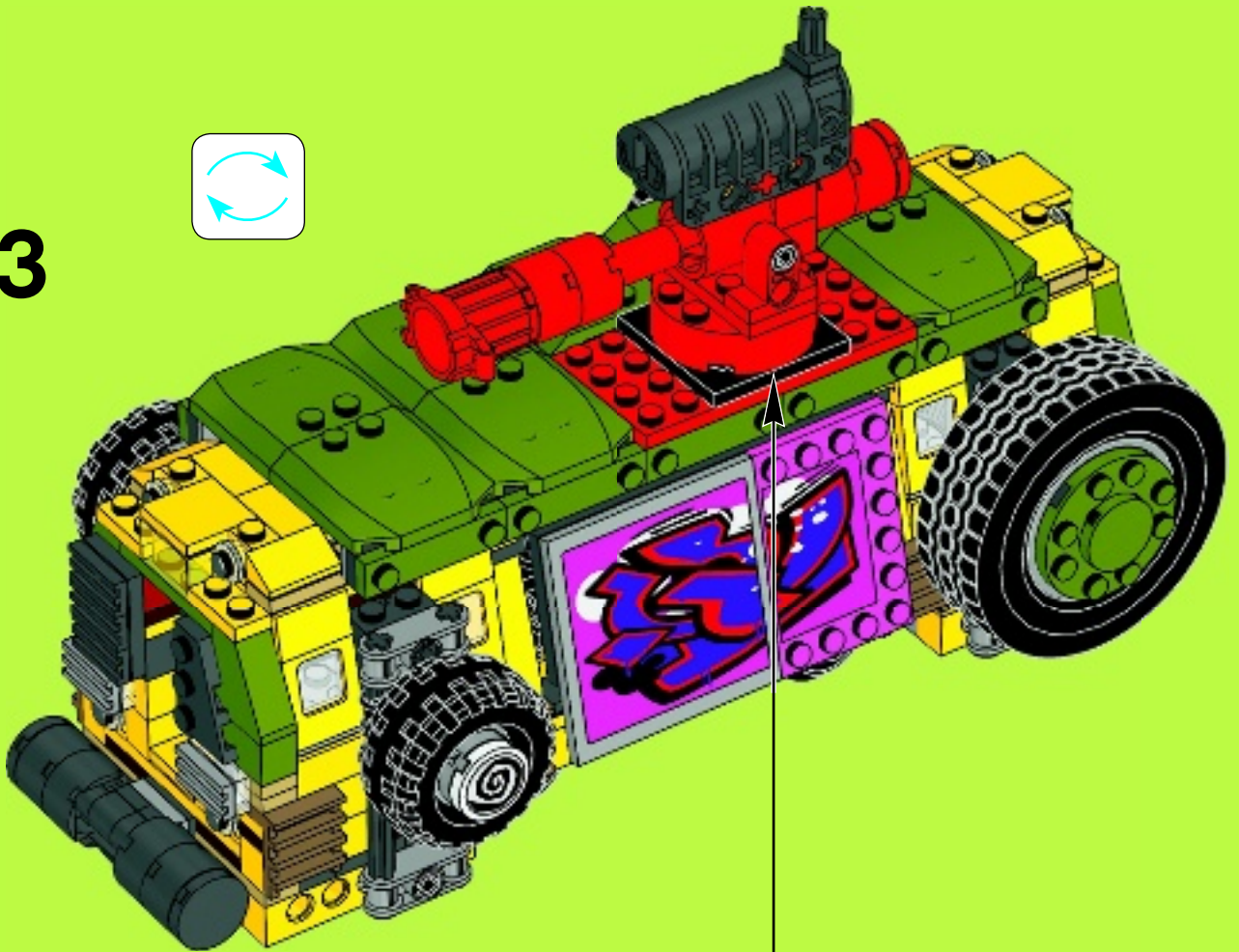

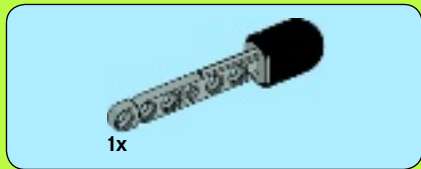

54

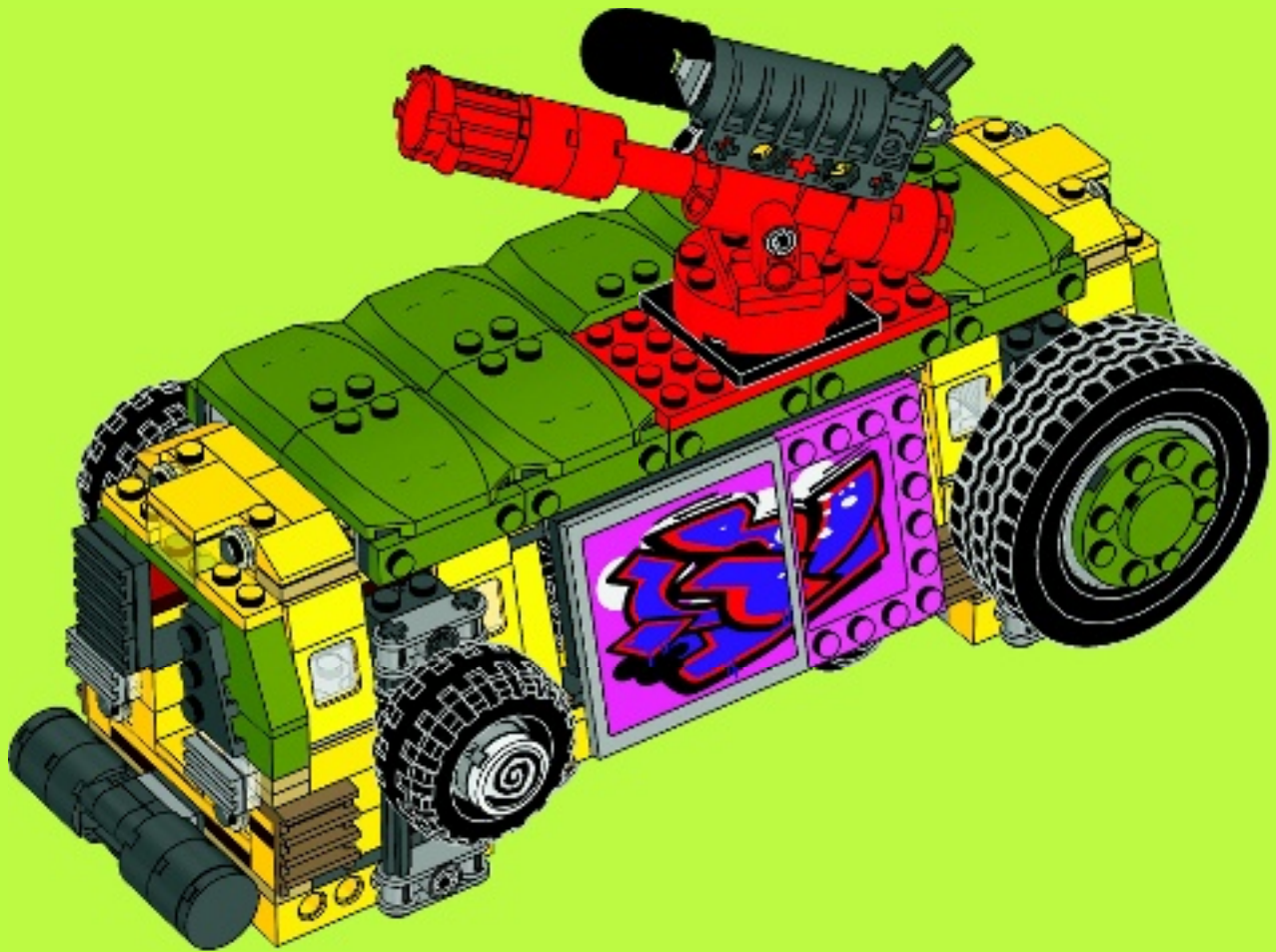

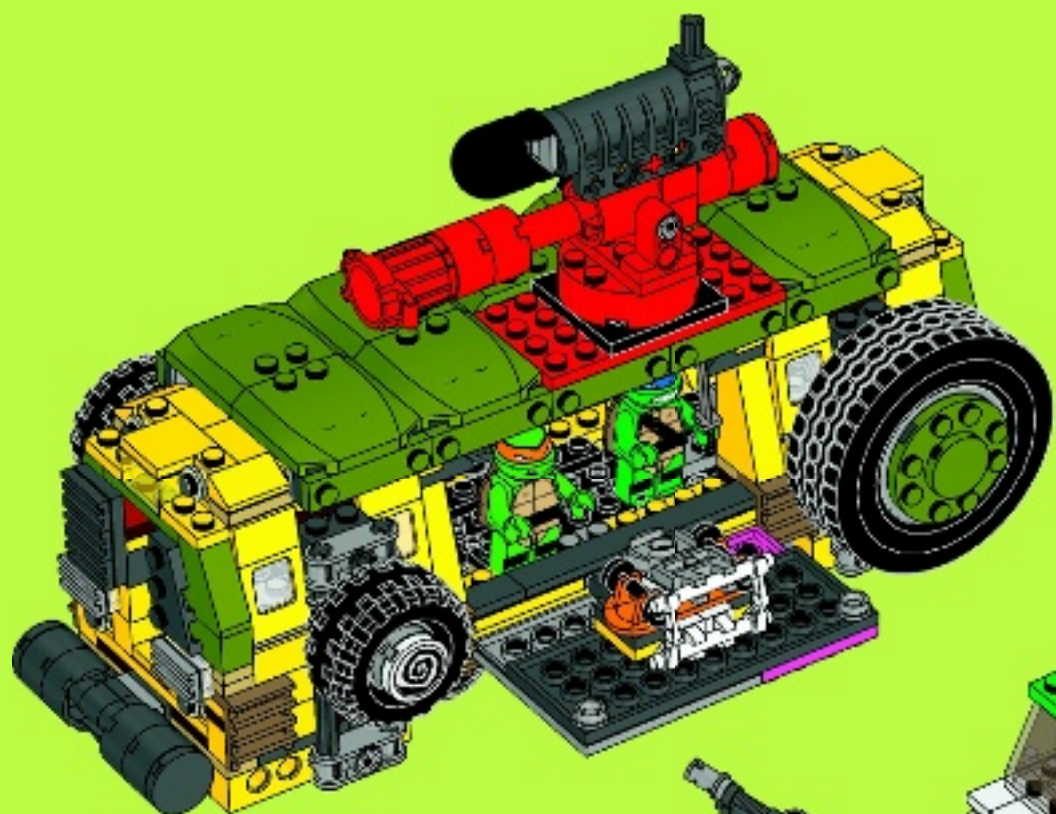

- 6x 362201
- 2x 4119013
- 2x 302401
- 2x 302201
- 2x 4597131
- 2x 6030716
- 4x 6044691
- 1x 4293350
- 5x 306901
- 2x 6018774
- 1x 306801
- 1x 4289304
- 3x 4560178
- 1x 4519345
- 1x 4519346
- 2x 4129836
- 2x 4260649
- 16x 4159553
- 6x 4121921
- 1x 4124067
- 4x 4114324
- 1x 4114001
- 2x 4114309
- 10x 4185273
- 2x 4143005
- 1x 4244747
- 1x 4610843
- 2x 366521
- 2x 4259678
- 1x 371021
- 1x 302021
- 1x 303521





- 2x 4207715
- 1x 6066342
- 1x 6030164
- 1x 4142865
- 1x 4526984
- 2x 4513987
- 4x 614321
- 2x 4542673
- 12x 300524
- 6x 300424
- 4x 362224
- 8x 407024
- 4x 389424
- 10x 4121965
- 4x 6024687
- 22x 302324
- 4x 302224
- 1x 371024
- 9x 366624
- 7x 379524



- 4x 4550348
- 2x 306924
- 2x 306824
- 4x 4560181
- 8x 4521134
- 8x 486524
- 8x 393724
- 1x 4175441
- 2x 4264963
- 2x 249626
- 4x 4140430
- 2x 4599499
- 1x 302026
- 1x 6048855
- 20x 4121715
- 2x 416226
- 2x 383226
- 2x 370226
- 2x 370326

- 1x 6022943
- 2x 300426
- 1x 6030414
- 6x 366626
- 3x 292626
- 1x 6020193
- 4x 4496343
- 2x 287826
- 1x 4517986
- 4x 4617848
- 2x 4547373
- 1x 370626
- 2x 4218868
- 4x 300226
- 2x 4506553
- 1x 4173328



Customer Service
Kundenservice
Service Consommateurs
Servicio Al Consumidor
LEGO.com/service or dial

00800 5346 5555 :     

1-800-422-5346 :  

1x 4507311
2x 302128
1x 302028
1x 366628
1x 6025395
1x 6024647
1x 6023042
2x 6016931
4x 306928
4x 4666322
1x 6030804
1x 6030807
1x 6030803
2x 4167842
10x 3005740
8x 6024020
2x 4201019
2x 3005741
2x 306544
2x 611649

1x 6030411
1x 6029901
1x 6029936
1x 4654448
8x 6024723
1x 6023060
1x 6023062
1x 6034152
1x 6029899
18x 4211150
4x 4211257
2x 6029774
8x 4211621
8x 4211470
4x 4535738
2x 4211506
1x 4211387
5x 4211397
2x 4211396
1x 6030203

2x 4211716
1x 4211401
1x 4662161
2x 6052200
4x 4211350
4x 4654582
1x 4556157
2x 4211419
6x 6014615
4x 4211356
2x 6014617
11x 4211525
6x 4211475
4x 4211515
1x 4550170
1x 4211760
2x 4299119
1x 4226995

2x 4551421
1x 4211483
2x 4211807
1x 4211815
1x 4211639
1x 4299625
8x 4558955
2x 4213574
4x 4211095
2x 6019987
4x 4211046
18x 4249139
1x 4567887
4x 6069164
2x 4234534
2x 4211119
1x 4211043
4x 4211001
2x 4211065

3x 4211134
4x 4257526
2x 4210997
2x 4211122
2x 4211008
6x 4587212
8x 4210719
2x 4620079
4x 4210631
2x 4211052
1x 6048854
1x 6000606
4x 4521187
2x 4210869
1x 4210872
2x 4211039
1x 4623236
1x 4600437
2x 4560177

8x 4499858
1x 6064131
1x 4614404
2x 4619636
2x 4612900
1x 4612901
4x 4624473
2x 4298979
6x 6024722
4x 6024692
10x 6024727
2x 6020144
2x 6024665
2x 6024666
8x 6024696
2x 6024672
1x 6030246
1x 6023047
1x 6025366



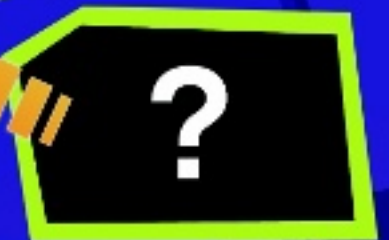

LEGO.COM/TURTLES

79104



79100



79102



79101



79103



79105





79100



79100



79100



79101



79101



79101



79102



79102



79102



79103



79103



79103



79103



79103



79104



79104



79104



79104



79104



79105



79105



79105



79105



nickelodeon.
TEENAGE MUTANT NINJA
TURTLES™



club™

Free*! Gratuit !

* Paid subscription in Australia and New Zealand.
Abonnement payant en Australie et Nouvelle-Zélande.

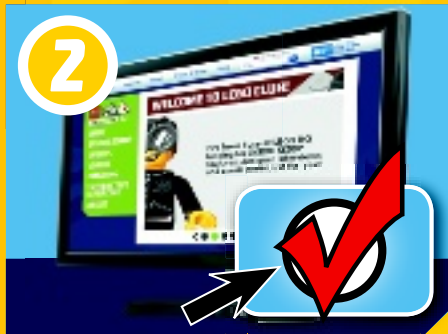

LEGO.com/club



WIN!

Go to www.LEGOsurvey.com/product to fill out a survey for a chance to win a cool LEGO® Product.

No purchase necessary.

Open to all residents where not prohibited.



LEGO.com



www.LEGOsurvey.com/product

GEWINNE!

Nimm an der Umfrage auf www.LEGOsurvey.com/product teil und hab die Chance ein cooles LEGO® Produkt zu gewinnen!
Die Teilnahme am Gewinnspiel führt zu keinerlei Kaufverpflichtungen. Teilnahme in allen nicht ausgeschlossenen Ländern möglich.

WIN!

Ga naar www.LEGOsurvey.com/product, vul een enquêteformulier in en maak kans op een cool LEGO® product.
Geen aankoopverplichting.
Iedereen mag deelnemen, uitgezonderd ingezetenden van landen waar een enquêteverbod geldt.

GAGNE !

Visite www.LEGOsurvey.com/product pour répondre à un questionnaire et avoir une chance de gagner un produit LEGO® très cool !
Aucune obligation d'achat.
Ouvert à tous les résidents des pays autorisés.

当てよう!

www.LEGOsurvey.com/product にアクセスして、アンケートにご記入ください。当選者にはレゴ®製品を差し上げます。
お買い上げの必要はありません。
禁止されていない限り、すべての皆様にご利用いただけます。