



THE HOBBIT

AN UNEXPECTED JOURNEY

79002







1

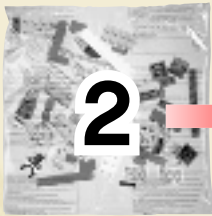

2

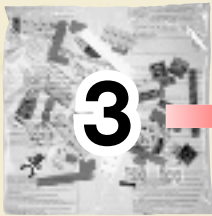

3

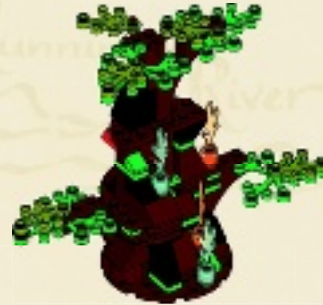

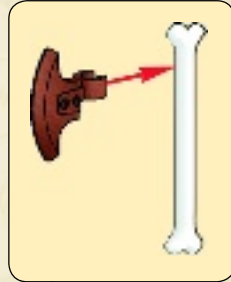
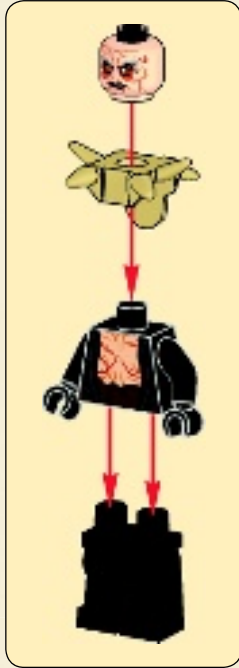

1



2



3

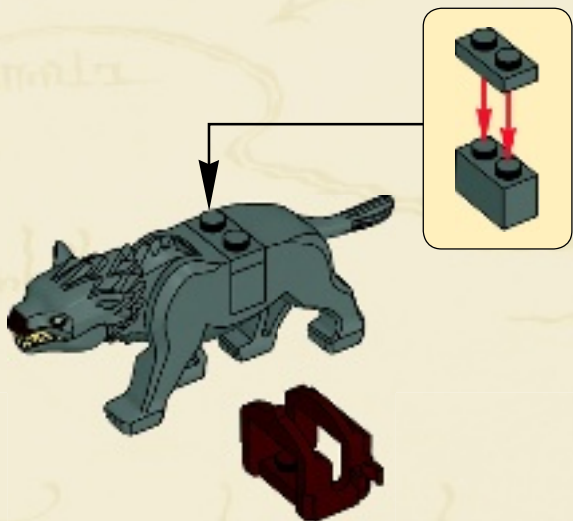

1

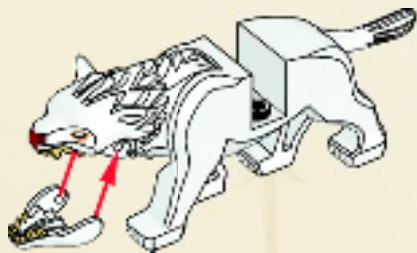

2



3

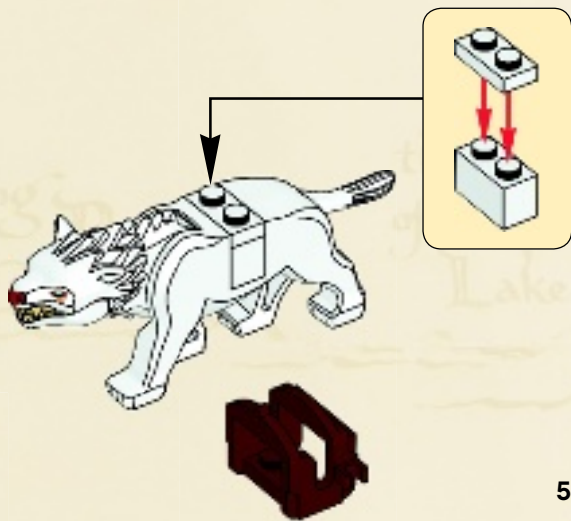

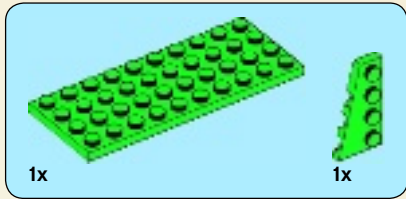

1

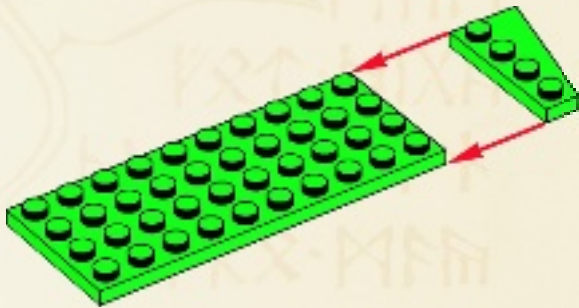

2

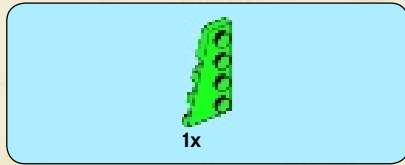

3





4

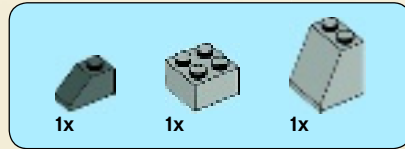
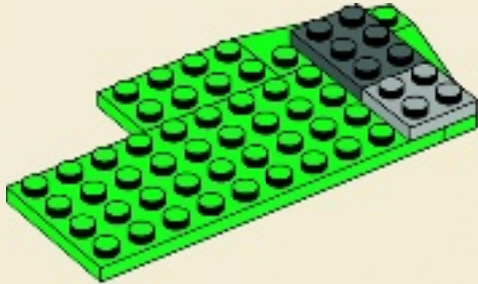

6

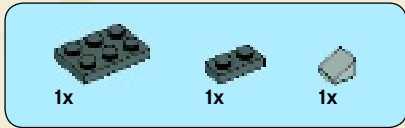
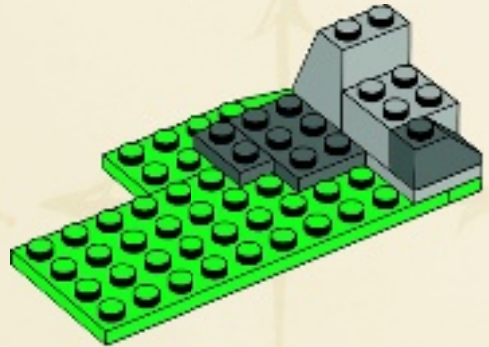

5

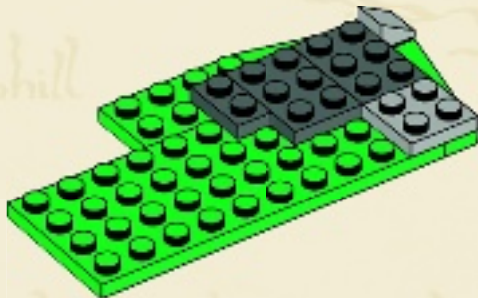

7





8

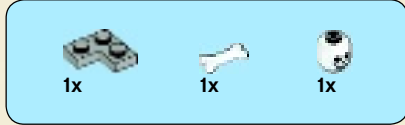
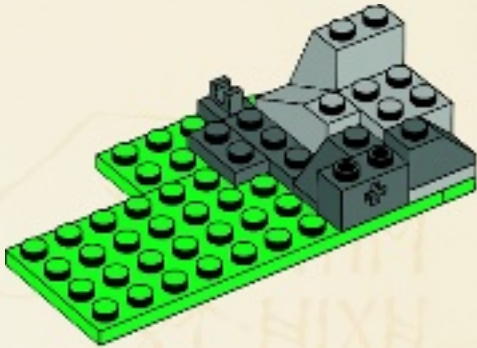

9

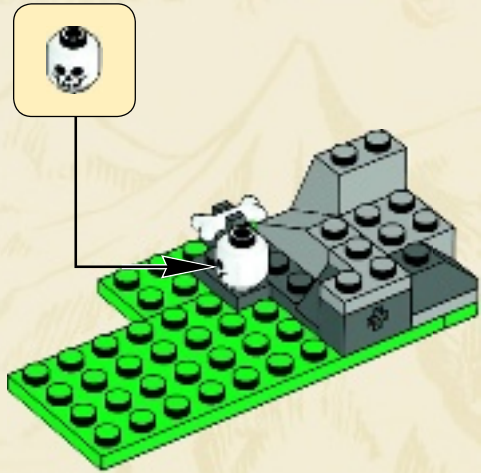

Here of old was Thror
King under the Moun

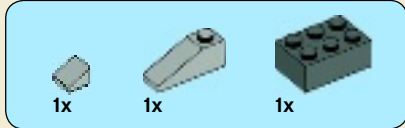

10

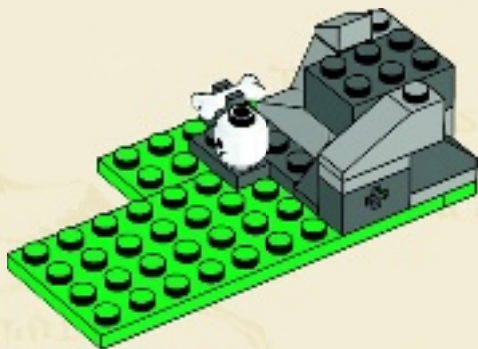

11





1x

12

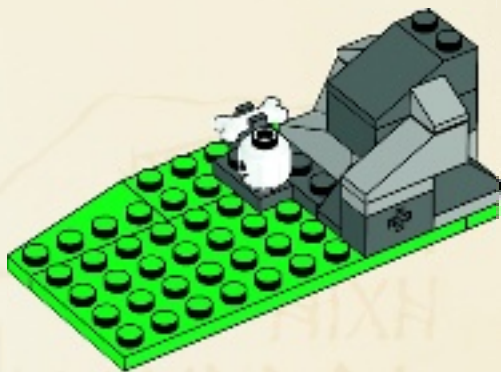

1x



1x

13





2x

14

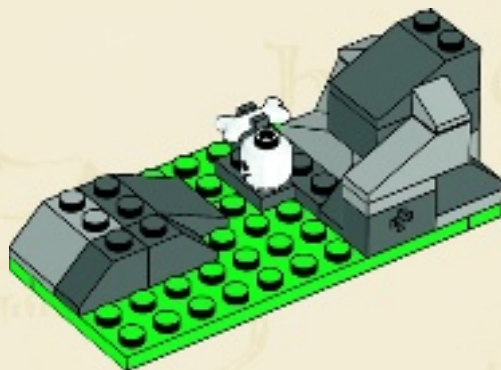

1x



1x

15





1x

16

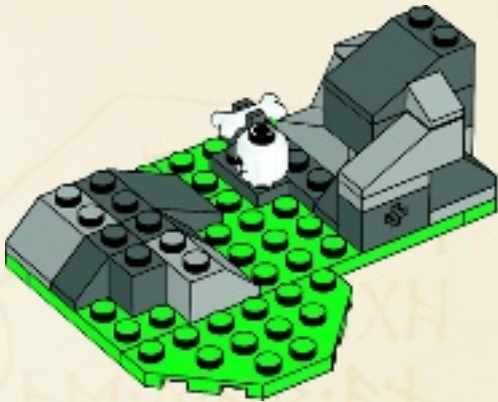

1x



2x

17

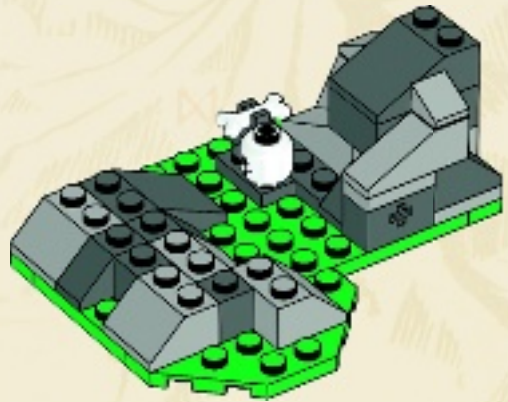



1x



1x

18

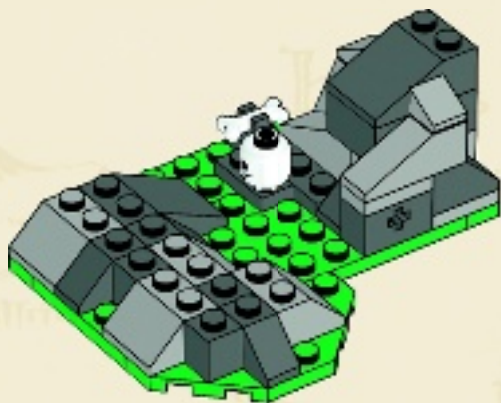

1x



2x



1x



2x

19

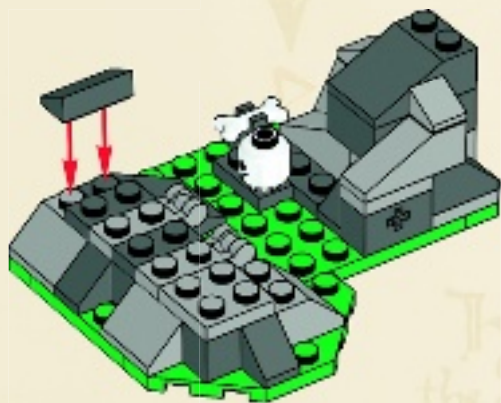

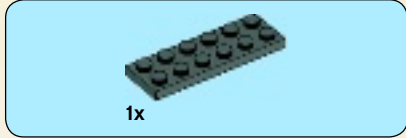

20

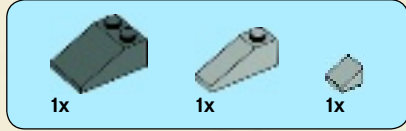
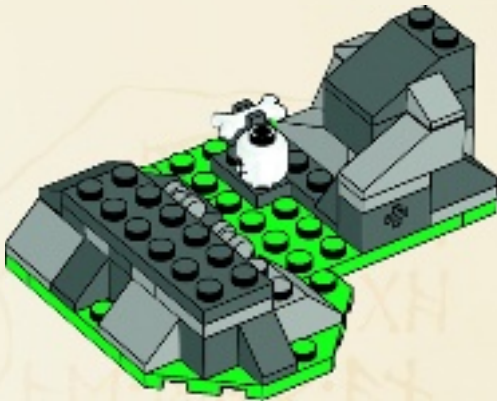

21

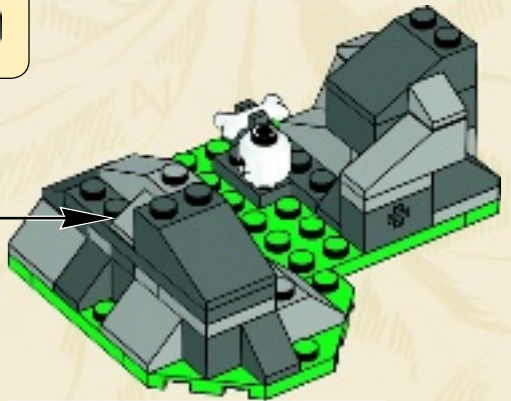

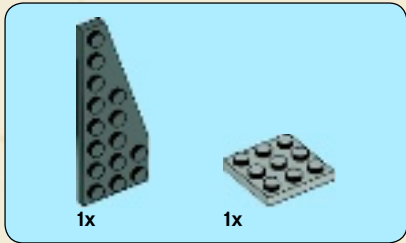

1



2

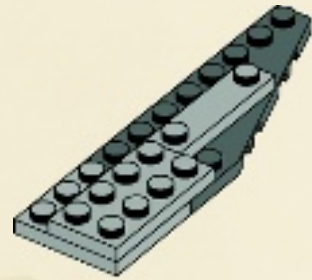

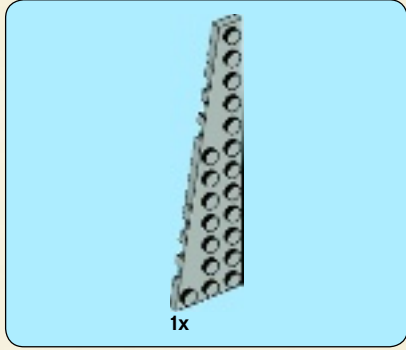

1x

3

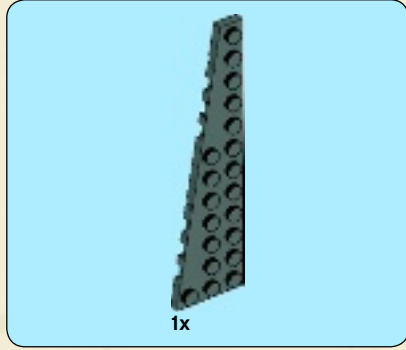
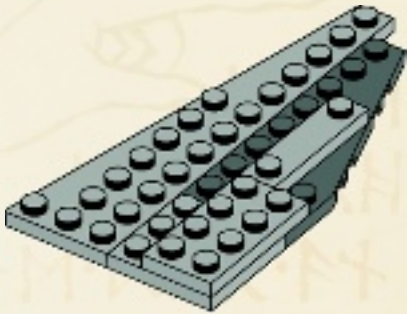

1x

4

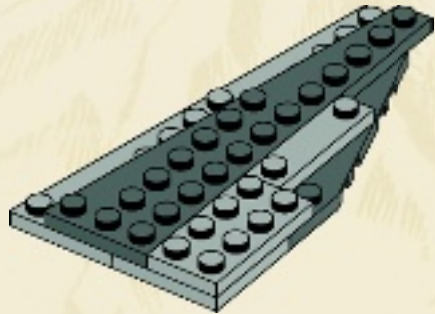



5

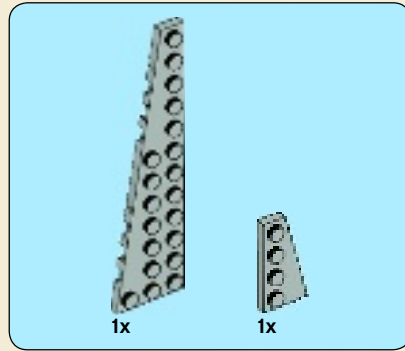
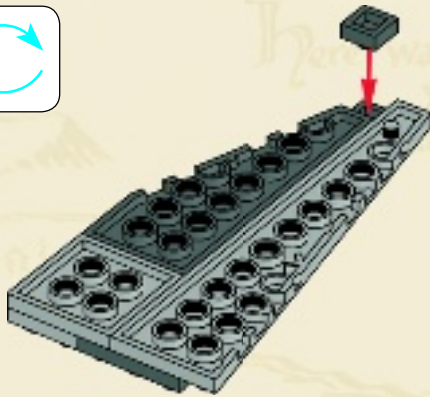
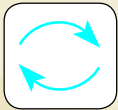

6

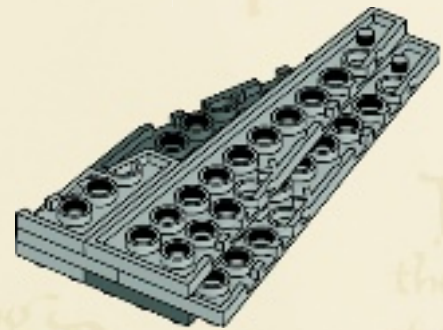



1x

7

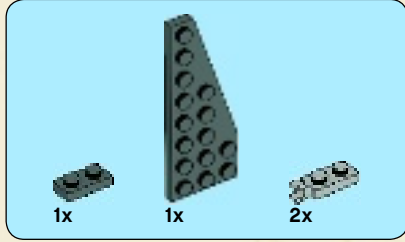
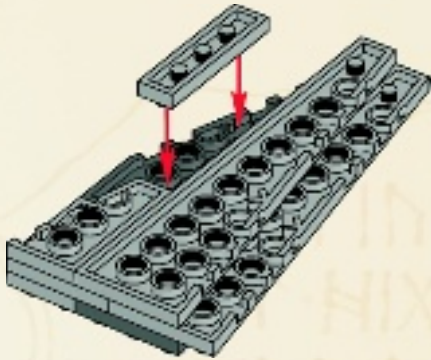

8

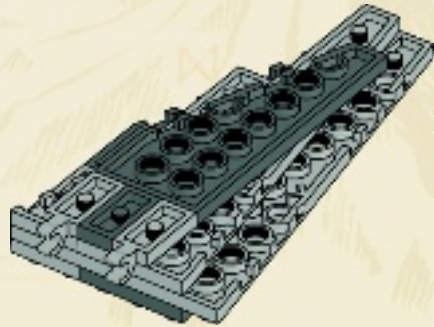



1x

9

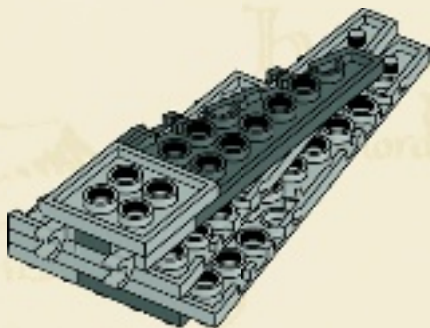

1x



1x

10

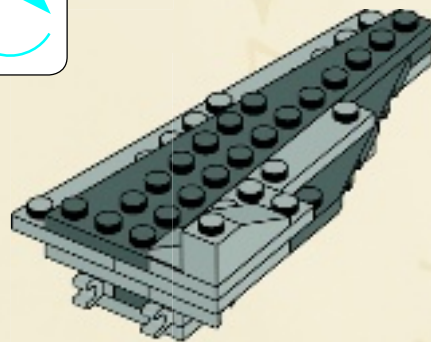
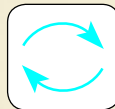

22

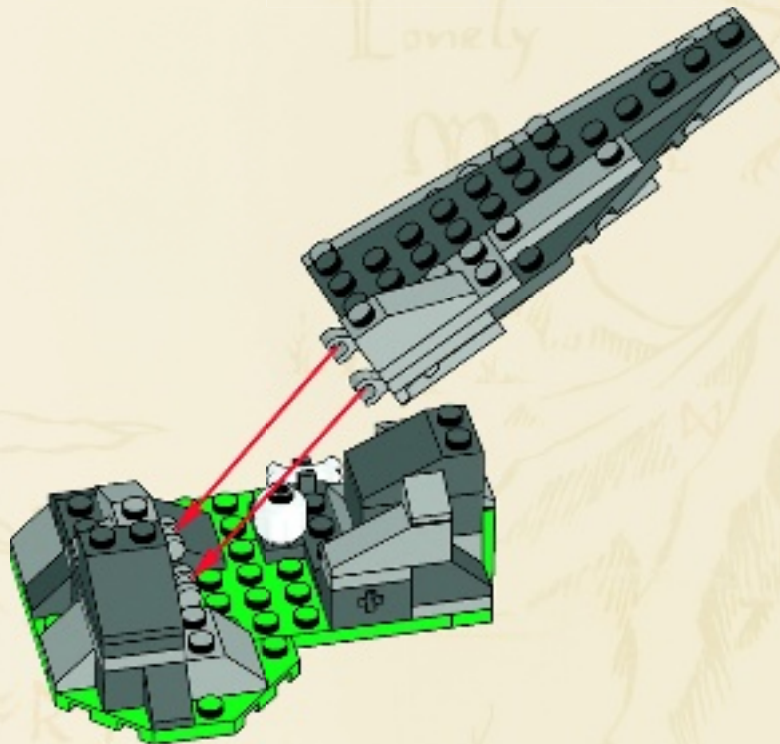

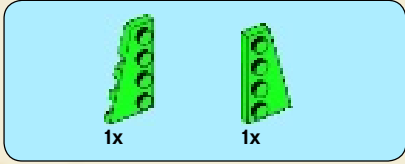

1

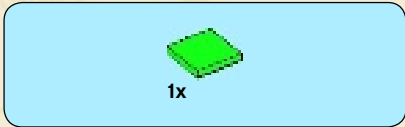
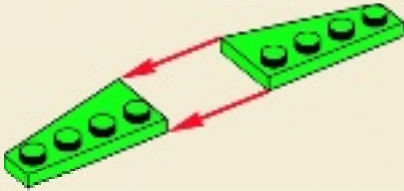

2

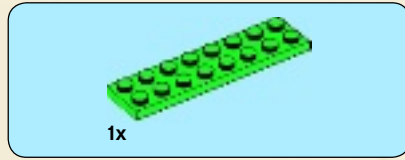
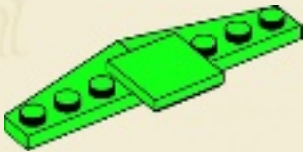

3

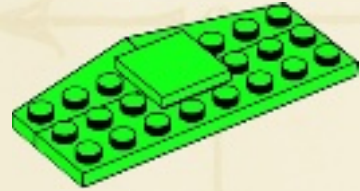

4

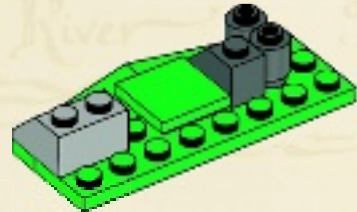



2x

5

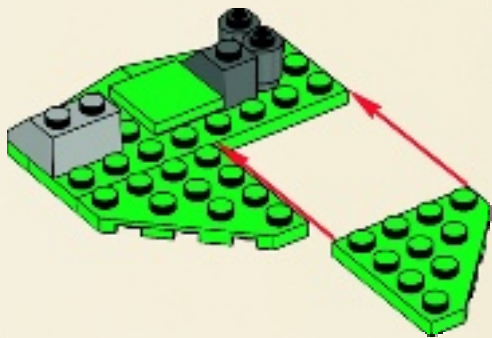

1x



1x

6



3x

7



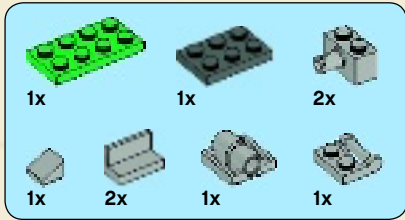

8

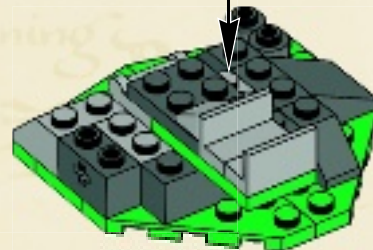
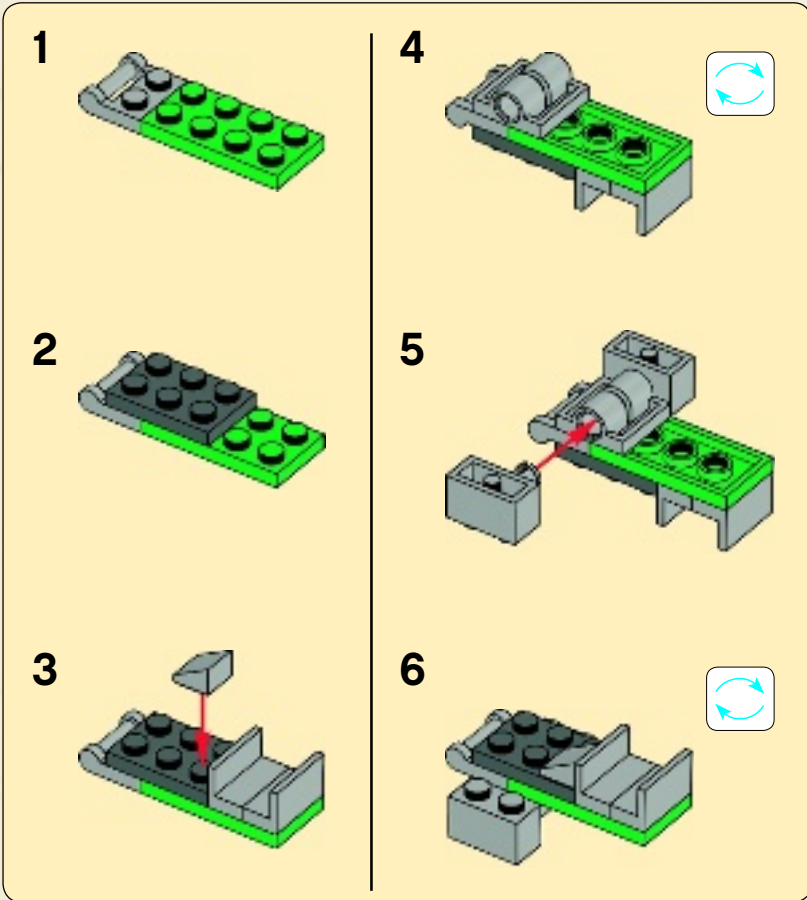

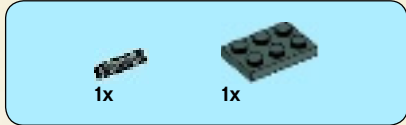

9

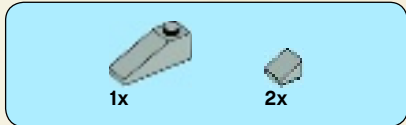
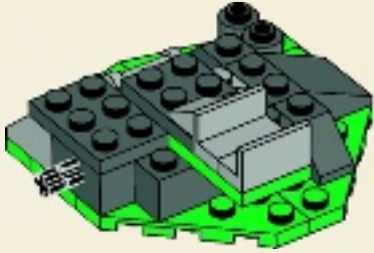

10

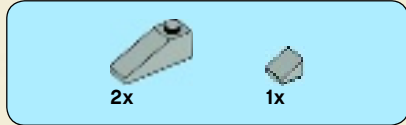
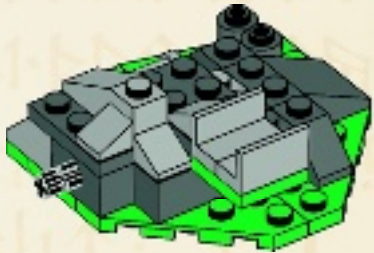

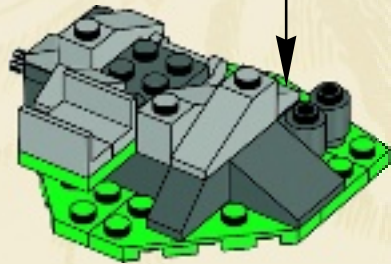
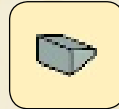
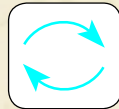

11

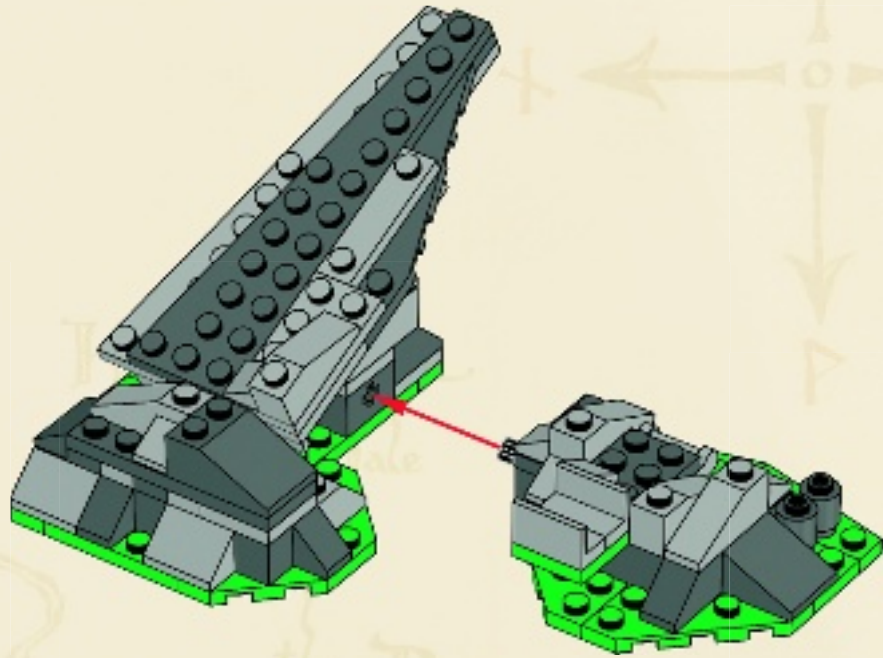

23



				
2x	2x	8x	8x	10x

24

1



2



3



4



5



6



2x

↑ East lie the Iron Hills
where is Dair

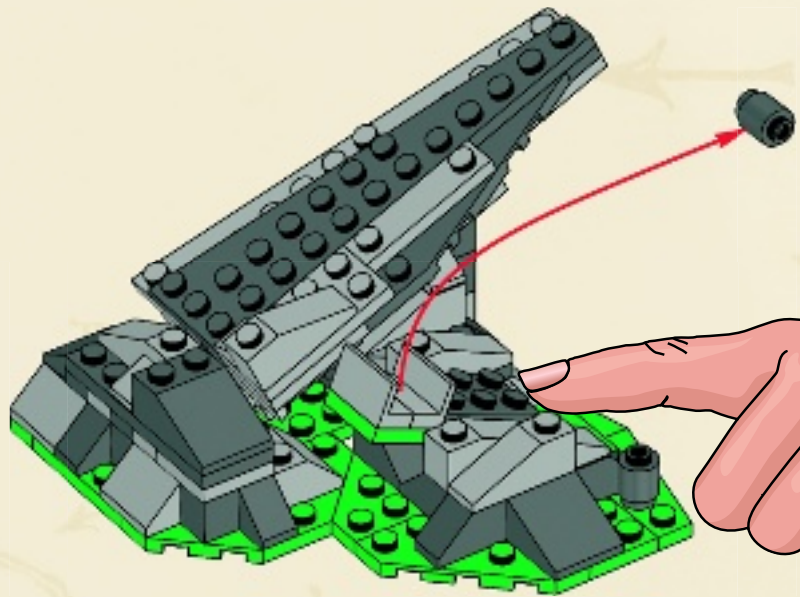

Amaly

Ravenhill



Running River

Here is
the gateway
of the Long
Lake

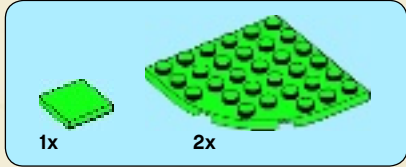

1

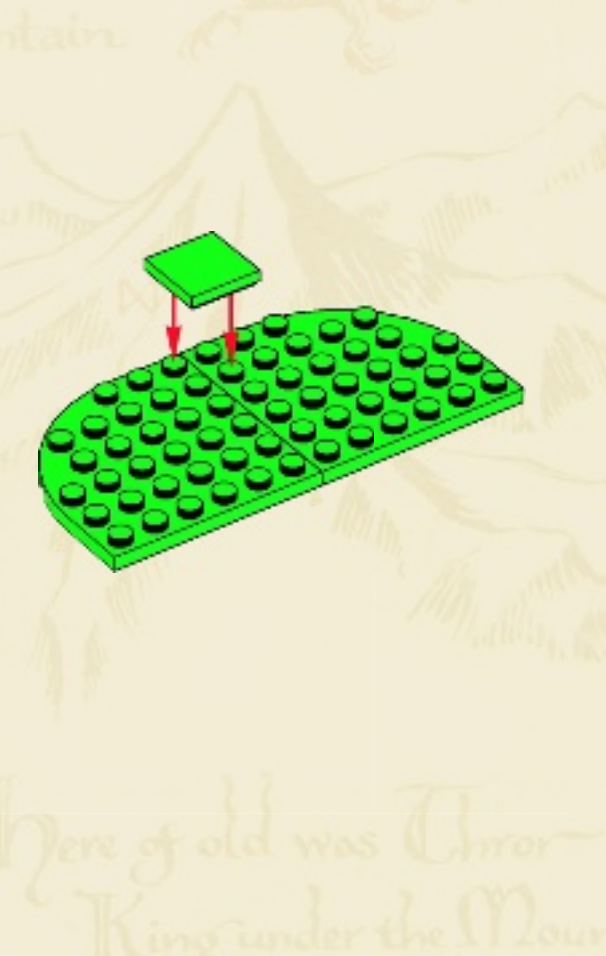
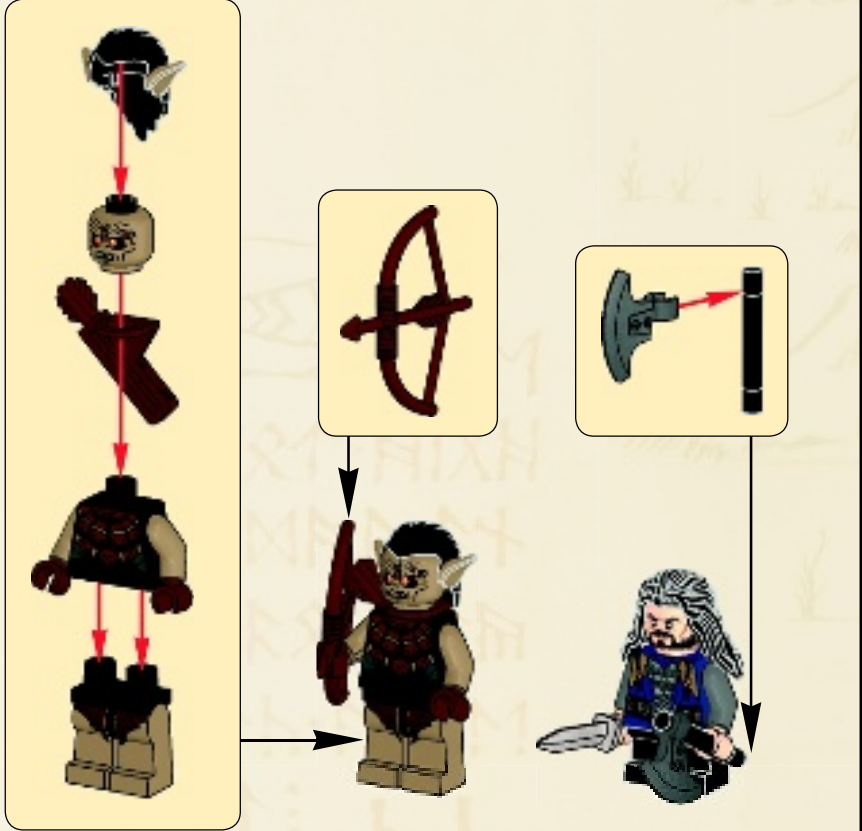

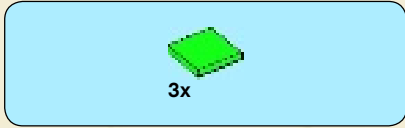

2

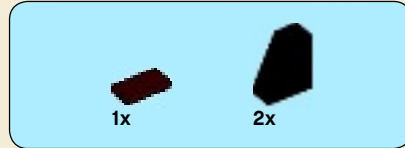
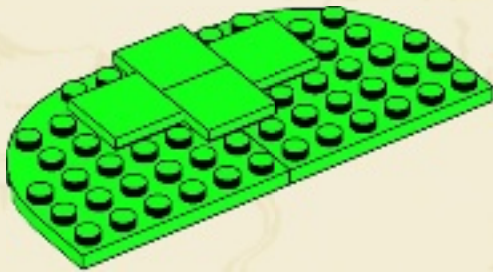

3

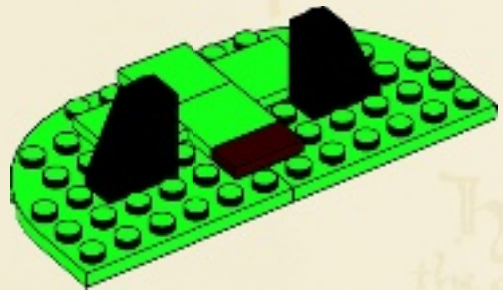

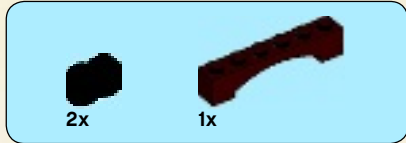

4

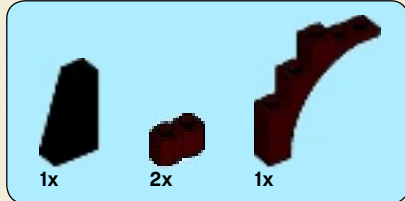
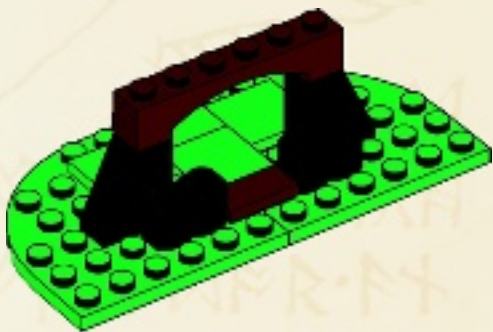

5

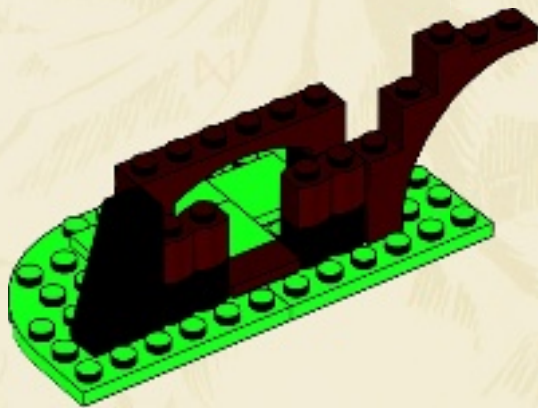

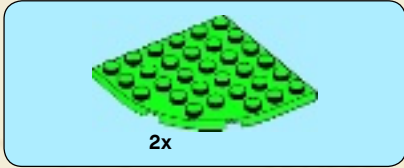

6

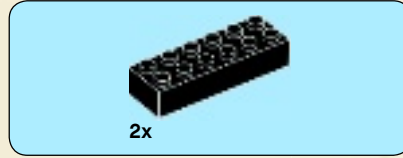
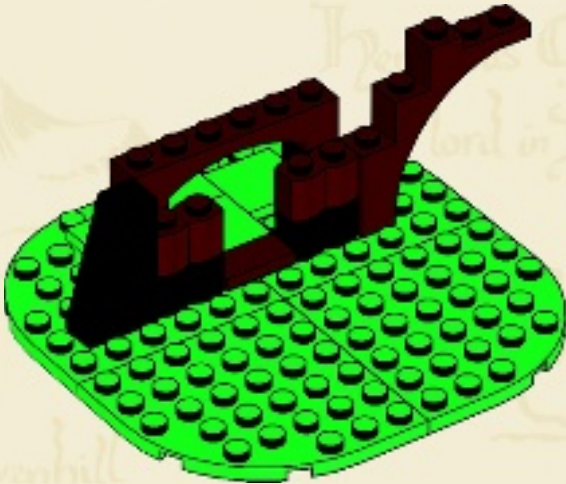

7

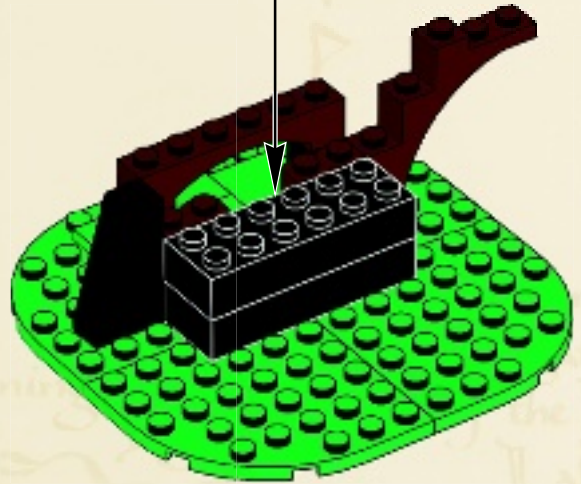
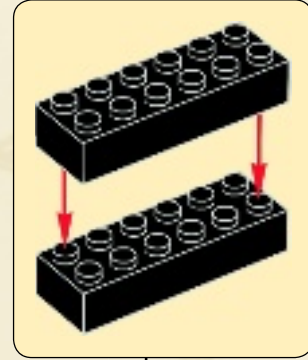



8

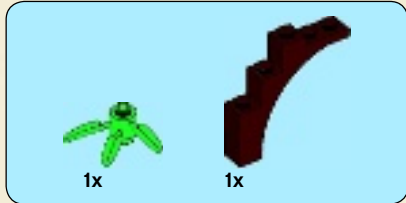
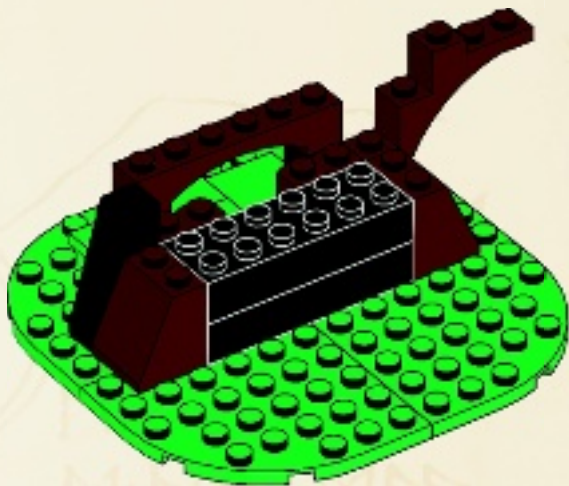

9

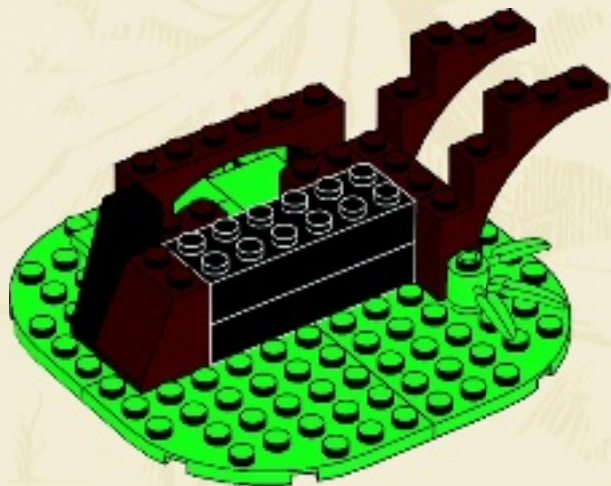



4x

10

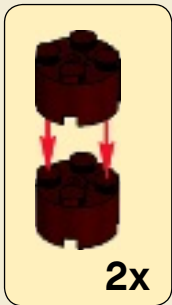

2x

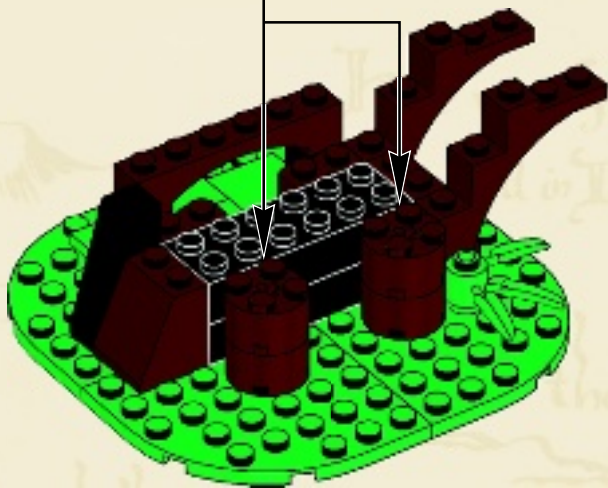

1x



2x

11

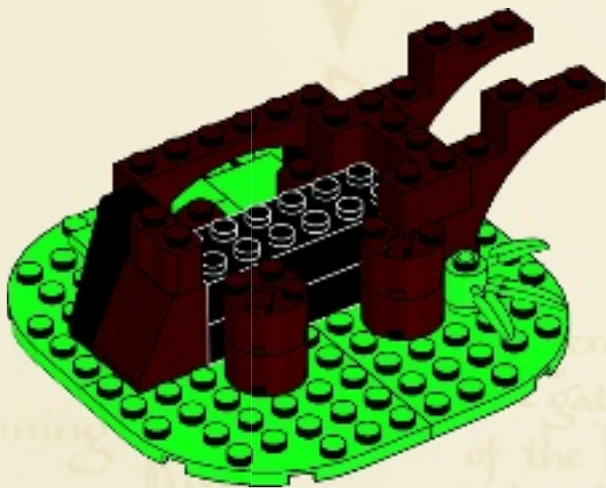



12

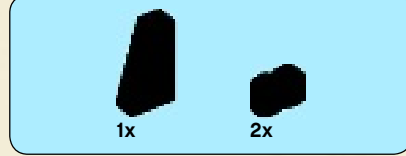
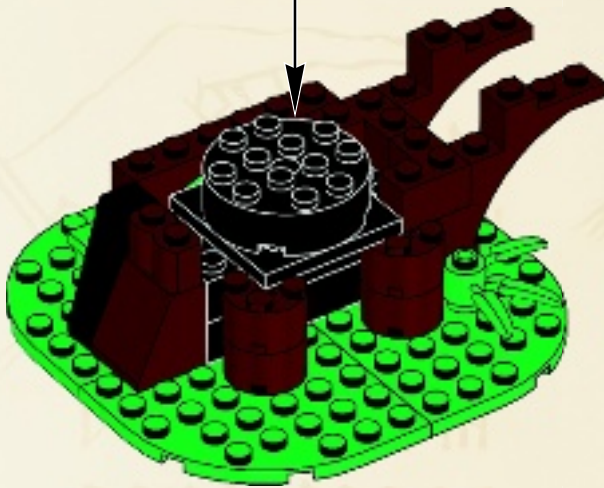
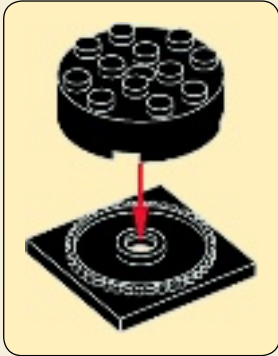

13

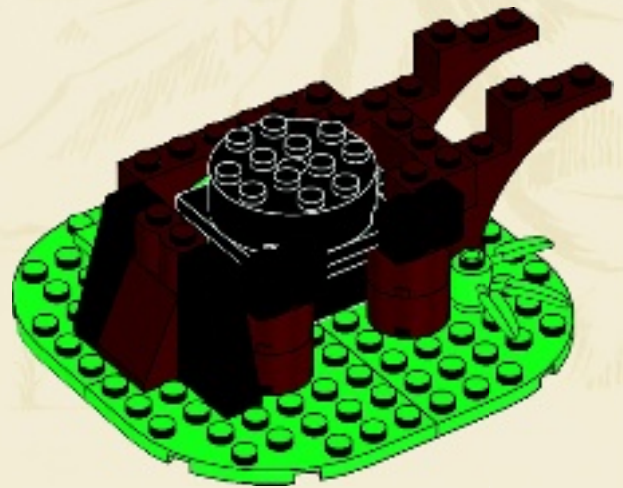



4x

14

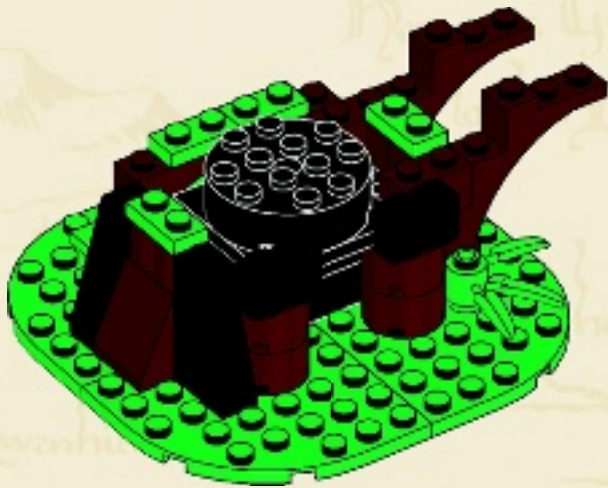

4x

15

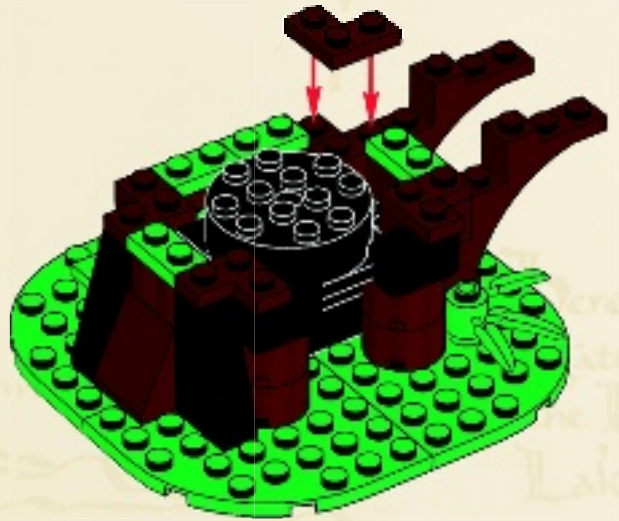



2x

16

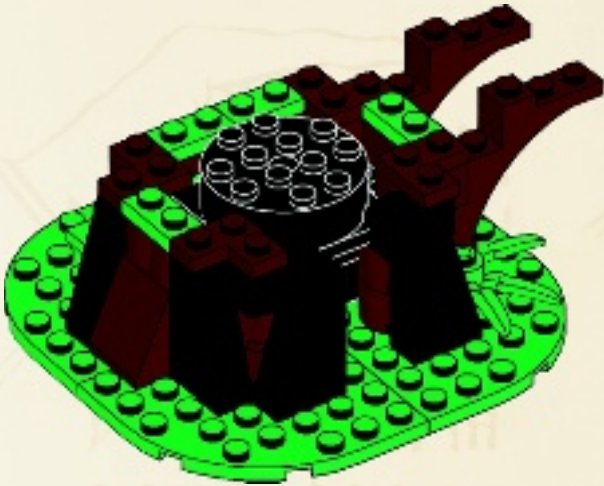

1x



1x

17

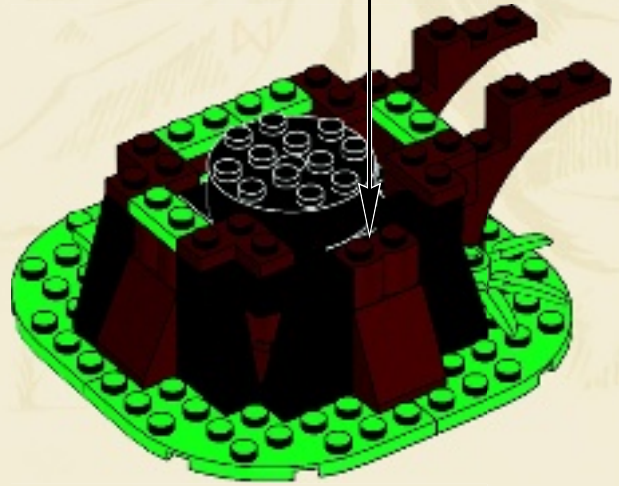
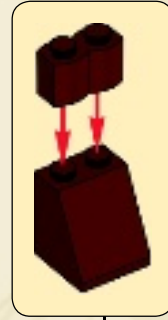



18

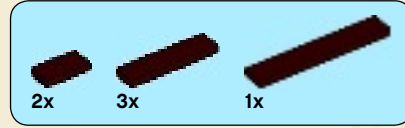

19

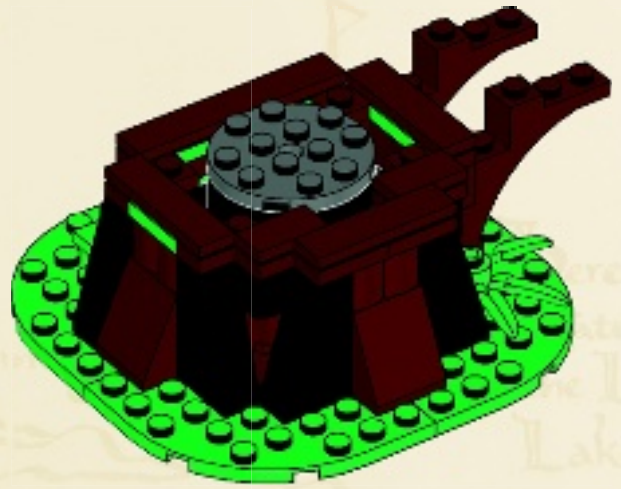

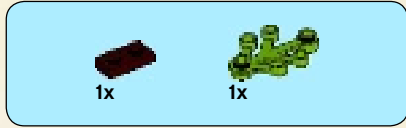



20



21



		
1x	2x	2x

22

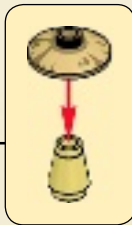
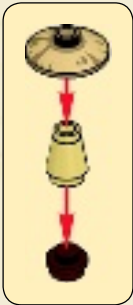

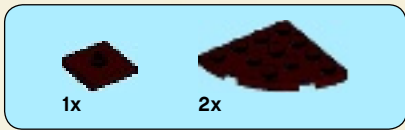

1



2

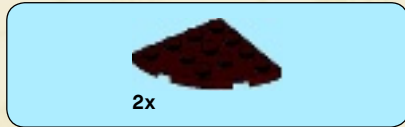

3



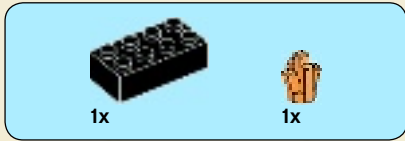

4



6



5



7



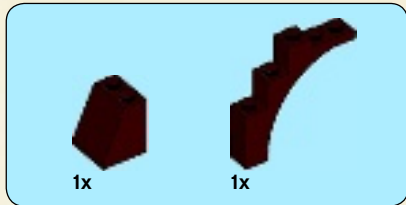

8

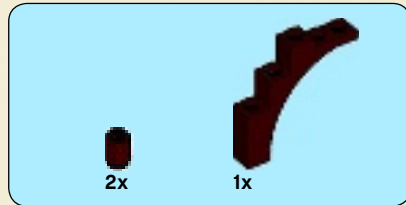

9

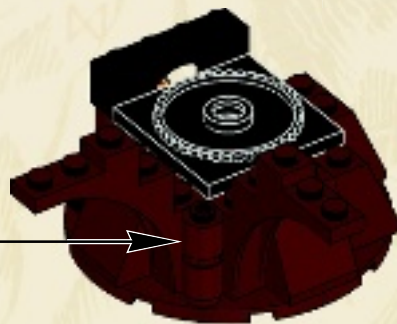
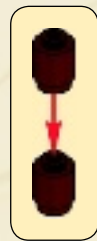

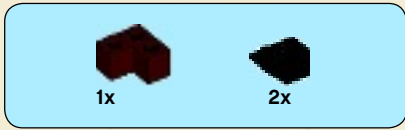

10

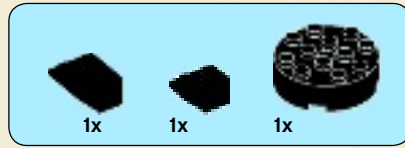
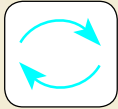

11





2x

12



13



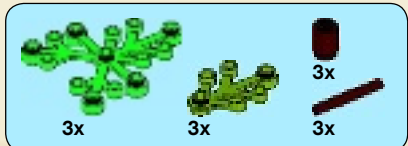

14

1

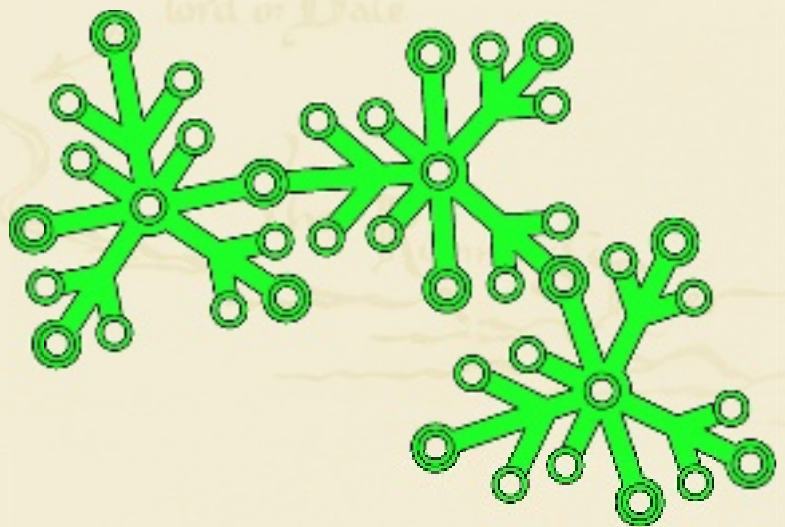
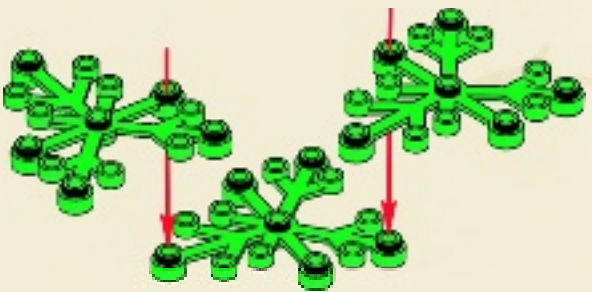

1:1

2

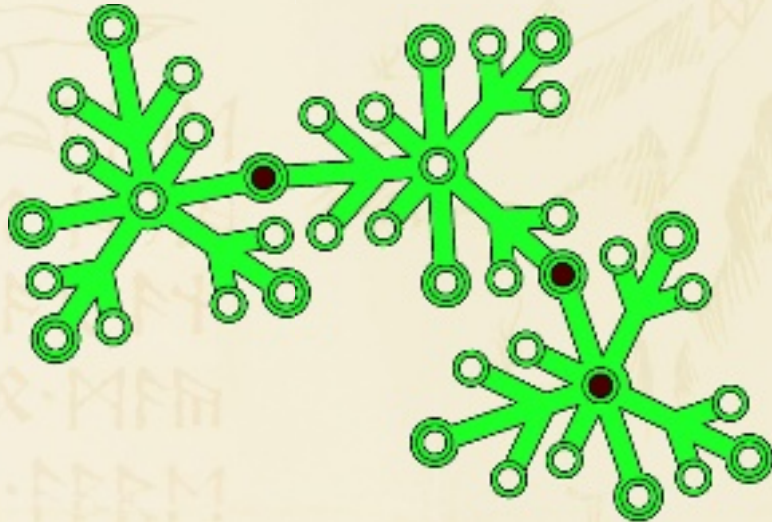

1:1

3



4



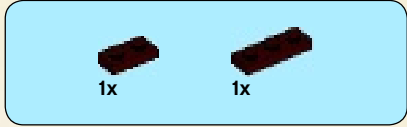

15



16



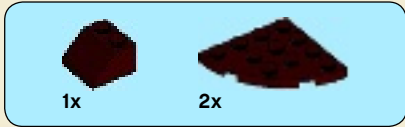
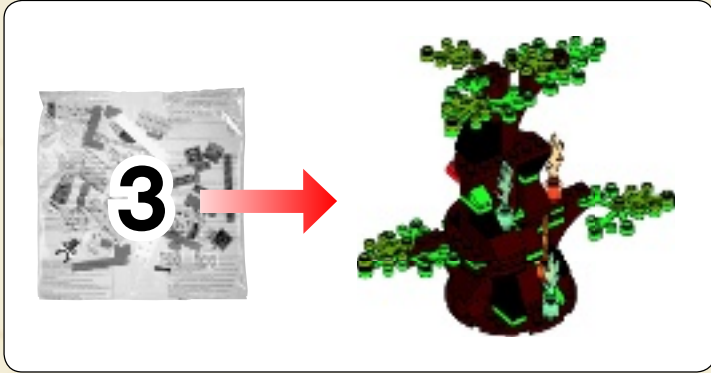

1

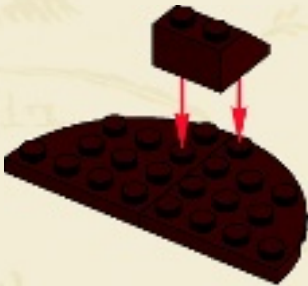

2

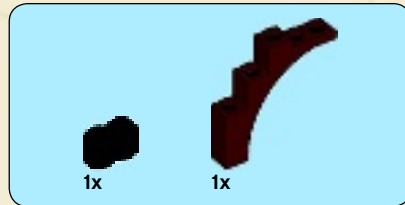
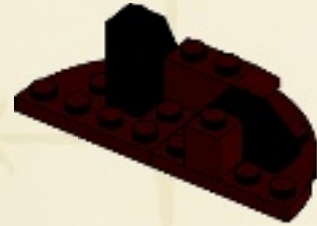

3

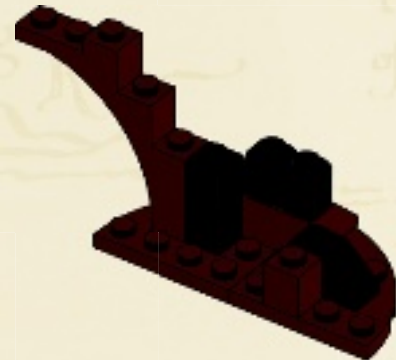



2x

4



3x

5

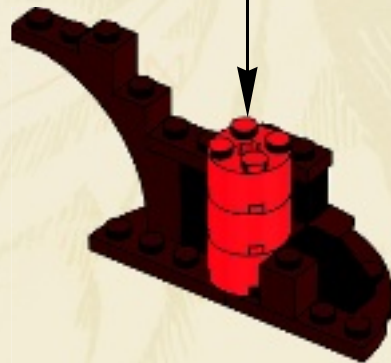



6

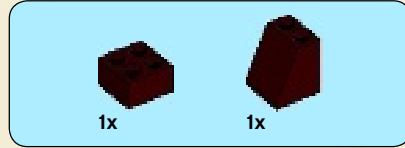

7





8

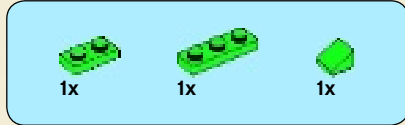
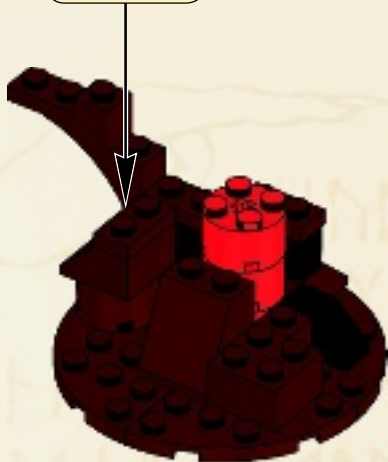
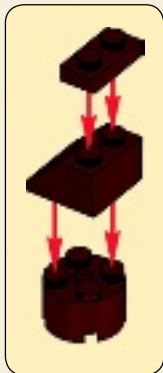

9



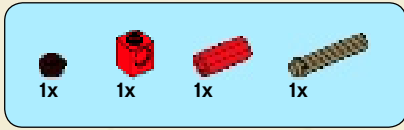

10

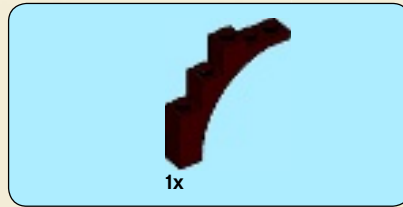
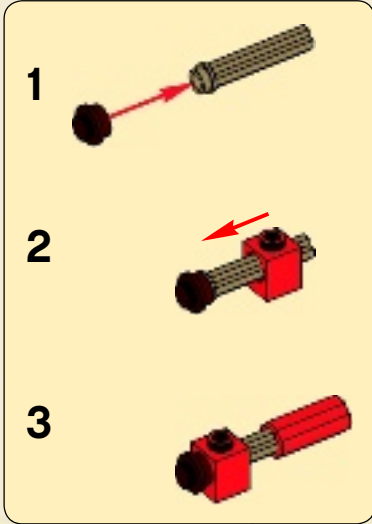

11





12



13





14



15





2x

16

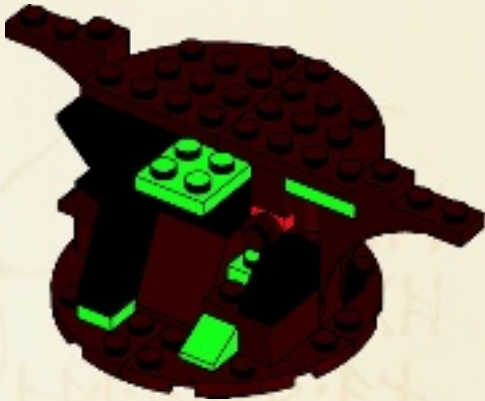

3x



3x



1x



2x

17



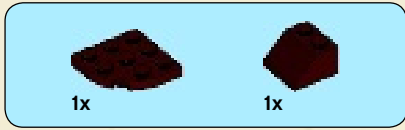

18

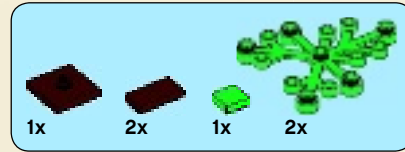
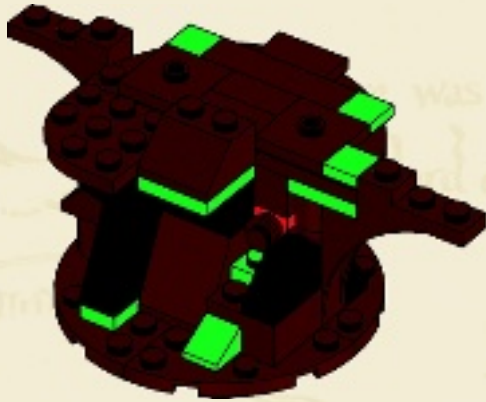

19

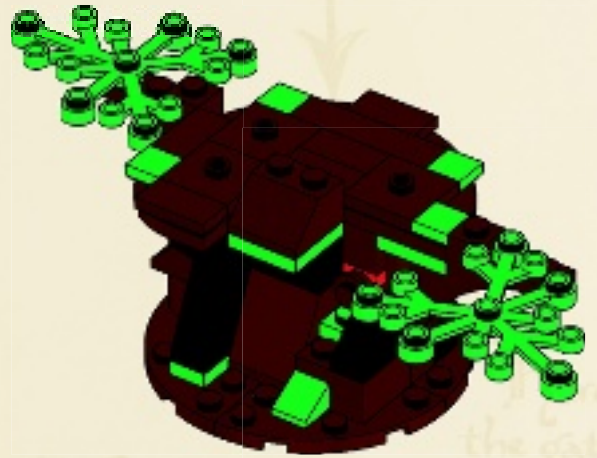

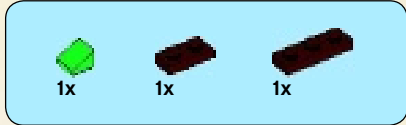

20



21

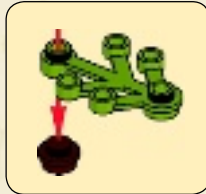

22

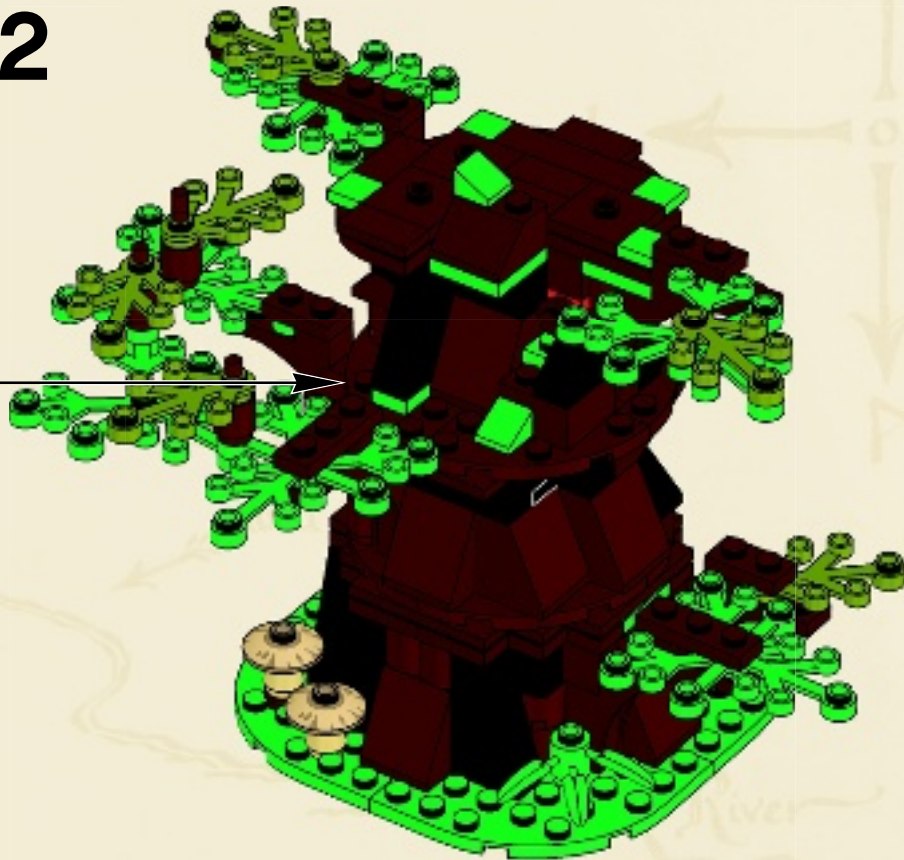



1

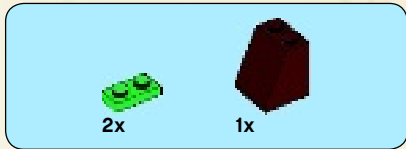
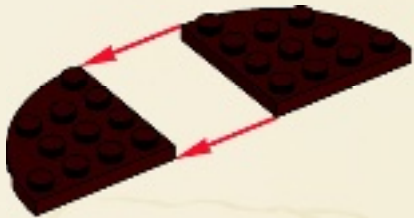

2

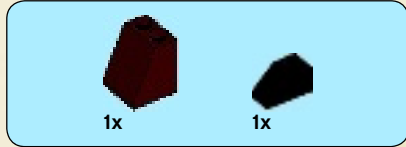

3



4



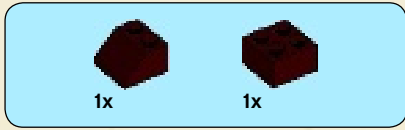

5



6

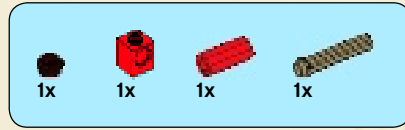

7

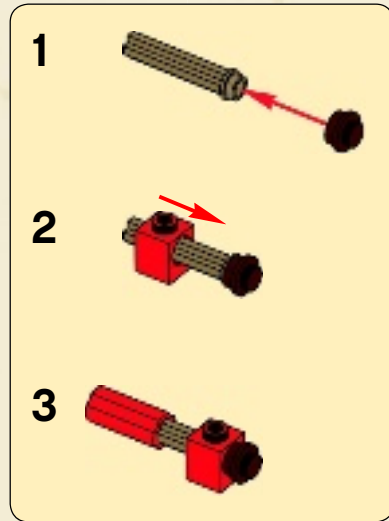



1x



1x

8



1x



1x



1x



1x

9



1x



1x



3x

10





2x

11

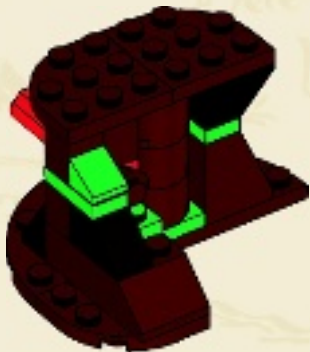

2x

12

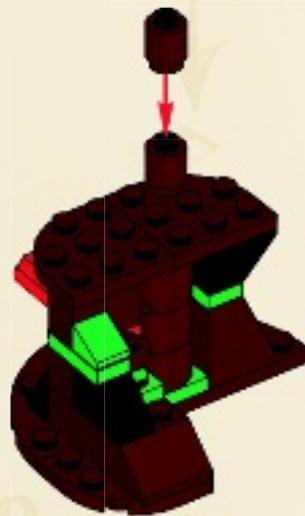

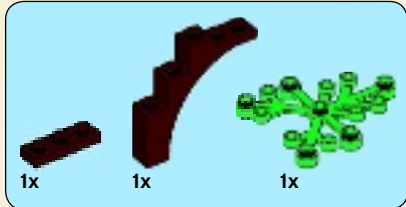

13

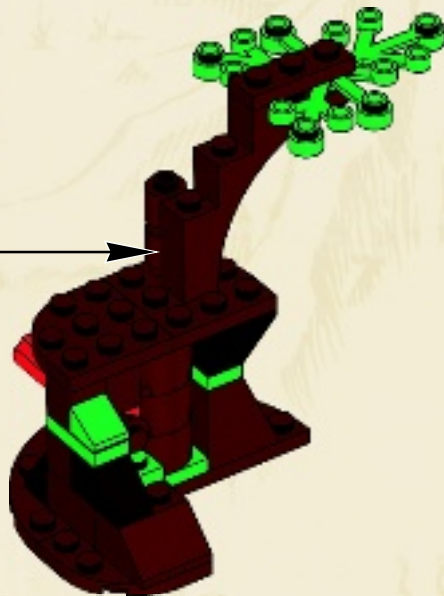
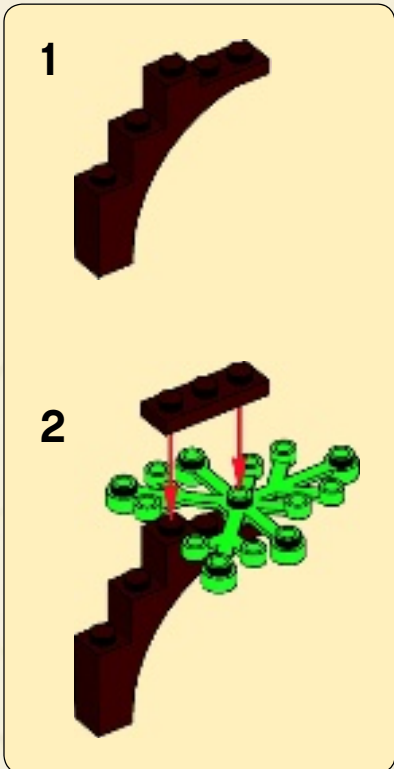



2x

14



2x



1x

15

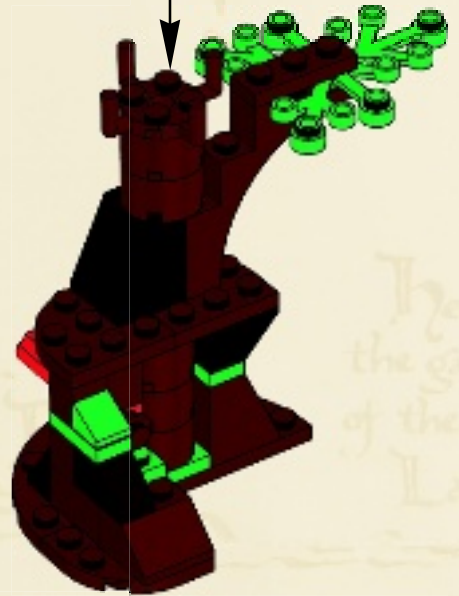
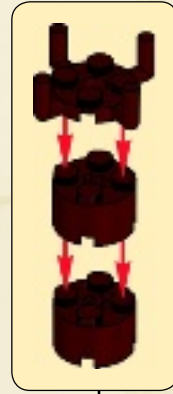



16

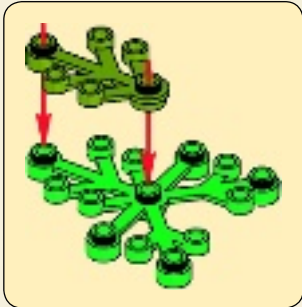

17

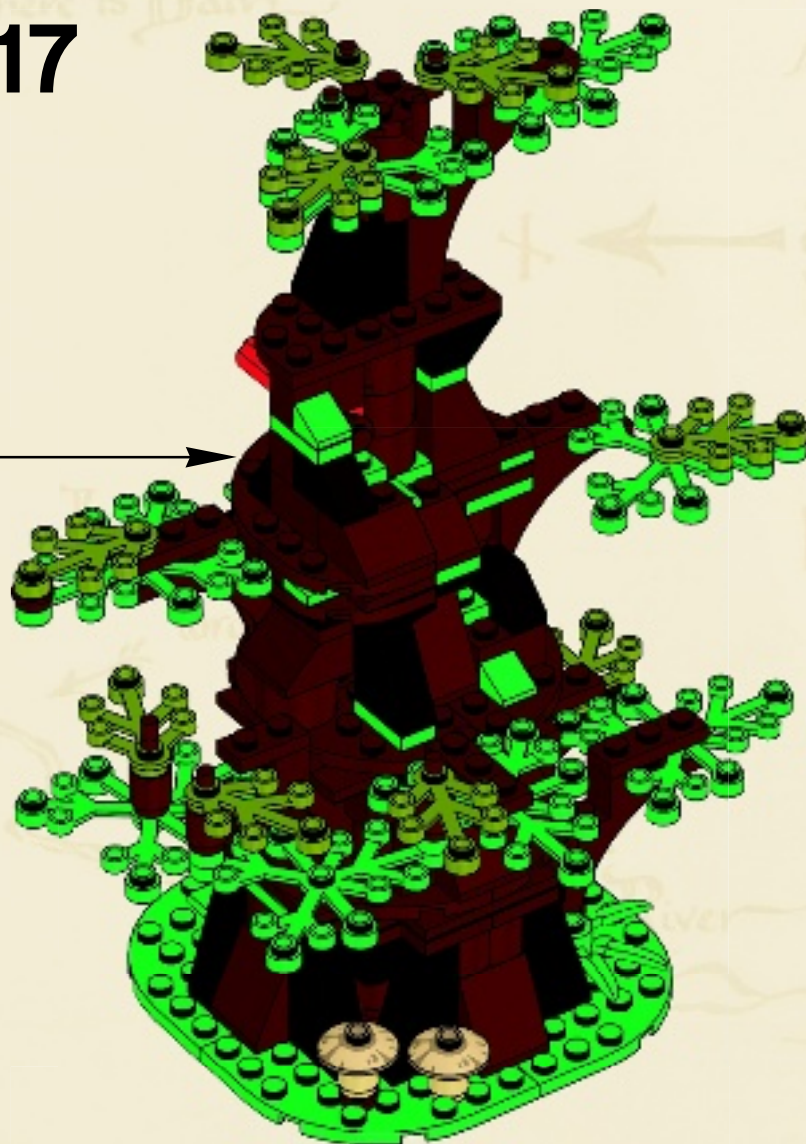



18

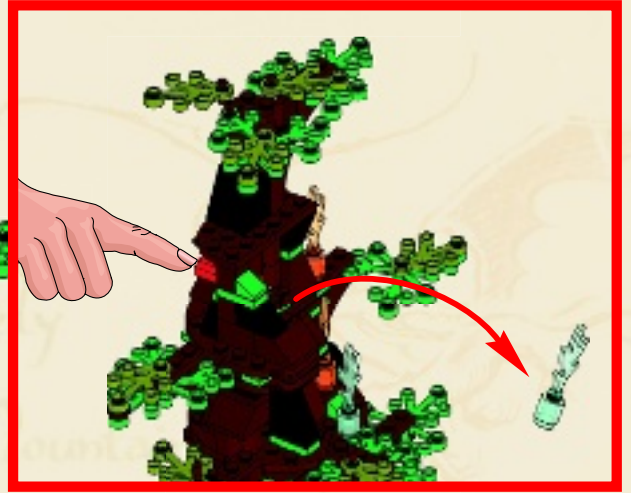
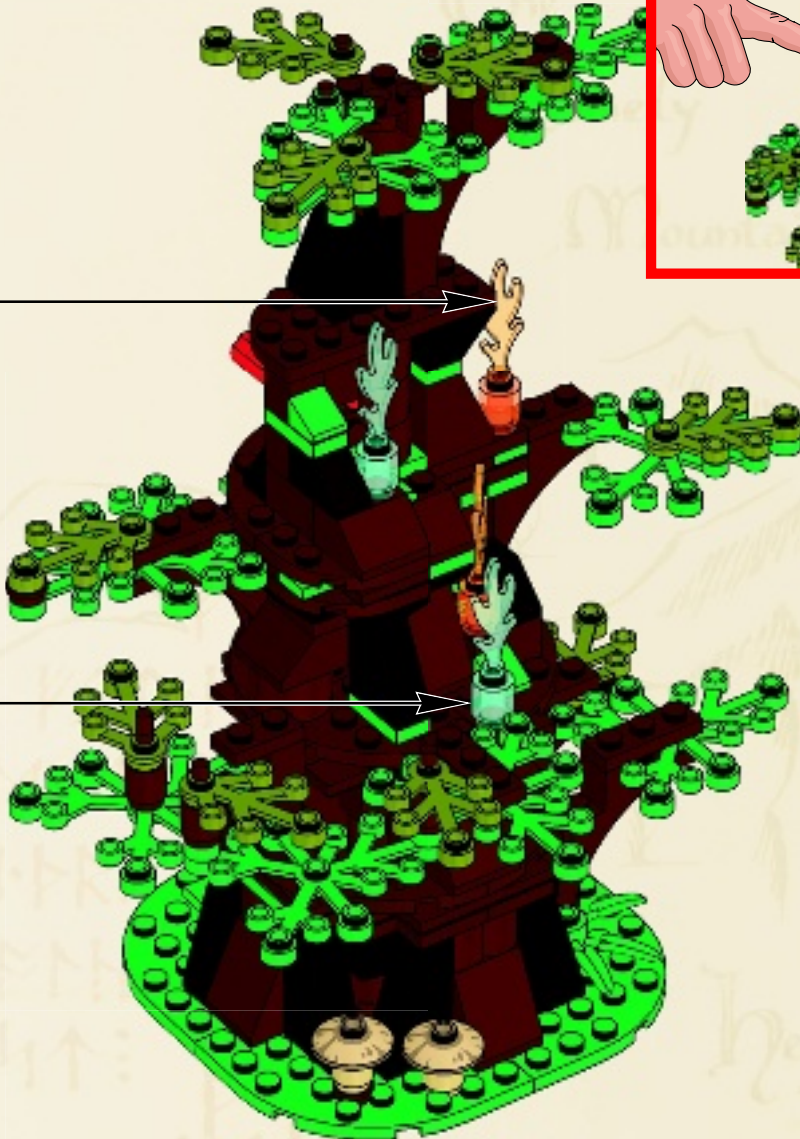
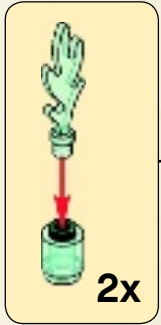
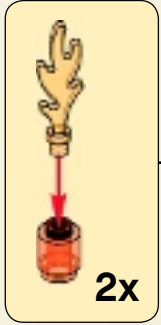

Here of old was Horror
King under the Mountain

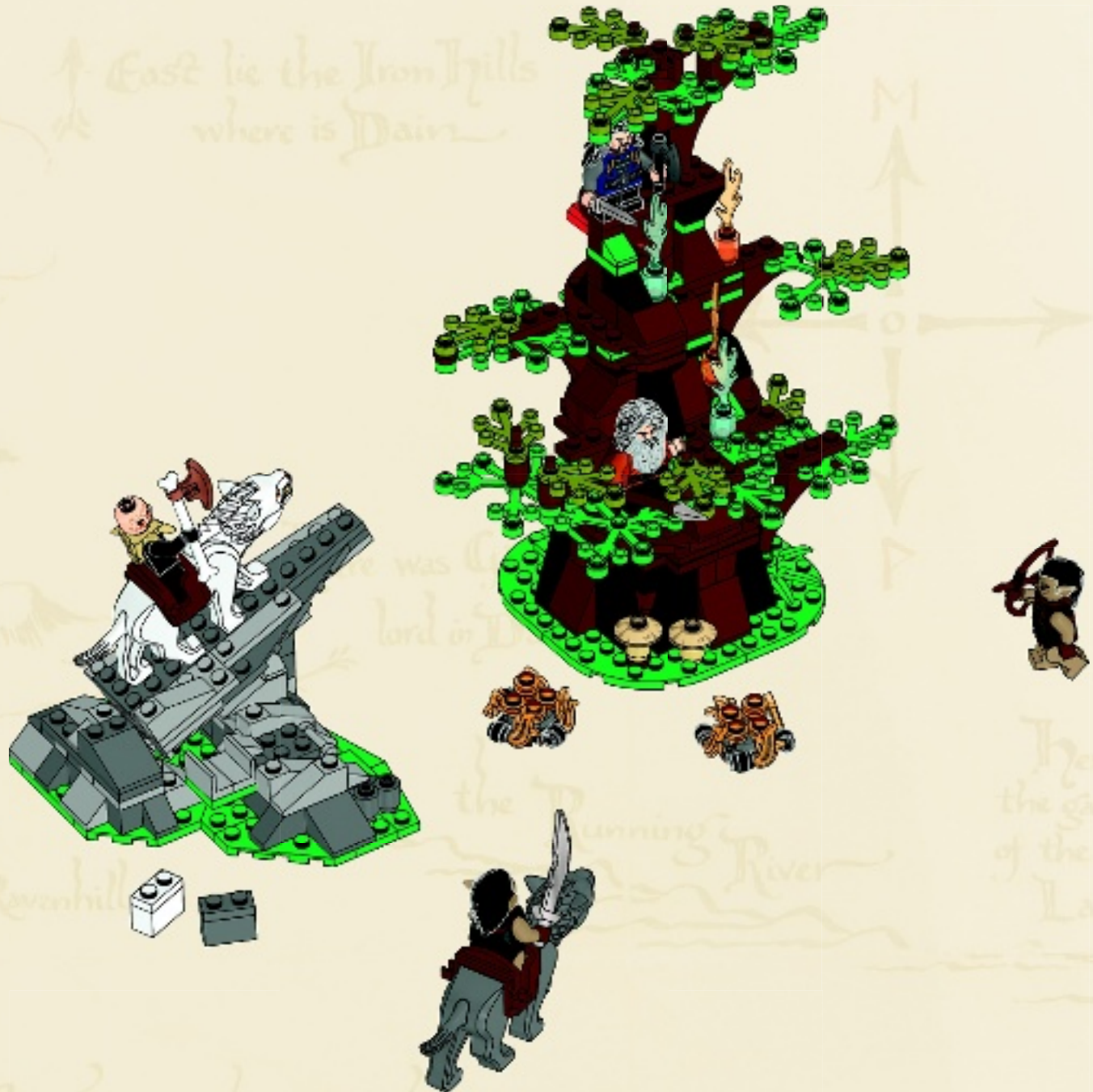

East lie the Iron Hills
where is Dain

M

was G
lord of D

Ravenhill

the Running River

Here is
the gateway
of the Long
Lake



2x
4558957



8x
4632571



1x
4653208



1x
4596914



1x
6025264



2x
6034969



1x
6023030



1x
6021616



2x
4517986



1x
4109810



2x
300126



2x
4181144

70



1x
4114348



8x
4613823



11x
302328



2x
4107758



3x
302028



2x
4543259



3x
4543262



1x
241928



2x
4651215



4x
6021999



1x
303428



1x
4223986



3x
4546705



5x
4558593



5x
4107762



2x
4535738



2x
4515369



2x
4211515



1x
4211376



1x
4211387



2x
4211364



9x
4521921



1x
4234535



5x
4211410



7x
4211488



1x
4211732



2x
4208988



2x
4211397



1x
4211353



2x
4599498



2x
6015347



1x
4211395



1x
4244627



3x
4633032



1x
4507139



1x
4211160



2x
4550331

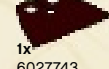

1x
6027743



1x
4648118



6x
4211194



1x
4579690

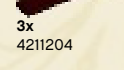

3x
4211204



4x
4216581



2x
4211159



4x
4283660



12x
4636170



7x
6012805



1x
4655611



1x
4610100



6x
4211150



4x
4565394



6x
4211257



4x
4211152



8x
4211151



3x
4211242



2x
4211210



3x
4211200



6x
4211180



8x
4211183



10x
4211166



4x
4211202



10x
4211320



4x
4211195



1x
6022261



2x
4183544



2x
4155537



2x
4153989



2x
6022908



2x
6024433



2x
6004384



2x
6031821



1x
6022247



10x
4222960



8x
4649066



2x
4261397



9x
6006425



1x
4529672



2x
6010063



6x
4519970



4x
4654915



8x
4518557



4x
4518562



6x
4624089



6x
4648296



1x
4623775



1x
6005225



1x
4210719



5x
4211063



4x
4211043



1x
4211002



2x
4211042



1x
4586562



2x
4529727



1x
4528323



1x
6024439



1x
6025342



3x
4211098



1x
4211088



1x
4211105



2x
4210935



9x
4211135



4x
4211106



2x
4211090



1x
4567887



1x
6030710



1x
6024432



1x
6025339



1x
300401



1x
302301



1x
4651445



1x
4600294



1x
4600307



2x
4529237



1x
6028104



1x
6000291



1x
4611882



1x
6025236



1x
6020749



1x
6020743



1x
4516816



1x
4594655



1x
4613958



3x
614321



2x
654121



2x
4513174

Customer Service

Kundenservice

Service Consommateurs

Servicio Al Consumidor

LEGO.com/service or dial



: 00800 5346 5555

: 1-800-422-5346



□ 79010
Goblin Soldier



□ 79010
Nori the Dwarf



□ 79004
Bilbo Baggins™



□ 79010
Goblin Soldier

□ 79010
Dori the Dwarf

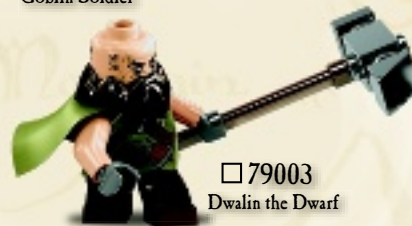

□ 79003
Dwalin the Dwarf



□ 79002
Hunter Orc



□ 79010
The Goblin King



□ 79004
Oin the Dwarf



□ 79004
Mirkwood™ Elf Chief



□ 79003
Balin the Dwarf



□ 79010
Gandalf™ the Grey



□ 79001
Kili the Dwarf



□ 79003
Bilbo Baggins™



□ 79000
Bilbo Baggins™

□ 79000
Gollum™



□ 79003
Bofur the Dwarf



□ 79004
Mirkwood™ Elf Guard



□ 79004
Gloin the Dwarf



□ 79001
Fili the Dwarf



□ 79001
Legolas Greenleaf™



□ 79002
Thorin Oakenshield™



□ 79002
Yazneg™

□ 79002
Warg



□ 79002
Warg



□ 79002
Bifur the Dwarf

□ 79010
Goblin Scribe



□ 79010
Ori the Dwarf



□ 79003
Bombur the Dwarf



□ 79003
Gandalf™ the Grey



□ 79001
Tauriel™



□ 79002
Hunter Orc

79010



Special The Hobbit Trilogy
Preview Set!

79004



79003





THE HOBBIT

AN UNEXPECTED JOURNEY

LEGO.com/thehobbit



THE HOBBIT™

AN UNEXPECTED JOURNEY



3920
The Hobbit: An
Unexpected Journey

7+



2-4



15-25



GAMES





THE LORD OF THE RINGS



The Quest of the Fellowship Continues in 2013

LEGO.com/thelordoftherings

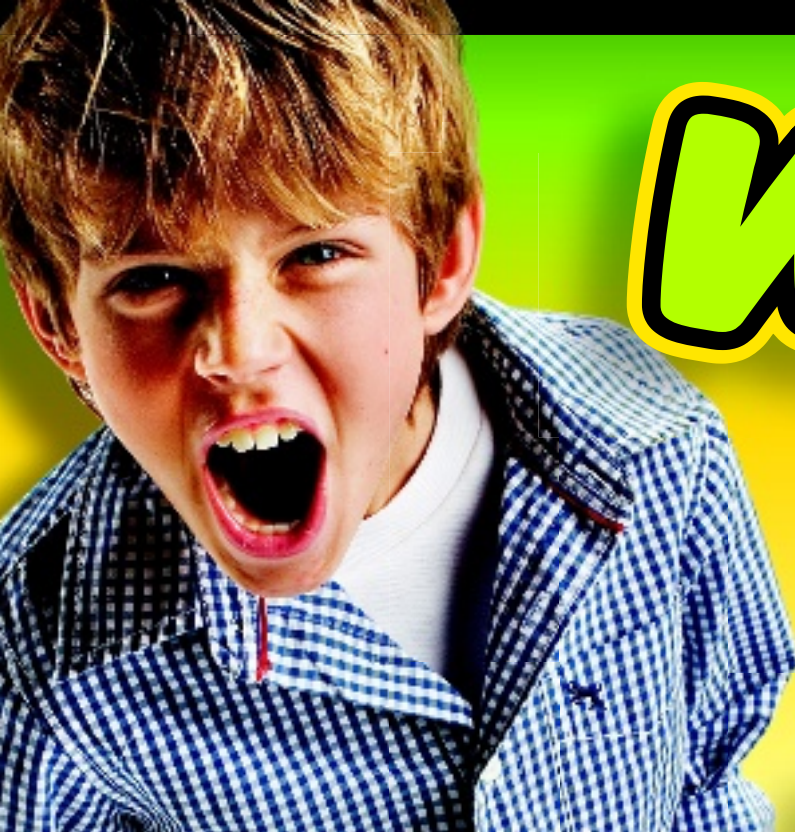

WIN!

Go to www.LEGOsurvey.com/product
to fill out a survey for a chance
to win a cool LEGO® Product.
No purchase necessary.
Open to all residents where not prohibited.



www.LEGOsurvey.com/product

GEWINNE! WIN!

Nimm an der Umfrage auf
www.LEGOsurvey.com/product
teil und hab die Chance ein cooles
LEGO® Produkt zu gewinnen!

Die Teilnahme am Gewinnspiel führt zu keinerlei
Kaufverpflichtungen. Teilnahme in allen nicht
ausgeschlossenen Ländern möglich.

Ga naar www.LEGOsurvey.com/product,
vul een
enquêteformulier in en maak
kans op een cool LEGO® product.

Geen aankoopverplichting.
Iedereen mag deelnemen, uitgezonderd
ingezetenden van landen waar een
enquêteverbod geldt.

GAGNE! 当てよう!

Visite www.LEGOsurvey.com/product
pour répondre à un
questionnaire et avoir une chance de
gagner un produit LEGO® très cool!

Aucune obligation d'achat.
Ouvert à tous les résidents des pays
autorisés.

www.LEGOsurvey.com/product にアクセスして、
アンケートにご記入ください。当選者にはレゴ
製品を差し上げます。

お買い上げの必要はありません

禁止されていない限り、すべての皆様にご利用いただけます。