



MARVEL

76280



Q LEGO® Builder



Get excited about our new packaging!

We're switching from plastic to paper-based packaging. That's why you might find a mix of paper and plastic in our boxes!

Nos nouveaux emballages vous emballeront !

Nous passons des emballages en plastique aux emballages à base de papier. C'est pourquoi vous pourriez trouver un mélange de papier et de plastique dans nos boîtes !

¡Te presentamos nuestros nuevos empaques!

Estamos sustituyendo las bolsas de plástico por bolsas con base de papel. ¡Por eso, puedes encontrar una mezcla de papel y de plástico en nuestras cajas!

[LEGO.com/sustainable-packaging](https://www.lego.com/sustainable-packaging)

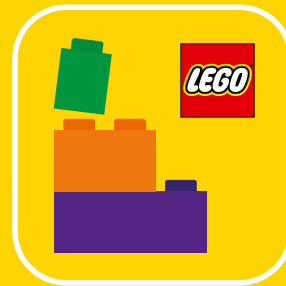

BUILDER



Apple and the Apple logo are trademarks of Apple Inc., registered in the U.S. and other countries and regions. App Store is a service mark of Apple Inc. Google Play and the Google Play logo are trademarks of Google LLC. Tencent and the Tencent logo are trademarks of Tencent Inc.

LEGO.com/devicecheck

EN Ask parents' permission before going online | DE Eltern um Erlaubnis bitten, bevor du online gehst | FR Demande l'autorisation d'un parent avant d'aller en ligne | IT Chiedi il permesso ai tuoi genitori prima di andare online | ES Pídeles permiso a tus papás antes de conectarte a Internet | PT Pede autorização aos pais antes de acederes online | ZH 上网前应先征得父母的同意 | PL Poproś rodziców o zgodę, zanim wejdiesz do Internetu | CS Než půjdeš na internet, požádej rodiče o svolení | SK Skôr než pôjdeš na internet, vypýtaj si povolenie od rodičov | HU Kérj szülői engedélyt, mielőtt online csatlakoznál! | RO Cere permisiunea părinților înainte de a te conecta online | BG Поискайте разрешение от родител, преди да влезете онлайн | LV Pirms došanās tiešsaistē palūdz atļauju vecākiem | ET Enne Interneti kasutamist küsi vanematelt luba | LT Prieš prisijungdami prie interneto, atsilkauskite tėvų

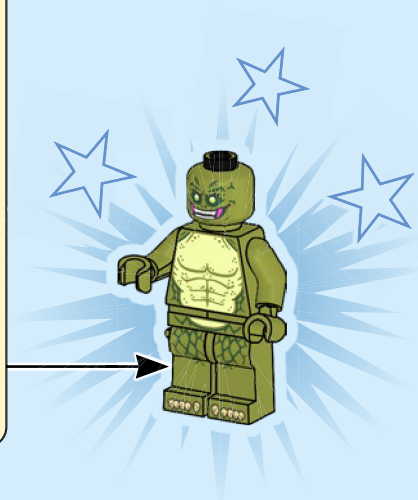
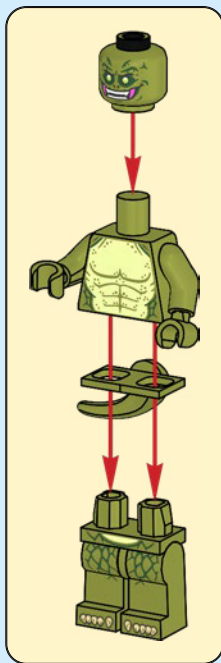

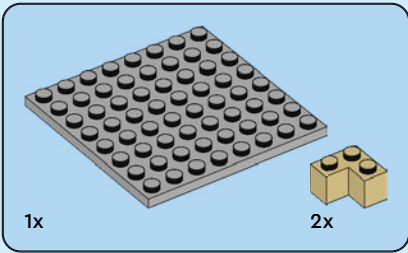
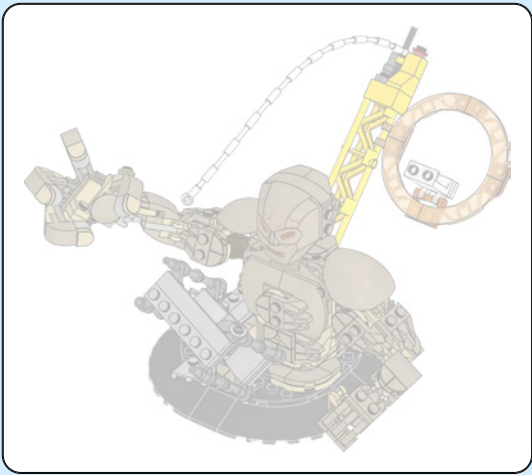

1

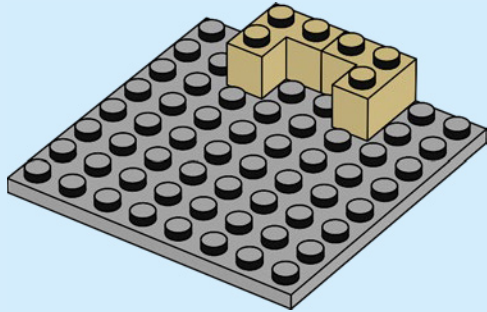

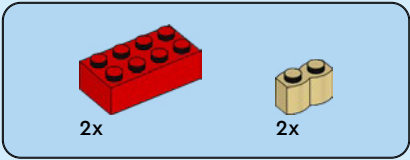

2

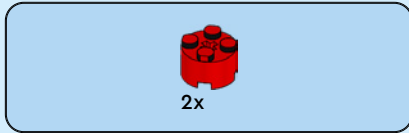
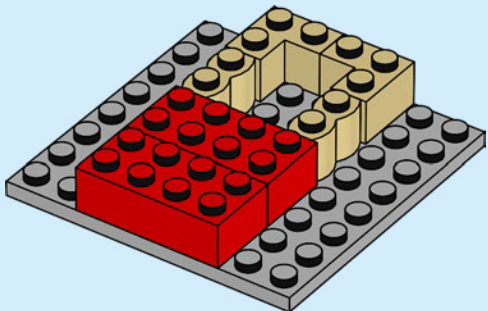

3

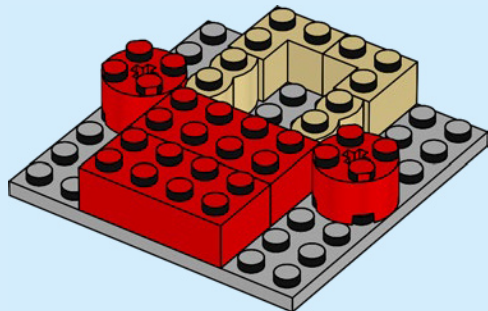

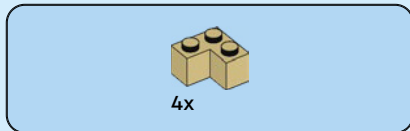

4

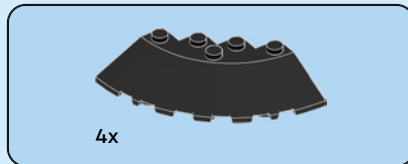
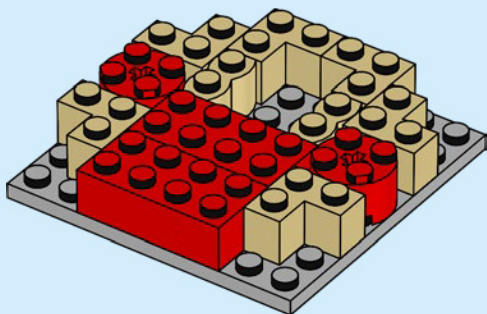

5

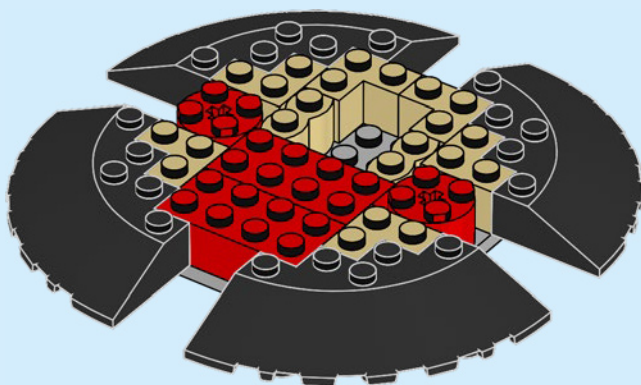

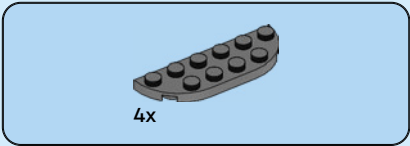

6

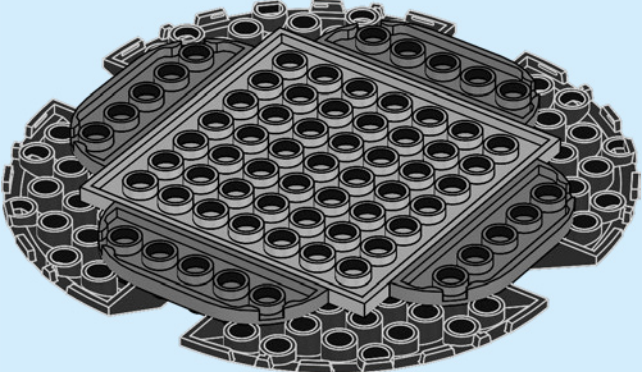

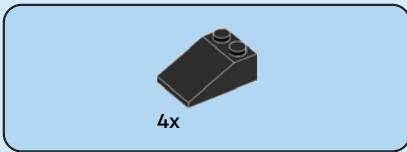

7

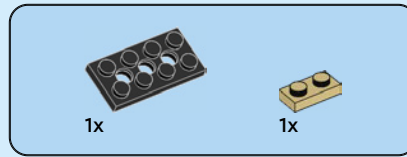
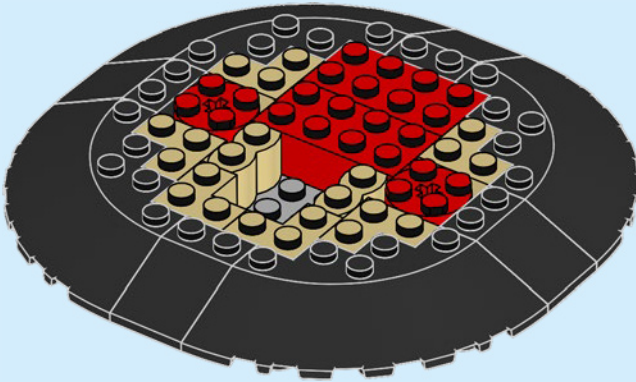

8

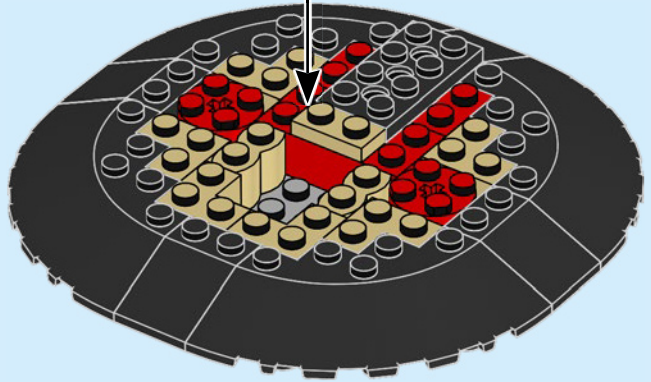

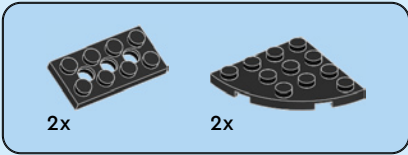

9

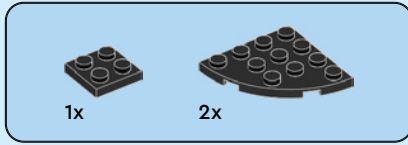
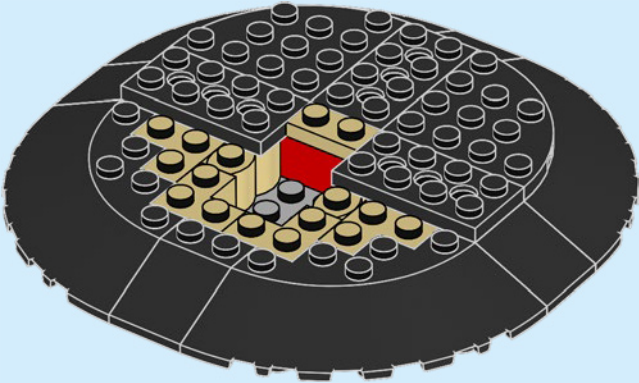

10

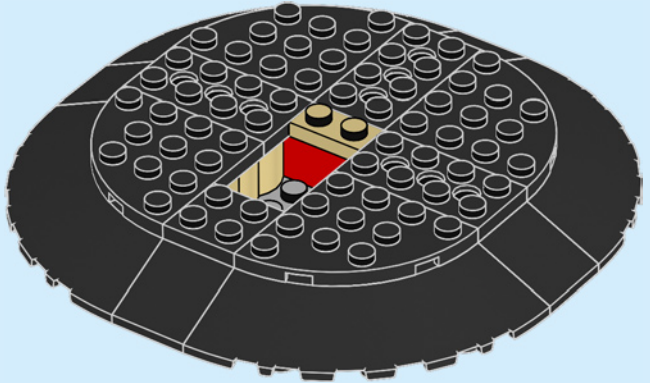

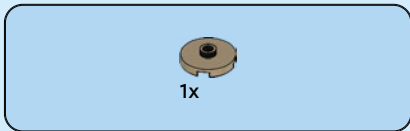

11

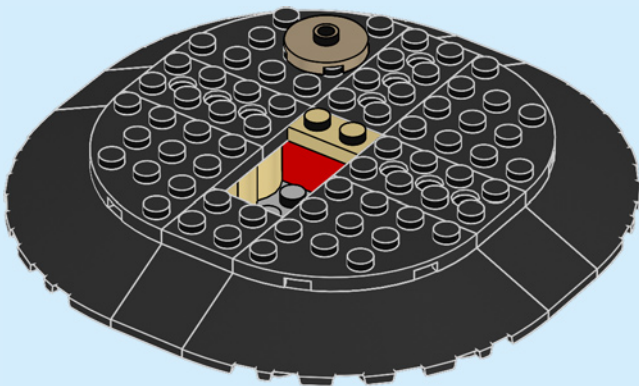

12

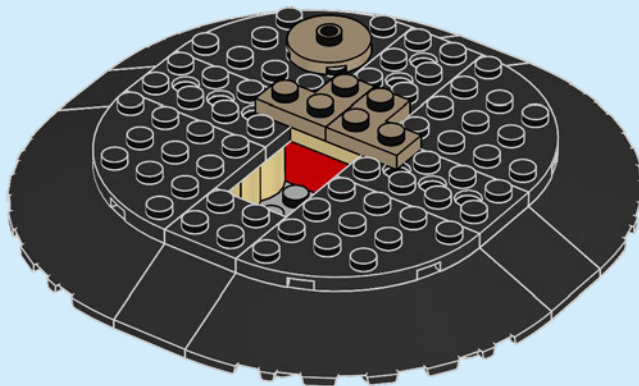



1x



1x

13

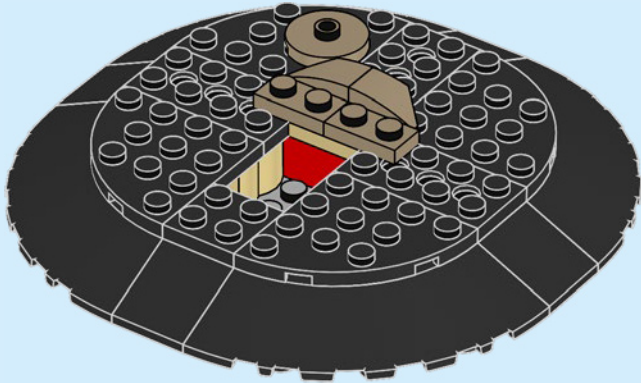

1x

14

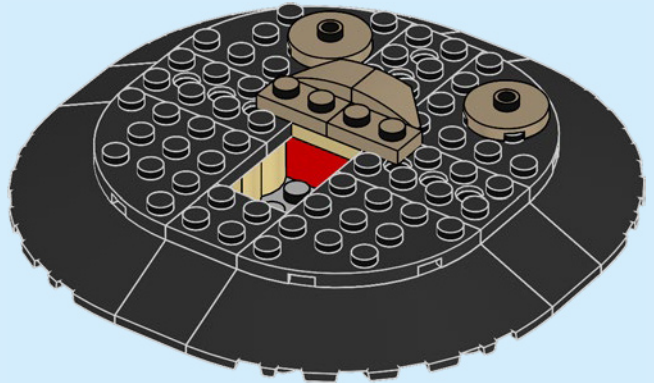

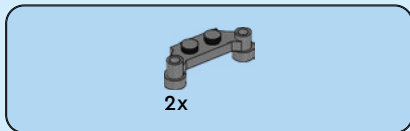

15

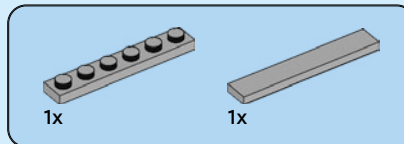
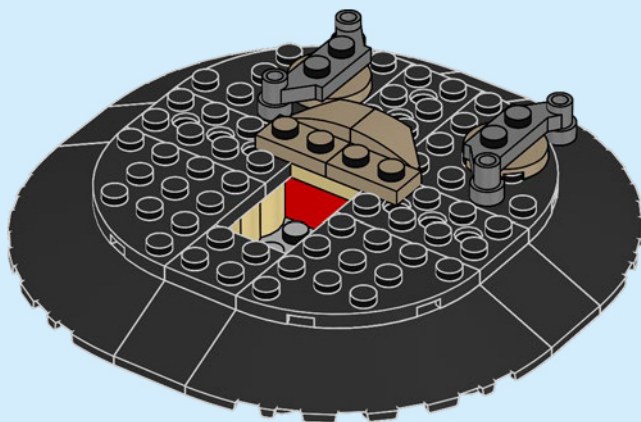

16

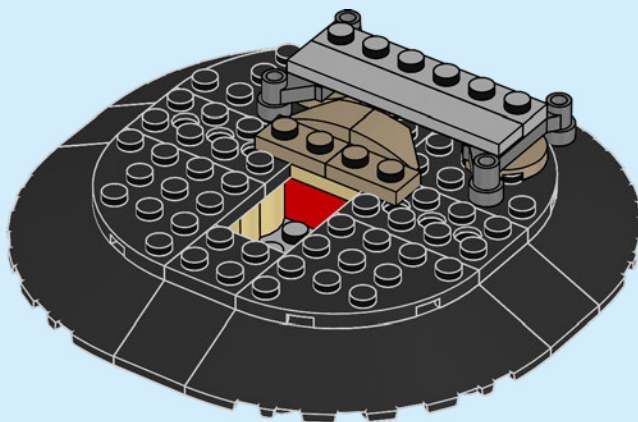

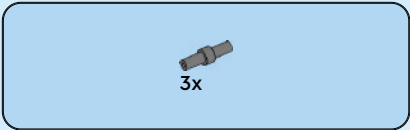

17

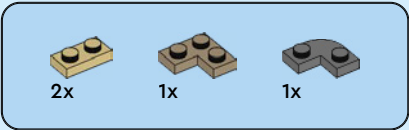
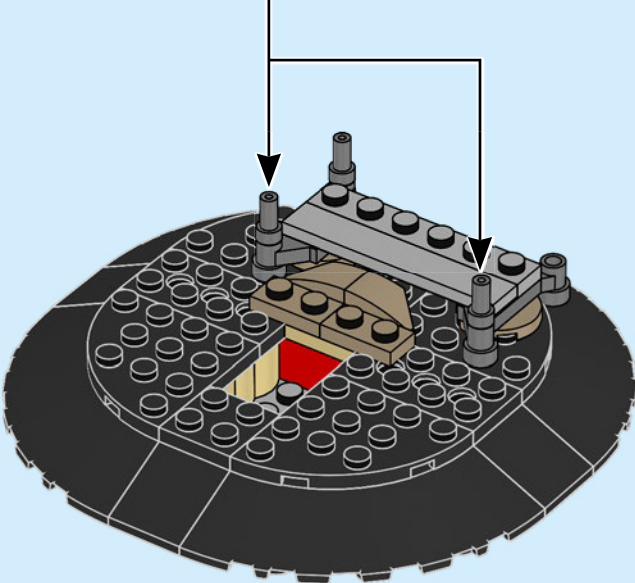
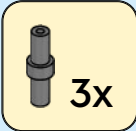

18

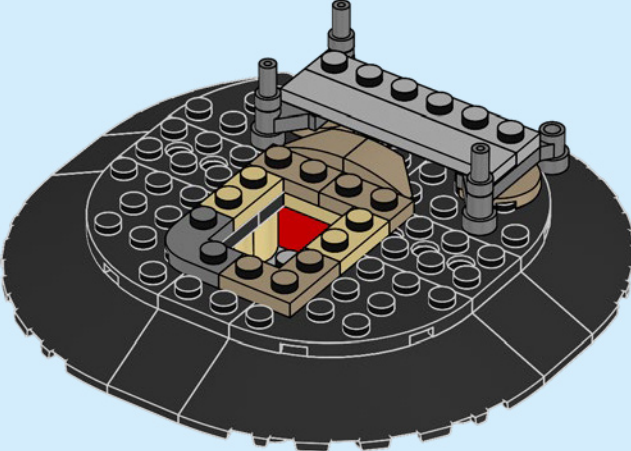

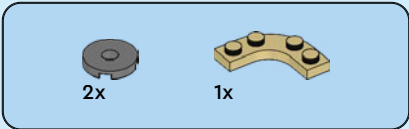

19

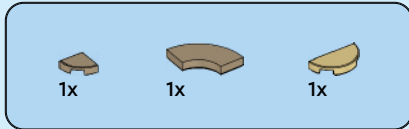
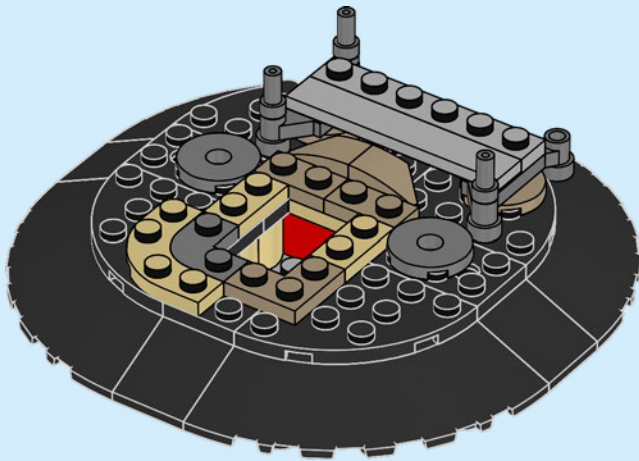

20

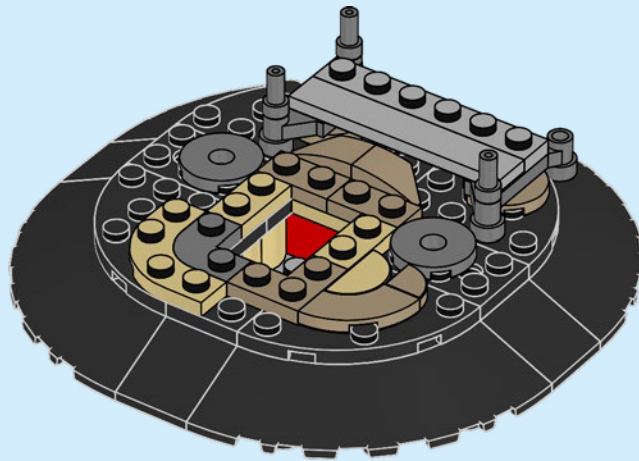

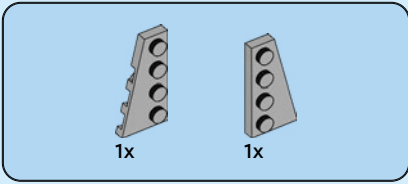

21

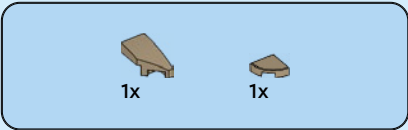
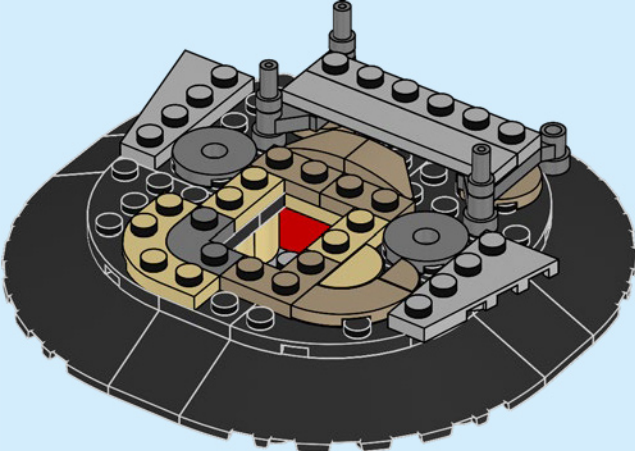

22

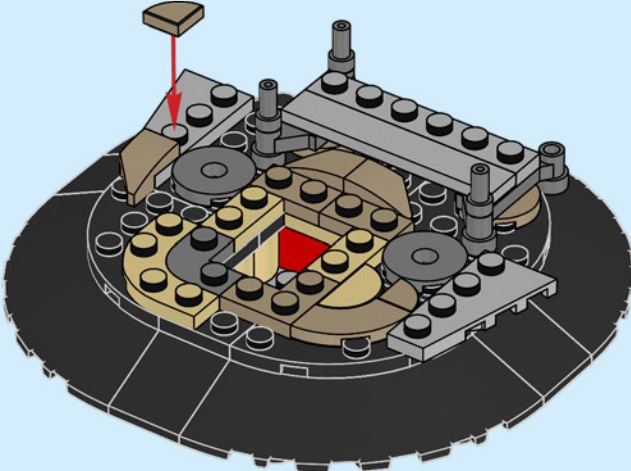

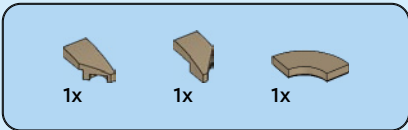

23

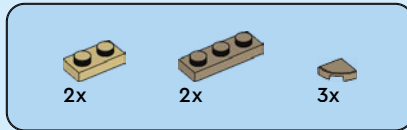
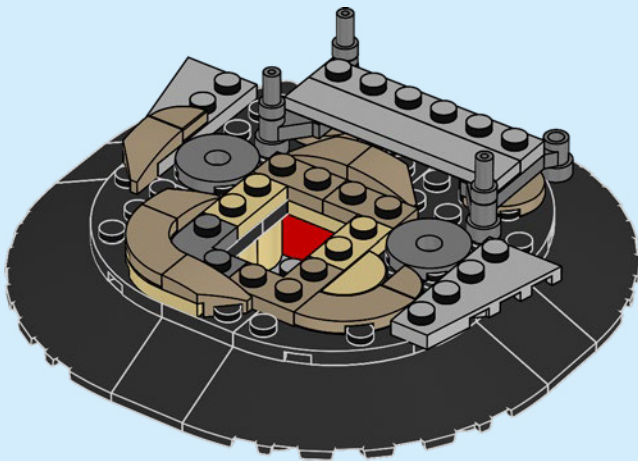

24

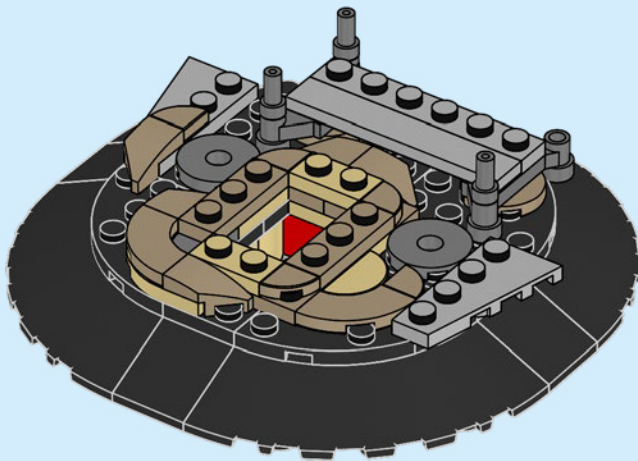

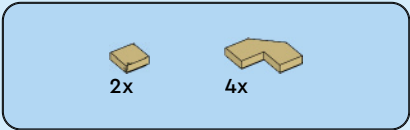

25

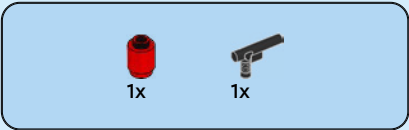
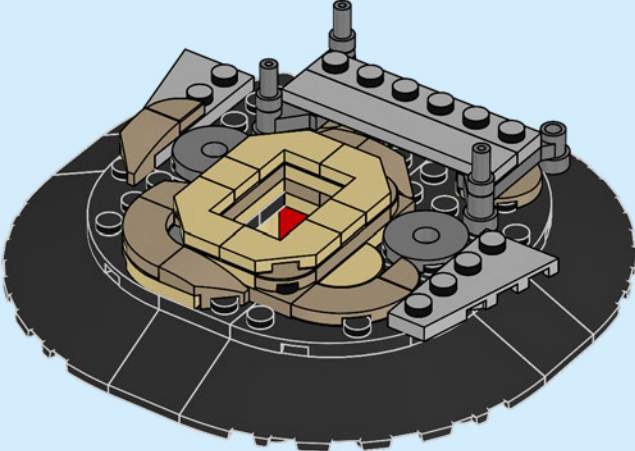

26

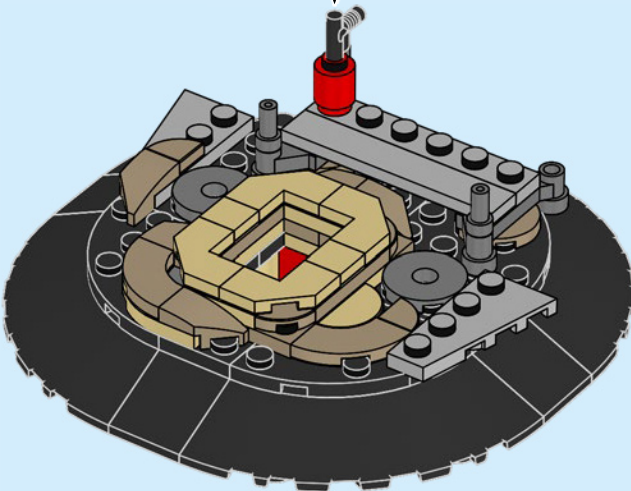
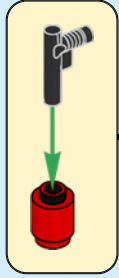

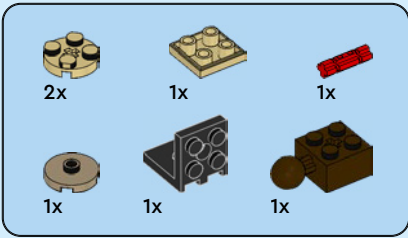

27

1

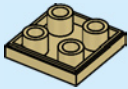

2

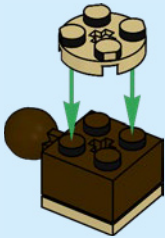

3

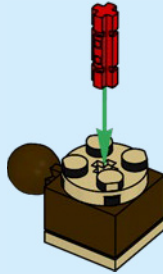

4

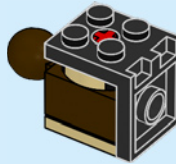

5

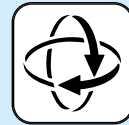
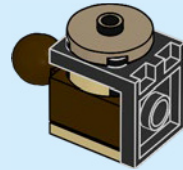

6

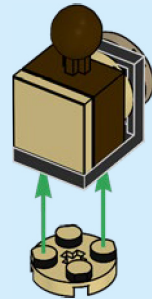

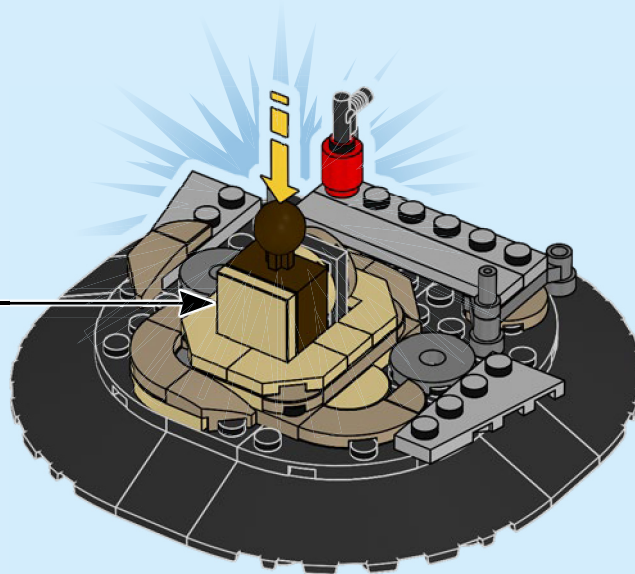

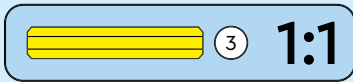
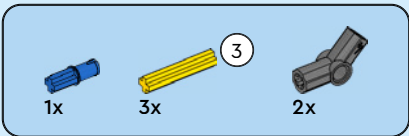

28

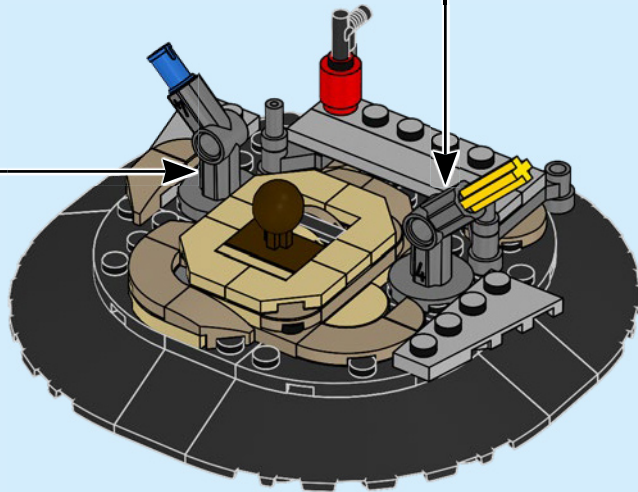
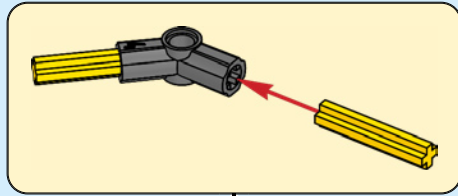
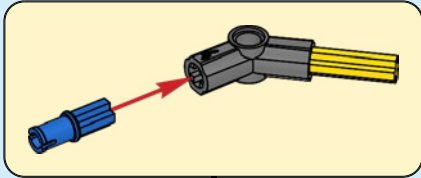

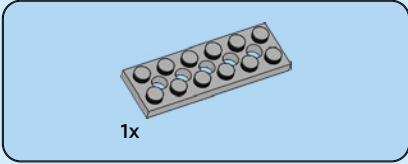
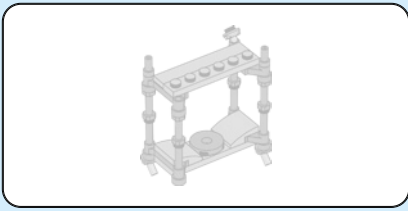

29

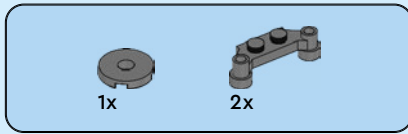
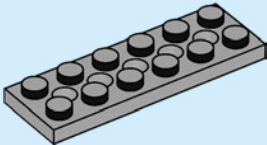

30

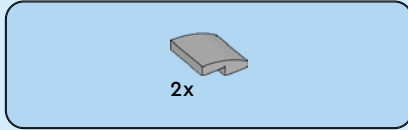
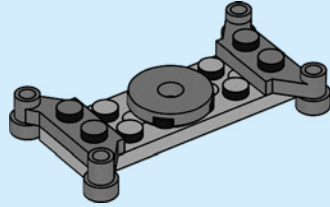

31

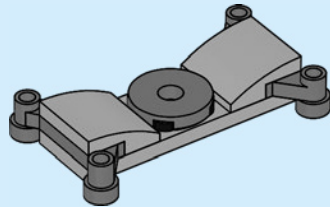

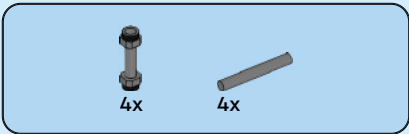

32

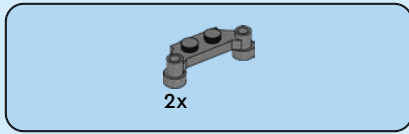
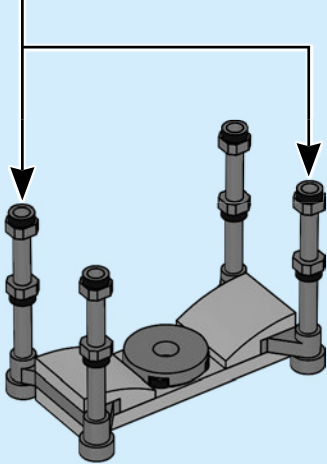
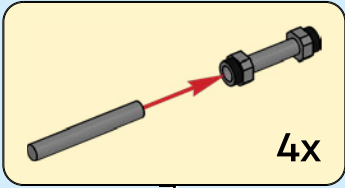

33

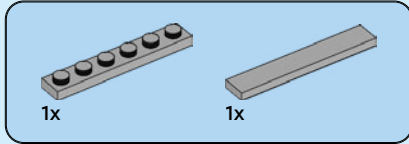
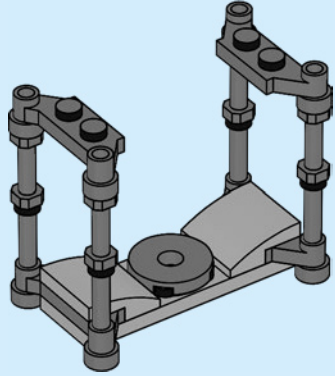

34

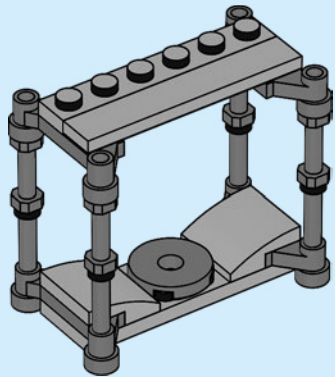



1x

35

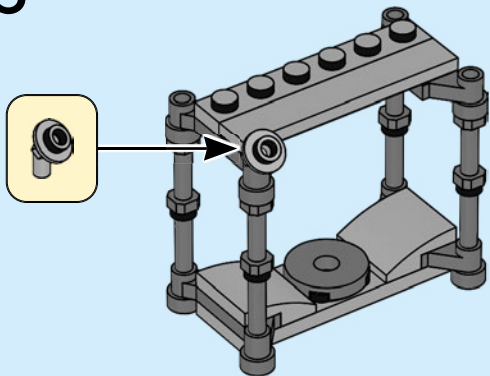

2x

36

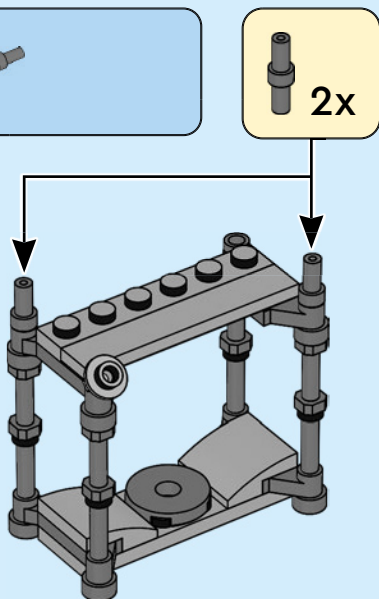

2x

37



2x

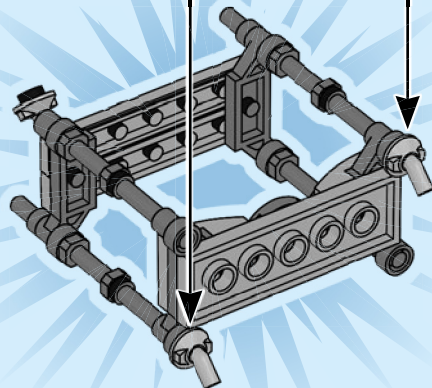

38

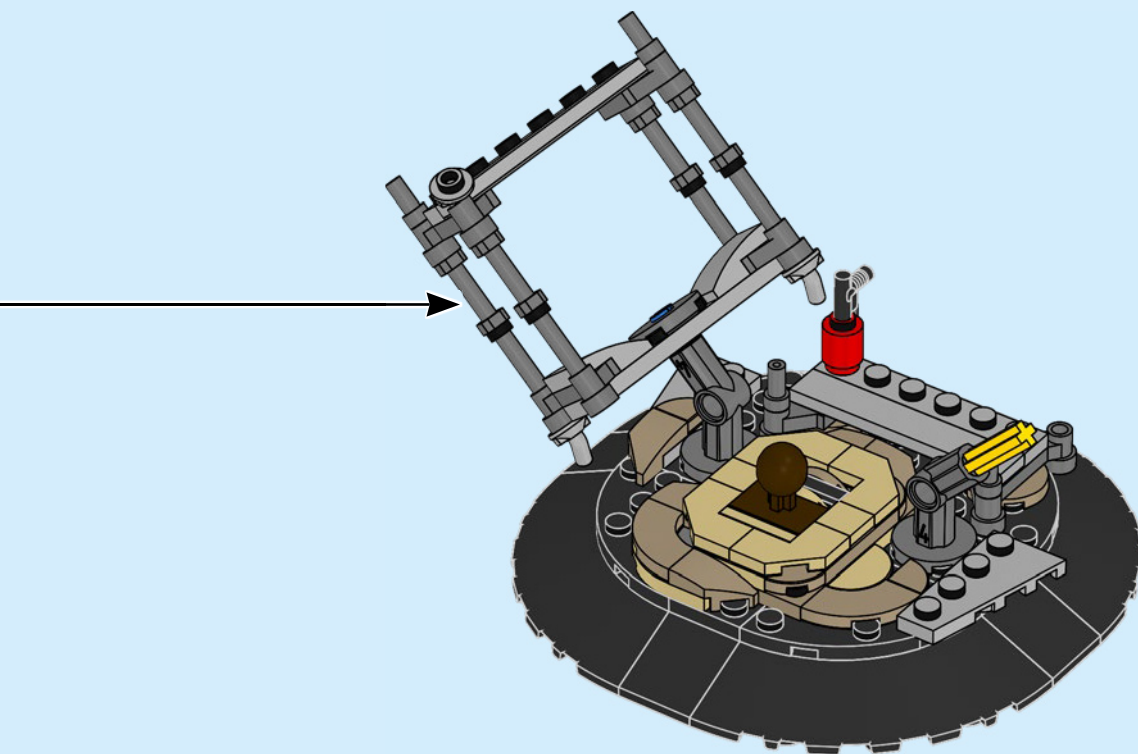

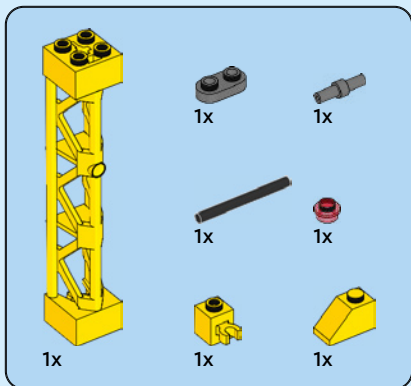

39

1

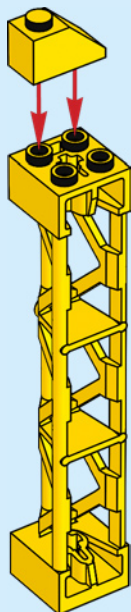

2

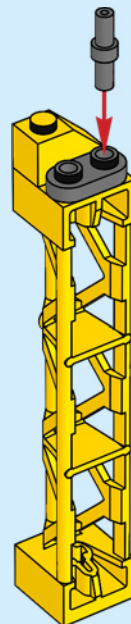

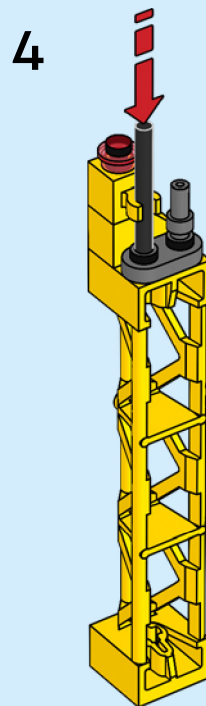
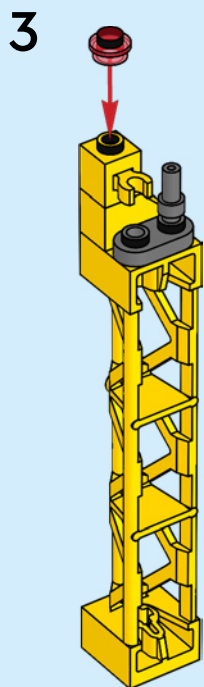

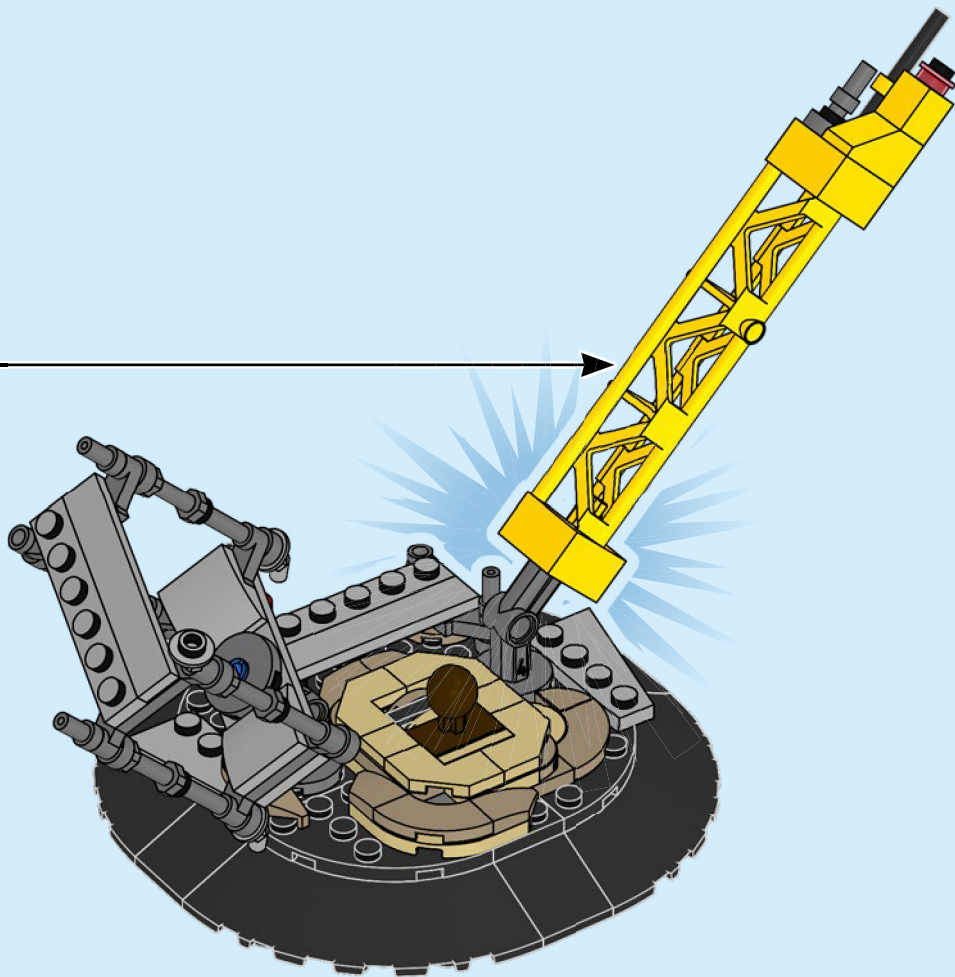

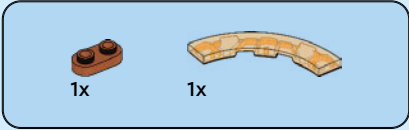
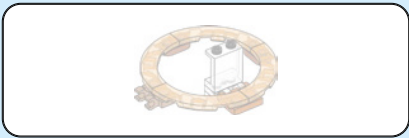

40

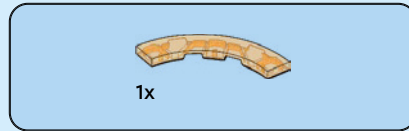
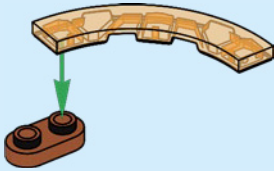

41

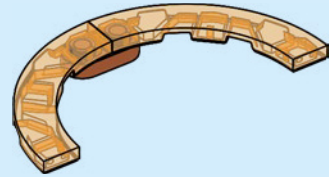

42

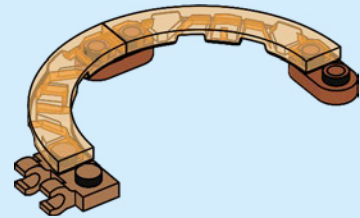

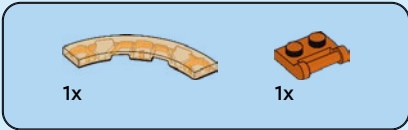

43

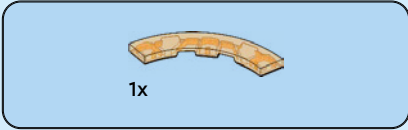
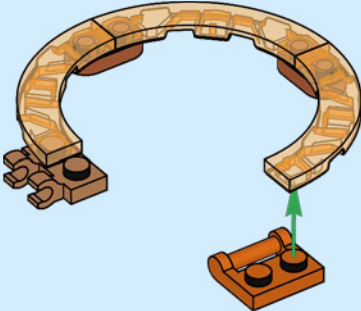

44

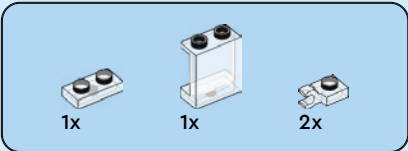
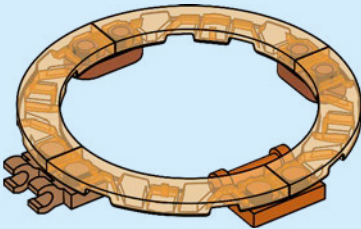

45

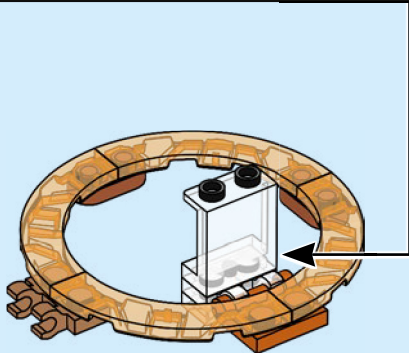
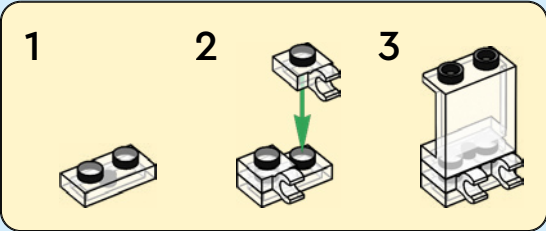

46

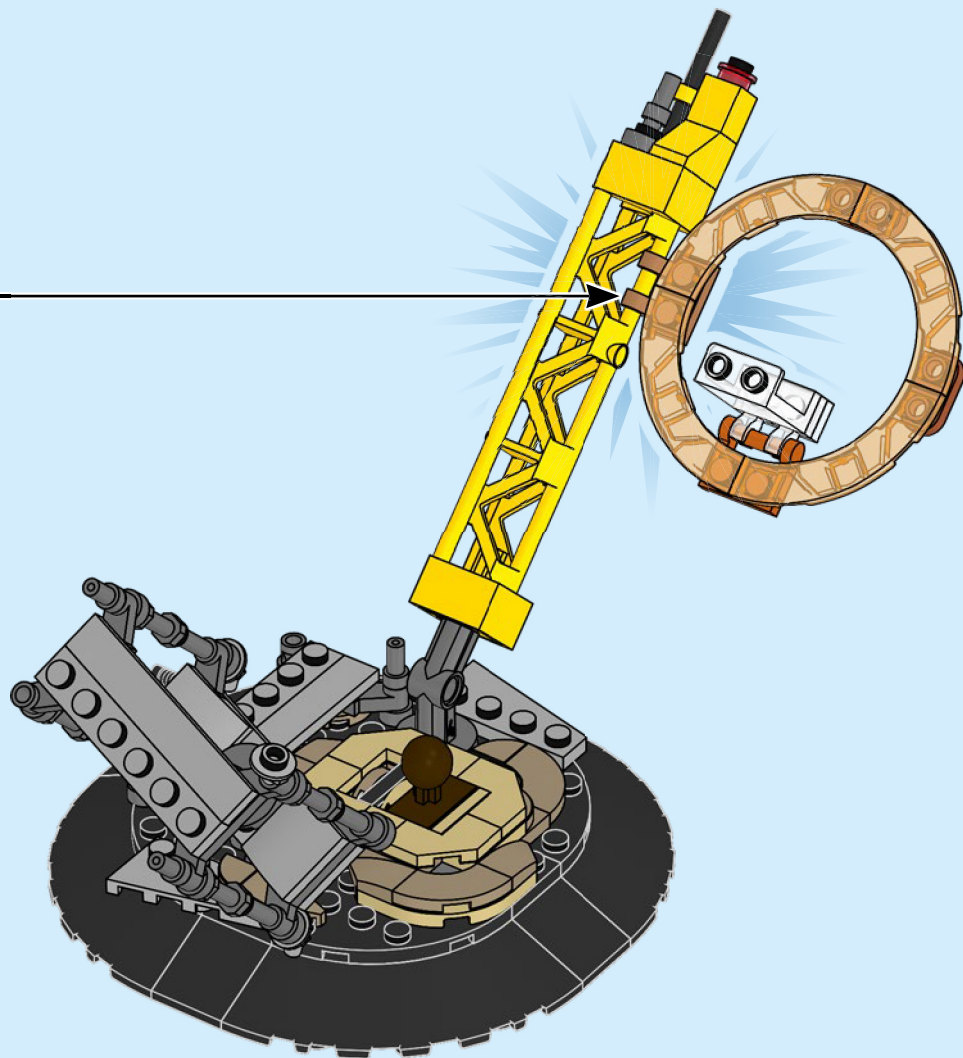

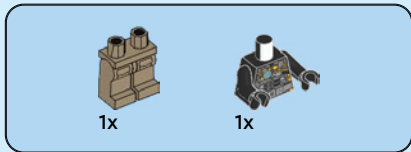

1

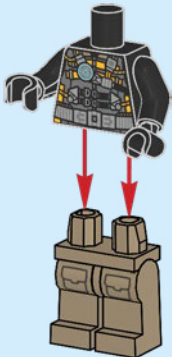

2

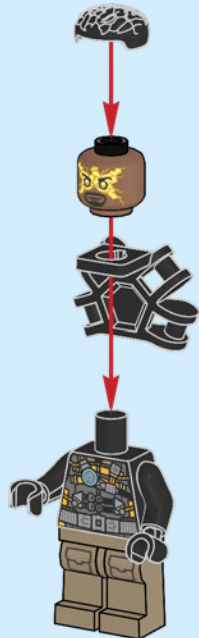

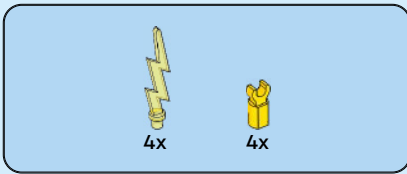

3

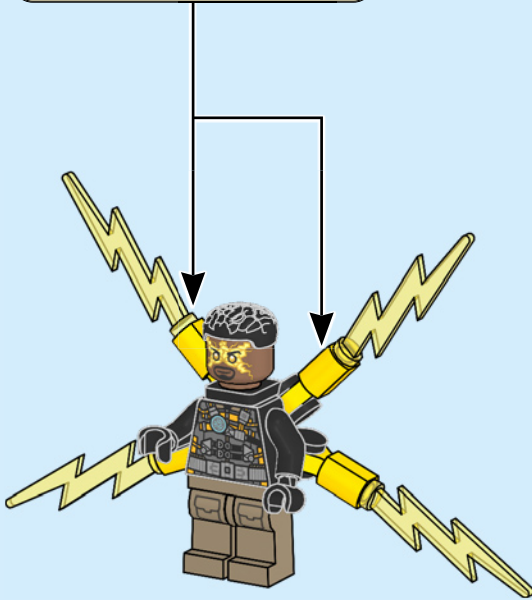
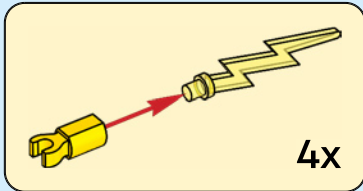

4

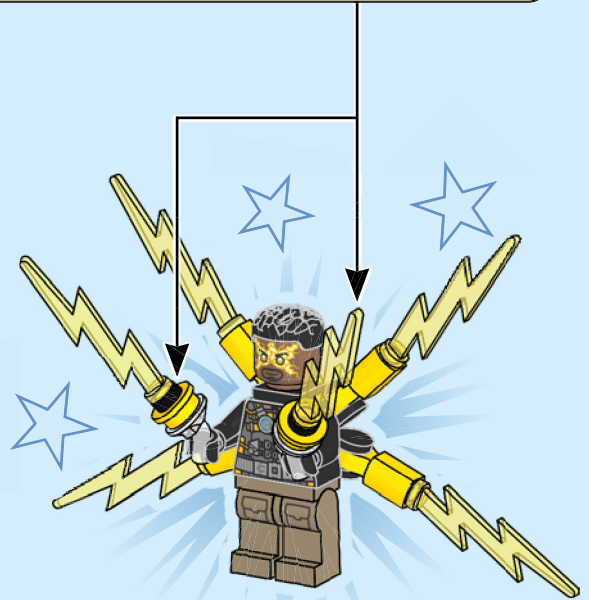
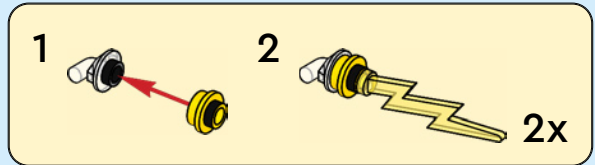

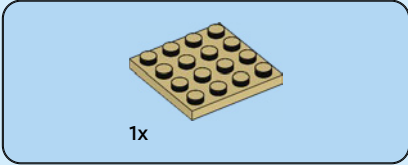
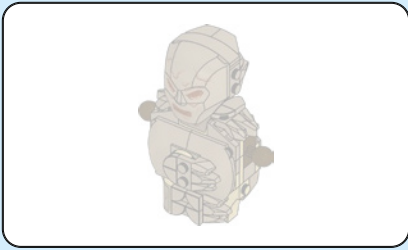

47

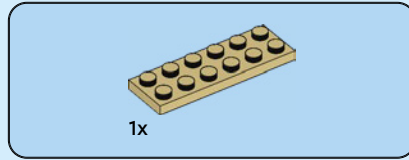
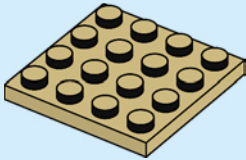

48

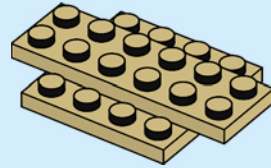

49

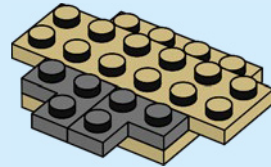



1x

50

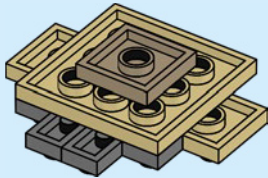

3x

51

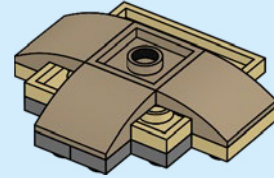

2x

52

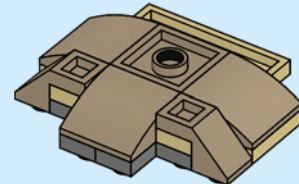

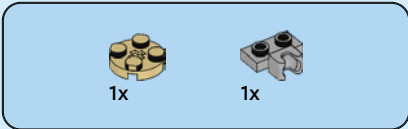

53

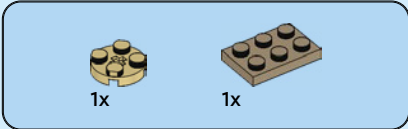
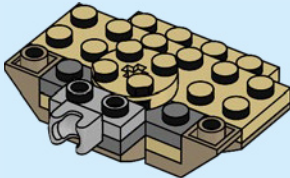

54

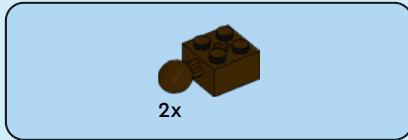
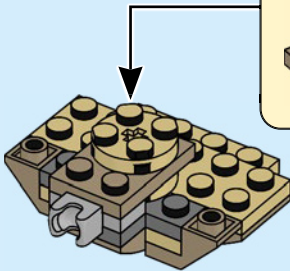
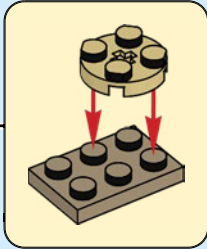

55

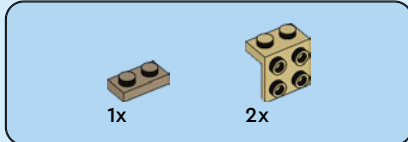
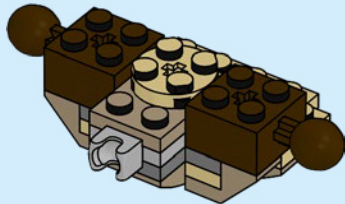

56

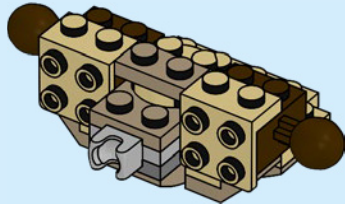

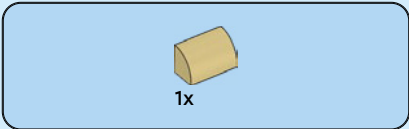

57

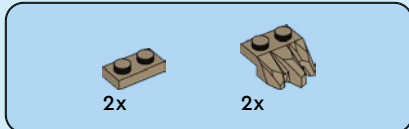
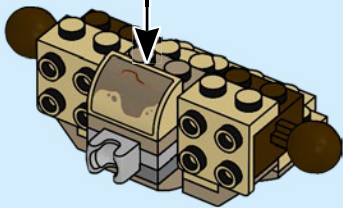
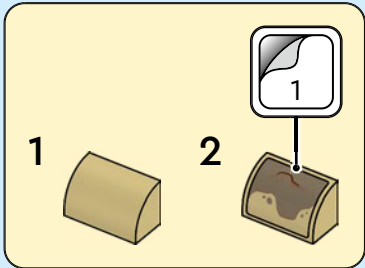

58

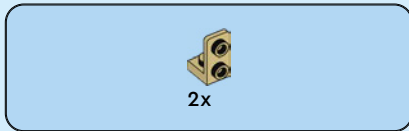
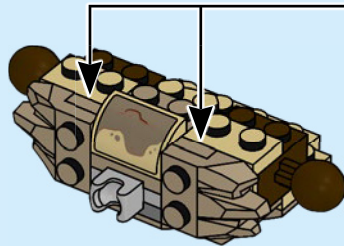
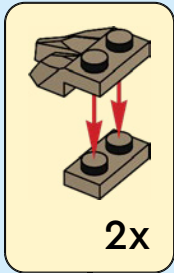

59

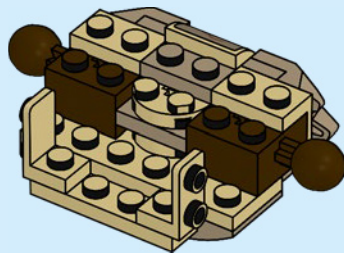



2x

60

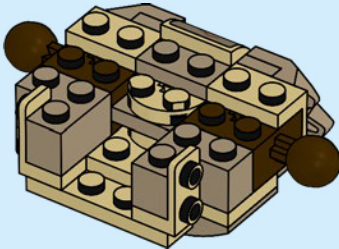

2x



1x



1x

61

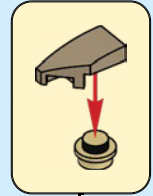
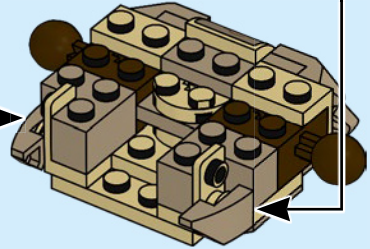
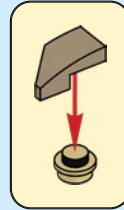

1x

62

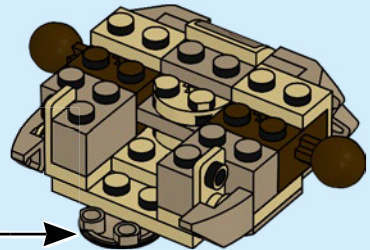

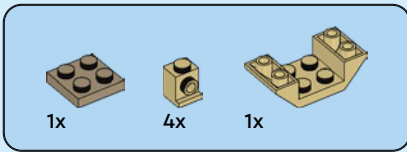

63

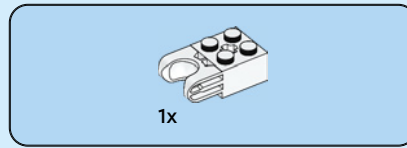
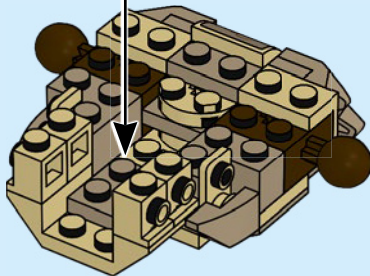
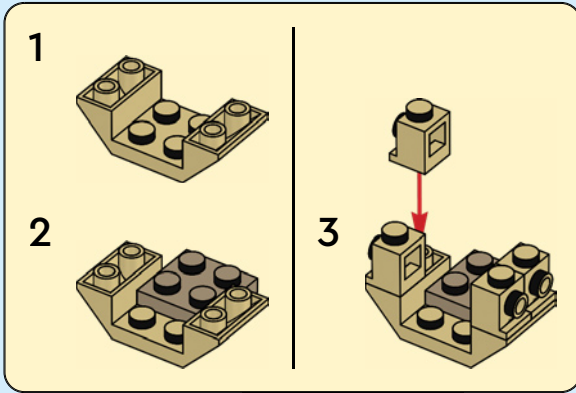

64

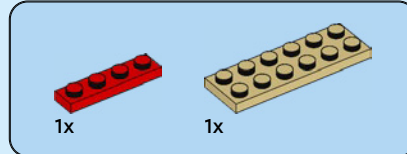
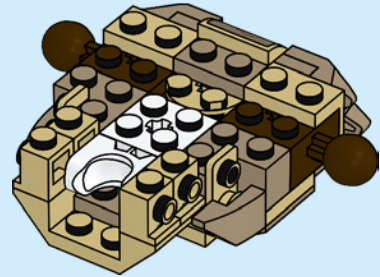

65

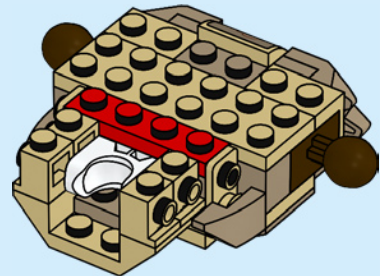



2x

66

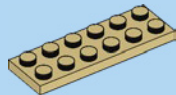
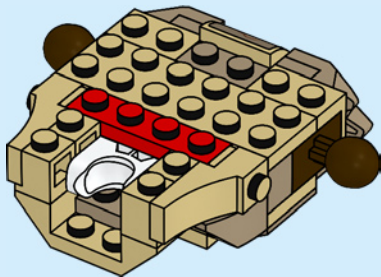

1x

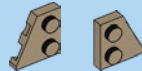

1x

1x

67

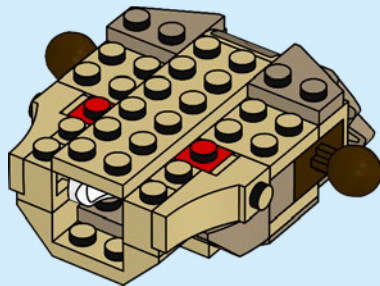

2x



2x

68

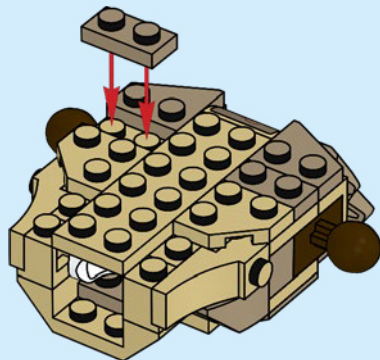

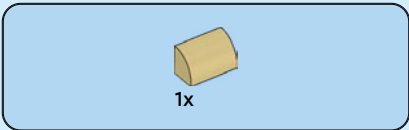

69

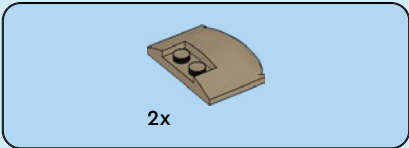
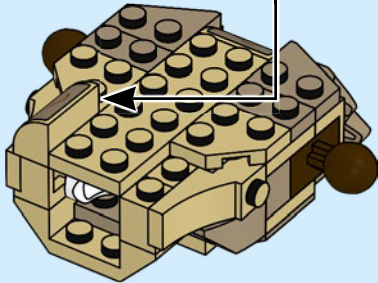
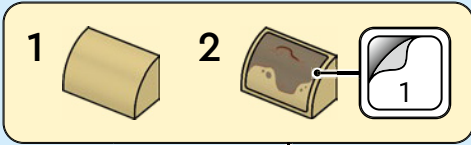

70

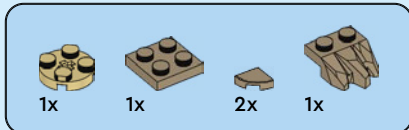
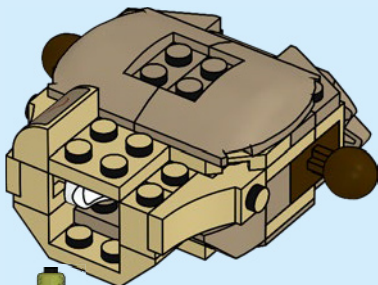

71

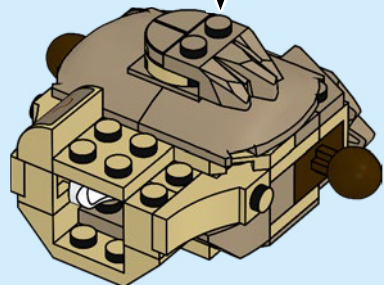
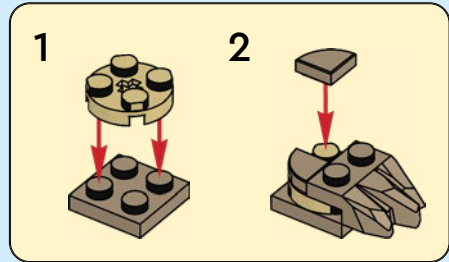

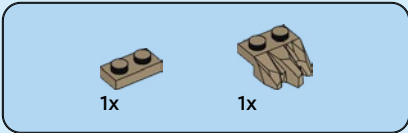

72

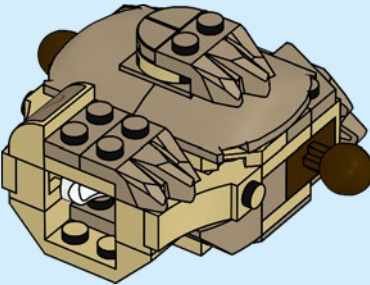

73

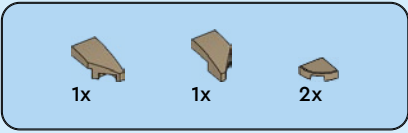
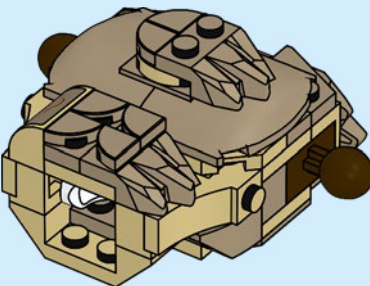

74

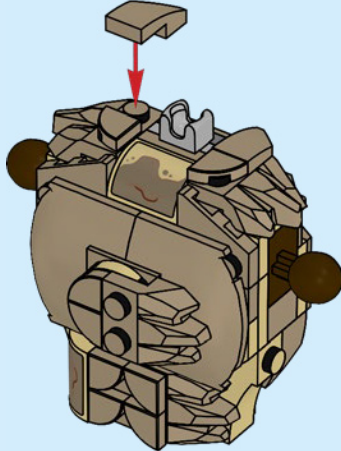

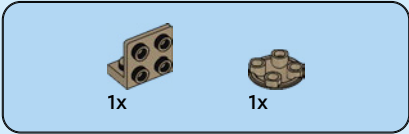

75

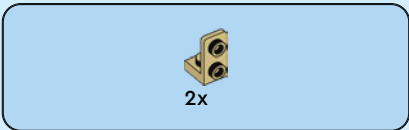
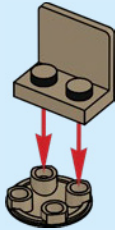

76

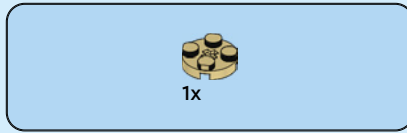
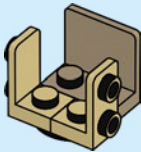

77

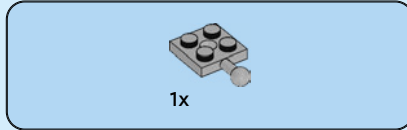
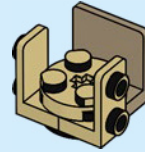

78

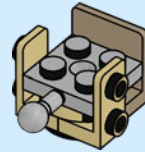

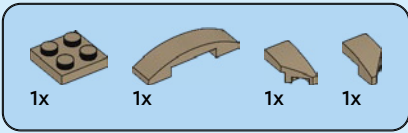

79

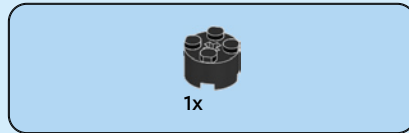
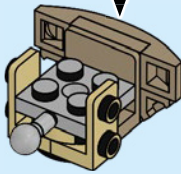
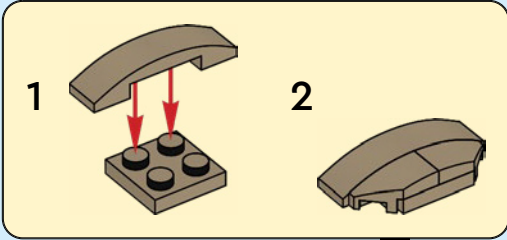

80

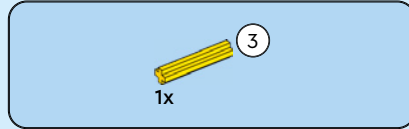
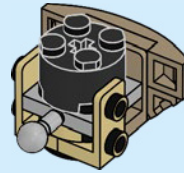

81

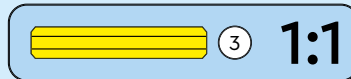
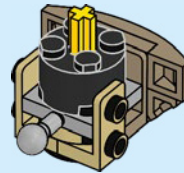

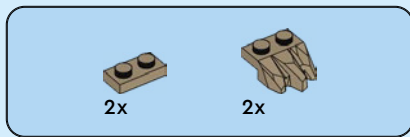

82

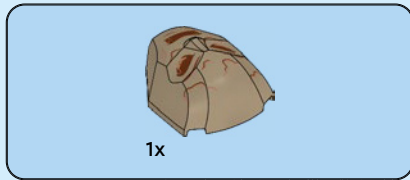
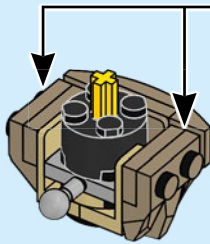
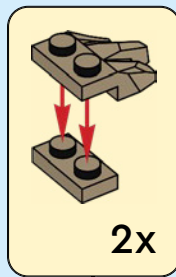

83



84

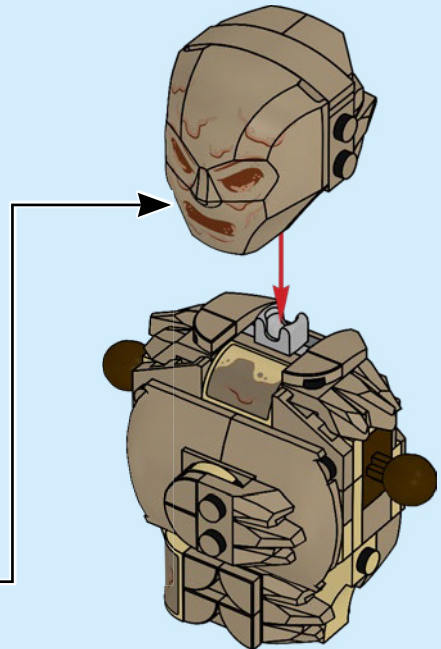

85

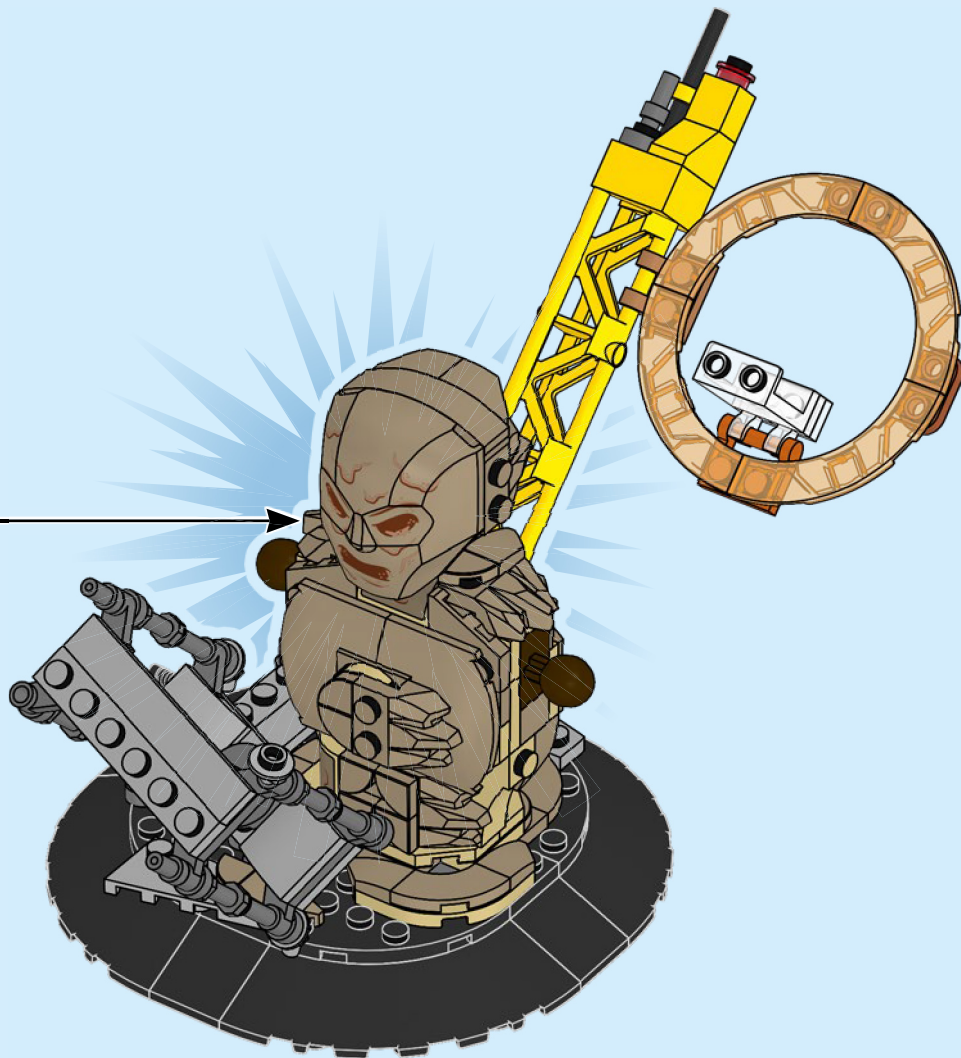

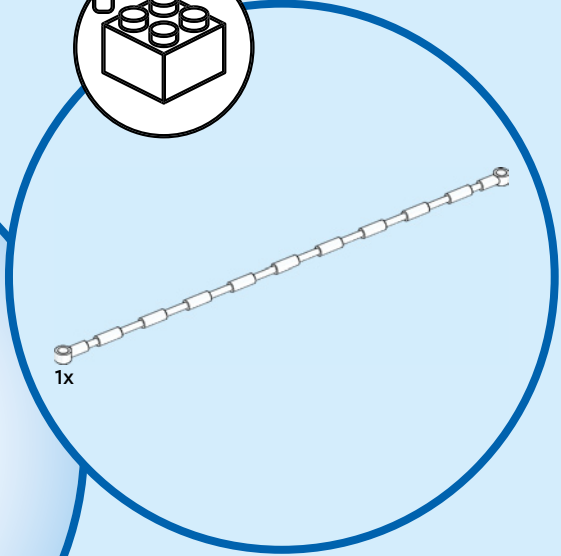
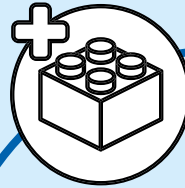

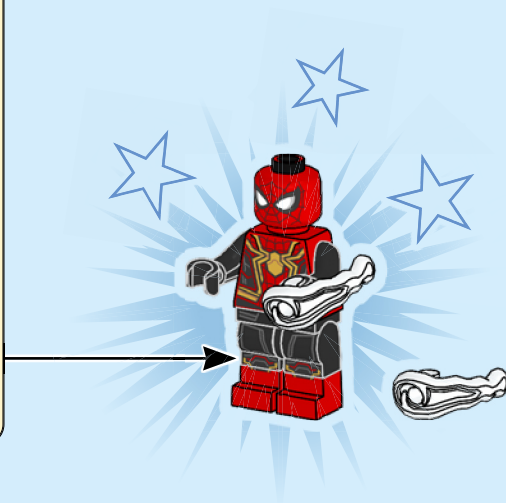
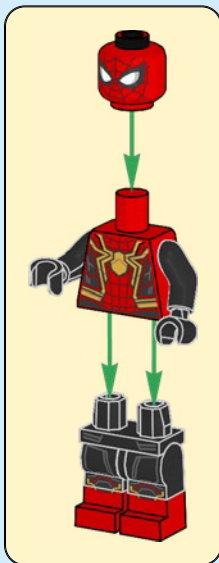
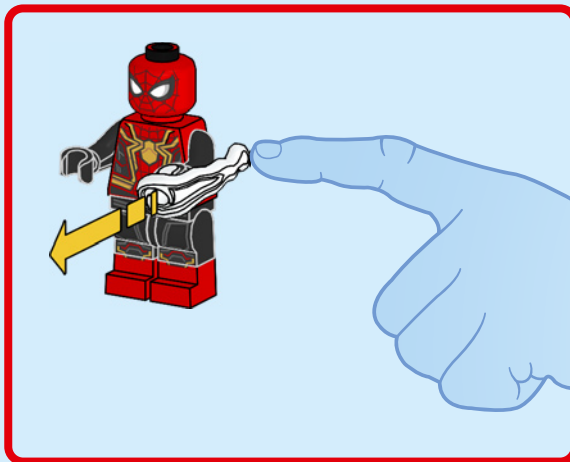

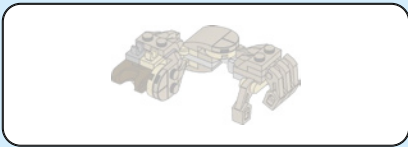

86

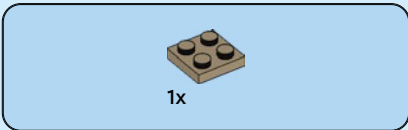
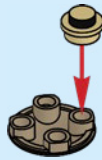

87

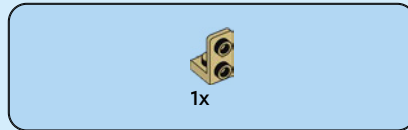

88

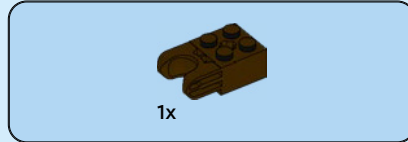

89

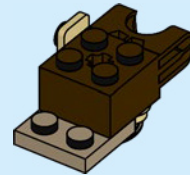



1x

90

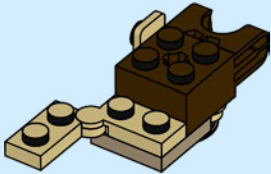

1x

91

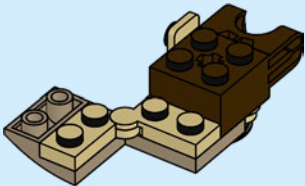

1x



1x

92

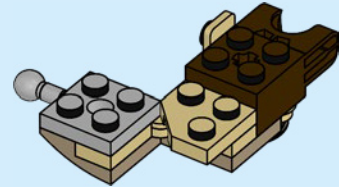

1x

93

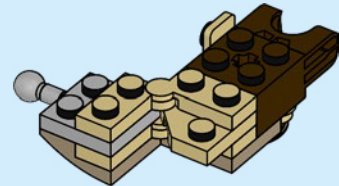

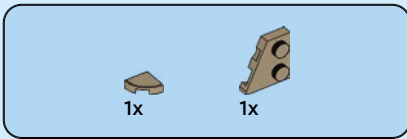

94

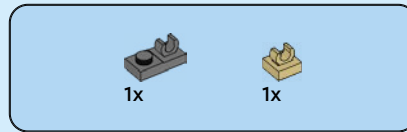
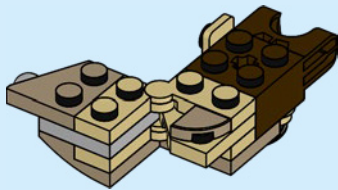

96

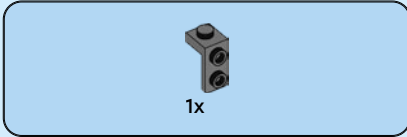
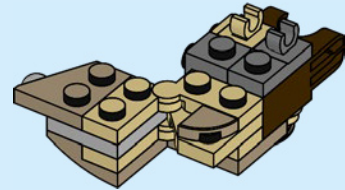

95

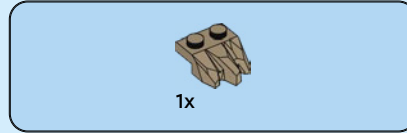
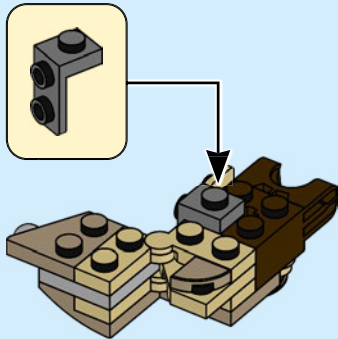

97

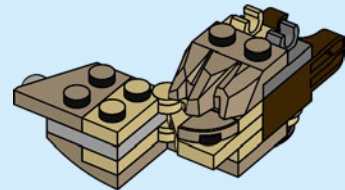

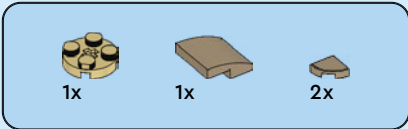

98

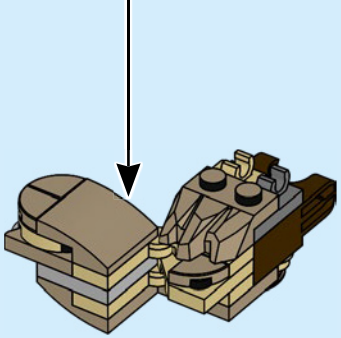
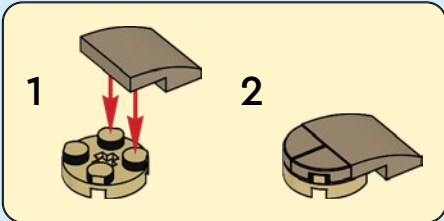

99

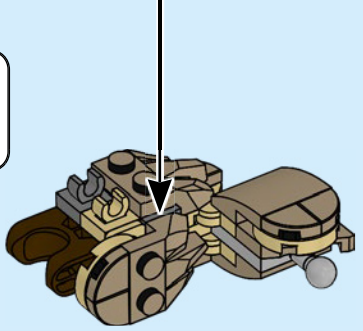
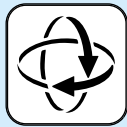
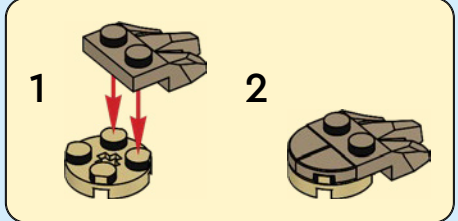

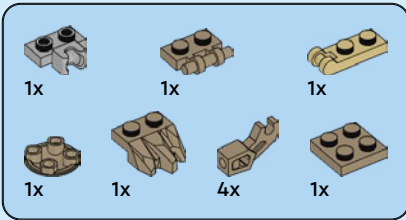

100

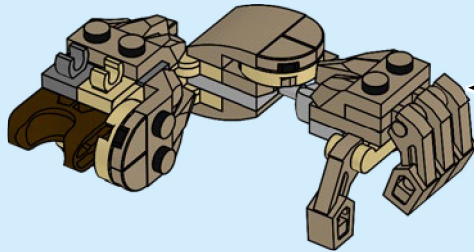
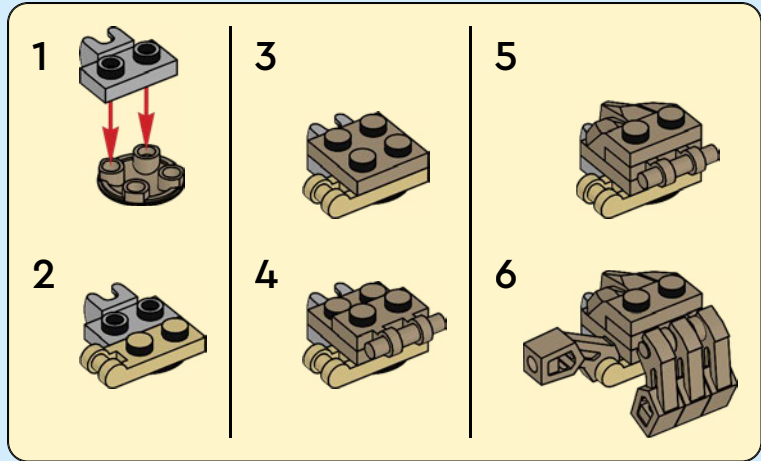

101

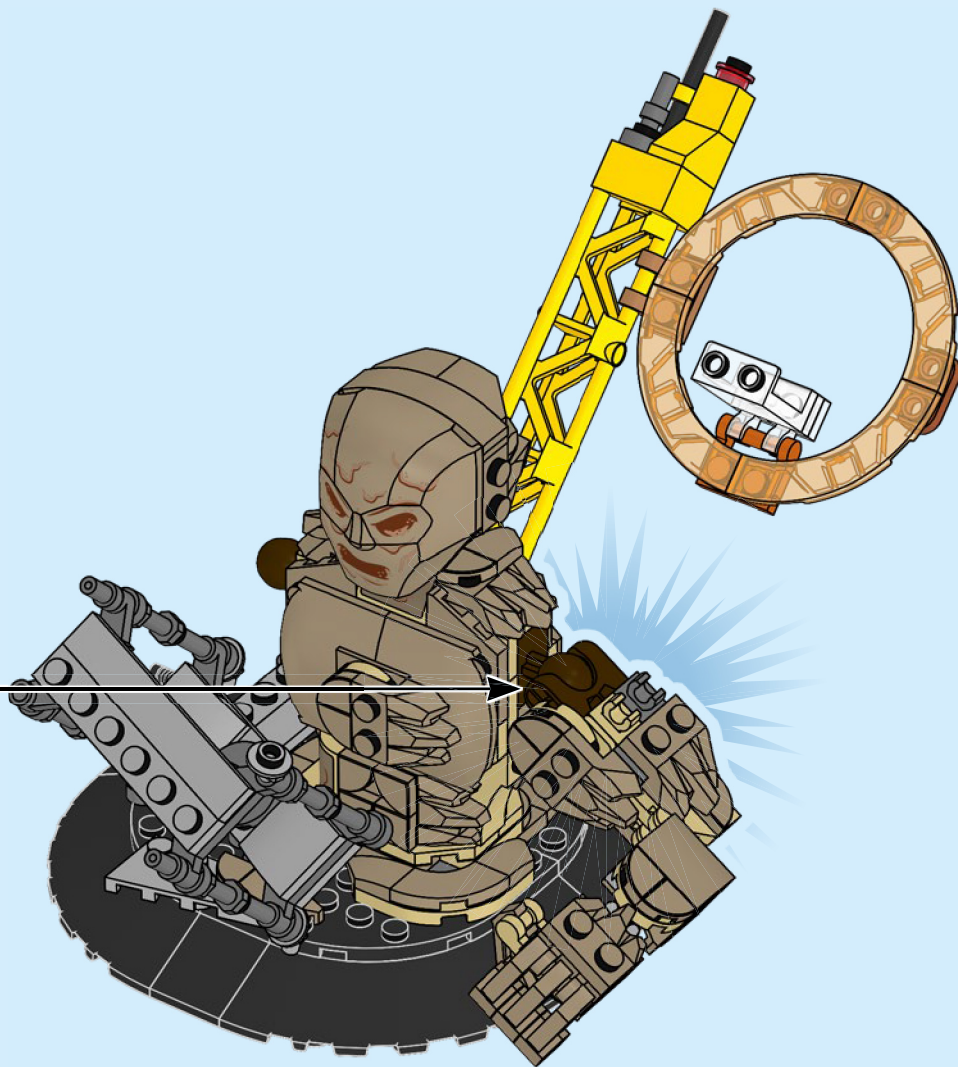

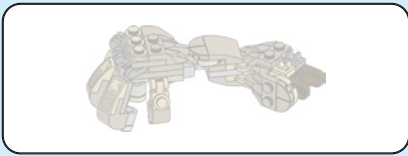

102

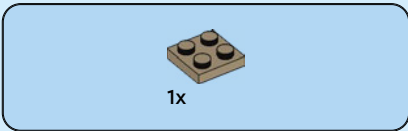
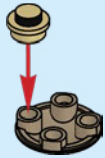

103

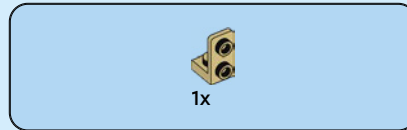

104

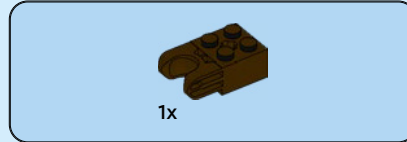

105

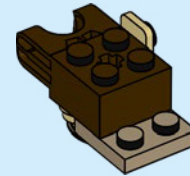



1x

106

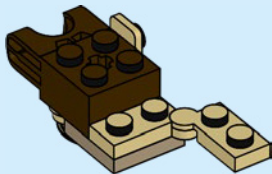

1x

107

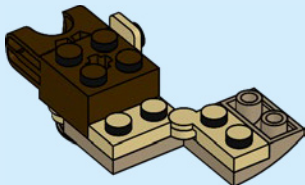

1x



1x

108

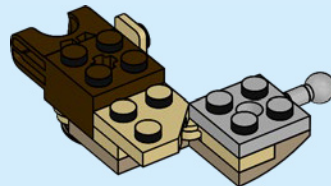

1x

109

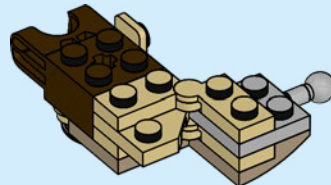

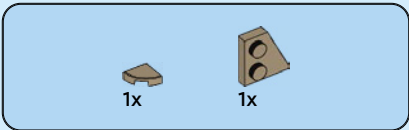

110

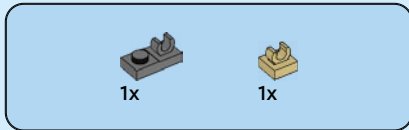
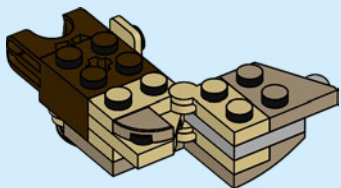

112

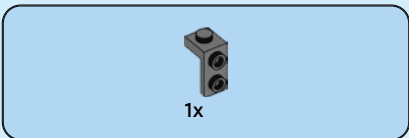
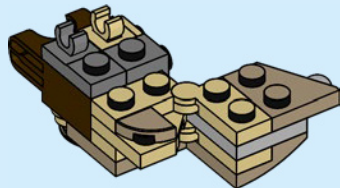

111

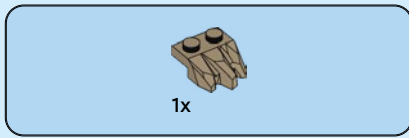
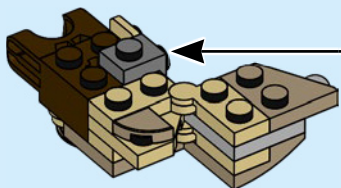

113

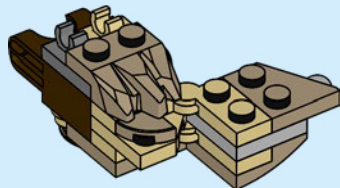

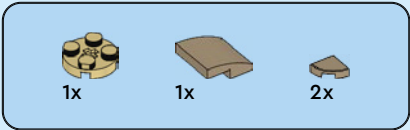

114

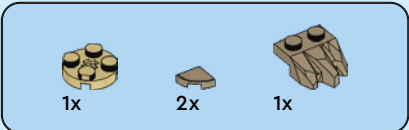
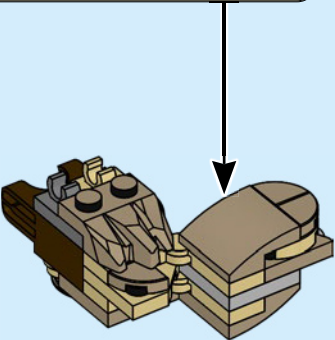
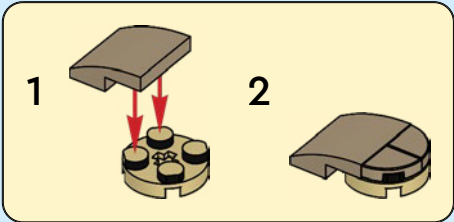

115

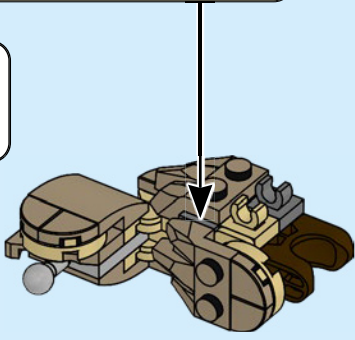
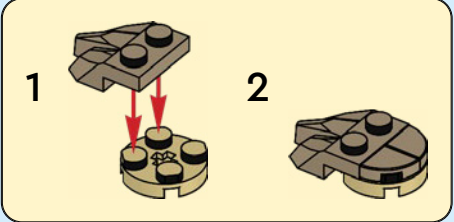

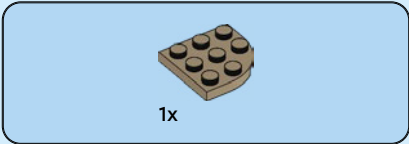

116

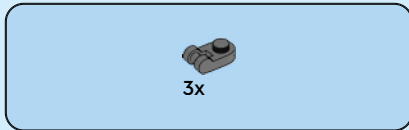
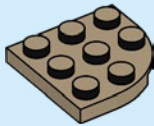

117

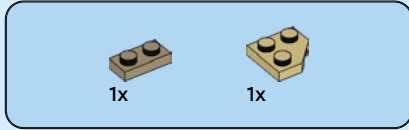
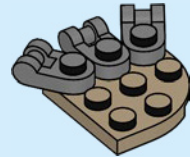

118

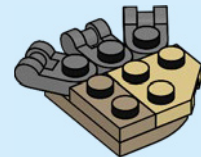



1x

119

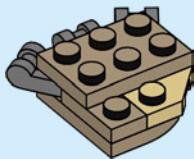

3x

120

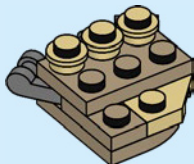

1x



1x

121

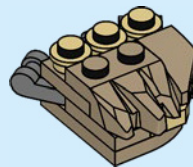

1x

122

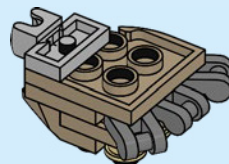
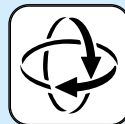

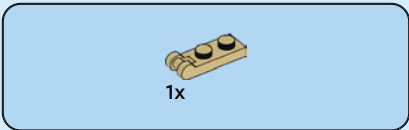

123

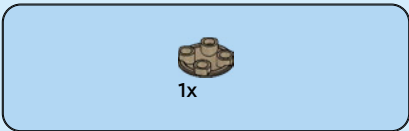
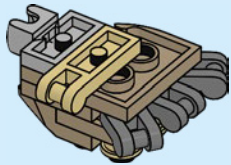

124

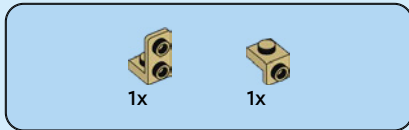
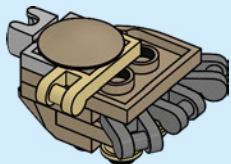

125

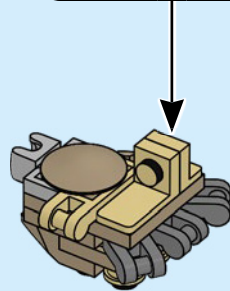
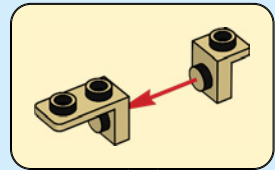

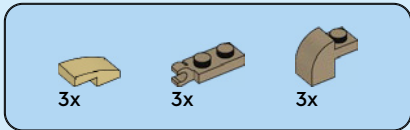

126

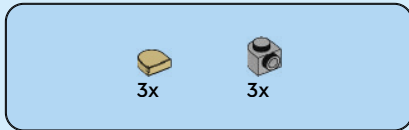
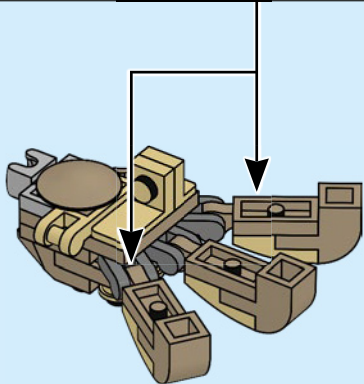
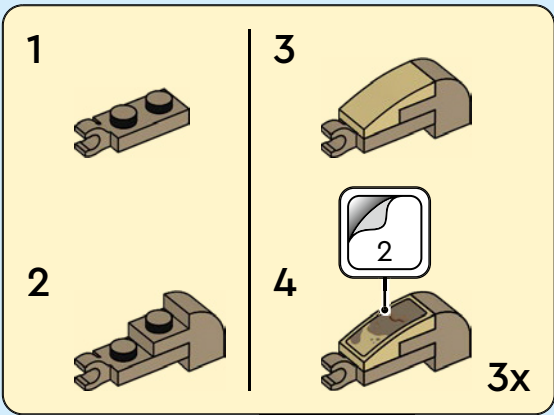

127

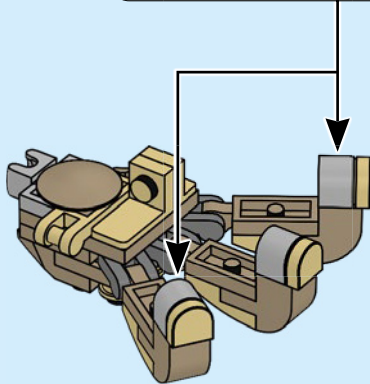

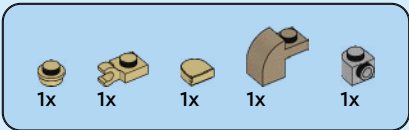

128

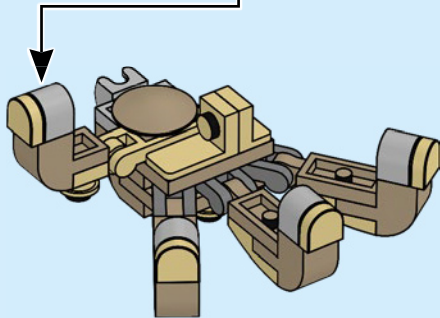
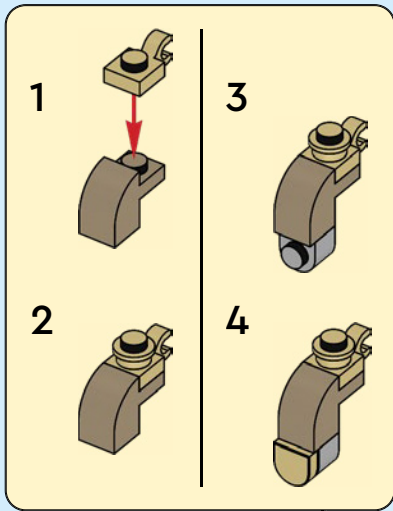

129

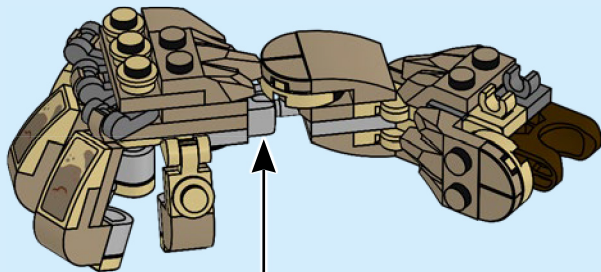

130

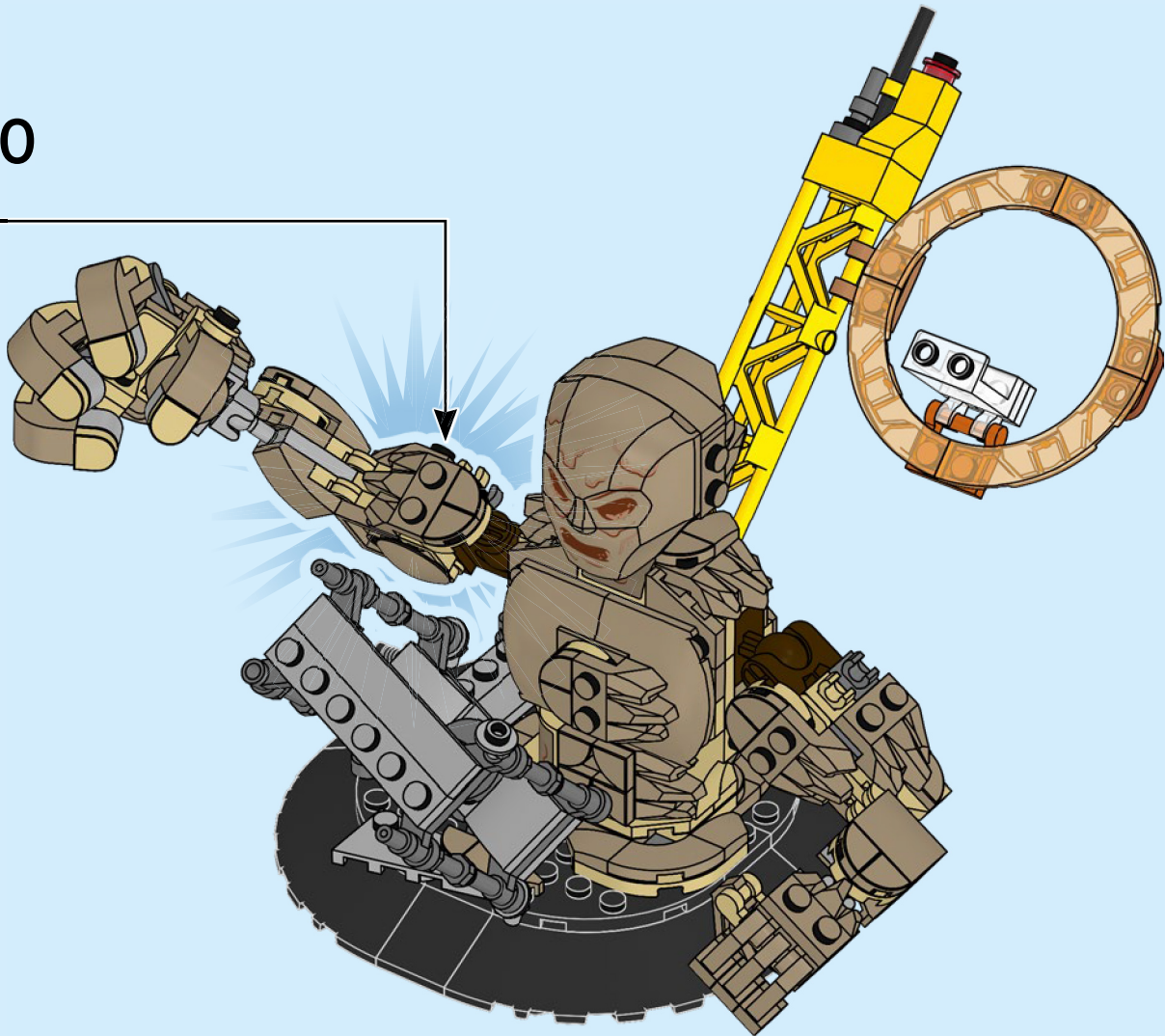

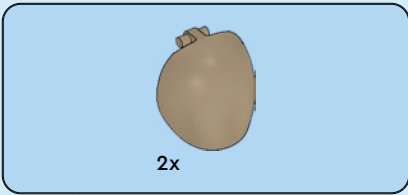

131

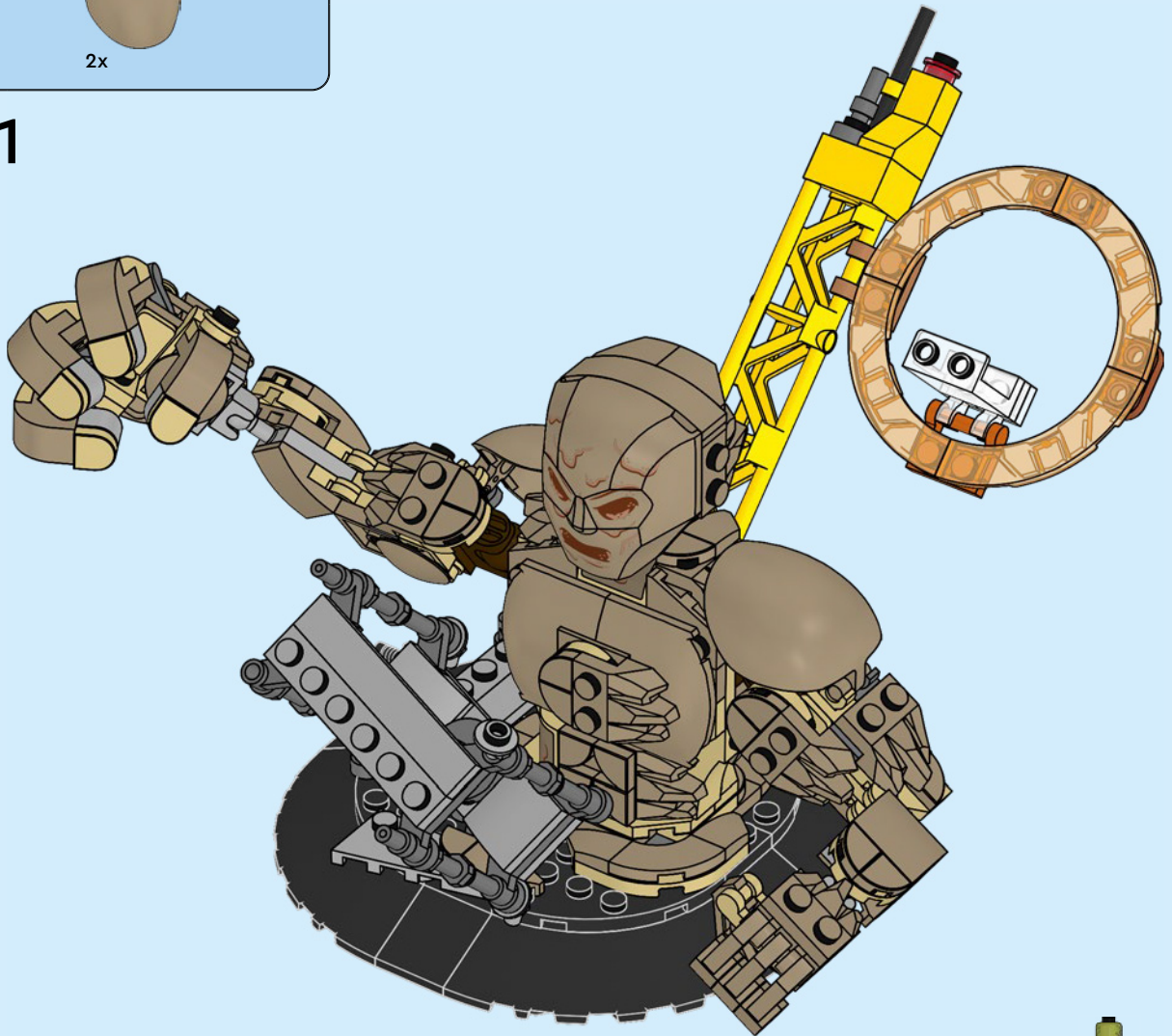

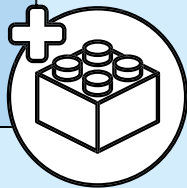
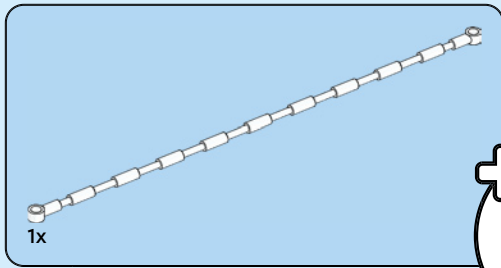

132

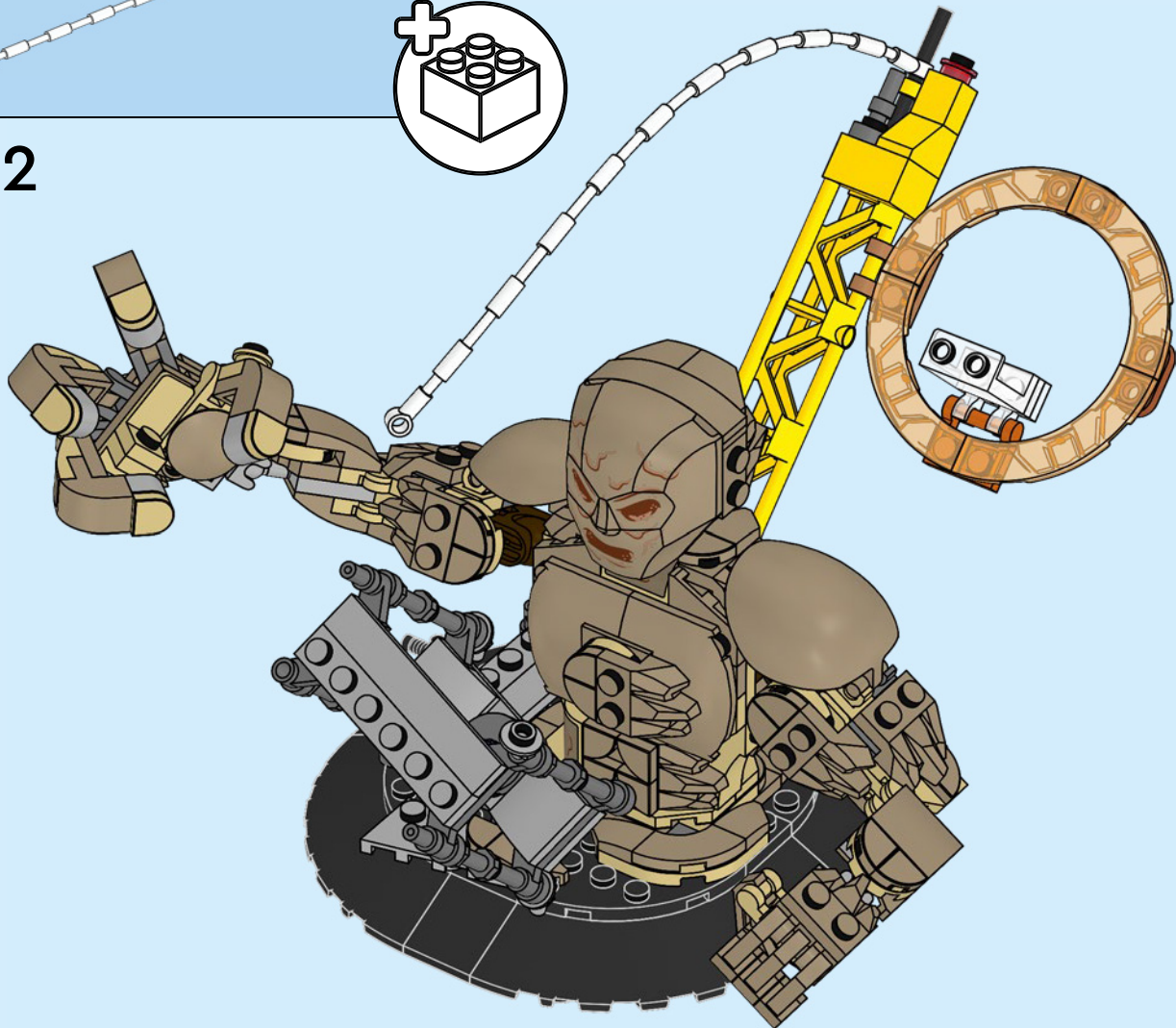

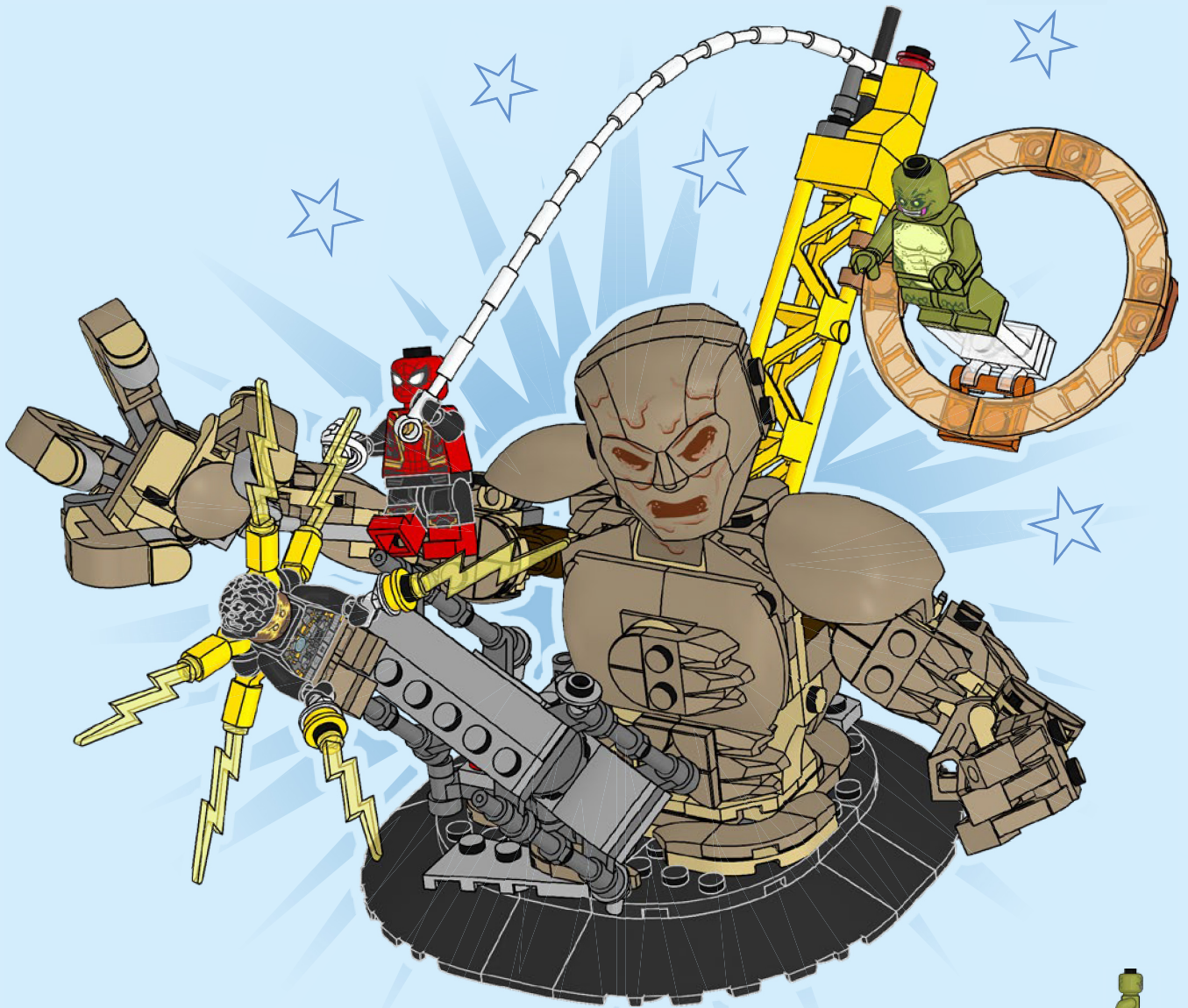



1

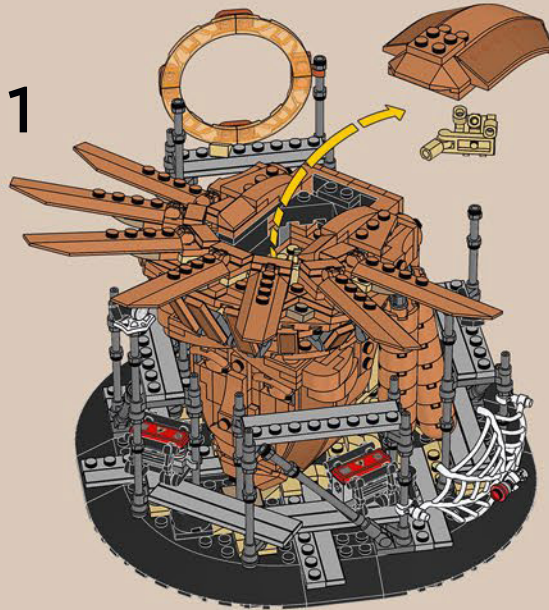

76280

2



76261

3

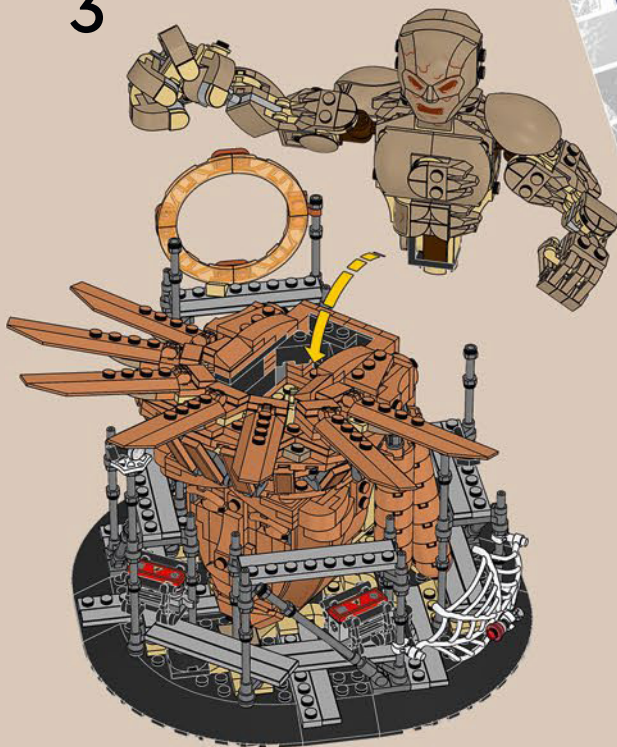

MARVEL

 8x 4161734	 5x 4113917	 1x 6356860	 4x 6337391	 6x 6353064	 7x 6047415
 4x 6353196	 2x 6117975	 1x 4537551	 1x 306221	 3x 6132767	 2x 6310830
 2x 6360078	 6x 4124455	 1x 614326	 1x 6349786	 1x 6343796	 3x 4550168
 4x 4118793	 1x 6013081	 1x 6462056	 1x 4142865	 4x 6401028	 2x 6395753
 2x 4125253	 4x 6265572	 1x 6420716	 2x 614321	 9x 4528604	 2x 6132768
 1x 6374192	 2x 6211975	 1x 302226	 1x 6370402	 4x 6360295	 1x 6368432
 7x 6357613	 2x 6328182	 1x 6254808	 1x 371021	 2x 6452010	 2x 6466712
 1x 6347292	 1x 6397561	 1x 6457902	 2x 300121	 1x 6330148	 2x 6035540
 1x 6408047	 4x 6416525	 1x 6116604	 6x 6258951	 1x 6210495	 1x 6167936
 10x 4140562	 1x 6139363	 4x 329826	 23x 6362967	 3x 6354662	 2x 6398013
 2x 4218749	 1x 4243824	 3x 370926	 2x 6385277	 12x 6401026	 2x 6093038
 5x 6236914	 3x 4113993	 4x 6101857	 2x 6388214	 2x 6093038	 1x 6467561
 3x 6046922			 6x 6258949	 5x 6356427	
 2x 6391523					

4x
6296951

2x
6435043

1x
6221607

3x
6388119

6x
6350724

3x
6055313

2x
6344754

4x
6310596

2x
6262899

2x
4210635

1x
6411395

6x
6302647

4x
6388294

4x
6341463

2x
6168644

1x
6336971

1x
4121965

4x
6130007

1x
6074687

1x
4206482

1x
6208450

6x
6211795

4x
6404369

2x
6369194

3x
6045909

2x
6360827

1x
6467558

1x
6467560

1x
6476246

1x
6469726

1x
6468361

2x
6285587

2x
6429708

1x
6240204



1x
6253231



1x
6347306

1x
6448799

3x
6326748

4x
6448793



1x
4211732

1x
4211735

3x
6043656

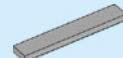

2x
6102357

3x
6448319

2x
4211549

2x
4211438

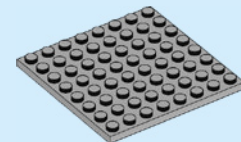
1x
4211542

1x
4166618

2x
6335278



1x
6360826

1x
6409728

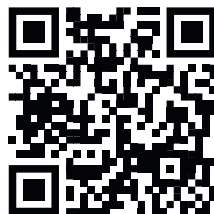

 LEGO.com/service

YOU COULD **WIN**



Scan this QR code or go to **LEGO.COM/PRODUCTFEEDBACK** and give us your short feedback about this LEGO® set for a chance to win a cool LEGO prize.

Terms and Conditions apply*



EN: YOU COULD WIN. Terms and Conditions apply* **DE: Du könntest GEWINNEN.** Es gelten die Teilnahmebedingungen* **FR: Tu pourrais GAGNER.** Des conditions s'appliquent* **IT: Potresti VINCERE tu.** Termini e condizioni sono applicabili* **ES: Puedes GANAR.** Aplican términos y condiciones* **PT: Poderá GANHAR.** Aplicam-se termos e condições* **ZH: 轻松获奖. 条款和条件适用*** **PL: Szansa na WYGRANĄ.** Obowiązują warunki korzystania* **CS: Máte šanci VYHRÁT.** Platí všeobecné smluvní podmínky* **SK: Máte šancu VYHRAŤ.** Platia všeobecné zmluvné podmienky* **HU: TE IS NYERHETSZ.** Felhasználási feltételek érvényesek* **RO: Ai putea CÂȘTIGA.** Se aplică termeni și condiții* **BG: Можете да СПЕЧЕЛИТЕ.** Има определени правила и условия* **LV: Tu vari LAIMĒT.** Ir spēkā noteikumi un nosacījumi.* **ET: Sul on võimalus VÕITA.** Kehtivad tingimused* **LT: Jūs galite LAIMĖTI.** Taikomos sąlygos*

*[LEGO.com/productfeedback-terms](https://www.lego.com/productfeedback-terms)

LEGO and the LEGO logo are trademarks of the/son des marques de commerce du/son marcas registradas de LEGO Group. ©2024 The LEGO Group.
© Marvel © CPII