



76265





Get excited about our new packaging!

We're switching from plastic to paper-based packaging. That's why you might find a mix of paper and plastic in our boxes!

Nos nouveaux emballages vous emballeront !

Nous passons des emballages en plastique aux emballages à base de papier. C'est pourquoi vous pourriez trouver un mélange de papier et de plastique dans nos boîtes !

¡Te presentamos nuestros nuevos empaques!

Estamos sustituyendo las bolsas de plástico por bolsas con base de papel. ¡Por eso, puedes encontrar una mezcla de papel y de plástico en nuestras cajas!

[LEGO.com/sustainable-packaging](https://www.lego.com/sustainable-packaging)



BUILDER



Apple and the Apple logo are trademarks of Apple Inc., registered in the U.S. and other countries and regions. App Store is a service mark of Apple Inc. Google Play and the Google Play logo are trademarks of Google LLC. Tencent and the Tencent logo are trademarks of Tencent Inc.

Q [LEGO.com/devicecheck](https://www.lego.com/devicecheck)

EN Ask parents' permission before going online | DE Eltern um Erlaubnis bitten, bevor du online gehst | FR Demande l'autorisation d'un parent avant d'aller en ligne | IT Chiedi il permesso ai tuoi genitori prima di andare online | ES Pídeles permiso a tus papás antes de conectarte a Internet | PT Peça autorização aos pais antes de acederes online | ZH 上网前应先征得父母的同意 | PL Poproś rodziców o zgodę, zanim wejdiesz do Internetu | CS Než půjdeš na internet, požádej rodiče o svolení | SK Skôr než pôjdeš na internet, vypýtaj si povolenie od rodičov | HU Kérj szülői engedélyt, mielőtt online csatlakoznál! | RO Cere permisiunea părinților înainte de a te conecta online | BG Поискайте разрешение от родител, преди да влезете онлайн | LV Pirms došanās tiešsaistē palūdz atļauju vecākiem | ET Enne Interneti kasutamist küsi vanematelt luba | LT Prieš prisijungdami prie interneto, atsklauskite tėvų

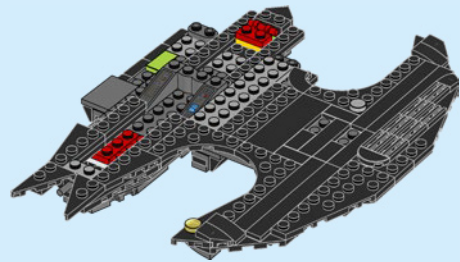
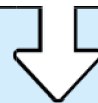
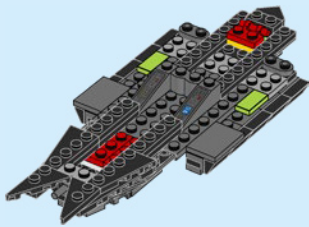
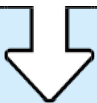

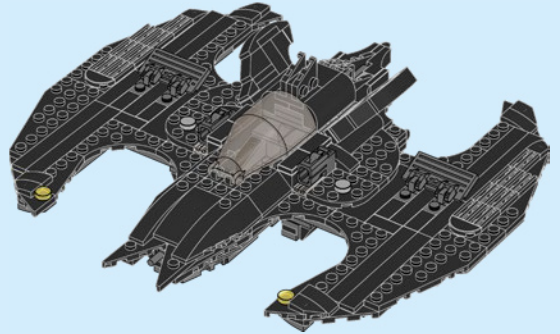
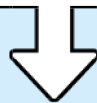
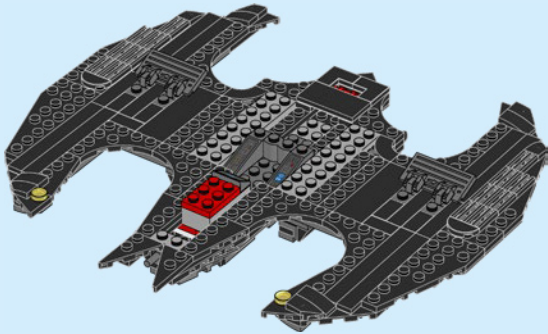
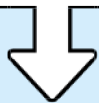

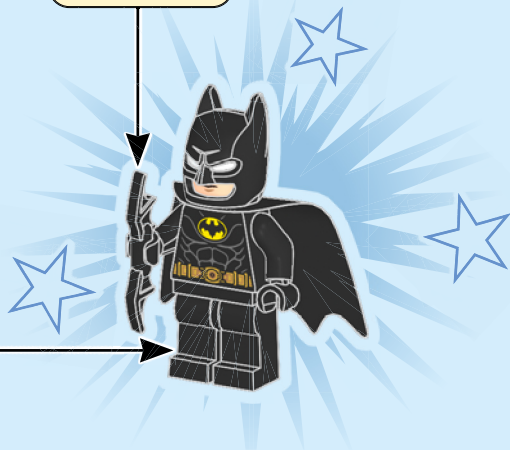
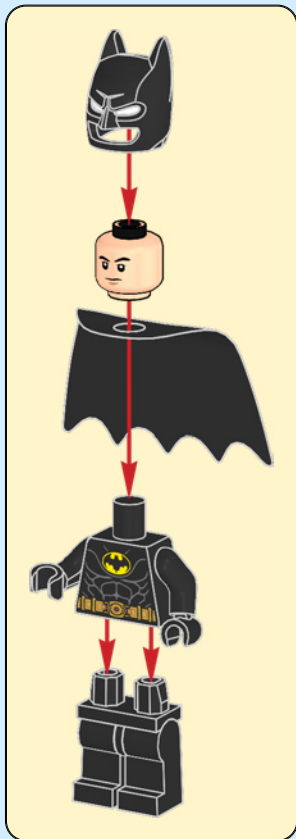

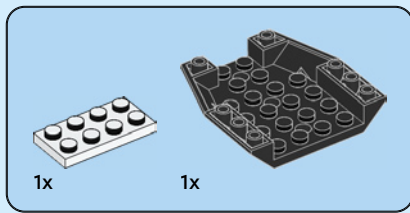

1

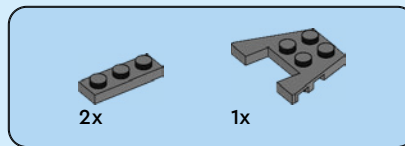
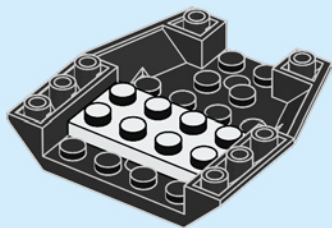

2

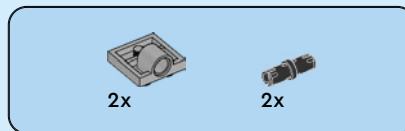
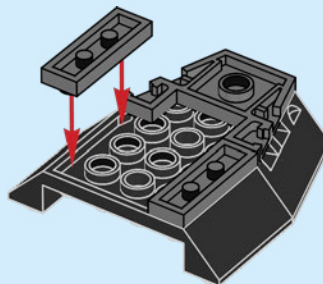

3

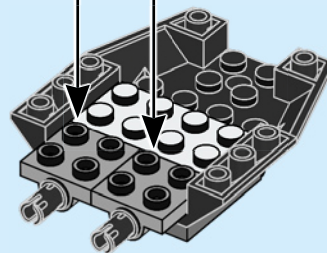
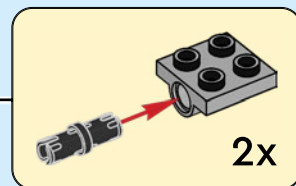

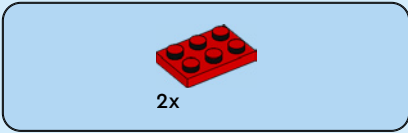

4

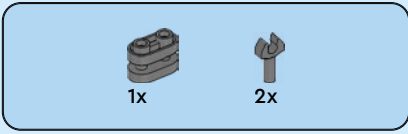
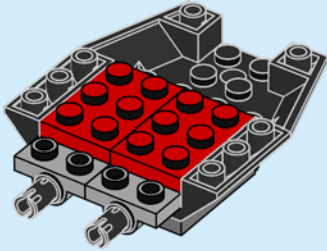

5

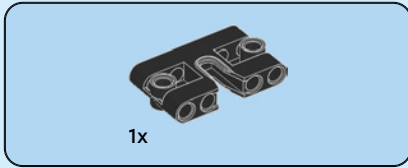
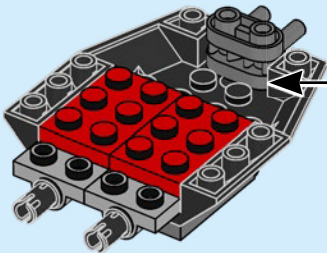
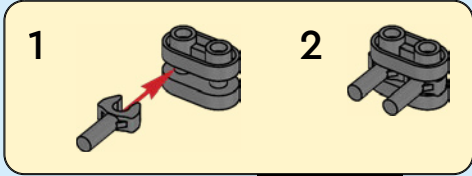

6

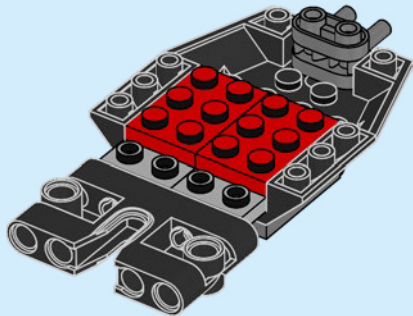
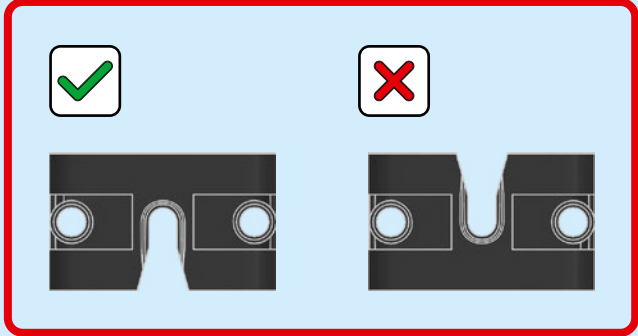

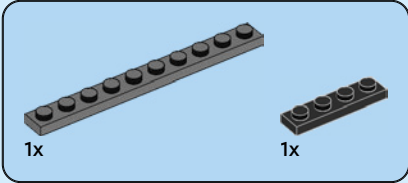
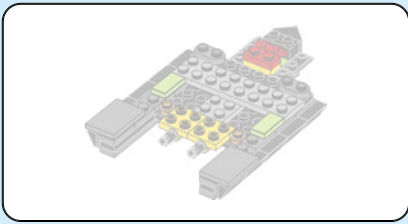

7

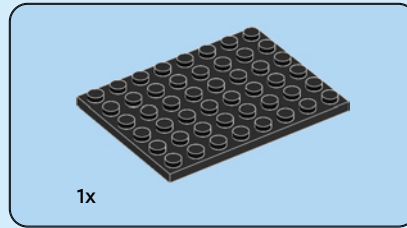
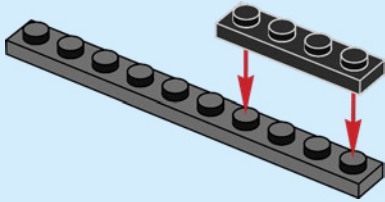

8

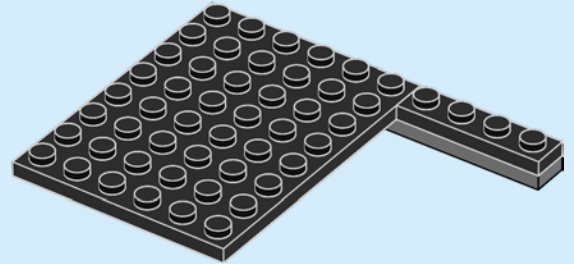

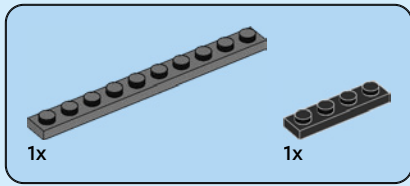

9

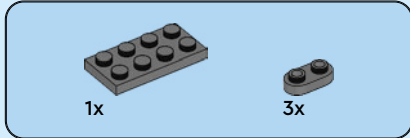
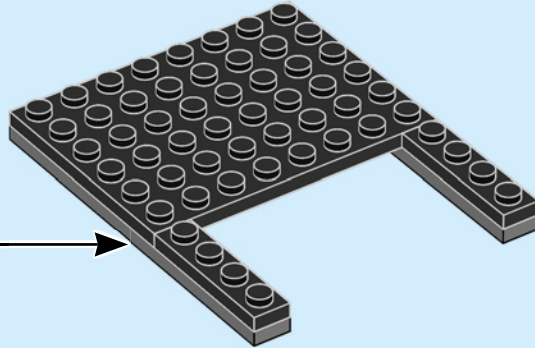
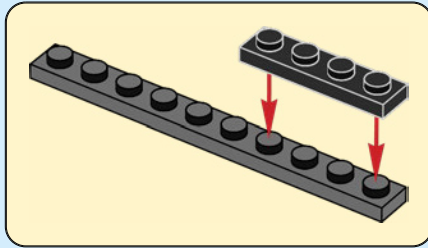

10

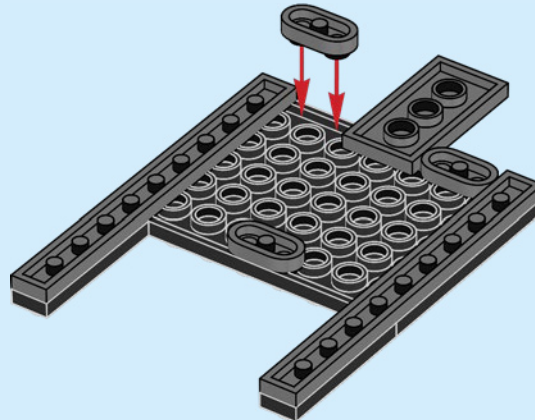

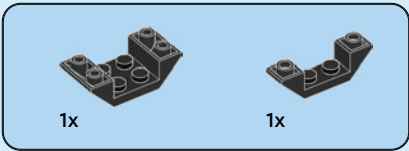

11

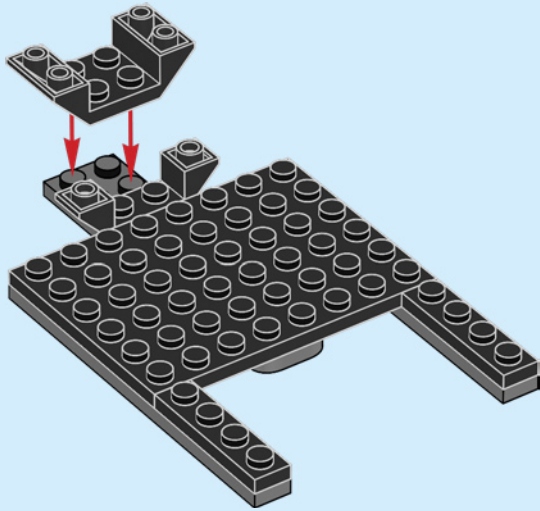

12

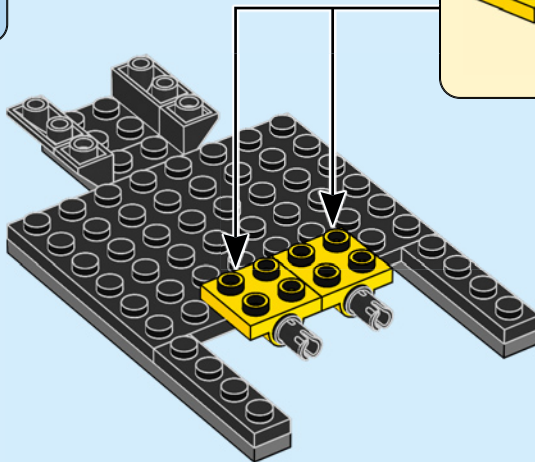
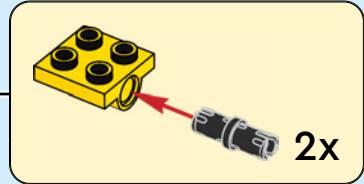

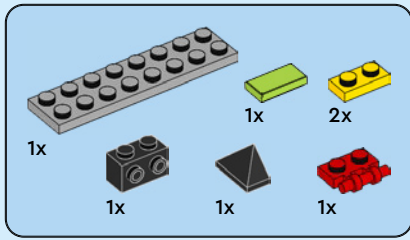

13

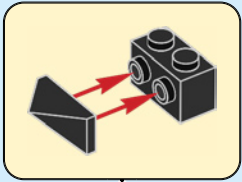

1

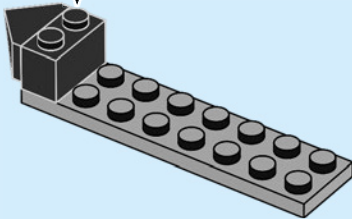

2

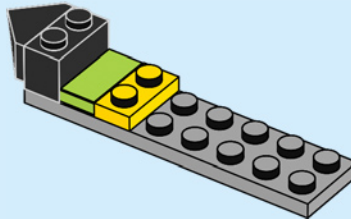

3

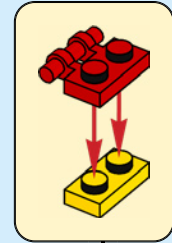
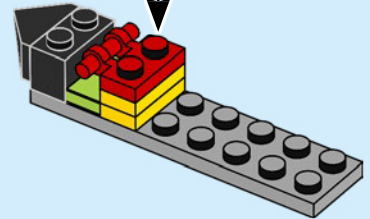

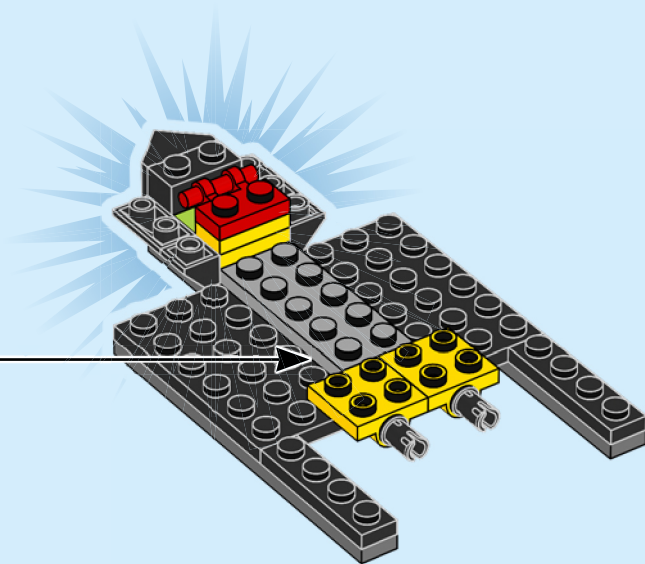



2x



2x

14

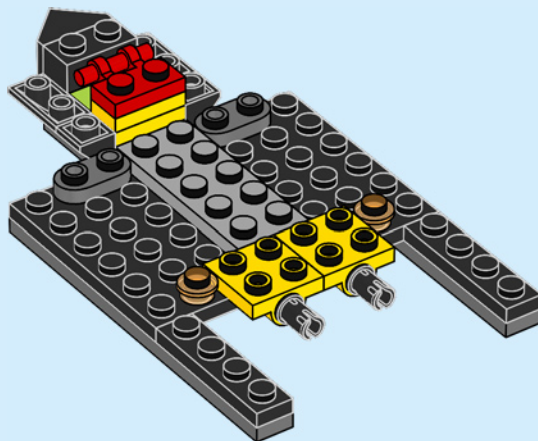

5x

15

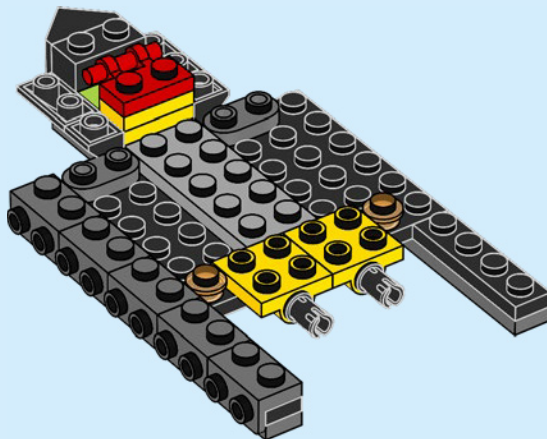



5x

16

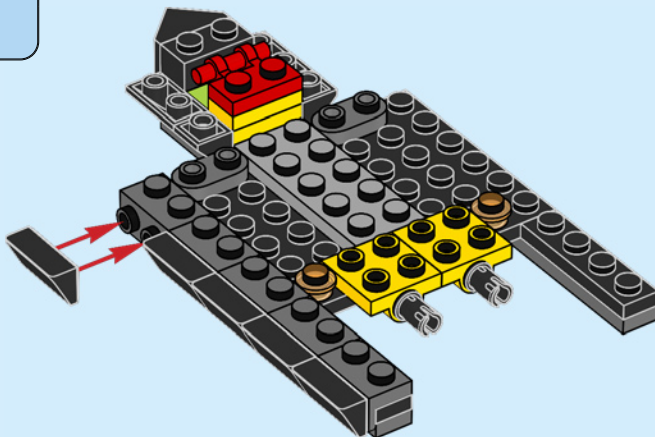

5x

17

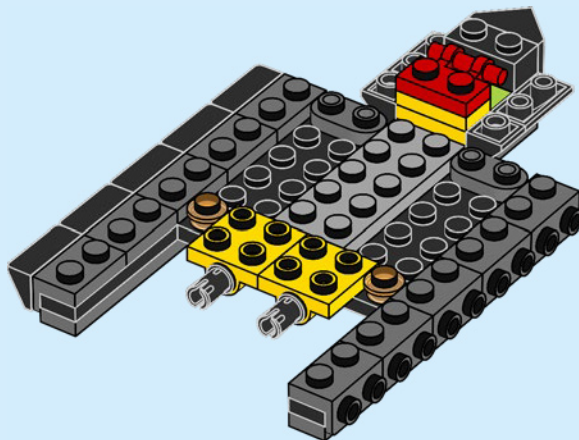



5x

18

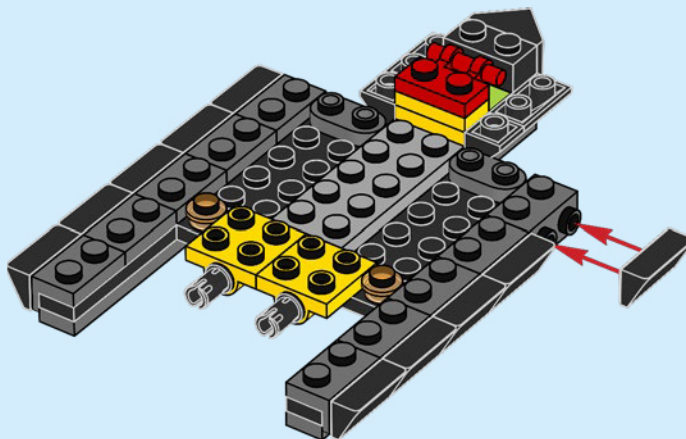

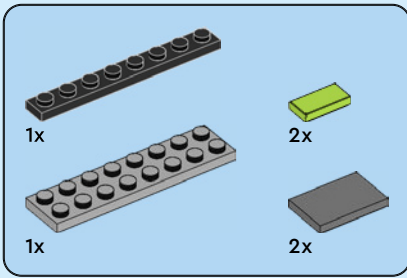

19

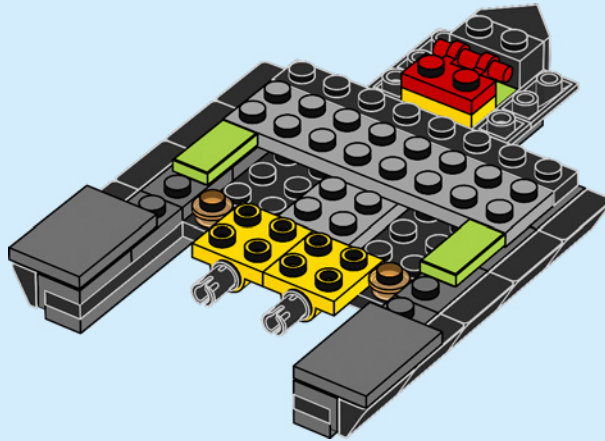

20

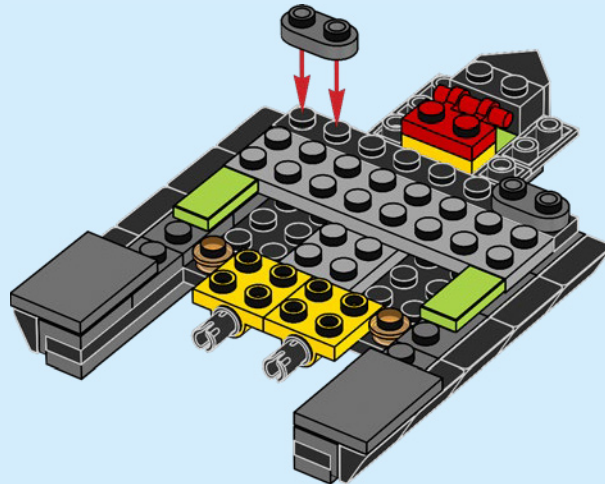

21

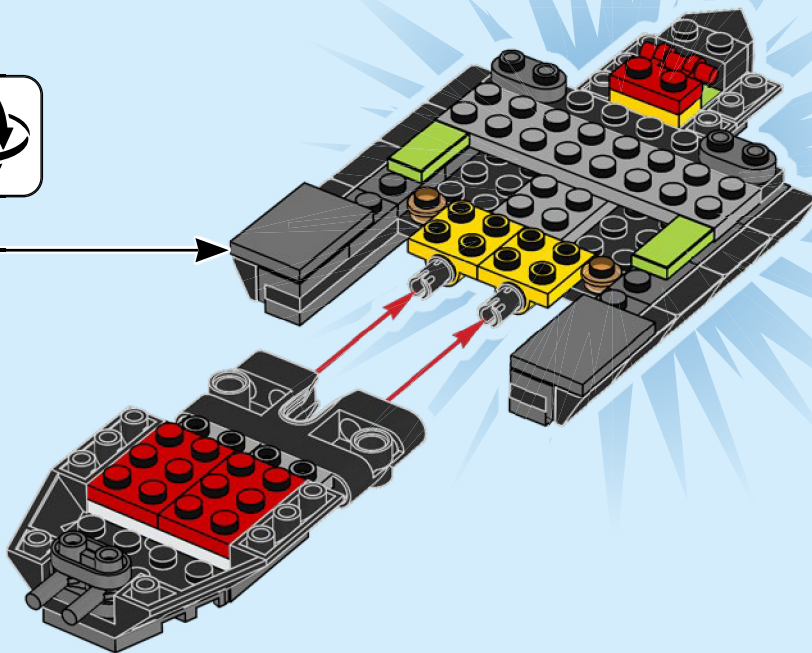
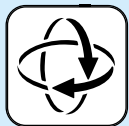

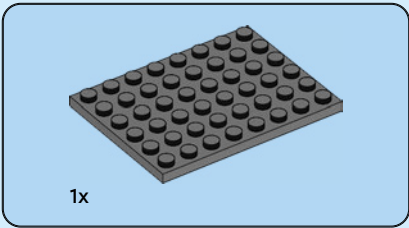

22

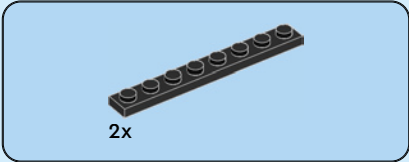
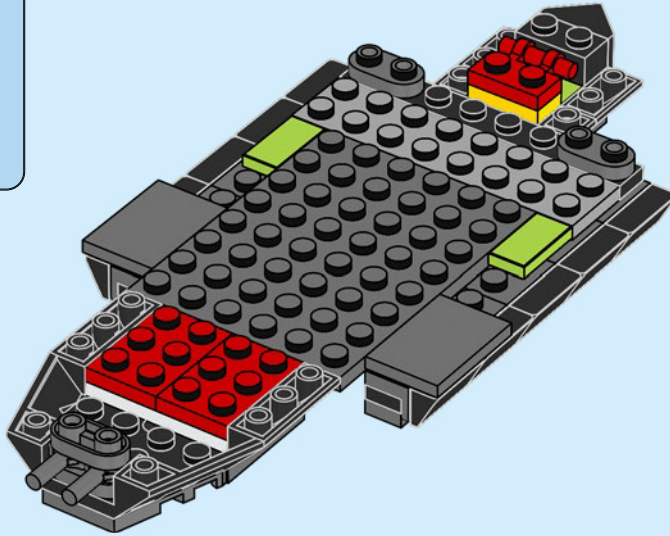

23

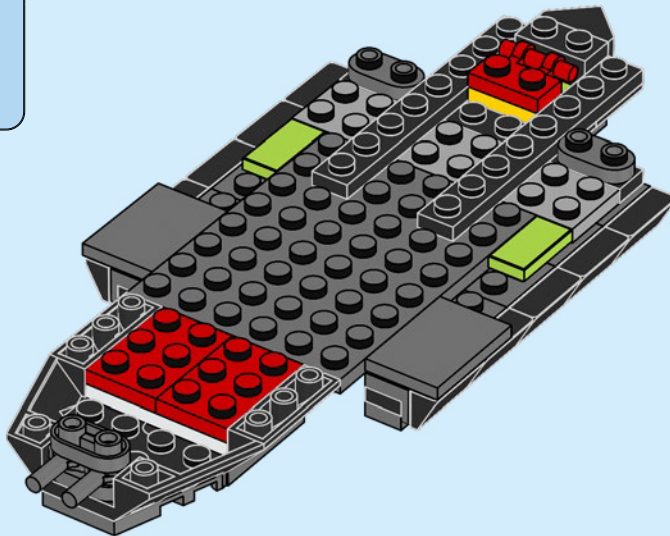

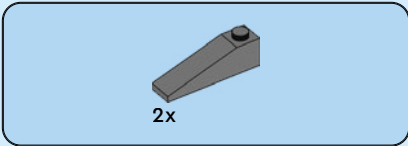

24

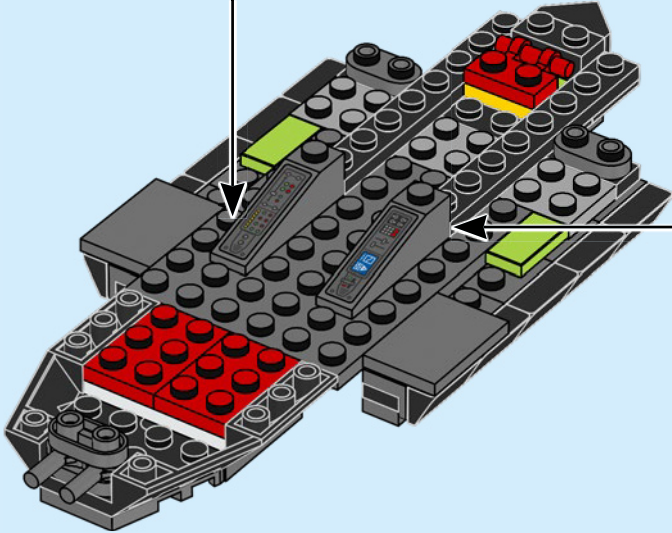
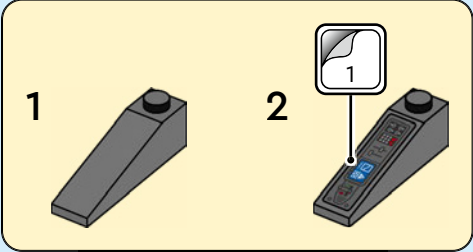
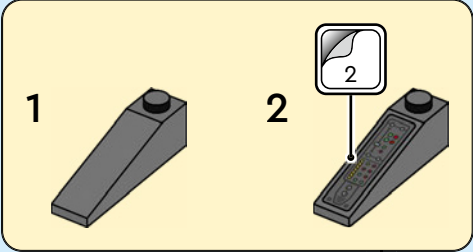

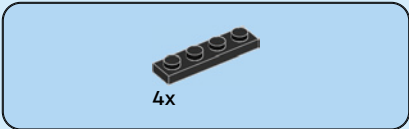

25

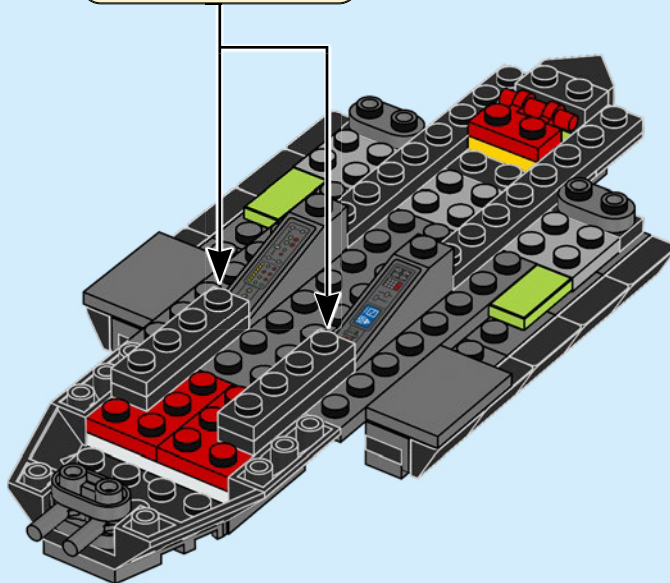
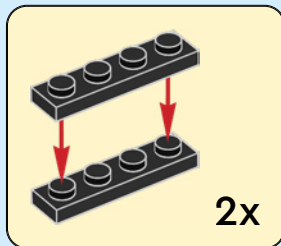

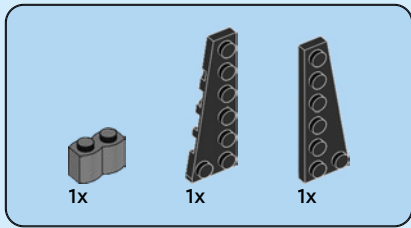

26

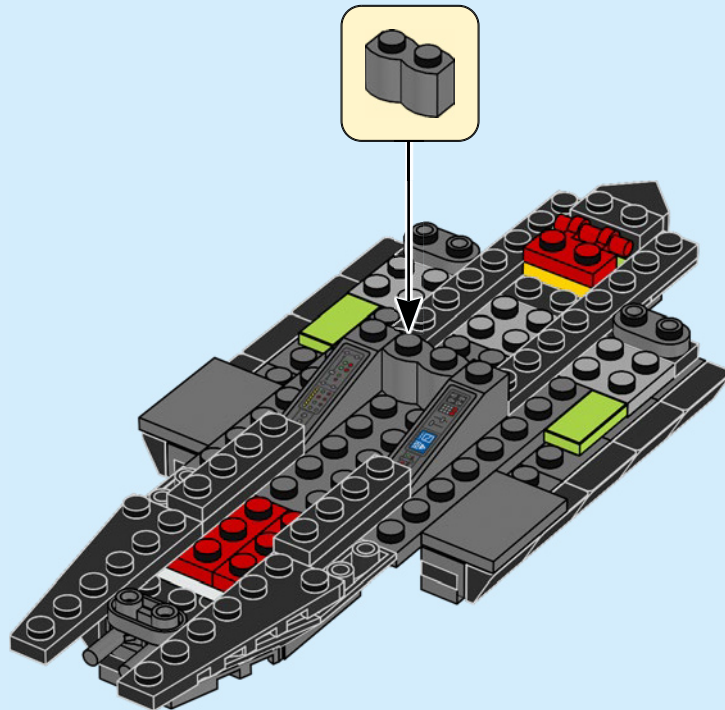

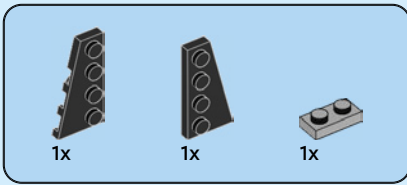

27

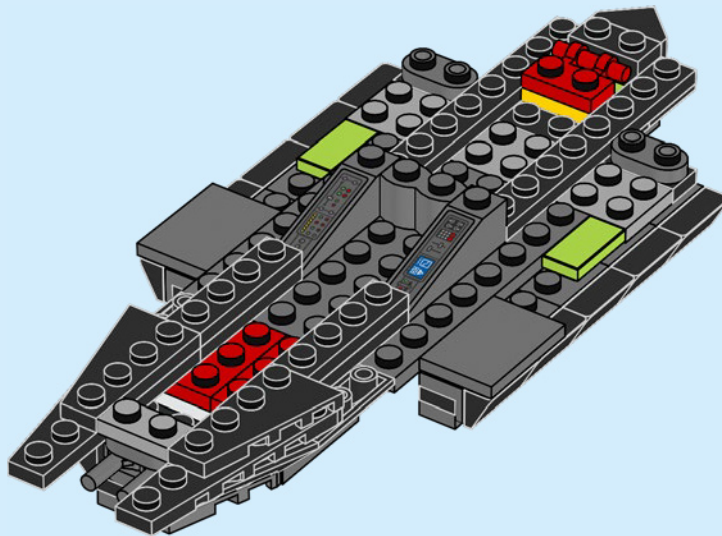

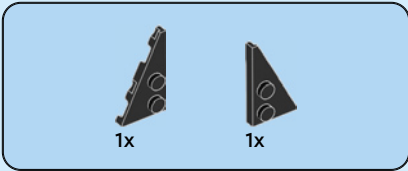

28

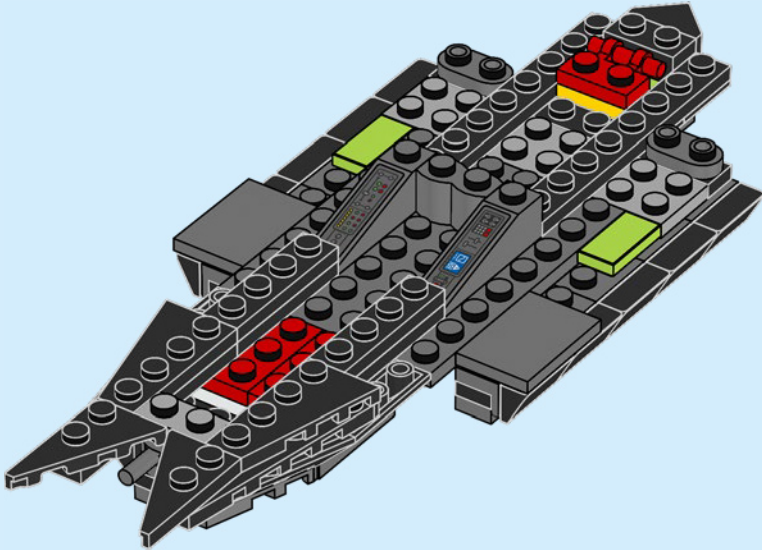

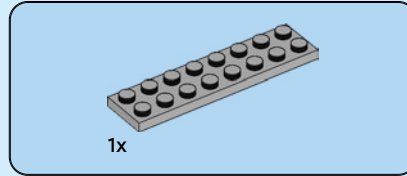
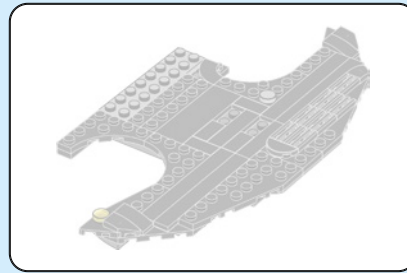

29

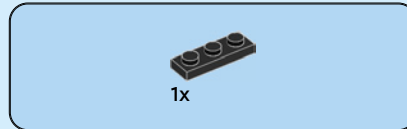
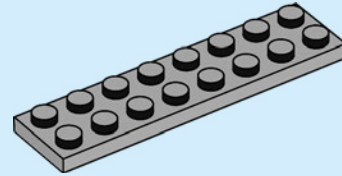

30

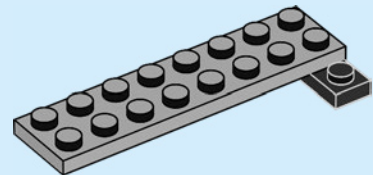
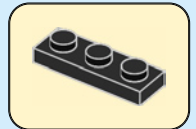

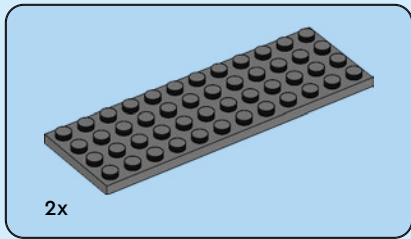

31

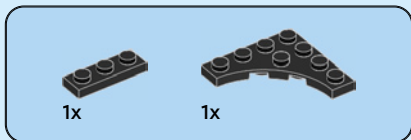
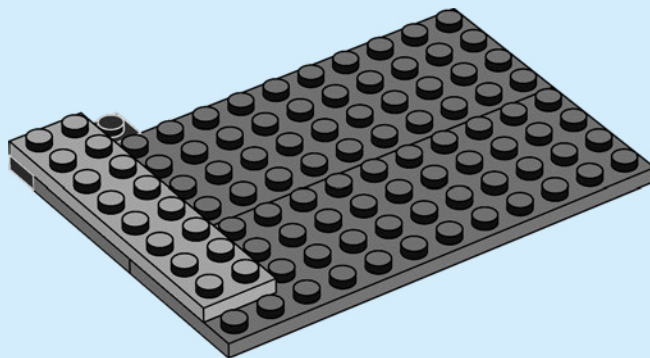

32

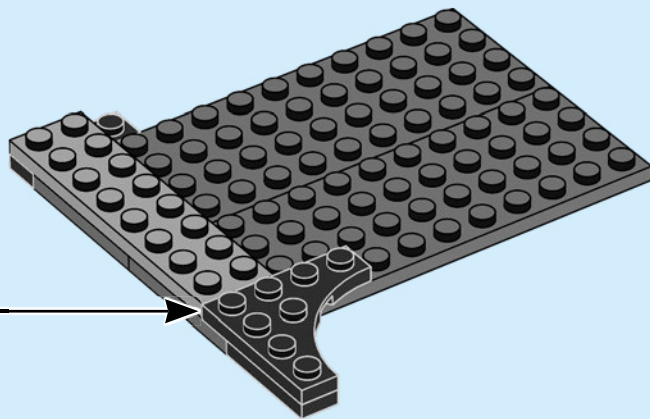
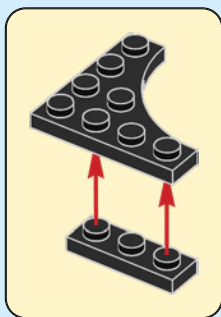

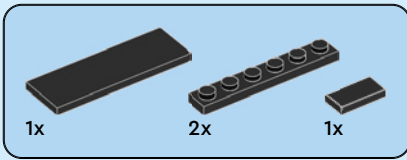

33

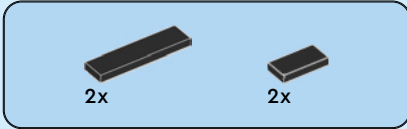
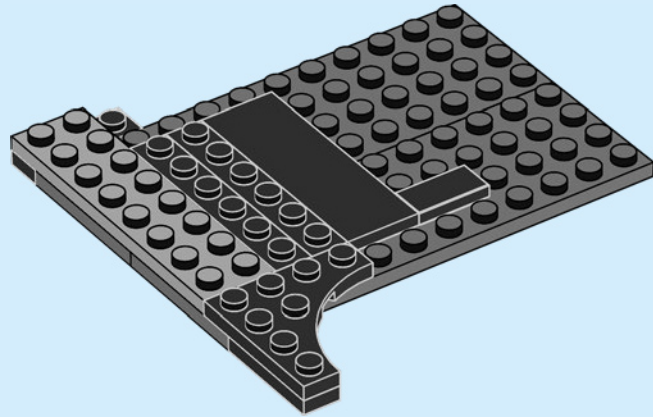

34

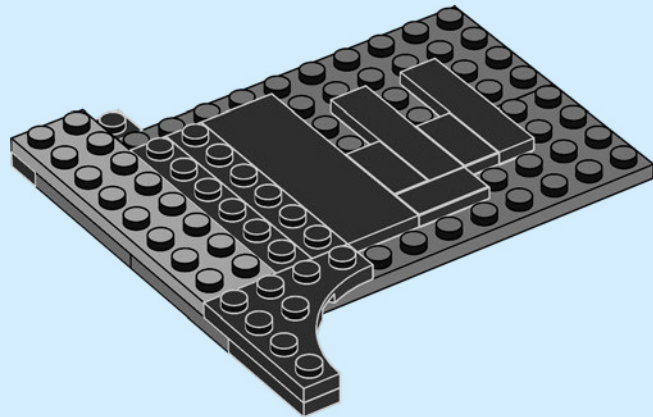



1x

35

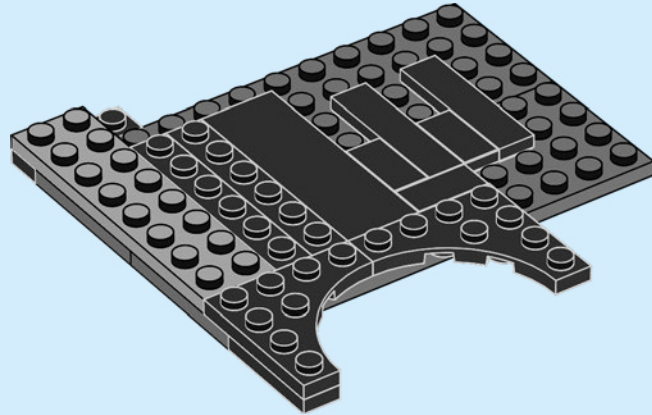

1x

36

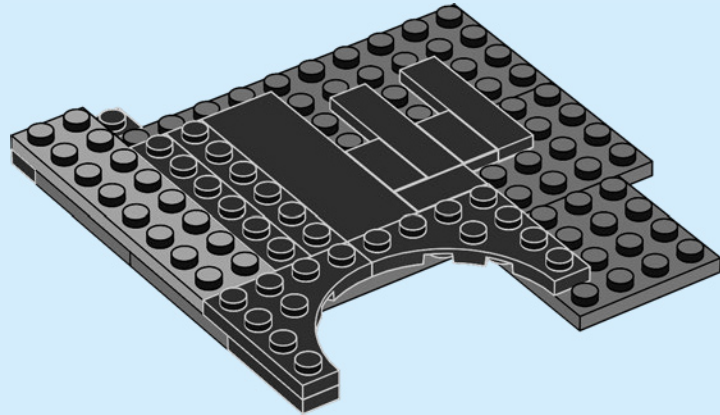

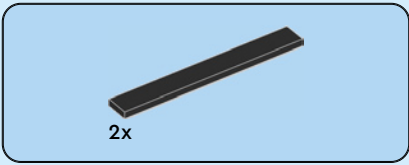

37

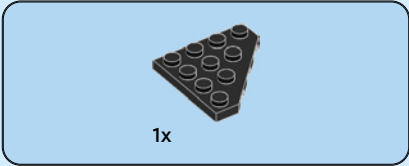
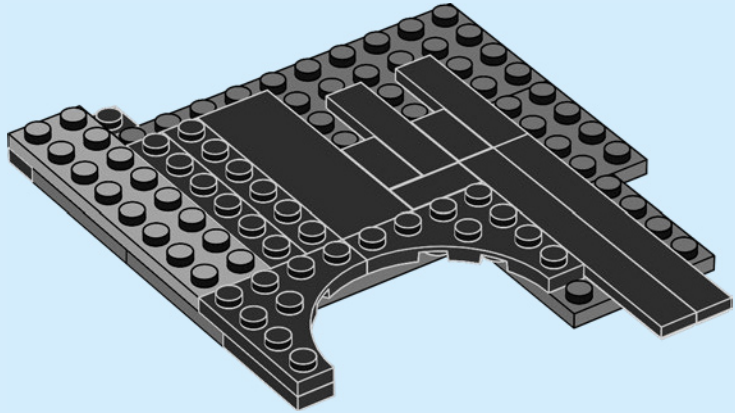

38

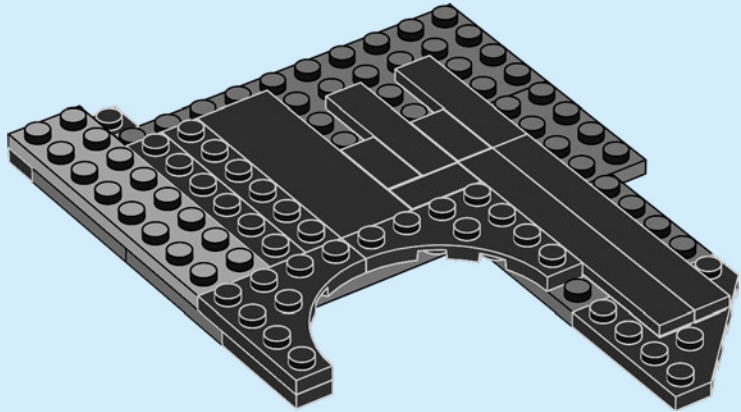

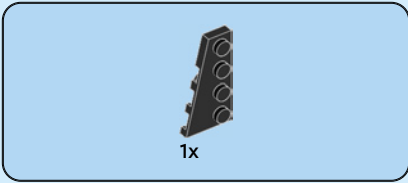

39

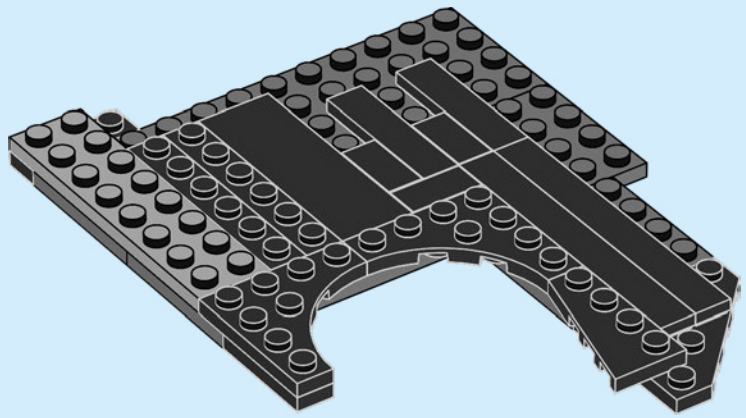

40

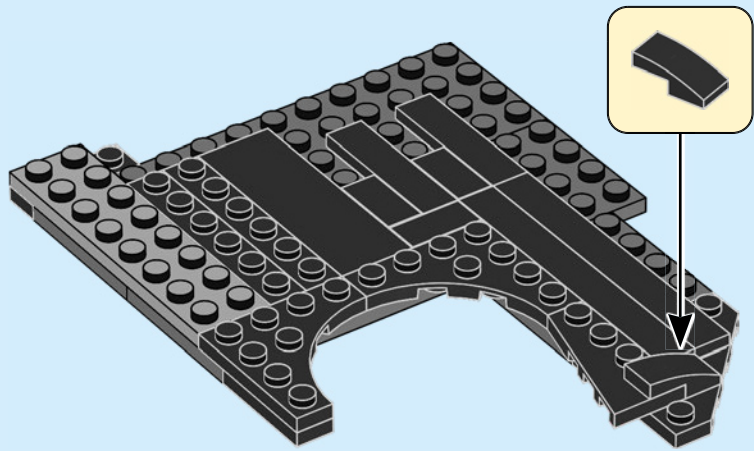

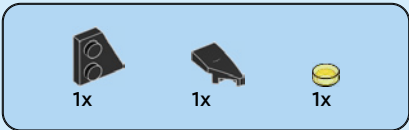

41

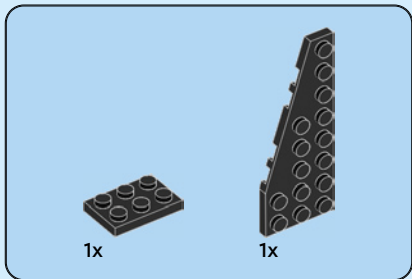
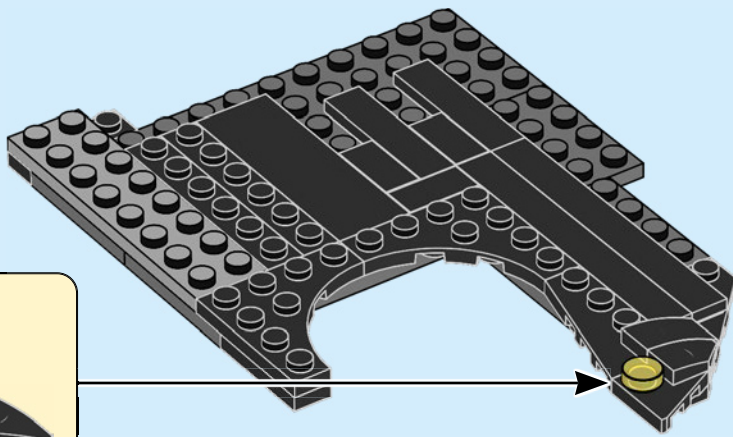
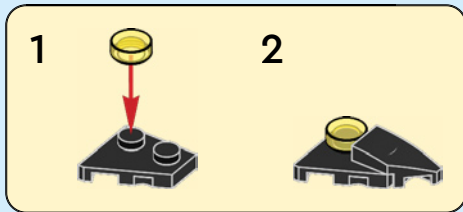

42

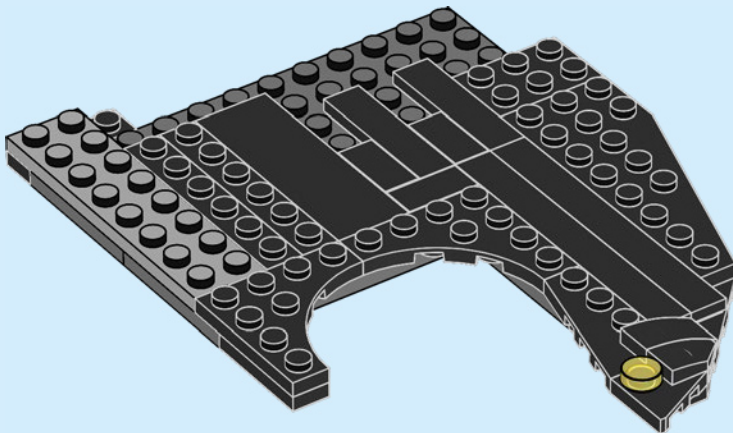

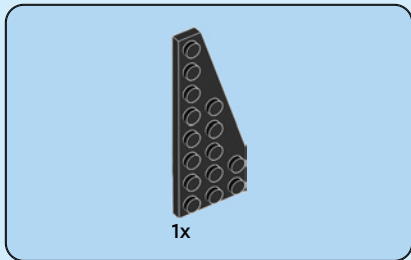

43

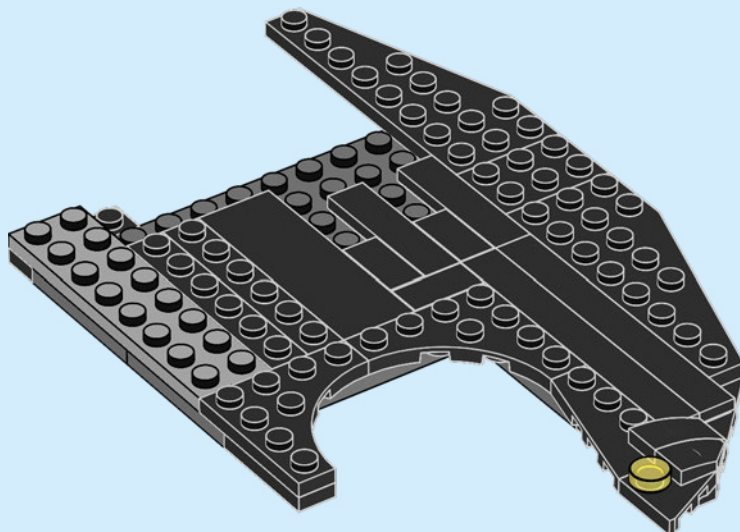

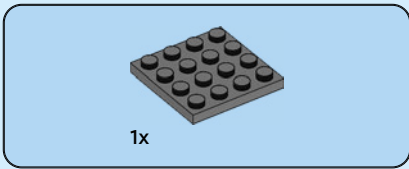

44

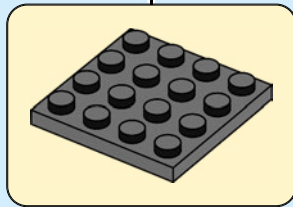
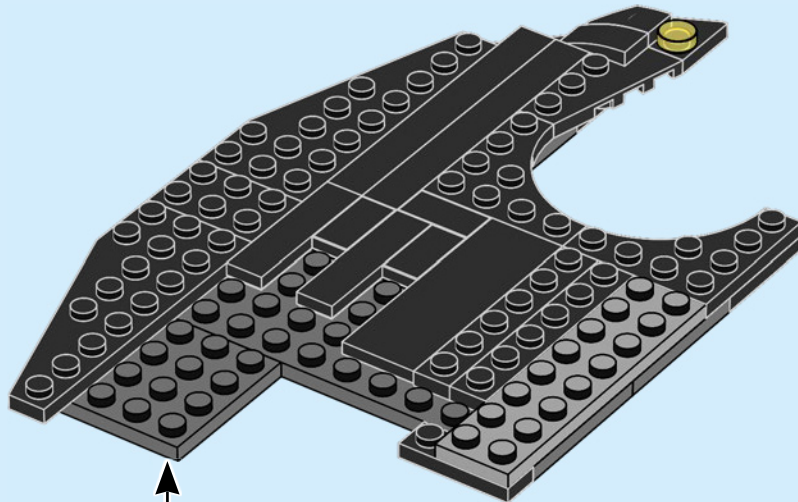

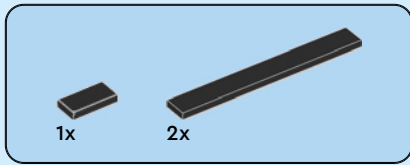

45

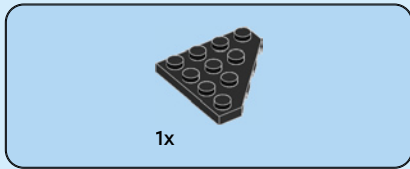
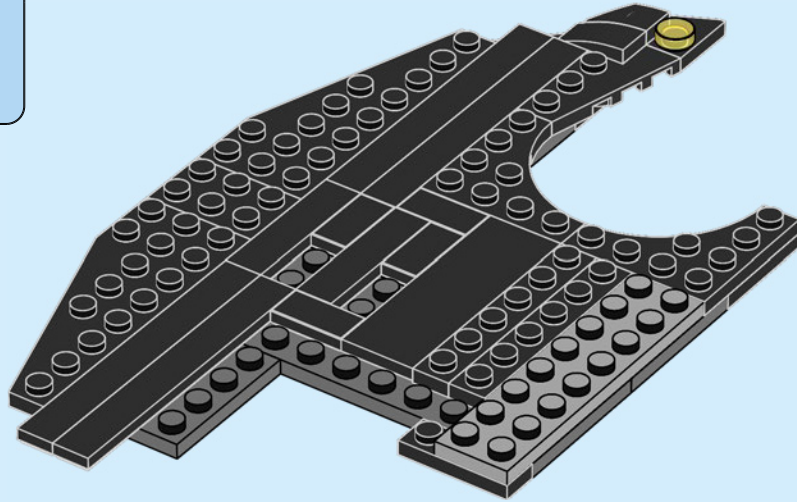

46

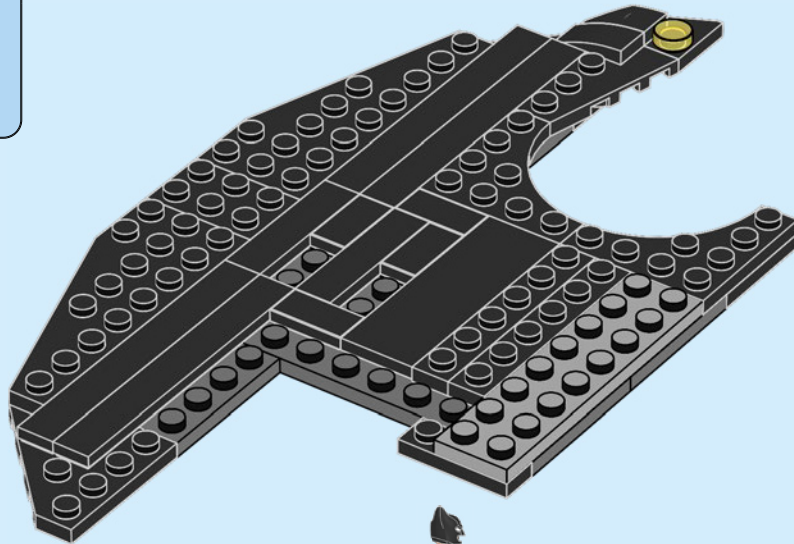

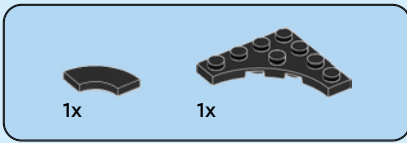

47

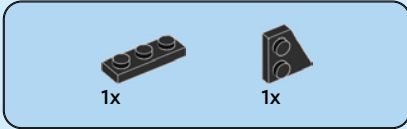
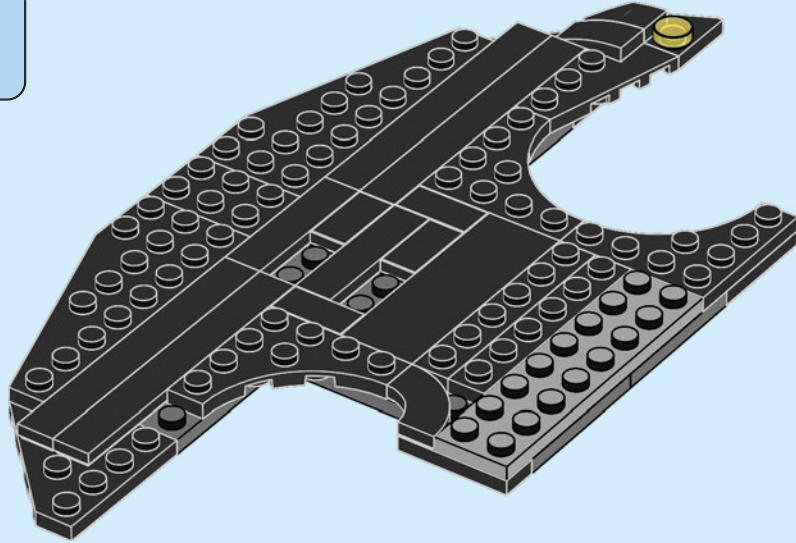

48

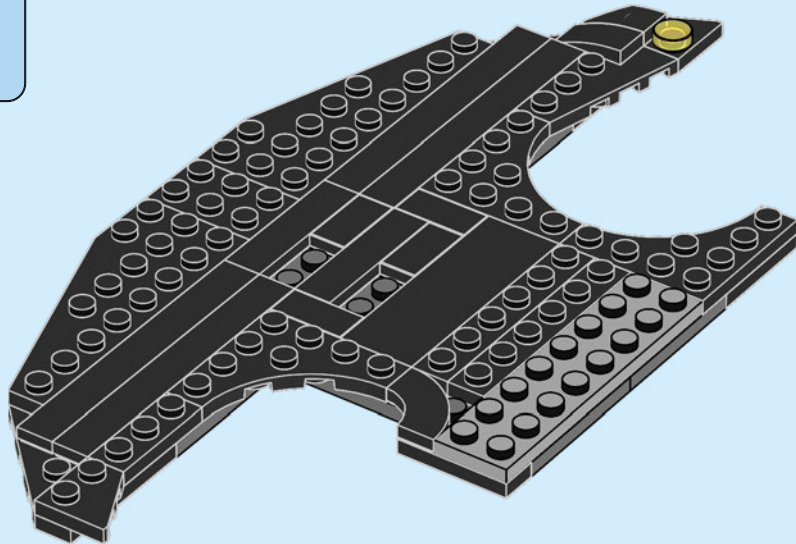

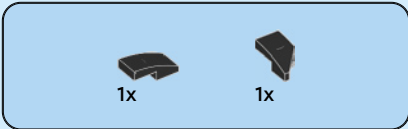

49

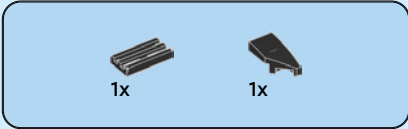
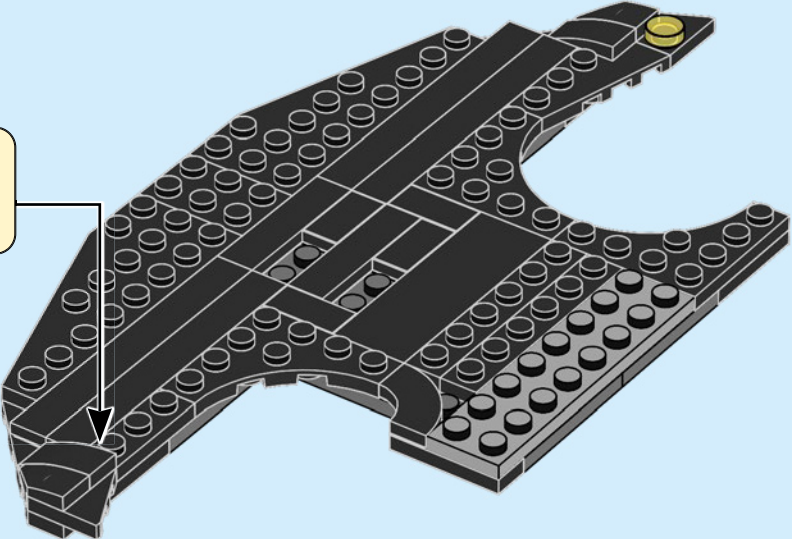

50

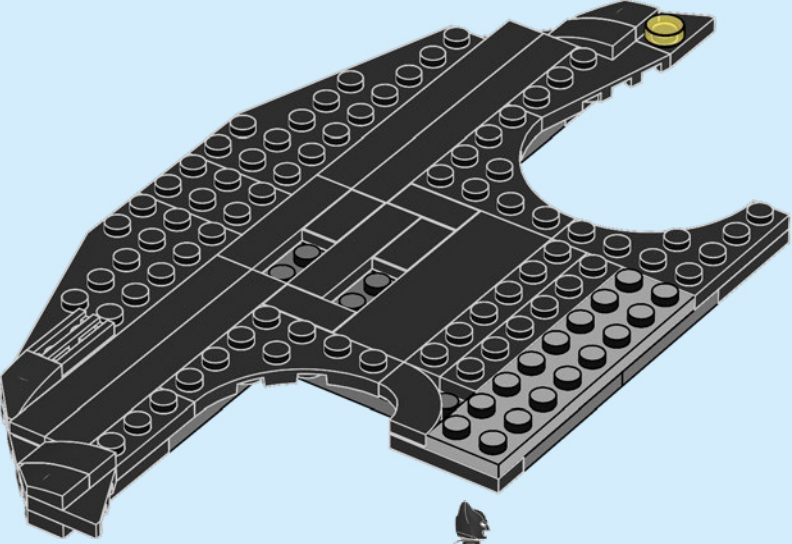



6x

51

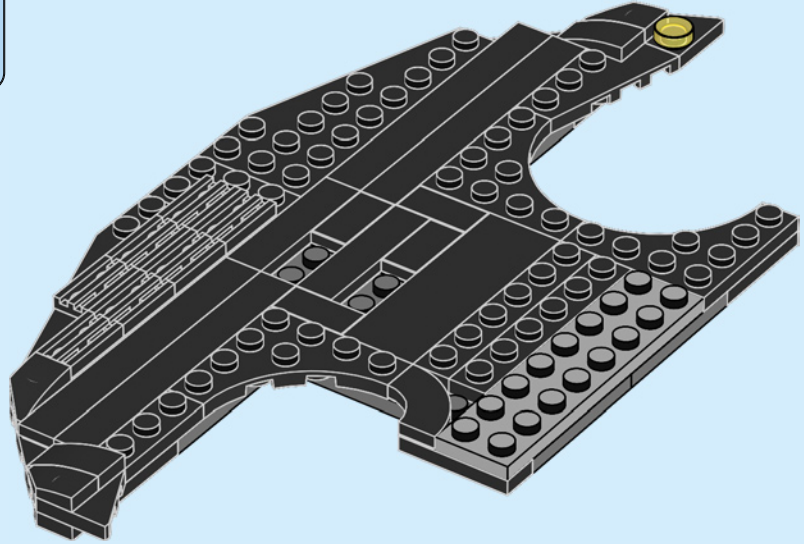

1x



1x

52

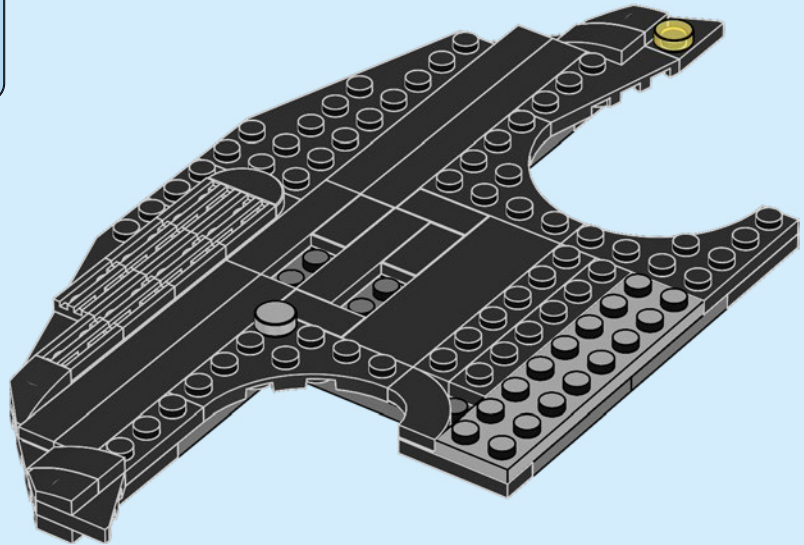



3x

53

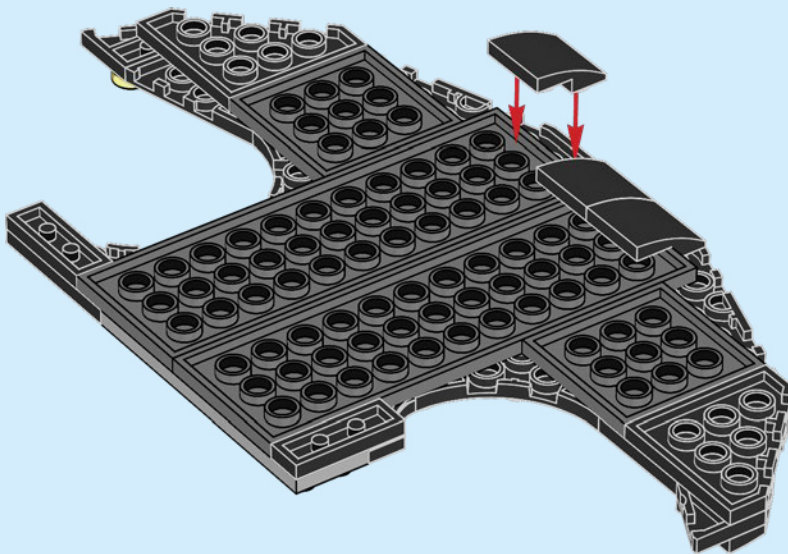
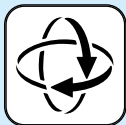

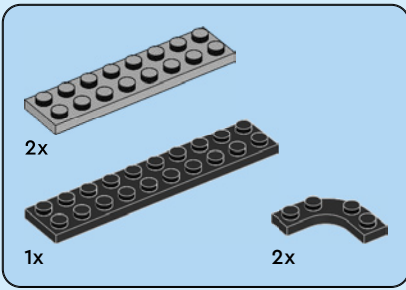

54

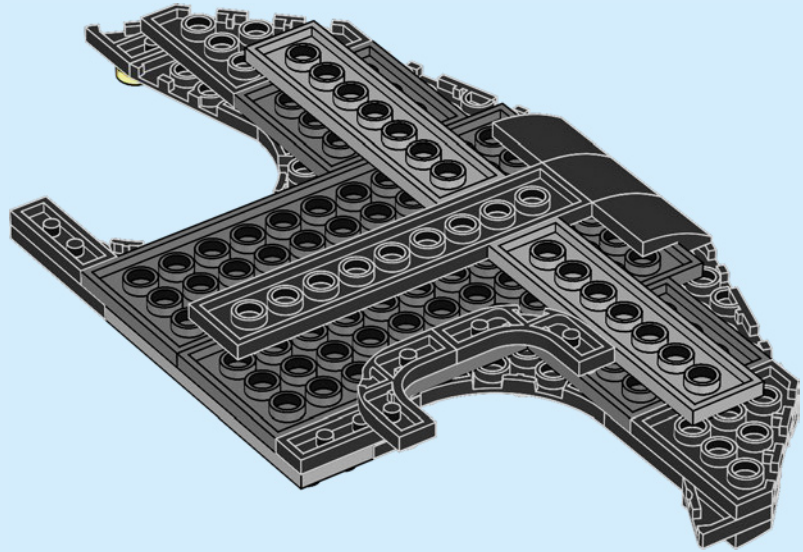



2x



2x

55

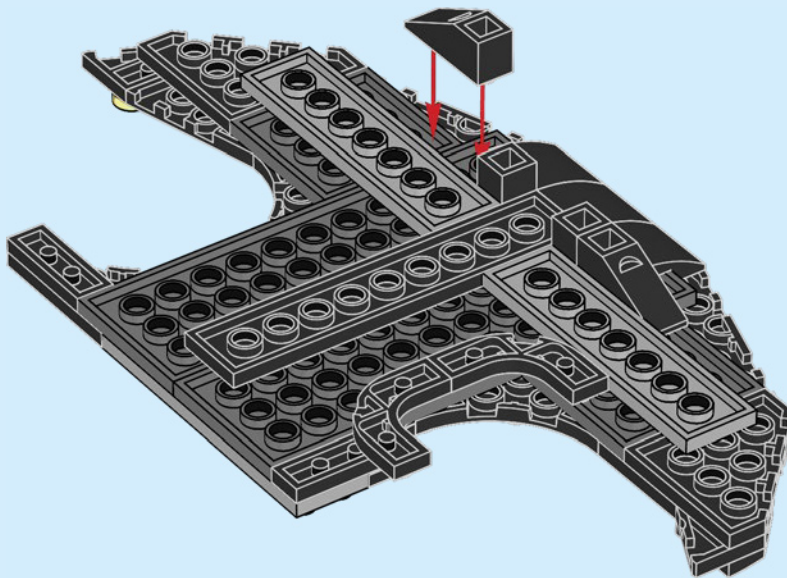



1x



2x

56

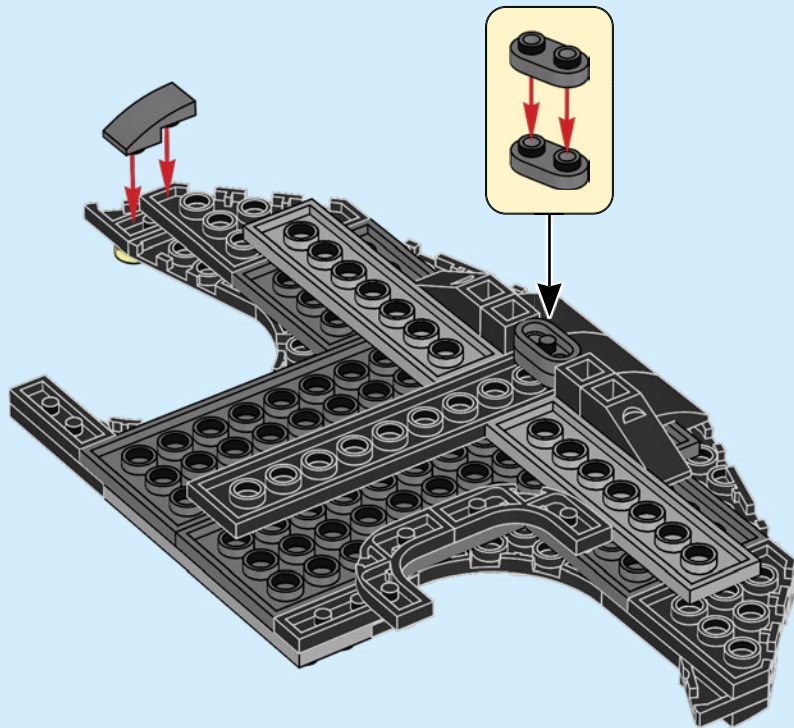

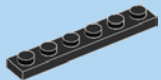

1x

57

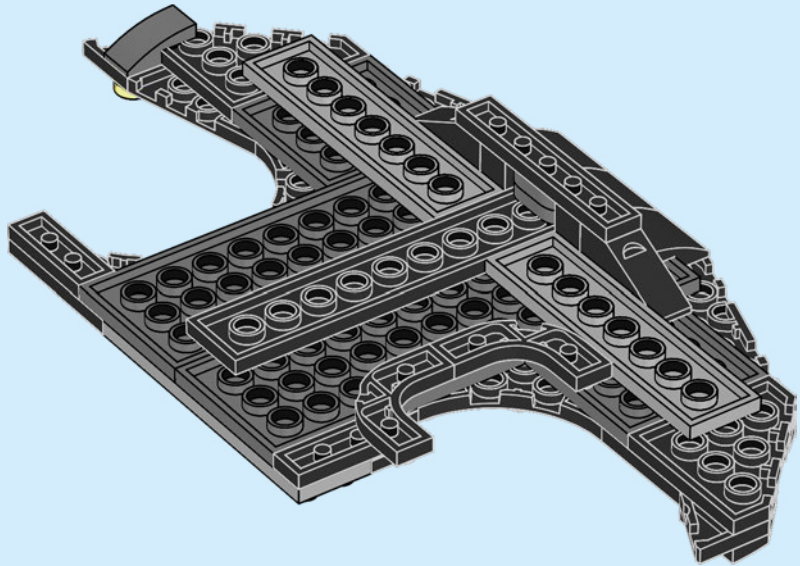



3x

58

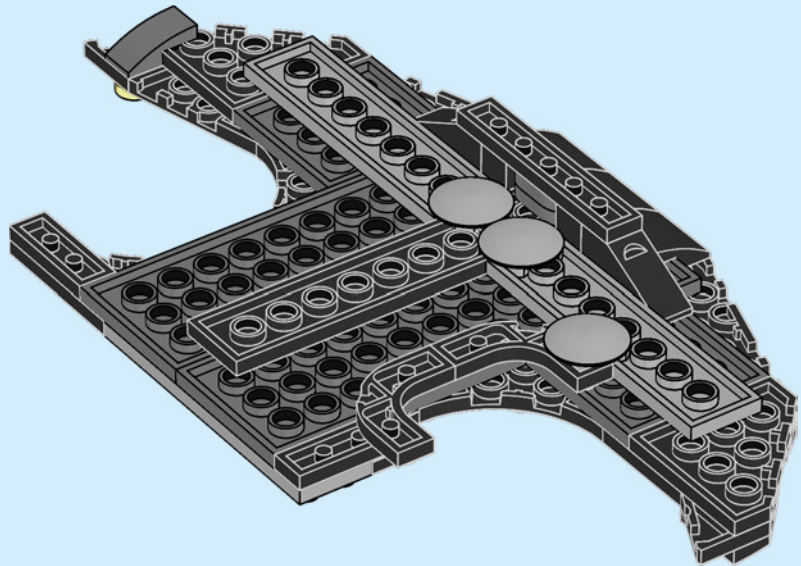

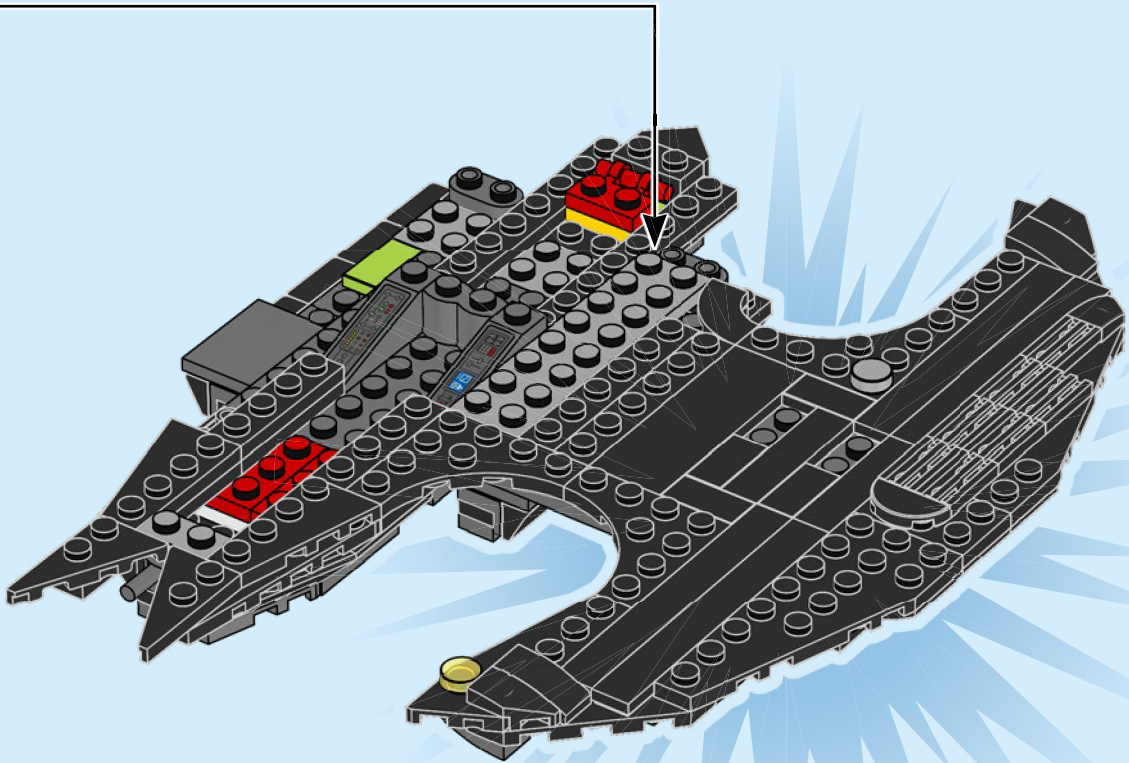

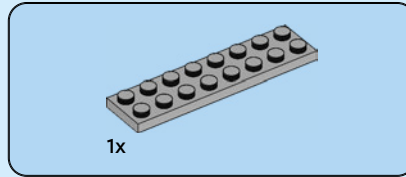
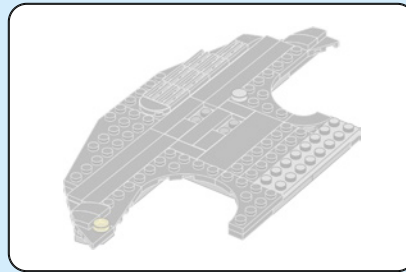

60

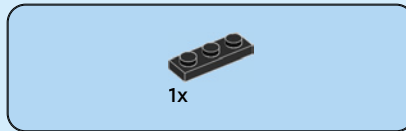
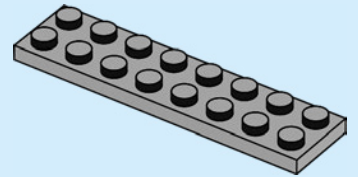

61

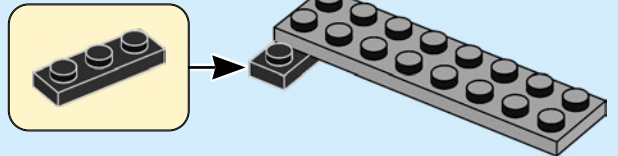

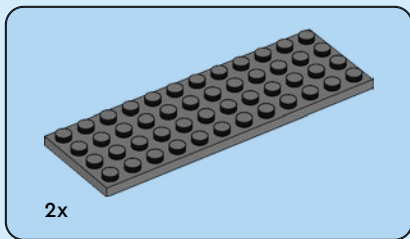

62

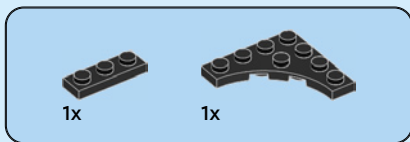
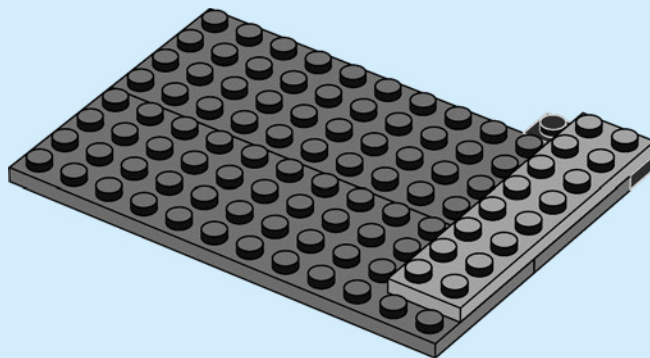
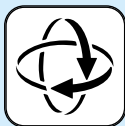

63

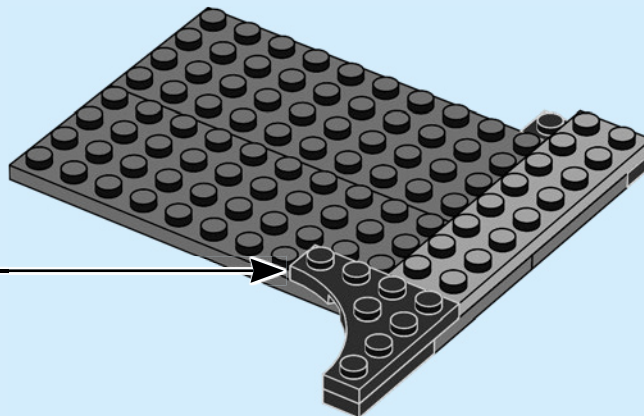
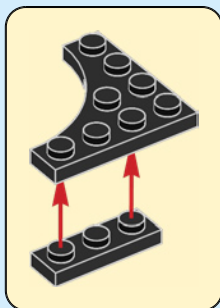

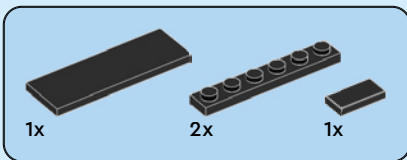

64

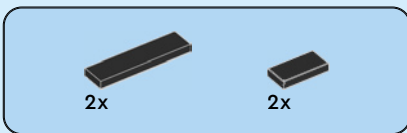
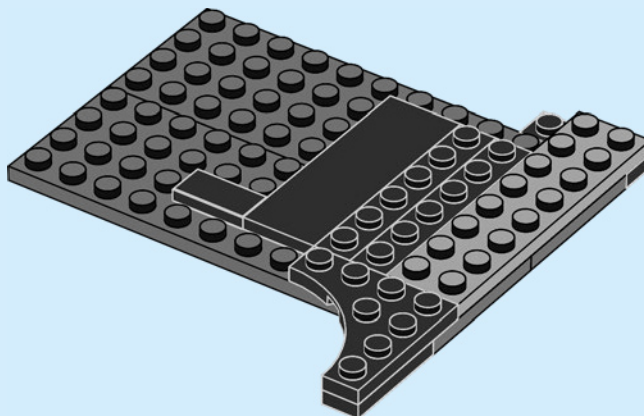

65

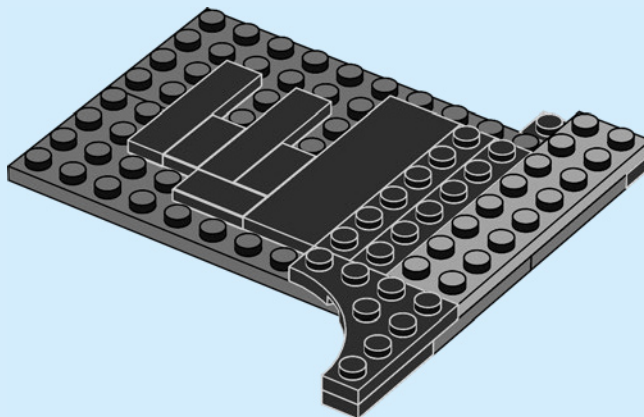



1x

66

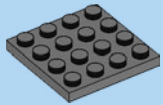
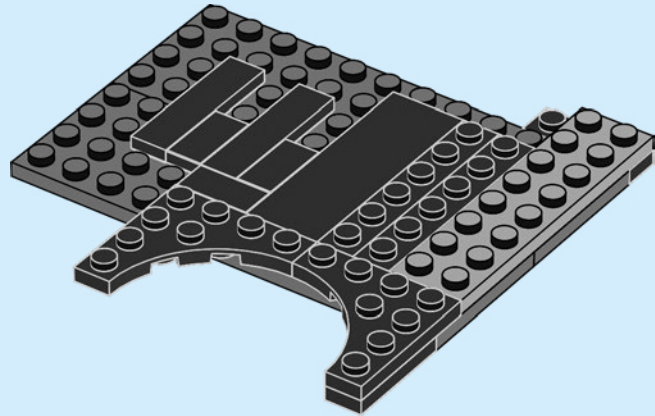

1x

67

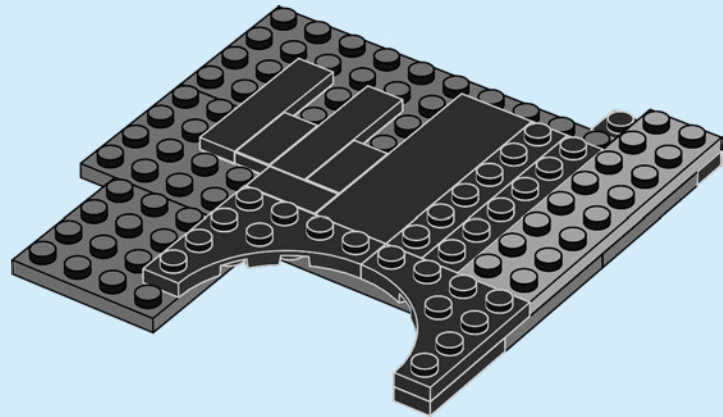

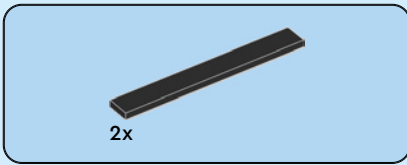

68

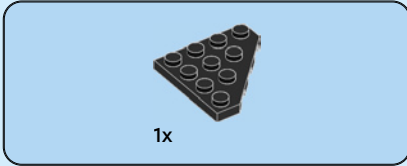
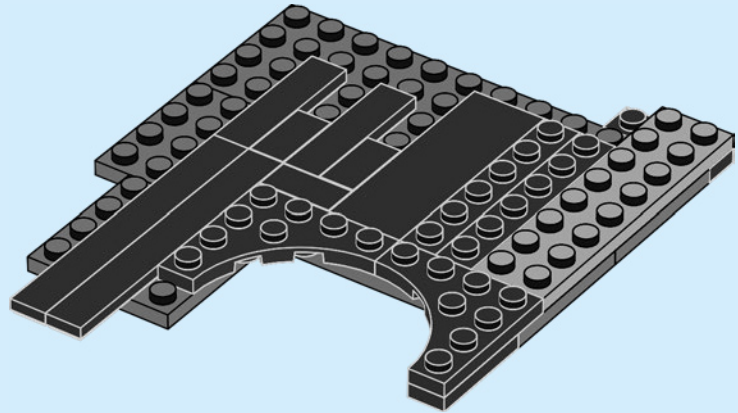

69

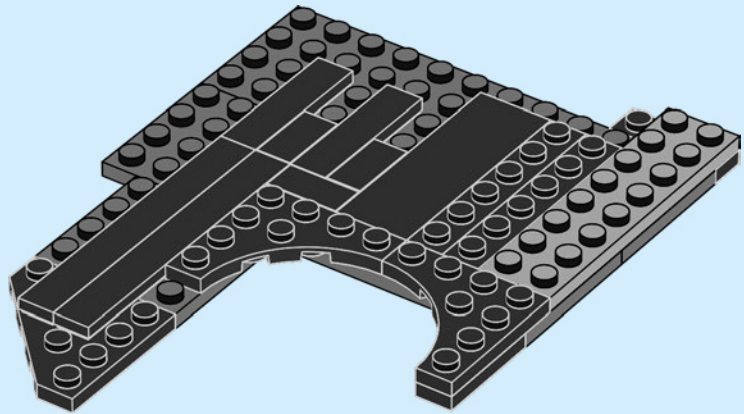

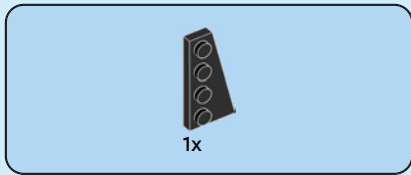

70

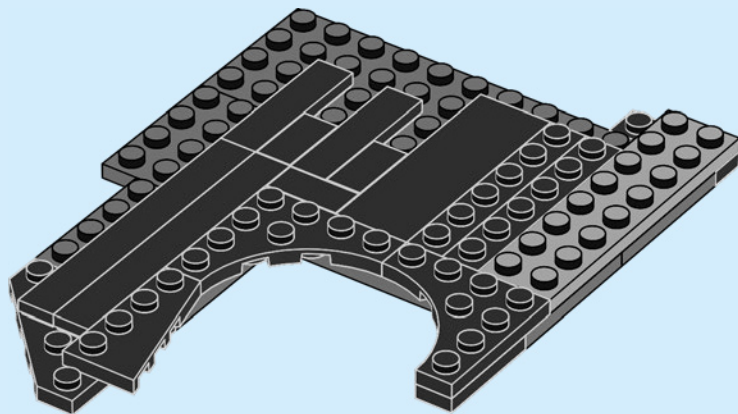

71

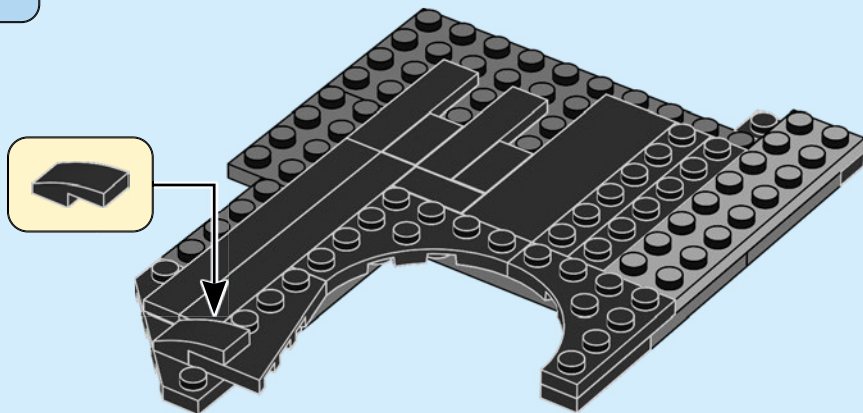

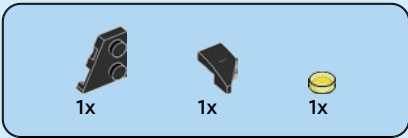

72

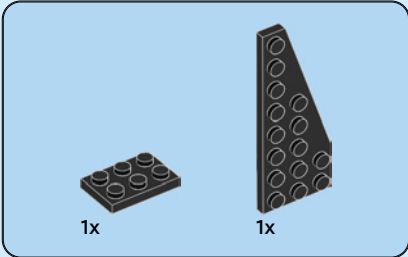
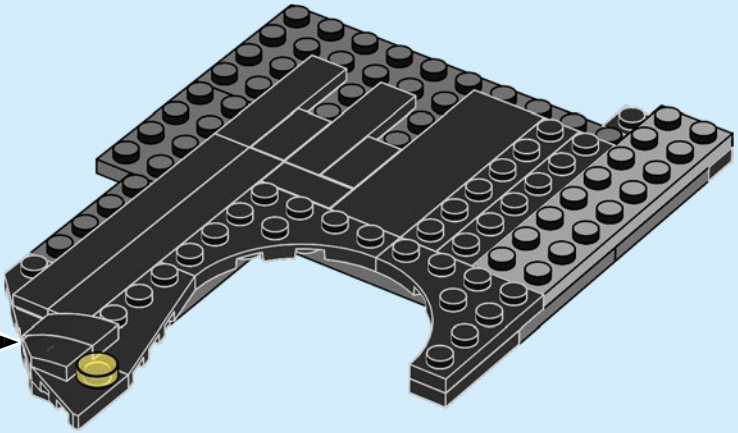
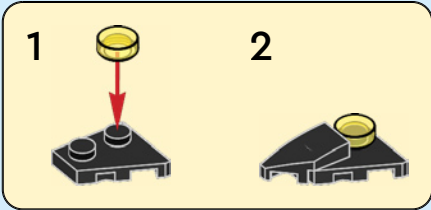

73

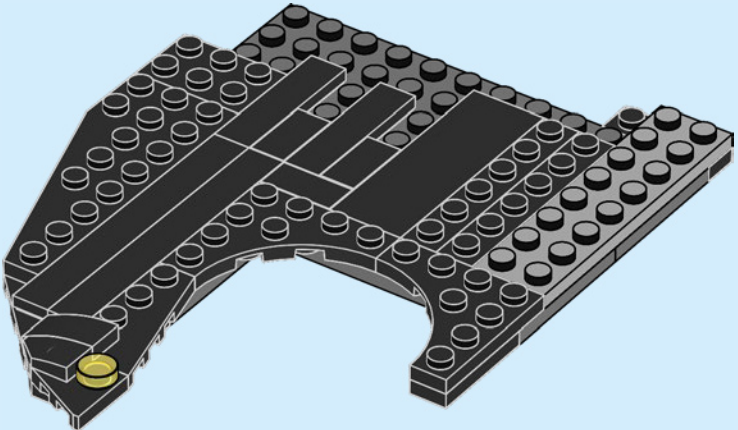

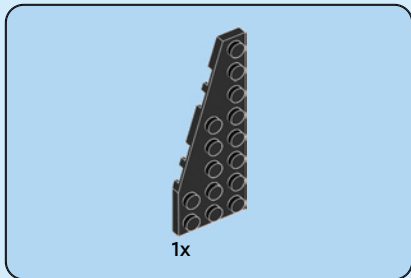

74

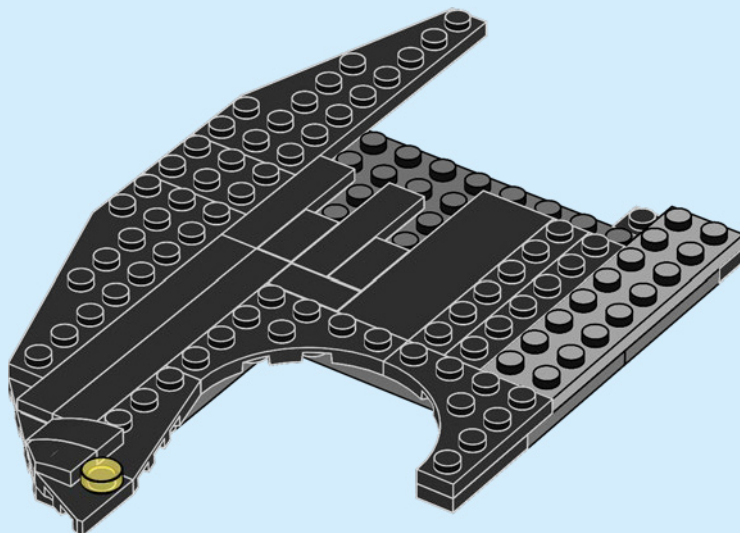

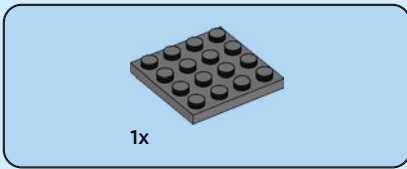

75

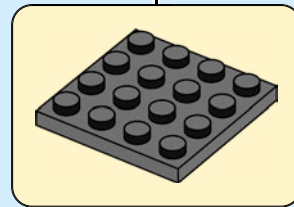
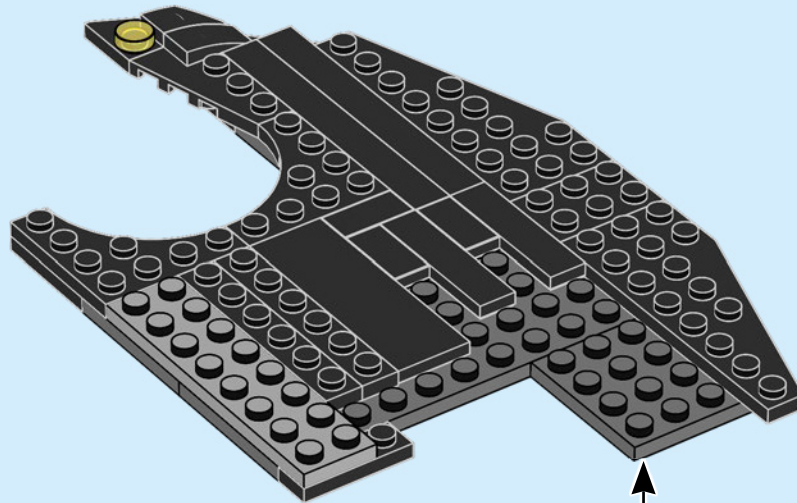

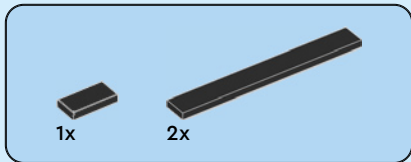

76

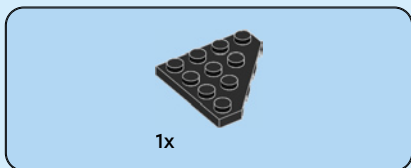
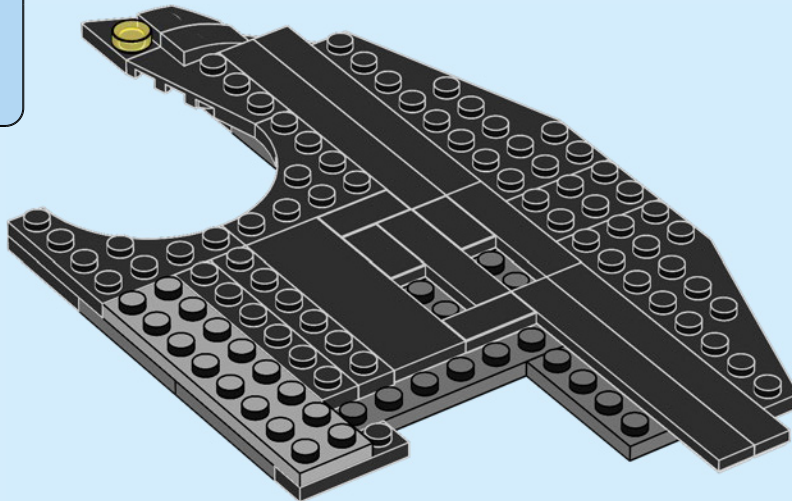

77

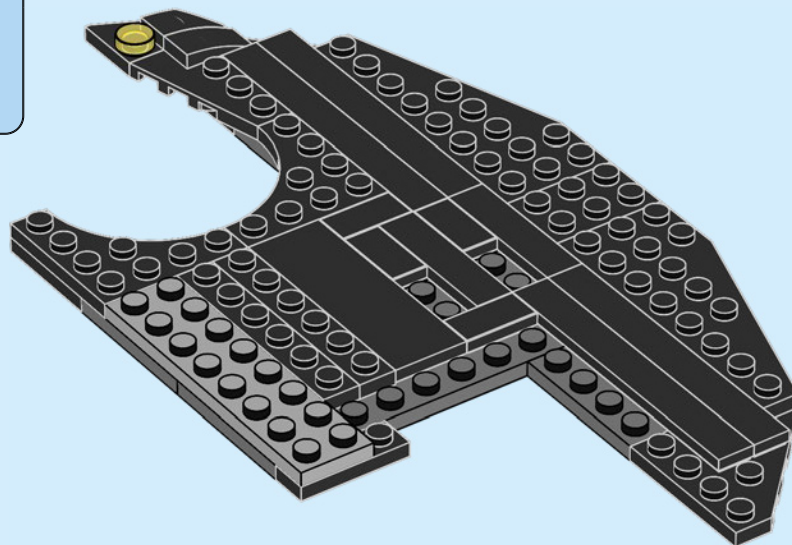

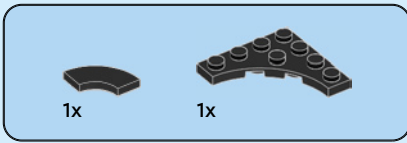

78

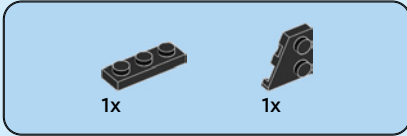
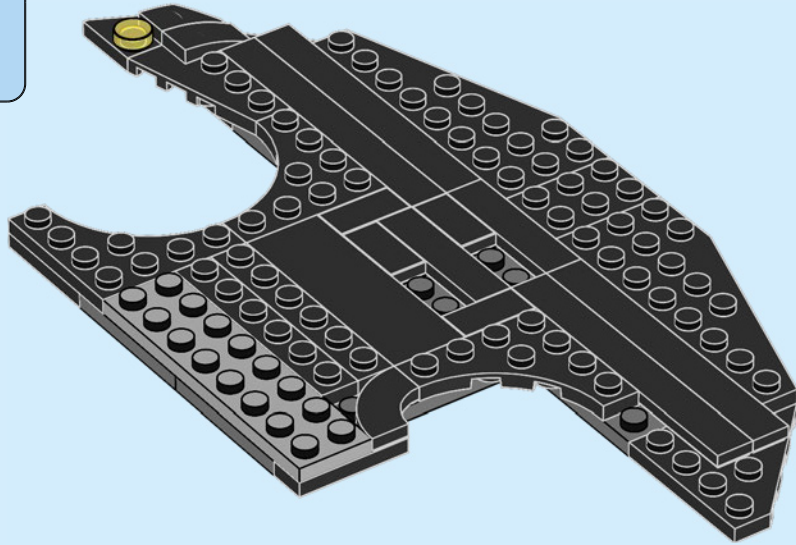

79

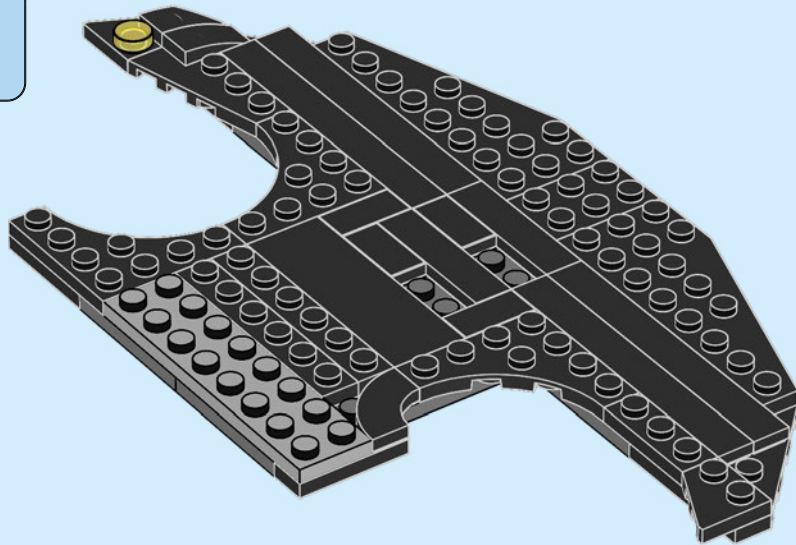

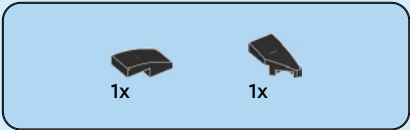

80

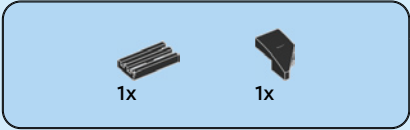
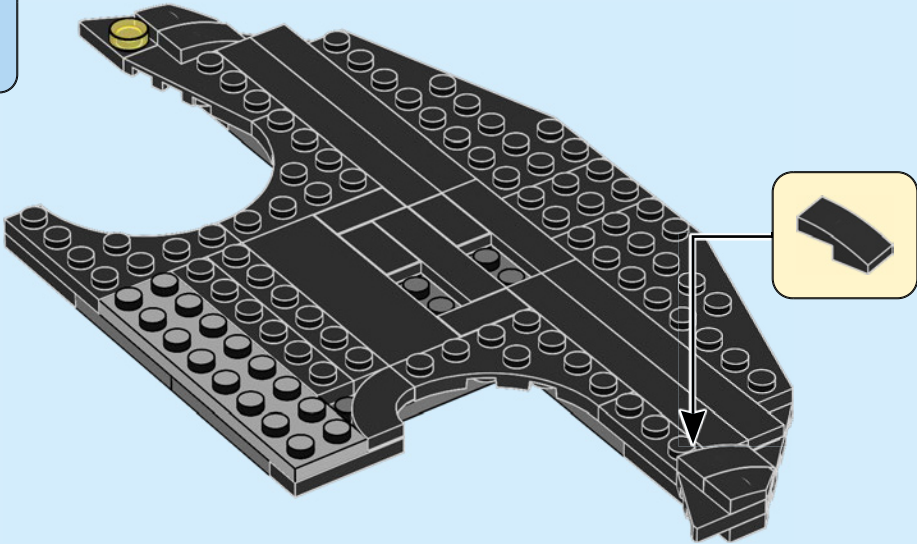

81

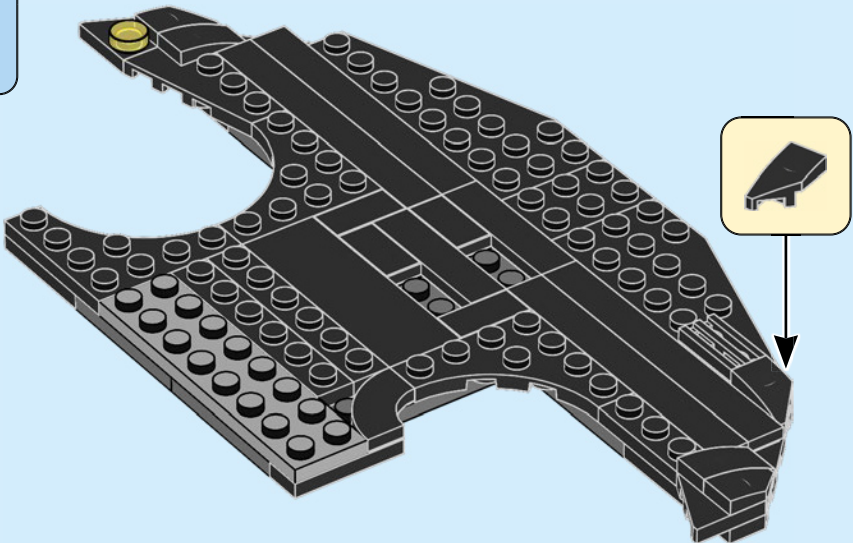



6x

82

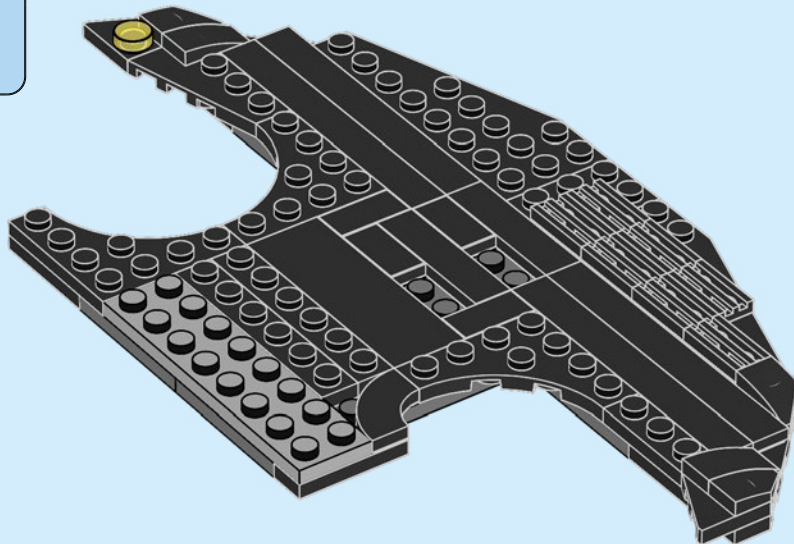

1x



1x

83

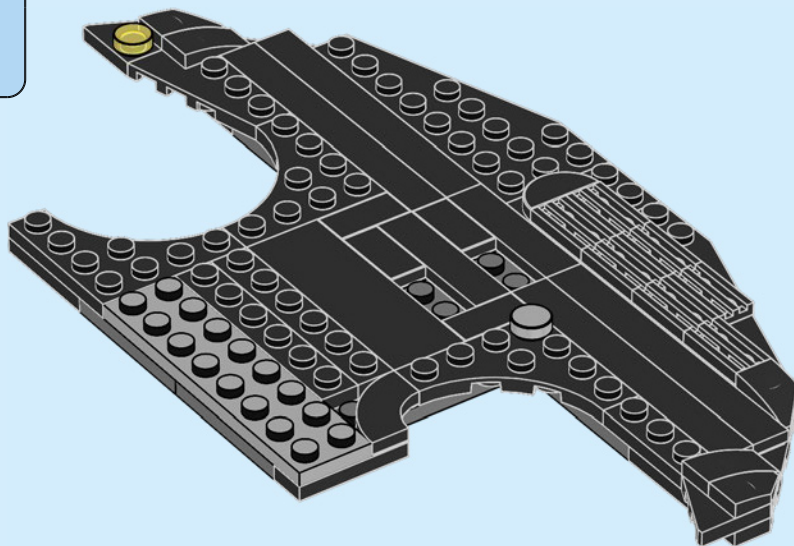



3x

84

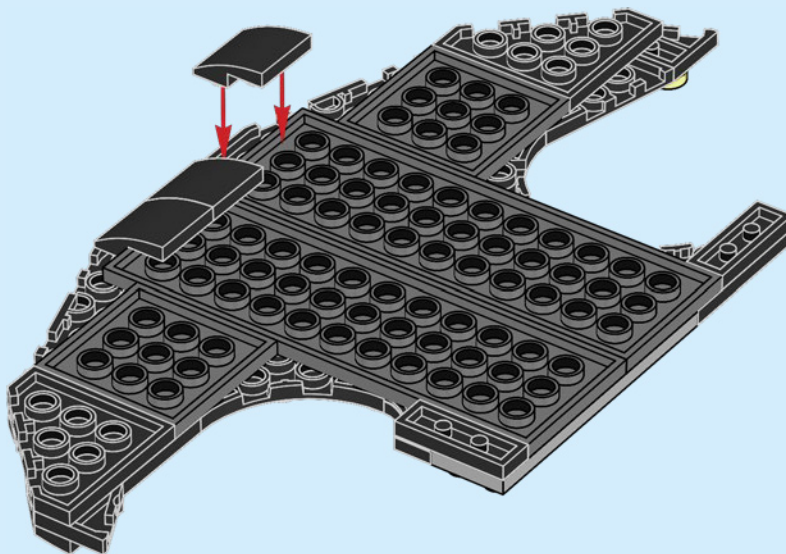

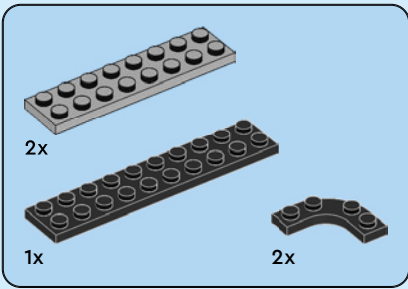

85

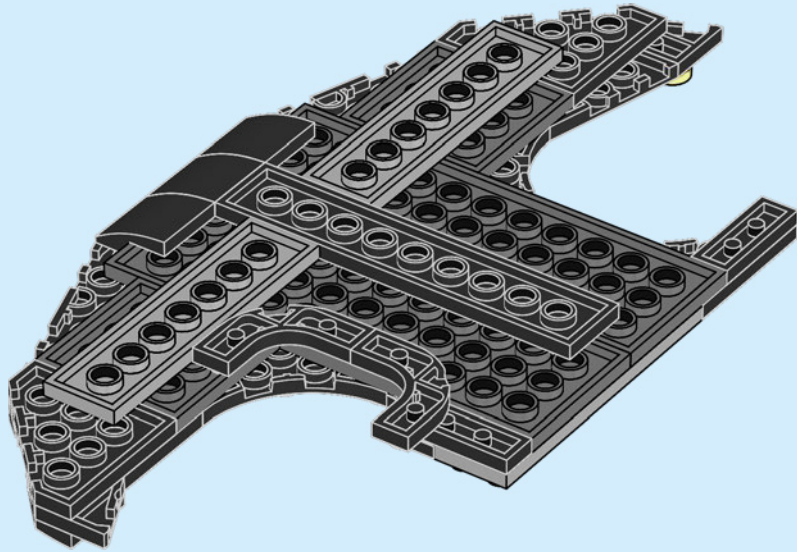



2x



2x

86

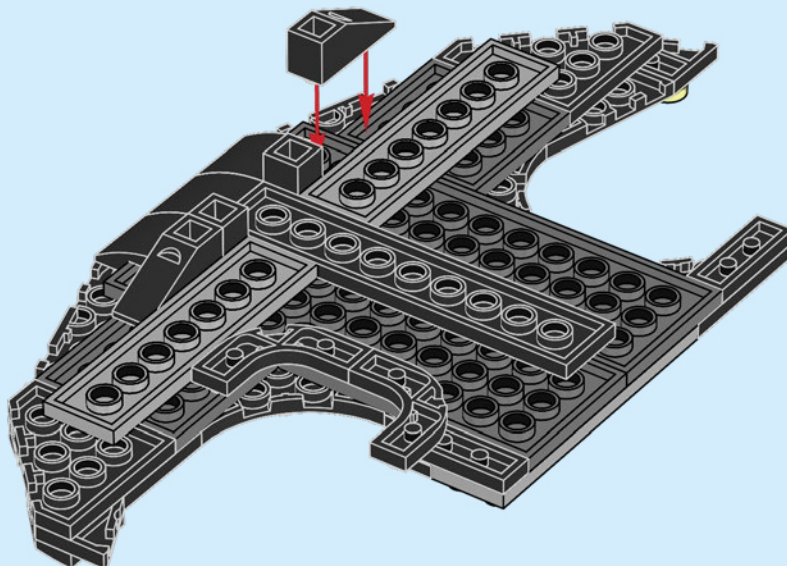



1x



2x

87

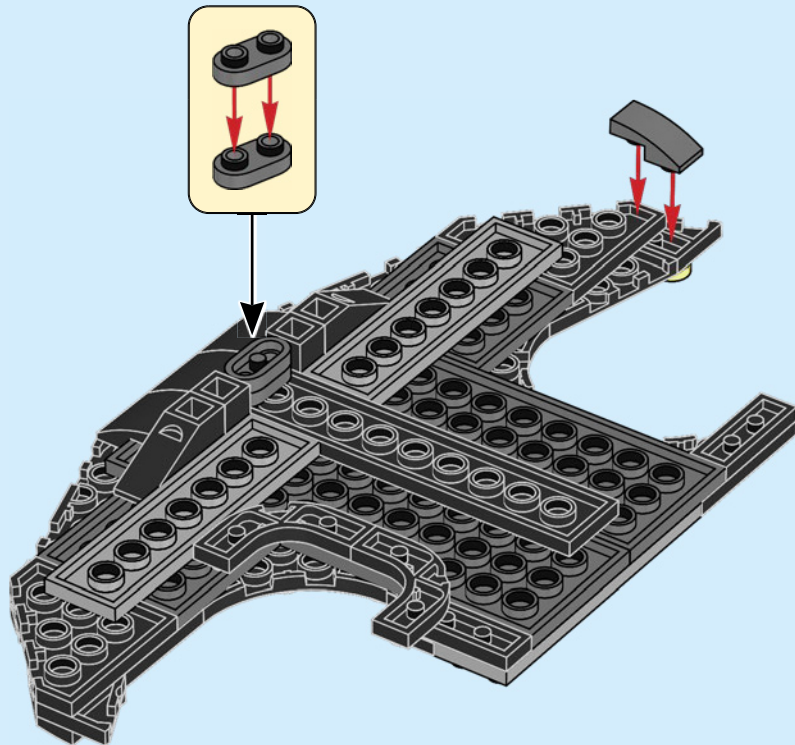

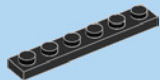

1x

88

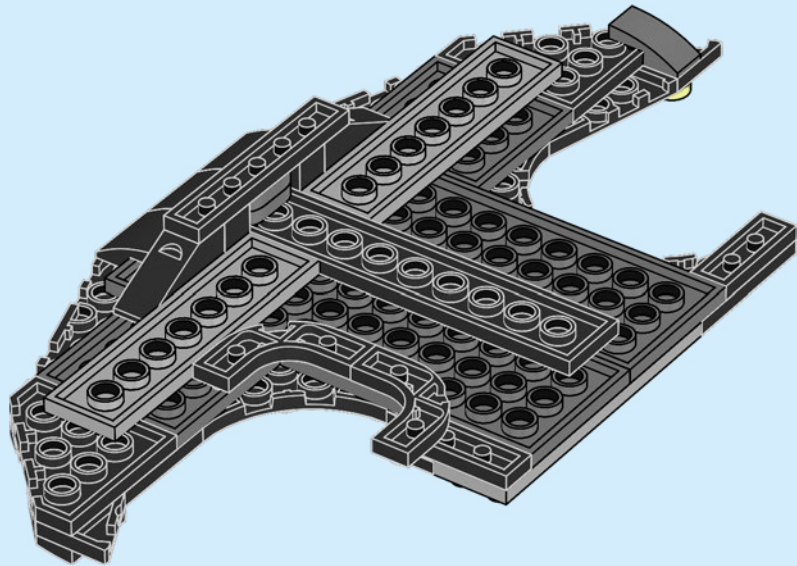



3x

89

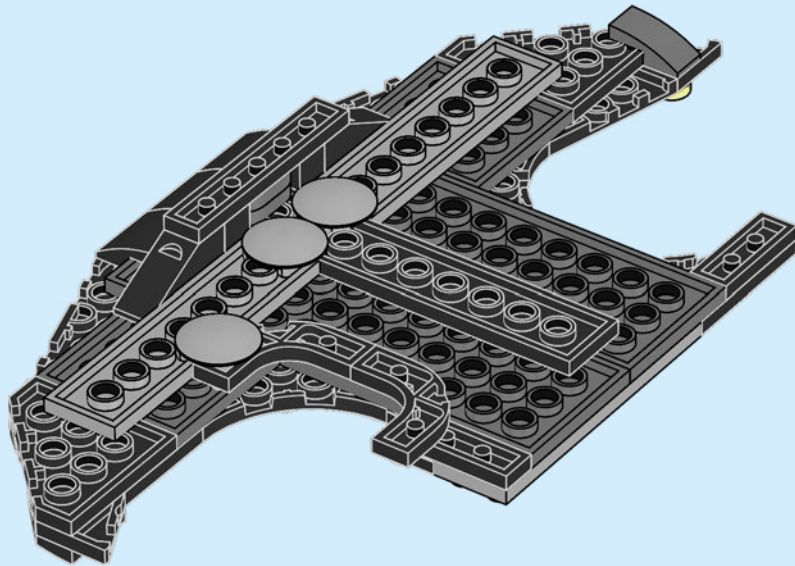

90

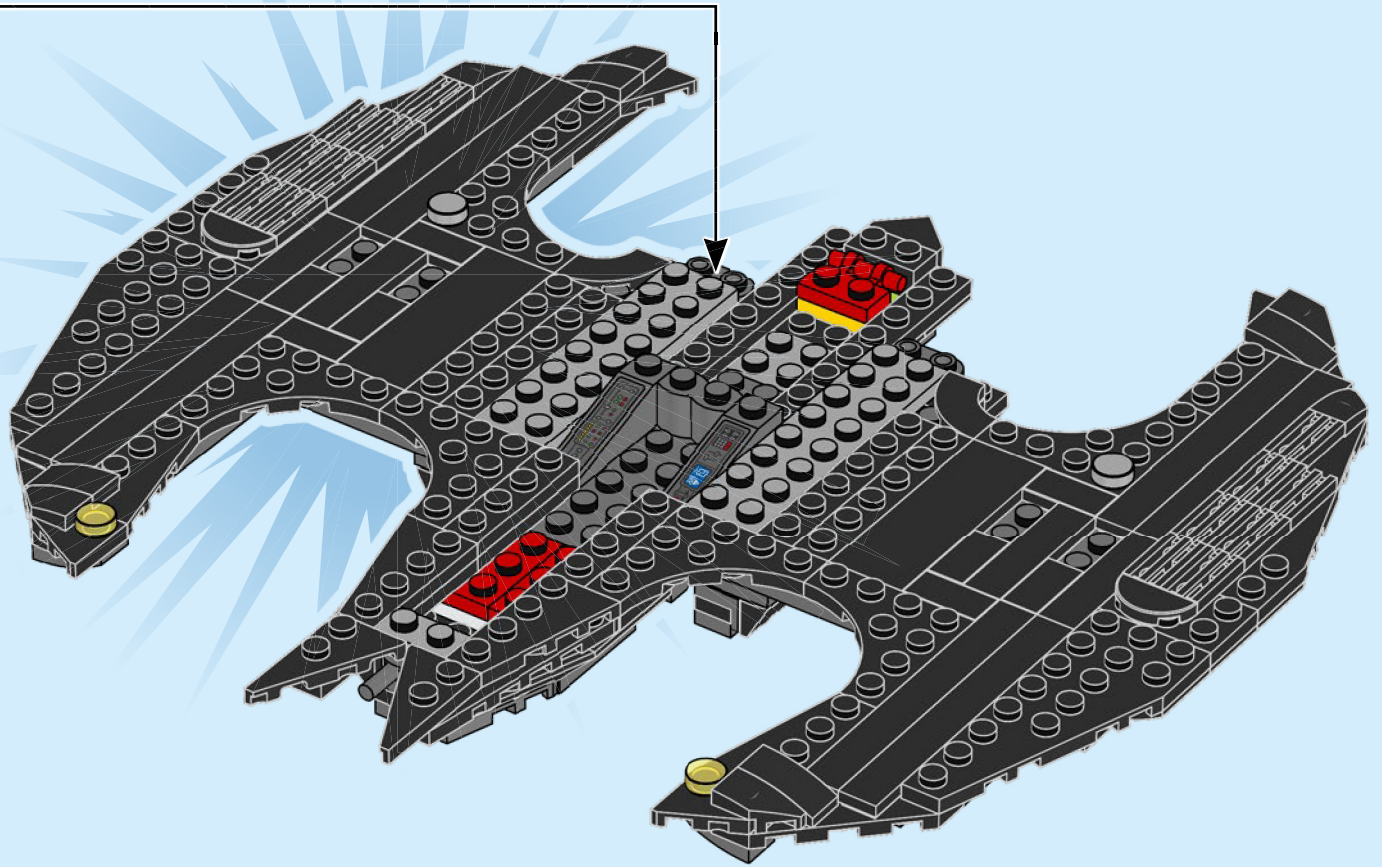



2x

91

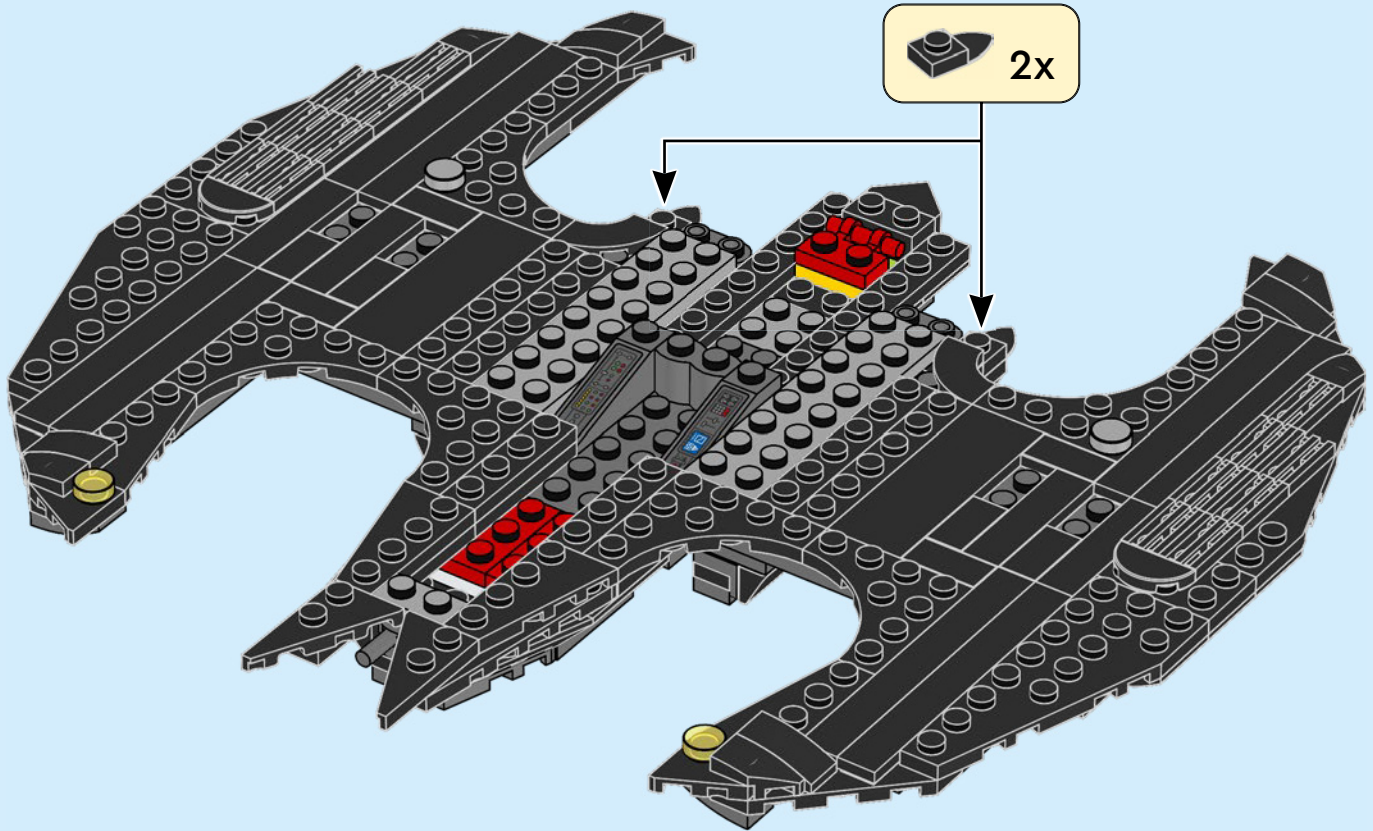



2x

92

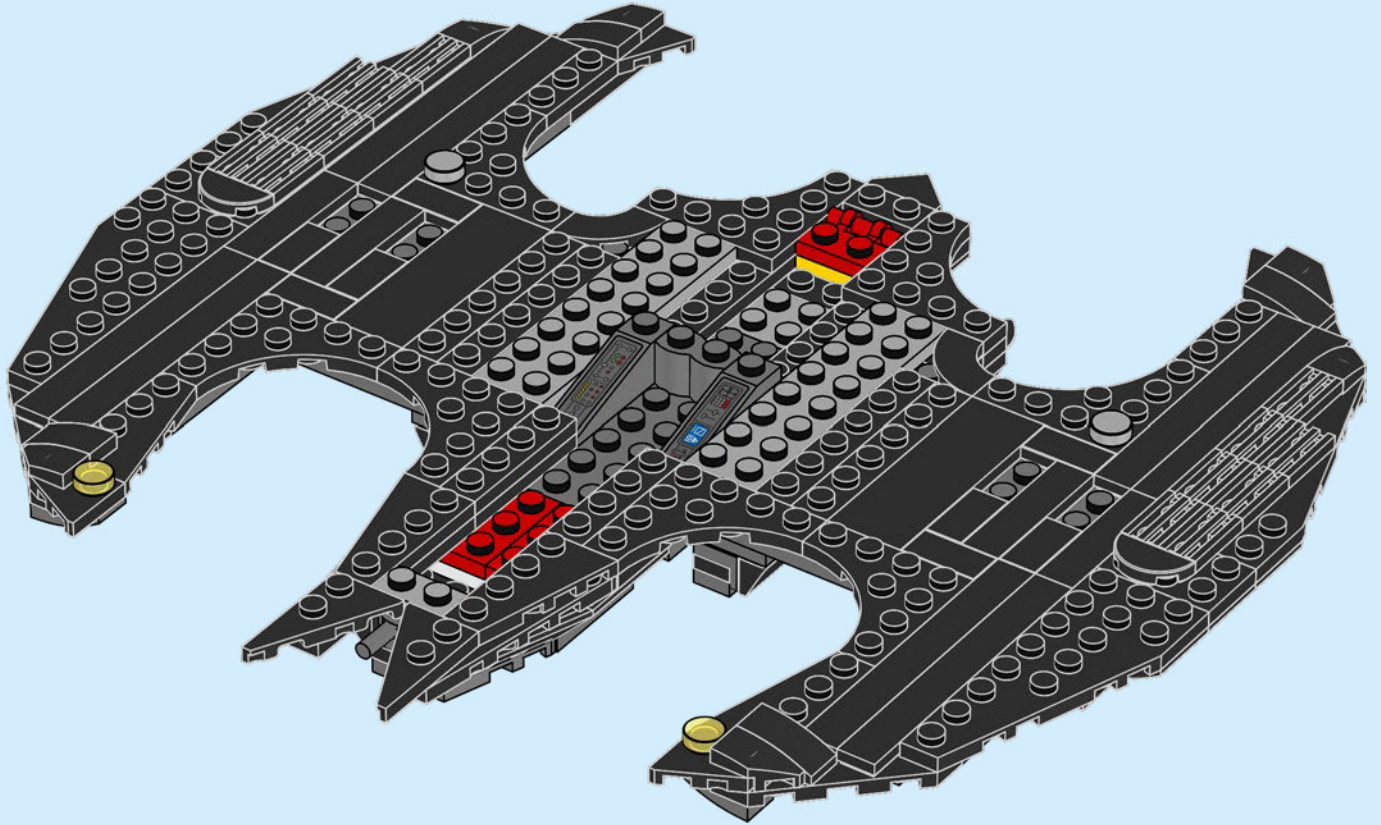

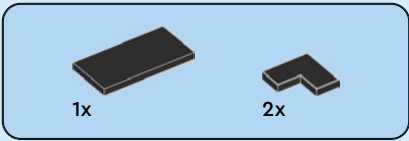

93

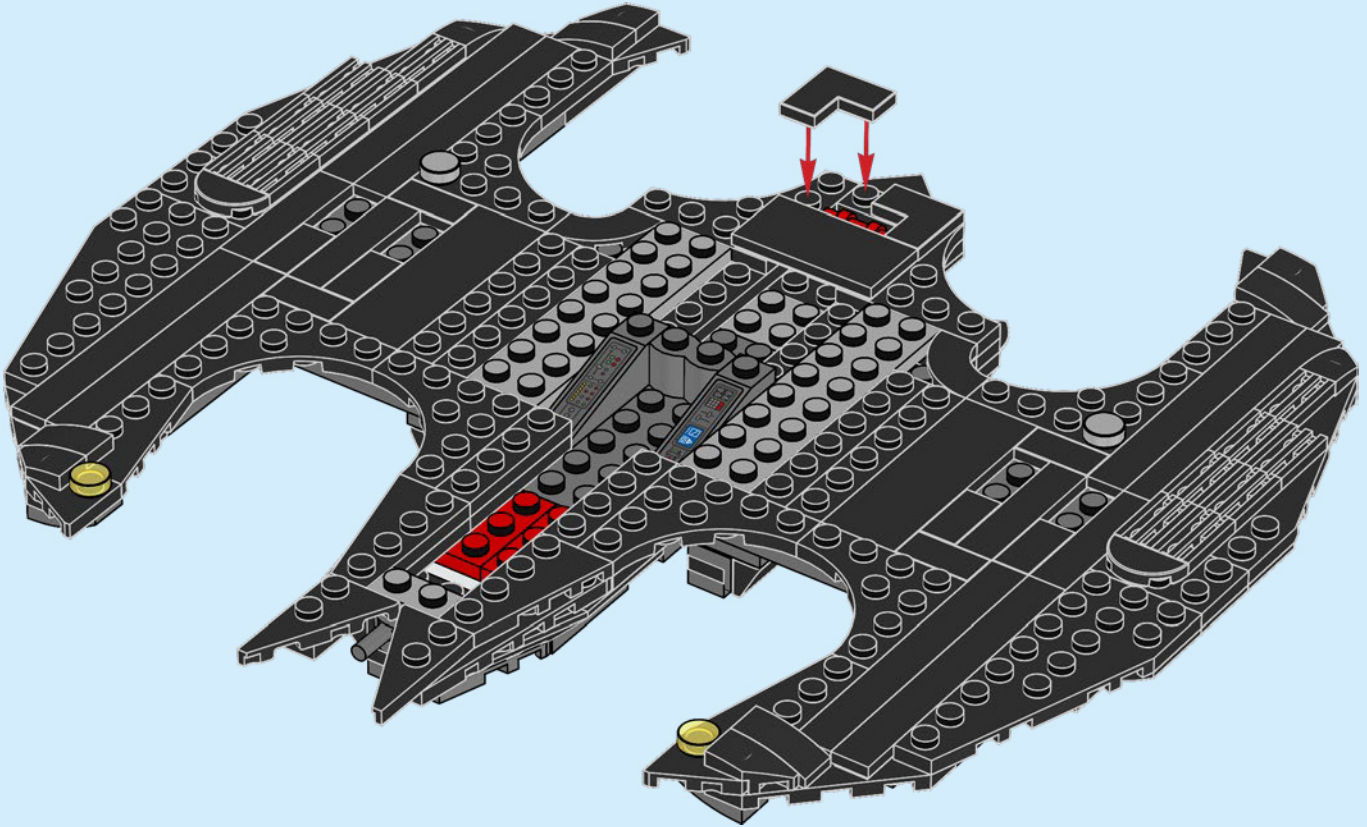

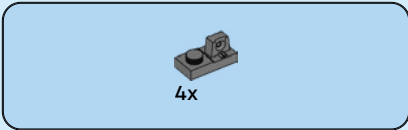

94

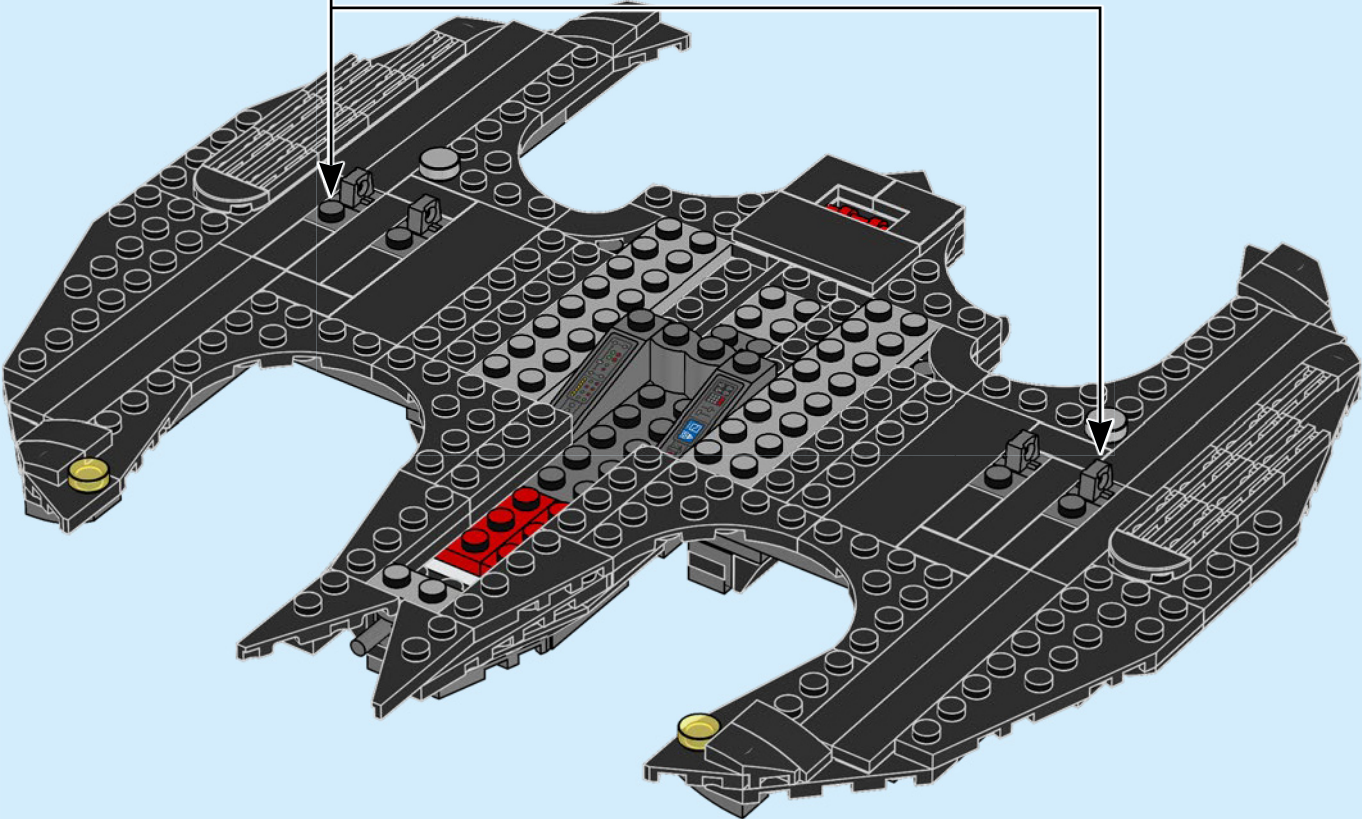
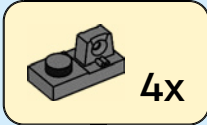

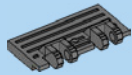

2x

95

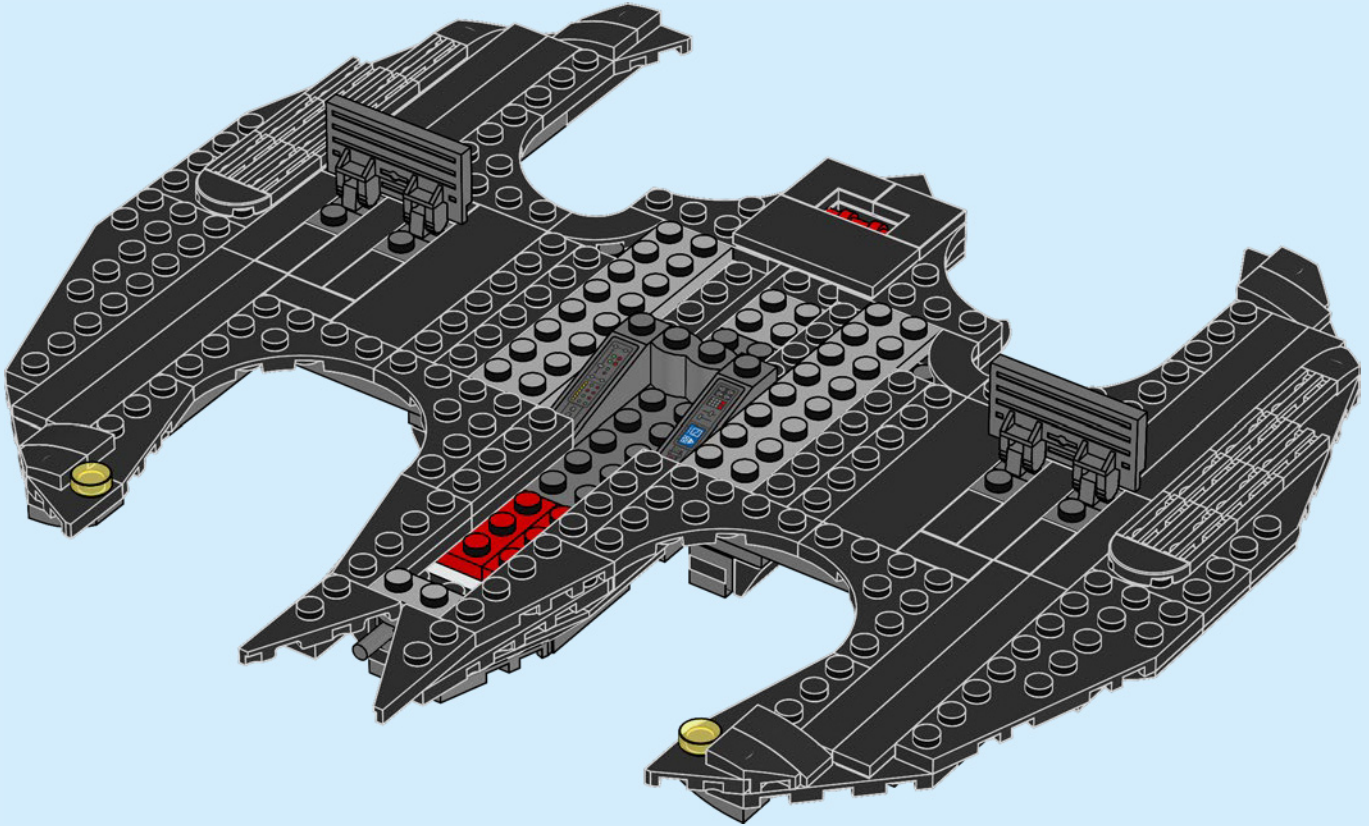

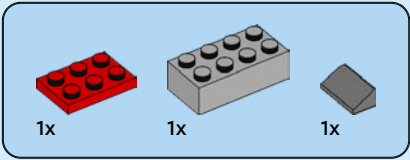

96

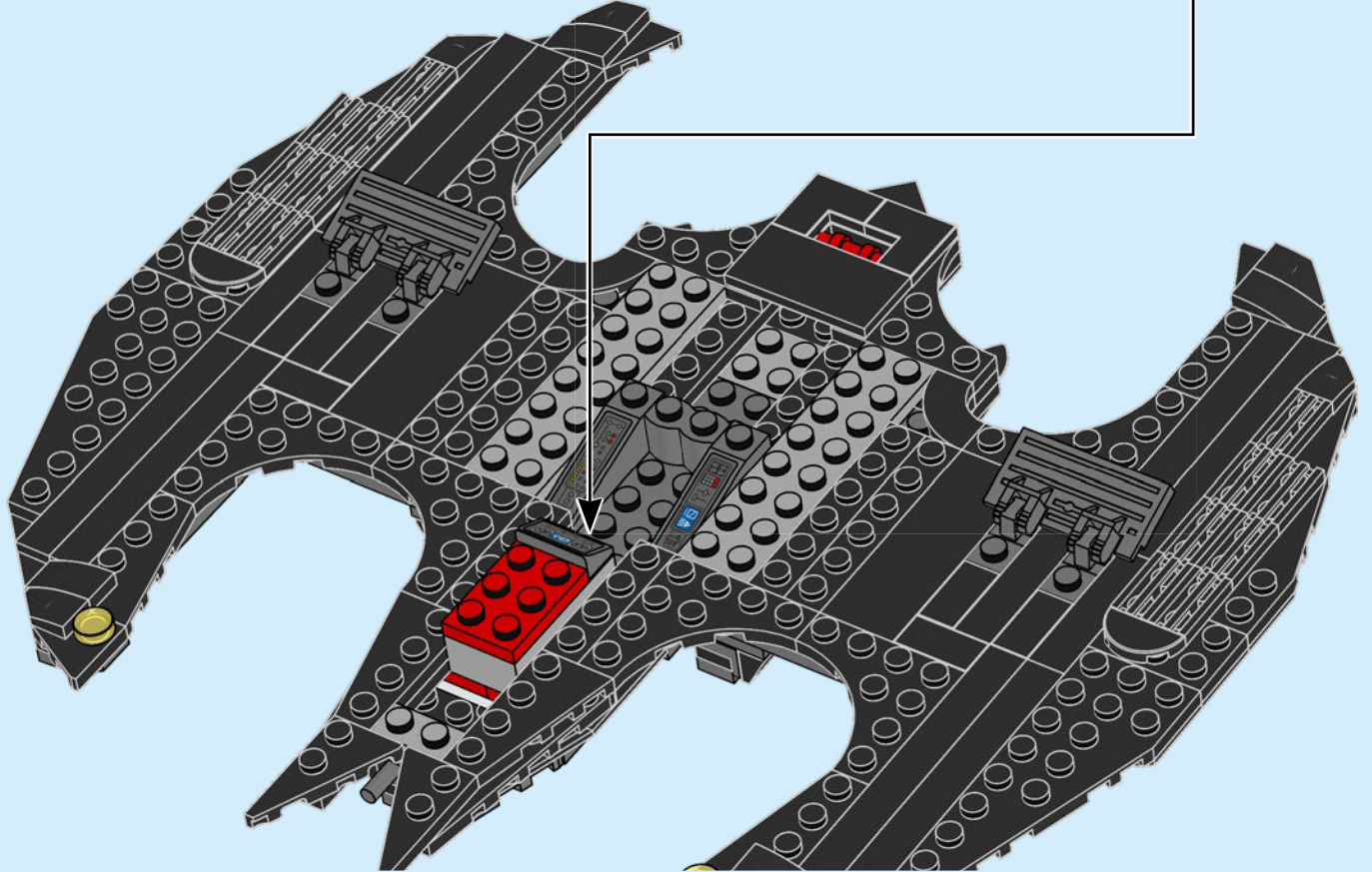
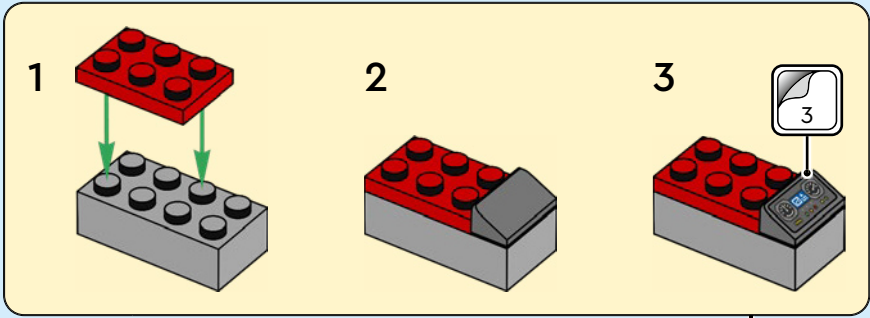

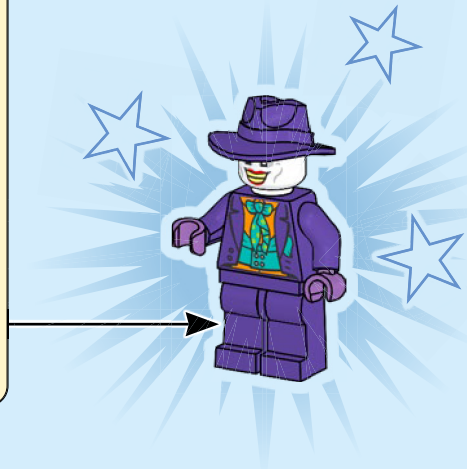
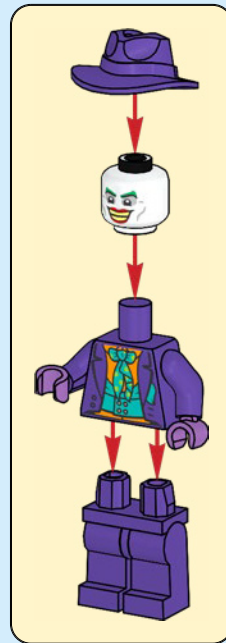

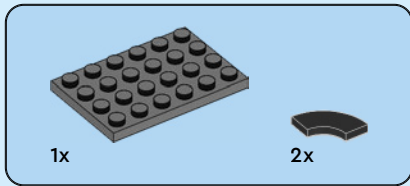

97

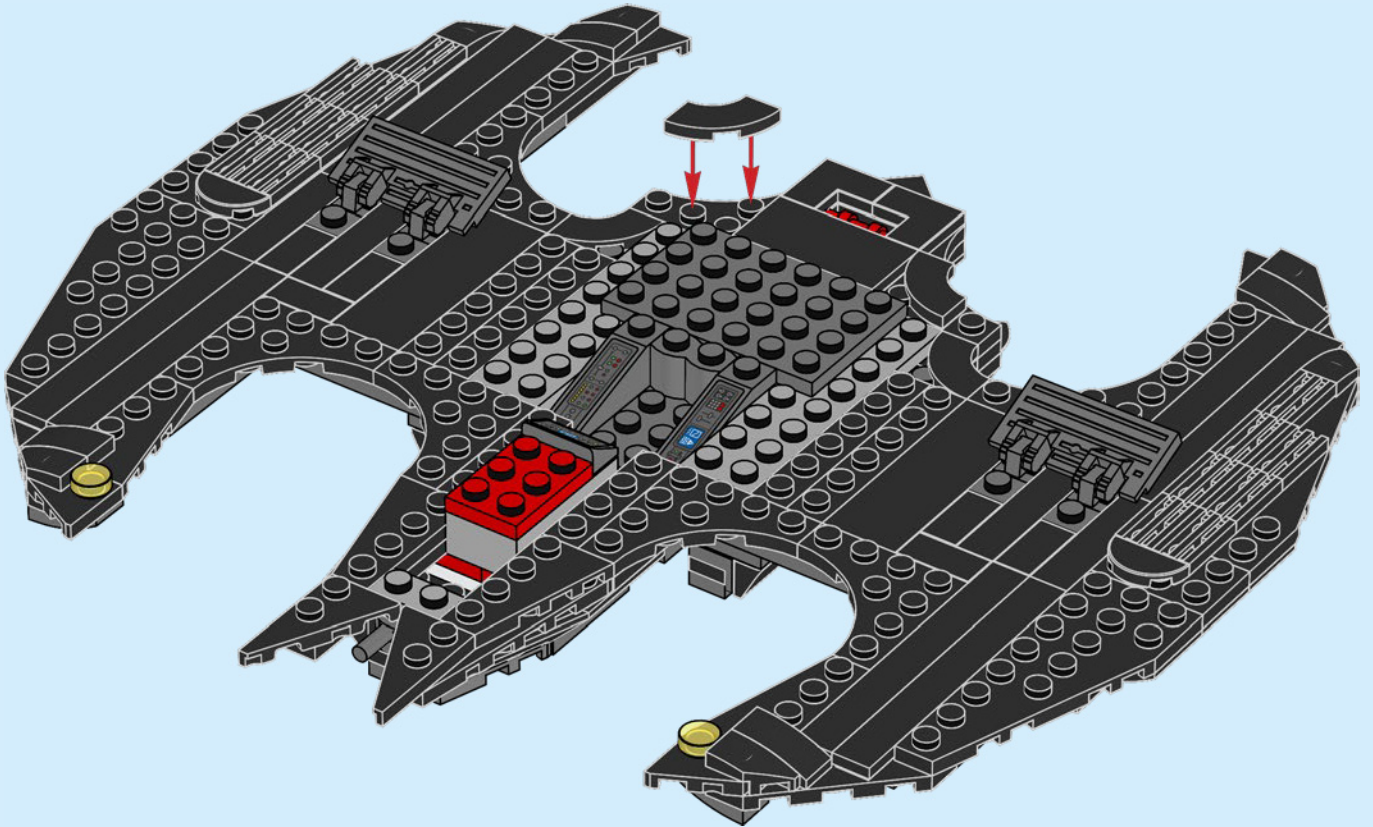



2x

98

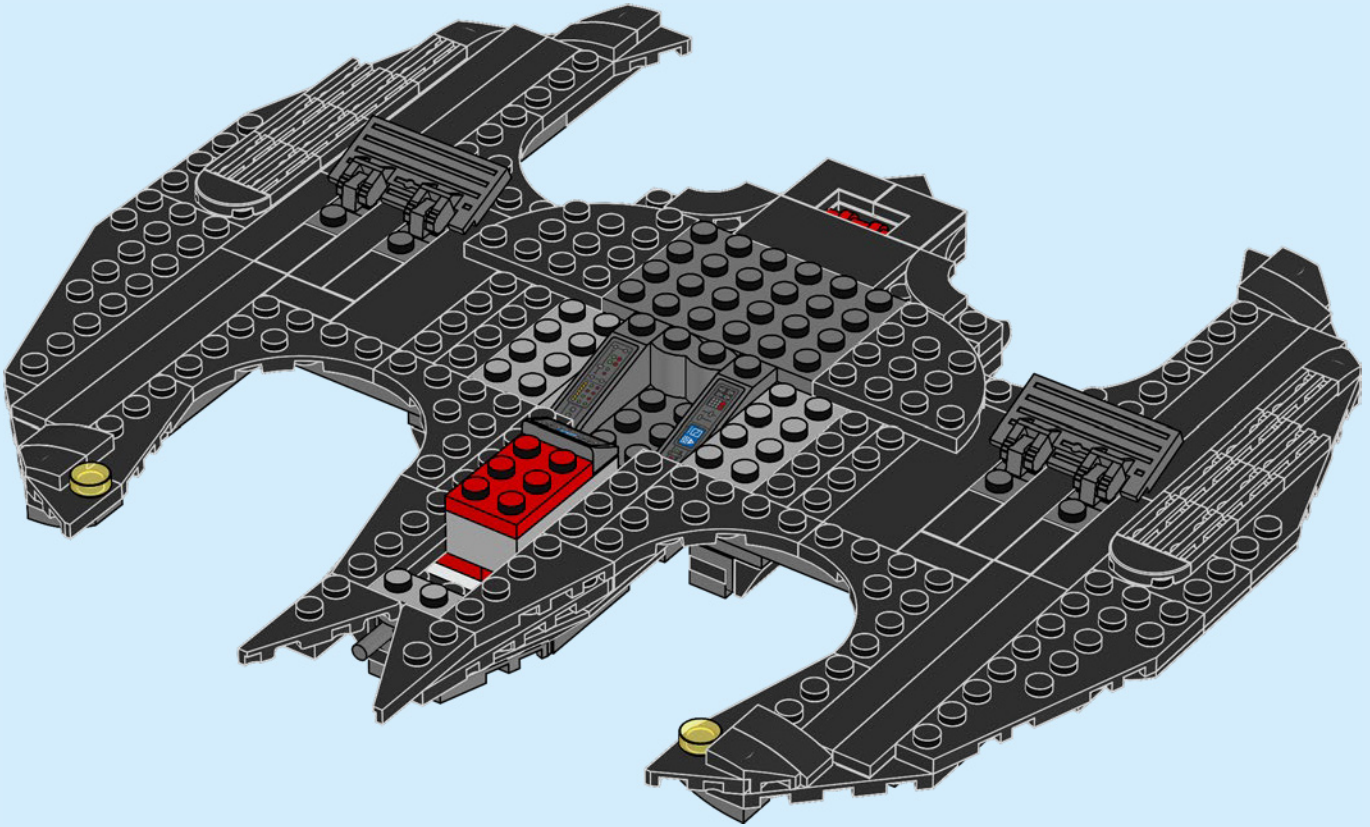

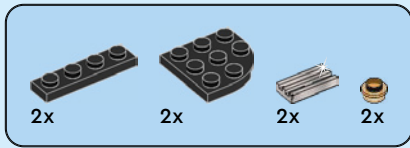

99

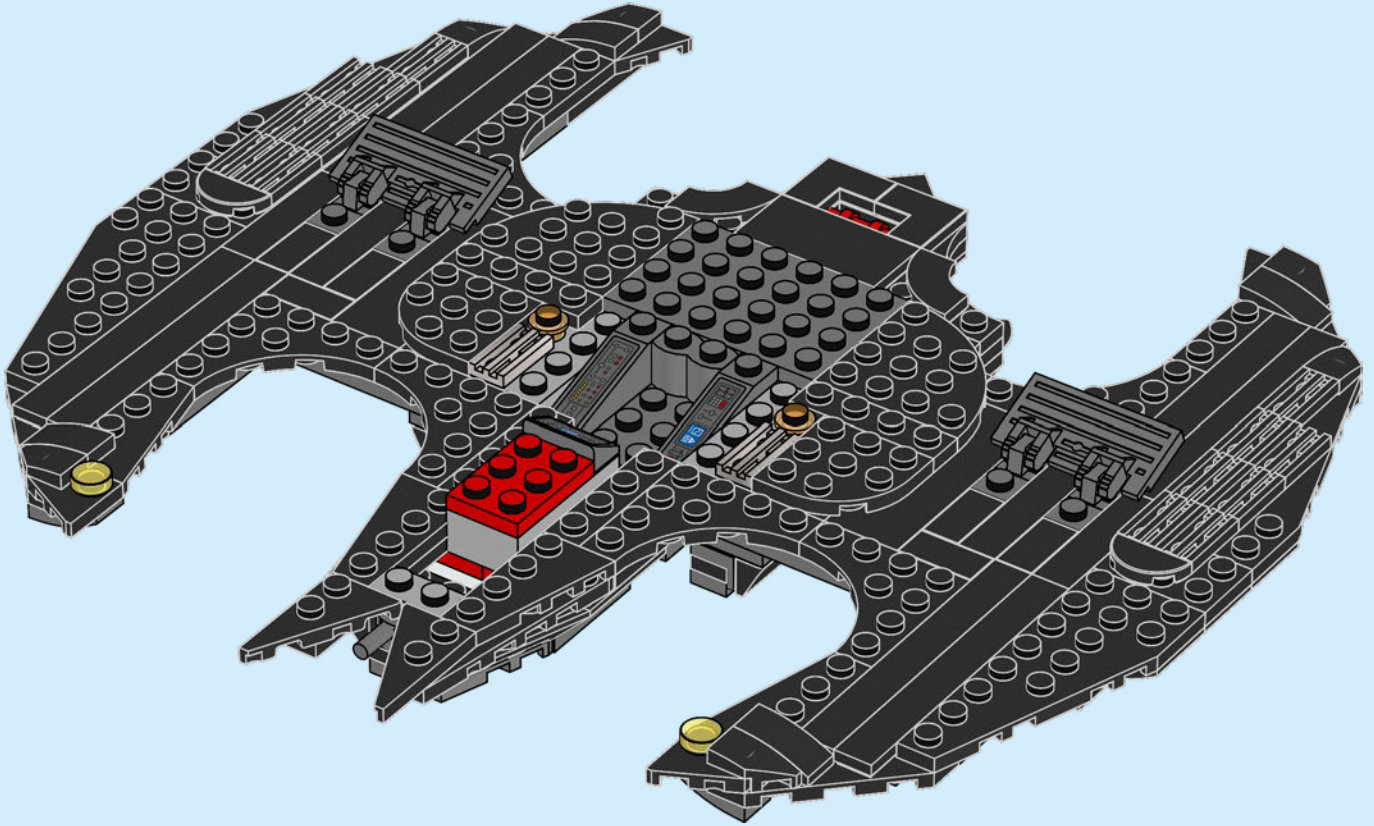

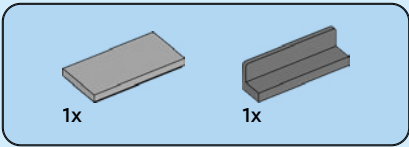

100

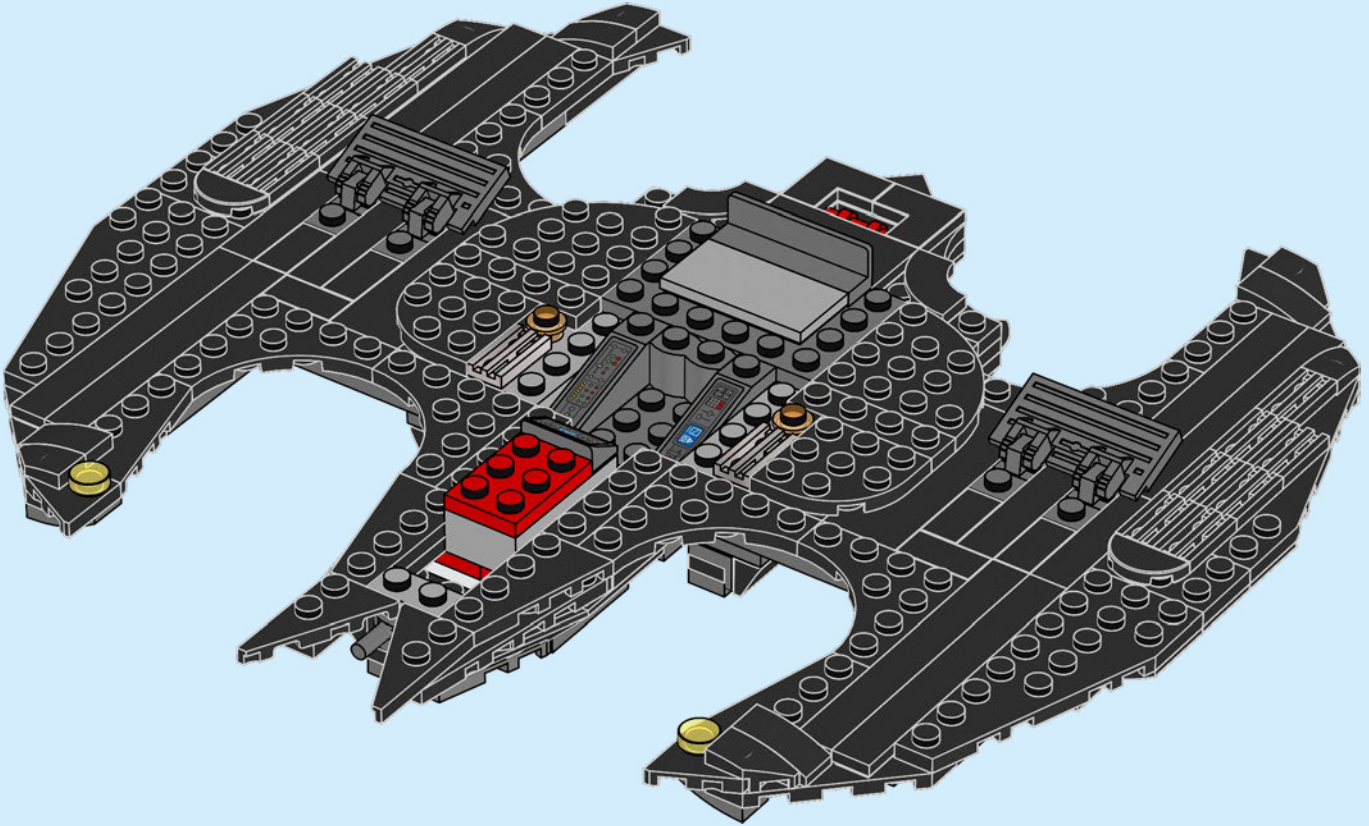



4x

101

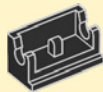

4x

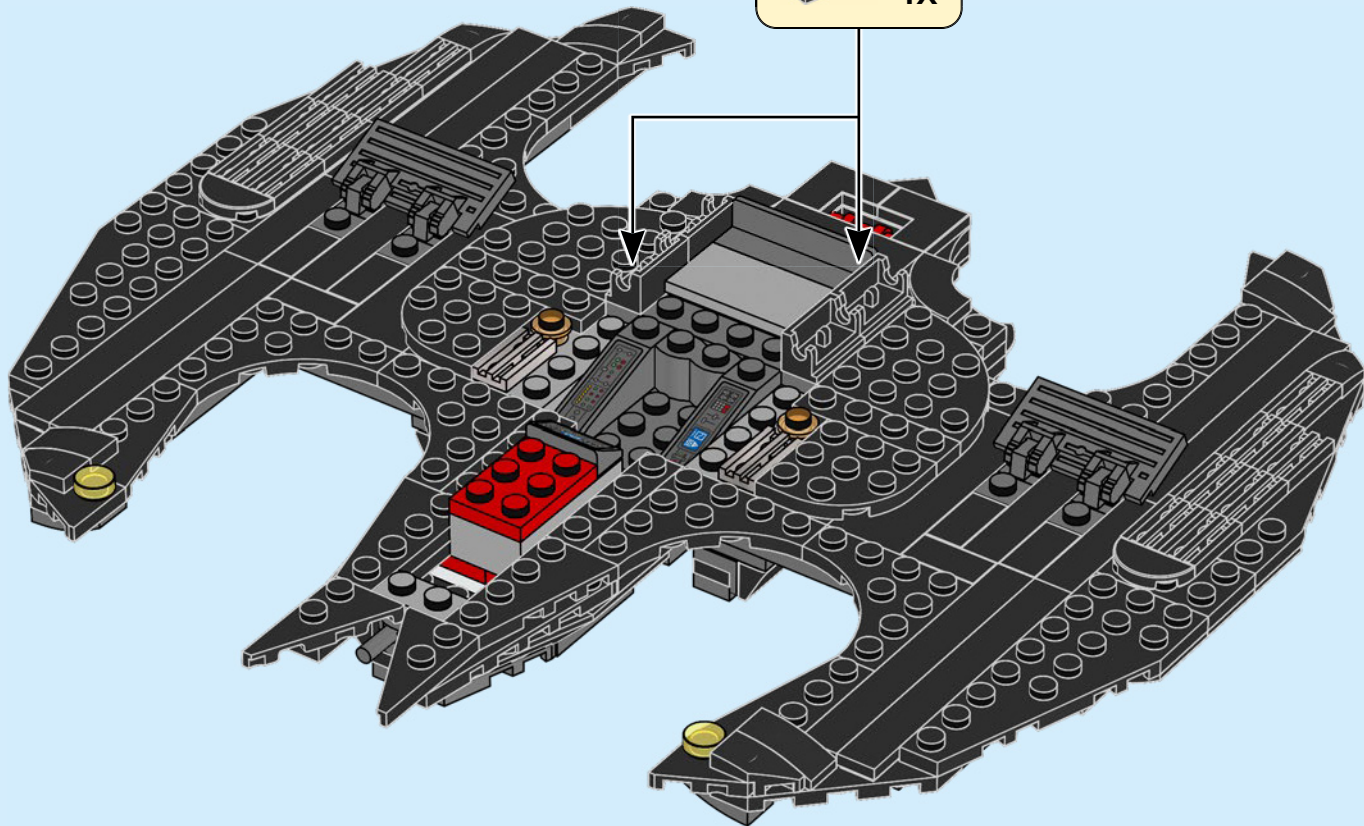



102

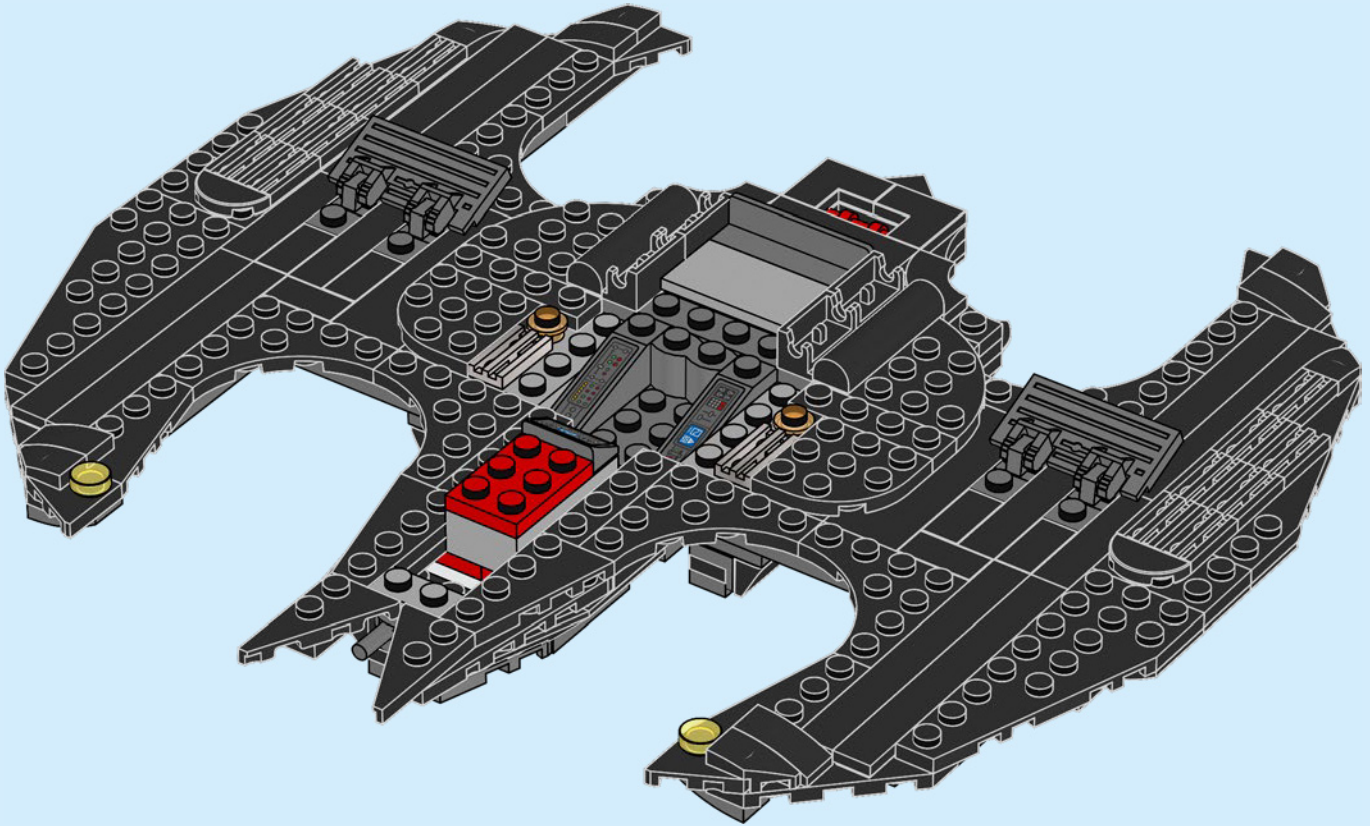



2x

103

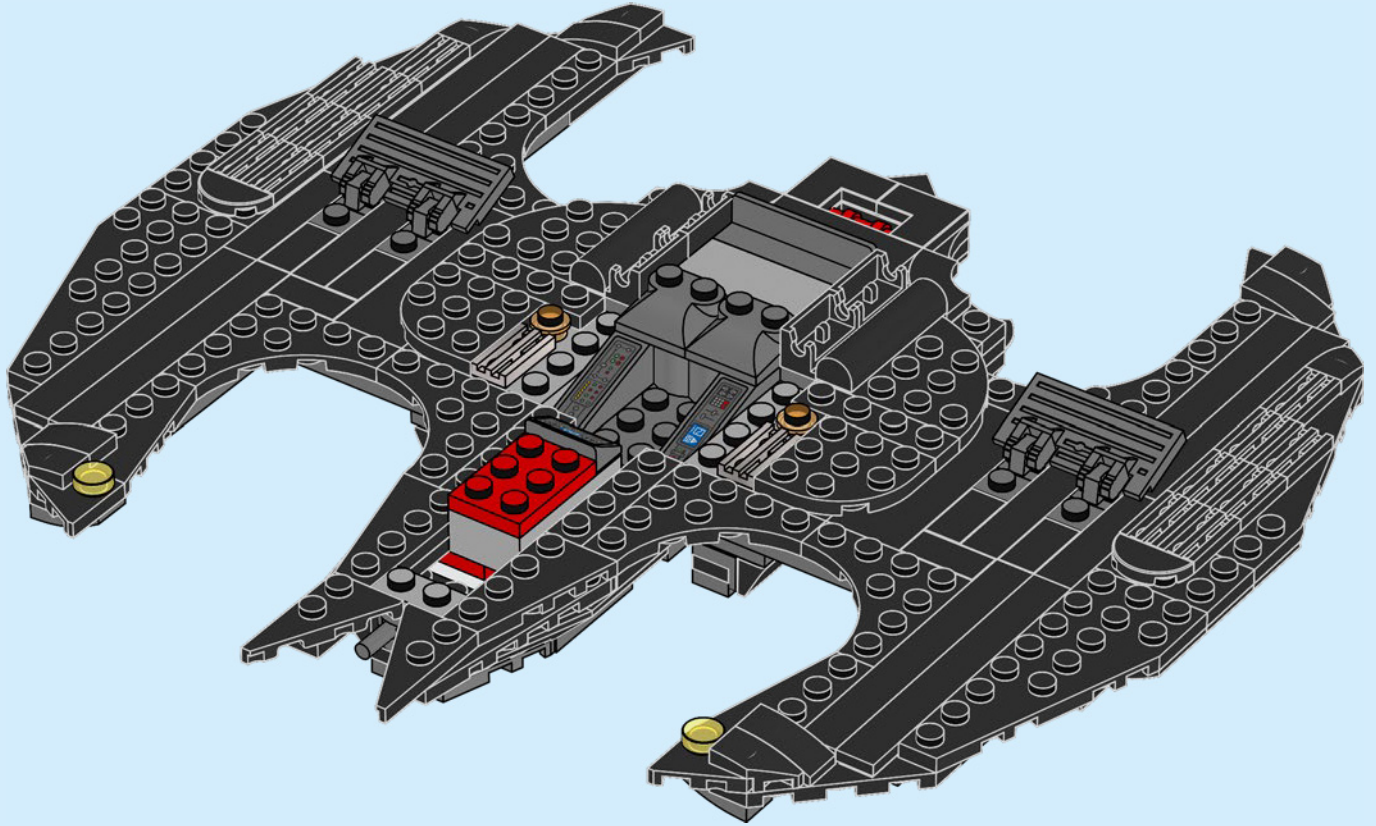

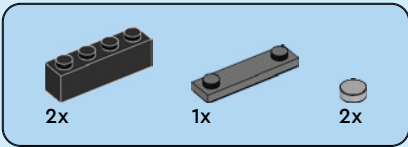

104

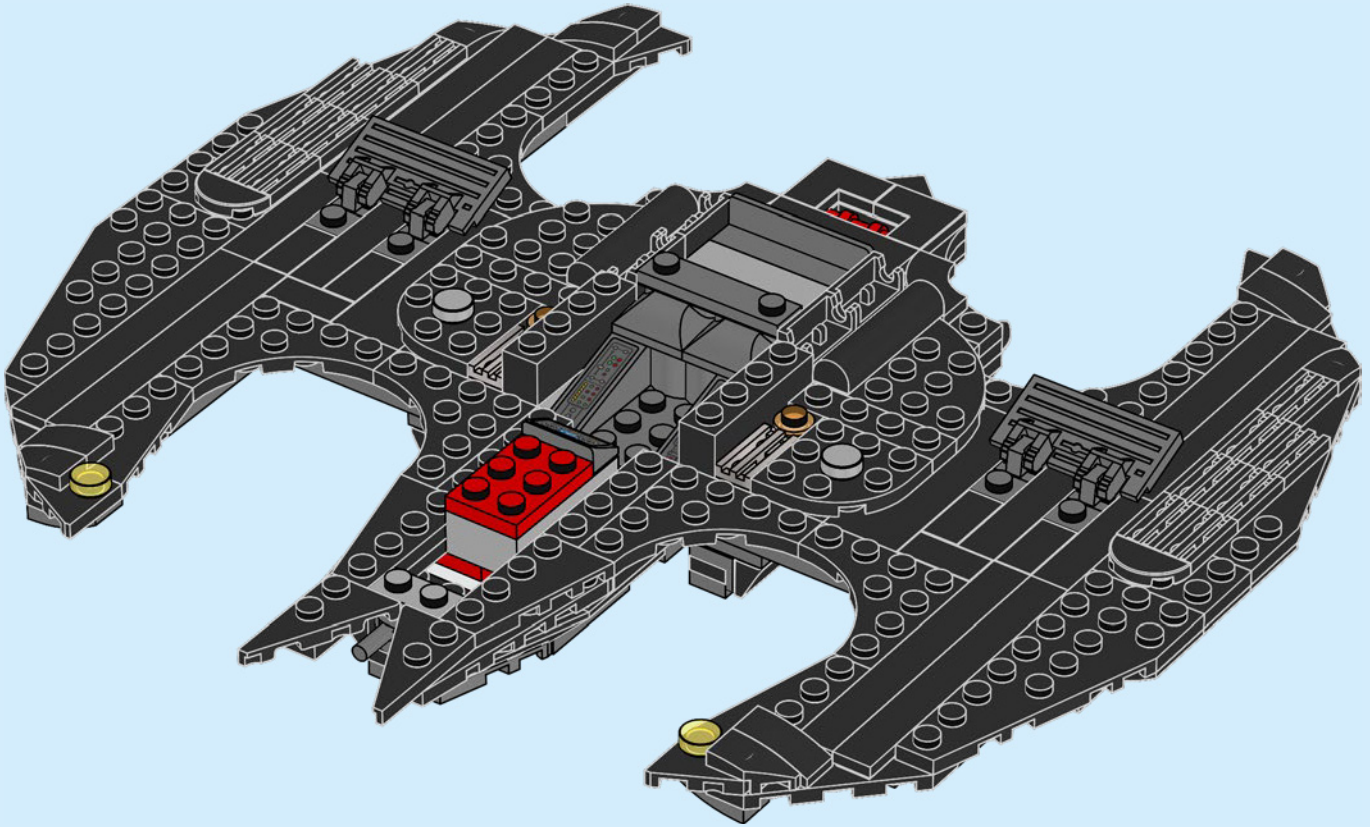

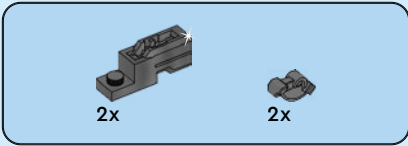

105

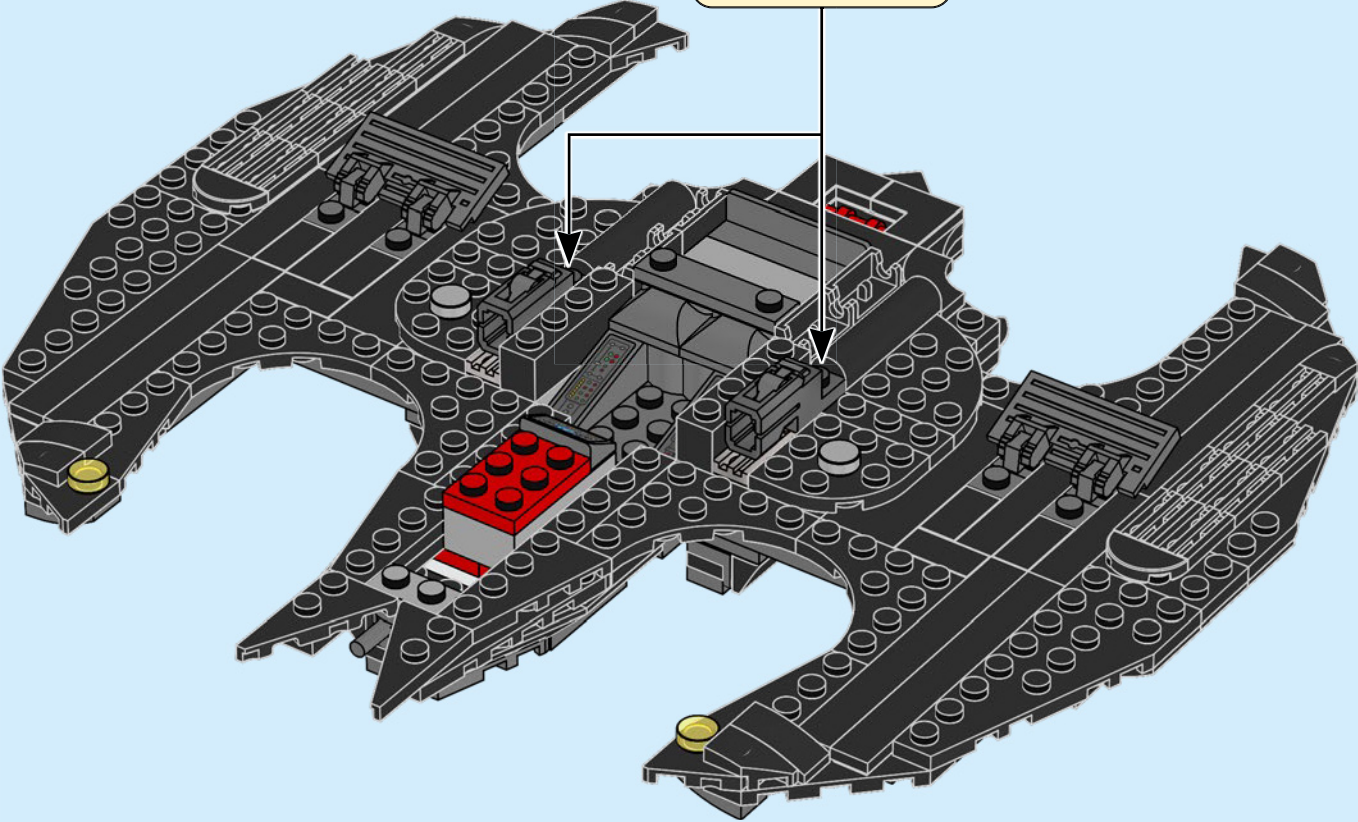
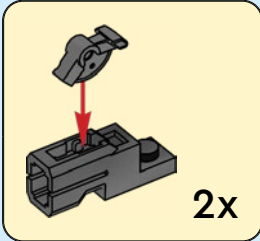



2x

106



2x

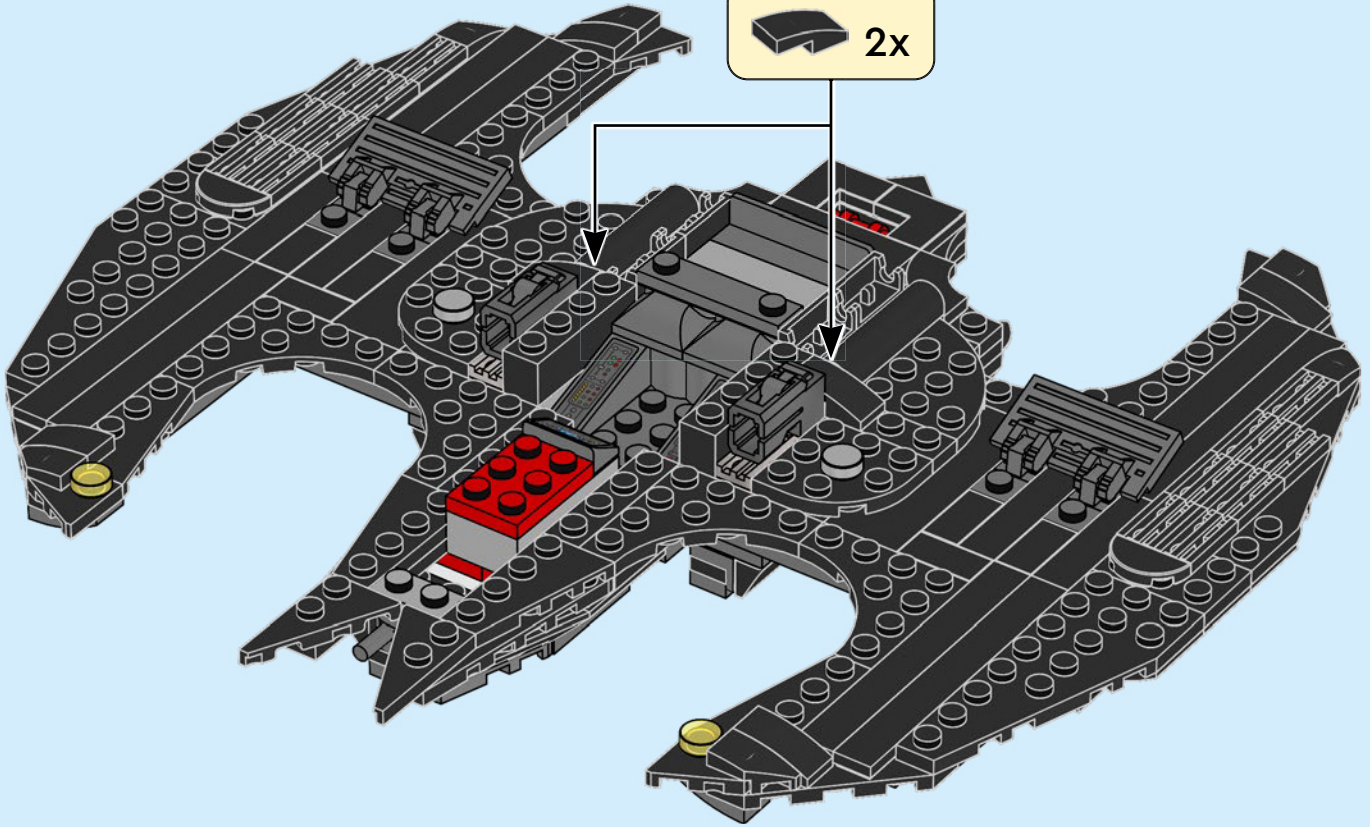

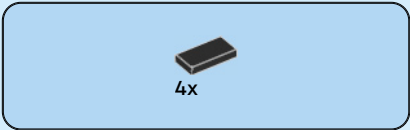

107

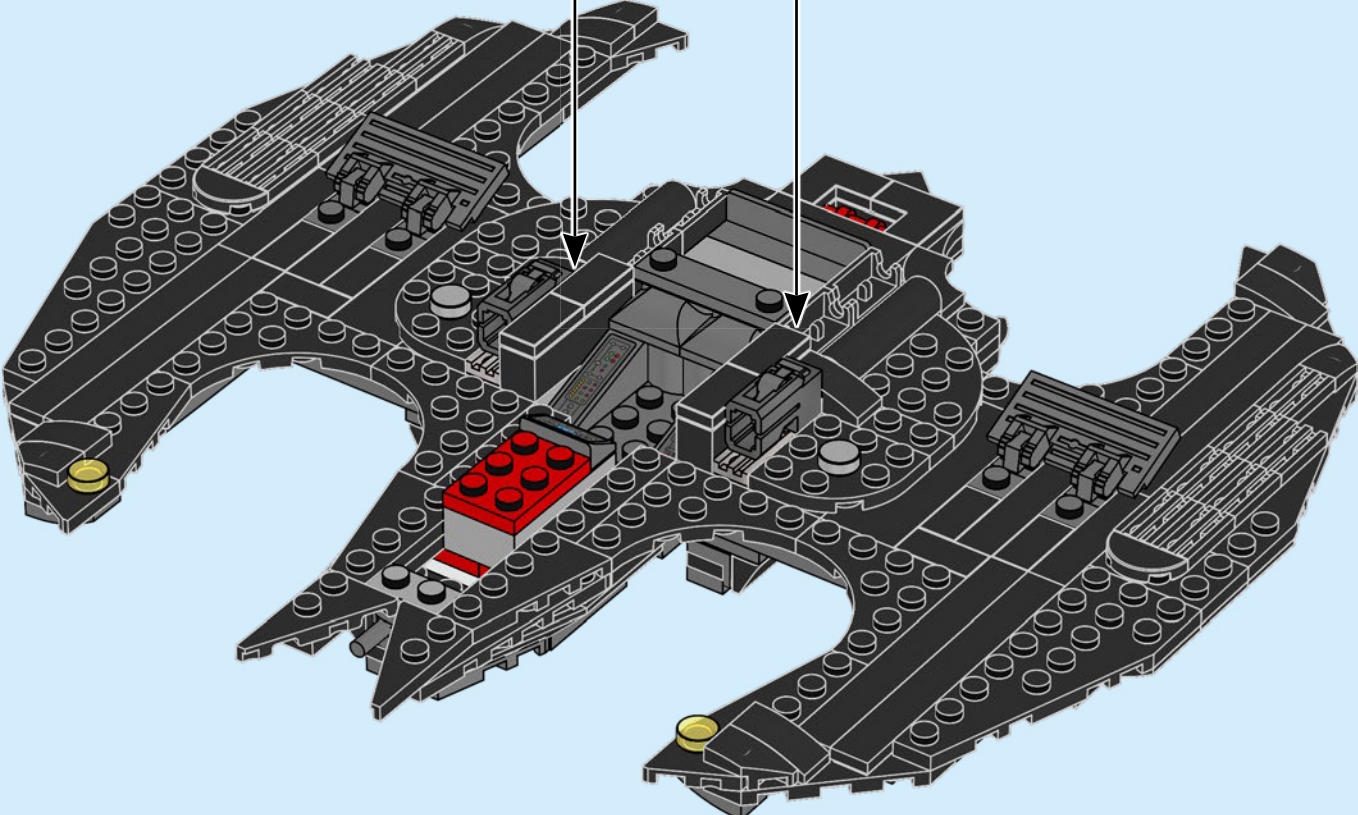



108

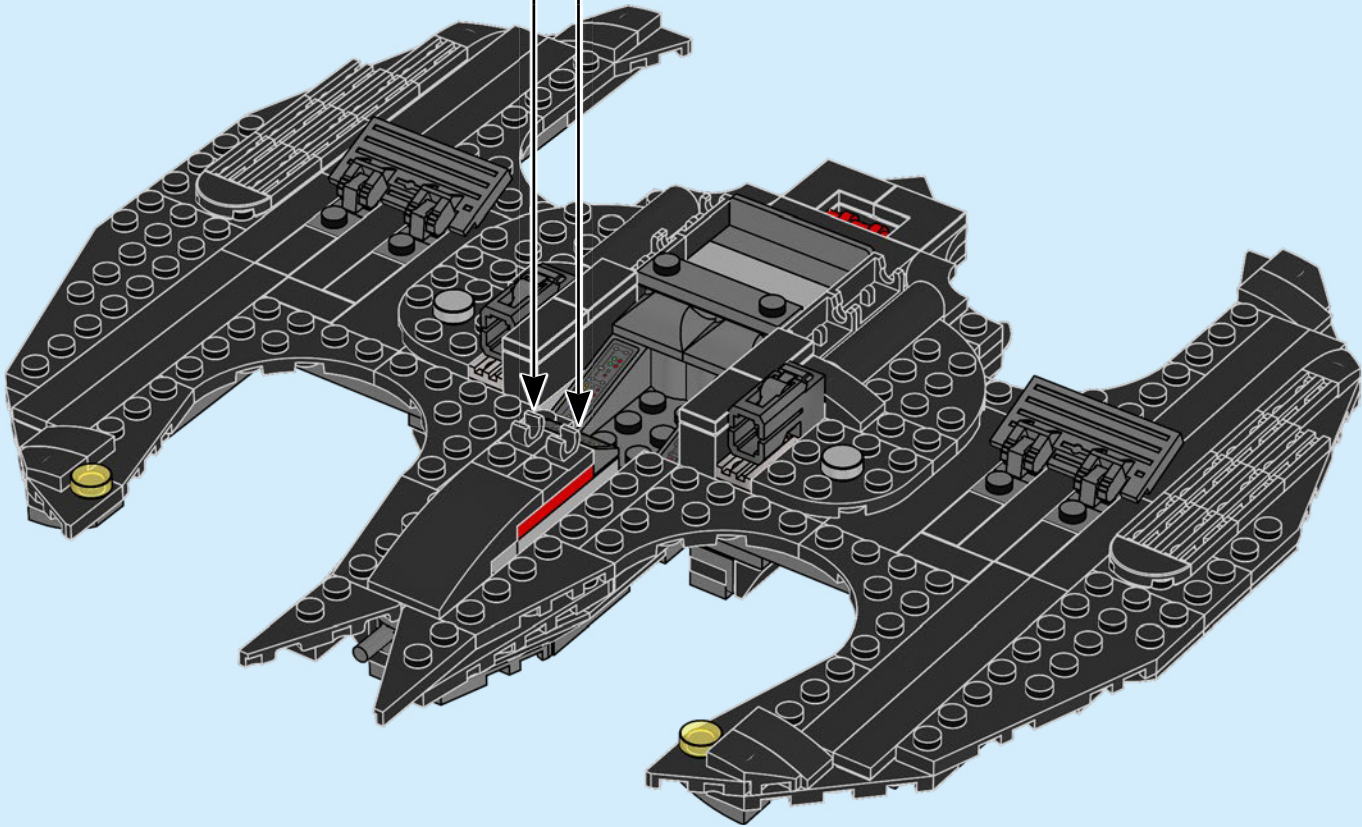

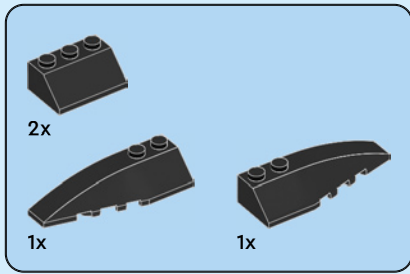

109

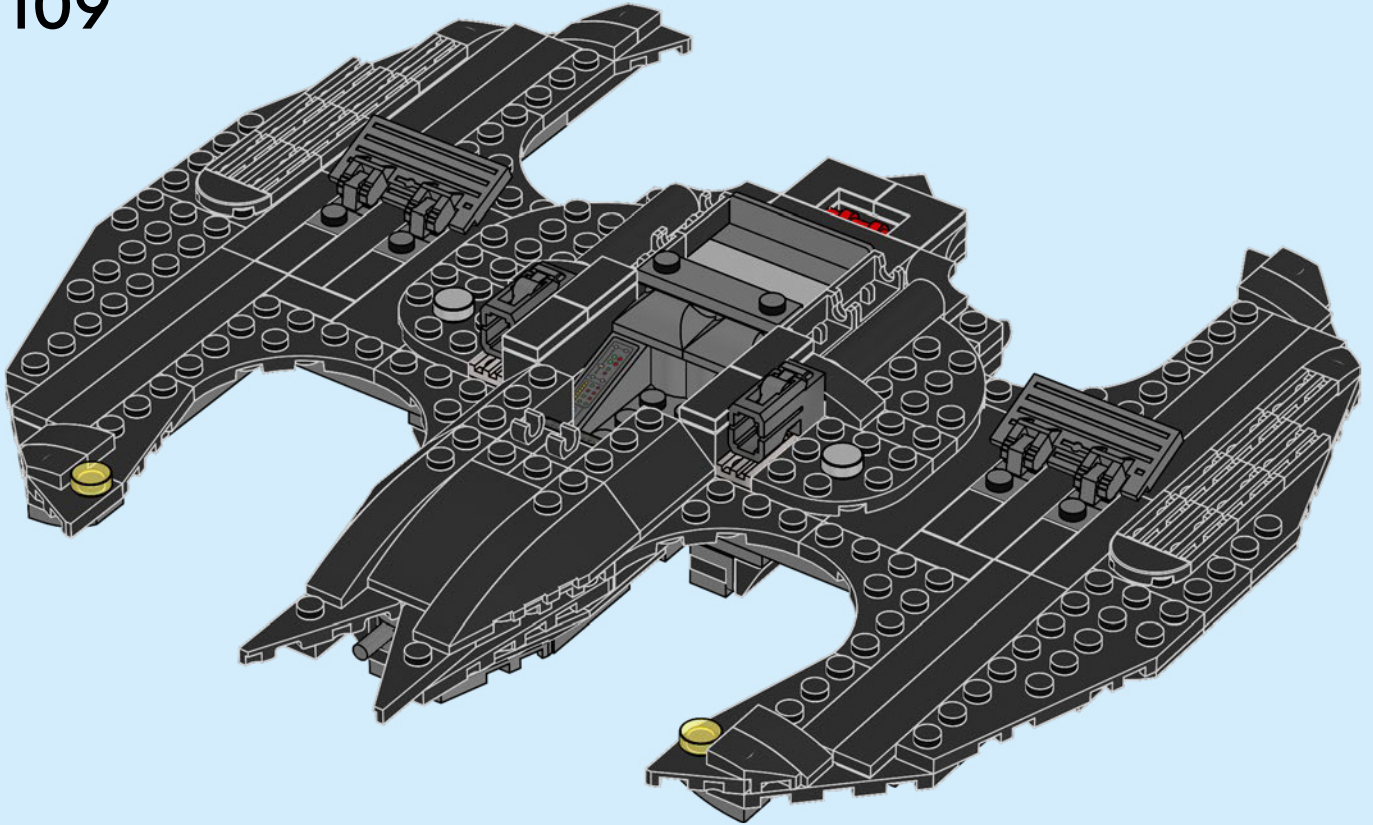

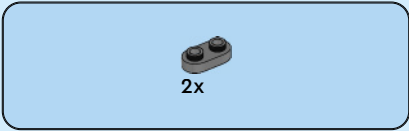
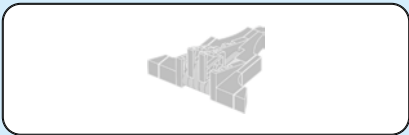

110

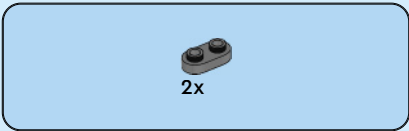
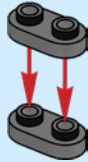

111

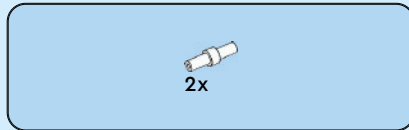
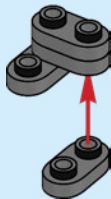

112

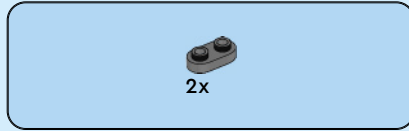
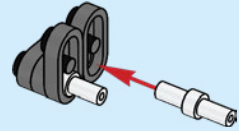
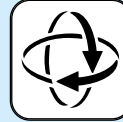

113

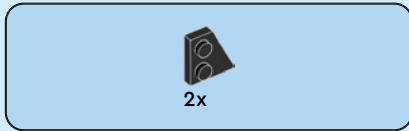
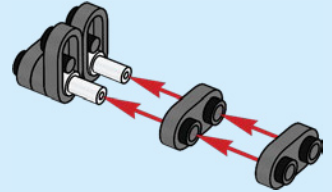

114

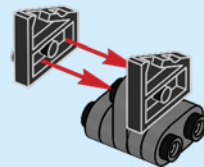

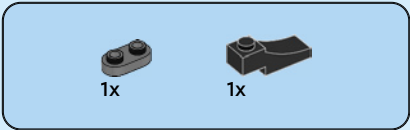

115

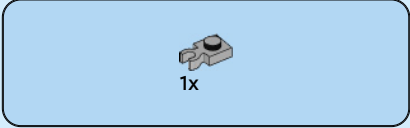
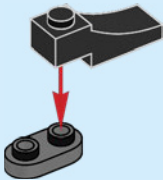

116

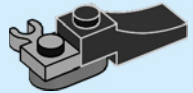

117

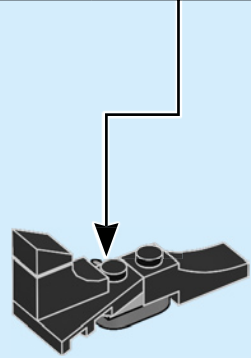
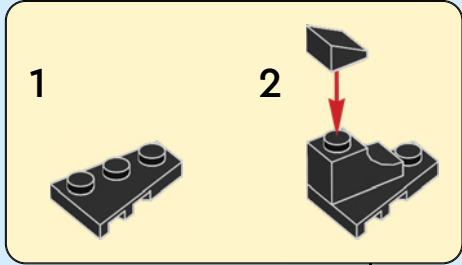
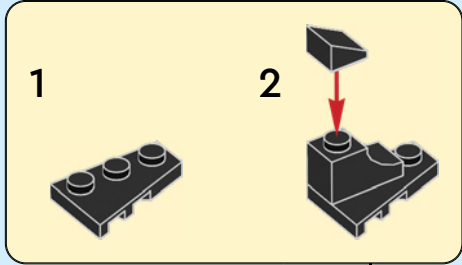

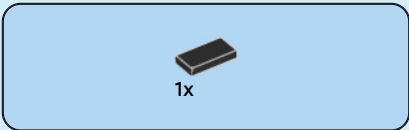

118

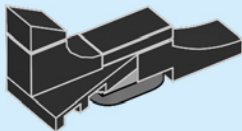

119

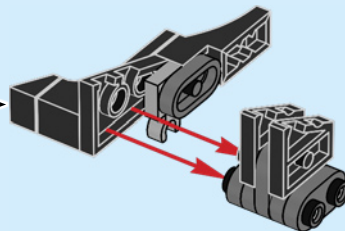

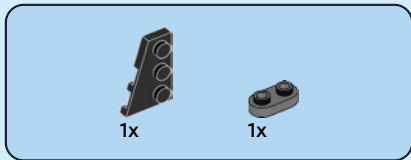

120

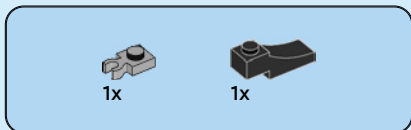
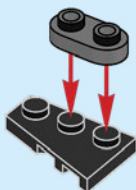

121

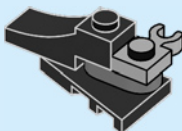

122

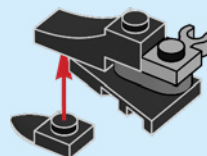

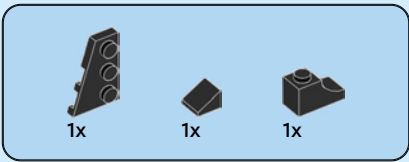

123

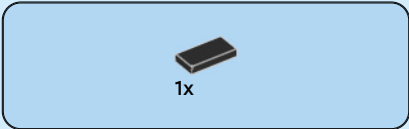
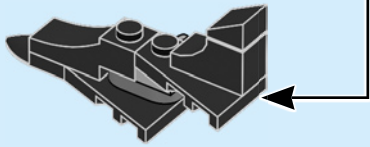
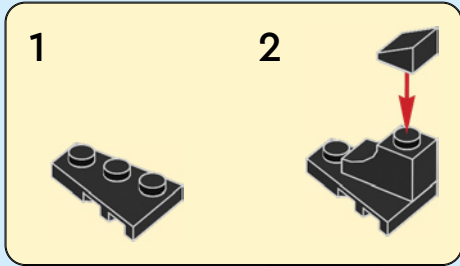

124

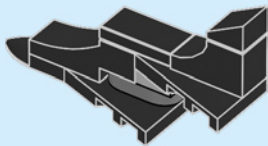

125

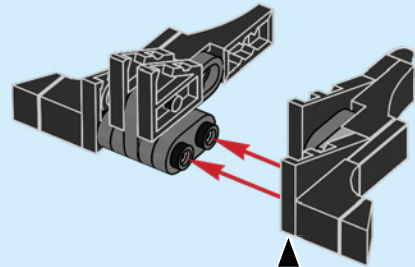

126

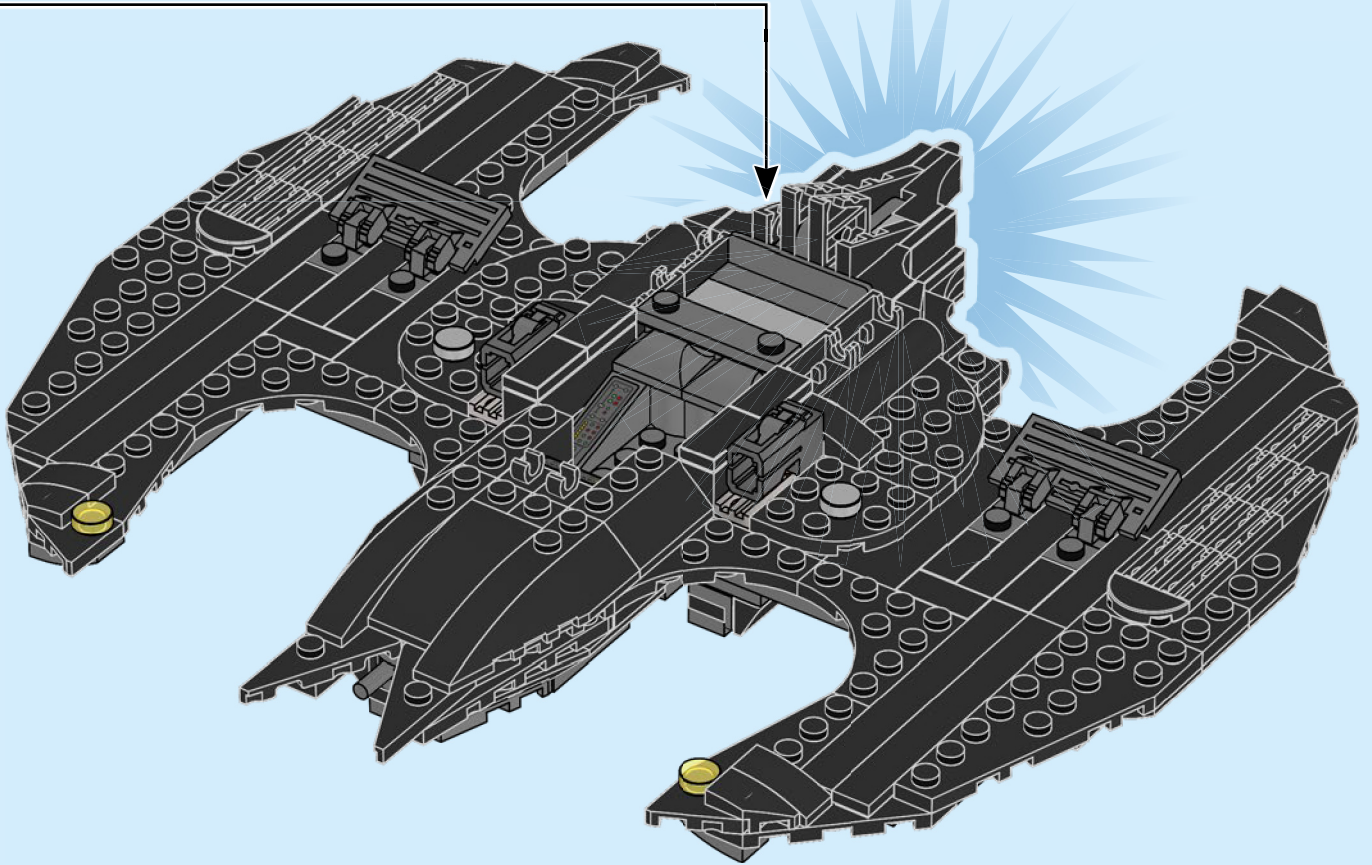



2x



1x



1x

127

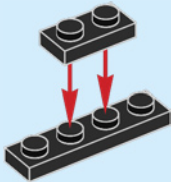

1x



1x

128

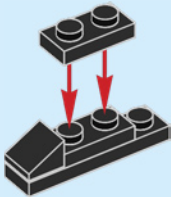

1x



1x



1x

129

1



2

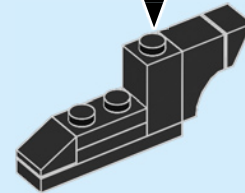
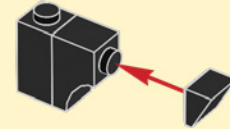

1x

130

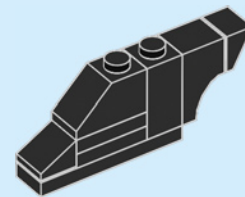

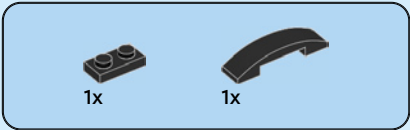

131

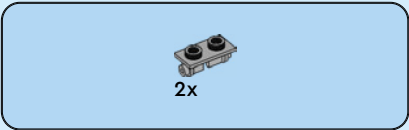
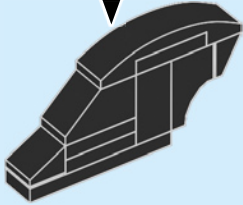
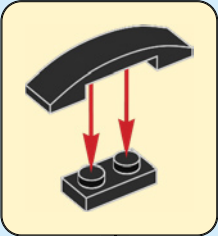

132

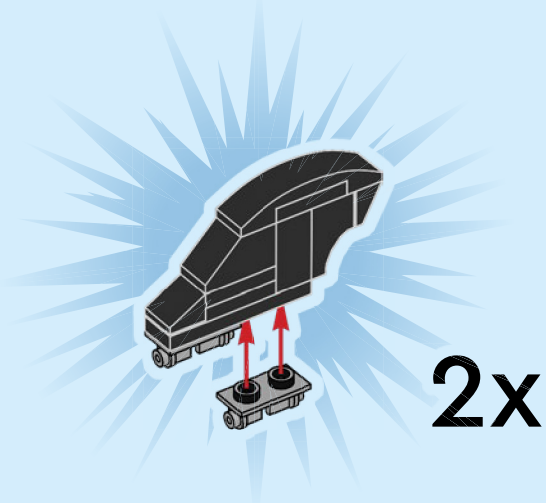

133

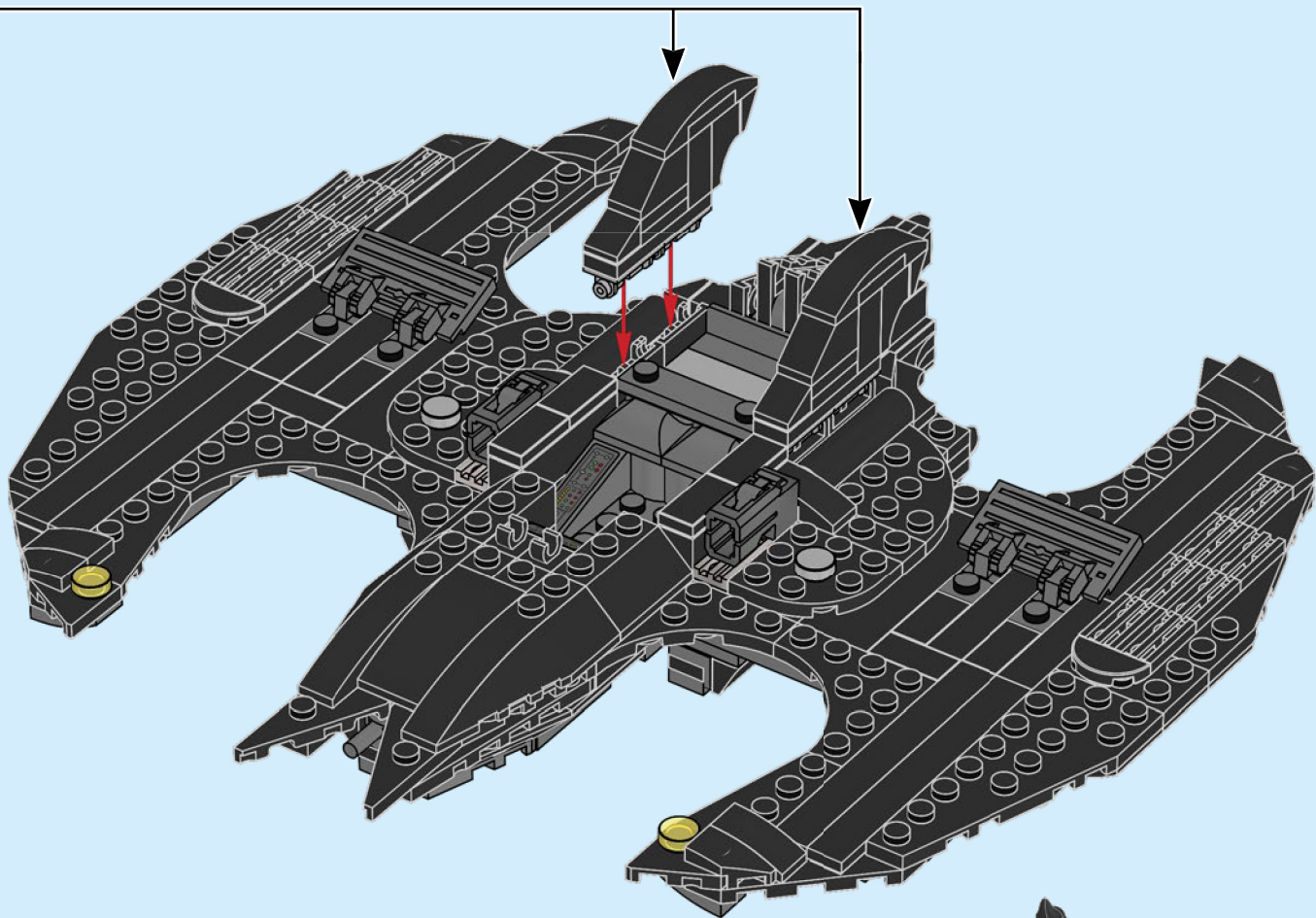



134

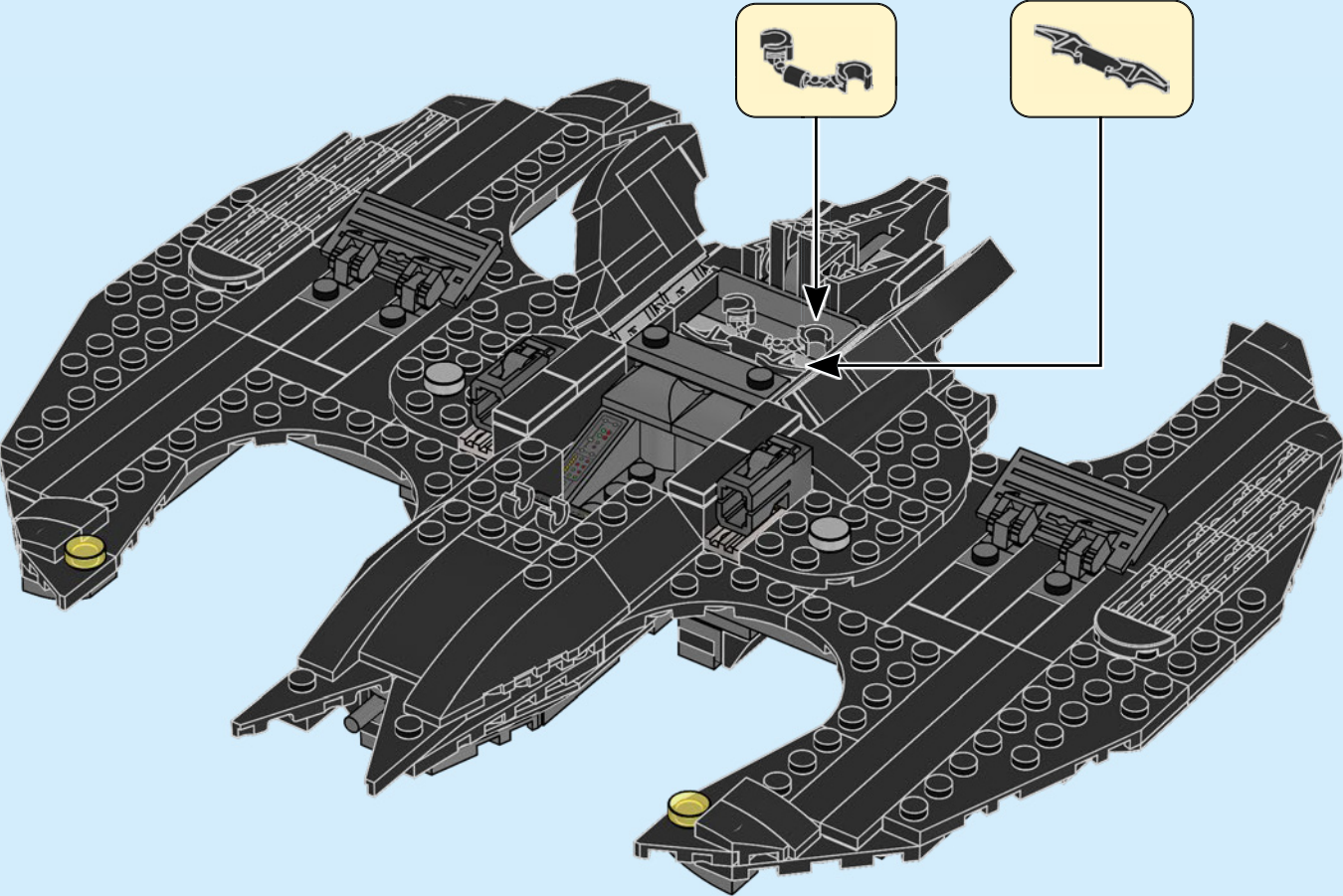

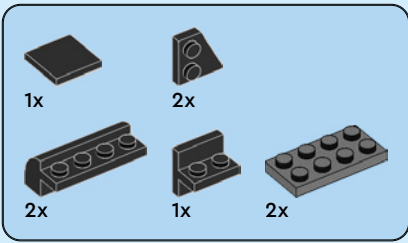

135

1

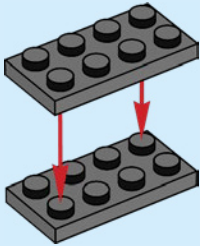

2

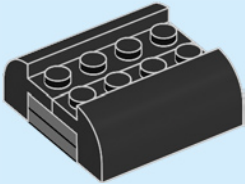

3

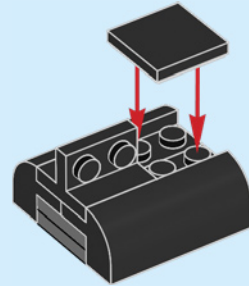

4

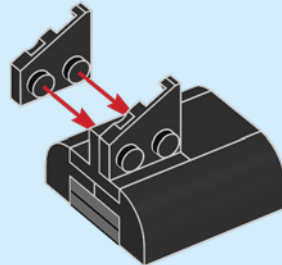

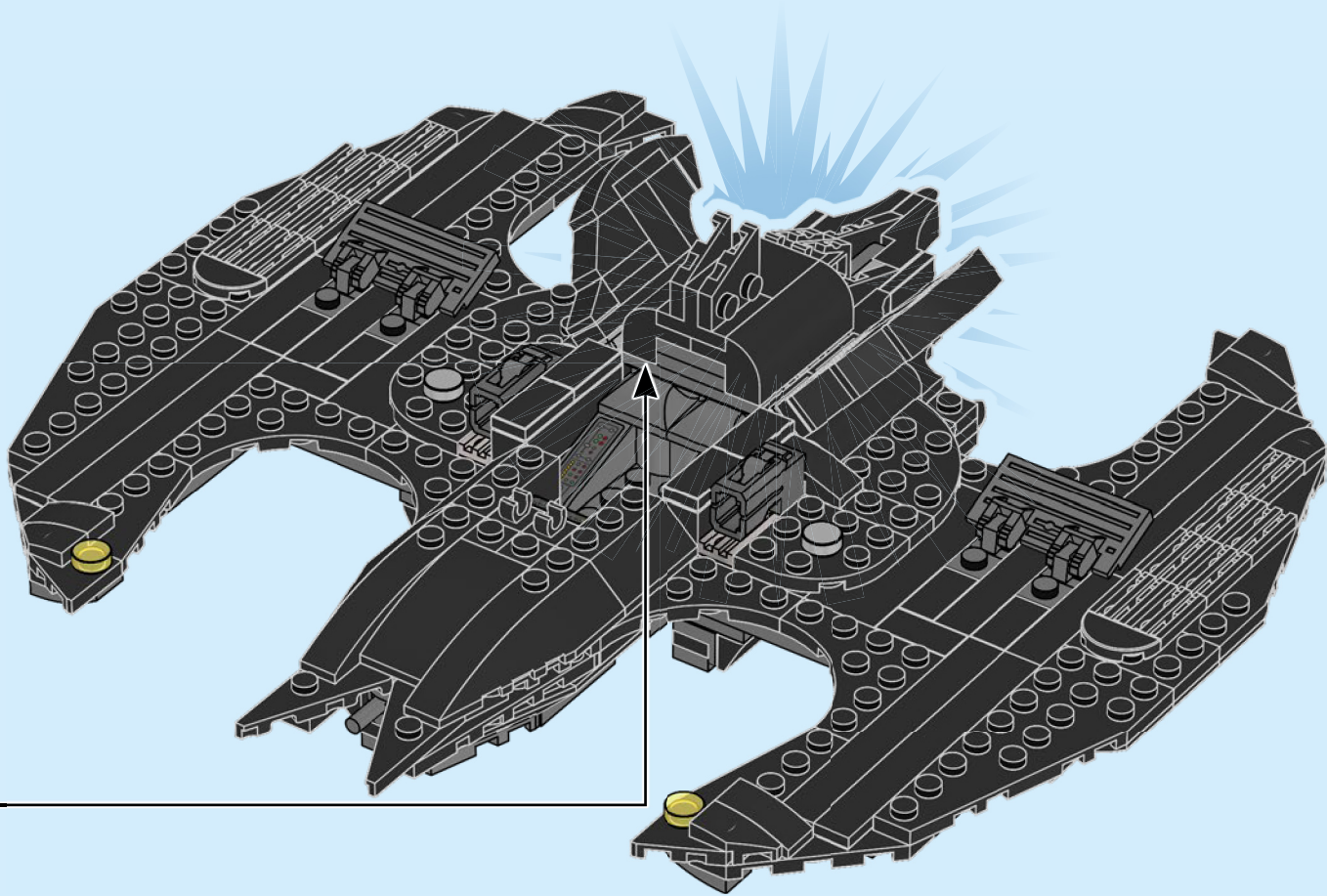

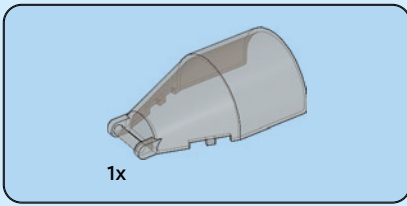

136

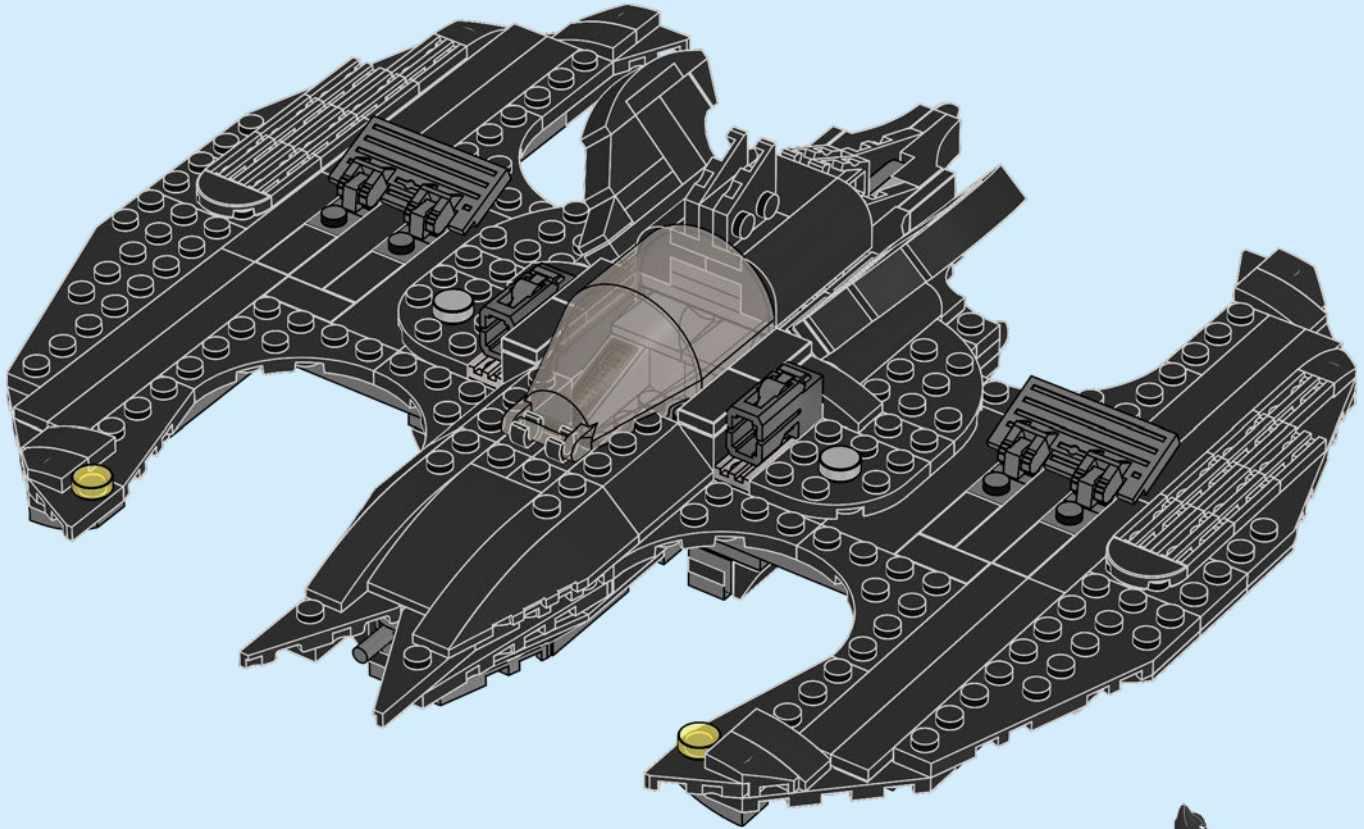

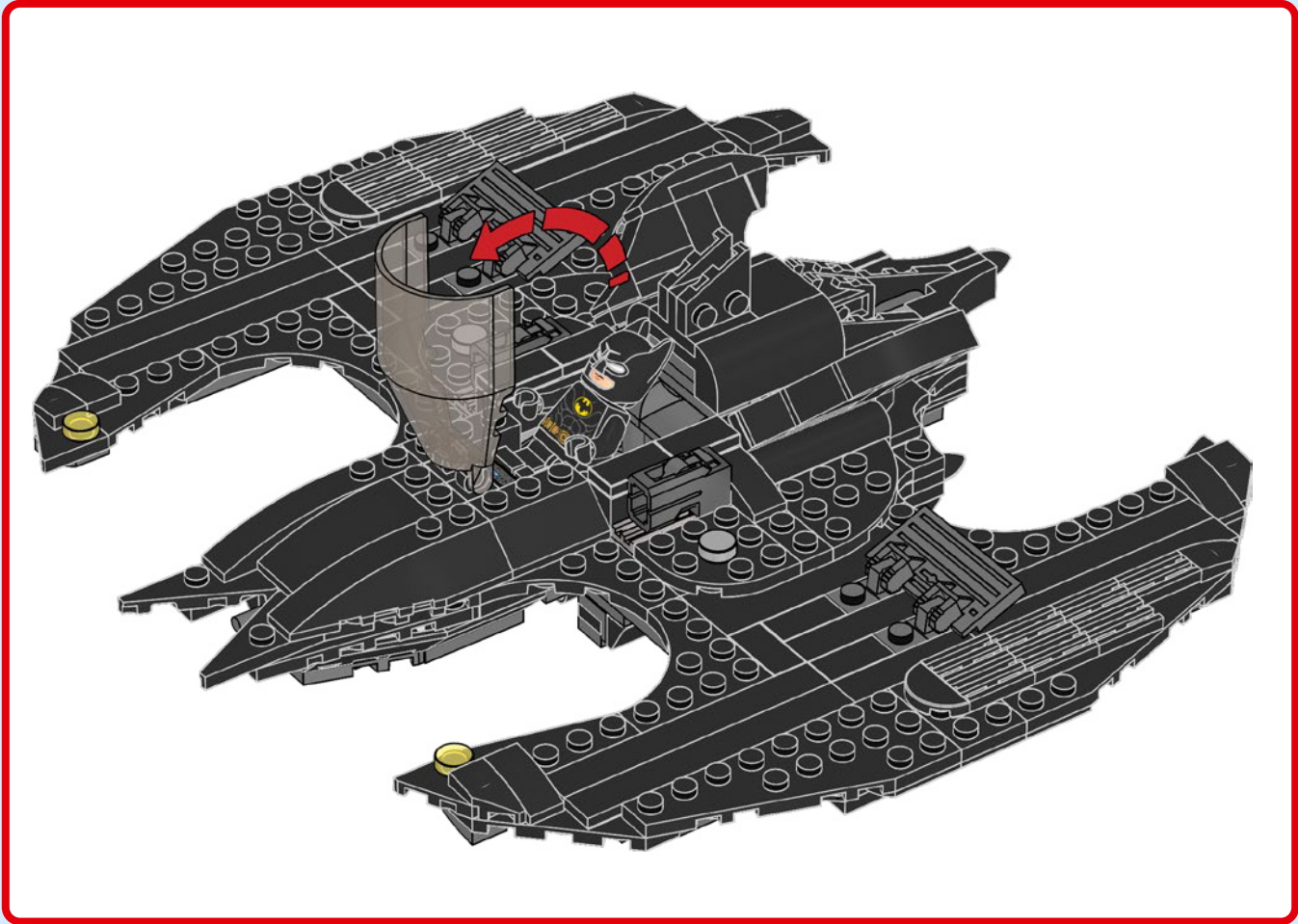



137

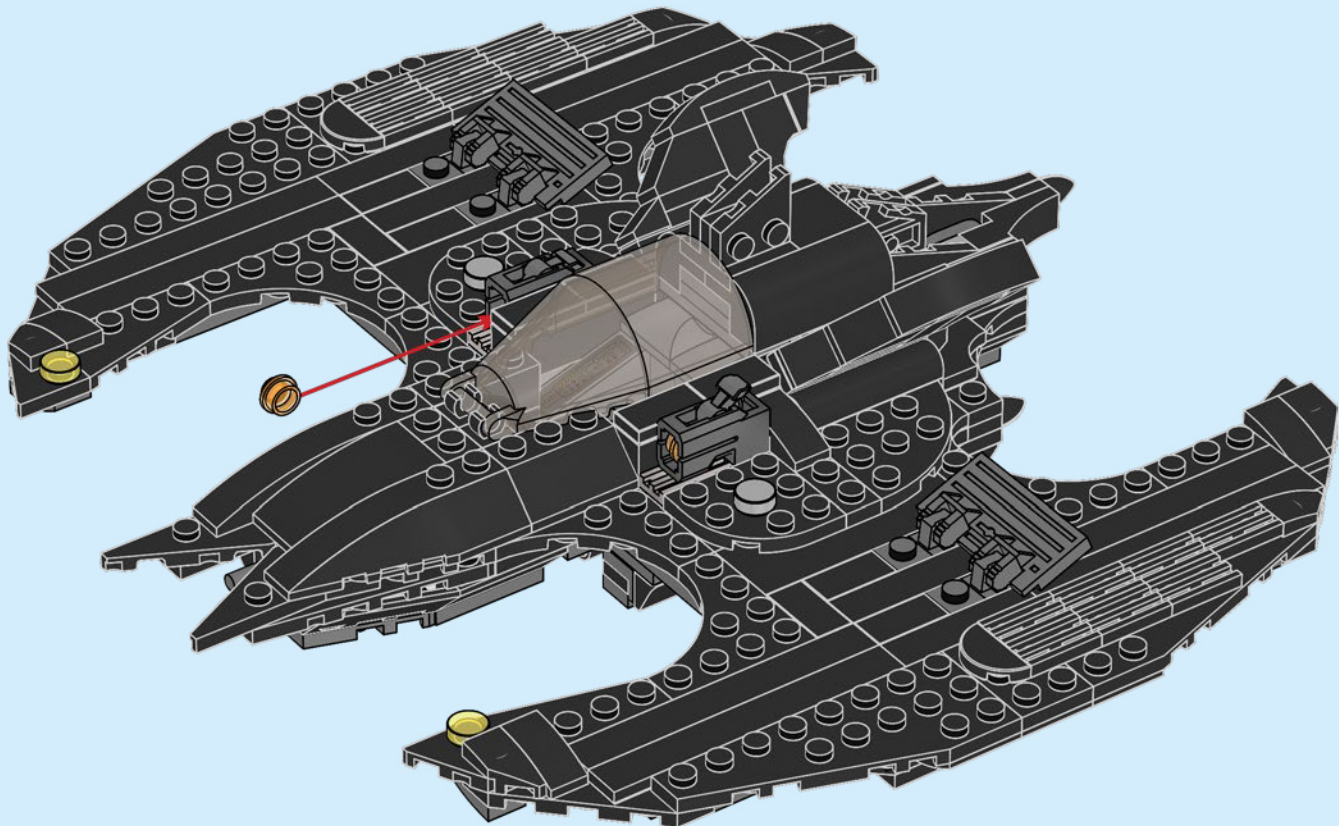

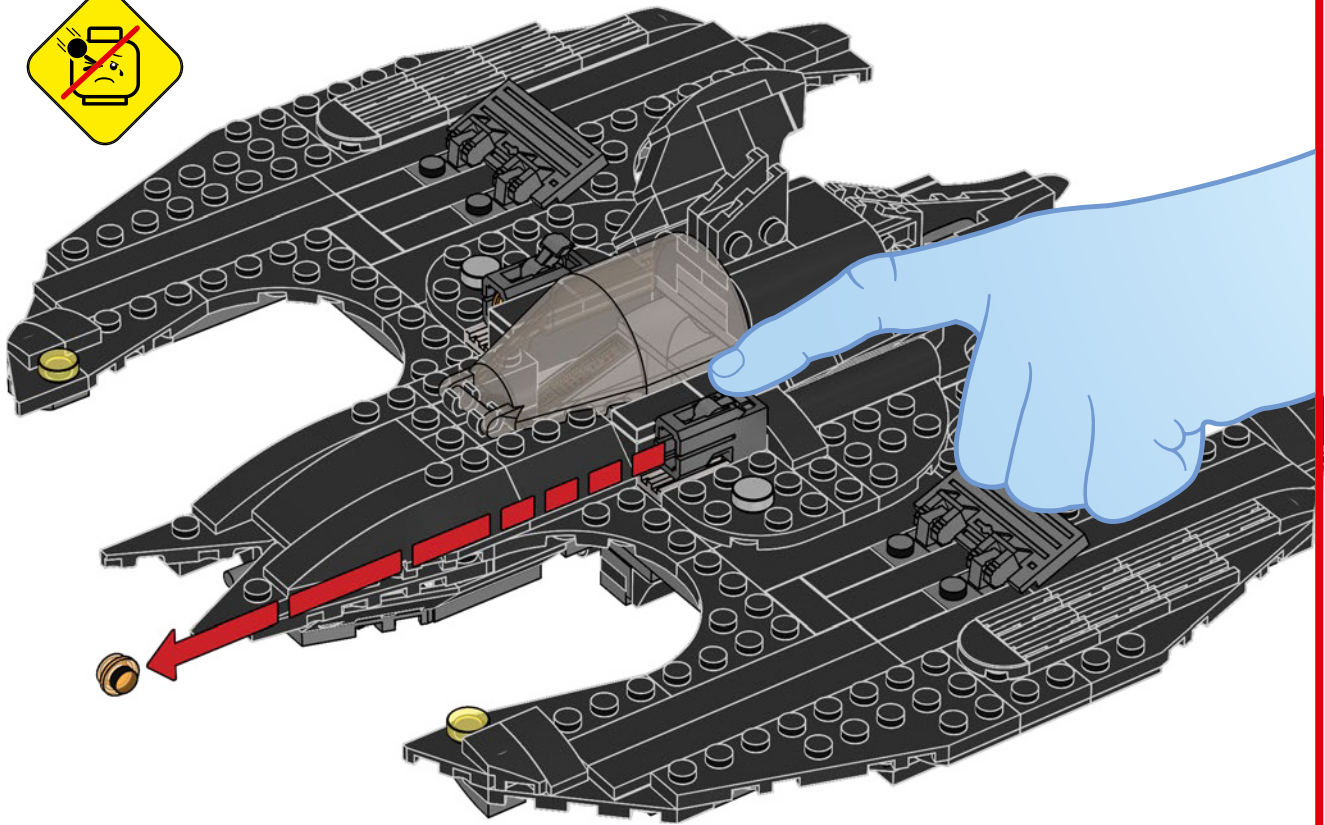



2x
6439040

2x
6360675

19x
6221607

1x
6390673

1x
4567887

1x
4211095

4x
6265693

2x
6215212

10x
6214341

2x
4218696

2x
4211133

2x
6187008

1x
6257592

1x
6092649

2x
4535930

1x
6170522

3x
4211065

2x
6301930

4x
4243831

1x
4211115

2x
4257526

1x
4210794

4x
4210706

4x
6284071

2x
6296894

6x
4278273

1x
4211398

4x
4211470

2x
6045988

1x
4211385

1x
4560183

8x
4211406

1x
6448890

2x
6357680

1x
302001

1x
4140585

3x
302121

2x
302324

2x
6061025

1x
4586410

1x
6455177

1x
6453180

1x
6258524

2x
4619636

2x
6345952

1x
6337336

3x
4500125

8x
6240227

2x
6274740



 [LEGO.com/service](https://www.LEGO.com/service)

YOU COULD **WIN**



Scan this QR code or go to **LEGO.COM/PRODUCTFEEDBACK** and give us your short feedback about this LEGO® set for a chance to win a cool LEGO prize.

Terms and Conditions apply*



EN: YOU COULD WIN. Terms and Conditions apply* **DE: Du könntest GEWINNEN.** Es gelten die Teilnahmebedingungen* **FR: Tu pourrais GAGNER.** Des conditions s'appliquent* **IT: Potresti VINCERE tu.** Termini e condizioni sono applicabili* **ES: Puedes GANAR.** Aplican términos y condiciones* **PT: Poderá GANHAR.** Aplicam-se termos e condições* **ZH: 轻松获奖. 条款和条件适用*** **PL: Szansa na WYGRANĄ.** Obowiązują warunki korzystania* **CS: Máte šanci VYHRÁT.** Platí všeobecné smluvní podmínky* **SK: Máte šancu VYHRAŤ.** Platia všeobecné zmluvné podmienky* **HU: TE IS NYERHETSZ.** Felhasználási feltételek érvényesek* **RO: Ai putea CÂȘTIGA.** Se aplică termeni și condiții* **BG: Можете да СПЕЧЕЛИТЕ.** Има определени правила и условия* **LV: Tu vari LAIMĒT.** Ir spēkā noteikumi un nosacījumi.* **ET: Sul on võimalus VÕITA.** Kehtivad tingimused* **LT: Jūs galite LAIMĖTI.** Taikomos sąlygos*

*[LEGO.com/productfeedback-terms](https://www.lego.com/productfeedback-terms)

LEGO and the LEGO logo are trademarks of the/son des marques de commerce du/son marcas registradas de LEGO Group.
©2023 The LEGO Group.

BATMAN and all related characters and elements © & ™ DC (s23)

6475251