

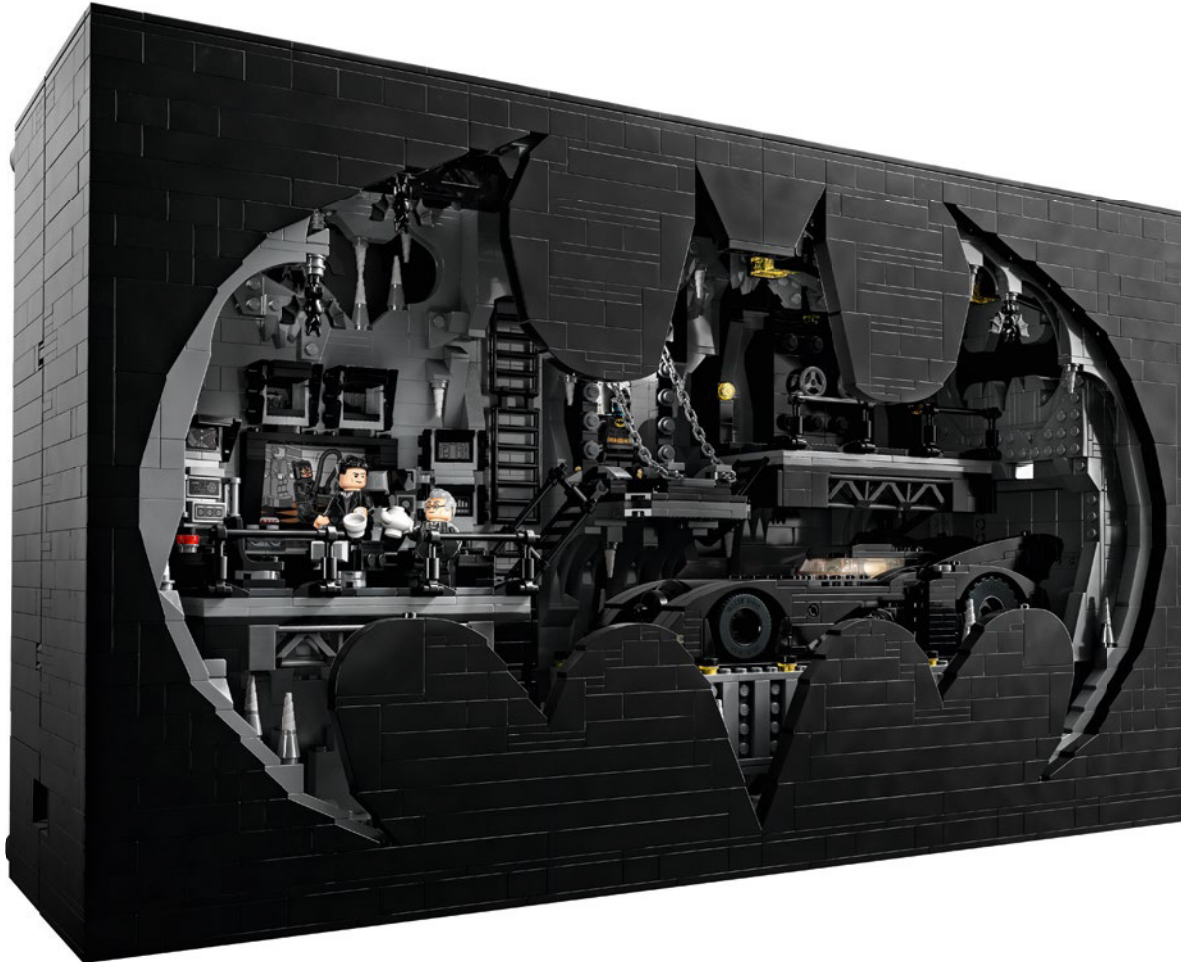

1

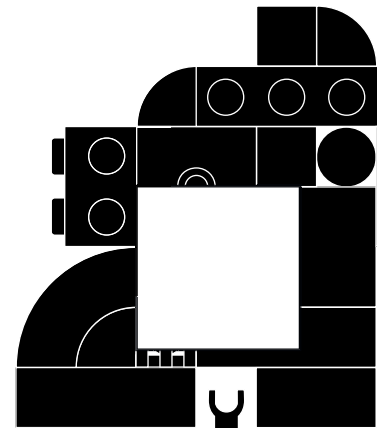

Booklet available in English on
Livret disponible en français sur
Folleto disponible en español en





WE'RE MAKING OUR PACKAGING MORE SUSTAINABLE

We're transitioning from single-use plastic to paper-based packaging. As we progress, you may find a mix of paper and plastic in our boxes.

NOUS RENDONS NOS EMBALLAGES PLUS DURABLES

Nous passons des emballages en plastique à usage unique aux emballages à base de papier. Durant la transition, vous pourriez trouver un mélange de papier et de plastique dans nos boîtes.

QUEREMOS HACER MÁS SUSTENTABLES NUESTROS MATERIALES DE EMBALAJE

Estamos cambiando las bolsas de plástico desechables por bolsas con base de papel. Conforme avanzamos en este propósito, puedes encontrar una mezcla de papel y de plástico en nuestras cajas.

LEGO.com/sustainable-packaging

LEGO® VIP

- 1.** SIGN UP
INSCRIVEZ-VOUS
REGÍSTRATE

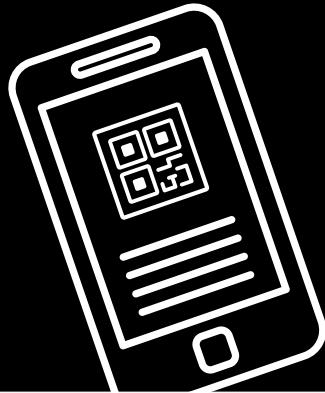

- 2.** EARN POINTS
FOR PURCHASES
GAGNEZ DES POINTS
POUR VOS ACHATS
GANA PUNTOS POR
TUS COMPRAS

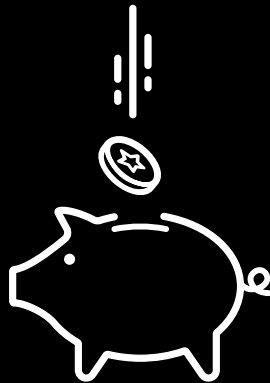

- 3.** REDEEM POINTS FOR REWARDS, EXPERIENCES,
DISCOUNTS & MORE
ÉCHANGEZ DES POINTS CONTRE DES RÉCOMPENSES,
DES EXPÉRIENCES, DES RÉDUCTIONS ET PLUS ENCORE
CANJEA PUNTOS POR RECOMPENSAS, EXPERIENCIAS,
DESCUENTOS Y MUCHO MÁS

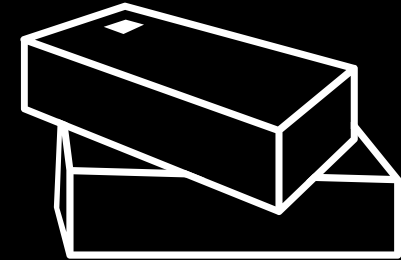
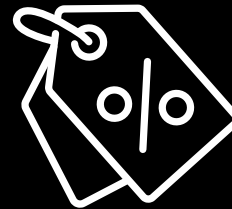



"MUST YOU BE THE ONLY LONELY MAN-BEAST IN TOWN?"

- Alfred Pennyworth™



**« DEVEZ-VOUS RESTER LA SEULE ET UNIQUE BÊTE
HUMAINE DE GOTHAM ? »**

- Alfred Pennyworth™



**"¿DEBE SER USTED EL ÚNICO HOMBRE BESTIA EN
GÓTICA?"**

- Alfred Pennyworth™

THE SECRETS OF THE BATCAVE™

The Shadow Box, an elegant and versatile hybrid between a traditional picture frame and a display case, is an endlessly creative medium for displaying your treasured mementos. It wraps your collectibles in a certain ambiance, and the depth effect elevates them to a unique work of art. It seemed only fitting that the first LEGO® Shadow Box model envelops the atmosphere, and reveals the secrets, of the Batcave™; the legendary lair of a Super Hero who operates in the shadows to protect GOTHAM CITY™.

LES SECRETS DE LA BATCAVE™

La boîte-cadre, ou Shadow Box, un hybride élégant et polyvalent entre un cadre photo traditionnel et une vitrine, est un moyen infiniment créatif d'exposer vos souvenirs les plus précieux. Elle enveloppe vos objets de collection dans une certaine ambiance, et l'effet de profondeur les élève à une œuvre d'art unique. Il semblait tout à fait approprié que le premier modèle LEGO® La boîte-cadre enveloppe l'atmosphère et révèle les secrets de la Batcave™, le repaire légendaire d'un superhéros qui opère dans l'ombre pour protéger GOTHAM CITY™.

LOS SECRETOS DE LA BATICUEVA

La Caja Sombria, un elegante y versátil híbrido entre un marco de fotos tradicional y un estuche de exhibición, es un medio infinitamente creativo para exponer tus recuerdos más preciados. Este particular estuche envuelve tus objetos de colección en un ambiente exclusivo y su efecto de profundidad los eleva a la categoría de obras de arte irrepitibles. Con tales antecedentes, resultaba natural que el modelo inaugural de la Caja Sombria LEGO® replicara la atmósfera y revelara los secretos de la Baticueva, la legendaria guarida de un superhéroe que opera desde las sombras para proteger CIUDAD GÓTICA.

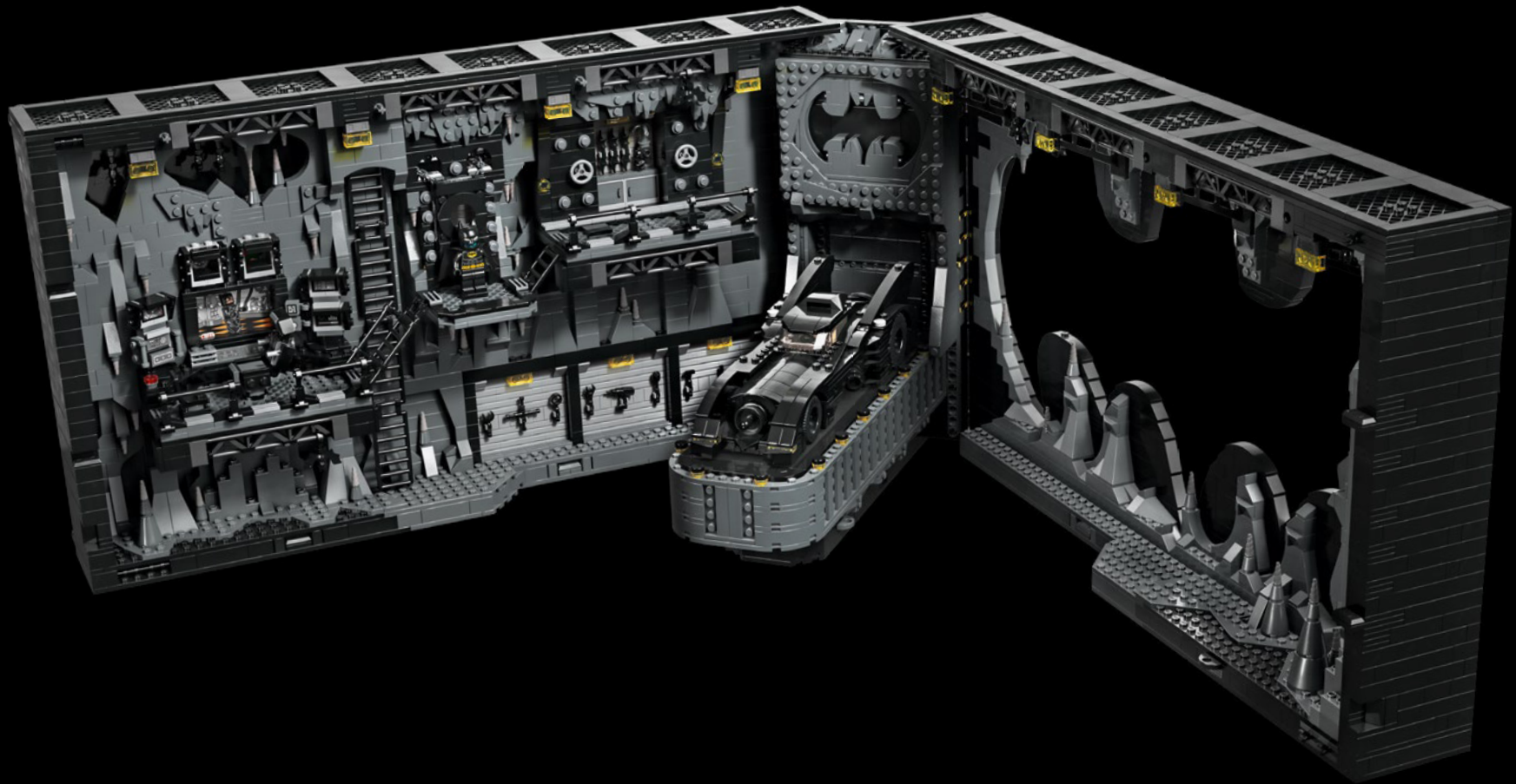



The LEGO® DC Batman™ designers, from left to right: Connie Bork, Bjarke Lykke Madsen, Daniel Lundin, Adam Corbally, Christian Barnkob, Carter Luce Baldwin, Jesper C. Nielsen, Ashwin Visser.

Les concepteurs LEGO® DC Batman™ de gauche à droite : Connie Bork, Bjarke Lykke Madsen, Daniel Lundin, Adam Corbally, Christian Barnkob, Carter Luce Baldwin, Jesper C. Nielsen, Ashwin Visser.

Los diseñadores de LEGO® DC Batman™, de izquierda a derecha: Connie Bork, Bjarke Lykke Madsen, Daniel Lundin, Adam Corbally, Christian Barnkob, Carter Luce Baldwin, Jesper C. Nielsen y Ashwin Visser.

FROM CONCEPT TO COMPLETION

Creating any new LEGO® set, big or small, requires a whole team of specialists working together across departments and functions to create the best building and play experience: model design, graphic design, building instructions and many more. Jesper C. Nielsen, LEGO DC Batman™ Creative Lead, had long had a concept idea for what he called 'a vertical Batcave™' for adult fans: an intricate diorama narrow enough to display on a shelf. Senior Model Designer Bjarke Lykke Madsen had worked on four previous LEGO Batcave models and was asked to explore if, and how, this idea might be executed in a viable set.

DE LA CONCEPTION À LA RÉALISATION

La création d'un nouvel ensemble LEGO®, grand ou petit, nécessite toute une équipe de spécialistes travaillant ensemble dans tous les départements et fonctions pour créer la meilleure expérience de construction et de jeu : conception de modèles, conception graphique, instructions de montage et bien d'autres. Jesper C. Nielsen, responsable créatif de LEGO DC Batman™ avait depuis longtemps une idée de concept pour ce qu'il appelait « une Batcave™ verticale » pour les amateurs adultes : un diorama complexe assez étroit pour être affiché sur une étagère. Le concepteur de modèles principal Bjarke Lykke Madsen avait travaillé sur quatre modèles LEGO Batcave précédents, et on lui a demandé d'explorer si, et comment, cette idée pourrait être exécutée dans un ensemble viable.

DEL CONCEPTO AL PRODUCTO TERMINADO

Para la creación de todos los nuevos sets LEGO® grandes y pequeños se requiere del trabajo coordinado de un equipo completo de especialistas en distintos departamentos y funciones (diseño de modelos, diseño gráfico, instrucciones de construcción, entre otros) para crear la mejor experiencia de construcción y juego. Jesper C. Nielsen, director creativo de LEGO DC Batman™, tuvo durante mucho tiempo una idea conceptual de lo que llamaba "una Batcueva vertical" para fans adultos: un intrincado diorama lo suficientemente estrecho como para exhibirlo en un estante. El modelista sénior Bjarke Lykke Madsen había trabajado en cuatro modelos anteriores de Batcuevas LEGO, y a él se le pidió que explorara si esta idea era viable para convertirla en un set.

FINDING INSPIRATION

Bjarke found inspiration in the Shadow Box format and *Batman Returns*™ movie (1992): "In *Batman Returns*, you see all these amazing design details and functions in the Batcave™. I had an idea that a Shadow Box could add a complementary artistic aspect to a LEGO® version of it. Jesper loved the idea and suggested that the front cover could include a Batman™ logo cut-out. We agreed the Batmobile™ should be a centerpiece of the Batcave, so I created the Batman logo cut-out to fit a minifigure-scale Batmobile. And that dictated the size of the model. Then I built the first prototype, including a platform for the Batmobile, workstations with computers, the vault for the Batsuit, the gadgets cabinet, etc."

TROUVER L'INSPIRATION

Bjarke a trouvé l'inspiration dans le format d'une boîte-cadre et le film *Le retour de Batman* (1992) : « Dans *Le retour de Batman*, vous voyez tous ces détails et fonctions de conception incroyables dans la Batcave™. J'ai pensé qu'une boîte-cadre pourrait ajouter un aspect artistique complémentaire à une version LEGO® de celle-ci. Jesper a adoré l'idée et a suggéré que la couverture avant pourrait inclure une découpe du logo Batman™. Nous étions d'accord pour que la Batmobile™ soit une pièce maîtresse de la Batcave, j'ai donc créé la découpe du logo Batman pour qu'elle s'adapte à une Batmobile à l'échelle d'une figurine. Et cela a déterminé la taille du modèle. Puis j'ai construit le prototype initial, qui comprenait une plateforme pour la Batmobile, des postes de travail avec des ordinateurs, la voûte de la Batsuit, l'armoire à gadgets, etc. »

LA BÚSQUEDA DE LA INSPIRACIÓN

Bjarke se inspiró en el formato de la Caja Sombria y en la película *Batman regresa* (1992). "En *Batman regresa*, puedes ver todos los increíbles detalles y funciones de la Batcueva. Tenía la idea de que una Caja Sombria podría aportarle un aspecto artístico complementario a una versión de esta hecha con bricks LEGO®. A Jesper le encantó la idea y sugirió que la cara frontal tuviera un recorte con la forma del logotipo de Batman™. Acordamos que el Batimóvil fuera la pieza central de la Batcueva, por lo que incorporé un recorte a imagen del logotipo de Batman de un tamaño compatible con un Batimóvil a escala de minifigura. Y fue eso lo que dictó el tamaño del modelo. Después, construí un primer prototipo que incluía una plataforma para el Batimóvil, estaciones de trabajo con computadoras, la bóveda para el Batitraje, el gabinete de artilugios, etc."



ASSEMBLING THE TEAM OF DESIGNER SUPERHEROES

Realizing just how big the model would be, Bjarke teamed up with fellow Model Designer Carter Luce Baldwin, who suggested a function to open the box to access the platforms. Together, the two designers built the second prototype, including the opening feature and improved the details and functions of the interior and platforms. Carter designed the main entrance, amplified by the imposing Batman™ logo. Bjarke incorporated a light brick inside the vault to create added dramatic effect and a function to switch images on the computer screens. To emphasize this function, Graphic Designer Daniel Lundin created detailed stickers for the computer screens.

RASSEMBLER UNE ÉQUIPE DE SUPERHÉROS DE LA CONCEPTION

Réalisant à quel point le modèle serait grand, Bjarke s'est associé à son collègue concepteur de modèles Carter Luce Baldwin, qui a suggéré une fonction pour ouvrir la boîte afin d'accéder aux plateformes. Ensemble, les deux concepteurs ont construit le deuxième prototype, y compris la fonction d'ouverture, et amélioré les détails et les fonctions de l'intérieur et des plateformes. Carter a conçu l'entrée principale, amplifiée par l'imposant logo Batman™. Bjarke a incorporé une brique légère à l'intérieur de la voûte pour créer un effet dramatique supplémentaire et une fonction pour changer les images sur les écrans d'ordinateur. Pour souligner cette fonction, le graphiste Daniel Lundin a créé des autocollants détaillés pour les écrans d'ordinateur.

FORMACIÓN DEL EQUIPO DE SUPERHÉROS EL DISEÑO

Al darse cuenta de lo grande que sería el modelo, Bjarke hizo equipo con su compañero modelista Carter Luce Baldwin, quien sugirió una función para abrir la caja y acceder a las plataformas. Juntos, los dos diseñadores construyeron un segundo prototipo que tenía una función de apertura y mejoras en los detalles y las funciones del interior y las plataformas. Carter diseñó la entrada principal, amplificada por el imponente logotipo de Batman™. Bjarke incorporó un brick con luz dentro de la bóveda para crear un efecto dramático adicional y una función para cambiar las imágenes de los monitores de las computadoras. Para enfatizar esta función, el diseñador gráfico Daniel Lundin creó detalladas calcomanías que se colocan en las pantallas.





PEAUFINER LES FONCTIONS ET LES PERSONNAGES

Dans les dernières étapes du développement, Adam Grabowski, concepteur de modèles principal, s'est joint à l'équipe pour aider à optimiser le modèle et à affiner le design de la Batmobile™ afin qu'il s'adapte à l'entrée principale. Christian Barnkob, coach principal en conception de modèles, et Connie Bork, spécialiste des instructions de montage, ont été consultés sur l'expérience globale de construction, tandis que le maître de conception Adam Corbally et le graphiste principal Ashwin Visser ont travaillé ensemble pour capturer et recréer les personnages principaux du film en figurines LEGO®.

AJUSTE FINO DE LAS FUNCIONES Y PERSONAJES

El modelista sénior Adam Grabowski se unió al equipo en las últimas etapas con el fin de ayudar a optimizar el modelo y ajustar el diseño del Batimóvil para hacerlo caber por la entrada principal. Se invitó a Christian Barnkob, orientador de modelos sénior, y Connie Bork, experta en instrucciones de construcción, a aportar sus opiniones sobre la experiencia de construcción en general. Mientras tanto, el maestro de diseño Adam Corbally y el diseñador gráfico sénior Ashwin Visser trabajaban en capturar y recrear los personajes principales de la película en formato de minifiguras LEGO®.

FINE-TUNING FUNCTIONS AND CHARACTERS

In the final stages of development, Senior Model Designer Adam Grabowski joined the team to help optimize the model and fine-tune the Batmobile™ design to fit through the main entrance. Senior Model Coach Christian Barnkob and Building Instruction Specialist Connie Bork were brought in to consult on the overall building experience, while Design Master Adam Corbally and Senior Graphic Designer Ashwin Visser worked together to capture and recreate the main movie characters as LEGO® minifigures.



A VAULT OF DETAILS

- Of the seven minifigures included in the set, five of them (Bruce Wayne™, Alfred Pennyworth™, Catwoman™, The Penguin™ and Max Shreck™) are all new and exclusive for this set.
- The two Batman™ minifigures come with different cape and cowl designs; one with a soft cape that lets the minifigure fit inside the Batmobile™ and the vault, and one with a hard-shell cape for display on the platforms.
- Turn the yellow knobs on the back of your model to activate functions on the platforms and workstations.
- Store the flame element for the Batmobile™ in the secret hiding space.
- Turn on the light in the vault for a dramatic display of the Batsuit.
- Climb the staircase leading up to Wayne Manor.
- Find all the tools you need for fixing dents and damages sustained to the Batmobile™, Batsuit or gadgets during battles against villains.
- Release the drawbridge to enter the Batsuit vault.

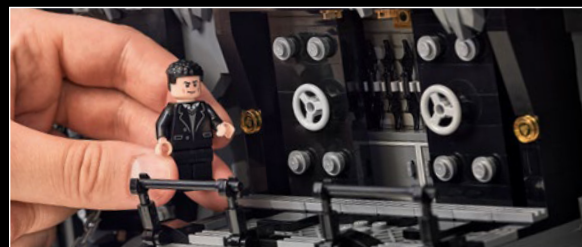

UNE FOULE DE DÉTAILS

- Sur les sept figurines incluses dans l'ensemble, cinq (Bruce Wayne™, Alfred Pennyworth™, Catwoman™, Le Pingouin™ et Max Shreck™) sont nouvelles et exclusives pour cet ensemble.
- Les deux figurines de Batman™ sont livrées avec des capes de conceptions différentes; l'une avec une cape souple qui permet à la figurine de s'insérer à l'intérieur de la Batmobile™ et de la voûte, et l'autre avec une cape à coque dure pour l'exposition sur les plateformes.
- Tournez les boutons jaunes à l'arrière de votre modèle pour activer les fonctions sur les plateformes et les postes de travail.
- Rangez l'élément de flamme pour la Batmobile™ dans la cachette secrète.
- Allumez la lumière dans la voûte pour exposer la Batsuit de manière spectaculaire.
- Montez l'escalier menant au Manoir Wayne.
- Trouvez tous les outils dont vous avez besoin pour réparer les bosses et les dommages subis par la Batmobile™, la Batsuit ou les gadgets lors de batailles contre des méchants.
- Relâchez le pont-levis pour entrer dans la voûte de la Batsuit.

UNA BÓVEDA DE DETALLES

- De las siete minifiguras incluidas en el set, cinco (Bruno Díaz, Alfred Pennyworth™, Gatúbela, el Pingüino y Max Shreck™) son nuevas y se diseñaron especialmente para este set.
- Las dos minifiguras de Batman™ vienen con diferentes diseños de capa y capucha: una lleva puesta una capa suave que le permite caber dentro del Batimóvil y la bóveda, mientras que la otra tiene una capa dura que funciona mejor para exhibirla en las plataformas.
- Gira las perillas amarillas de la parte posterior del modelo para activar las funciones de las plataformas y las estaciones de trabajo.
- Guarda el elemento del Batimóvil que representa fuego en el escondite secreto.
- Enciende la luz de la bóveda para añadir dramatismo a la exhibición del Batitraje.
- Sube por la escalera que conduce a la Mansión Wayne.
- Encuentra todas las herramientas que necesitas para reparar las abolladuras y daños sufridos por el Batimóvil, el Batitraje o los artefactos de tu héroe favorito durante sus peleas contra los malos.
- Suelta el puente levadizo para entrar en la bóveda del Batitraje.

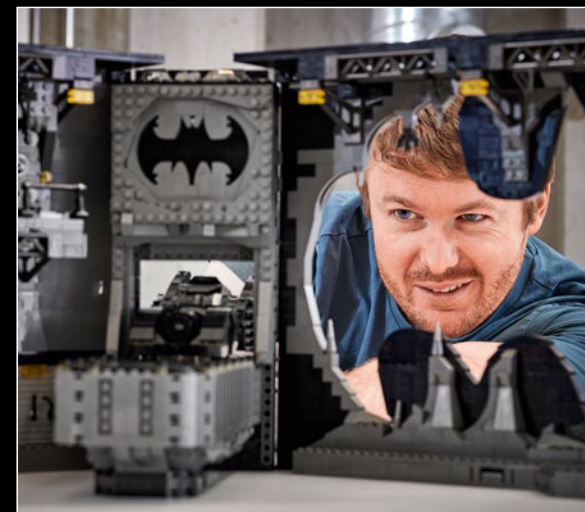

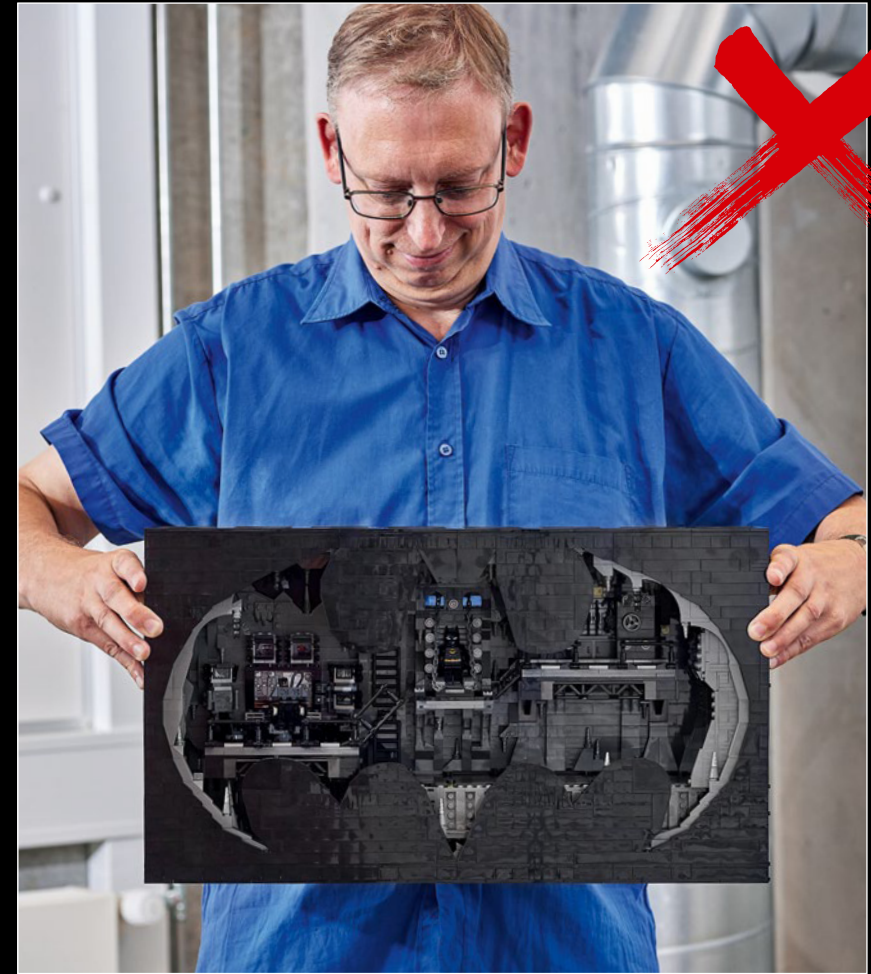
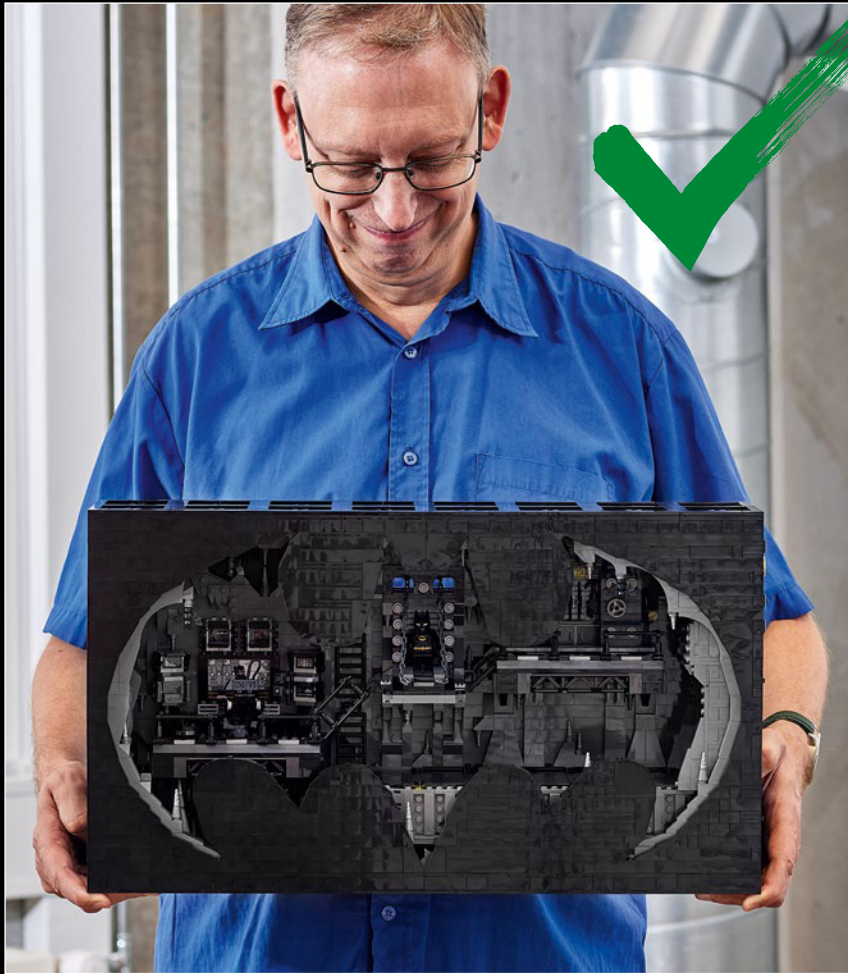

TIP: HOW TO LIFT YOUR MODEL

CAUTION: Your LEGO® Batcave™ Shadow Box is designed to be lifted and moved ONLY while in the closed position. Make sure you close your model securely and support it by the bottom edges when you lift and move it.

ASTUCE : COMMENT SOULEVER VOTRE MODÈLE

ATTENTION : Votre Boîte-cadre Batcave™ LEGO® est conçue pour être soulevée et déplacée UNIQUEMENT en position fermée. Assurez-vous de bien fermer votre modèle et de le soutenir par les côtés inférieurs lorsque vous le soulevez et le déplacez.

CONSEJO: CÓMO LEVANTAR EL MODELO

PRECAUCIÓN: El set LEGO® Batcueva: Caja Sombría está diseñado para levantarlo y trasladarlo SOLO en posición cerrada. Asegúrate de cerrar el modelo de forma segura y sostenerlo por los bordes inferiores cuando lo levantes para llevarlo a otro lugar.





DON YOUR CAPE AND COWL AND GET READY TO BUILD

"This is the Batcave™ as you've never seen it before, in a LEGO® Shadow Box format we've never released before. We hope you'll have as much fun exploring all the details and building techniques as we did. On behalf of our entire team, happy building and have fun playing!"

Bjarke Lykke Madsen

ENFILEZ VOTRE CAPE ET VOTRE CAPUCHE ET PRÉPAREZ-VOUS À CONSTRUIRE

« Voici la Batcave™ comme vous ne l'avez jamais vue auparavant, dans un format Boîte-cadre LEGO® inédit. Nous espérons que vous aurez autant de plaisir que nous à explorer tous les détails et les techniques de construction. Au nom de toute notre équipe, bonne construction et amusez-vous ! »

Bjarke Lykke Madsen

PONTE TU CAPA Y TU CAPUCHA, ¡Y PREPÁRATE PARA CONSTRUIR!

"Esta es la Baticueva como nunca la habías visto: ¡en un formato de Caja Sombria LEGO® que no se parece a ninguno de nuestros productos anteriores! Esperamos que, al igual que nosotros, te diviertas muchísimo explorando todos los detalles y las técnicas de construcción del set. En nombre de todo el equipo, ¡deseo a todos un feliz proceso de armado y que se diviertan jugando!".

Bjarke Lykke Madsen

**"I'M BATMAN."
« JE SUIS BATMAN. »
"SOY BATMAN".**

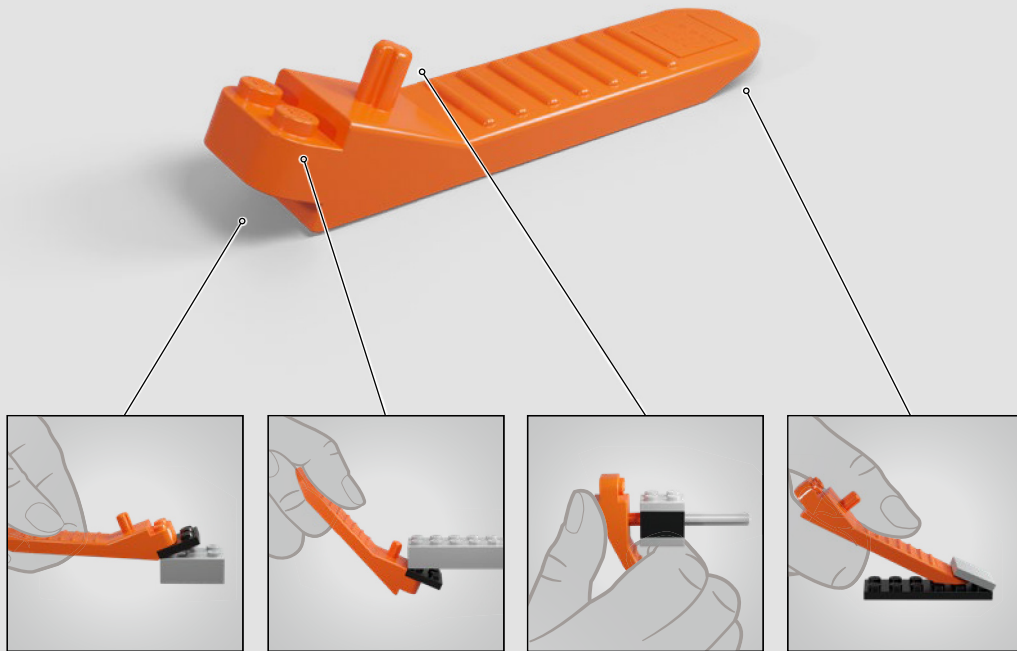

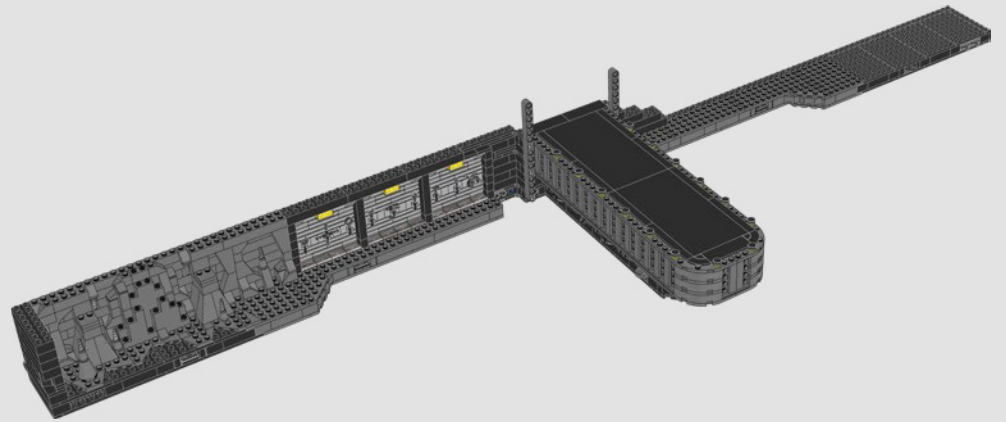
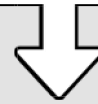
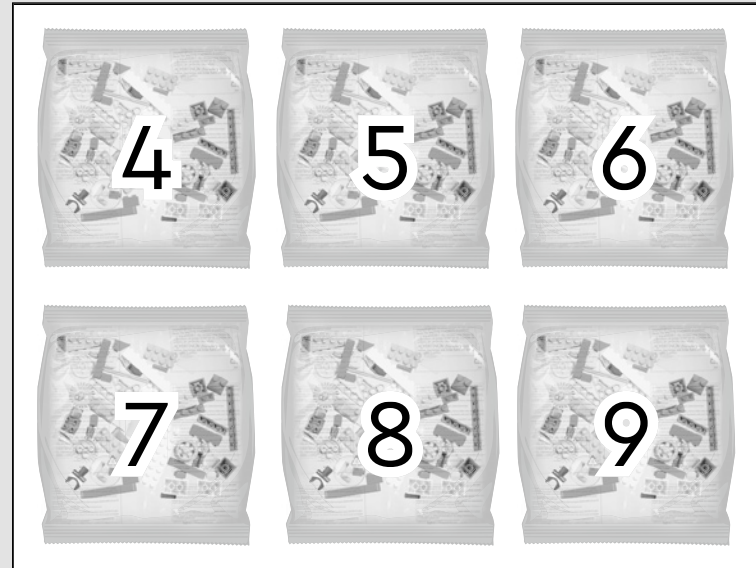
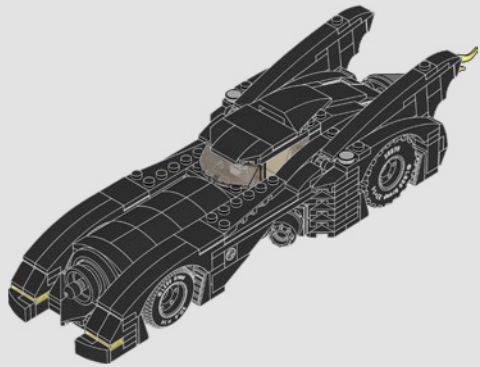
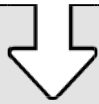
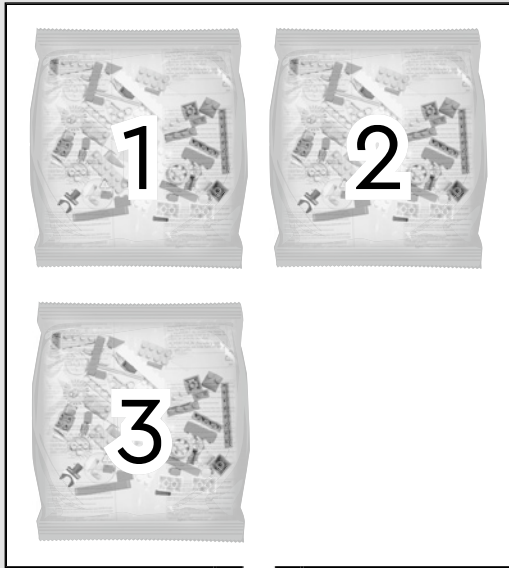

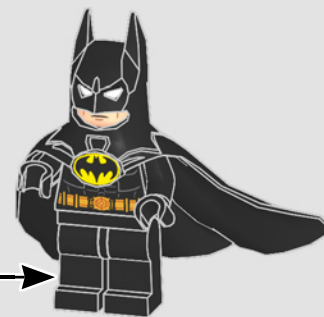
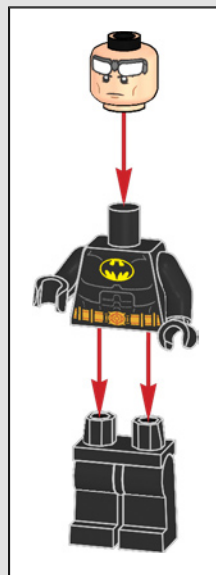



BATMAN™

A sophisticated hero of GOTHAM CITY™, Batman™ has inspired fans, writers and filmmakers for generations. A tormented, reclusive vigilante with a vulnerable heart, he does not seek fame or glory. Driven by tragedy, he feels called to shed light on the city's dark secrets, only to retreat into his own shadows.

BATMAN™

Héros sophistiqué de GOTHAM CITY™, Batman™ inspire les amateurs, les écrivains et les cinéastes depuis des générations. Un justicier tourmenté, reclus, au cœur vulnérable, il ne cherche ni la gloire ni la célébrité. Poussé par la tragédie, il se sent appelé à faire la lumière sur les sombres secrets de la ville pour finalement se réfugier dans ses propres ombres.

BATMAN™

Un sofisticado héroe de CIUDAD GÓTICA, Batman™ ha inspirado a fans, escritores y cineastas durante generaciones. Atormentado y retraído, este vigilante tiene un corazón vulnerable y no busca fama ni gloria. Impulsado por la tragedia, se siente llamado a arrojar luz sobre los secretos más oscuros de la ciudad, solo para retirarse después a sus propias tinieblas.

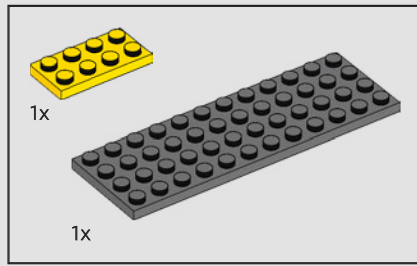
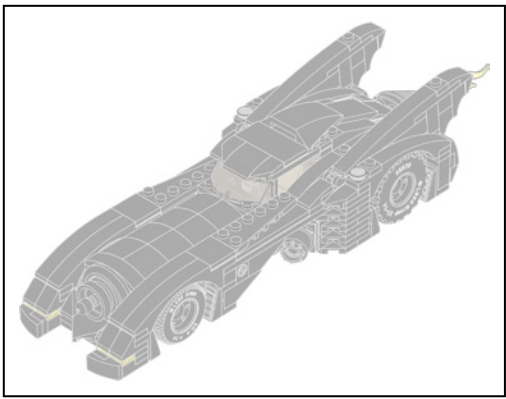

1

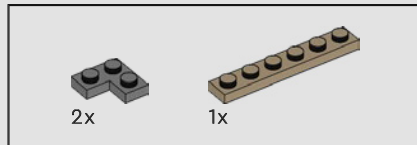
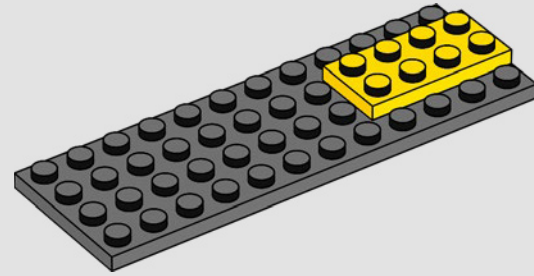

2

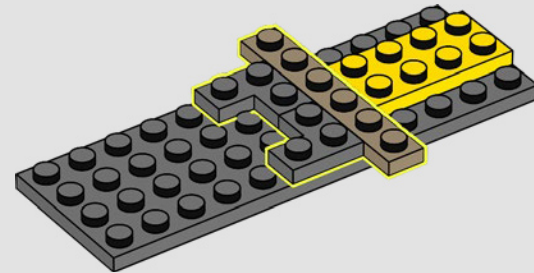

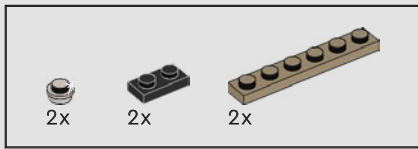

3

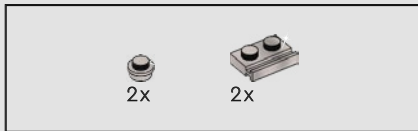
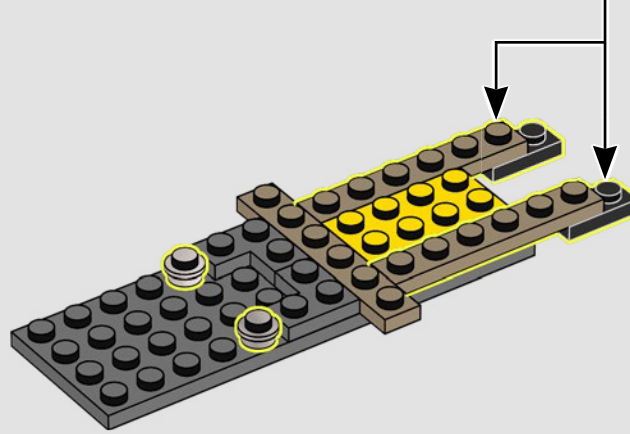
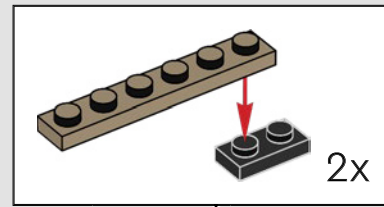

4

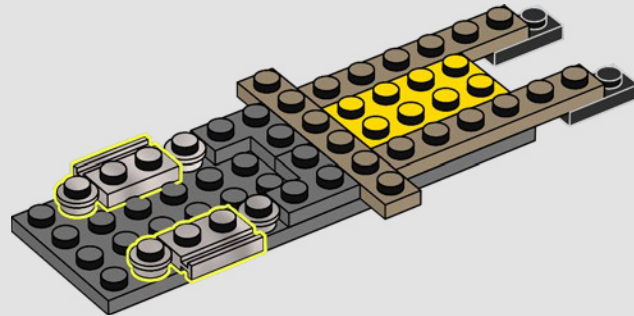

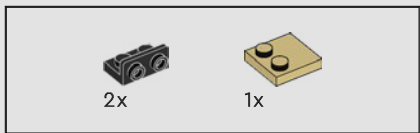

5

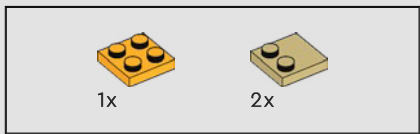
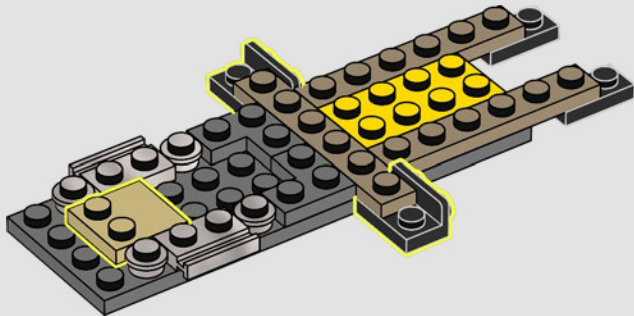

6

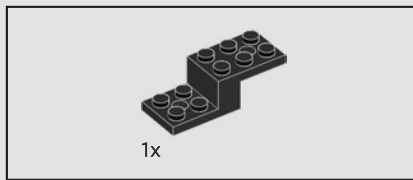
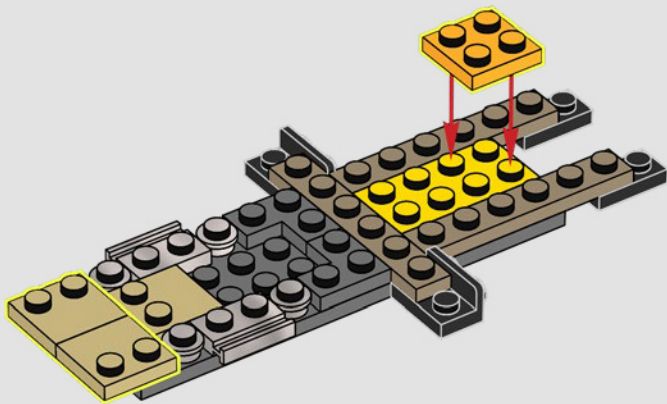

7

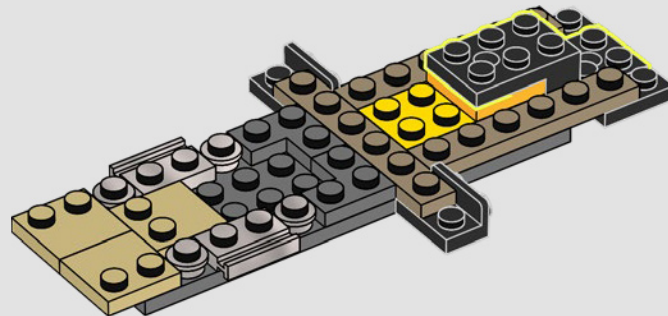

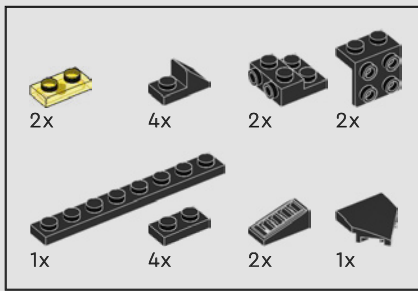

8

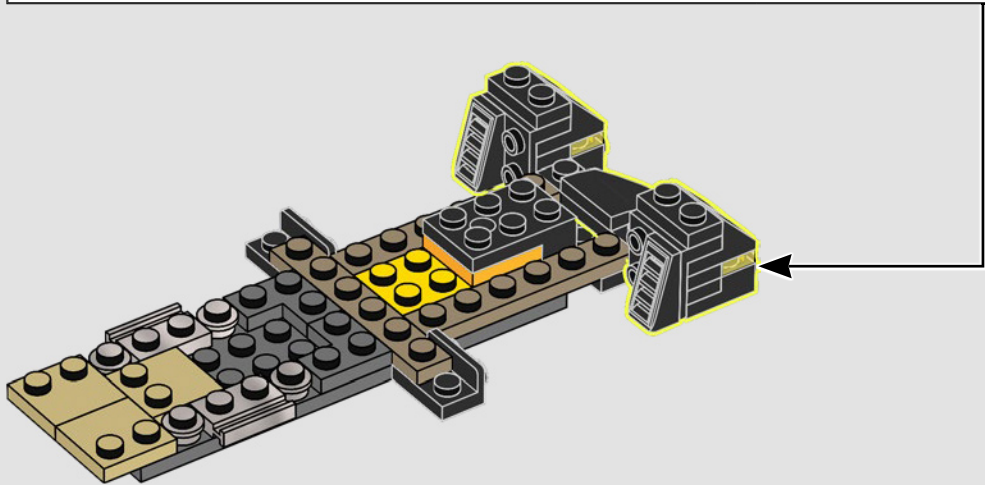
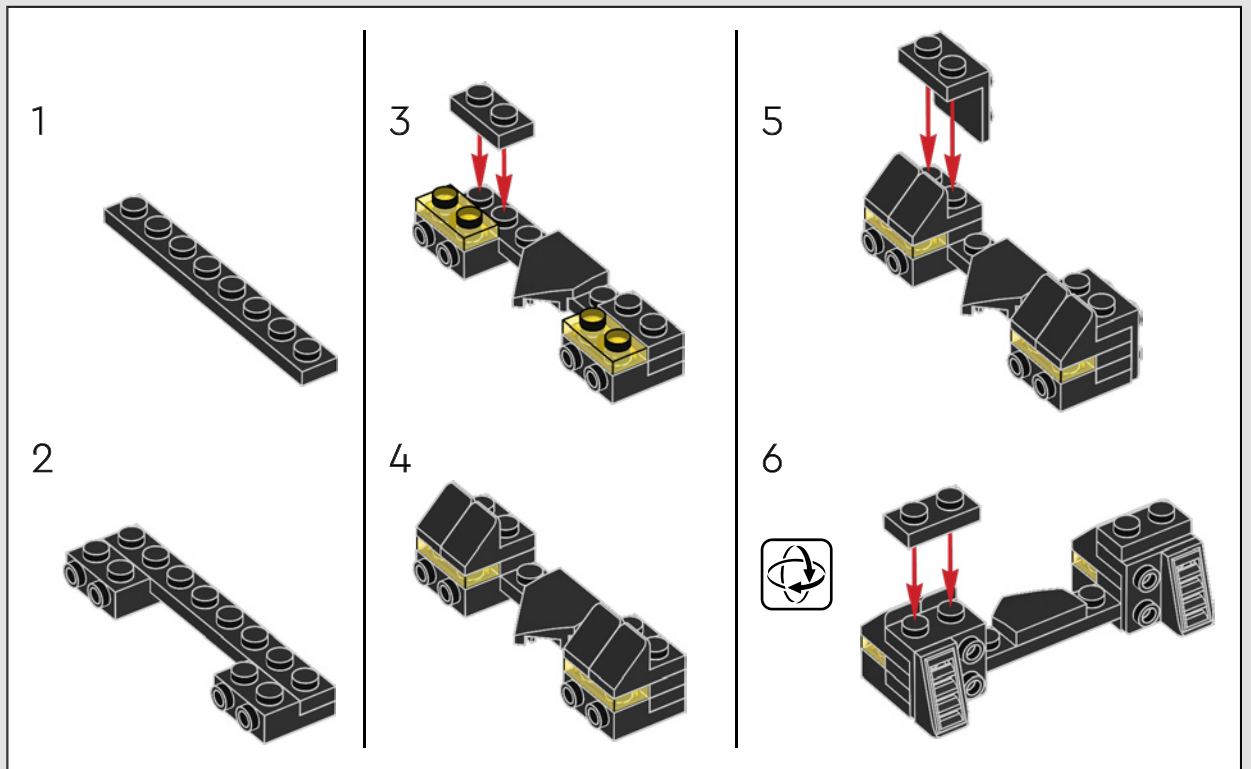



2x

9



2x

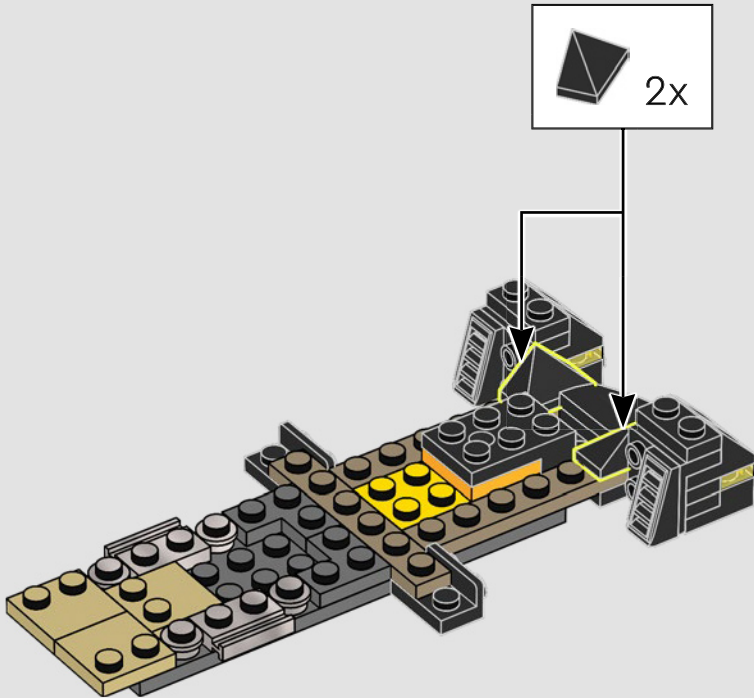

2x

10

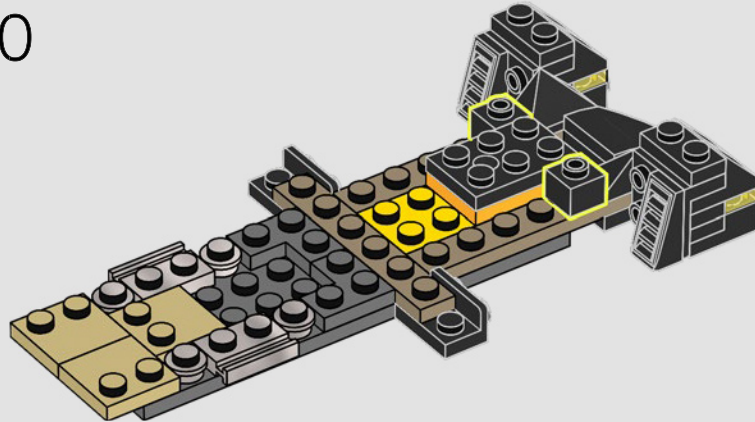

2x



2x



1x

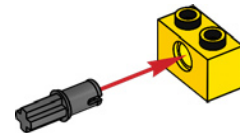

2x

11

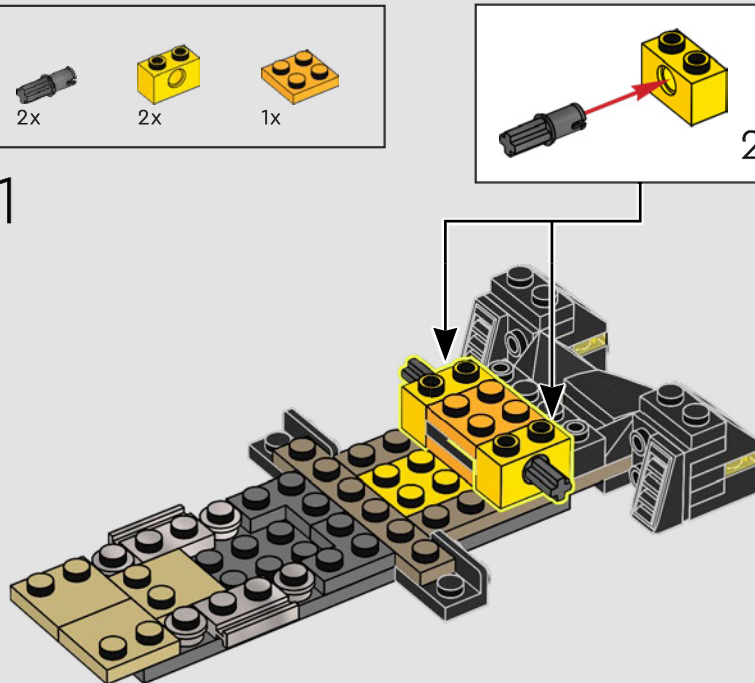

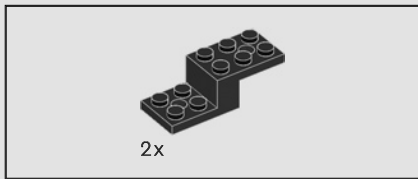

12

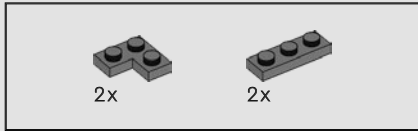
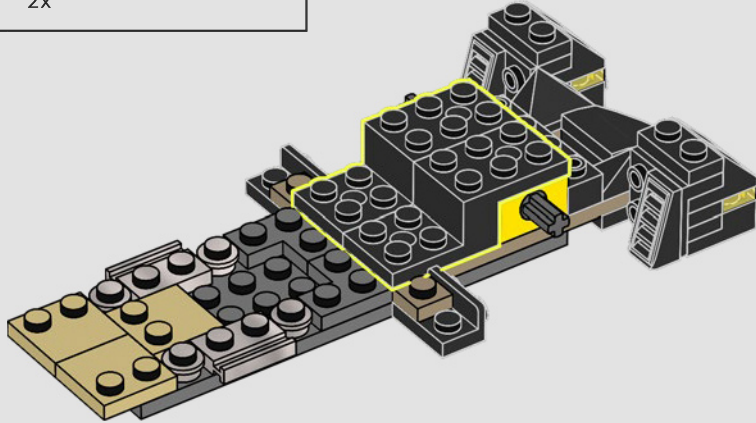

13

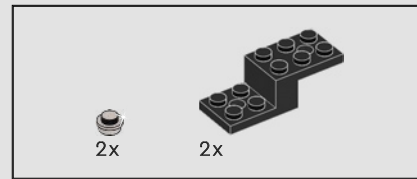
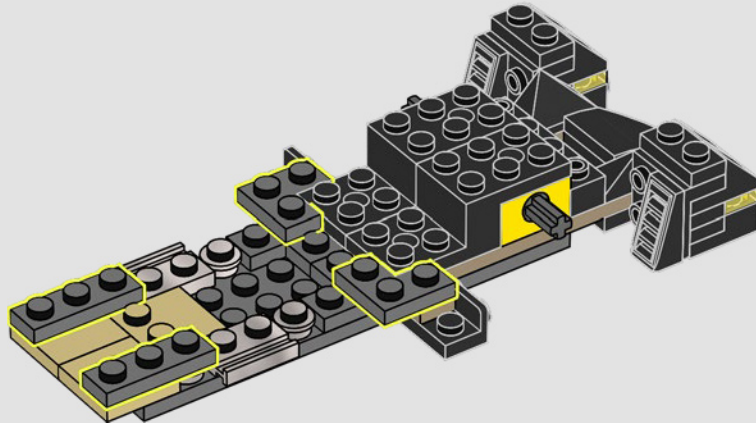

14

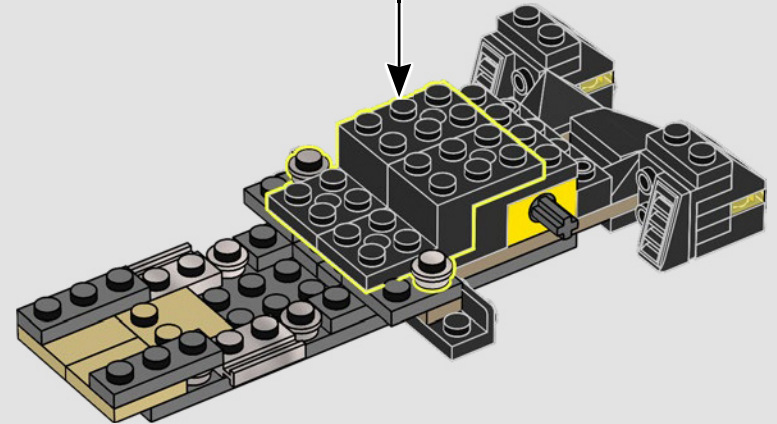
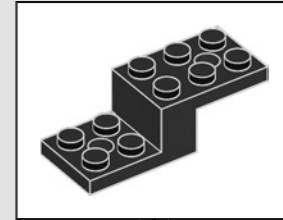

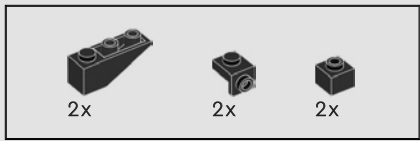

15

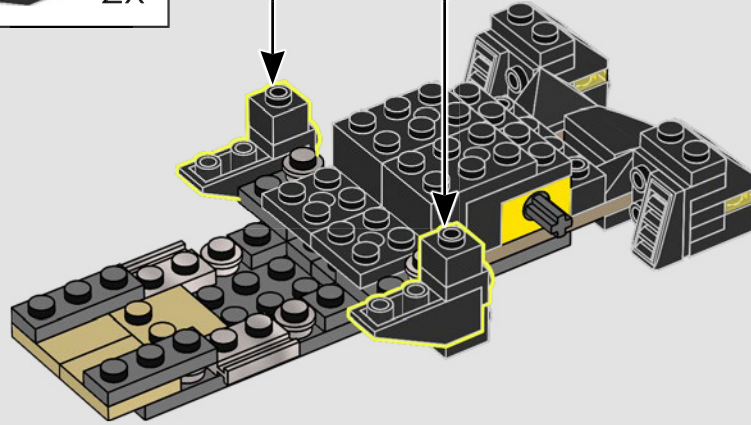
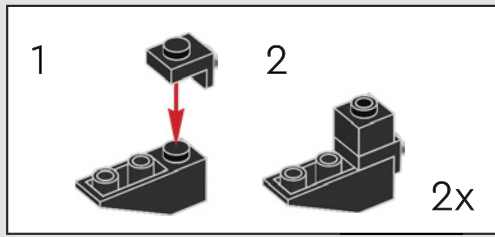

16

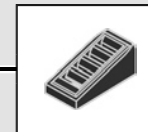
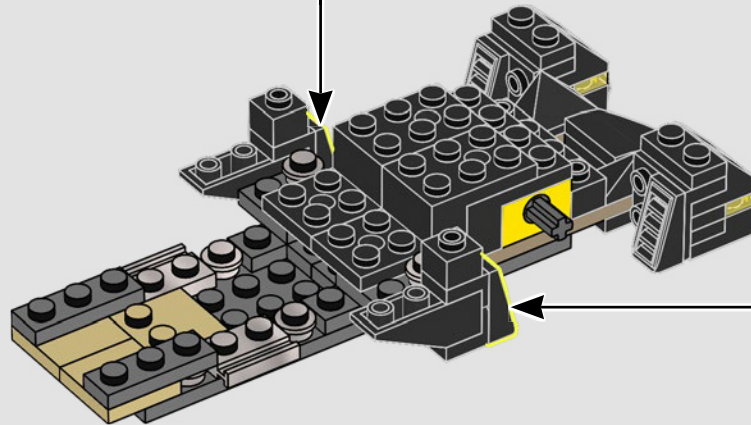

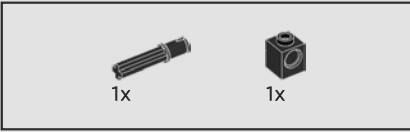
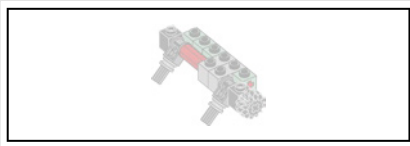

17

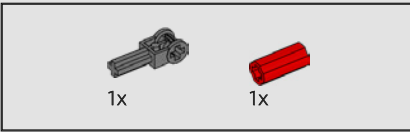
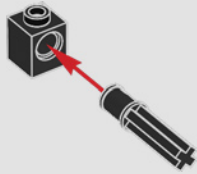

18

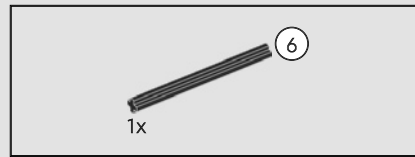
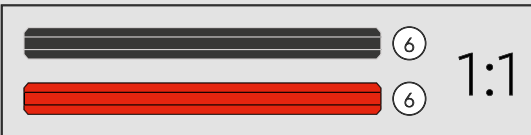
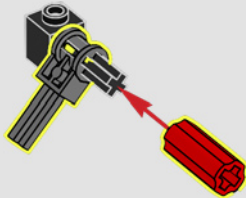

19

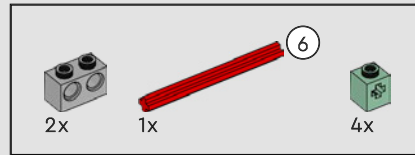
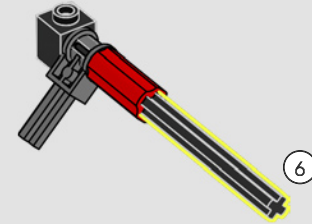

20

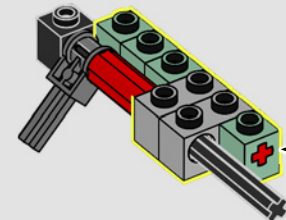
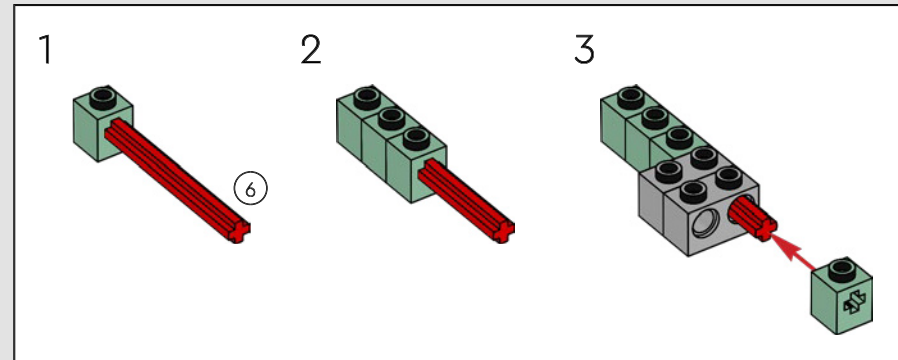



1x

21

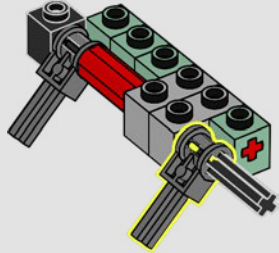

2x

22

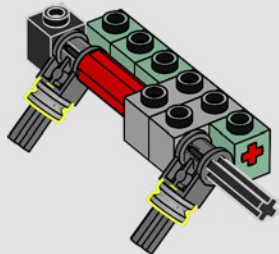

1x



1x

23

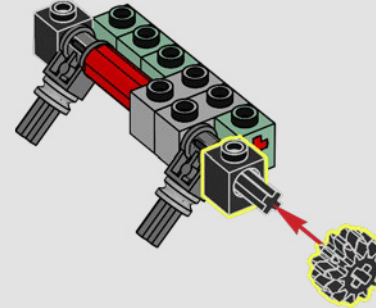

24

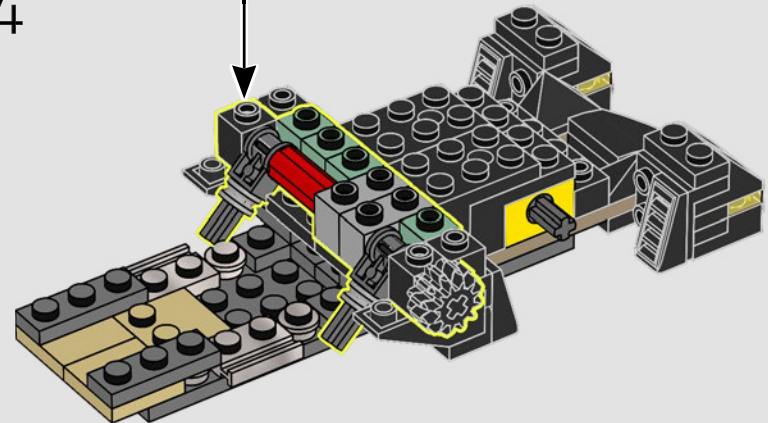

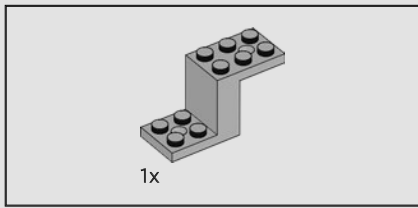

25

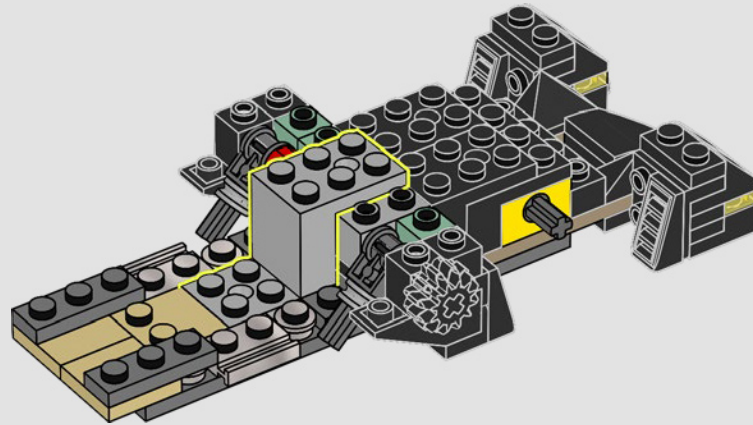

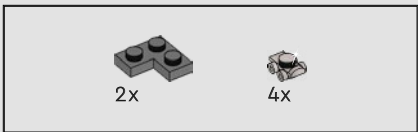

26

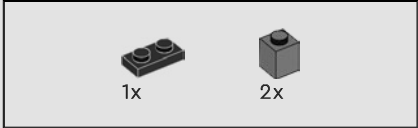
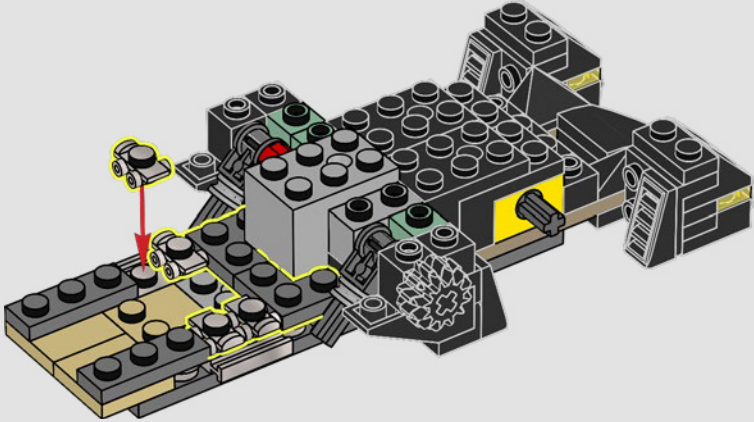

27

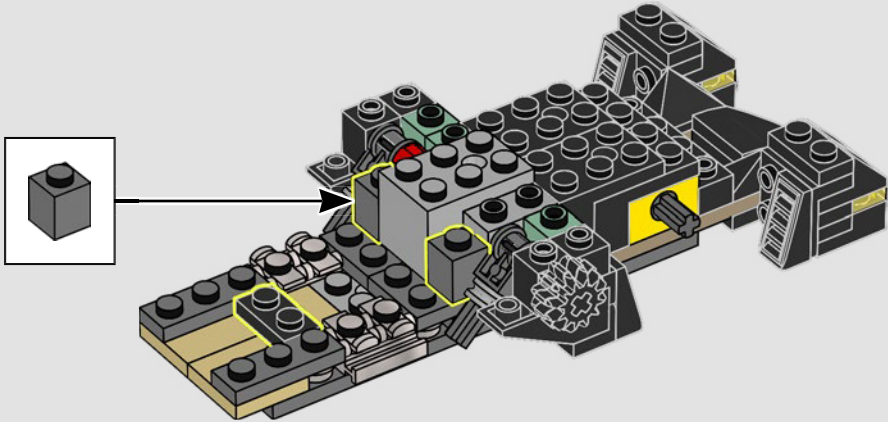

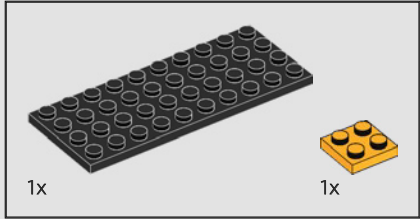
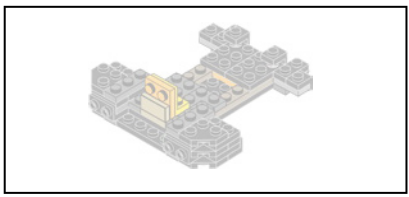

28

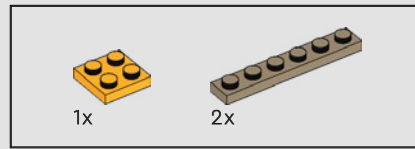
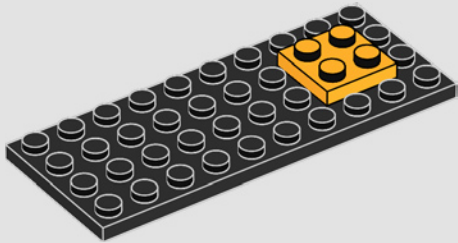

29

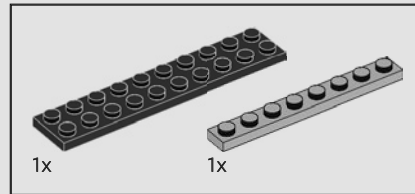
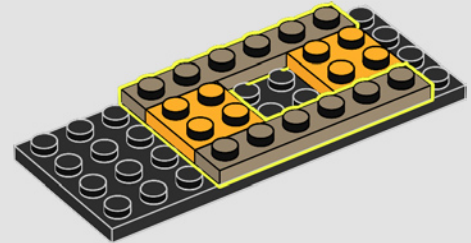

30

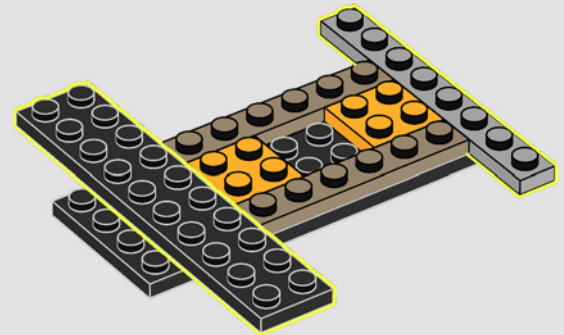

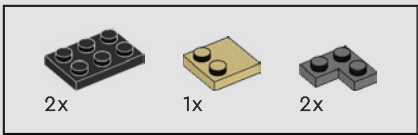

31

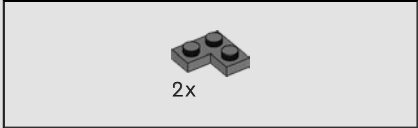
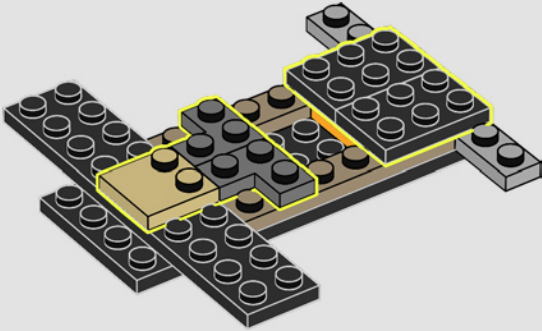

32

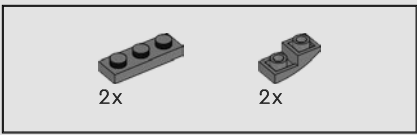
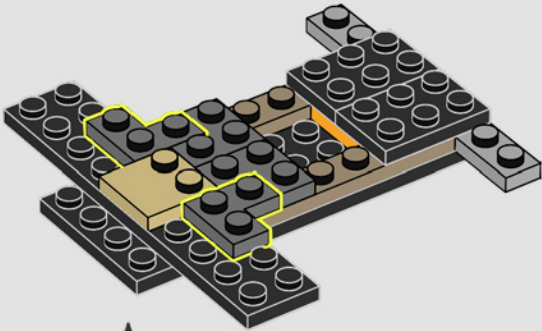

33

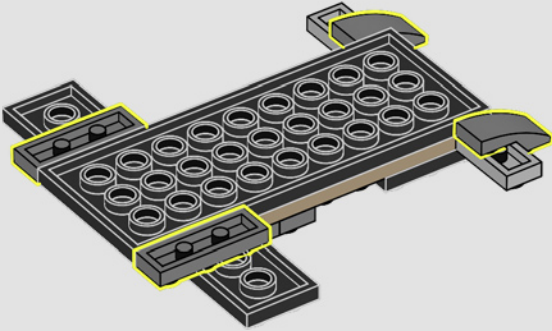

34

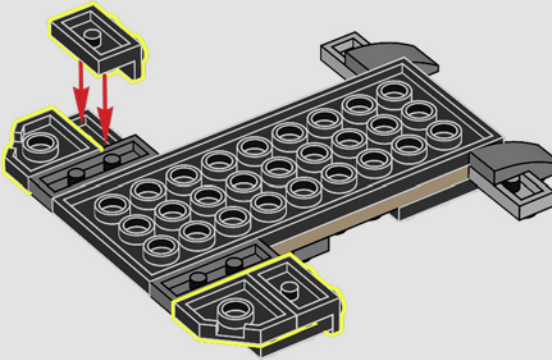

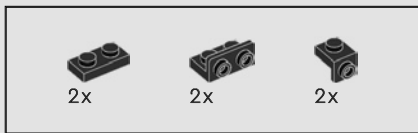

35

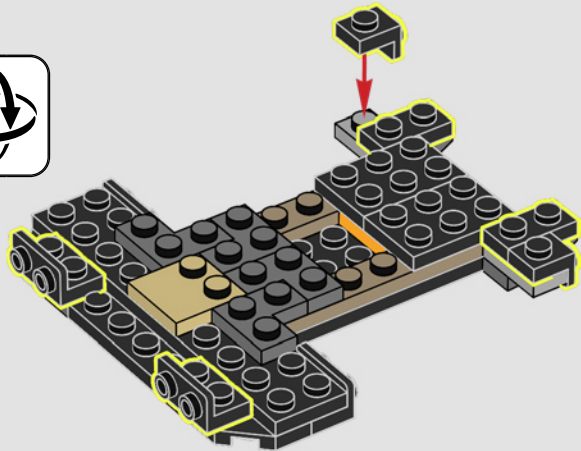

36

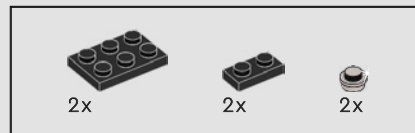
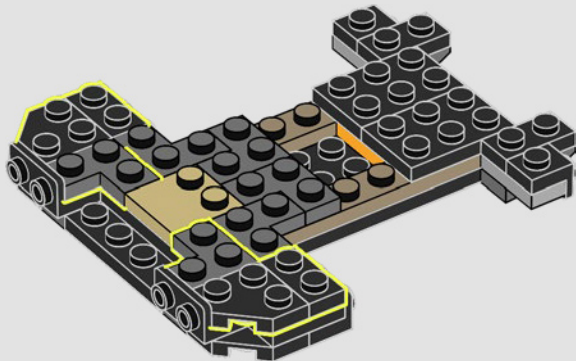

37

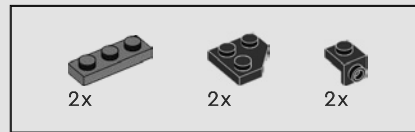
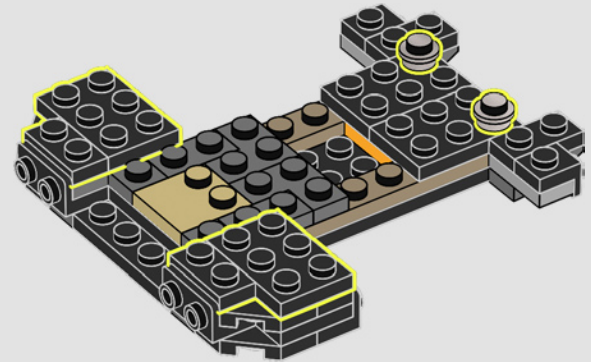

38

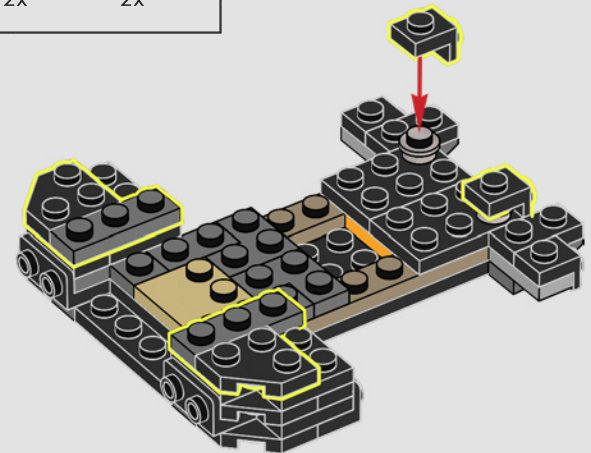



39

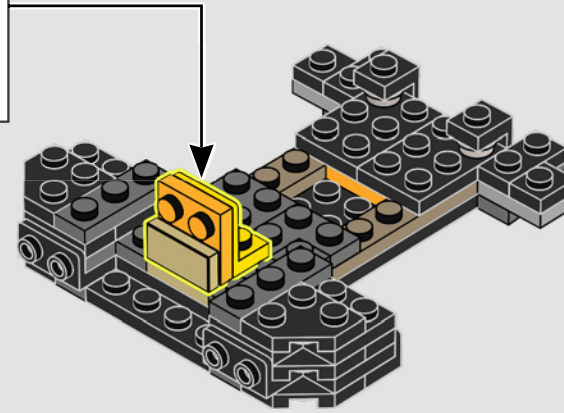
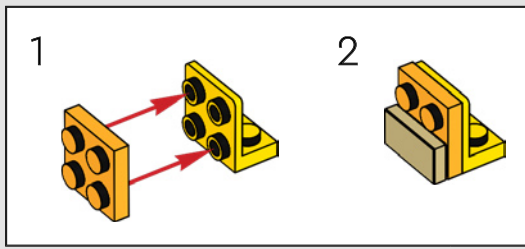

40

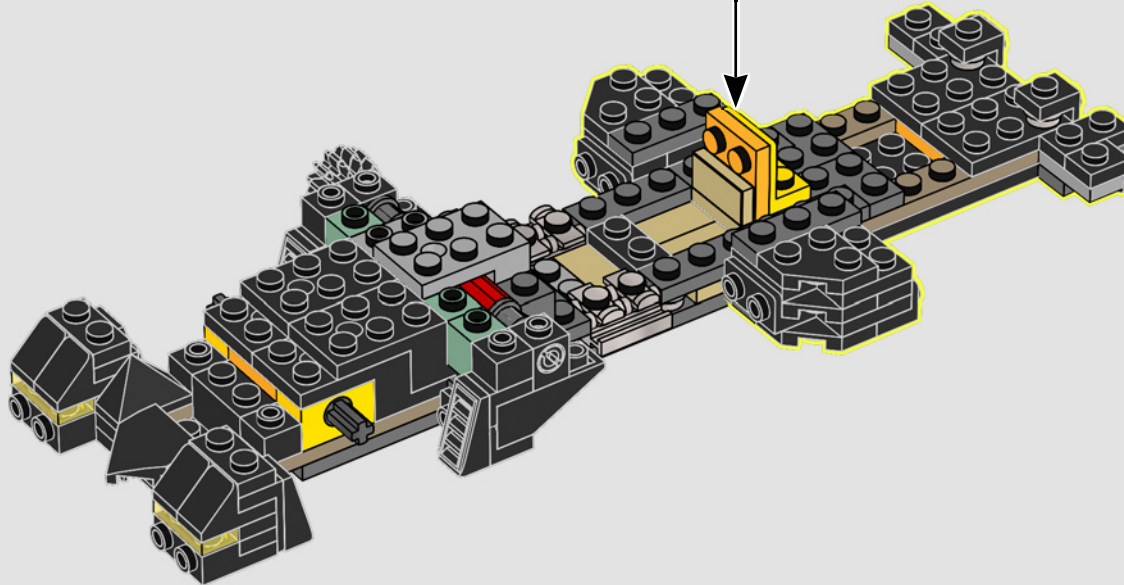

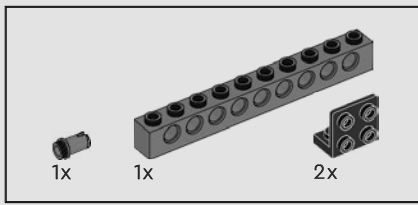

41

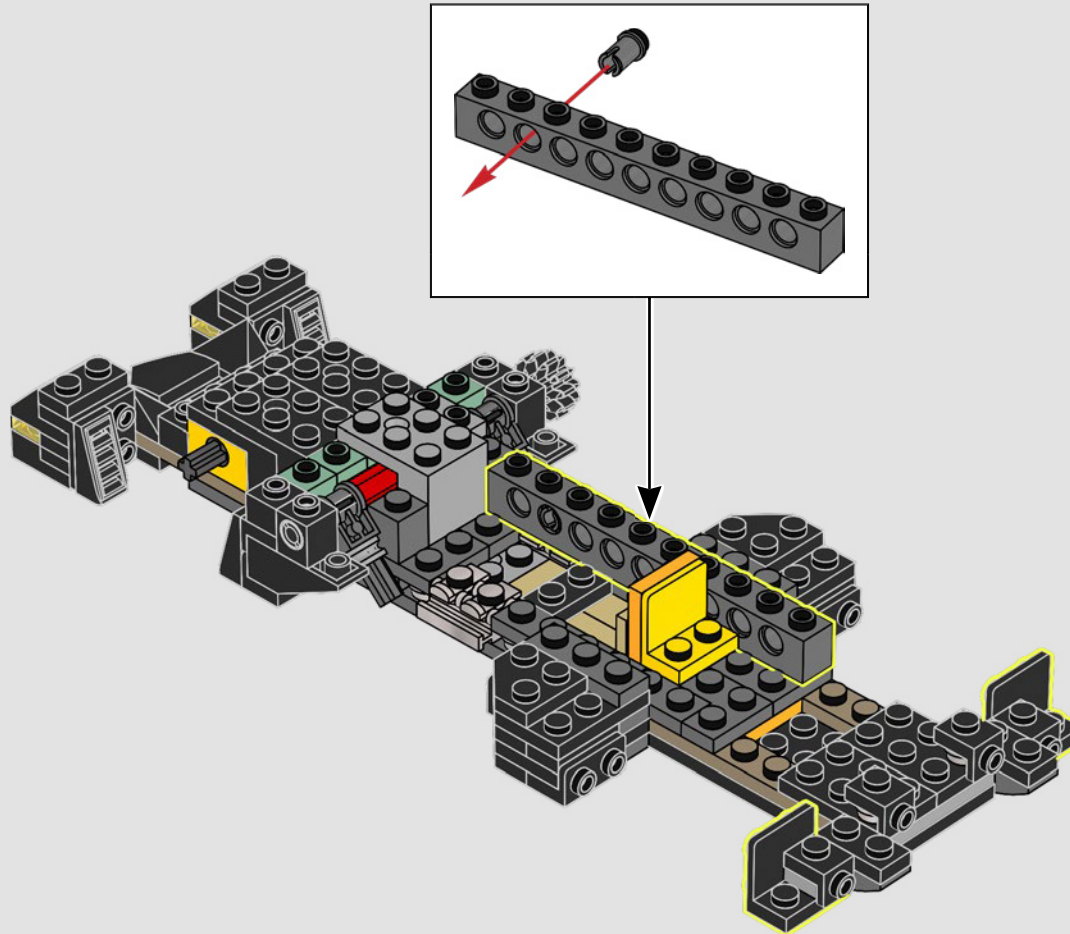



2x

42

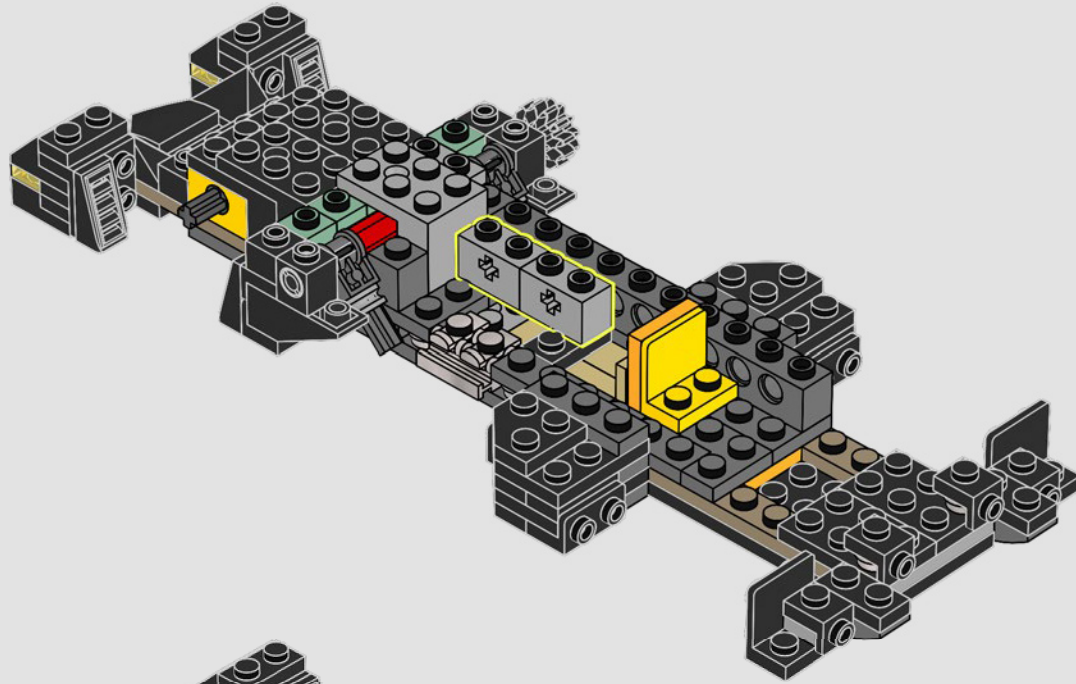

1x

43

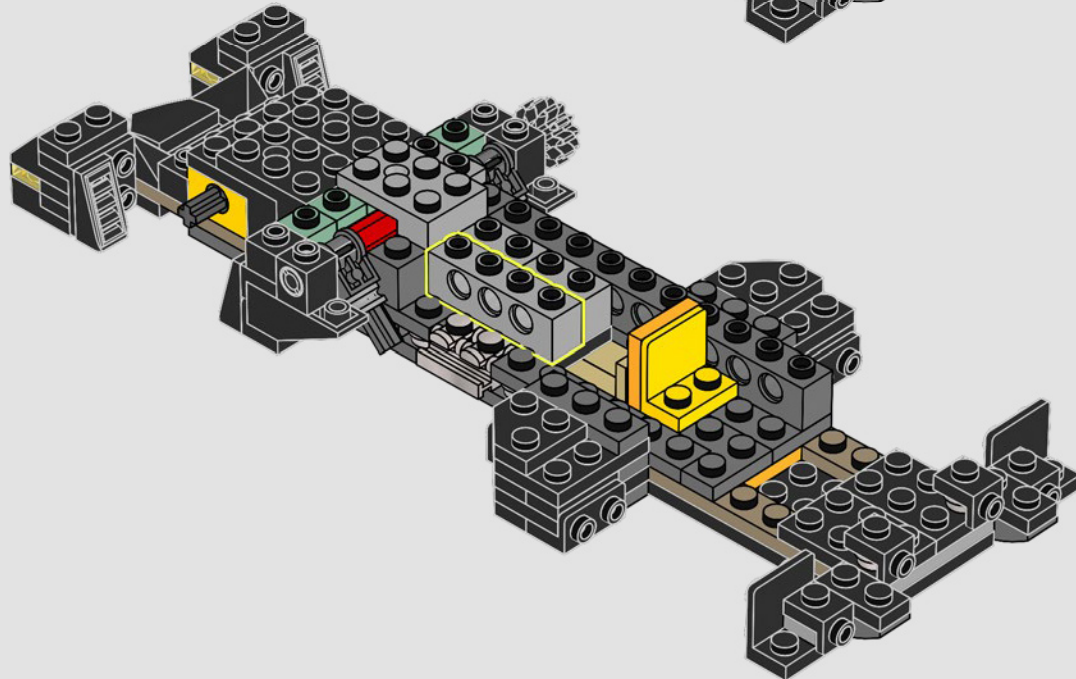

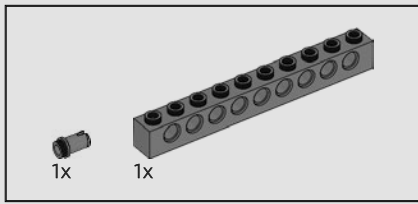

44

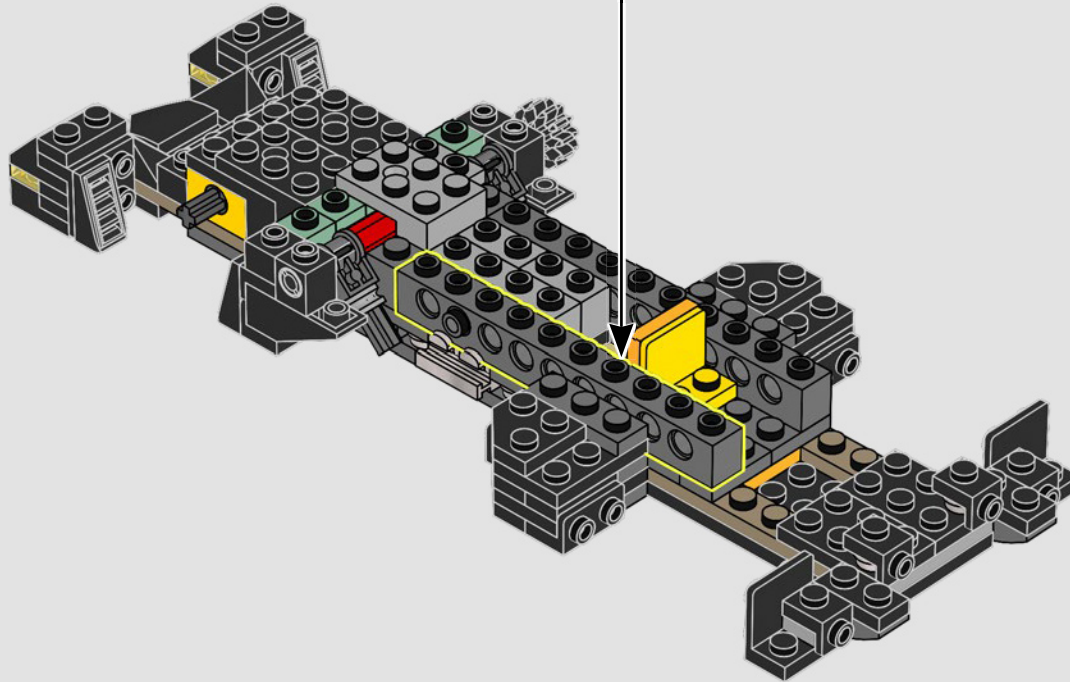
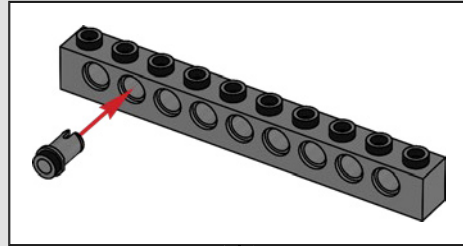

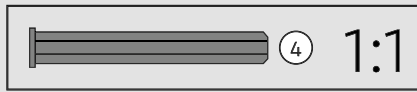
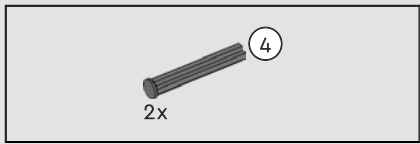

45

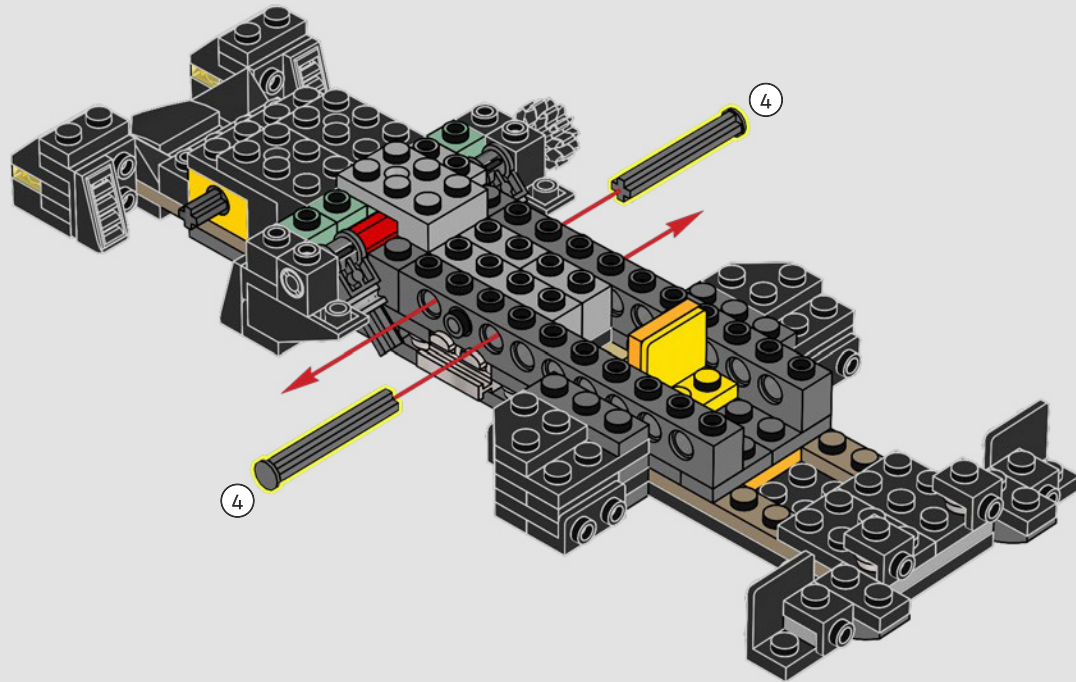

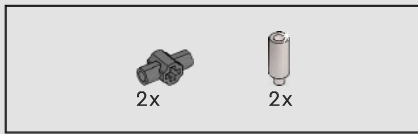

46

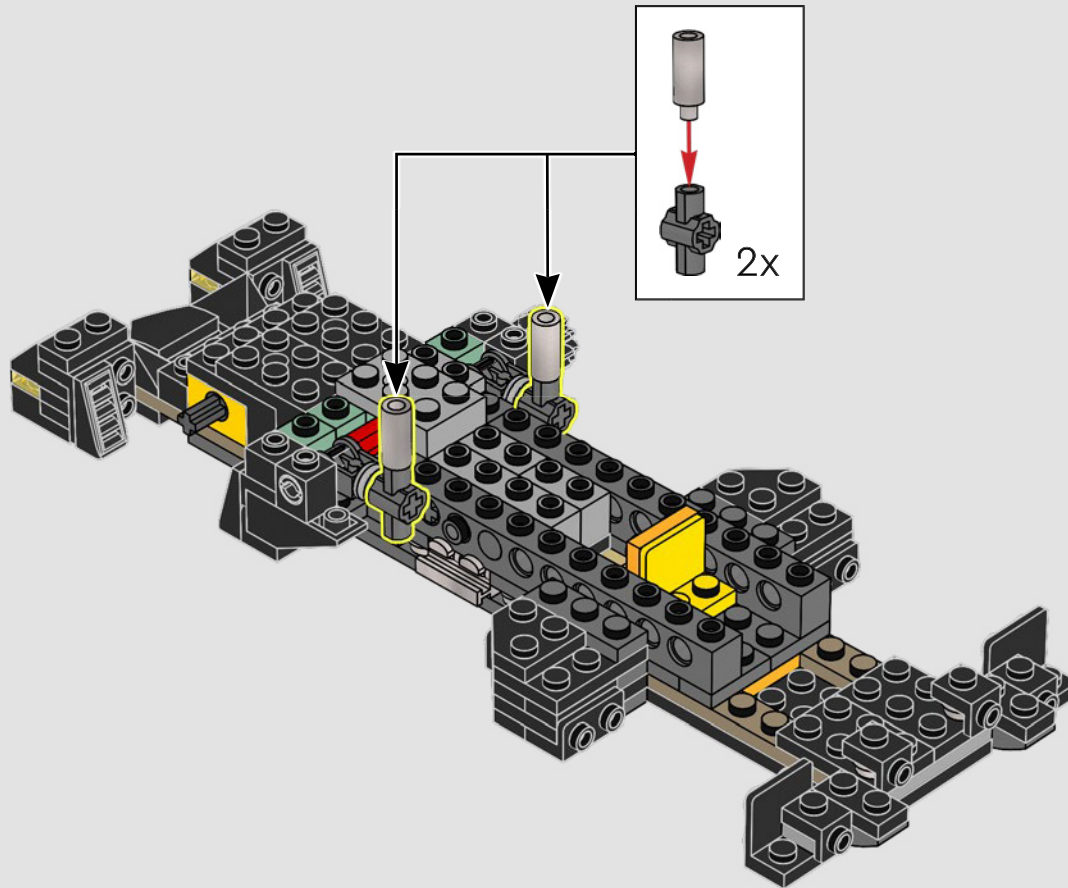



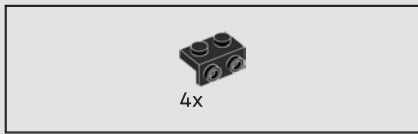

47

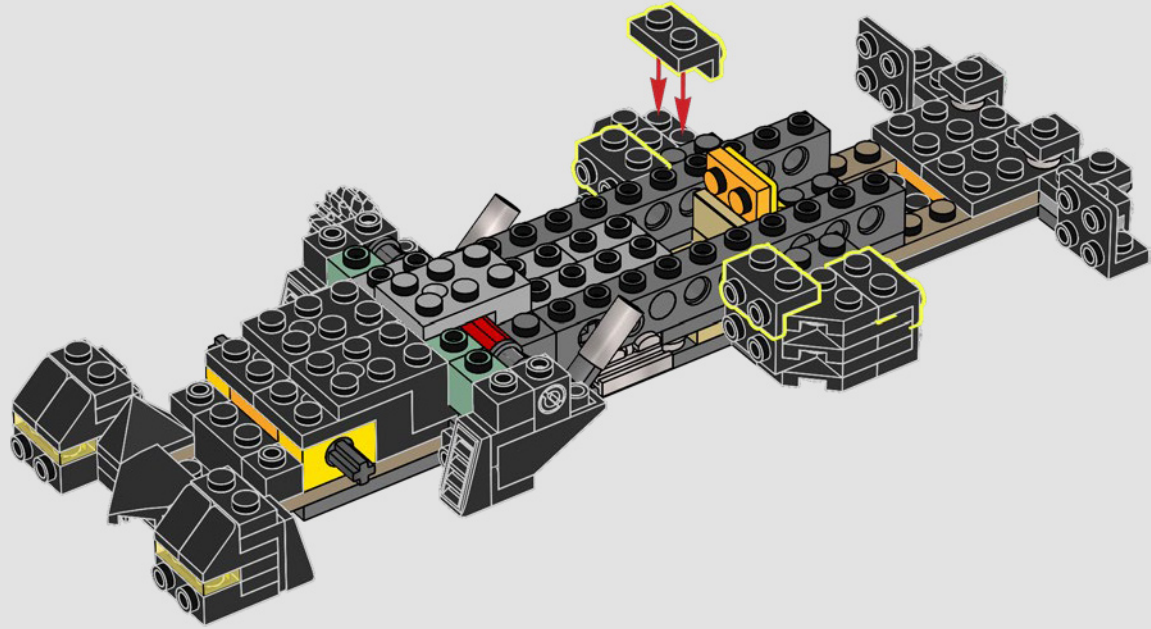

48

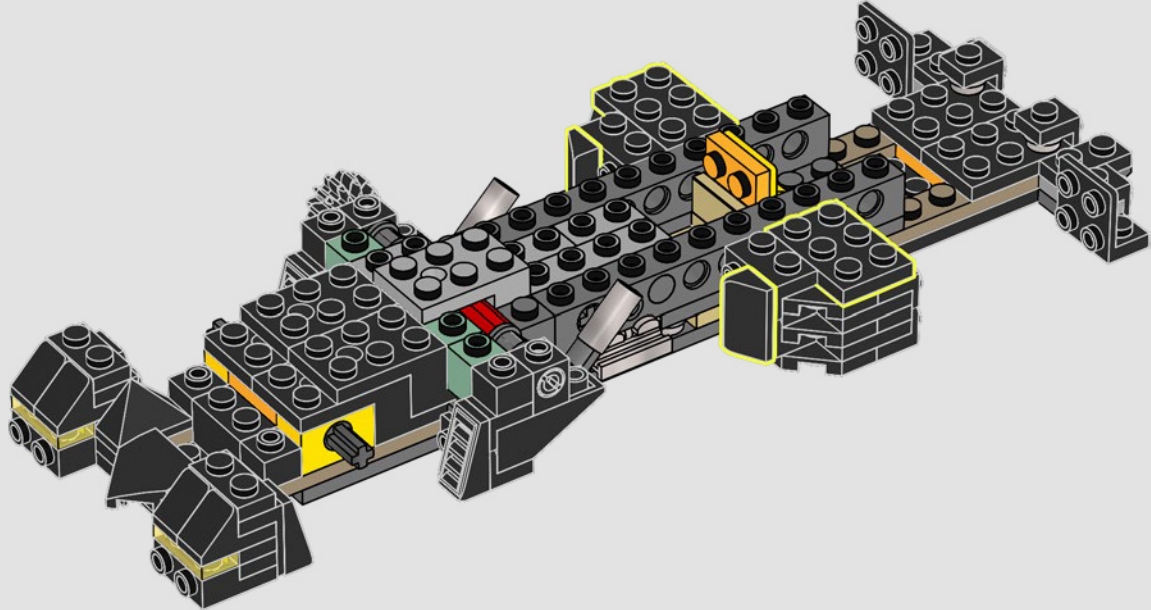

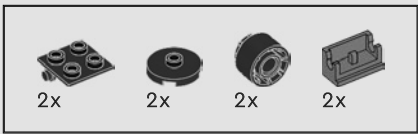

49

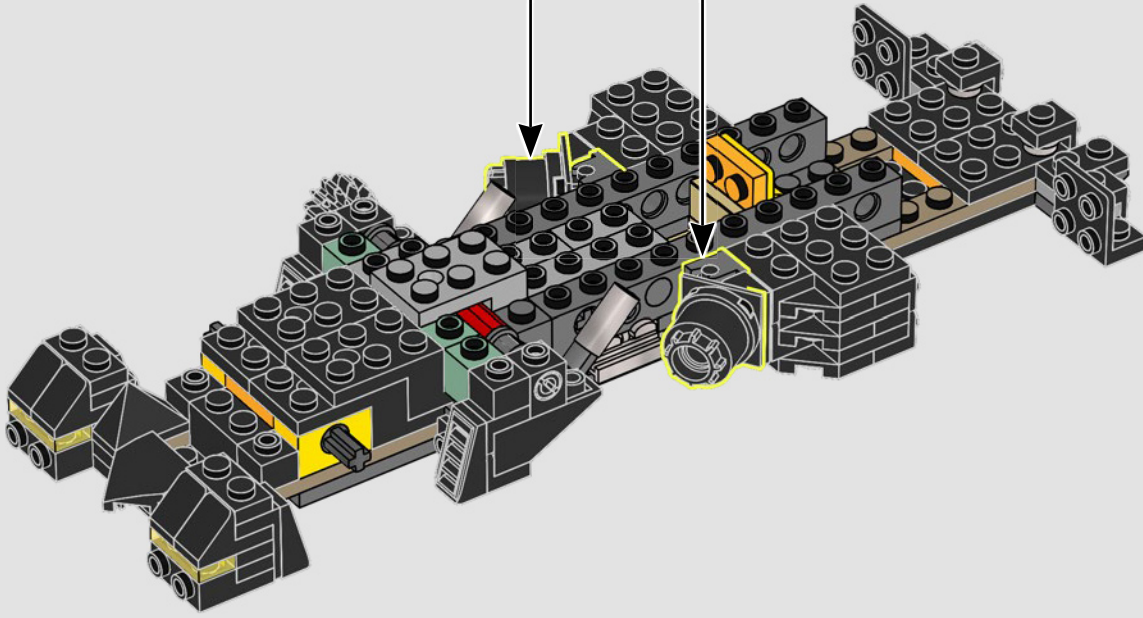
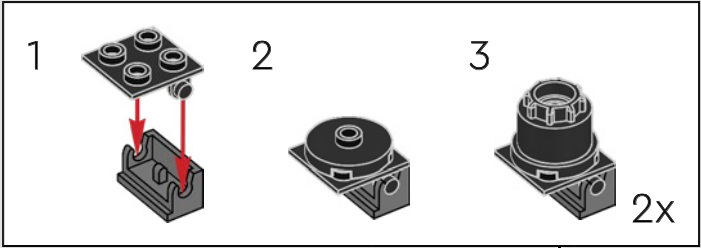

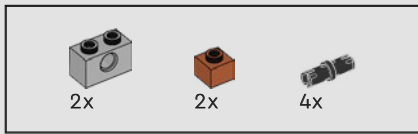

50

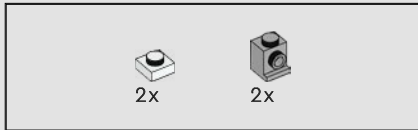
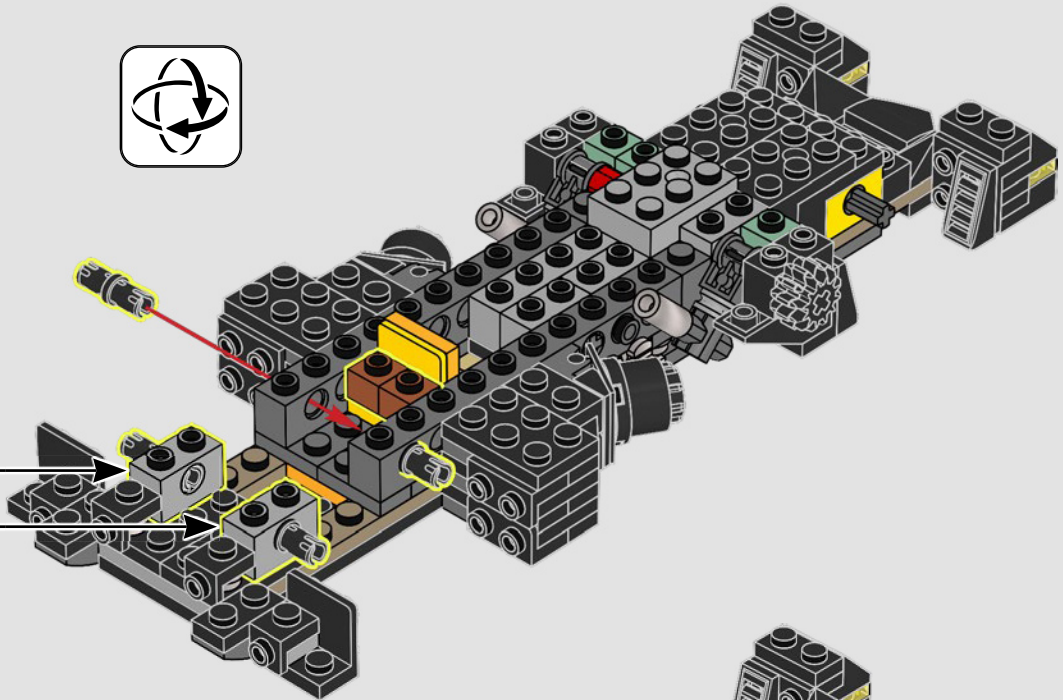
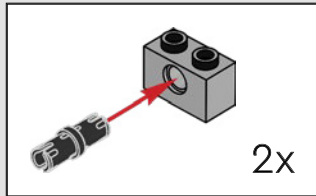
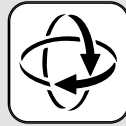

51

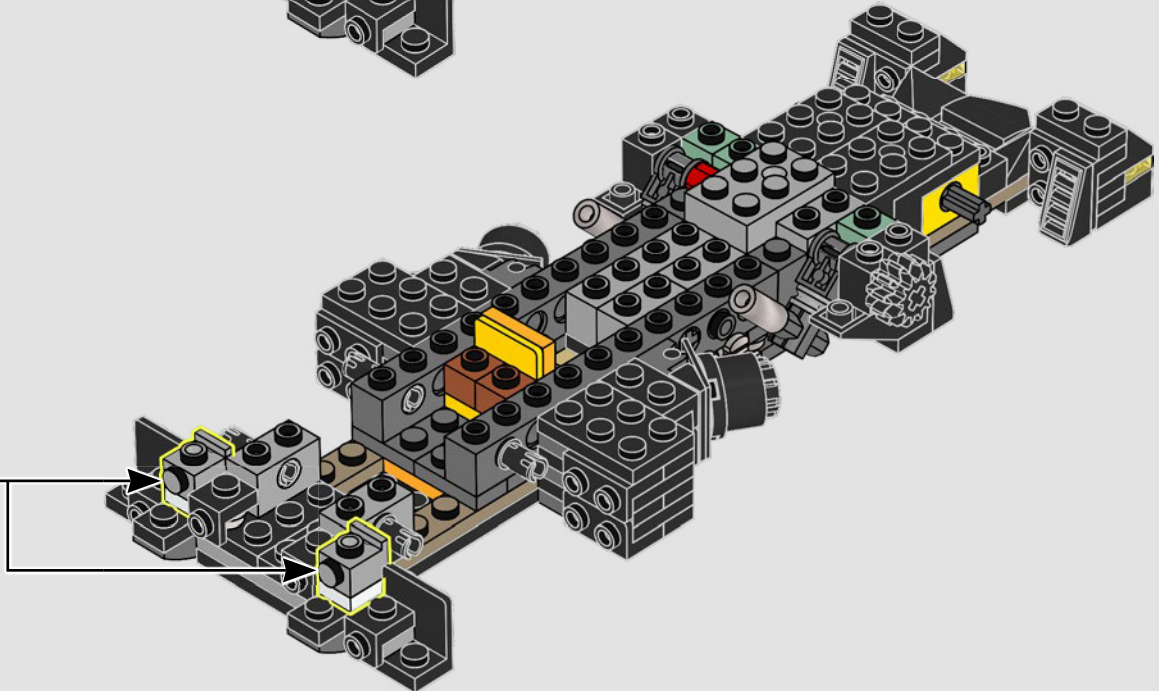
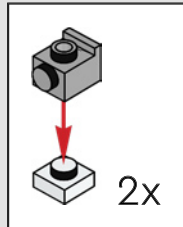

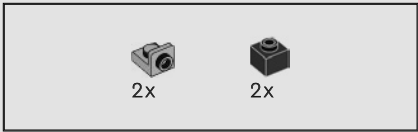

52

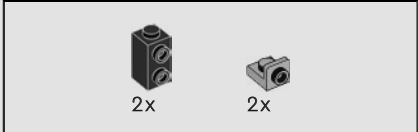
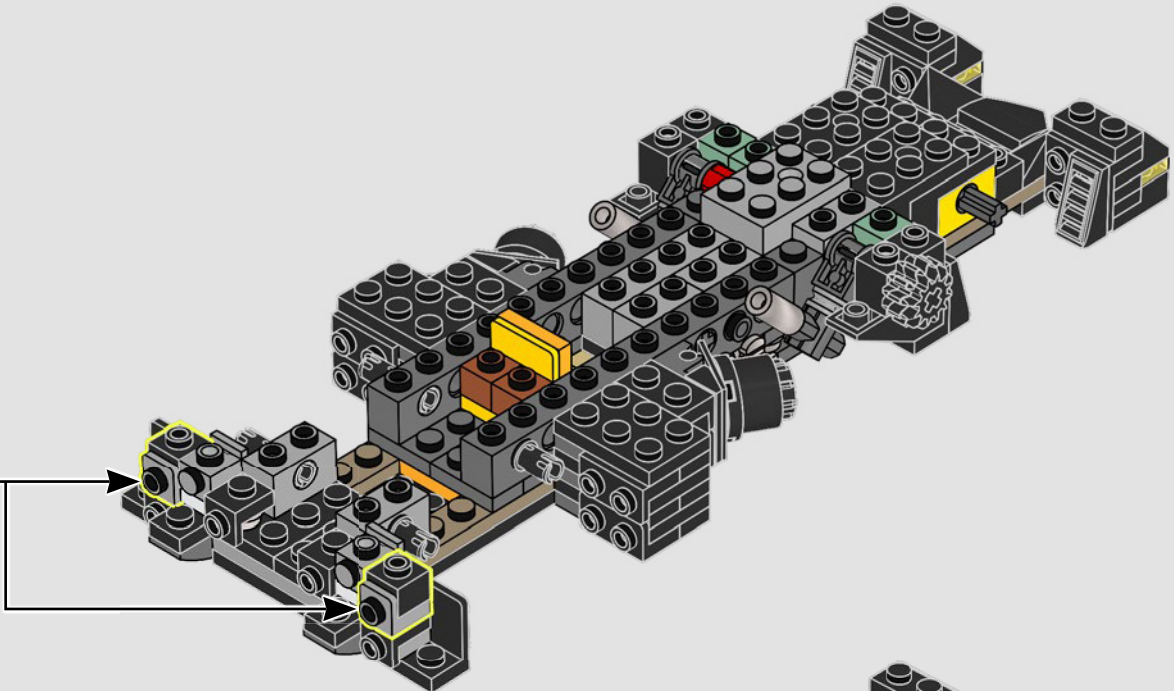
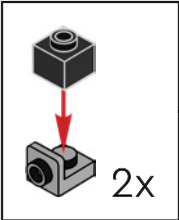

53

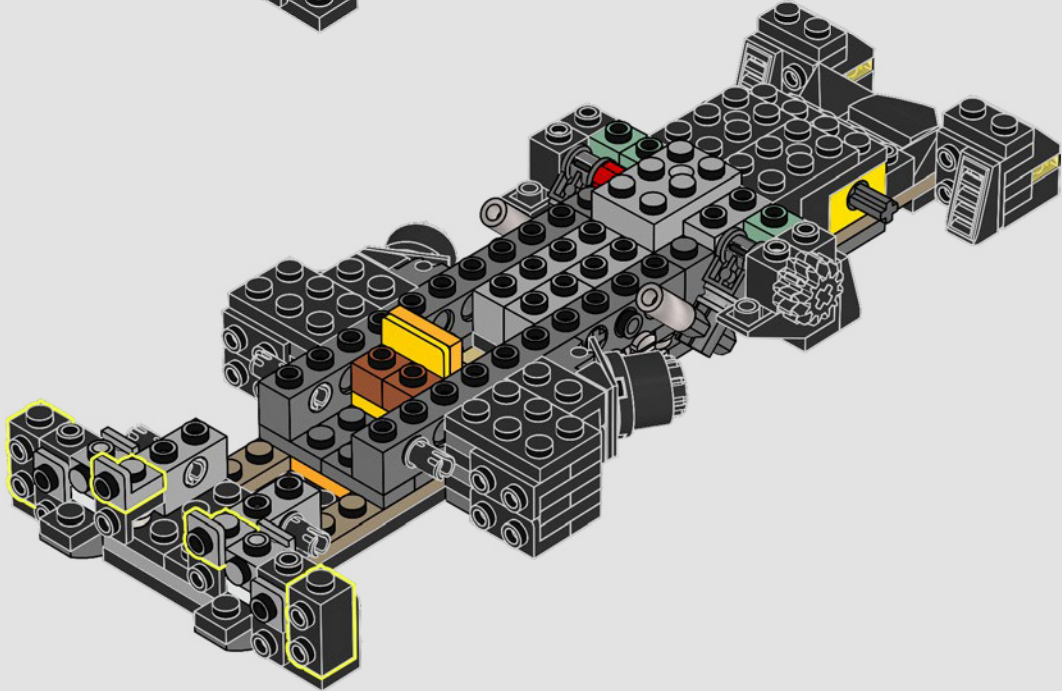

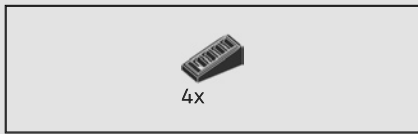

54

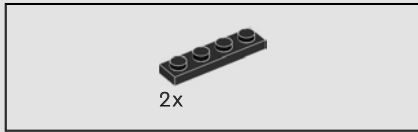
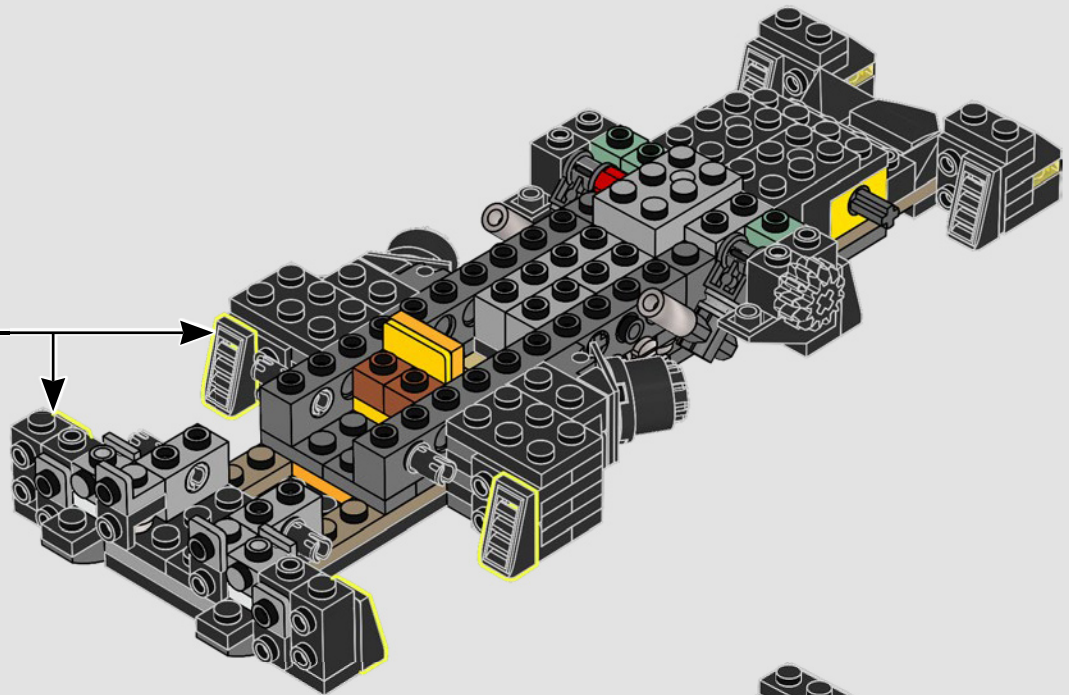
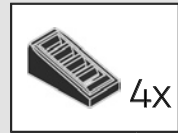

55

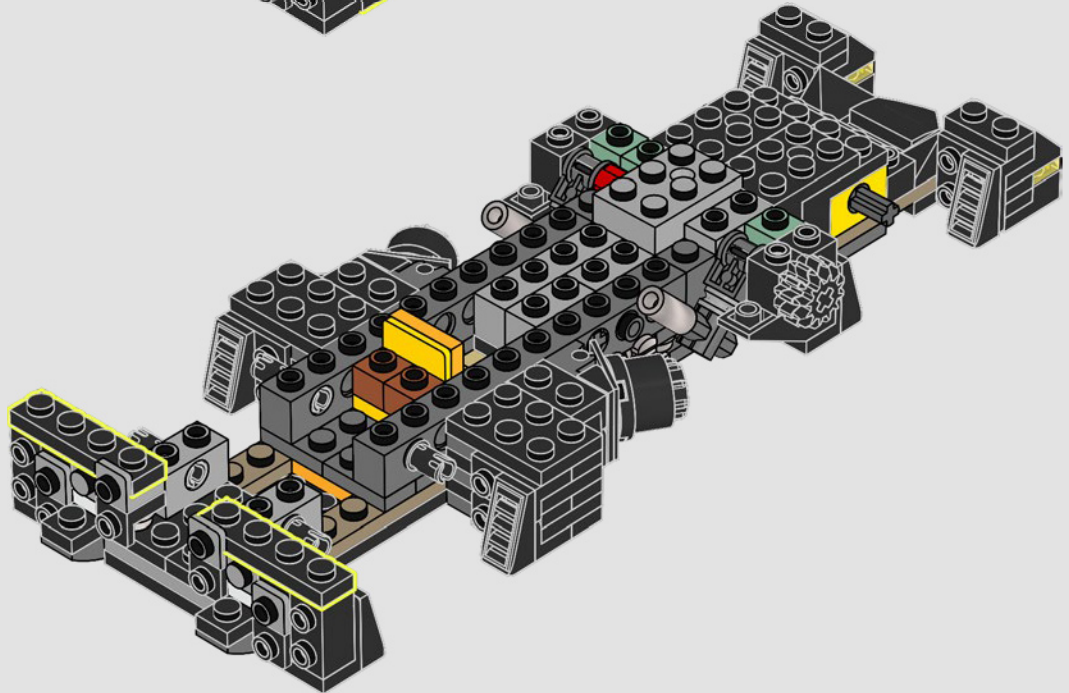

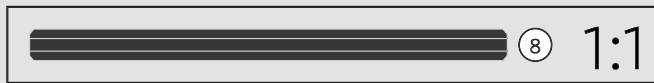
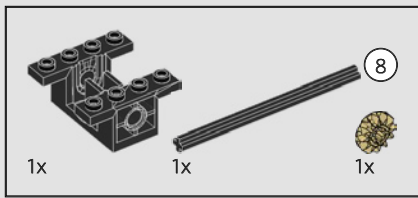

56

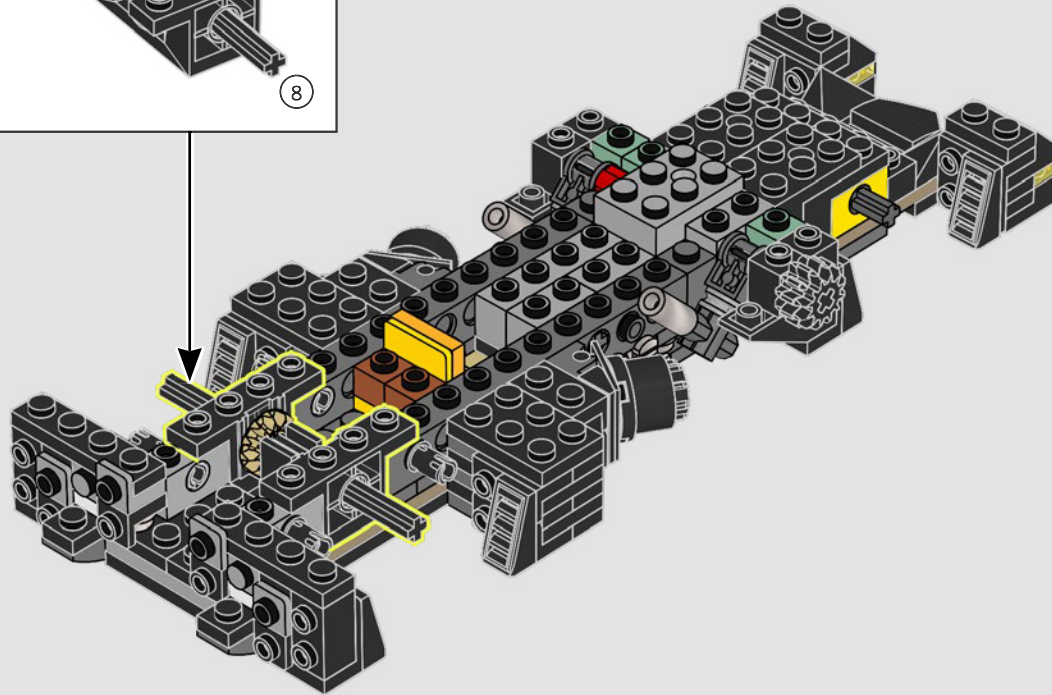
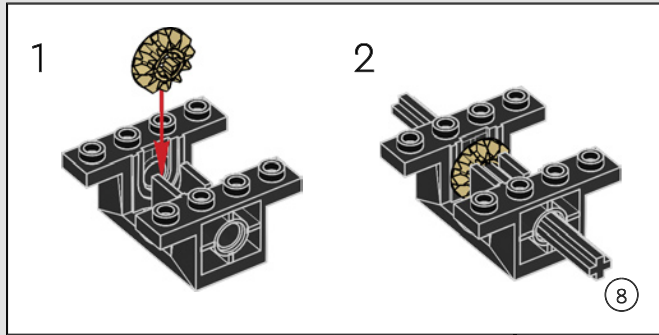

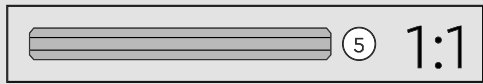
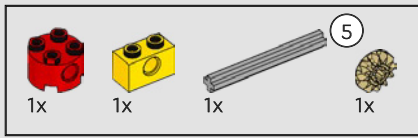

57

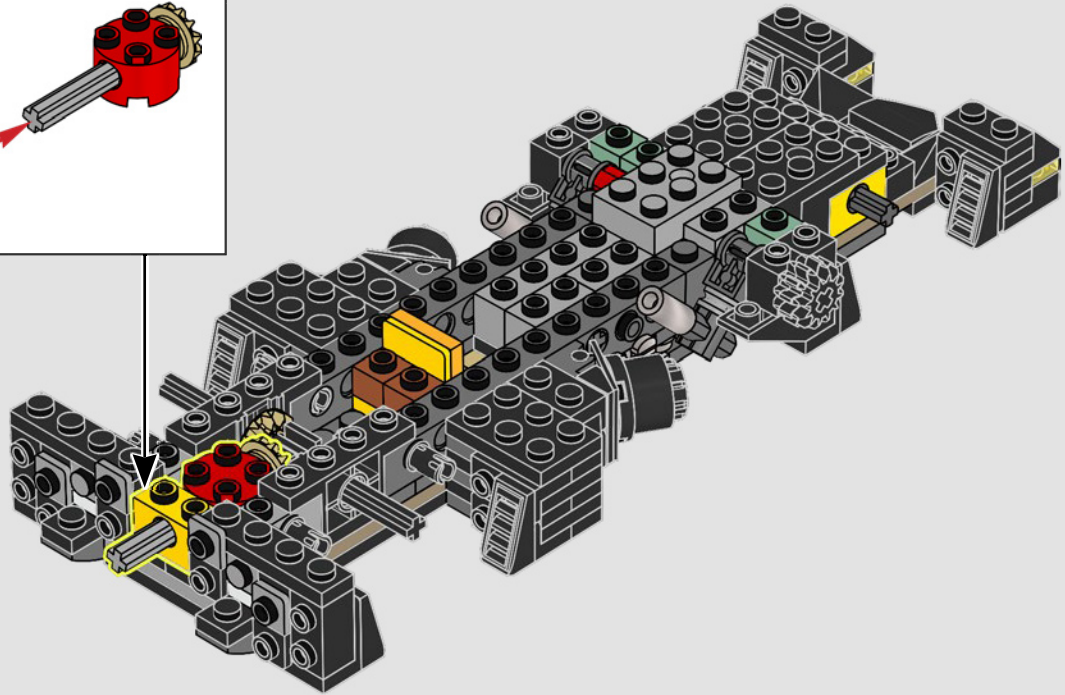
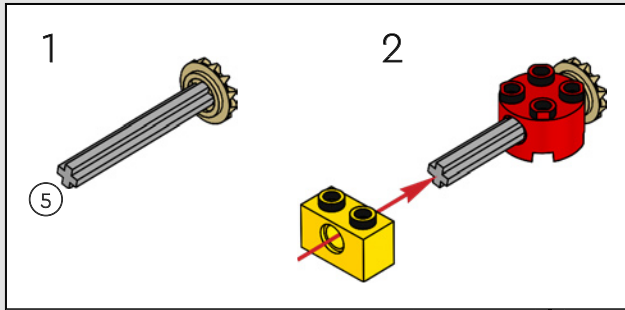

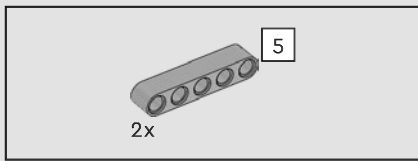

58

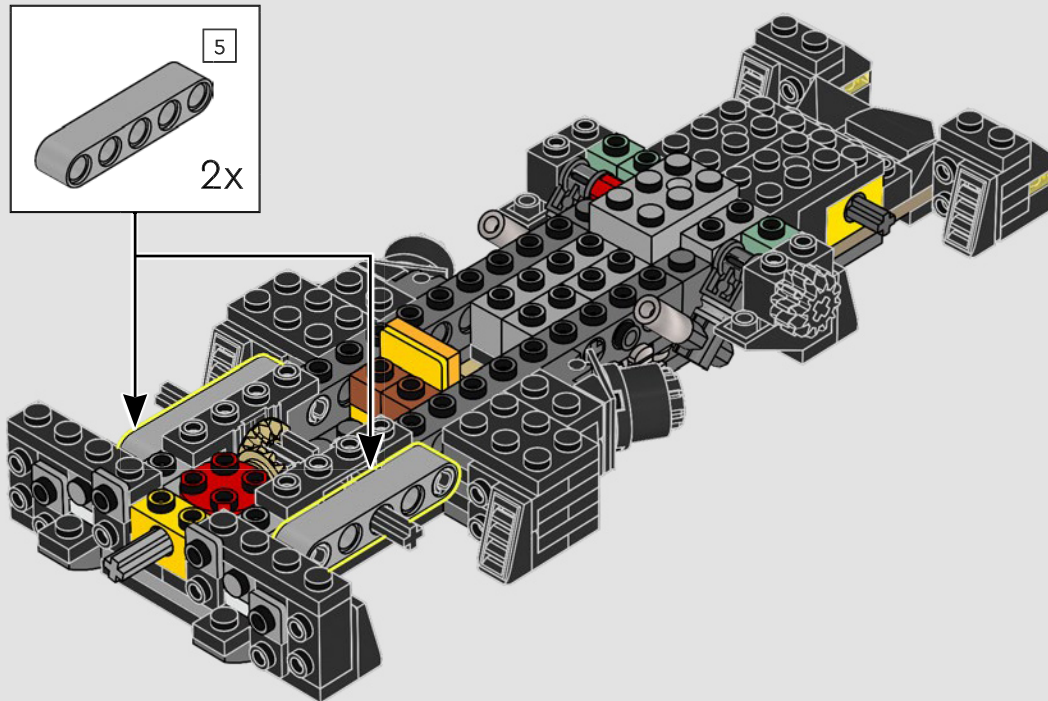

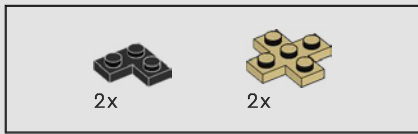

59

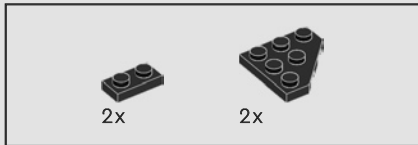
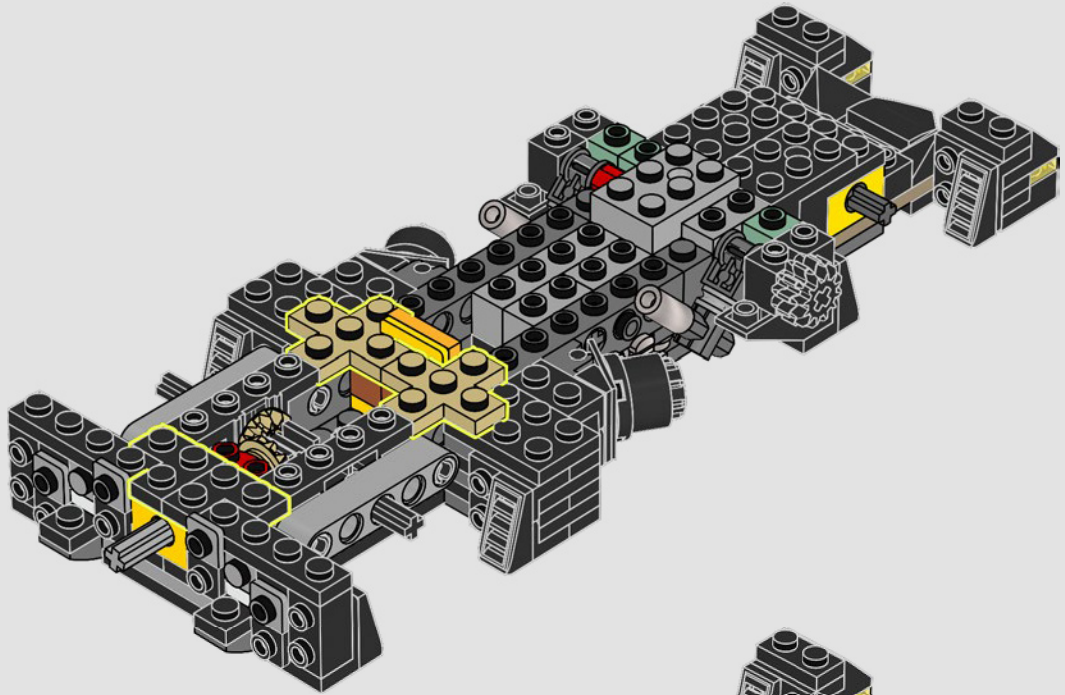

60

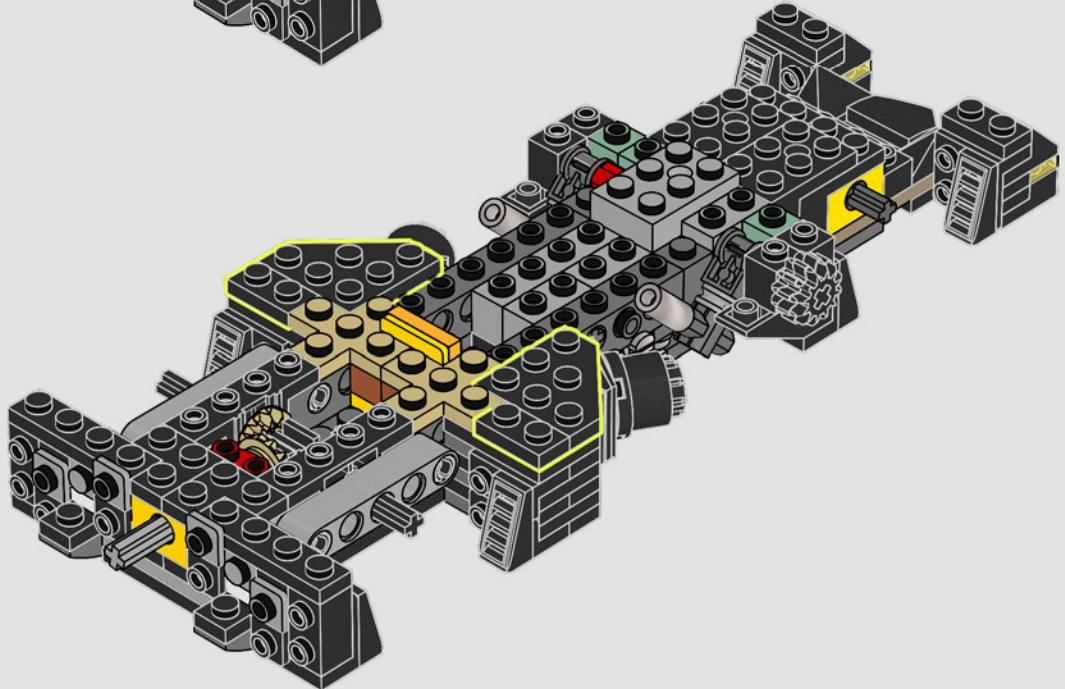

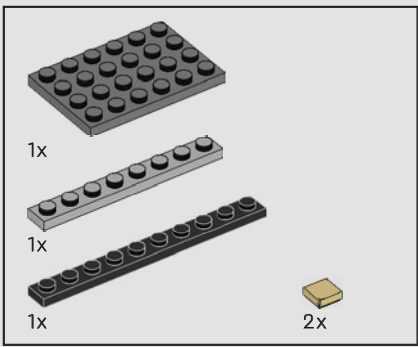

61

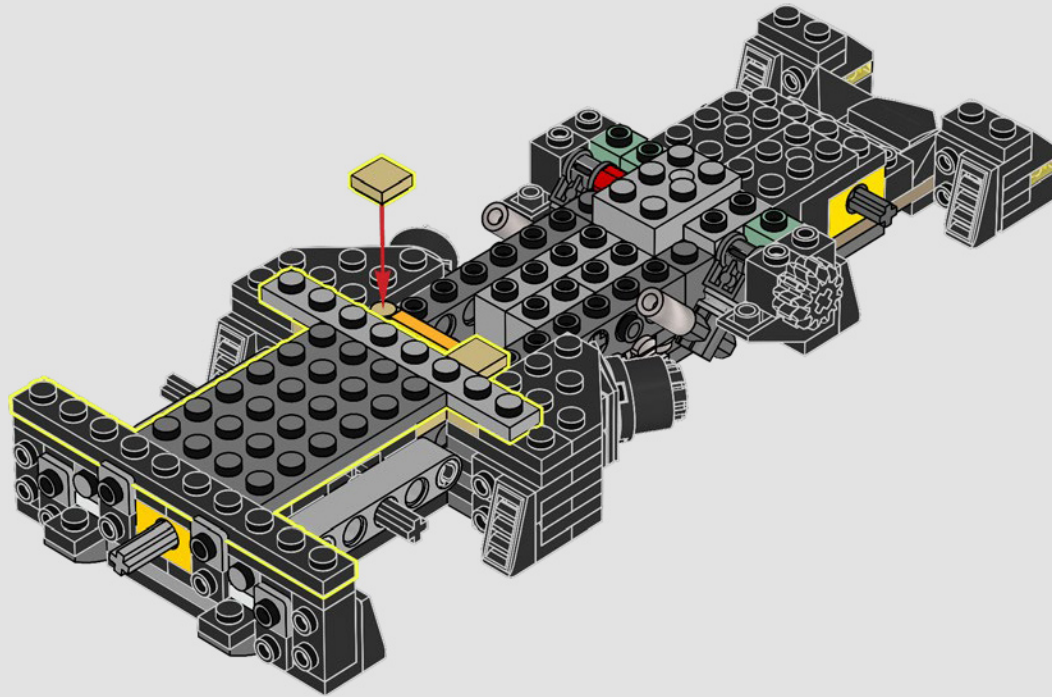

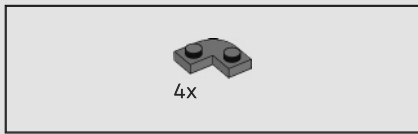

62

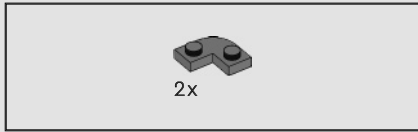
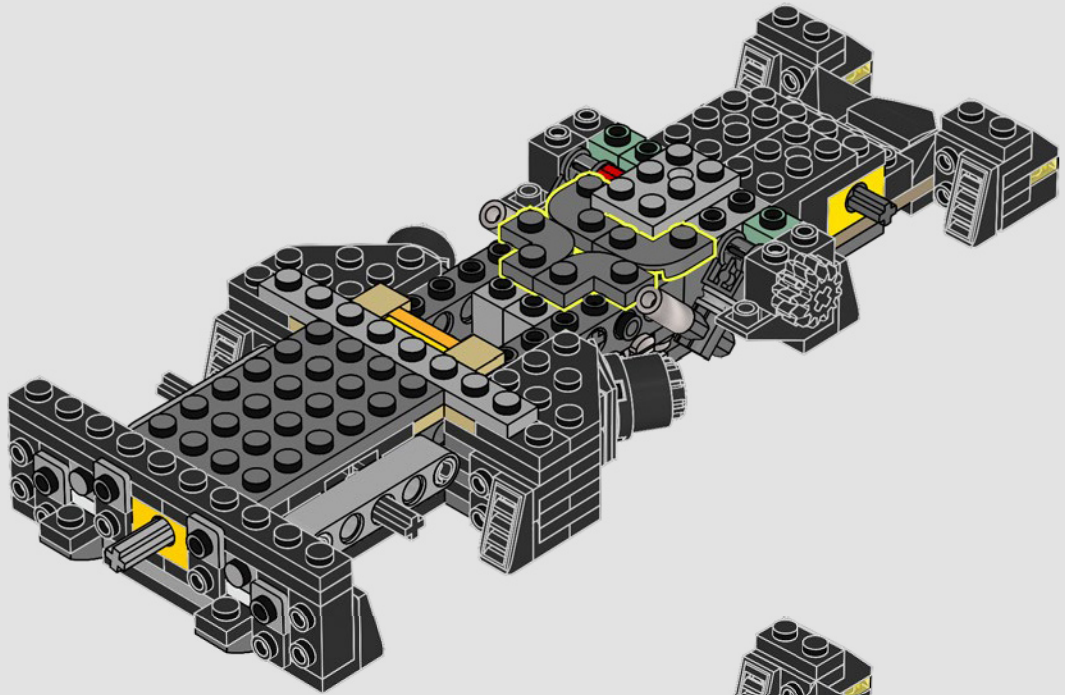

63

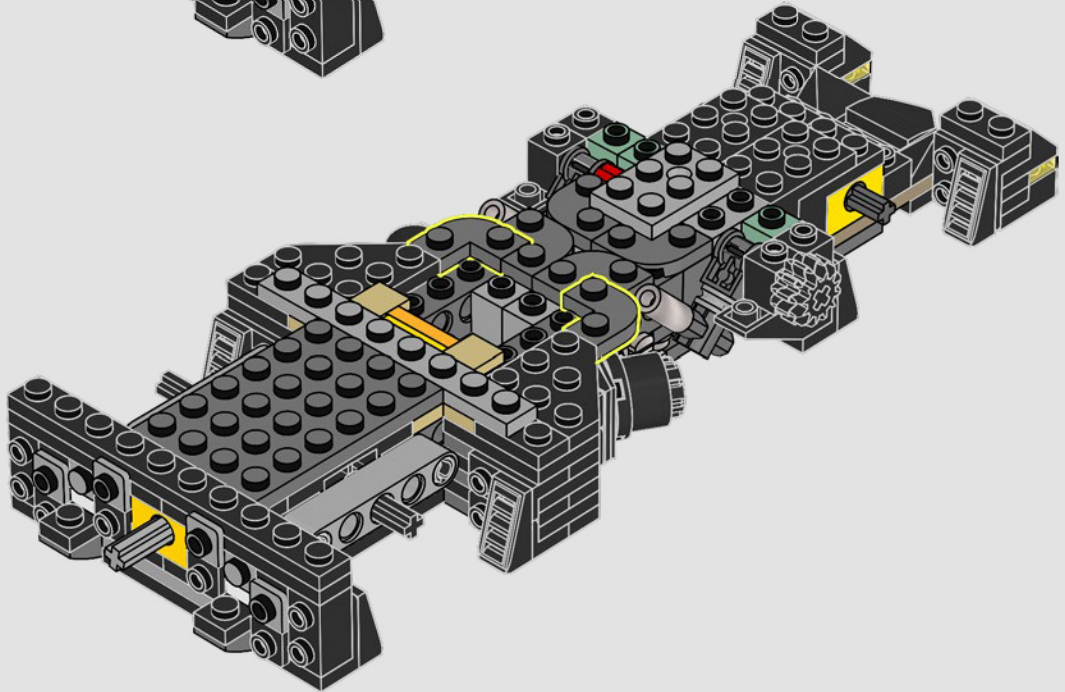

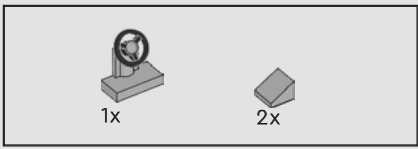

64

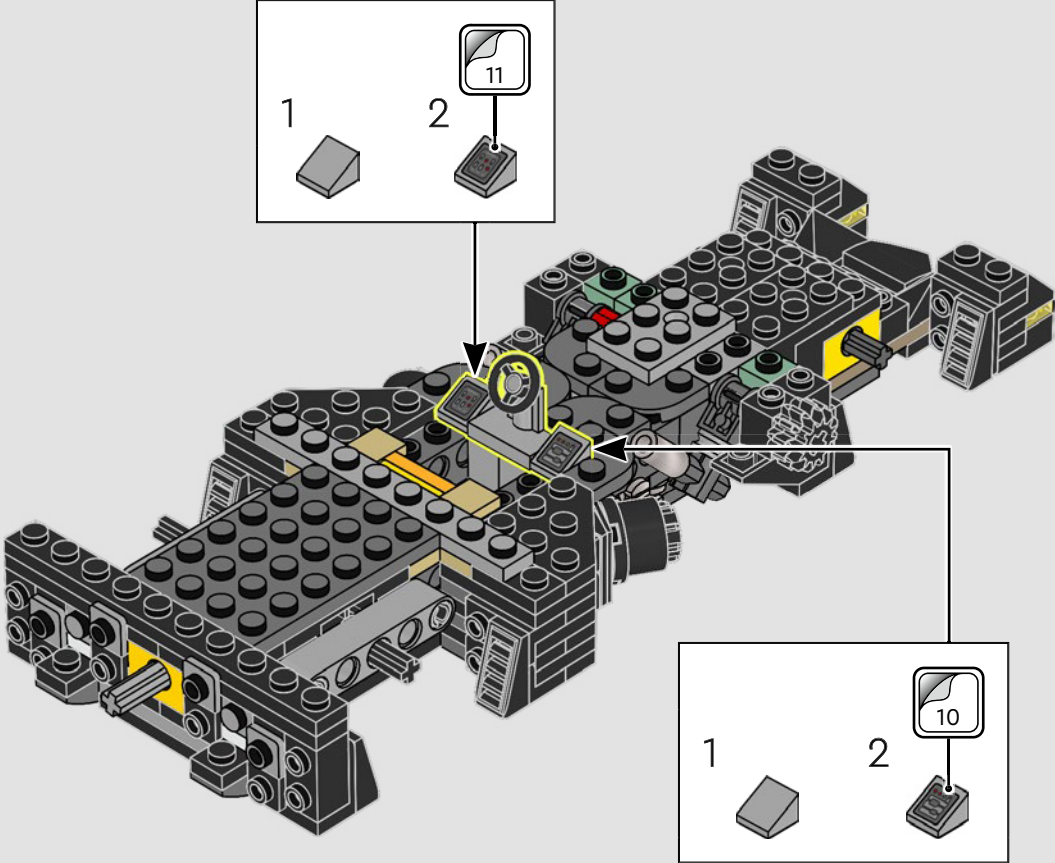

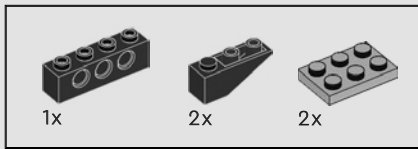

65

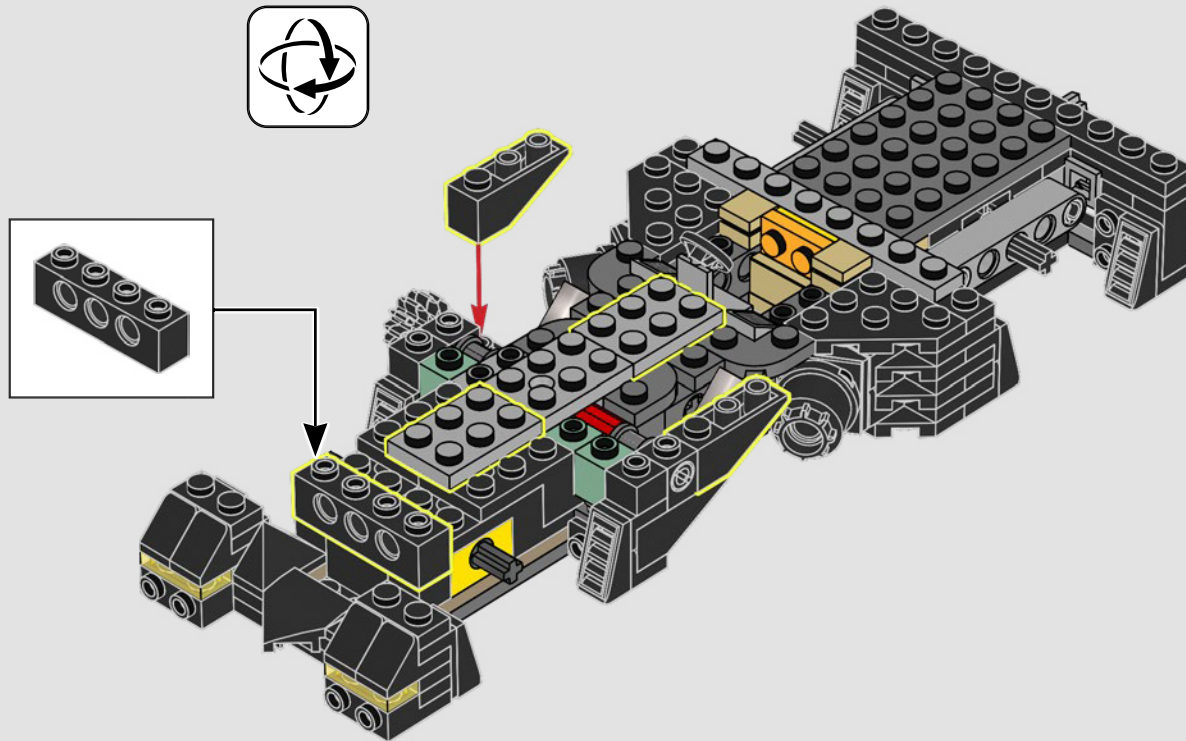

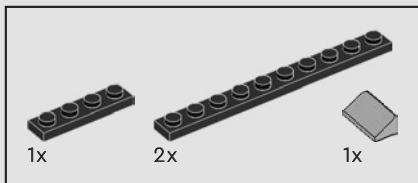

66

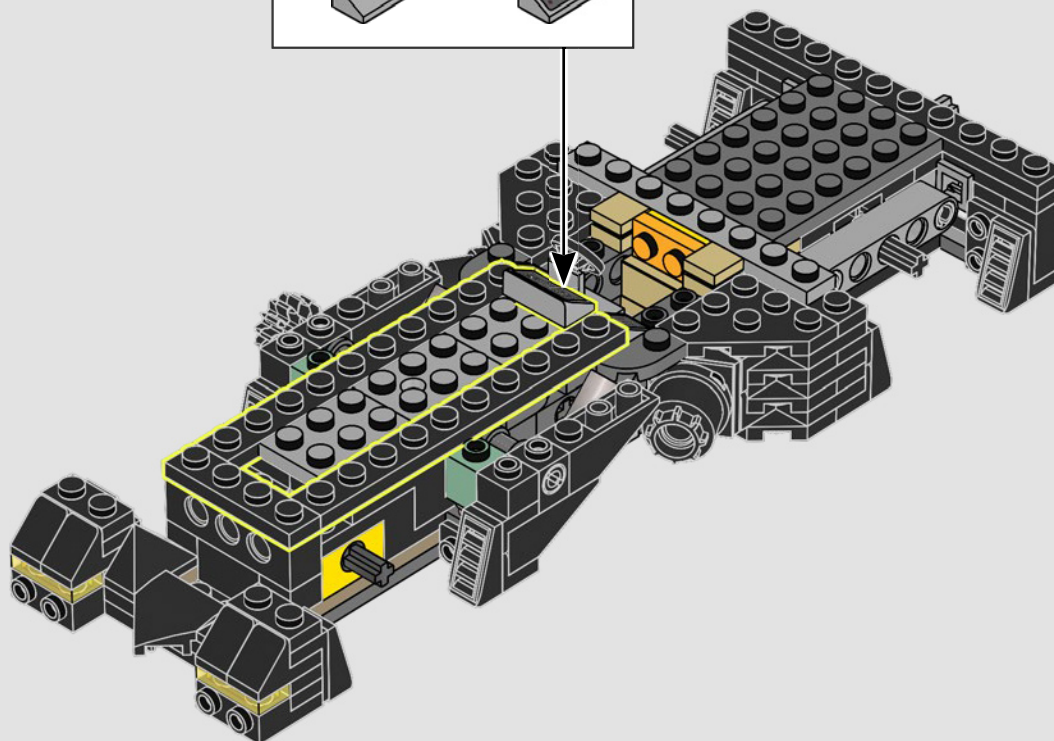
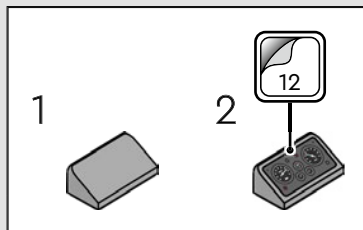

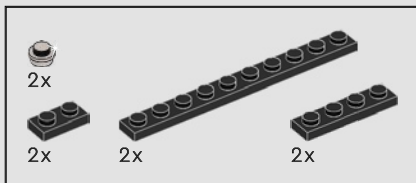

67

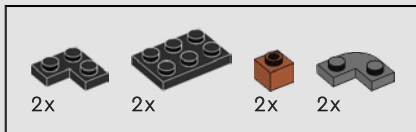
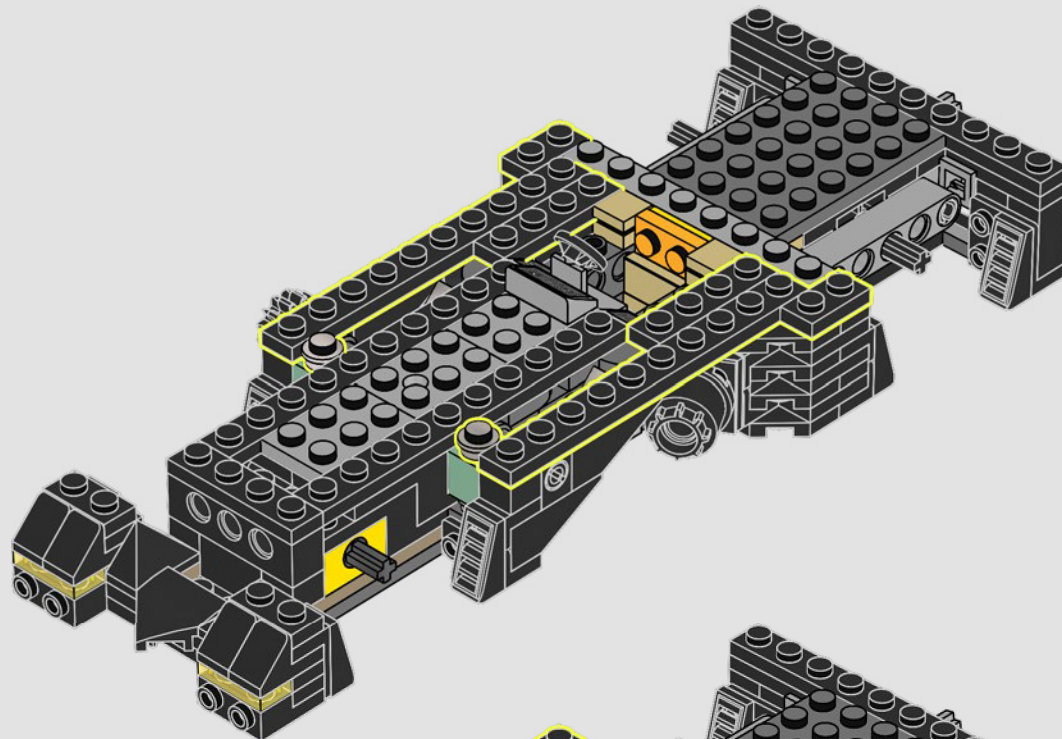

68

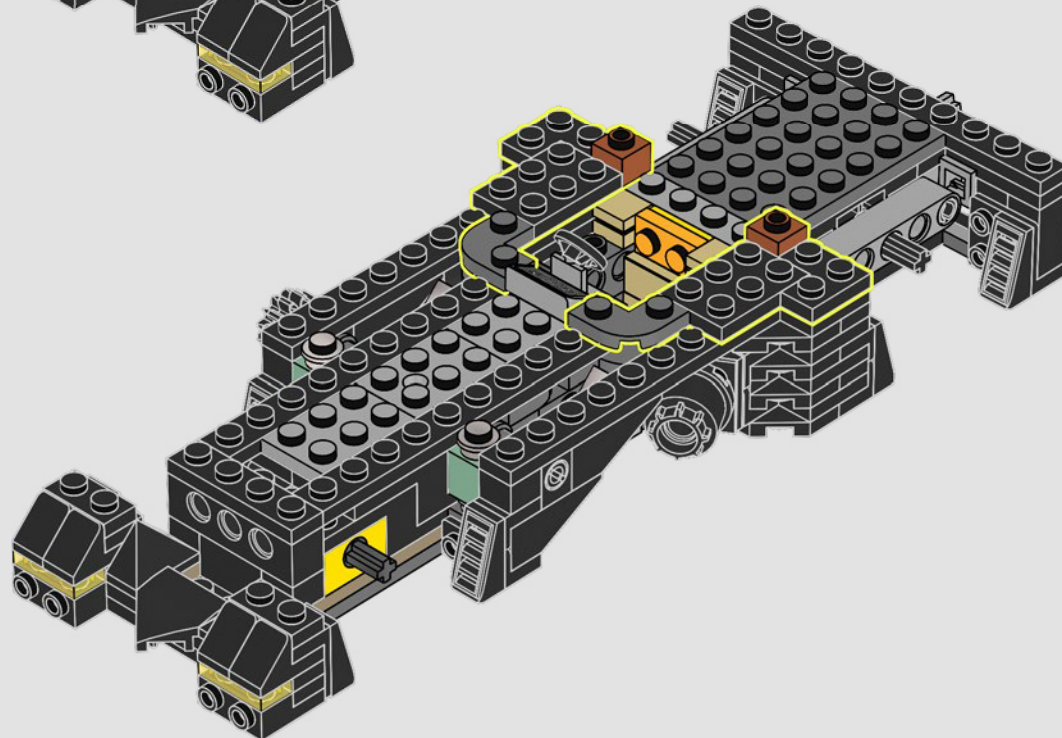

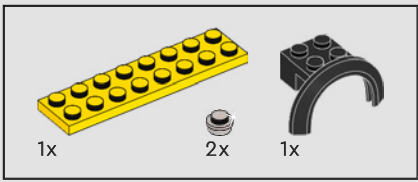

69

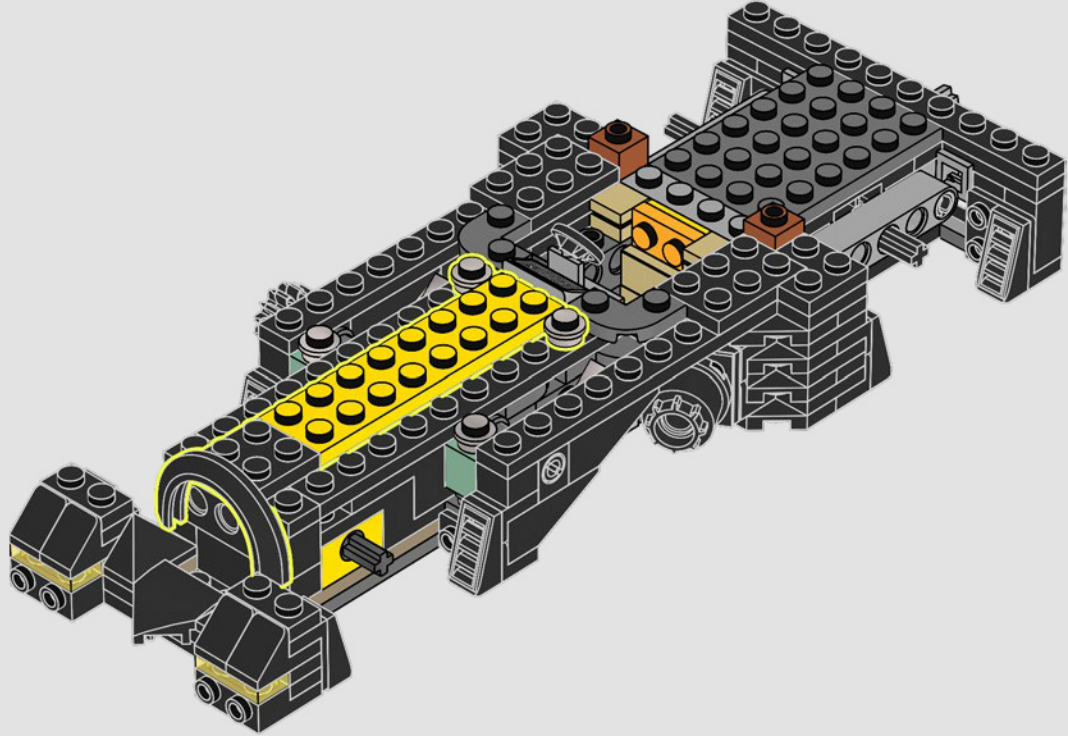

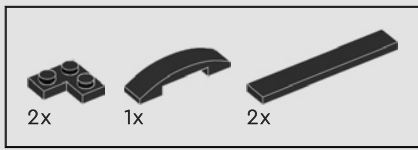

70

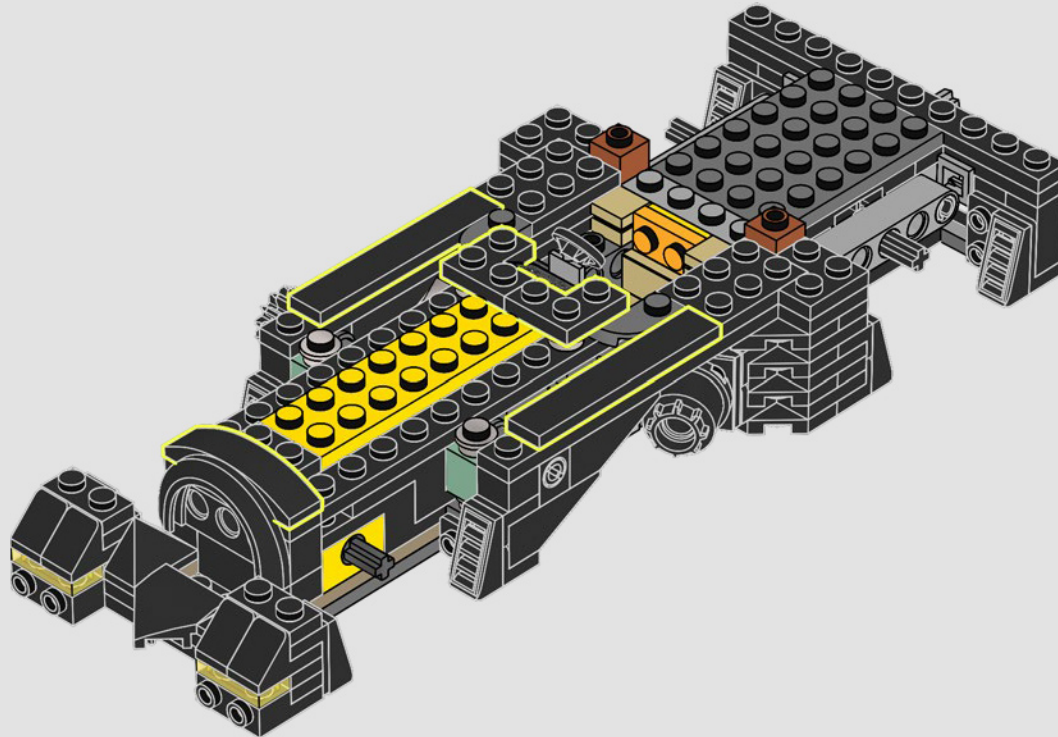

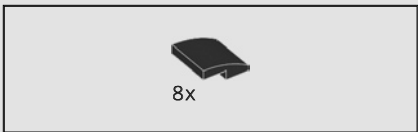

71

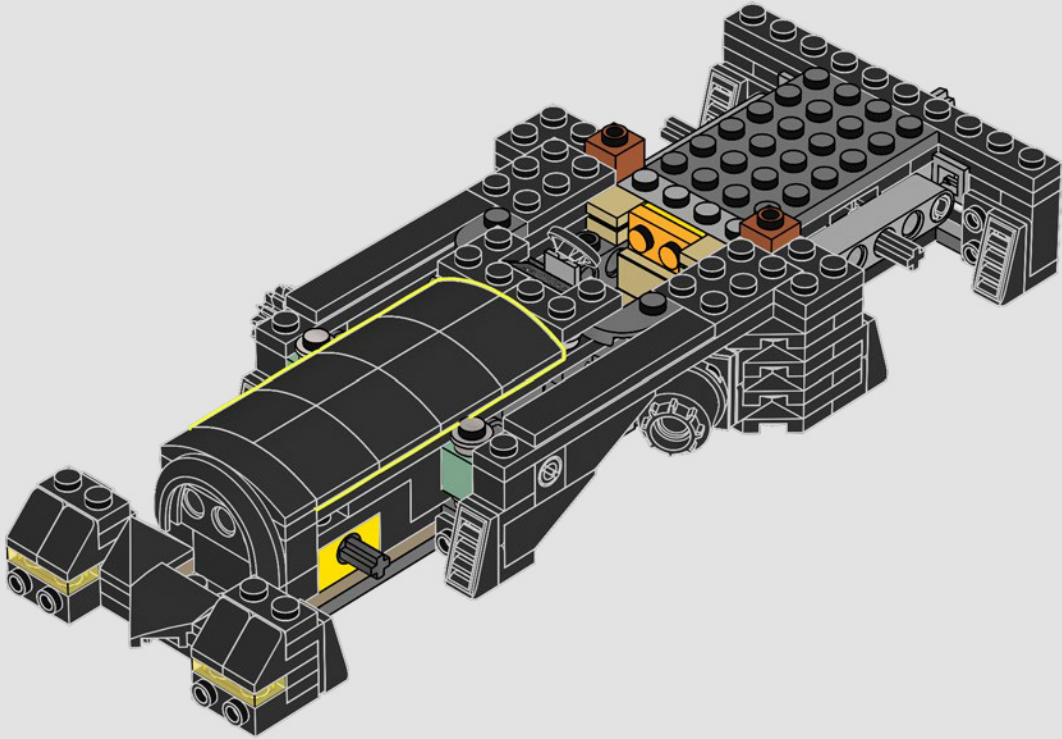

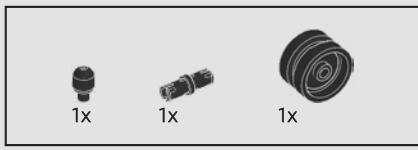

72

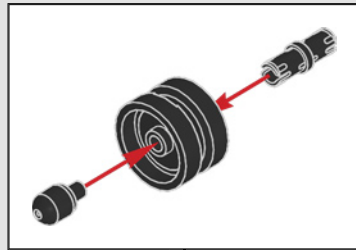
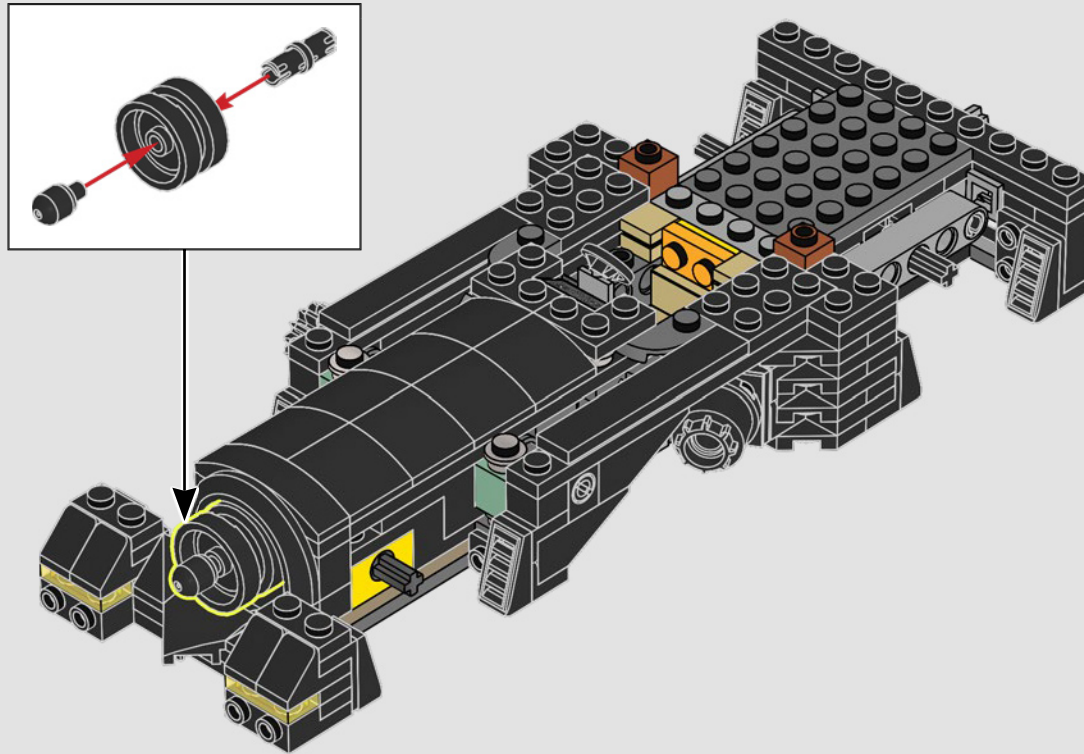



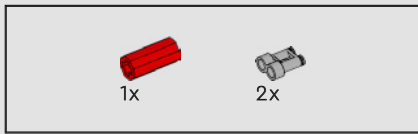

73

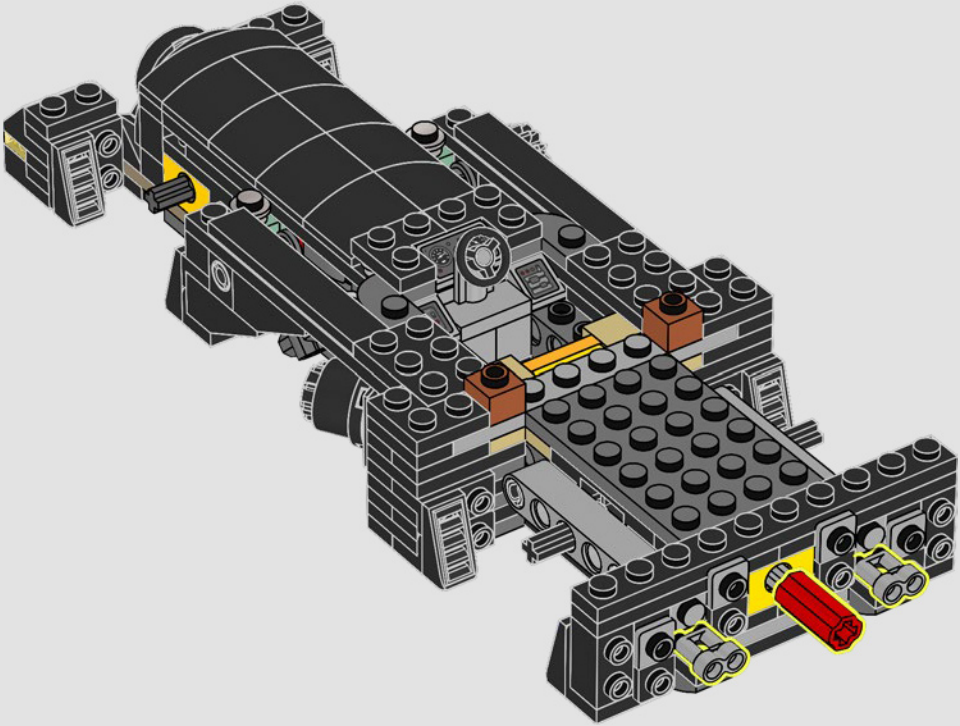



74

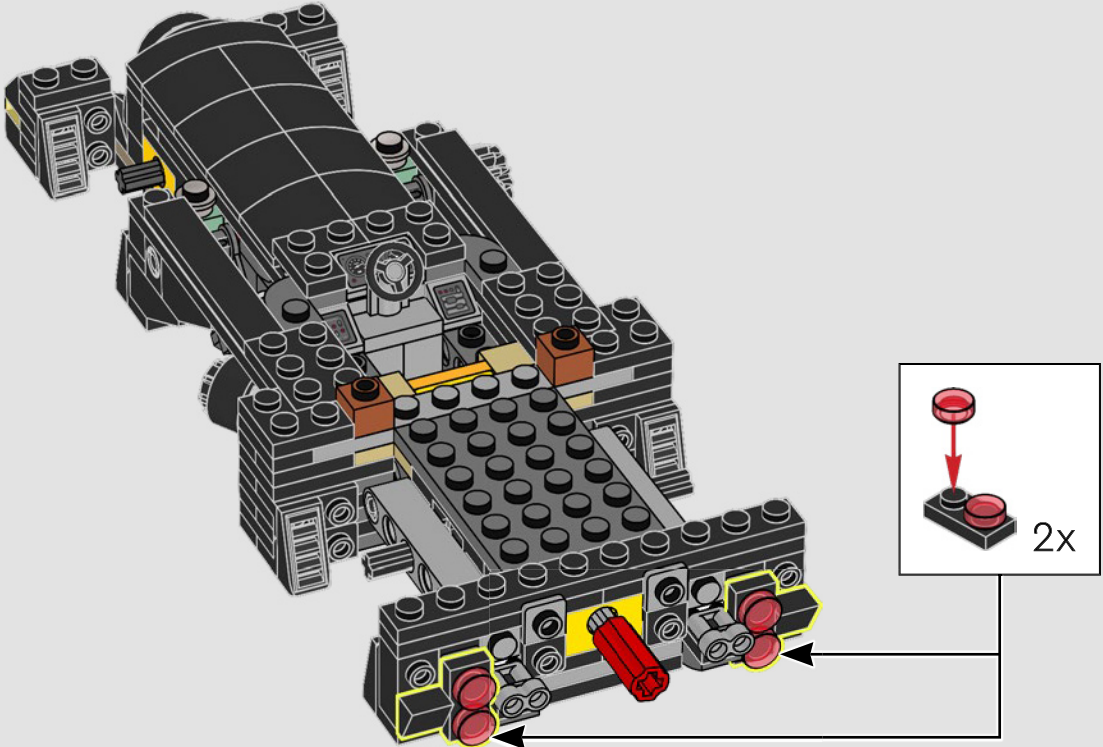

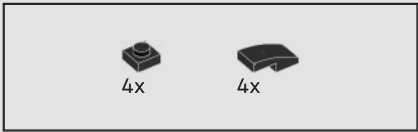

75

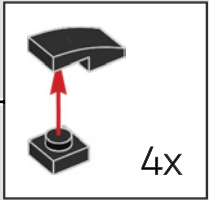
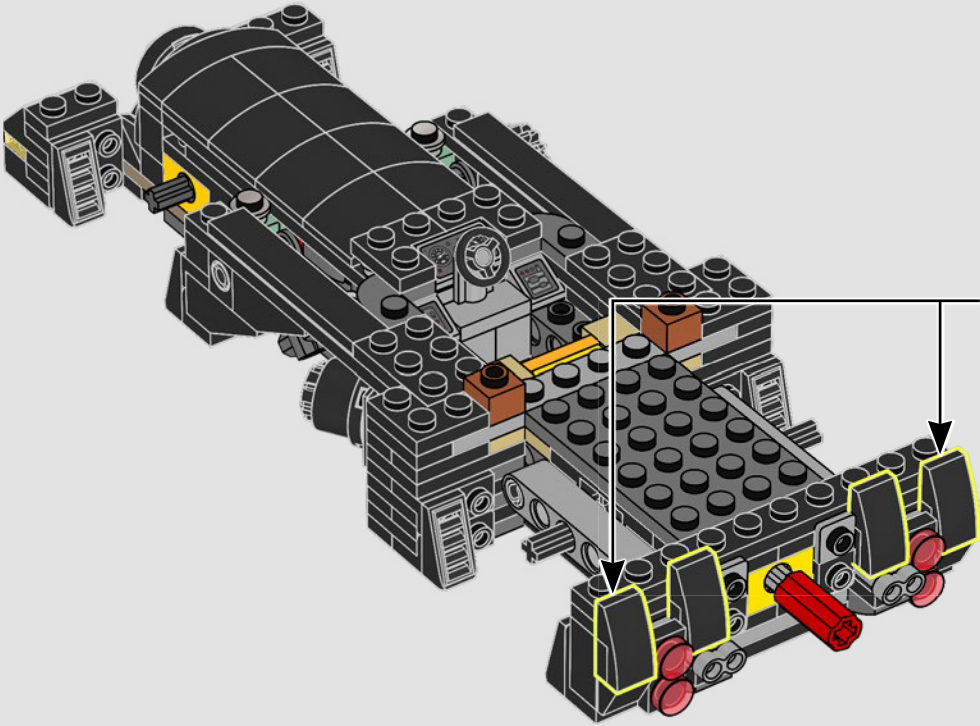

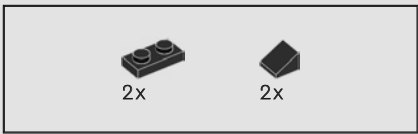

76

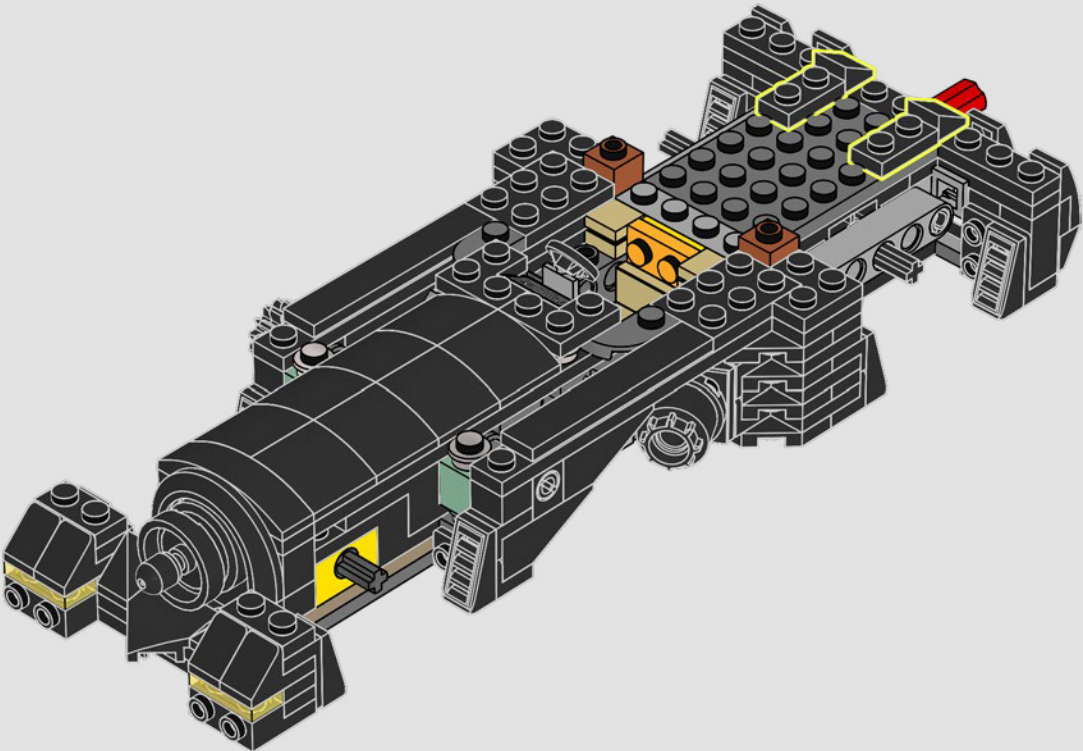

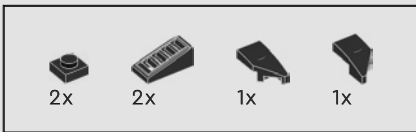

77

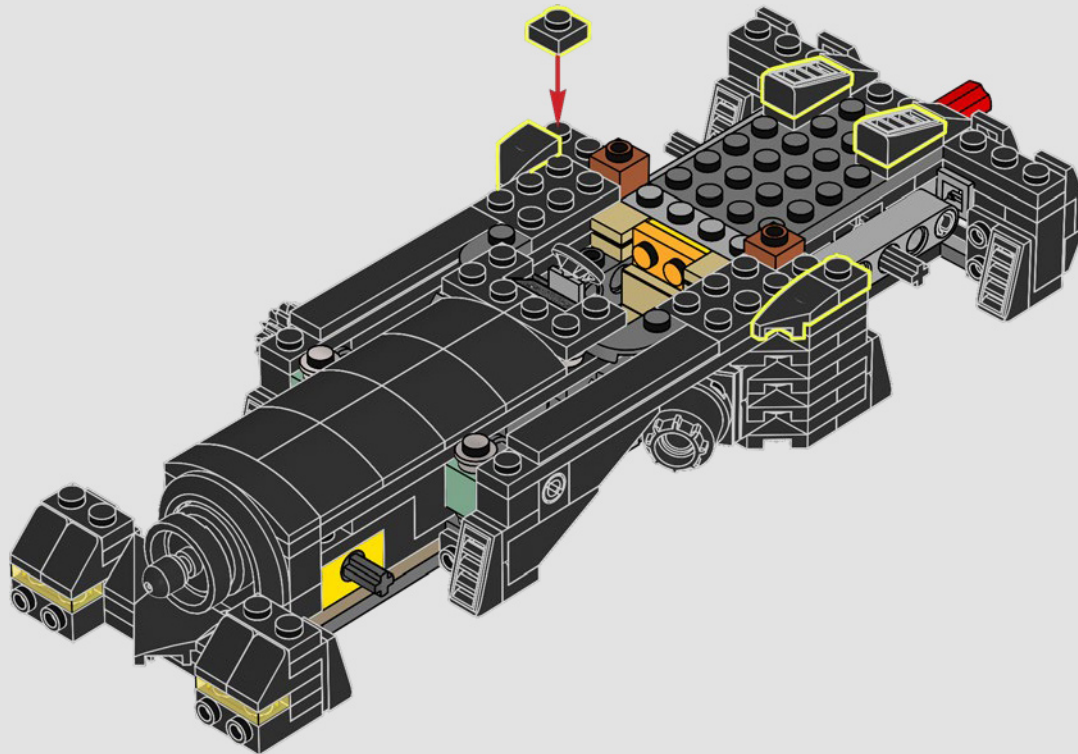

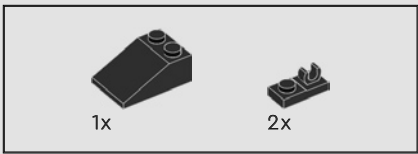

78

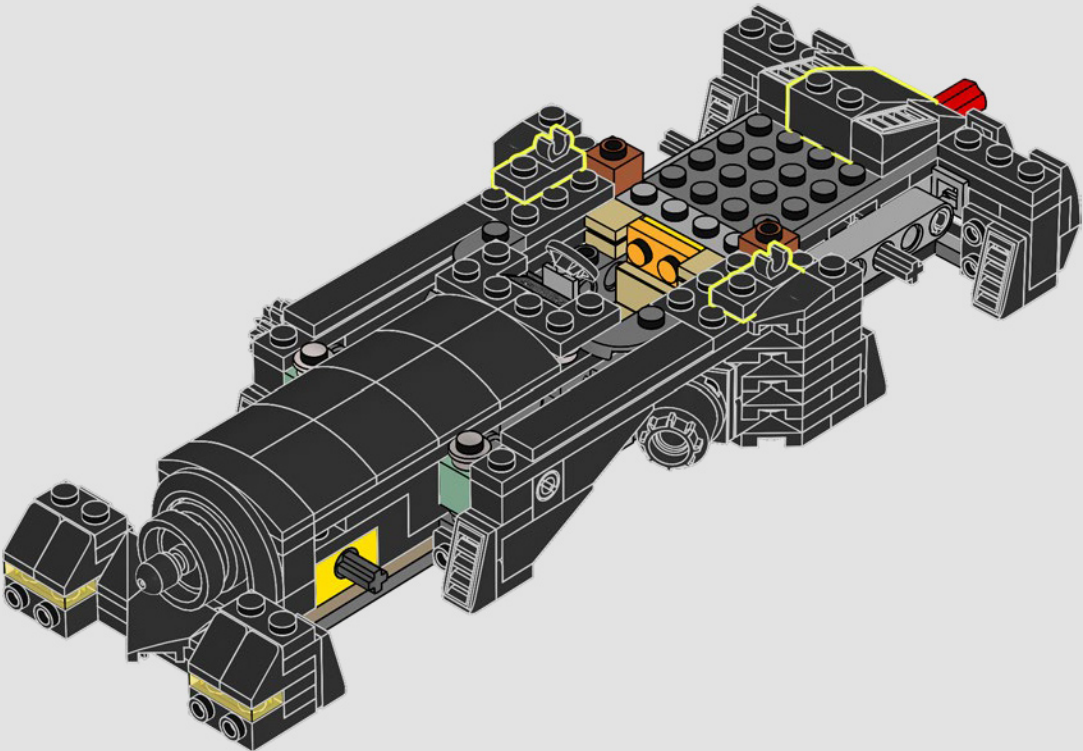

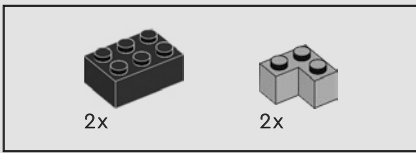

79

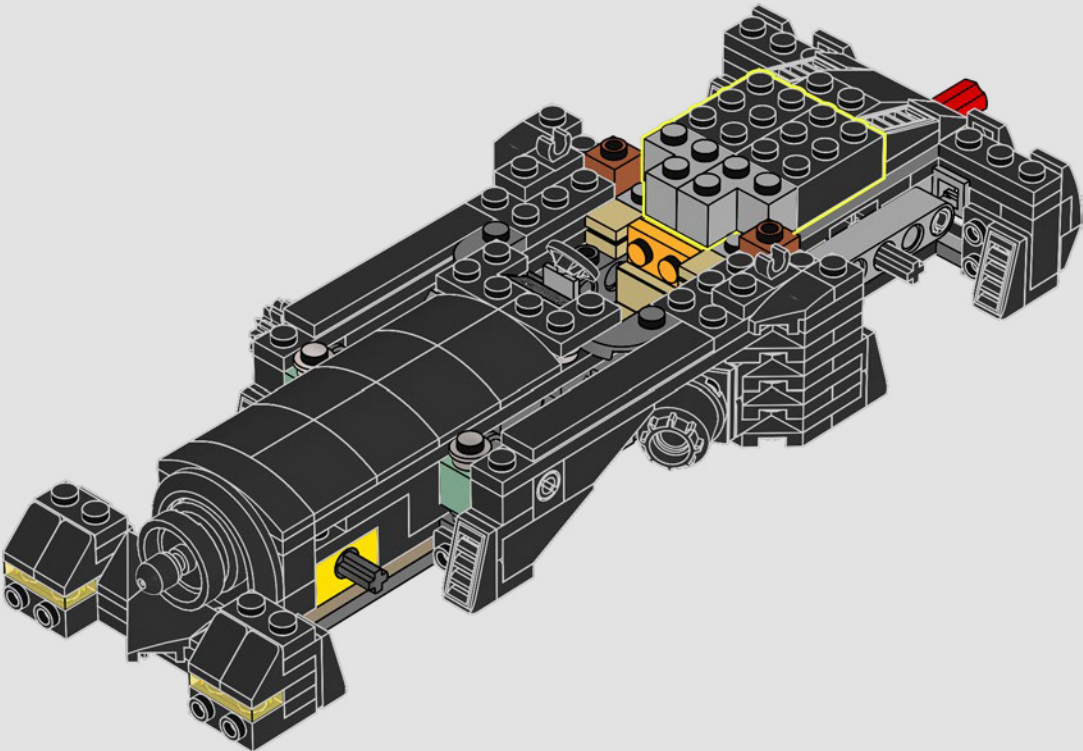

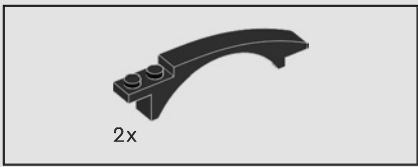

80

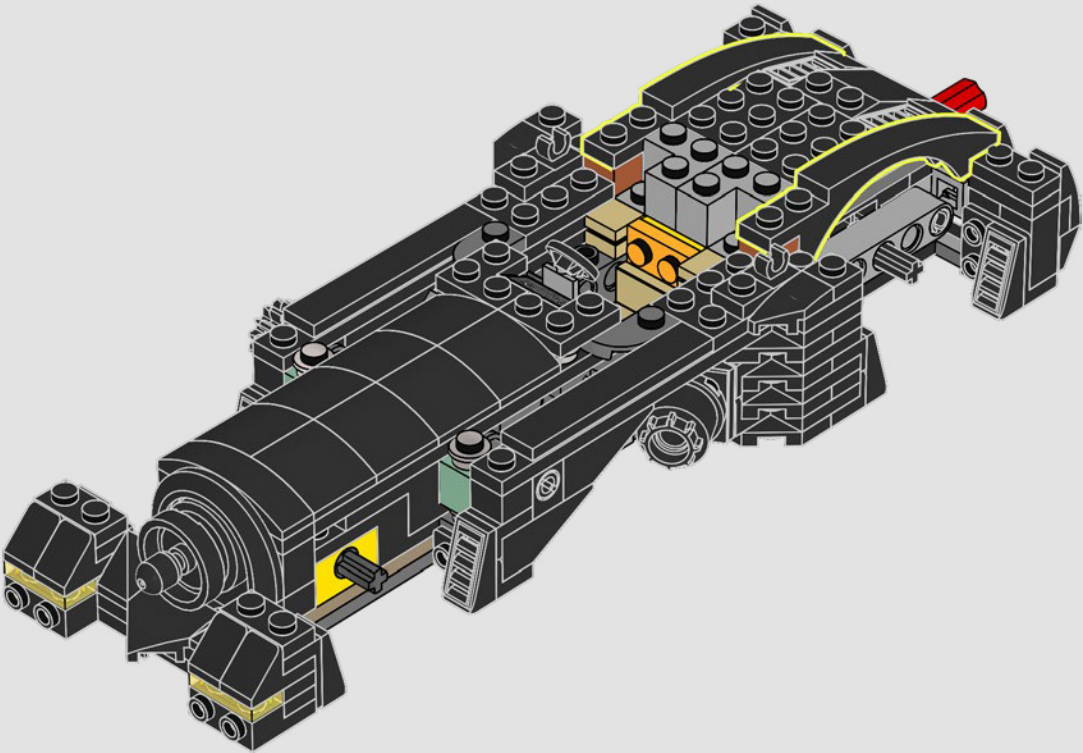



81

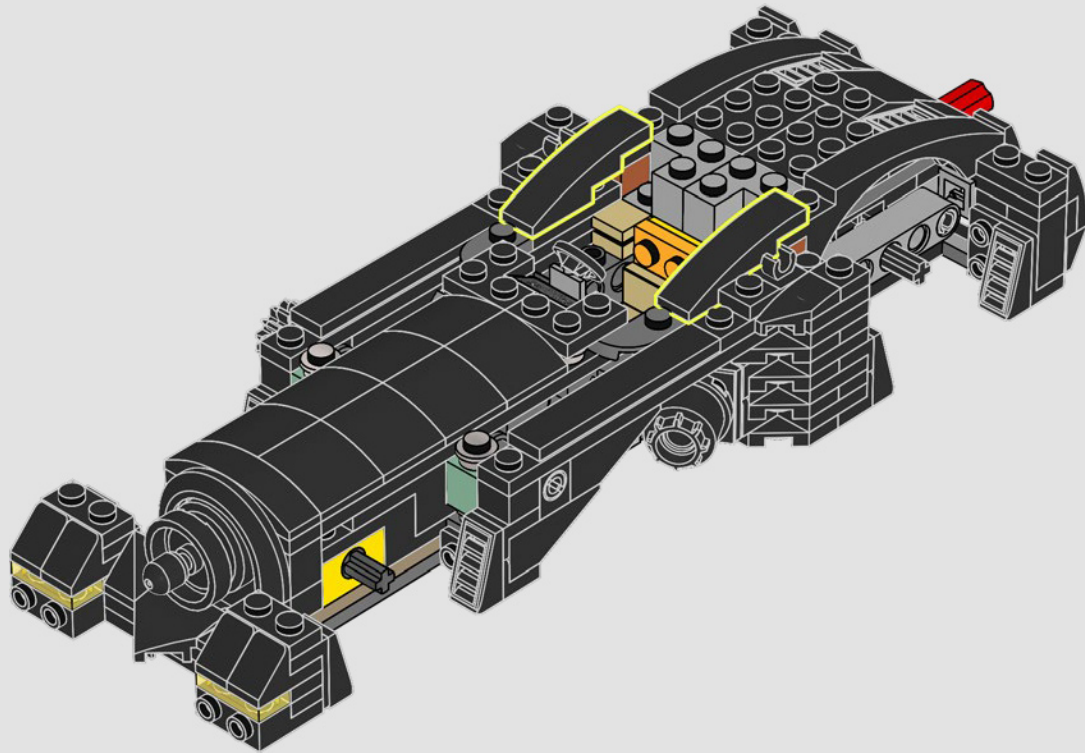

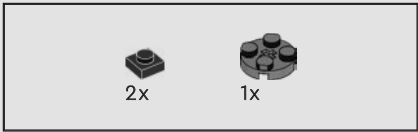

82

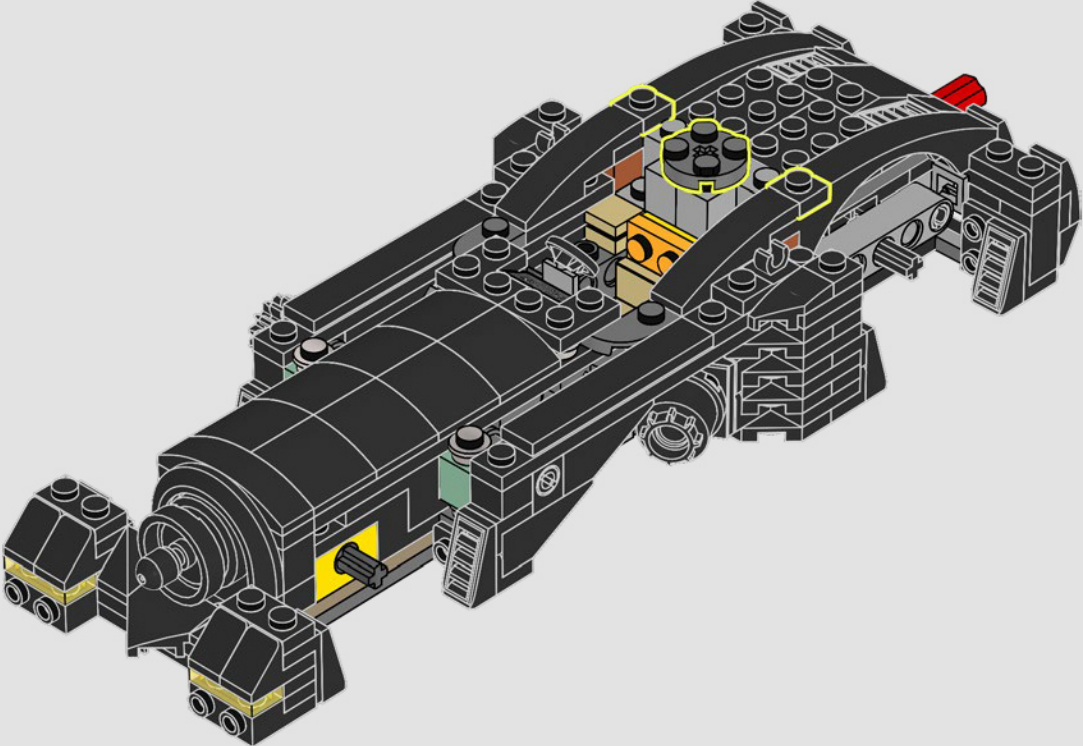

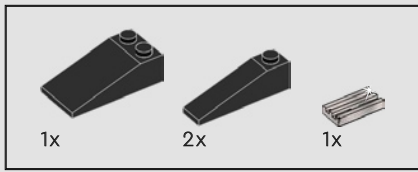

83

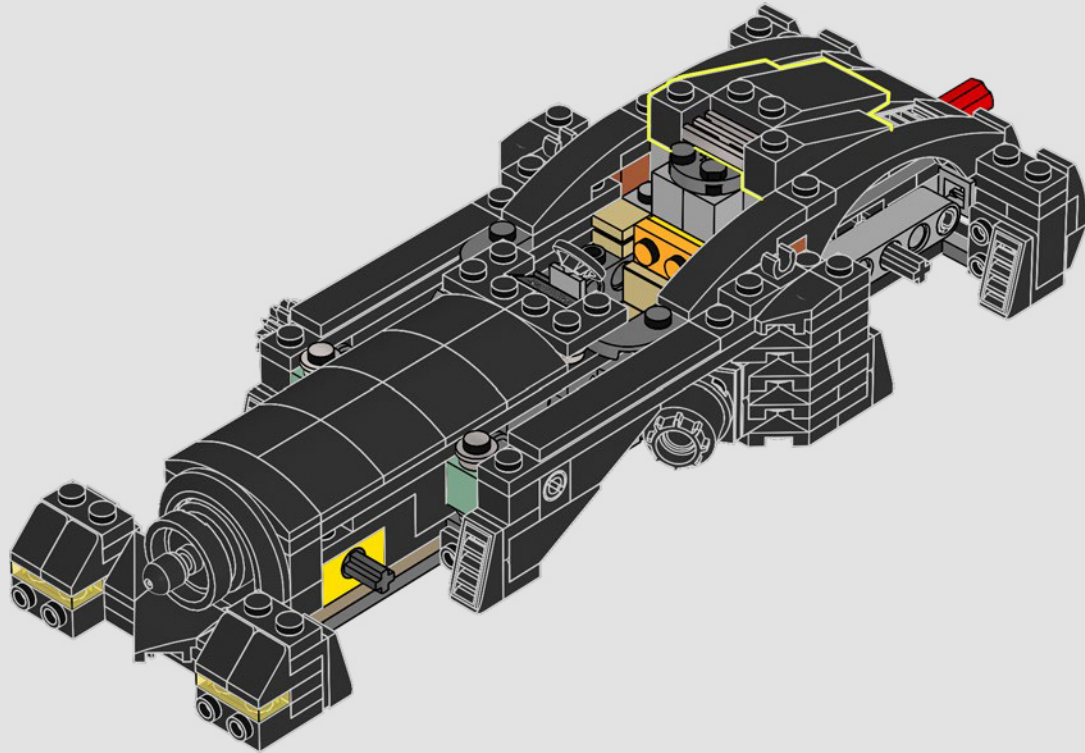

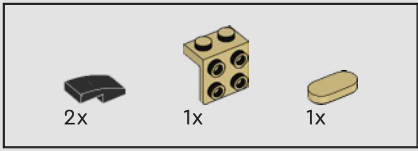

84

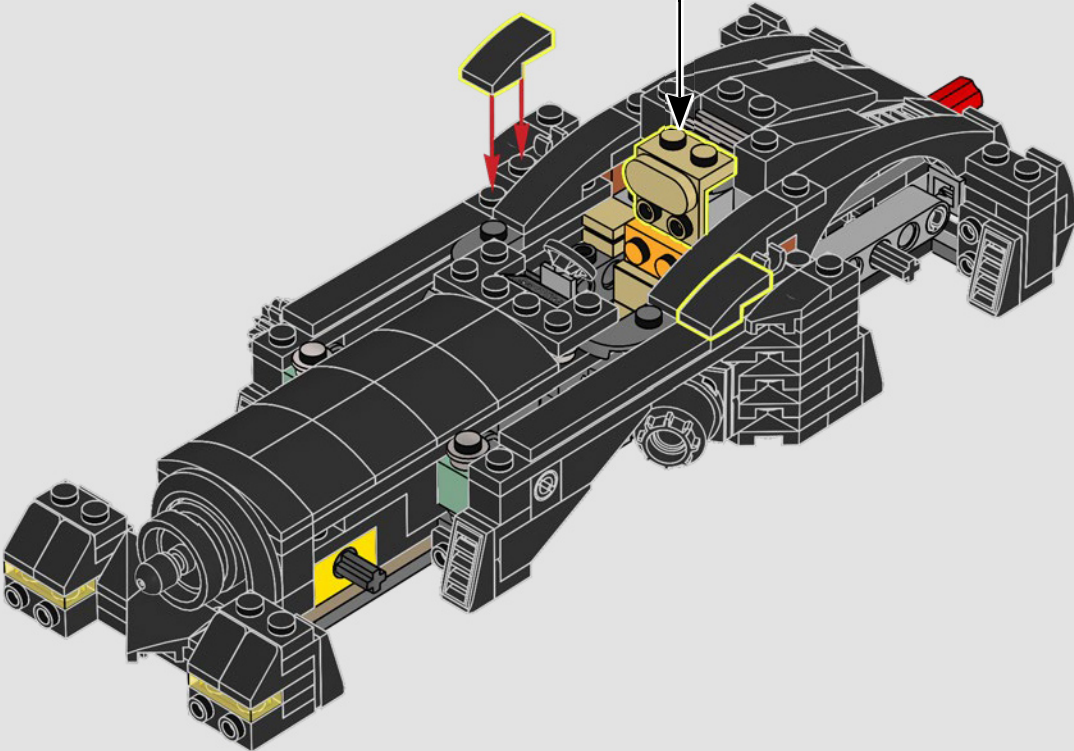
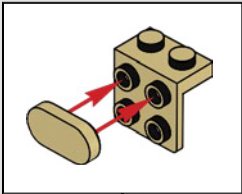

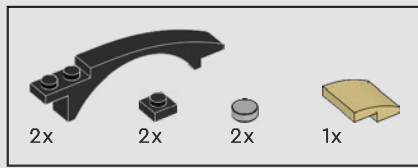

85

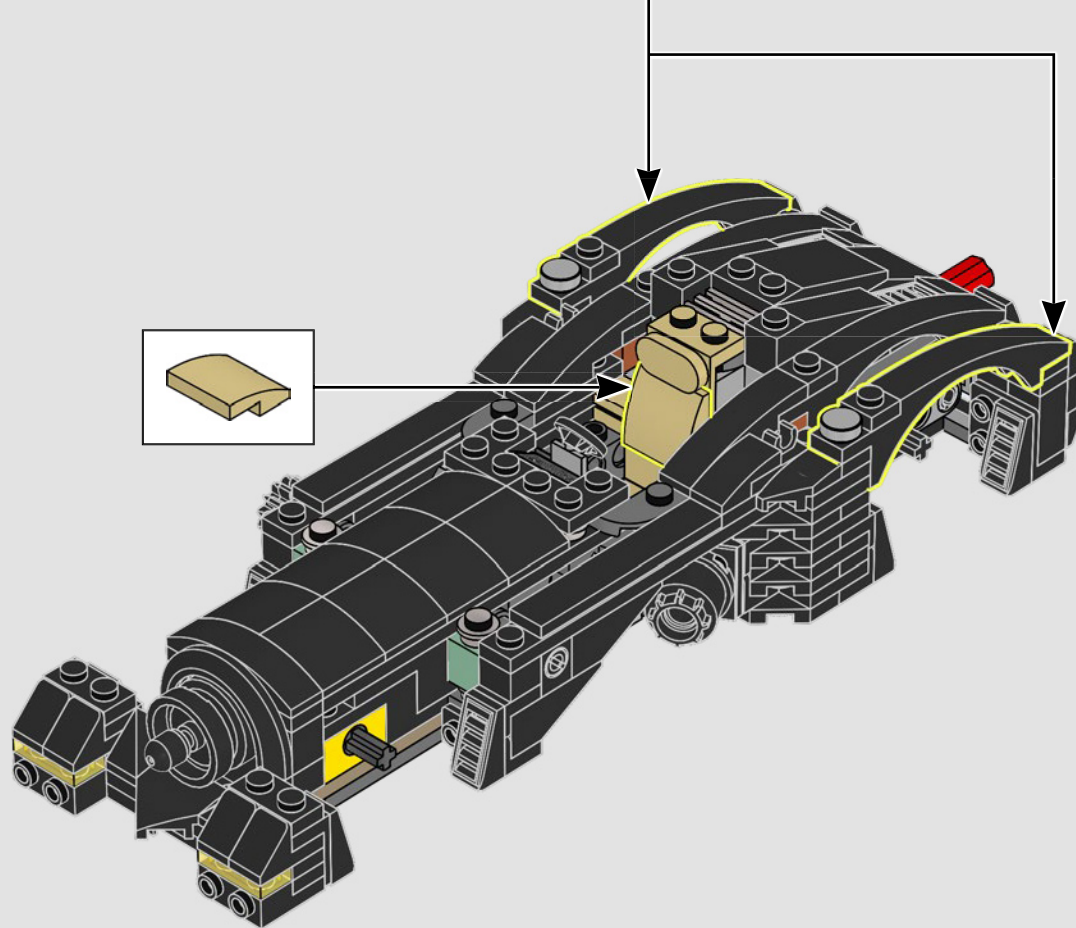
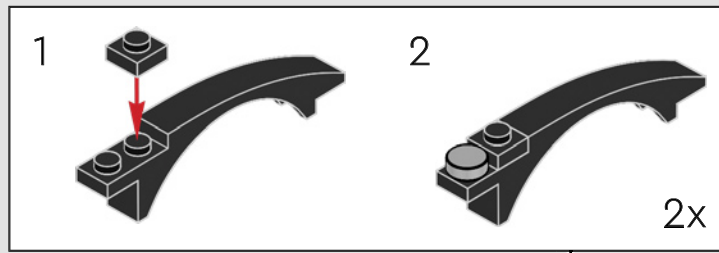

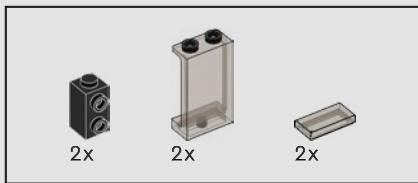

86

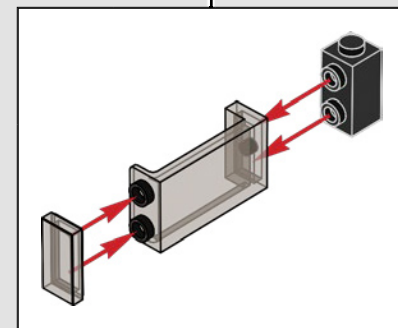
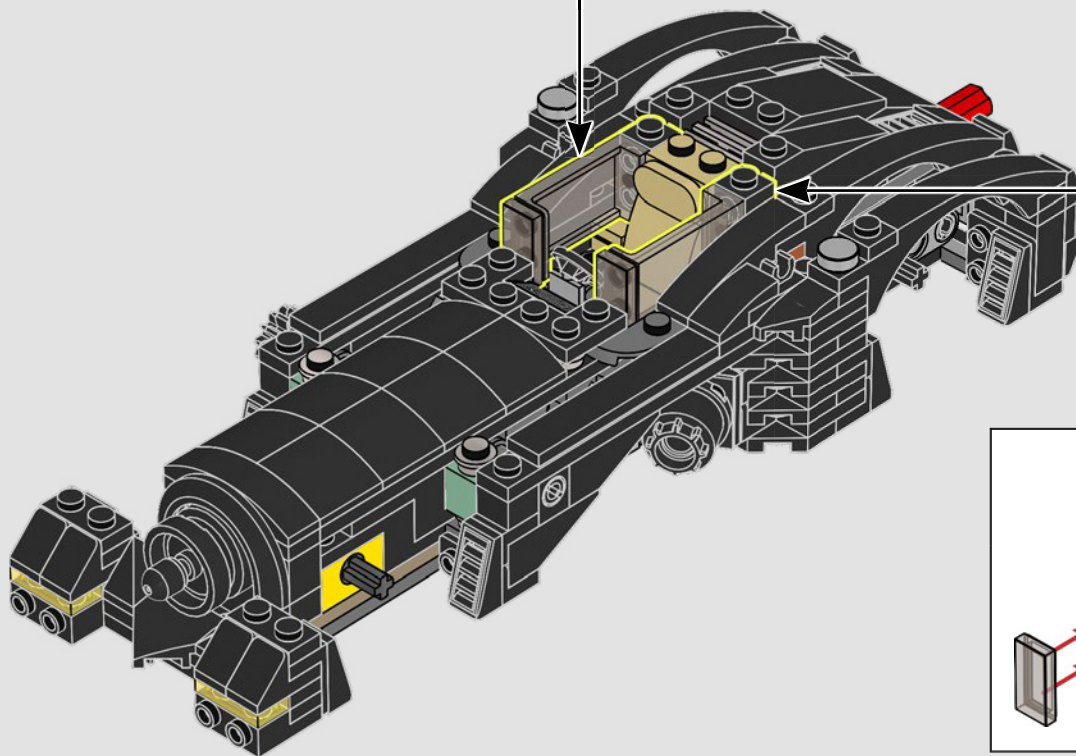
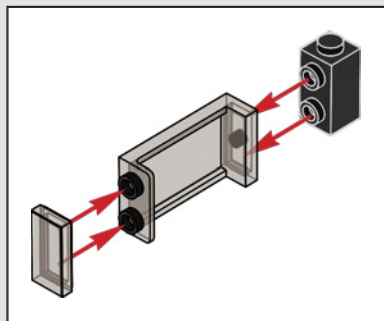

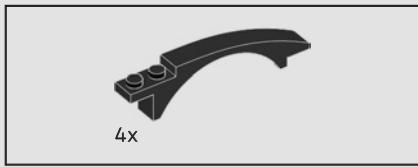

87

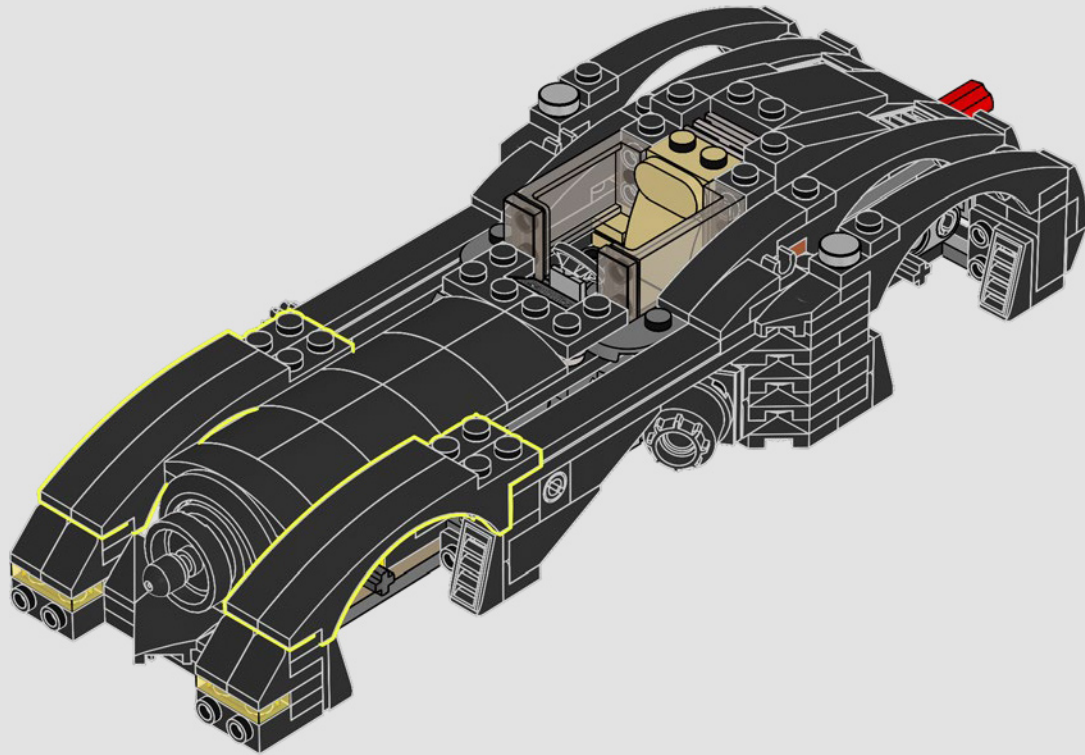

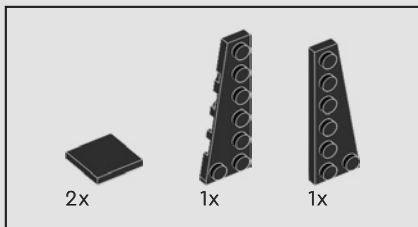

88

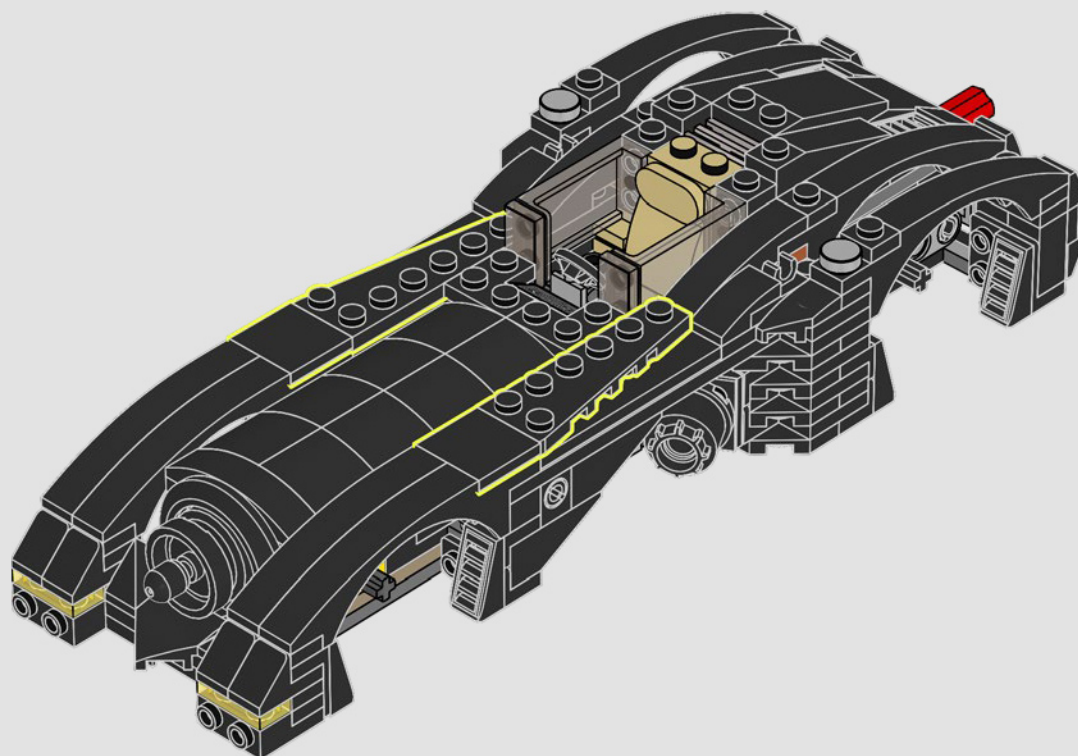

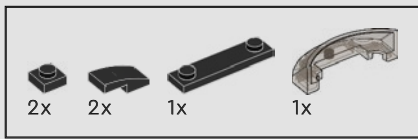

89

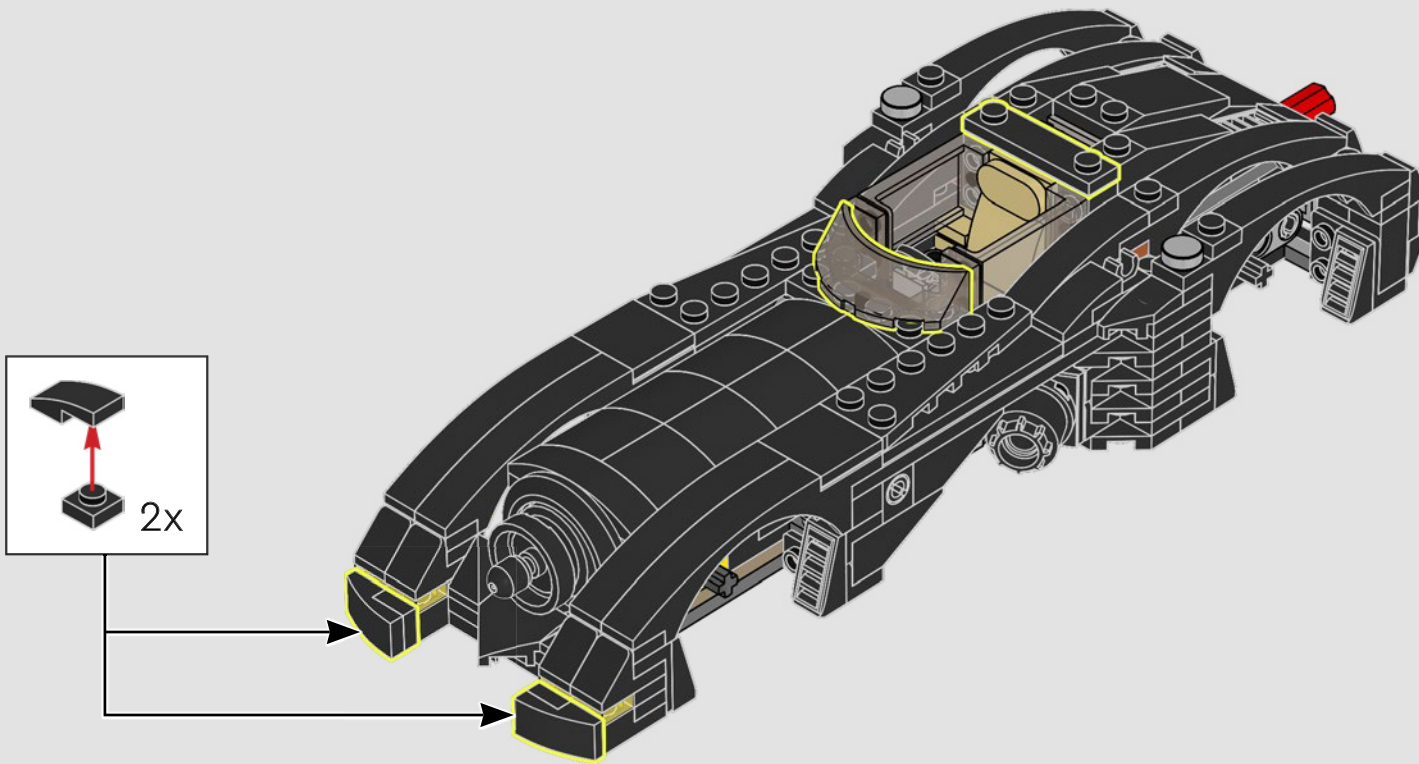

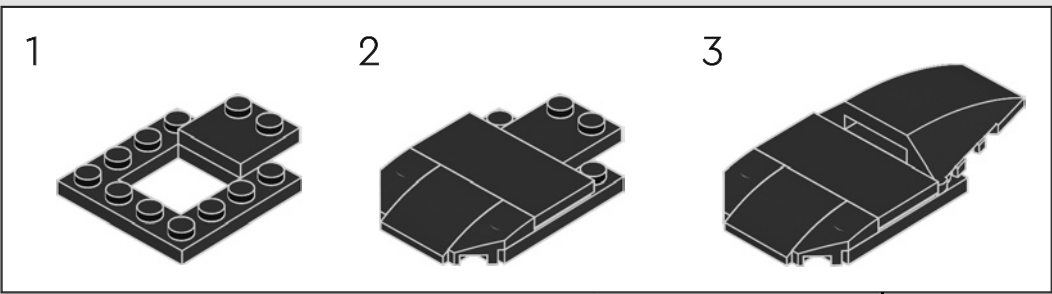
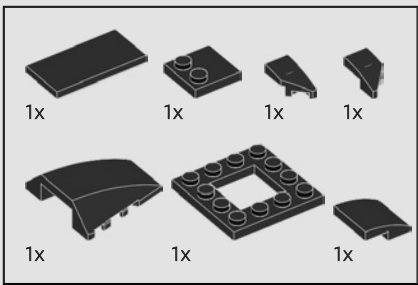

90

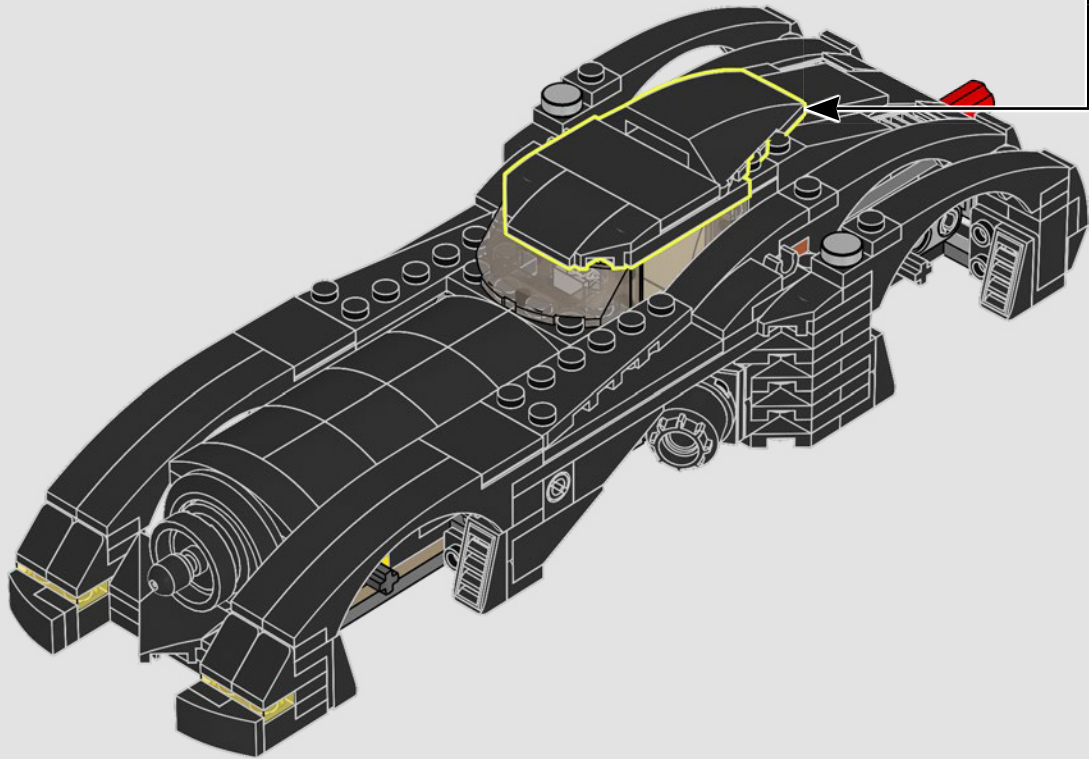

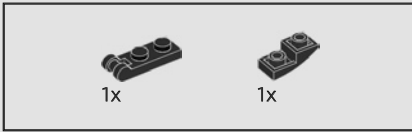
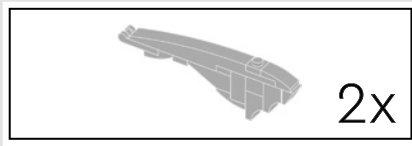

91

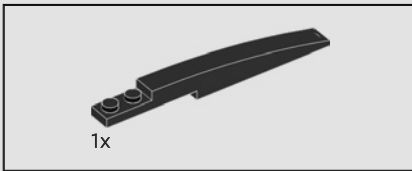
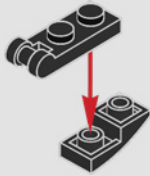

92

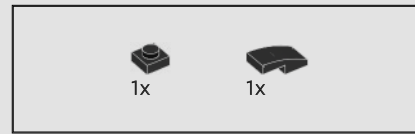
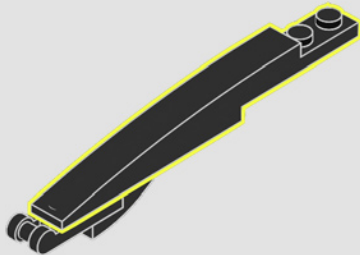

93

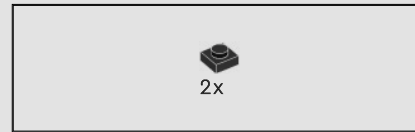
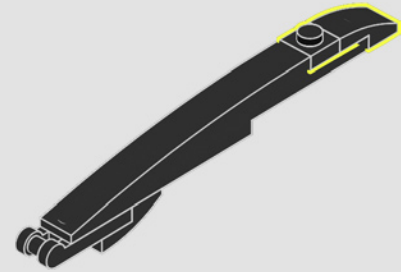

94

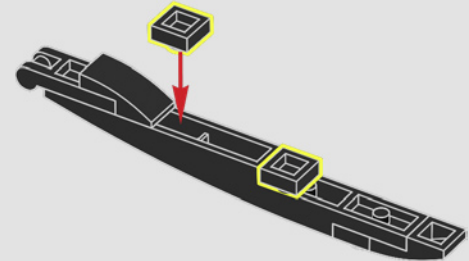
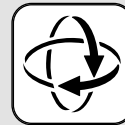

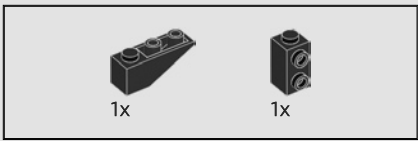

95

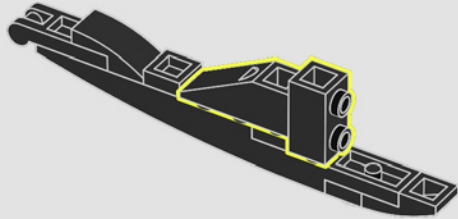

96

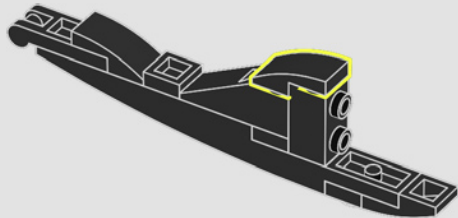

97

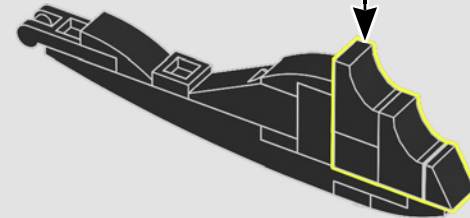
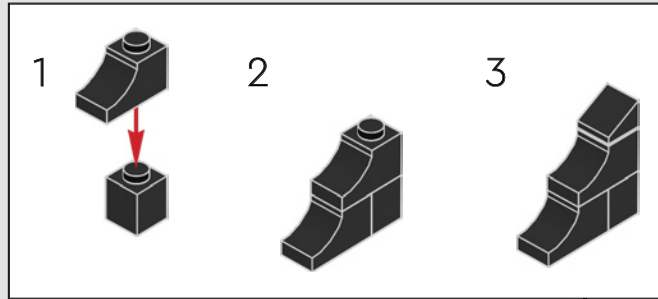

2x



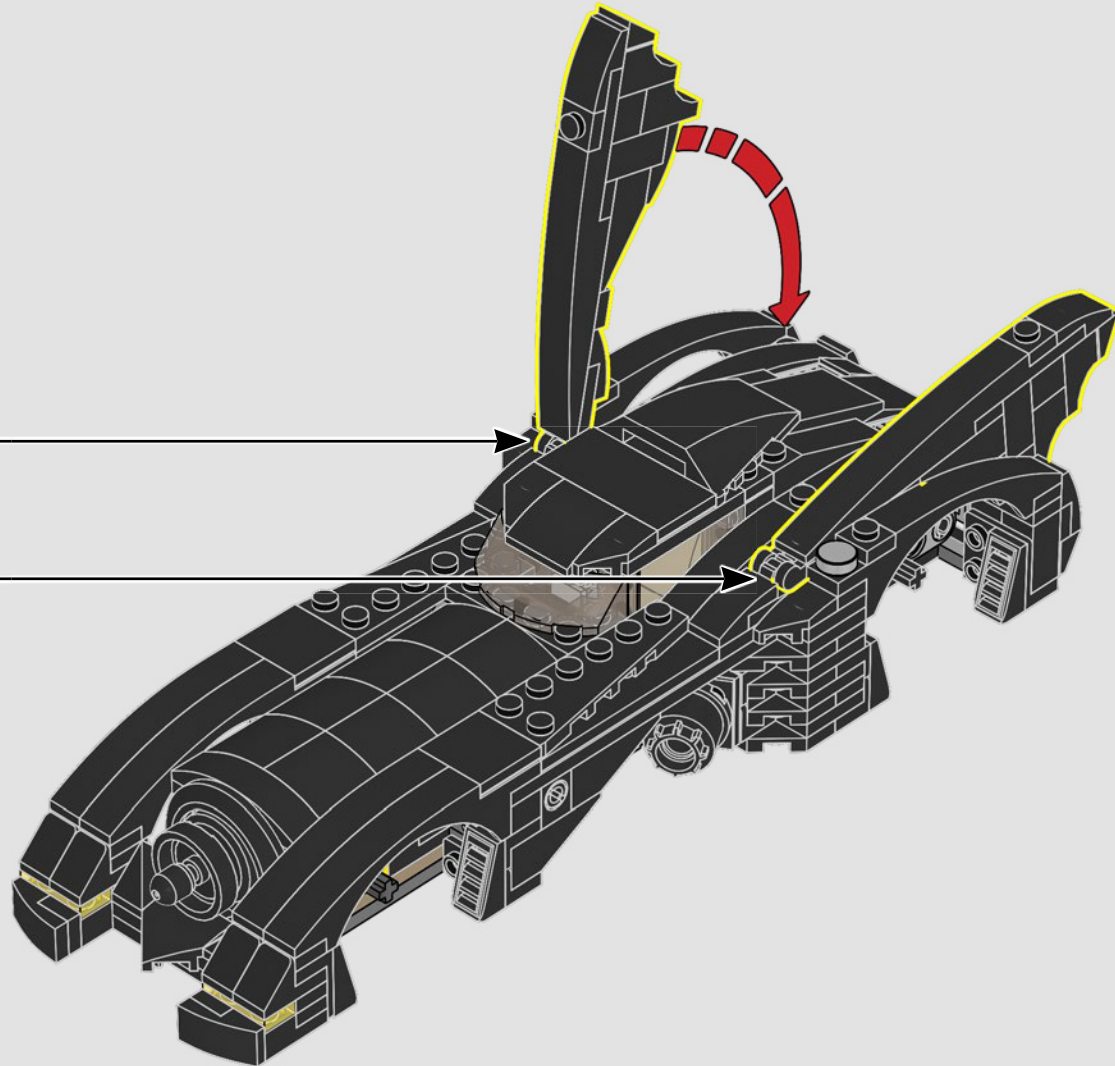

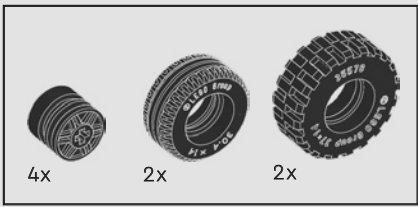

99

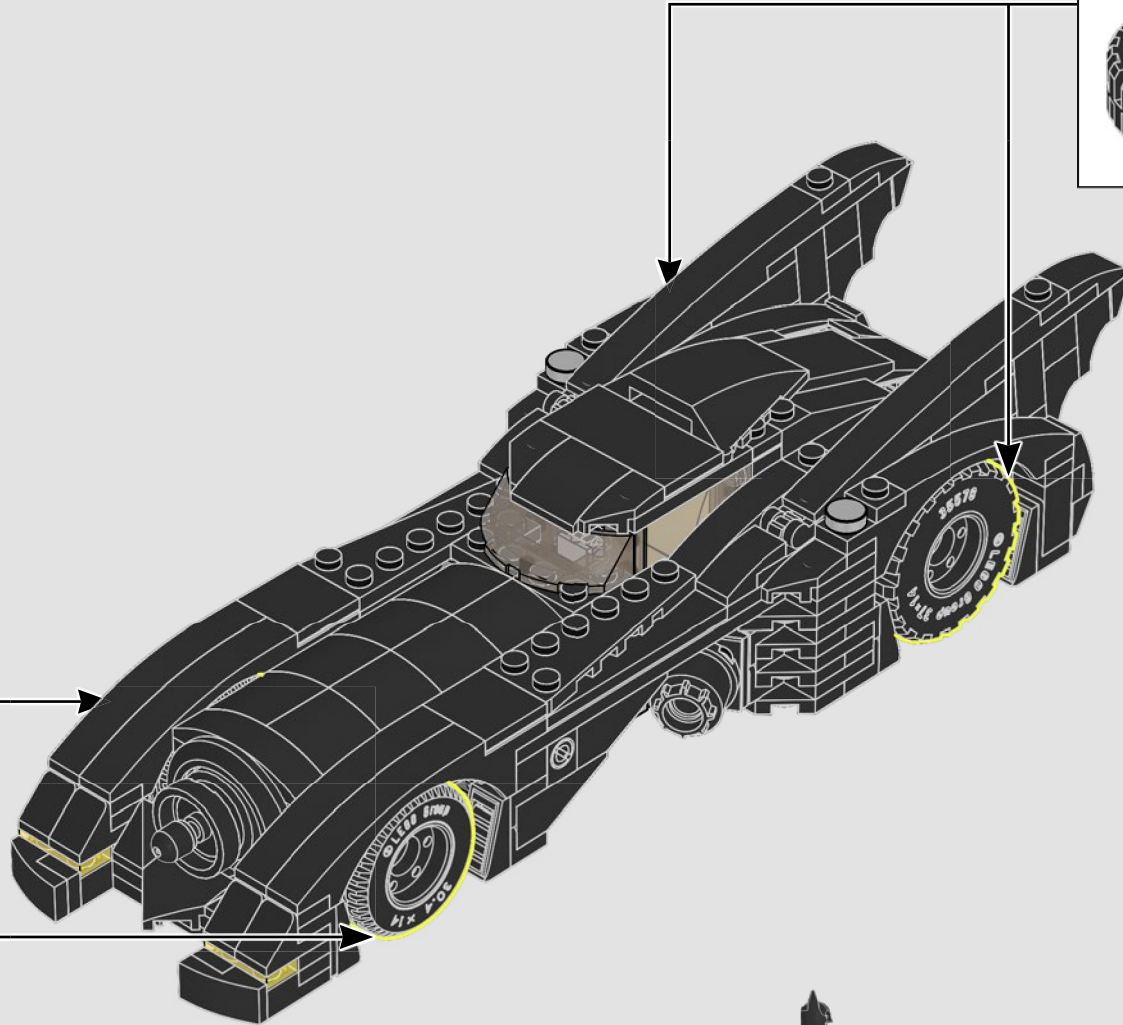
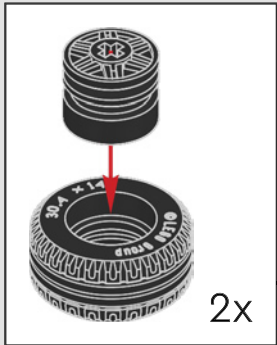
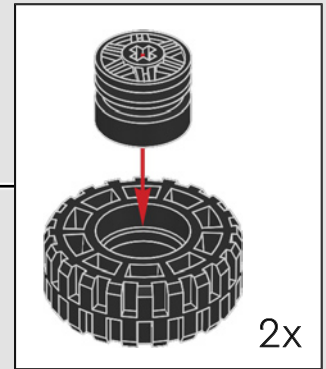

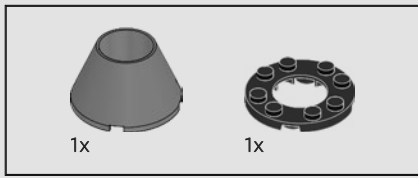

100

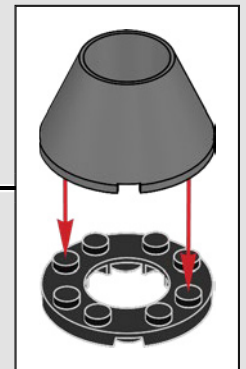
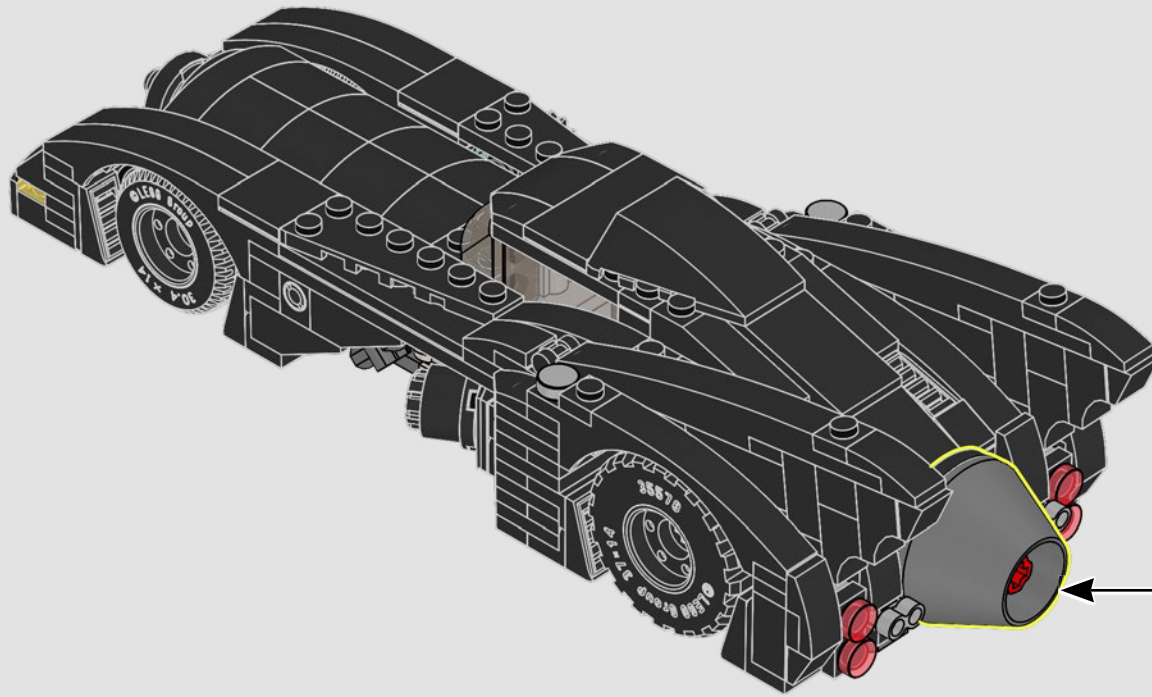



1x

101

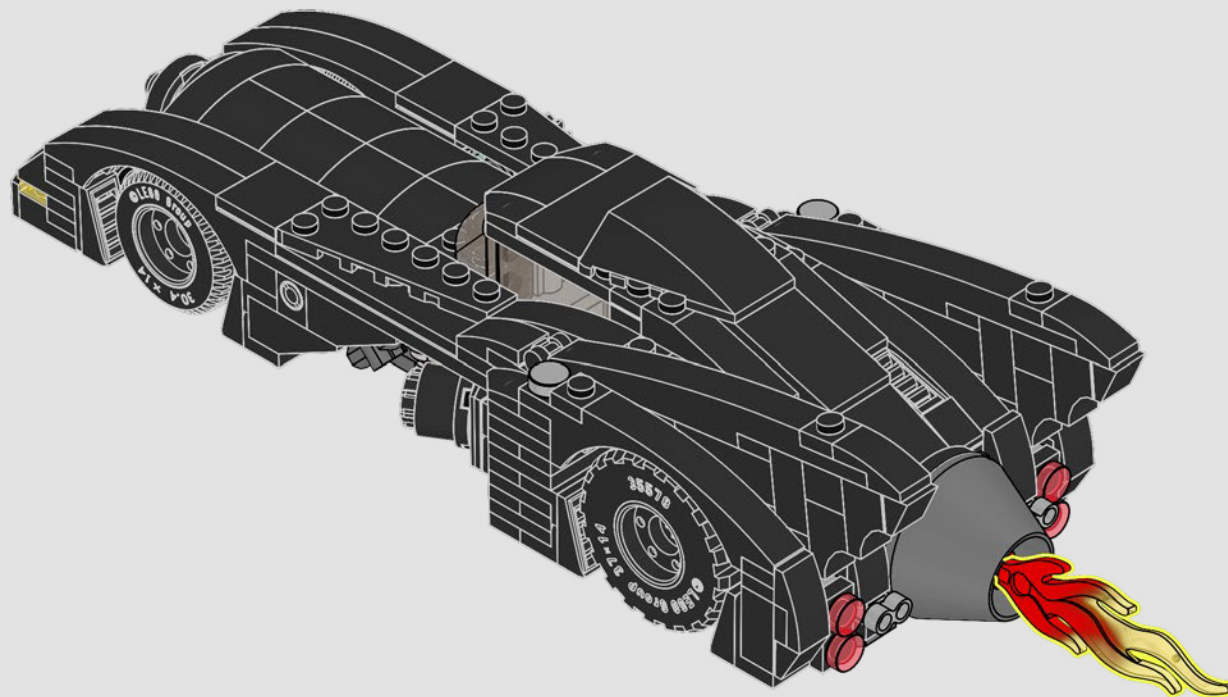

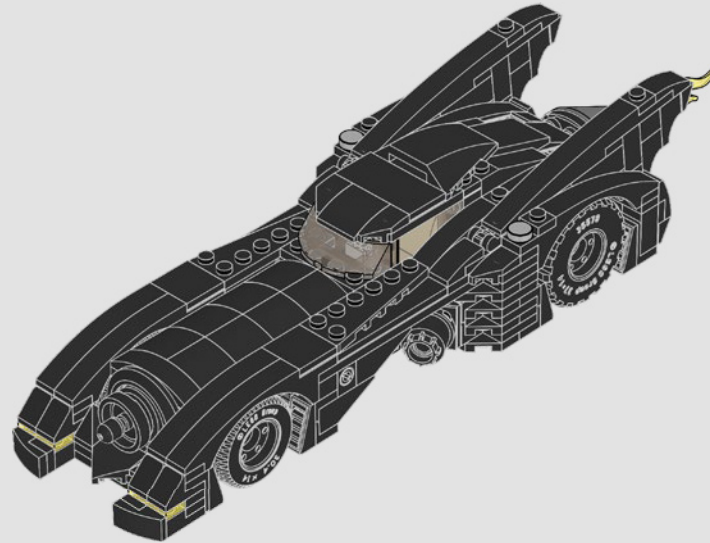

THE BATMOBILE™

You can't have the Batcave™ without the Batmobile™. Twist the lever on the passenger side to reveal and fire the hidden cannons, open the cockpit to fit the Batman™ minifigure (with the soft cape), attach the flame element and watch it spin when you drive the car.

LA BATMOBILE™

Il n'y a pas de Batcave™ sans Batmobile™. Tournez le levier du côté passager pour révéler les canons cachés et tirer, ouvrez le poste de pilotage pour y installer la figurine Batman™ (avec la cape souple), fixez l'élément flamme et regardez-le tourner lorsque vous conduisez la voiture.

EL BATIMÓVIL

No puedes tener una Baticueva sin Batimóvil. Gira la palanca del lado del pasajero para revelar y disparar los cañones ocultos; abre la cabina para colocar la minifigura de Batman™ (con la capa blanda), acopla el elemento que representa fuego y míralo girar cuando conduzcas el auto.

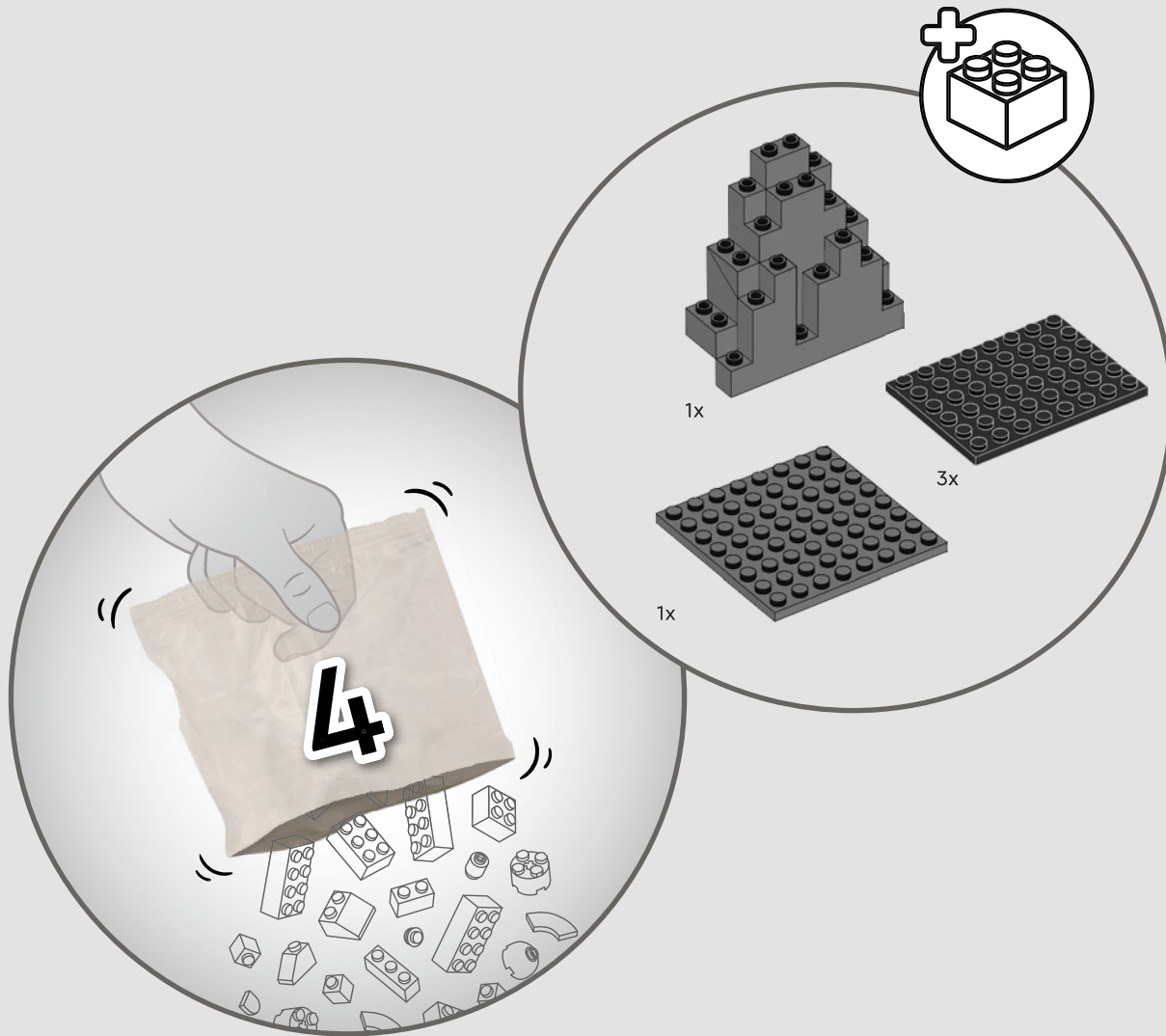

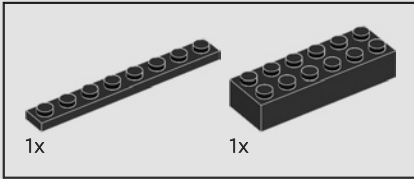
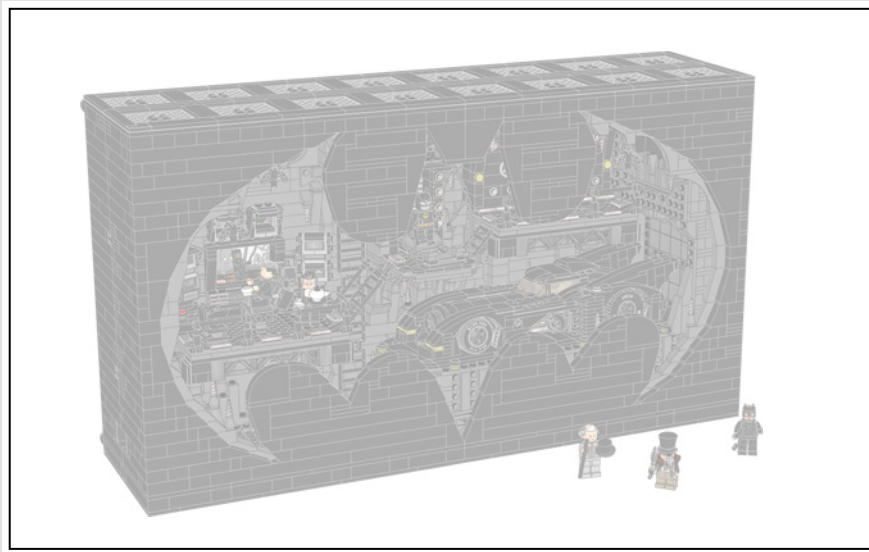

102

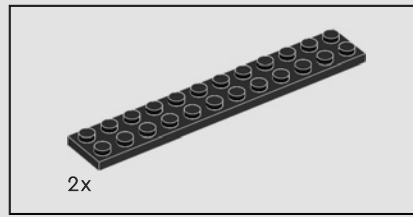
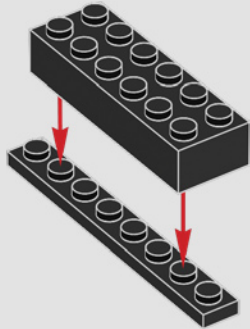

103

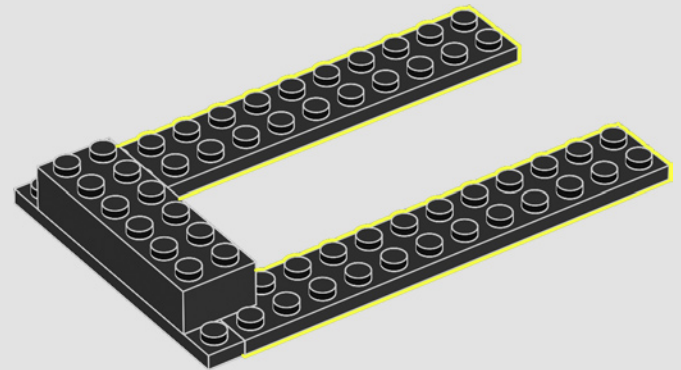

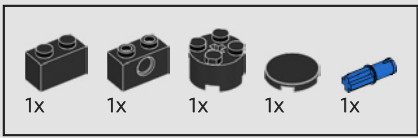

104

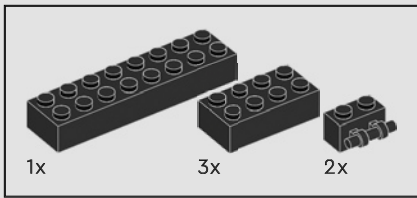
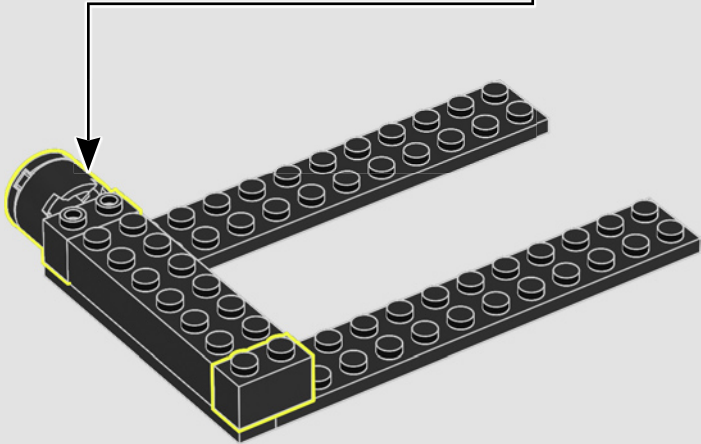
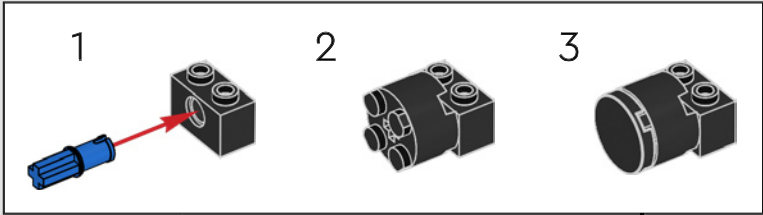

105

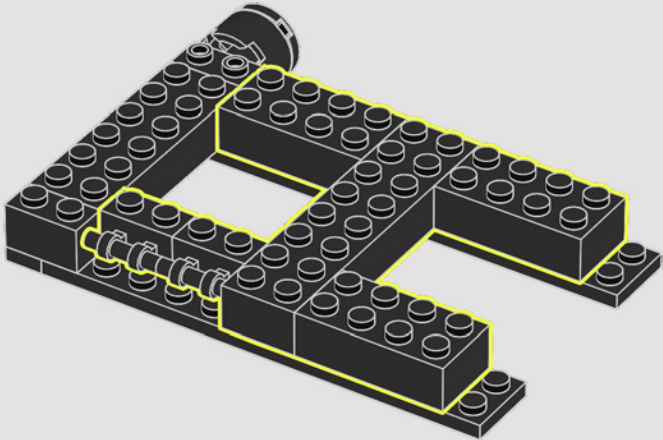

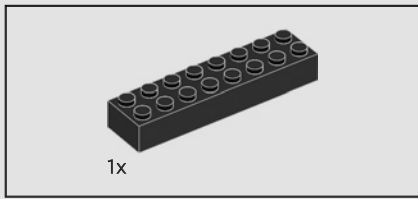

106

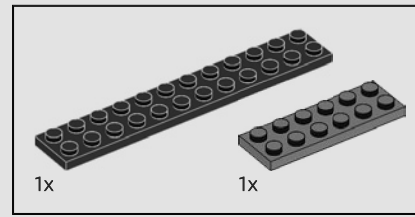
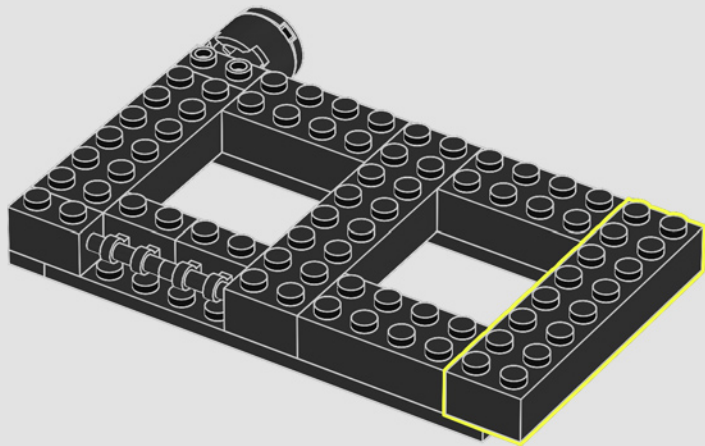

107

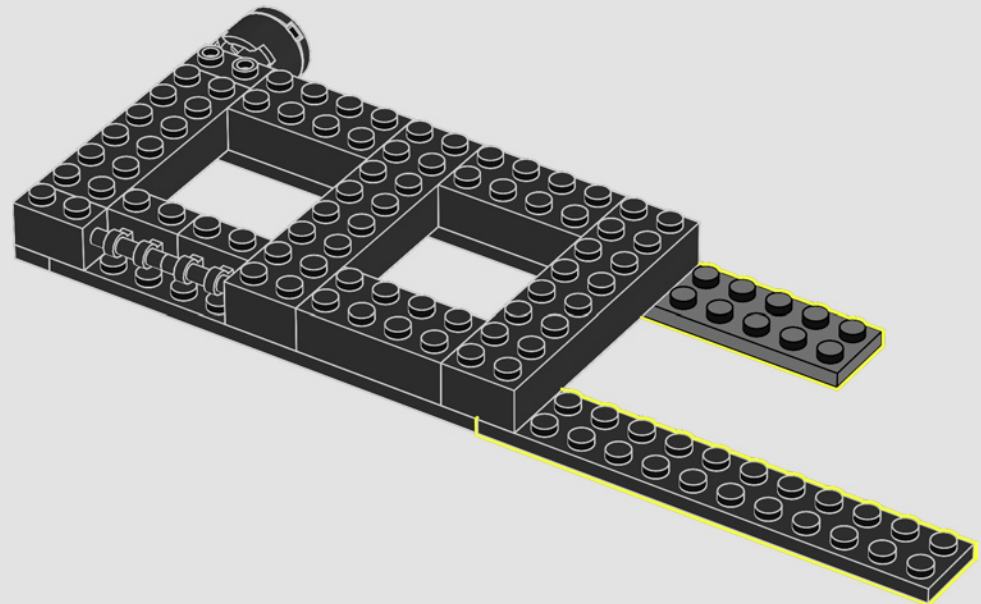

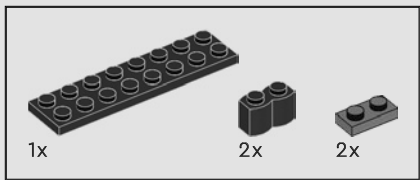

108

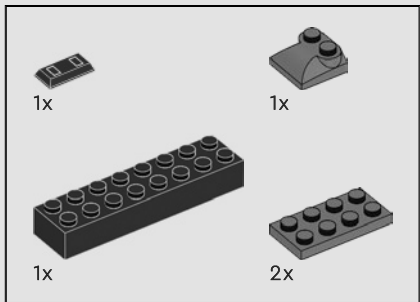
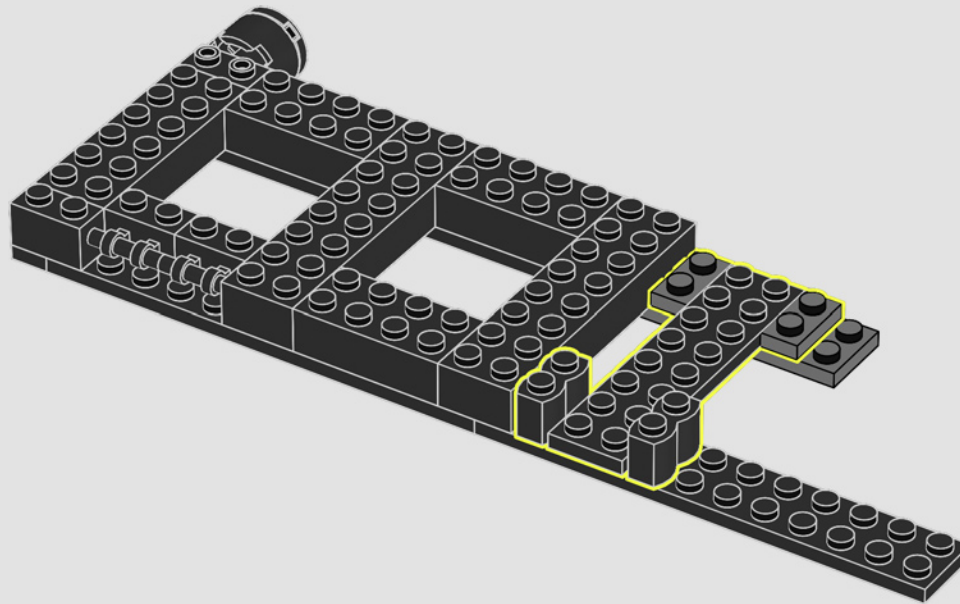

109

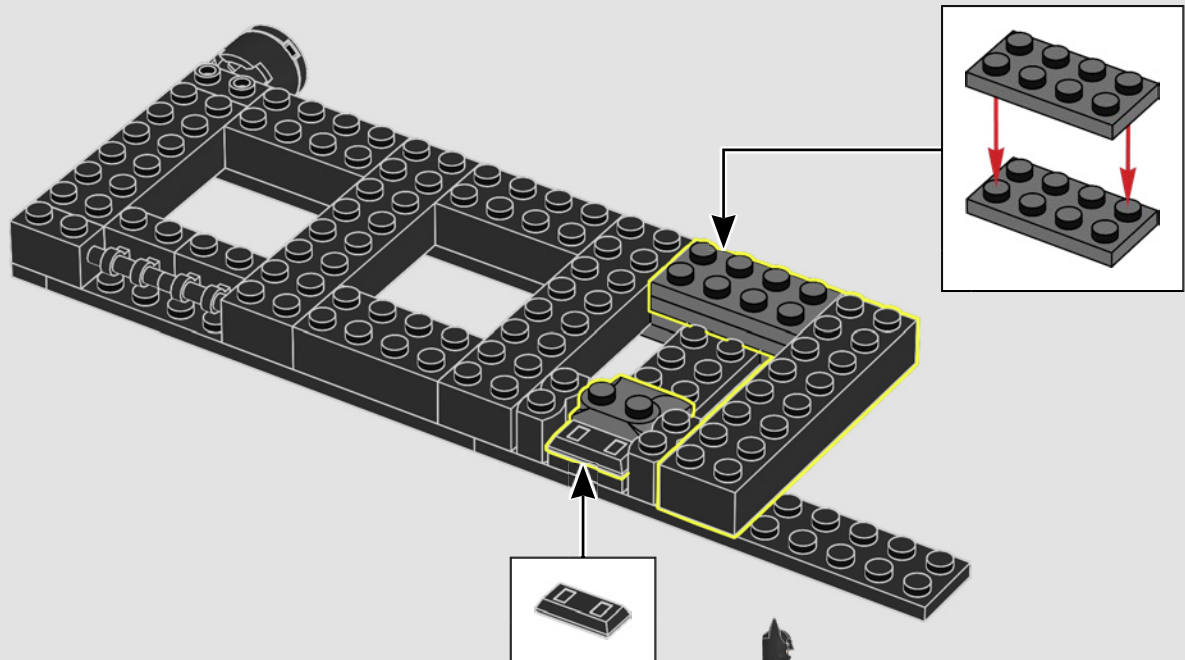

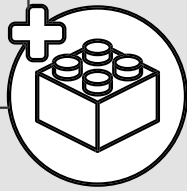
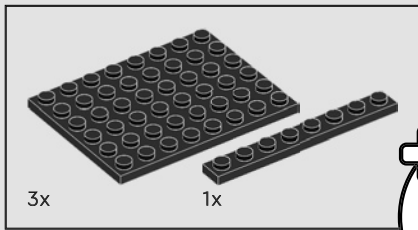

110

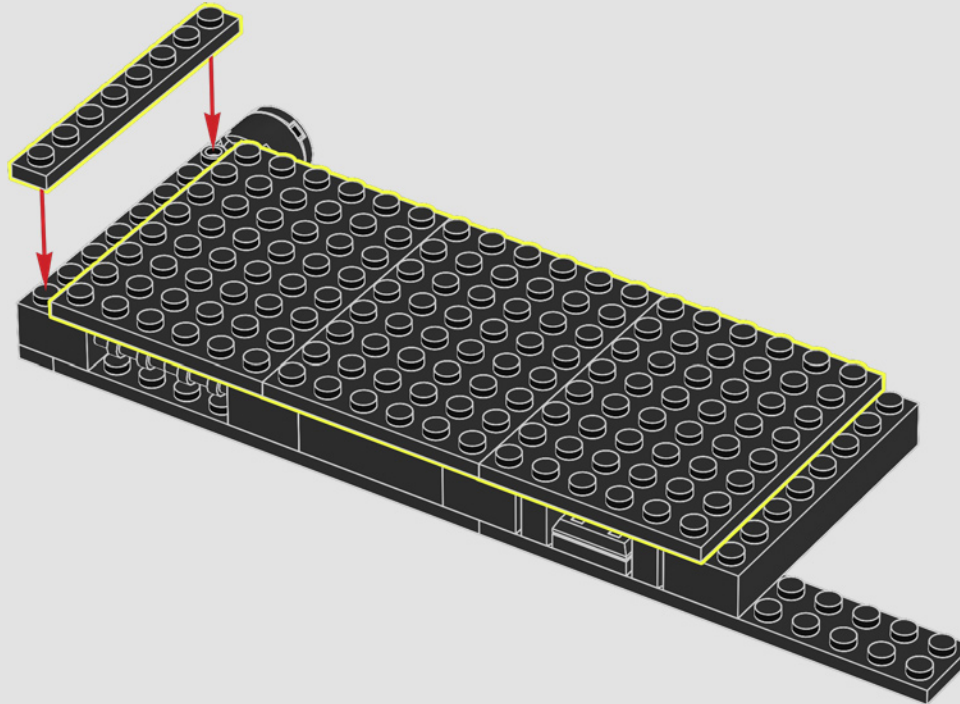

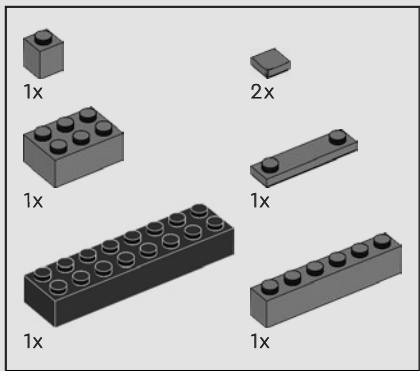

111

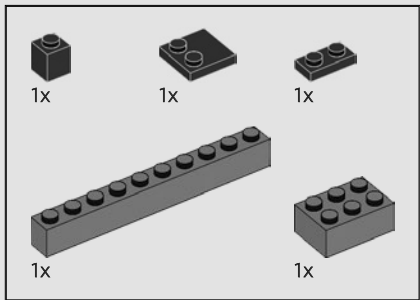
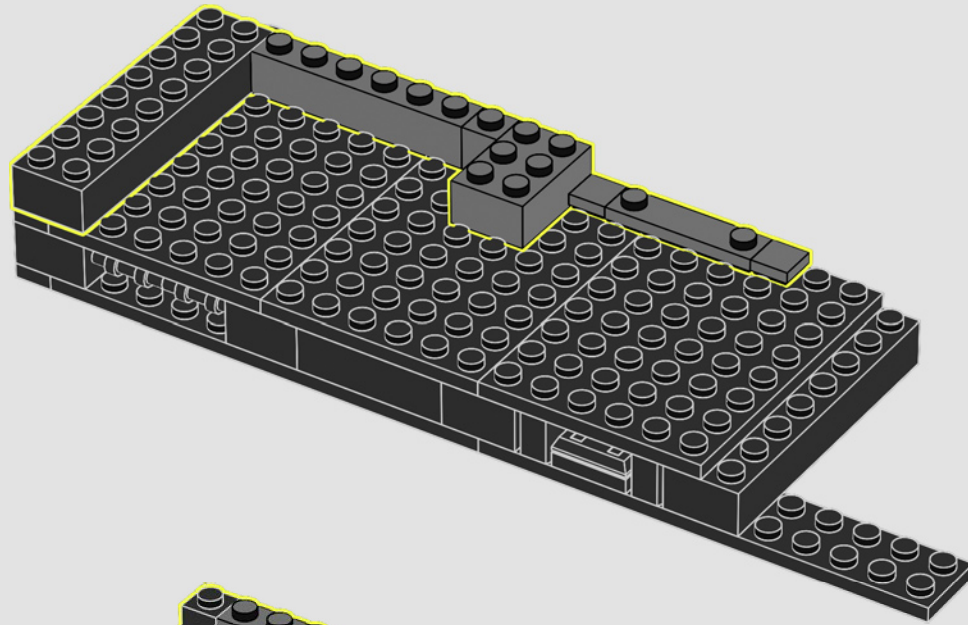

112

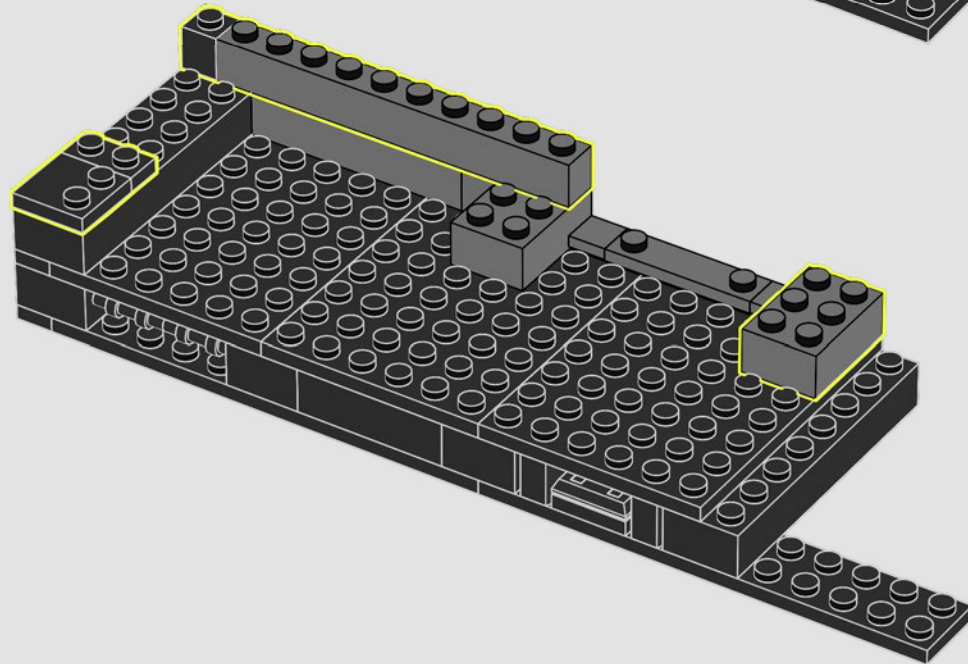

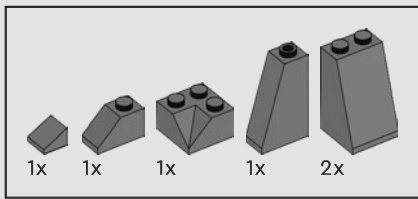

113

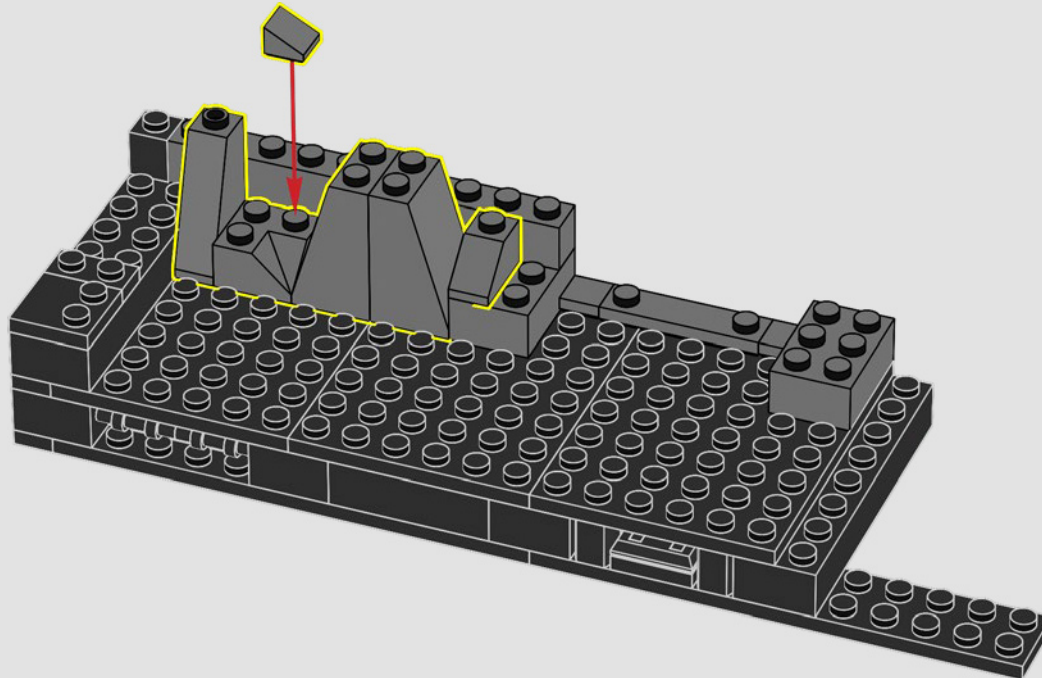

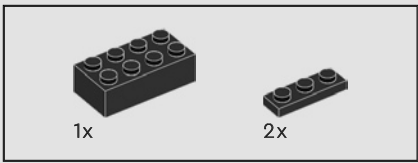

114

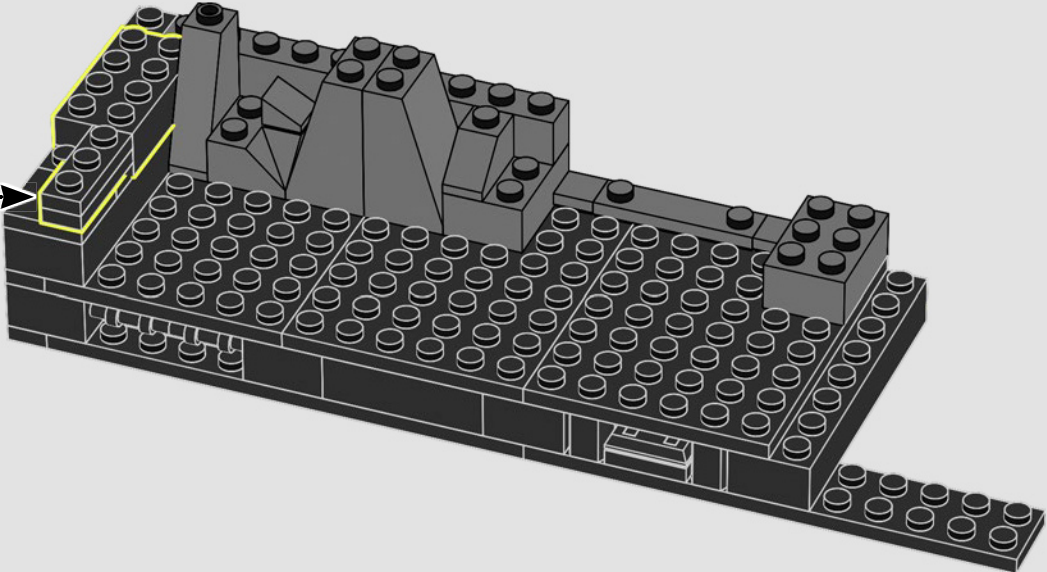
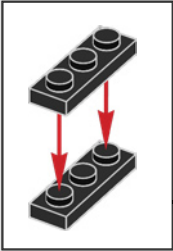

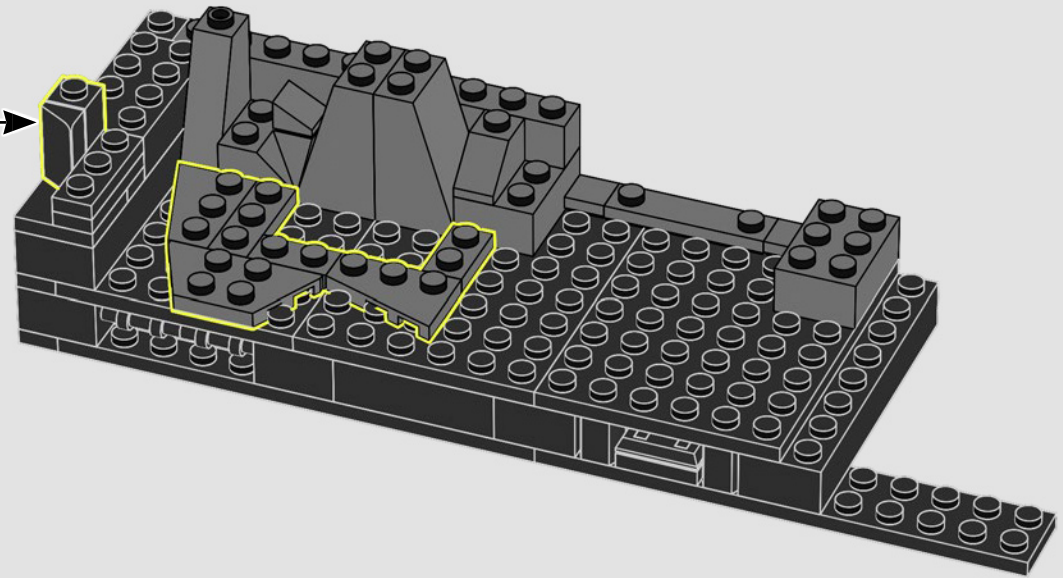
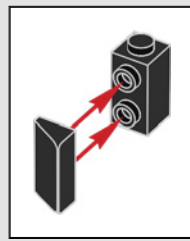
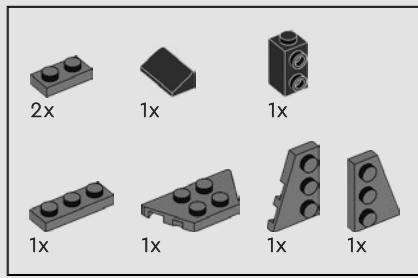

115

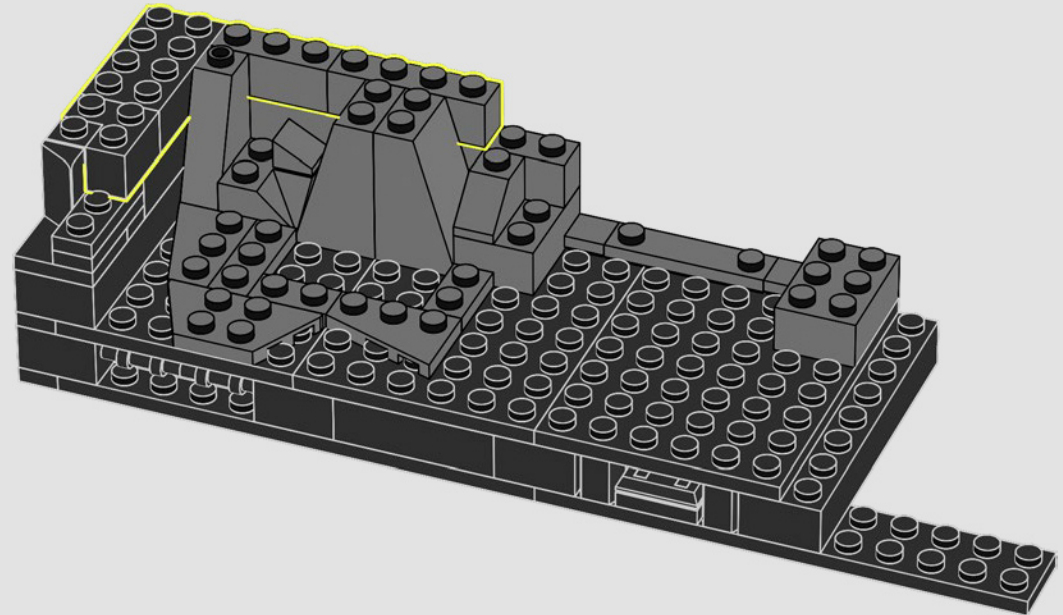
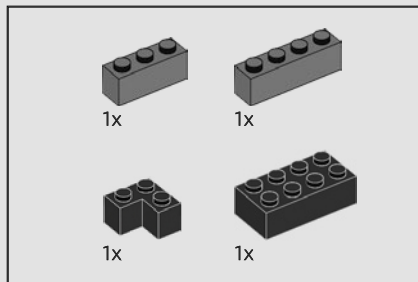

116

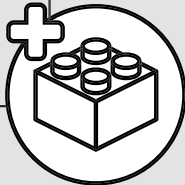
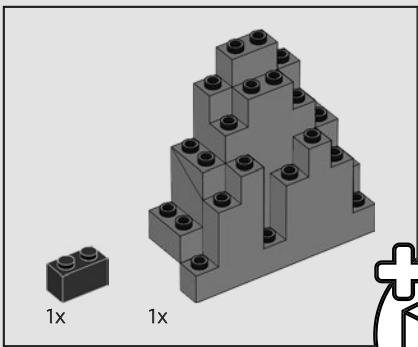

117

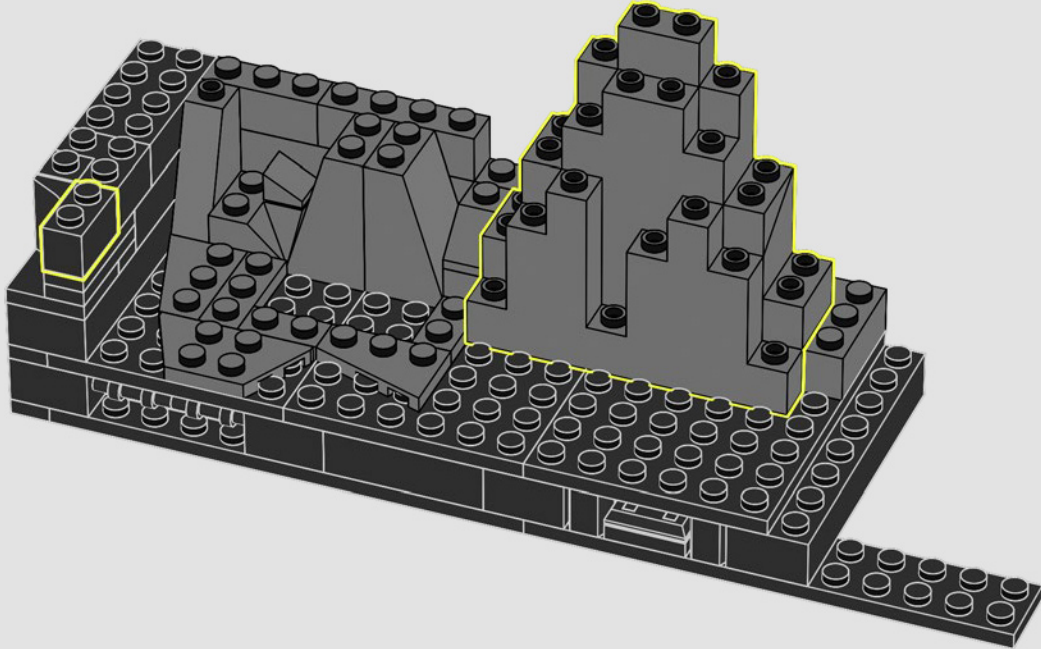

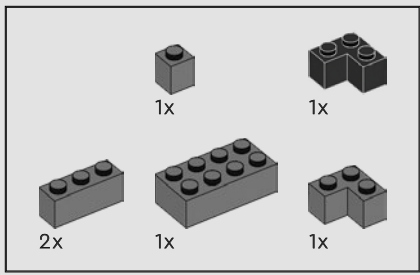

119

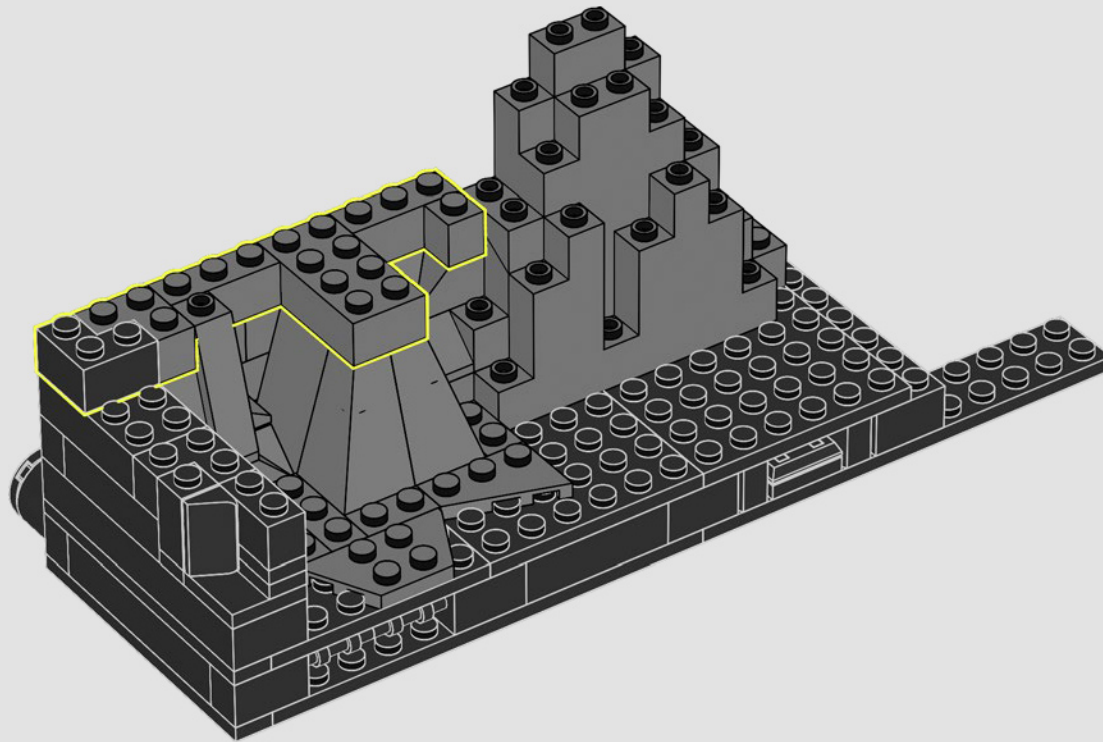

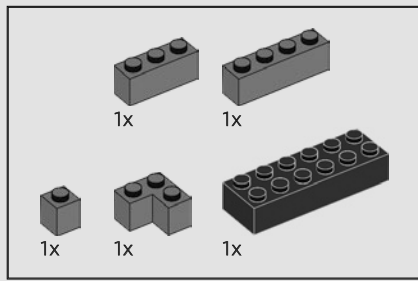

120

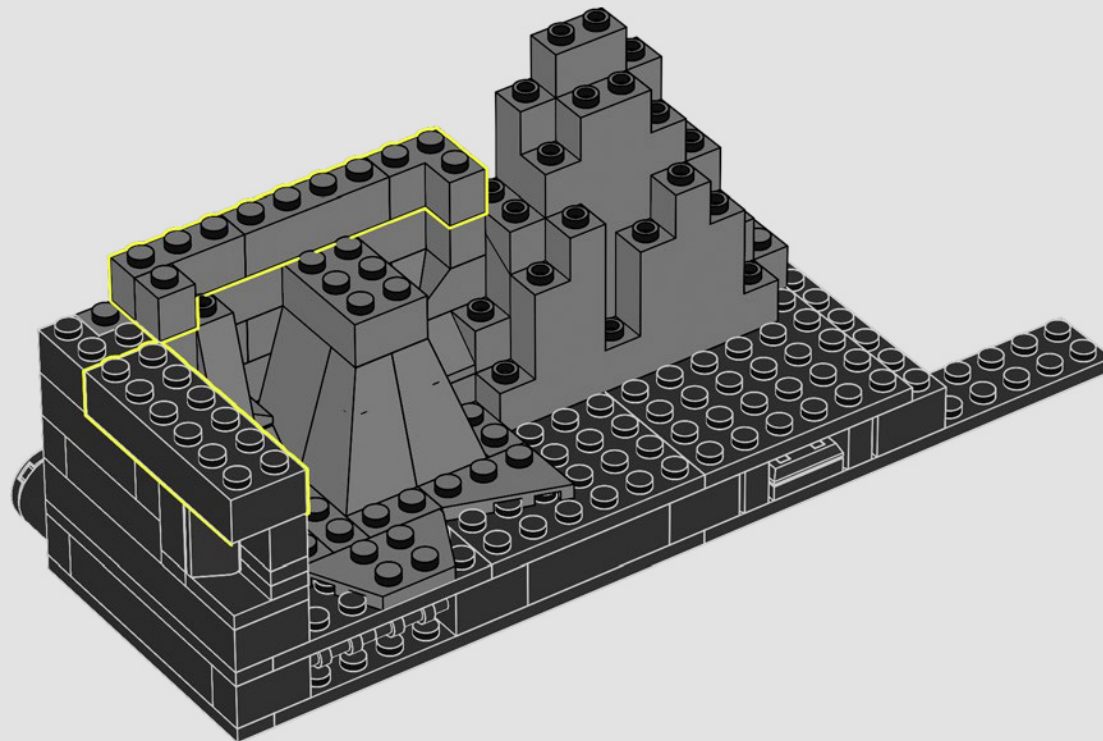

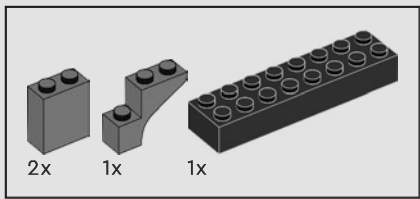

121

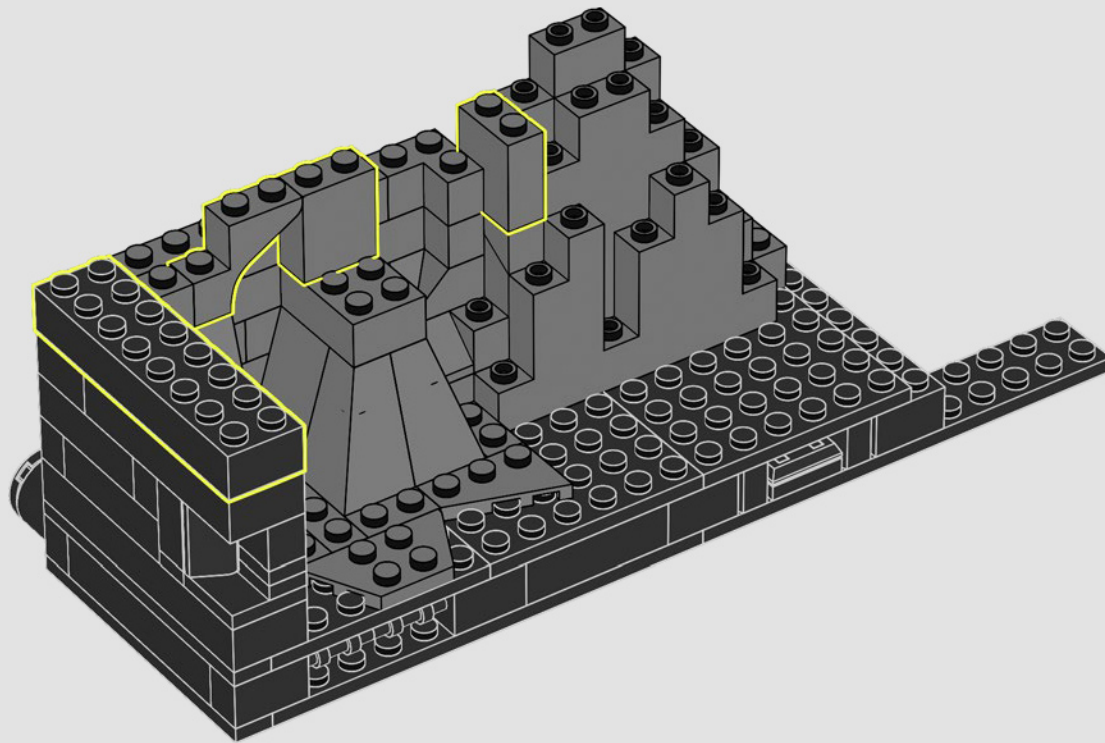

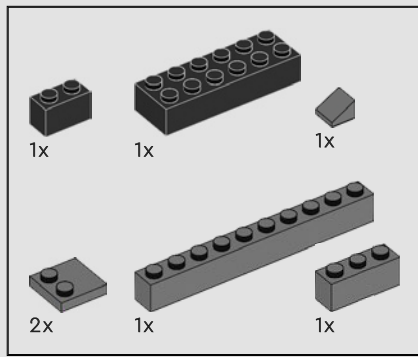

122

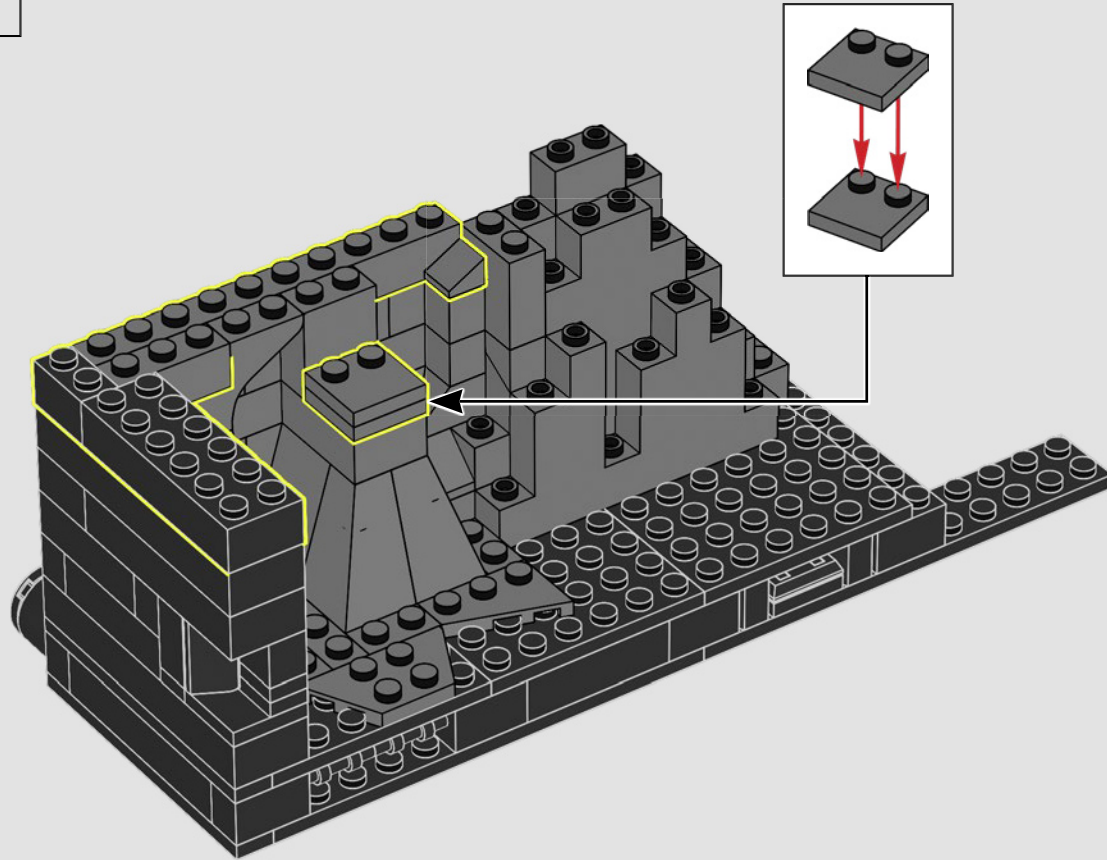

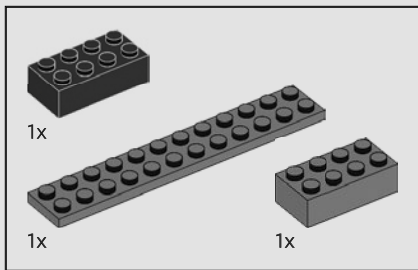

123

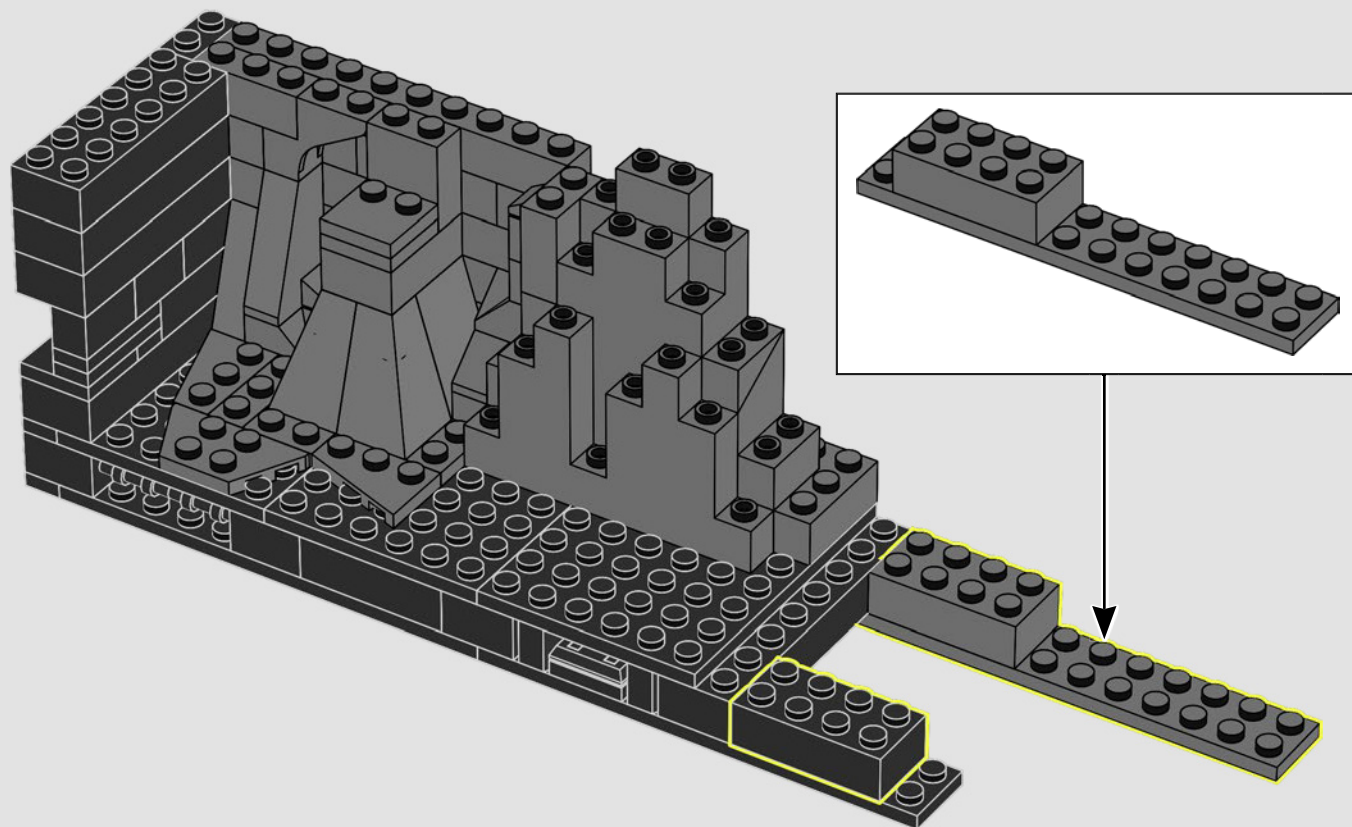

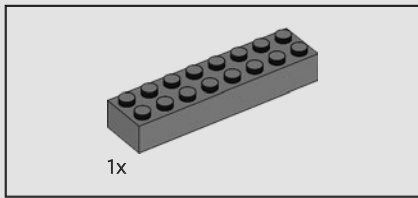

124

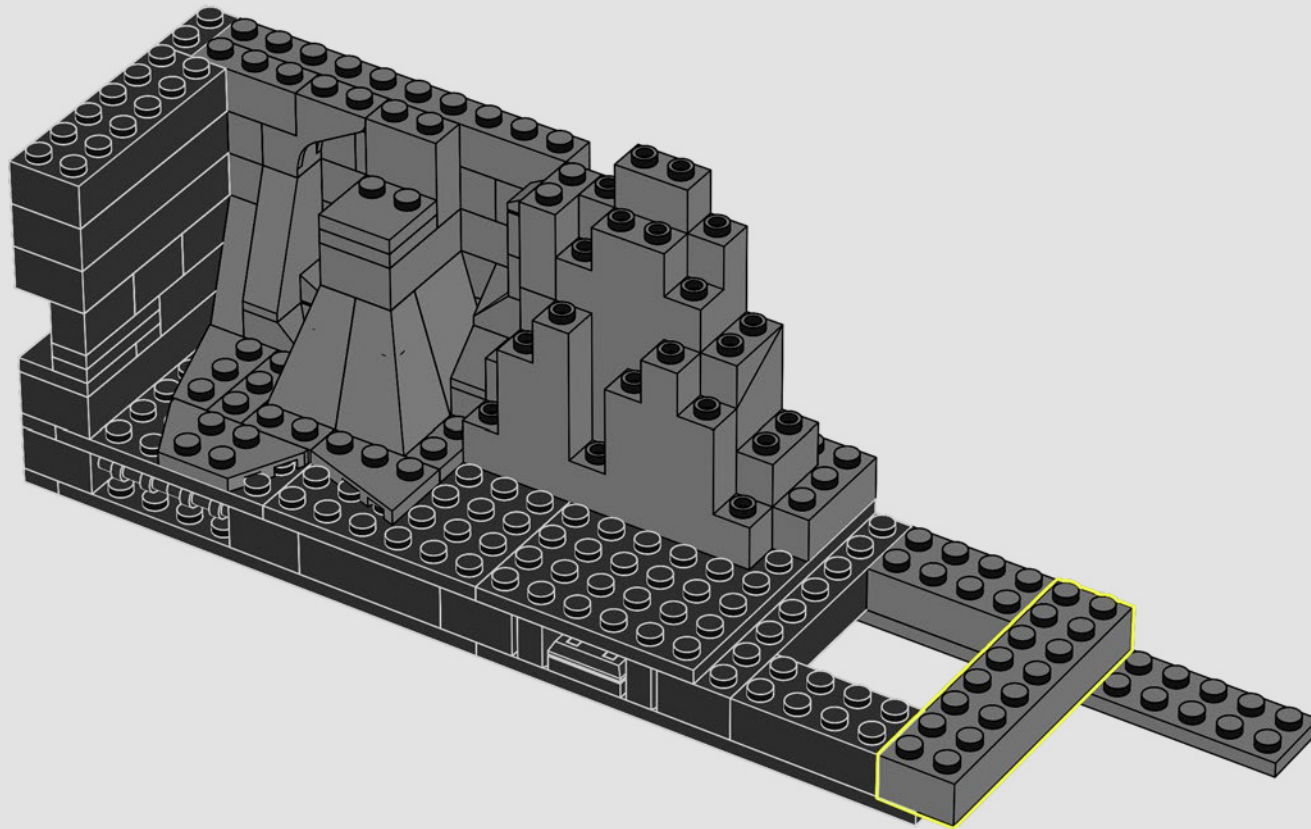

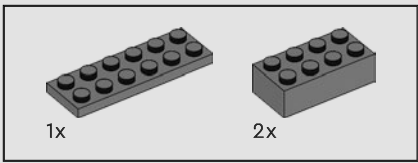

125

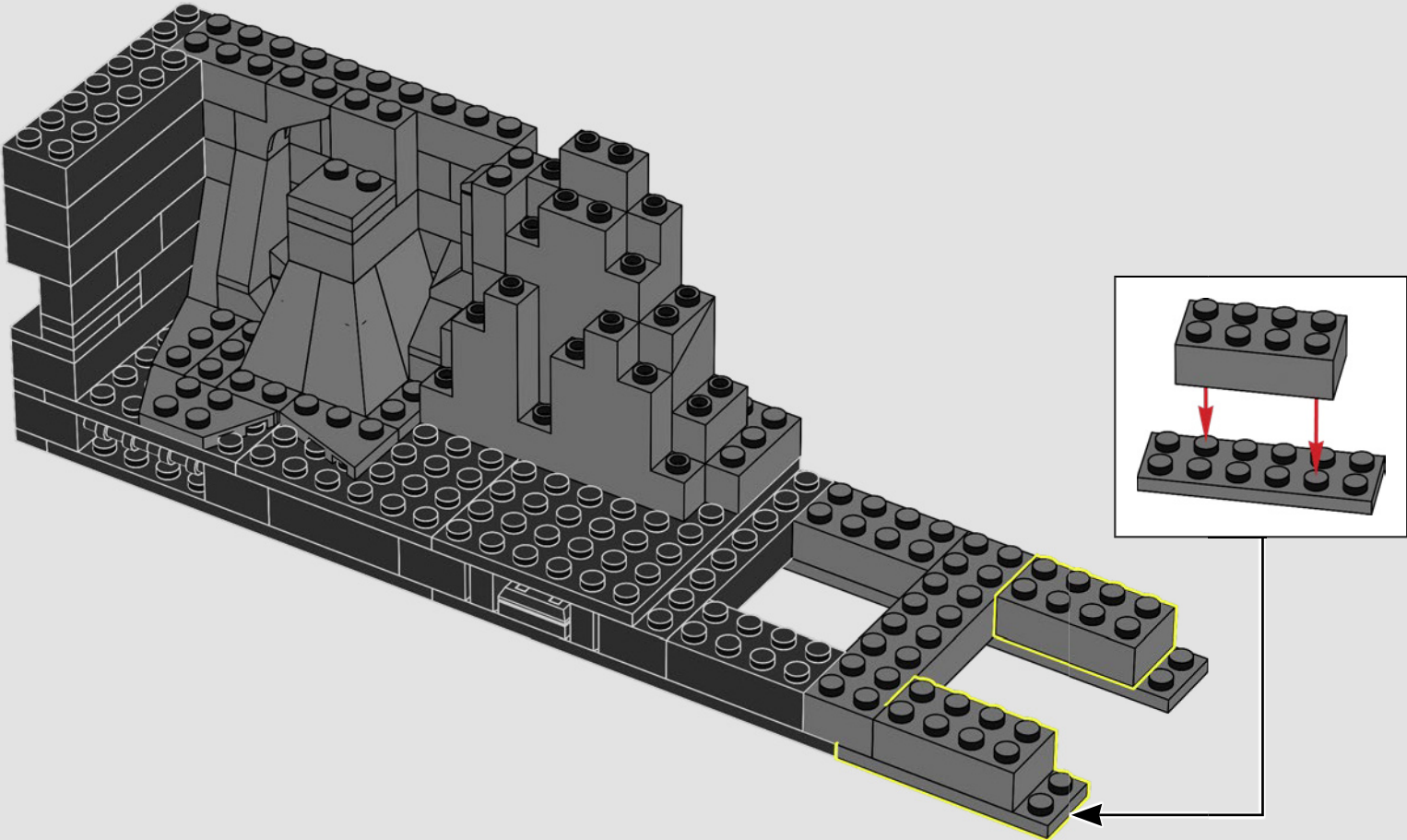

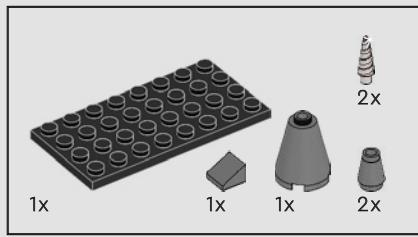

126

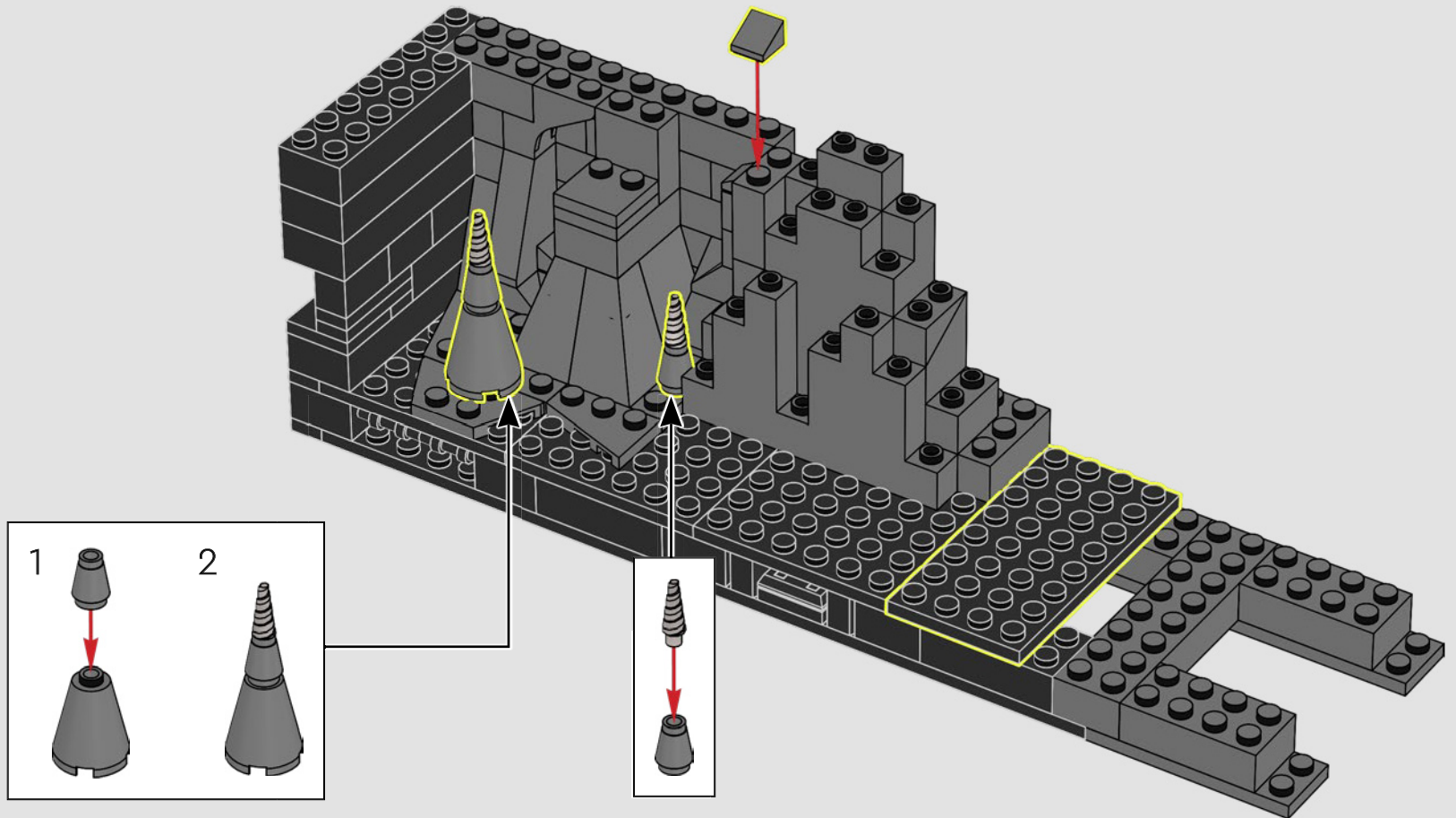

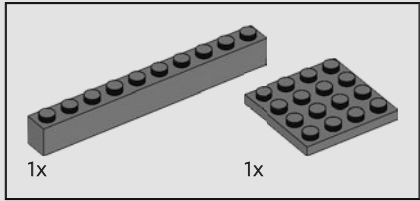
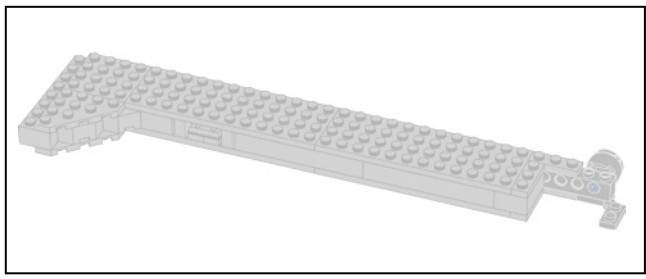

127

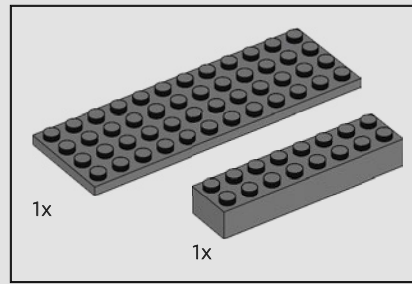
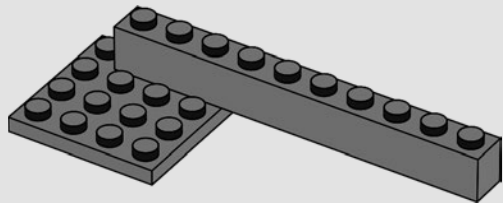

128

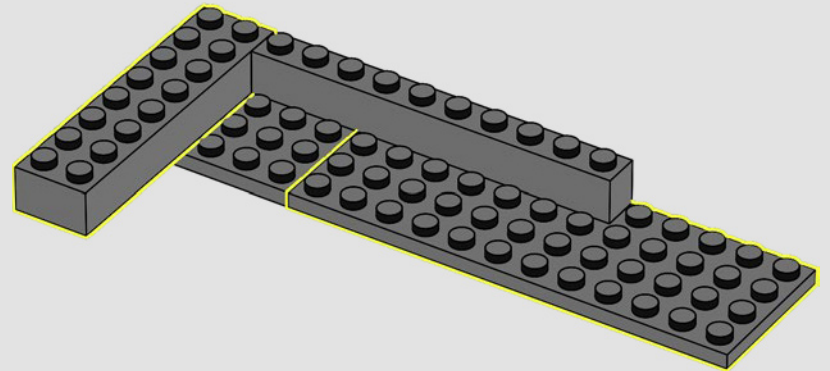

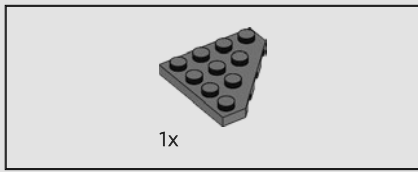

129

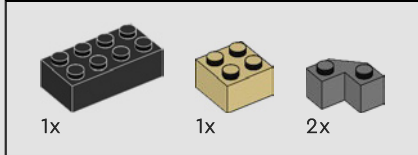
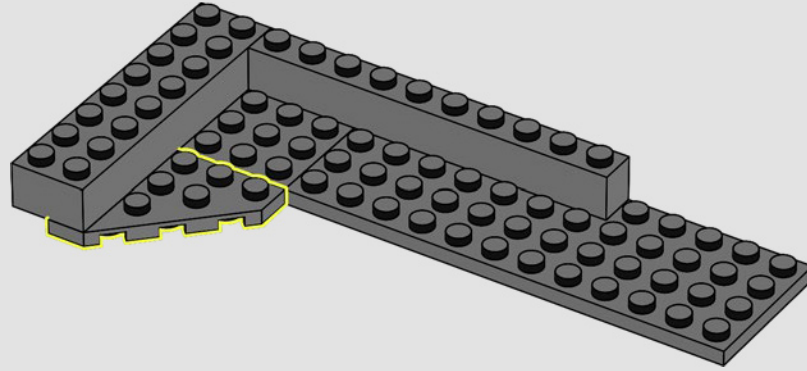

130

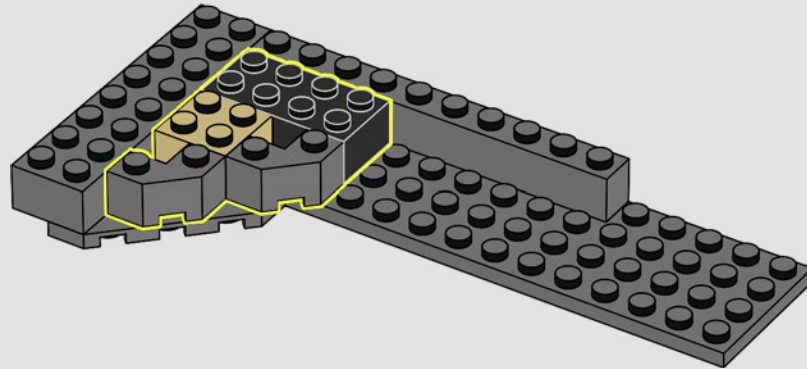

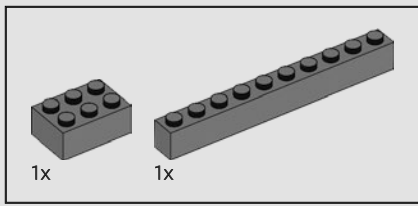

131

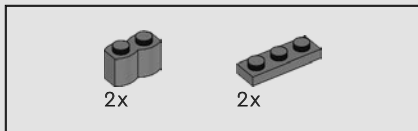
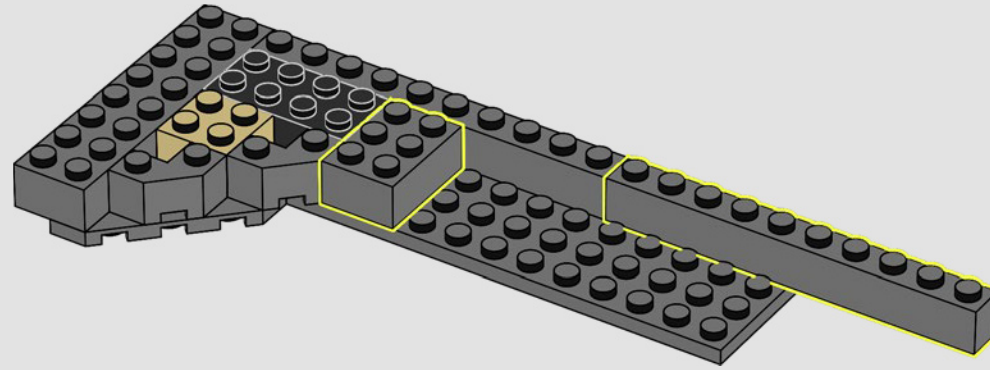

132

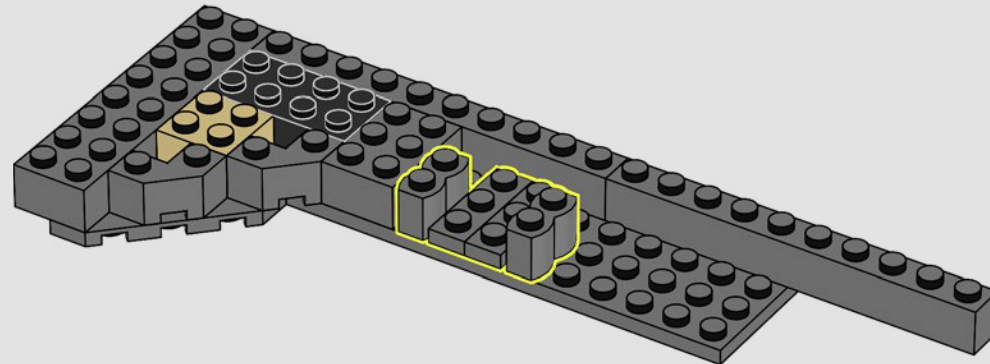

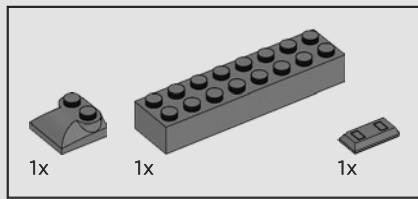

133

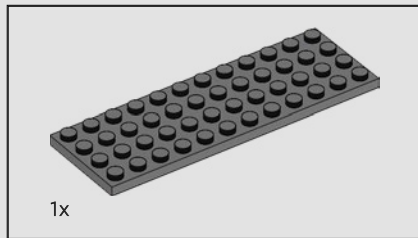
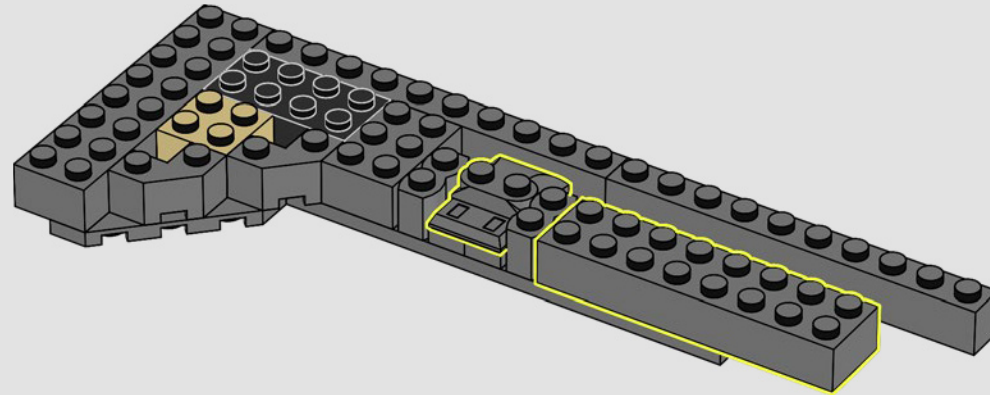

134

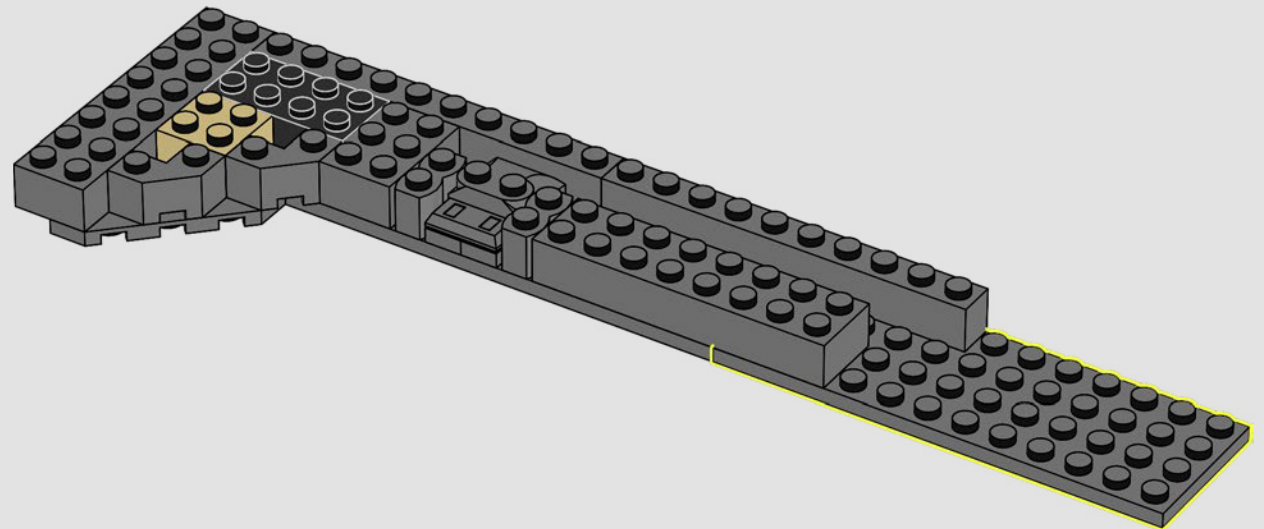

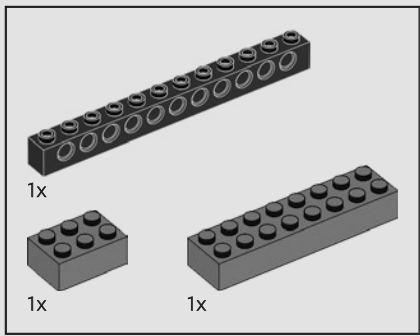

135

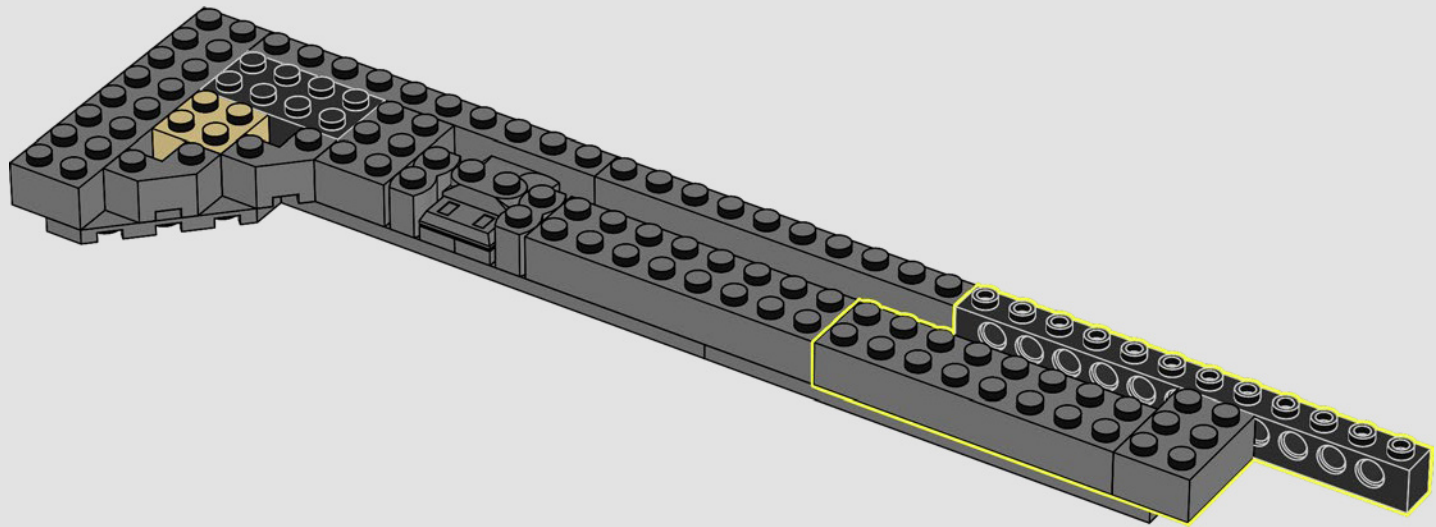

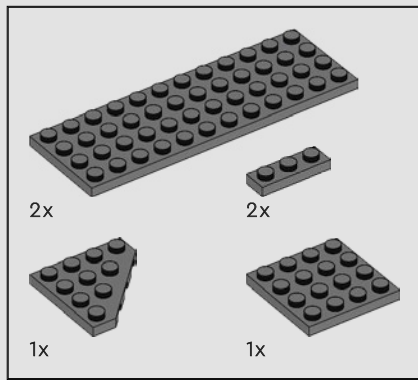

136

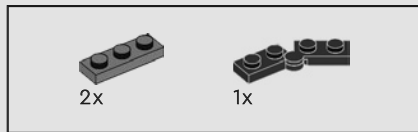
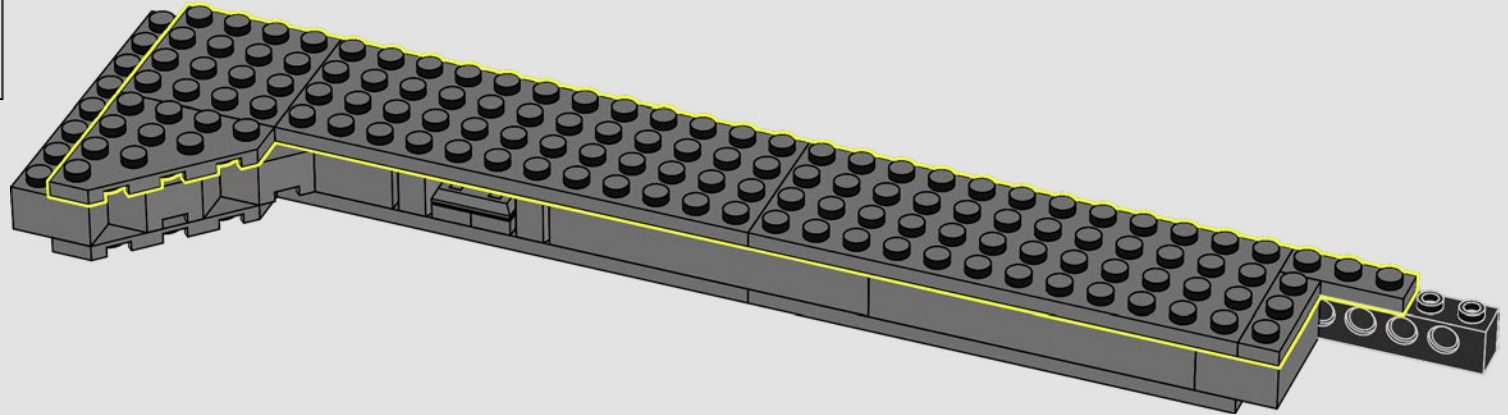

137

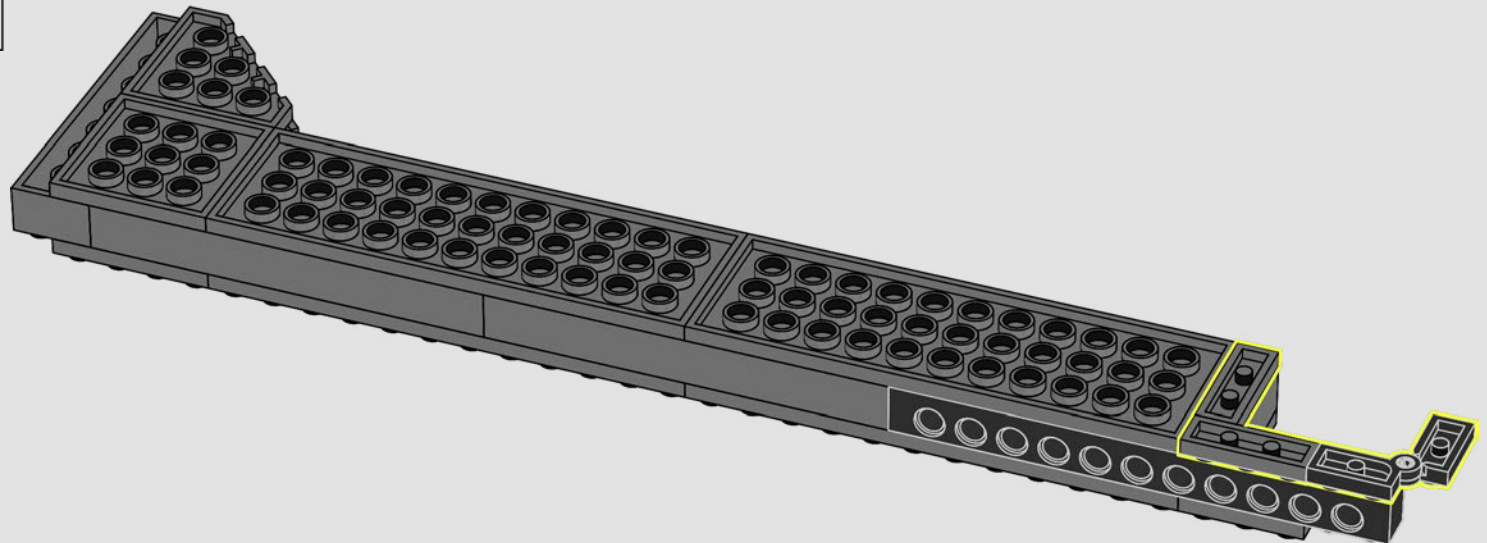

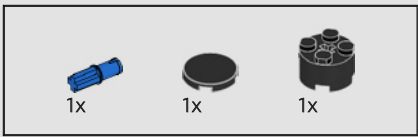

138

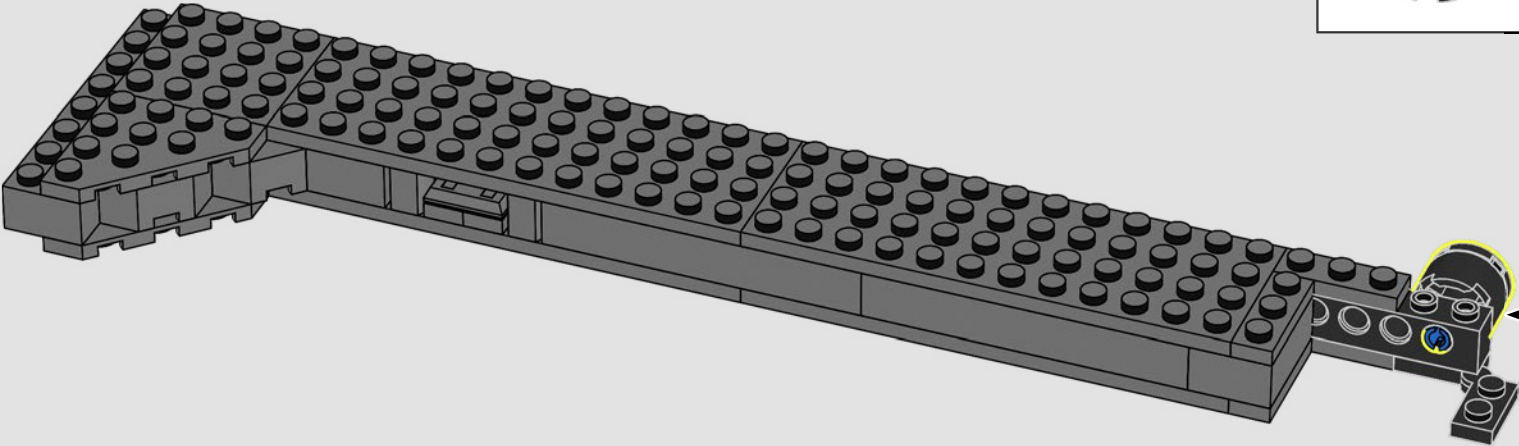
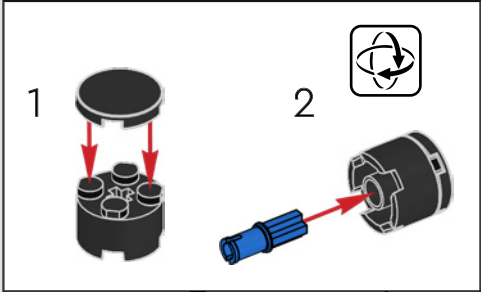

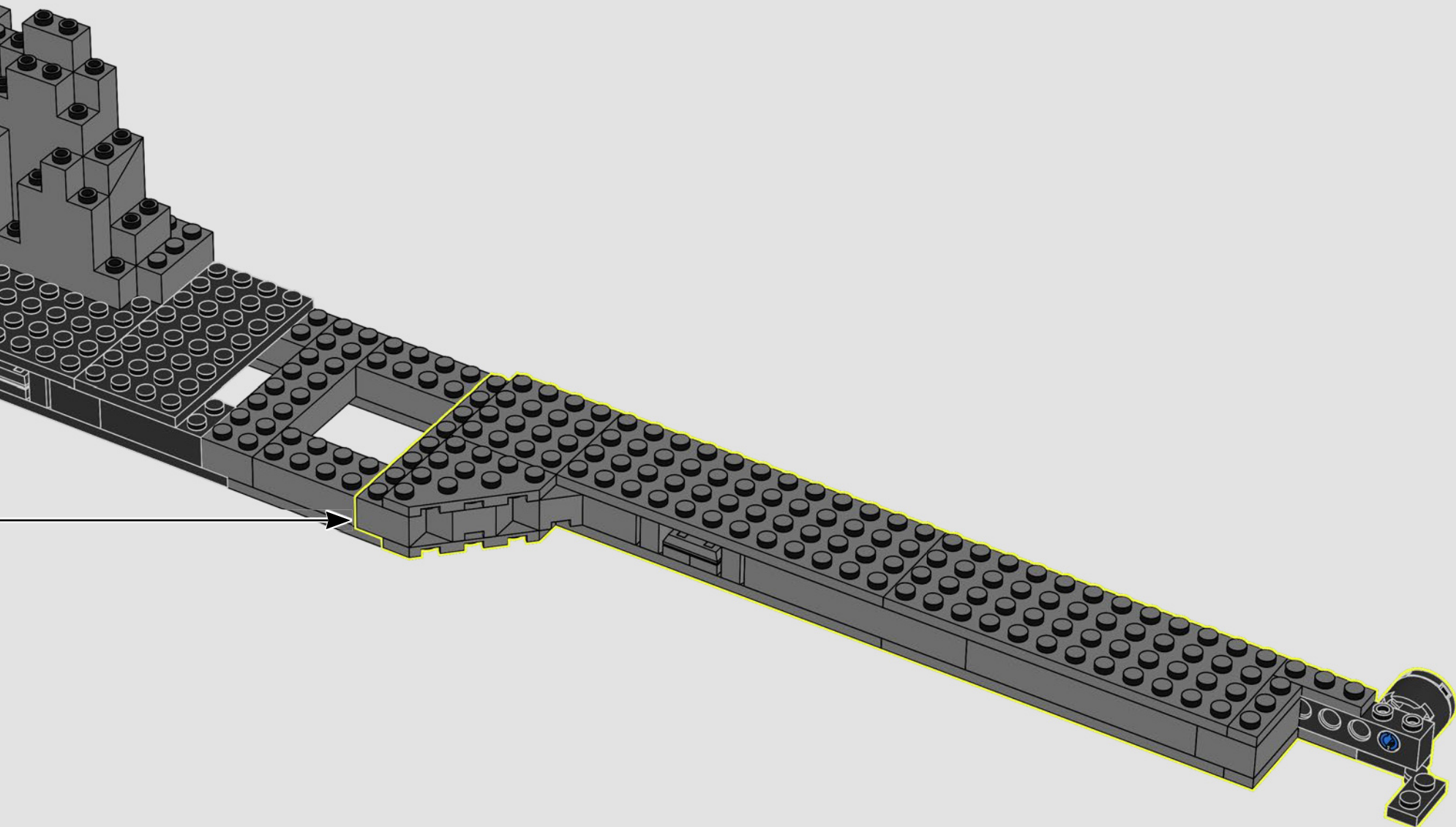

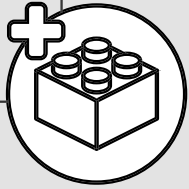
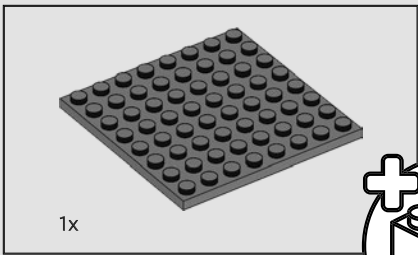

140

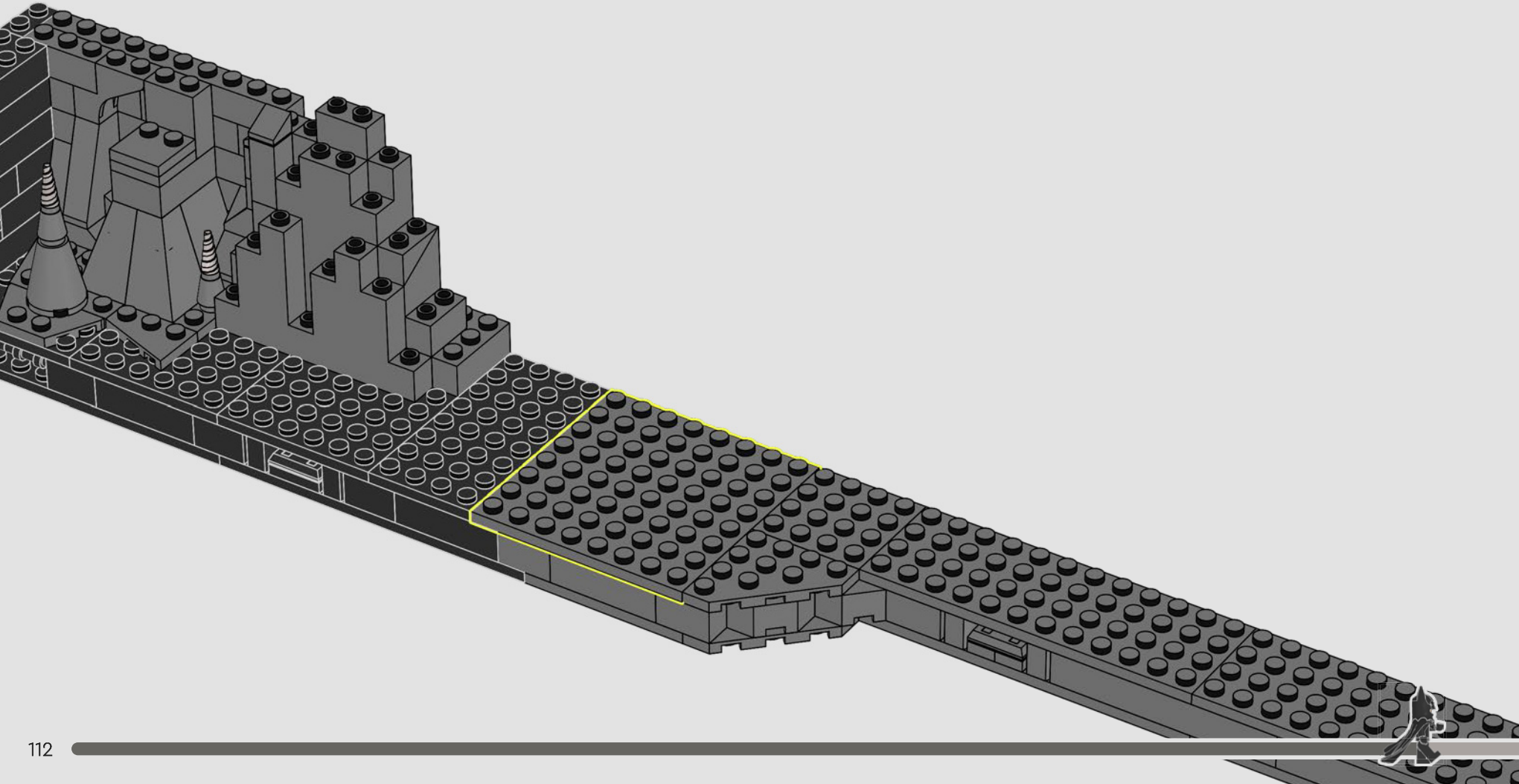



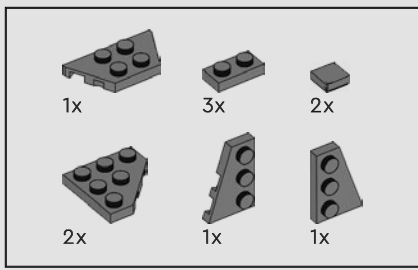

141

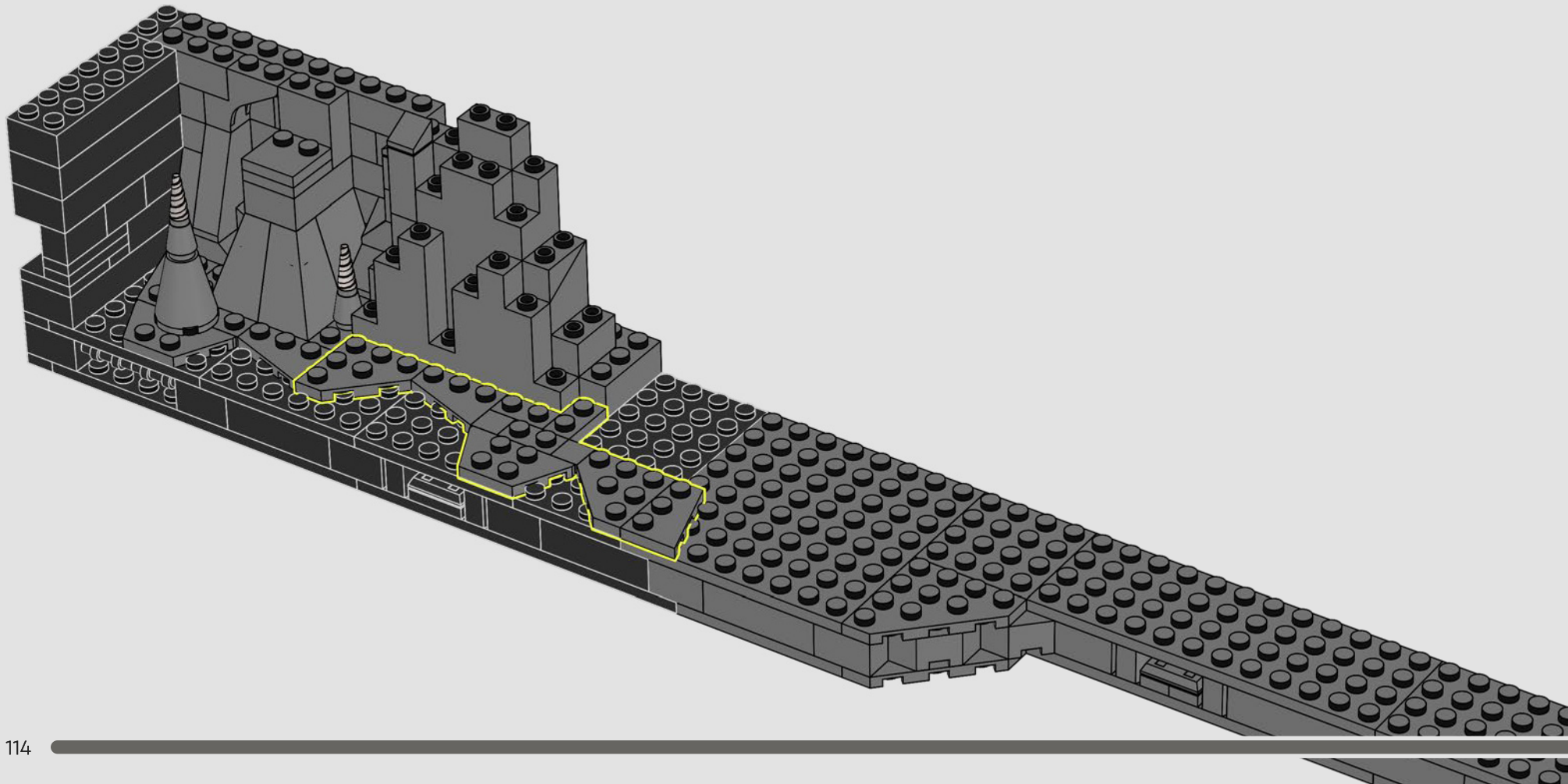

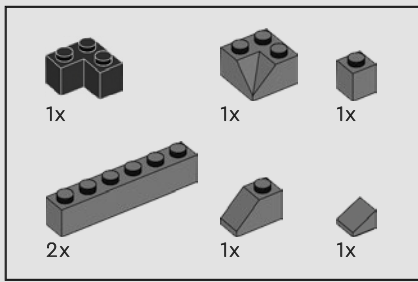

142

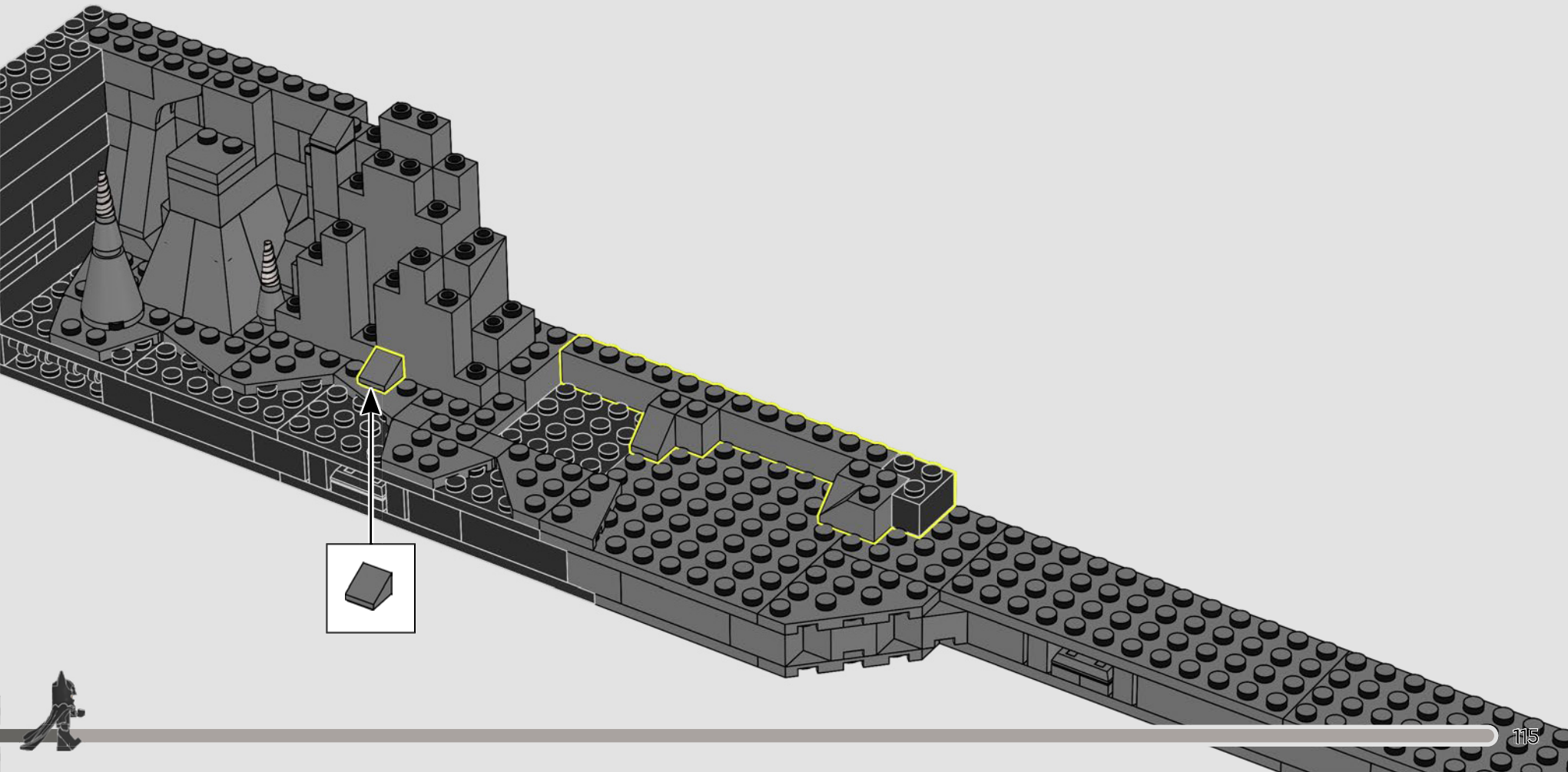

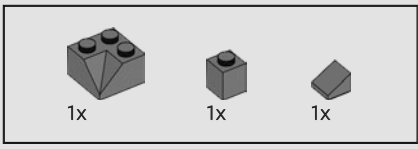

143

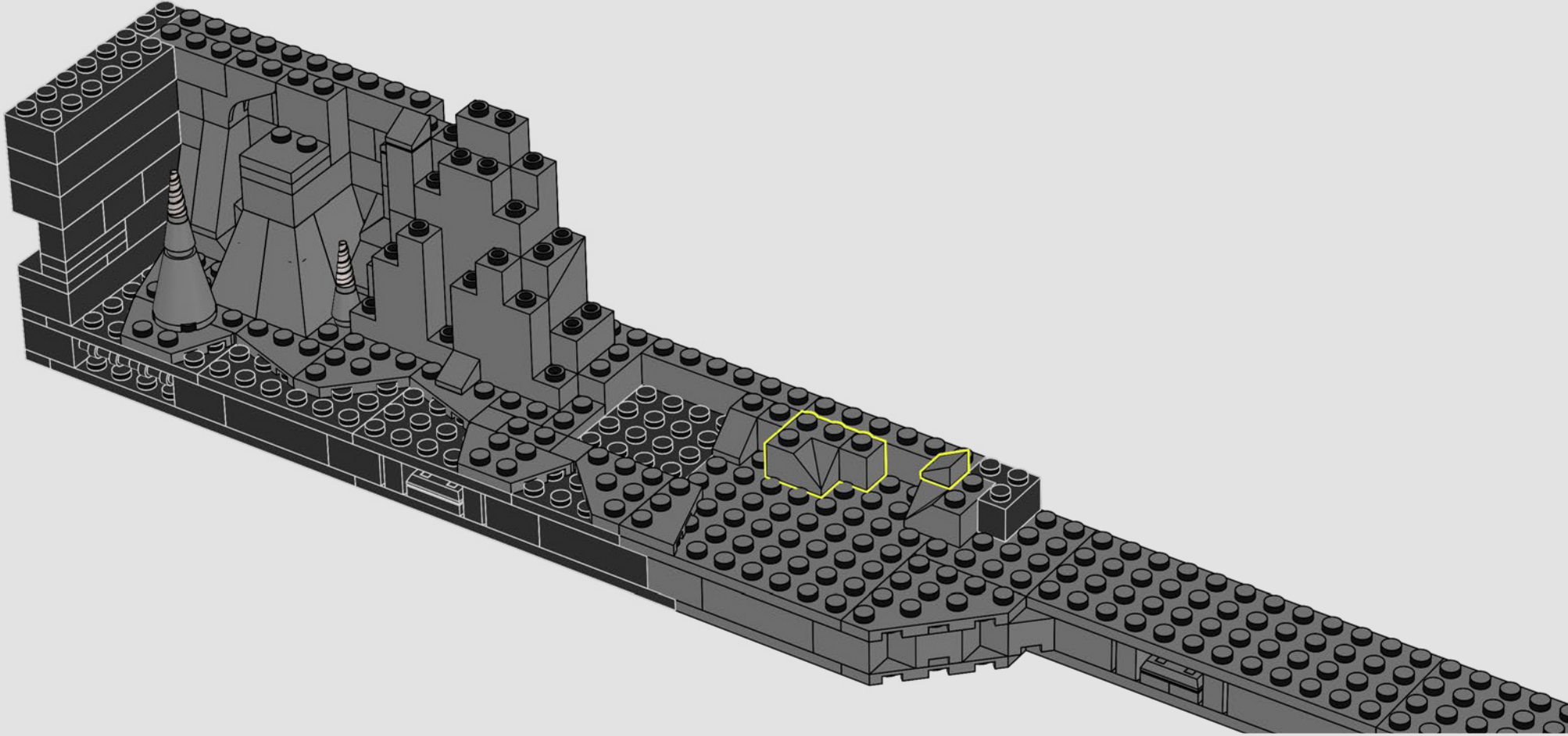

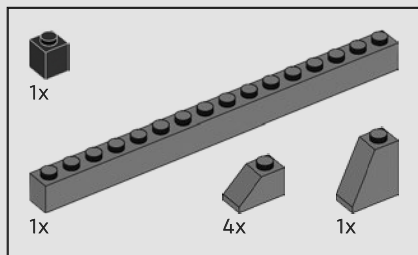

144

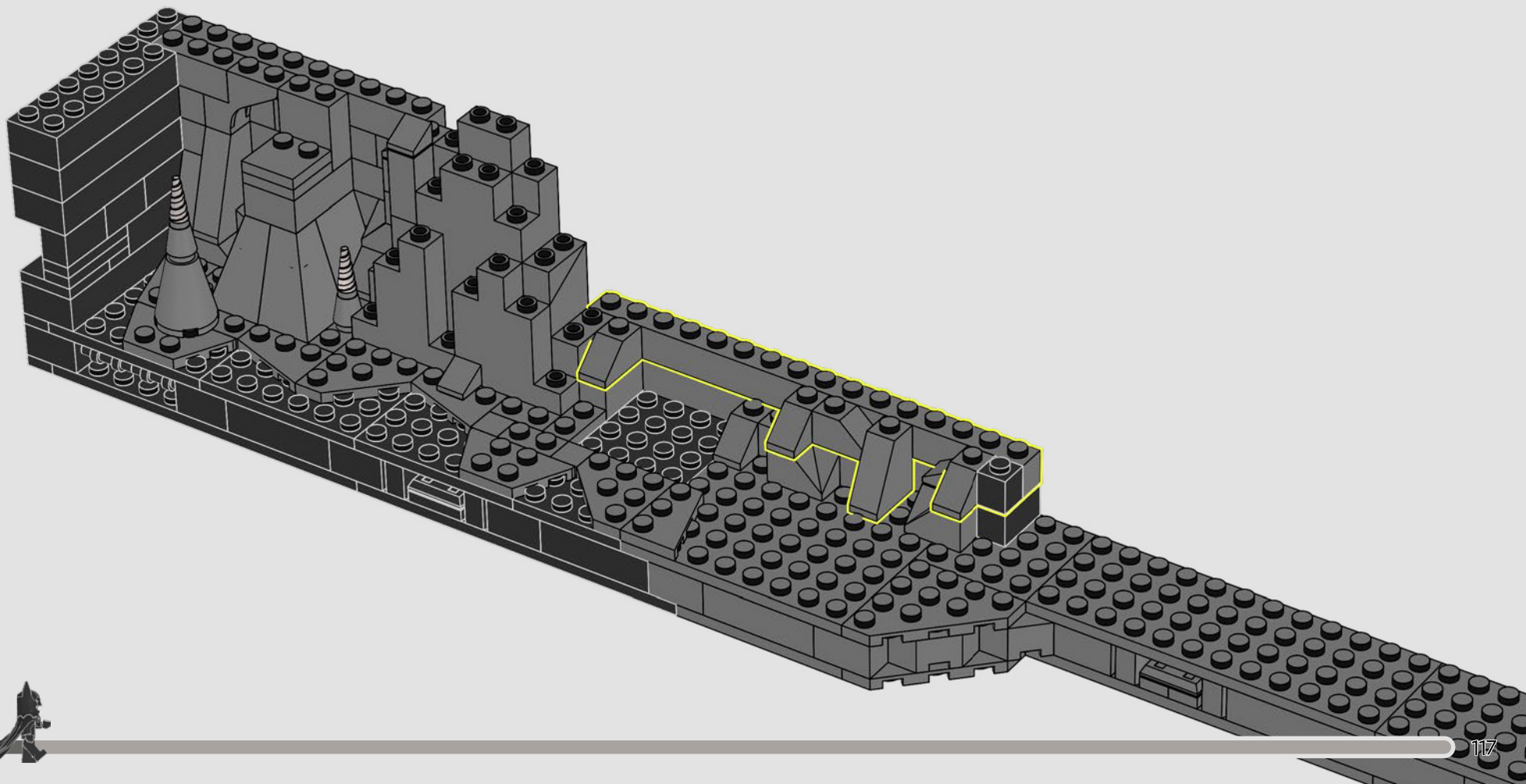

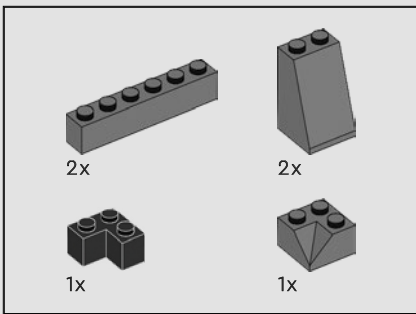

145

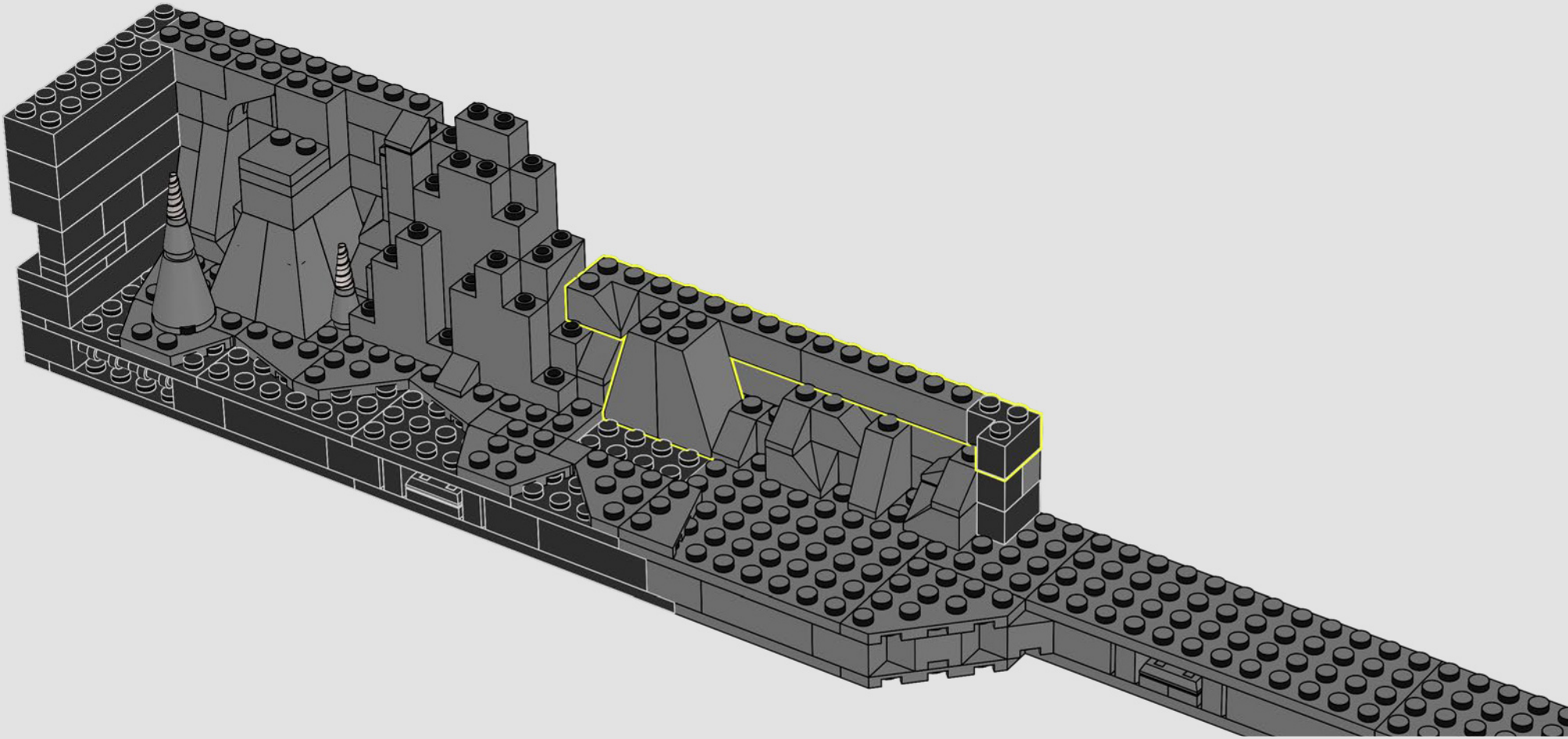

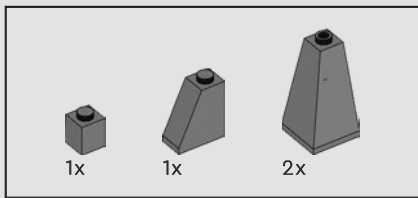

146

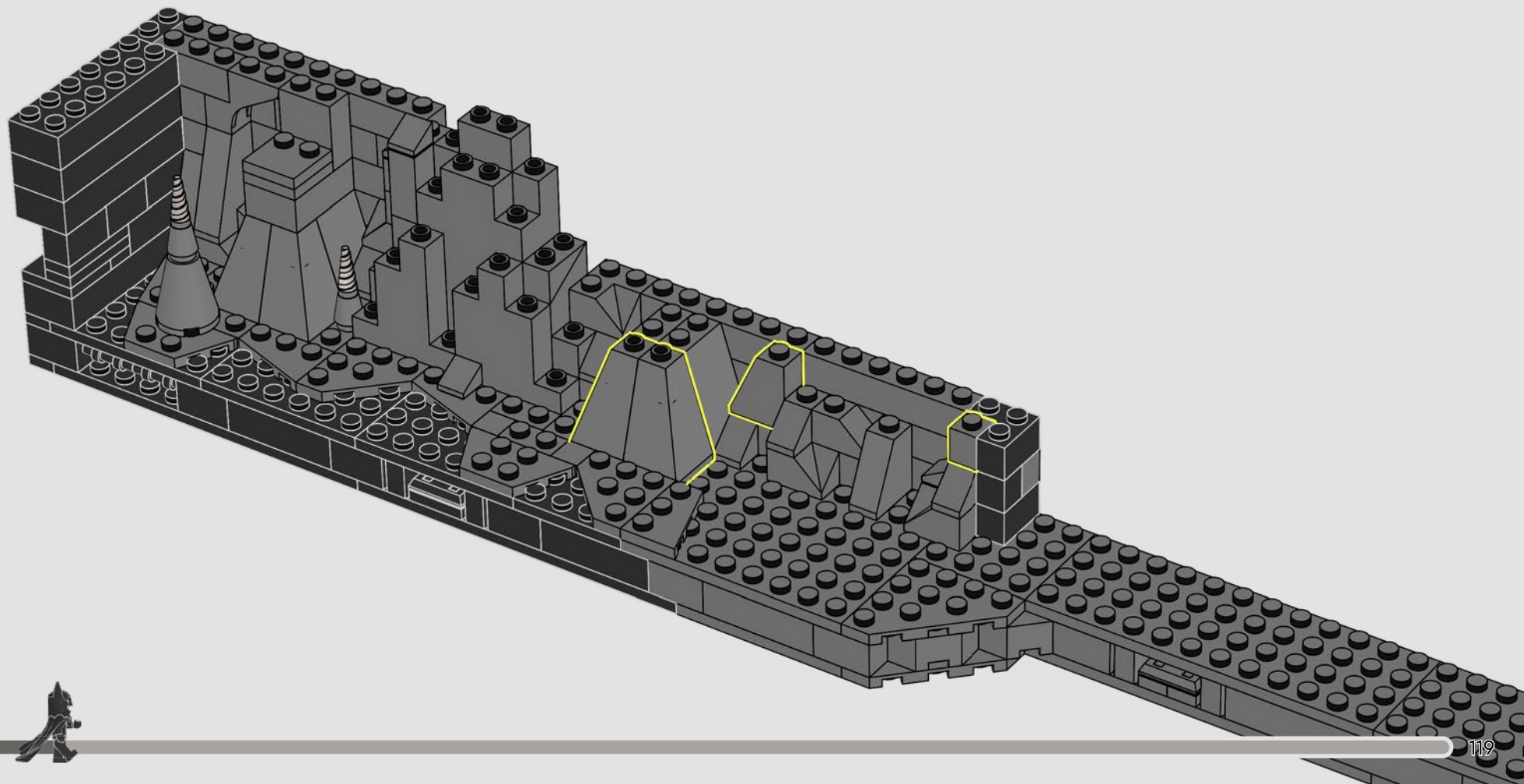

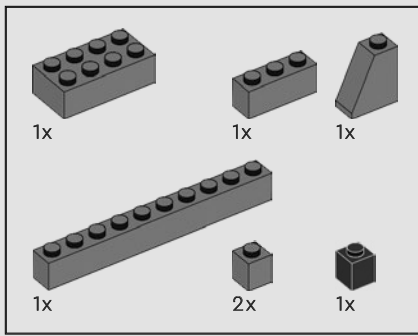

147

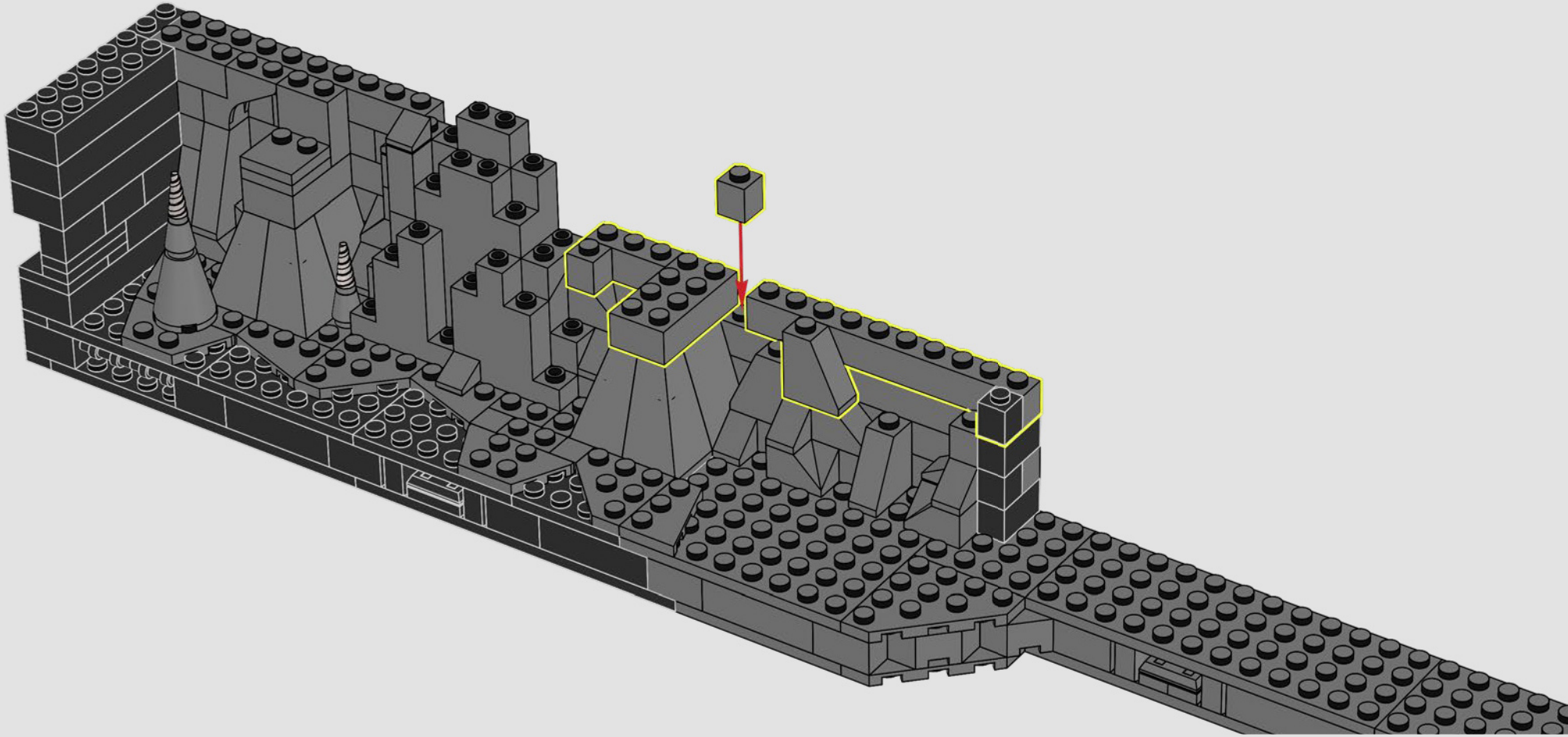

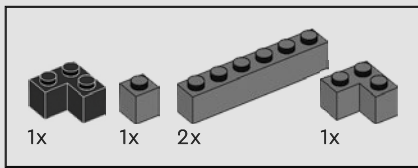

148

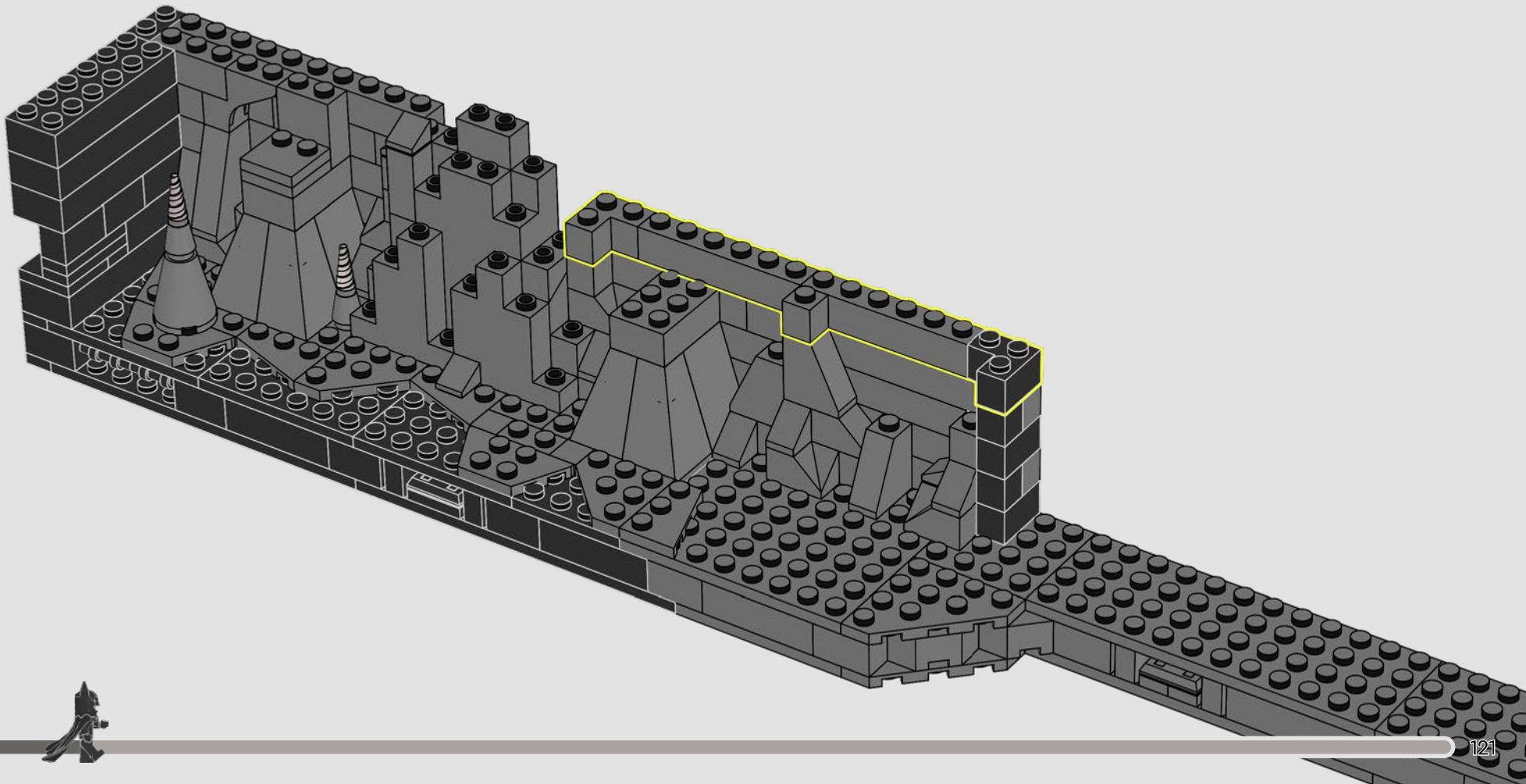

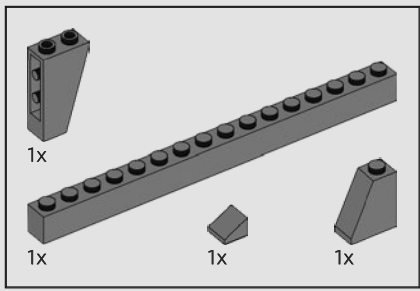

149

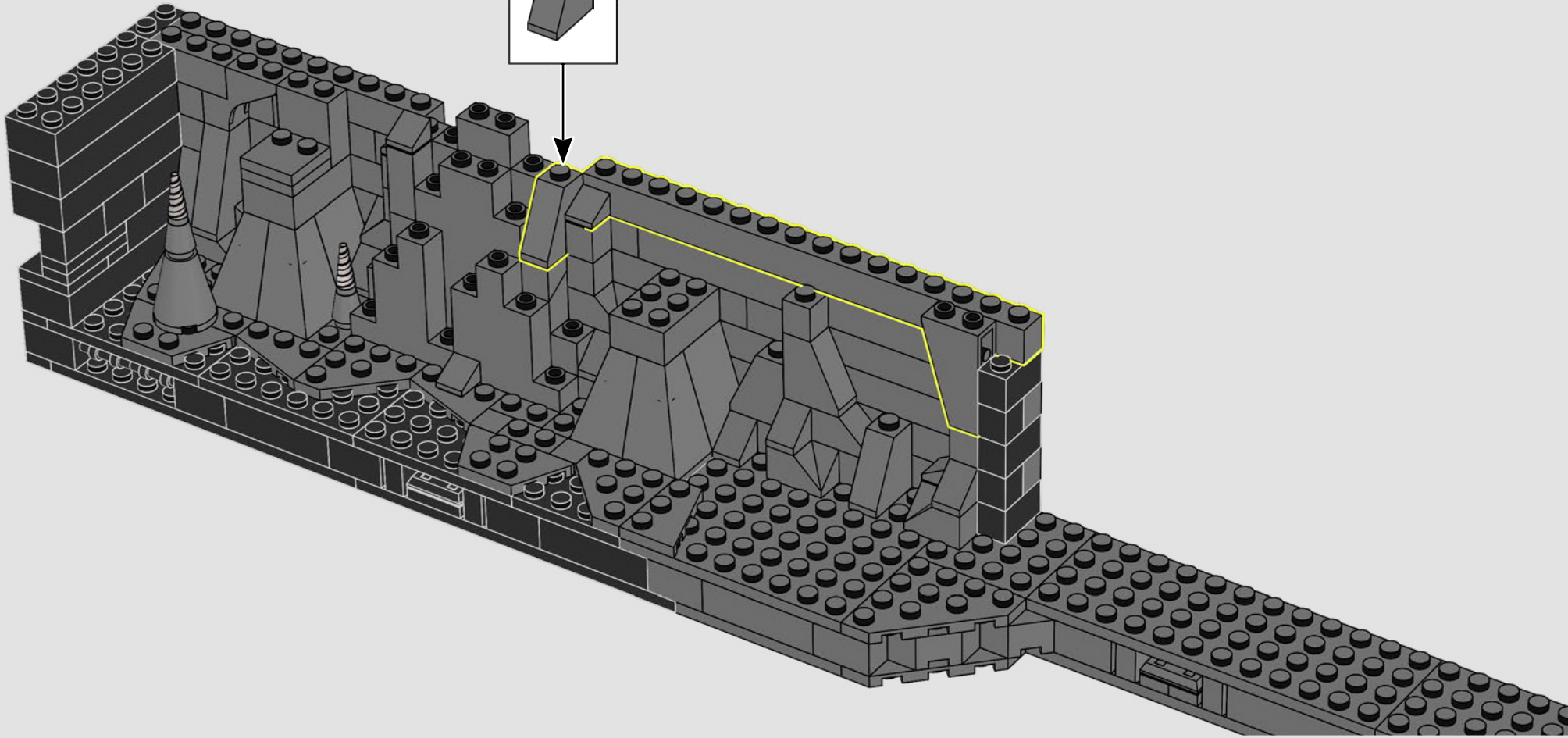
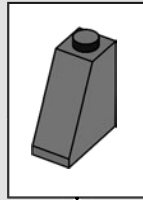

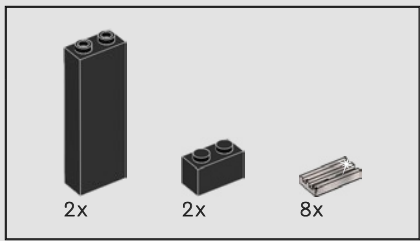

151

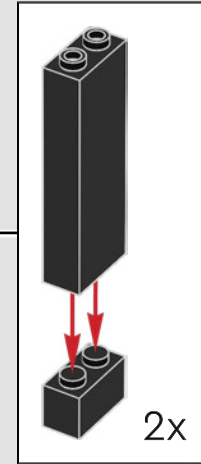
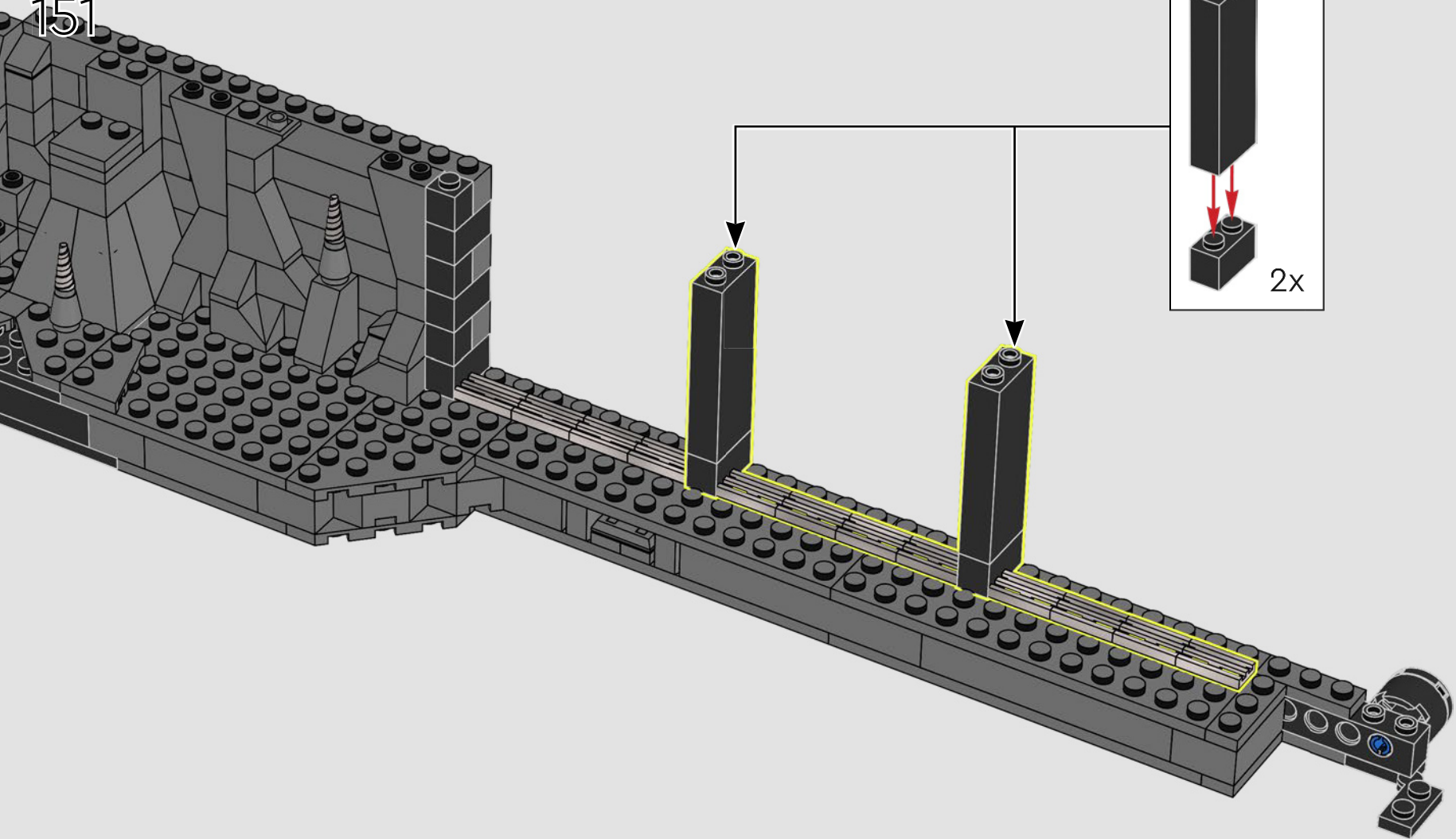

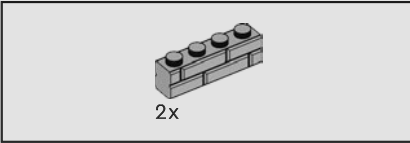
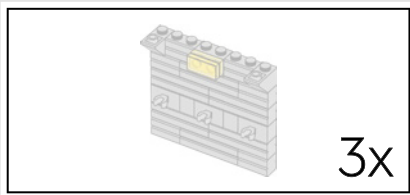

152

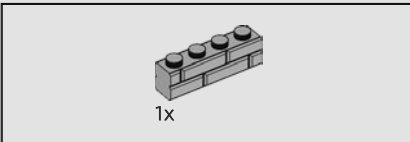
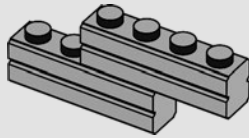

153

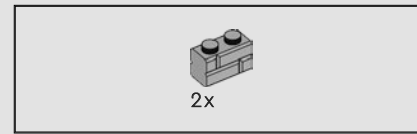
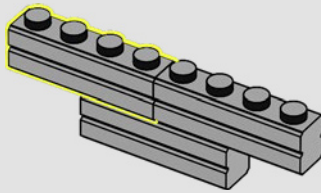

154

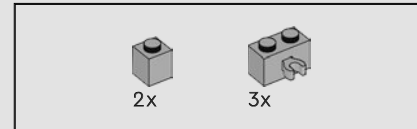
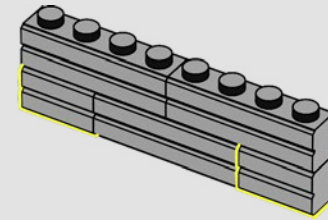

155

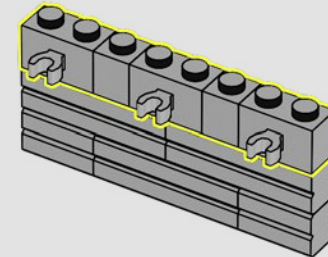

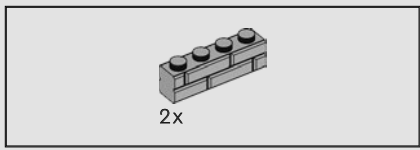

156

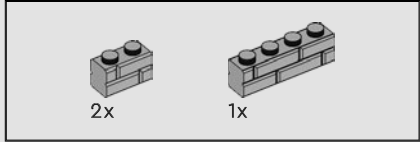
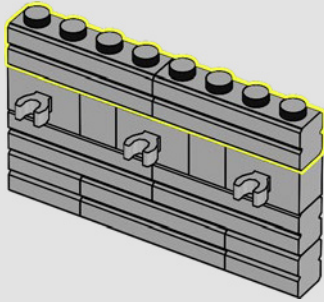

157

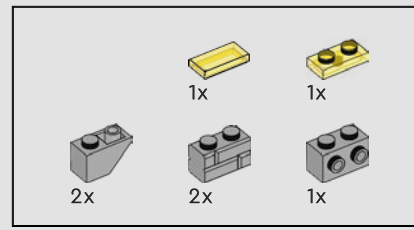
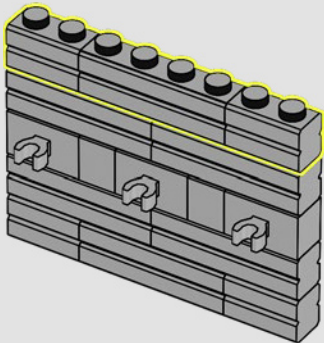

158

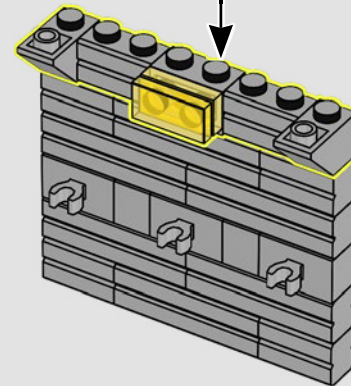
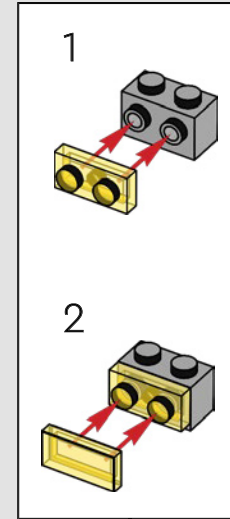

3x

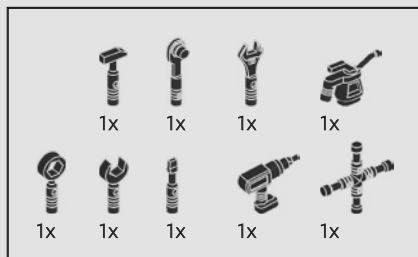

159

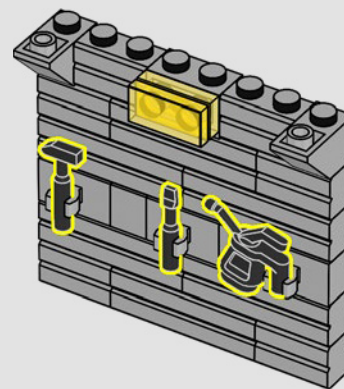
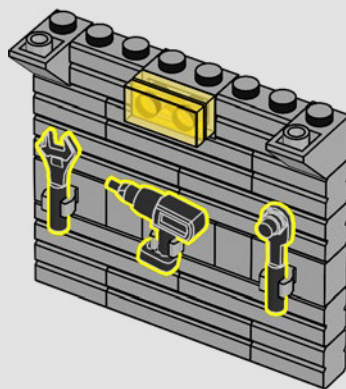
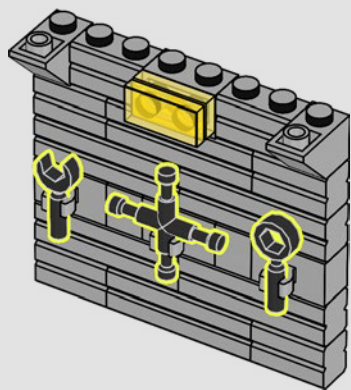

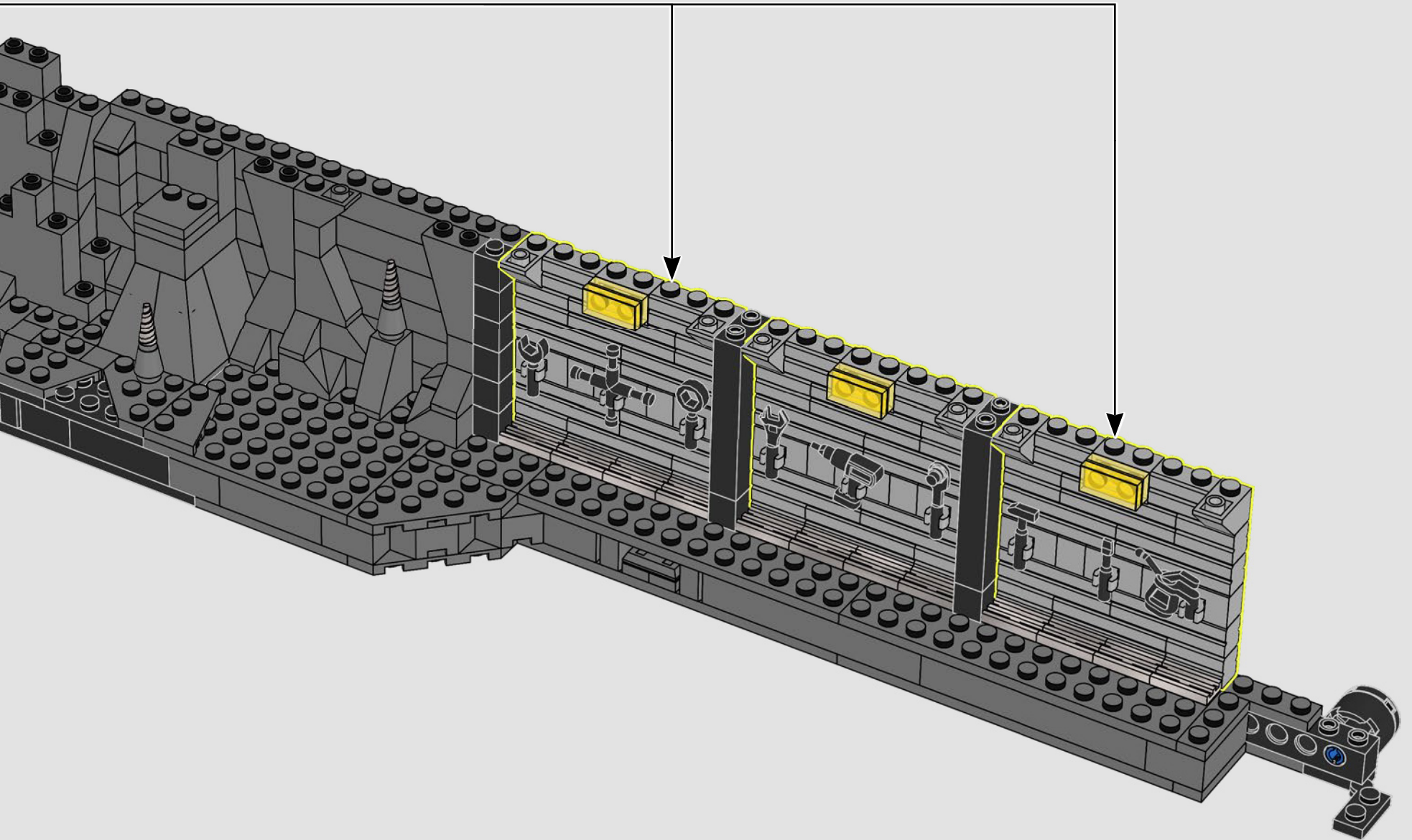

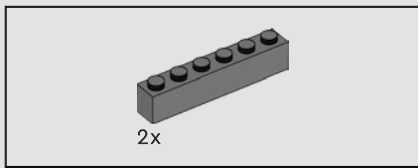

161

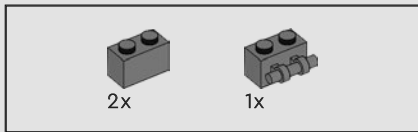
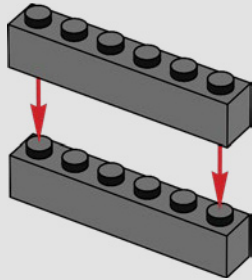

162

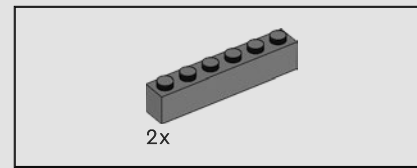
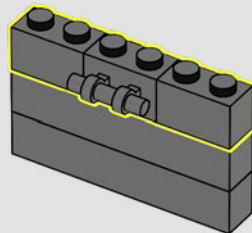

163

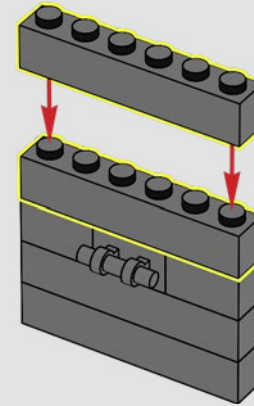

164

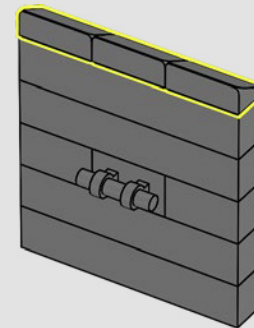

165

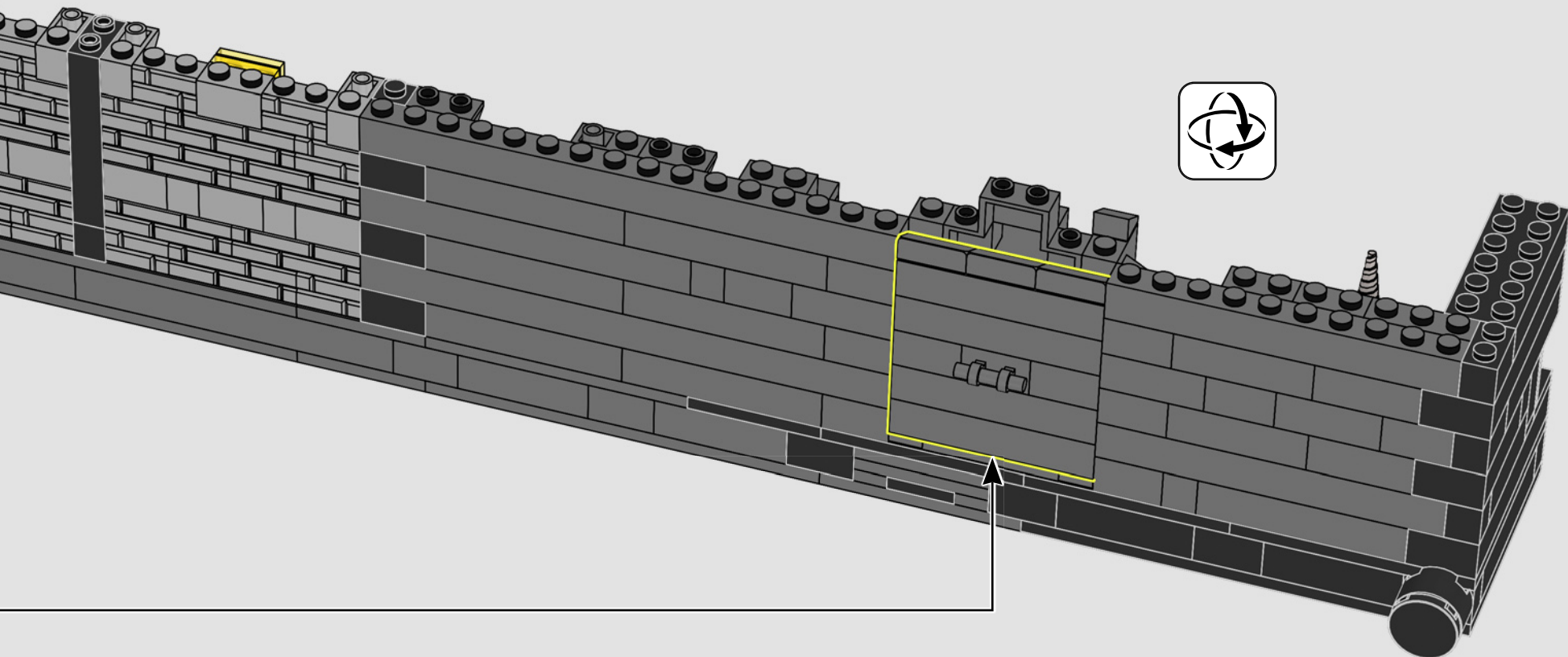

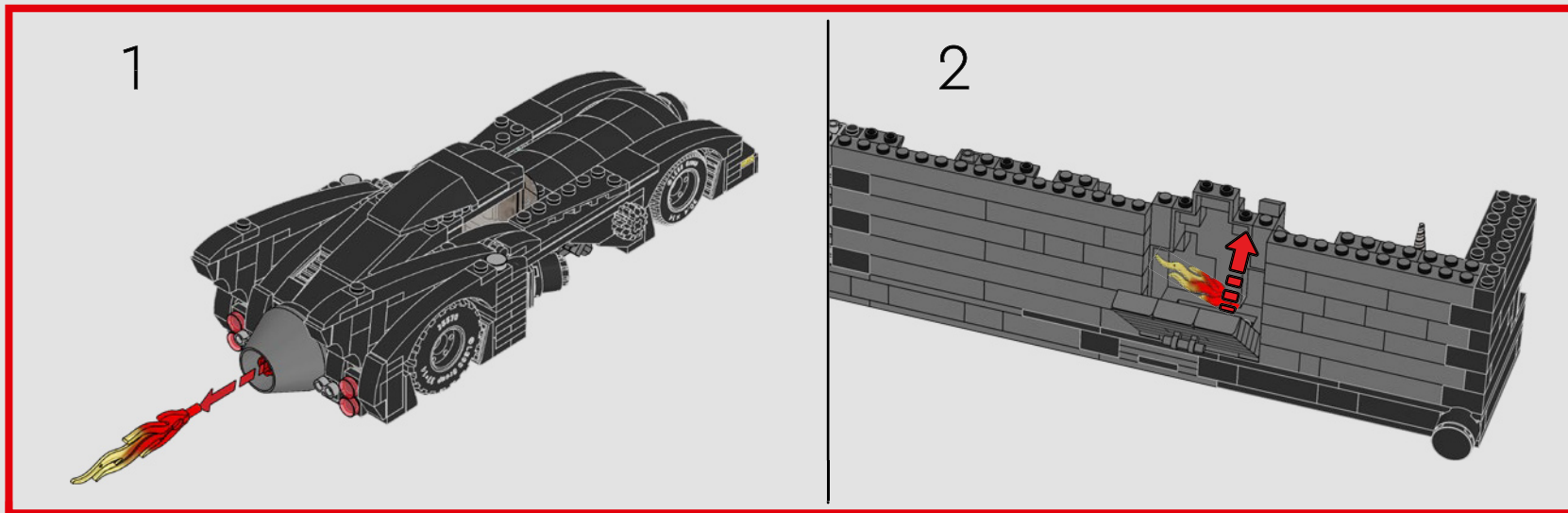

SECRET STORAGE COMPARTMENT

Even the exterior of the Batcave™ Shadow Box has its secrets. Look for the secret storage compartment where you can hide the Batmobile™ flame element when it's not in use.

COMPARTIMENT DE RANGEMENT SECRET

Même l'extérieur de la Boîte-cadre Batcave™ a ses secrets. Recherchez le compartiment de rangement secret où vous pouvez cacher l'élément de flamme de la Batmobile™ lorsqu'il n'est pas utilisé.

COMPARTIMENTO DE ALMACENAMIENTO SECRETO

Incluso el exterior del modelo Batcave™: Caja Sombría tiene sus secretos. Busca el compartimiento de almacenamiento secreto donde puedes ocultar el elemento que representa fuego del Batimóvil cuando no esté en uso.



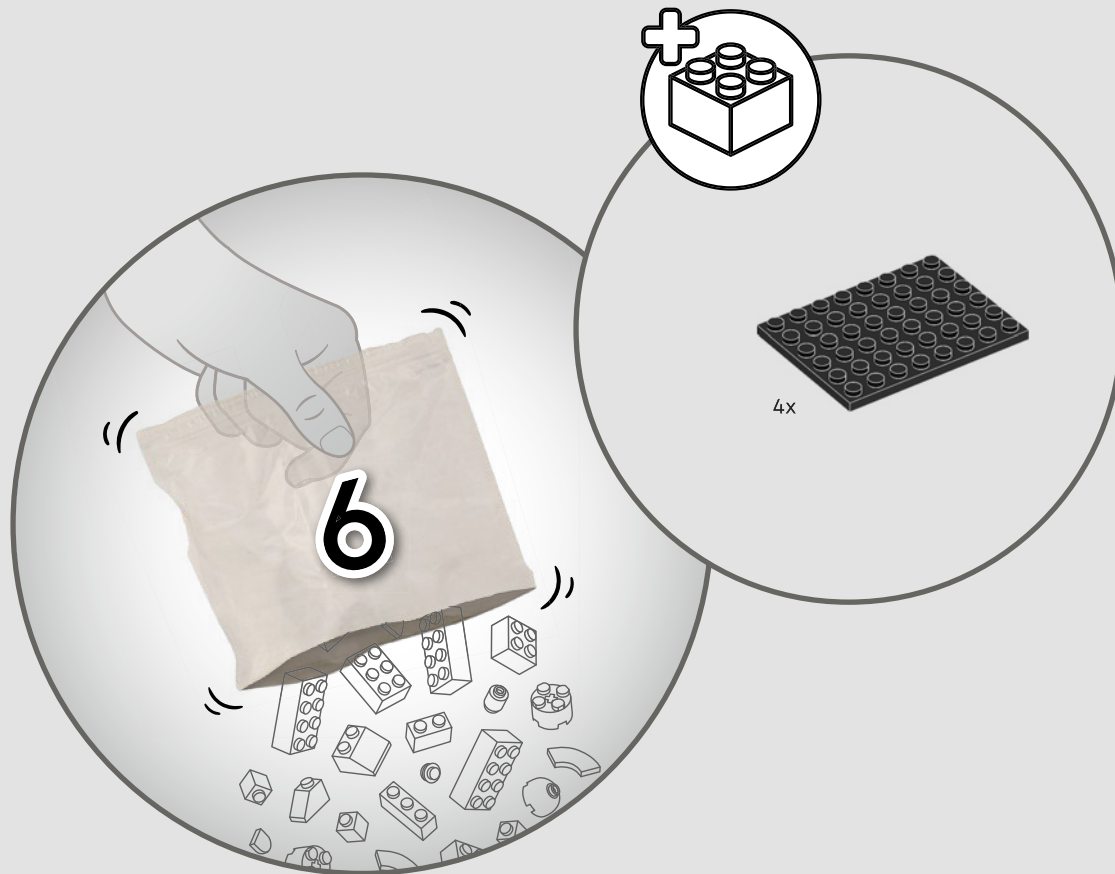

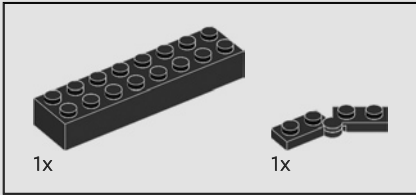
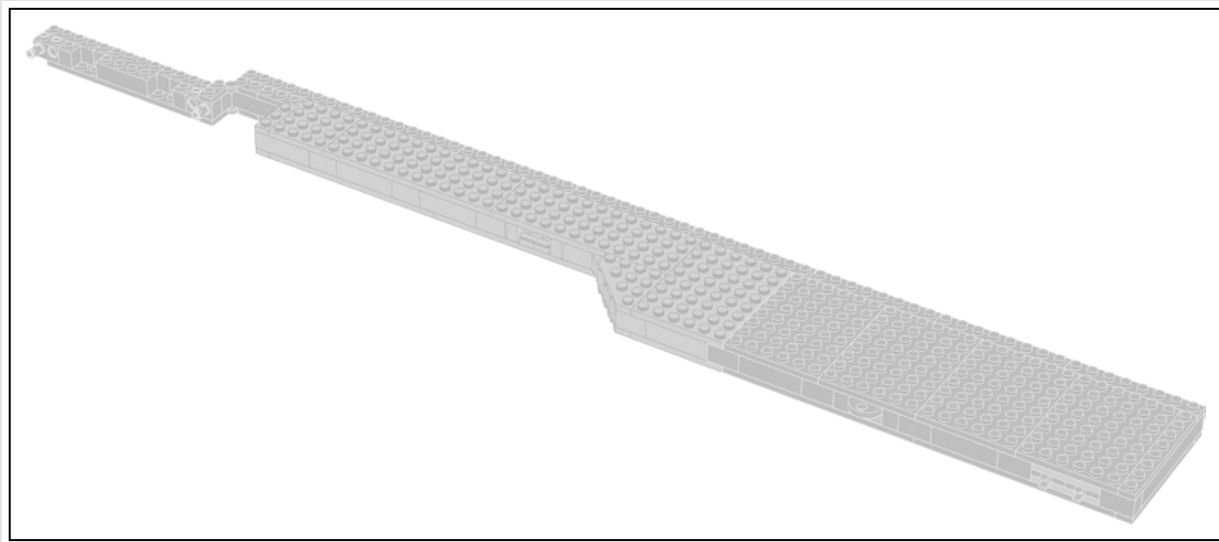

166

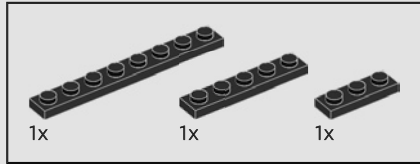
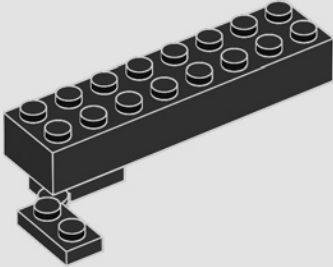

167

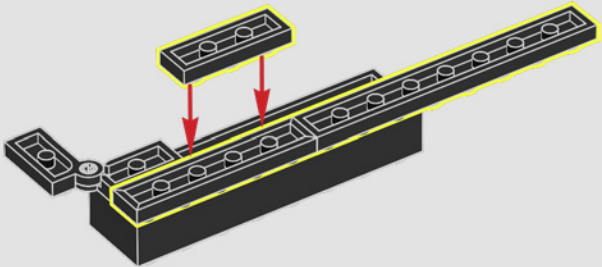

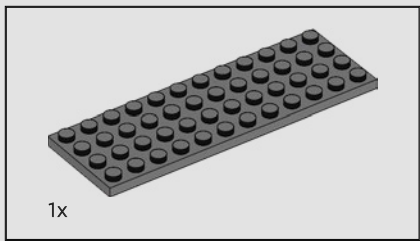

168

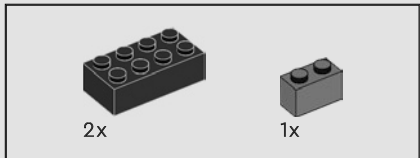
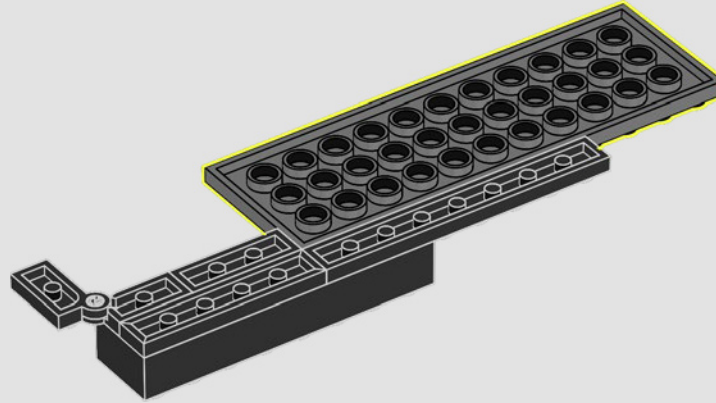

169

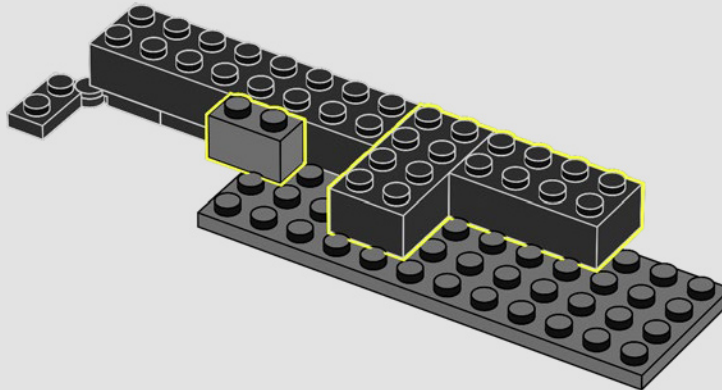

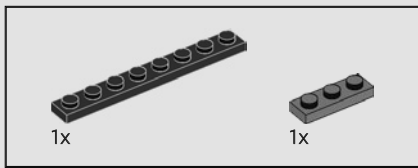

170

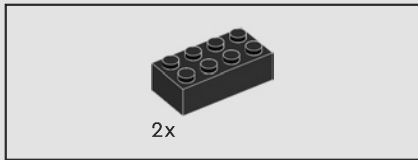
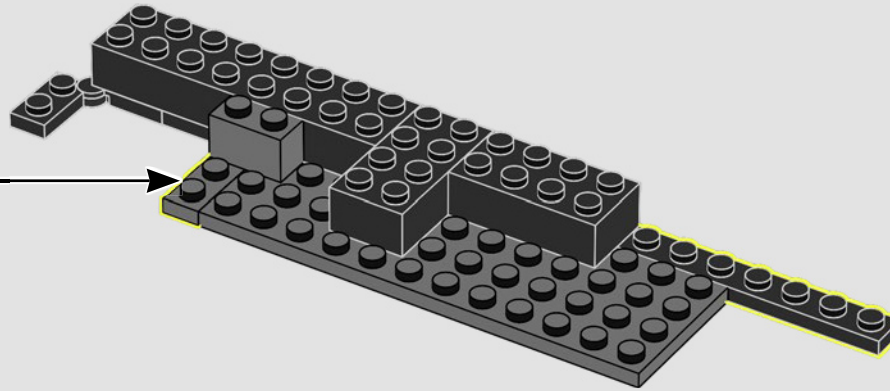
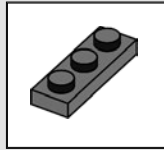

171

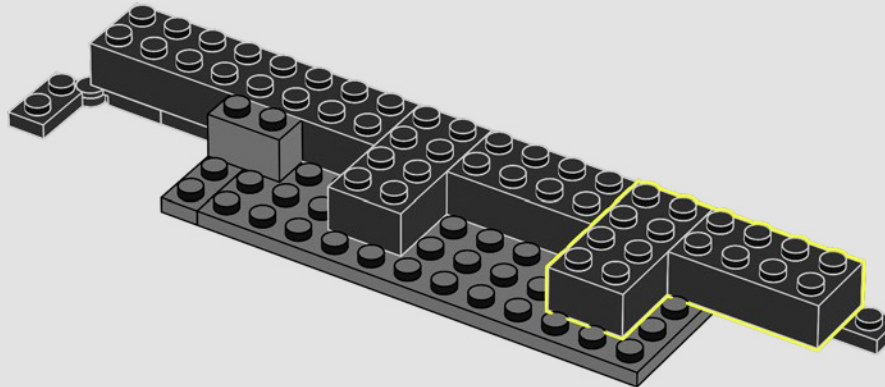

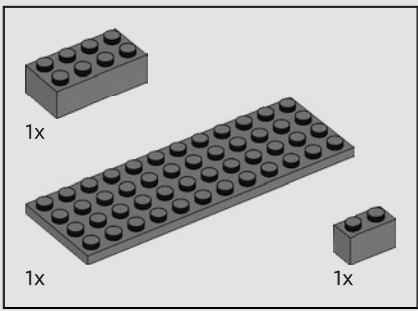

172

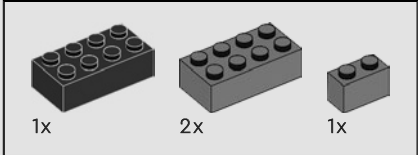
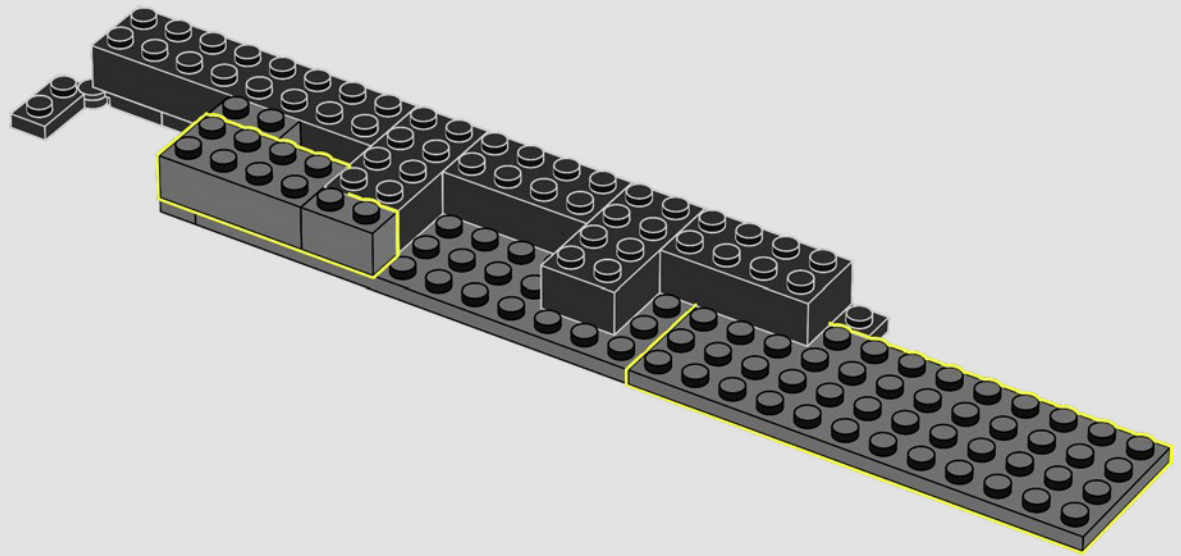

173

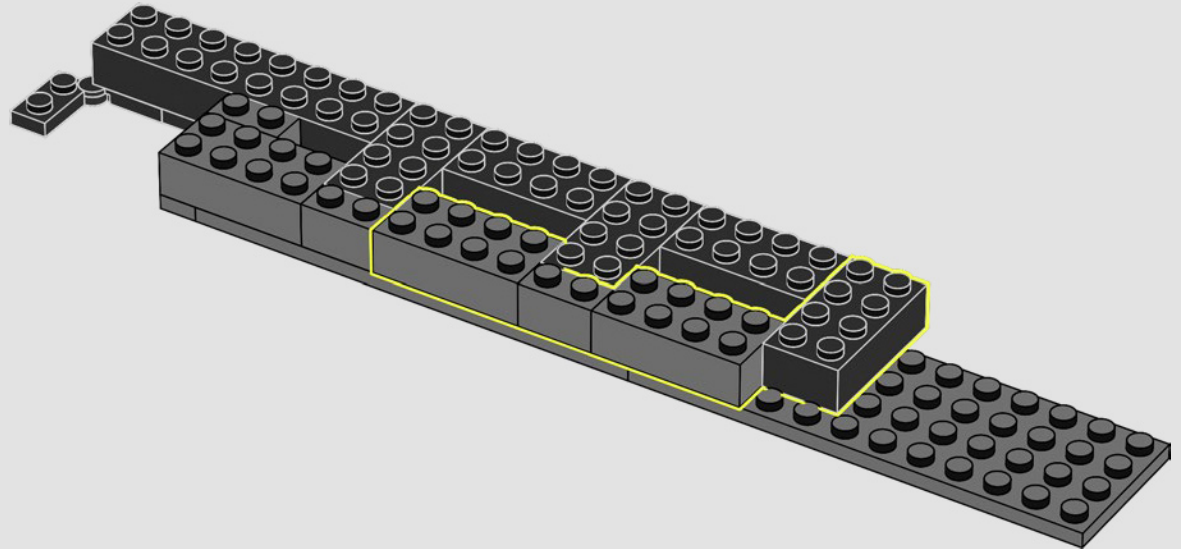

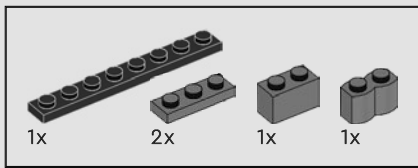

174

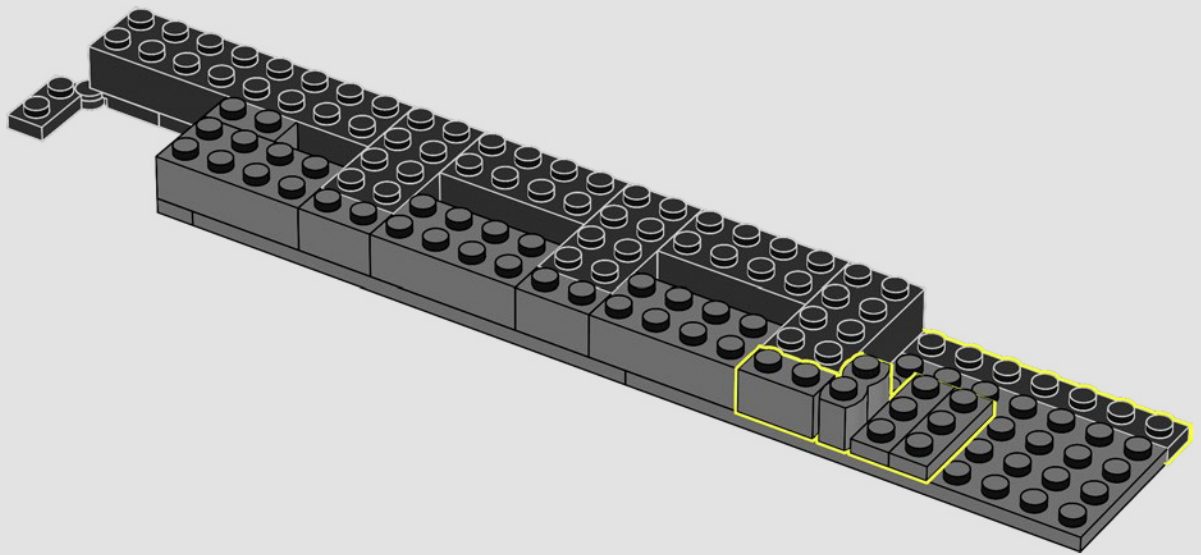

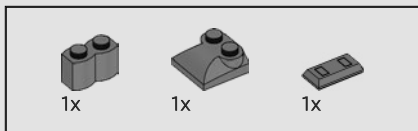

175

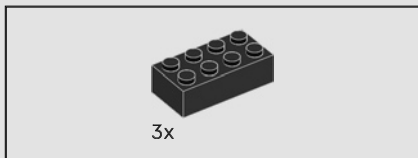
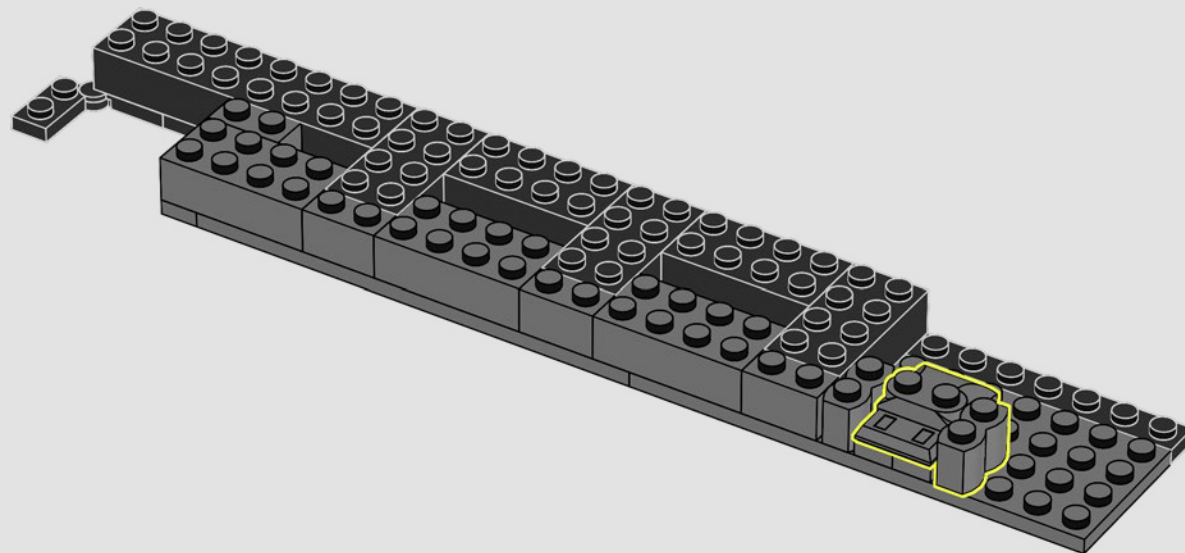

176

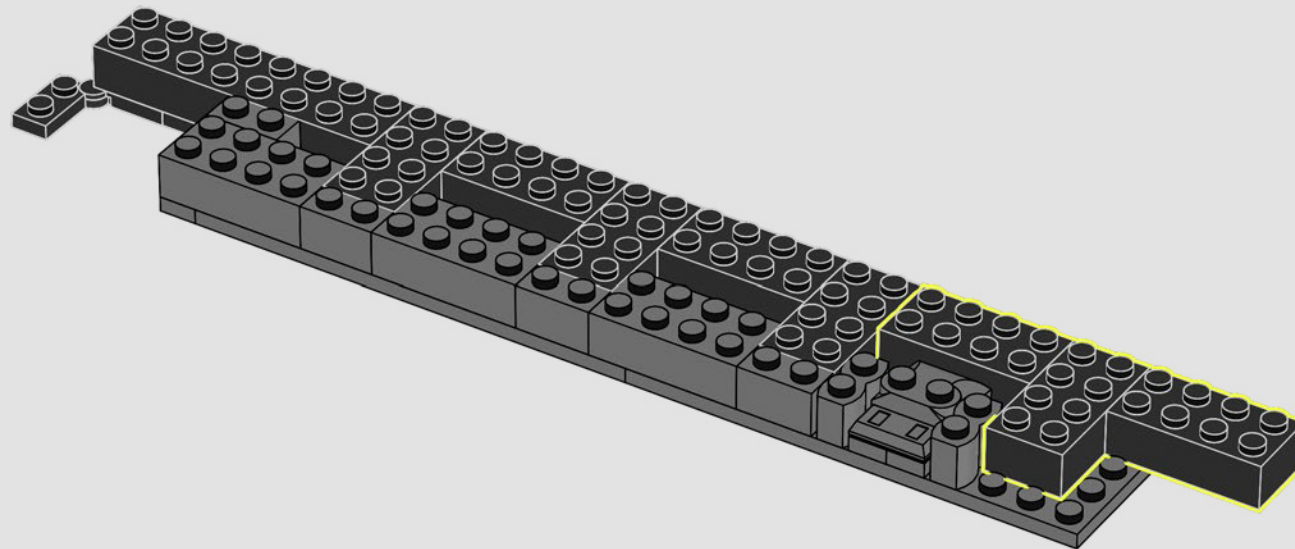

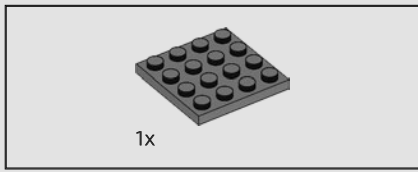

177

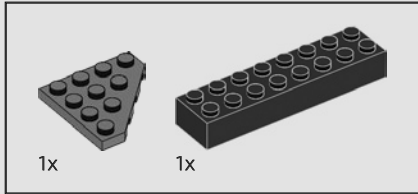
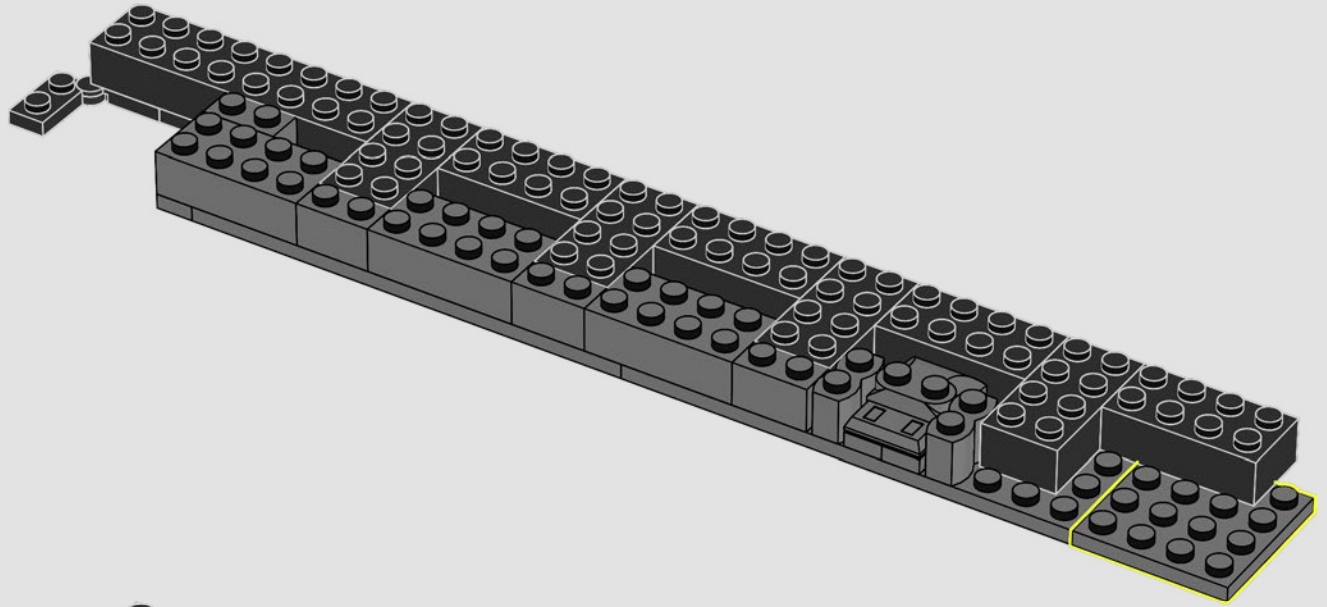

178

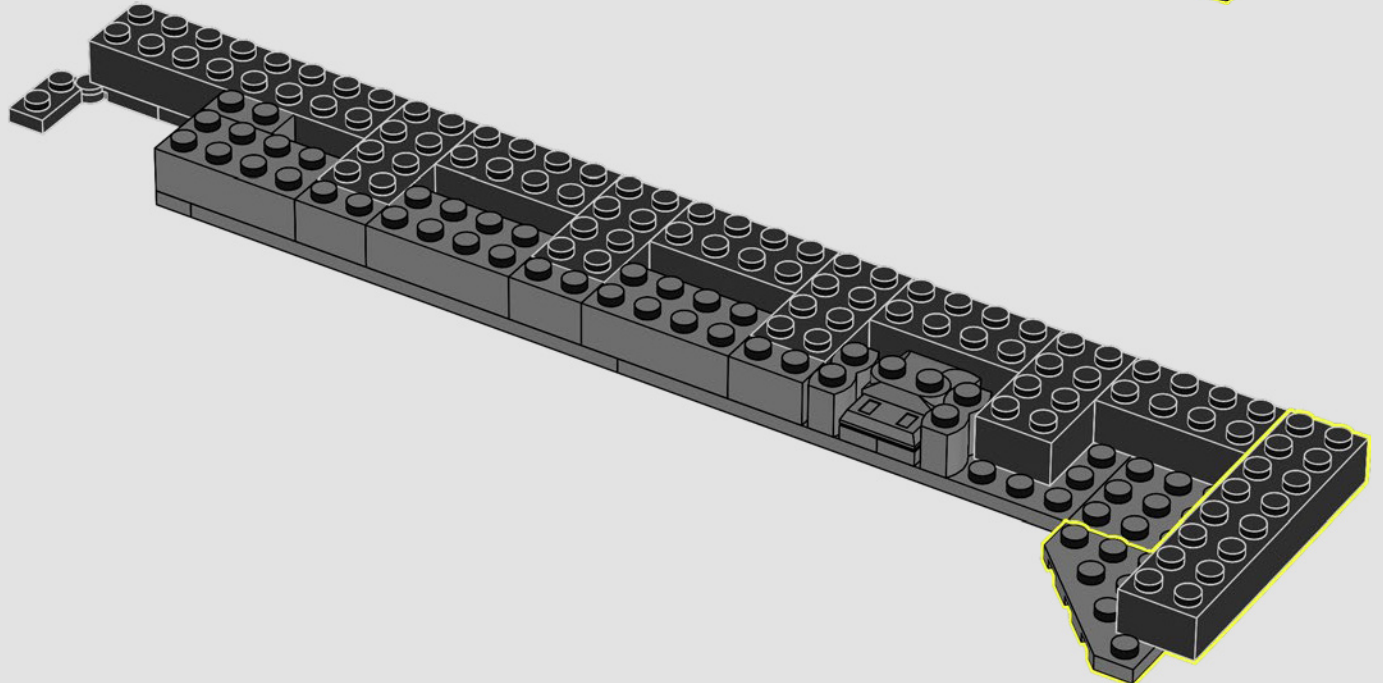



179

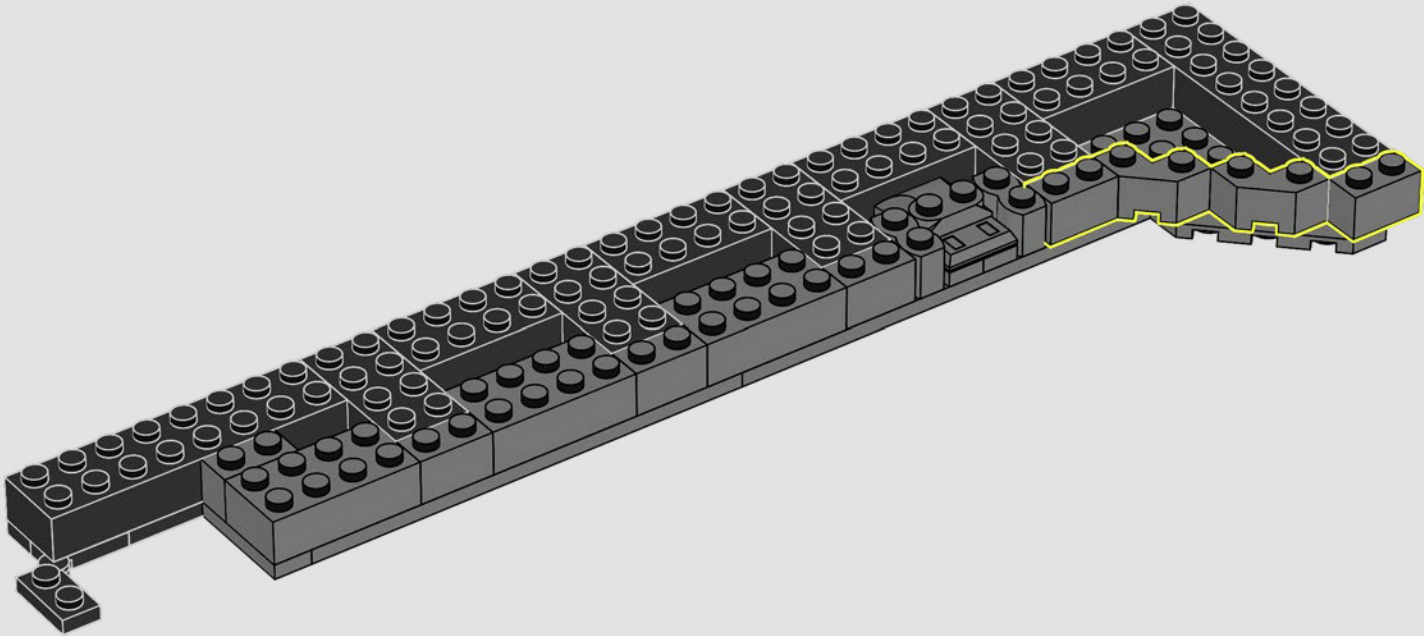

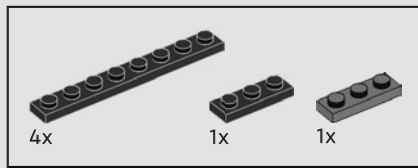

180

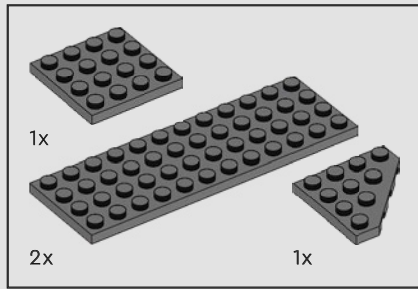
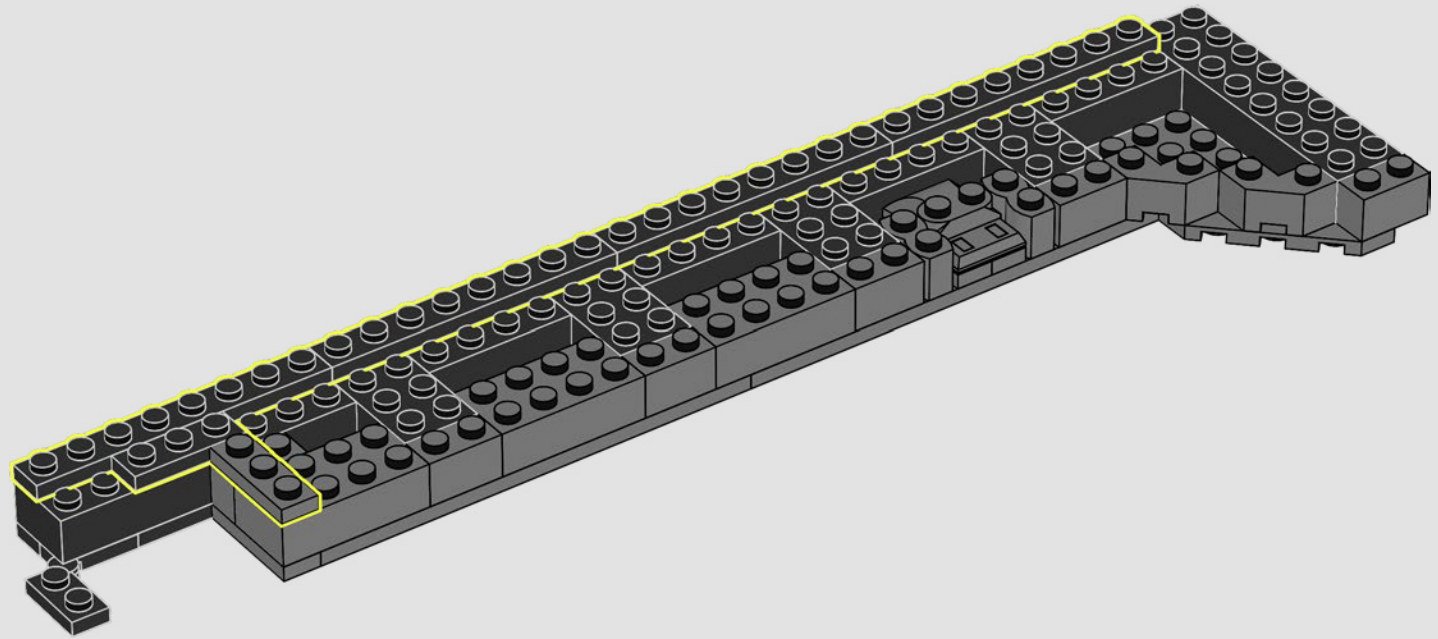

181

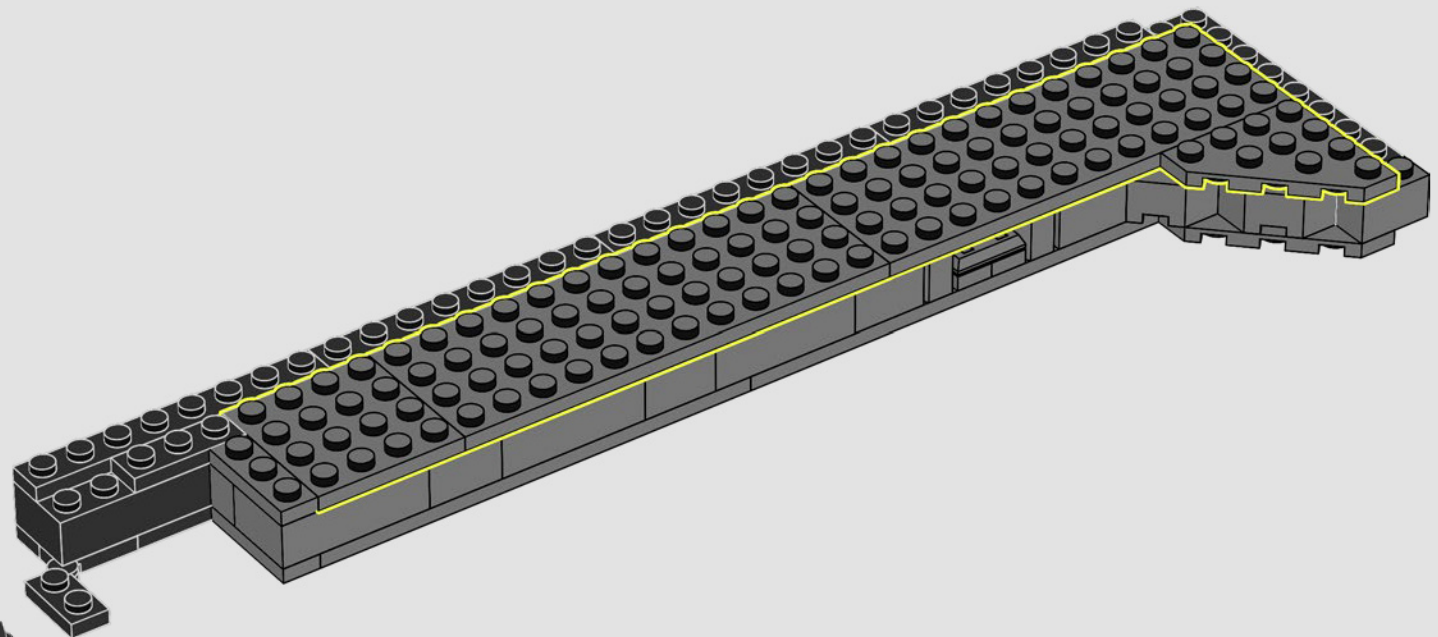

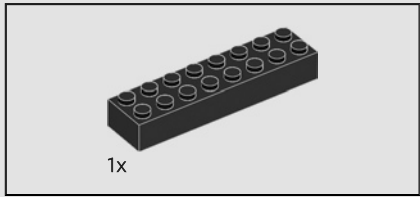
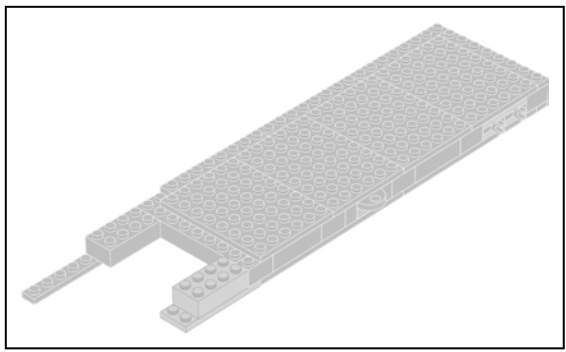

182

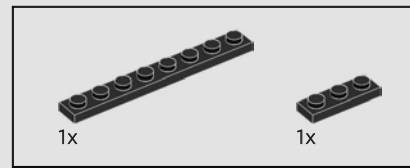
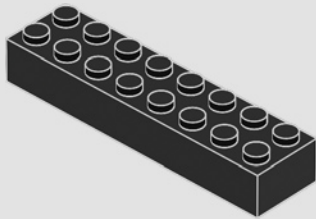

183

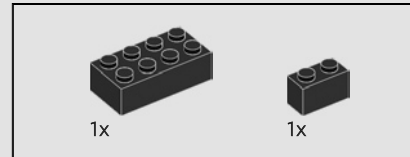
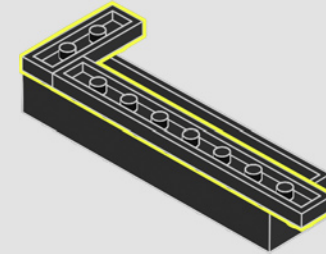
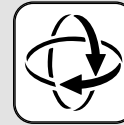

184

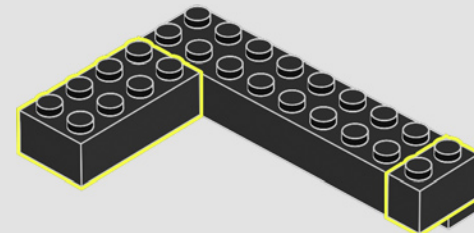
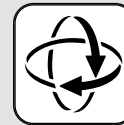

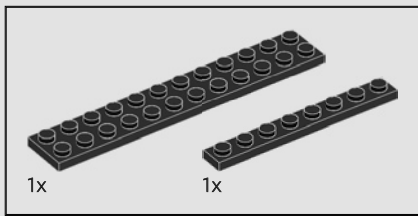

185

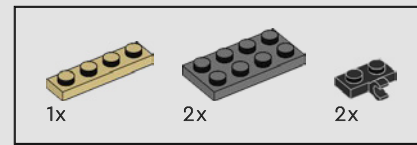
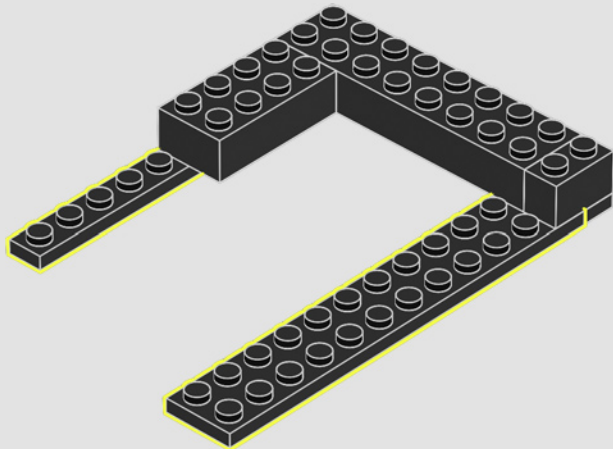

186

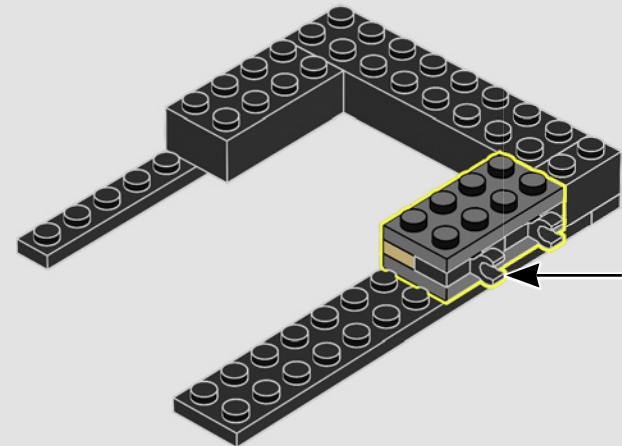
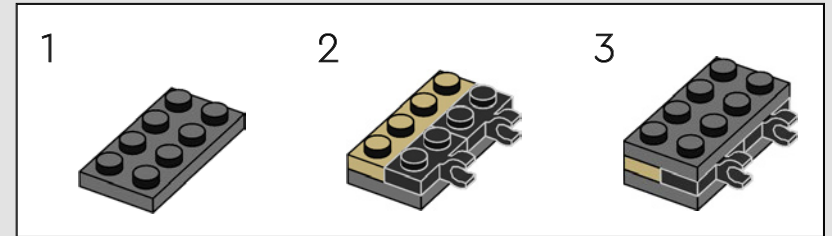

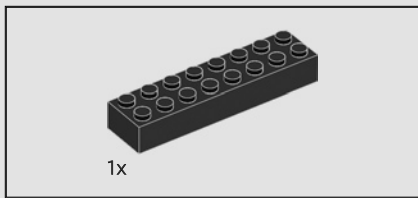

187

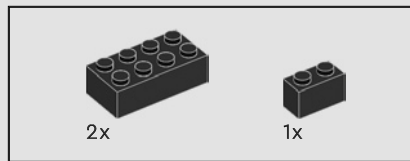
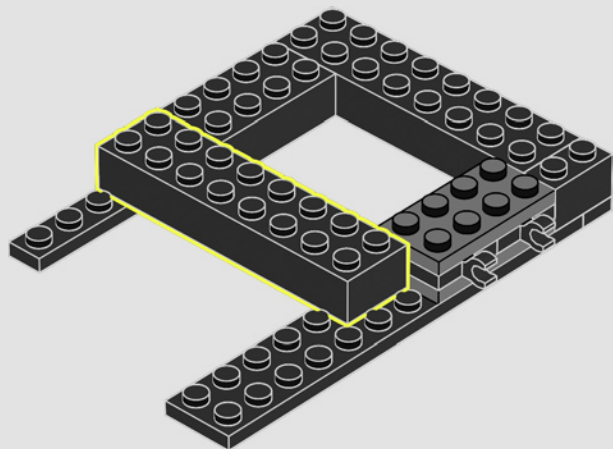

188

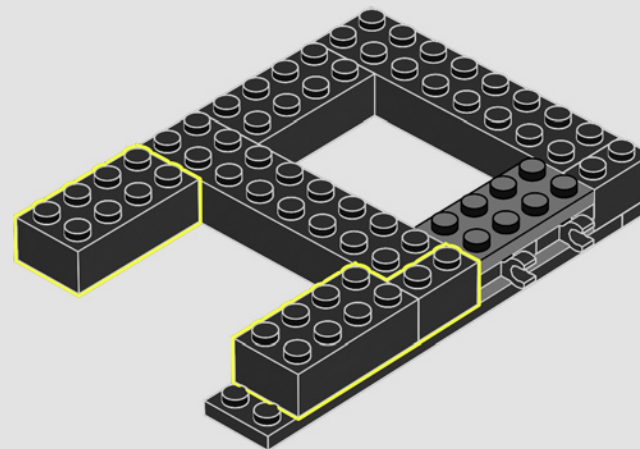

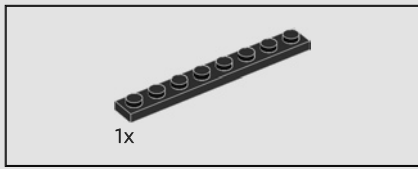

189

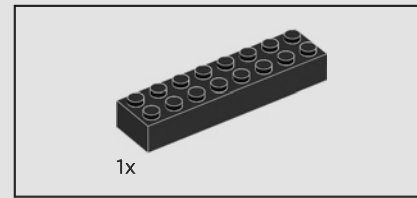
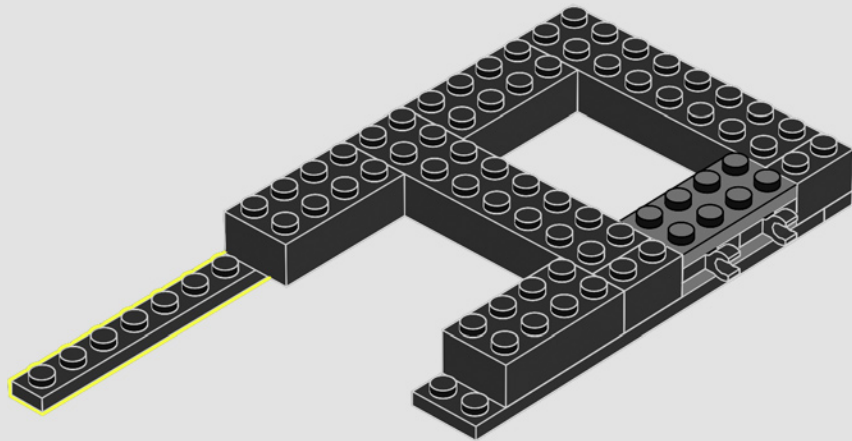

190

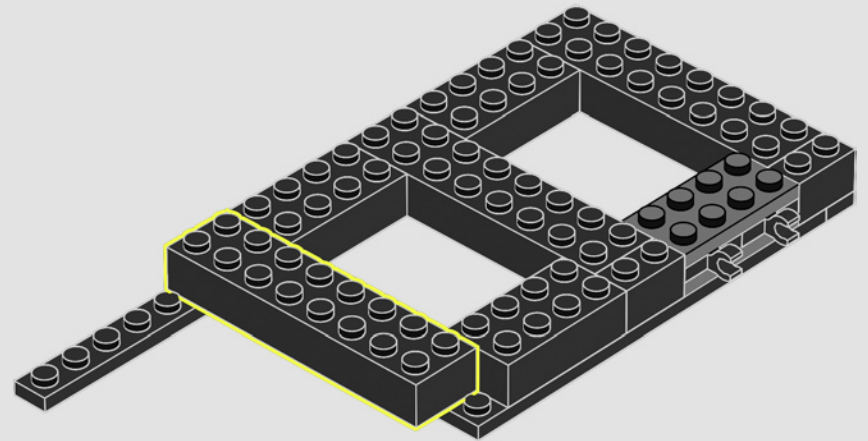

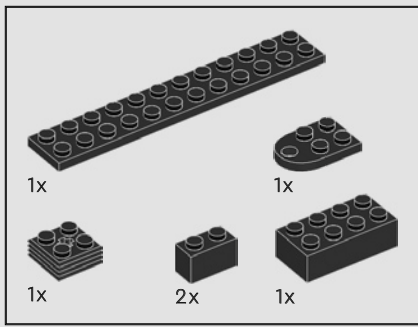

191

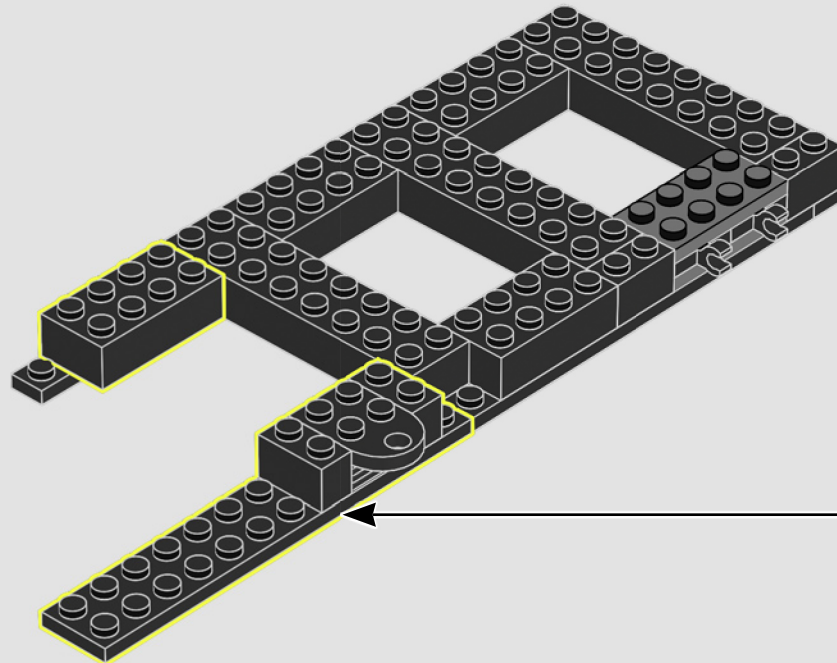
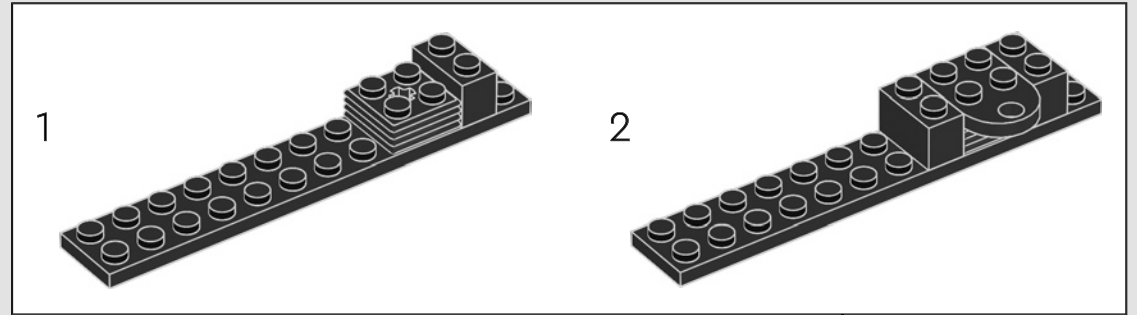

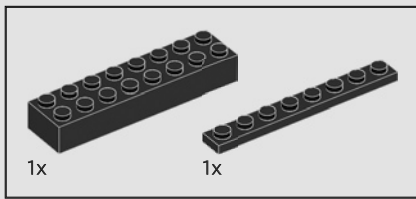

192

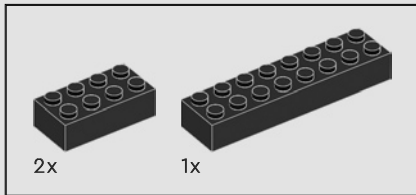
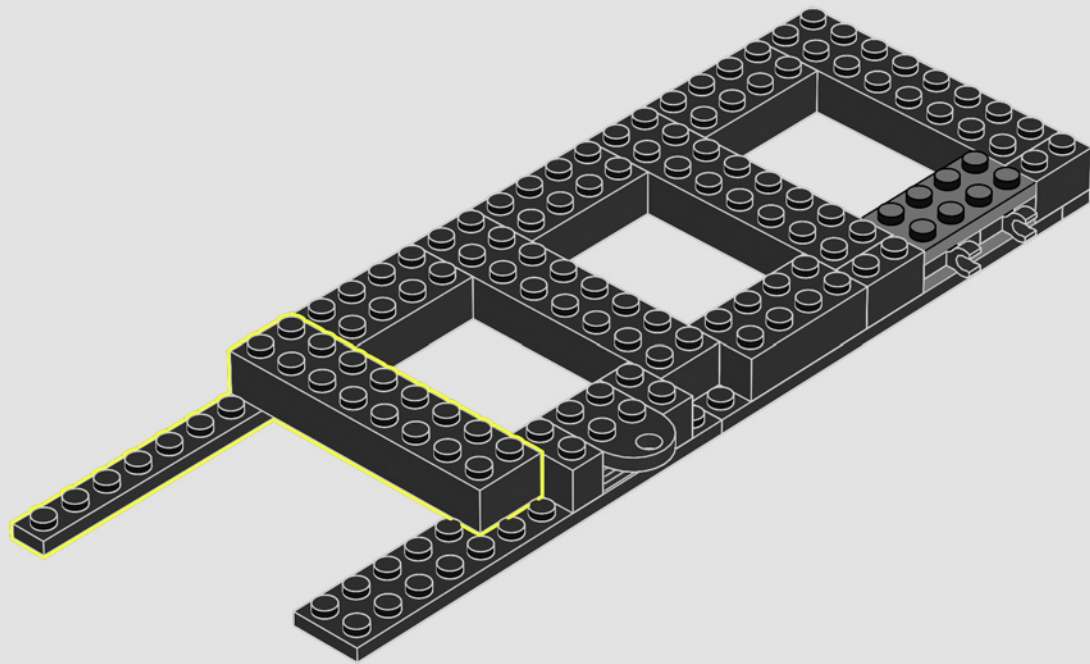

193

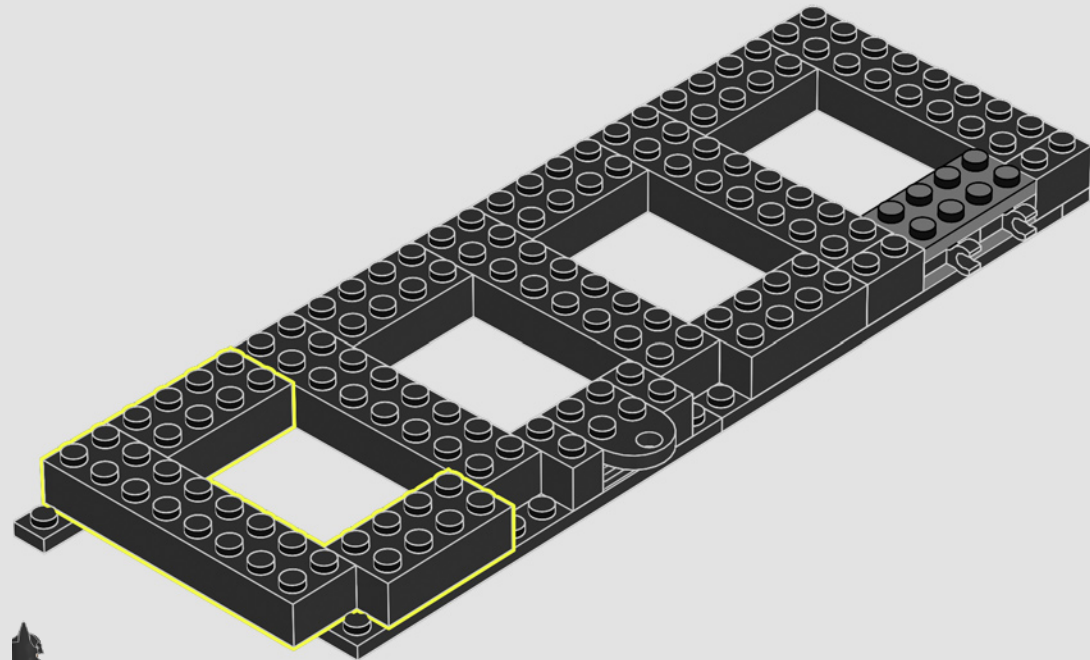

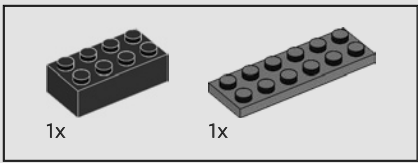

194

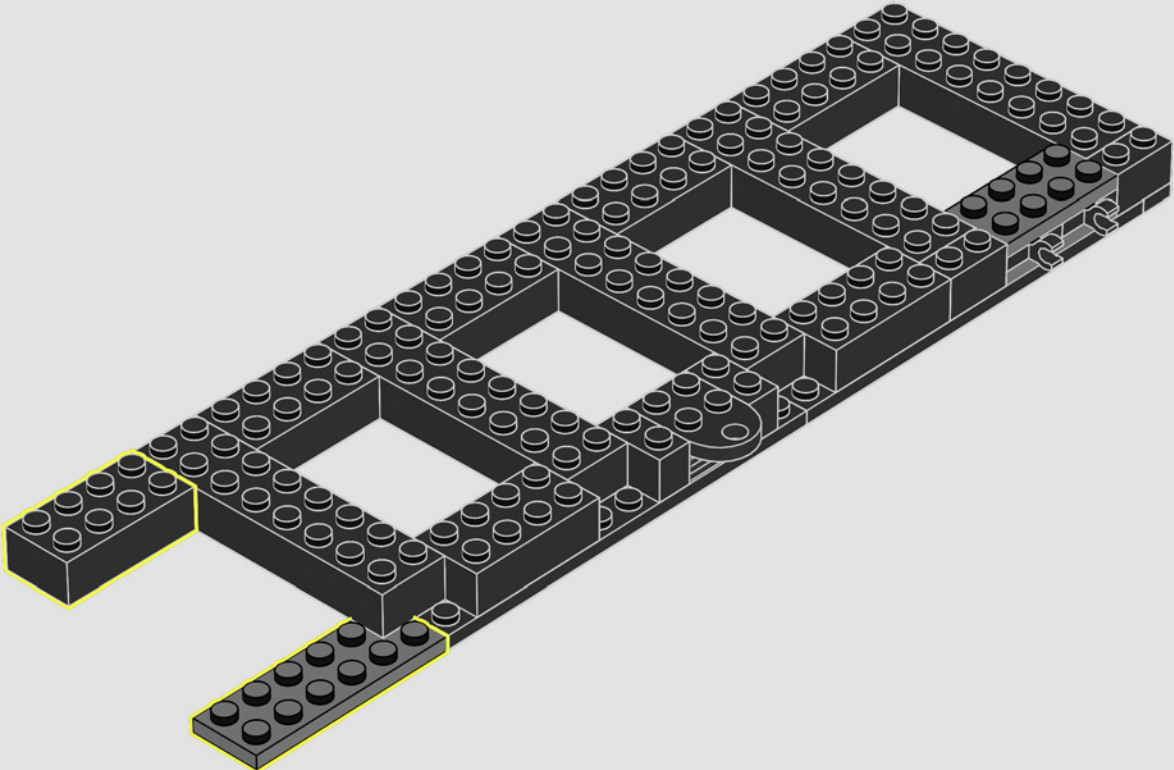

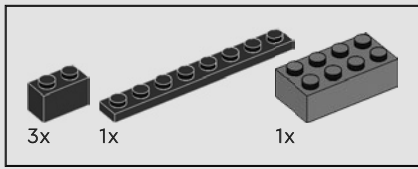

195

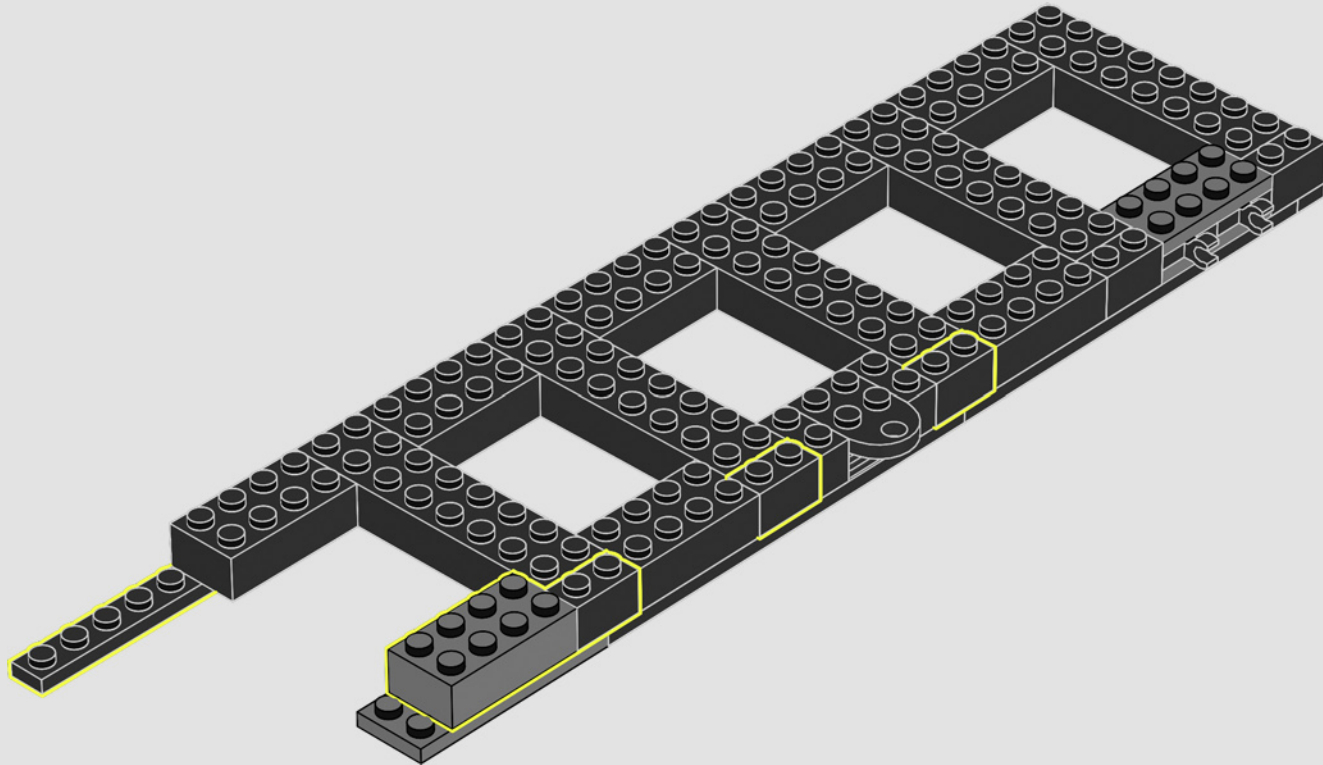

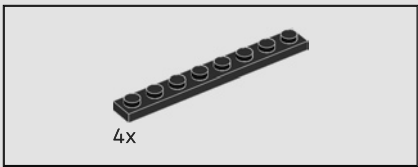

196

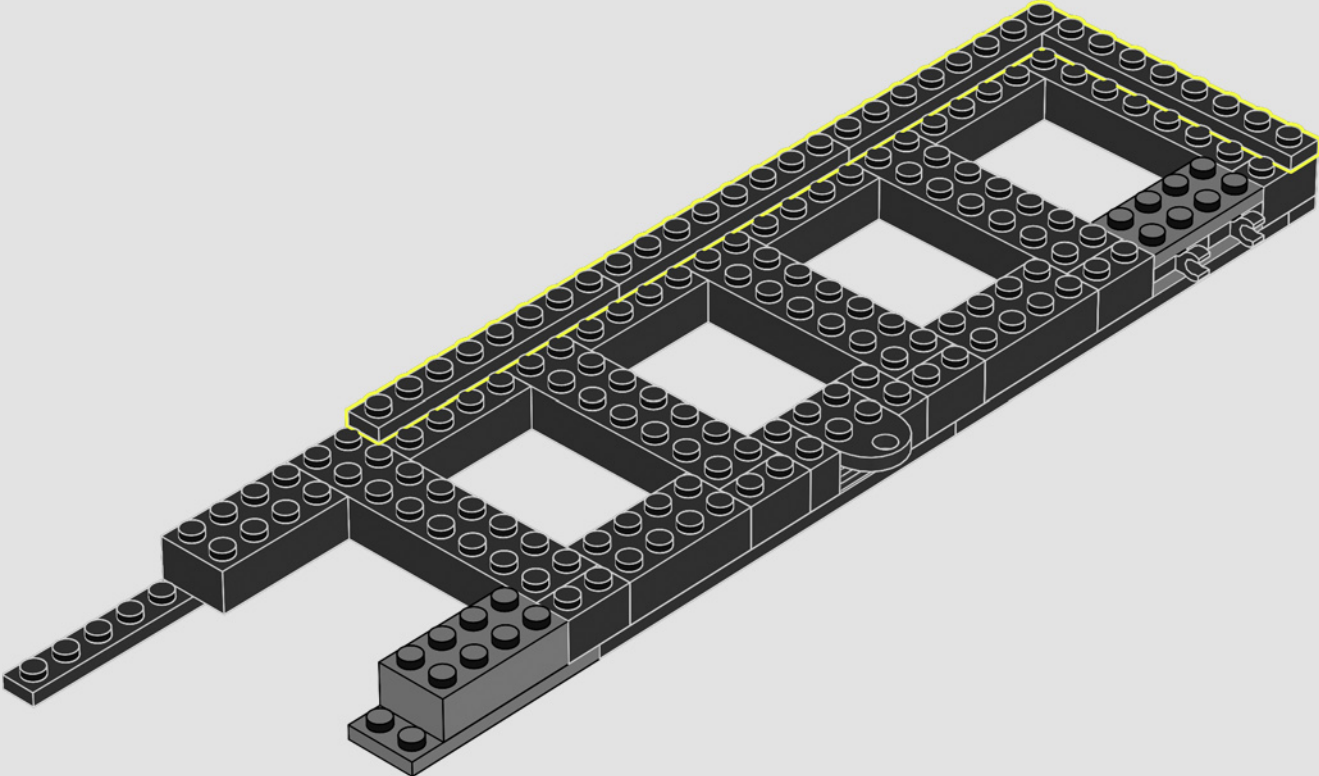

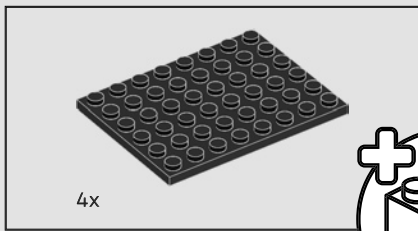

4x

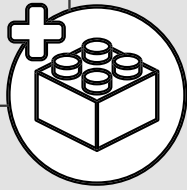

197

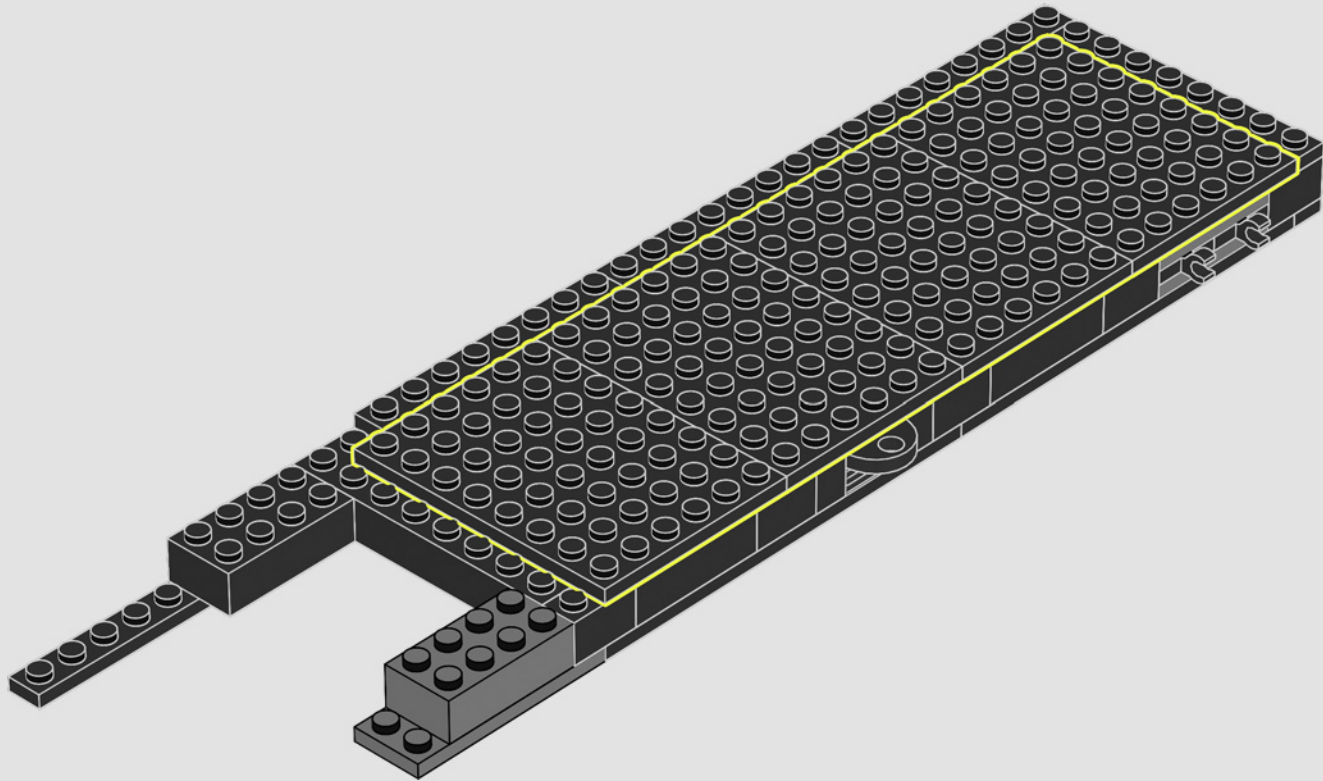

198

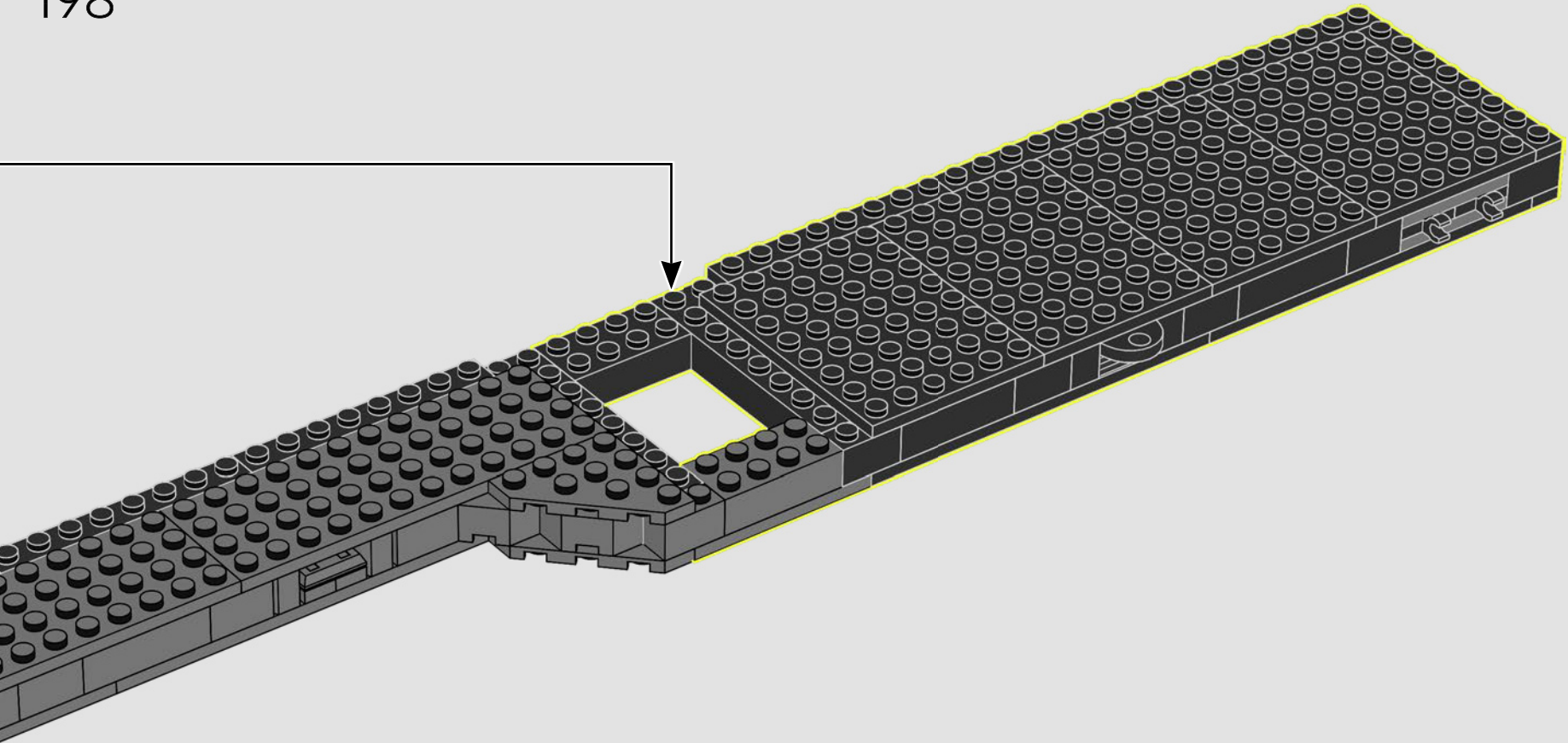

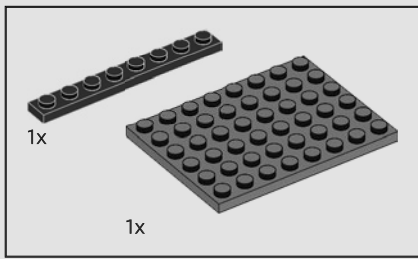

199

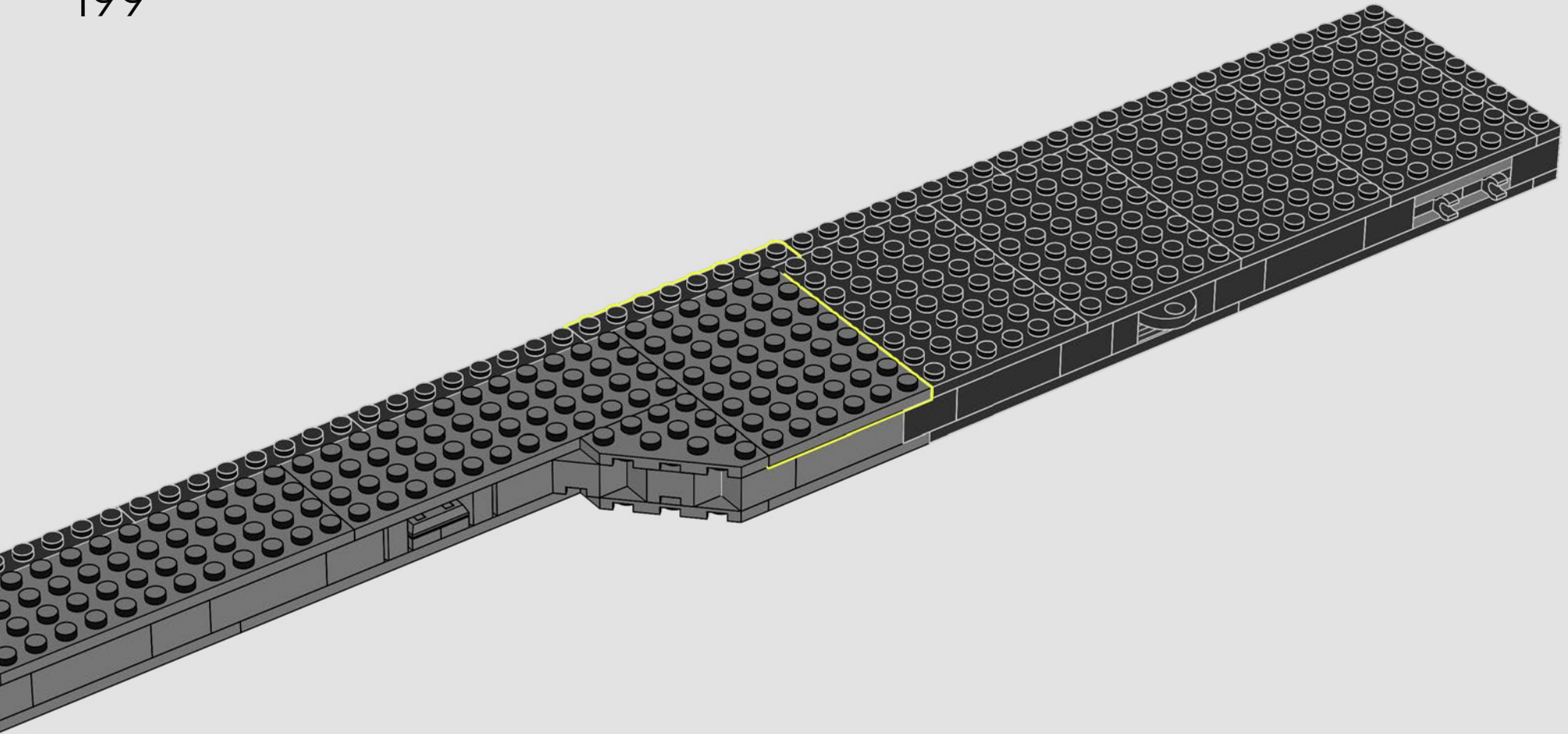

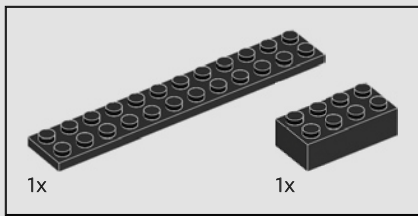

200

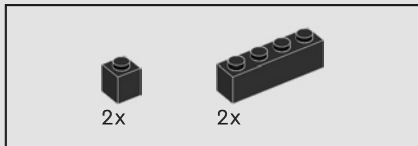
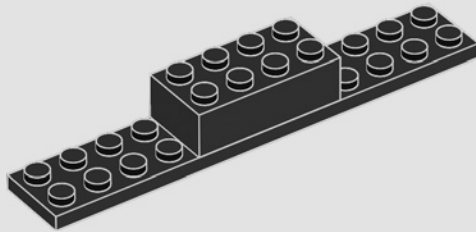

201

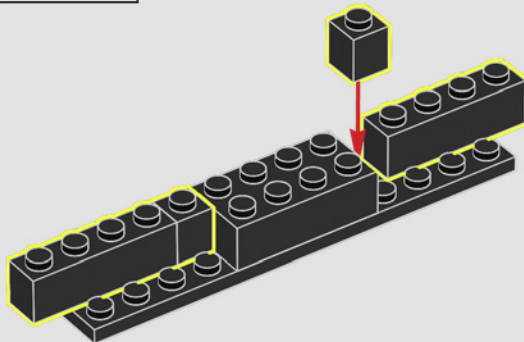

202

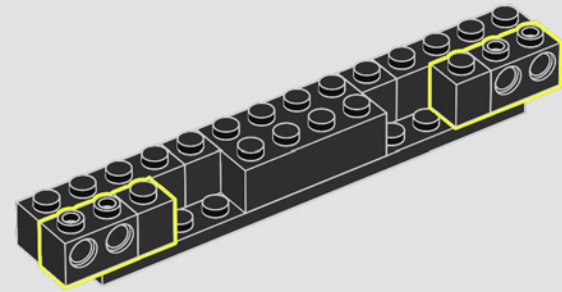

203

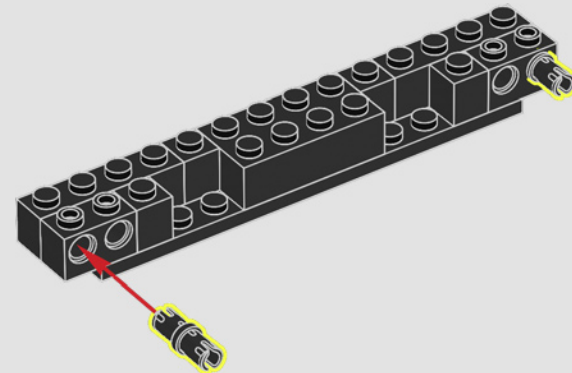

204

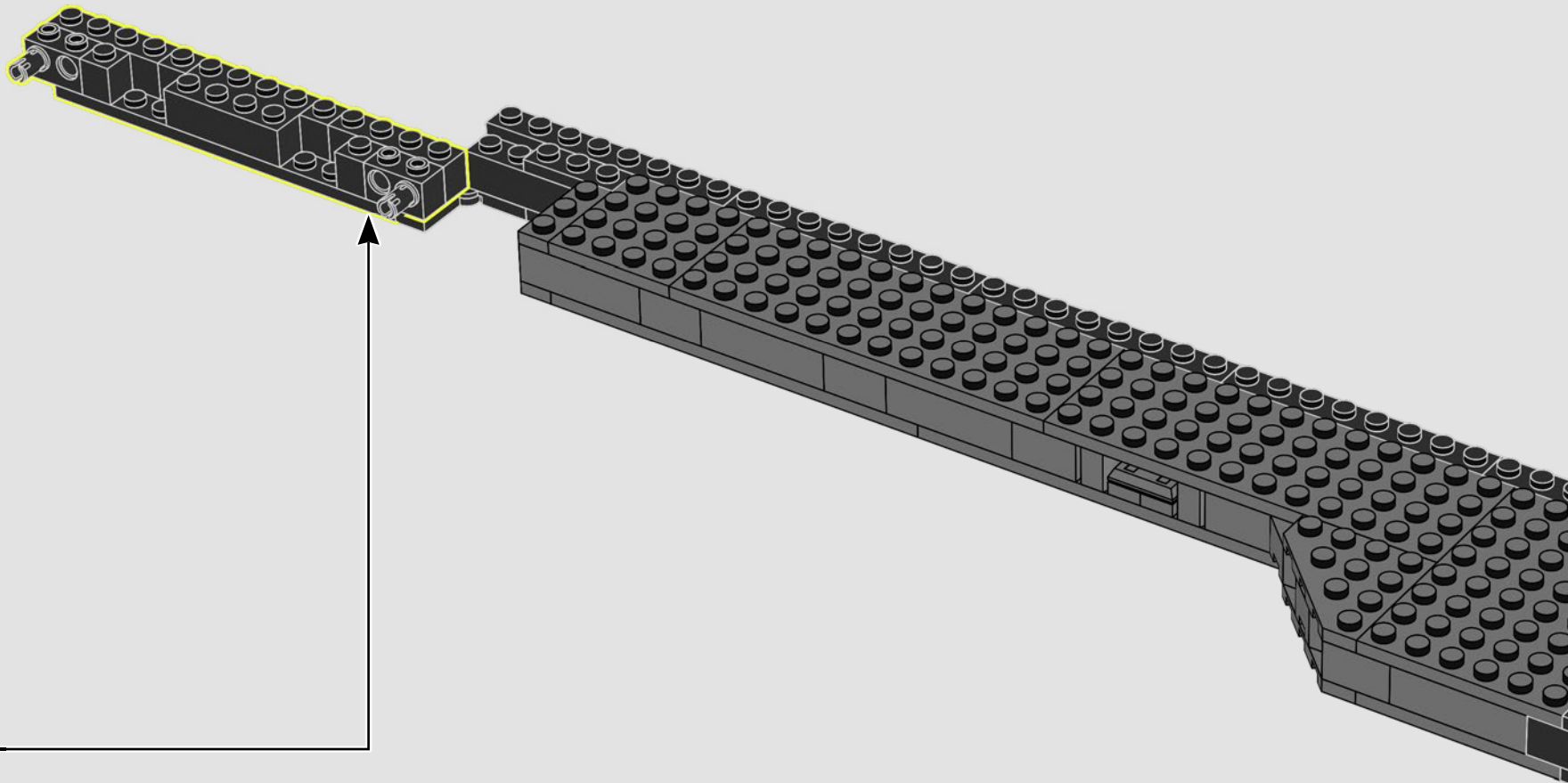

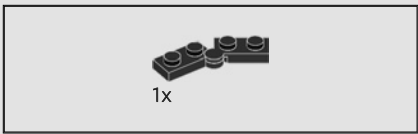

205

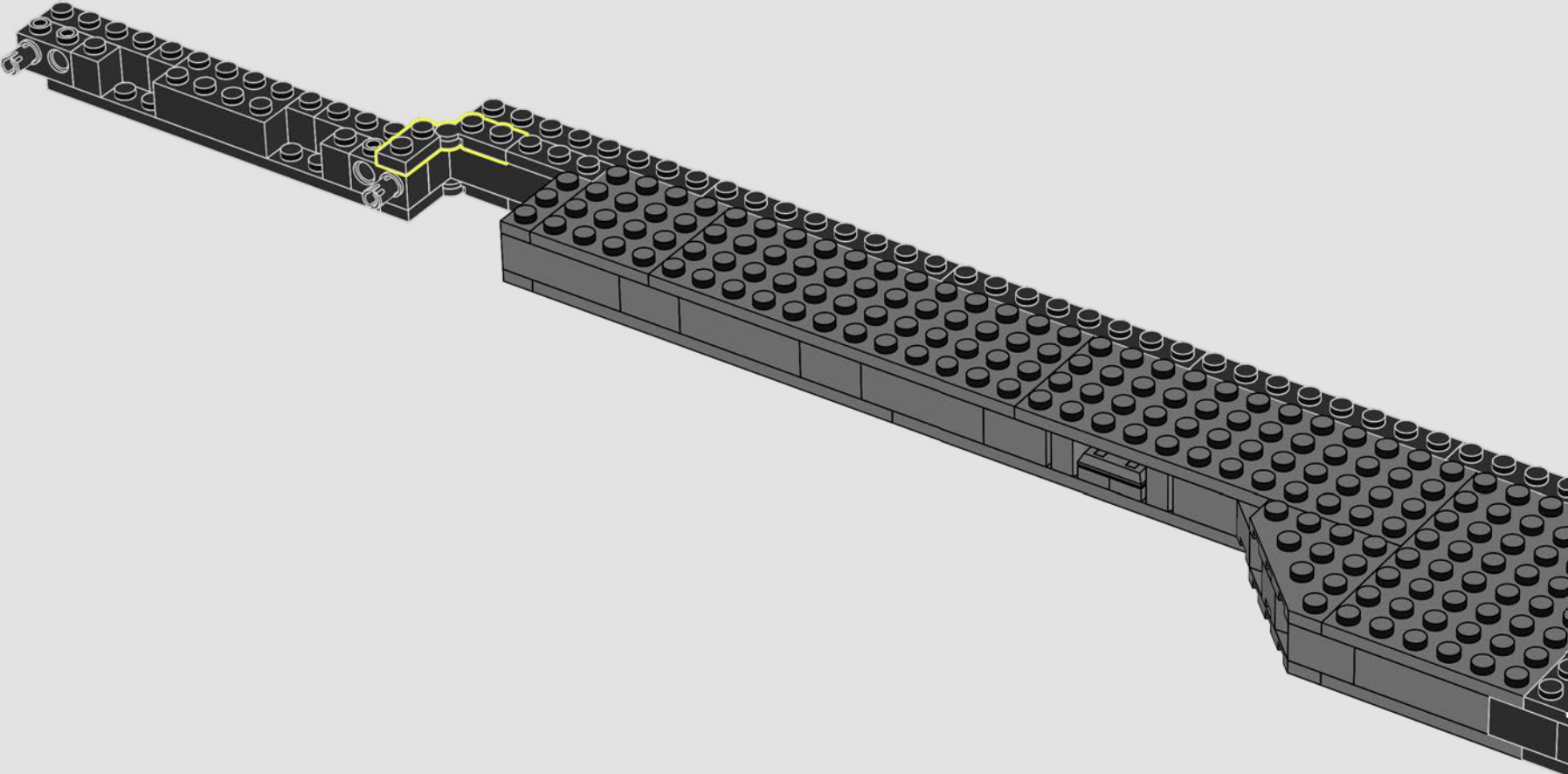

206

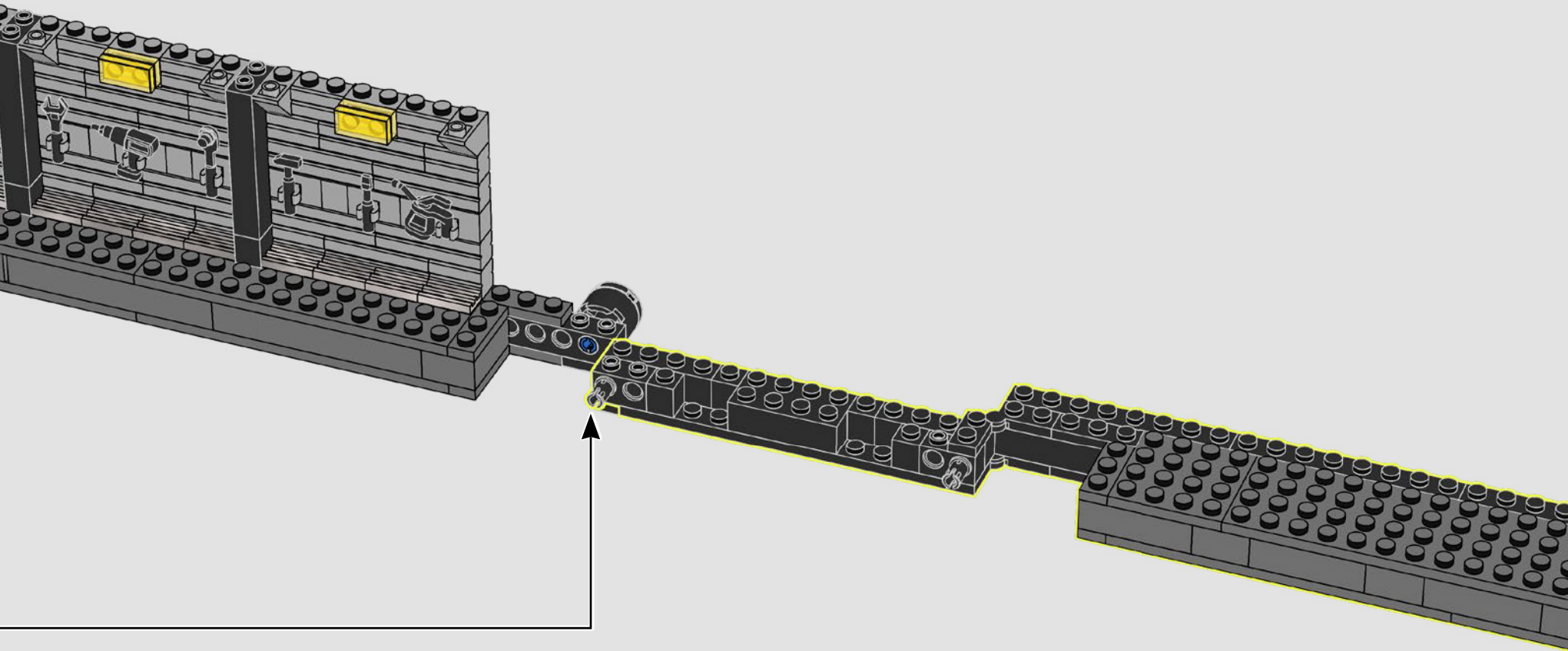

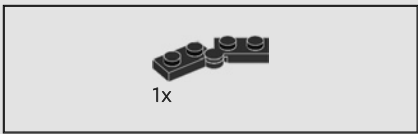

207

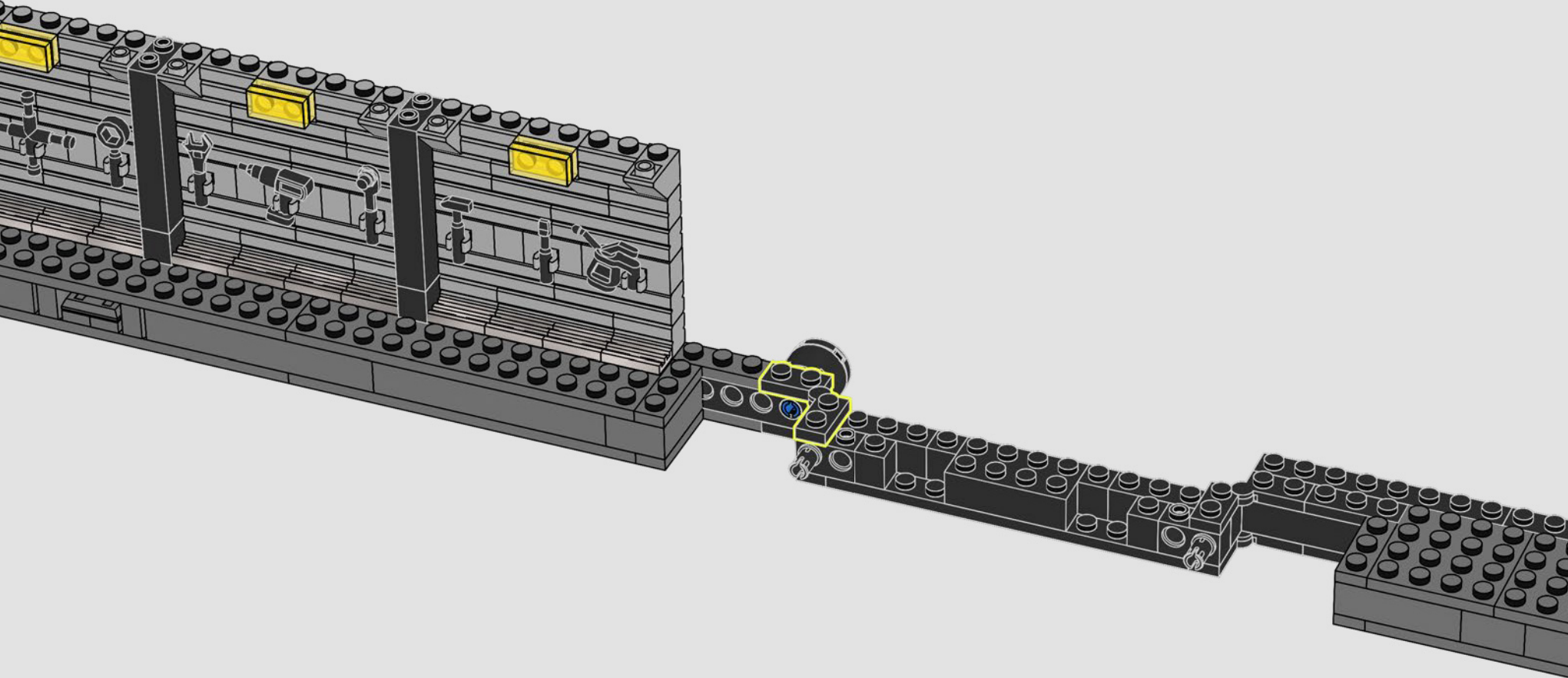



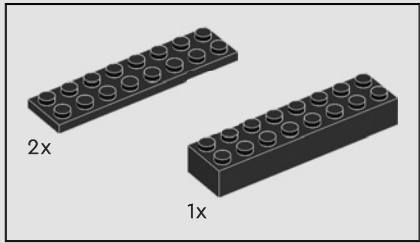
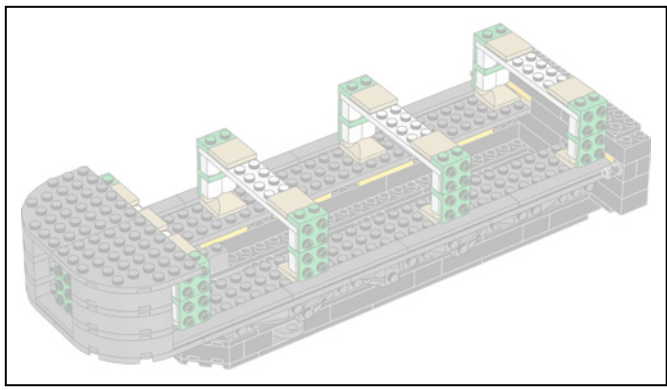

208

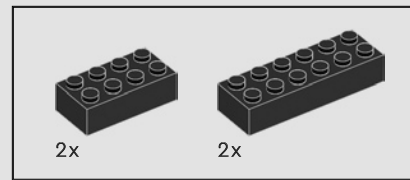
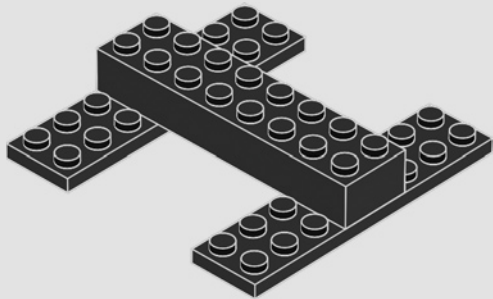

209

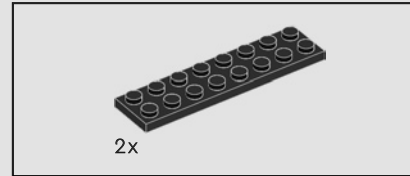
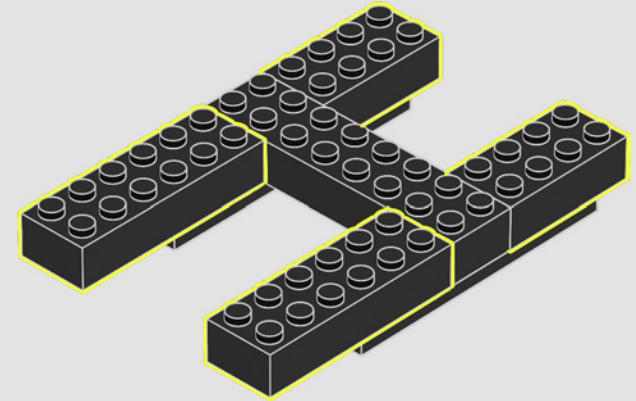

210

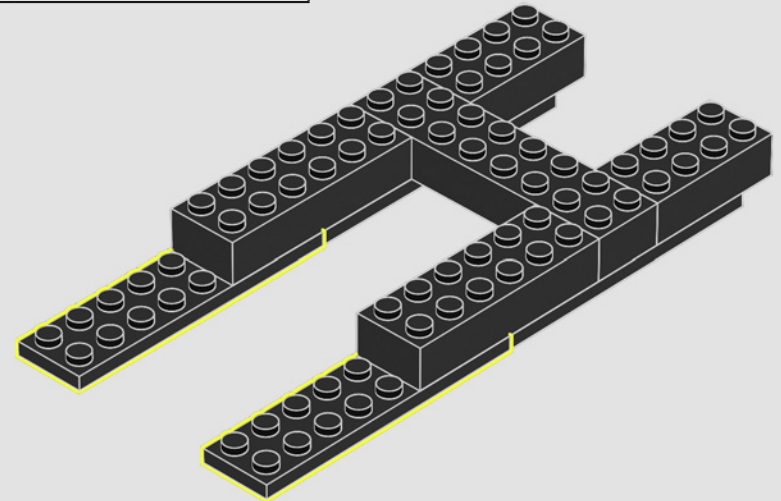

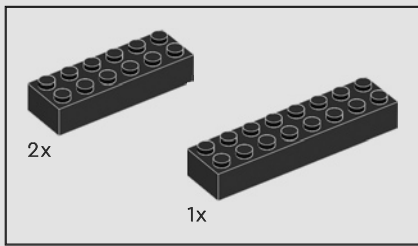

211

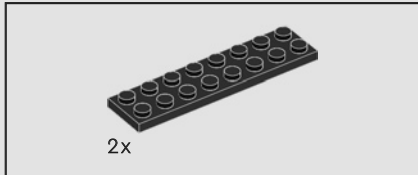
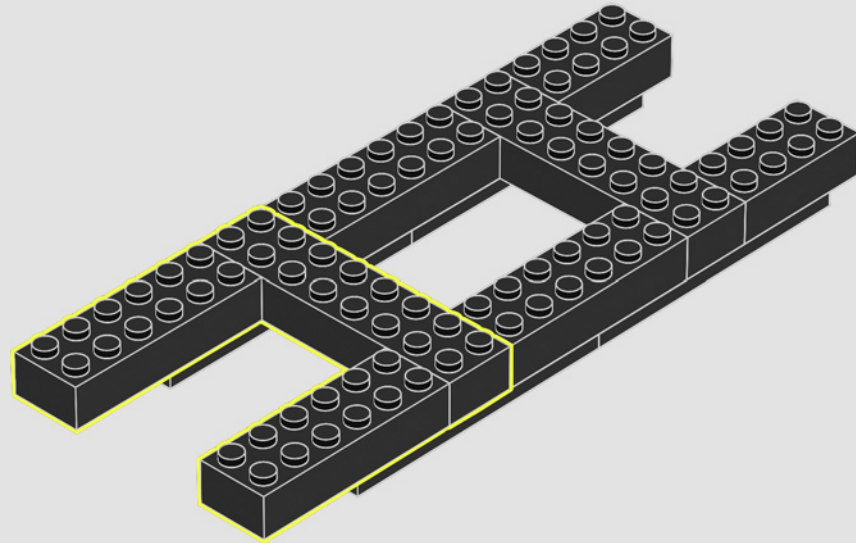

212

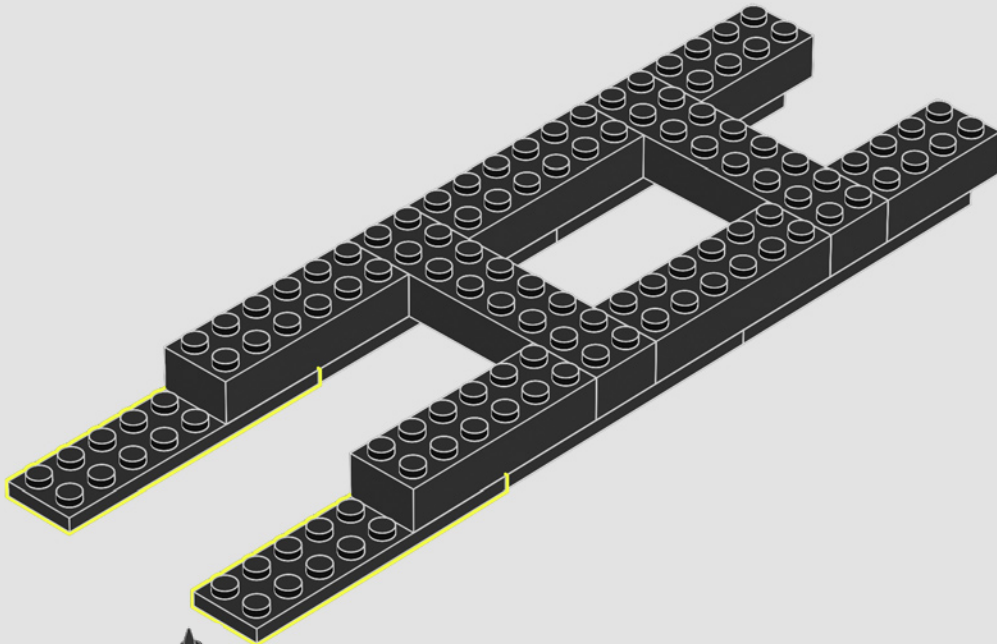

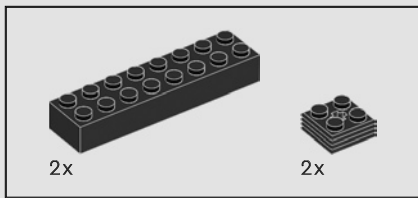

213

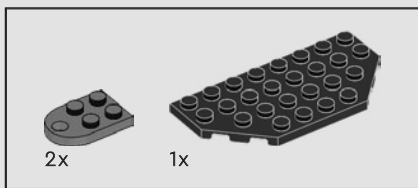
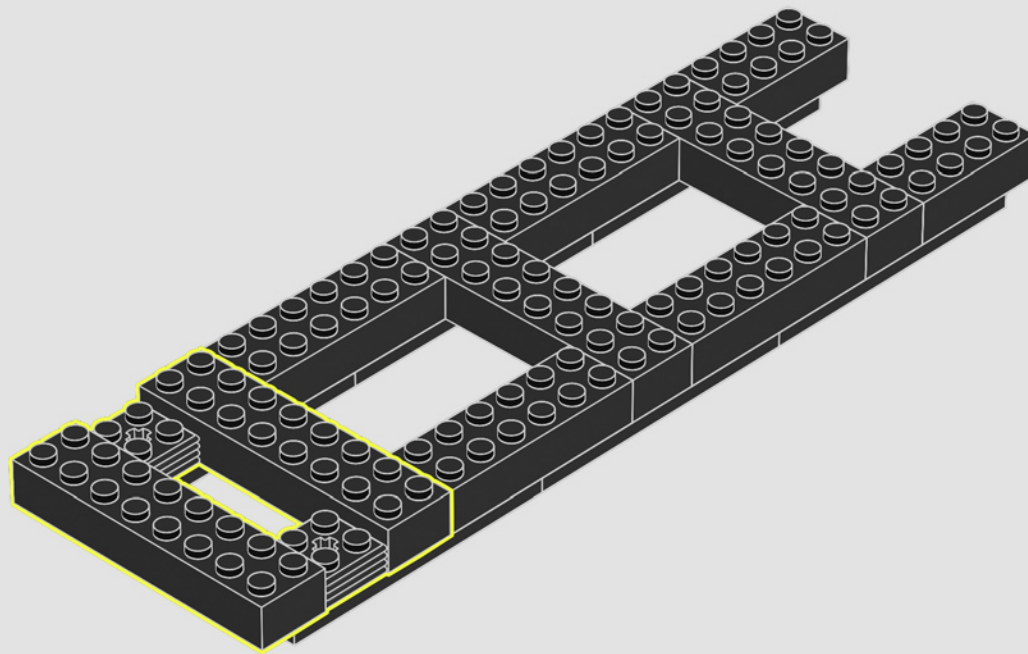

214

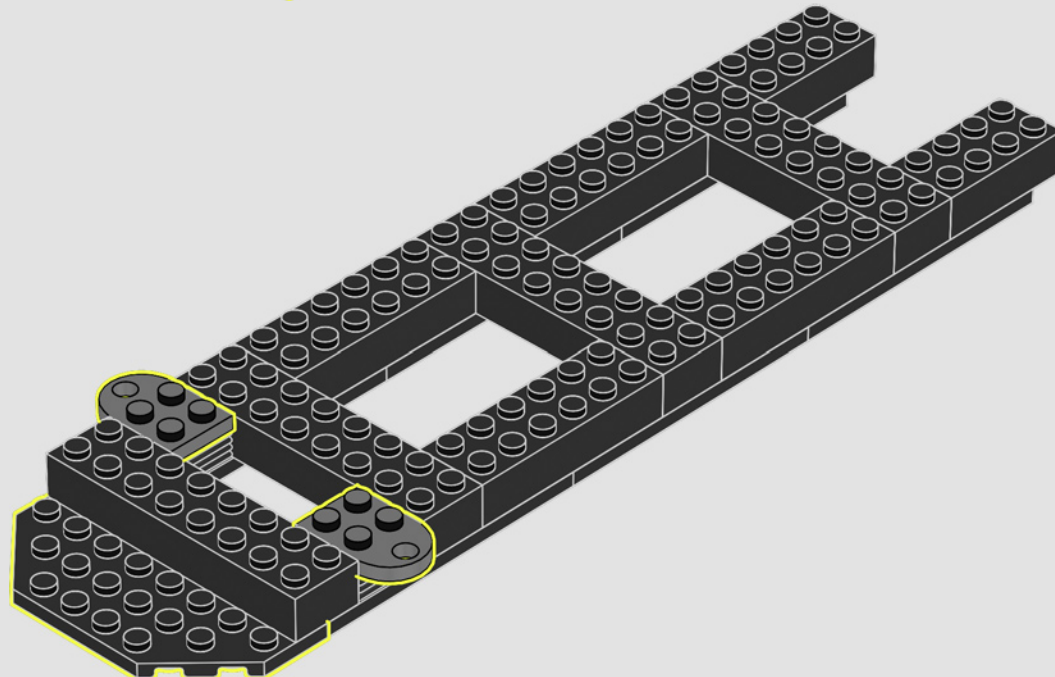

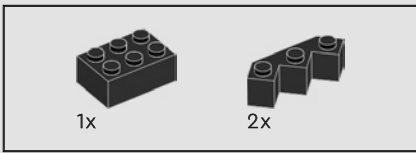

215

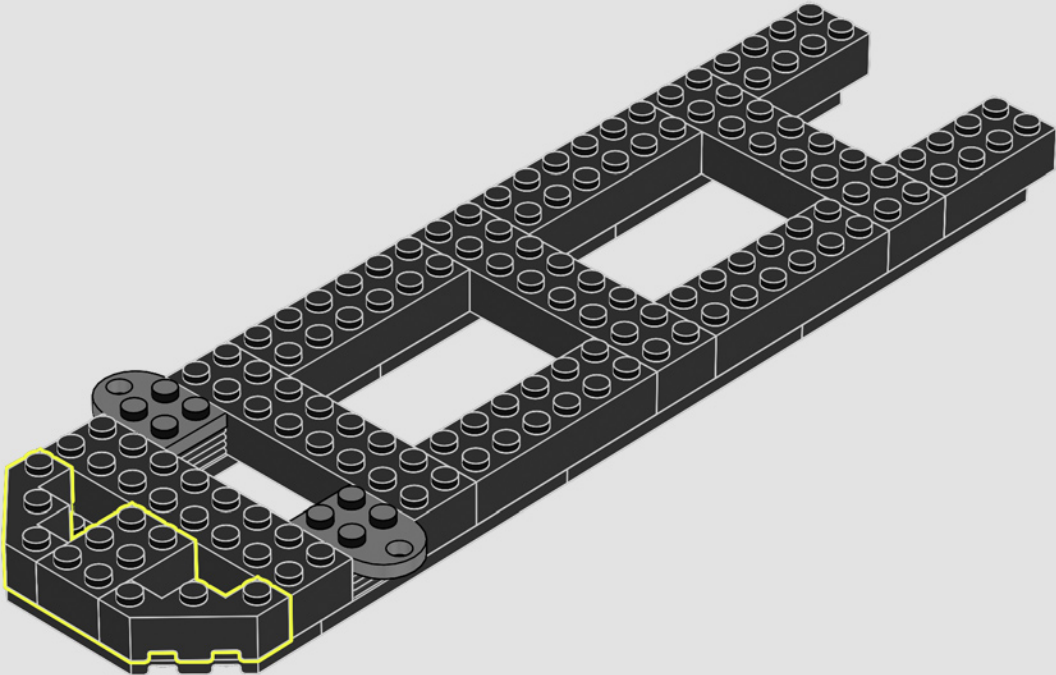

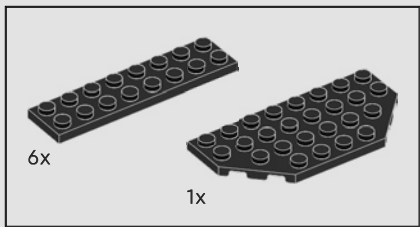

216

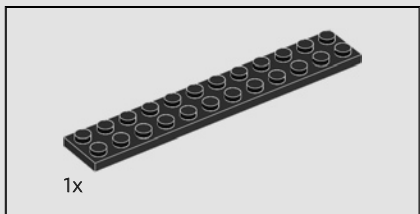
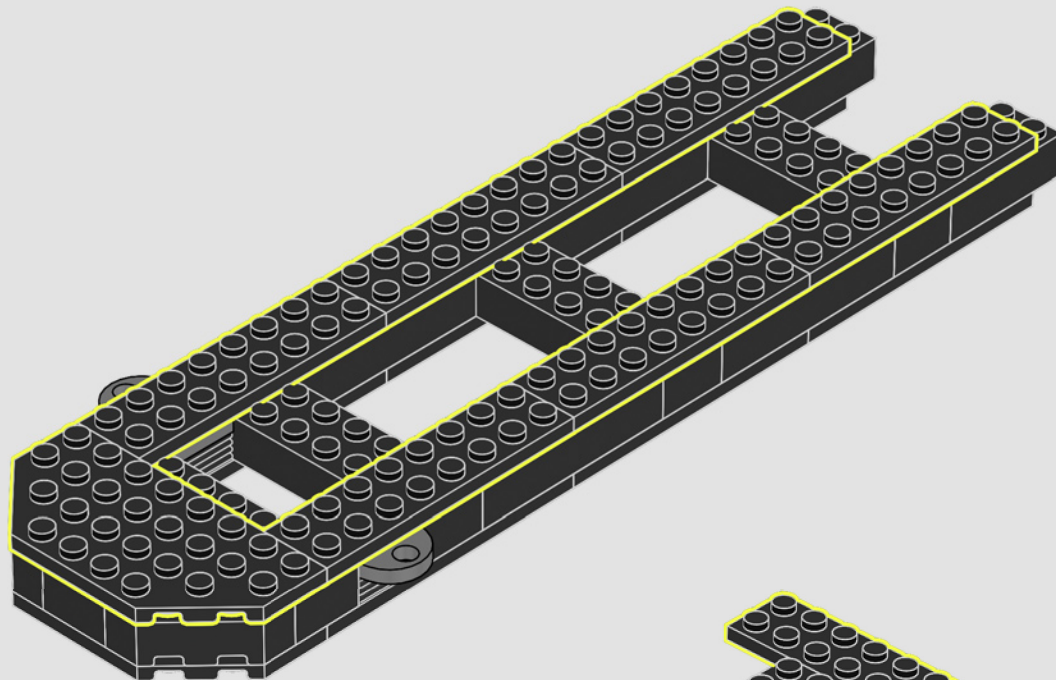

217

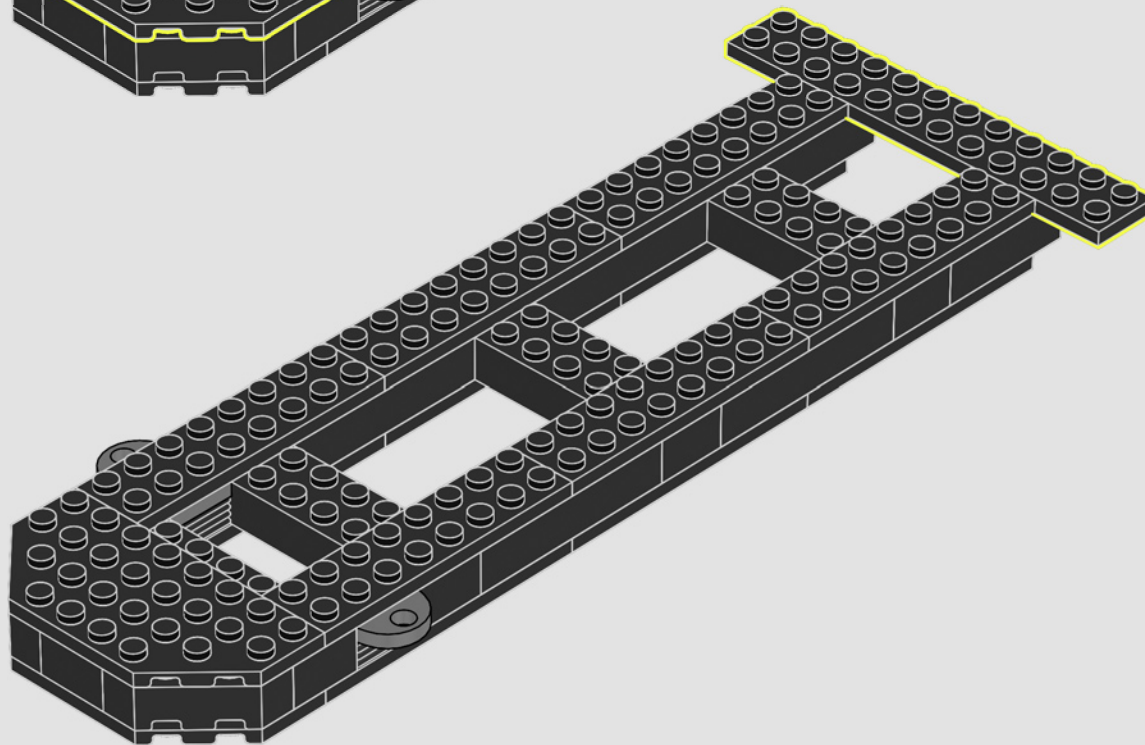

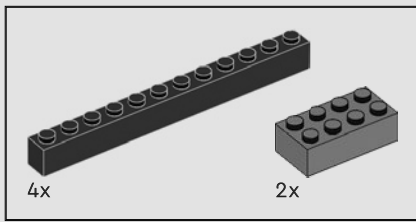

218

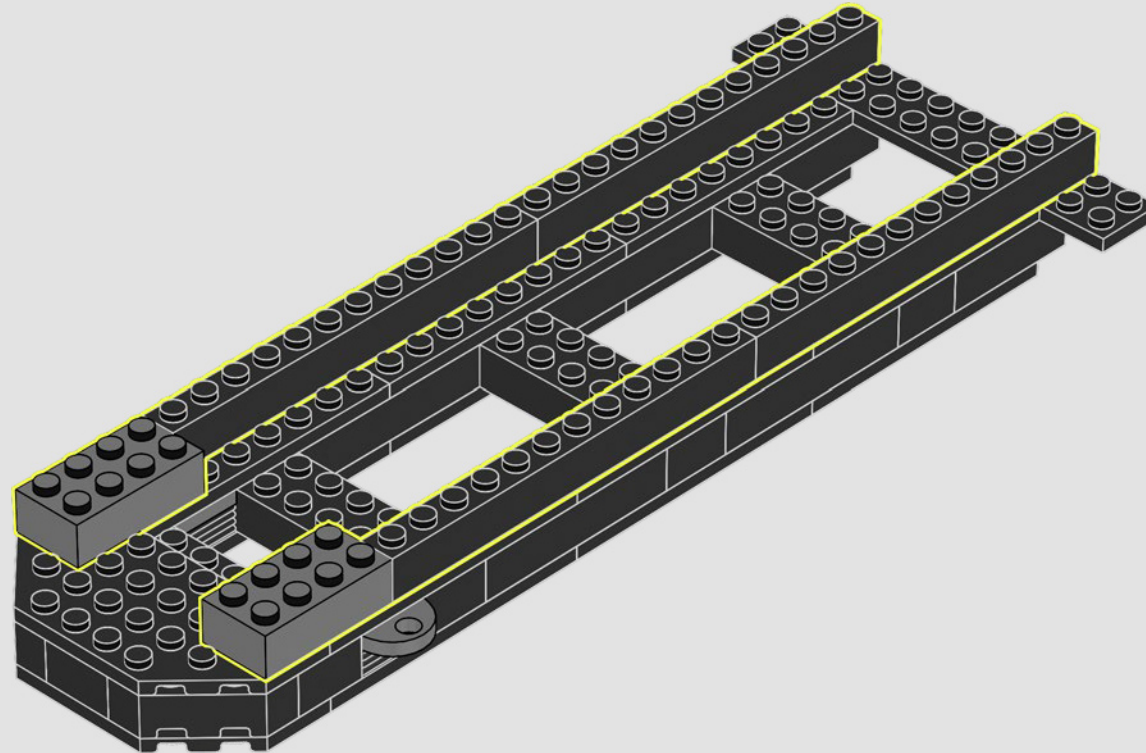

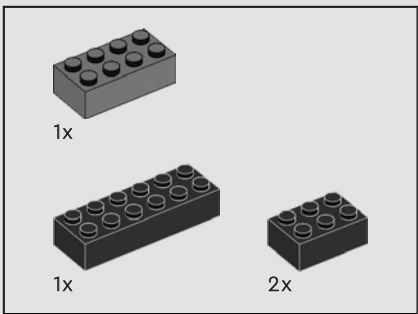

219

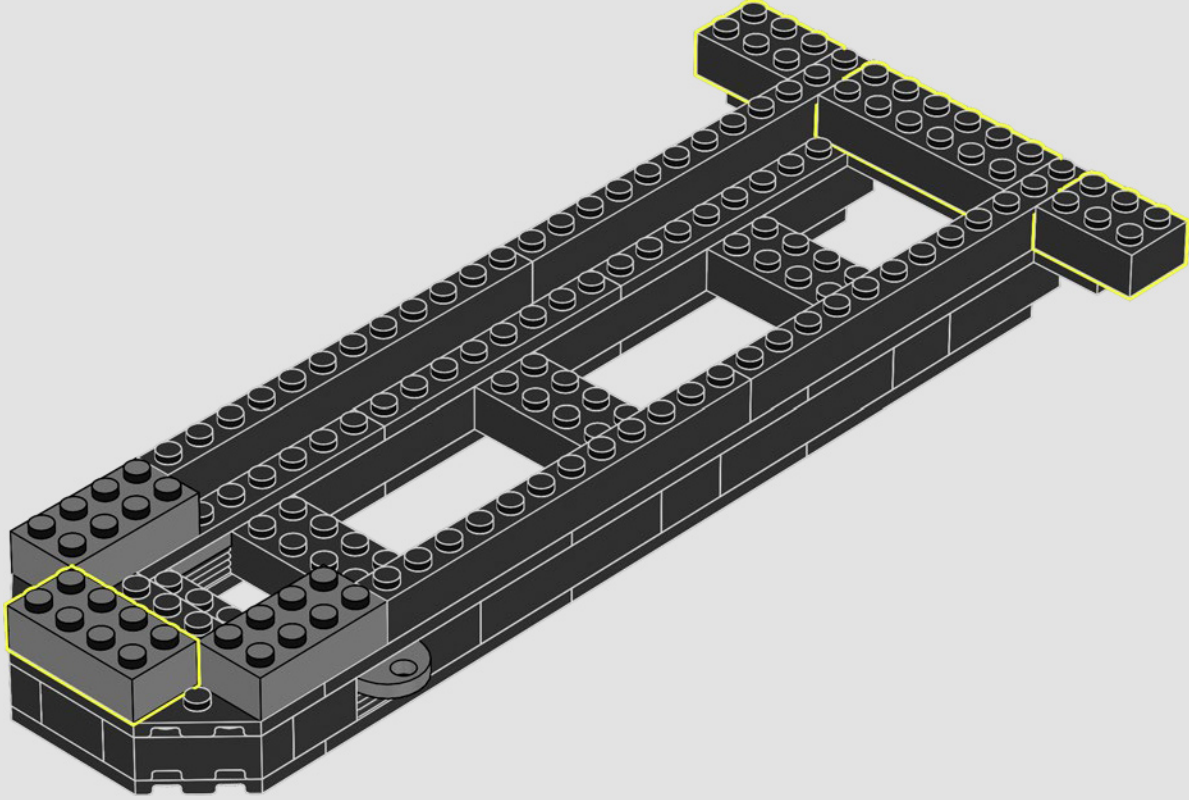

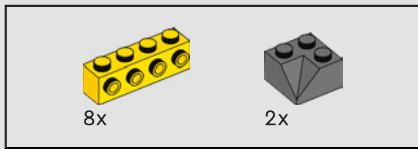

220

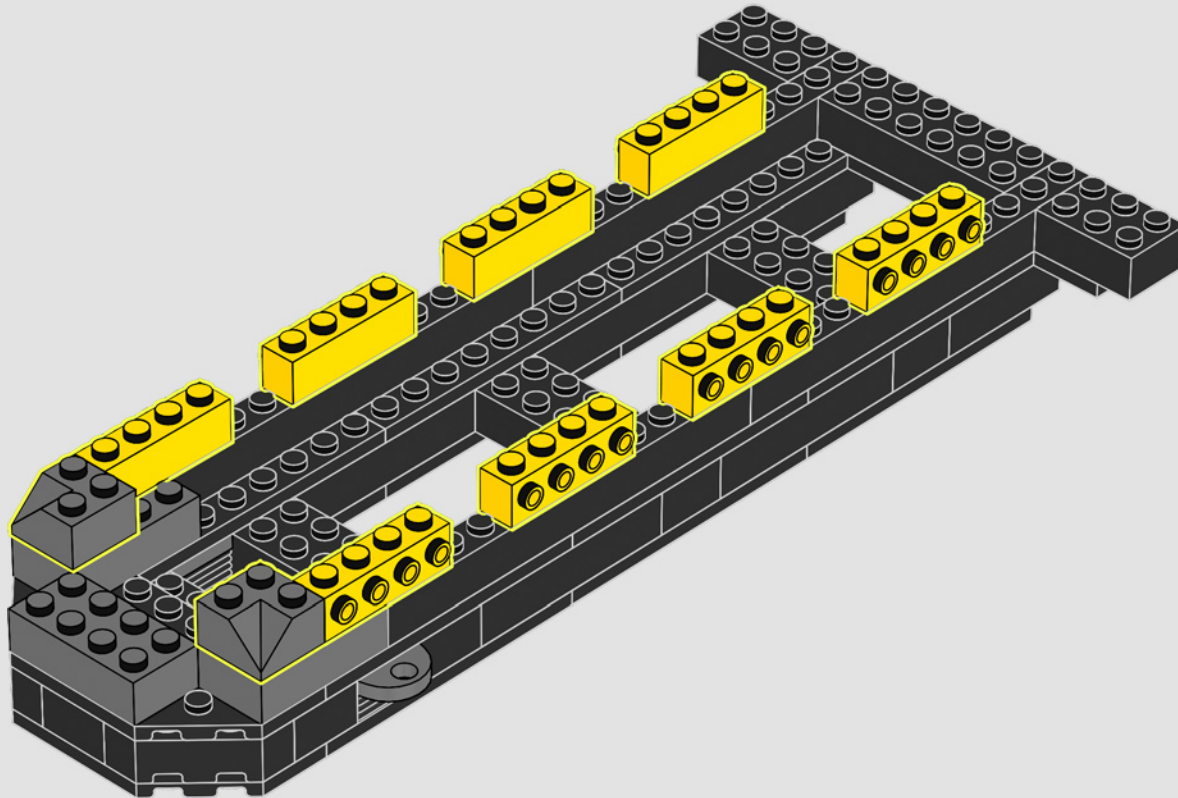

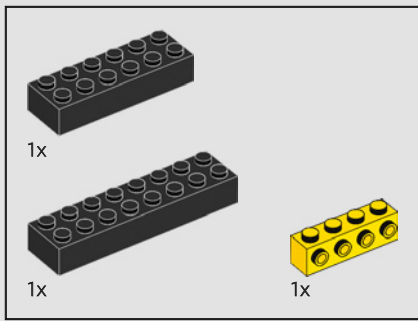

221

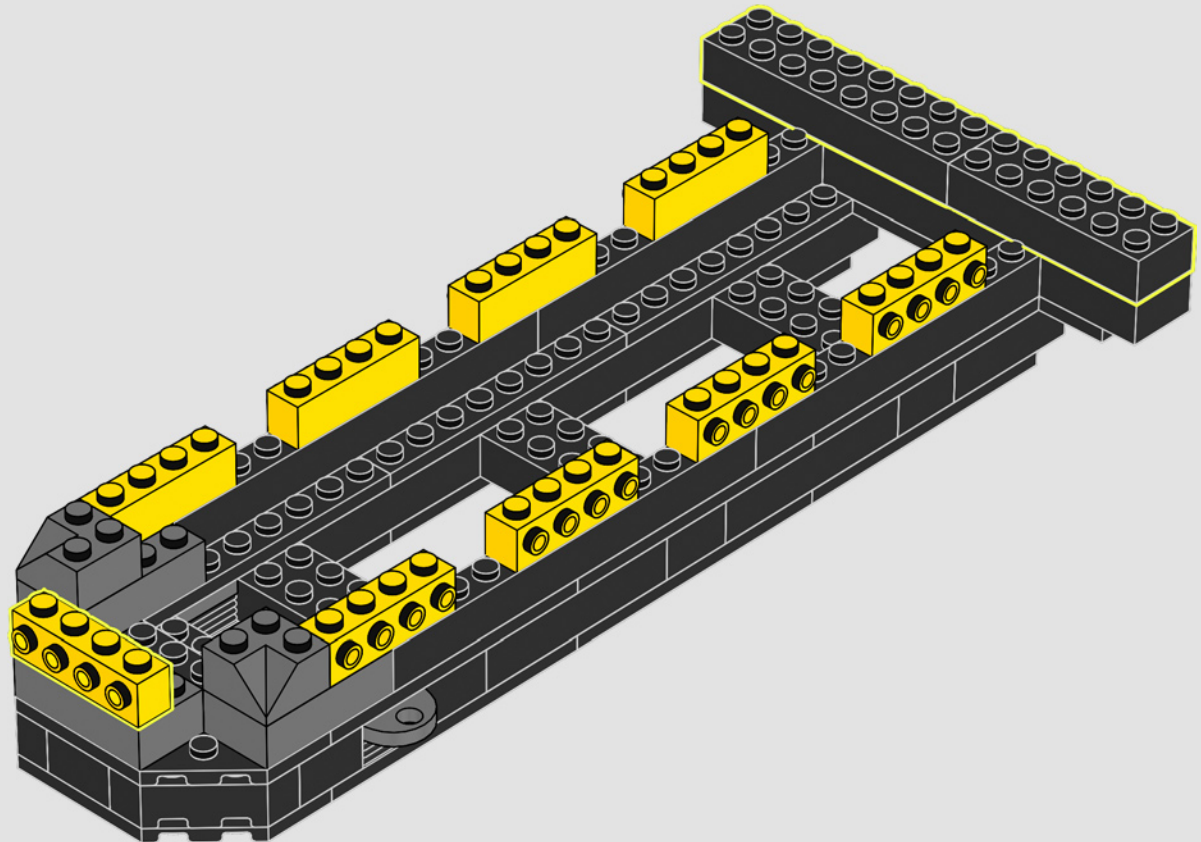

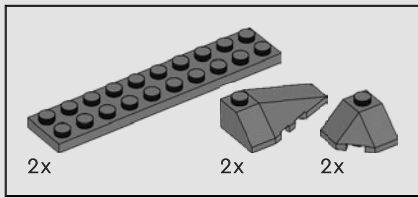

222

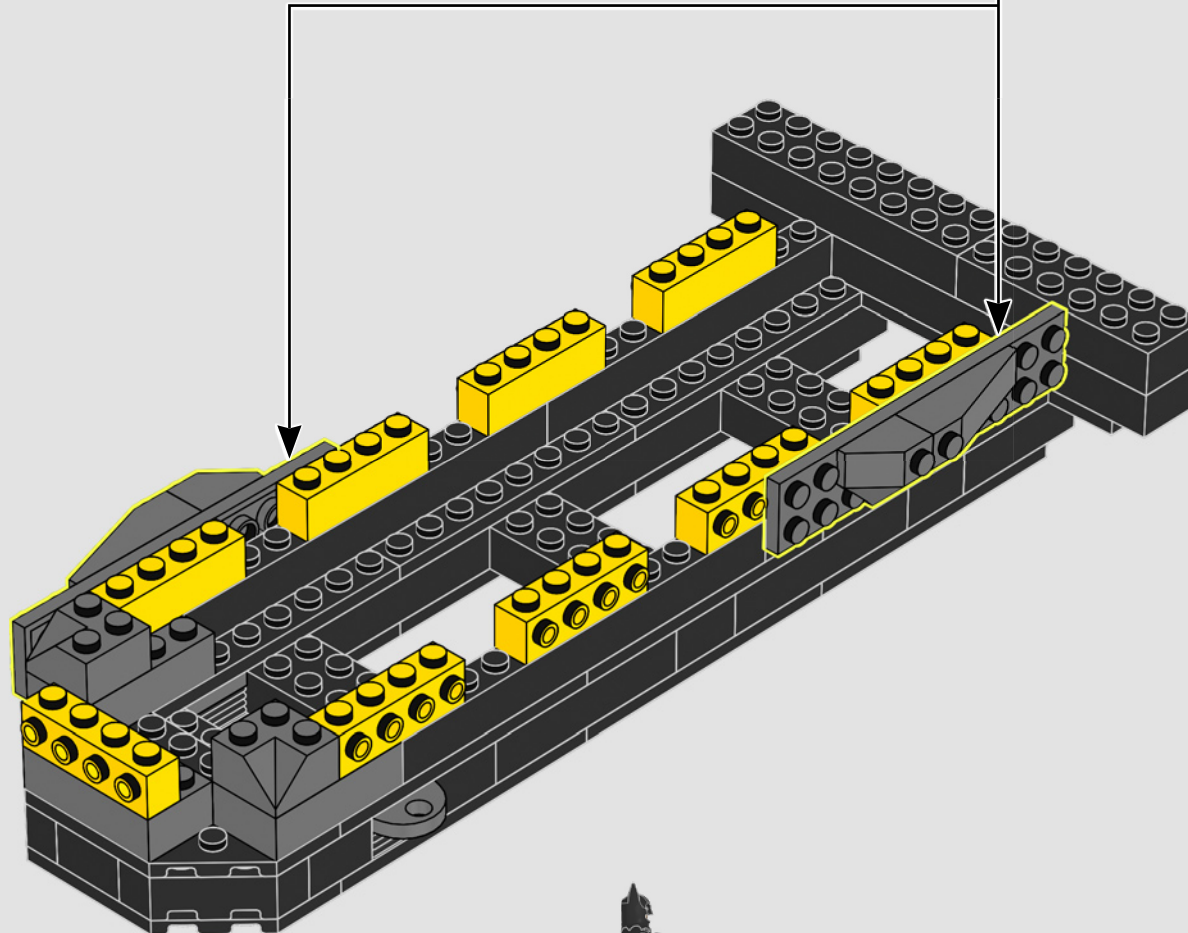
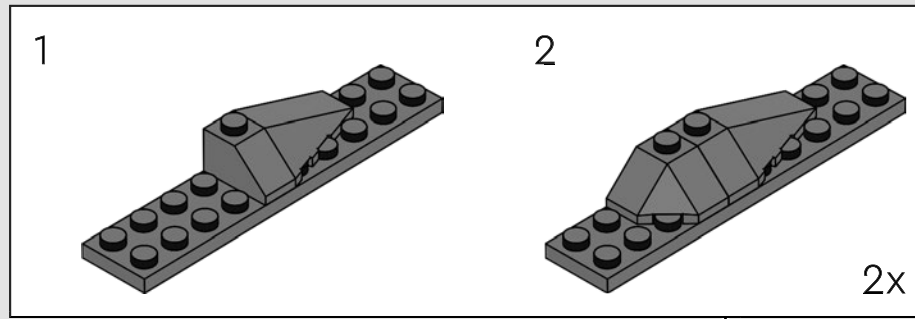

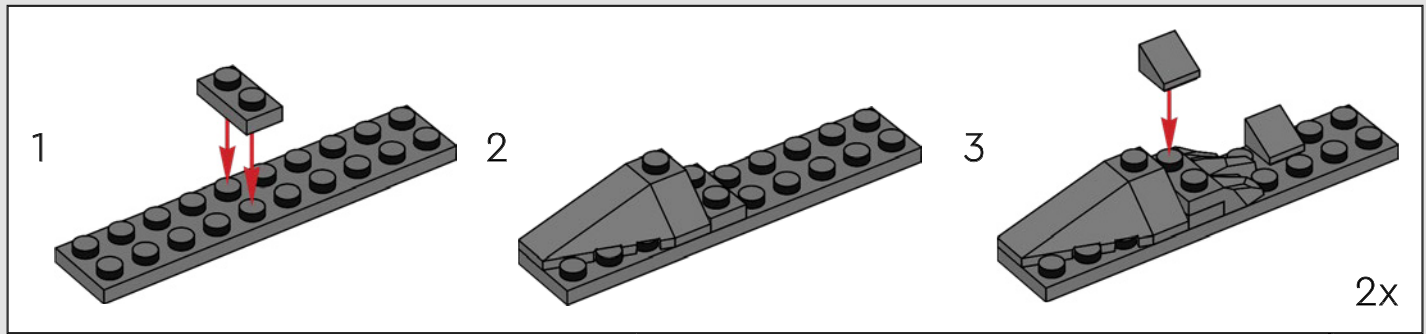
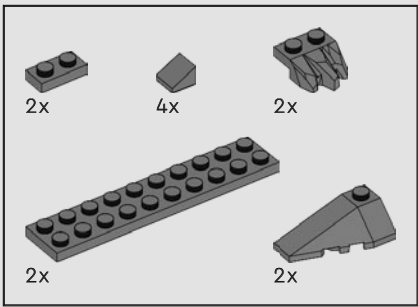

223

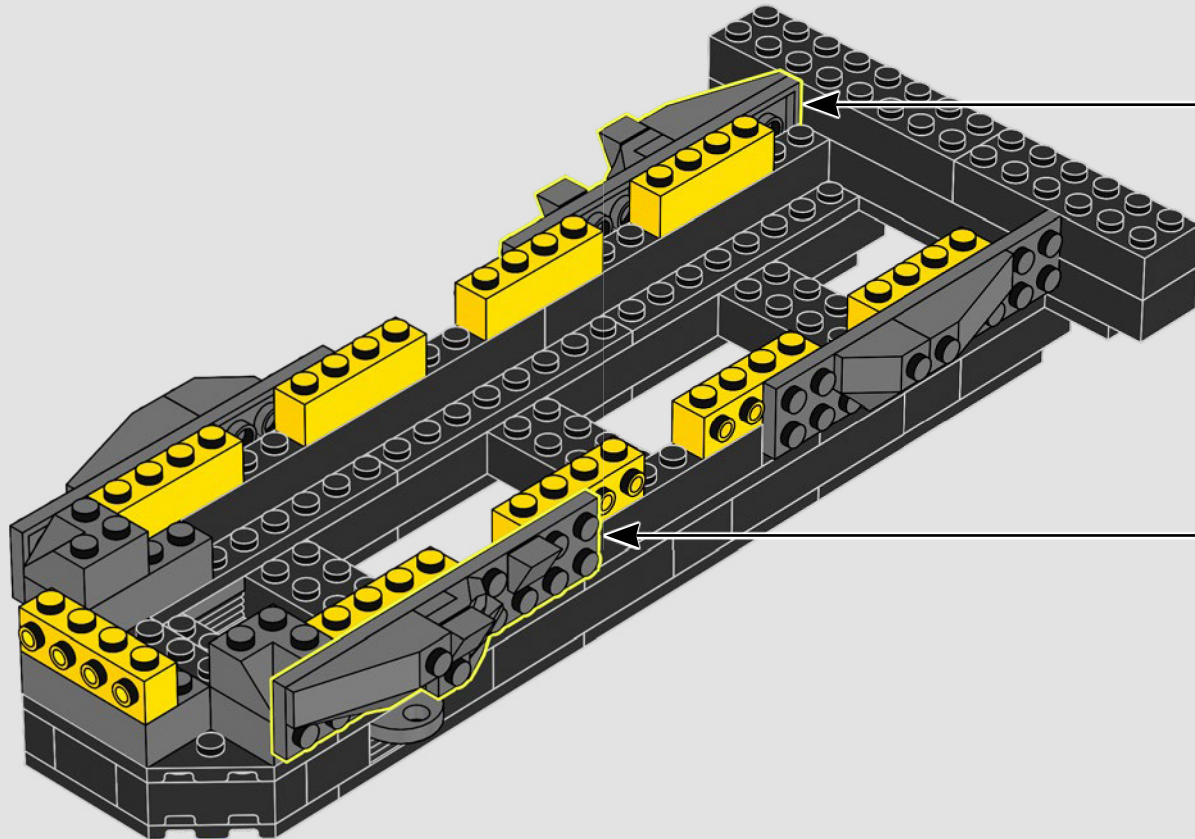

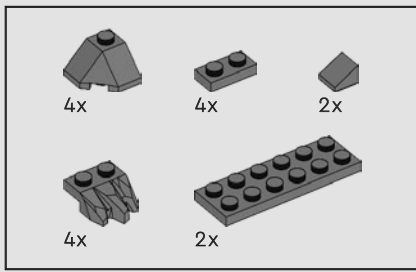

224

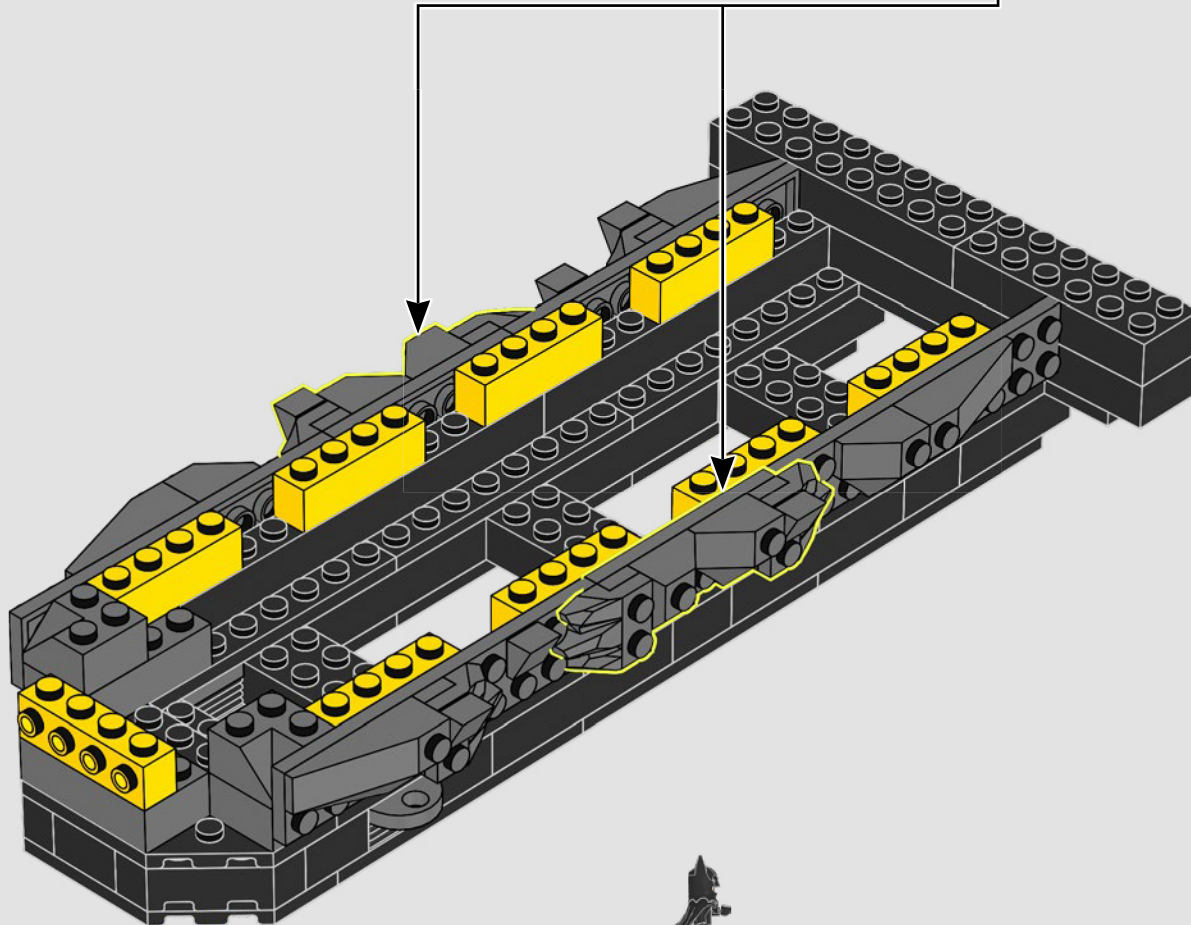
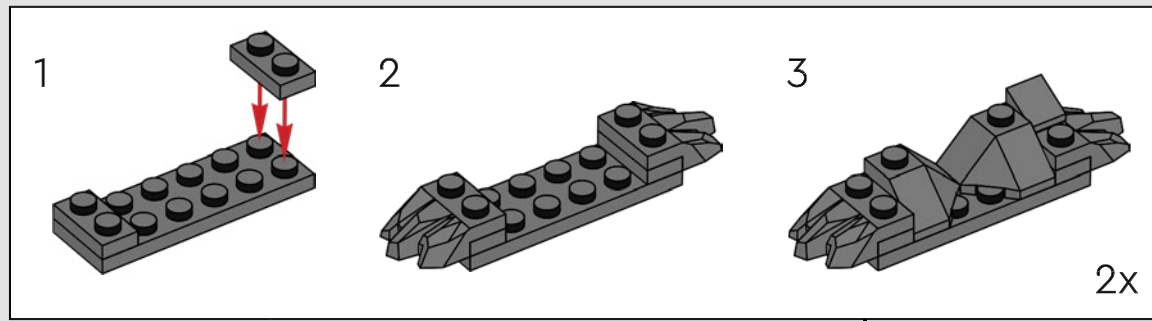



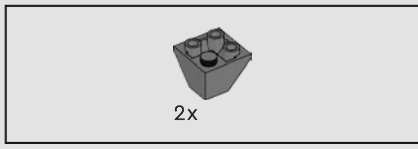

225

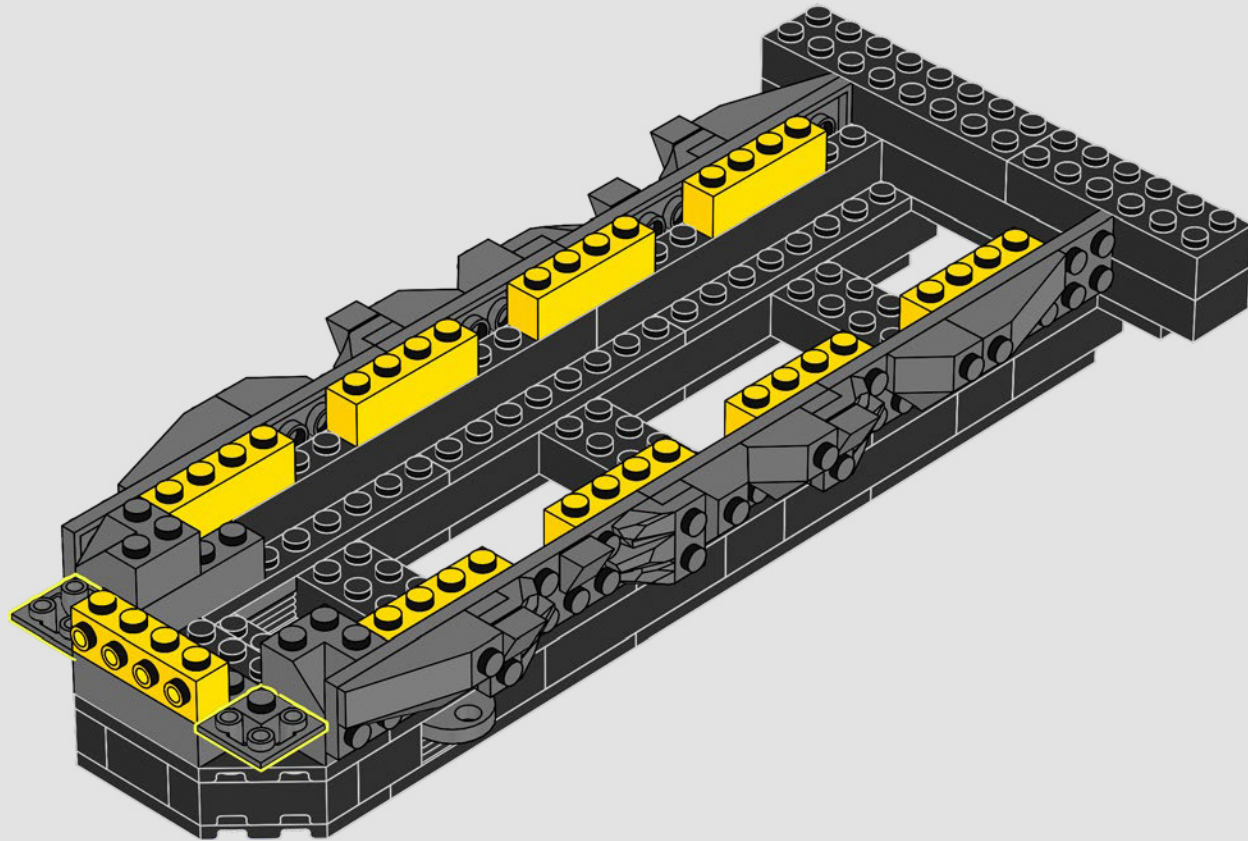

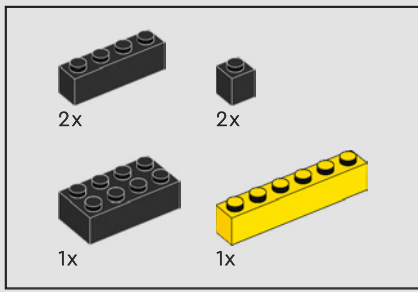

226

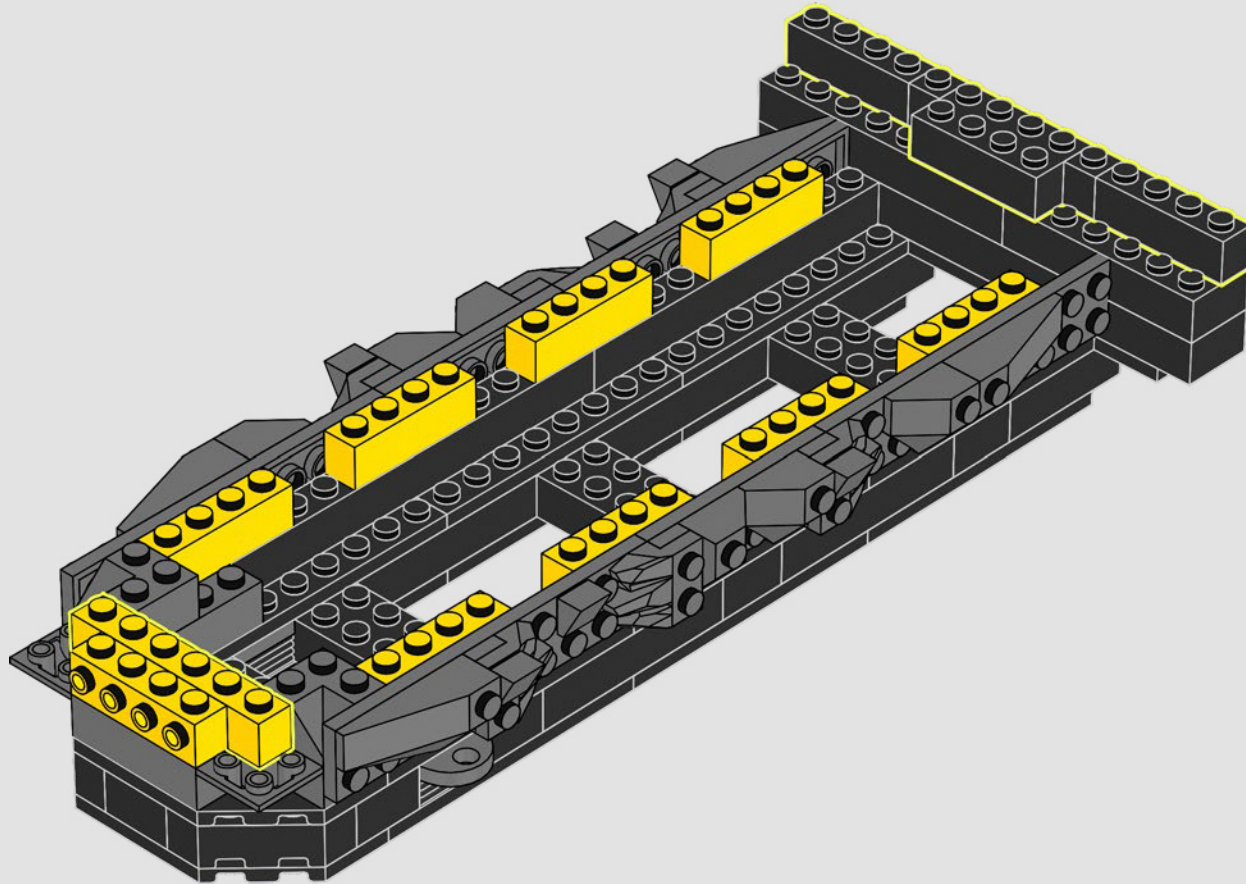



227

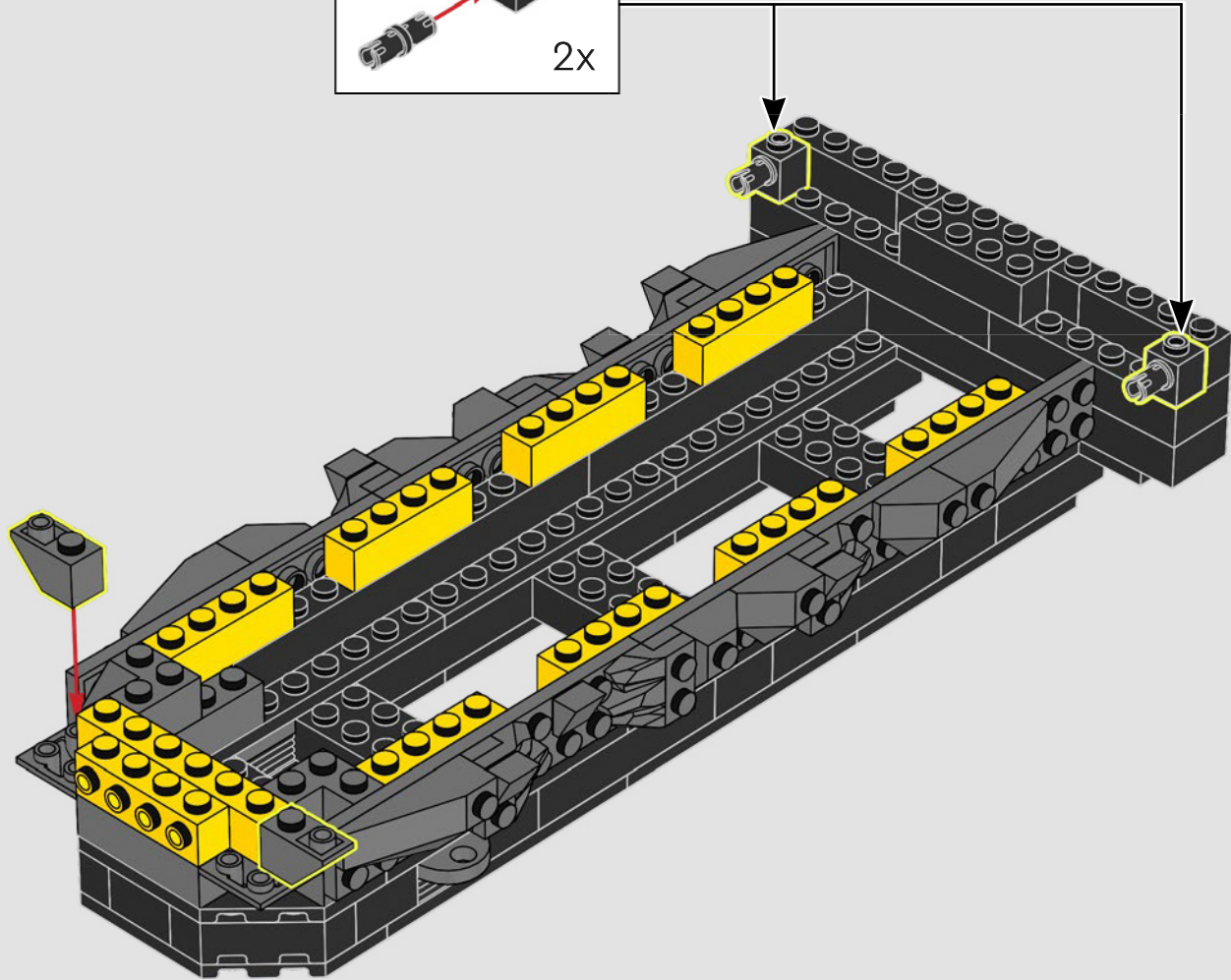
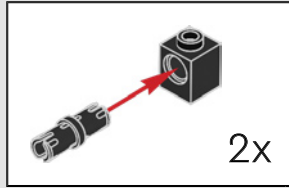

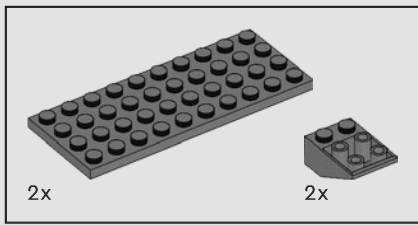

228

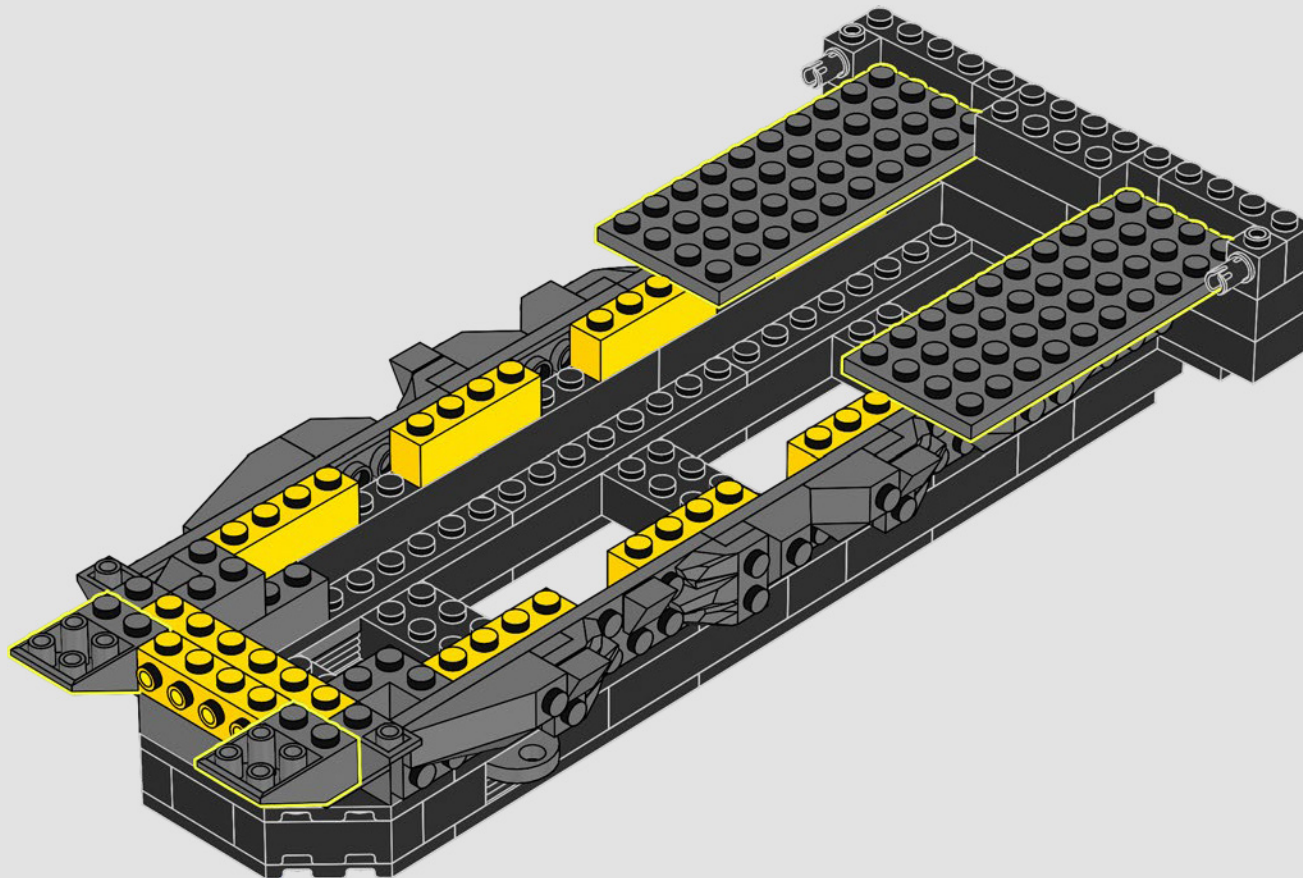

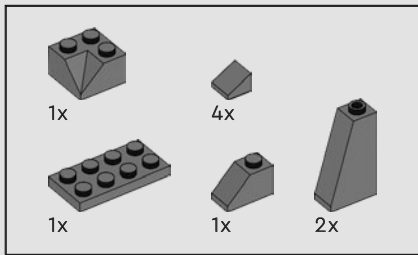

229

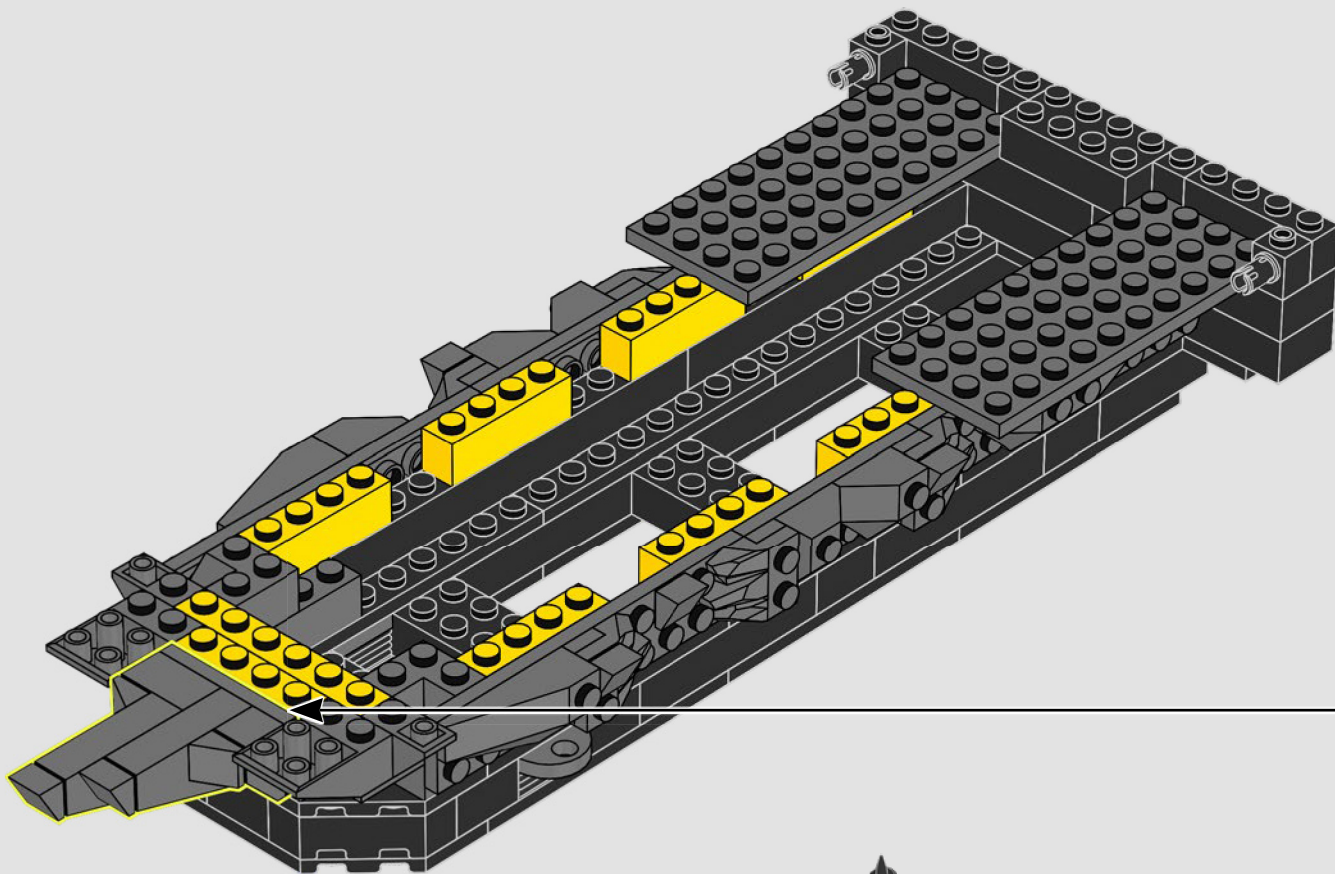
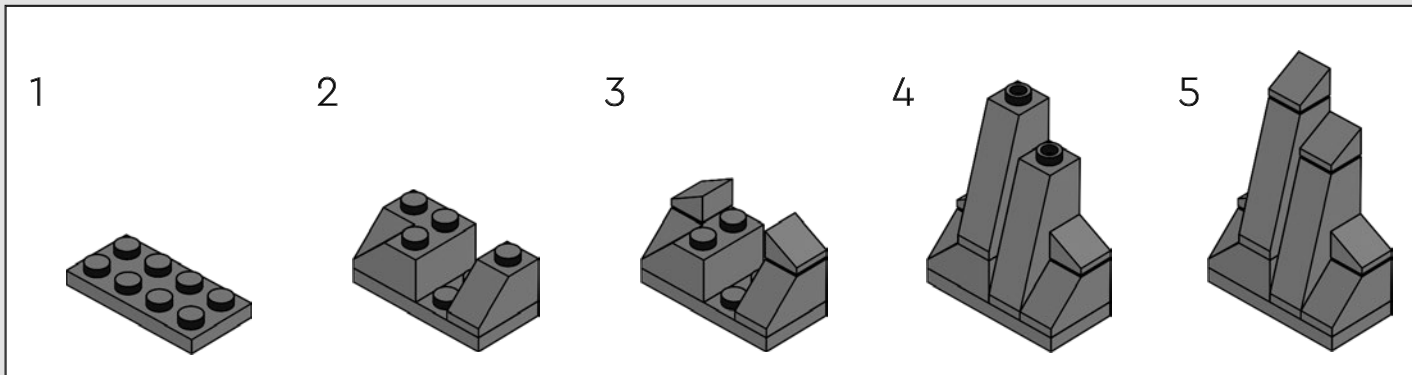

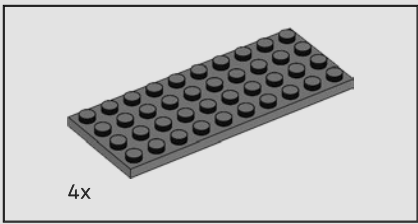

230

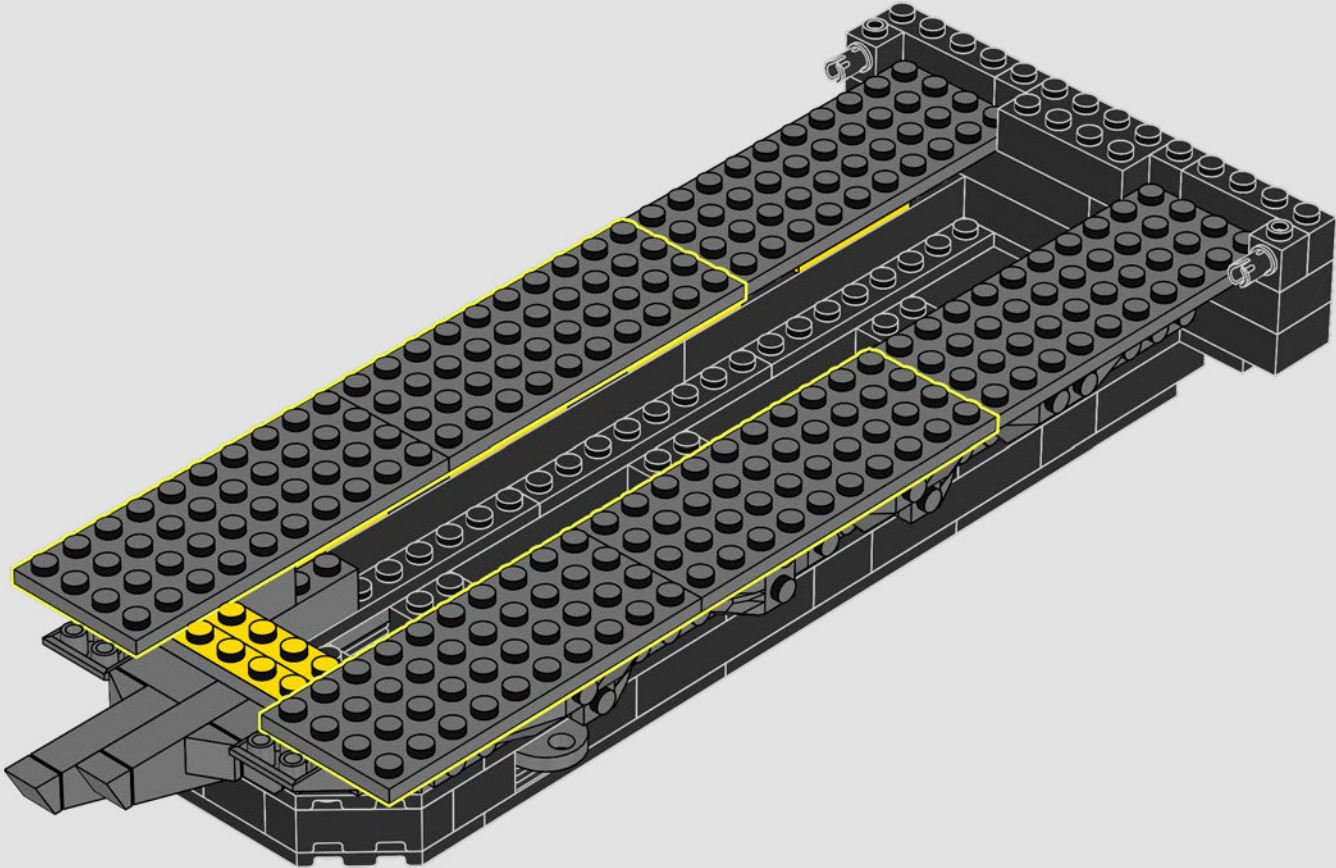

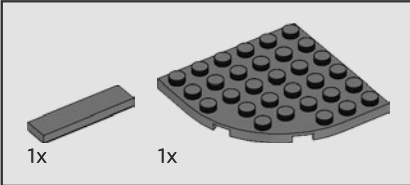
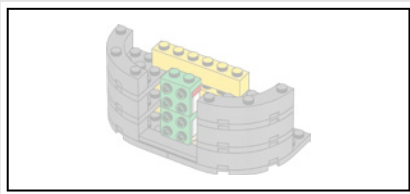

231

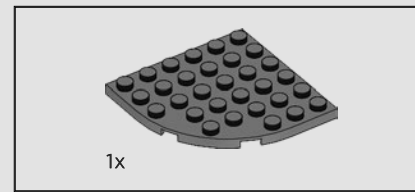
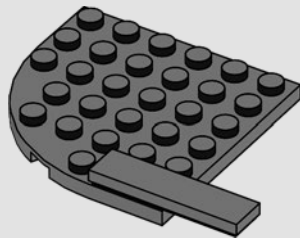

232

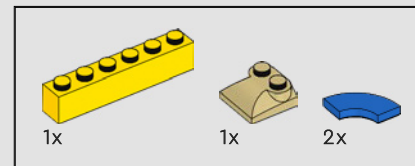
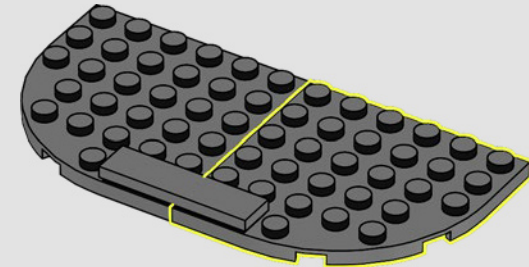

233

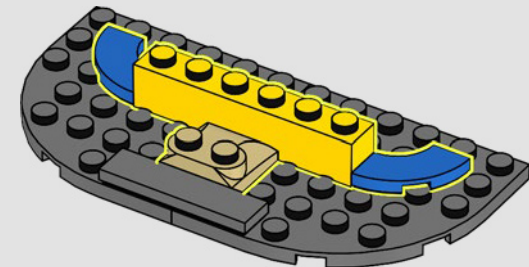

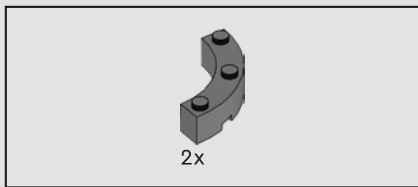

234

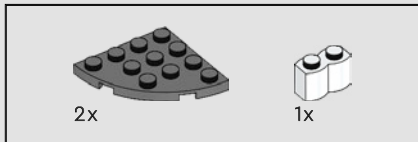
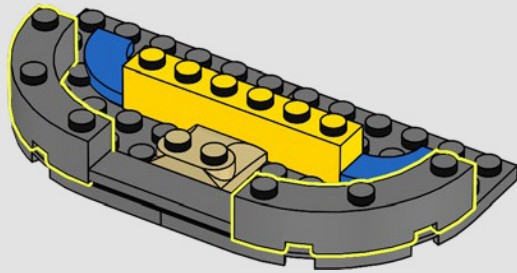

235

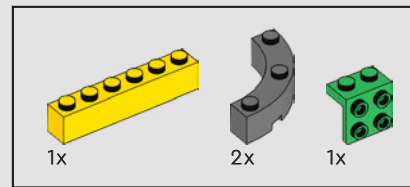
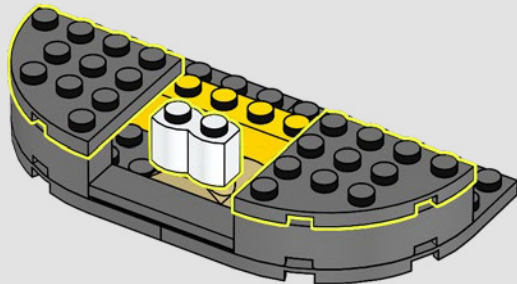

236

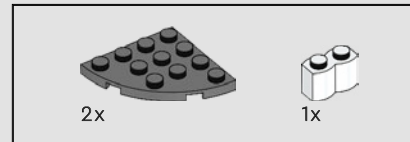
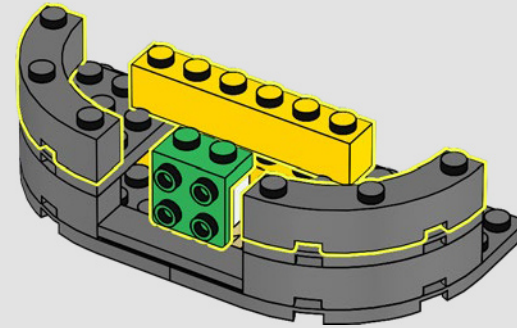

237

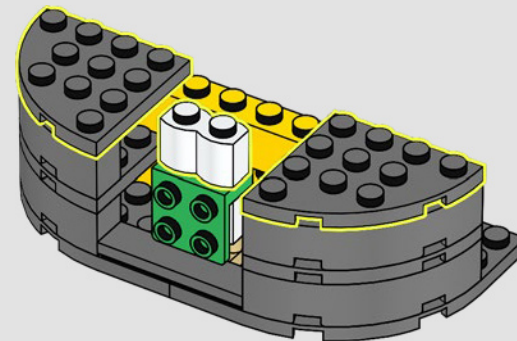

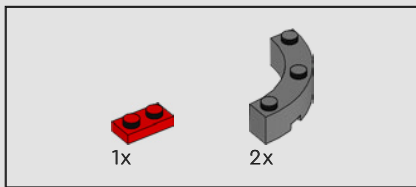

238

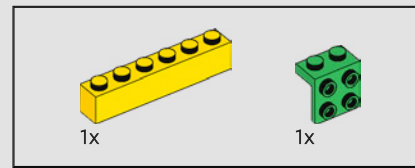
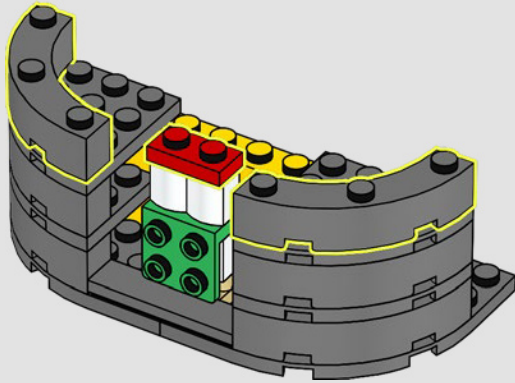

239

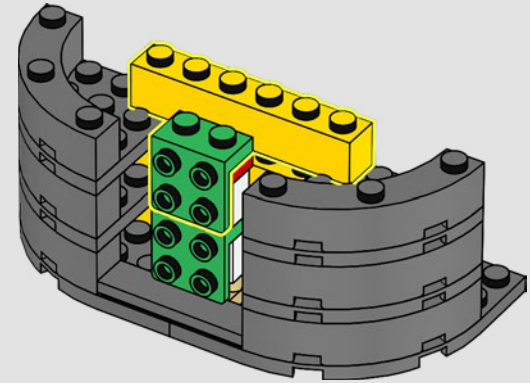

240

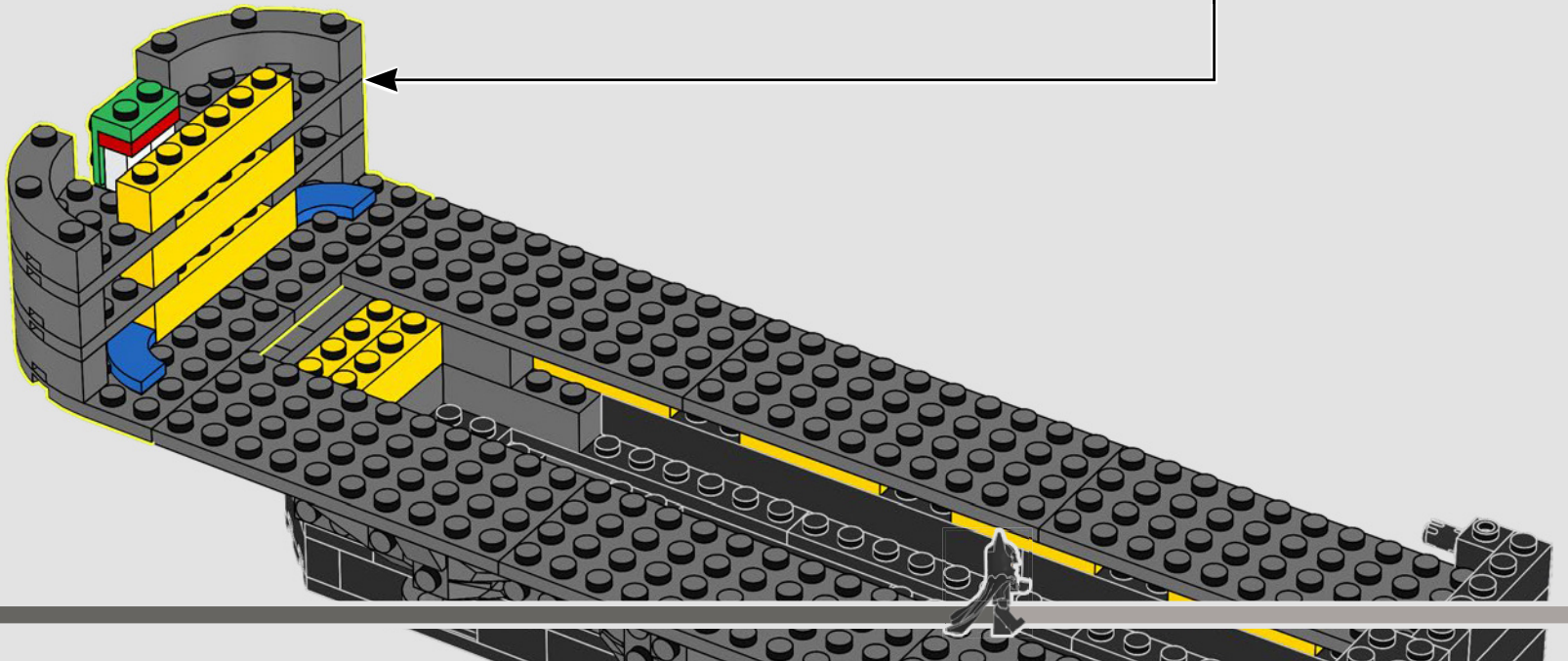

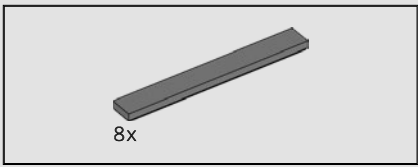

241

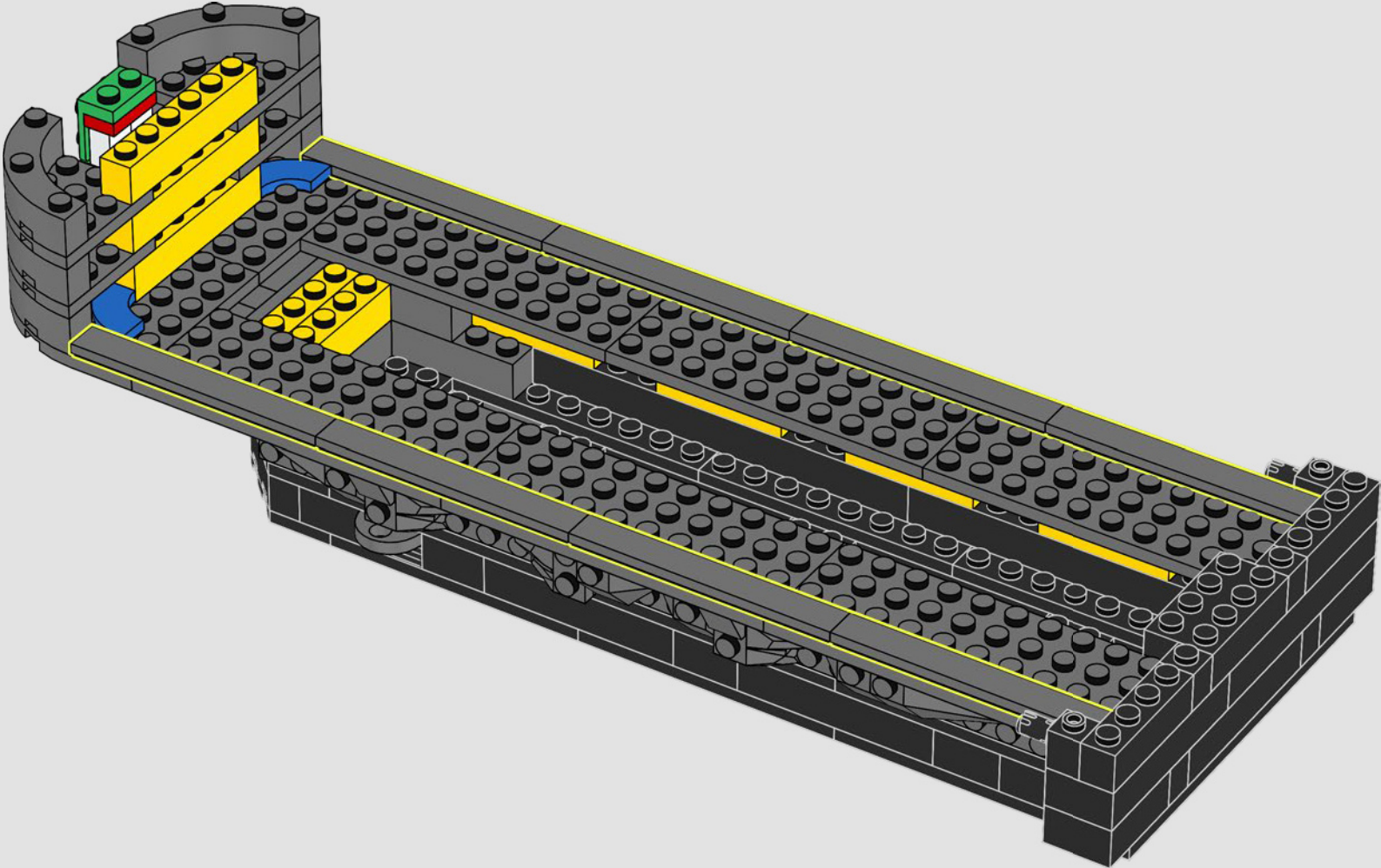

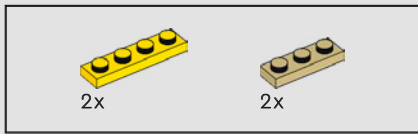

242

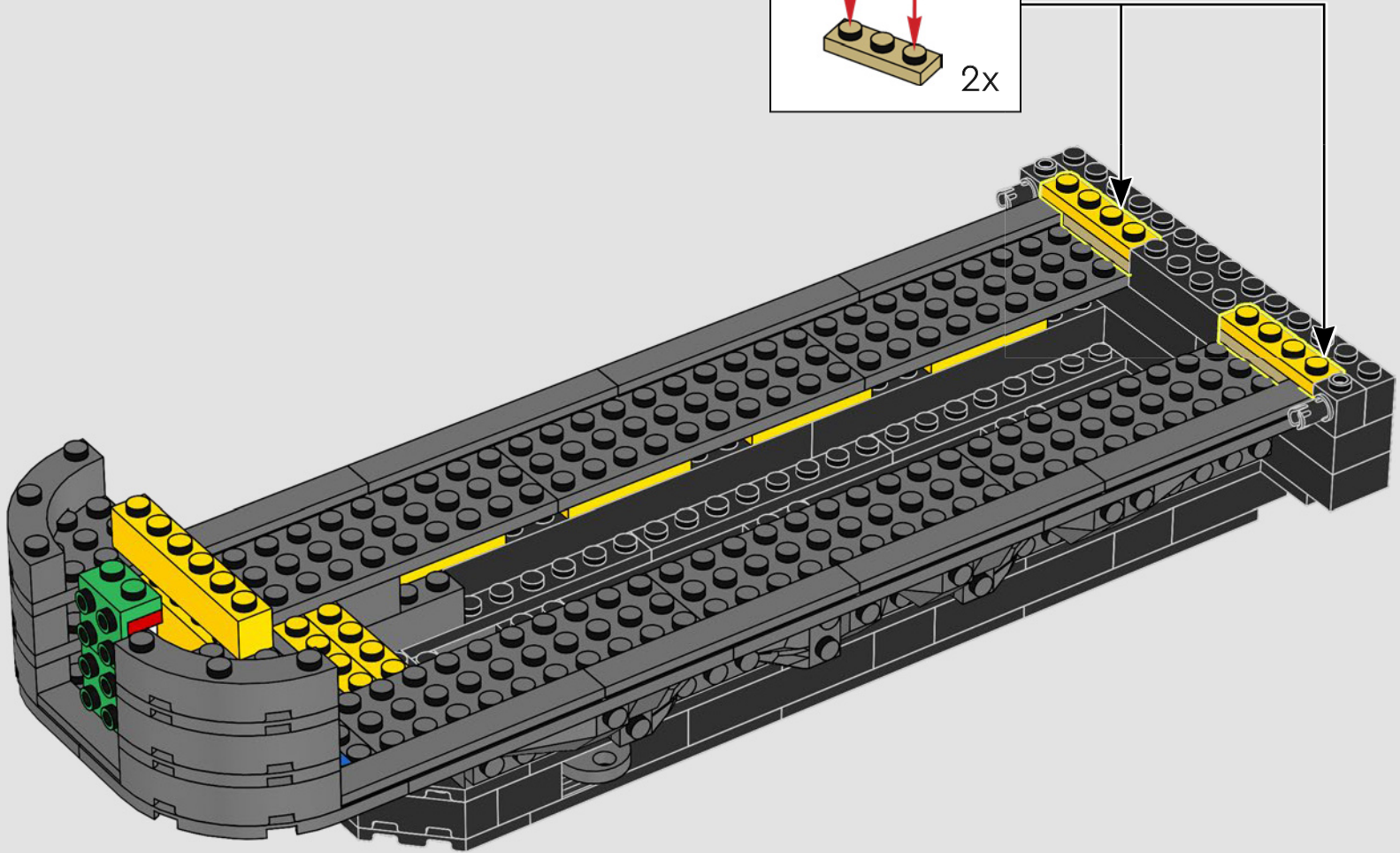
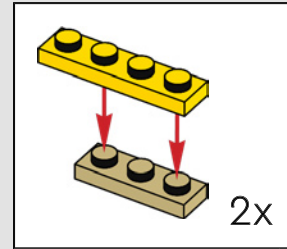

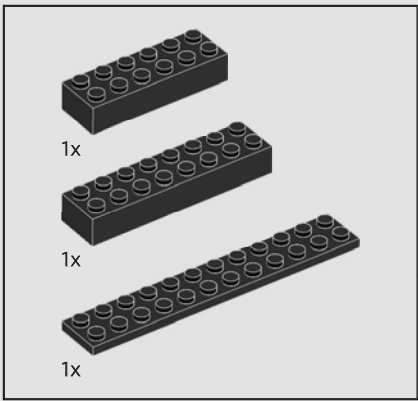

243

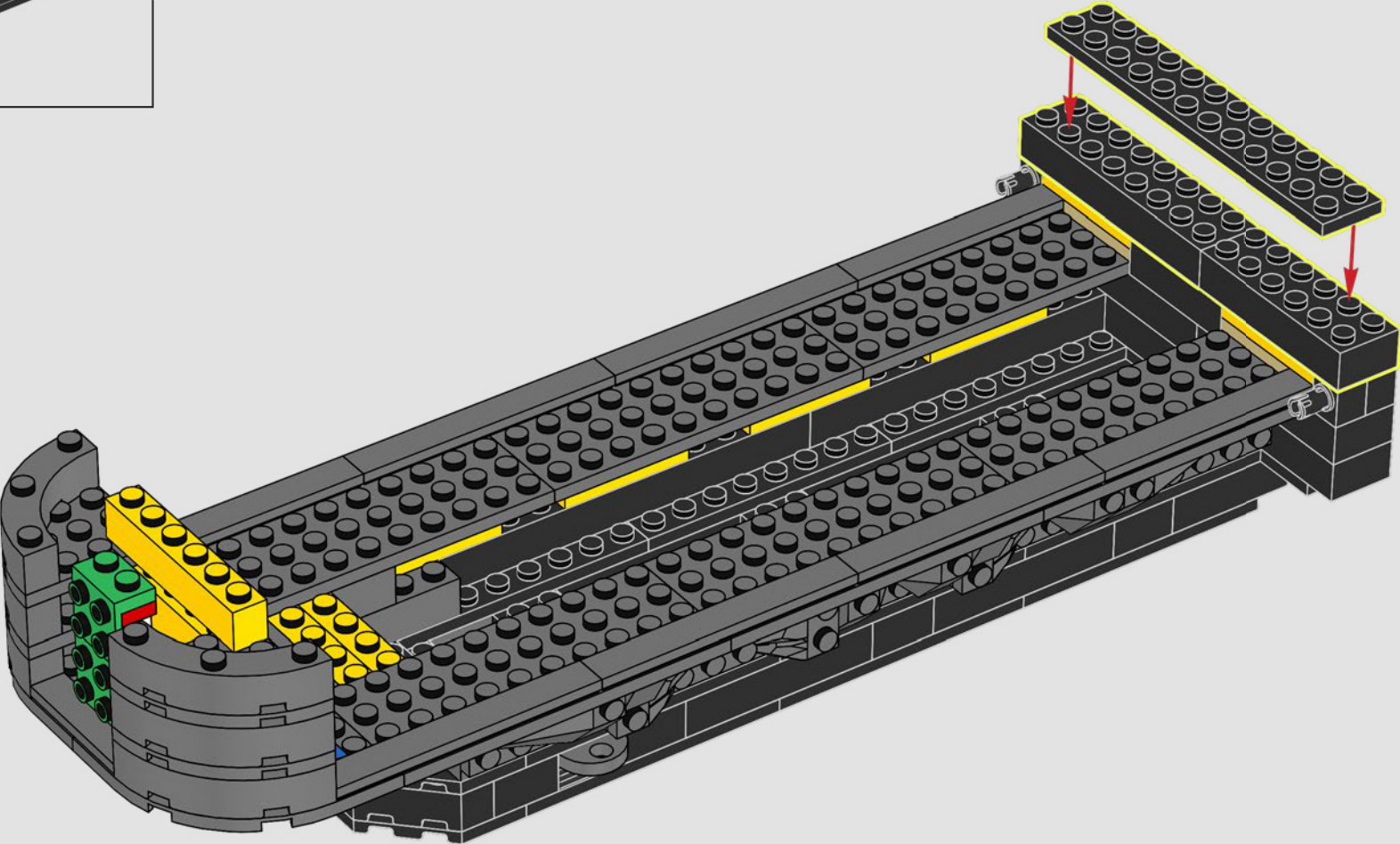



244

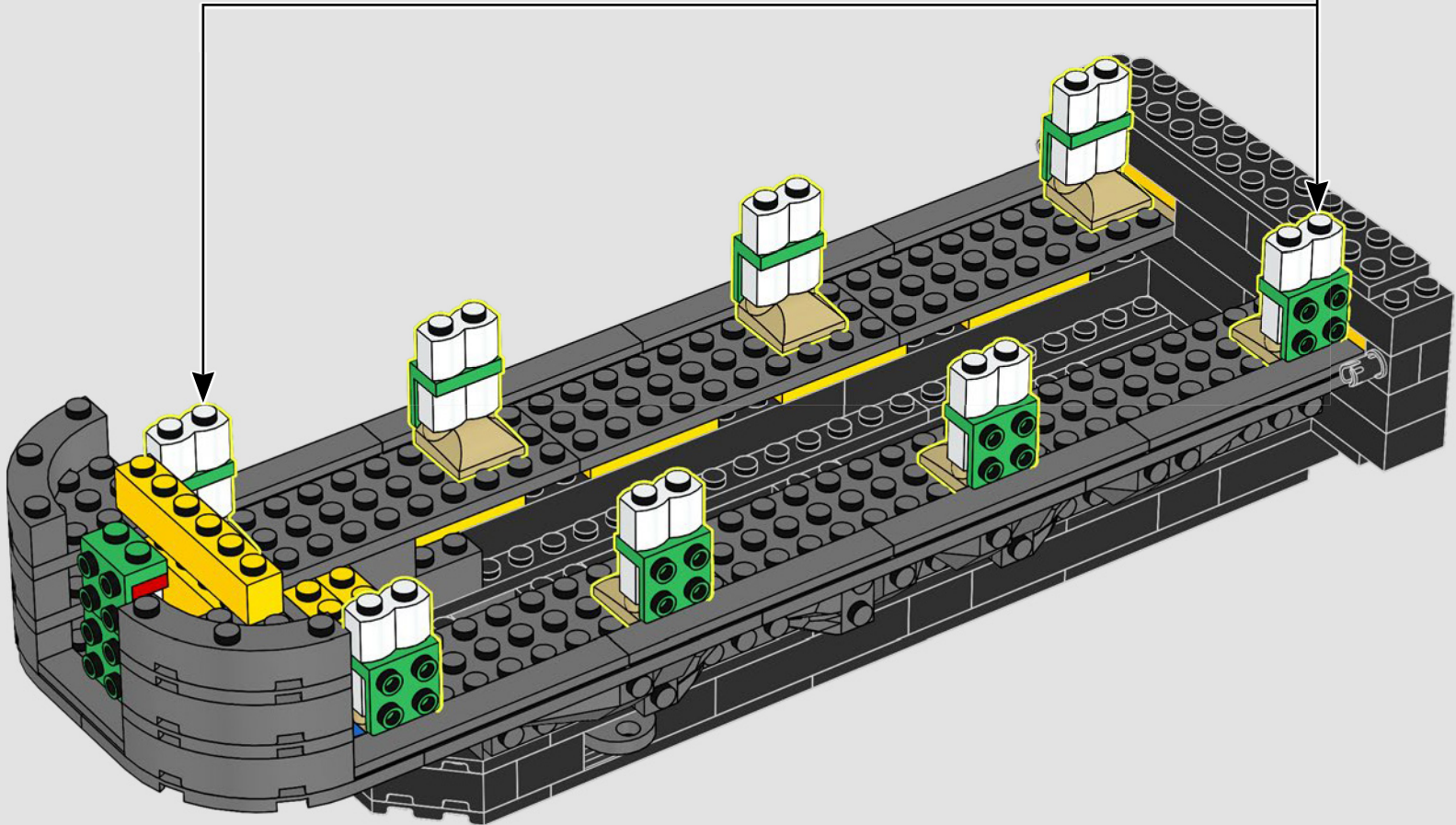
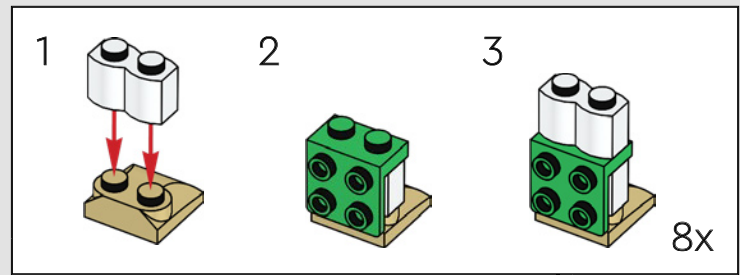

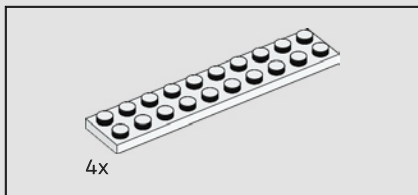

245

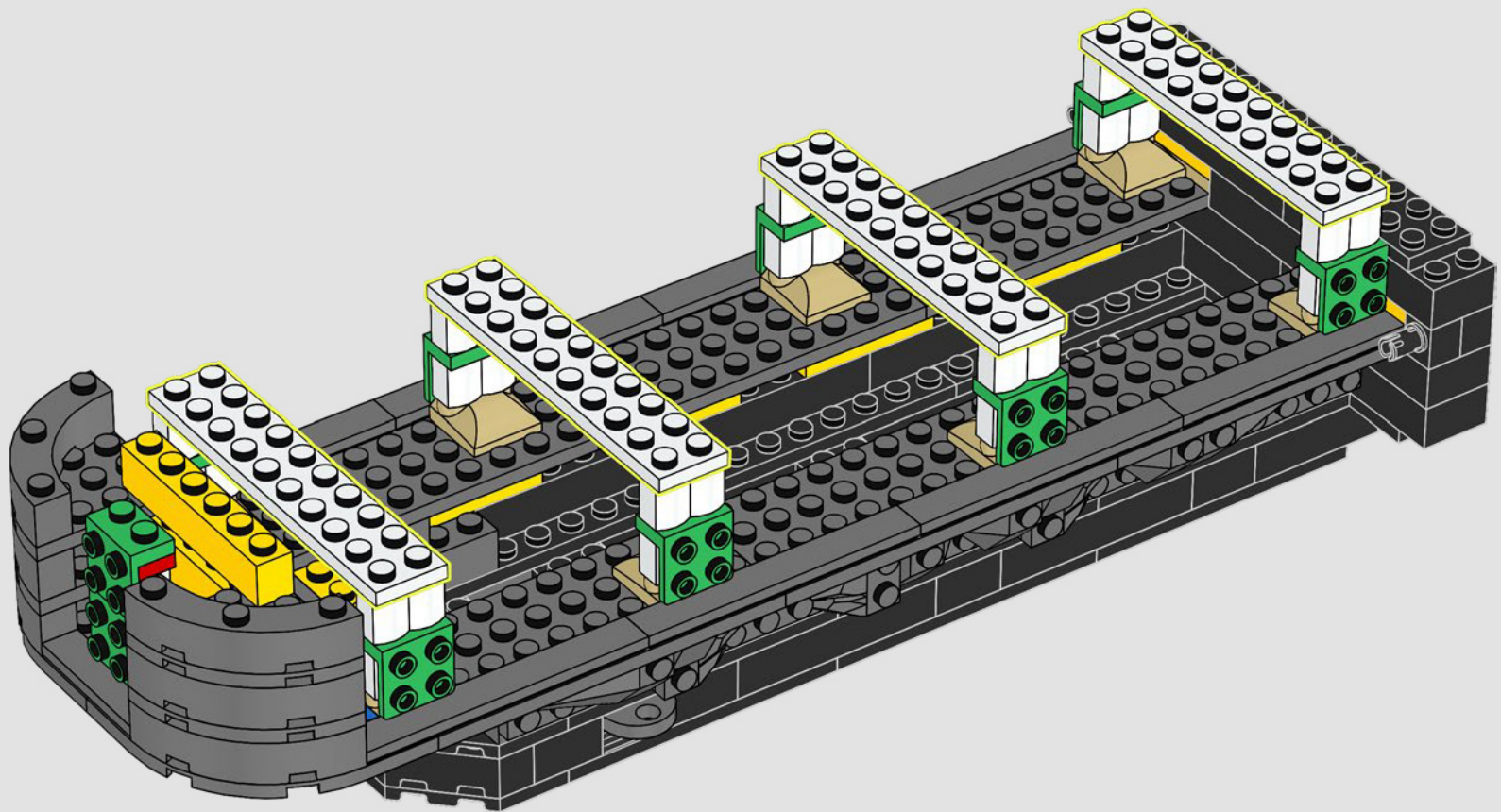

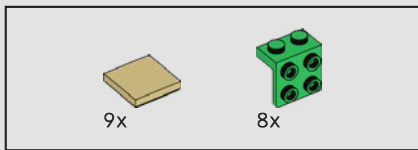

246

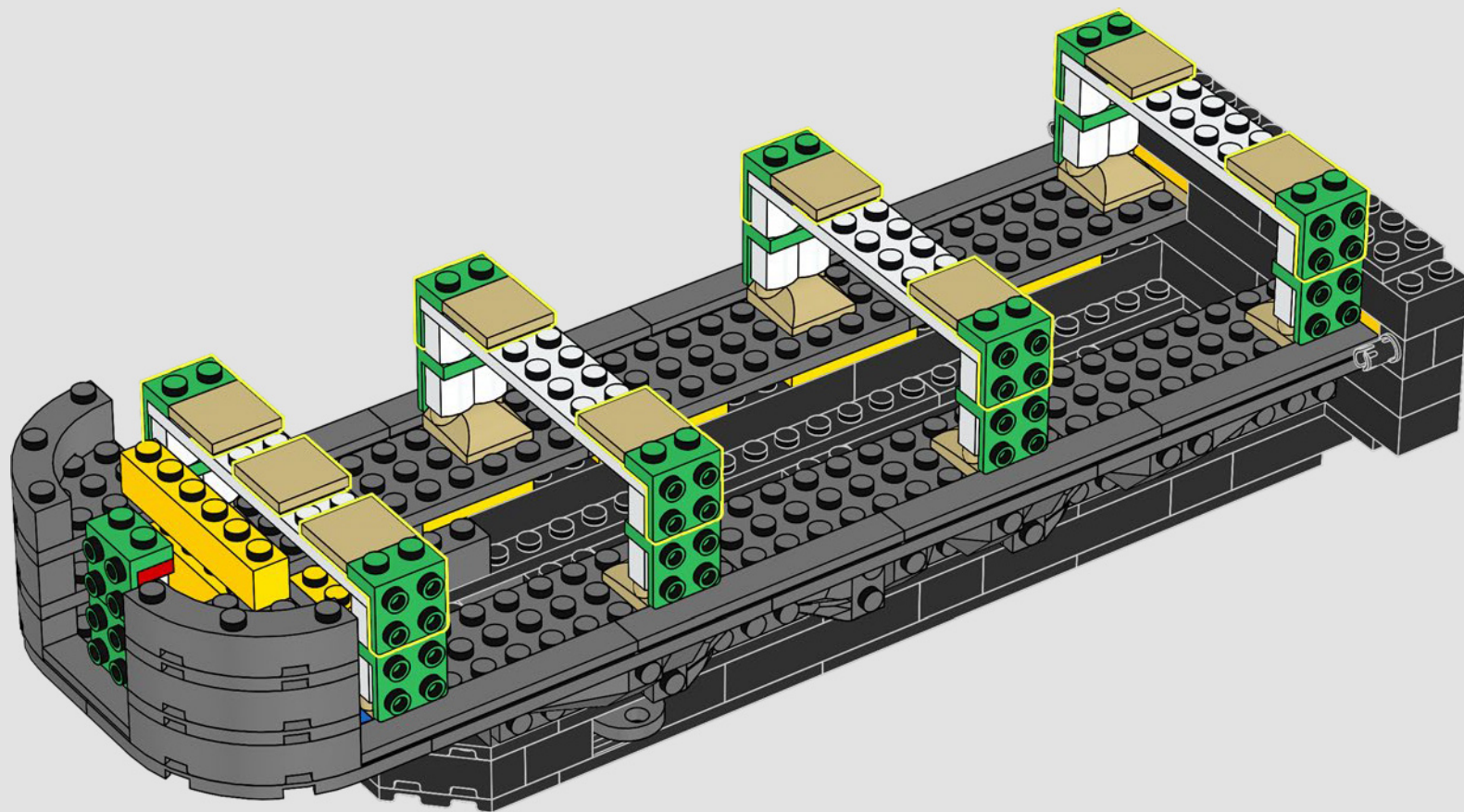

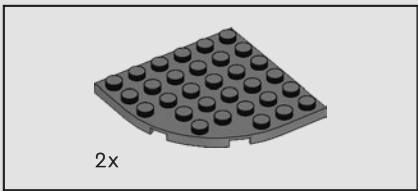

247

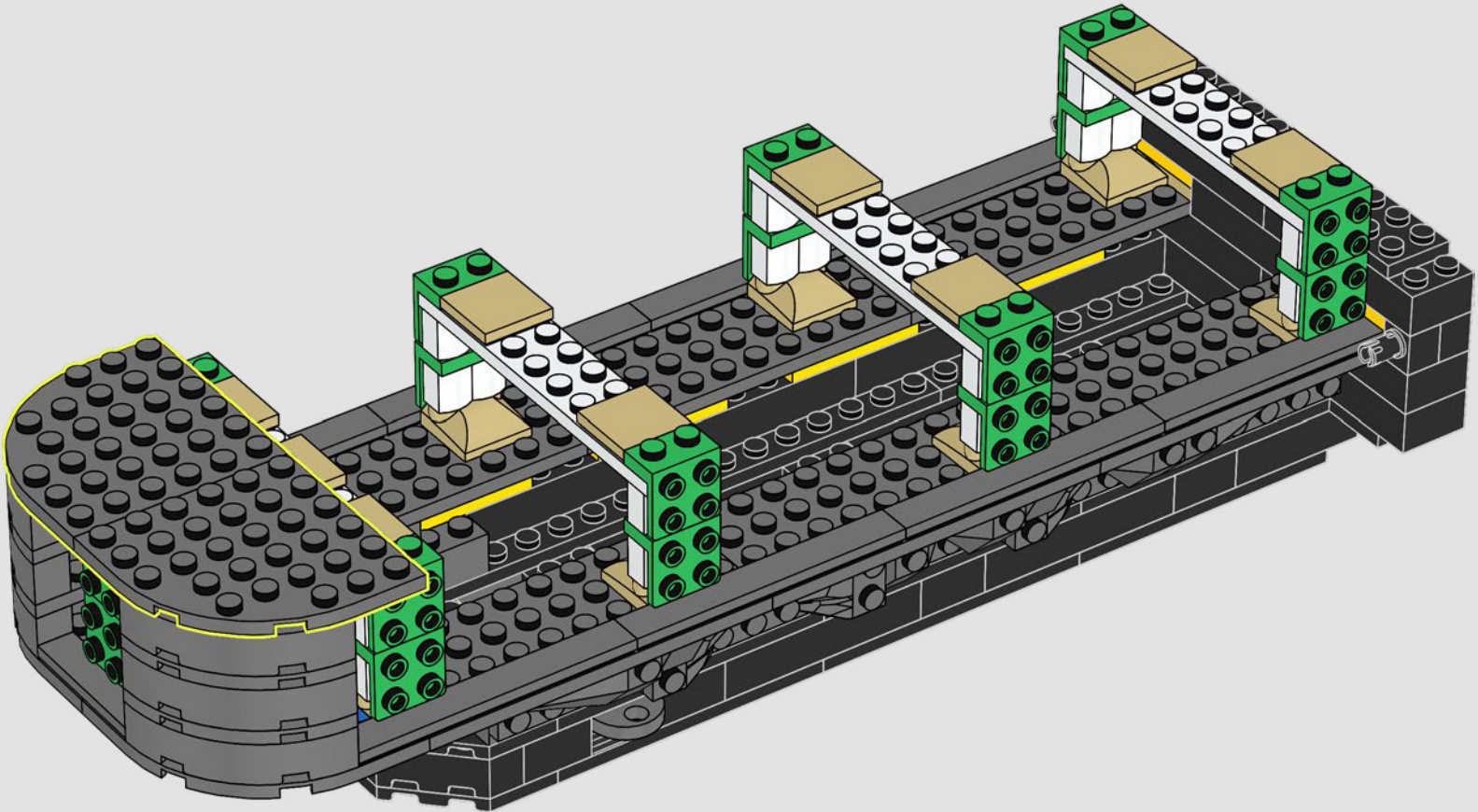

248

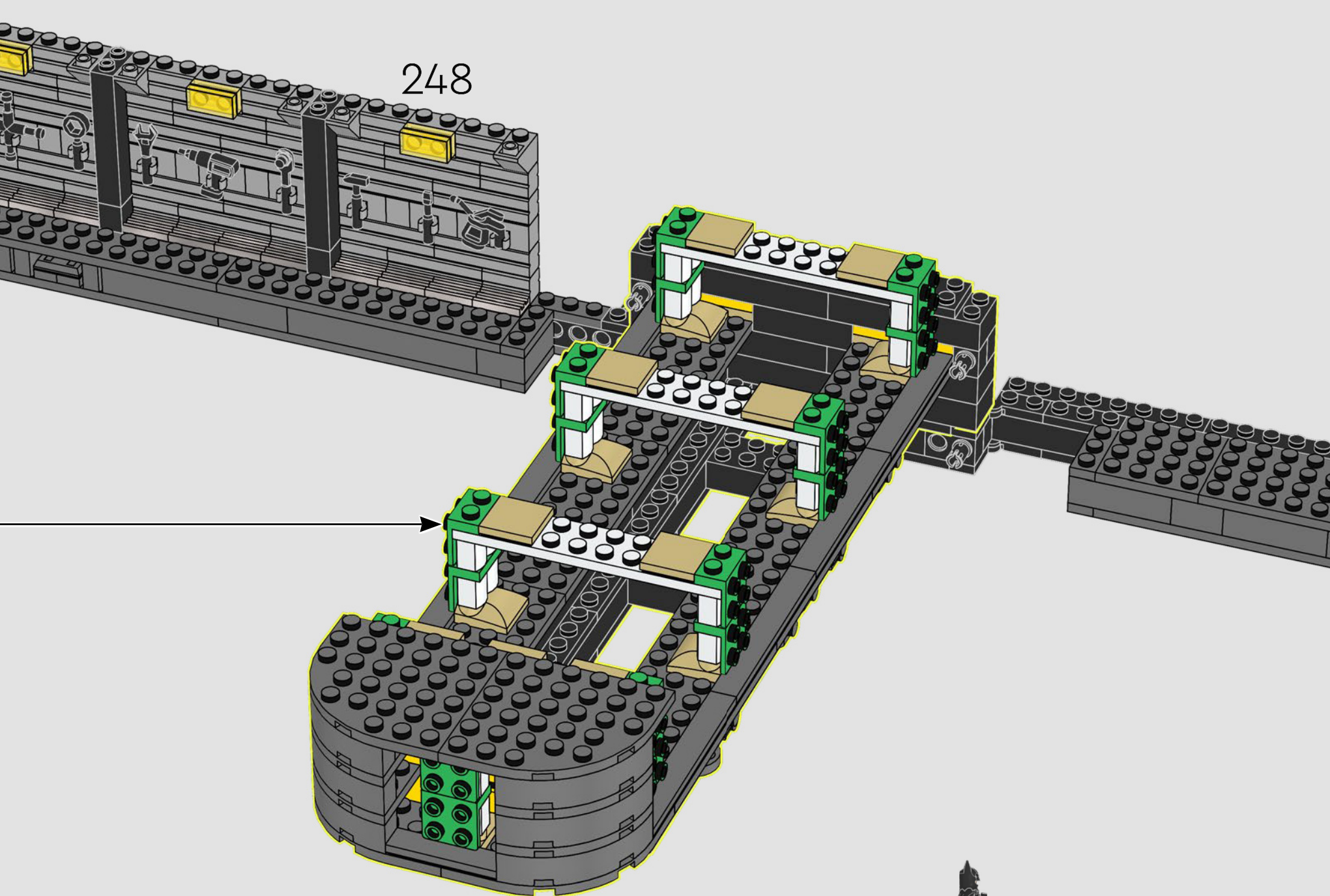

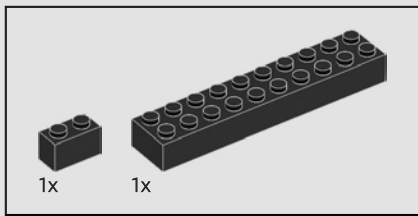

249

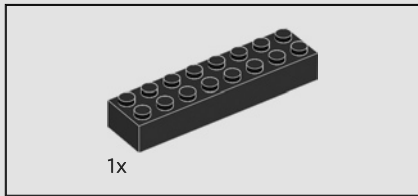
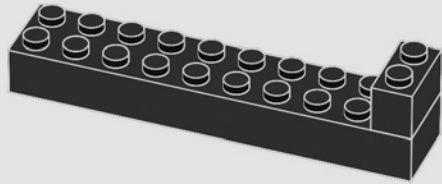

250

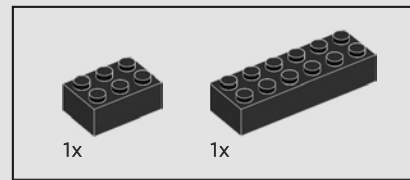
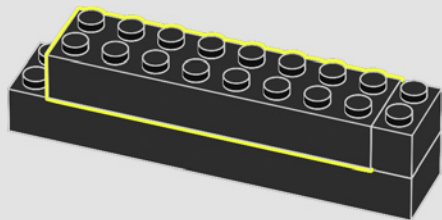

251

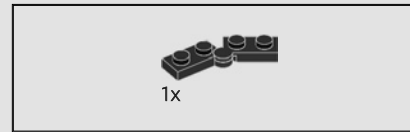
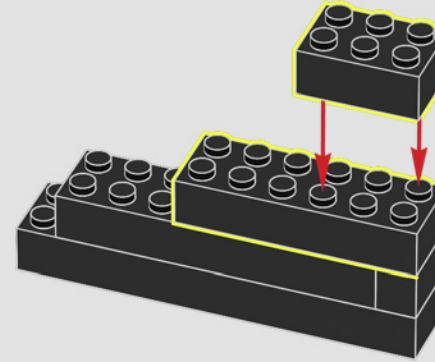

252

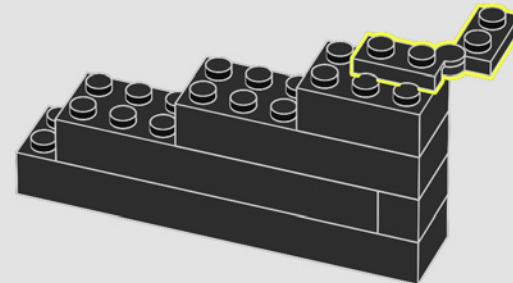

253

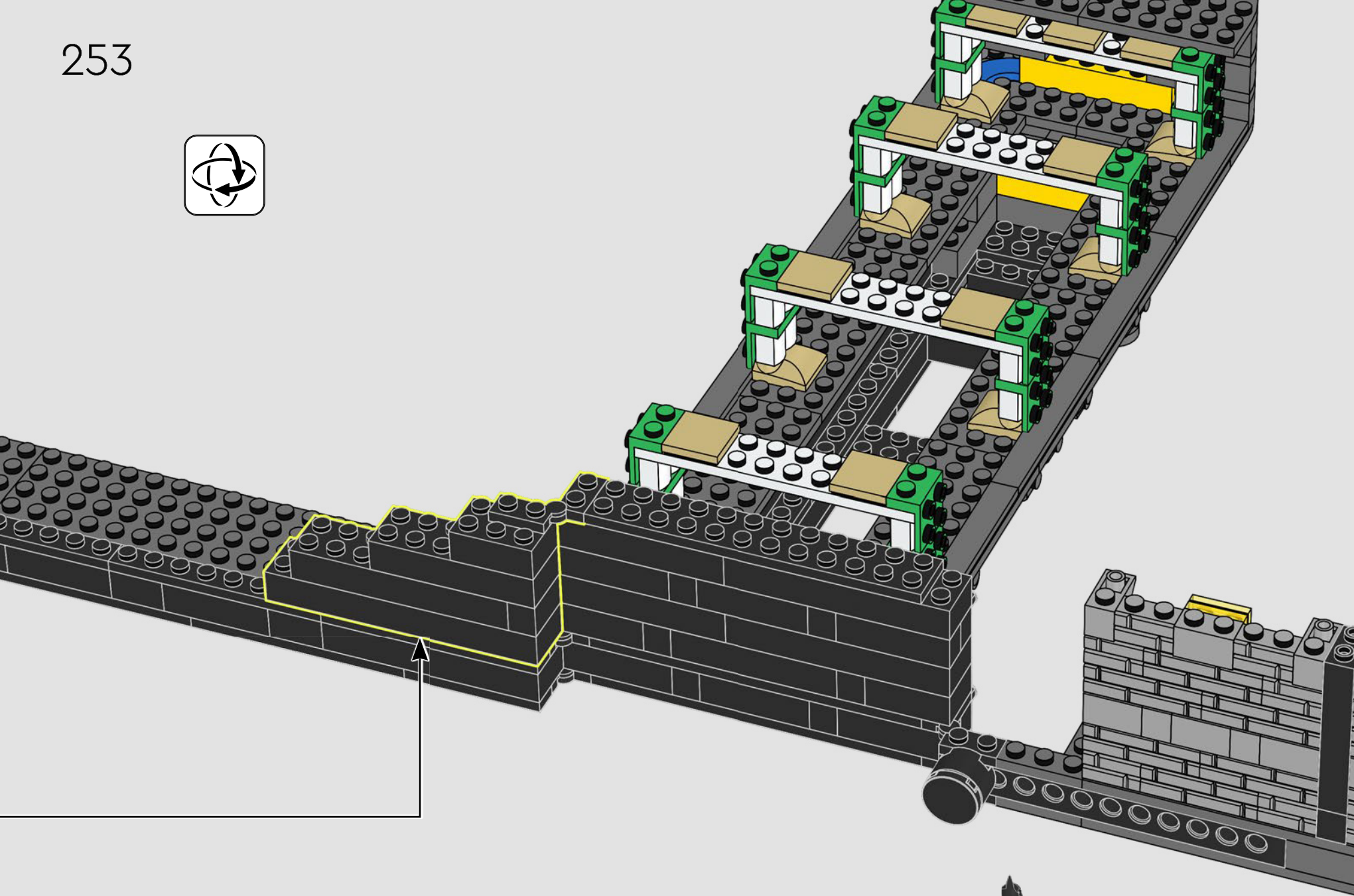

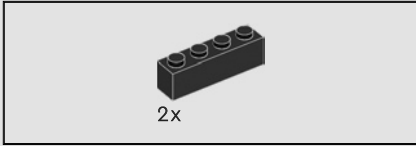
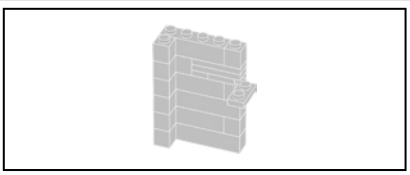

254

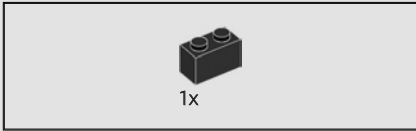
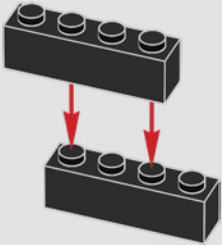

255

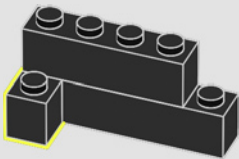

256

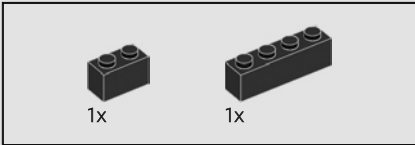
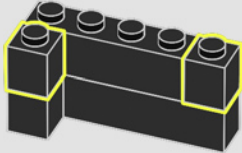

257

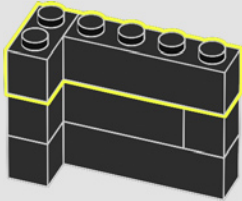

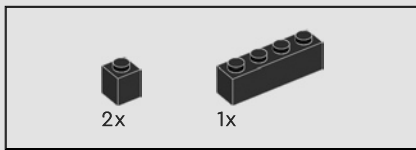

258

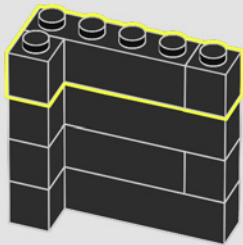

259

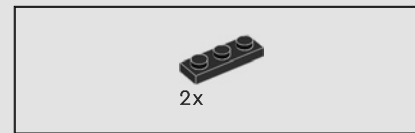
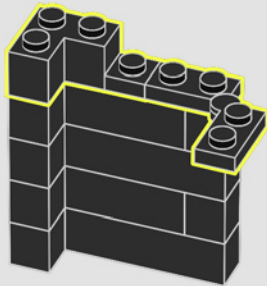

260

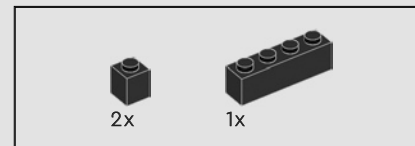
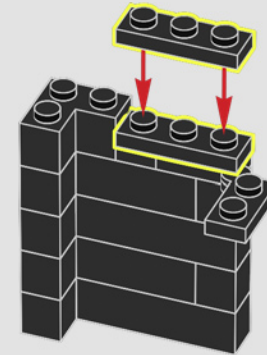

261

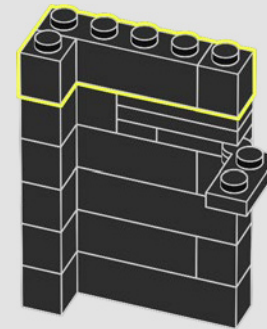

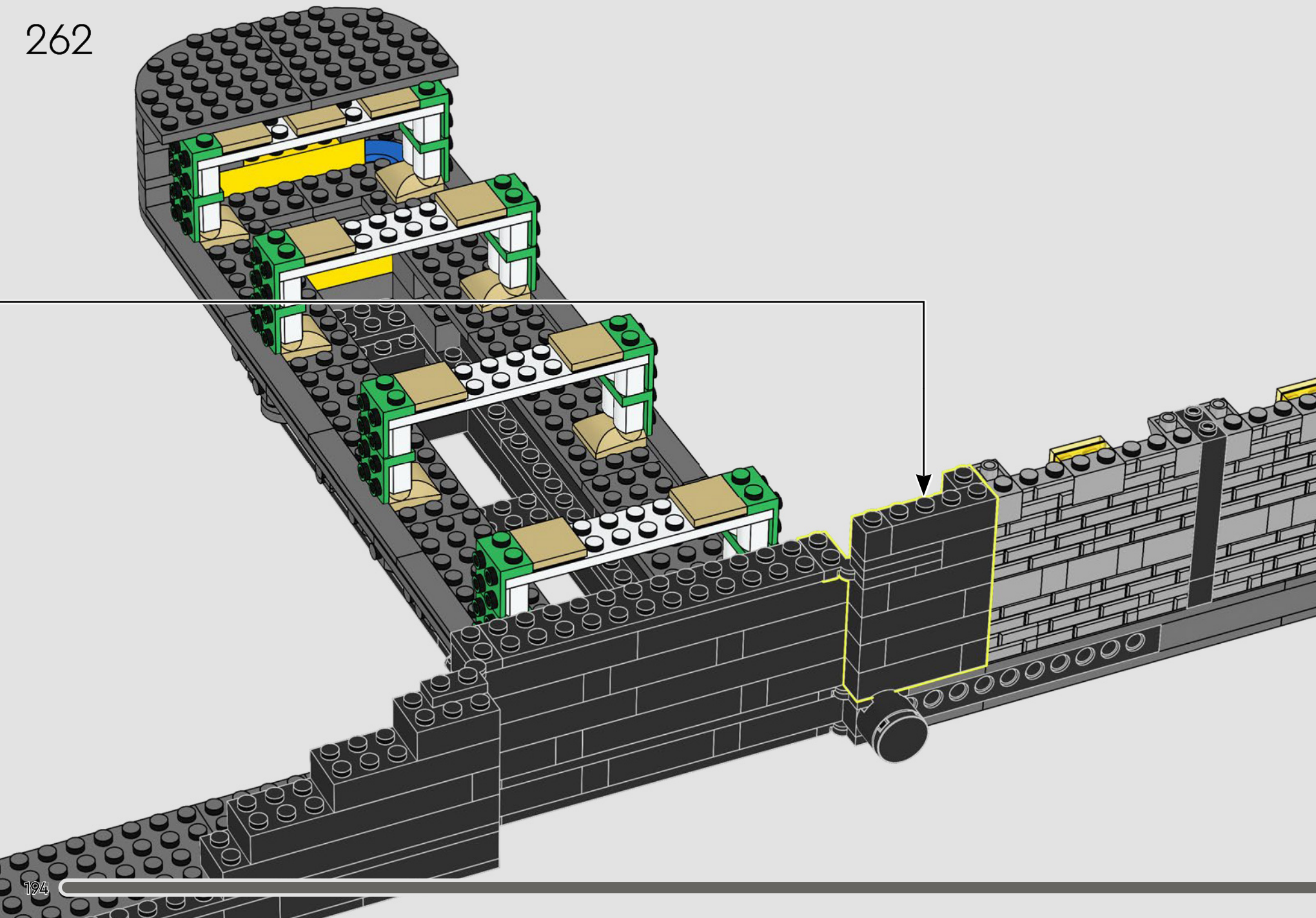

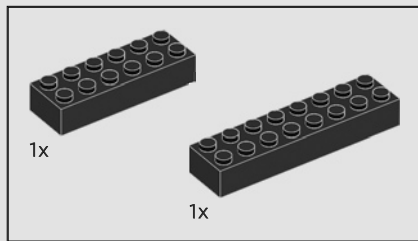

263

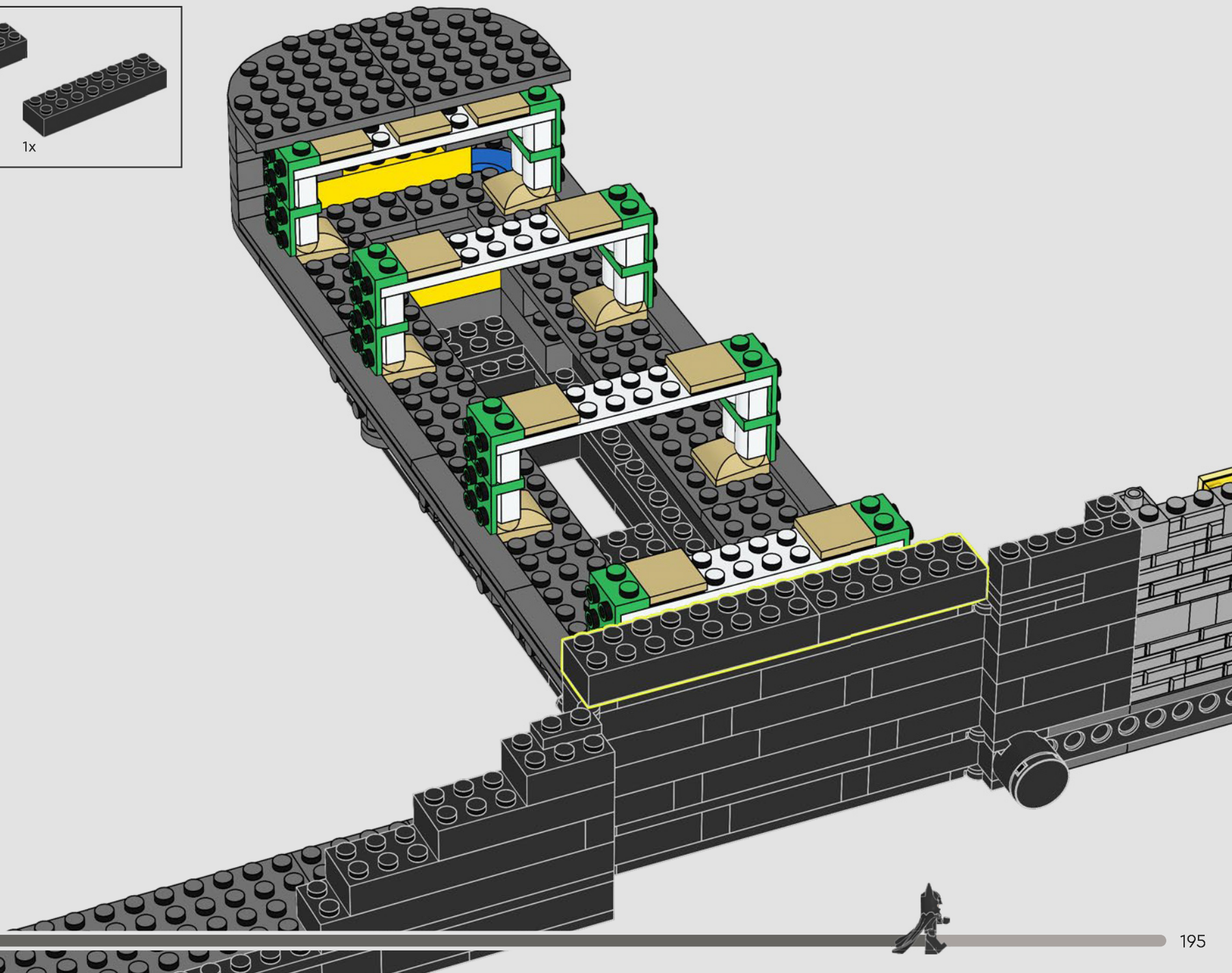

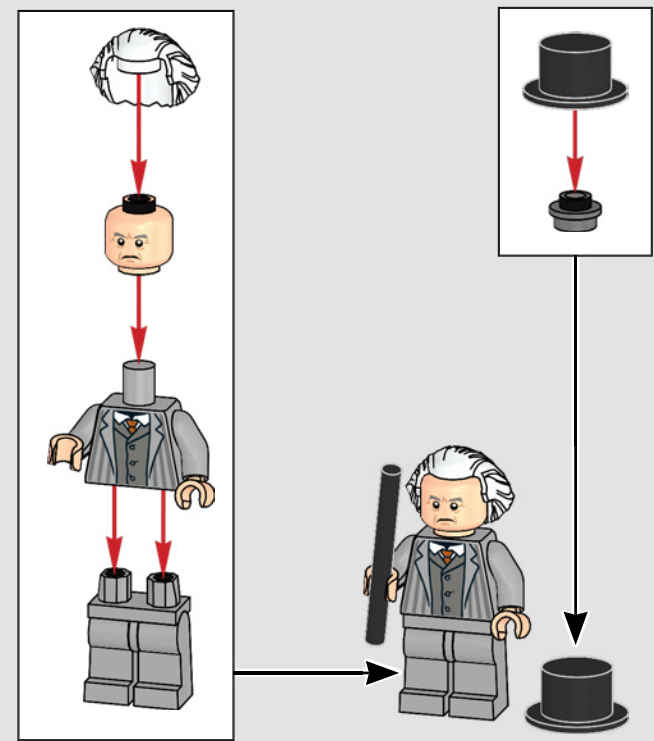
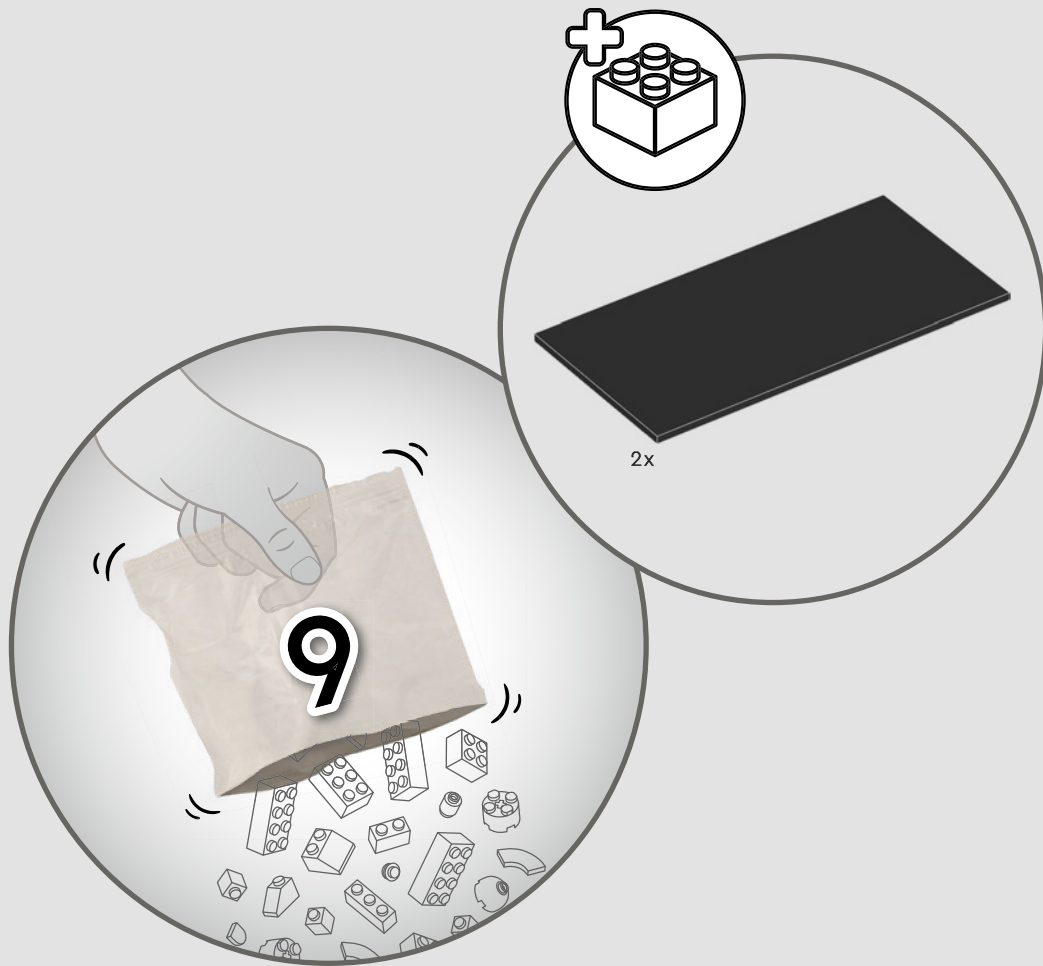



MAX SHRECK™

Max Shreck™ is a cutthroat business mogul with dubious morals and a supreme instinct for self-preservation. In his thirst for domination of GOTHAM CITY™, he partners with Oswald Cobblepot (The Penguin™), in a corrupt mayoral race, creating an unlikely nemesis in his timid assistant, Selina Kyle, in the process.

MAX SHRECK™

Max Shreck™ est un magnat des affaires impitoyable avec une moralité douteuse et un instinct suprême pour l'autopréservation. Dans sa soif de domination de GOTHAM CITY™, il s'associe à Oswald Cobblepot (Le Pingouin™), dans une course à la mairie corrompue, créant ainsi un ennemi improbable chez son assistant timide, Selina Kyle.

MAX SHRECK™

Max Shreck™ es un muy adinerado e implacable emprendedor de moral dudosa, así como el poseedor del instinto de conservación más desarrollado del que hayamos sabido. Para satisfacer su sed de dominación de CIUDAD GÓTICA, apoya a Oswald Cobblepot (el Pingüino) en su corrupta campaña por el puesto de alcalde al tiempo que orilla a su tímida asistente Selina Kyle a convertirse inesperadamente en su acérrima némesis.



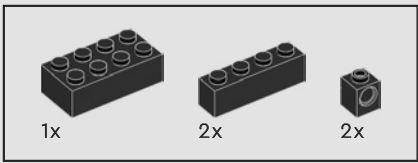

264

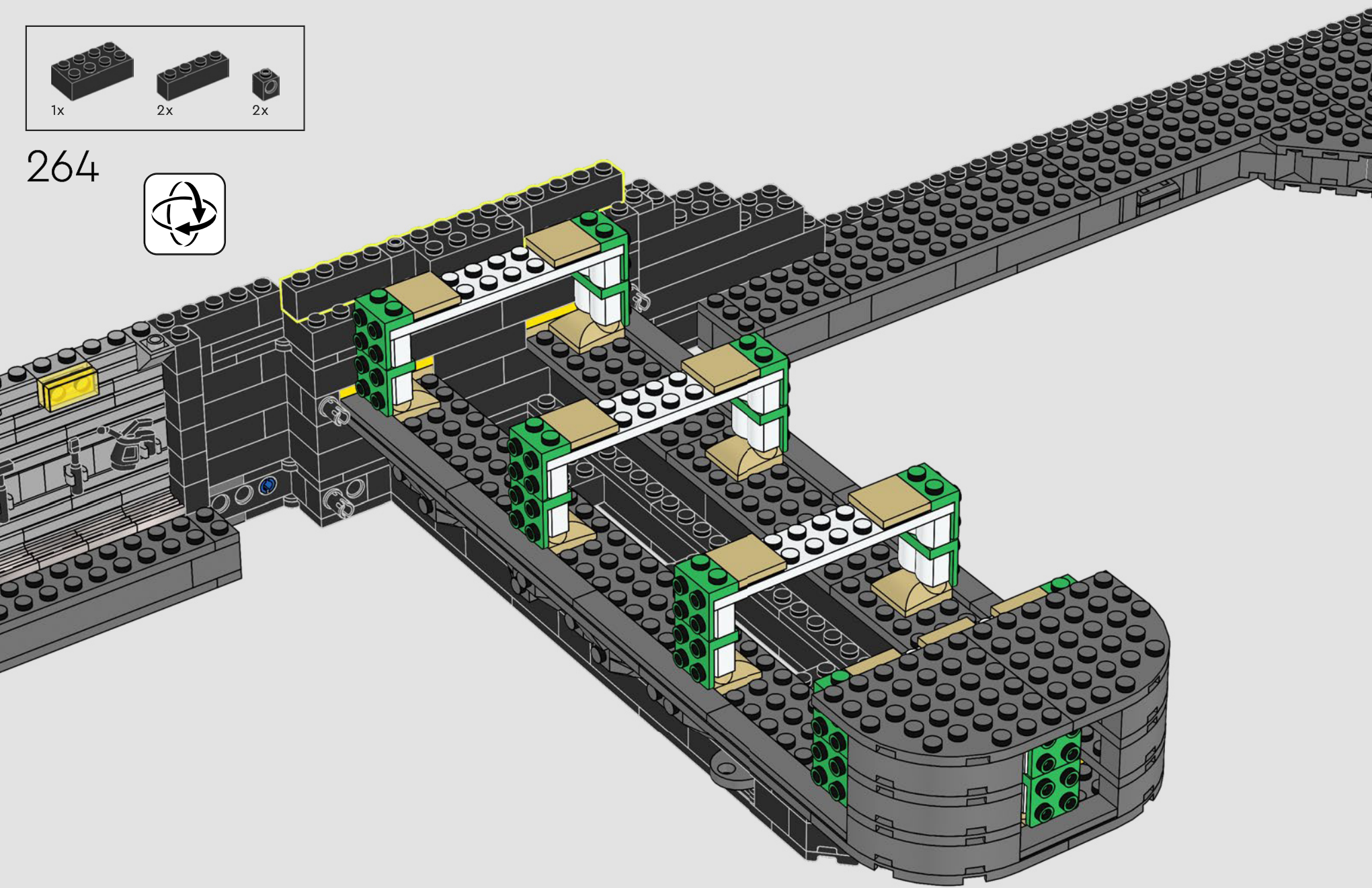

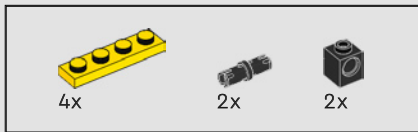

265

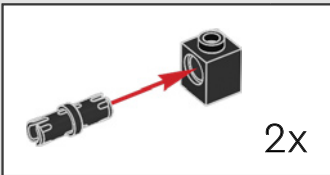
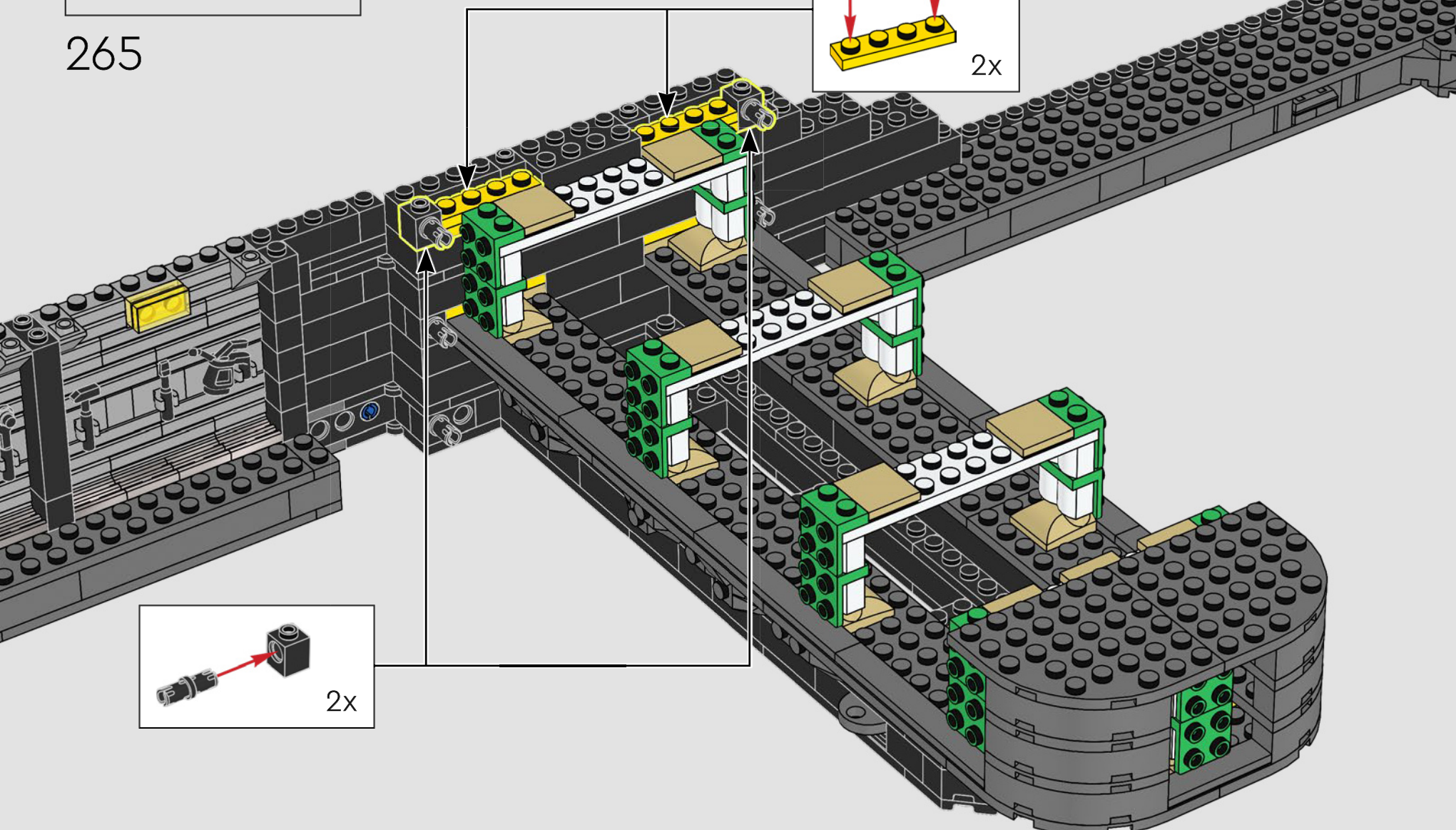
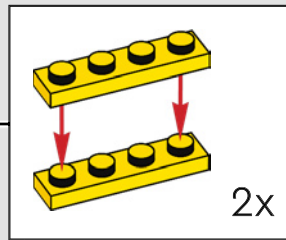

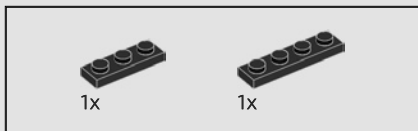

266

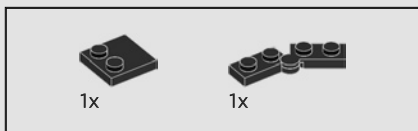
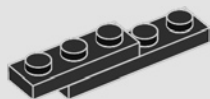

267

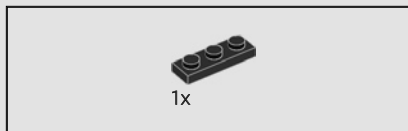
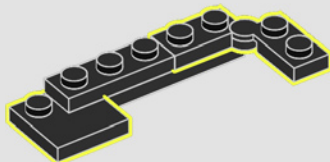

268

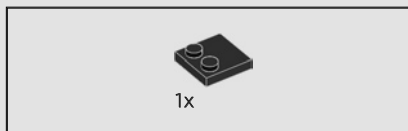
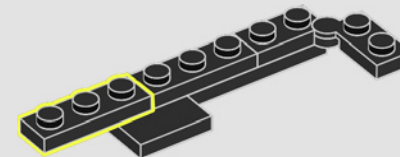

269

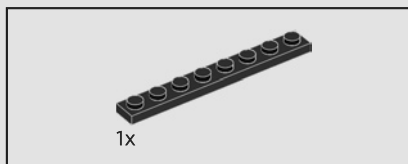
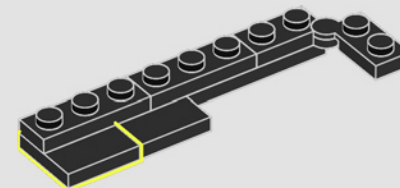

270

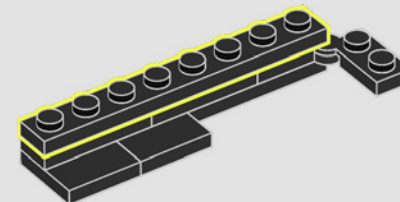

271

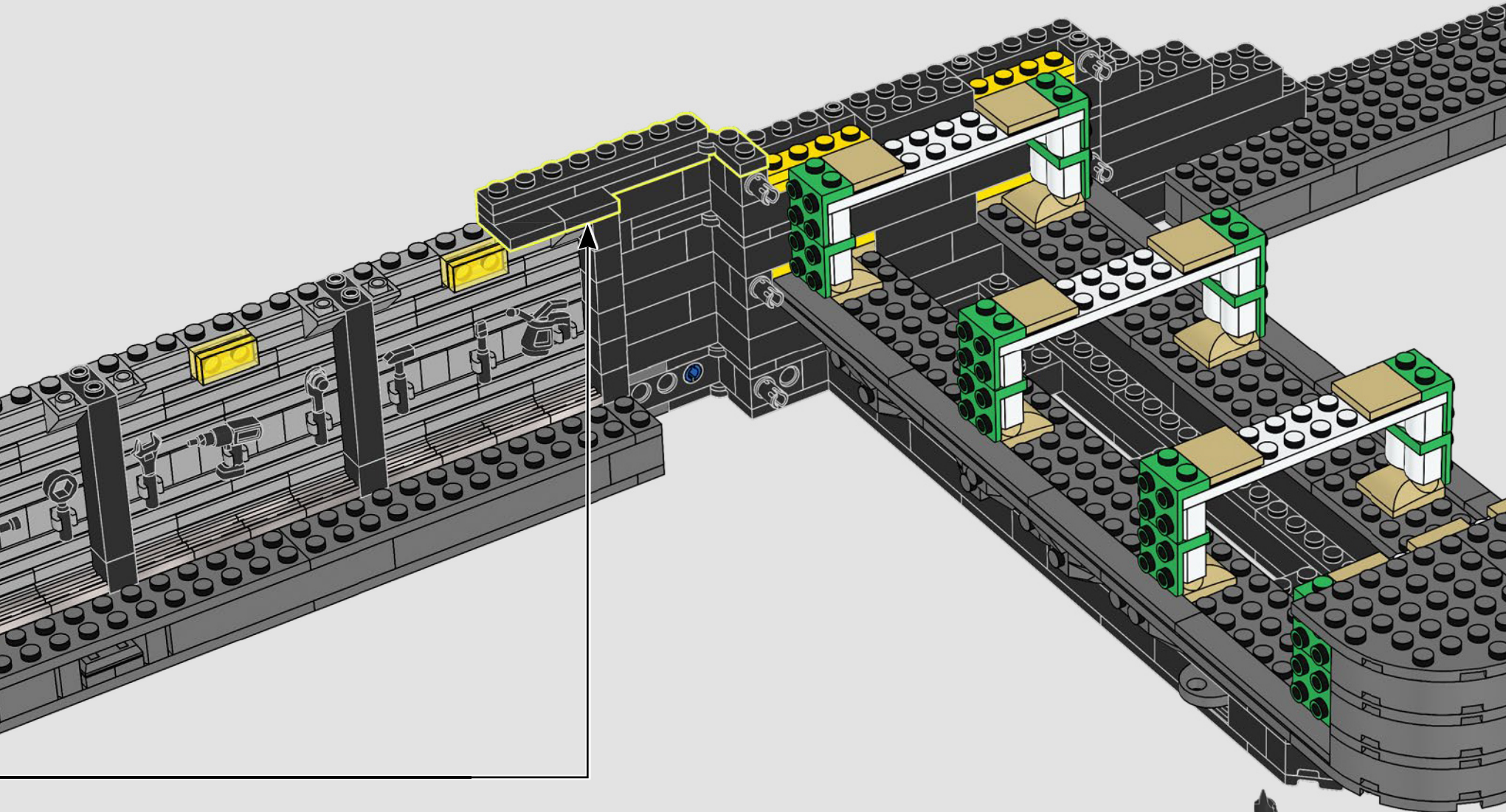

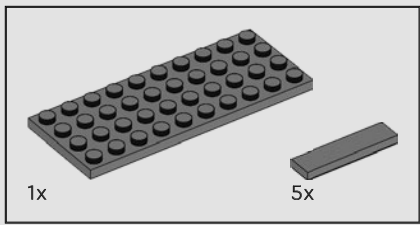

272

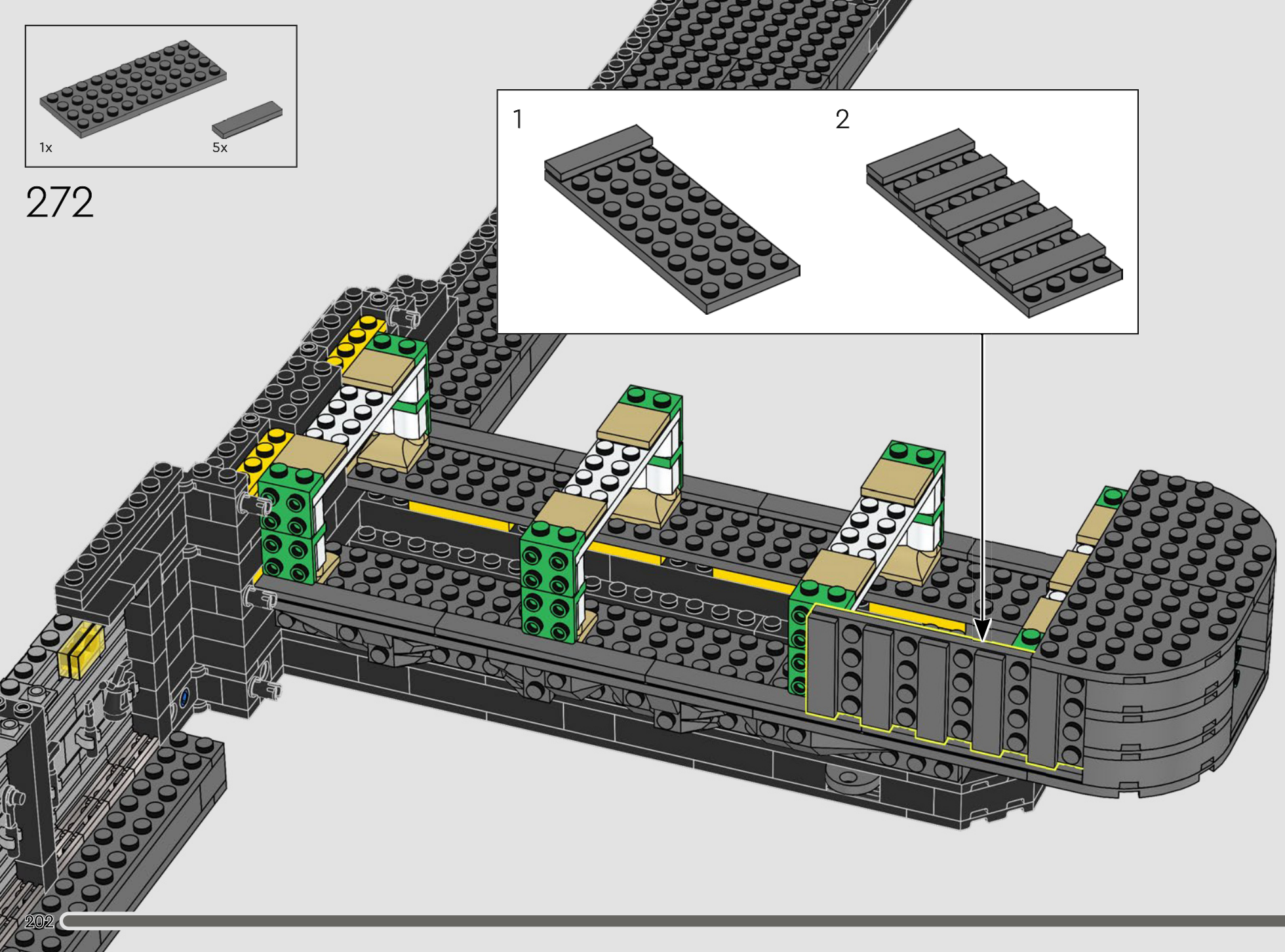
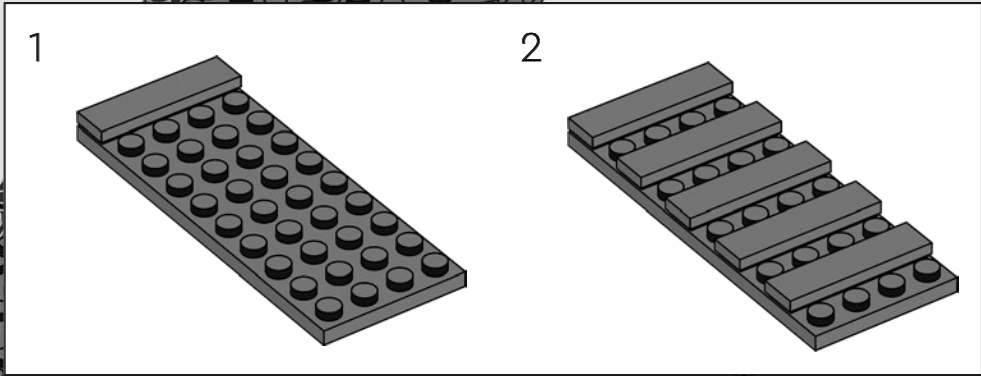

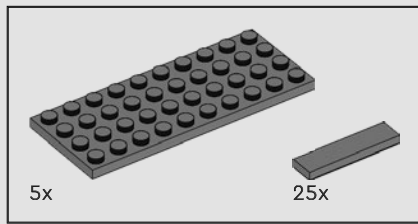

273

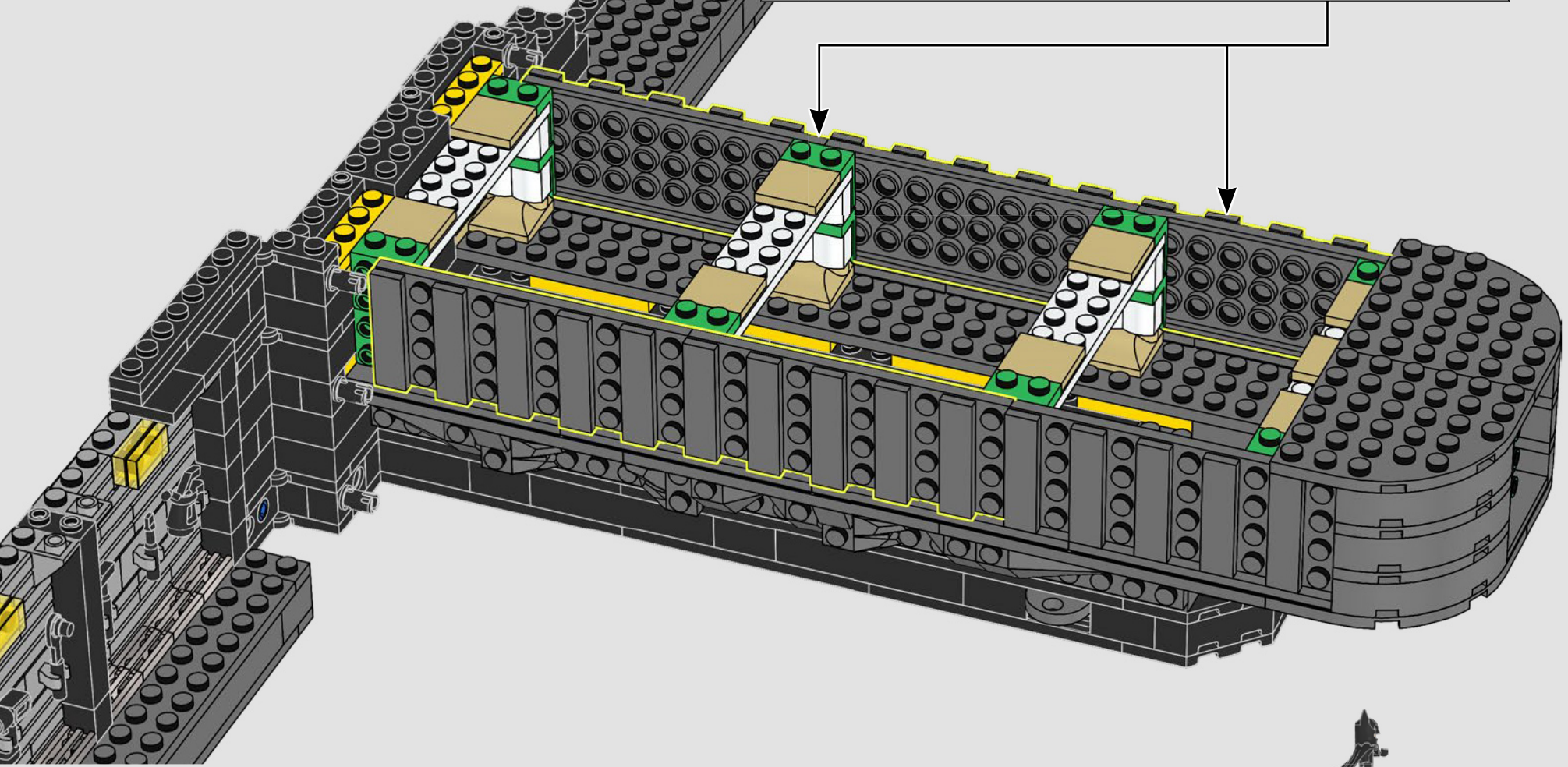
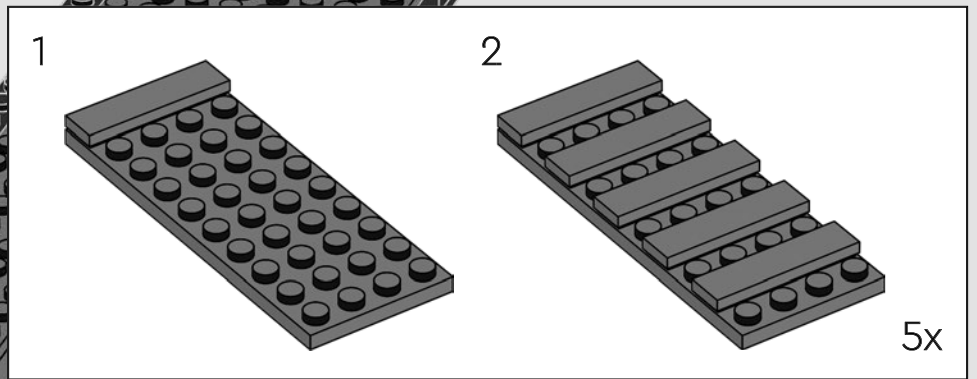

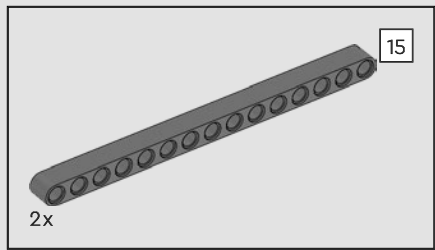

274

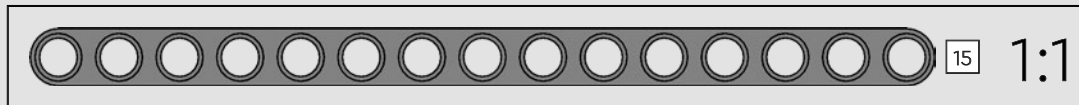
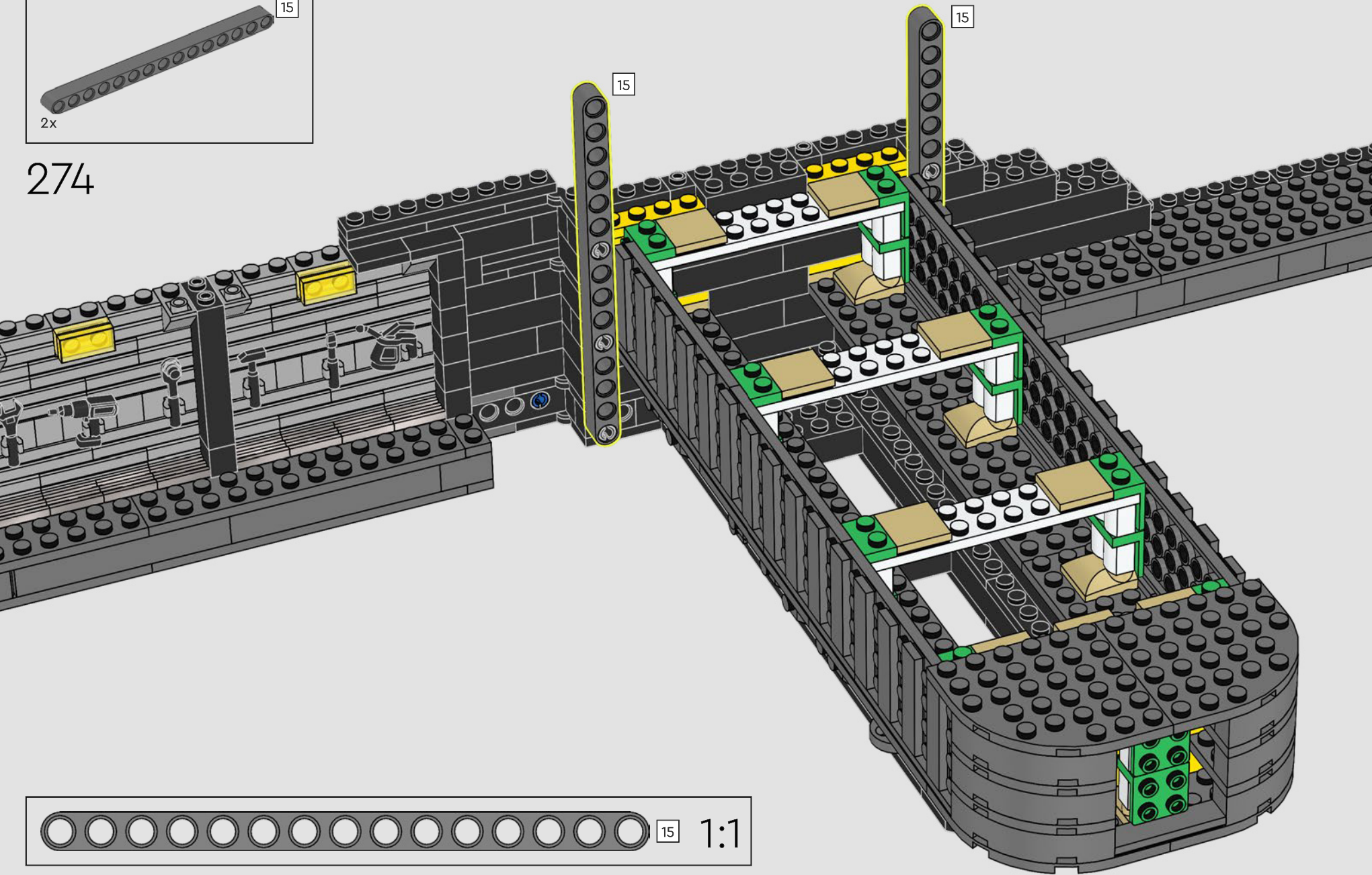

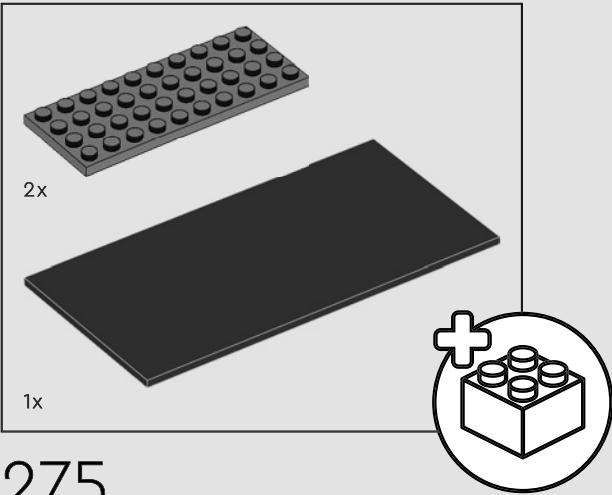
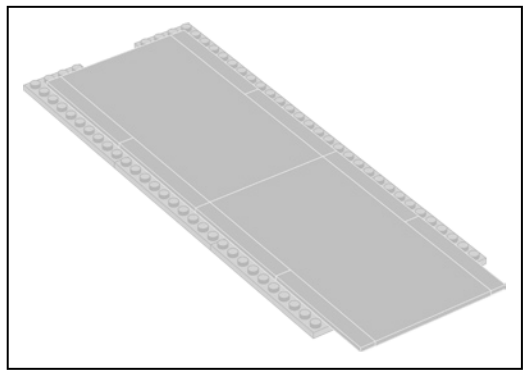

275

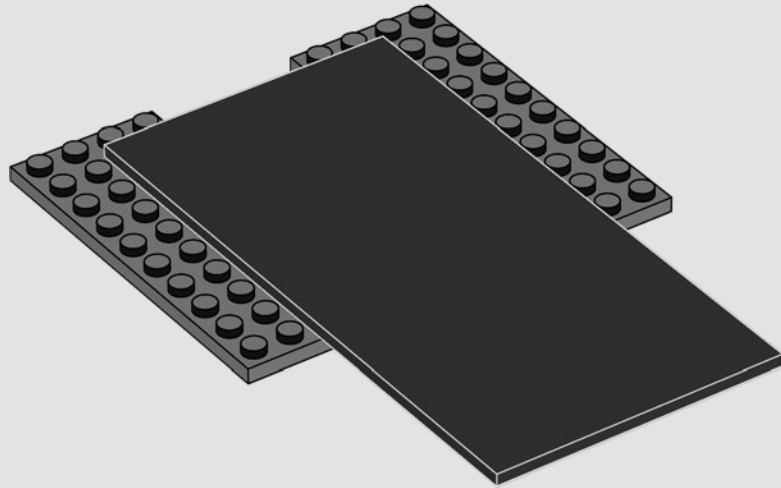

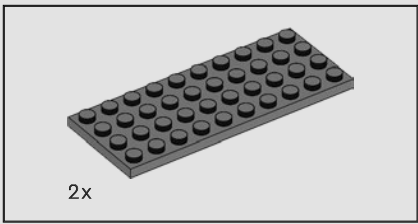

276

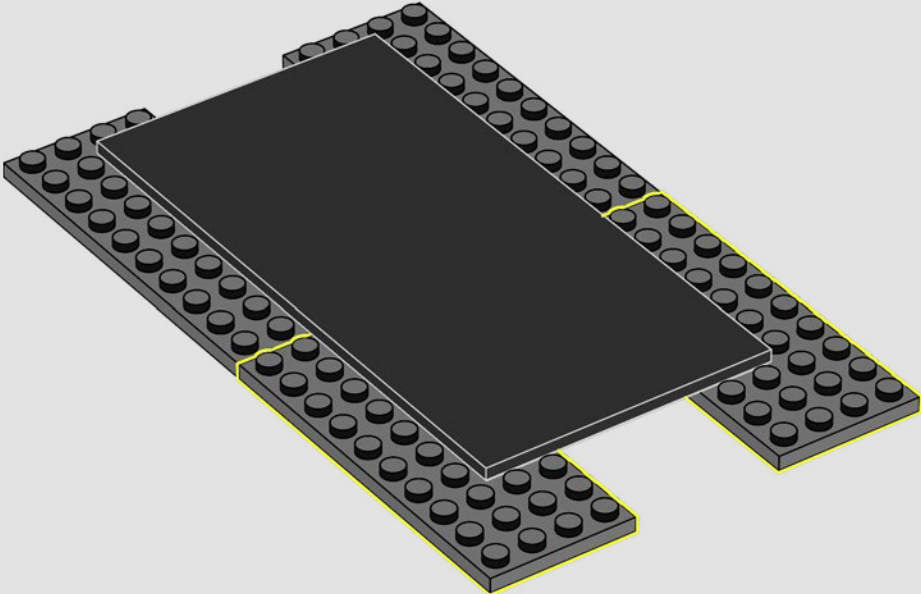

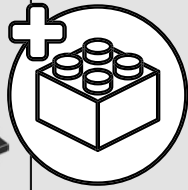
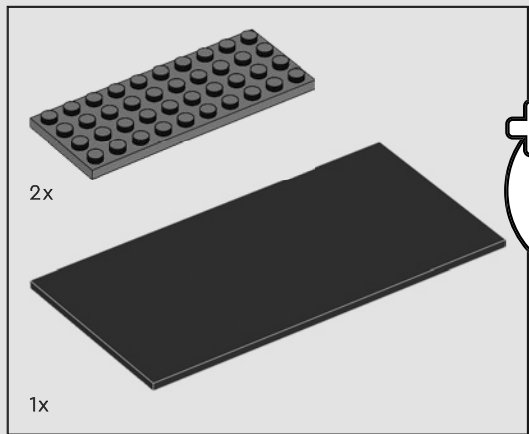

277

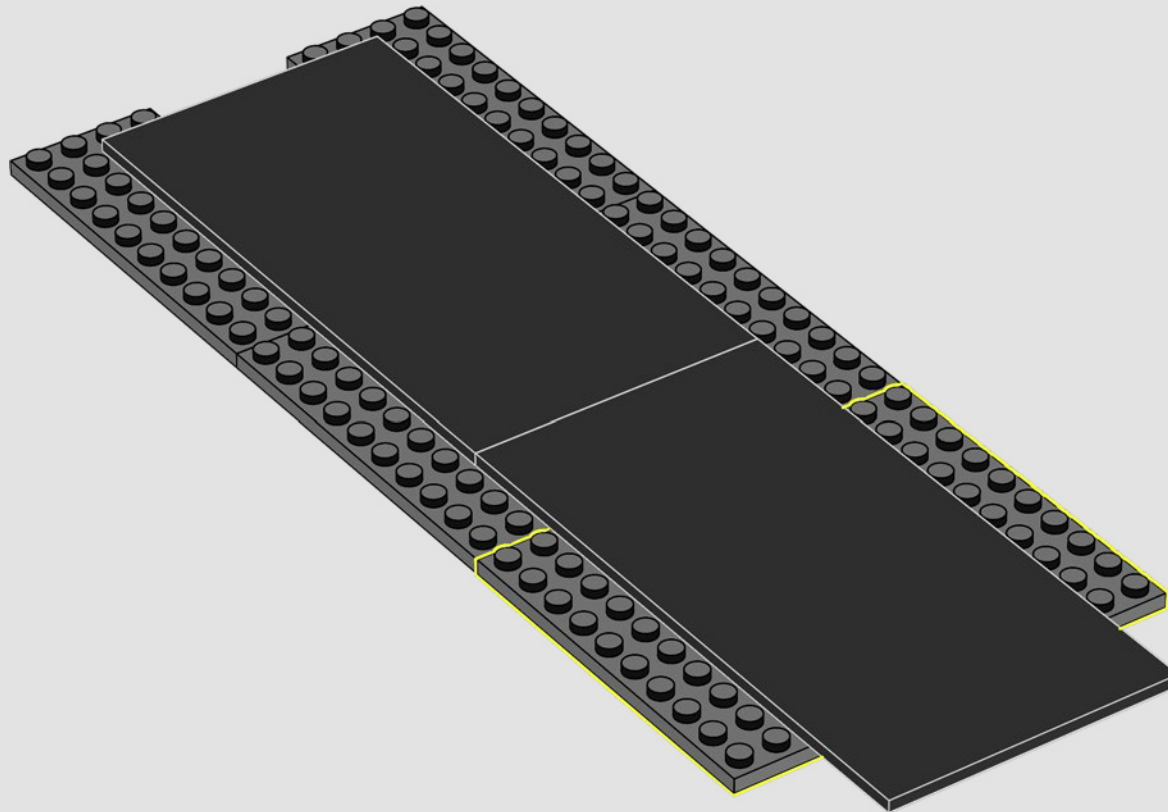

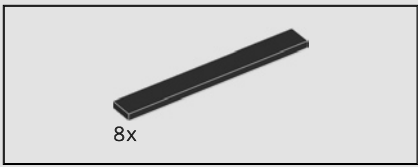

278

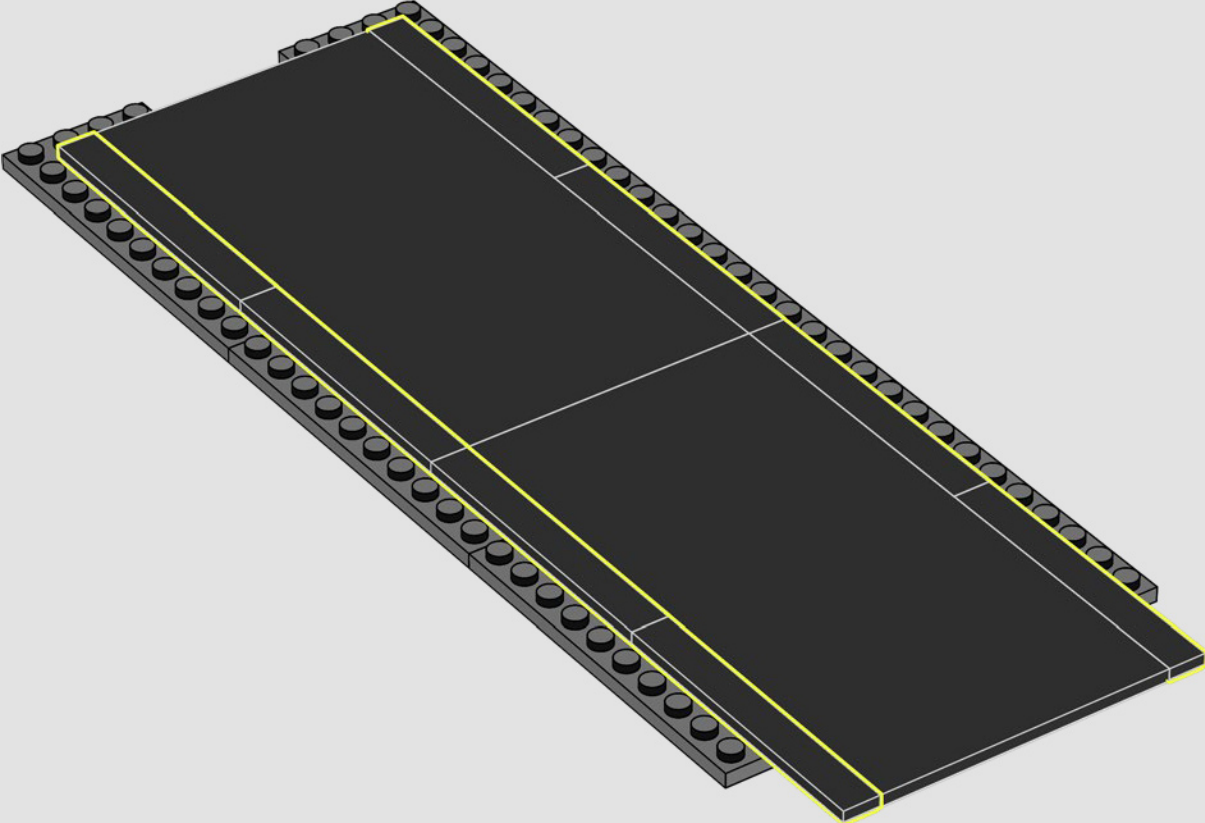

279

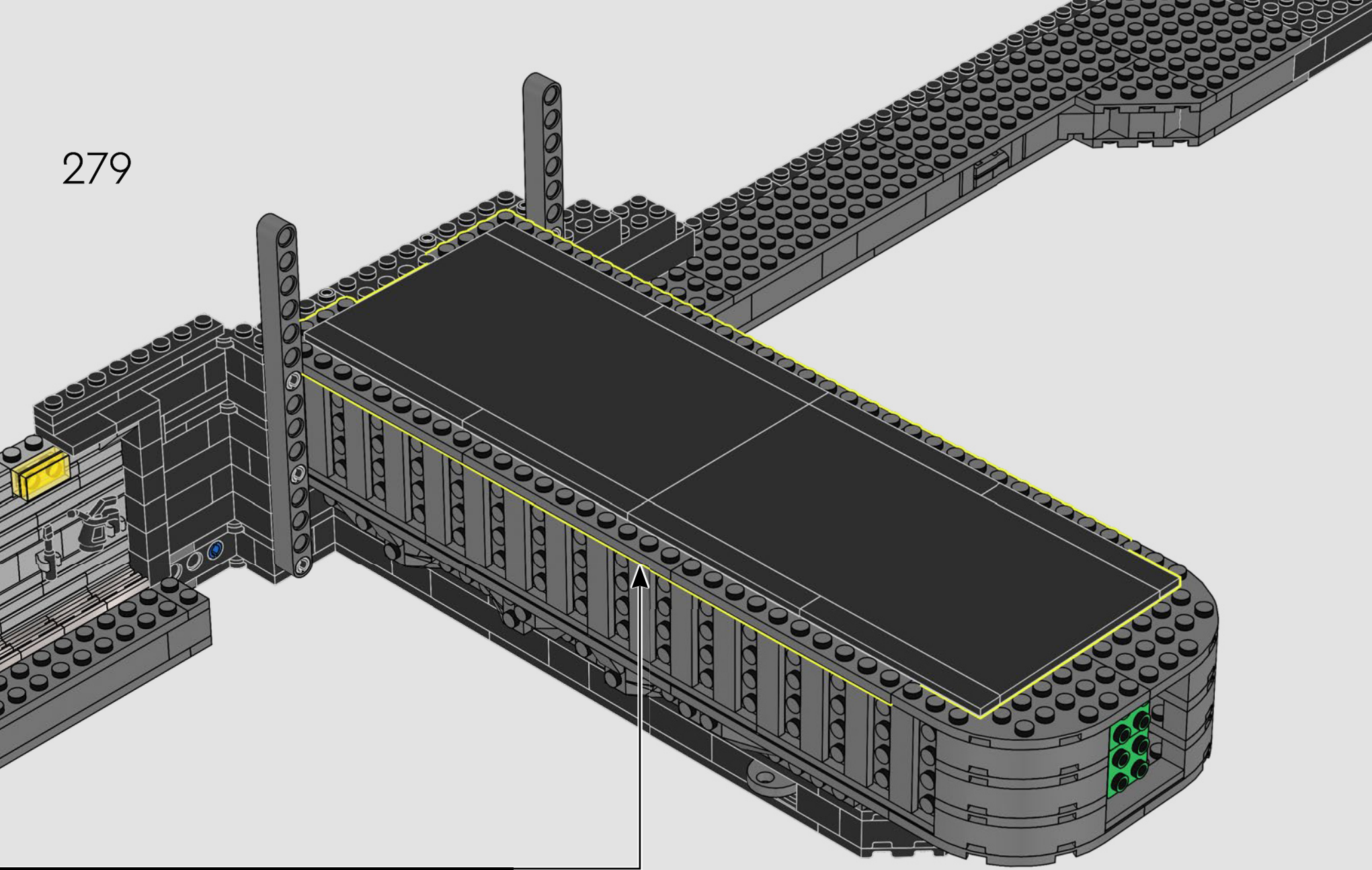

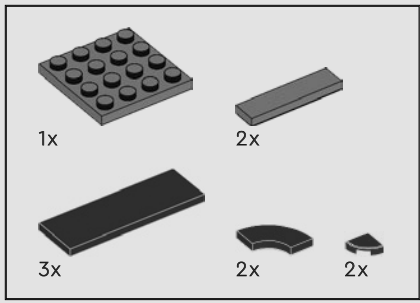

280

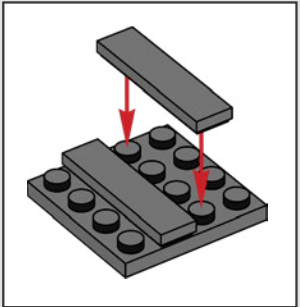
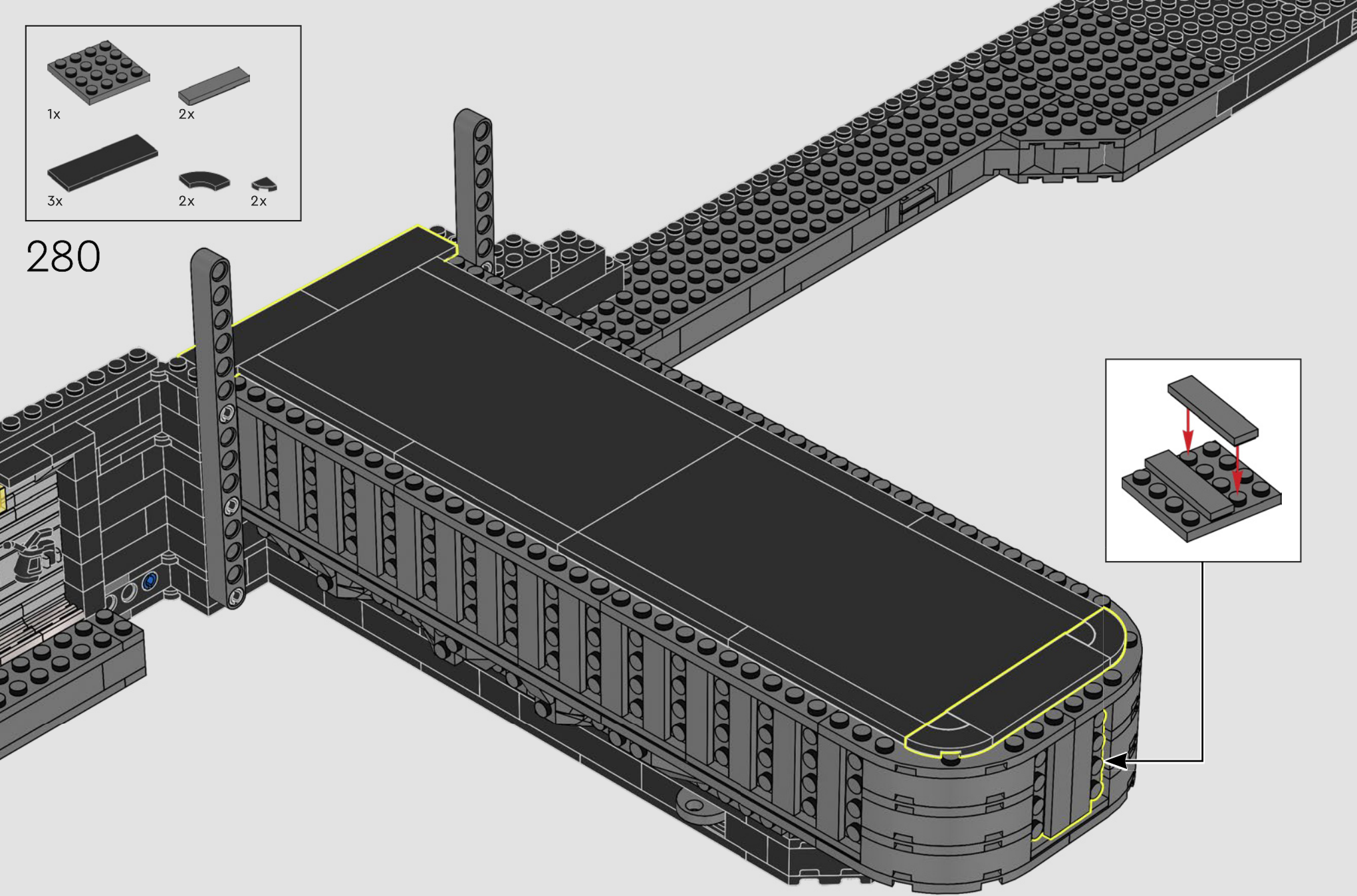

14x 14x

281

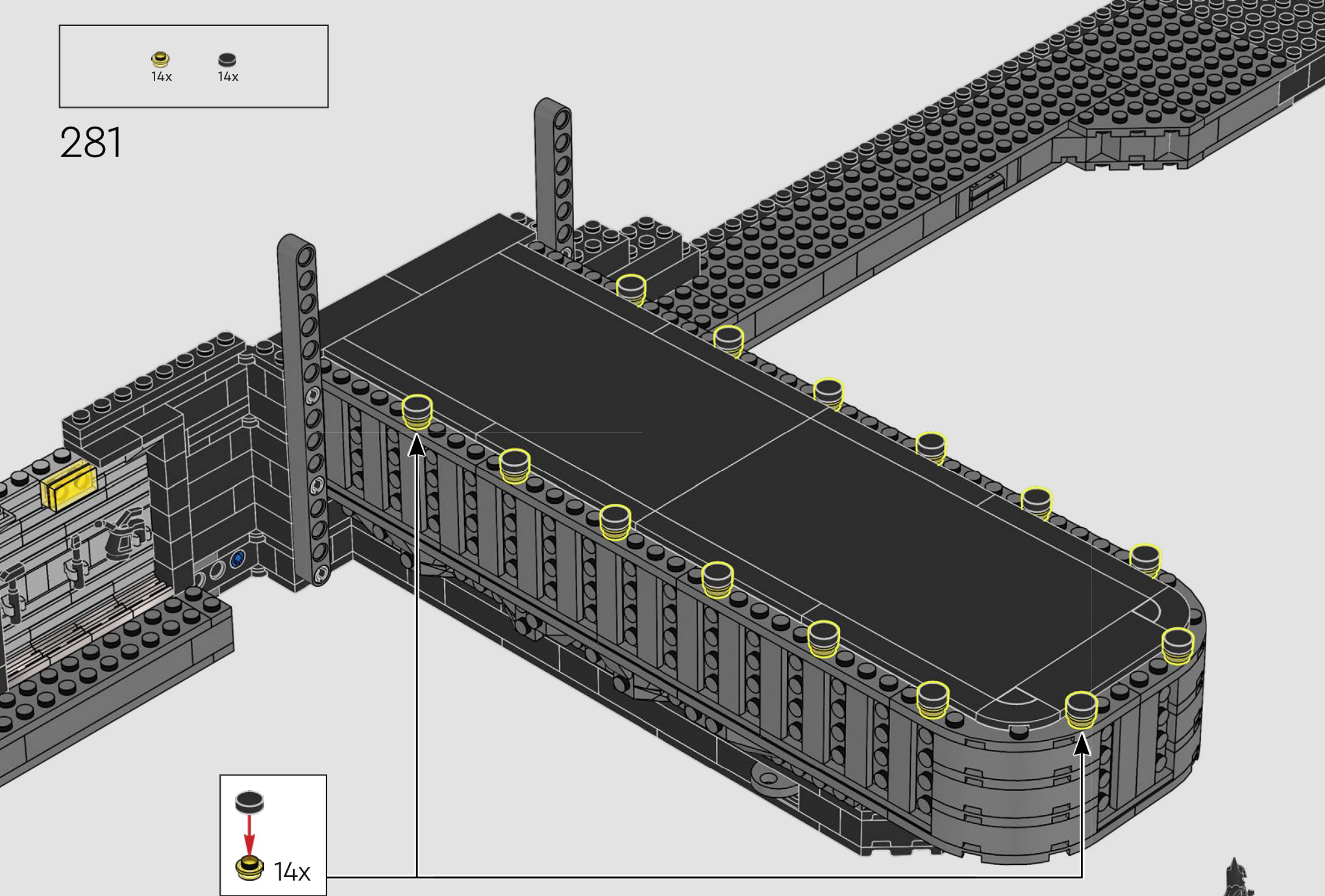

14x



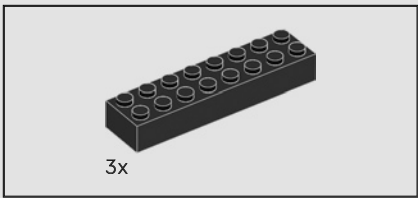

282

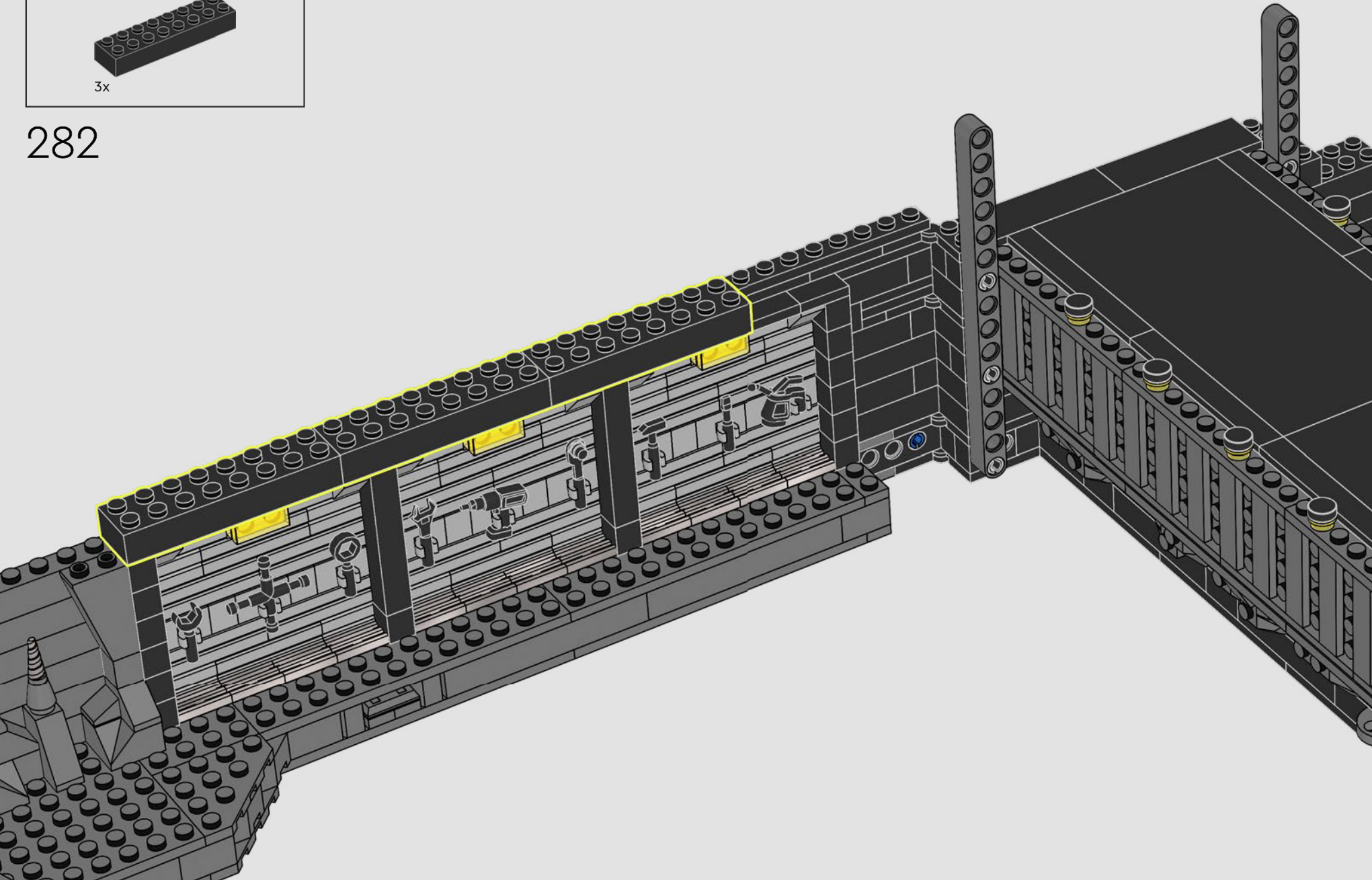

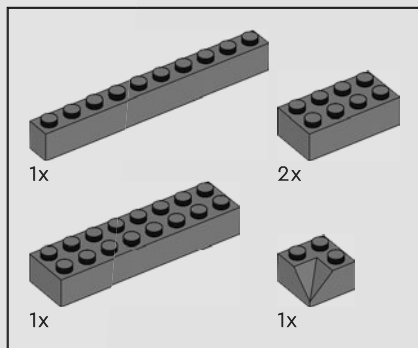

283

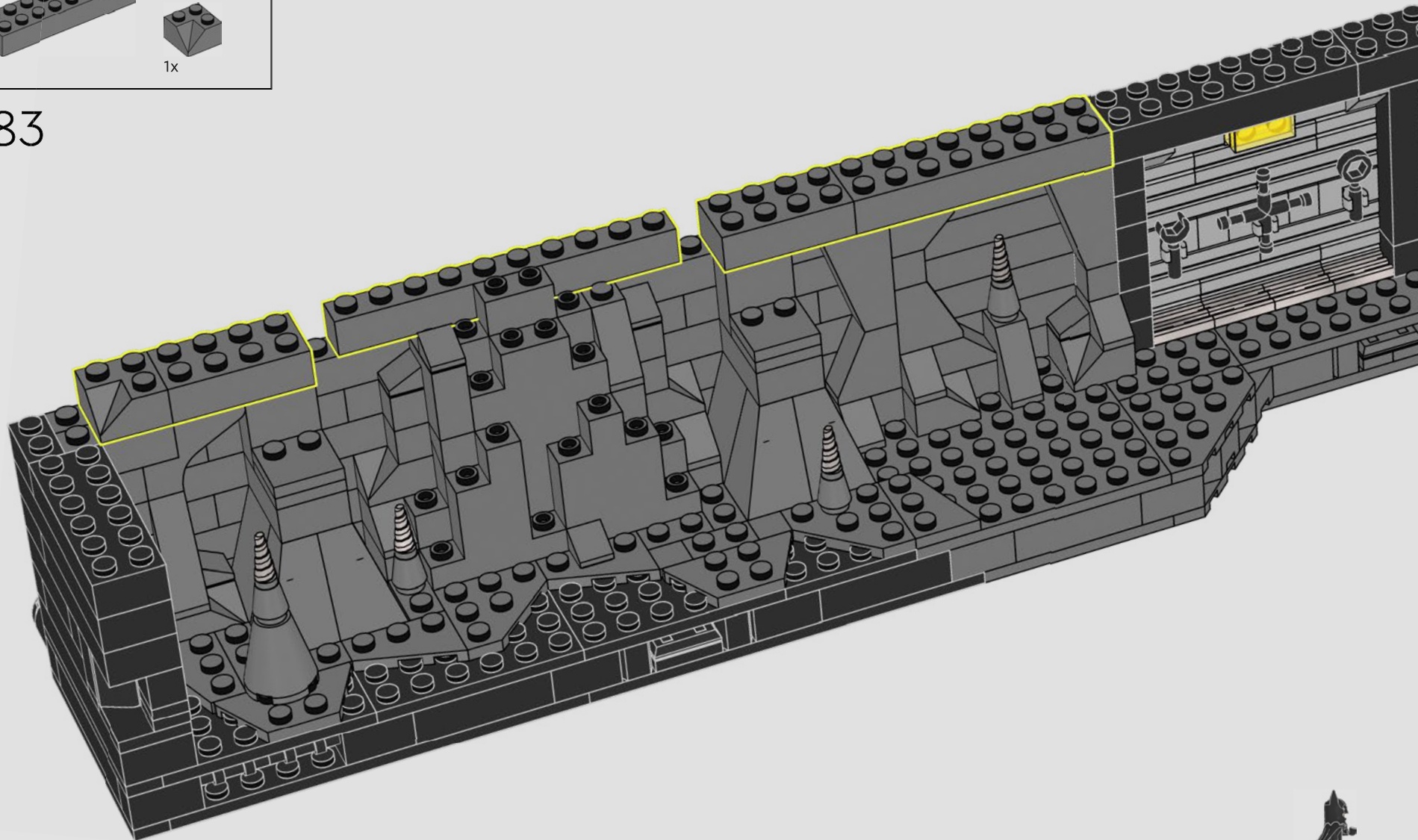

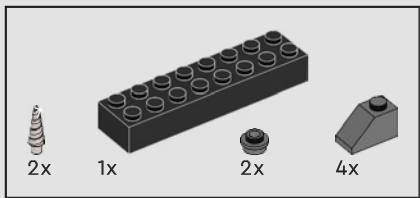

284

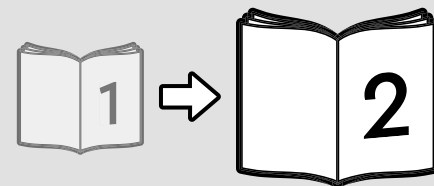
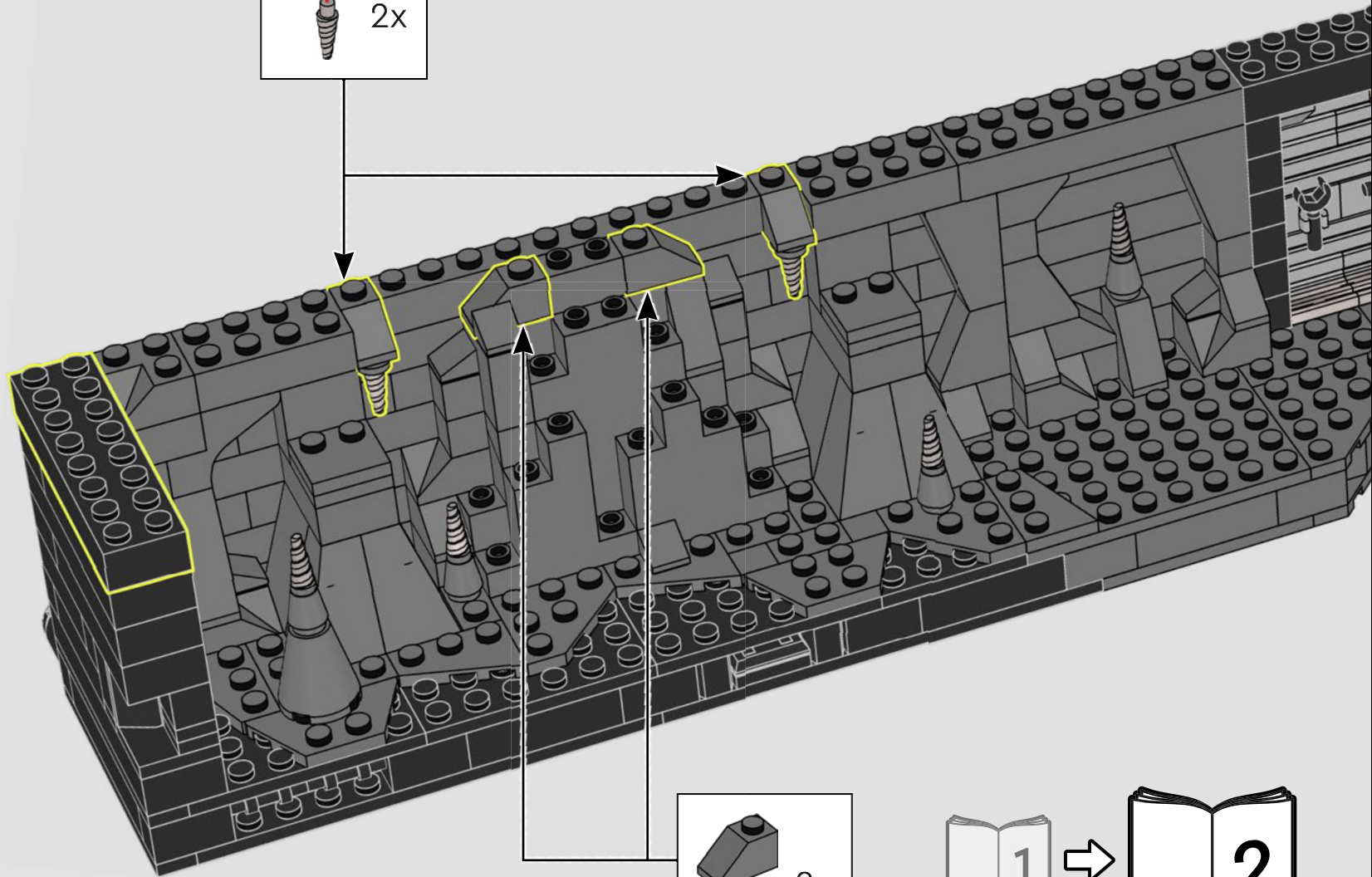
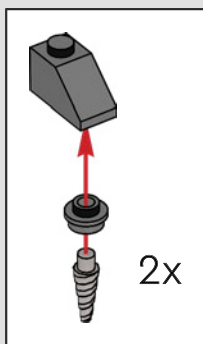



YOU COULD WIN



YOU COULD WIN

Your feedback will help shape the future development of this product series.

Visit:

DU KÖNNTEST GEWINNEN

Dein Feedback trägt zur Weiterentwicklung dieser Produktreihe bei.

Geh auf:

VOUS POURRIEZ GAGNER

Vos commentaires nous aideront à concevoir les futurs produits de cette gamme.

Visitez :

POTRESTI VINCERE TU

La tua opinione ci aiuterà a migliorare la creazione futura di questa linea di prodotti.

Visita:

PUEDES GANAR

Tu opinión contribuirá al futuro de esta serie de productos.

Visita:

轻松获奖

您的反馈将有助于我们在今后改进本产品系列。

请访问:

[LEGO.com/productfeedback](https://www.lego.com/productfeedback)

You also have the chance to win a LEGO® set.

Terms and conditions apply.*

Außerdem hast du die Chance, ein LEGO® Set zu gewinnen.

Es gelten die Teilnahmebedingungen.*

Vous pourriez également gagner un ensemble LEGO®.

Des conditions s'appliquent.*

Hai anche la possibilità di vincere un set LEGO®.

Termini e condizioni sono applicabili.*

También tienes la oportunidad de ganar un set LEGO®.

Aplican términos y condiciones.*

您还有机会赢取乐高®套装。

条款和条件适用。*

*[LEGO.com/productfeedback-terms](https://www.lego.com/productfeedback-terms)

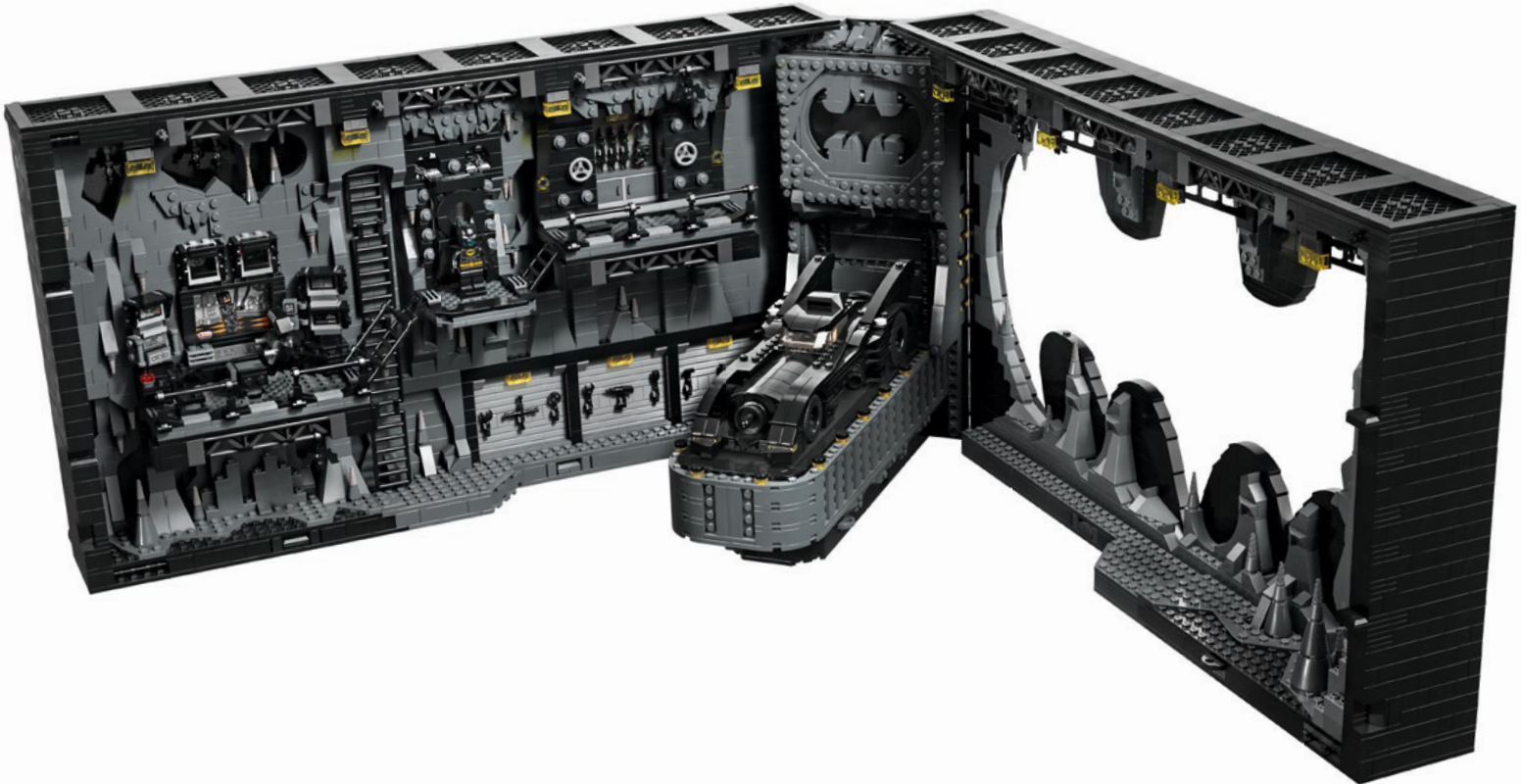

76252

LEGO and the LEGO logo are trademarks of the/sont des marques de commerce du/son marcas registradas de LEGO Group. ©2023 The LEGO Group.

BATMAN RETURNS and all related characters and elements © & ™ DC and Warner Bros. Entertainment Inc. (s23)

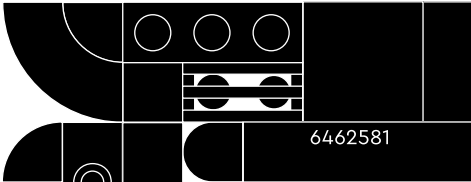

6462581