



MARVEL  
**SPIDERMAN**

76225





### **Get excited about our new packaging!**

We're switching from plastic to paper-based packaging. That's why you might find a mix of paper and plastic in our boxes!

### **Nos nouveaux emballages vous emballeront !**

Nous passons des emballages en plastique aux emballages à base de papier. C'est pourquoi vous pourriez trouver un mélange de papier et de plastique dans nos boîtes !

### **¡Te presentamos nuestros nuevos empaques!**

Estamos sustituyendo las bolsas de plástico por bolsas con base de papel. ¡Por eso, puedes encontrar una mezcla de papel y de plástico en nuestras cajas!

**[LEGO.com/sustainable-packaging](https://www.lego.com/sustainable-packaging)**



Check for compatibility  
Kompatibilität prüfen  
Vérifier la compatibilité  
Controlla la compatibilità  
Comprueba tu compatibilidad  
Verificar a compatibilidade  
Ellenőrizd a kompatibilitást  
Pārbaudīt saderību  
Verificarea compatibilității  
检查兼容性

[LEGO.com/devicecheck](https://www.lego.com/devicecheck)

## 乐高®拼搭指引



LEGO® Building Instructions



Apple and the Apple logo are trademarks of Apple Inc.  
Google Play and the Google Play logo are trademarks of Google LLC.  
Tencent and the Tencent logo are trademarks of Tencent Inc.

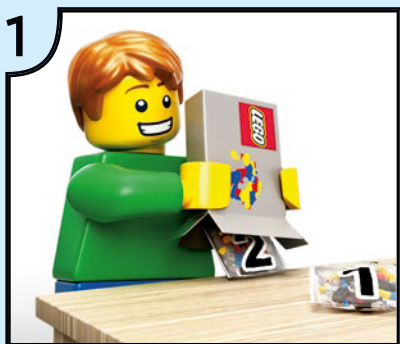

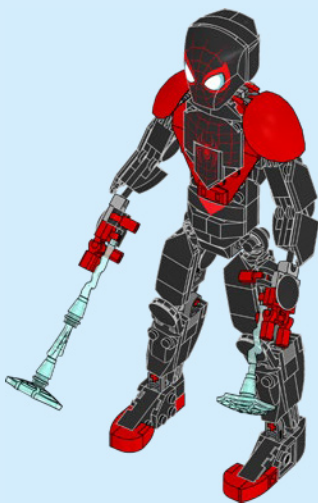
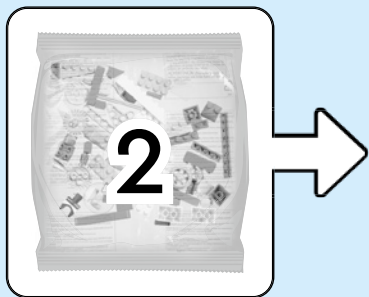
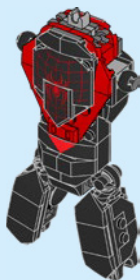
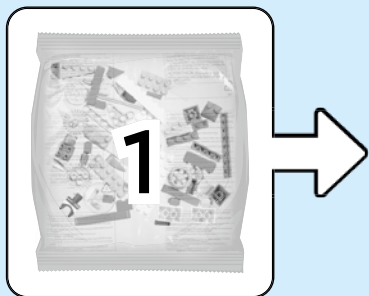

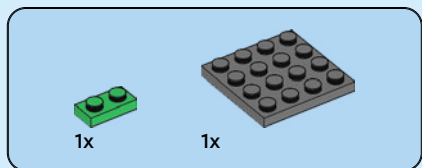

1

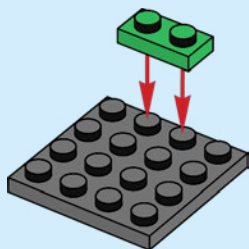

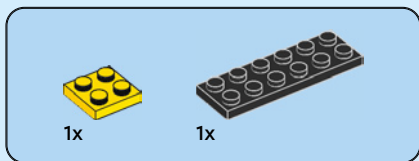

2

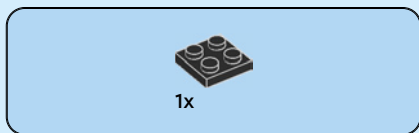
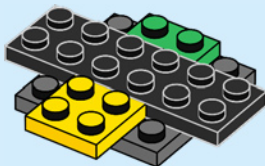

3

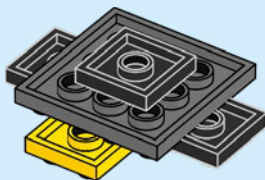



3x

4

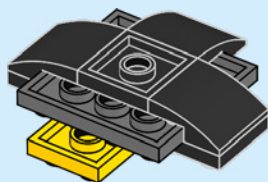

2x

5

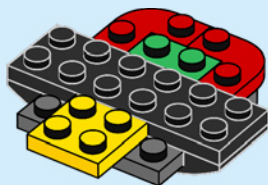
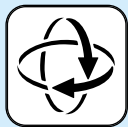





1x



4x

# 6

1

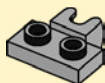

2

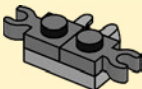

3

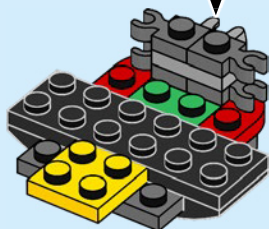
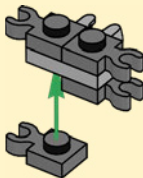



2x

7

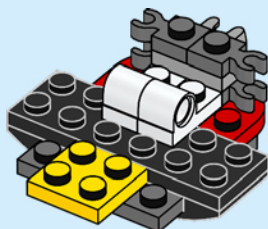

2x

8

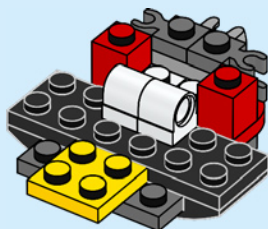



1x



2x

9

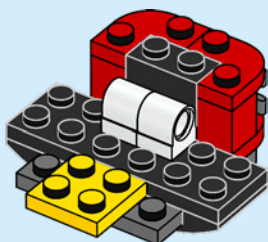

4x

10

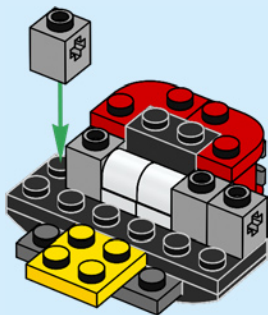

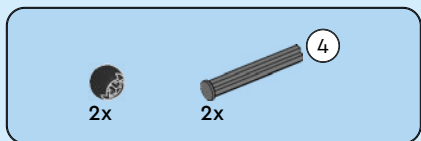

11

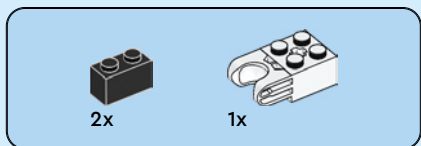
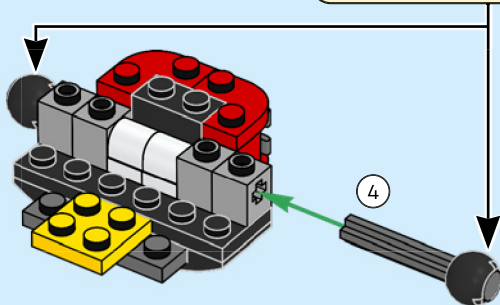
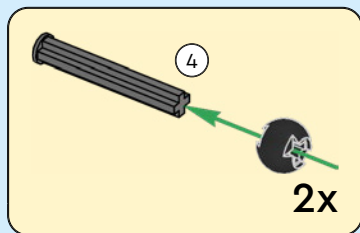

12

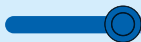
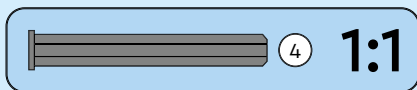
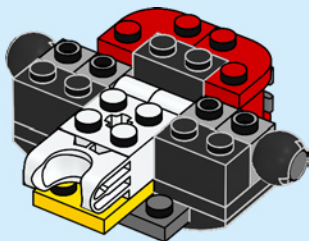

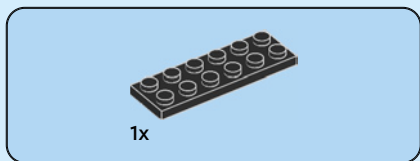

13

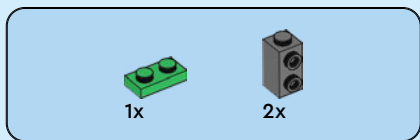
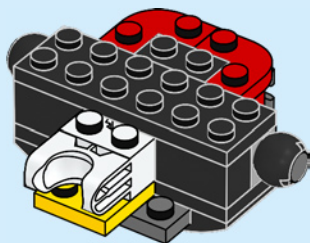

14

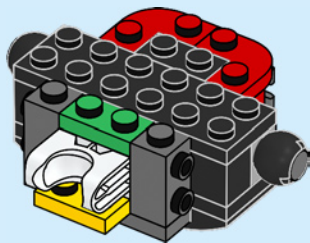



1x



1x

# 15

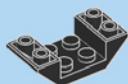
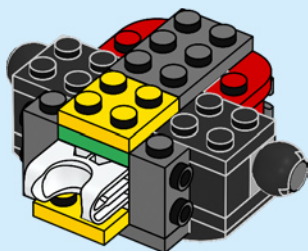

1x

# 16

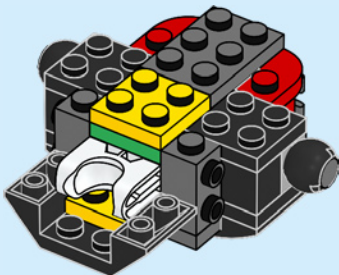



1x

17

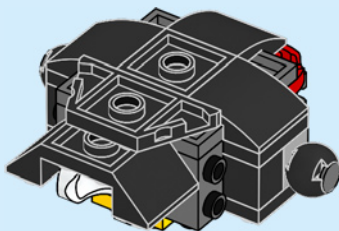
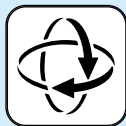

2x

18

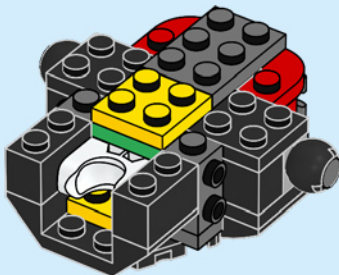
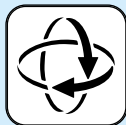



2x



2x

# 19

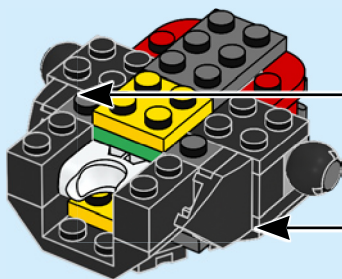
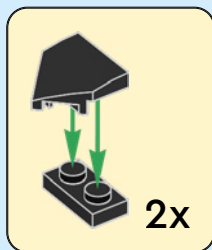



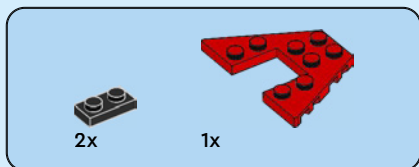

20

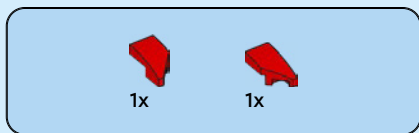
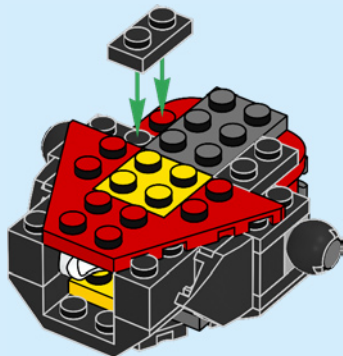

21

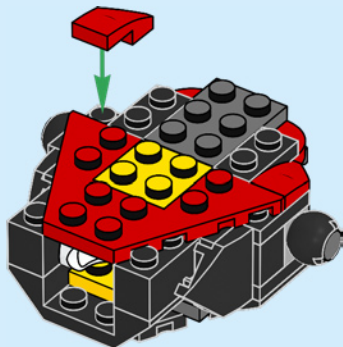



1x



1x

# 22

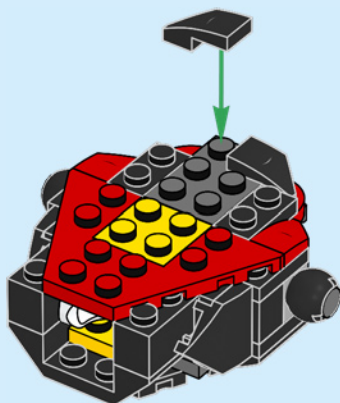

2x



1x



1x

# 23

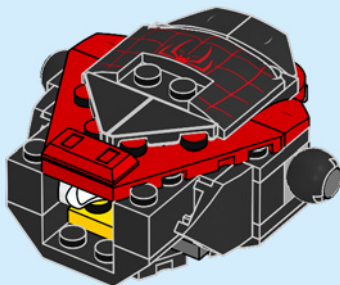



1x

24

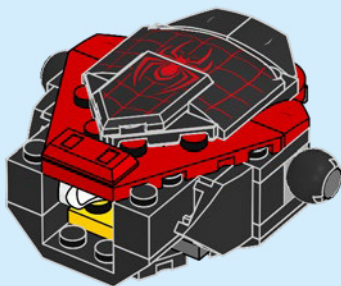

1x

25

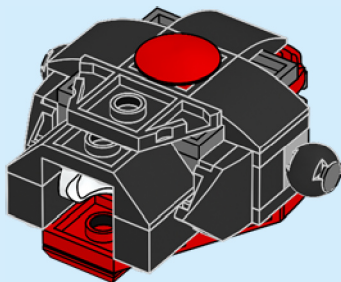

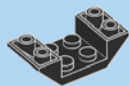

1x

# 26

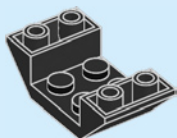

1x

# 27

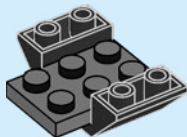



1x

# 28

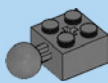
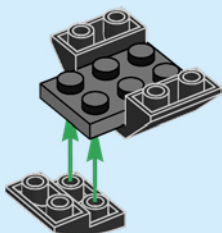

1x

# 29

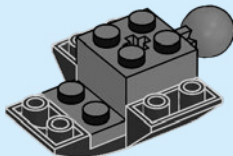



2x



1x

# 30

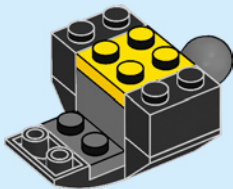

2x

# 31

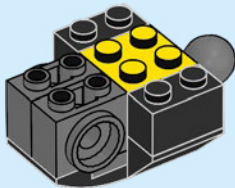



1x

# 32

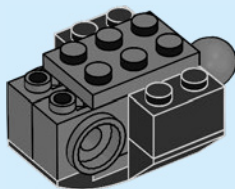

1x



1x

# 33

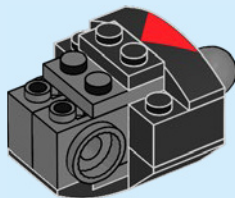



2x

# 34

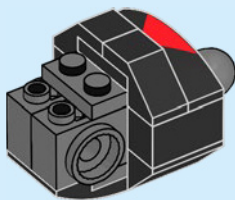

1x



1x



1x

# 35

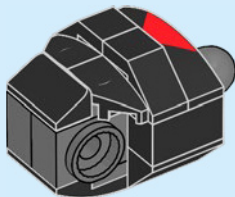



36

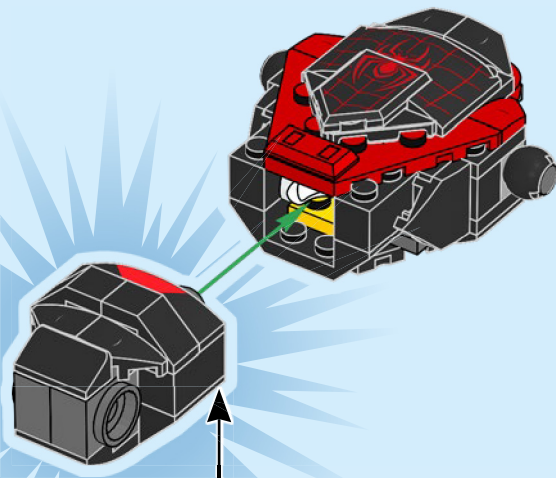

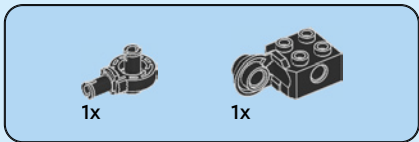
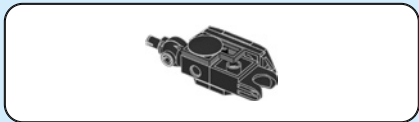

37

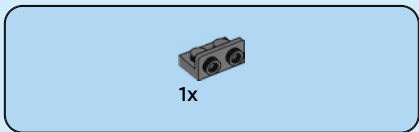
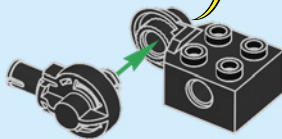

38

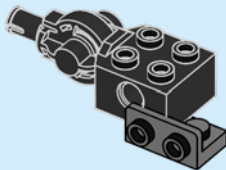



1x

# 39

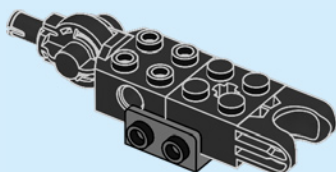

1x

# 40

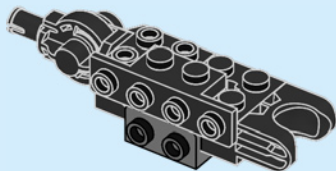



2x

# 41

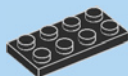
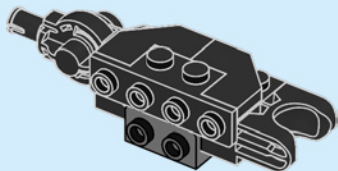

1x

# 42

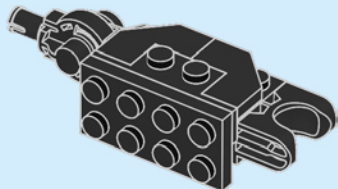



1x



2x

# 43

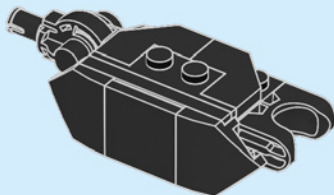

1x

# 44

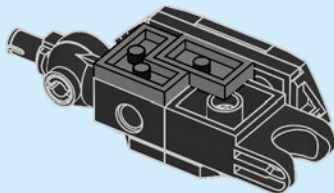
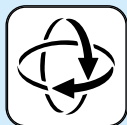



1x

45

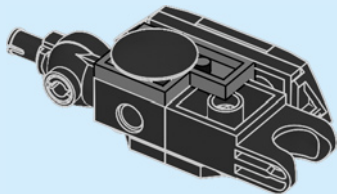

46

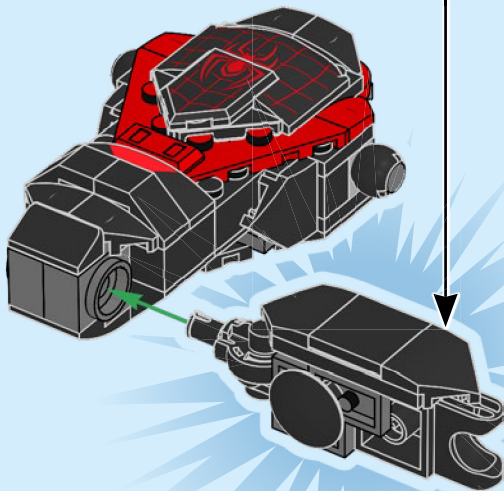

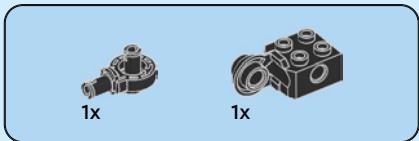
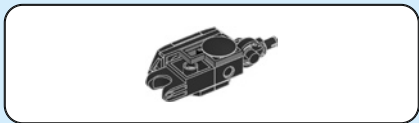

47

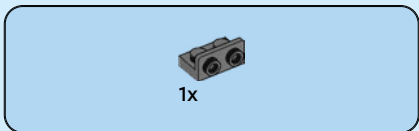
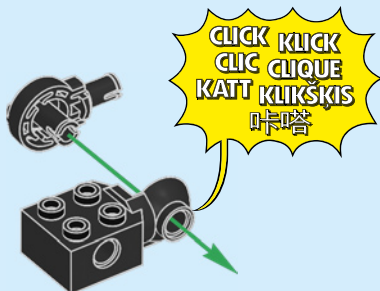

48

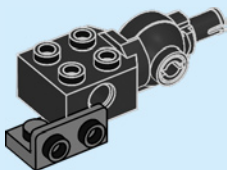



1x

# 49

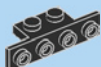
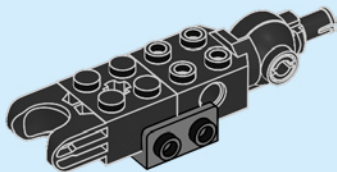

1x

# 50

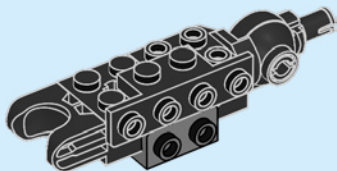





2x

# 51

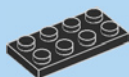
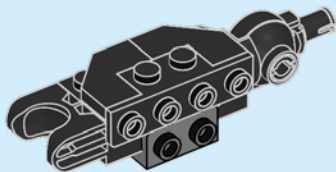

1x

# 52

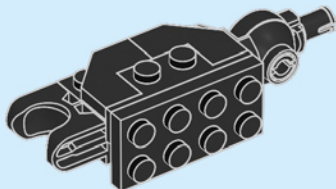



1x



2x

# 53

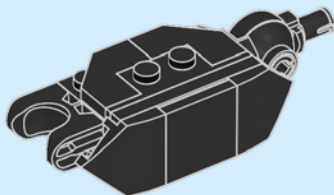

1x

# 54

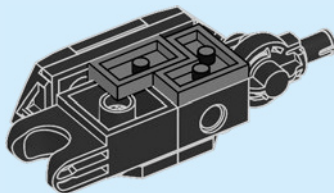
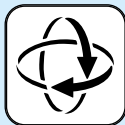



1x

55

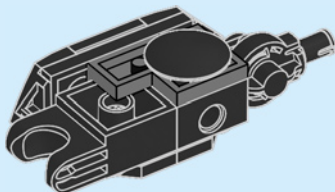

56

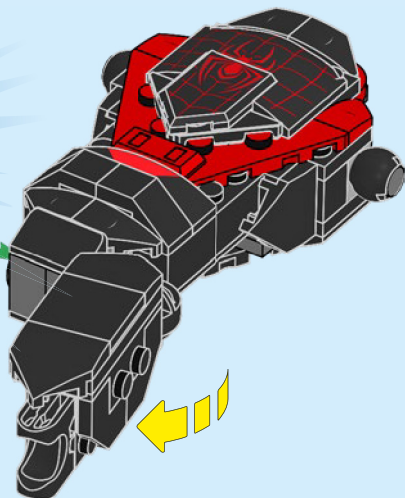
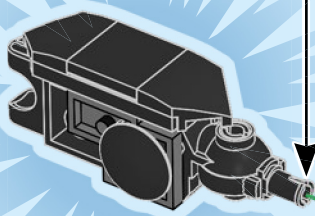

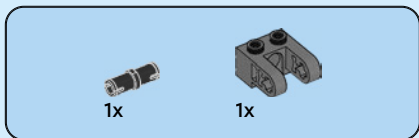
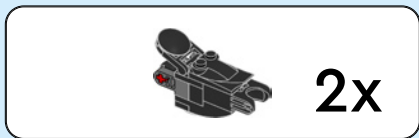
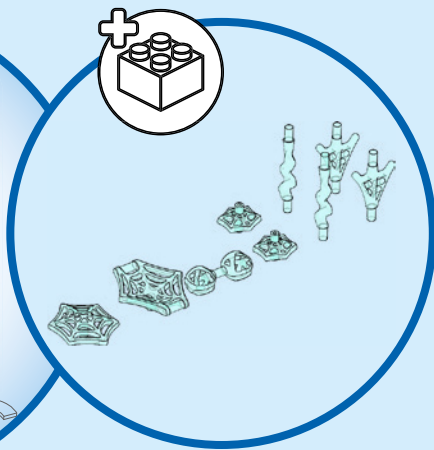

57

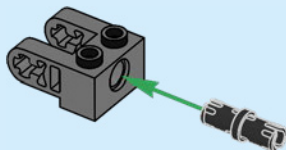



1x

58

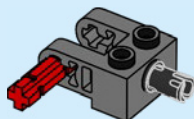

1x

59

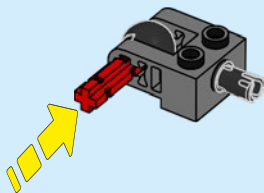



1x

60

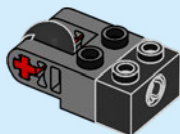

2x

61

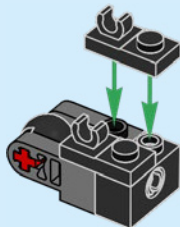

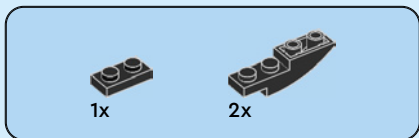

# 62

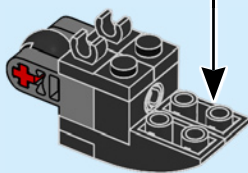
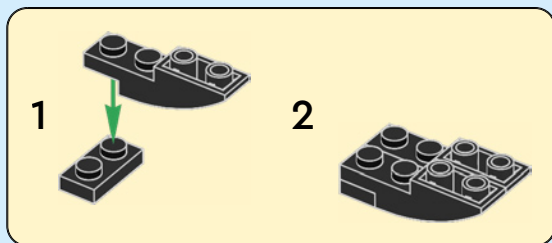



1x

63

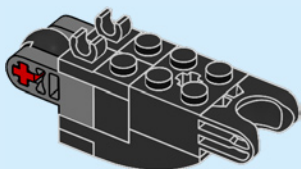



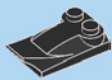

1x

64

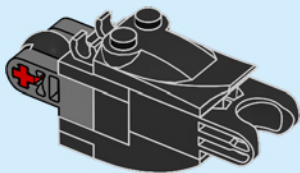

1x

65

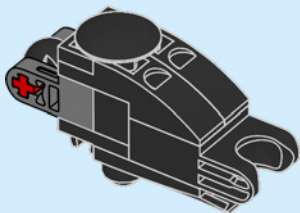



1x



1x



2x

# 66

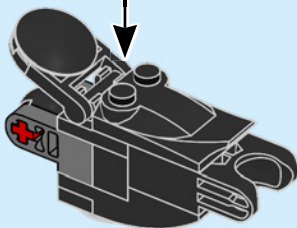
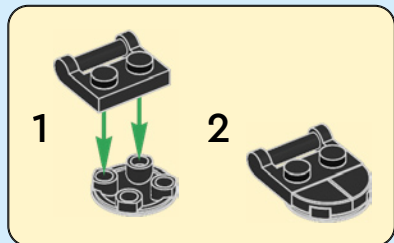

# 2x

67

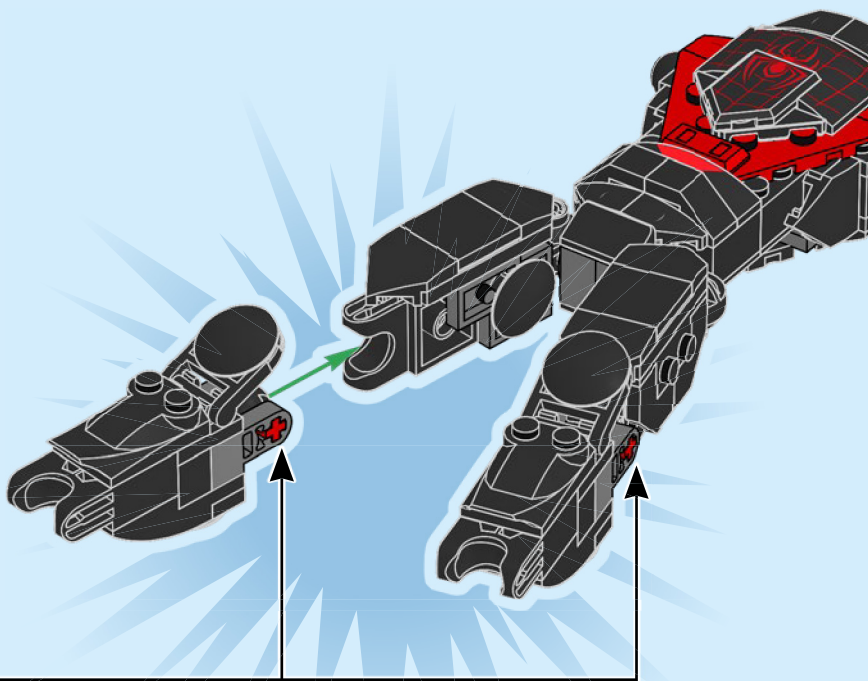

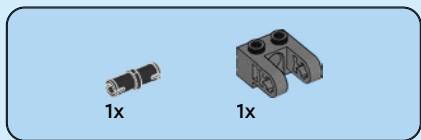

68

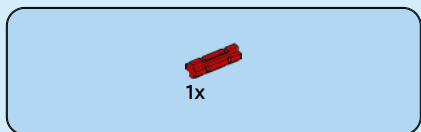
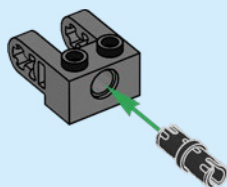

69

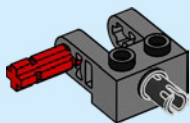



1x

70

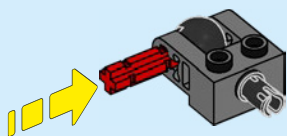

1x

71

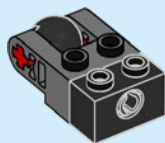



1x

# 72

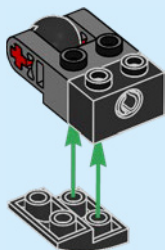

1x



1x

# 73

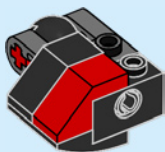



1x

# 74

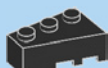
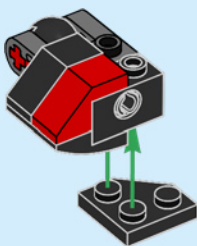

1x

# 75

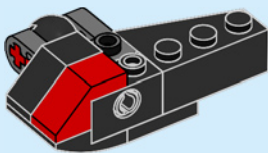



1x

# 76

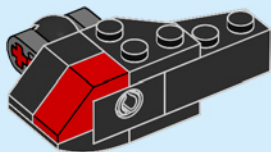

1x



1x

# 77

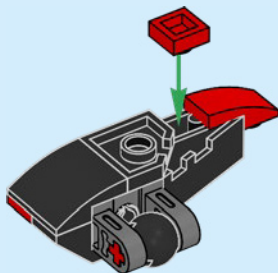





1x

78

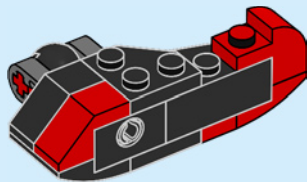

1x

79

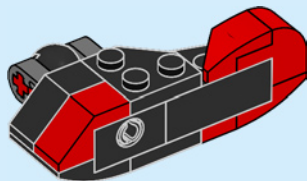

80

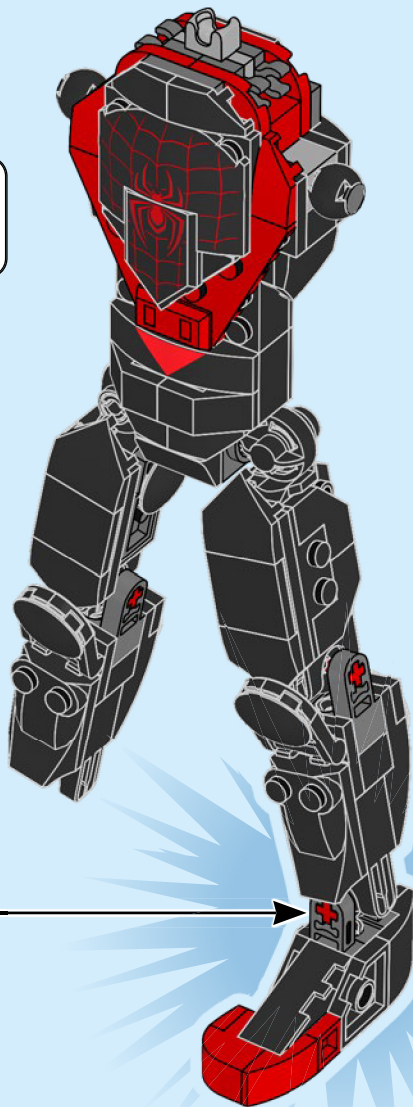
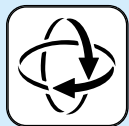

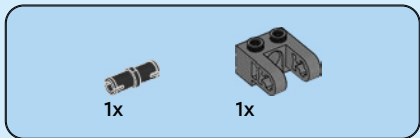
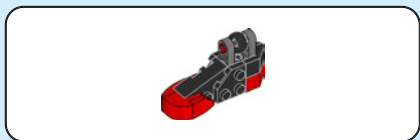

81

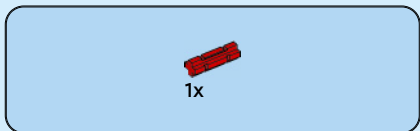
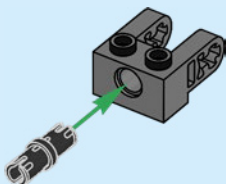

82

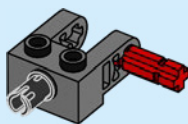



1x

# 83

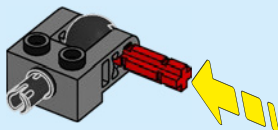

1x

# 84

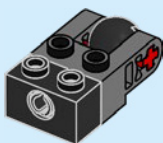



1x

# 85

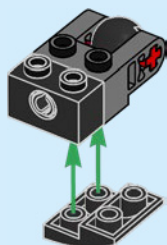

1x



1x

# 86





1x

# 87

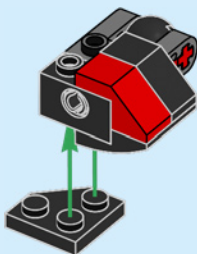

1x

# 88

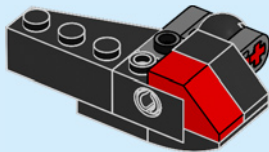



1x

# 89

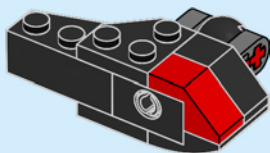

1x



1x

# 90

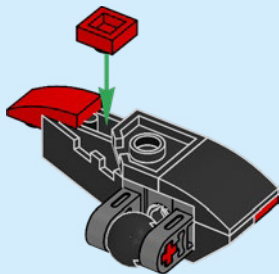
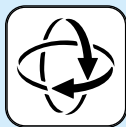



1x

91

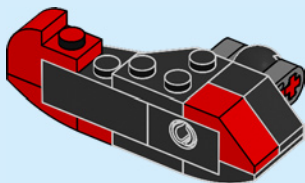

1x

92

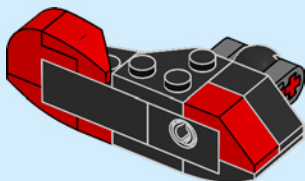



93

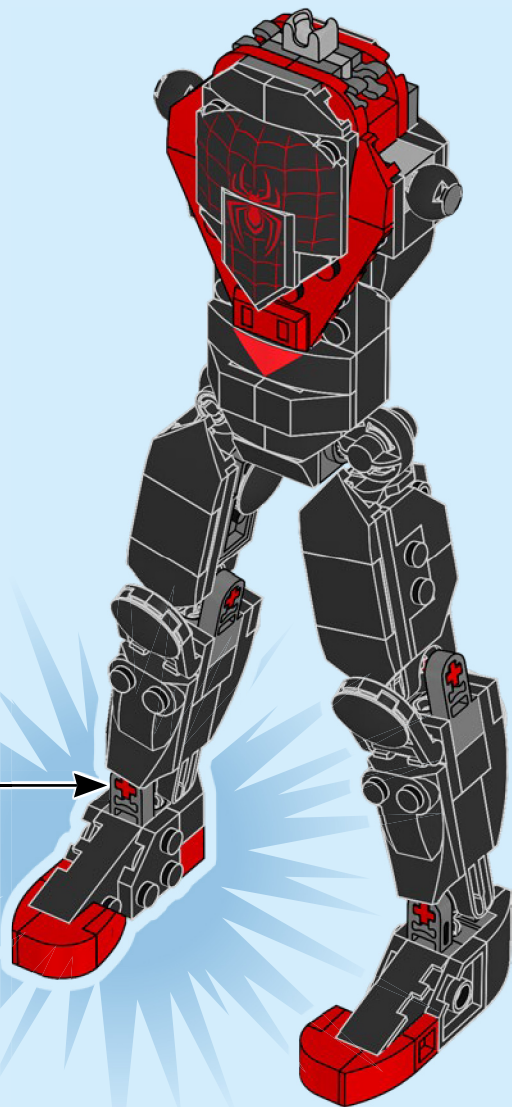

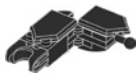

1x



1x

# 94

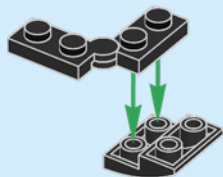

1x

# 95





1x

96

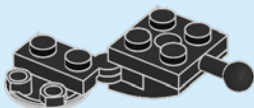

1x

97

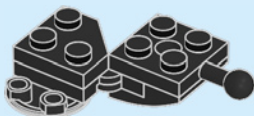





1x

# 100

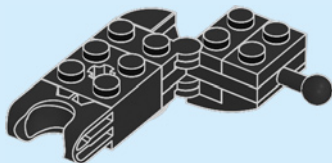

2x

# 101

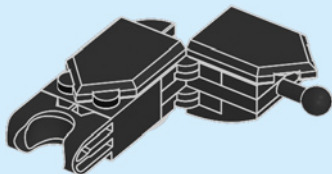

102

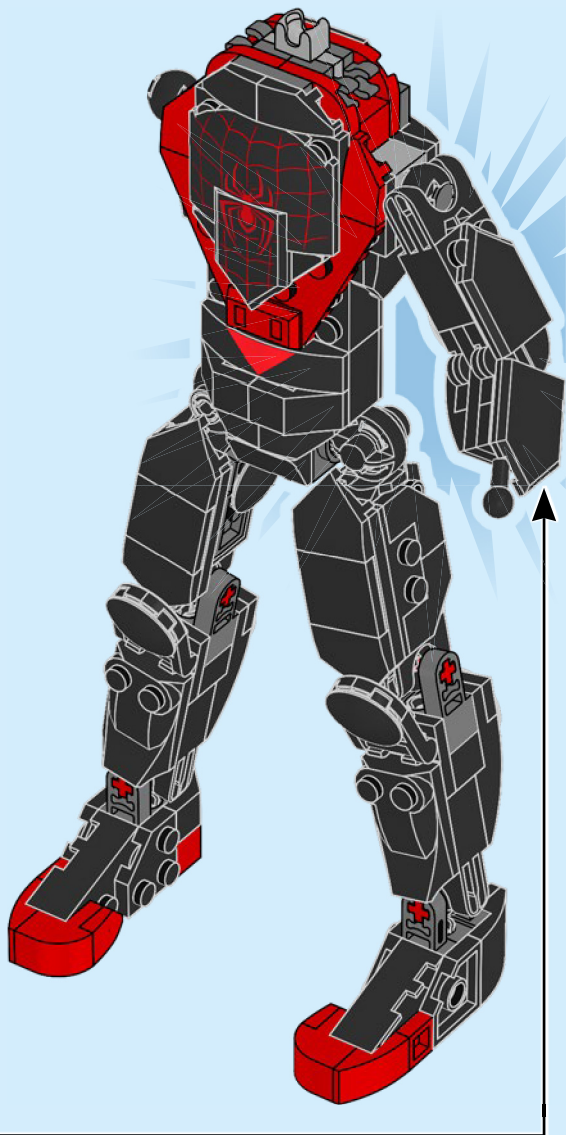

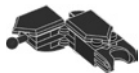

1x



1x

# 103

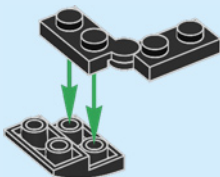

1x

# 104

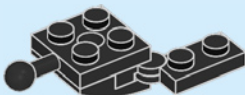



1x

# 105

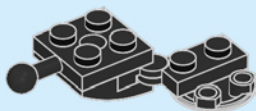

1x

# 106

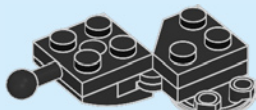





1x

# 107



1x



1x

# 108





1x

# 109

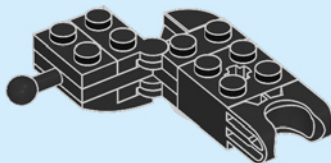

2x

# 110

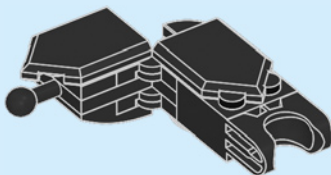

111

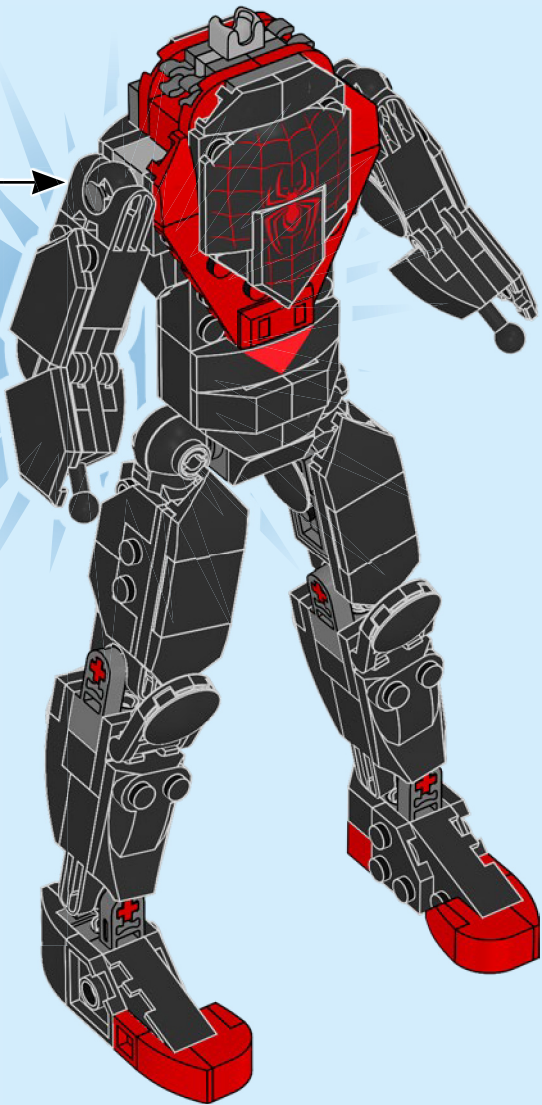



1x



1x

# 112

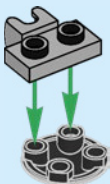

1x

# 113





1x



1x



1x

# 114

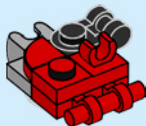

1x

# 115

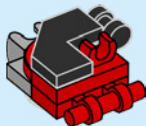



4x

# 116

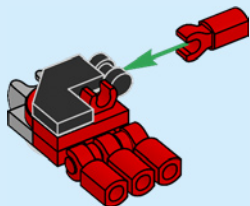

117

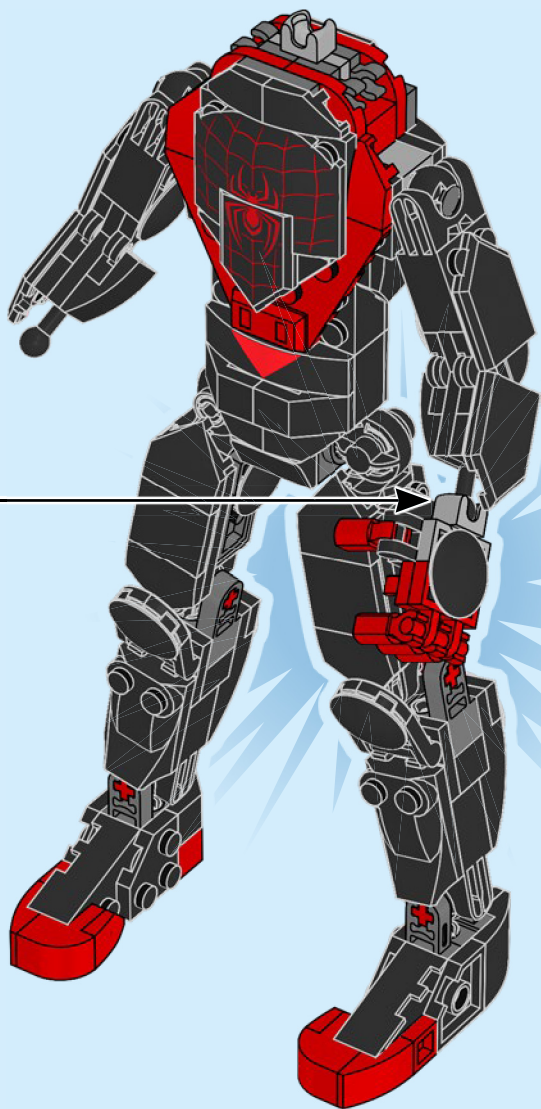



1x



1x

# 118

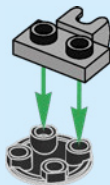

1x

# 119

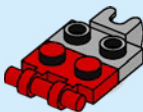





1x



1x



1x

# 120

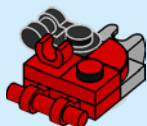

1x

# 121

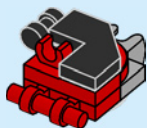



4x

122

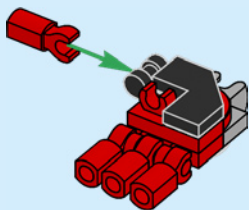

123

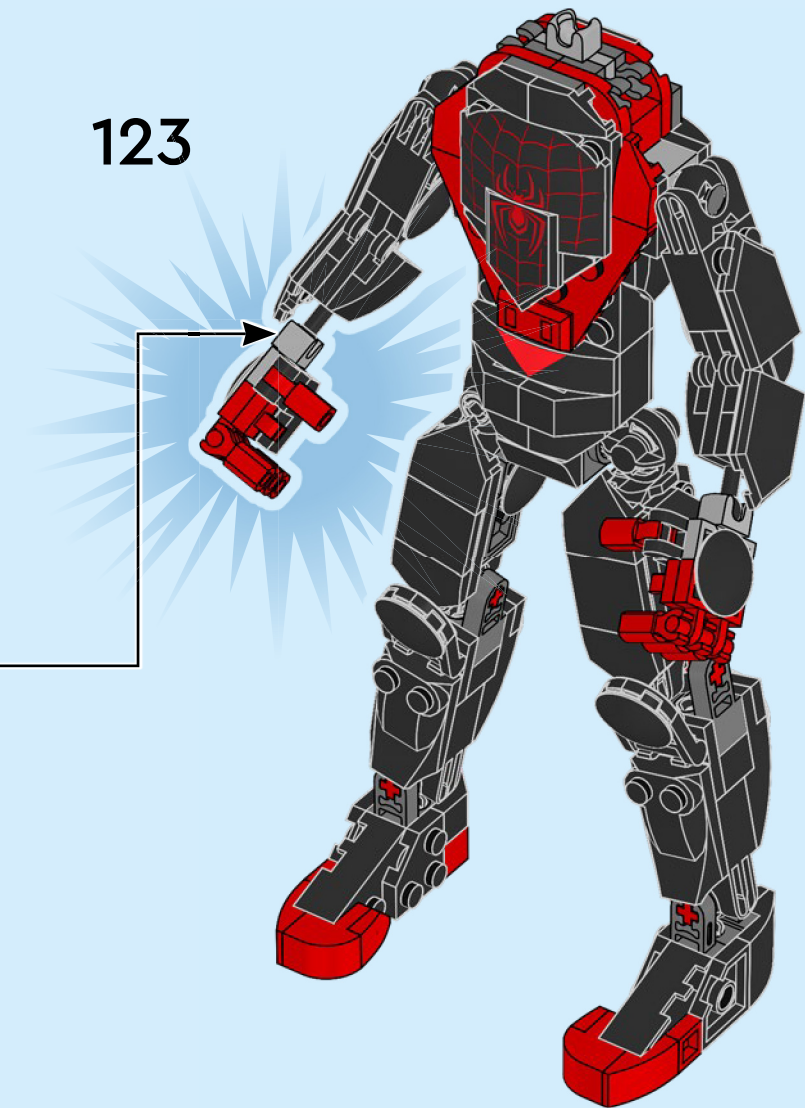

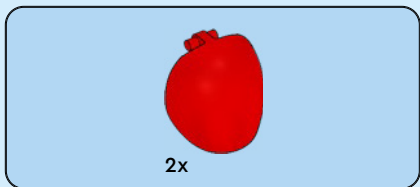

124

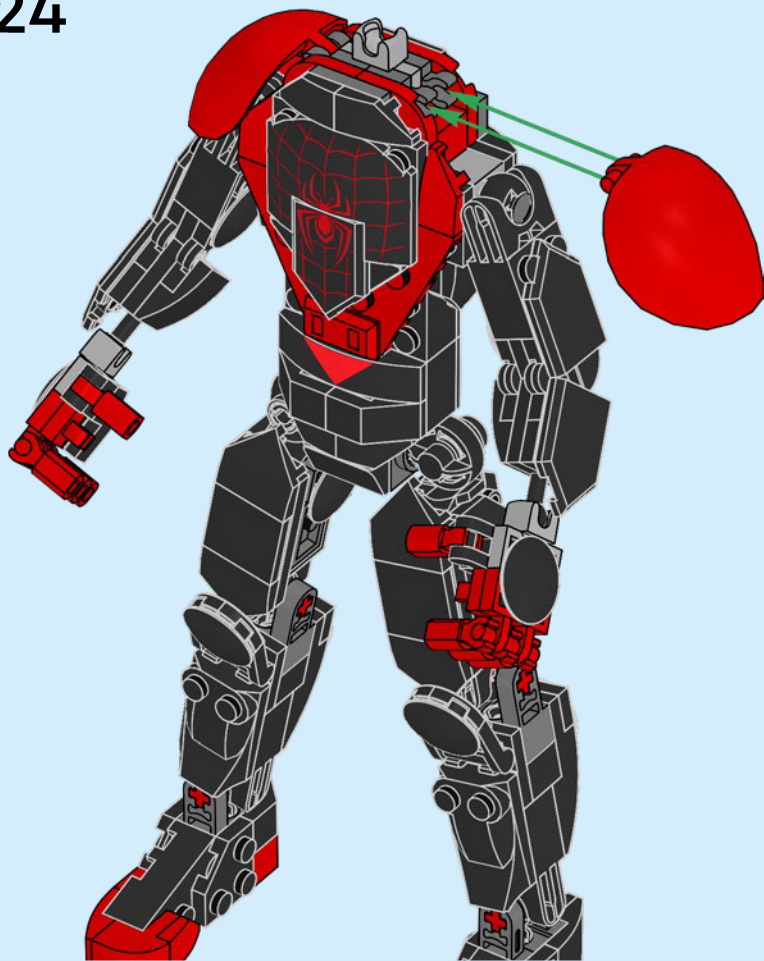



1x



1x

# 125

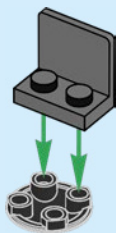

2x

# 126

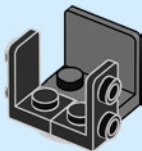



1x

127

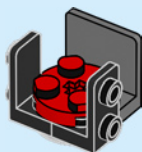



1x

# 128

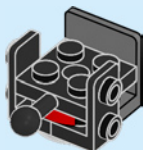

1x

# 129

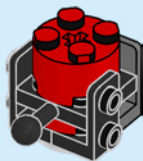



2x



2x

# 130

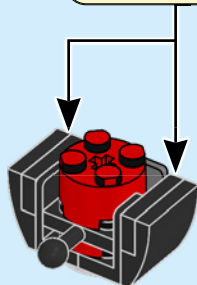
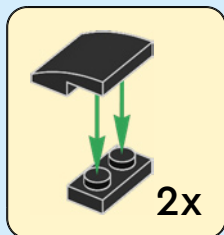





2x

# 131

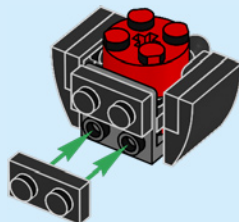
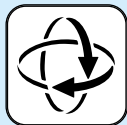

1x



1x



1x

# 132

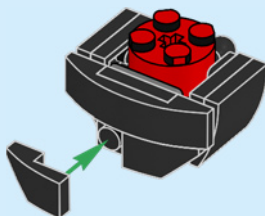

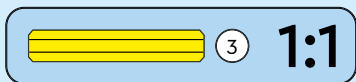
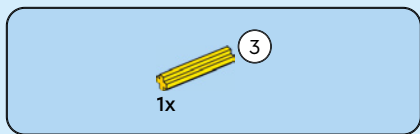

133

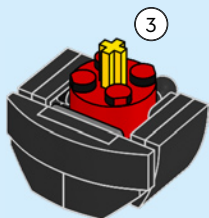

134

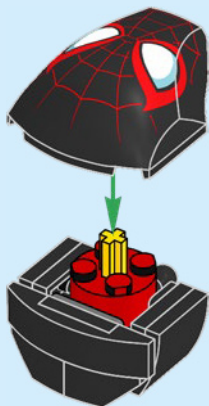

135

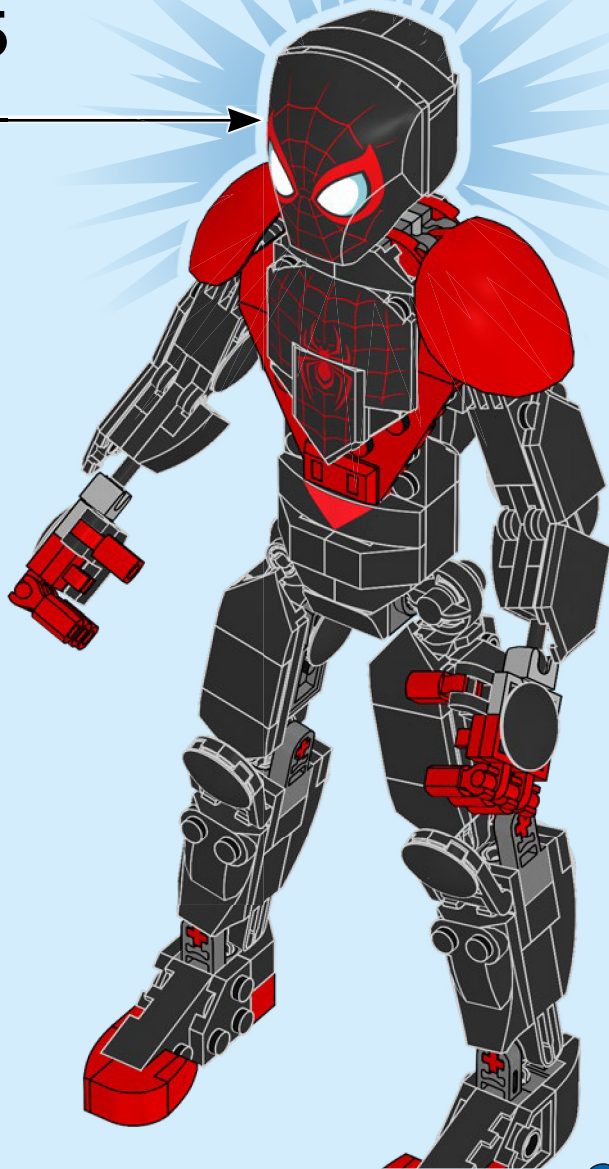

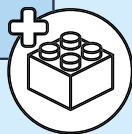
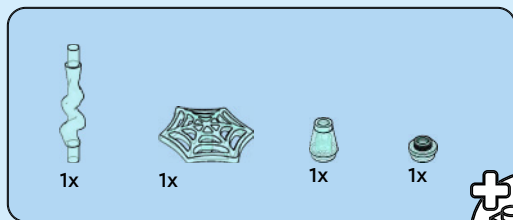

136

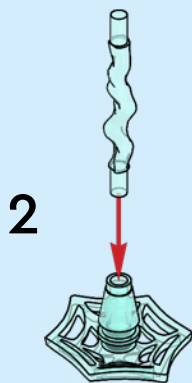
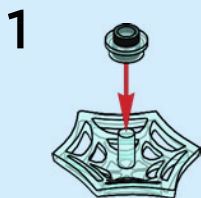

137

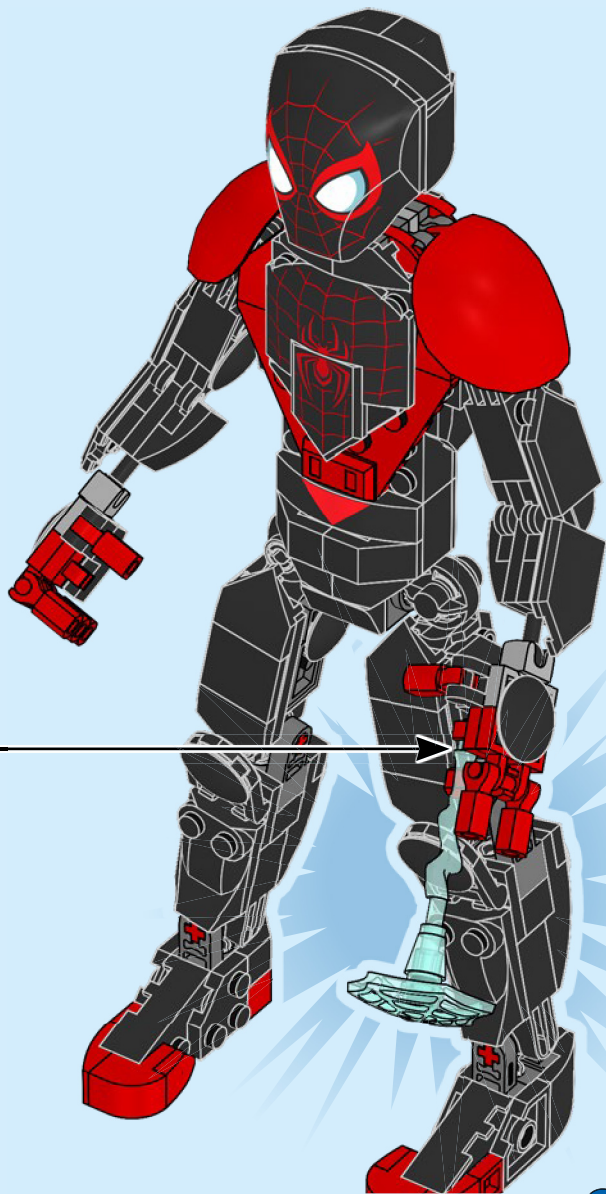

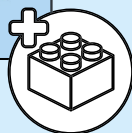
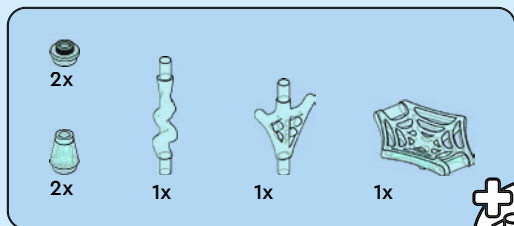

138

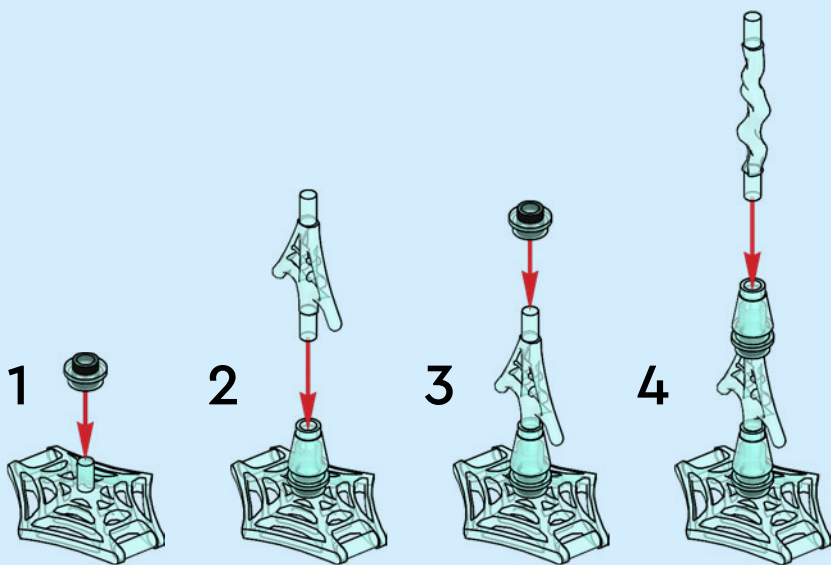

139

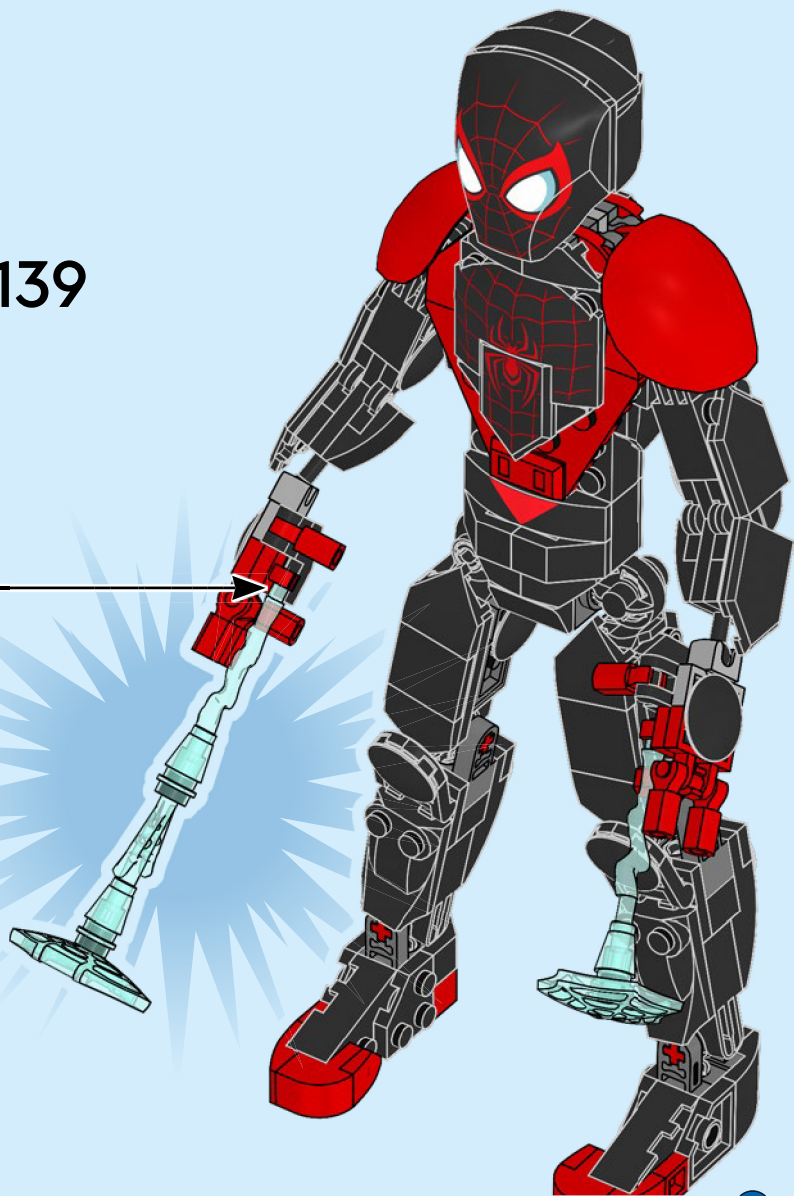

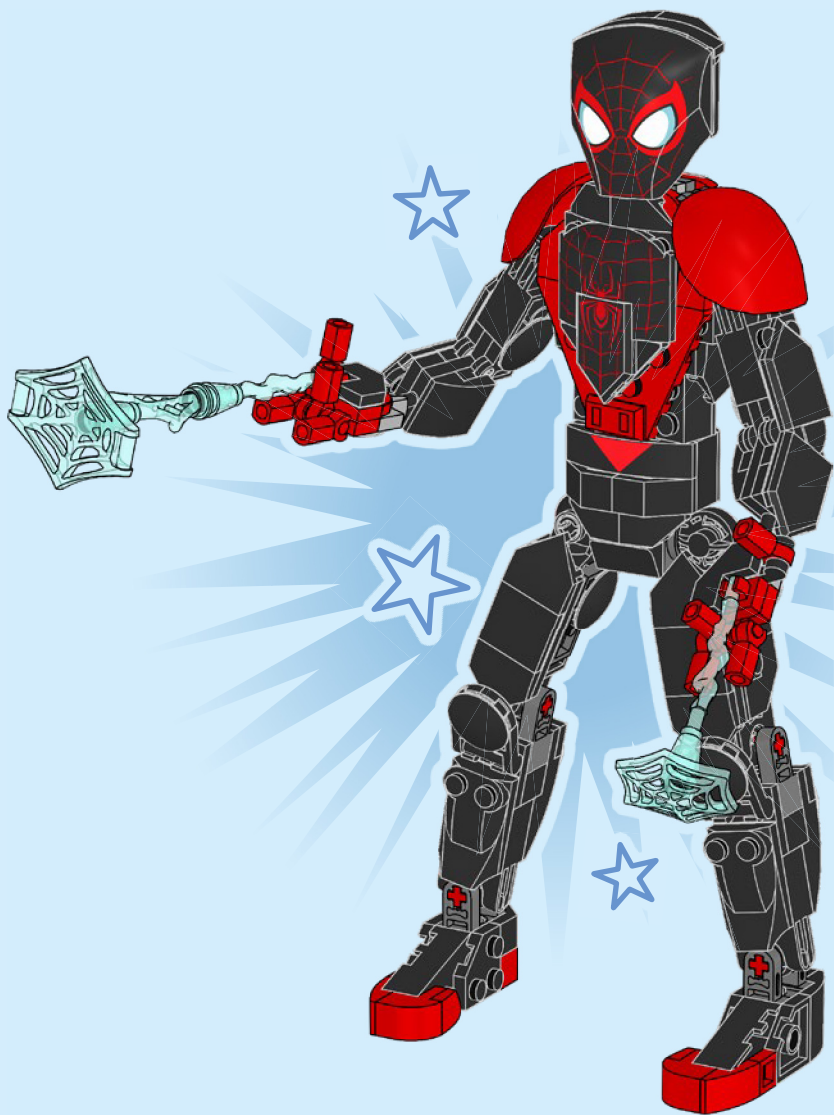





# MARVEL SPIDER-MAN



**MARVEL**  
marvelkids.com  
© Marvel © CPII





2x  
6057414



1x  
6360826



4x  
6336539



3x  
6043656



2x  
302328



3x  
302224



1x  
6130007



6x  
4286267



3x  
6181720



6x  
6172383



2x  
6335317



2x  
6157554



3x  
6181713



11x  
4278359



1x  
4548180



4x  
6279875



13x  
302326



6x  
6174243



7x  
300426



6x  
6308912



4x  
6267487



4x  
370026



4x  
6347310



2x  
6214807



2x  
4225201



2x  
4213374



8x  
6211476



1x  
302226



2x  
6053077



2x  
306826



6x  
6166859



3x  
6359224



4x  
6245251



1x  
6404118



1x  
4526931



2x  
6168620



1x  
4531412



1x  
4527766



2x  
4285883



1x  
4613153



1x  
6404119



4x  
6039869



6x  
6360825



2x  
6302828



1x  
6404117



4x  
6102782



2x  
6228923



1x  
4497253



1x  
614321



2x  
302026



4x  
6296892

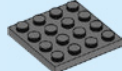

1x  
4243831



2x  
6347308



2x  
4188534



2x  
6398662



8x  
6341972



2x  
6184782



1x  
6308045



2x  
302421



2x  
6186398



1x  
6404116



2x  
6000606



2x  
300521



2x  
6275178



2x  
4210635



2x  
6177505



2x  
4140585

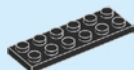

2x  
379526



4x  
6324639



2x  
6170390



4x  
6384910



3x  
6283590



3x  
4211043



2x  
6177507



2x  
6391203



3x  
6337639

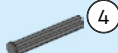

2x  
6083620



1x  
4278275



1x  
6275499



1x  
403221



4x  
4142865



1x  
6394880



1x  
6326582

Customer Service  
Kundenservice  
Service Client  
Assistenza clienti  
Atención al cliente

Serviço de Apoio ao Consumidor  
Ügyfélszolgálat

Klientu apkalpošanas dienests  
Serviciul pentru clienț

客户服务  
コンシューマーサービス  
고객 서비스

**LEGO.com/service**

# WIN



Scan this QR code or go to [LEGO.COM/PRODUCTFEEDBACK](https://LEGO.COM/PRODUCTFEEDBACK) and give us your short feedback about this LEGO® set for a chance to win a cool LEGO prize.

Terms & Conditions apply



## GEWINNE

Scanne diesen QR-Code oder geh auf [LEGO.COM/PRODUCTFEEDBACK](https://LEGO.COM/PRODUCTFEEDBACK)

und gib uns dein kurzes Feedback zu diesem LEGO® Set. Dann hast du die Chance, einen coolen LEGO Preis zu gewinnen.

Es gelten die Teilnahmebedingungen

## 获取奖品

只需扫描此二维码或访问 [LEGO.COM/PRODUCTFEEDBACK](https://LEGO.COM/PRODUCTFEEDBACK), 就这款乐高®套装提供简短反馈, 就有机会赢得很酷的乐高奖品。

《条款及条件》适用

## GAGNE

Scannez ce code QR ou rendez-vous sur [LEGO.COM/PRODUCTFEEDBACK](https://LEGO.COM/PRODUCTFEEDBACK)

pour donner votre avis sur ce produit LEGO® et avoir une chance de gagner un prix LEGO.

Voir Conditions Générales

## 경품 당첨 기회

이 QR 코드를 스캔하거나 [LEGO.COM/PRODUCTFEEDBACK](https://LEGO.COM/PRODUCTFEEDBACK) 페이지에 접속하여 이 레고® 세트에 대한 간략한 피드백을 적어주시고, 멋진 레고 상품을 받을 기회를 잡으세요.

약관 적용

## GANA

Escanea este código QR o visita [LEGO.COM/PRODUCTFEEDBACK](https://LEGO.COM/PRODUCTFEEDBACK) y comparte con nosotros tu opinión sobre este set LEGO® para tener la oportunidad de ganar un fantástico premio LEGO.

Términos y Condiciones aplicables

## ЗАПОЛНИ АНКЕТУ И ПОЛУЧИ ПРИЗ

Отсканируйте этот код или перейдите на веб-сайт [LEGO.COM/PRODUCTFEEDBACK](https://LEGO.COM/PRODUCTFEEDBACK), чтобы оставить краткий отзыв об этом наборе LEGO® и выиграть крутой приз LEGO.

Применяются Условия и правила участия

LEGO and the LEGO logo are trademarks of the/son des marques de commerce du/son marcas registradas de LEGO Group. ©2022 The LEGO Group.

© Marvel © CPII

6444466