



DC COMICS
**SUPER
HEROES**

76068

6187423

2

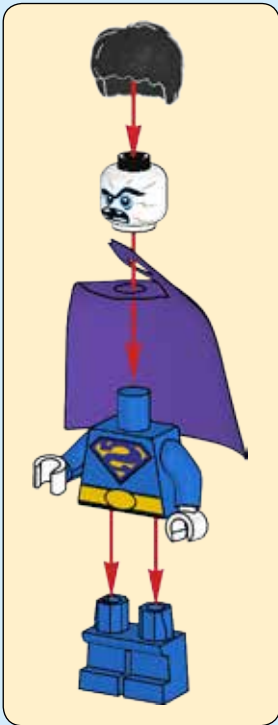

1



2

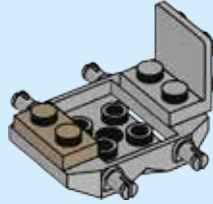

3

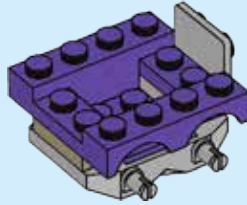

4

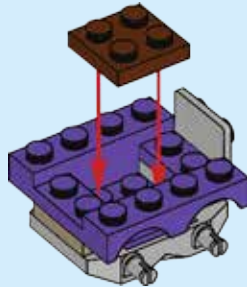

5

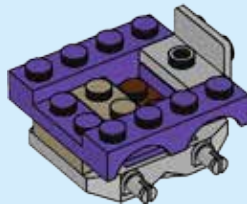

6

7 LEGO.com/DCSUPERHEROES

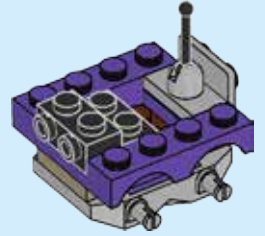

7

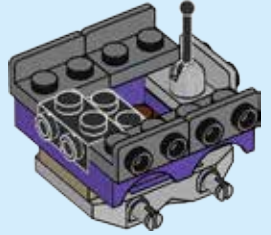

8

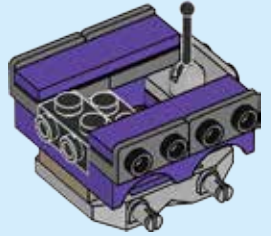

9

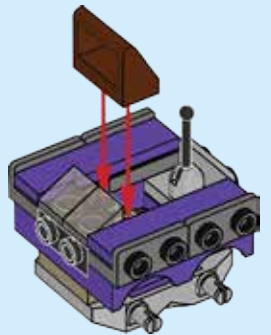

10

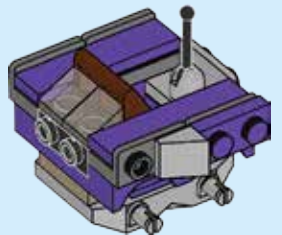

11

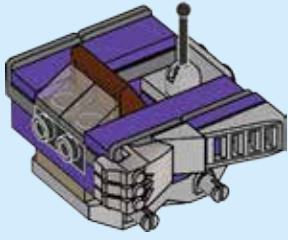

12

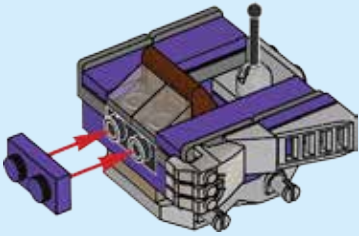

13

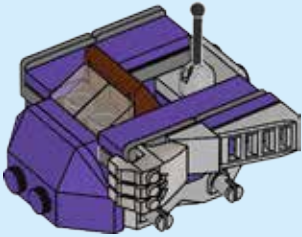

14

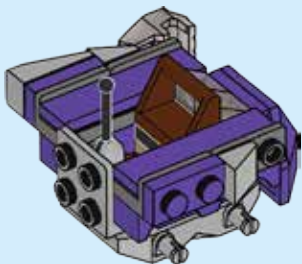
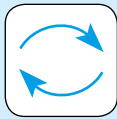

15

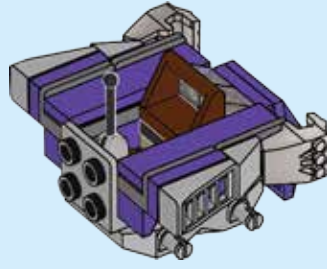

16

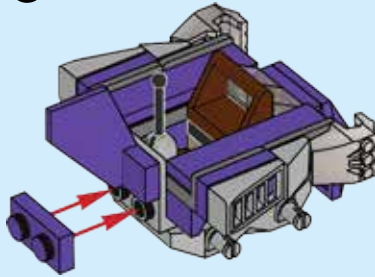

17

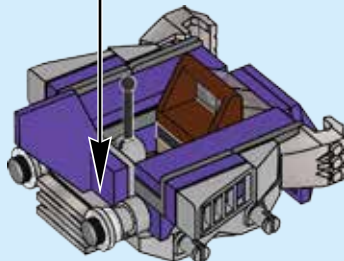
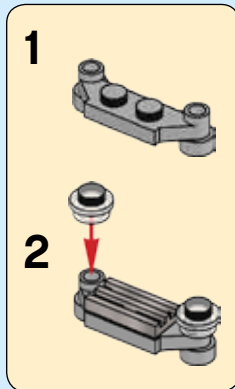

18

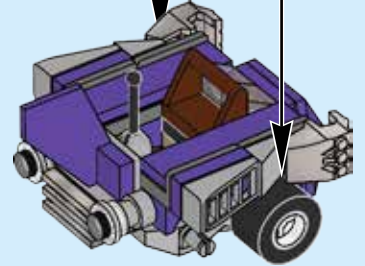
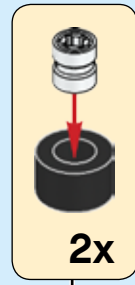

19

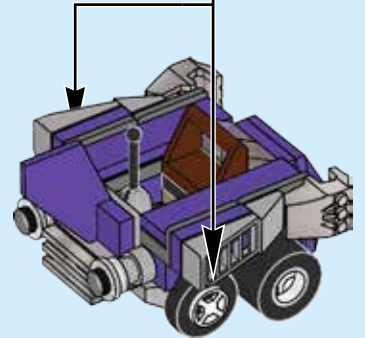
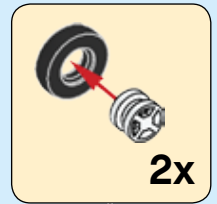

LEGO.com/service

LEGO and the LEGO logo are trademarks of the LEGO Group. ©2017 The LEGO Group. 6187423

DC All DC characters and elements © & TM DC Comics.

WB SHIELD: TM & © WBEI. (s17)