



Disney · PIXAR
**TOY
STORY**
3



7598



WARNING: CHOKING HAZARD.
Toy contains small parts and a small ball.
Not for children under 3 years.

1

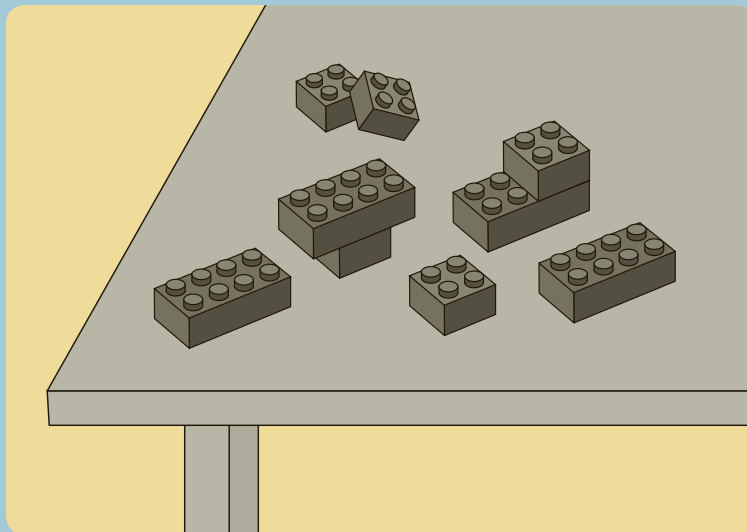
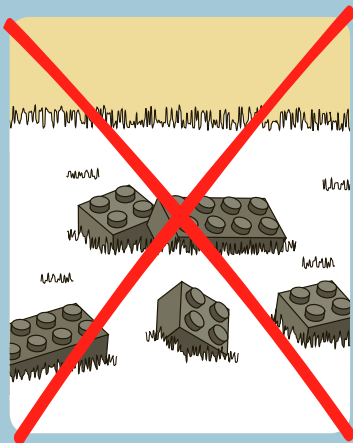

2



AVERTISSEMENT : RISQUE D'ÉTOUFFEMENT.
Le jouet contient des petites pièces ainsi qu'une petite boule.
Il ne convient pas aux enfants de moins de 3 ans.



ADVERTENCIA: PELIGRO DE ASFIXIA.
Juguete que contiene partes pequeñas y una pelota pequeña.
No recomendado para niños menores de 3 años.

1

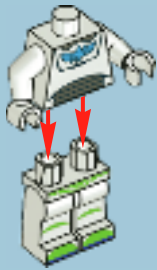

2



3



4

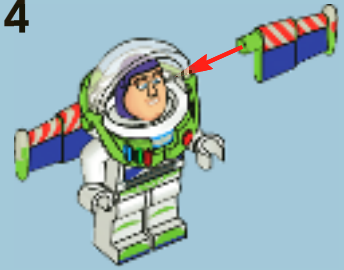

1

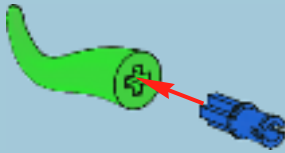

2

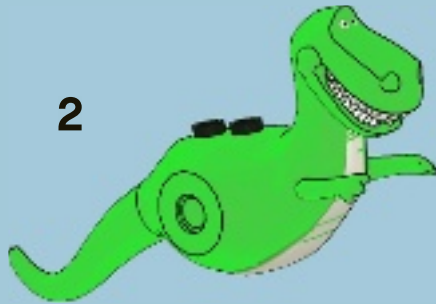

3

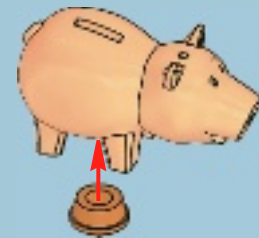
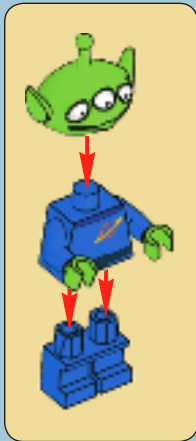
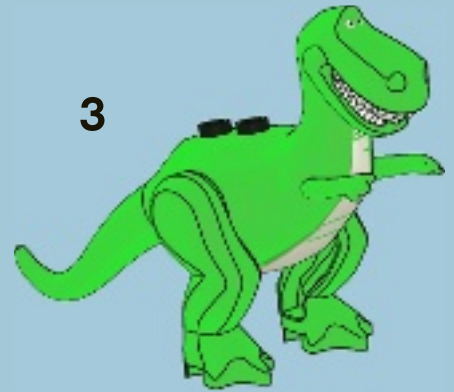

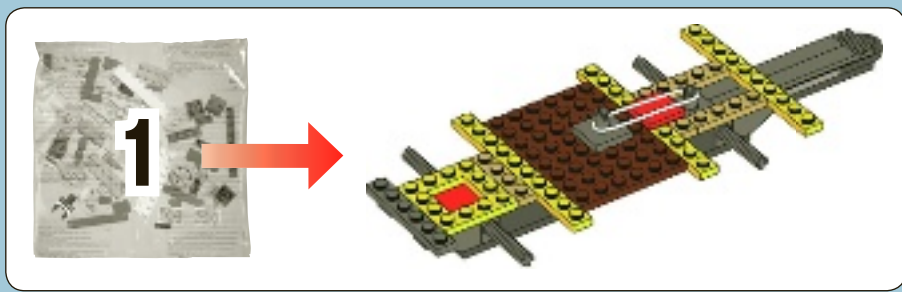

1

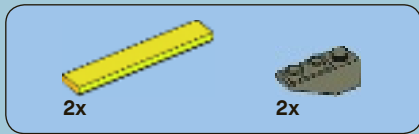
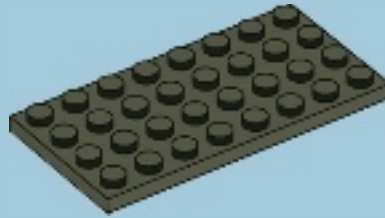

2

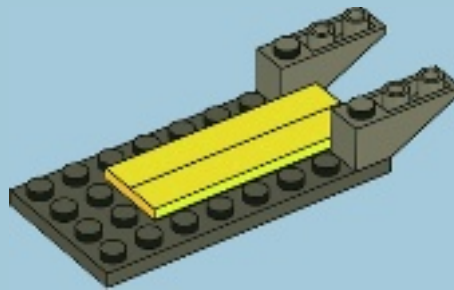

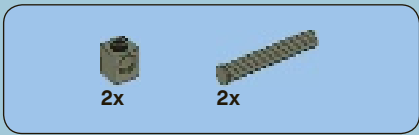

3

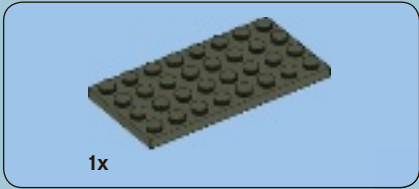
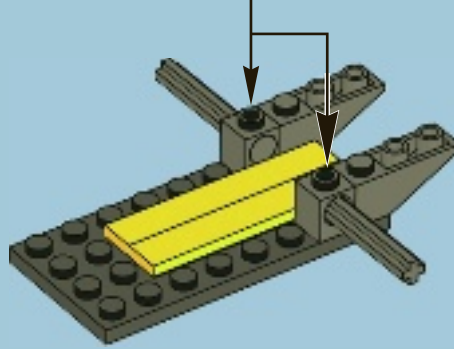
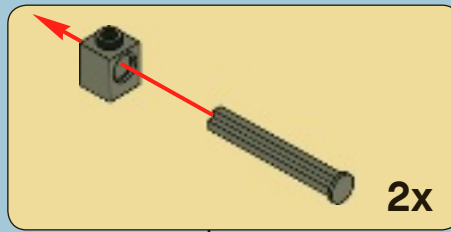

4

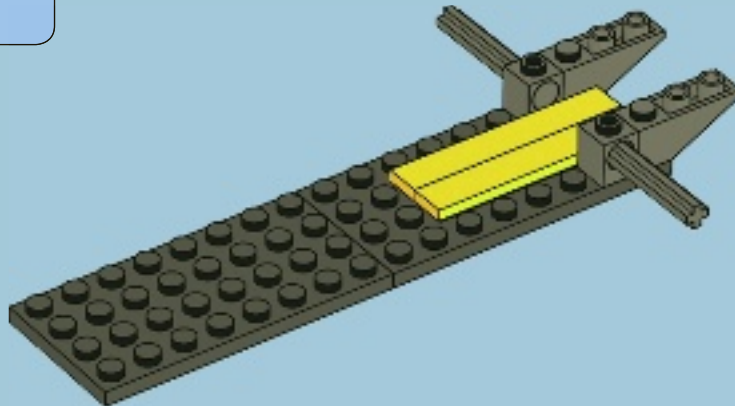

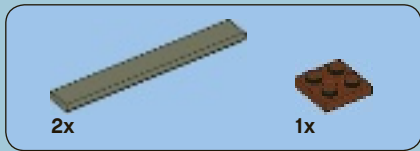

5

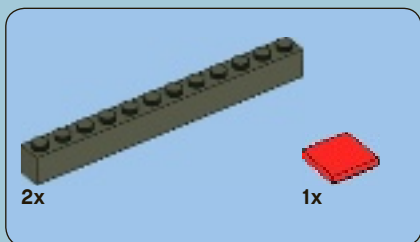
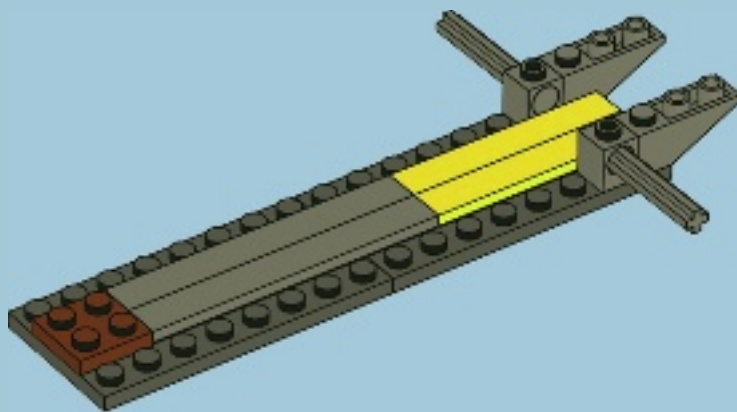

6

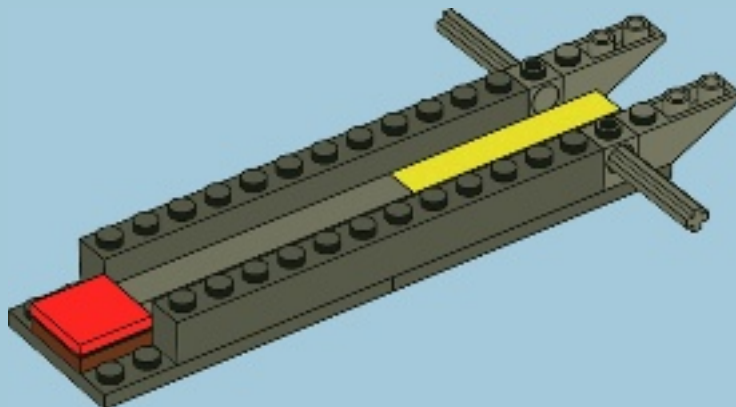



7

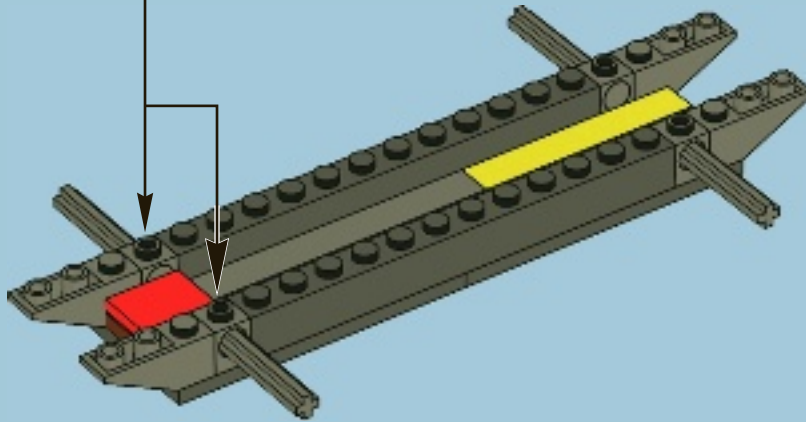
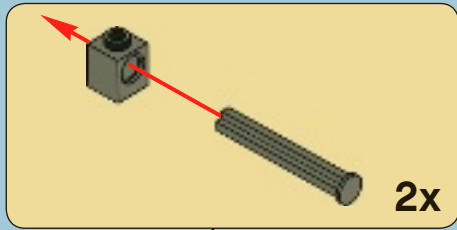

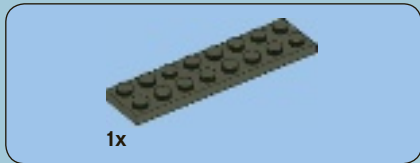
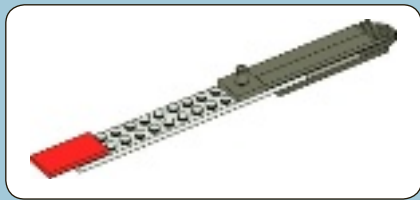

1x

1

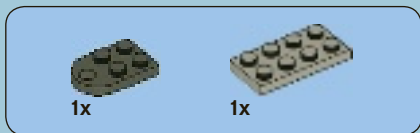
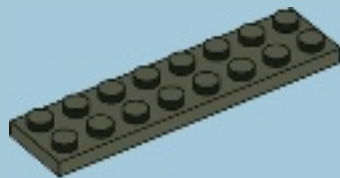

1x

1x

2

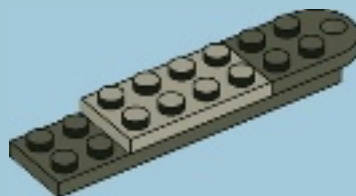

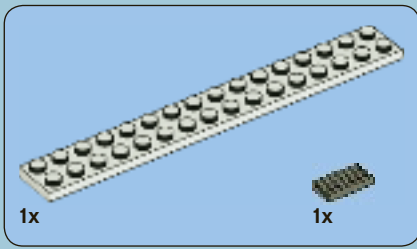

3

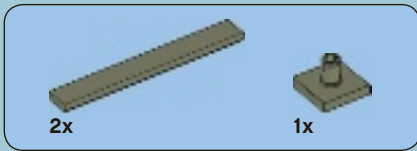
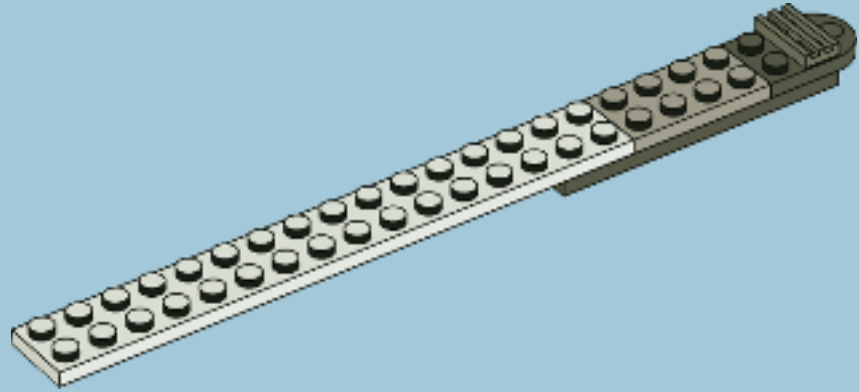

4

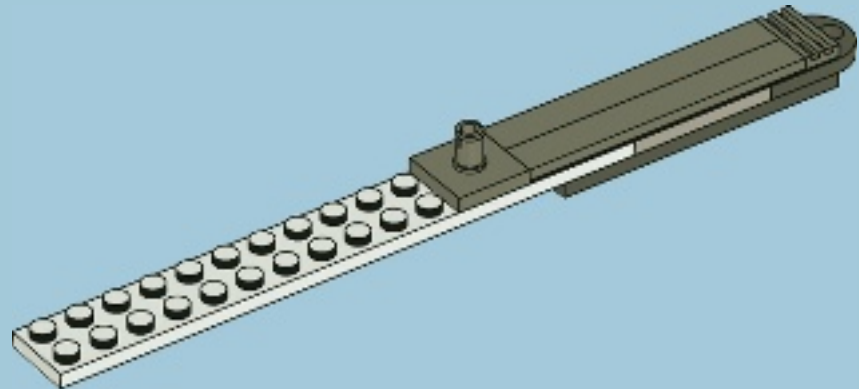

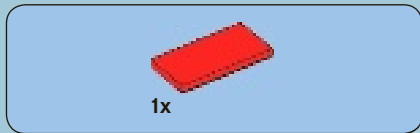

5

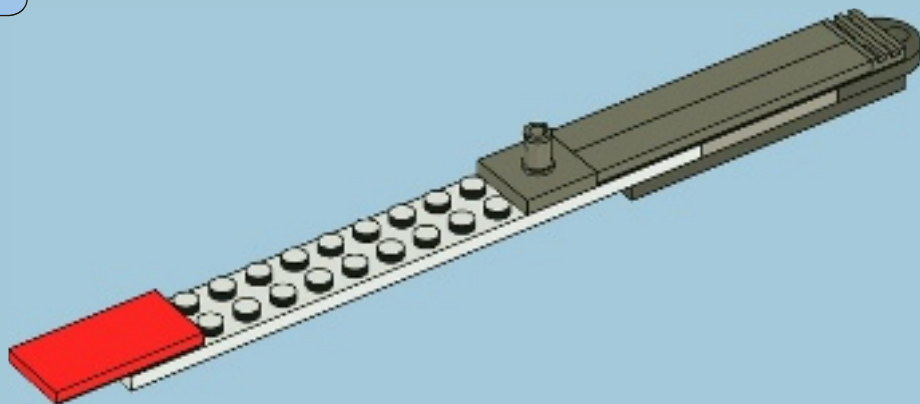

8

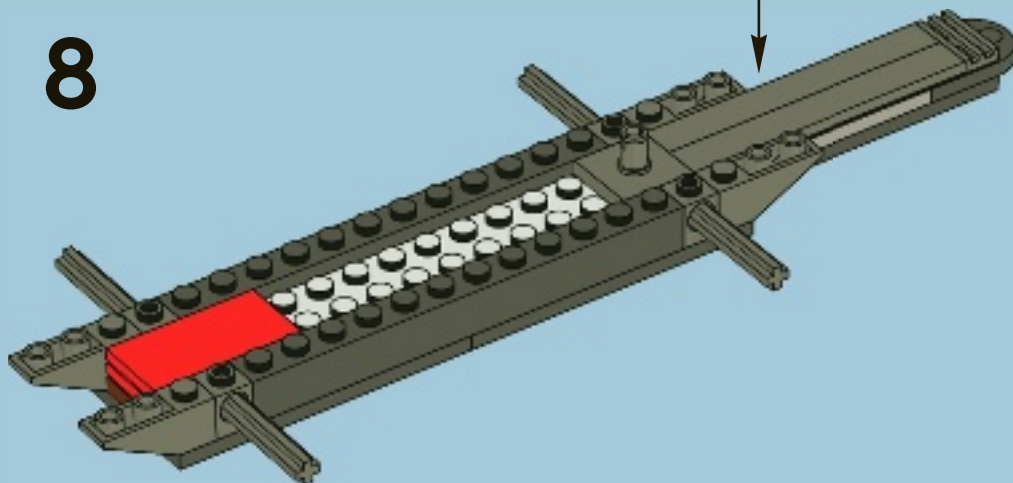

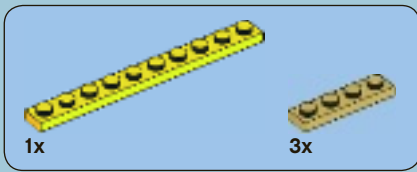

9

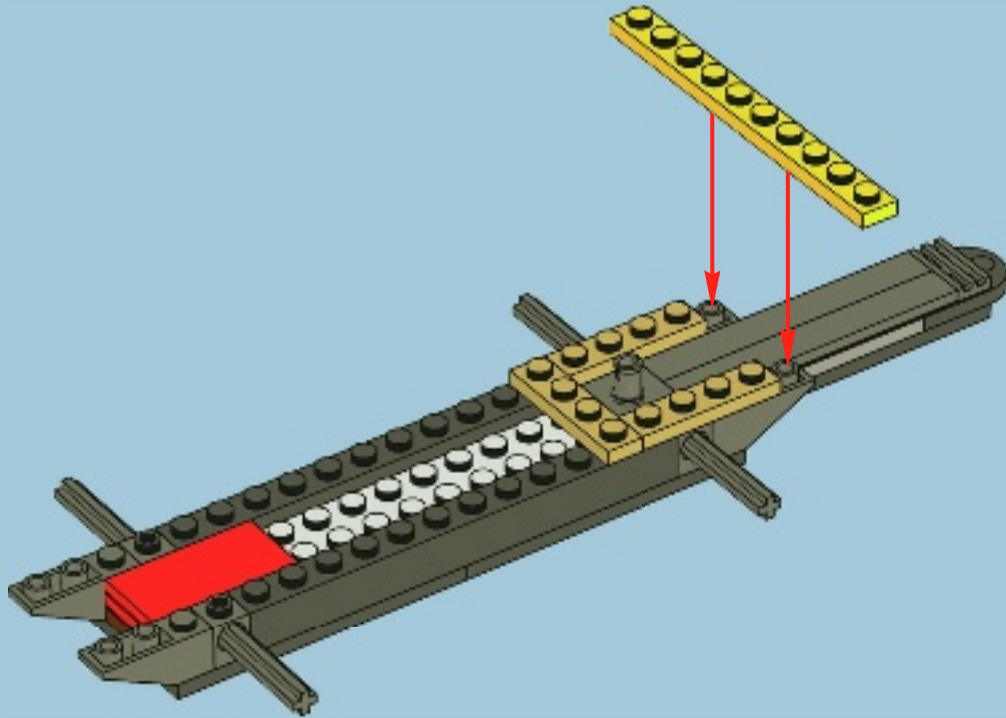

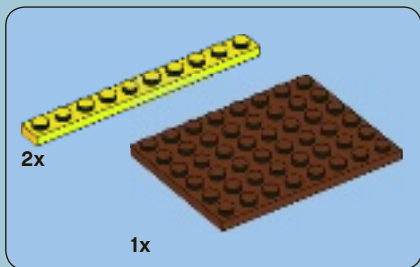

10

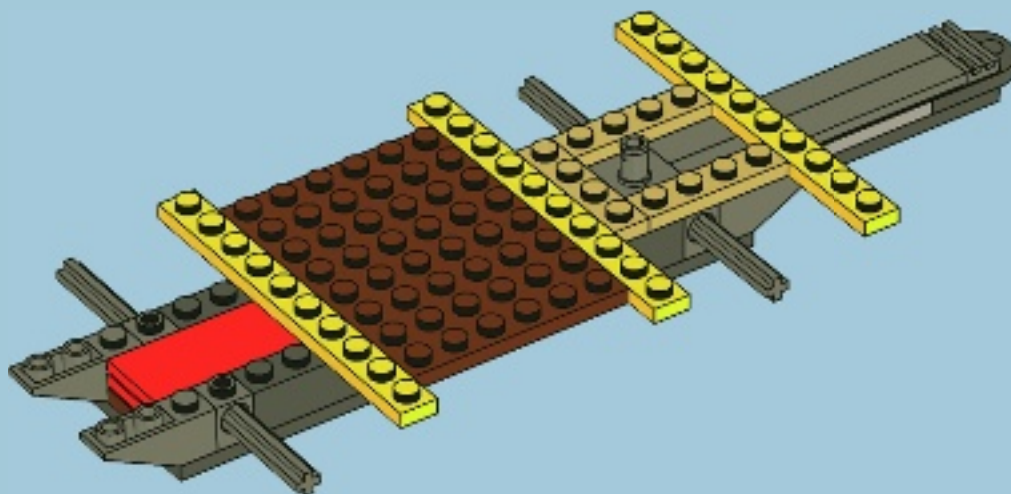

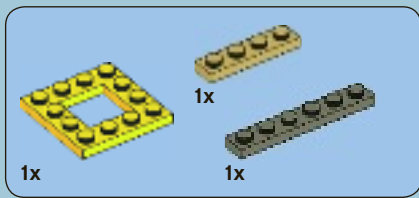

11

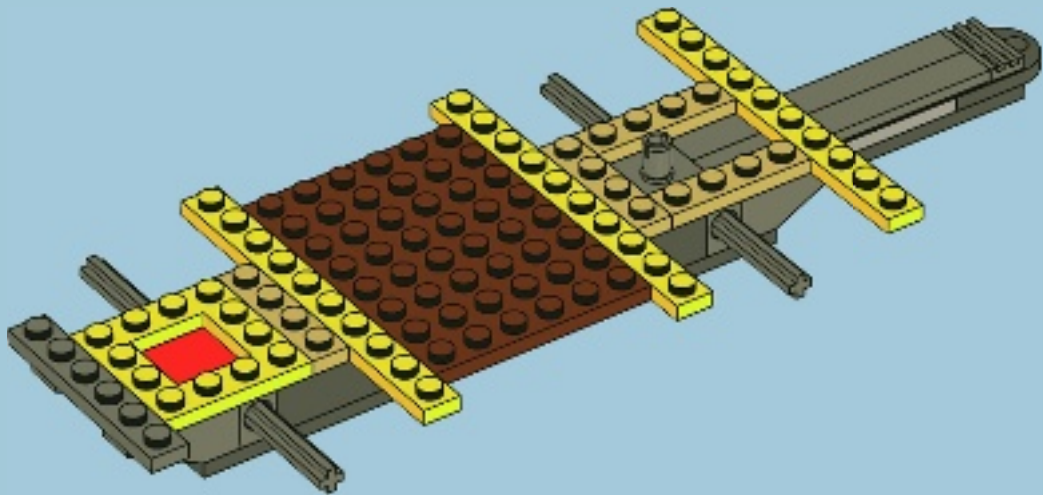



1x



1x

12

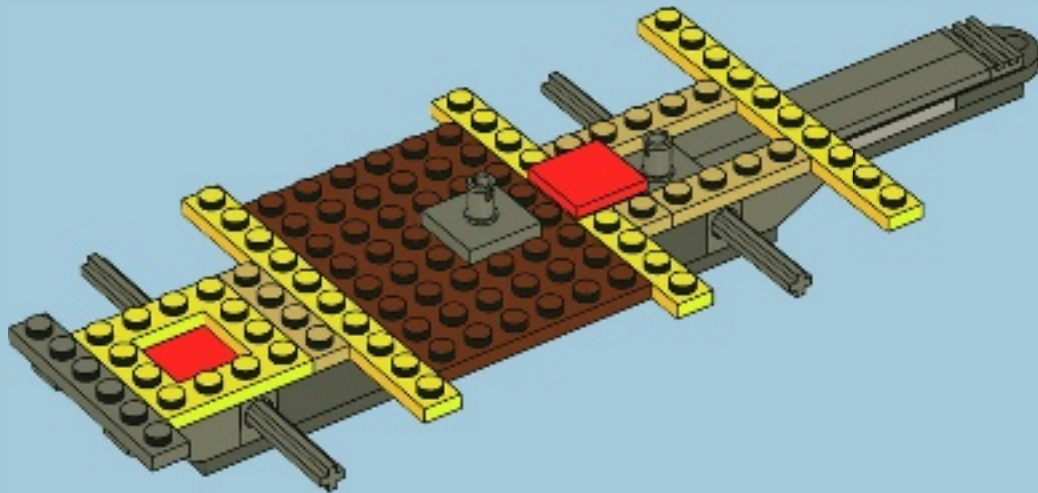



1x

13

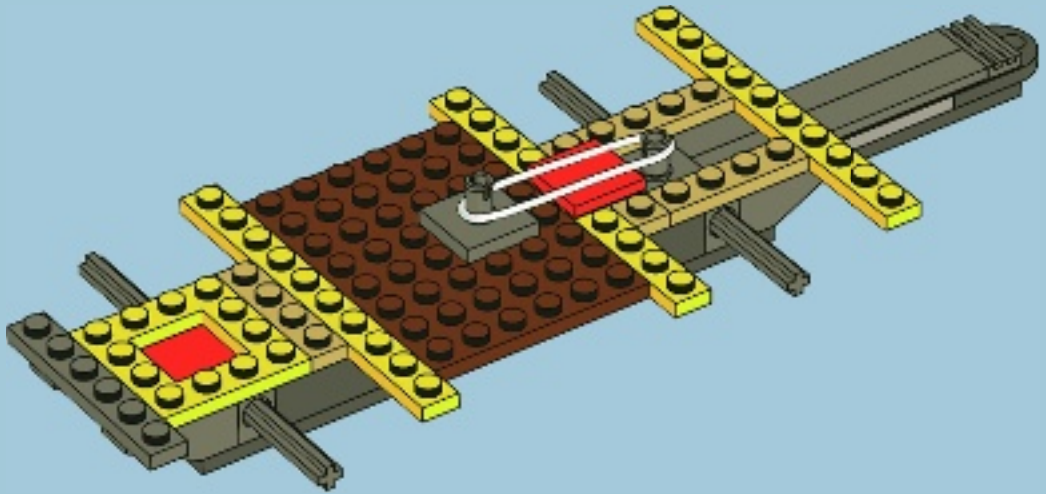

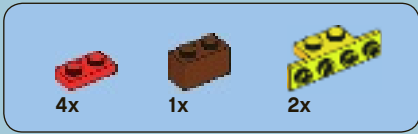
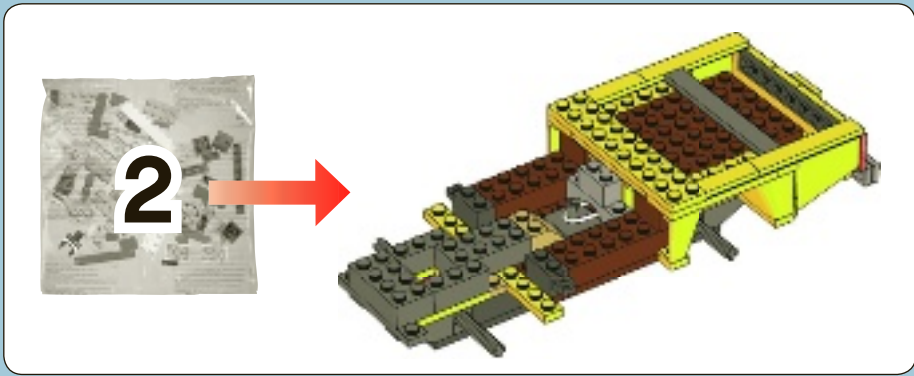

14

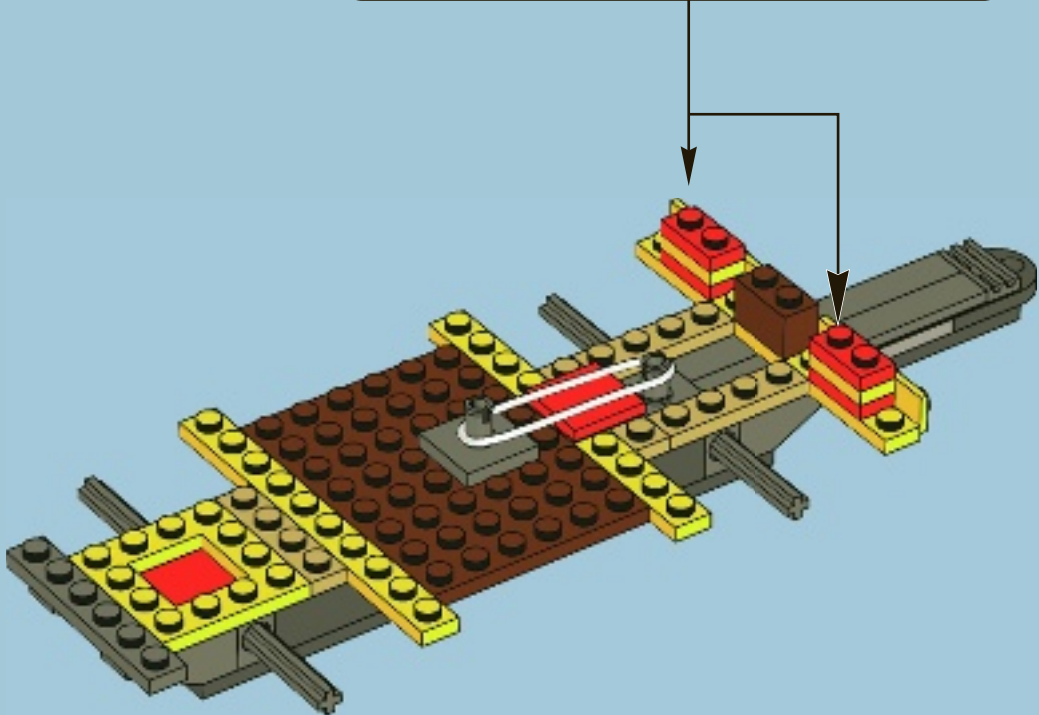
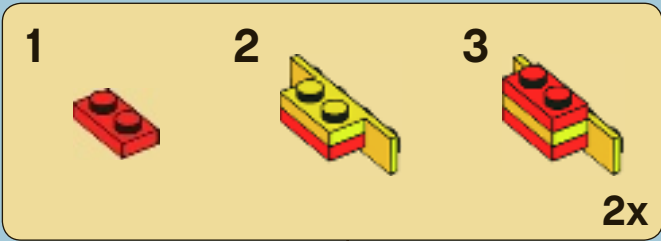

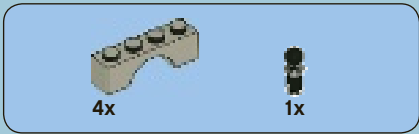

15

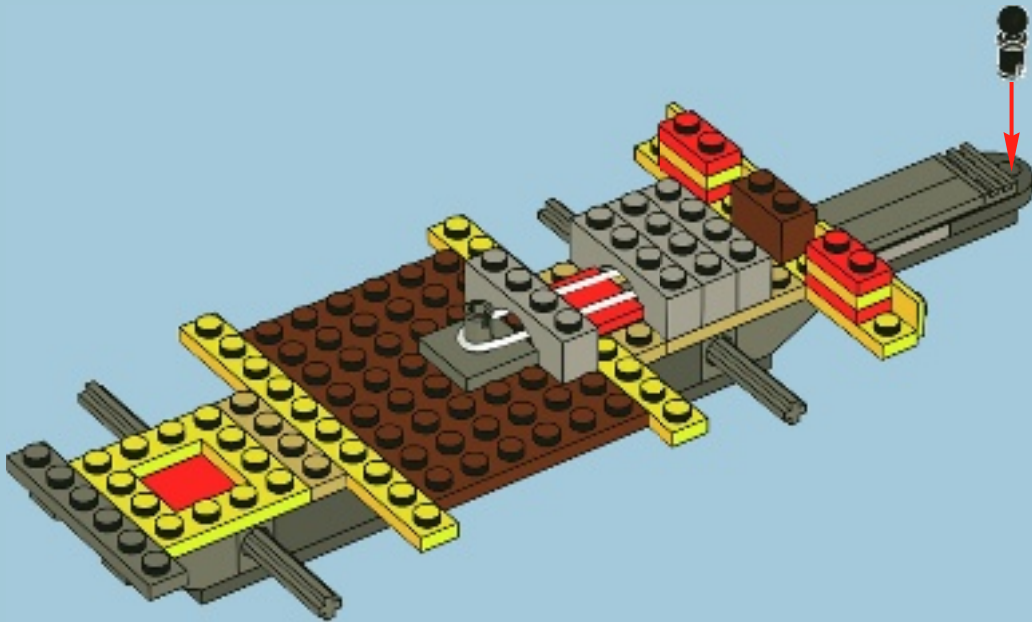

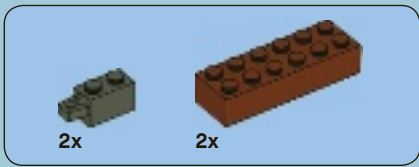

17

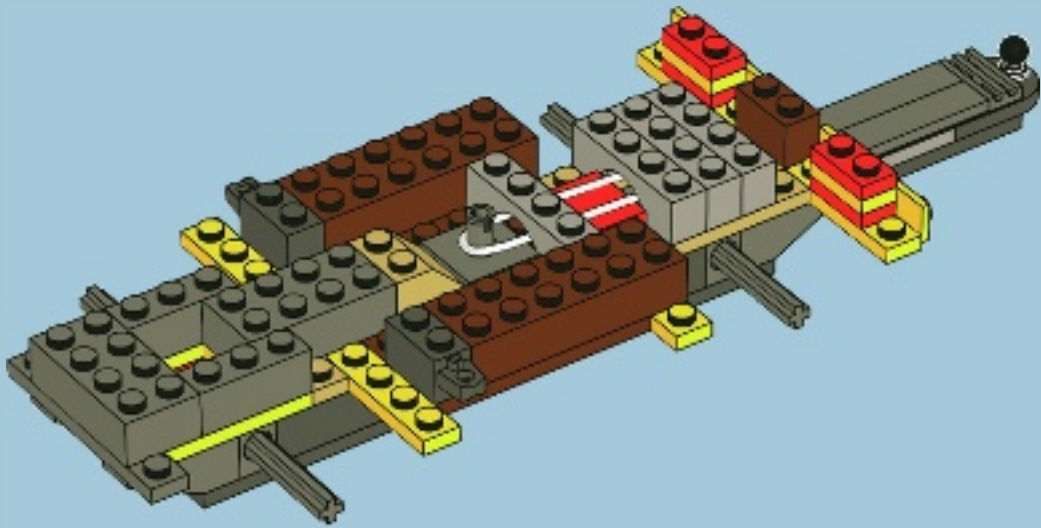

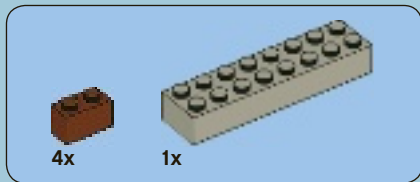

18

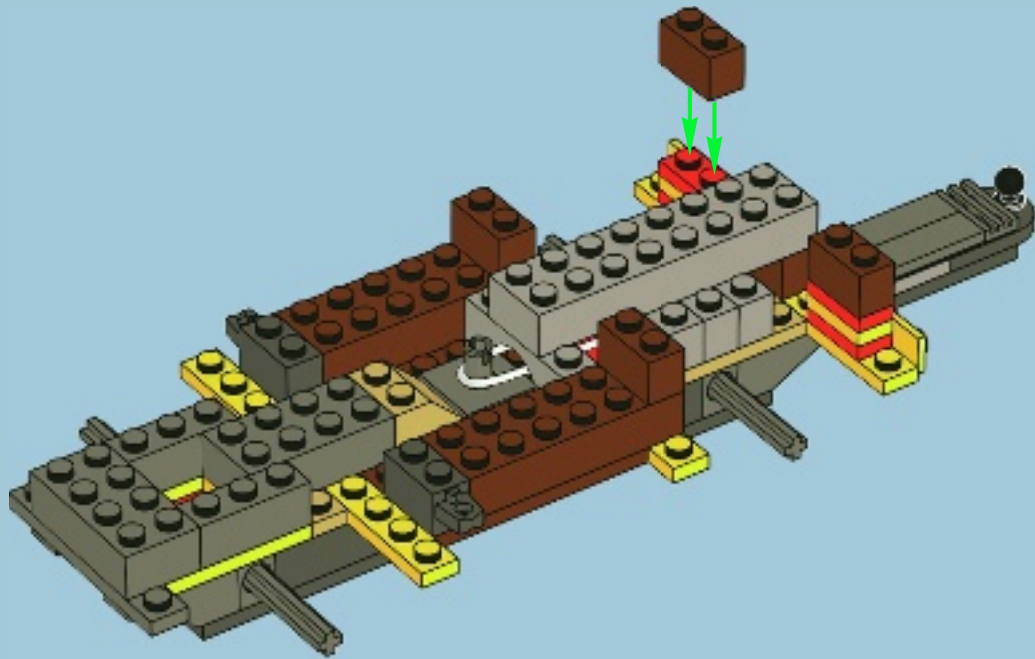



19

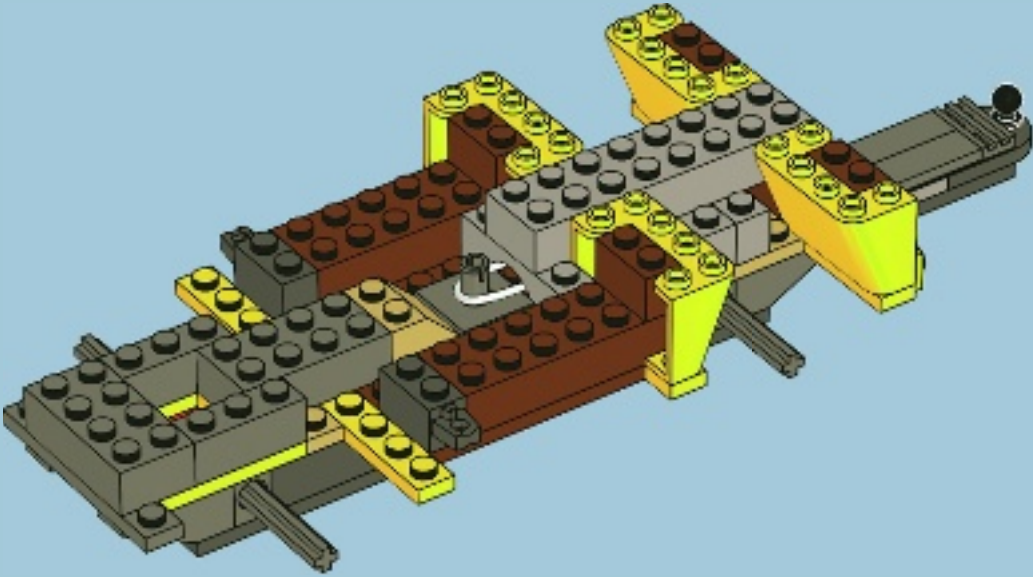

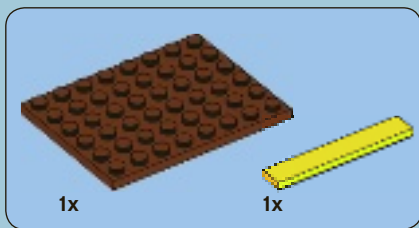

20

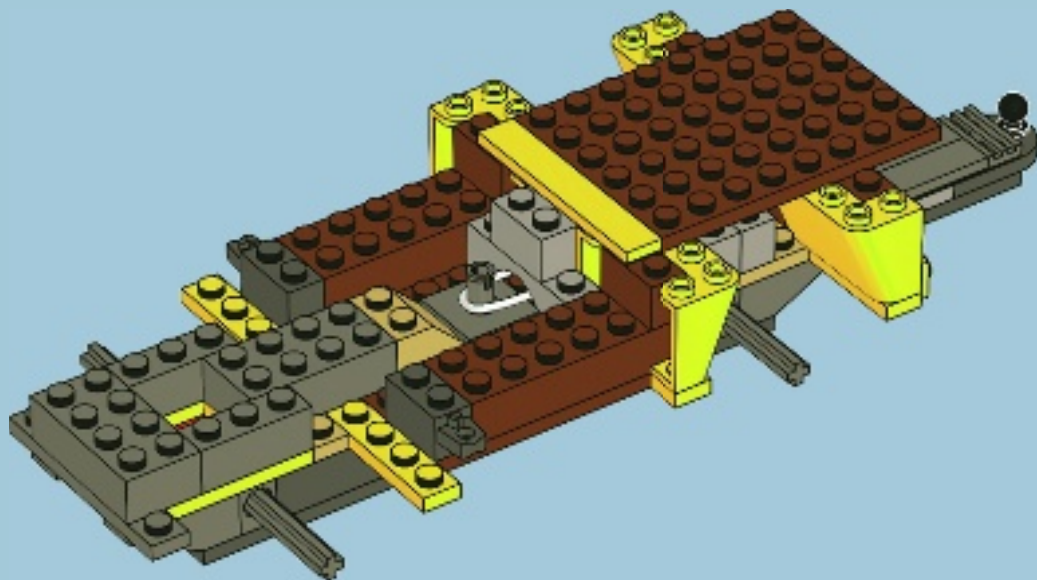

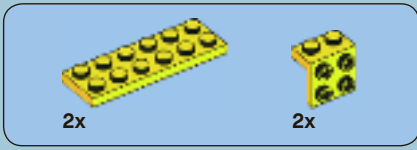

21

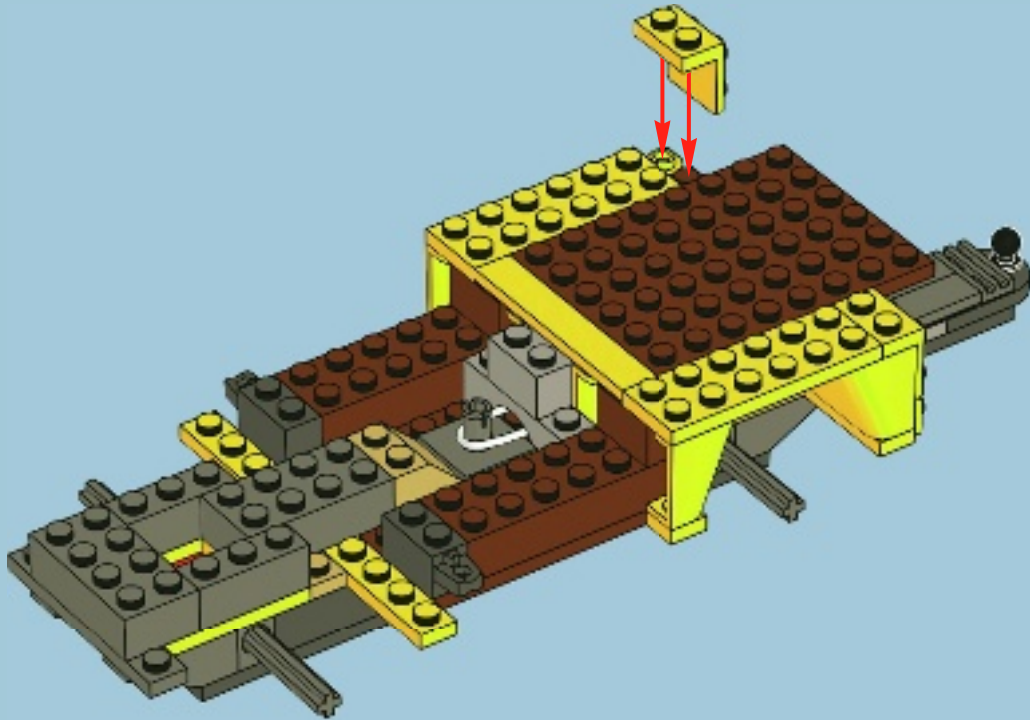

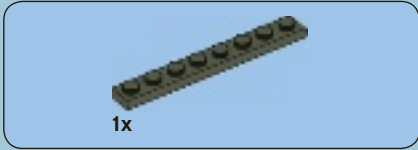
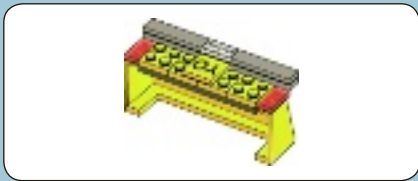

1x

1

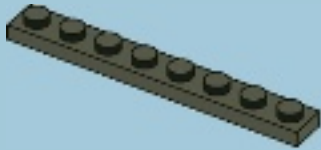

4x

2

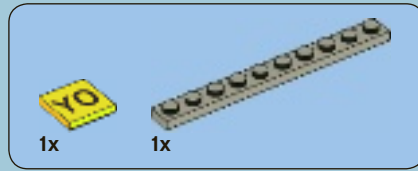
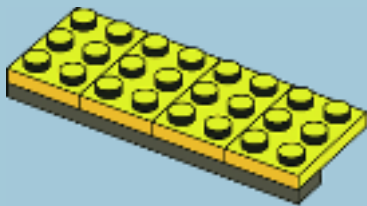

1x

1x

3

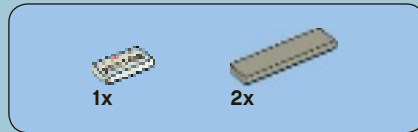
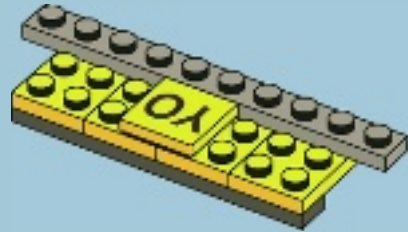

1x

2x

4

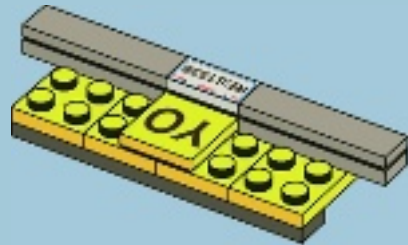

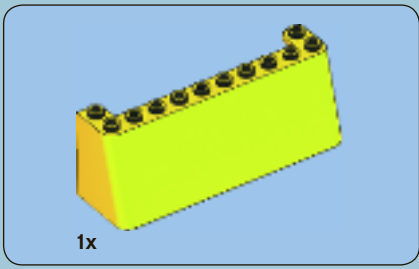

5

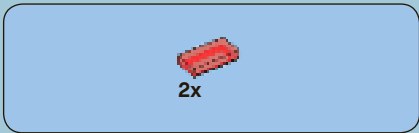
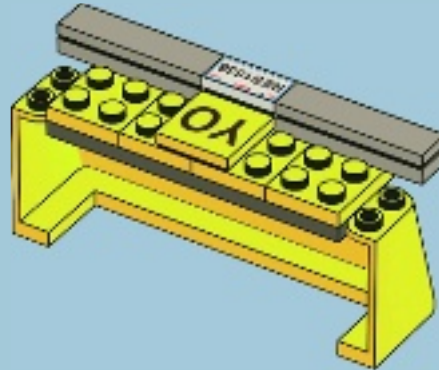

6

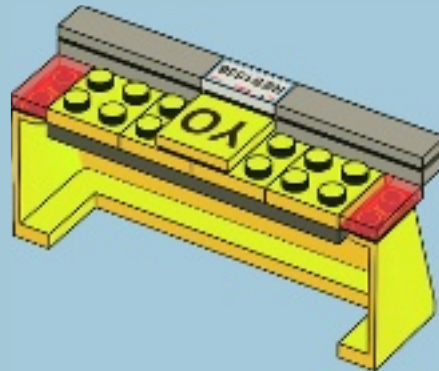

22

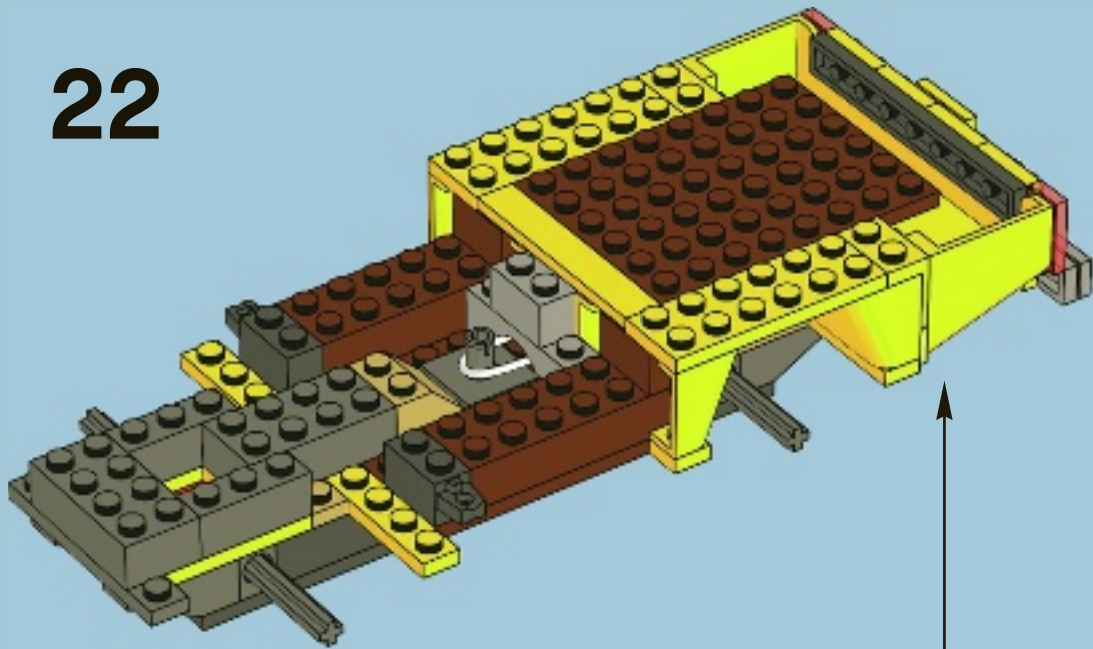

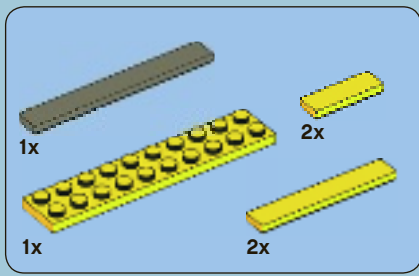

23

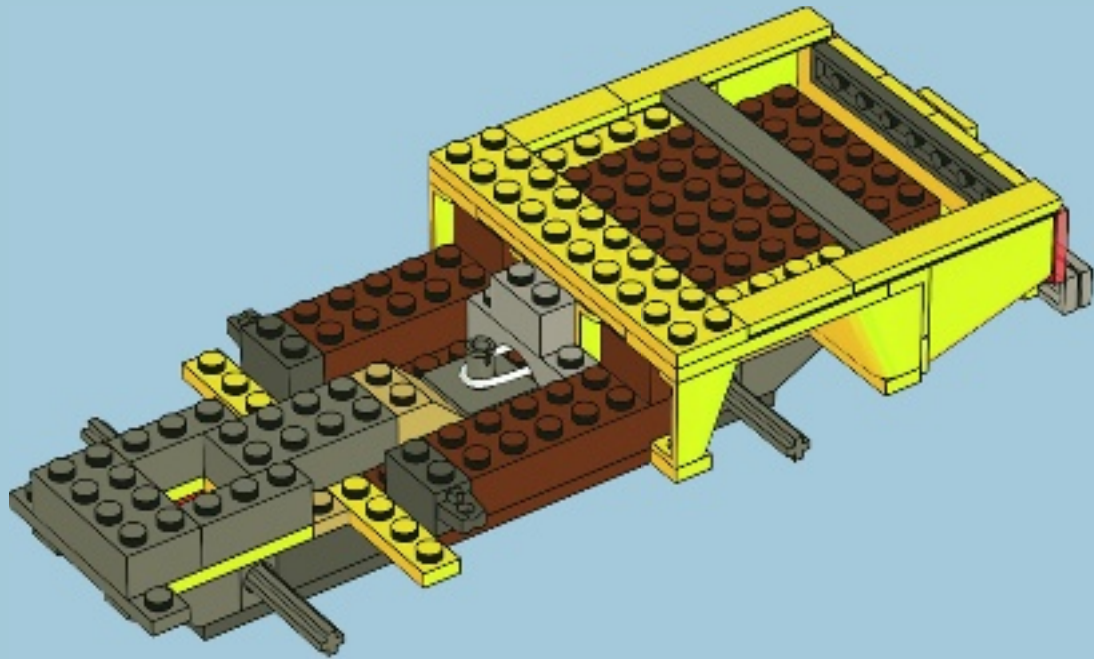

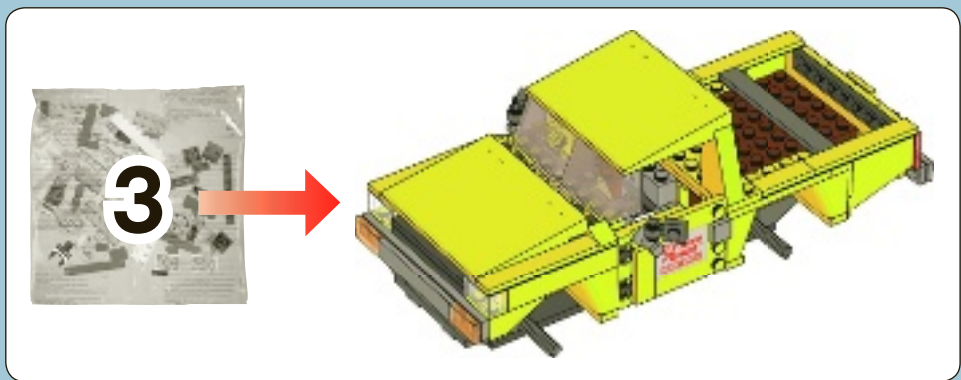

24

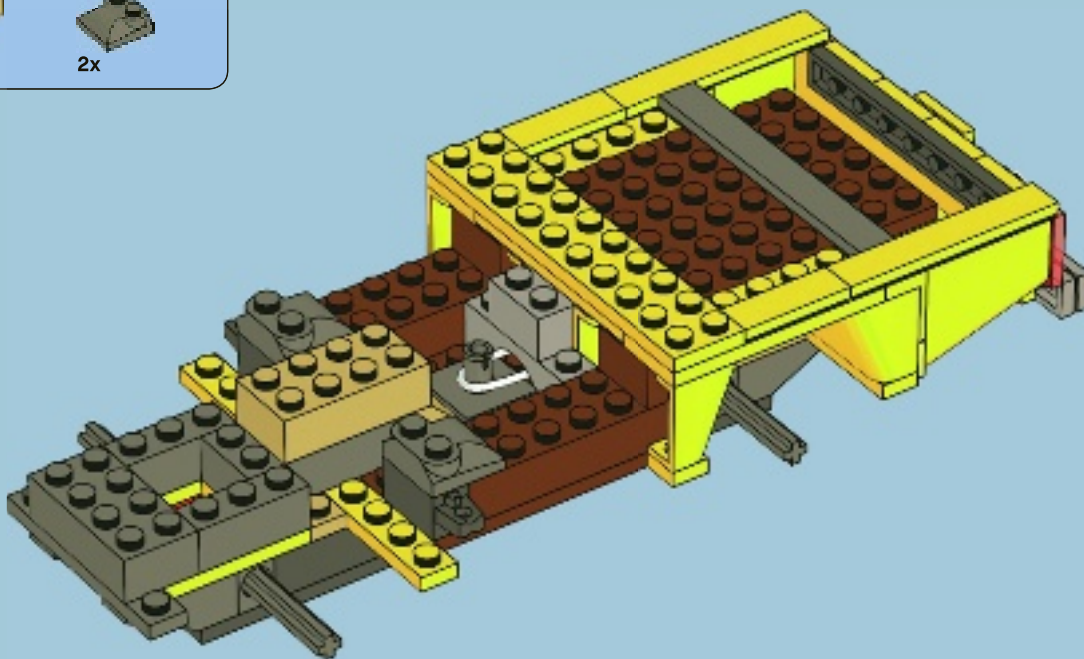



2x

25

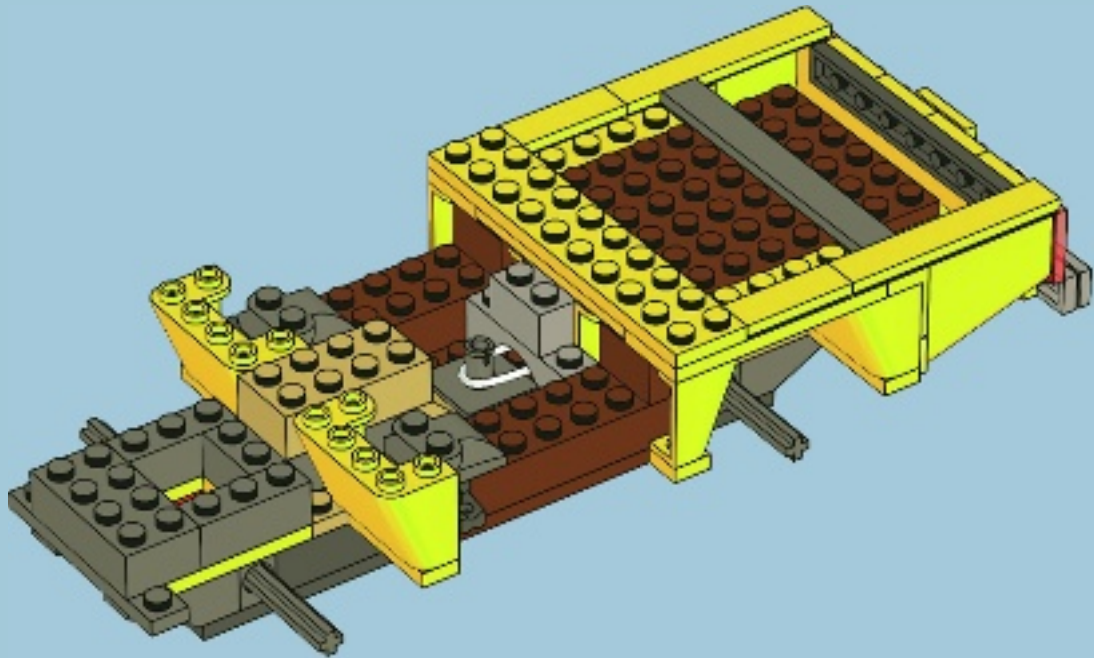



26

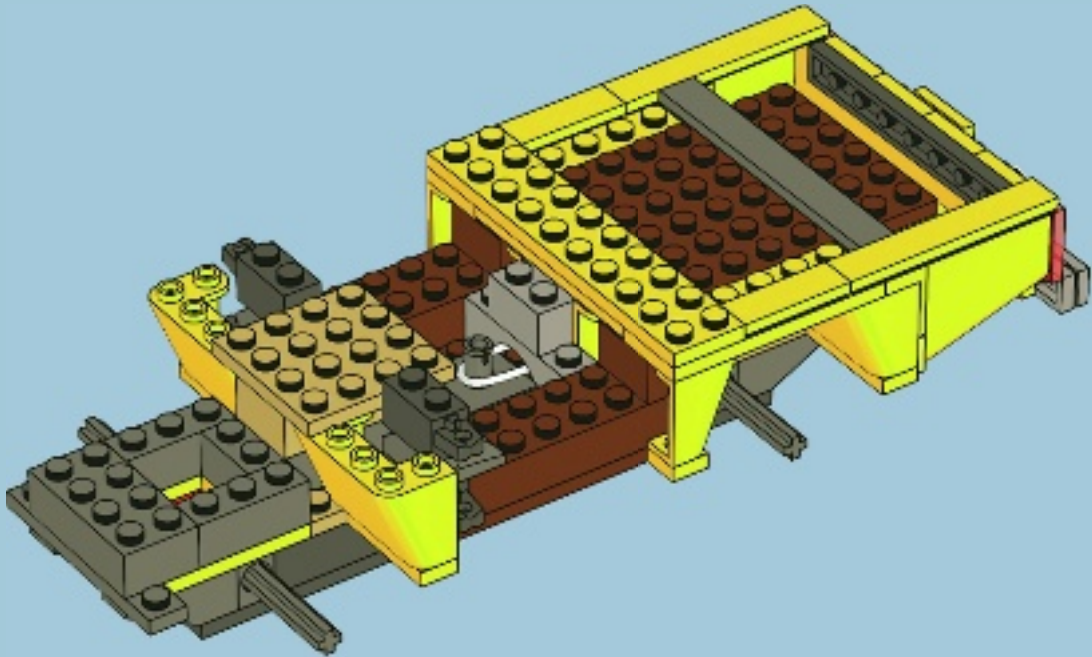



2x

27

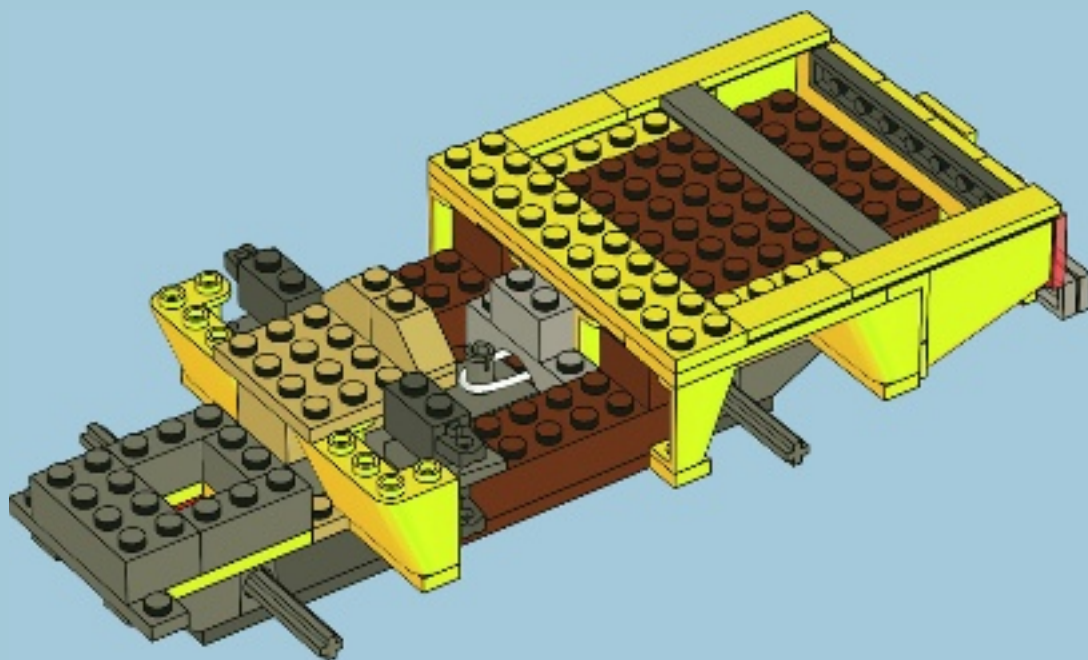

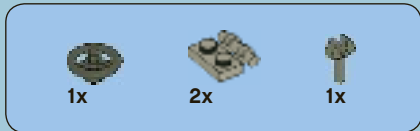

28

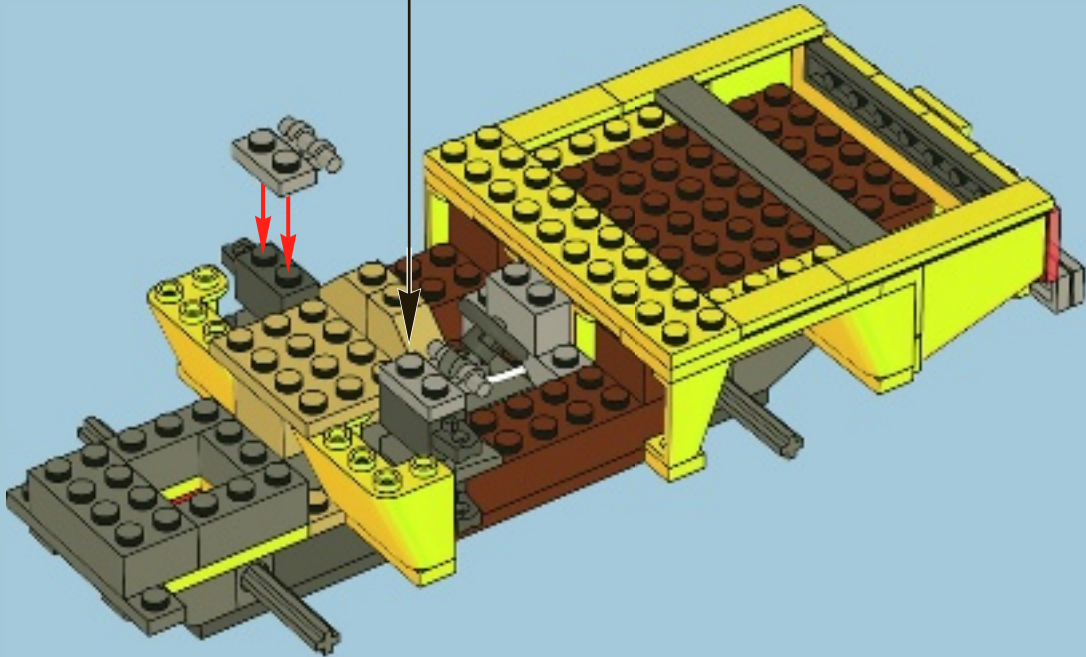
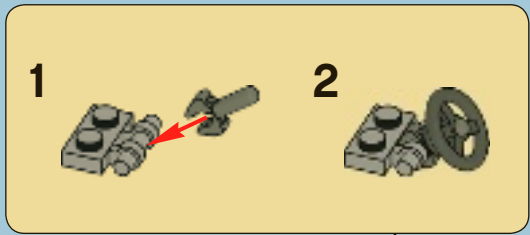

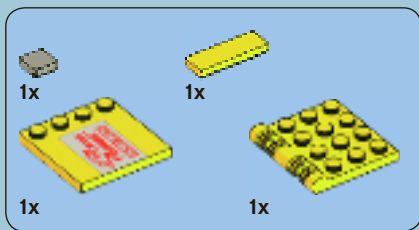

30

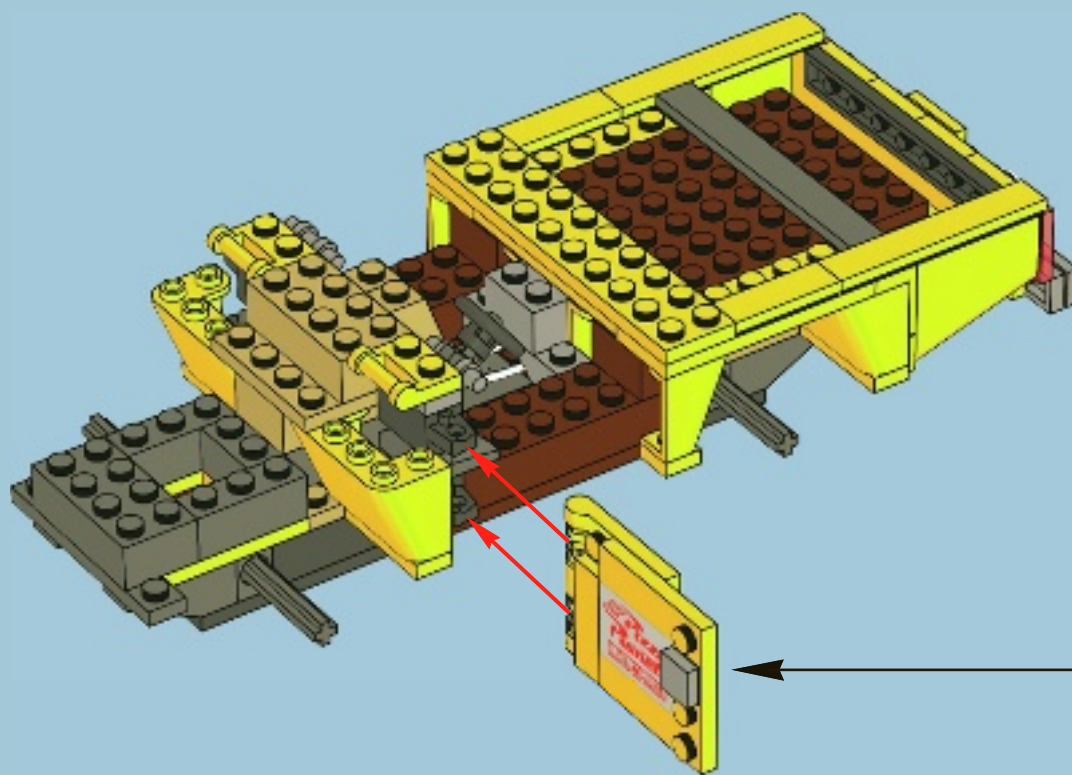

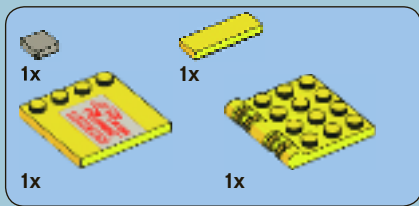

31

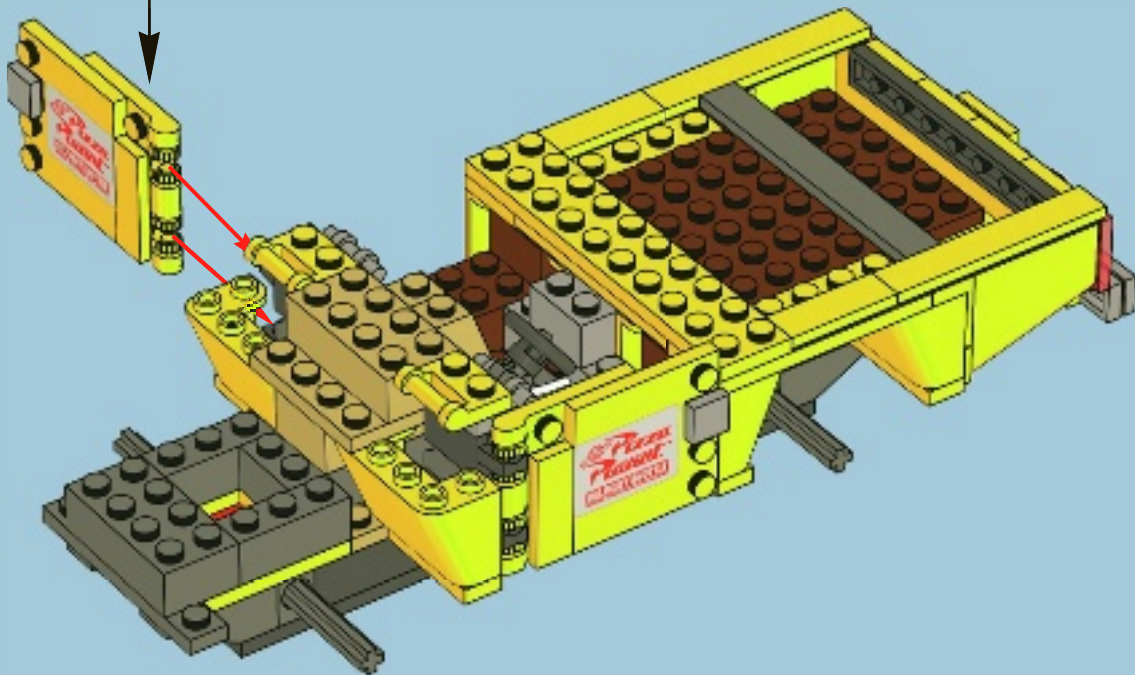
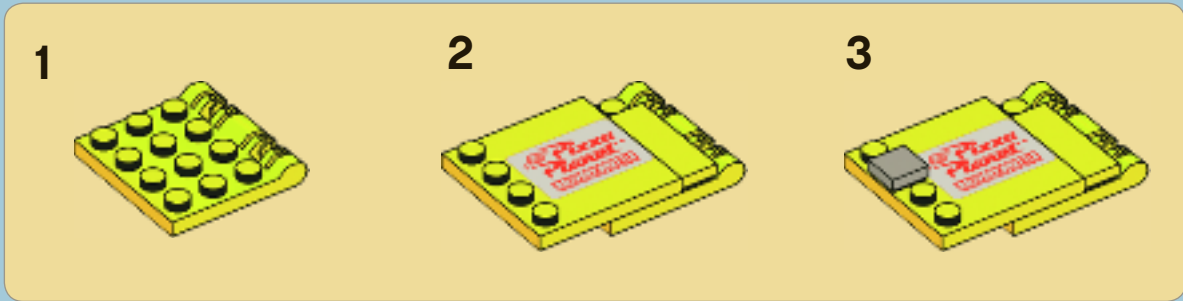



2x



2x

32

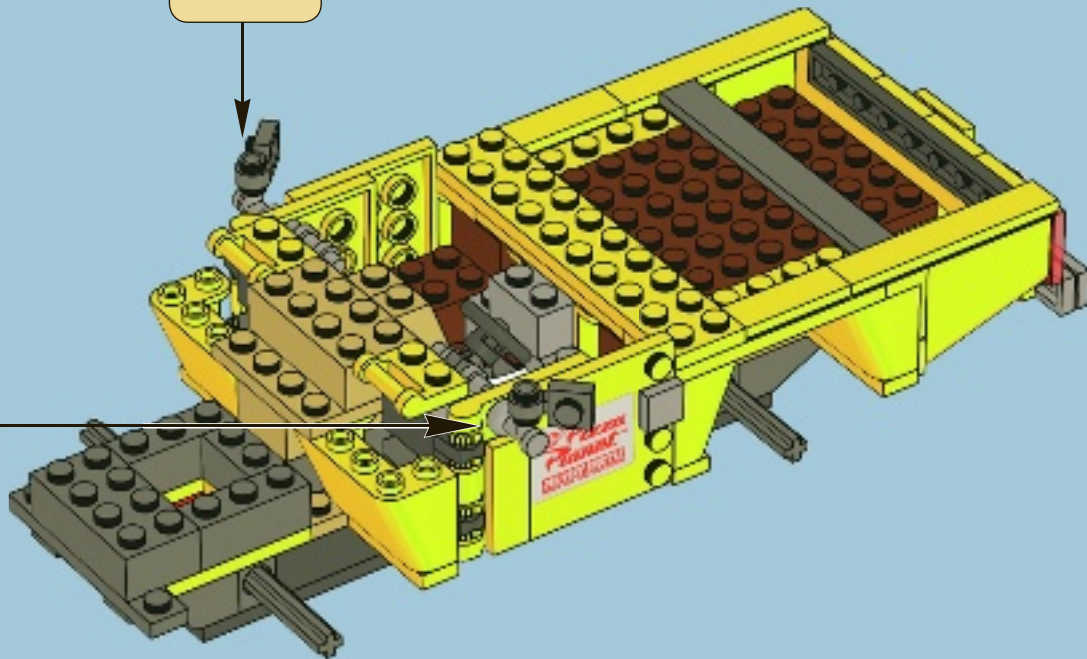
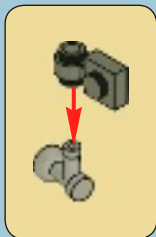
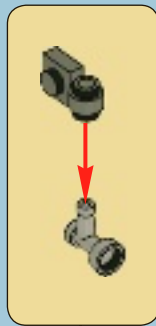

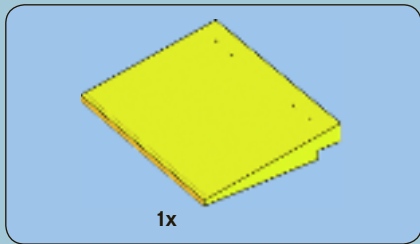

34

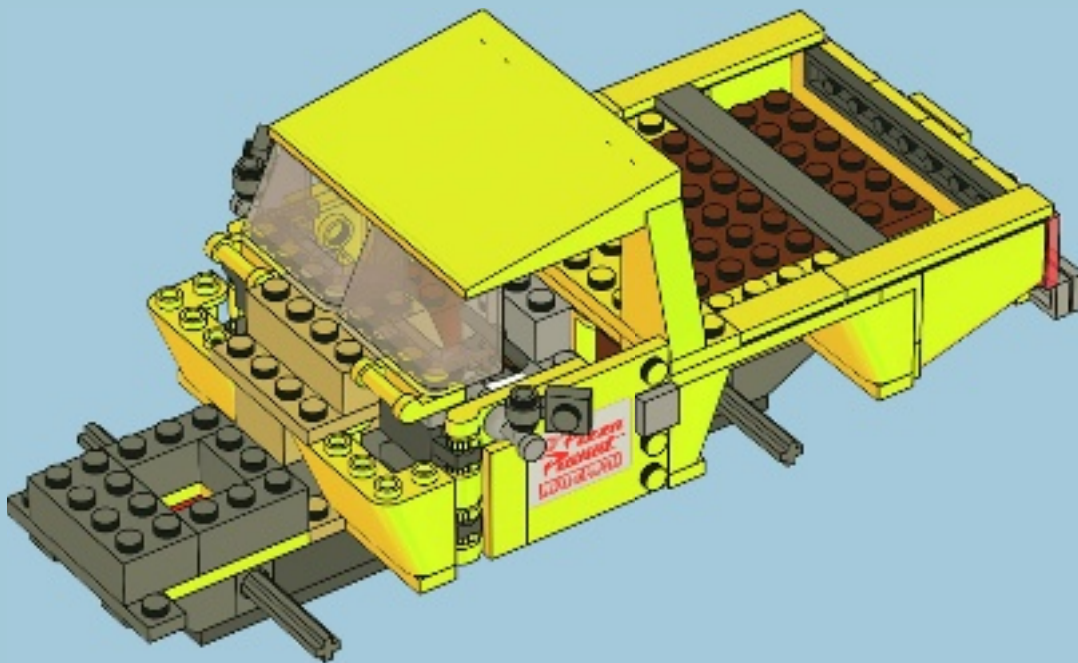



2x

35

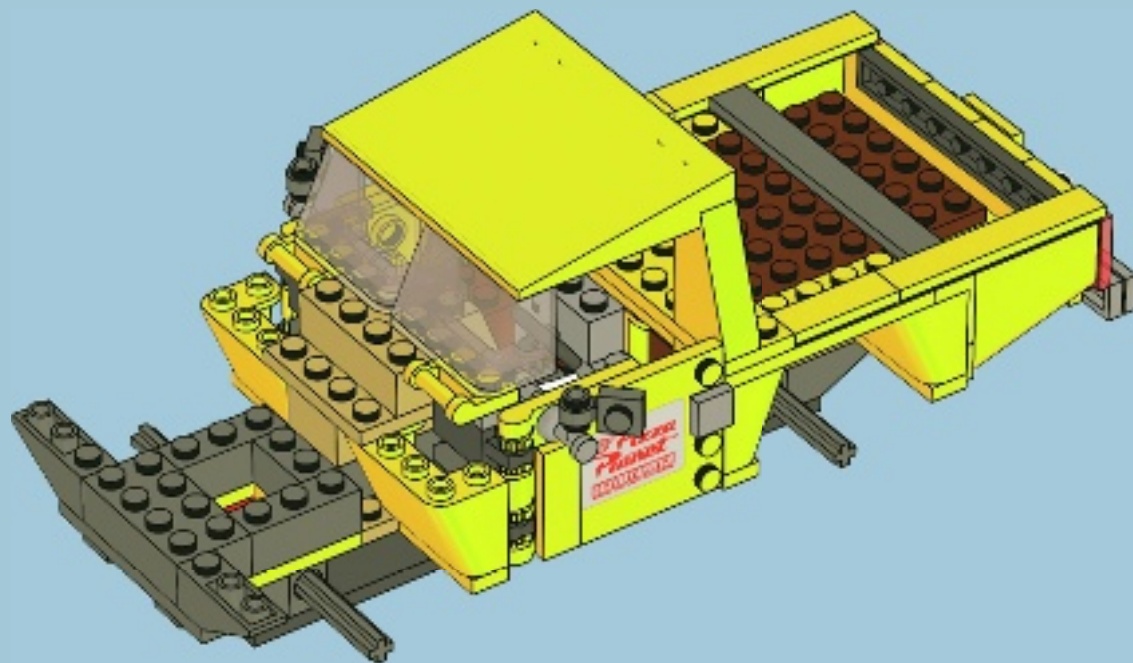



36

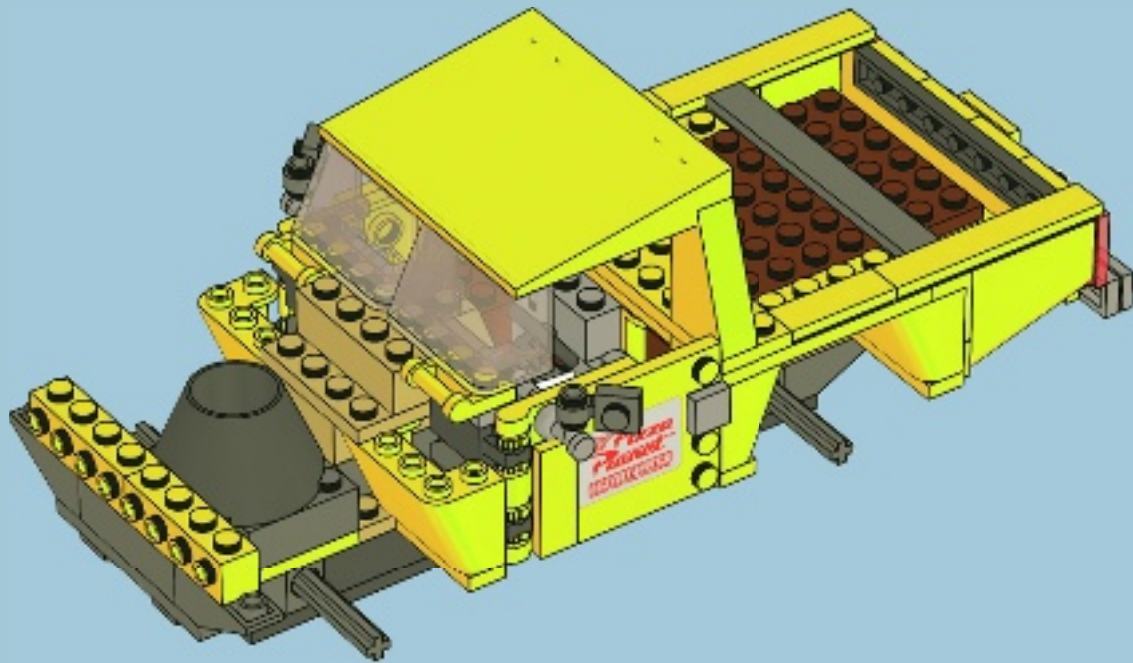



2x

37

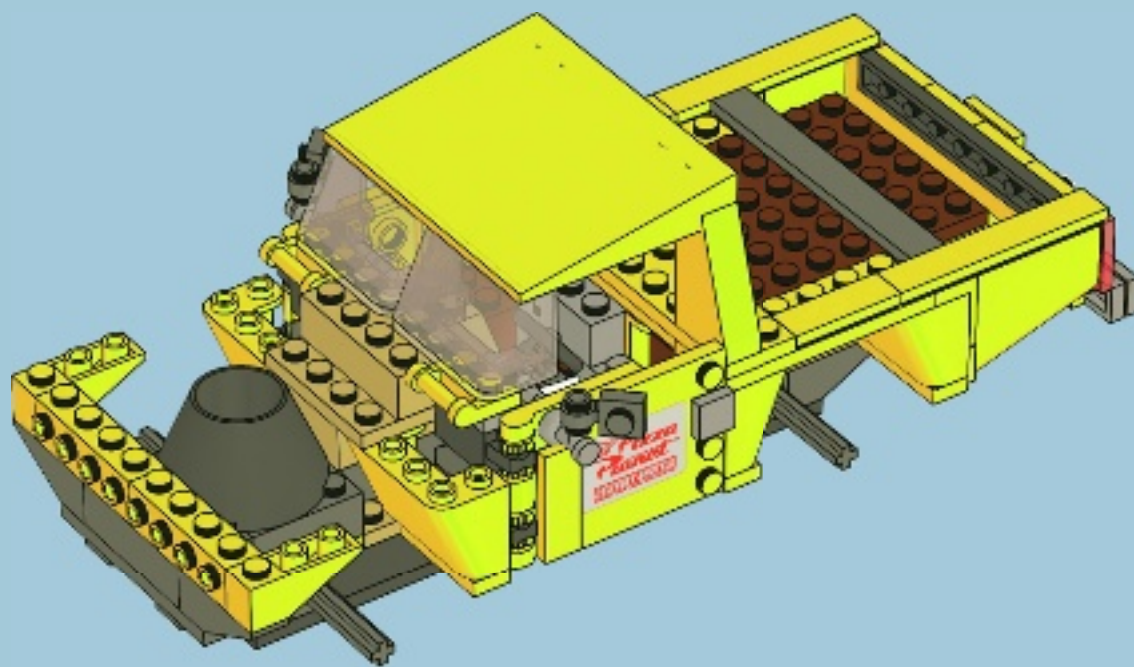



2x



1x

38

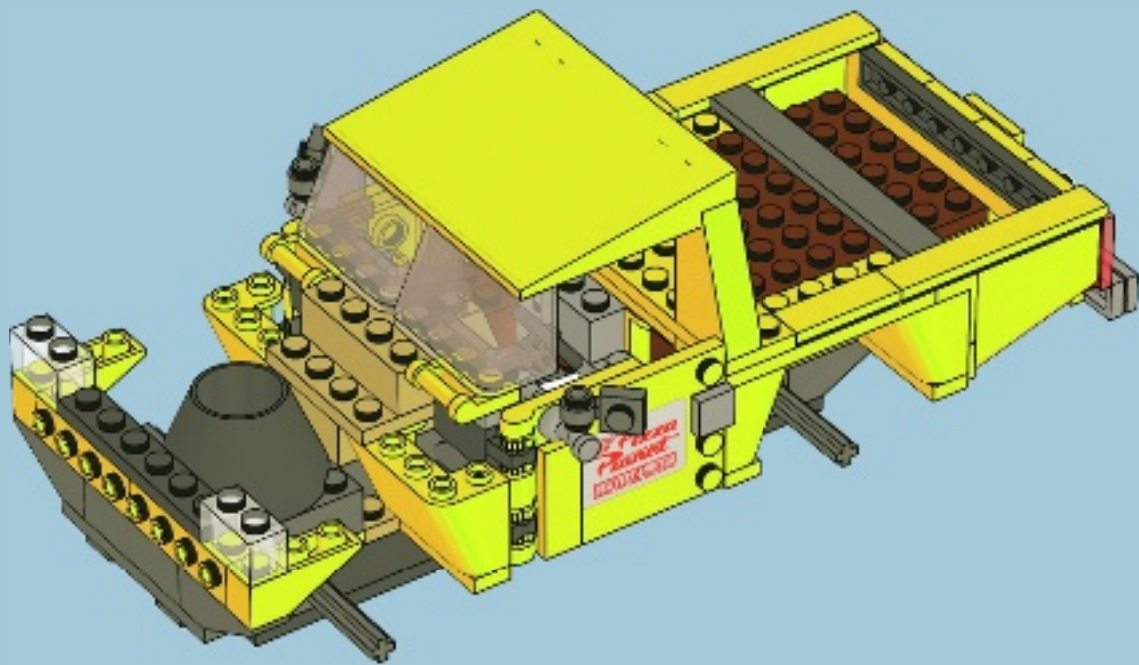

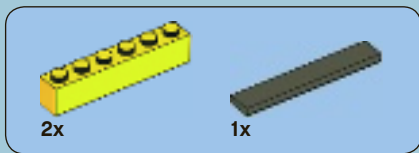

39

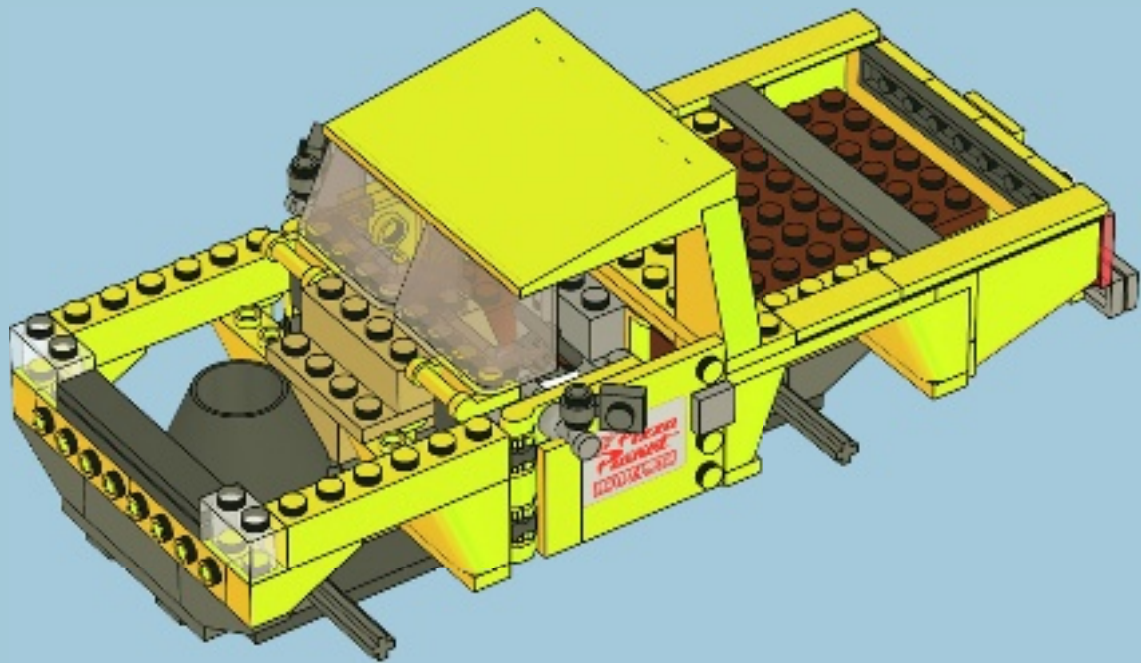

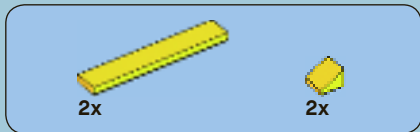

40

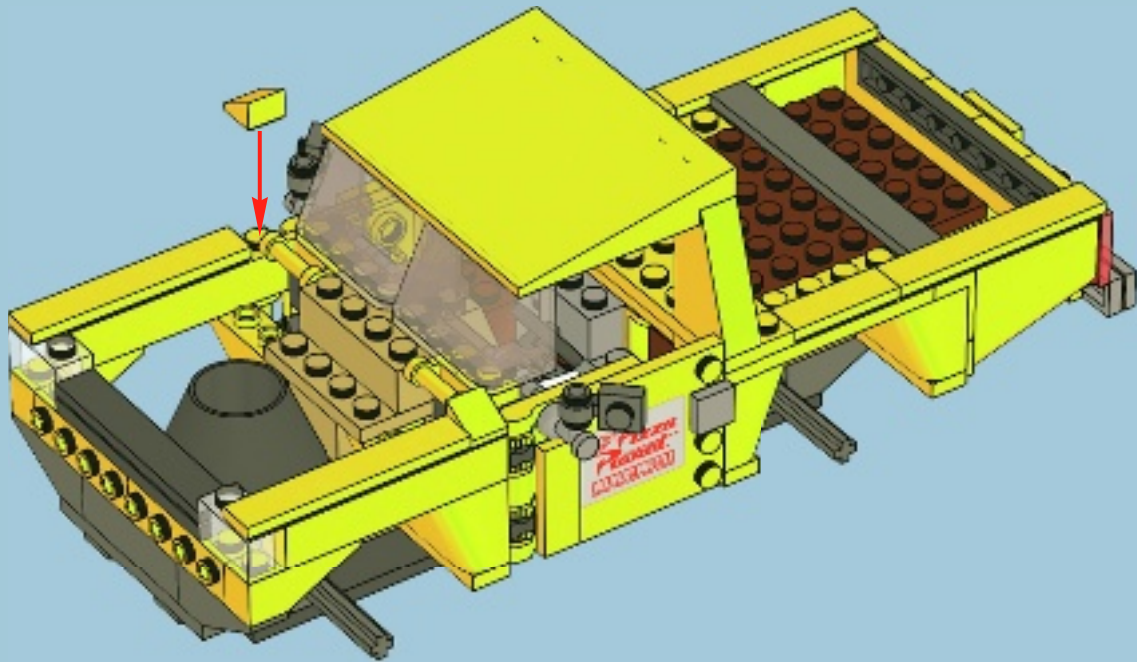

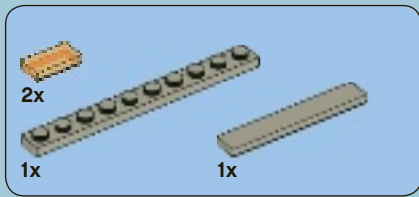

41

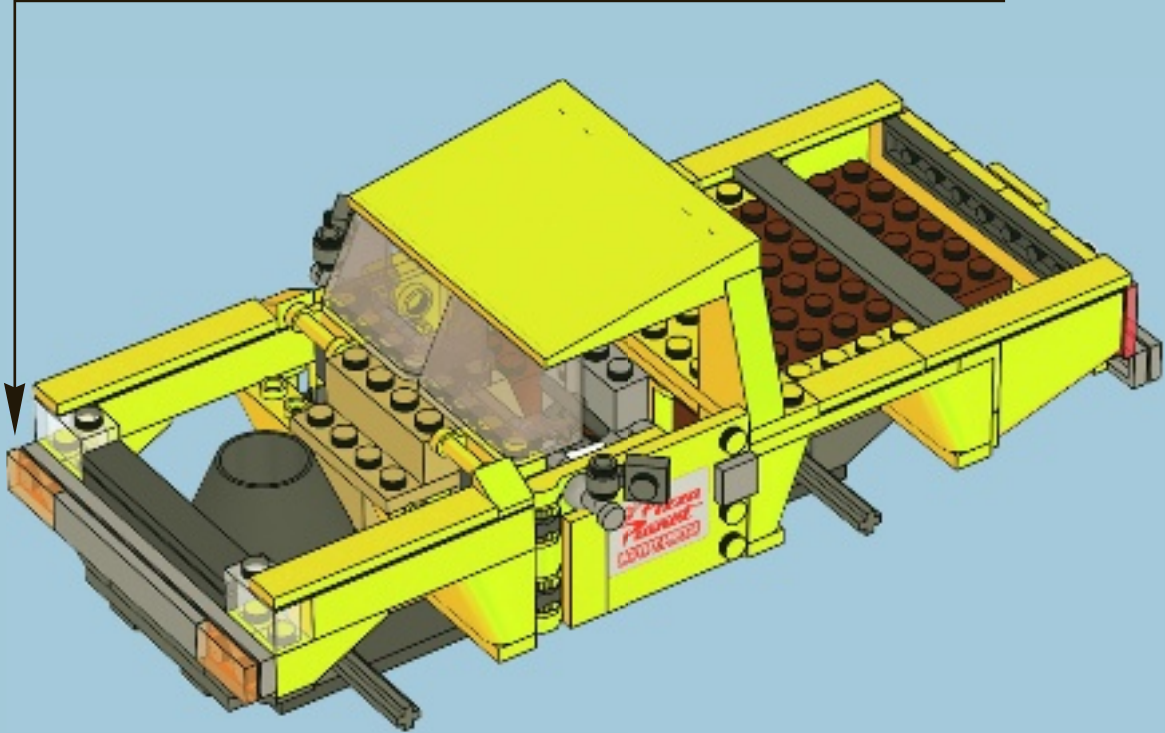
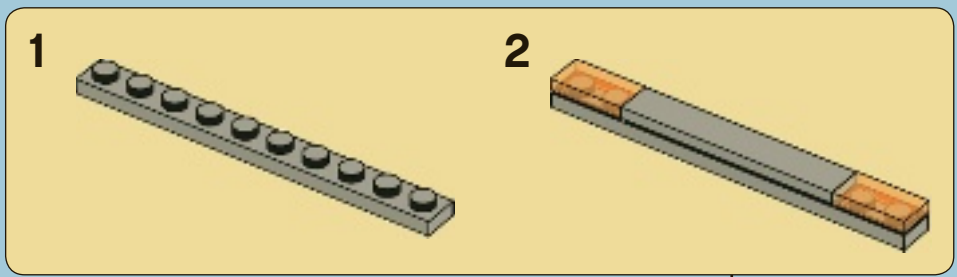

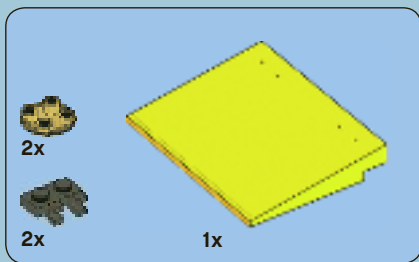

42

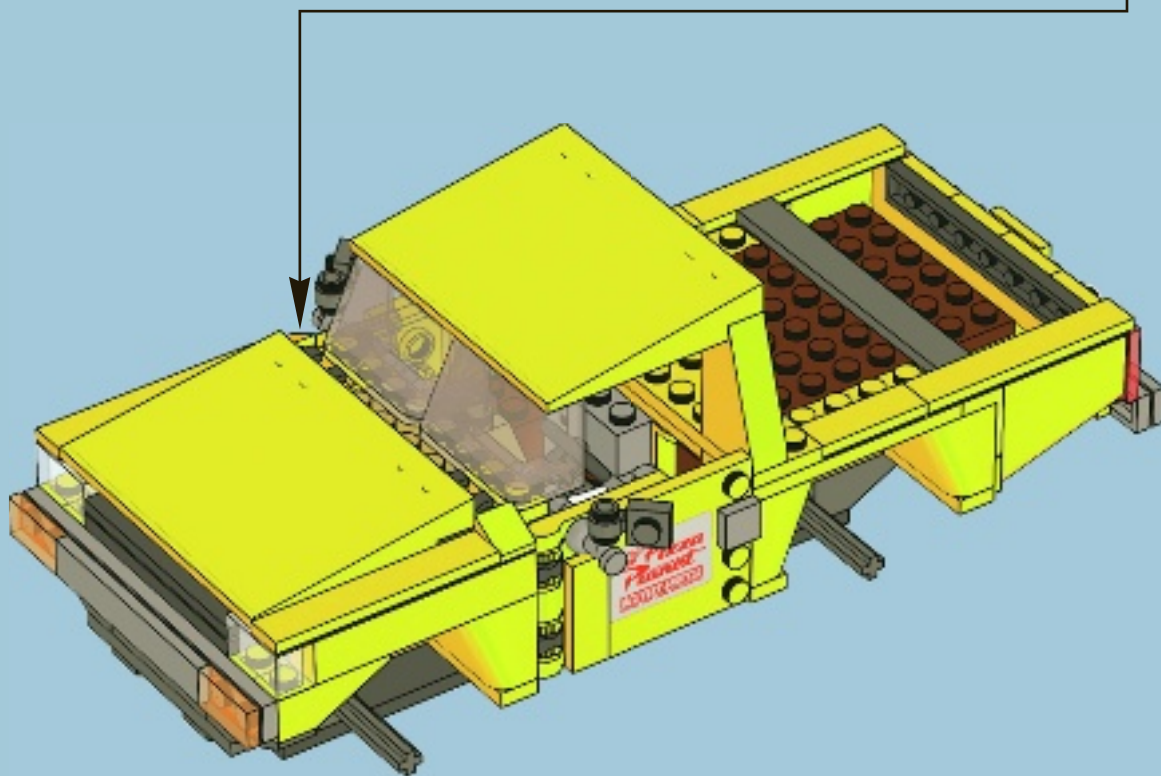
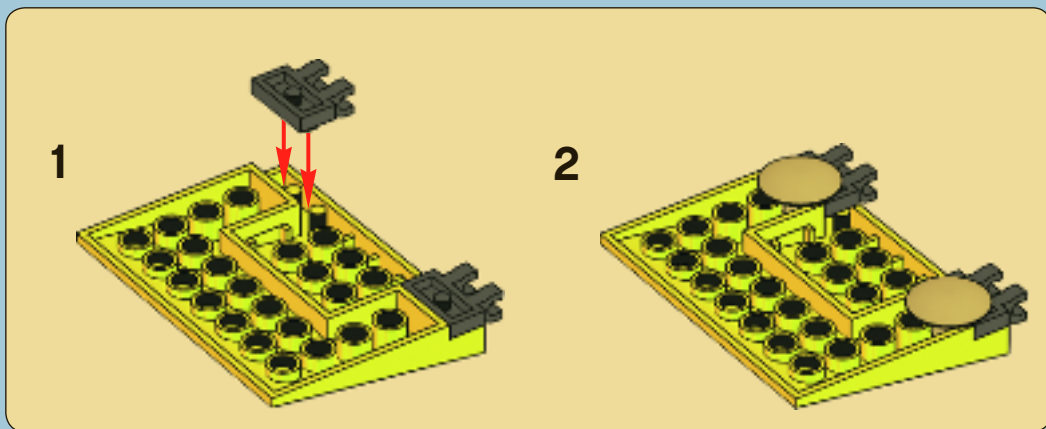



43

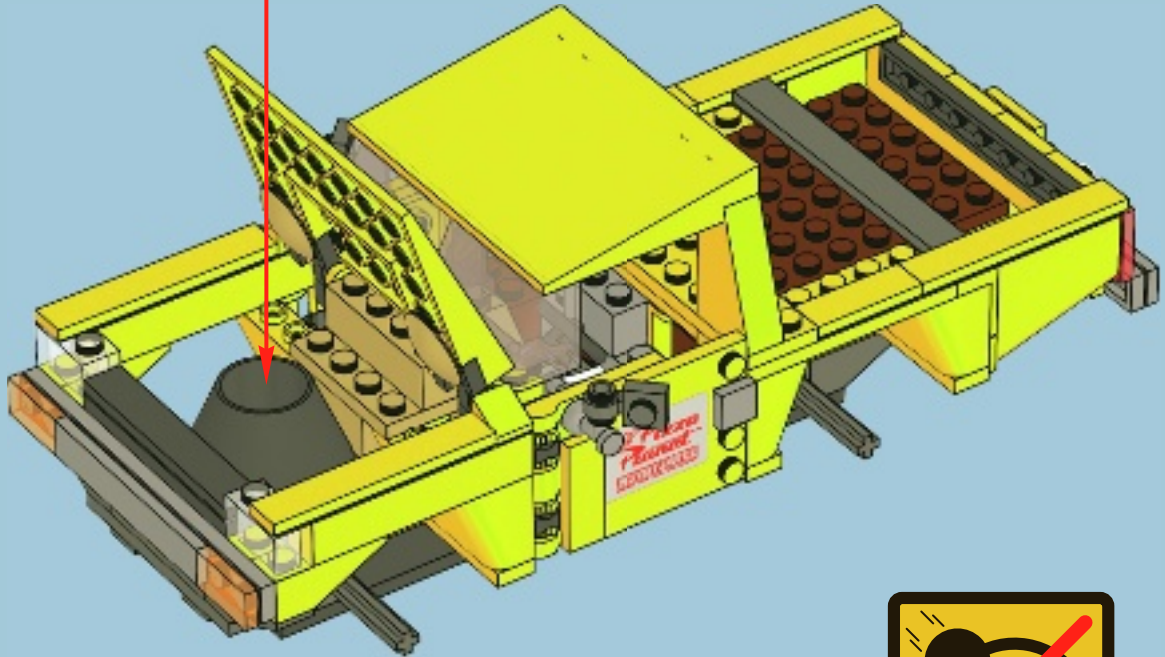

IMPORTANT: Never modify the elements or use other projectiles than provided with this toy.
IMPORTANT : Ne jamais modifier les éléments ni utiliser d'autres projectiles que ceux fournis avec ce jouet.
IMPORTANTE: No modifique los elementos ni utilice otros proyectiles diferentes a los suministrados junto con este juguete.

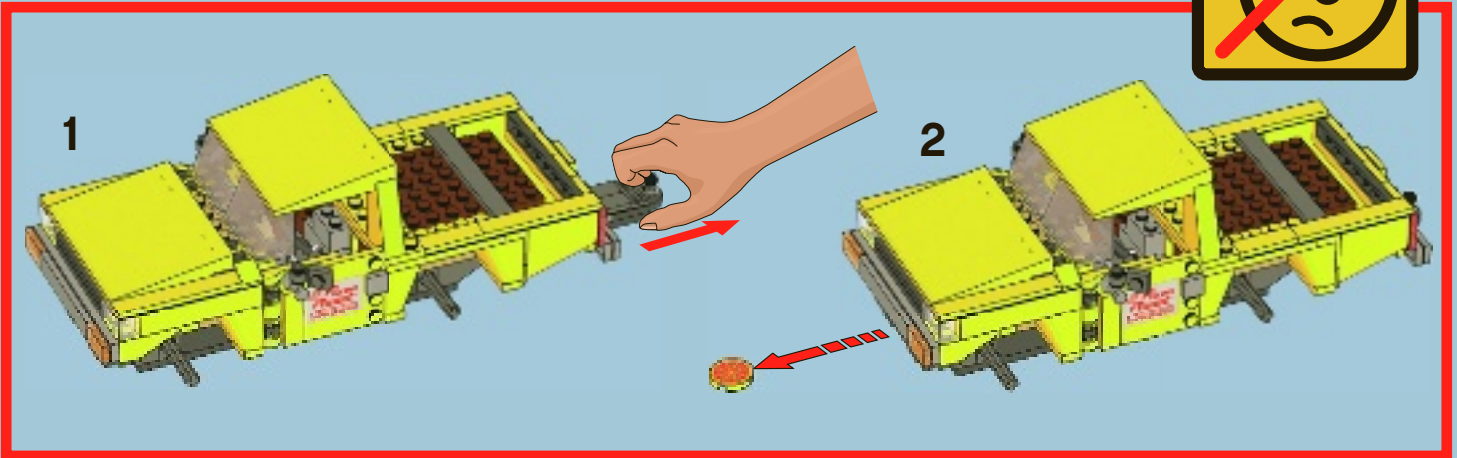

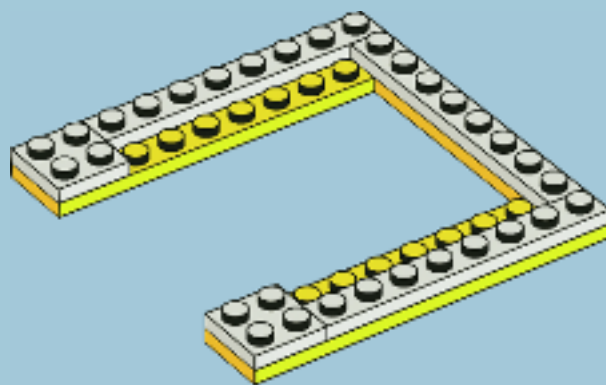
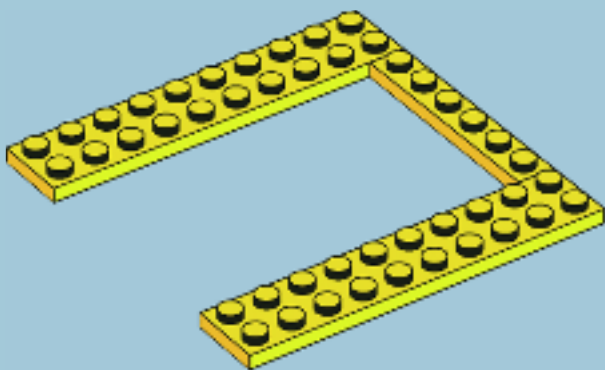
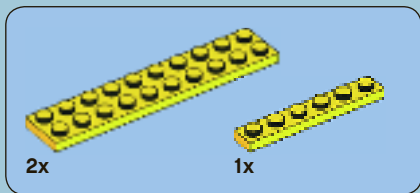
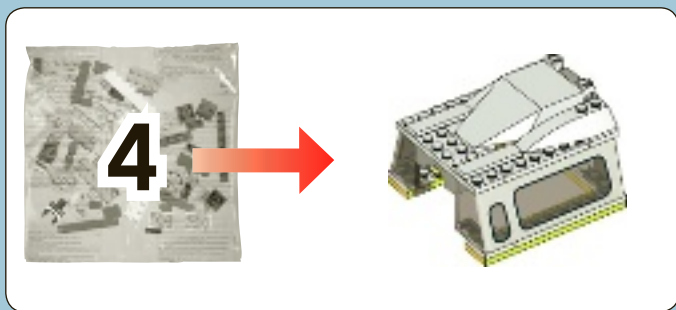

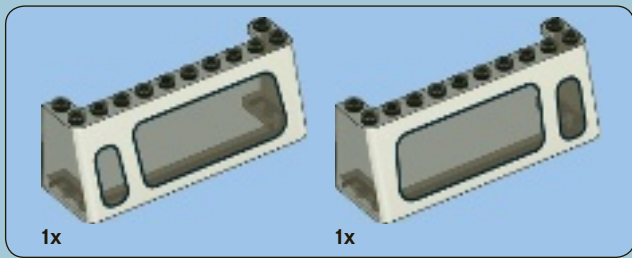

3

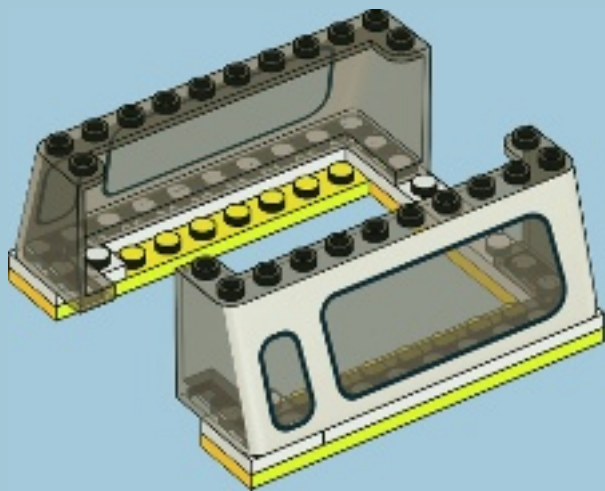

4

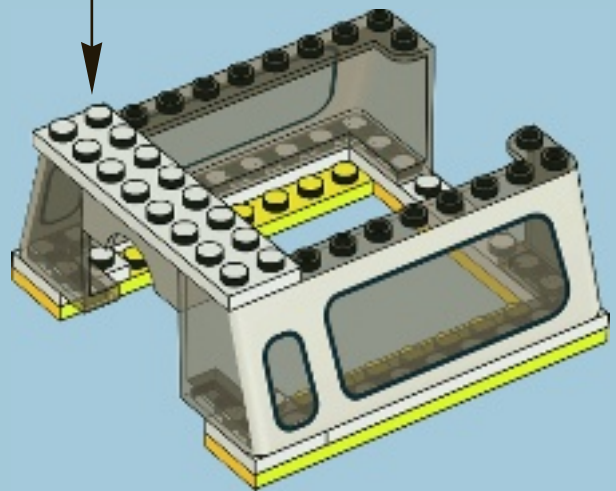
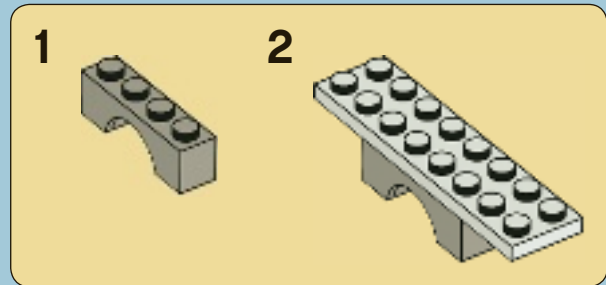

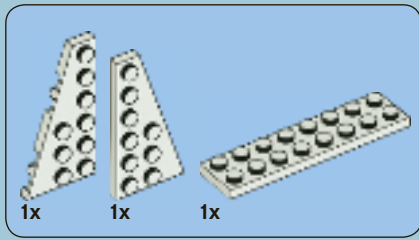

5

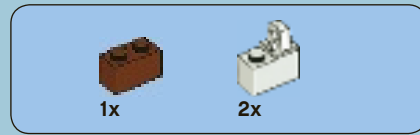
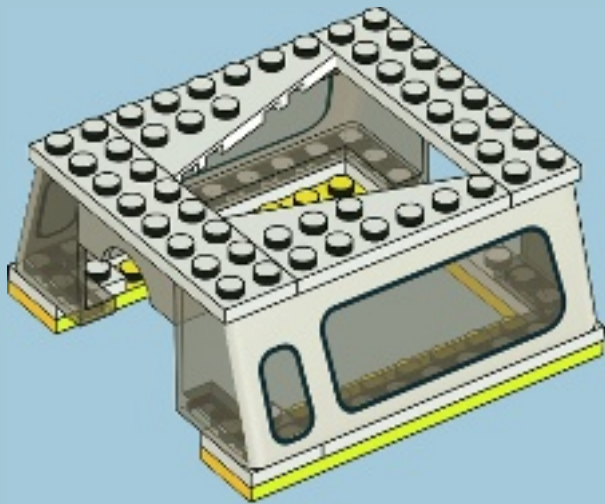

6

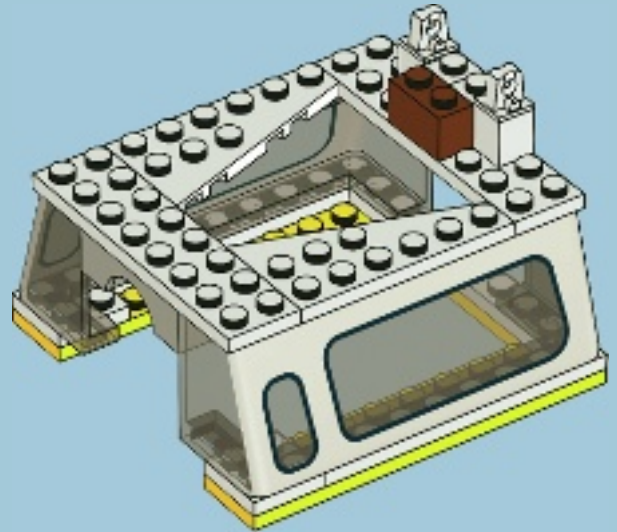

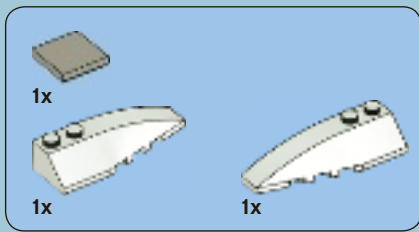

7

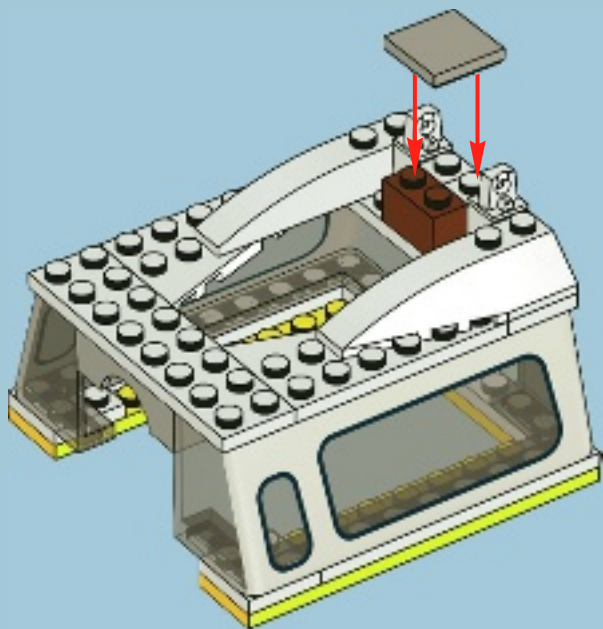

8

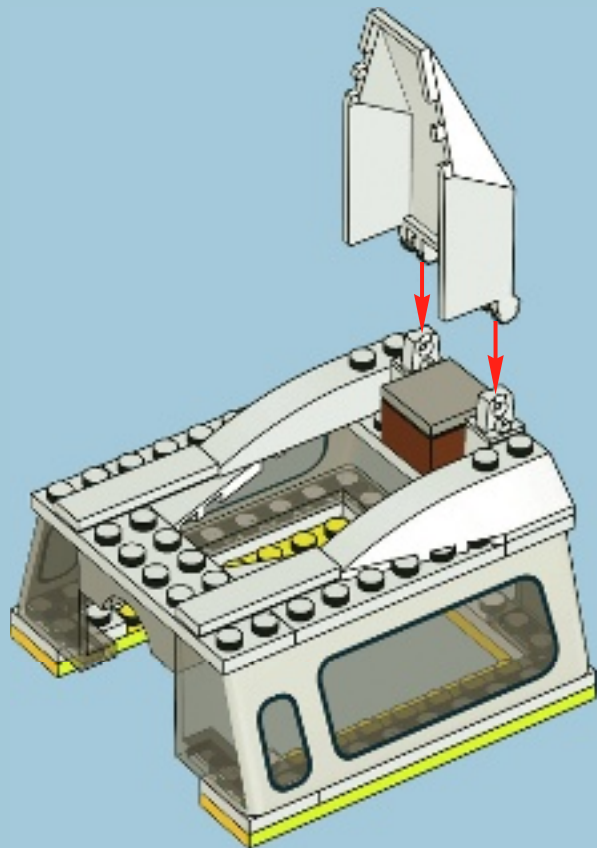

44

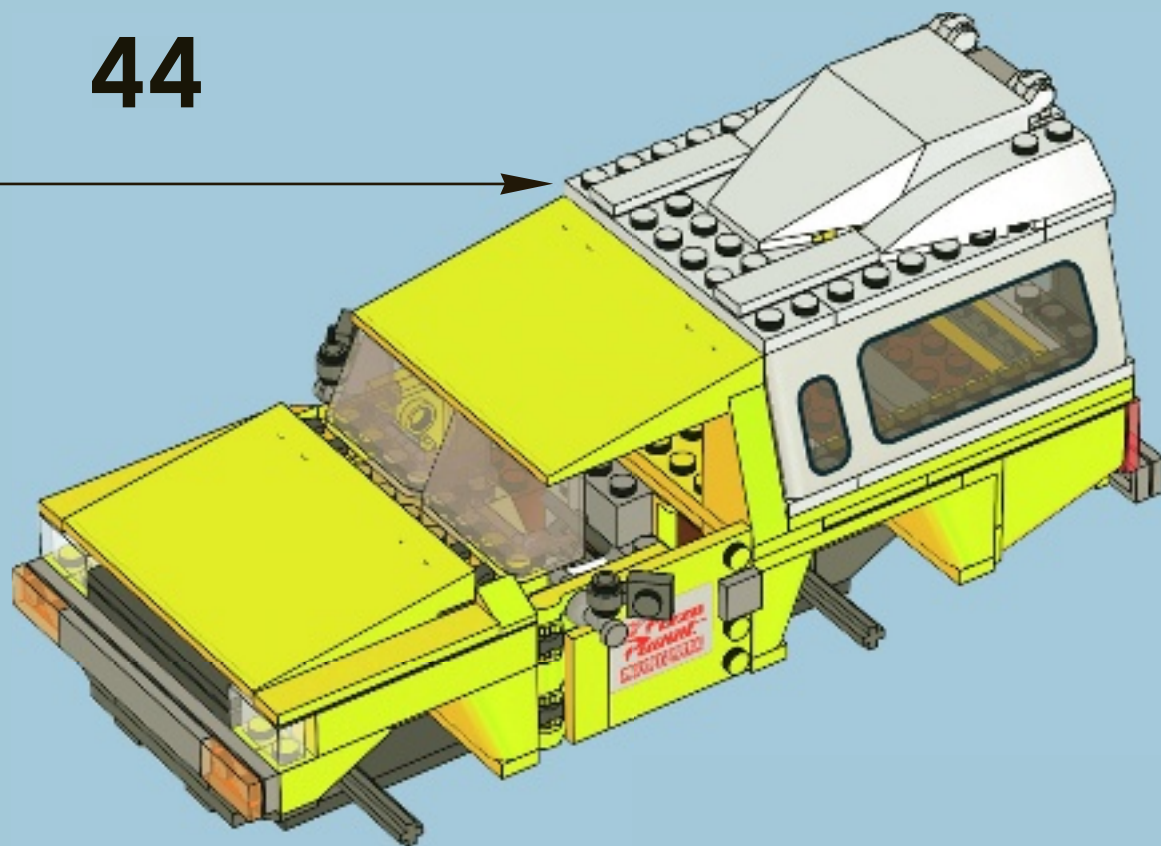

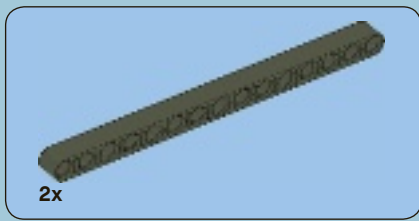

45

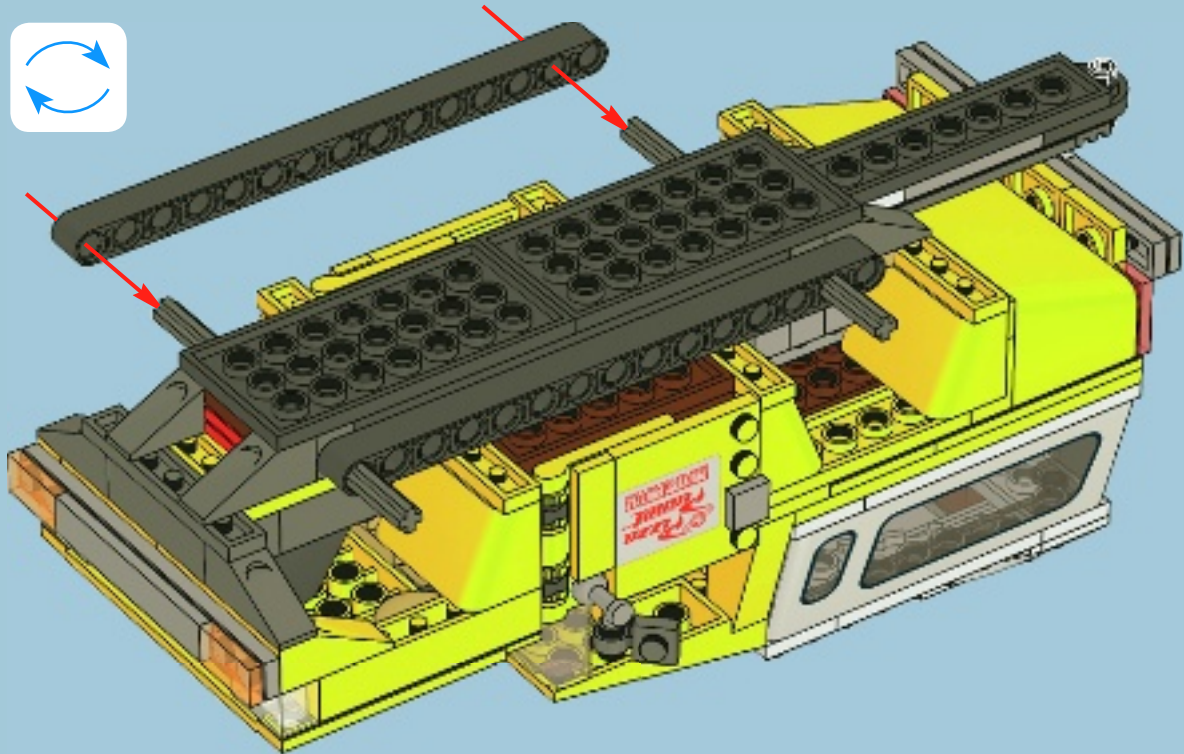

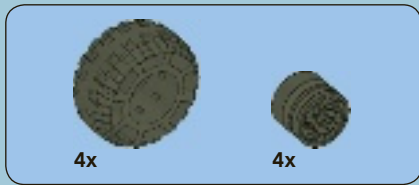

46

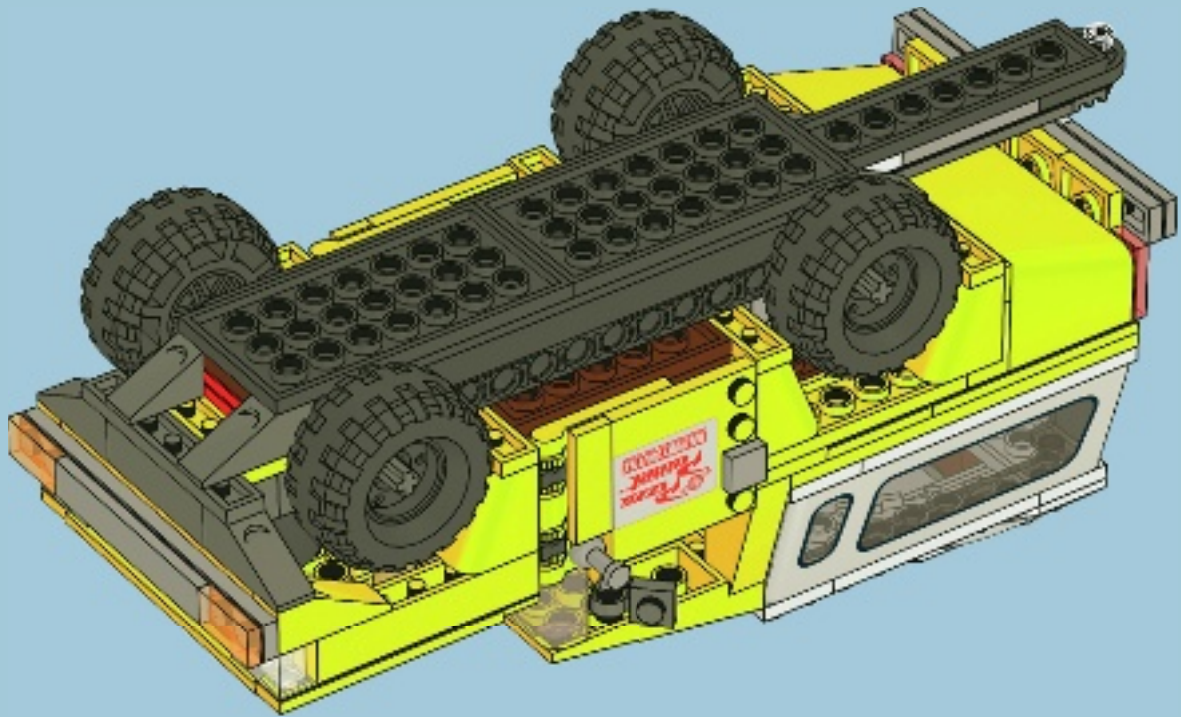

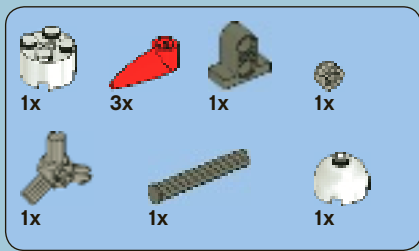

47

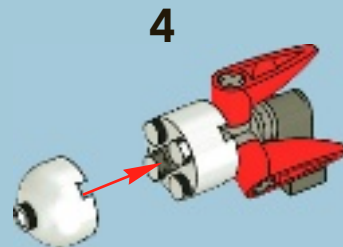
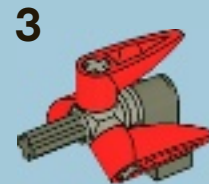
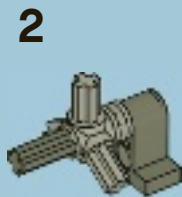
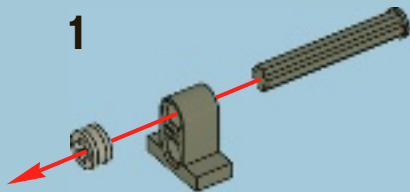

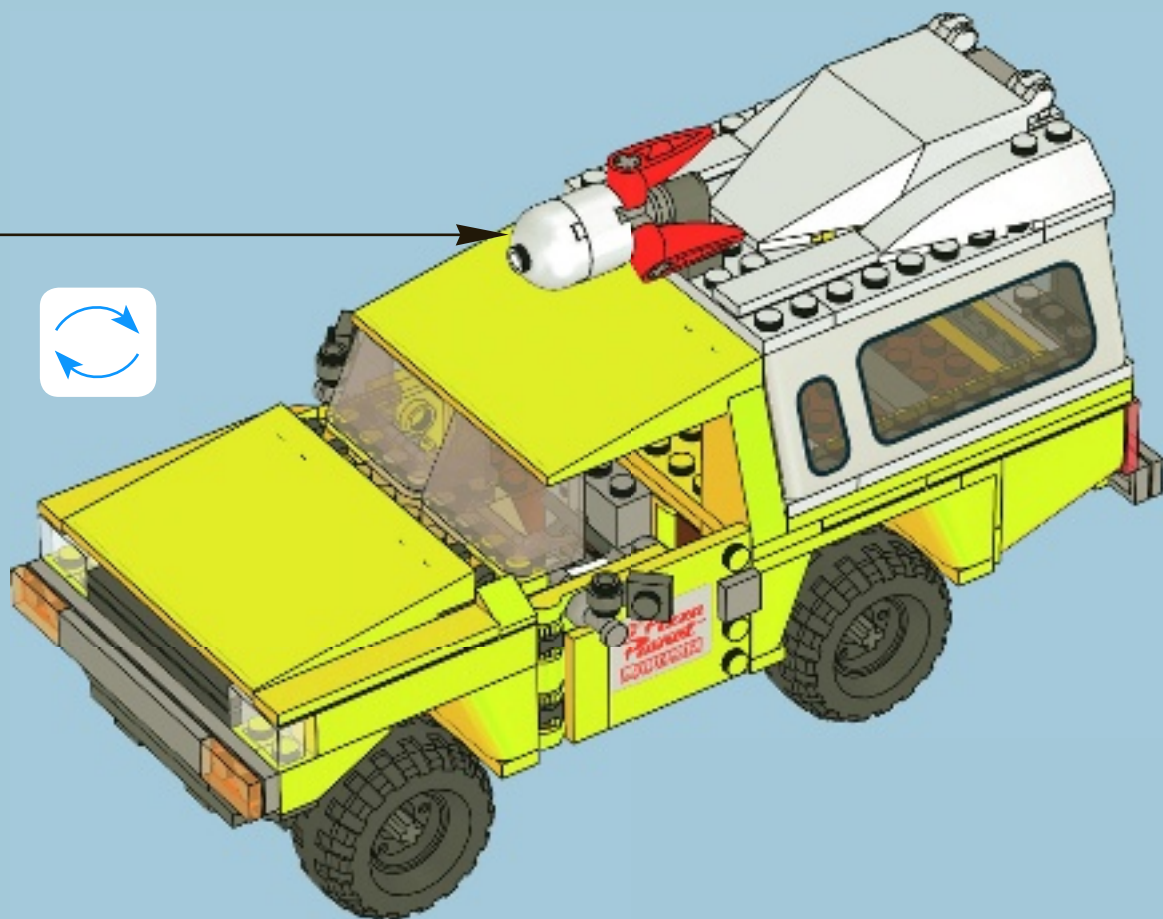

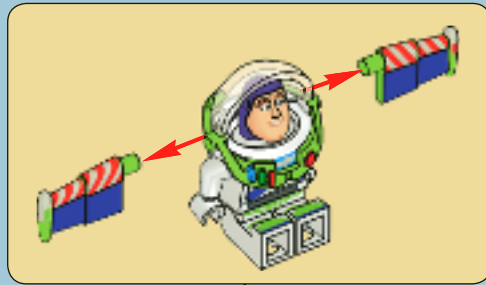

1

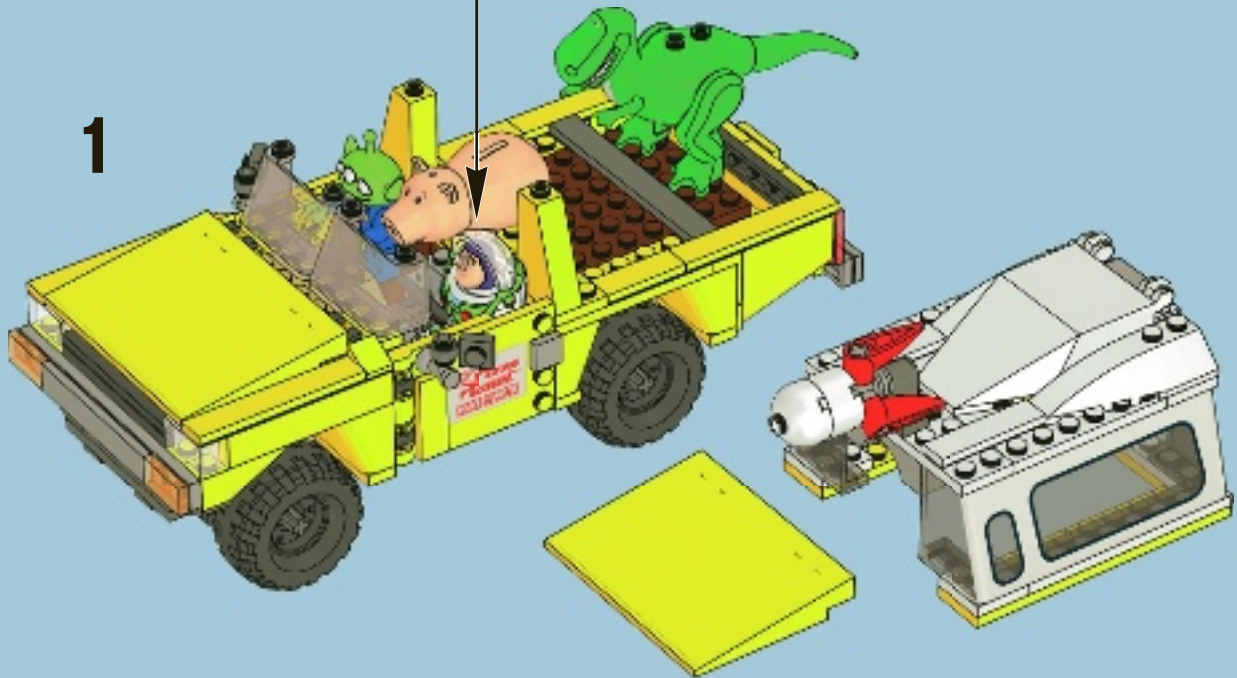

2

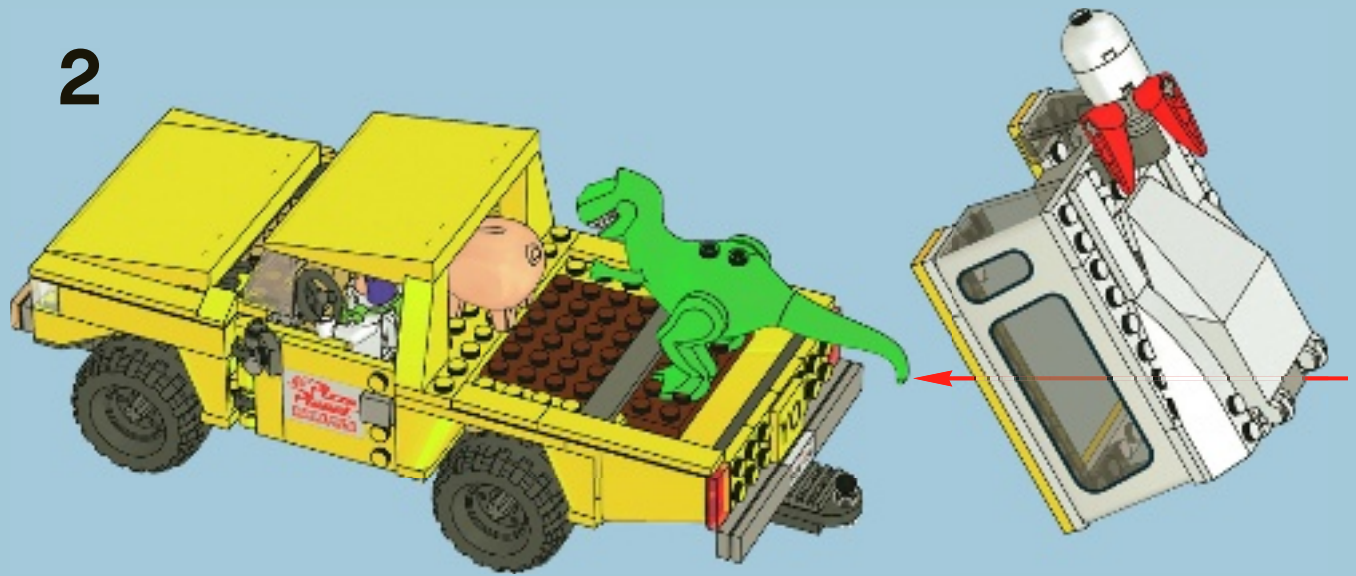

3





2x
4588029

1x
4216652

1x
614301

1x
4160101

1x
4160124

1x
4585527

2x
302201

2x
243101

1x
4287707

1x
4287708

1x
4499886

1x
4119227

2x
303401

1x
4578907

1x
4578800

1x
4569506

1x
4544140

2x
4114319

2x
4121972

1x
4114322

4x
4113233

1x
4243824

2x
4278422

1x
4583575

1x
4583573

1x
4583574

1x
4590598

4x
302321

2x
306821

1x
4560179

3x
4185661

1x
4206482

1x
4543857

1x
4565969

2x
4164073

2x
4504381

2x
300924

2x
4189323

2x
428724

2x
4501233

1x
4585525

4x
4558172

4x
302124

1x
366624

7x
663624

1x
4585524

1x
4586140

1x
4549896

2x
379524

3x
447724

3x
383224

2x
4277925

2x
4501232

2x
4282745

2x
4184179

6x
81867

6x
4583714

1x
4581990



2x
611226



4x
4143751



1x
4550922



1x
366626



1x
663626



1x
346026



1x
303426



2x
303526



2x
4556158



1x
317626



4x
4517737



4x
4506553



1x
4153044



2x
4542573



1x
4184169



2x
306540



1x
4566144



2x
4189801



2x
4167504



1x
4585711



1x
4586116



1x
4563687



2x
4541710



2x
4569507



6x
4211149

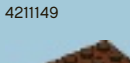

2x
4216615



1x
4216695



2x
4223729



1x
4211391



5x
4211435



2x
4211415



1x
4211413



2x
4211356



1x
4211395



1x
4211549



2x
4251149



2x
4211632



2x
4211503



1x
4211573



1x
4502595



2x
4211104



2x
4211085



4x
4210639



6x
4211068



1x
4211056



5x
4211008



2x
4210828



1x
4210631



1x
4210763



2x
4211129



2x
4218696



1x
4289542



5x
4560177



1x
4569543



1x
4584131



1x
4584129

Customer Service
Kundenservice
Service Consommateurs
Servicio Al Consumidor

www.lego.com/service or dial



: 00800 5346 5555
: 1-800-422-5346





Disney · PIXAR
**Toy
STORY**

LEGO and the LEGO logo are trademarks of the LEGO Group. ©2010 The LEGO Group.
© Disney/Pixar.



7596

7789



7597



LEGO.com/ToyStory

FREE! GRATIS! GRATUIT!





club
MAGAZINE™

www.LEGOclub.com



00800 5346 5555*        

  1-866-534-6258 • 1-877-518-5346

US & Canada only

Canada seule ment



VISIT THE WORLD'S
BIGGEST LEGO® SHOP!

www.LEGOshop.com

* Freephone. Mobile charges may apply. * Numéro sans Frais. Des Frais peuvent s'appliquer avec les téléphones cellulaires. * Gebührenfrei, Kosten für Anrufe aus Mobilfunknetzen können abweichen.
* Gratis telefonnummer vanaf vaste lijn. * Dot er ett gratis nummer, när du ringer från FastTelefon. * Det är gratis, när du ringer från en fast telefon.



WIN!

Go to www.nielsen.com/LEGO to fill out a survey for a chance to win a cool LEGO® Product.

No purchase necessary.

Open to all residents where not prohibited.



www.nielsen.com/LEGO

GEWINNE! WIN!

Nimm an der Umfrage auf www.nielsen.com/LEGO teil und hab die Chance ein cooles LEGO® Produkt zu gewinnen!

Die Teilnahme am Gewinnspiel führt zu keinerlei Kaufverpflichtungen. Teilnahme in allen nicht ausgeschlossenen Ländern möglich.

Ga naar www.nielsen.com/LEGO, vul een enquêteformulier in en maak kans op een cool LEGO® product.

Geen aankoopverplichting. Iedereen mag deelnemen, uitgezonderd ingezetenden van landen waar een enquêteverbod geldt.

GAGNE! 当てよう!

Visite www.nielsen.com/LEGO pour répondre à un questionnaire et avoir une chance de gagner un produit LEGO® très cool!

Aucune obligation d'achat. Ouvert à tous les résidents des pays autorisés.

www.nielsen.com/LEGOにアクセスして、アンケートにご記入ください。当選者にはレゴ製品を差し上げます。

お買い上げの必要はありません。

禁止されていない限り、すべての皆様にご利用いただけます。