



SCOOBY-DOO!

75904



 LEGO.com/scoobydoo

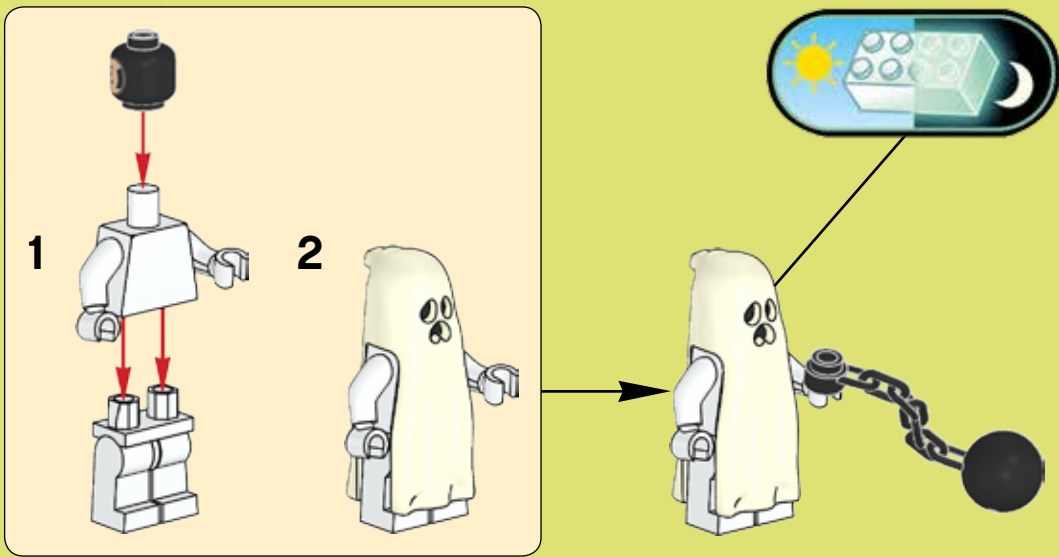
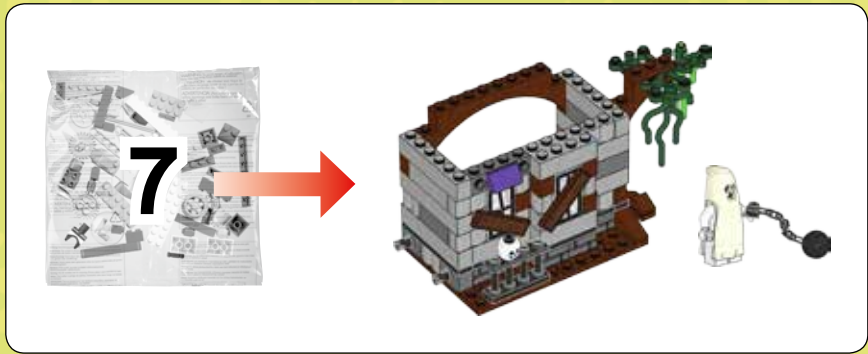



1

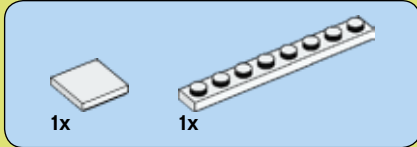
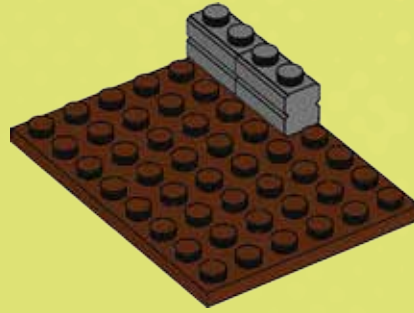

2

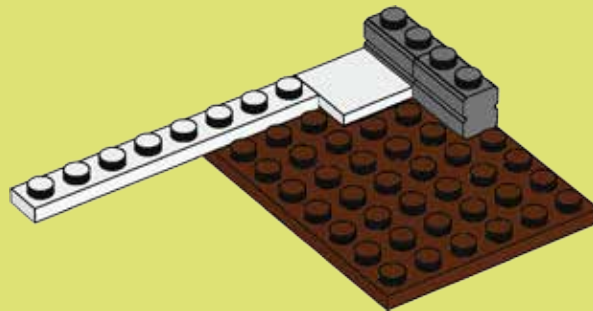

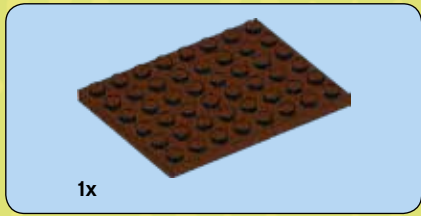

3

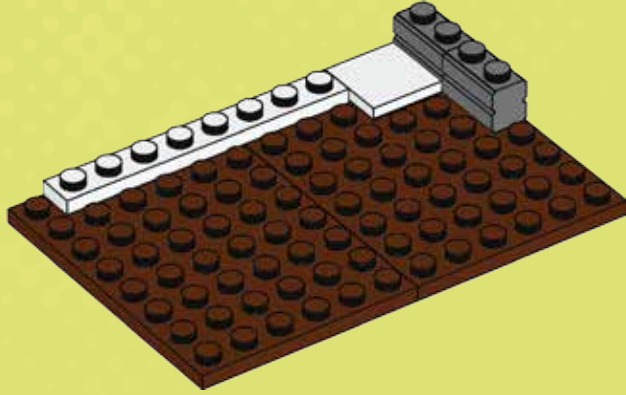

4

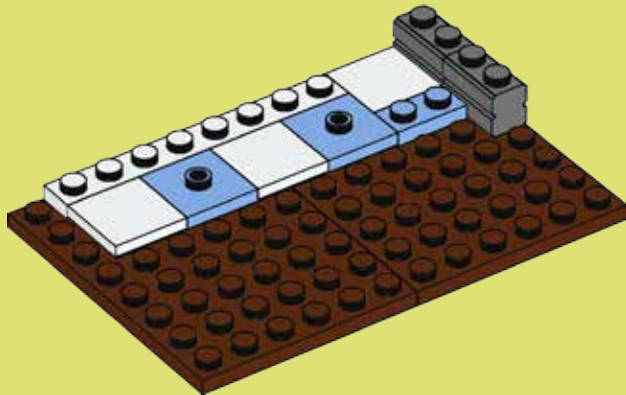

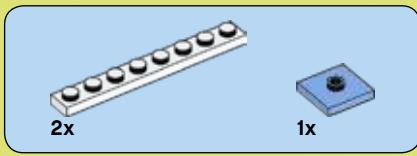

5

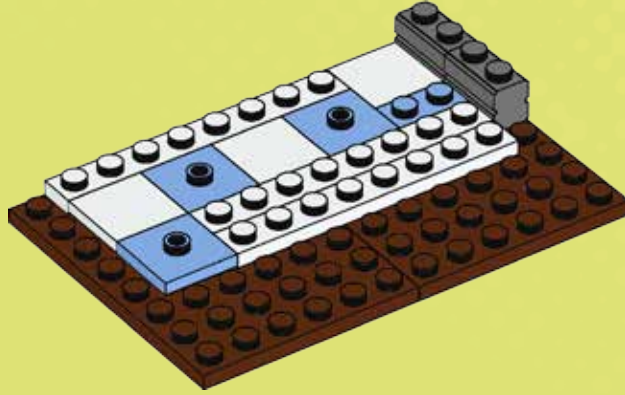

6

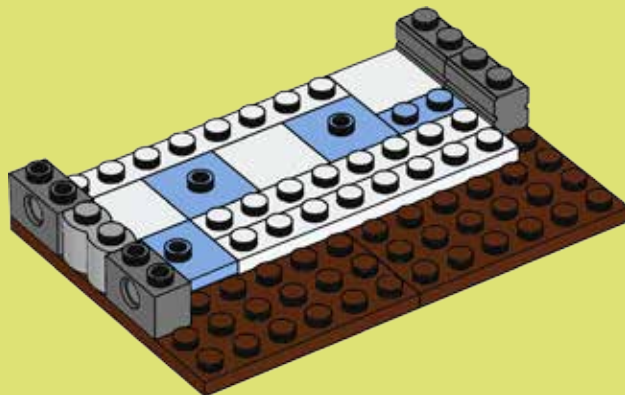



7

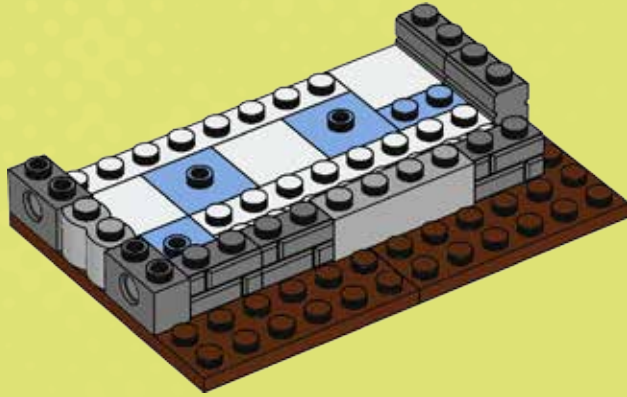

8

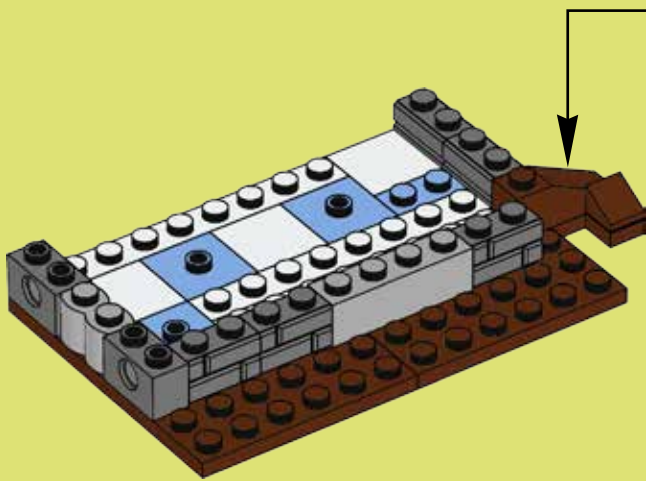
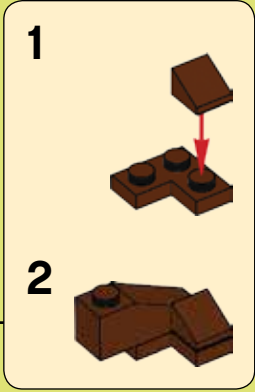



9

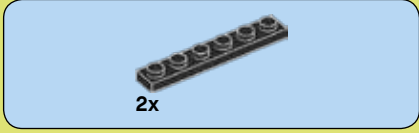
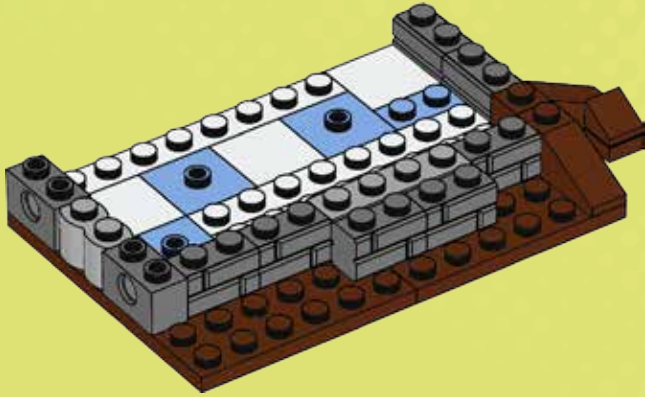

10

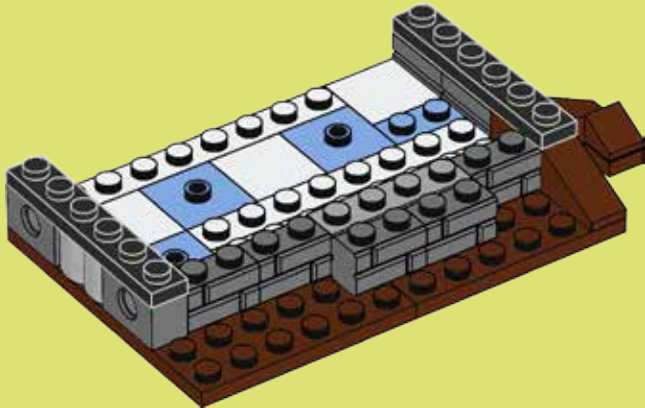

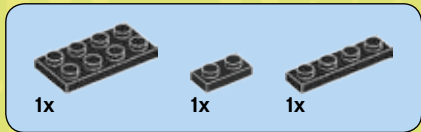

11

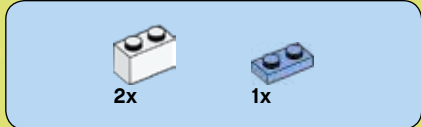
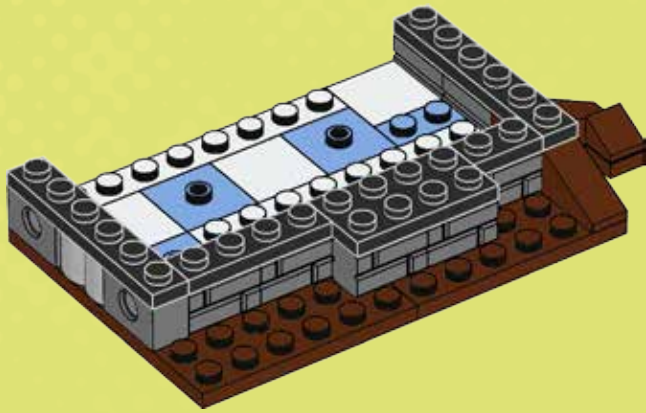

12

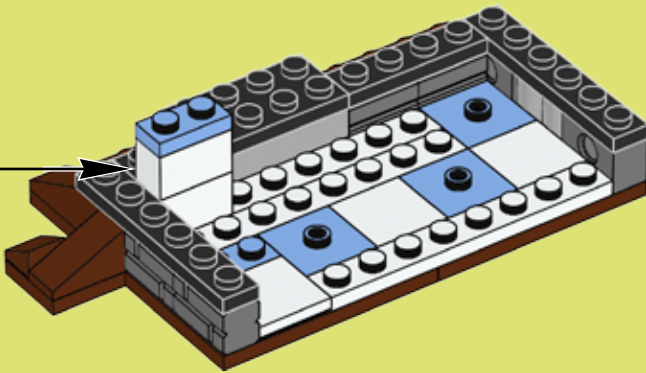
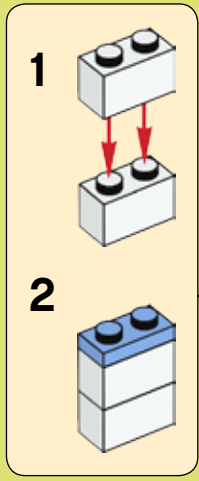
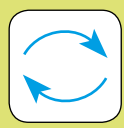

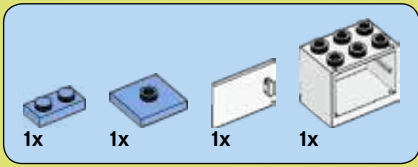

13

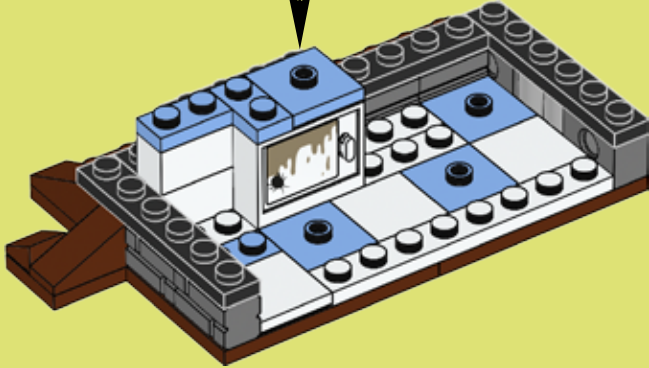
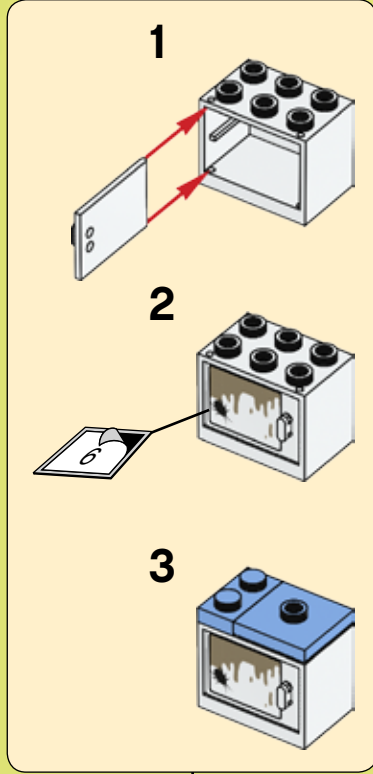

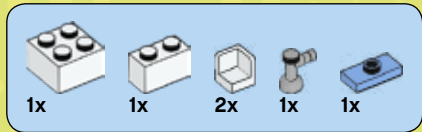

14

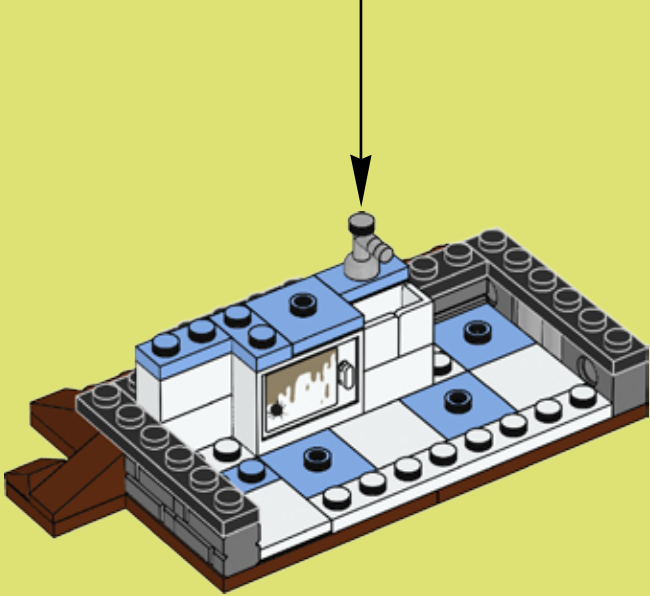
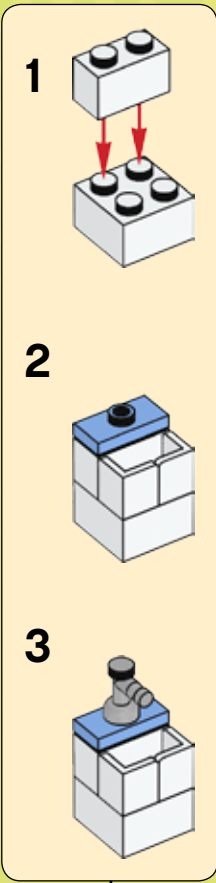

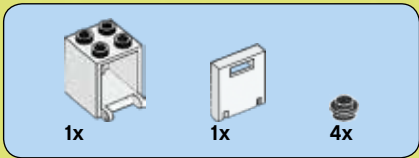

15

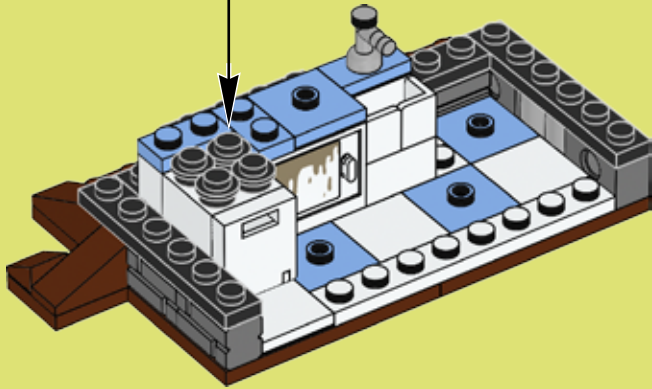
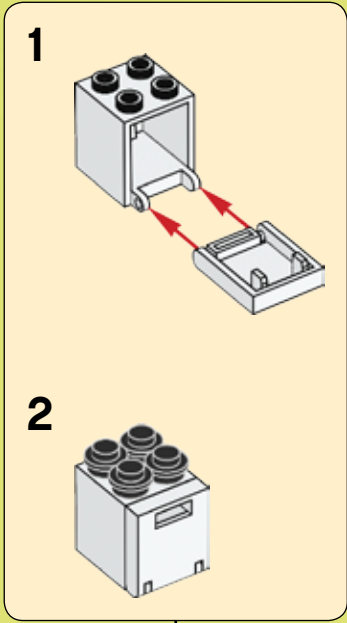



16

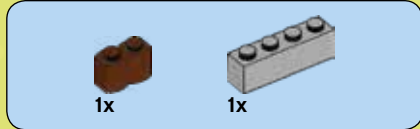
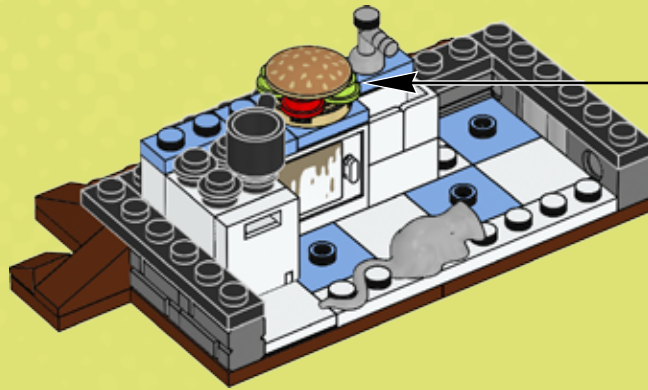

17

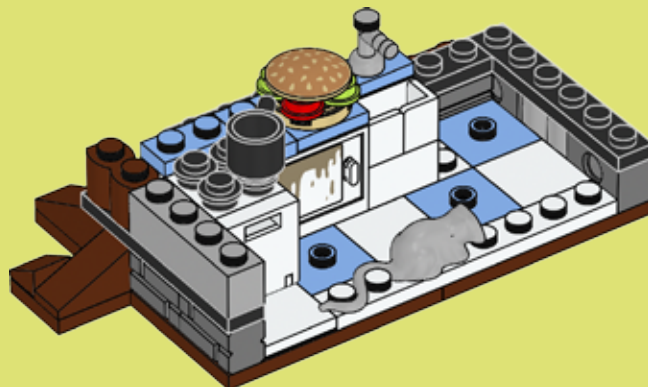

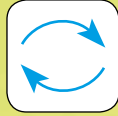
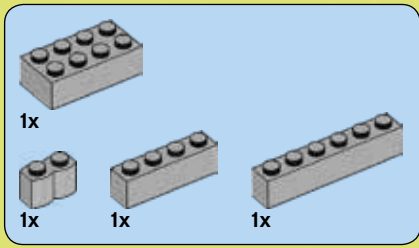

18

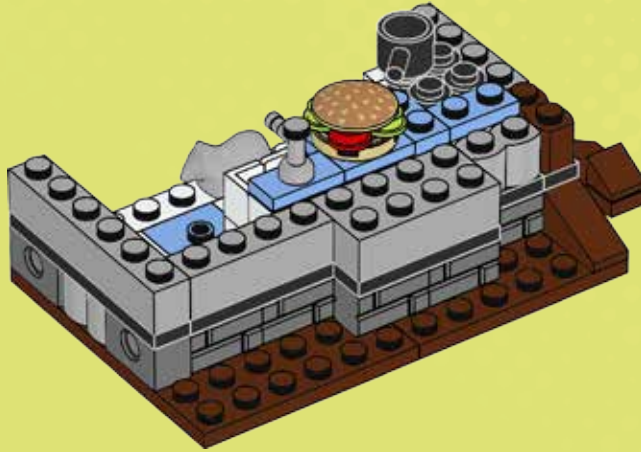

19

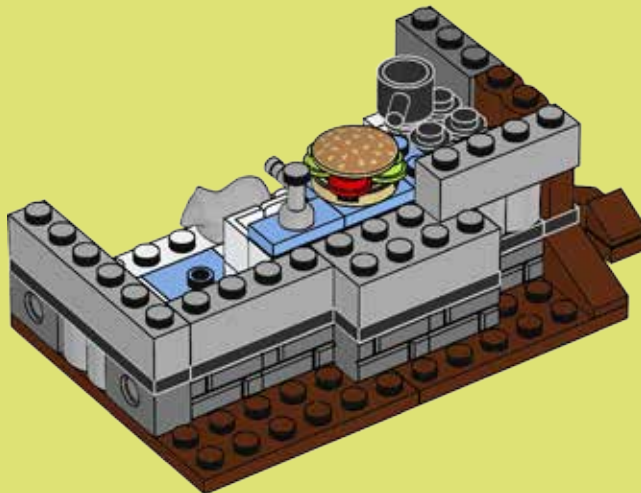



1x



1x

20

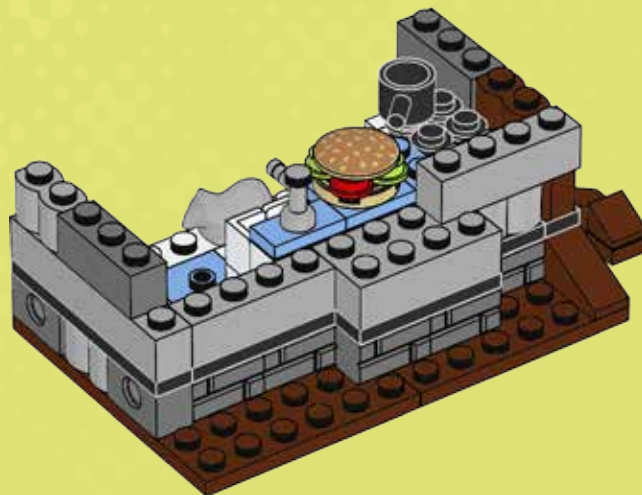

2x



1x

21

1



2

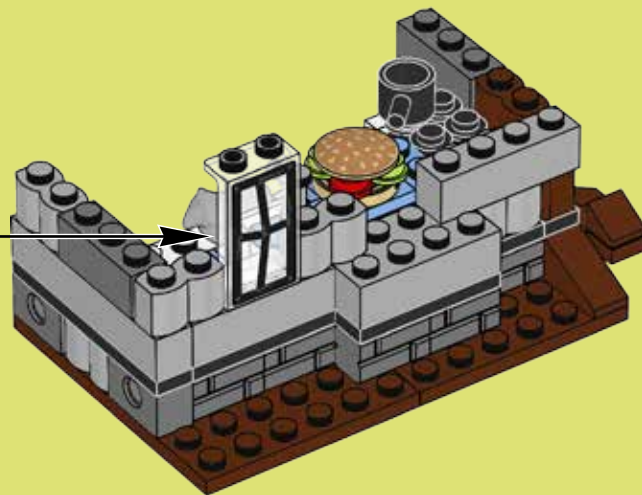
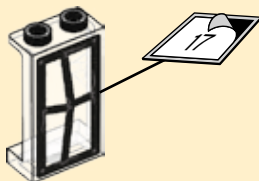

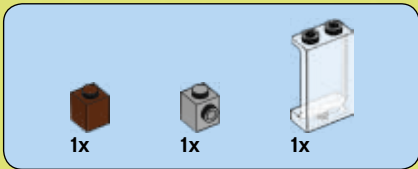

22

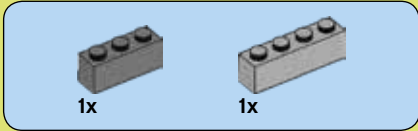
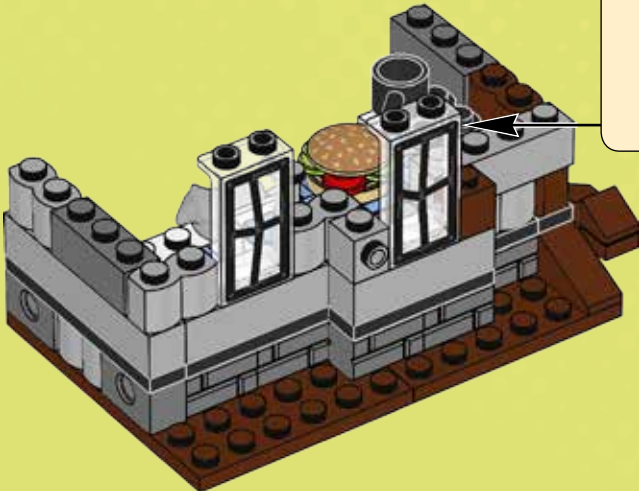
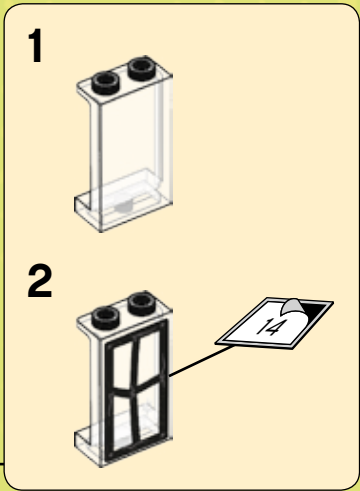

23

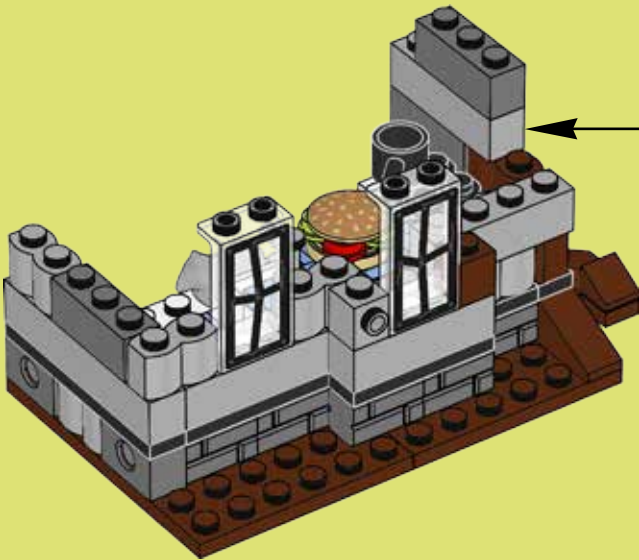
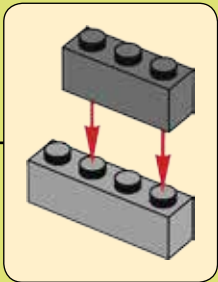



1x



1x

25

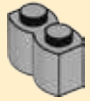
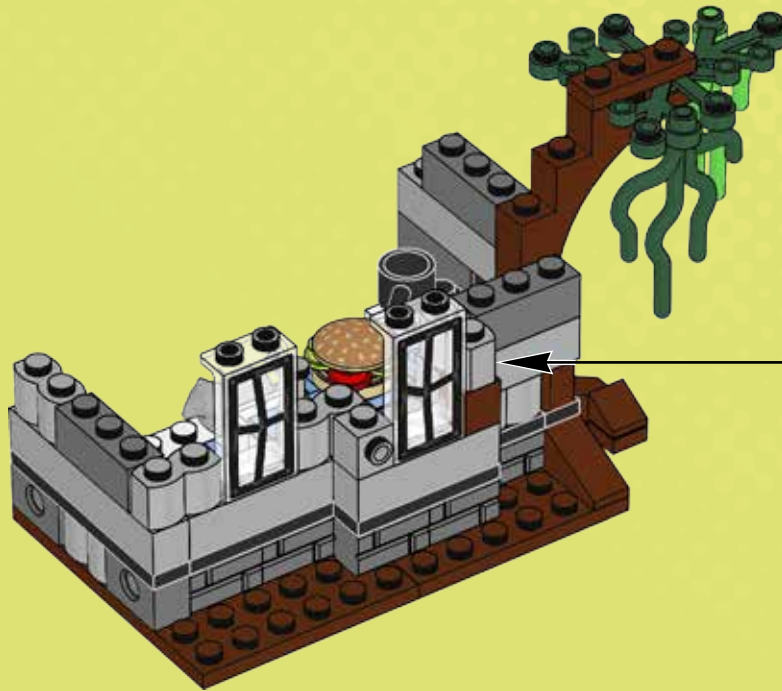

1x

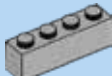

1x

26

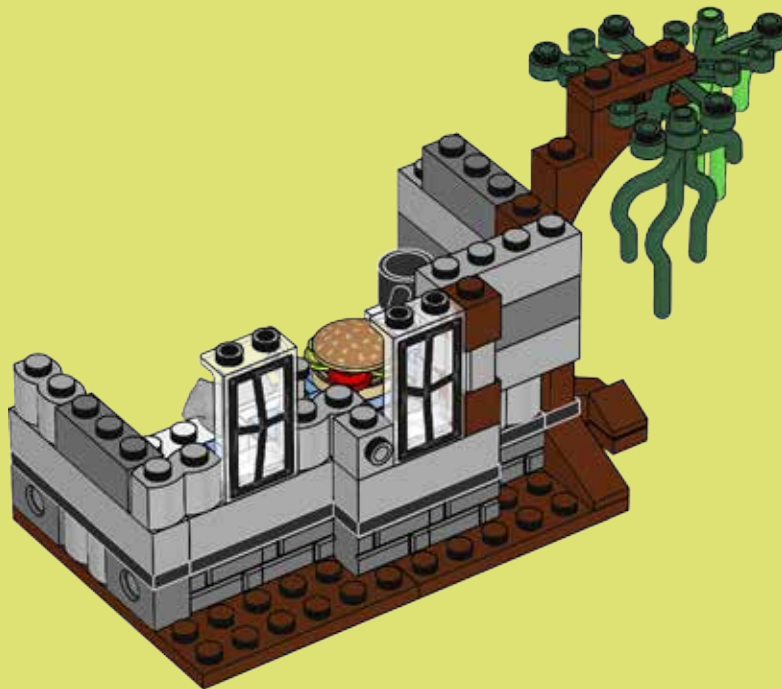

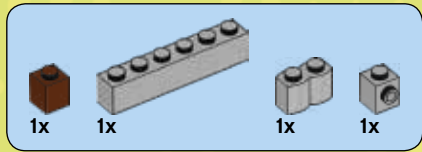

27

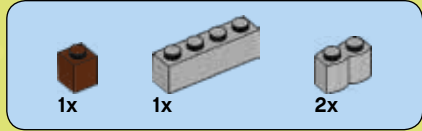
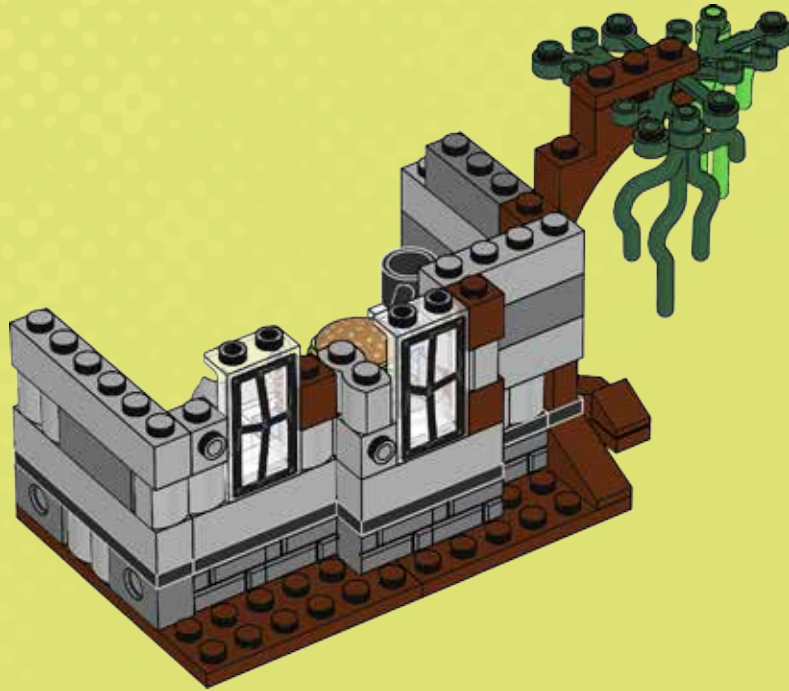

28

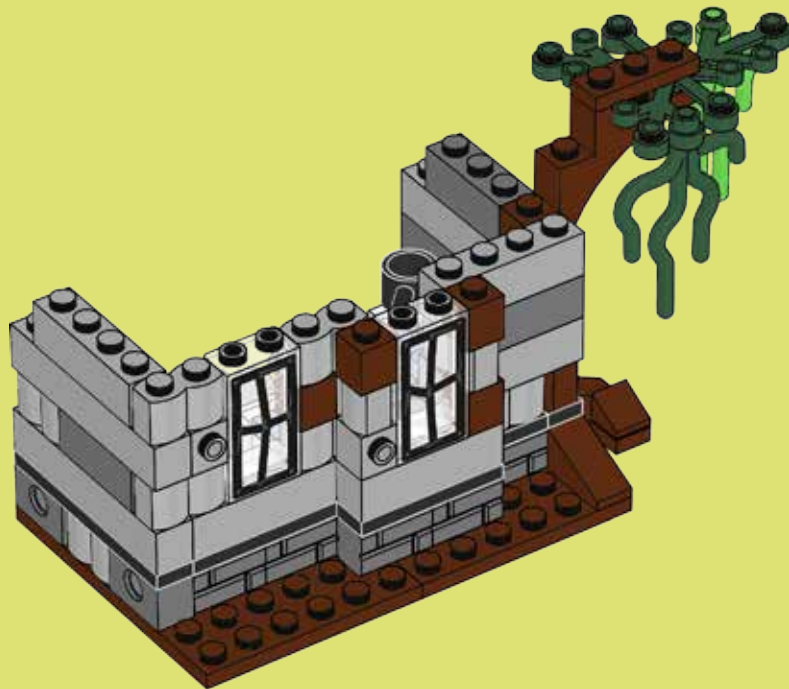

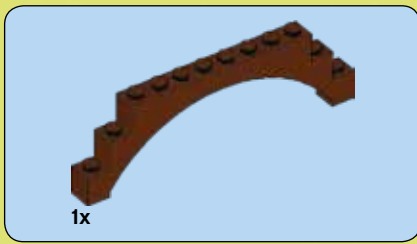

29

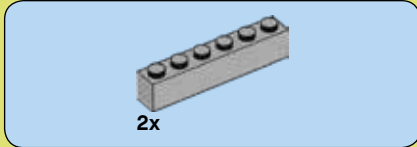
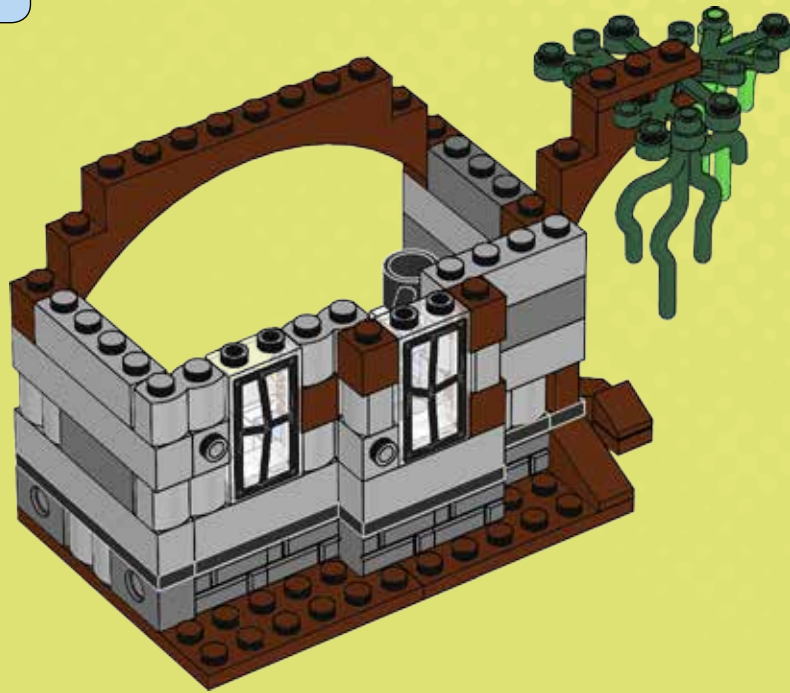

30

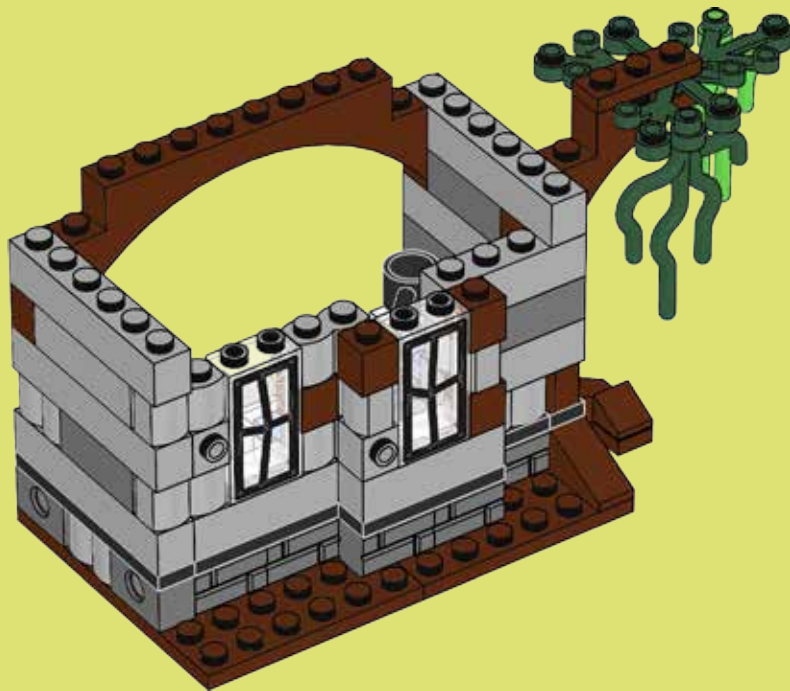

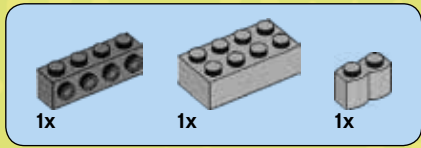

31

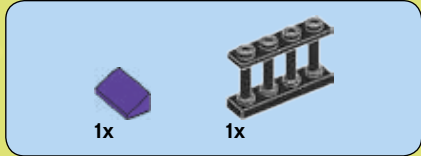
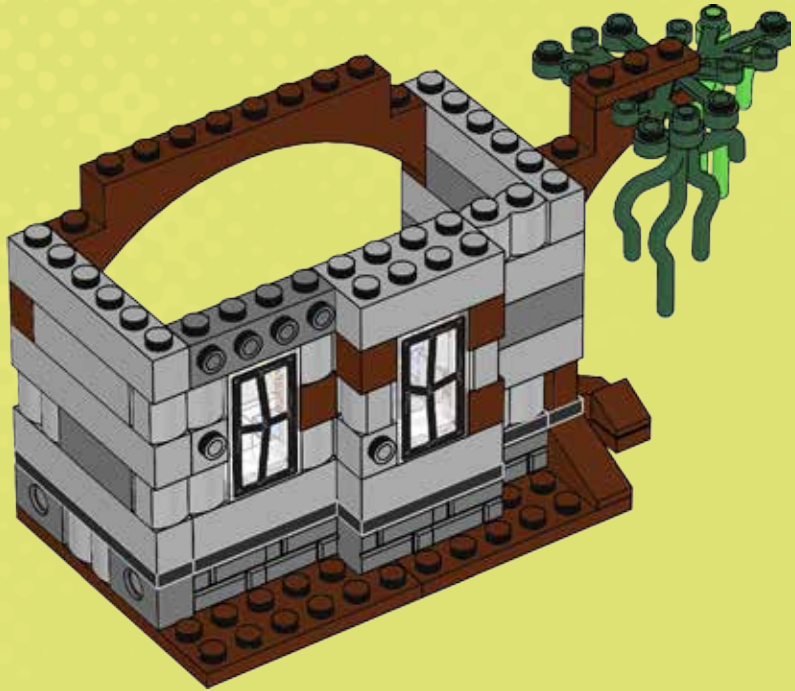

32

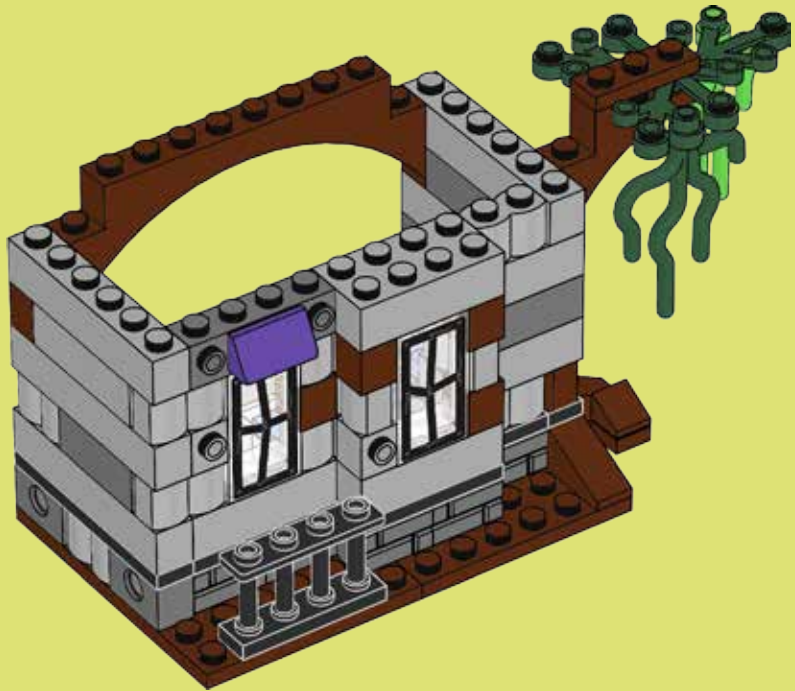



33

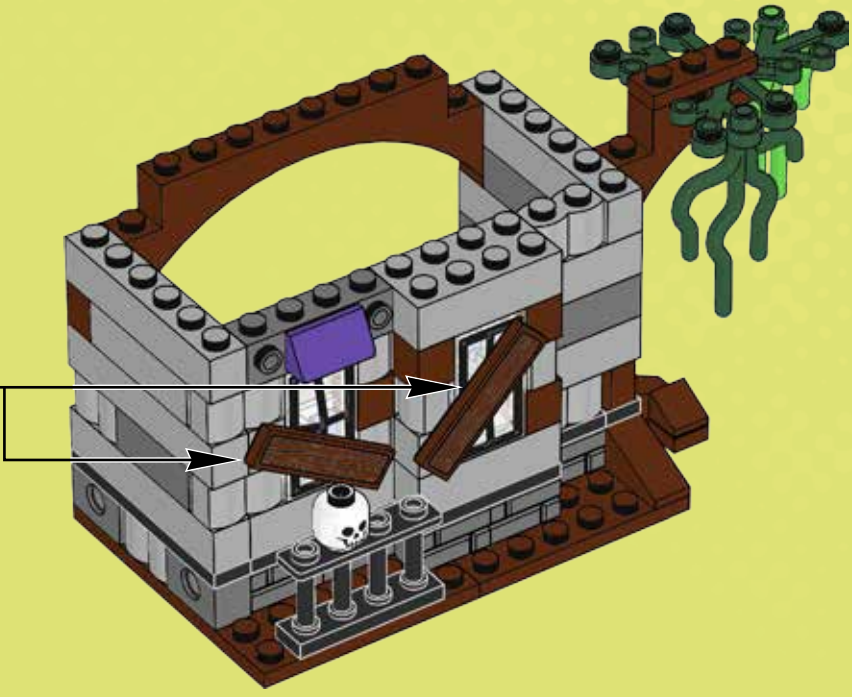
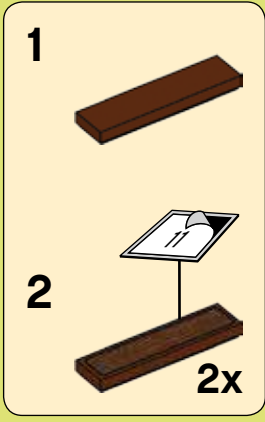

34

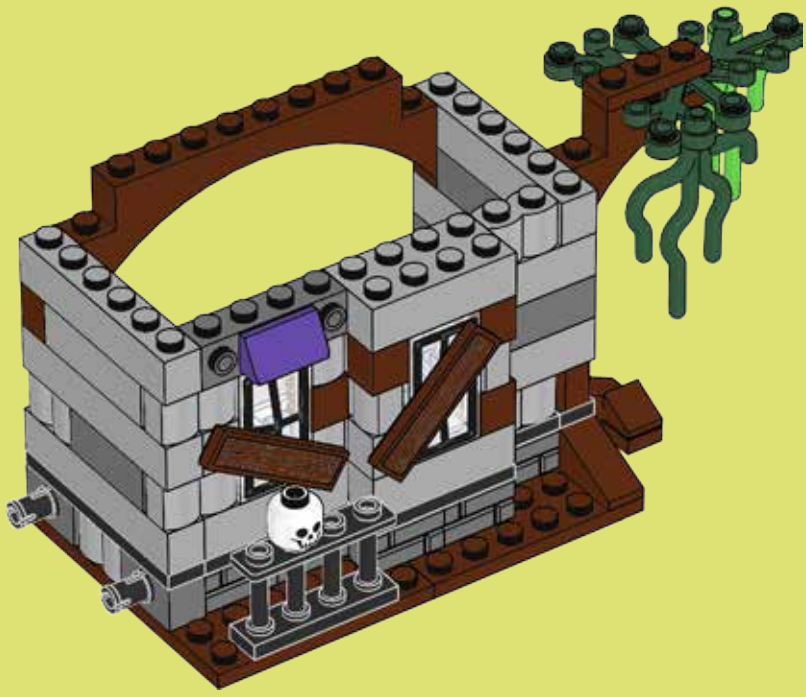

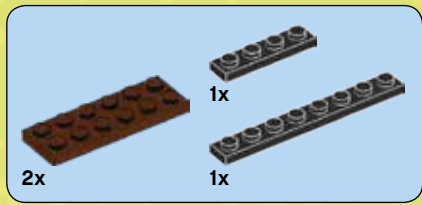
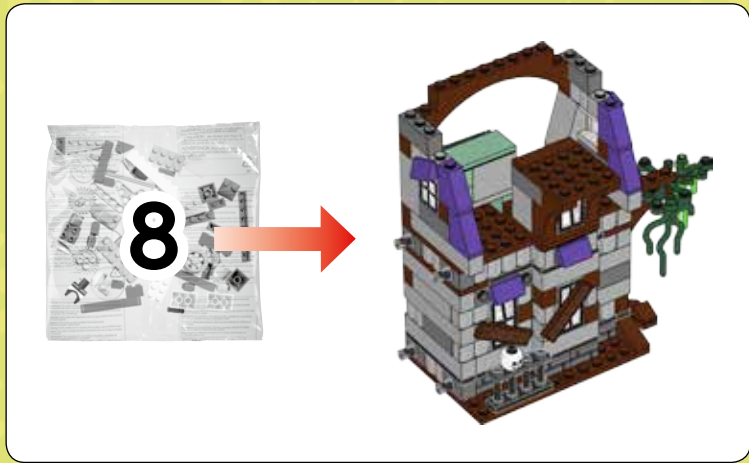

35

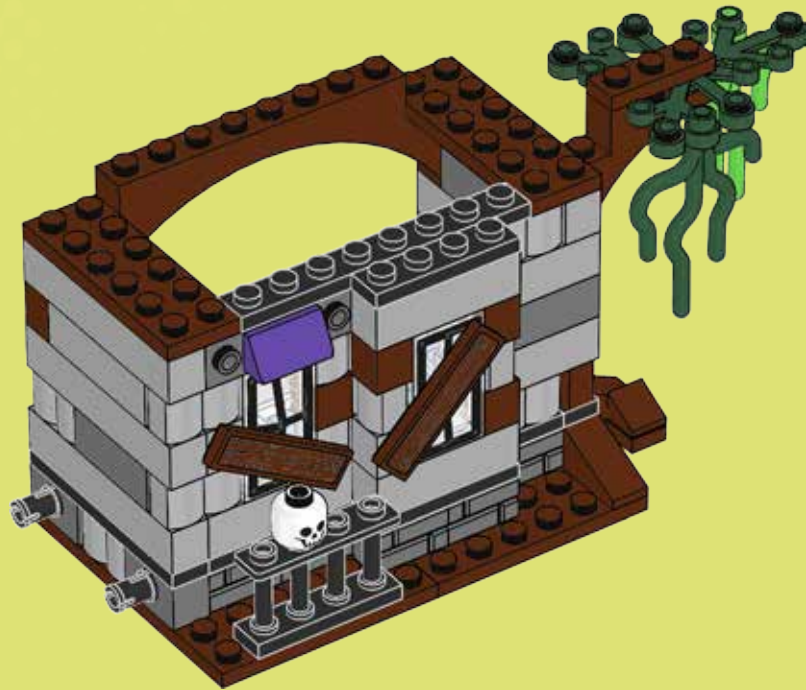

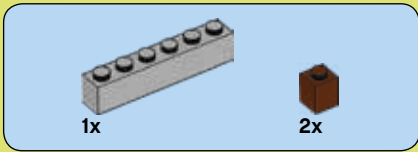

36

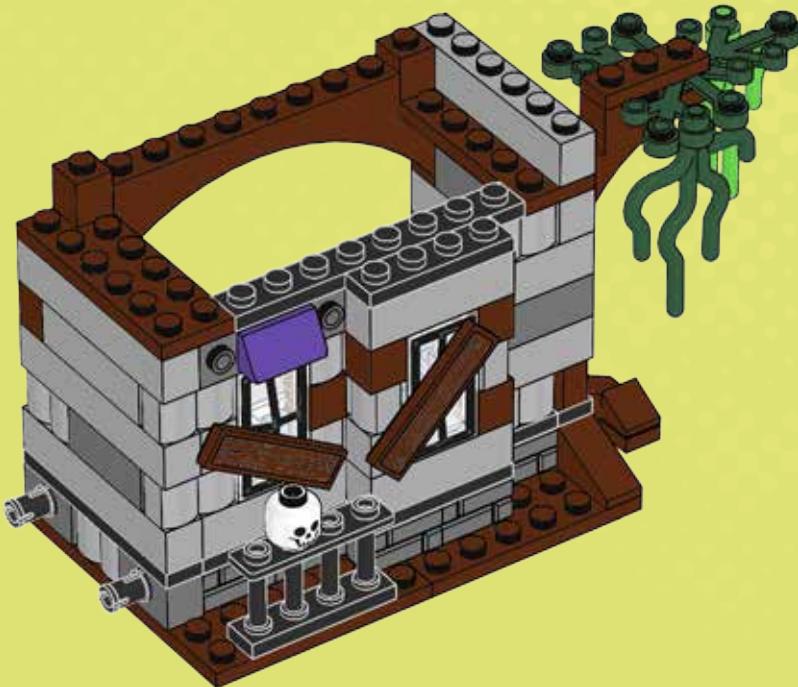

37

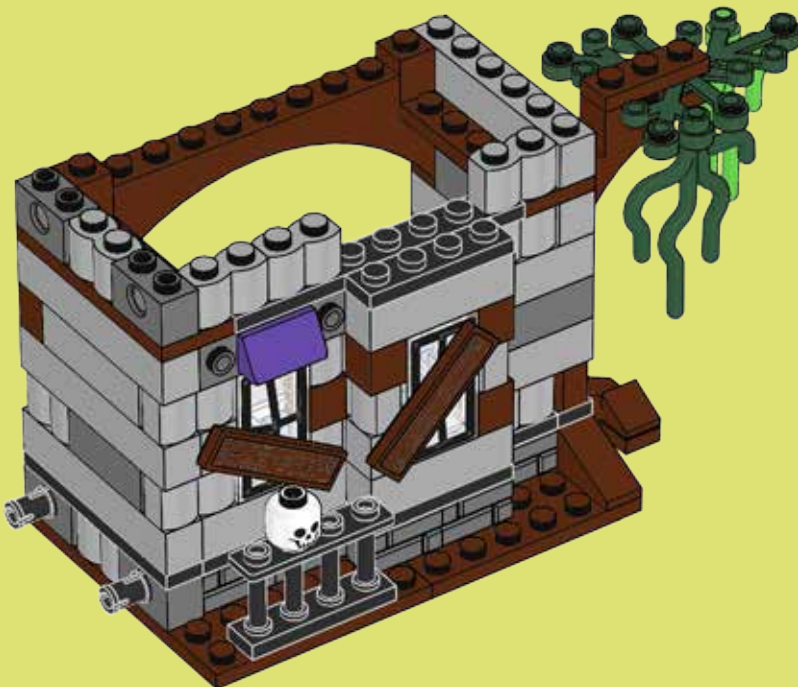

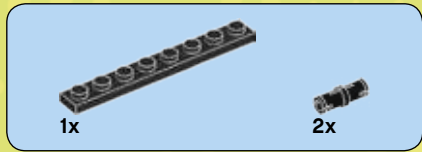

38

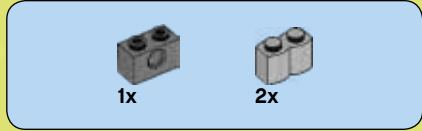
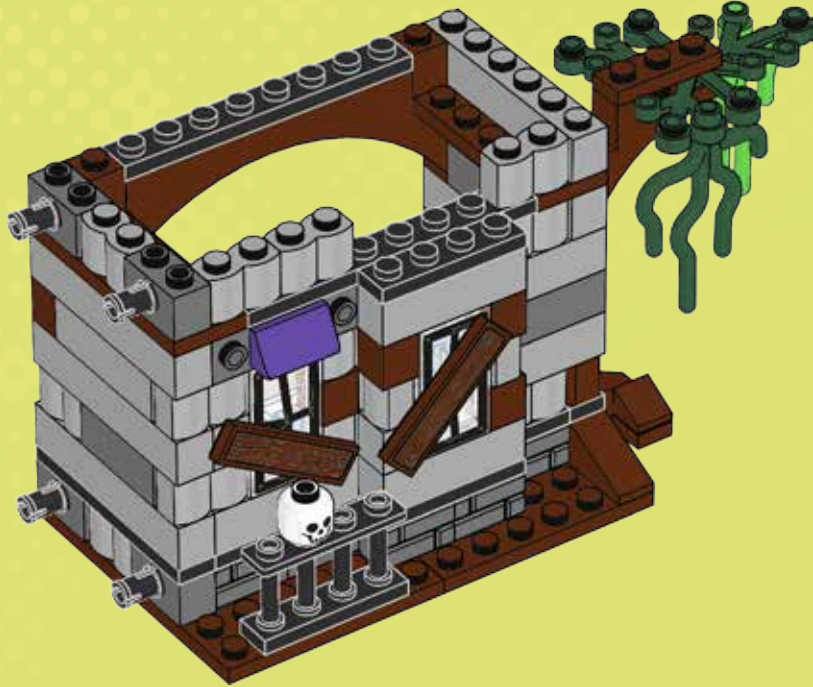

39

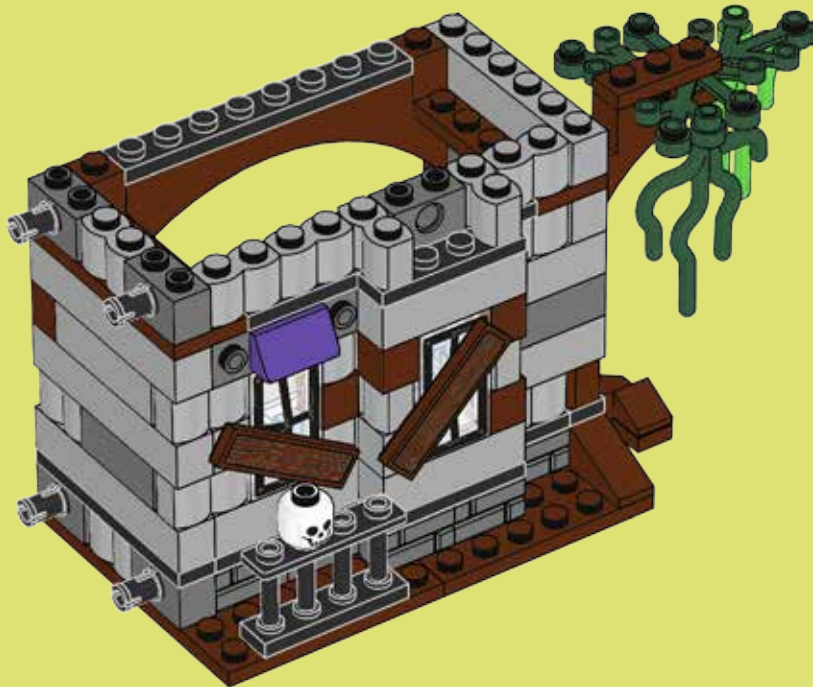



2x



1x

40

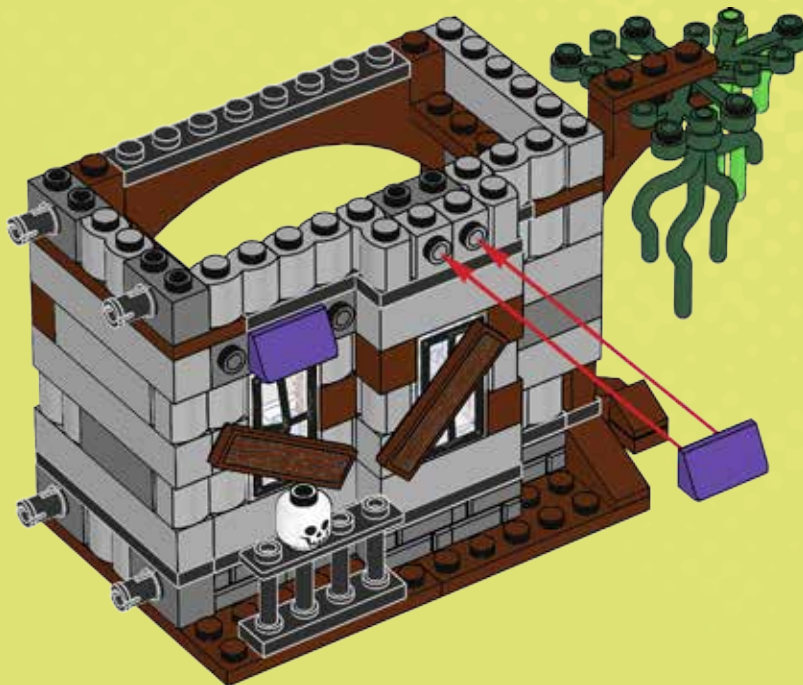

1x



2x

41

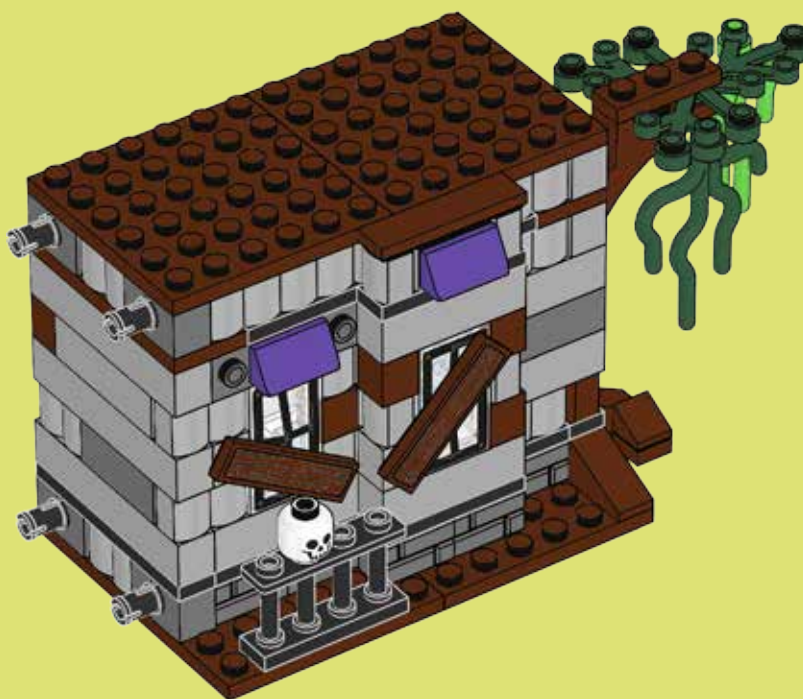



2x

42

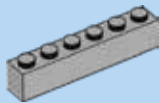
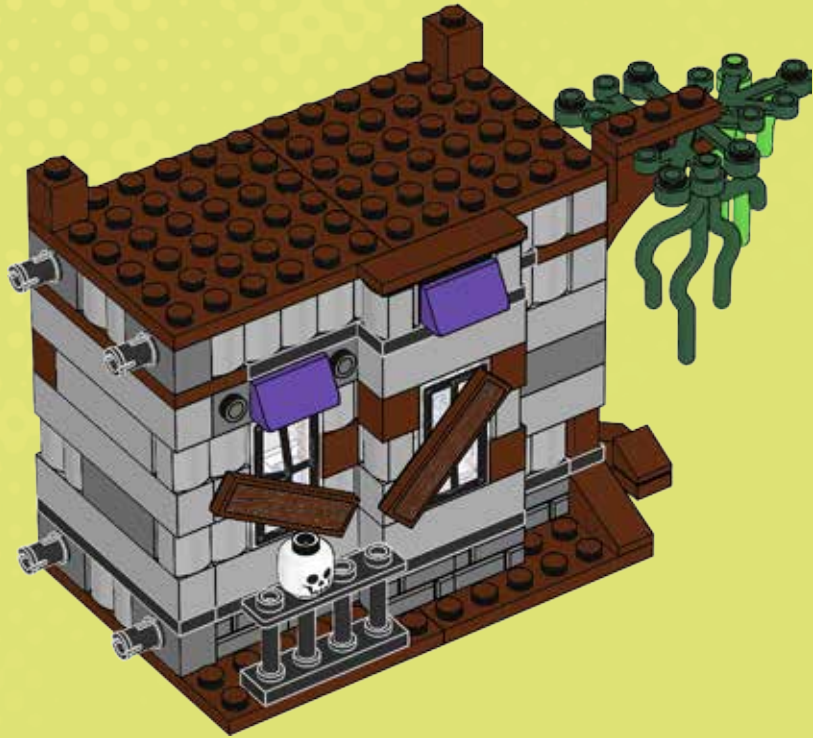

2x

43





2x

44

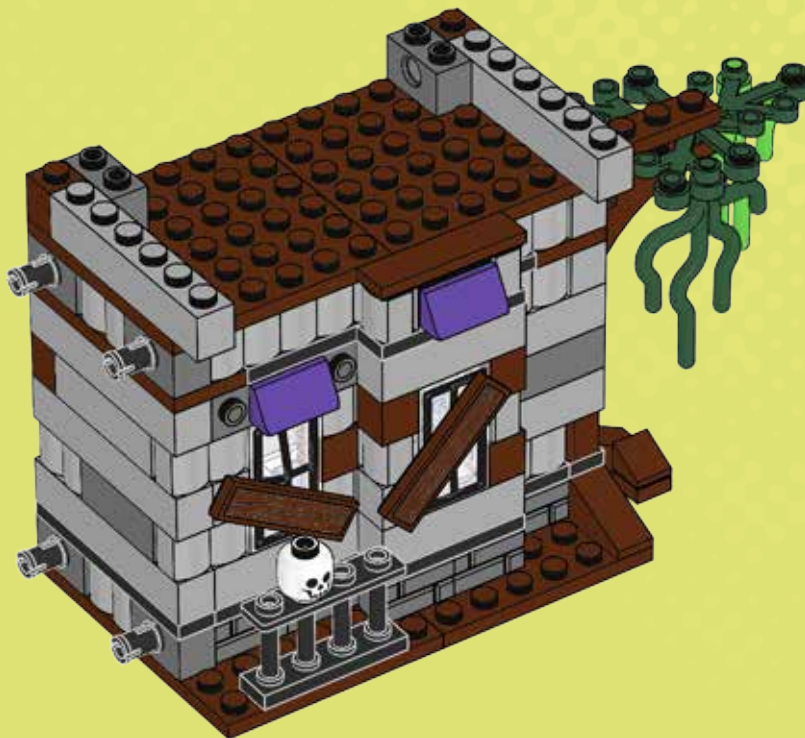

2x



2x

45





2x

46

1



2

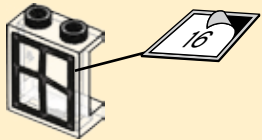

1



2

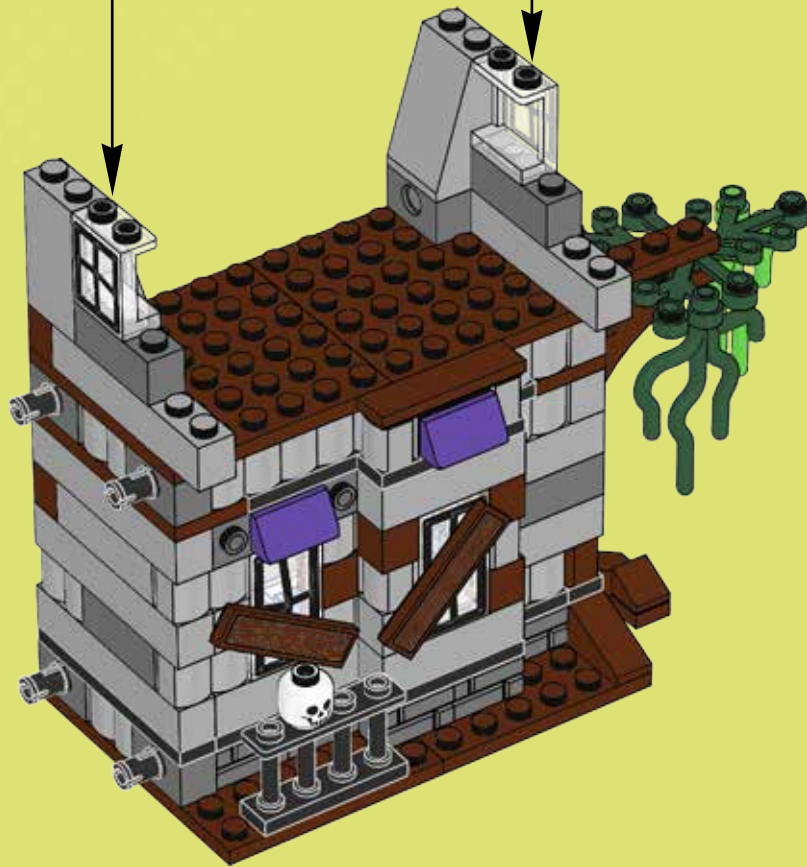
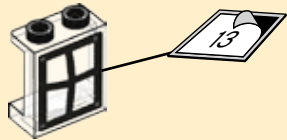



2x



2x

47



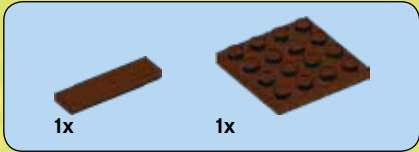

1

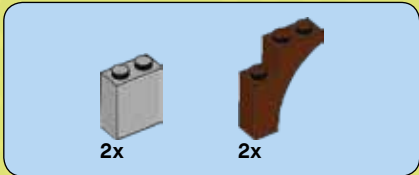
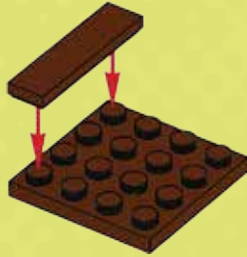

2

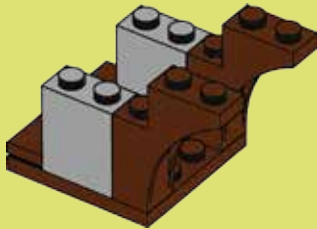

3

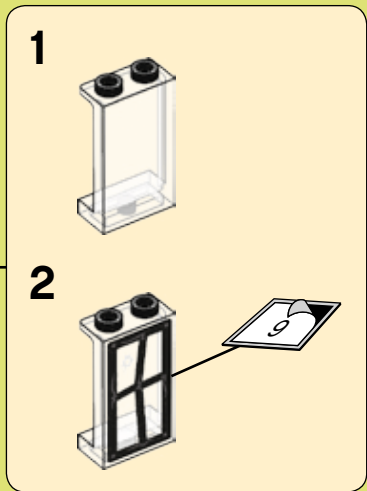
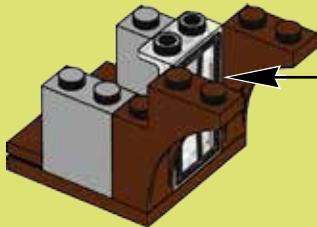

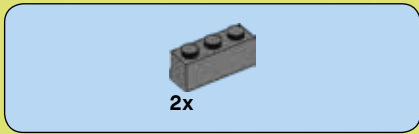

4

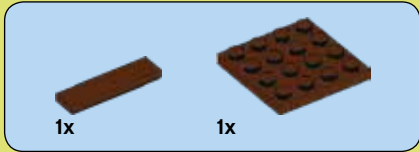
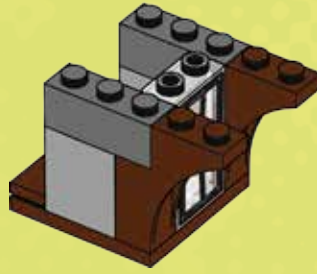

5

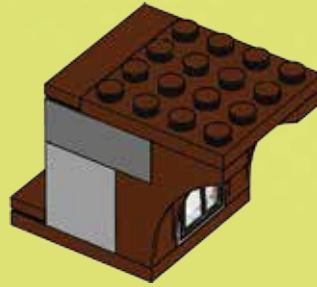

48



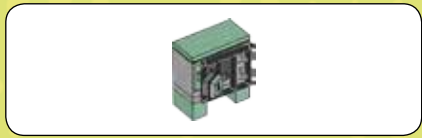

1

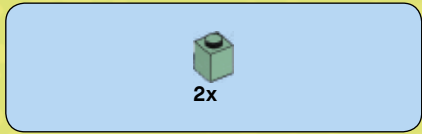

2

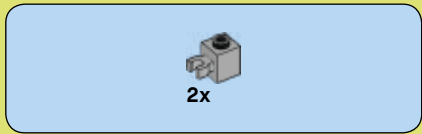
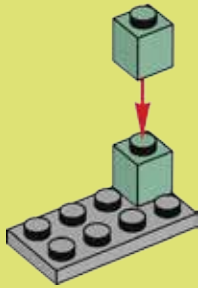

3

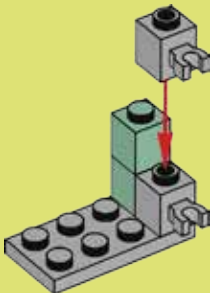

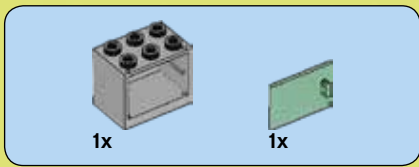

4

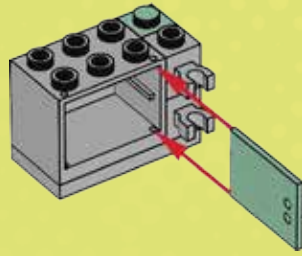

5

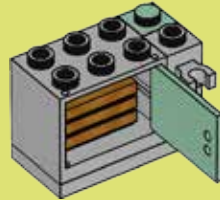

6

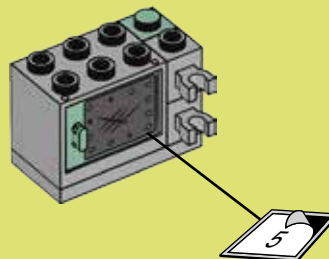

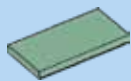

1x

7

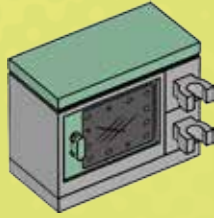

2x

8

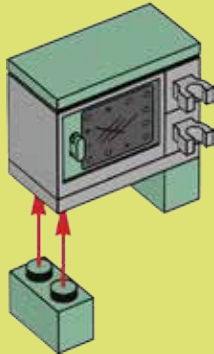

1x

9

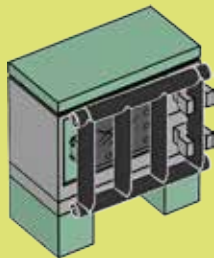



1x



1x

10

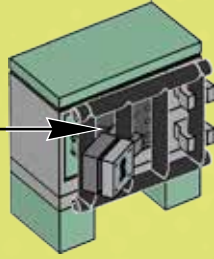
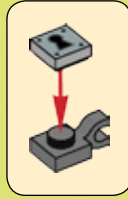

49

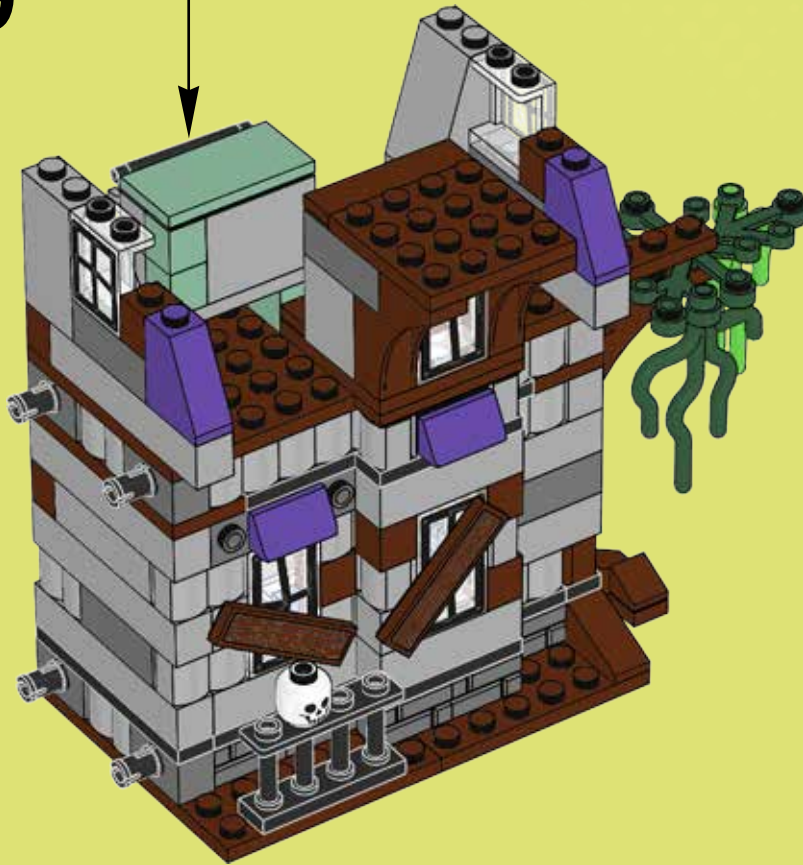



50



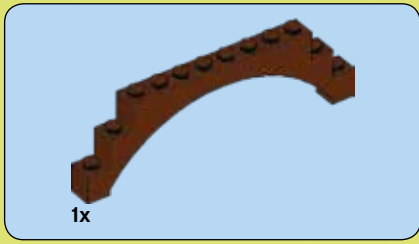

51





2x



2x

52



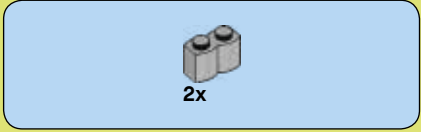

53



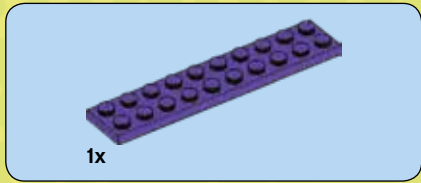
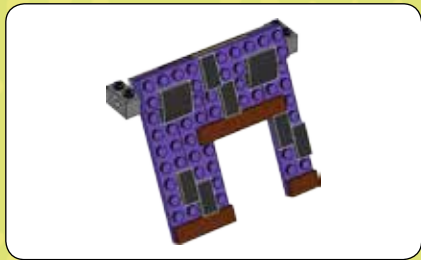

1

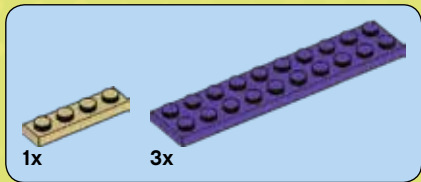
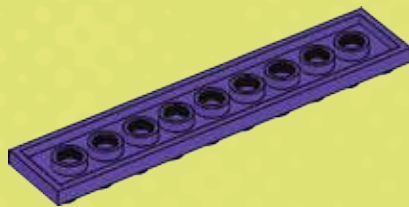

2

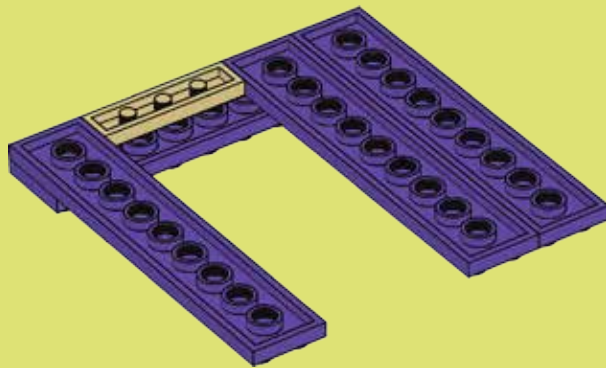

3

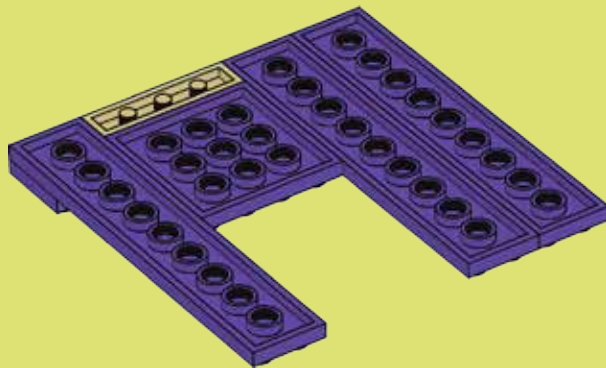



4

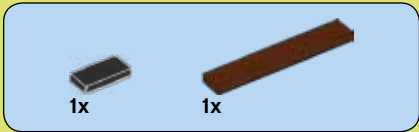
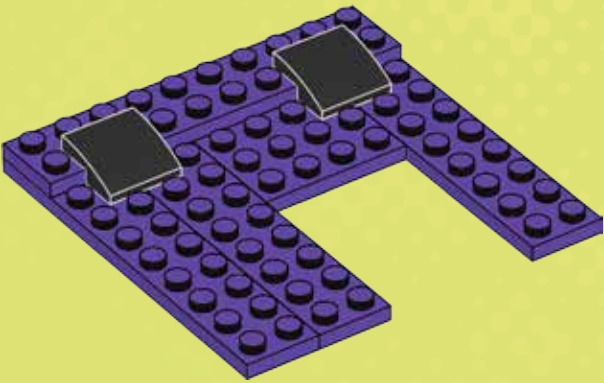

5

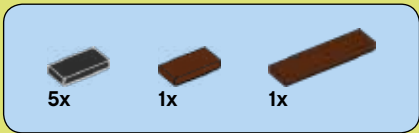
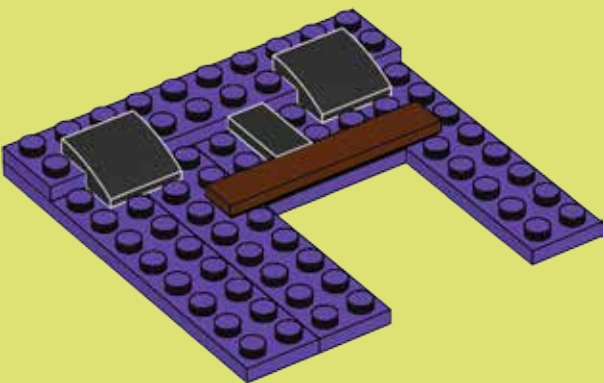

6

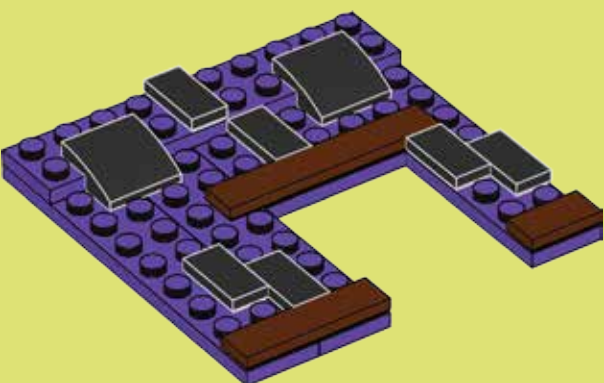



7

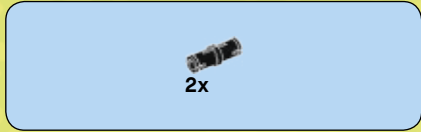
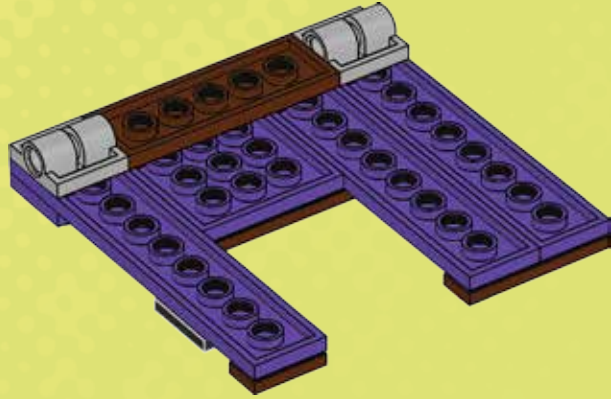

8

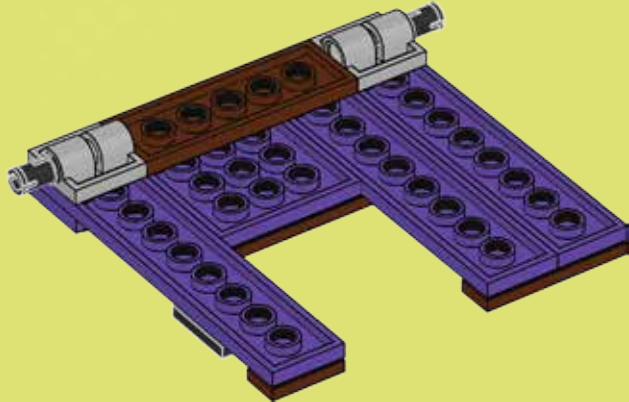

9

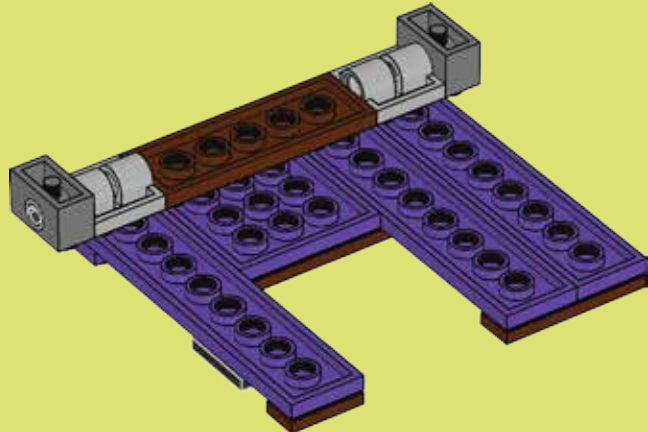

54





2x

55

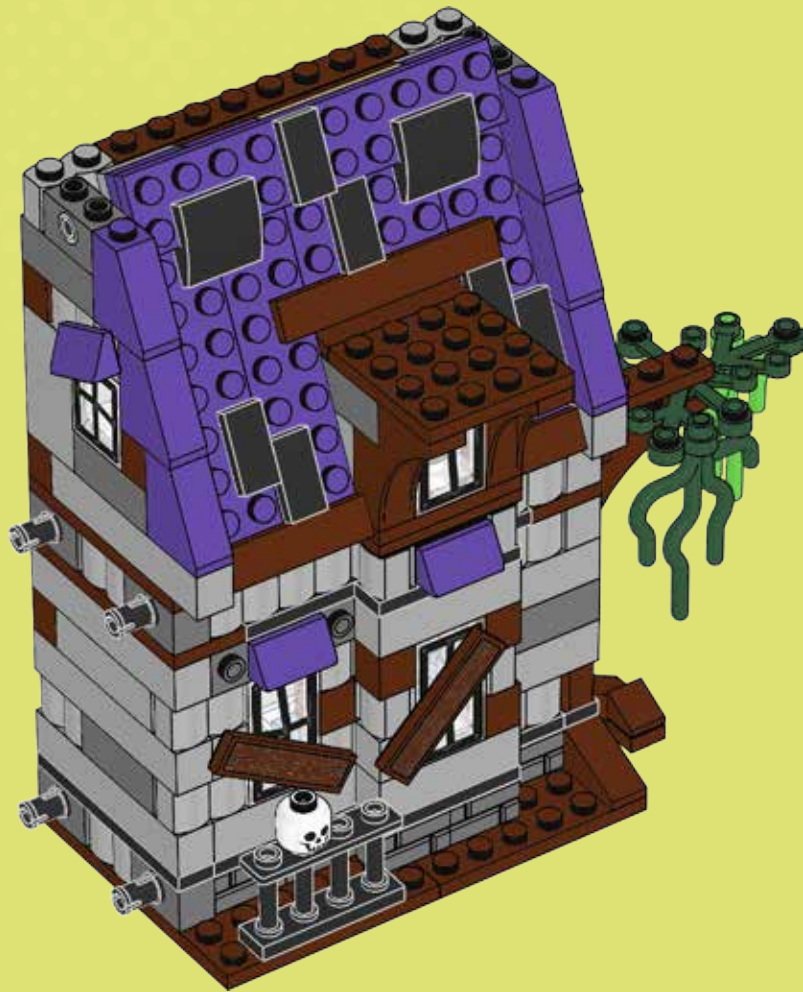



4x

56





2x

57

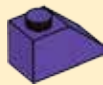

2x



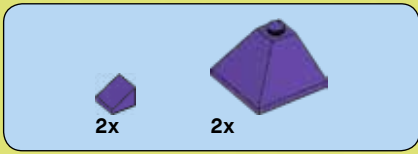

58





1x



1x

59



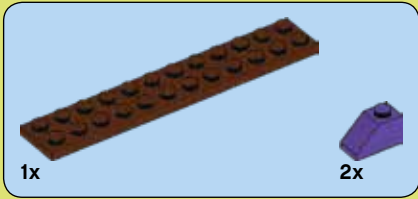

1

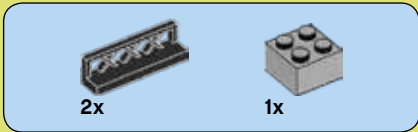
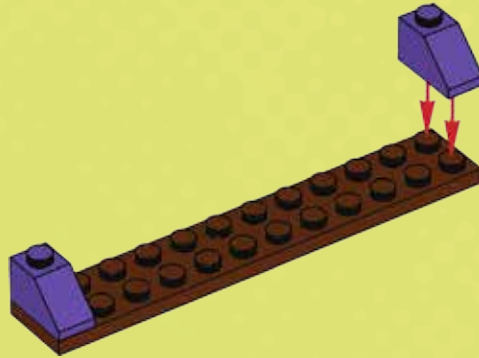

2

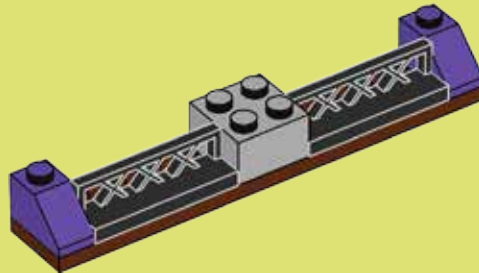

3

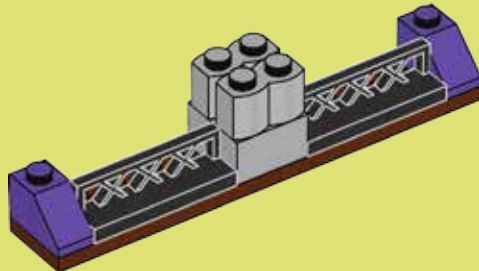

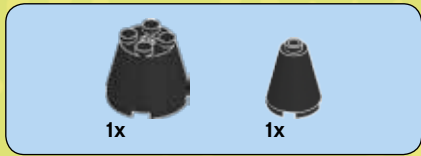

4

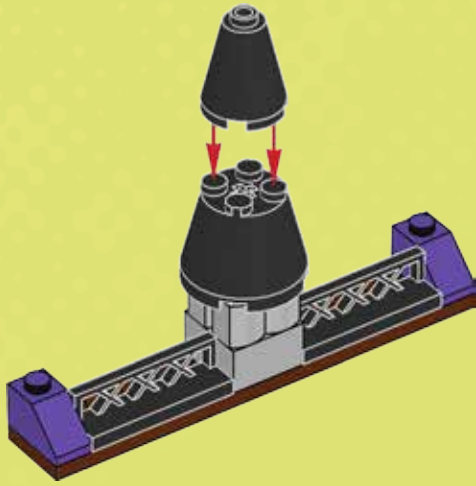

5

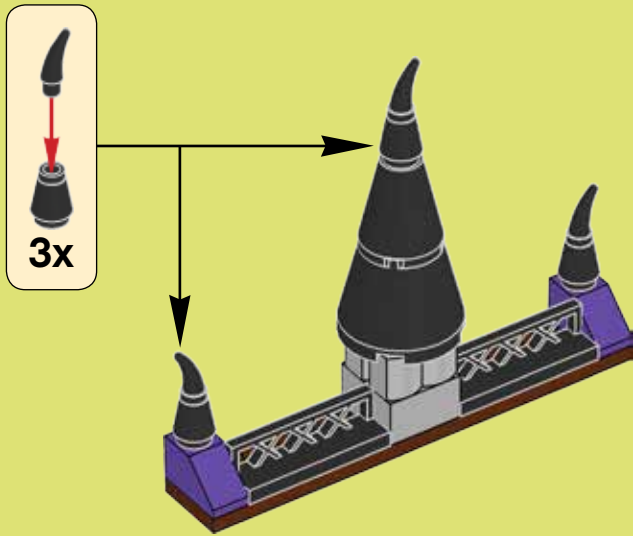



60

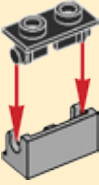
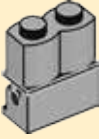

-  1x
-  1x
-  1x
-  2x
-  1x

61

- 1 
- 2 
- 3 
- 4 







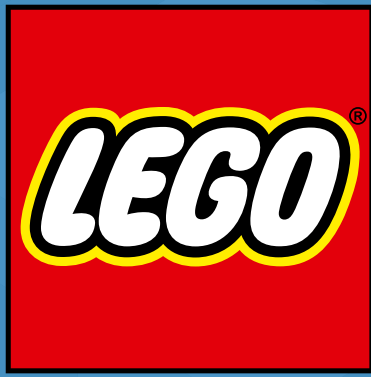

club™

**JOIN
FREE TODAY!**

**JOIGNEZ-VOUS
GRATUITEMENT!**



MAGAZINE INCLUDES:

- > Building Ideas and Game Tips
- > Kids' Creations
- > Comic Adventures

LE MAGAZINE COMPREND :

- > Des idées de construction
- > Des créations super cool
- > Des bandes dessinées

LEGO.com/club | 1-877-518-5346

1



LEGO.com/club

2



3



LEGO and the LEGO logo are trademarks of the/son des marques de commerce du/
son marcas registradas de LEGO Group. ©2015 The LEGO Group. 6132713



Download Zappar App
Scan the page
Play Activity!

Télécharge l'application Zappar
Scanne la page
Joue à l'activité!

Descarga la app Zappar
Escanea la página
¡Juega!



TM/MC & © Hanna-Barbera.
WB SHIELD: TM/MC & © Warner Bros. Entertainment Inc.
MR y © Hanna-Barbera.
WB SHIELD: MR y © Warner Bros. Entertainment Inc.
(s15)

Apple, the Apple logo, iPad, iPhone and iPod touch are trademarks of Apple Inc. Apple, le logo Apple, iPad, iPhone et iPod touch sont des marques de commerce d'Apple Inc. Apple, el logotipo de Apple, iPad, iPhone e iPod touch son marcas comerciales de Apple Inc. Google Play is a trademark of Google Inc. Google Play est une marque de commerce de Google Inc. Google Play es una marca comercial de Google Inc.