



SCOOBY-DOO!

75903



[LEGO.com/scoobydoo](https://www.lego.com/scoobydoo)



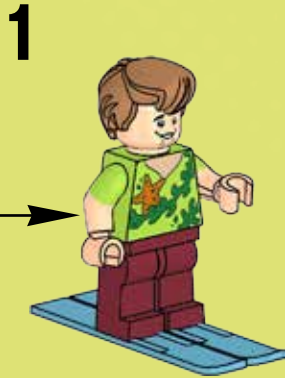
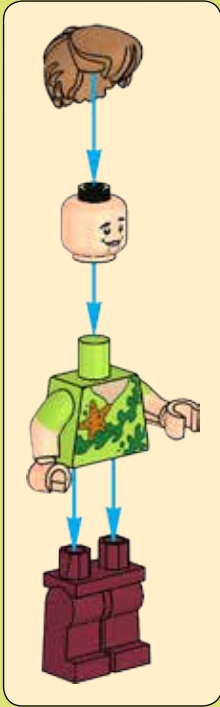
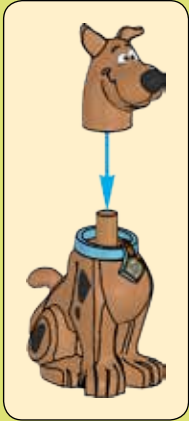

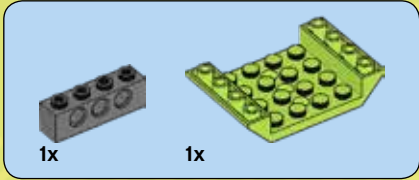
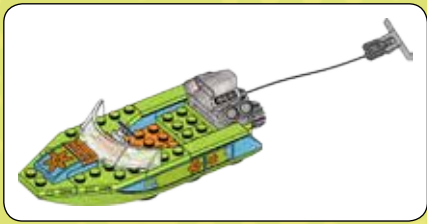

1

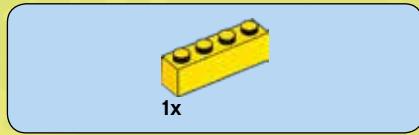
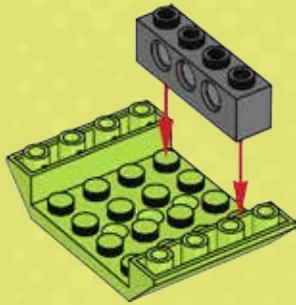

2

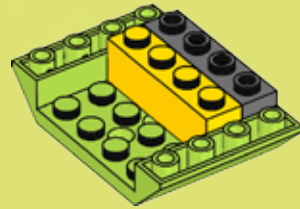



2x

3

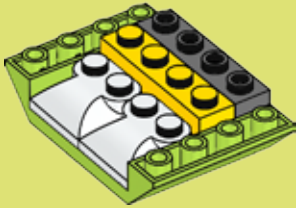

2x

4



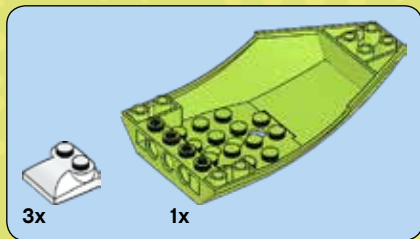

5

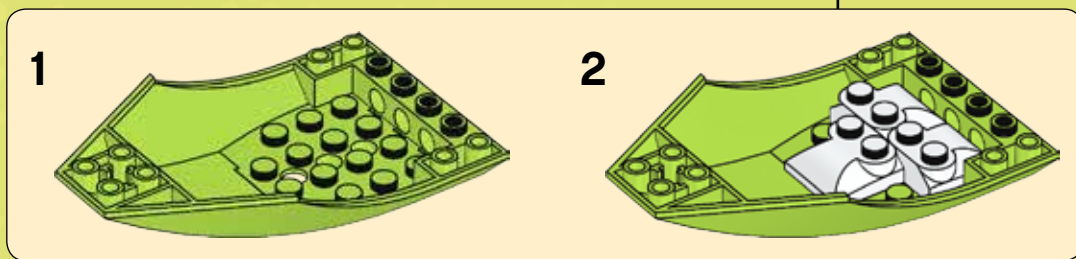
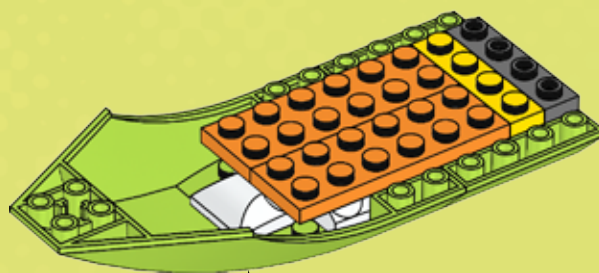



1x



2x

6

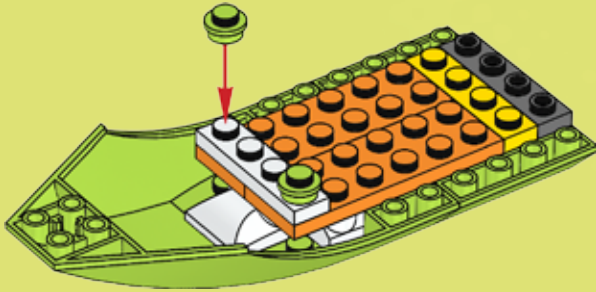

2x



2x

7

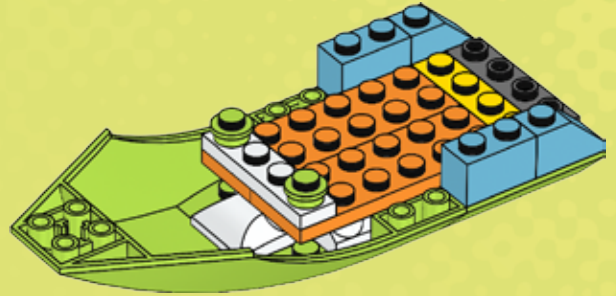

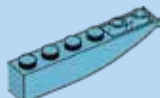

2x

8

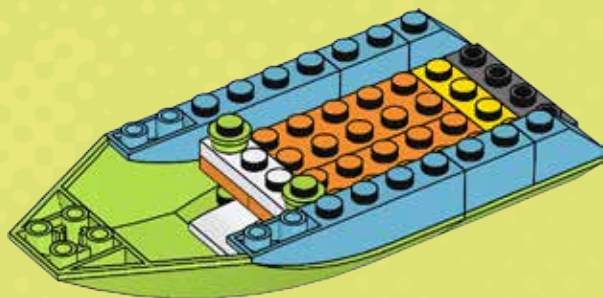

9

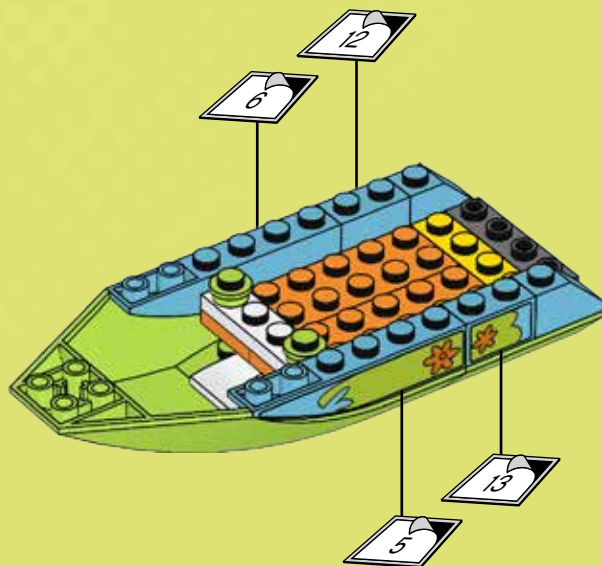



3x

10

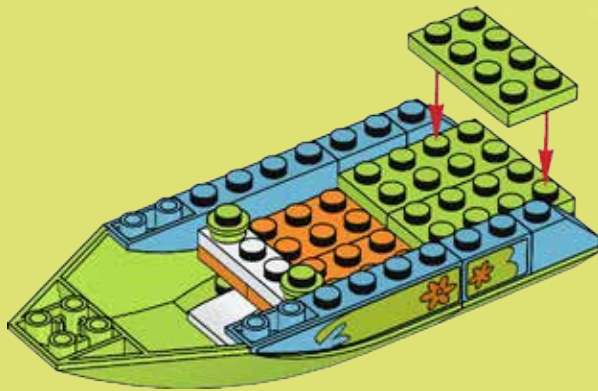

2x



1x

11

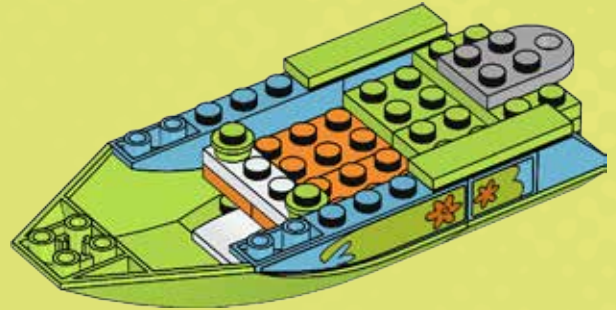

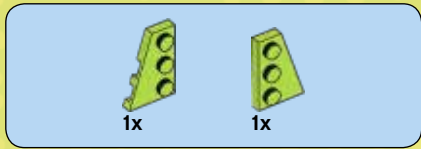

12

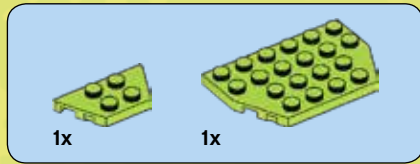
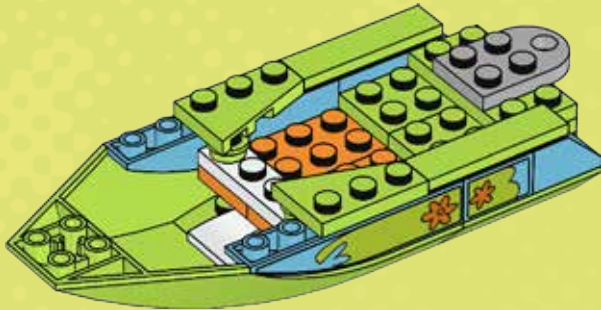

13

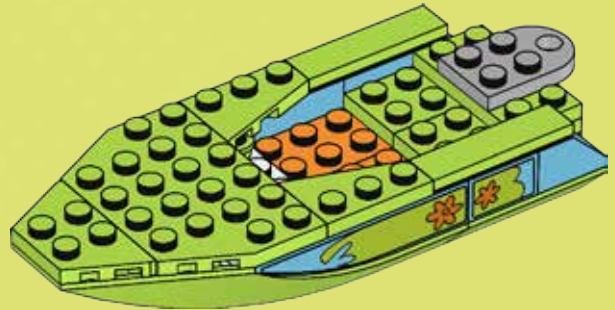



6x

14

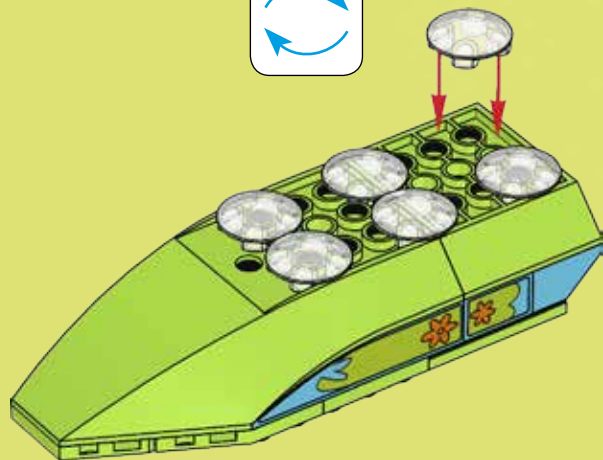
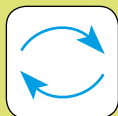

1x

15

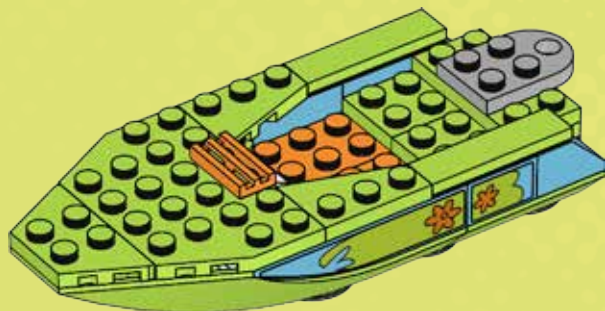



16

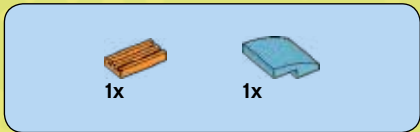
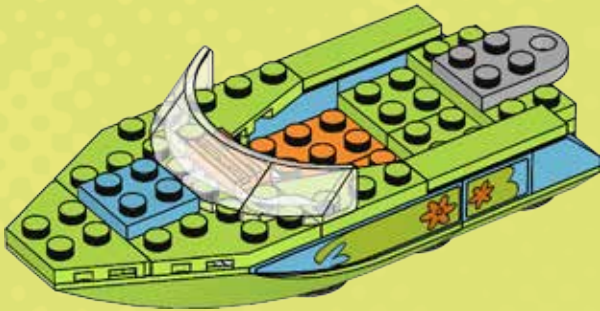

17

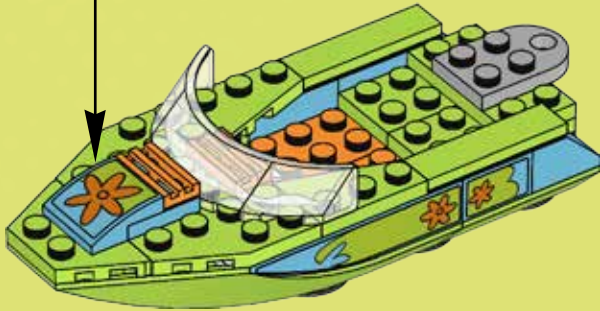
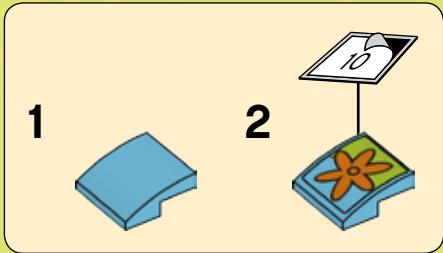



1x



2x

18

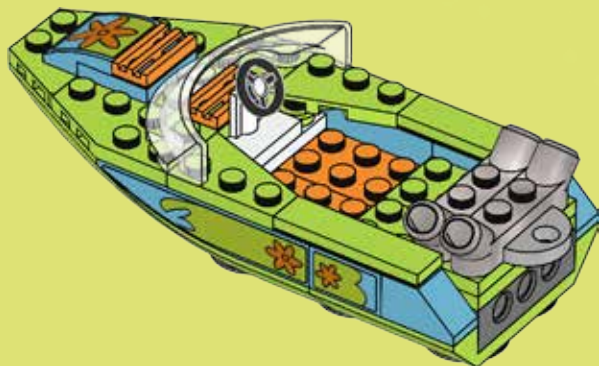

1x



1x



1x

19

1

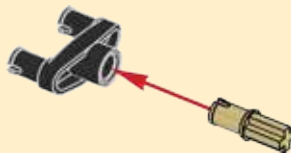

2

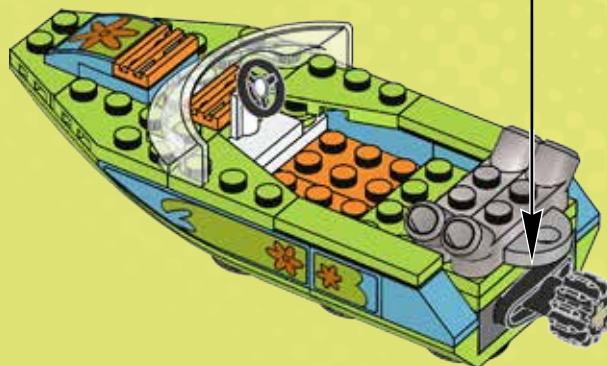

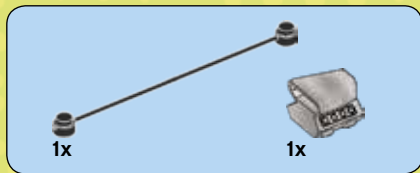

20

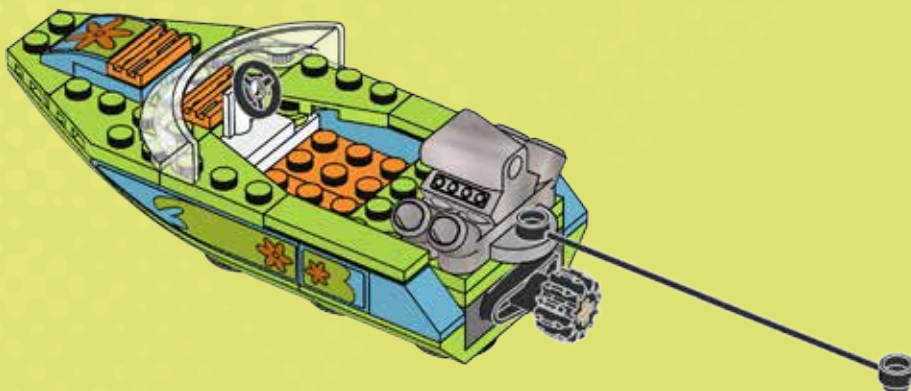



1x



1x

21

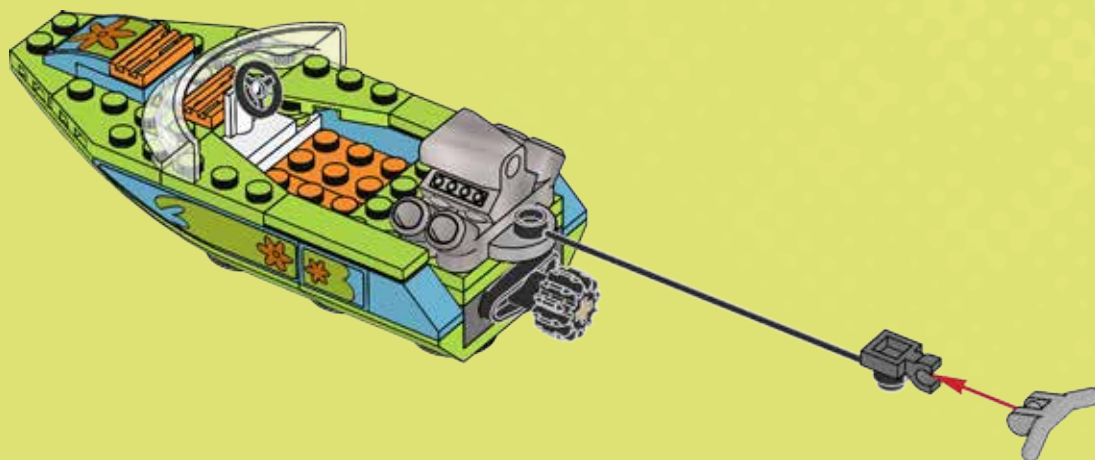



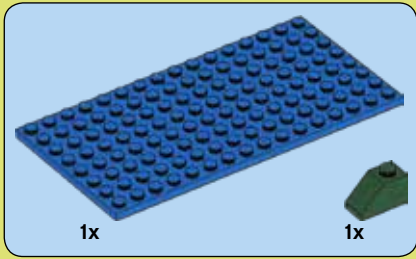
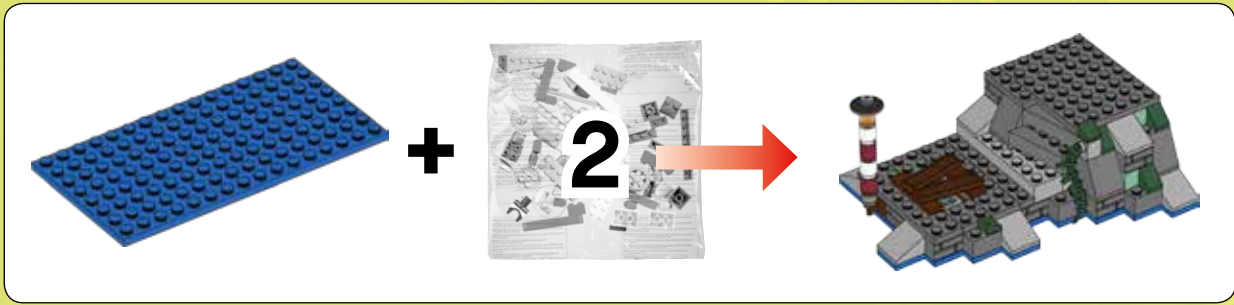

1

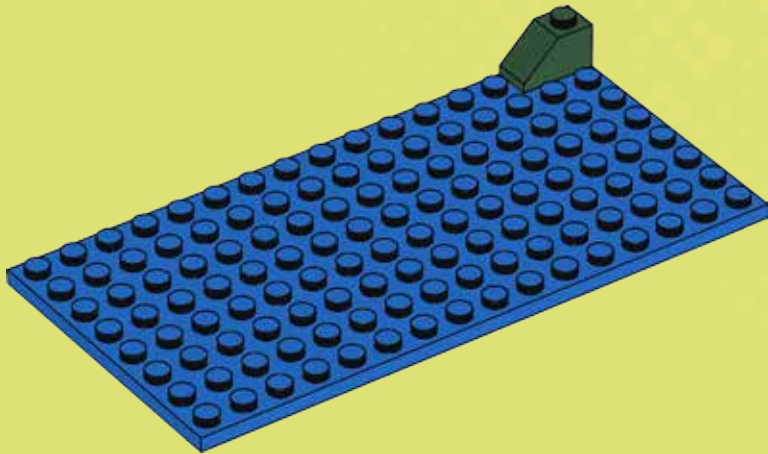



1x



1x

2

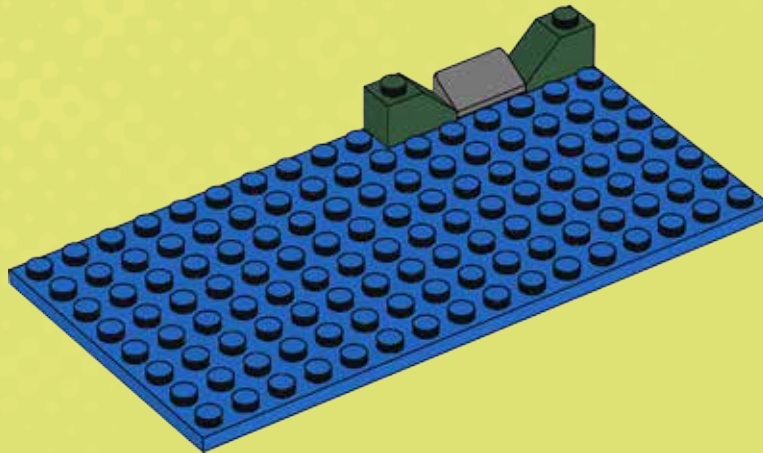

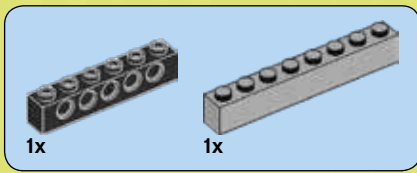

3

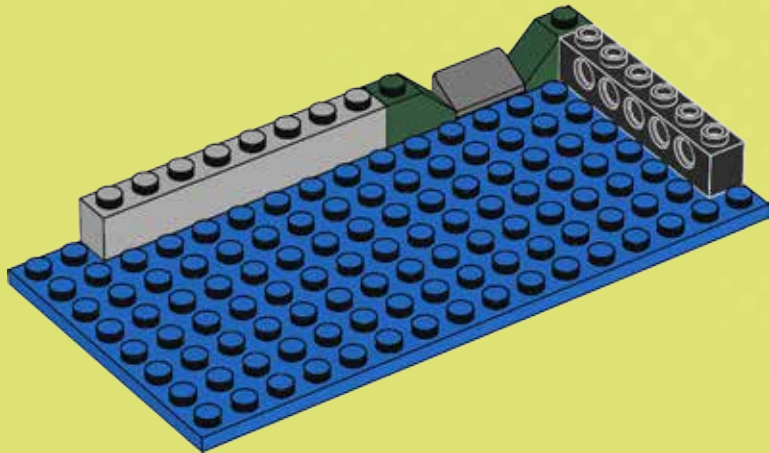

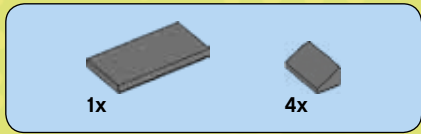

4

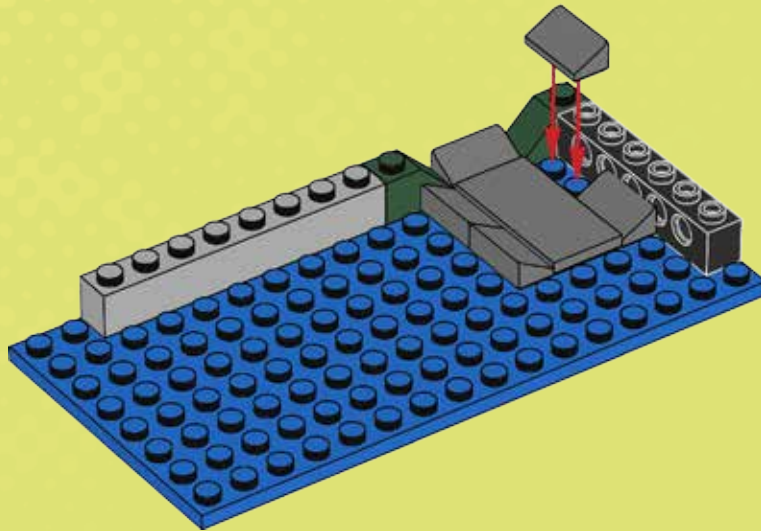

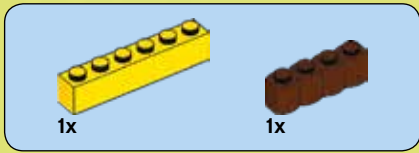

5

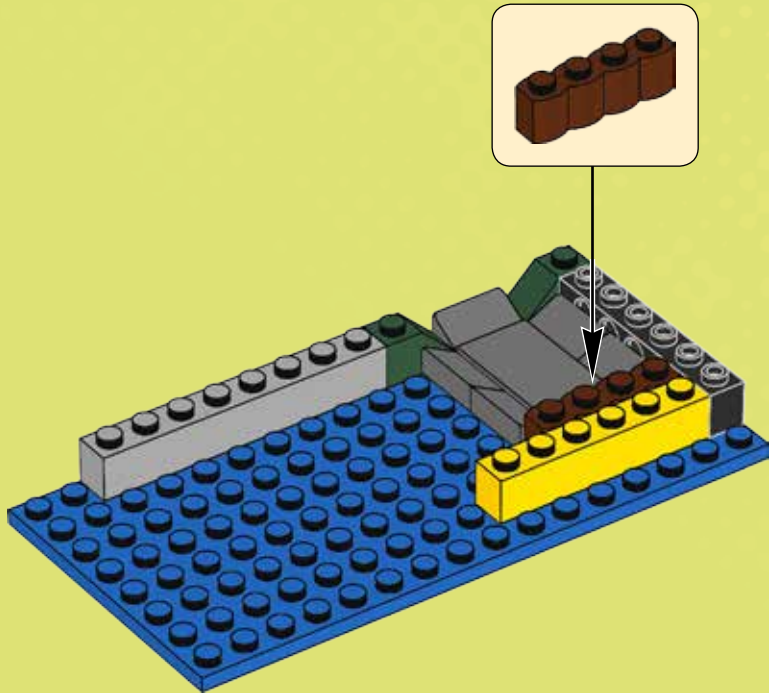

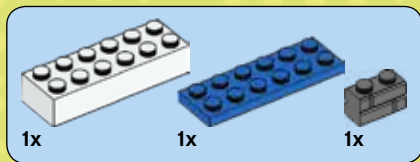

6

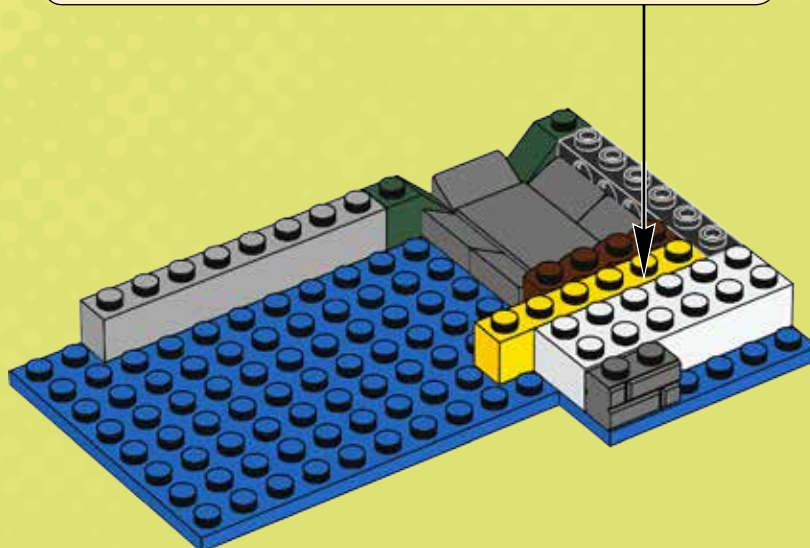
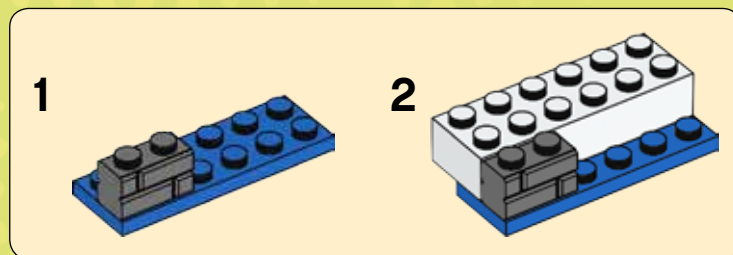

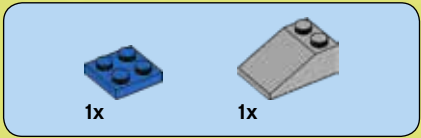

7

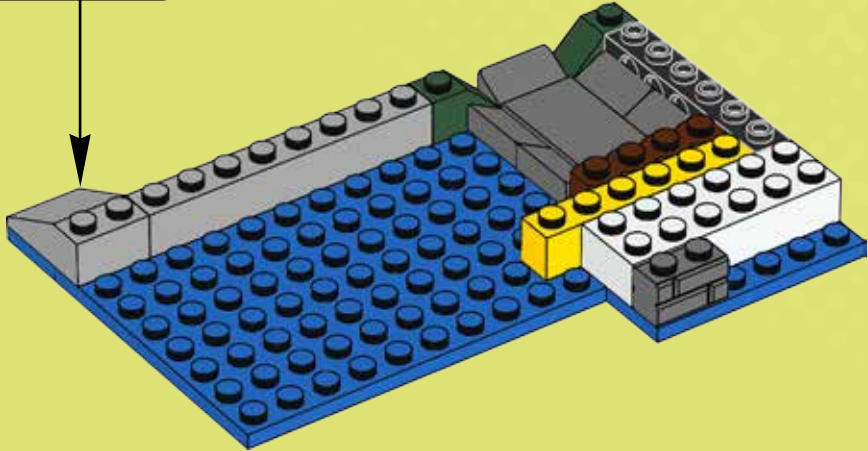
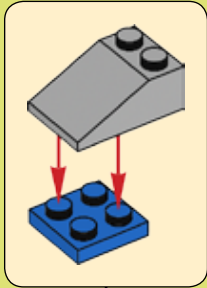



8

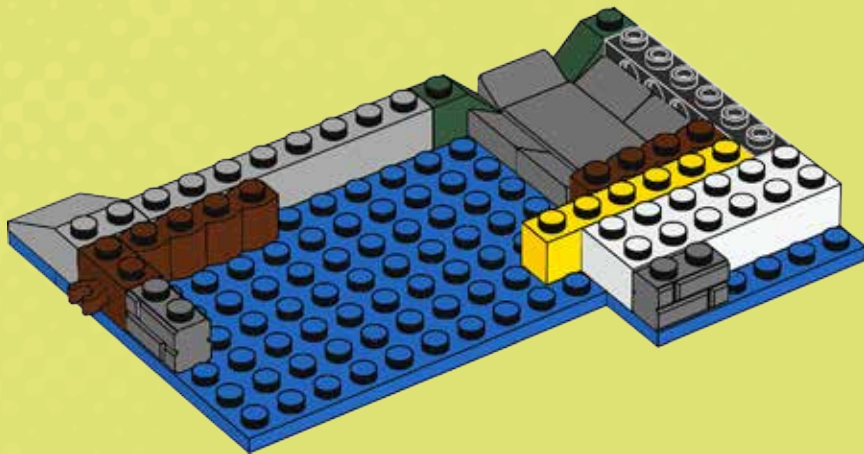

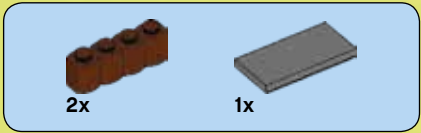

9

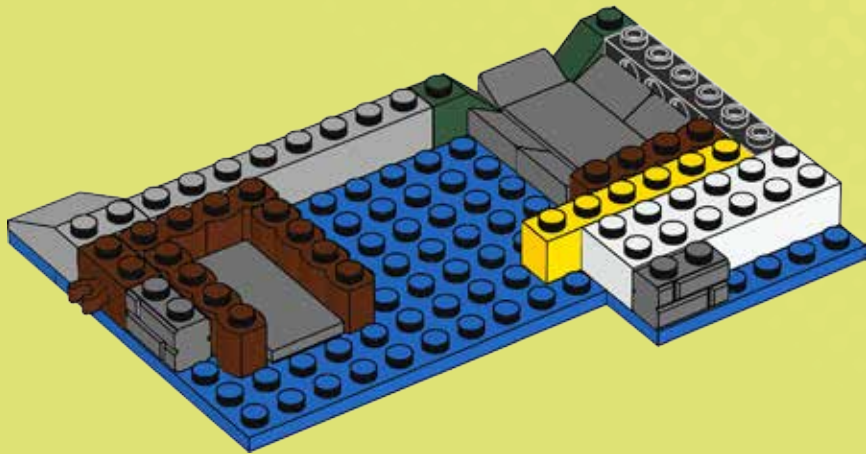



1x



1x

10

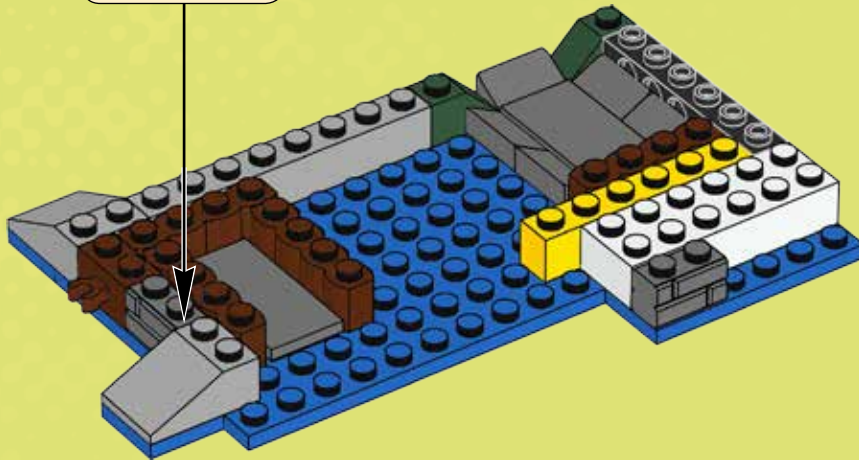
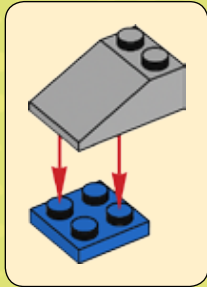

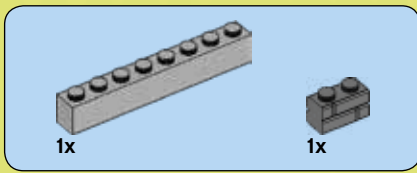

11

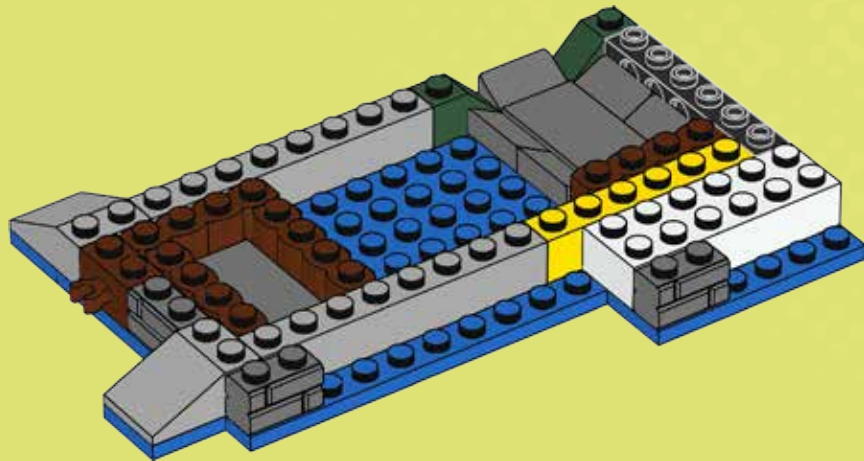



3x



3x

12

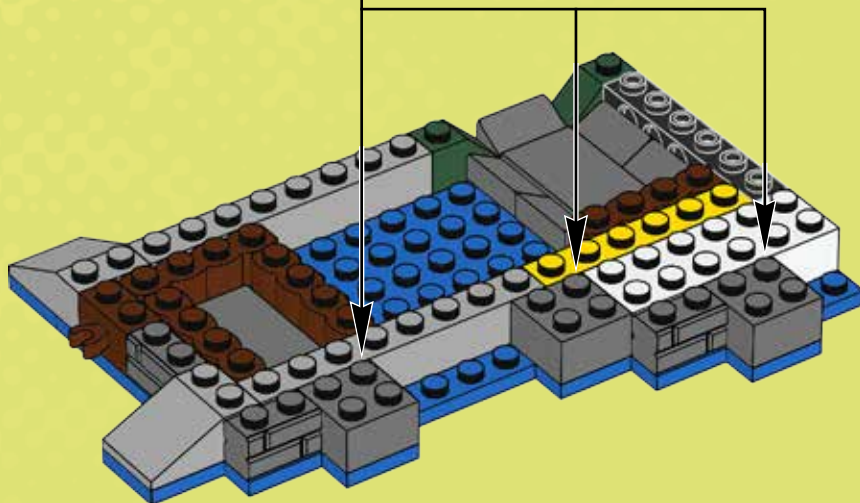
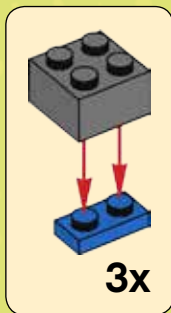

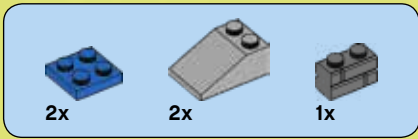

13

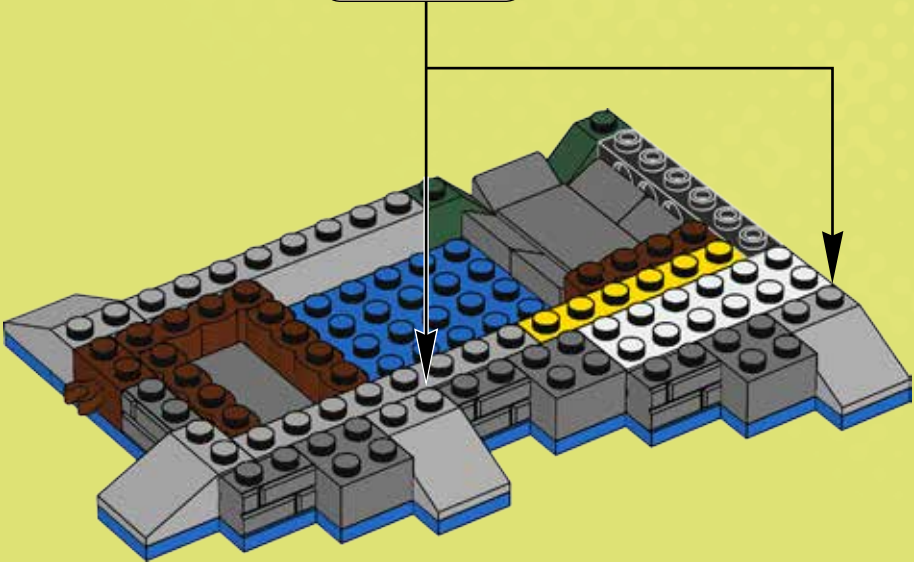
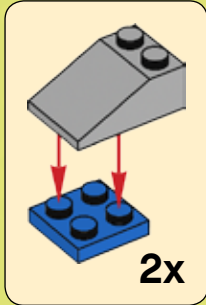



14

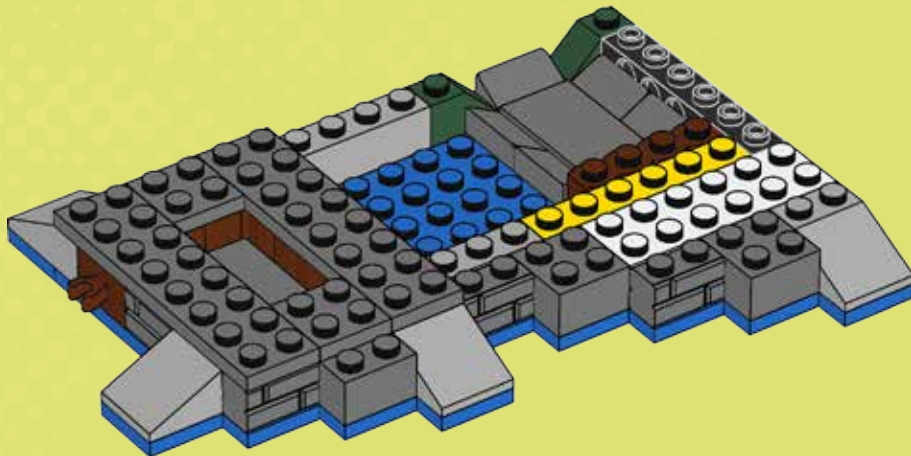

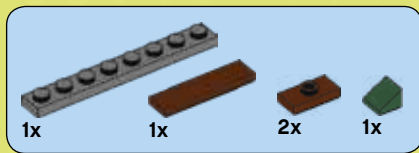

15

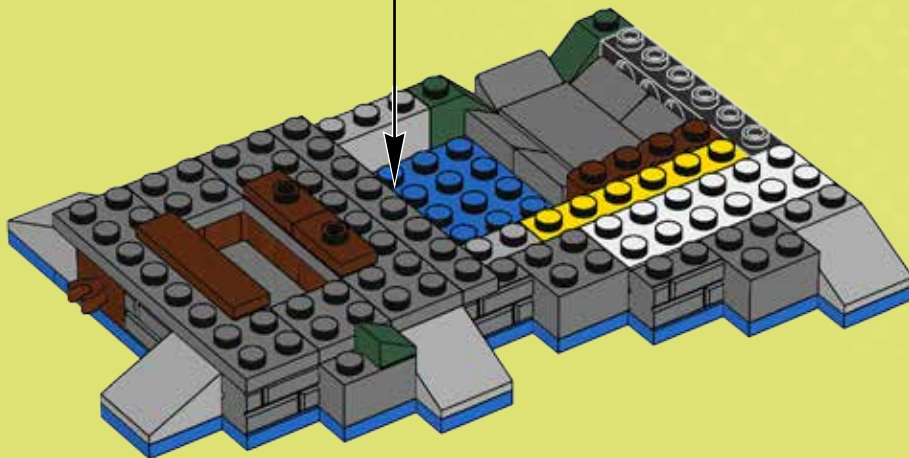
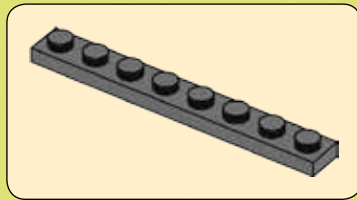

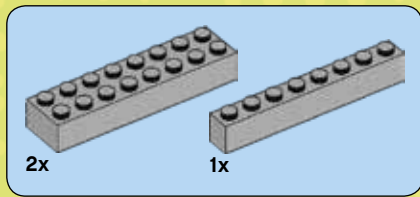

16

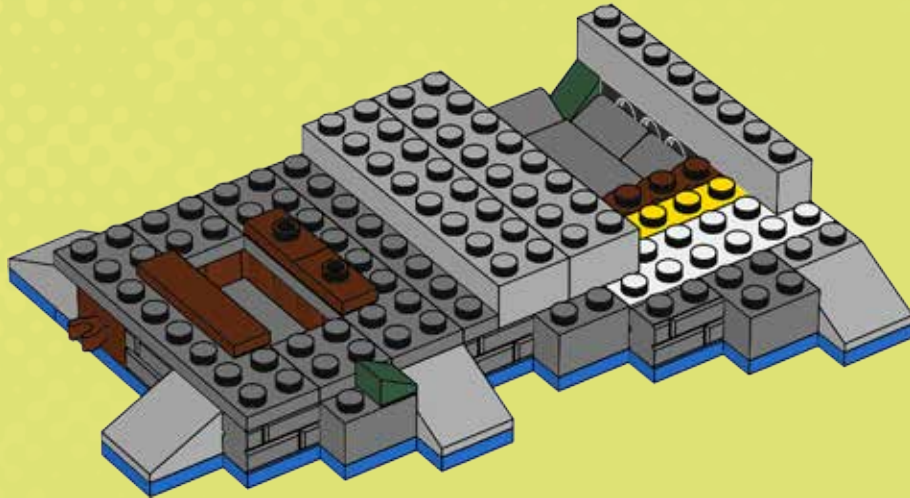

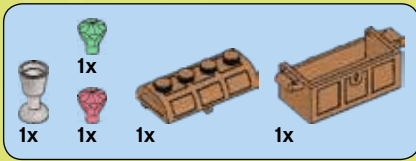

17

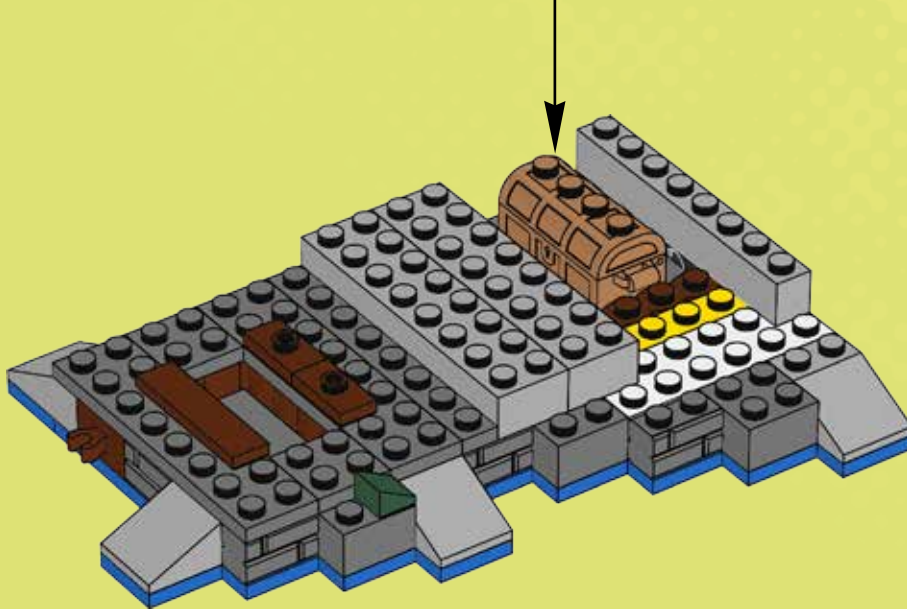
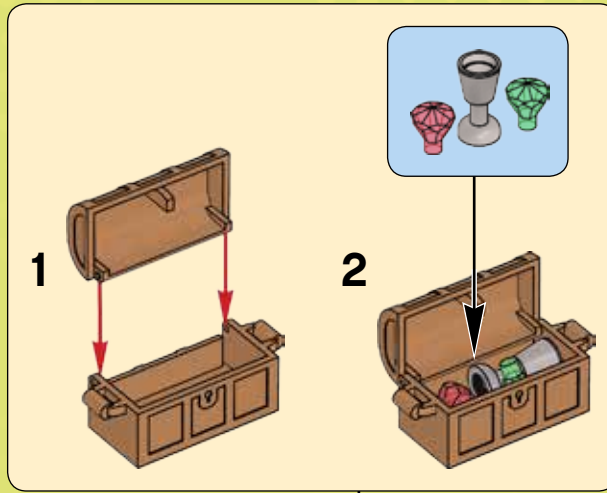

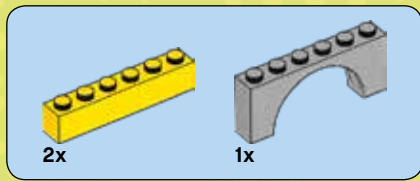

18



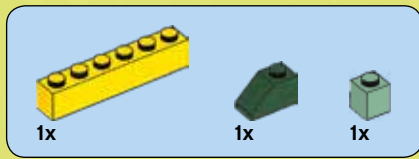

19

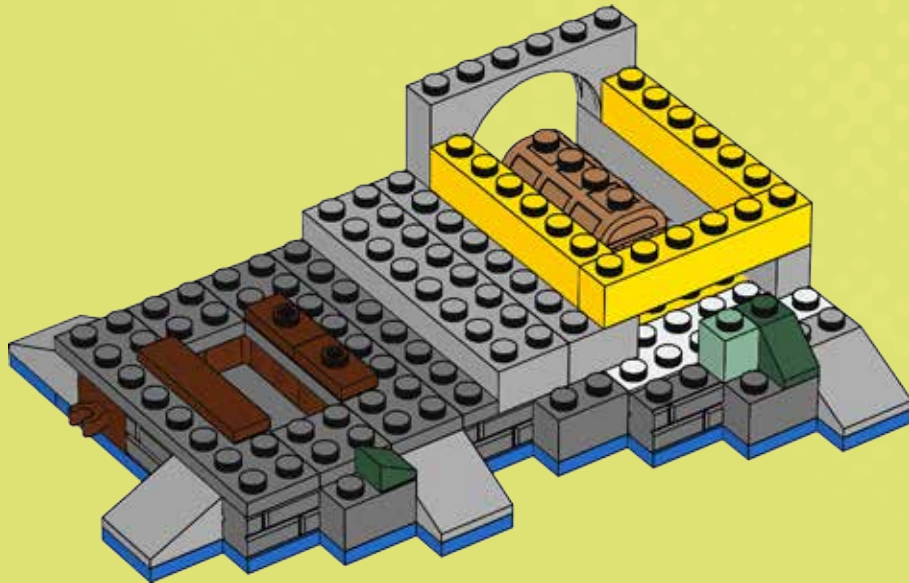



2x



1x

20

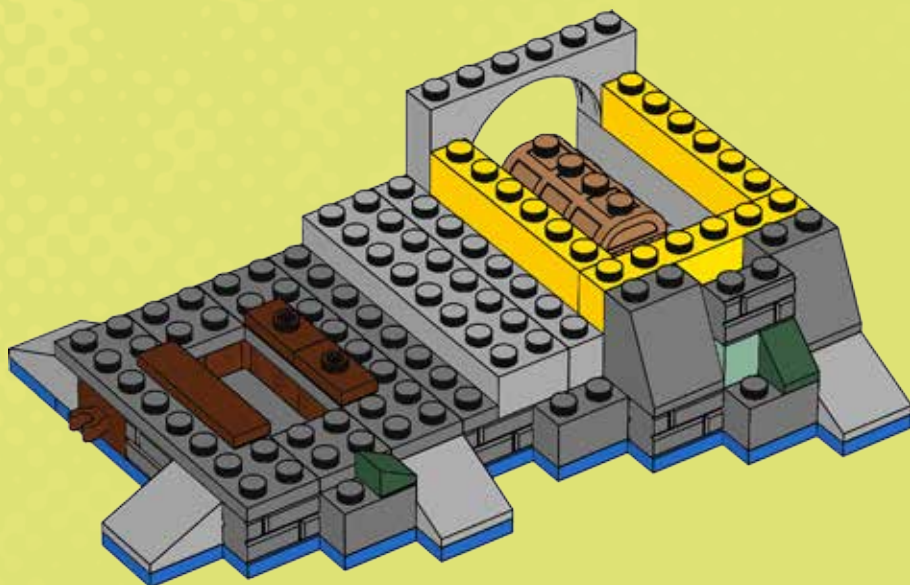

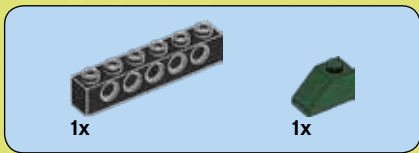

21

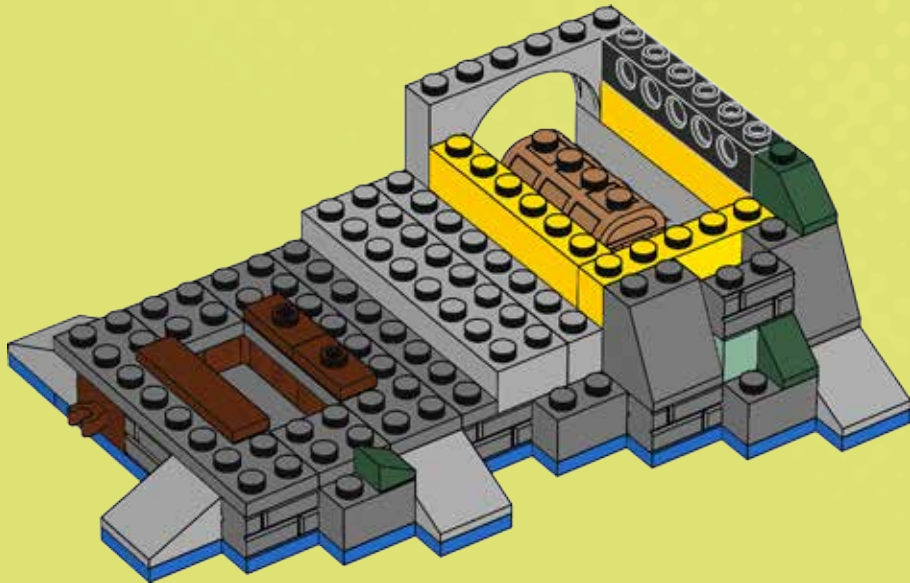



1x



1x



1x

22

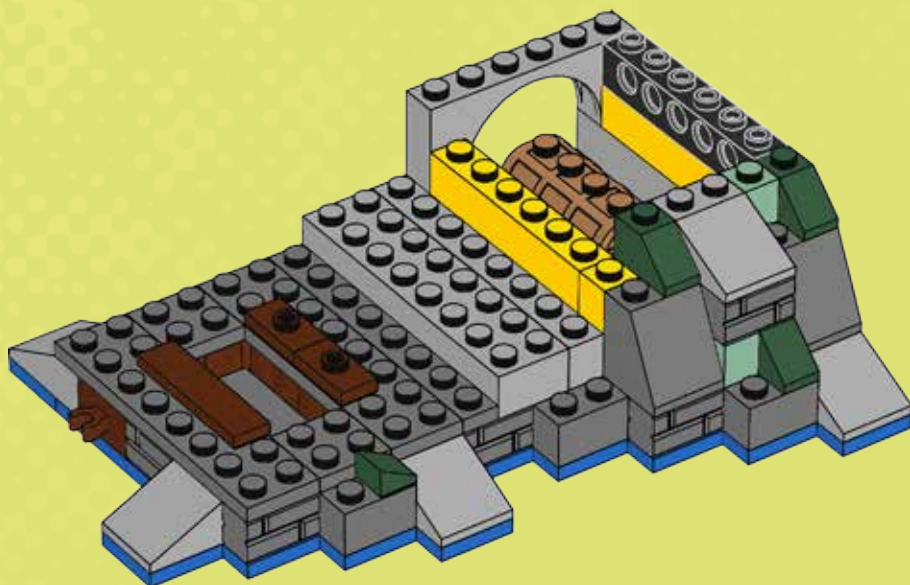



1x



1x

23

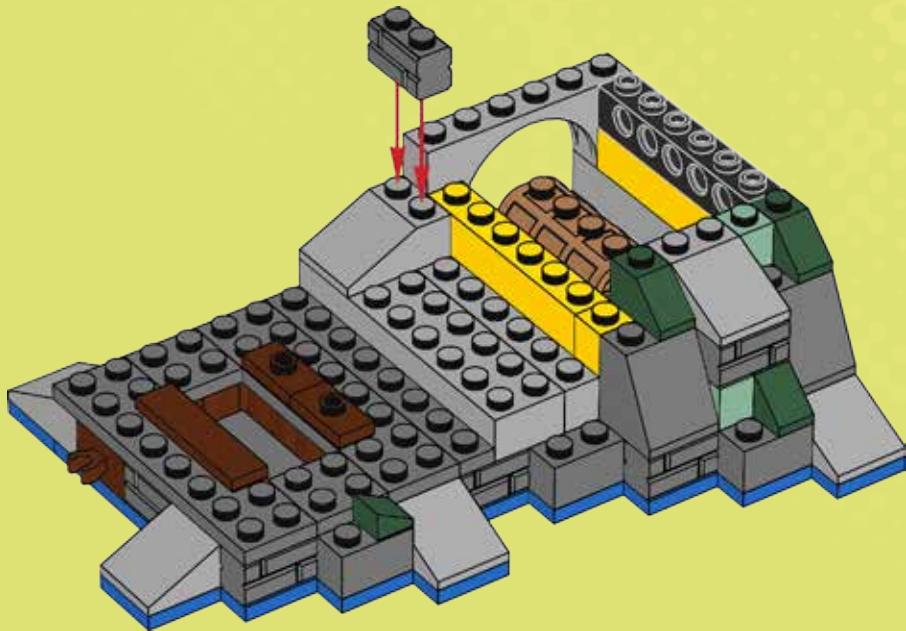



1x



1x

24

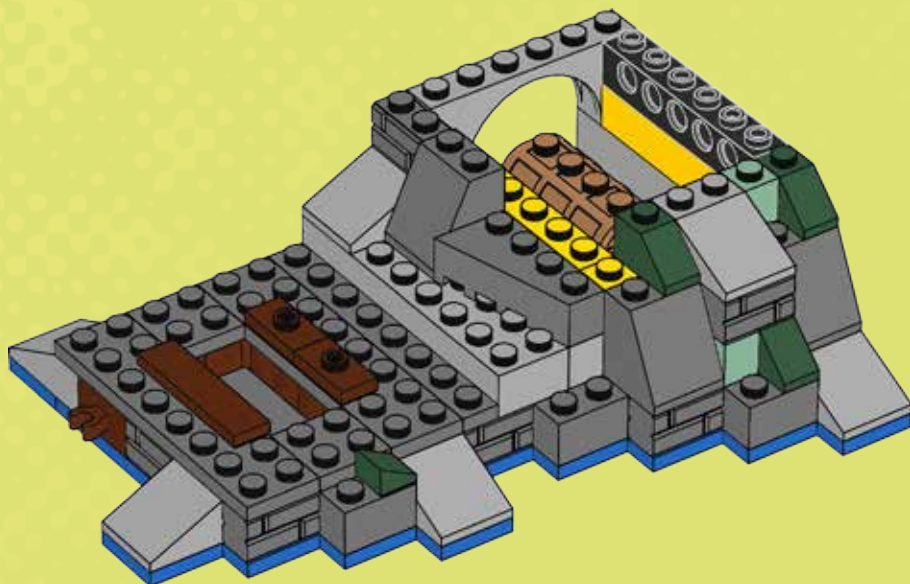



1x



1x

25

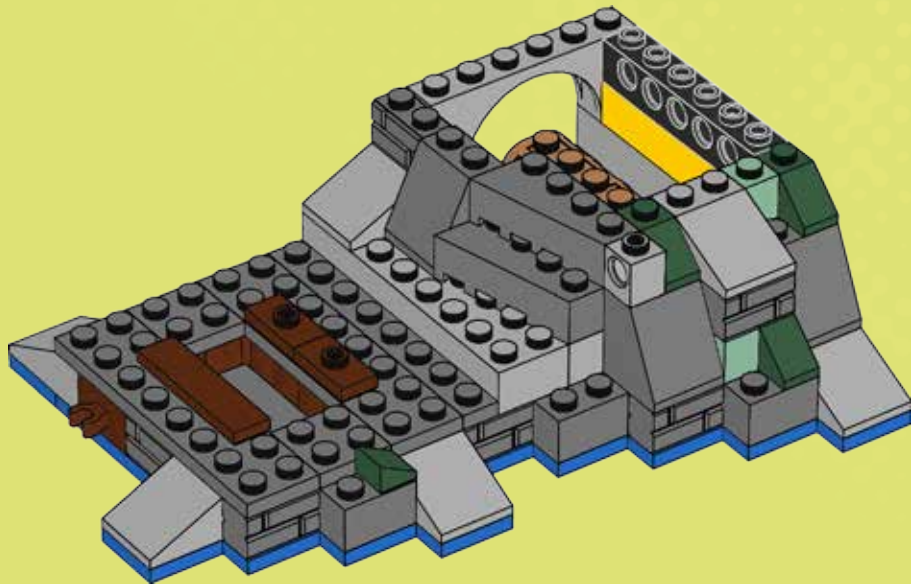

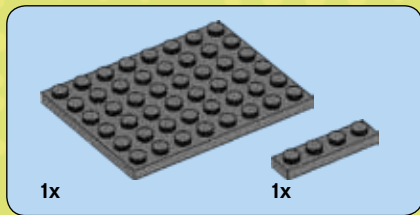

26

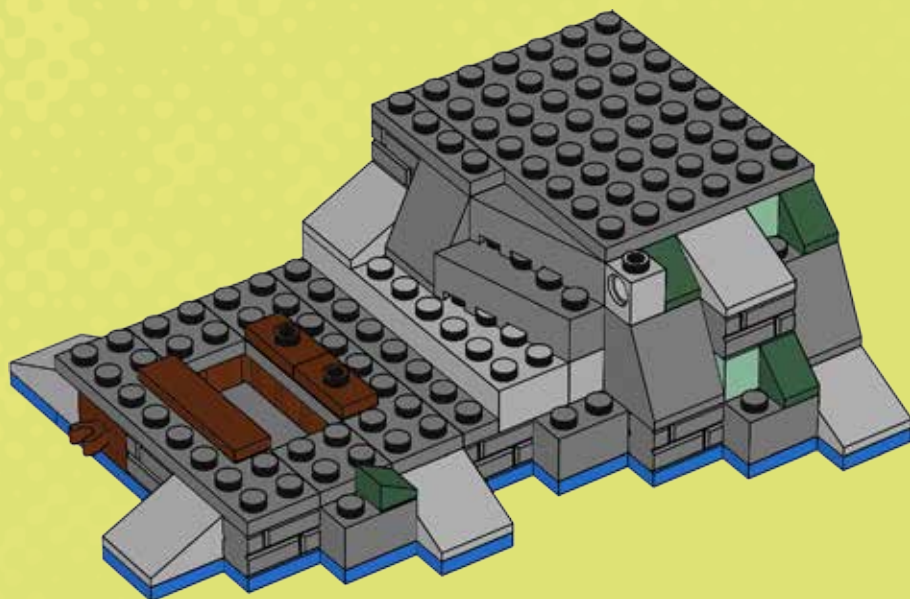

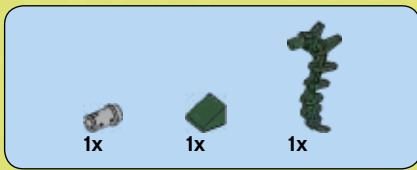

27

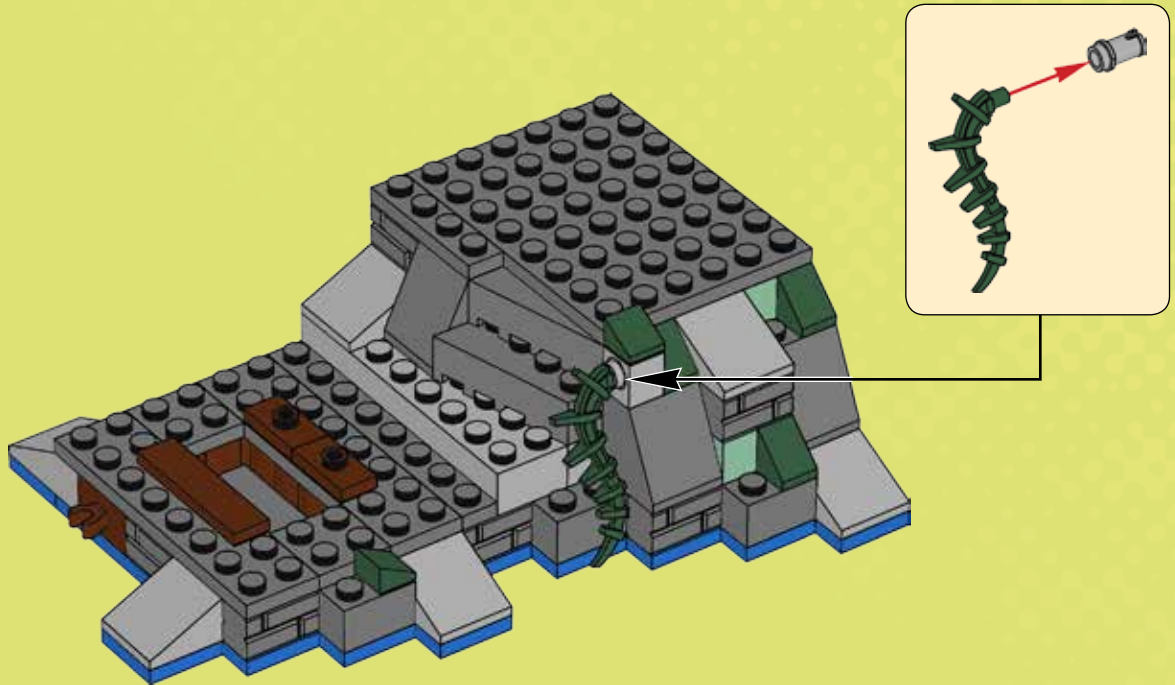

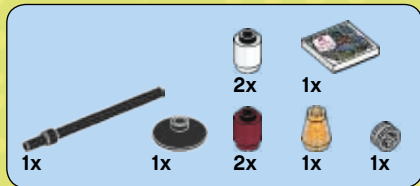

28

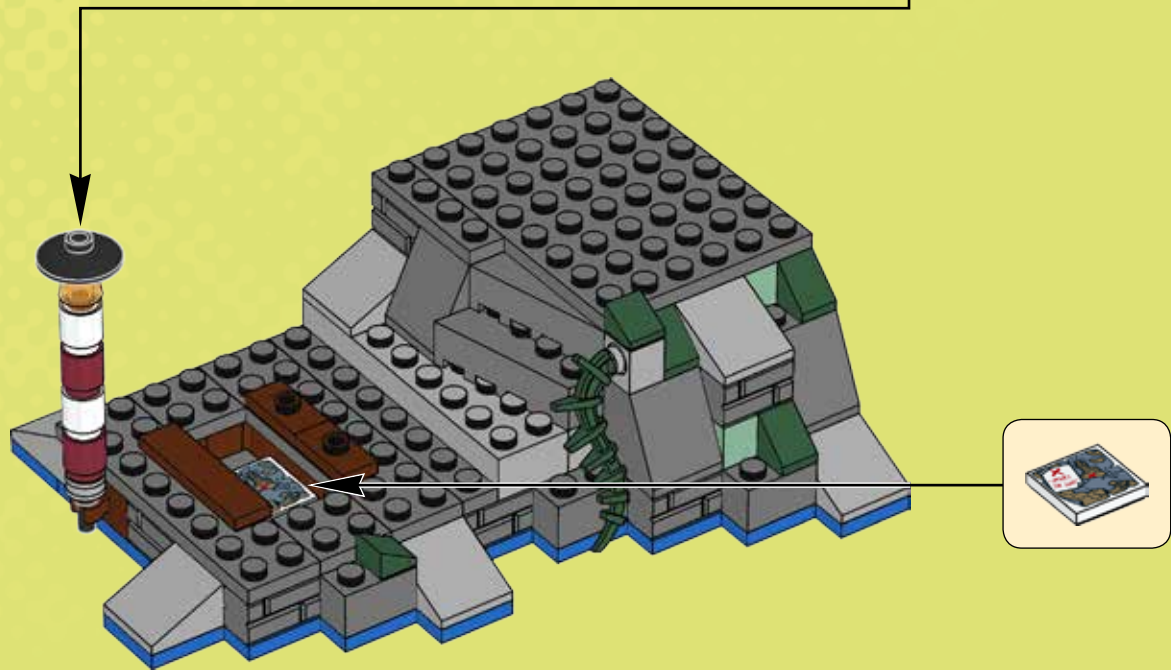
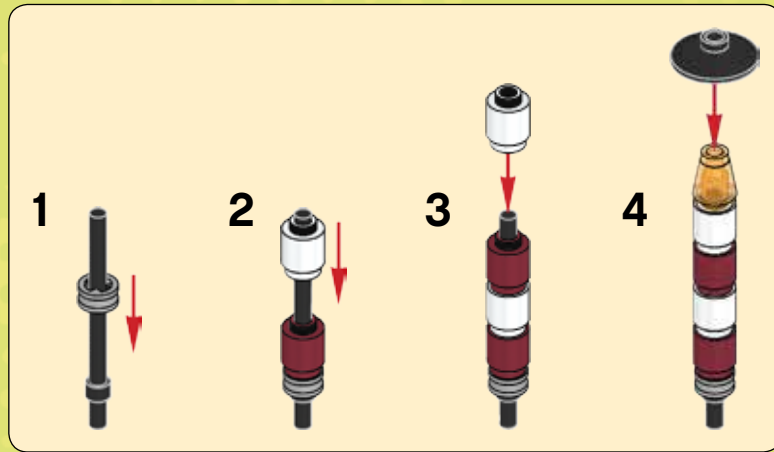



29

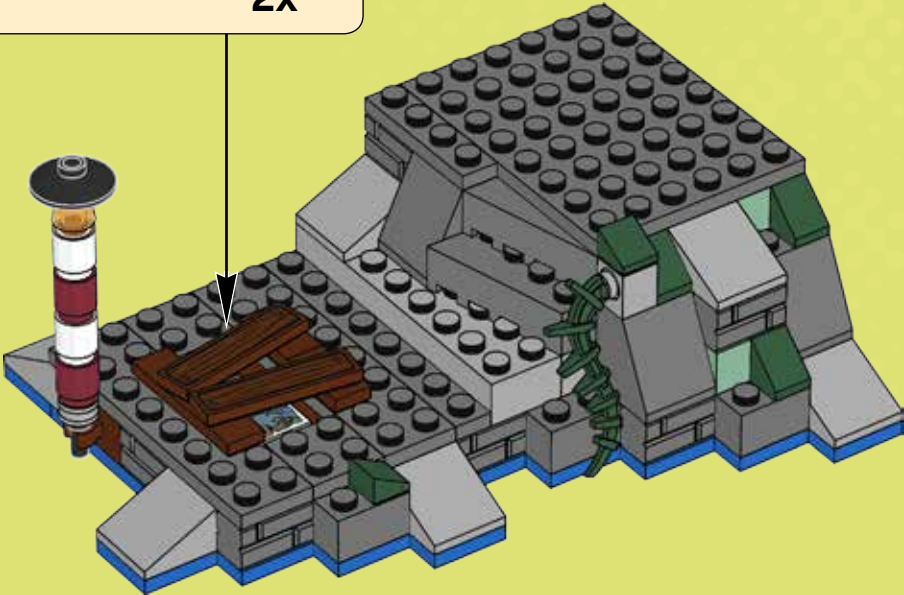
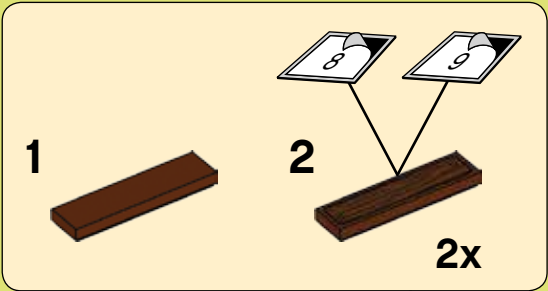

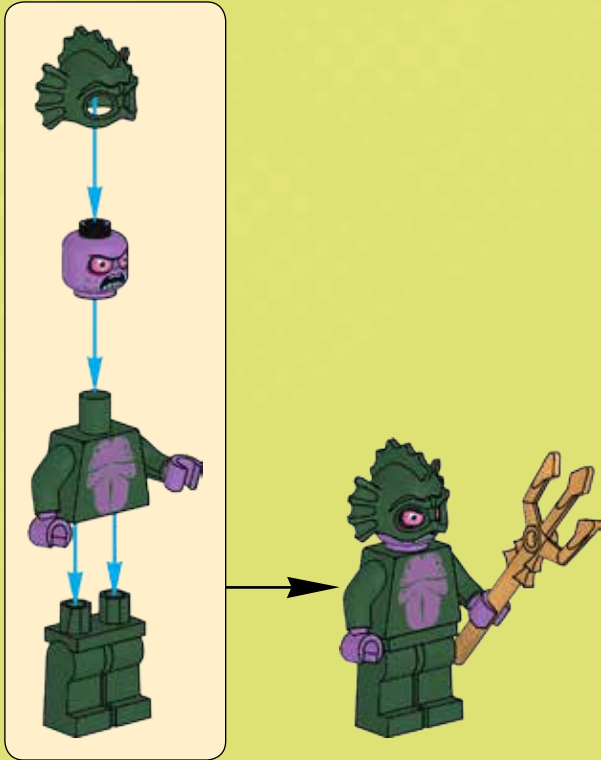

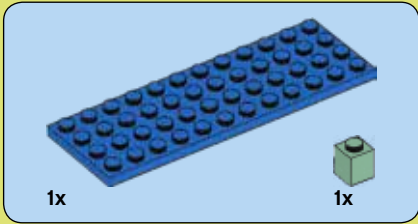
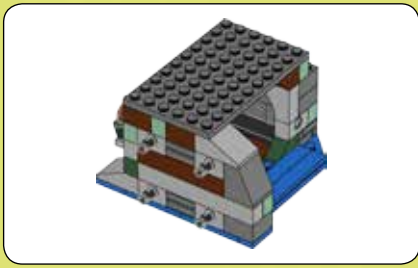

1x

1x

1

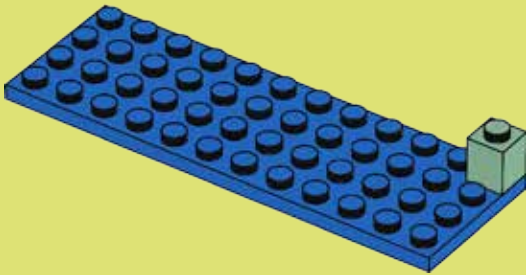

1x

1x

2

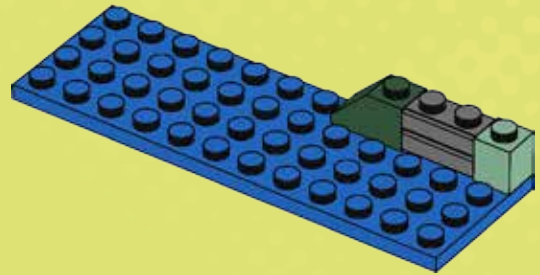

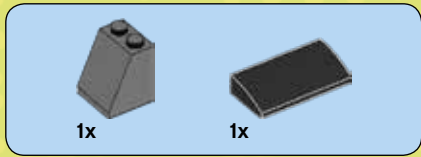

3

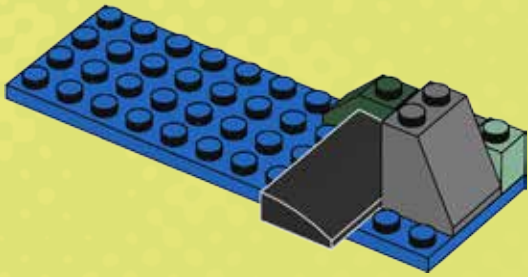

4

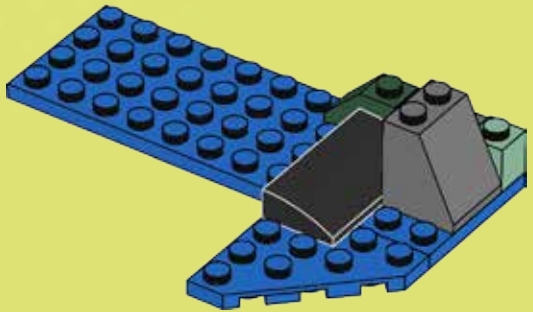

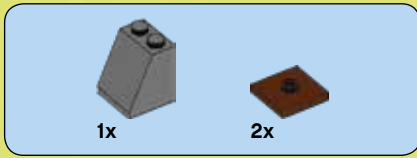

5

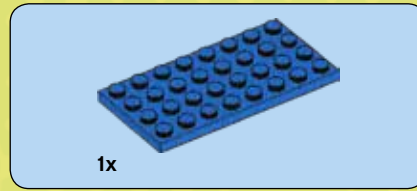
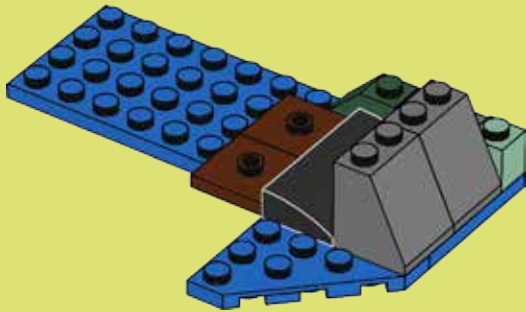

6

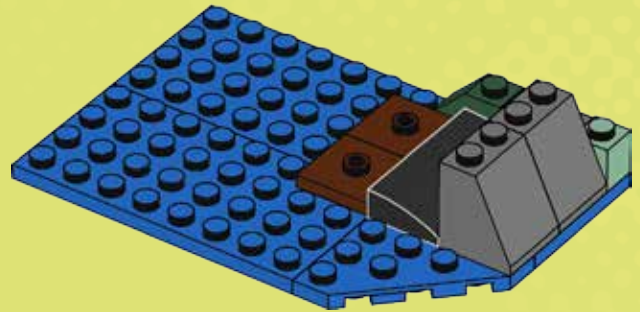

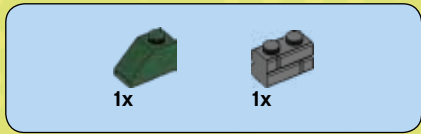

7

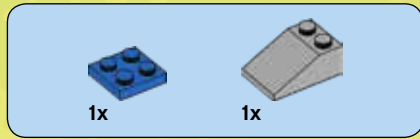
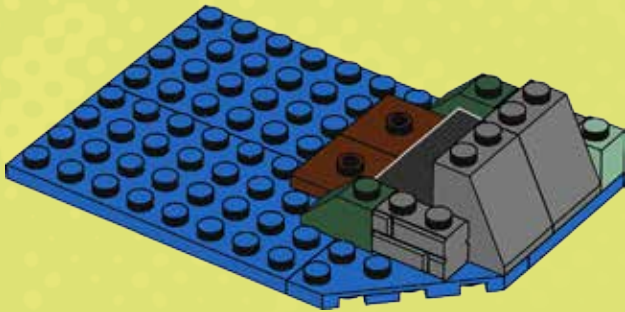

8

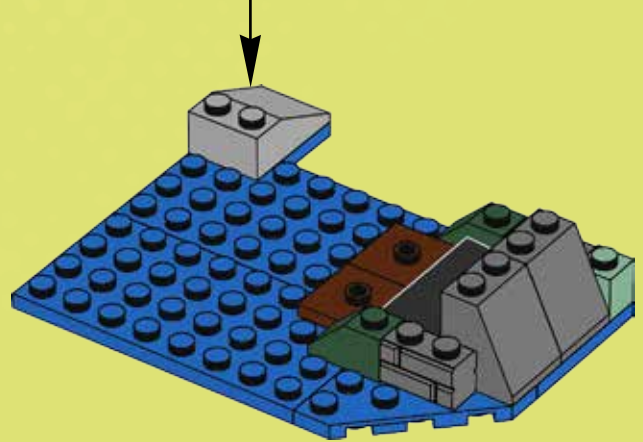
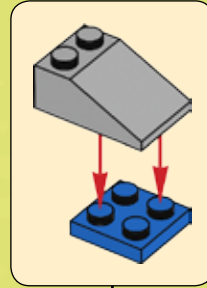



2x



1x

9

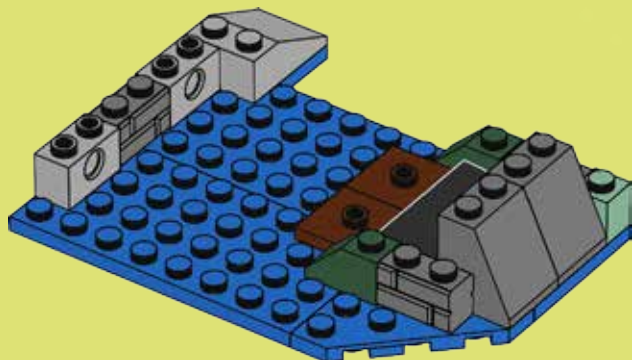

1x



1x



1x

10

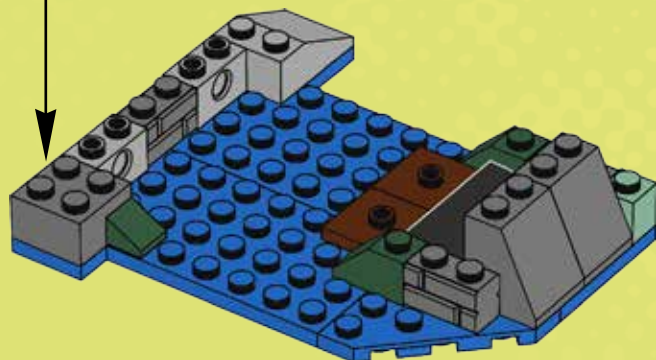
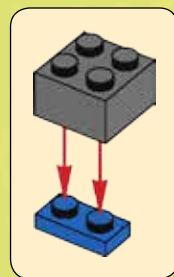



2x

11

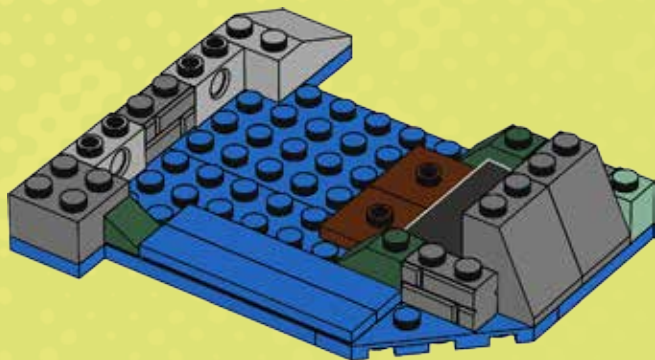

2x

12

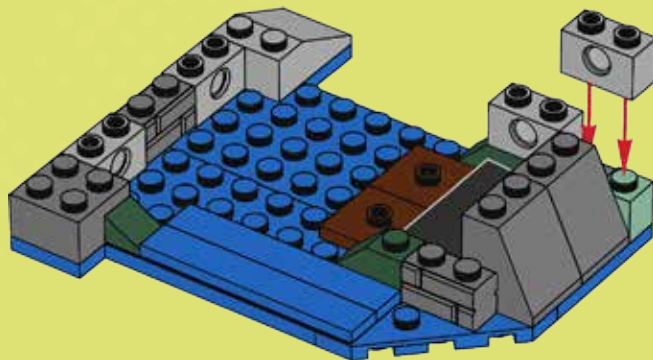



13

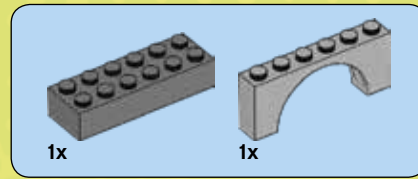
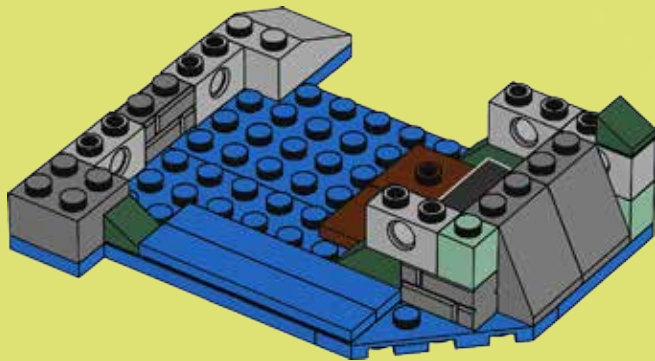

14

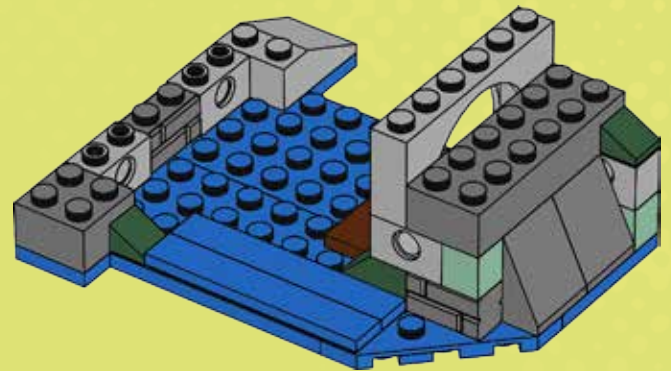



2x



2x

17

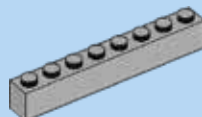
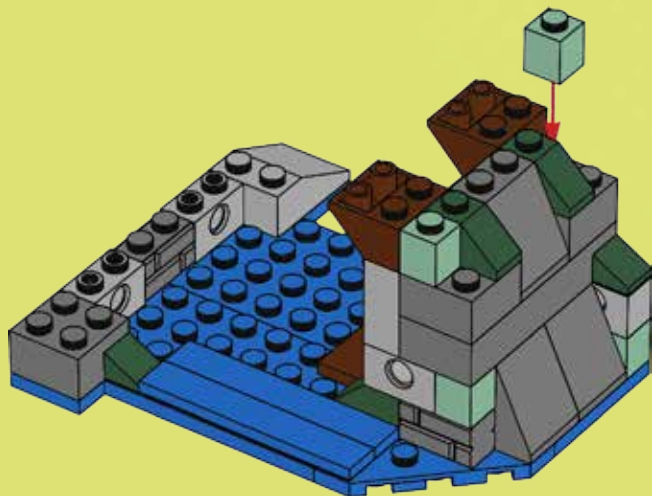

1x



1x



2x

18

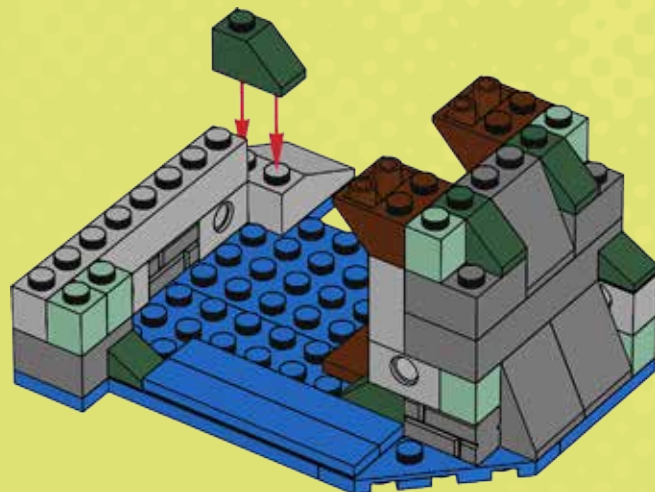

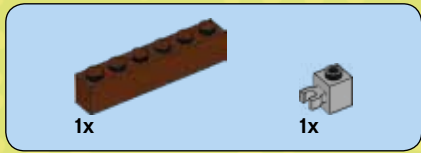

19

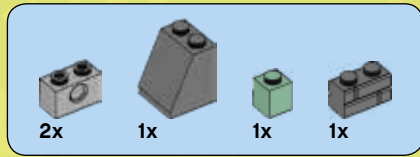
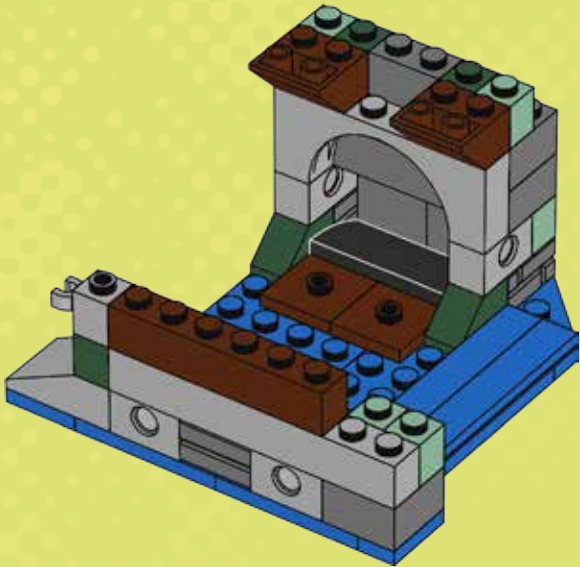

20

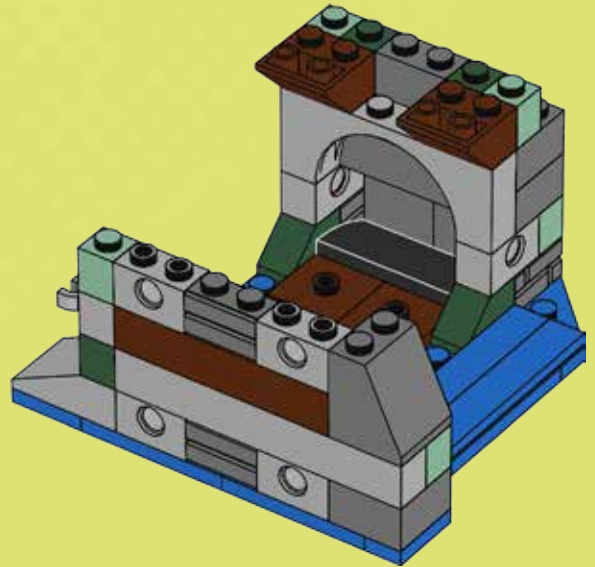

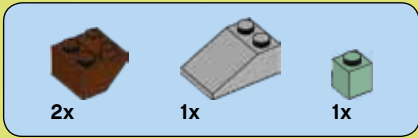

21

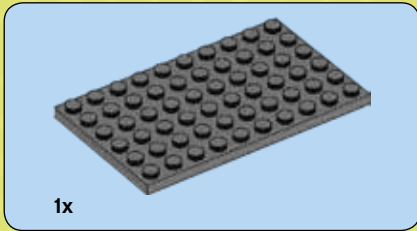
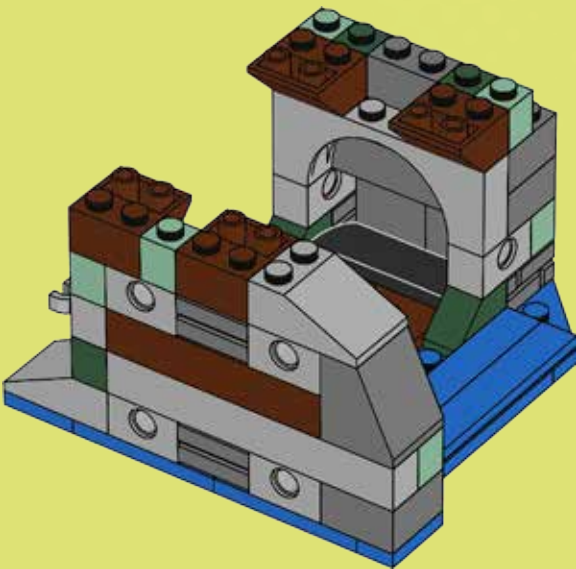

22

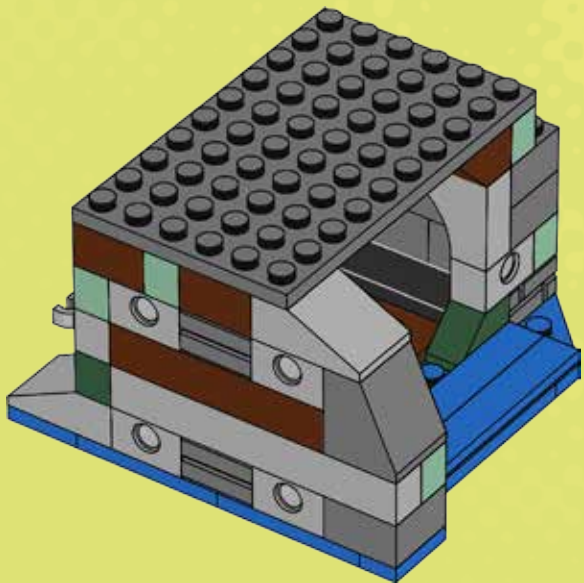

4x



1x



1x



23

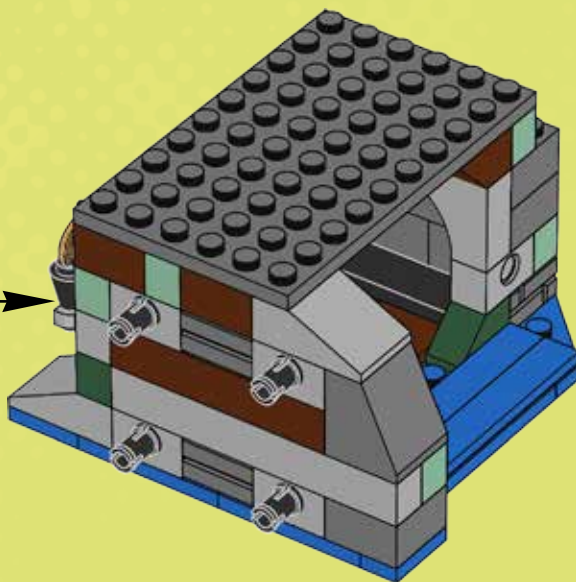
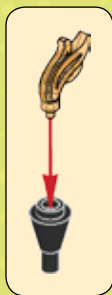

30

