



# PRINCE OF PERSIA

THE SANDS OF TIME



# 7571





1

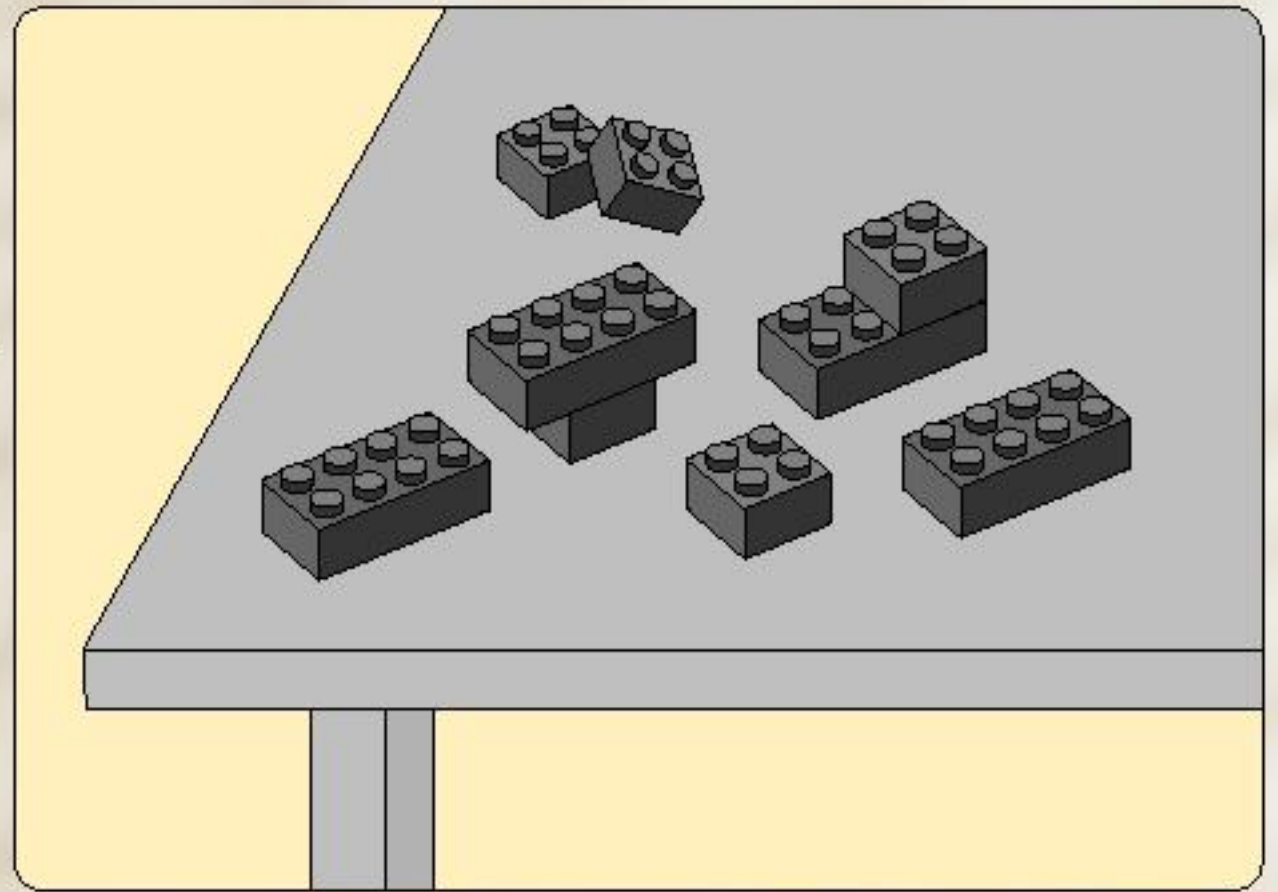
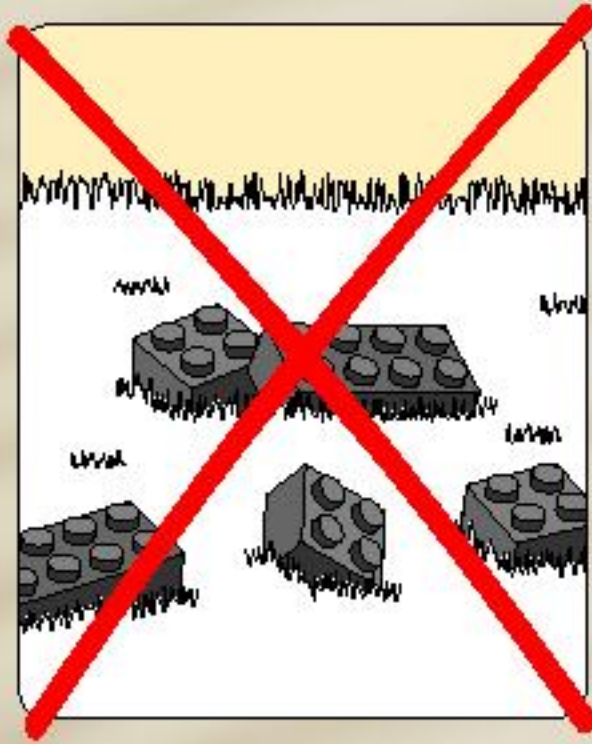

2

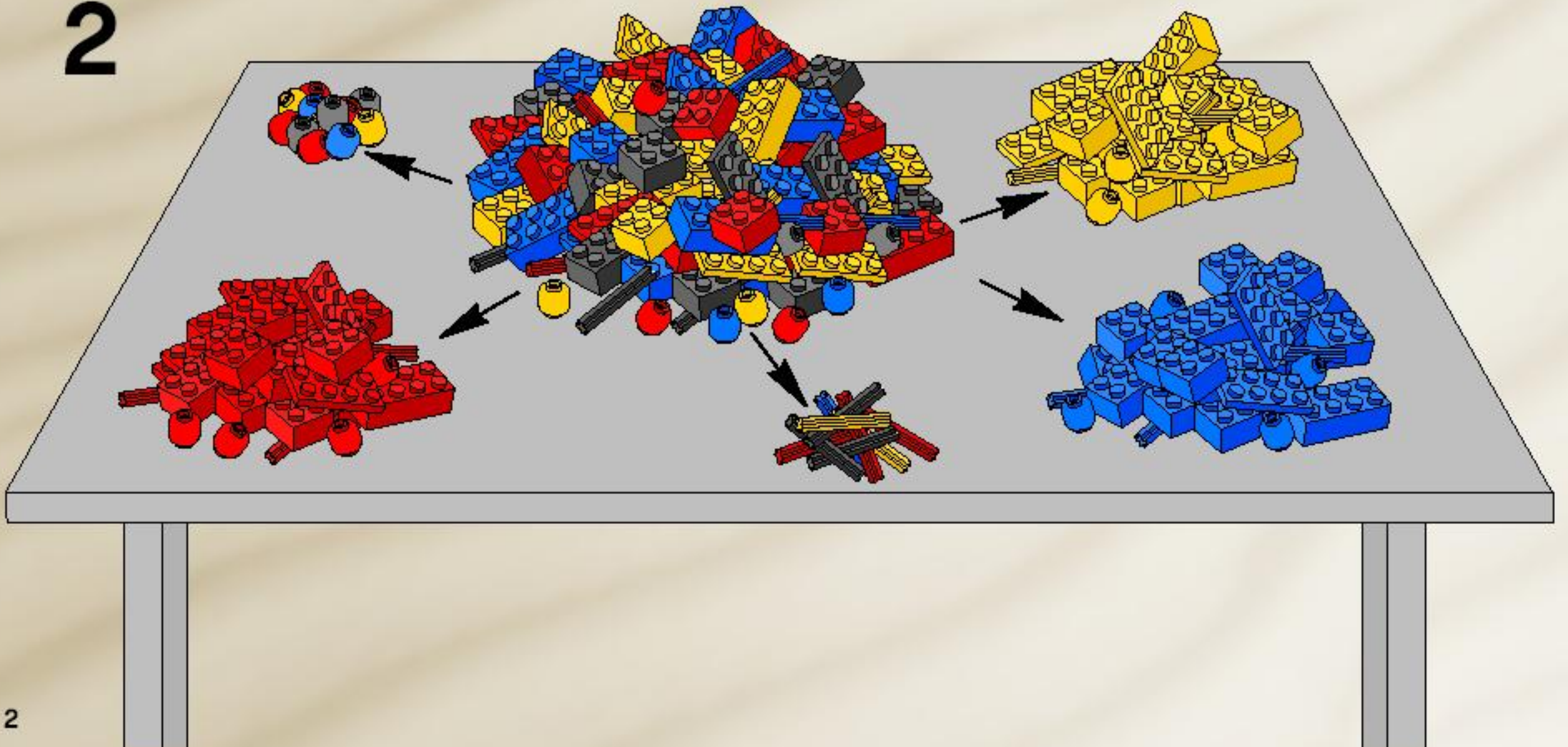

3

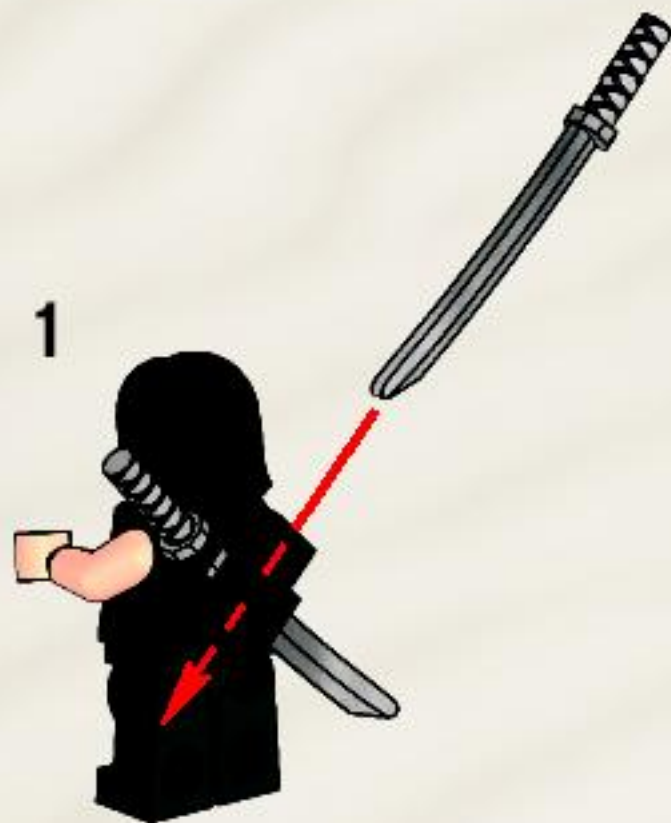
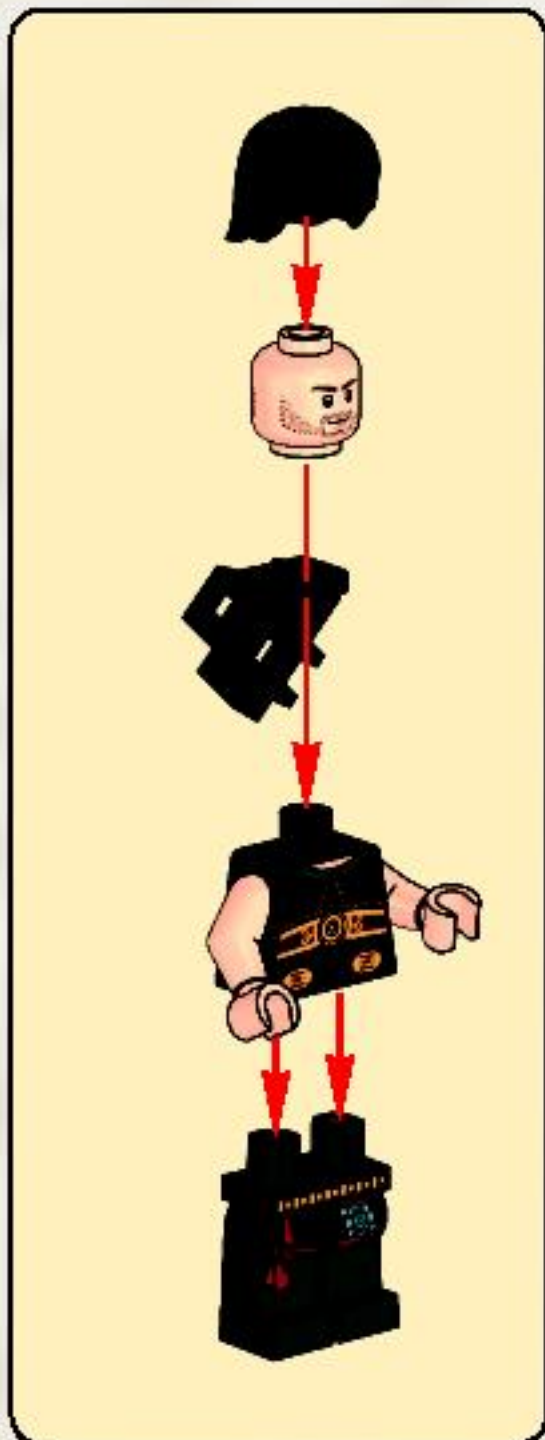



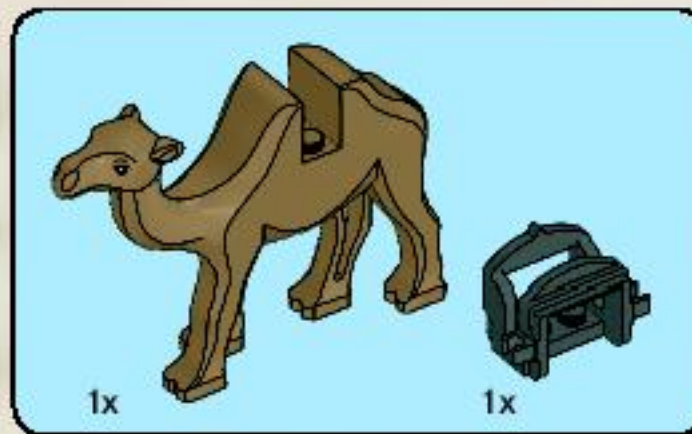
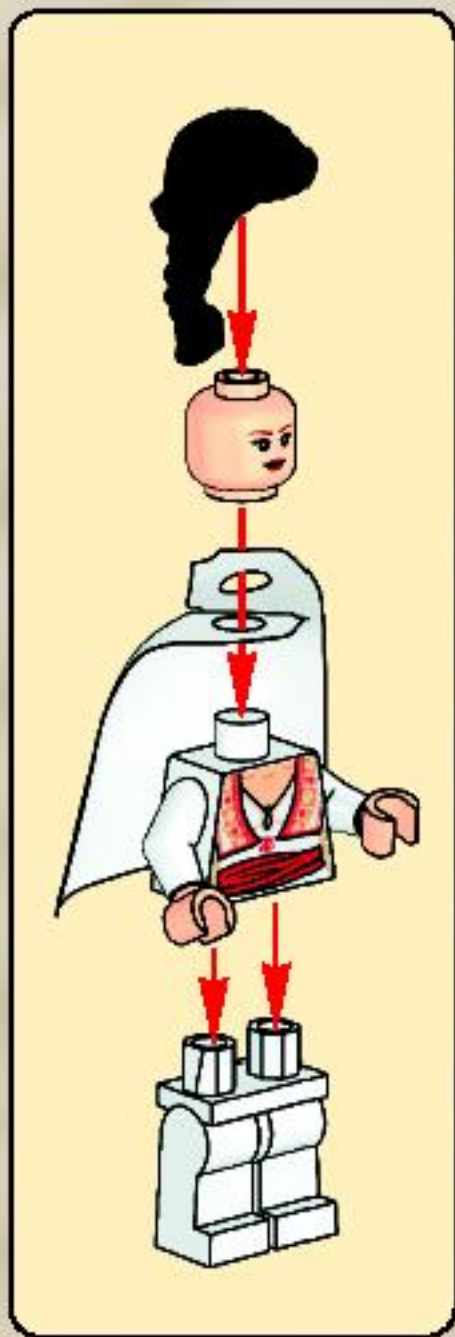

1

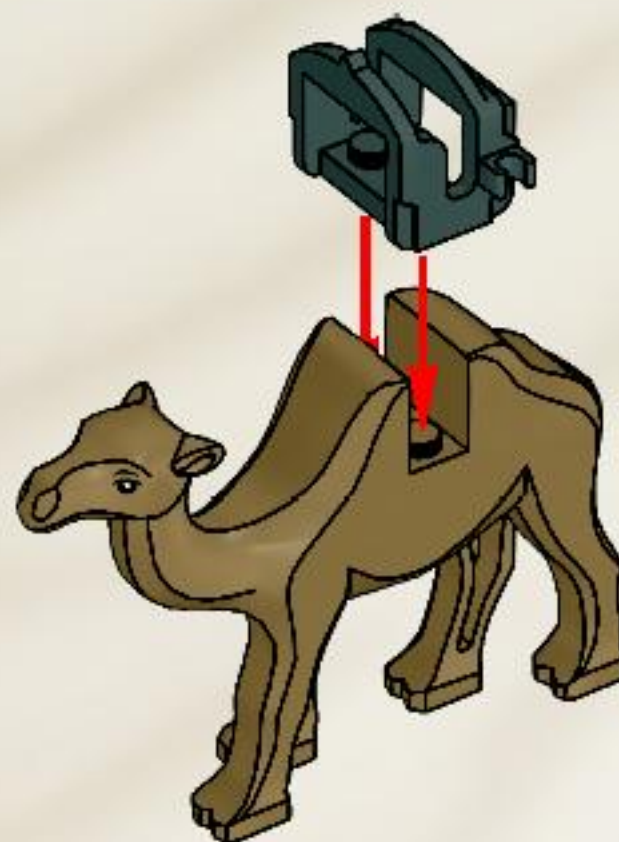

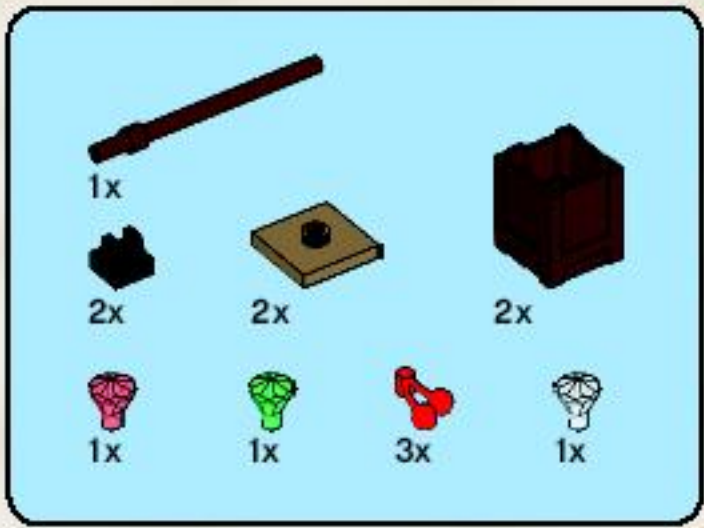

2

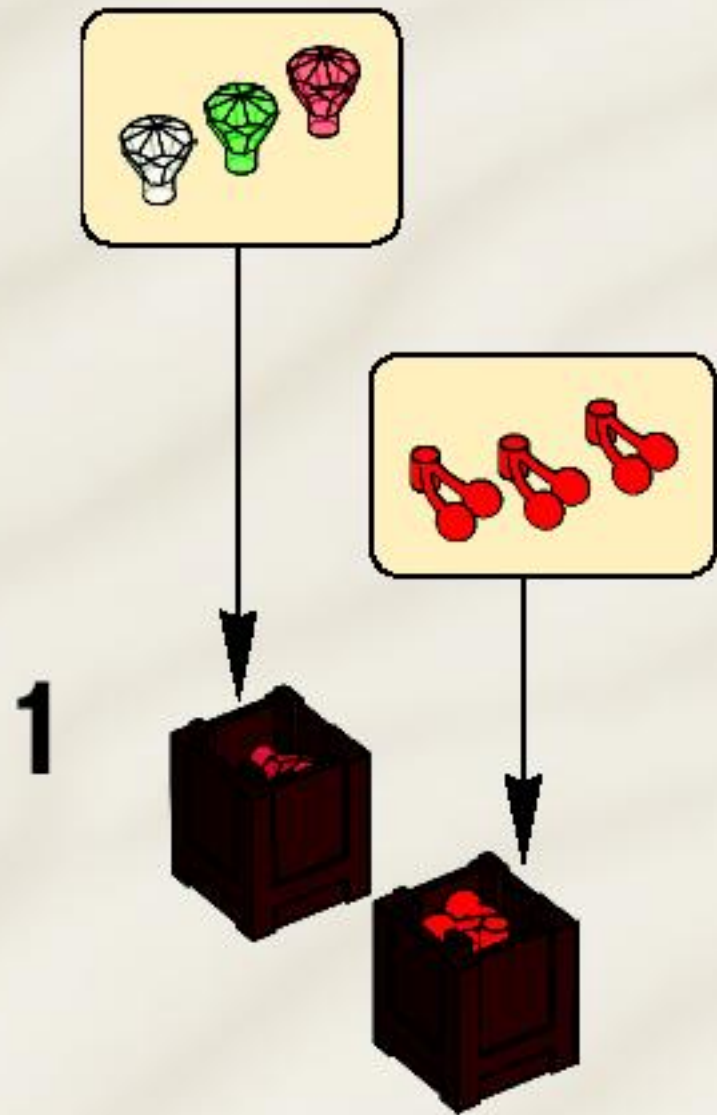

2

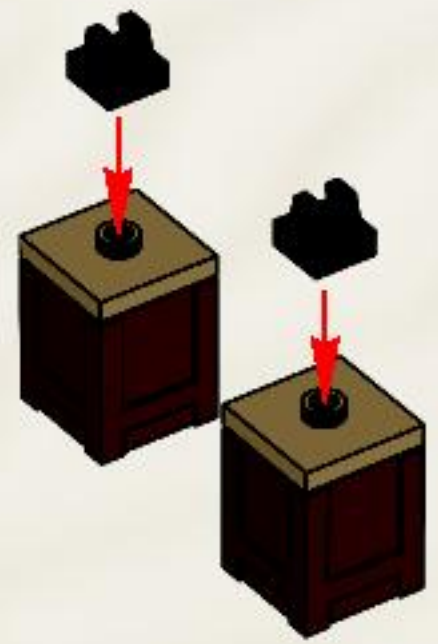

3

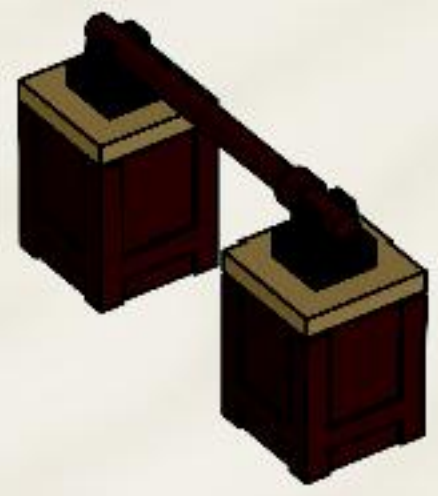



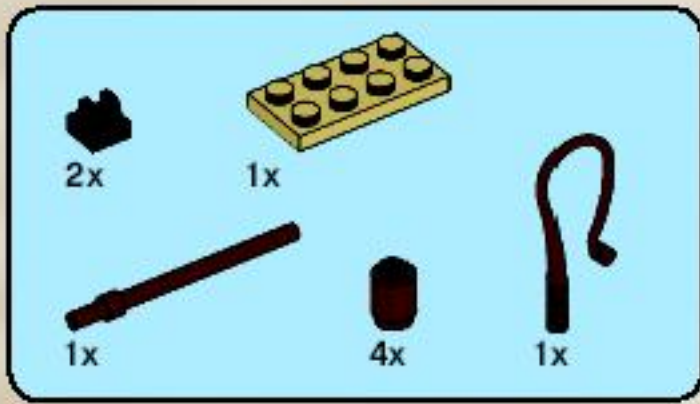

3

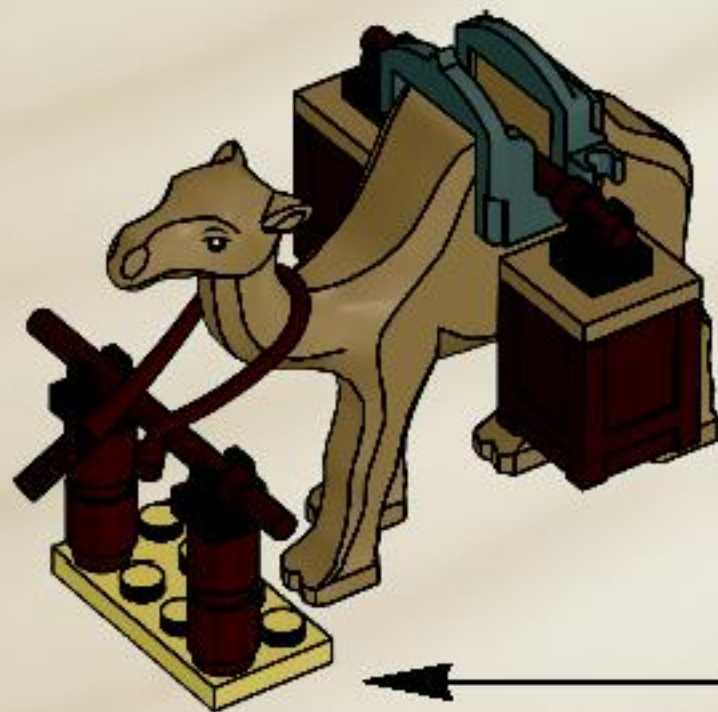
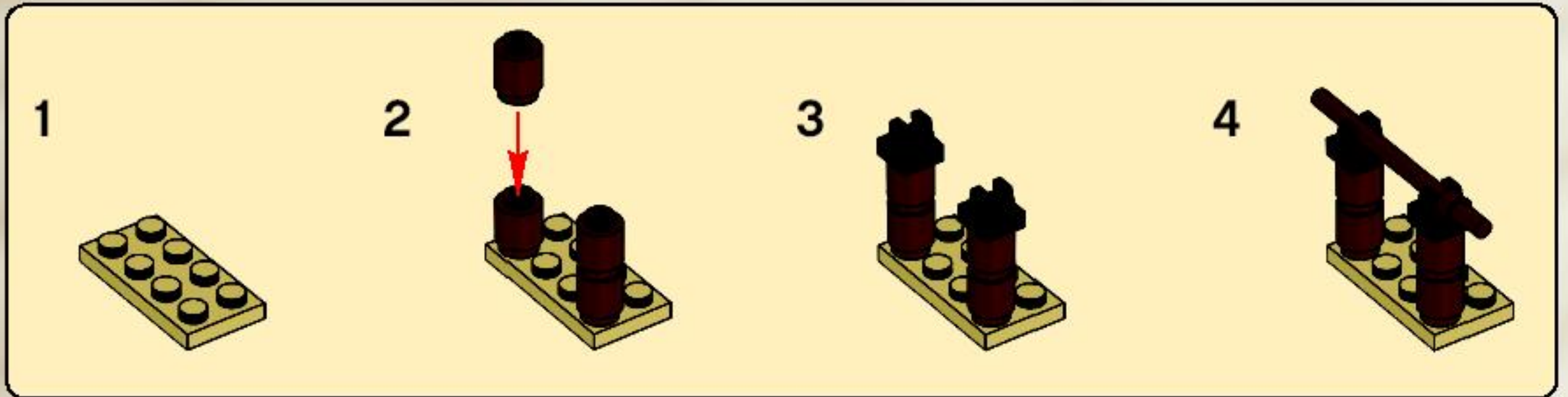

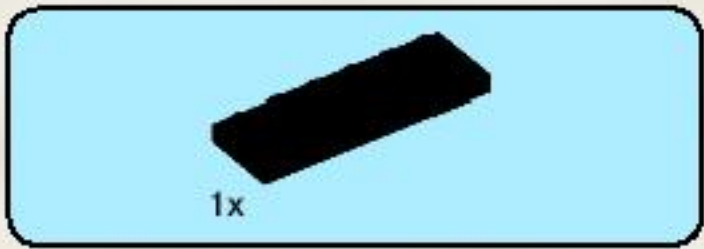

1



2



3

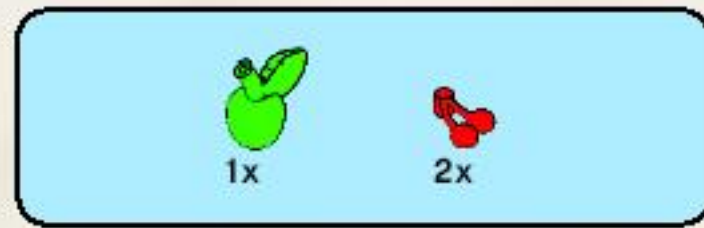

4

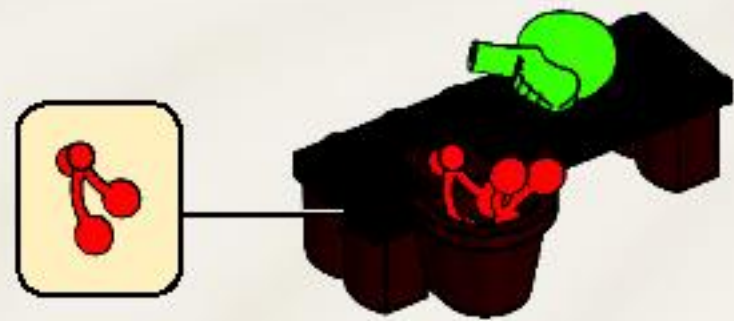

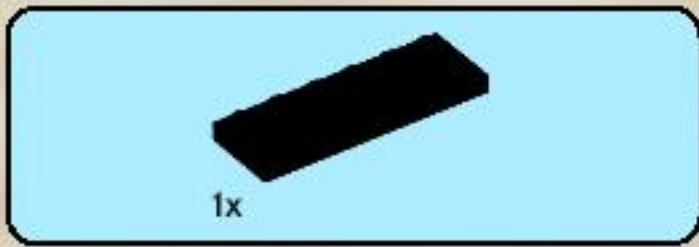

1



2

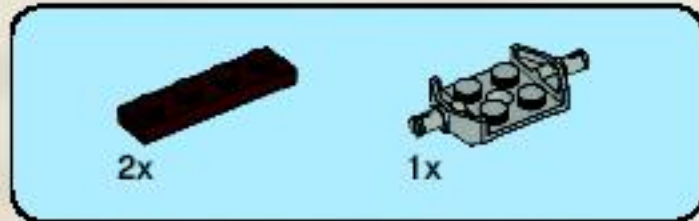

3

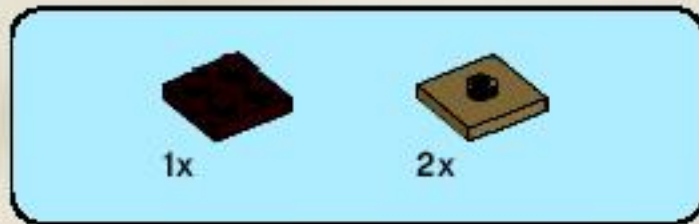

4

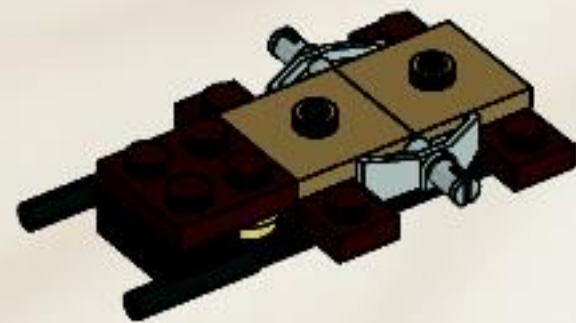





5

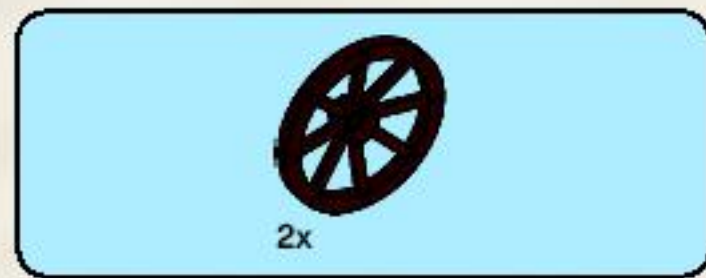
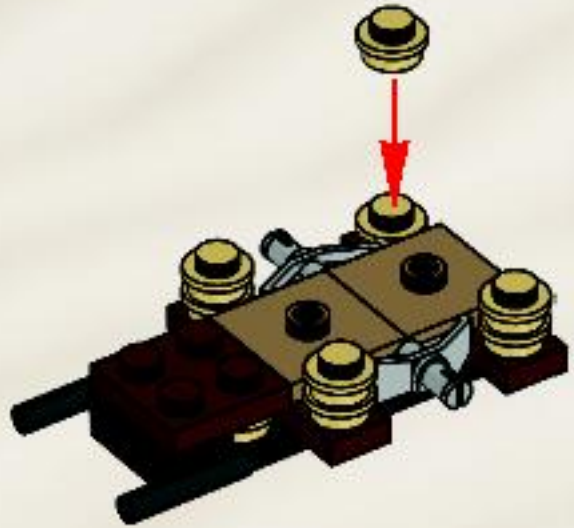

7

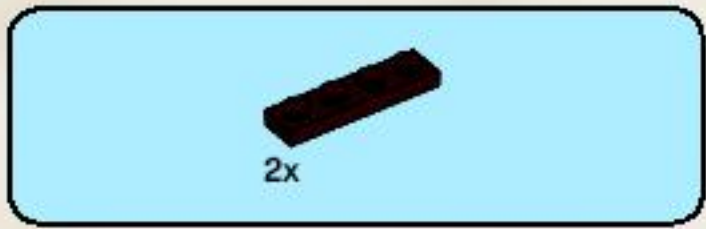
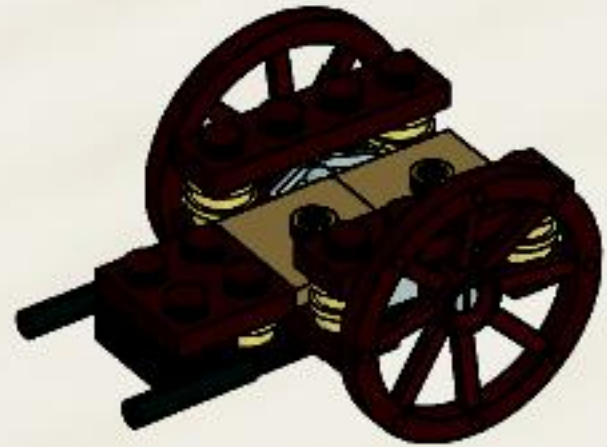

6

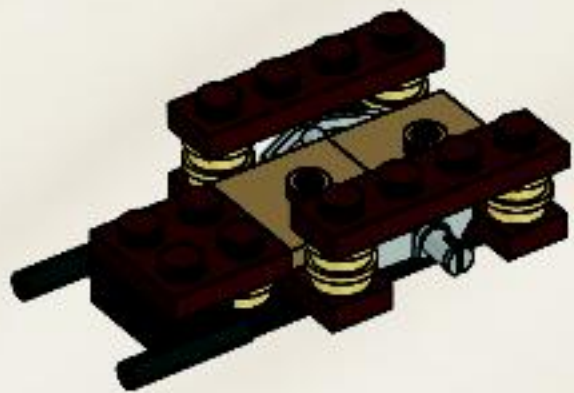

8



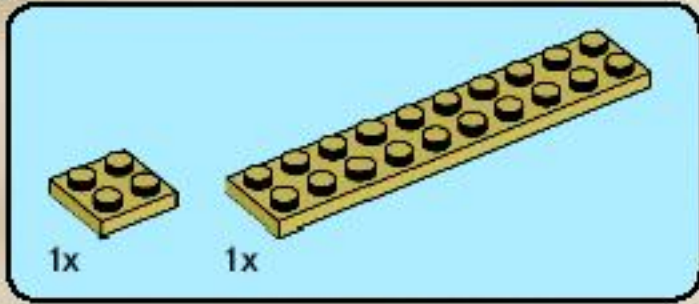
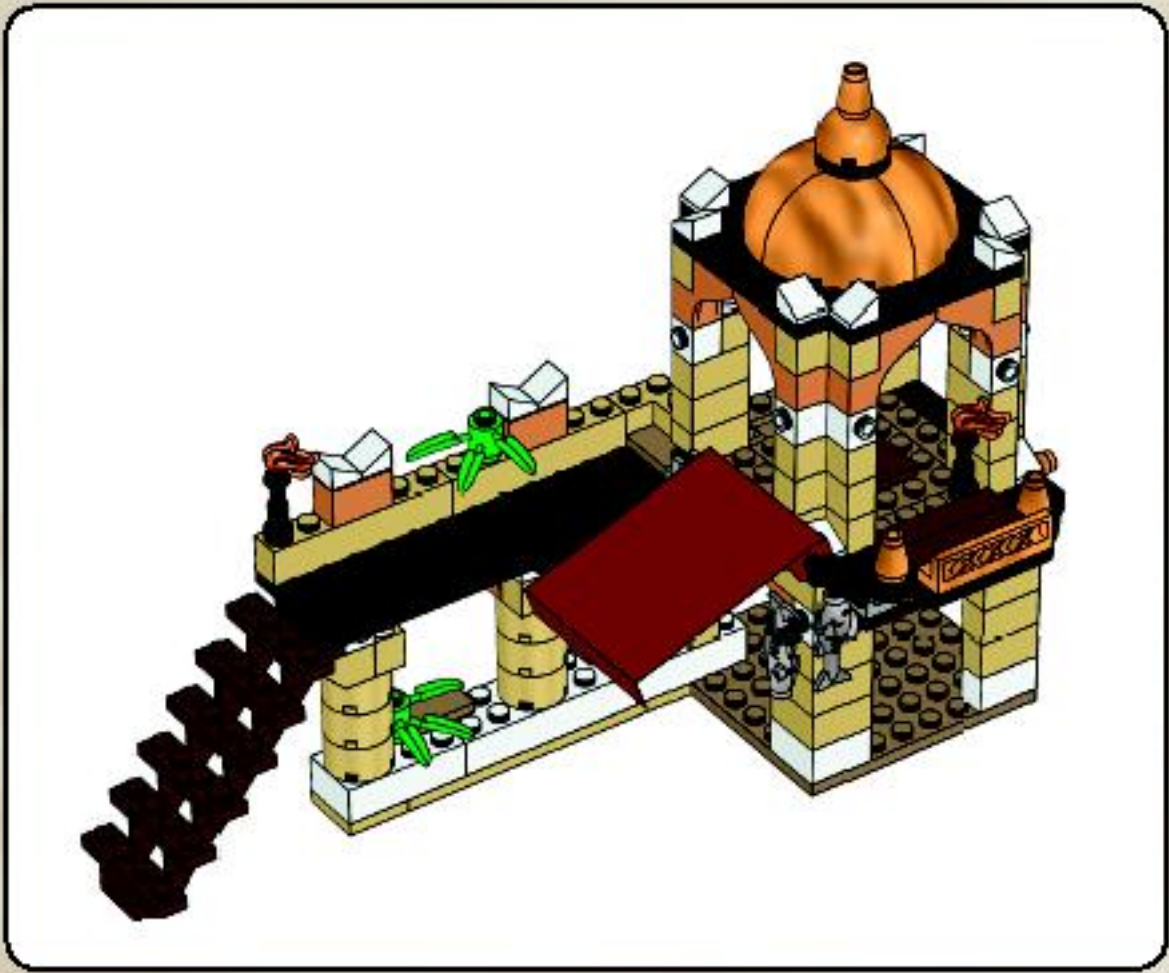

1

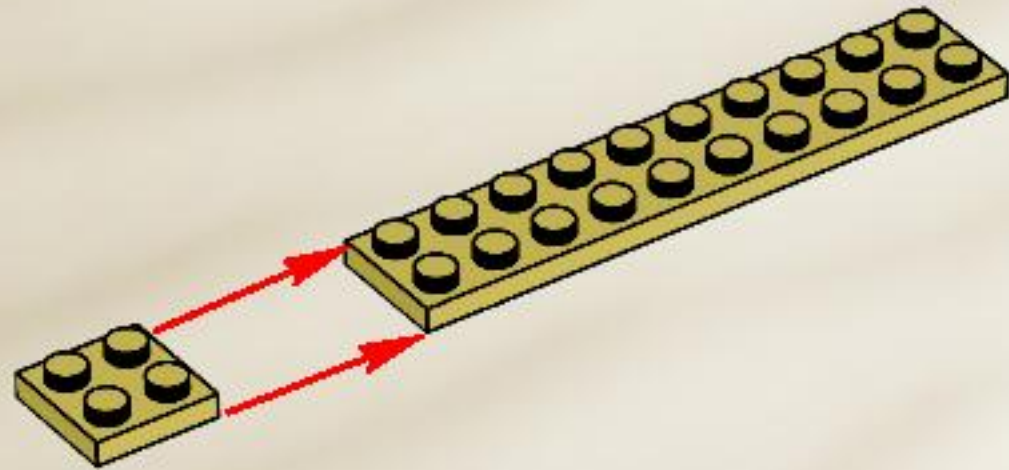



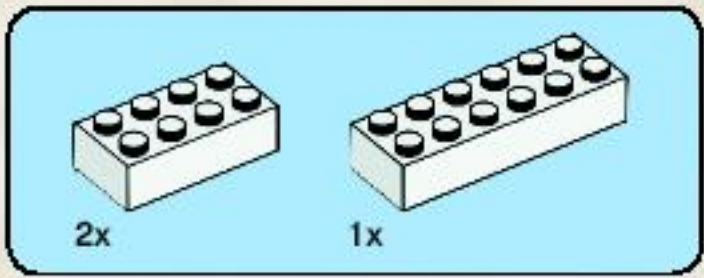

2

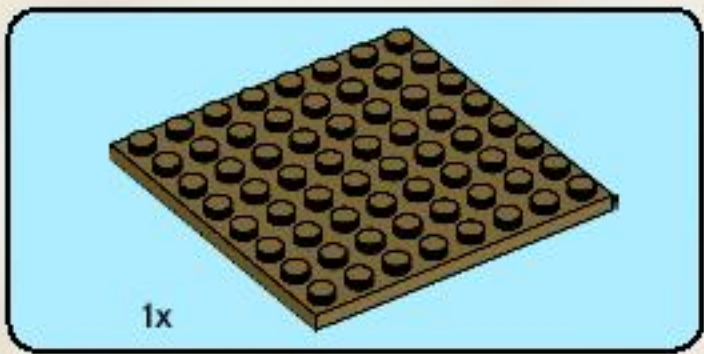
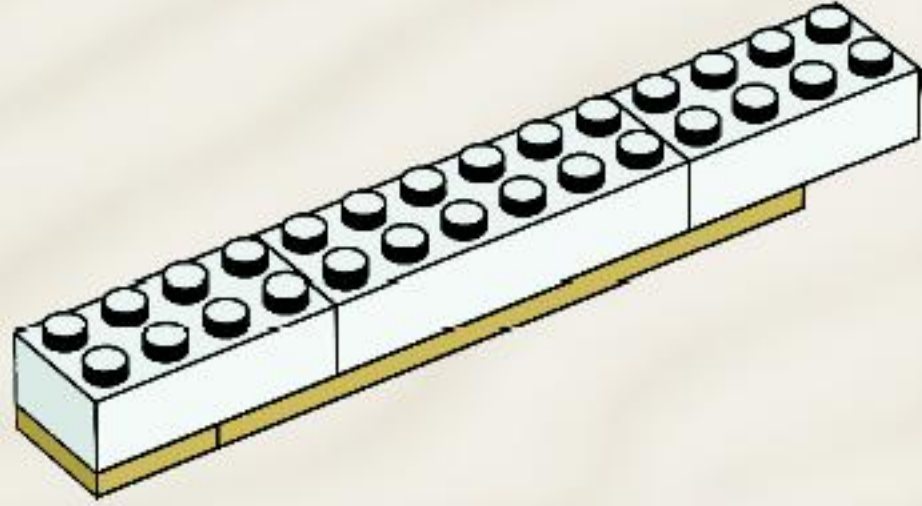

3

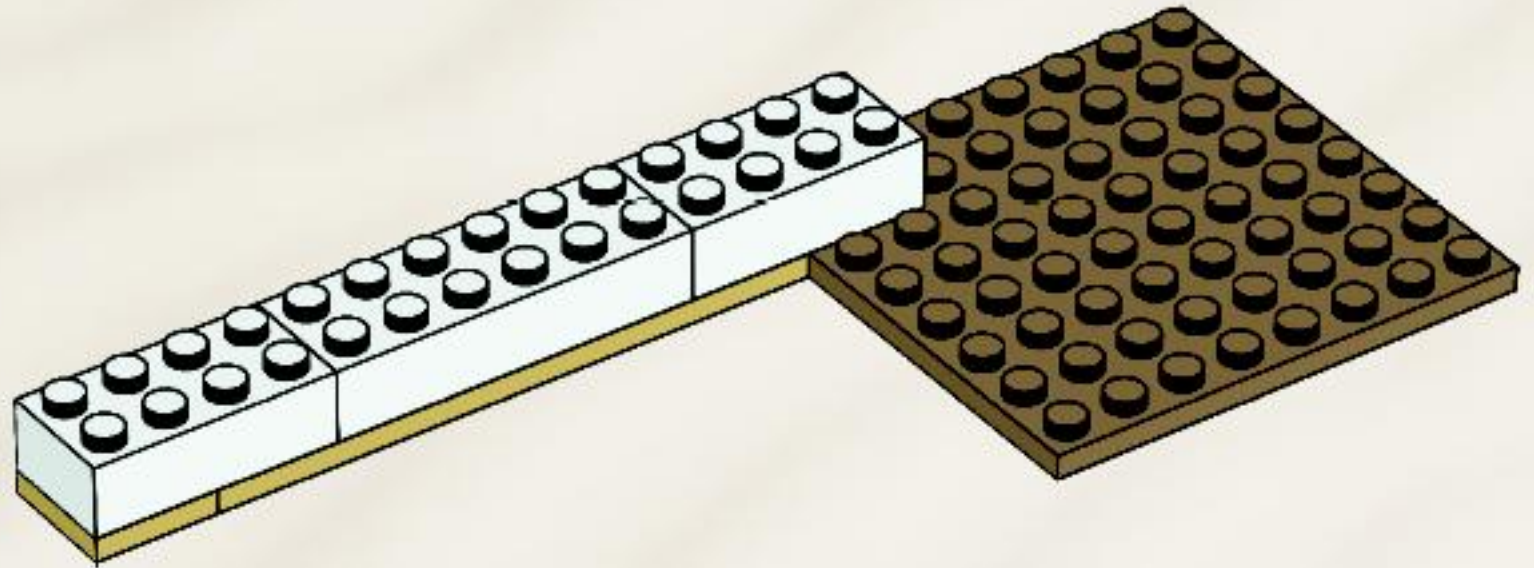

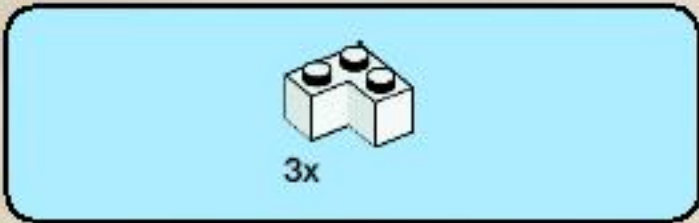

4

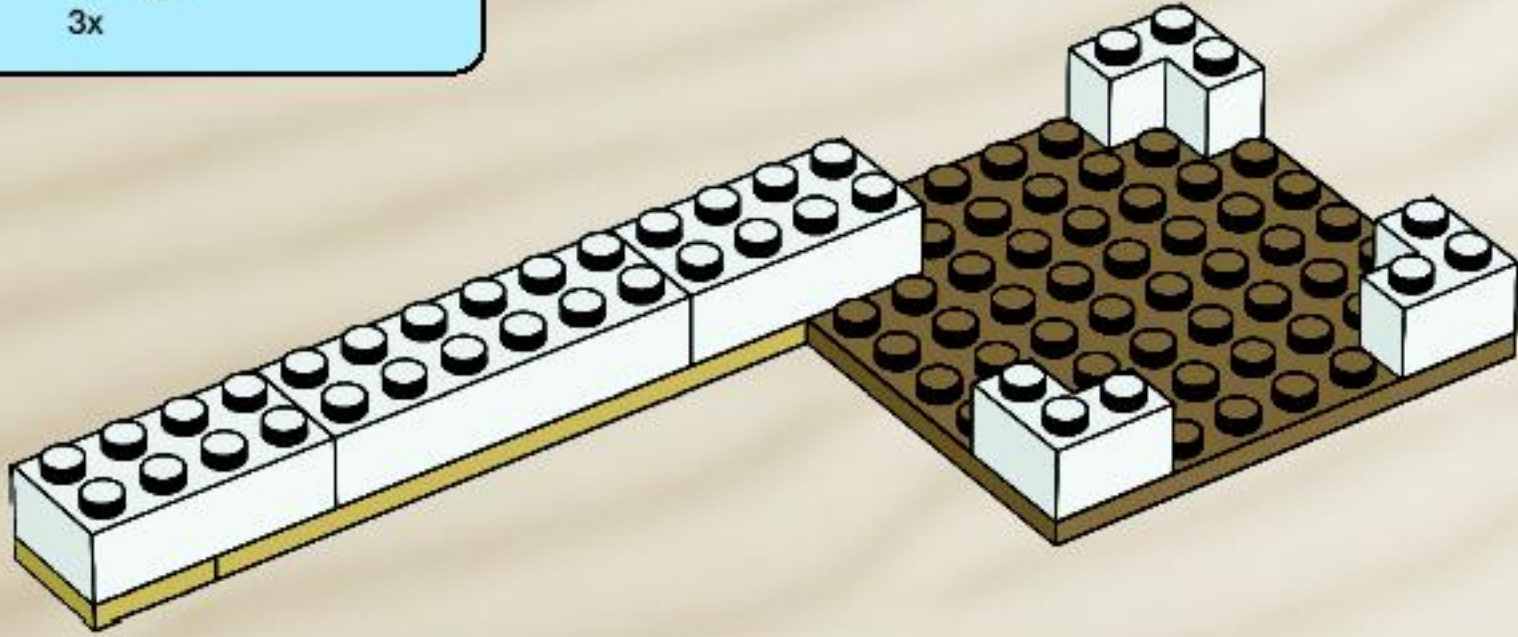

5

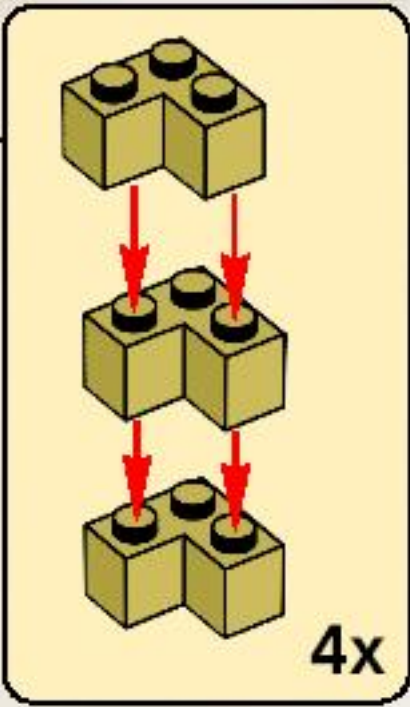
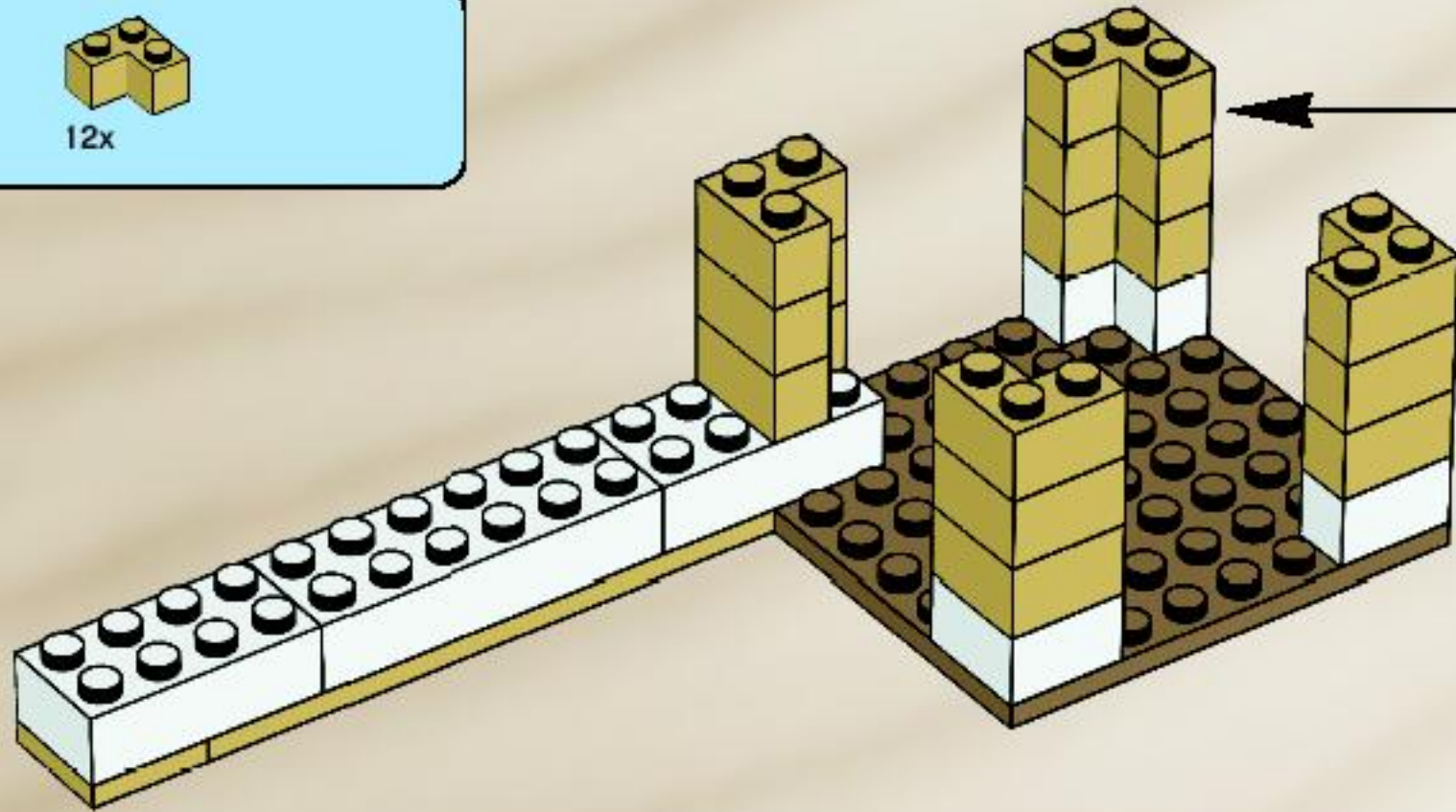



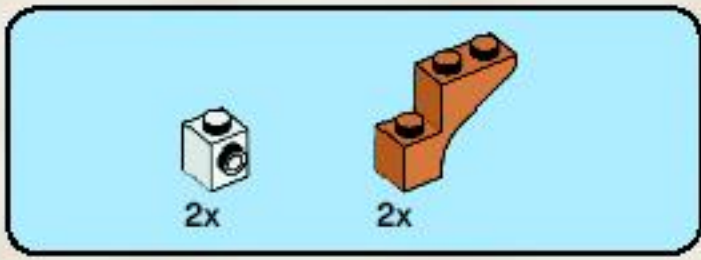

6

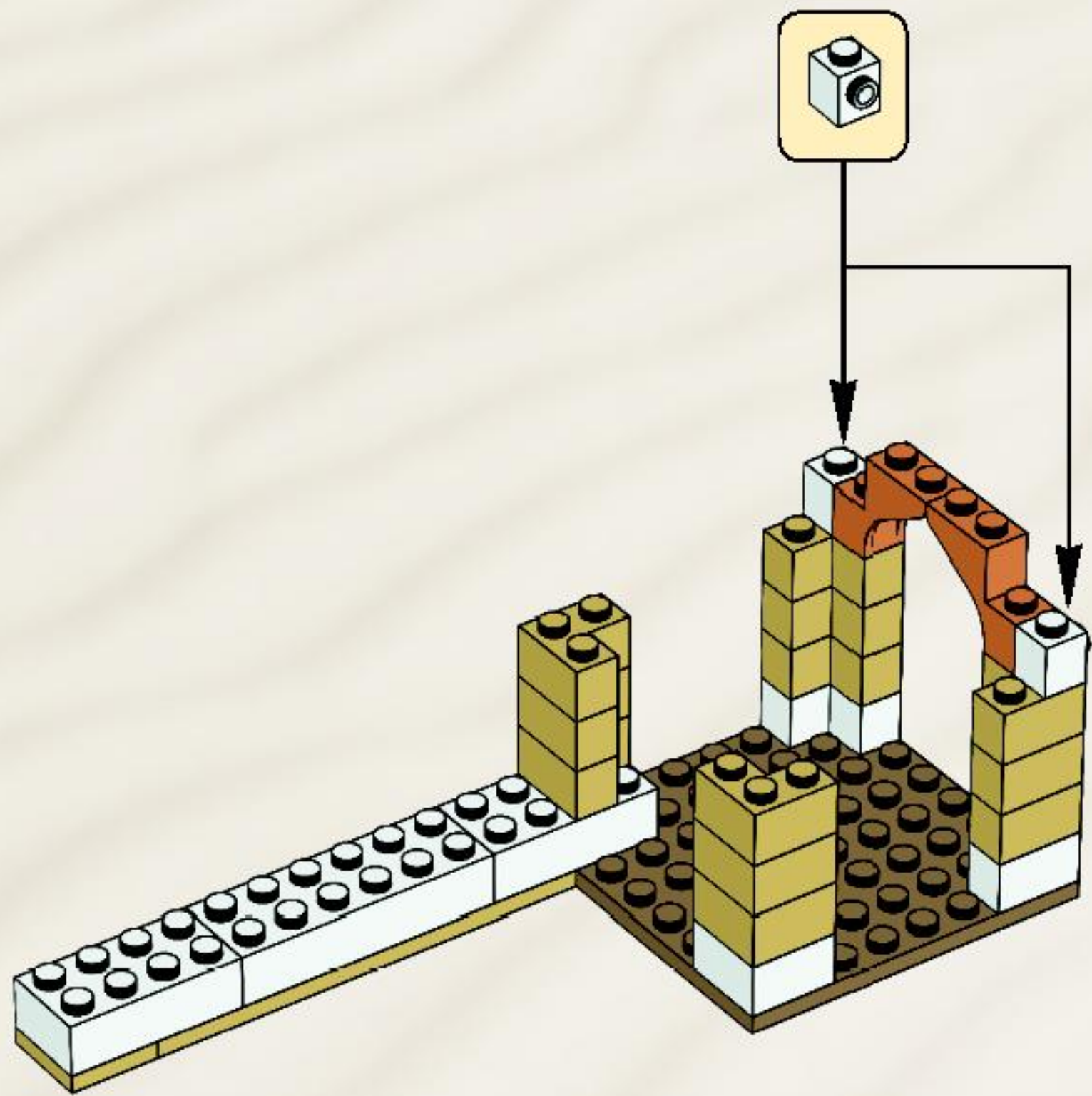

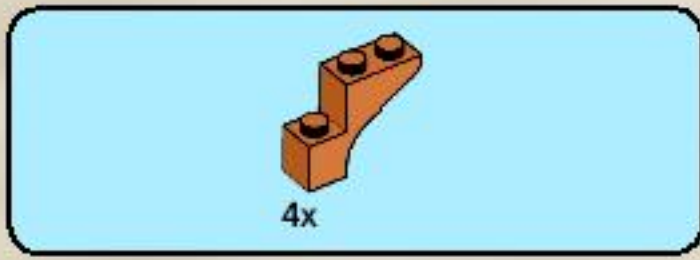

7

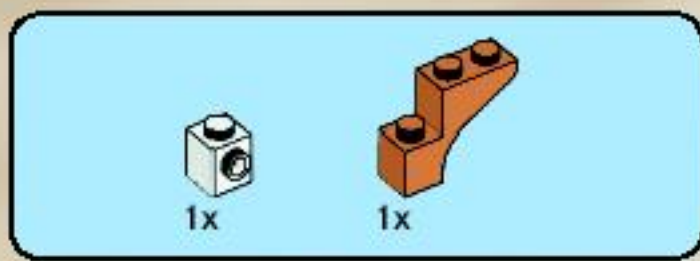
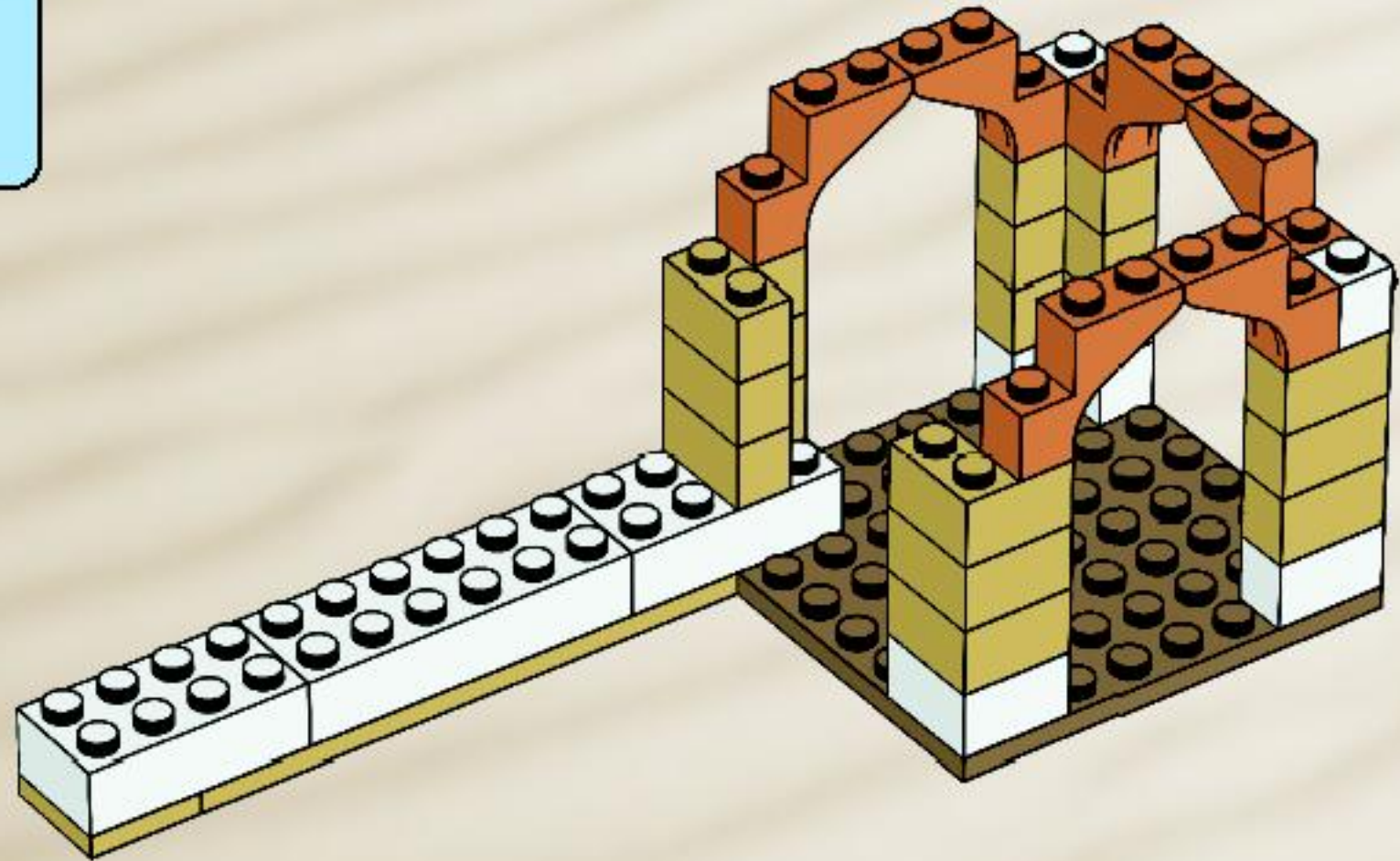

8

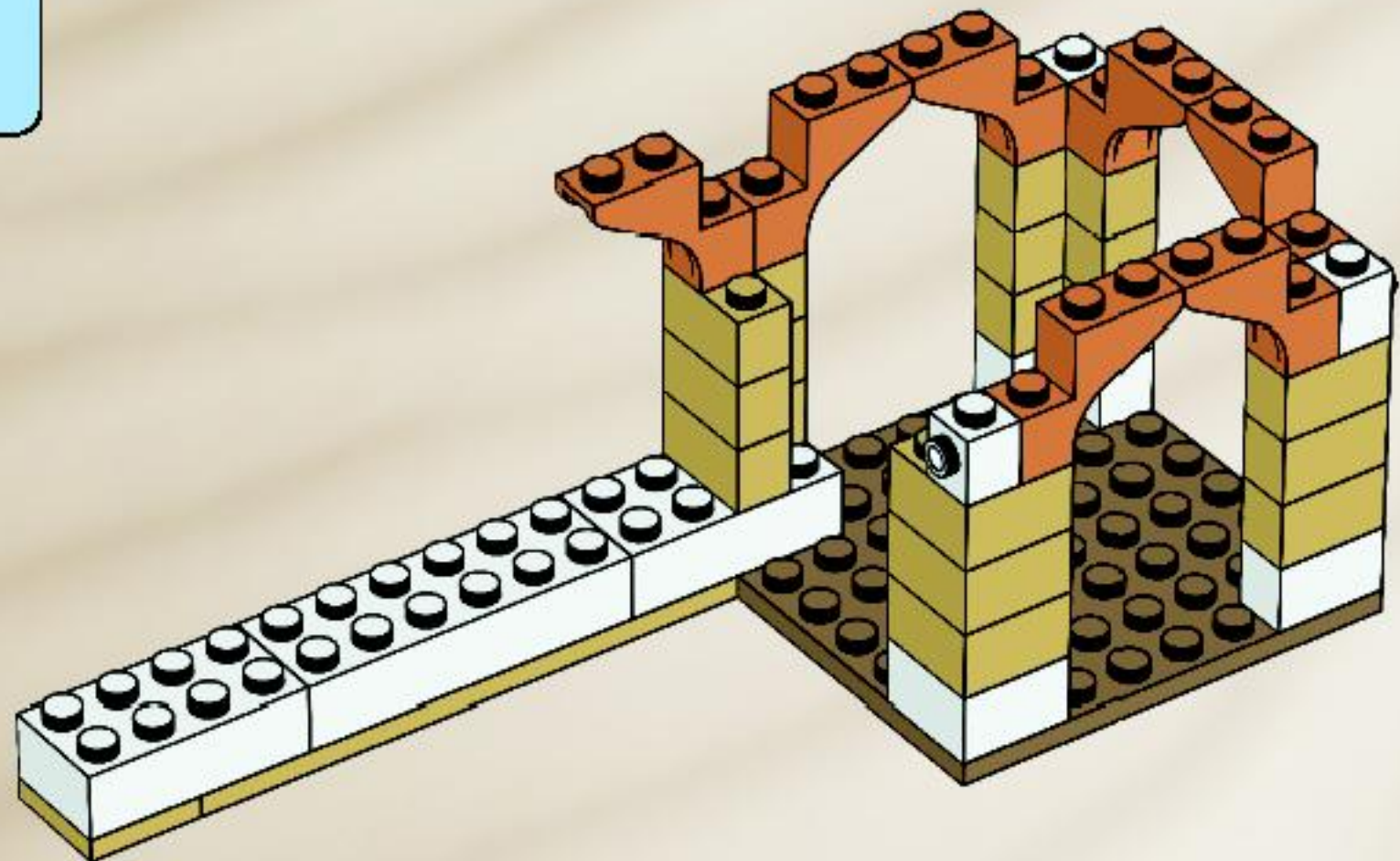



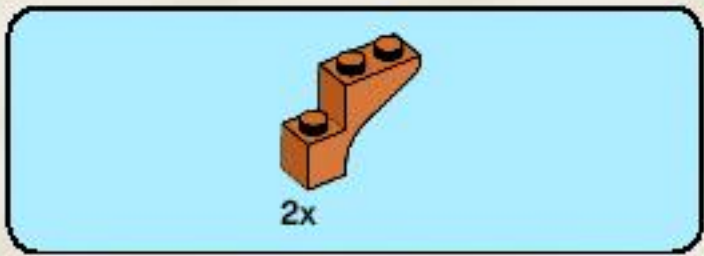

9

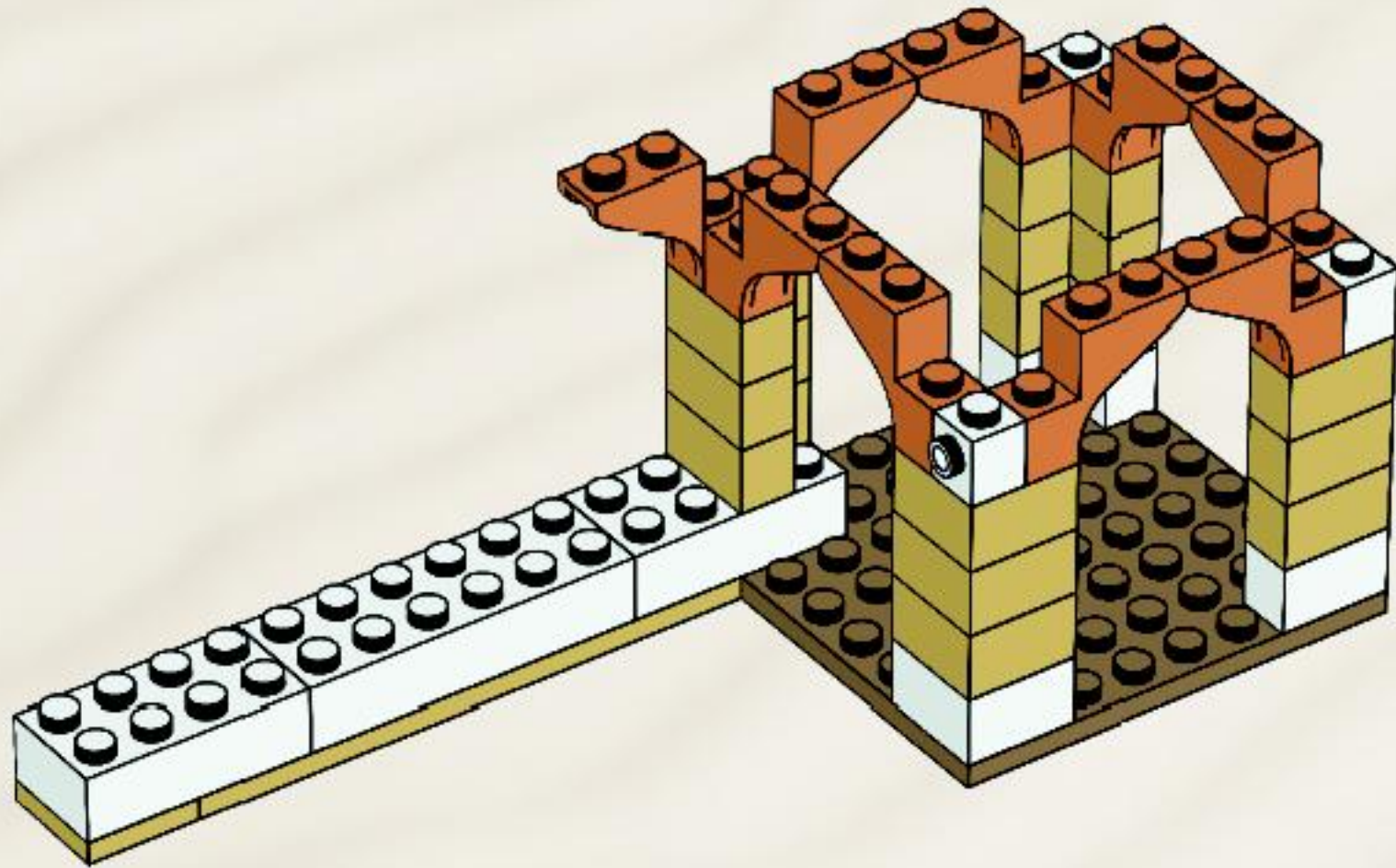



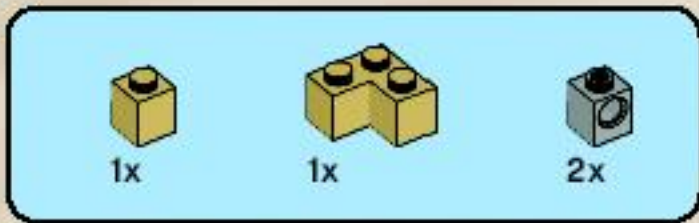

10

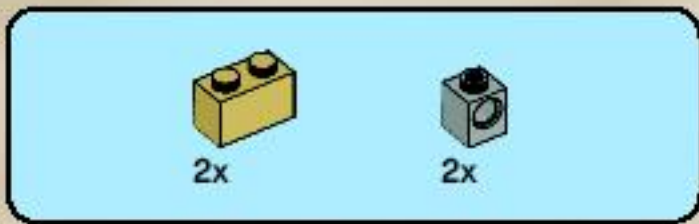
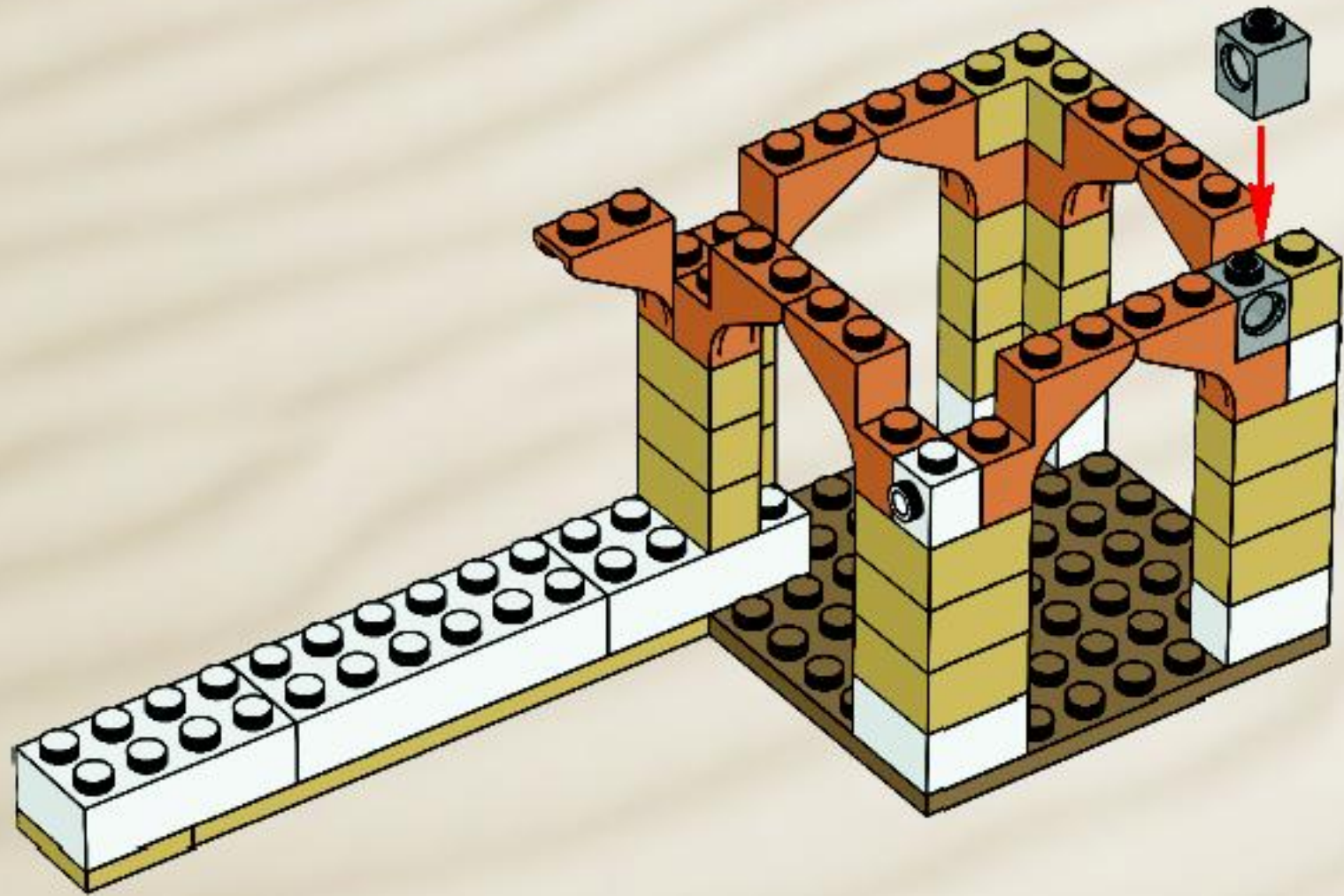

11

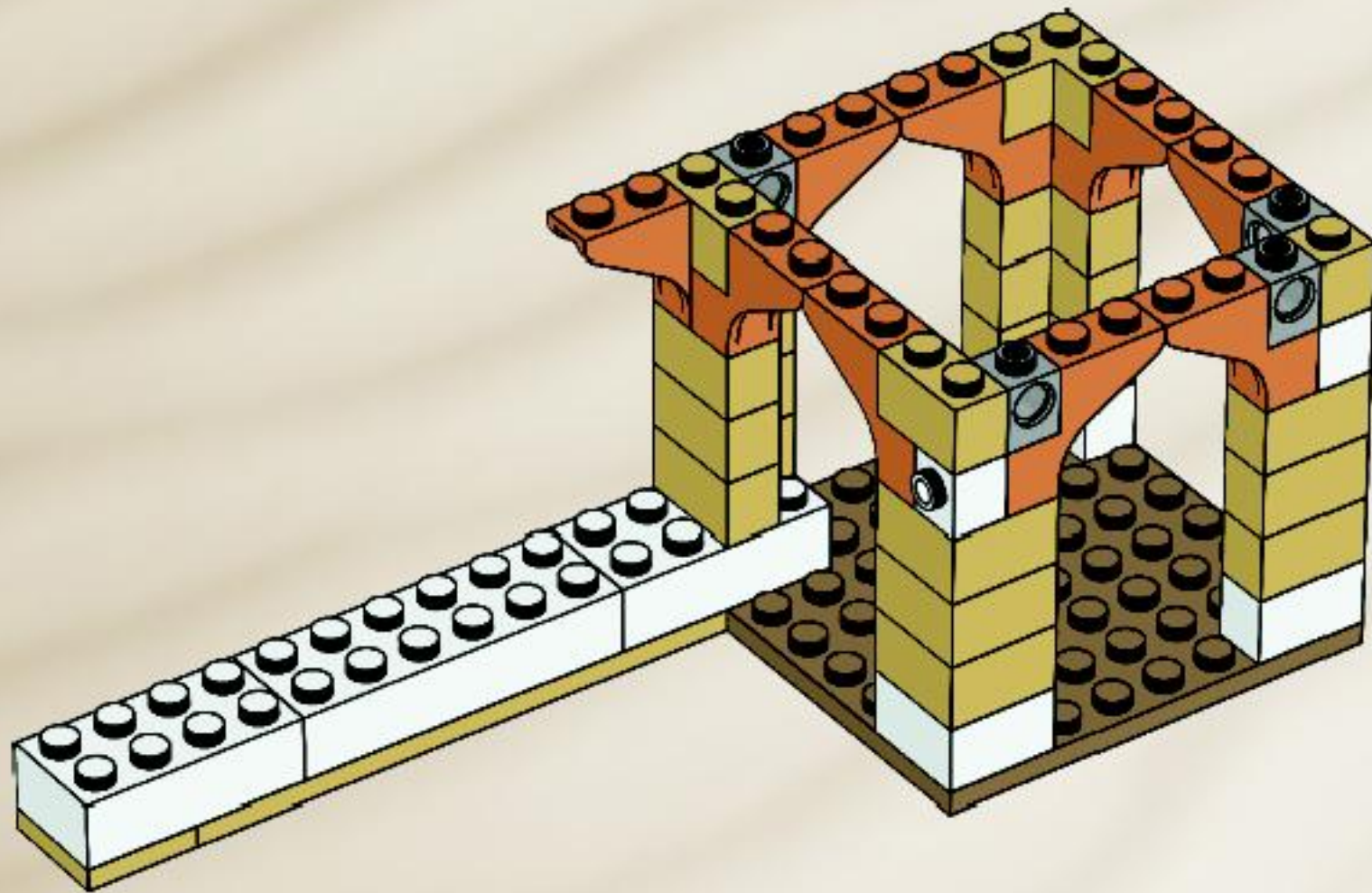



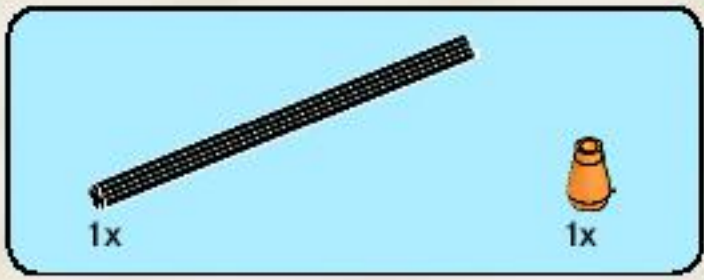

12

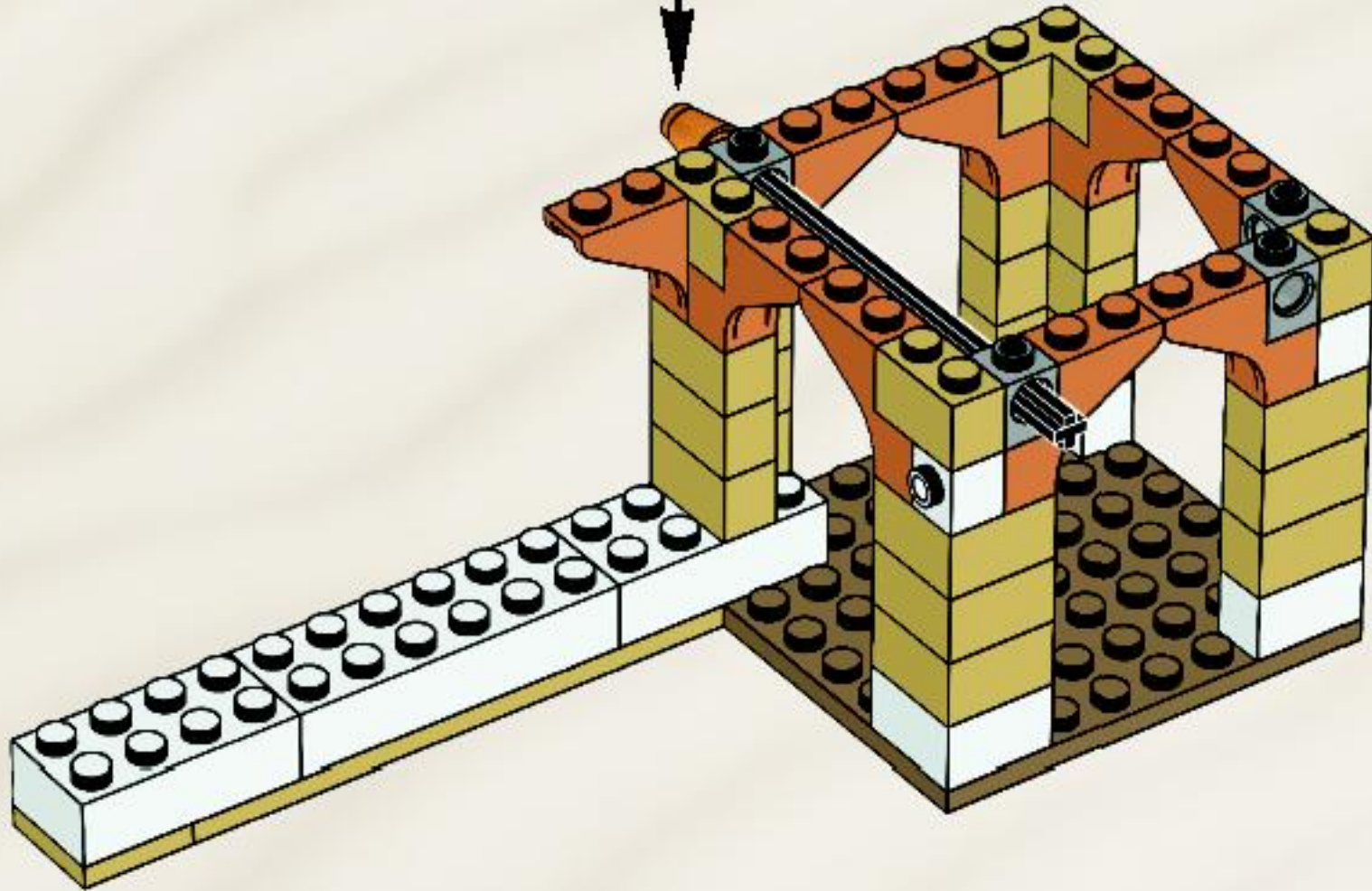
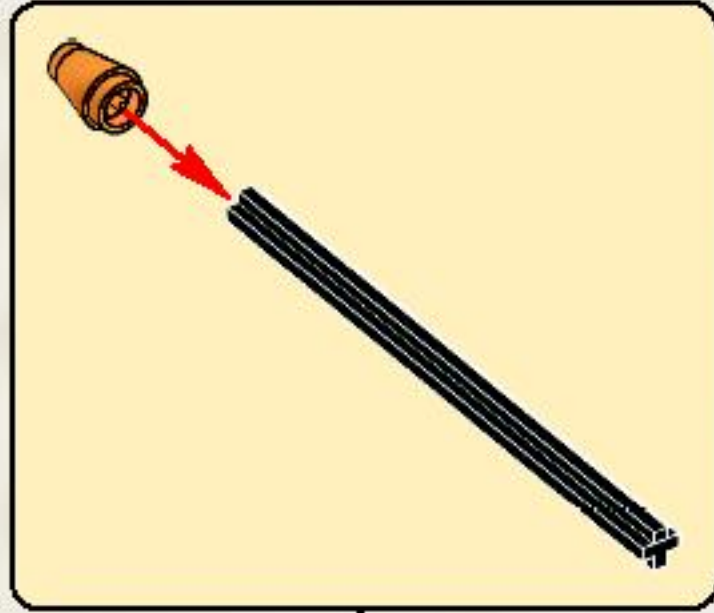

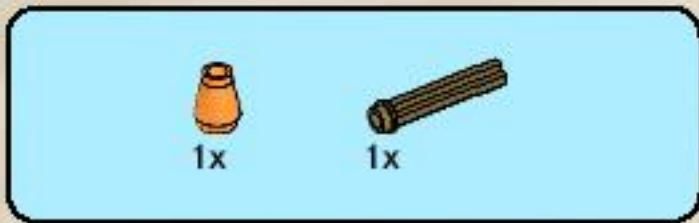

13

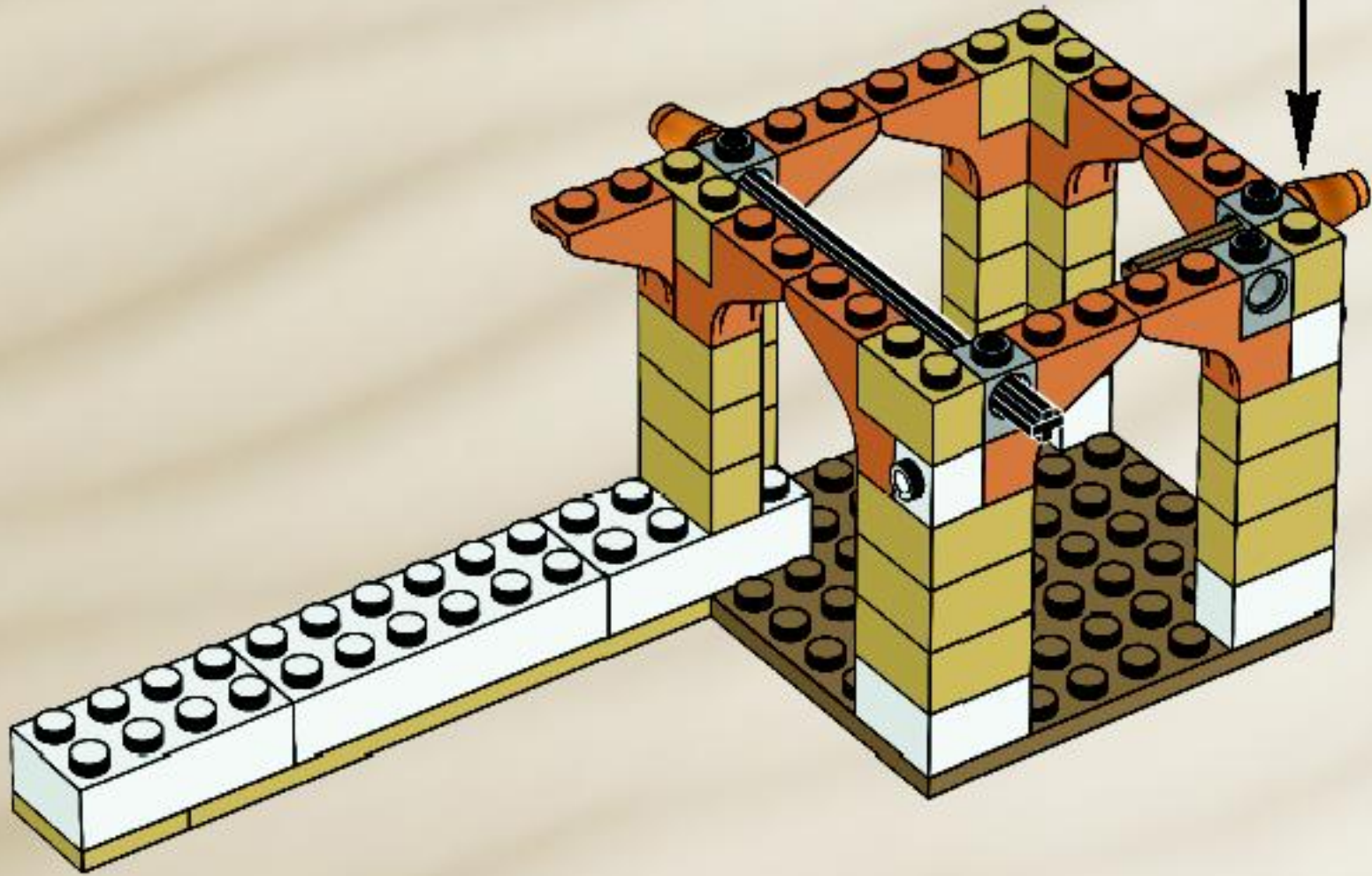
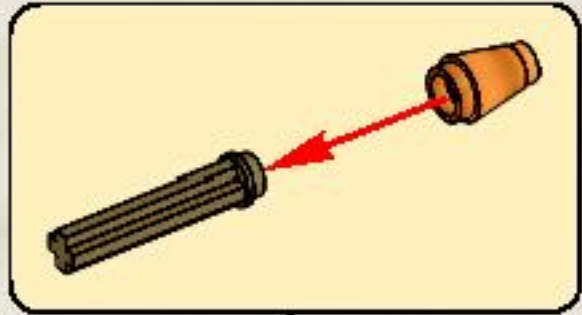



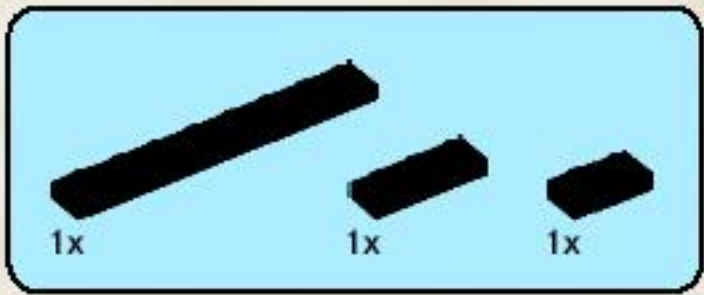

14

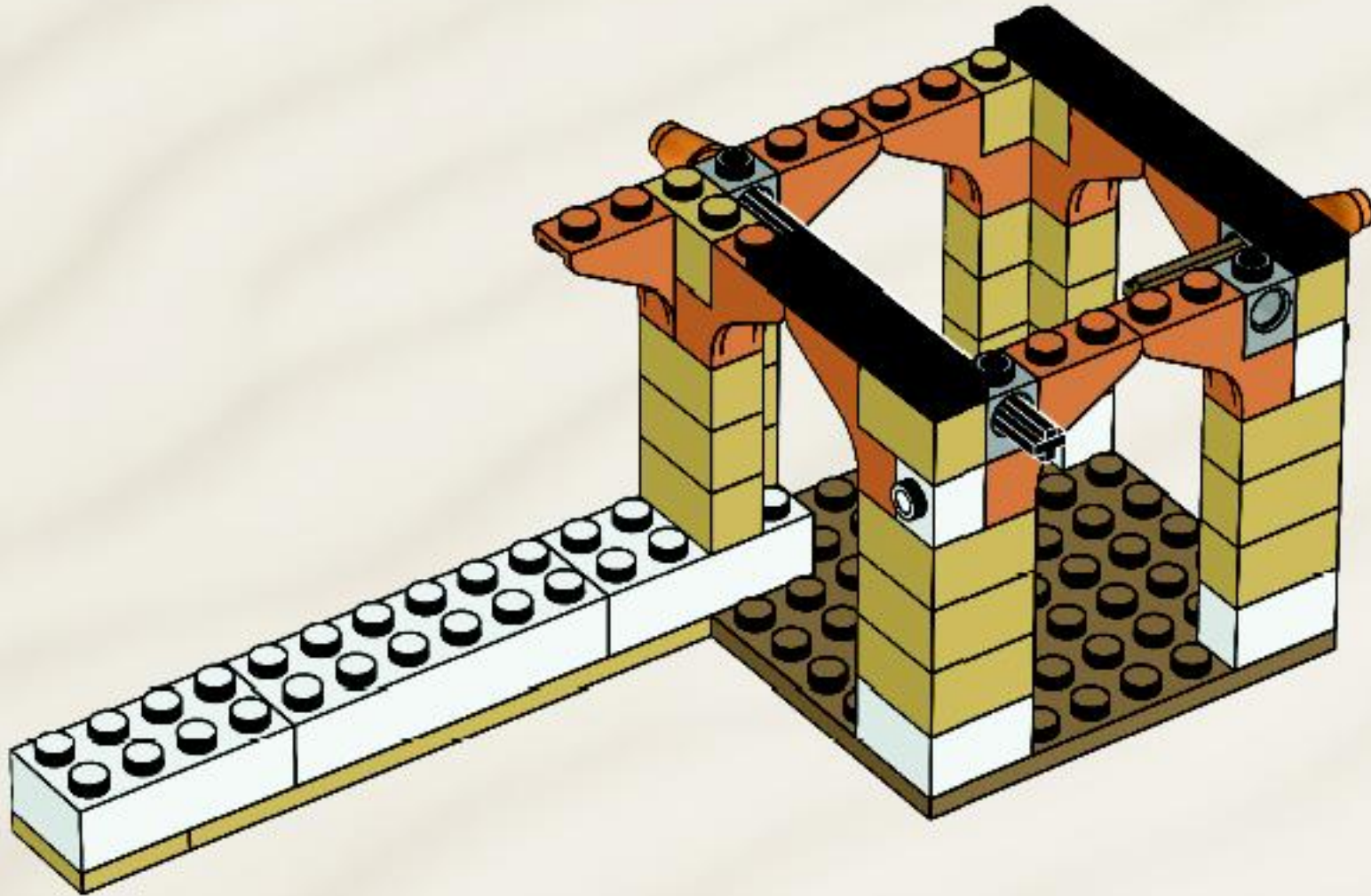



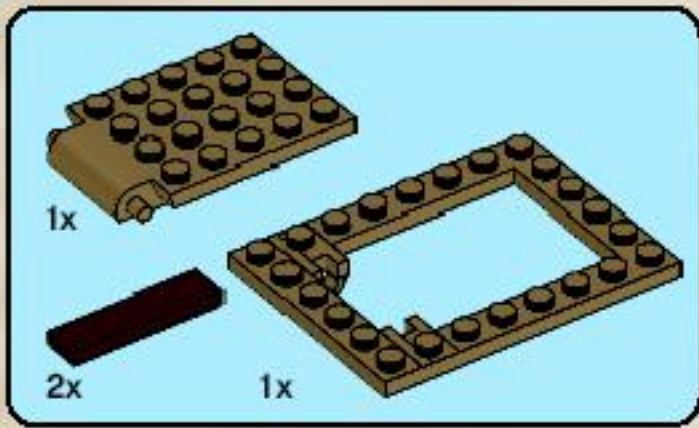

15

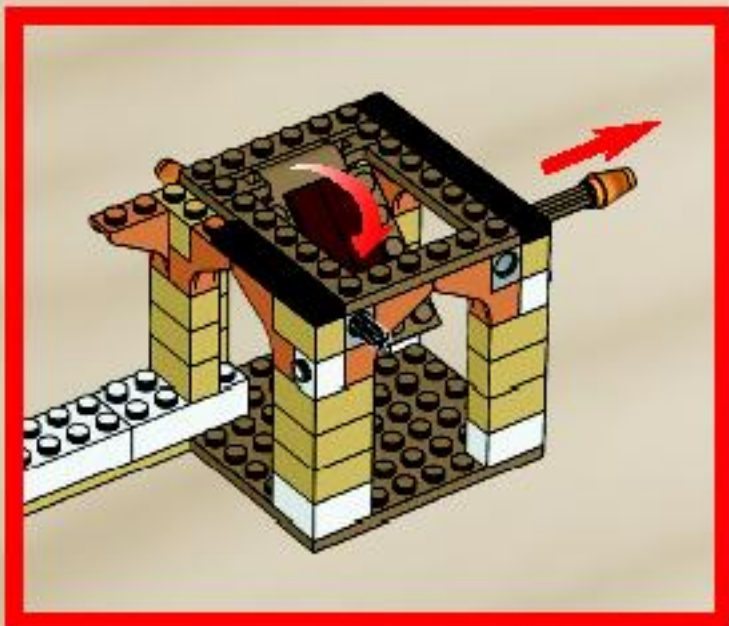
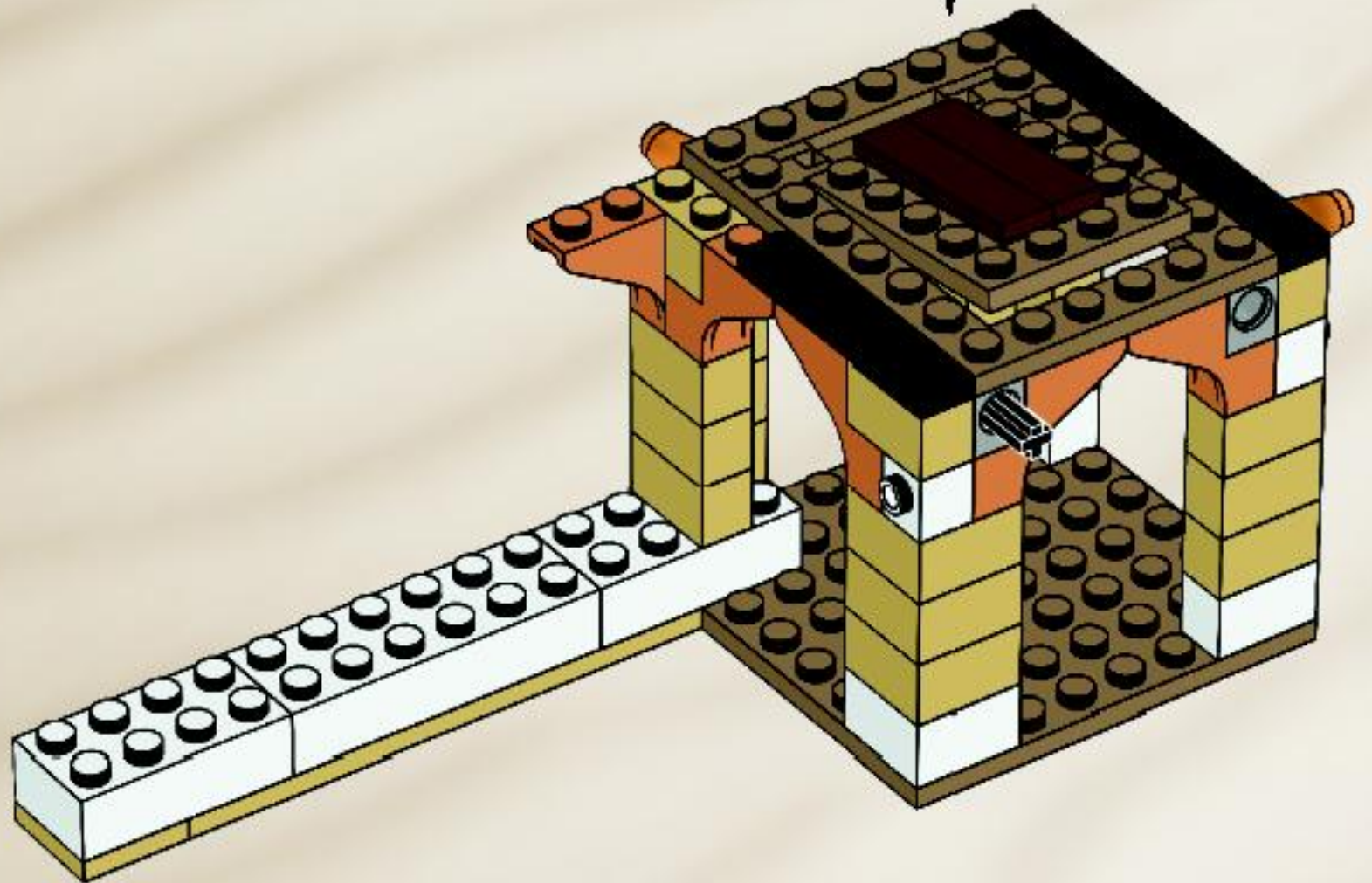
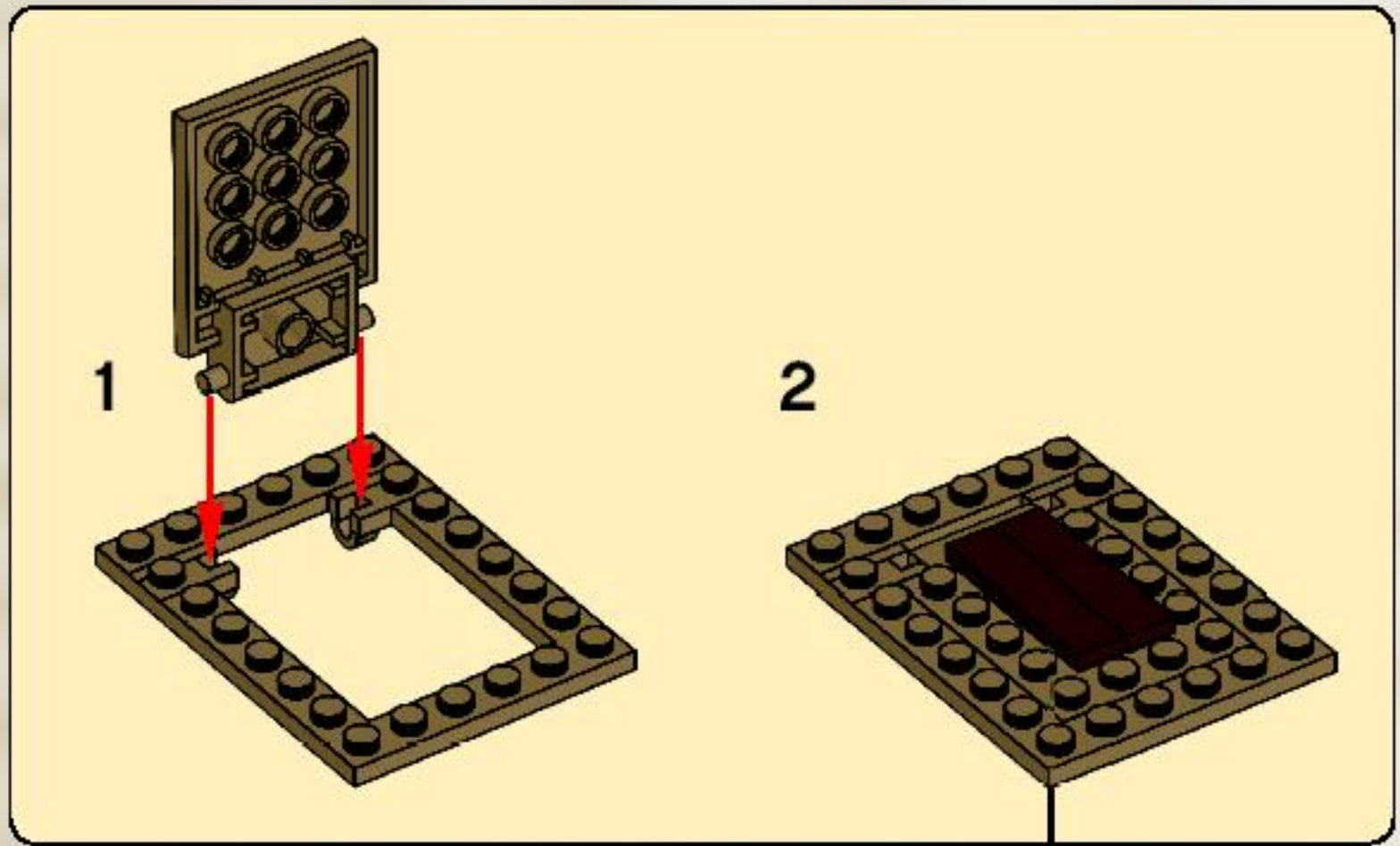



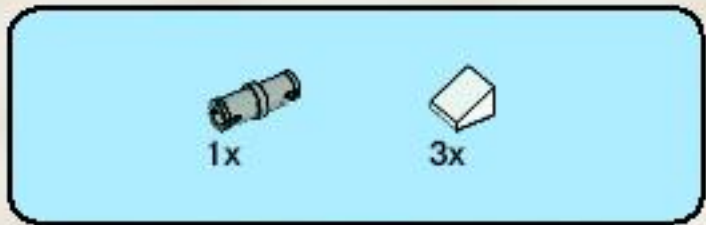

16

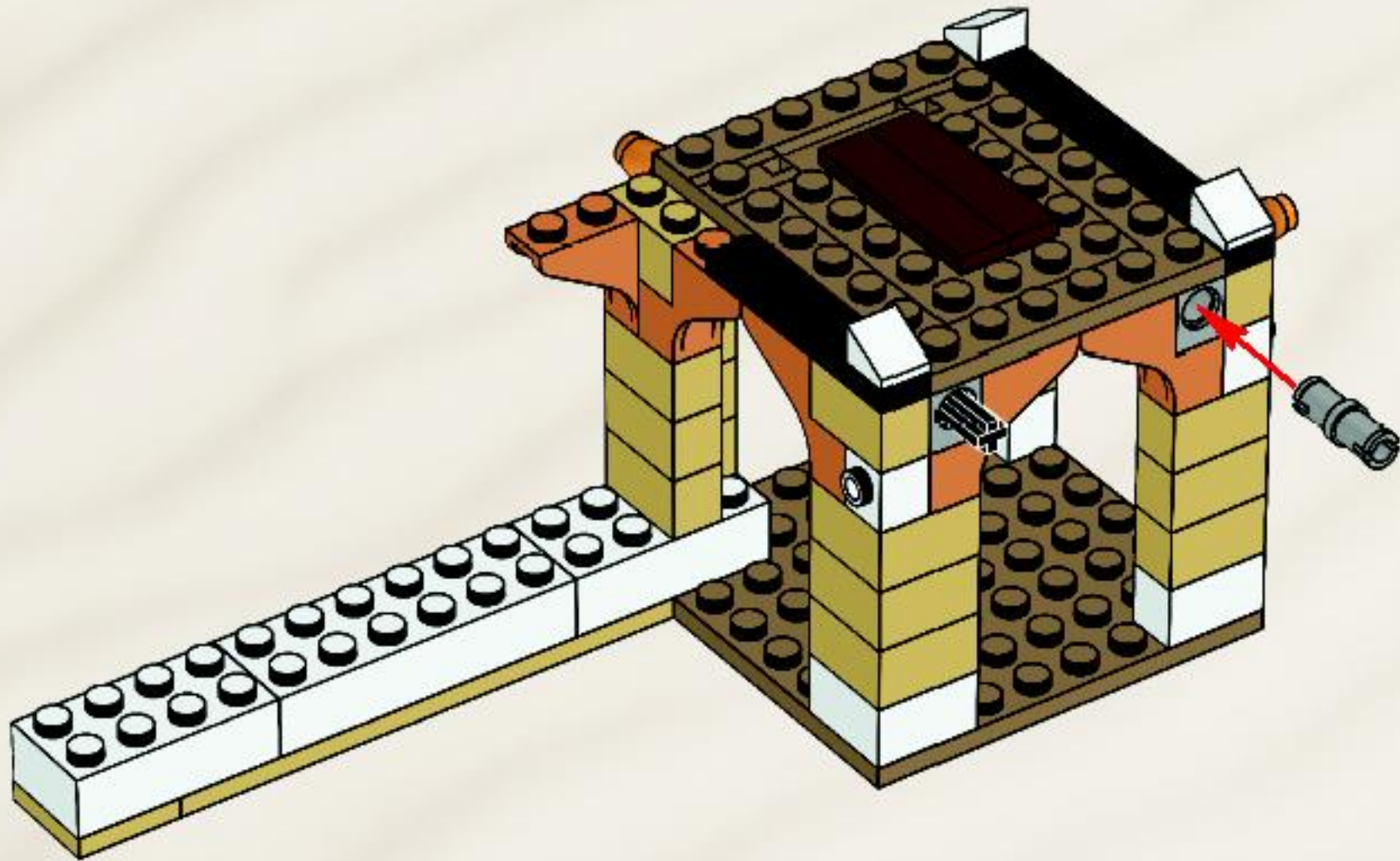

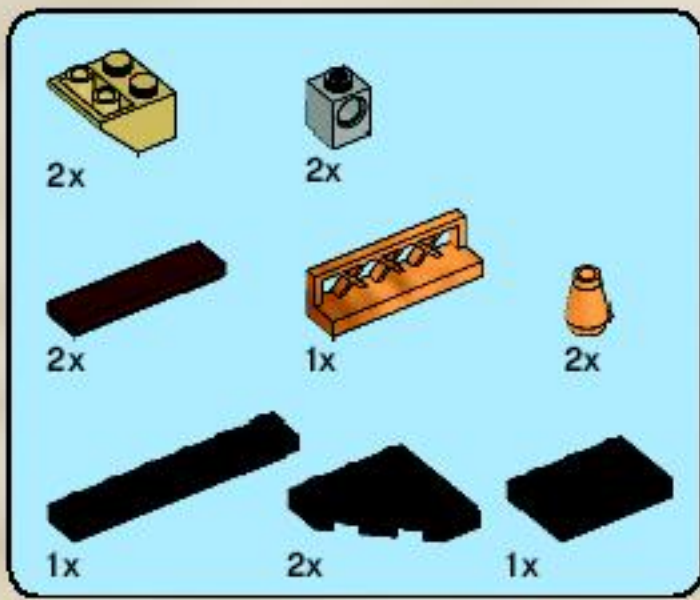

17

1



2

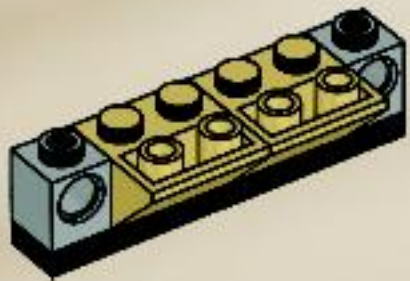

3

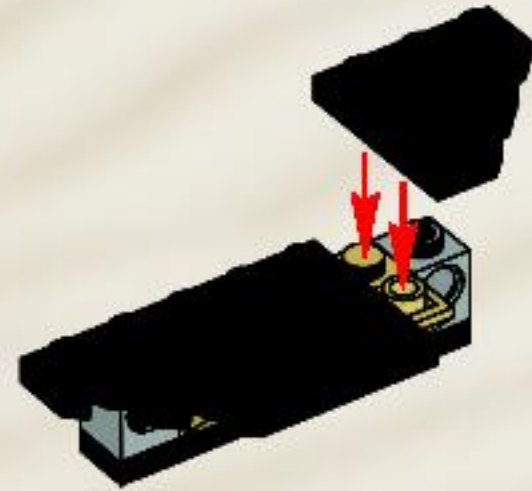

4



5





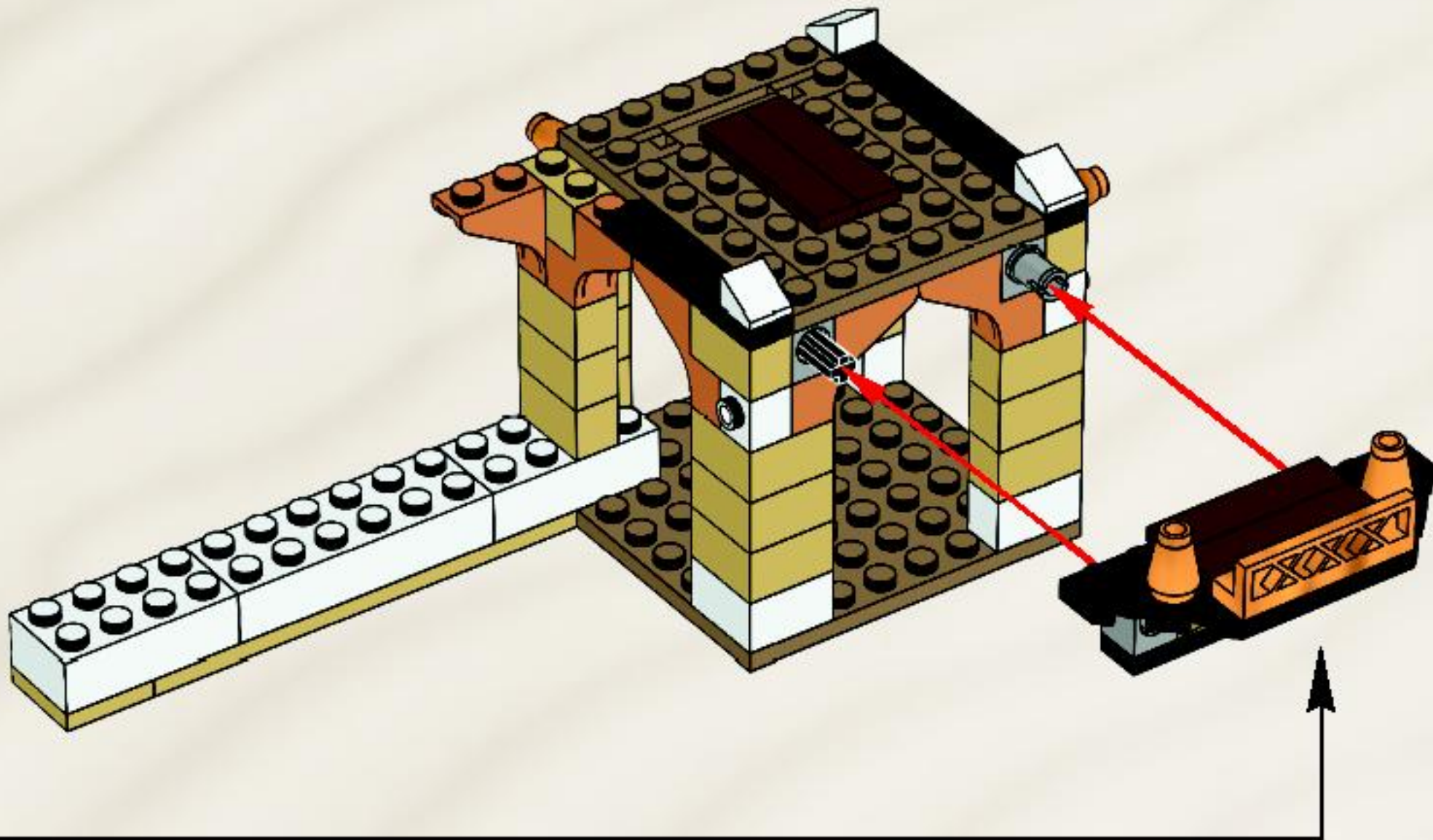





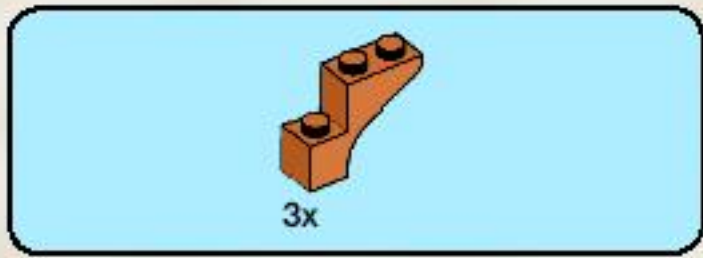

19

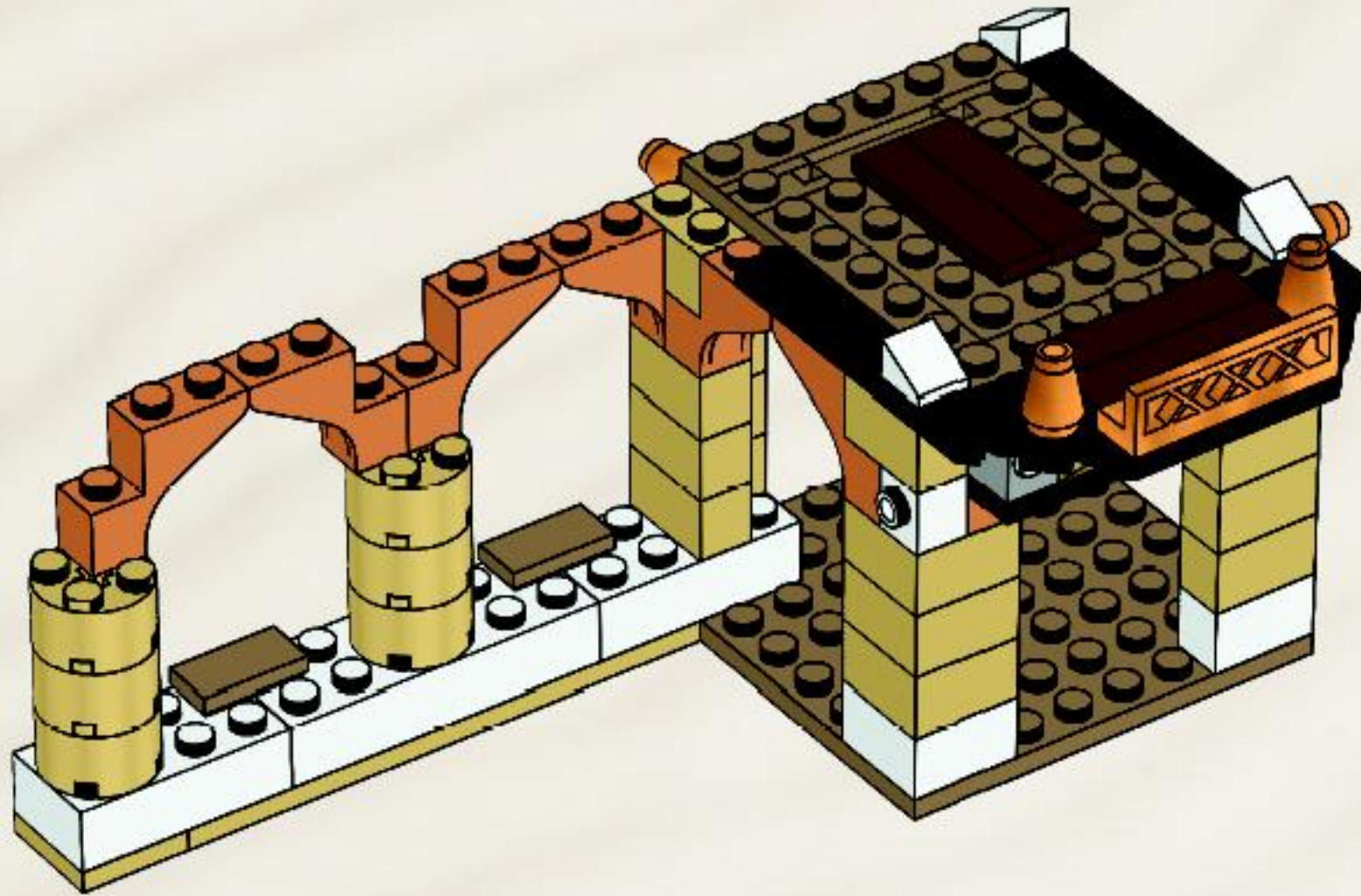



20

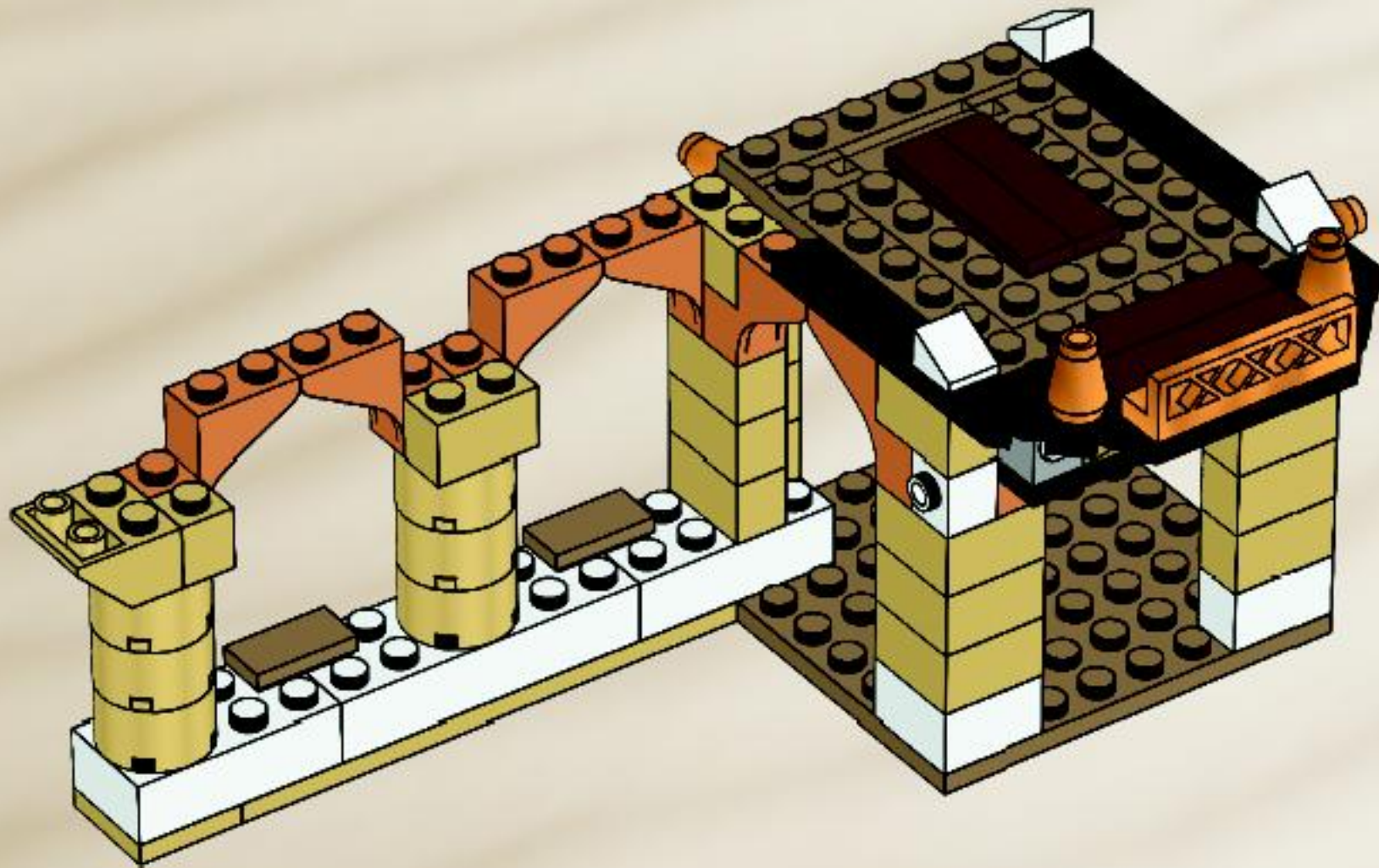



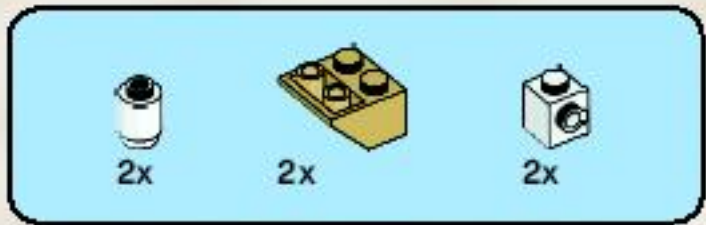

21

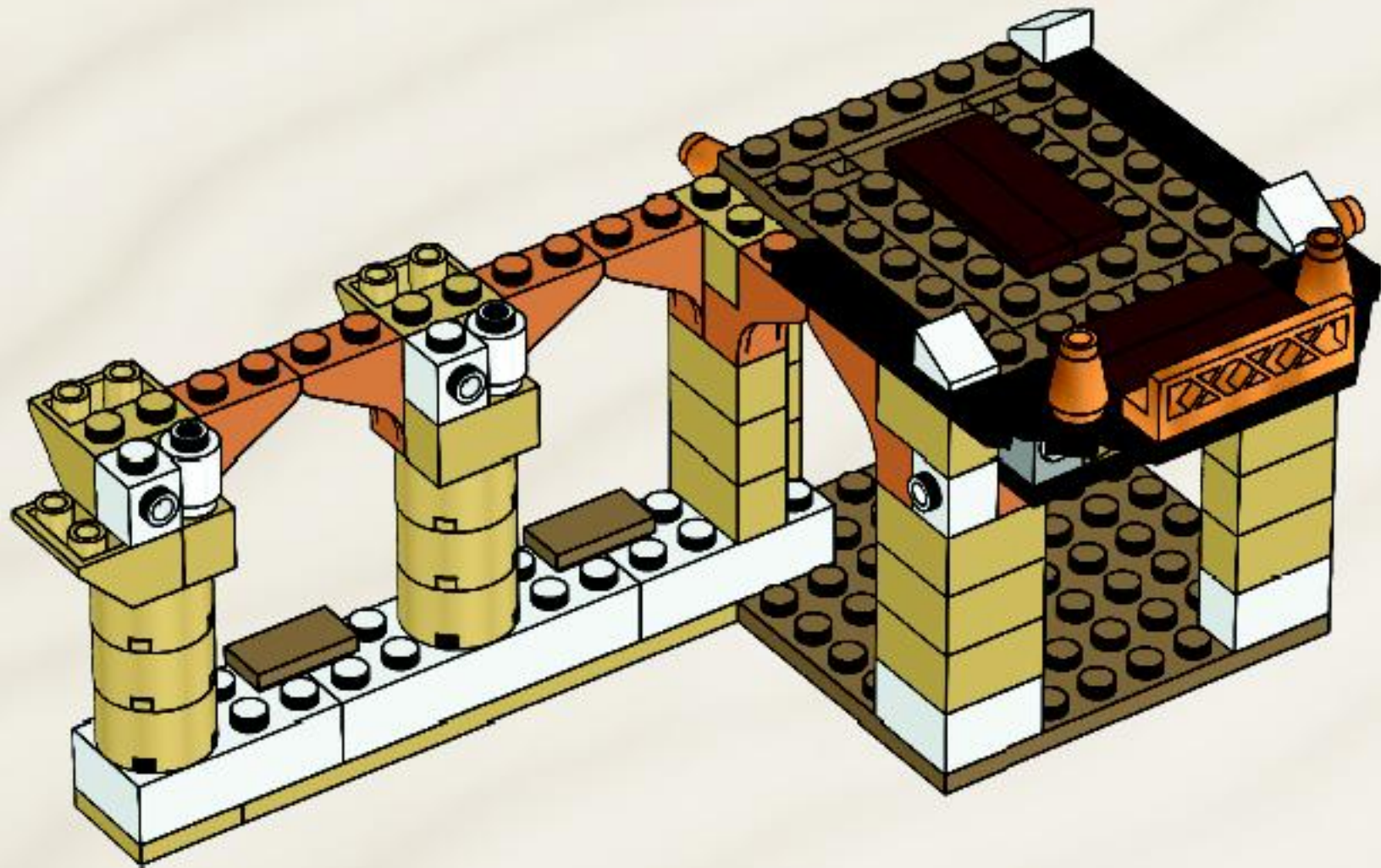



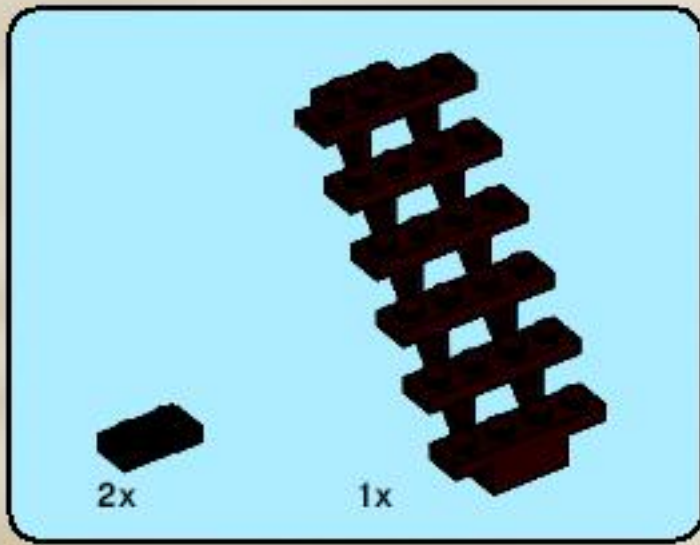

22

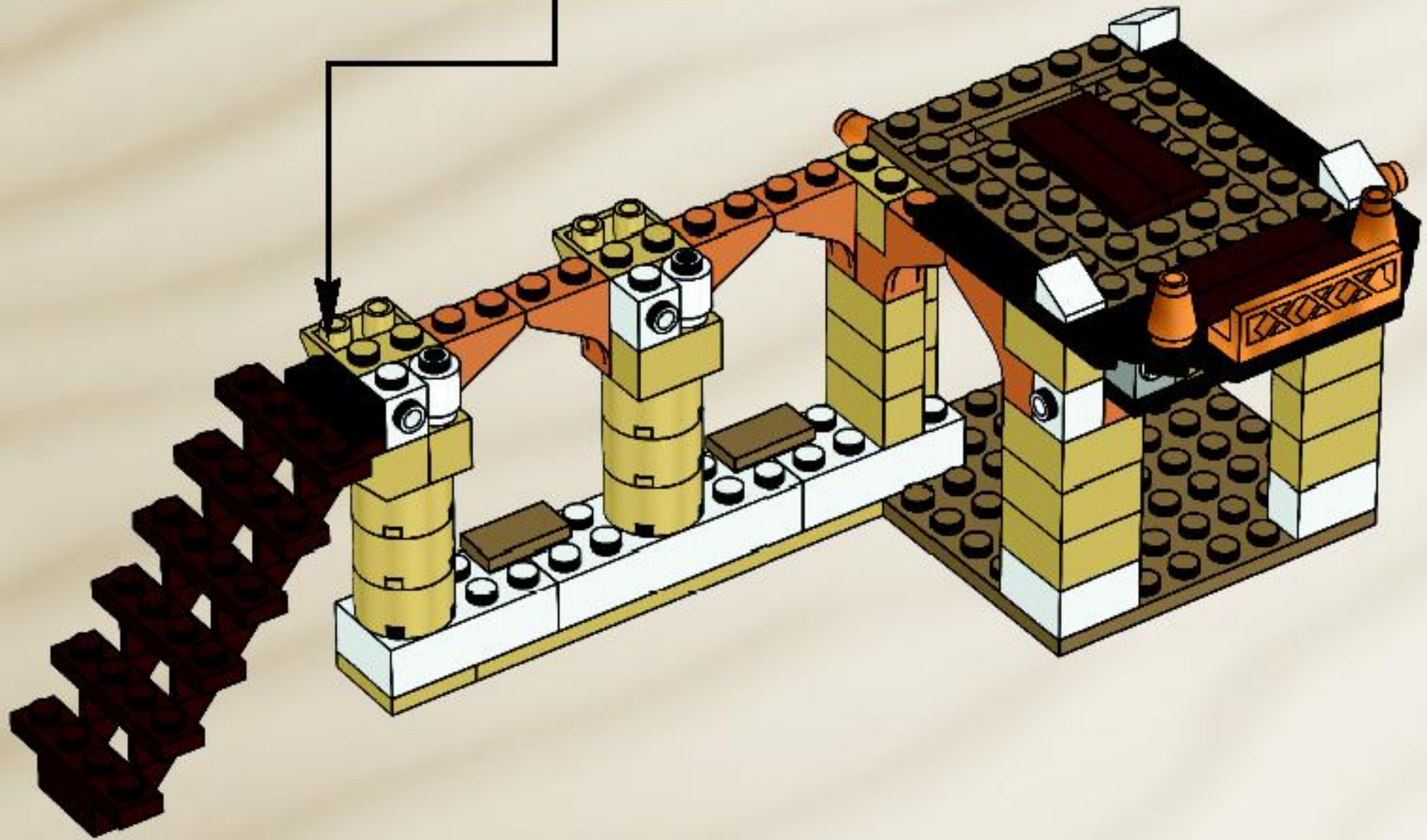
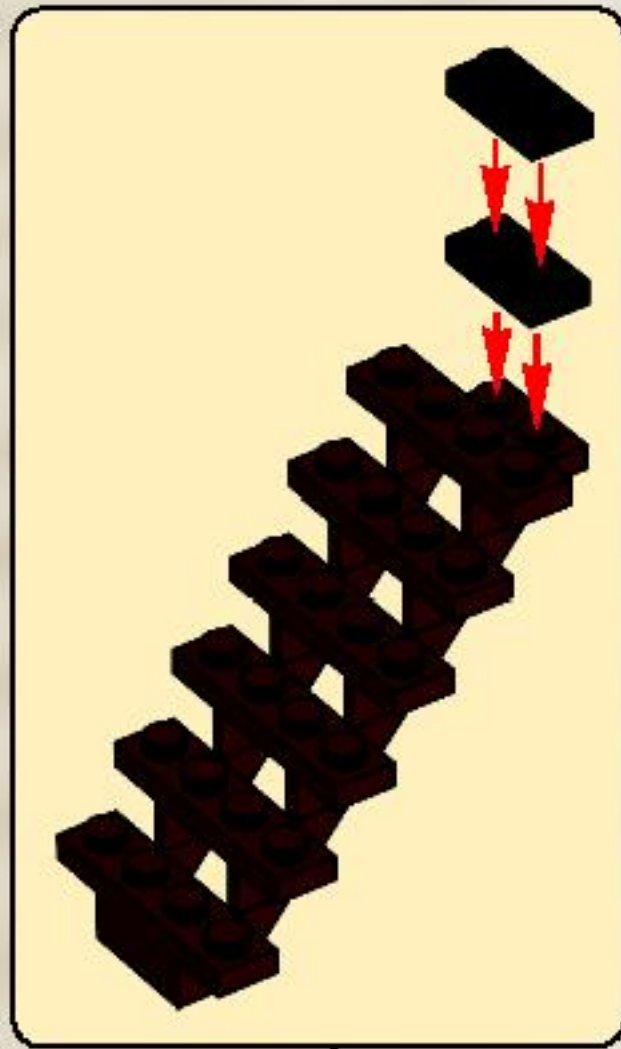



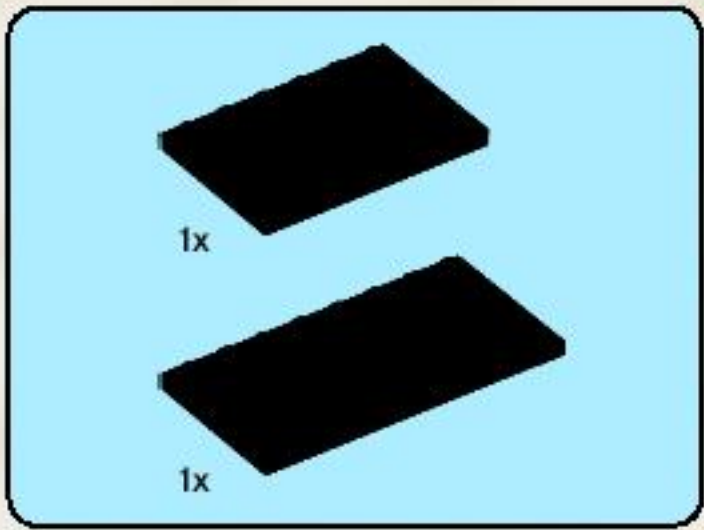

23

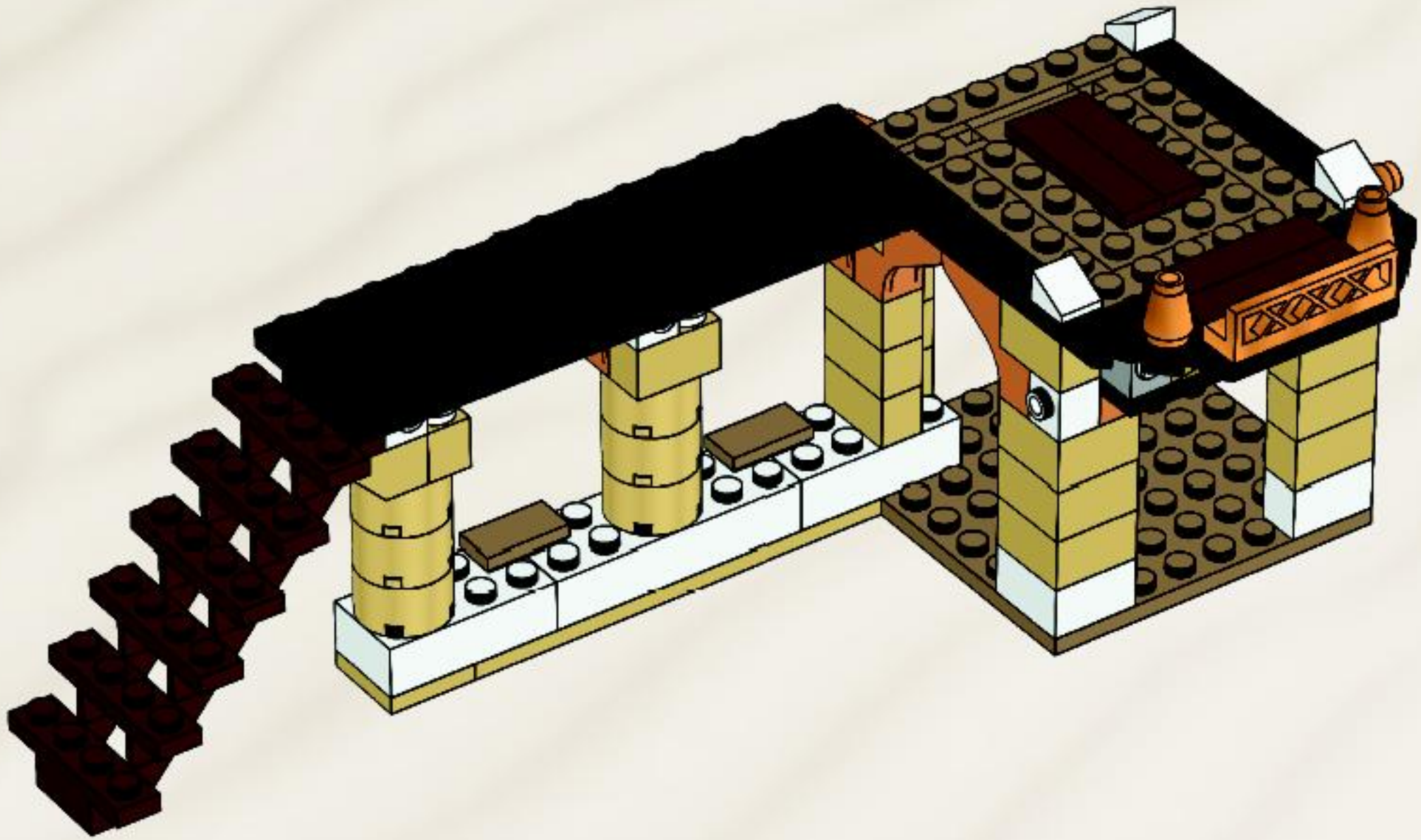

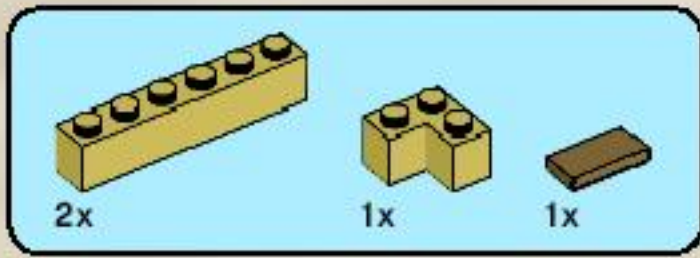

24

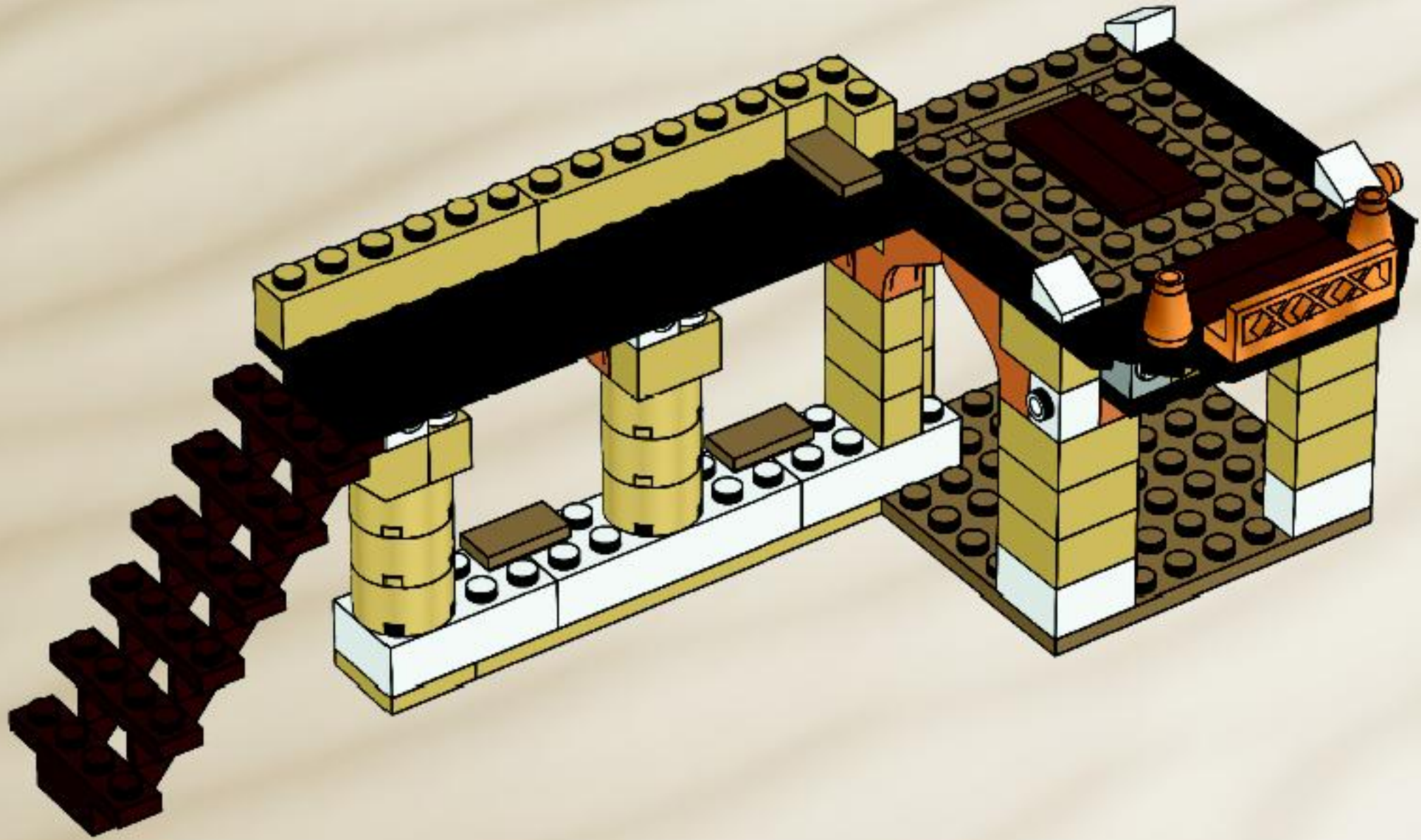



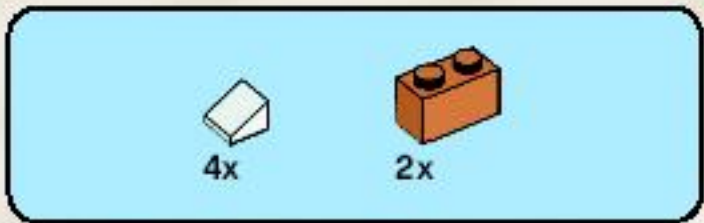

25

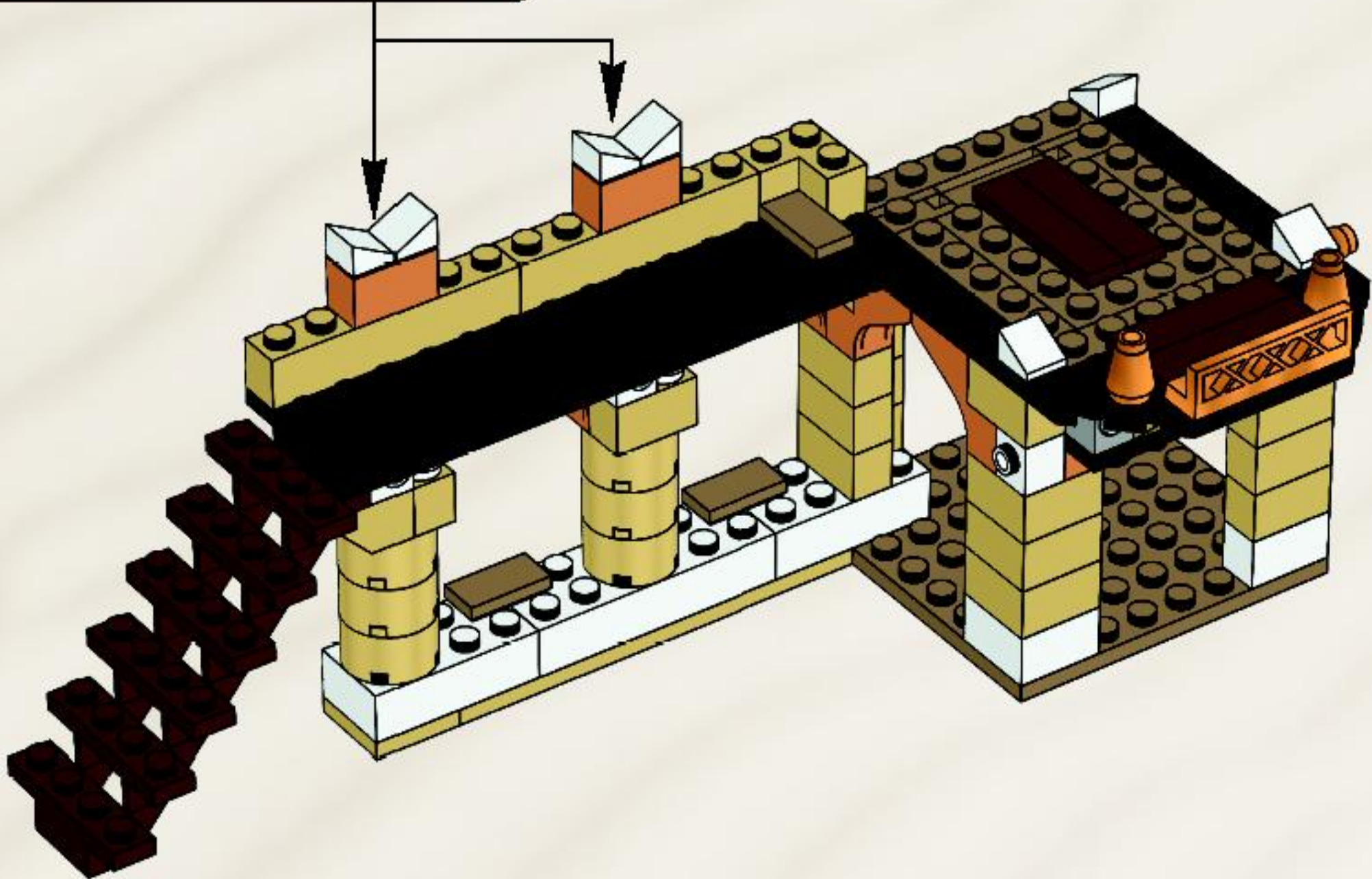
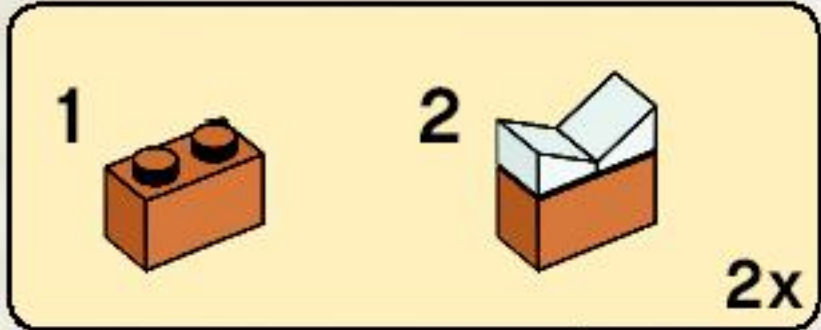



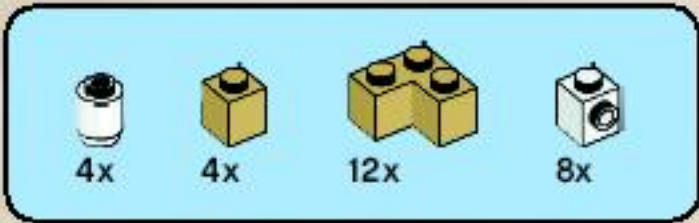

26

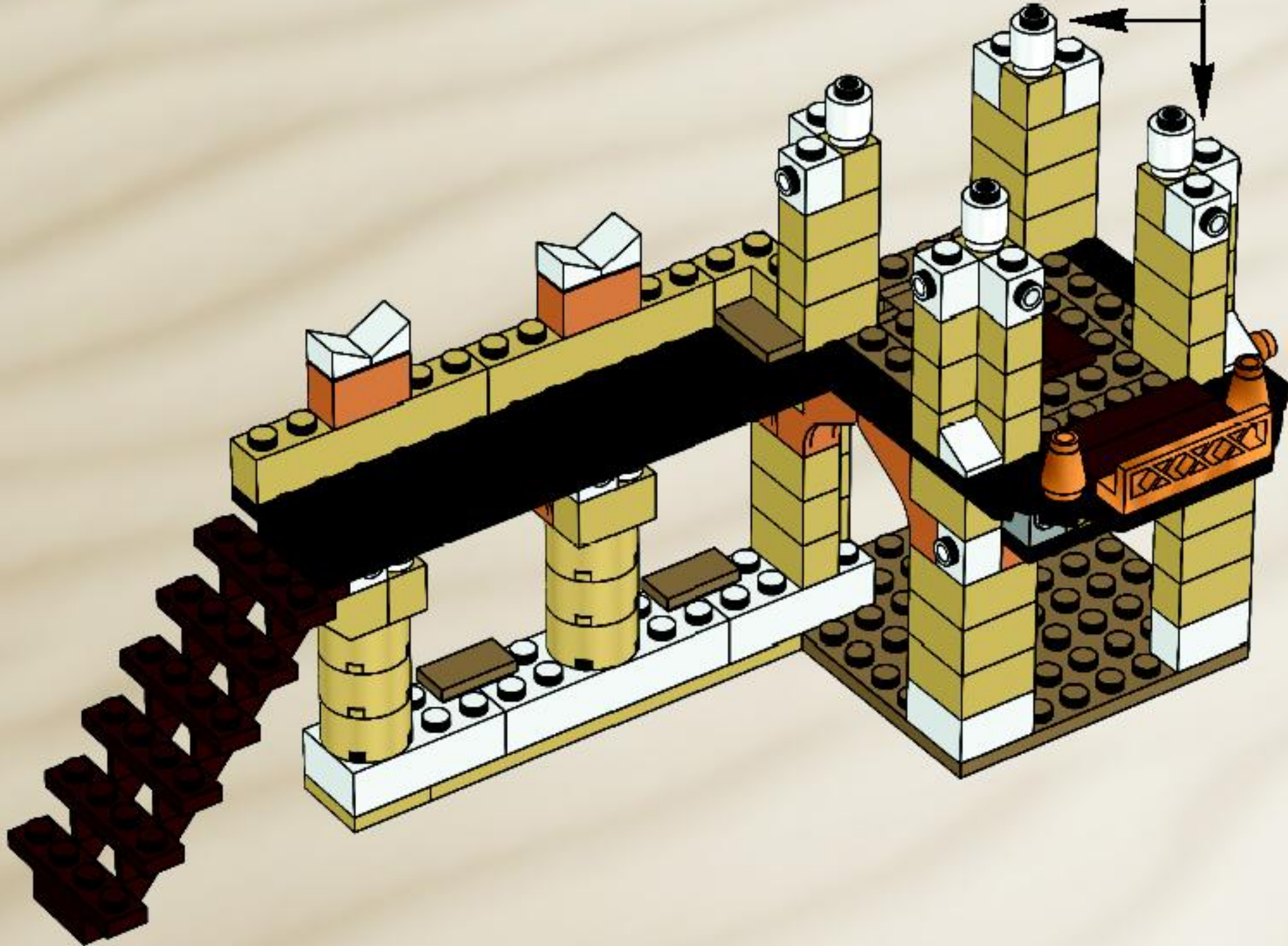
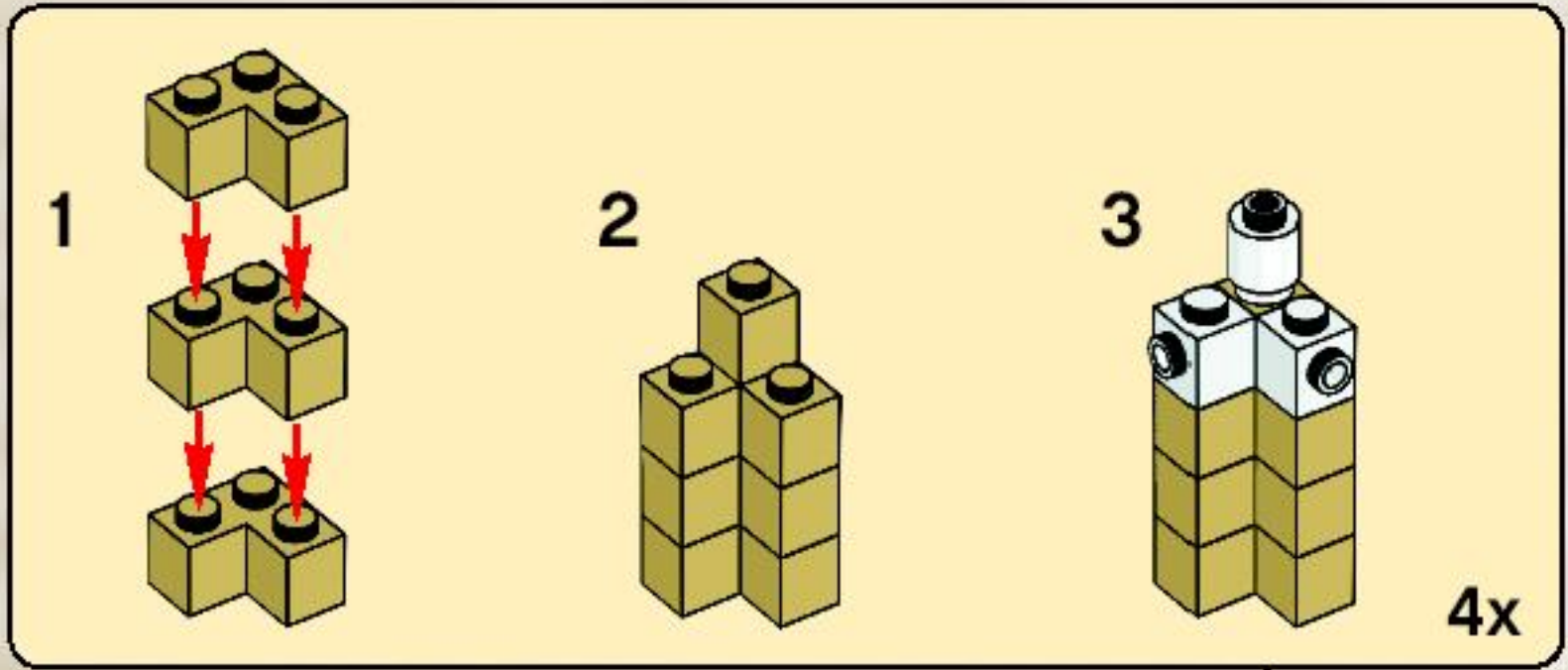



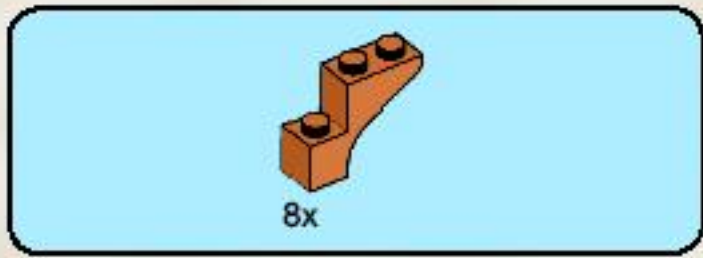

27

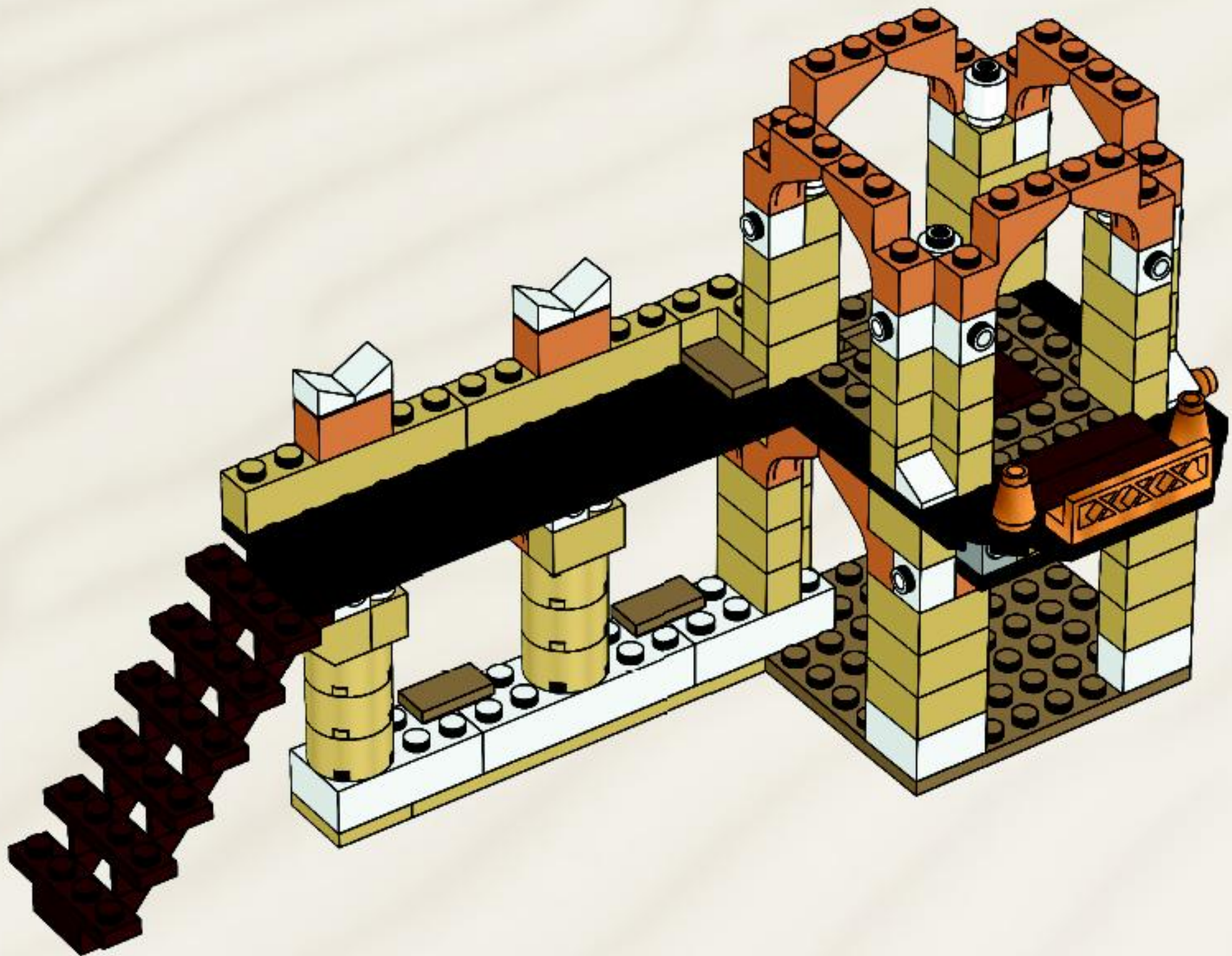





4x

28

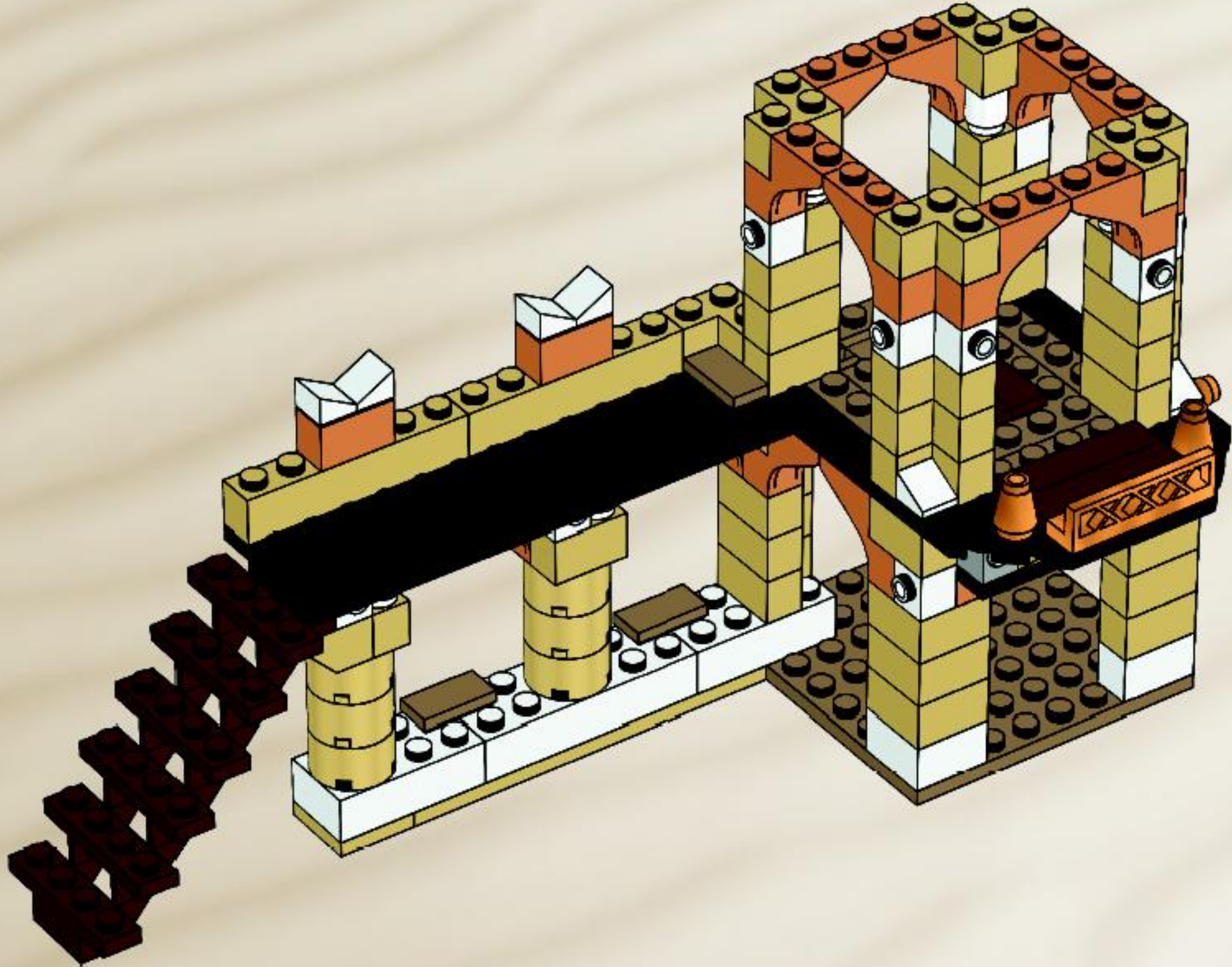



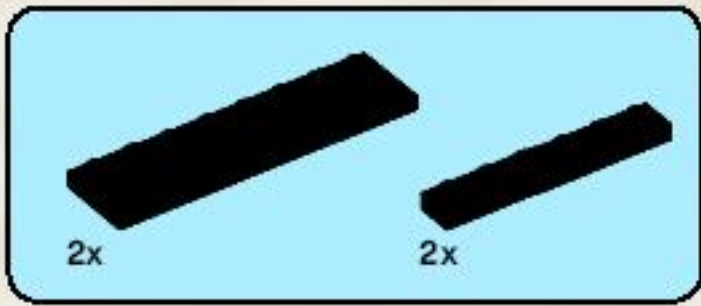

29

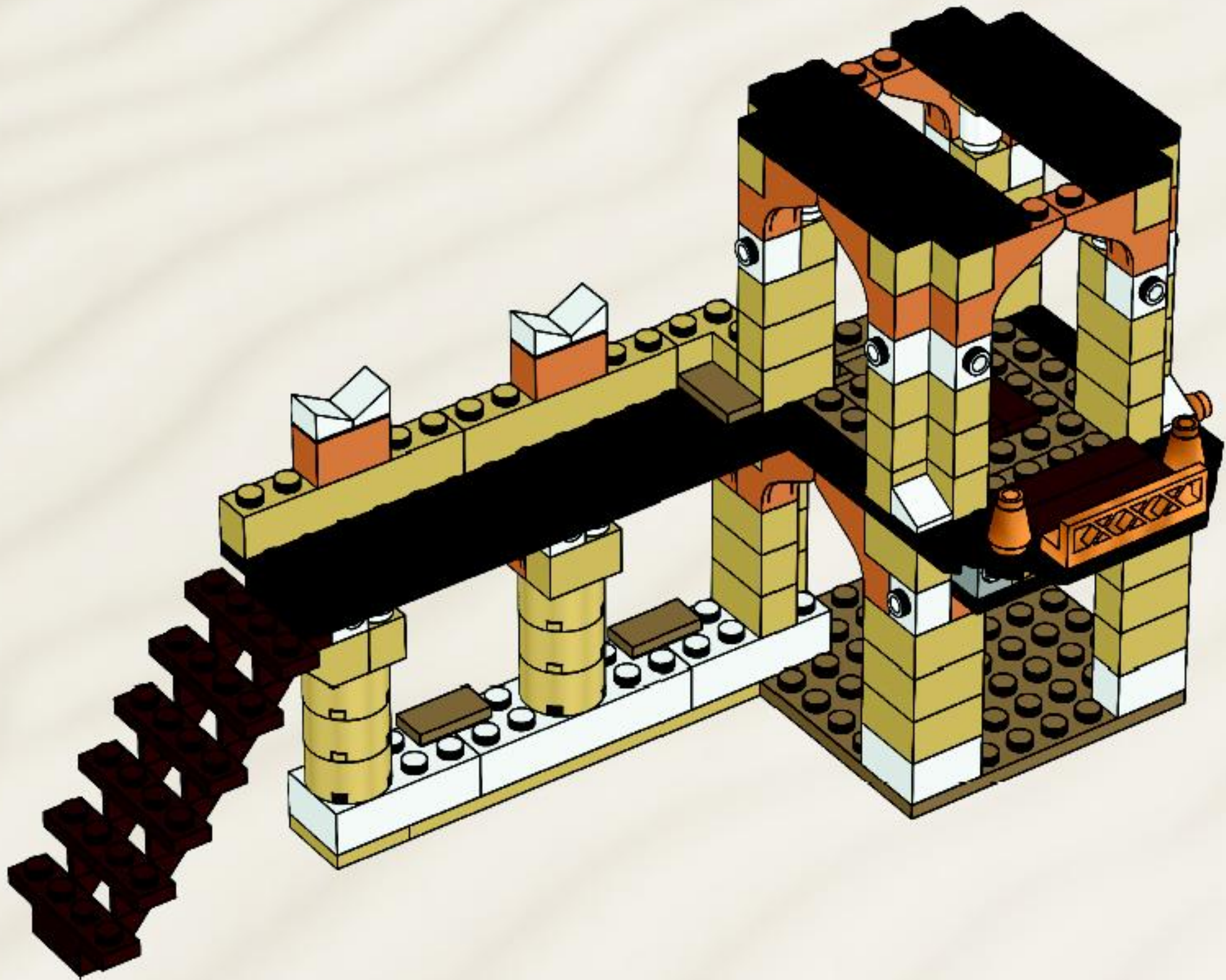



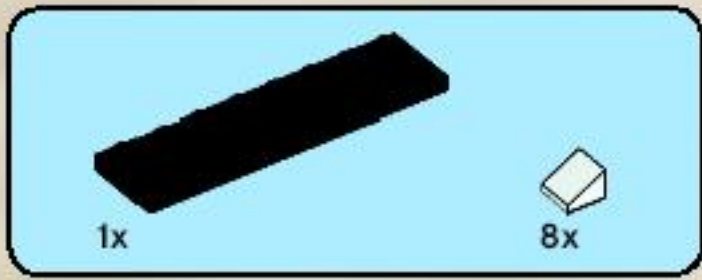

30

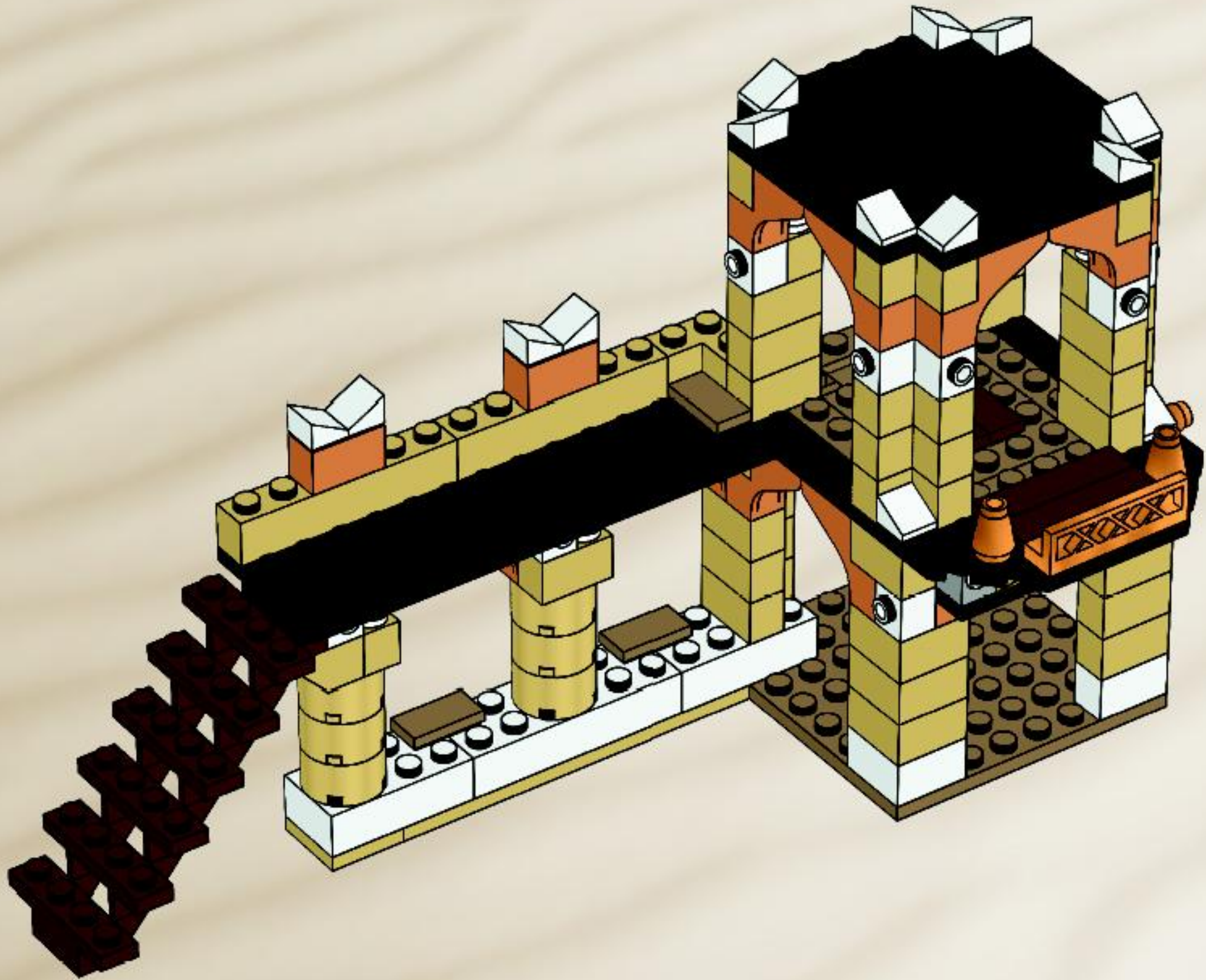



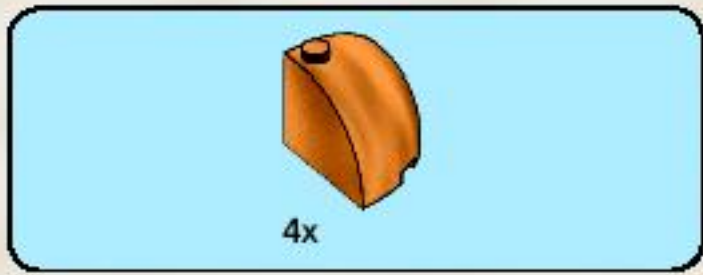

31

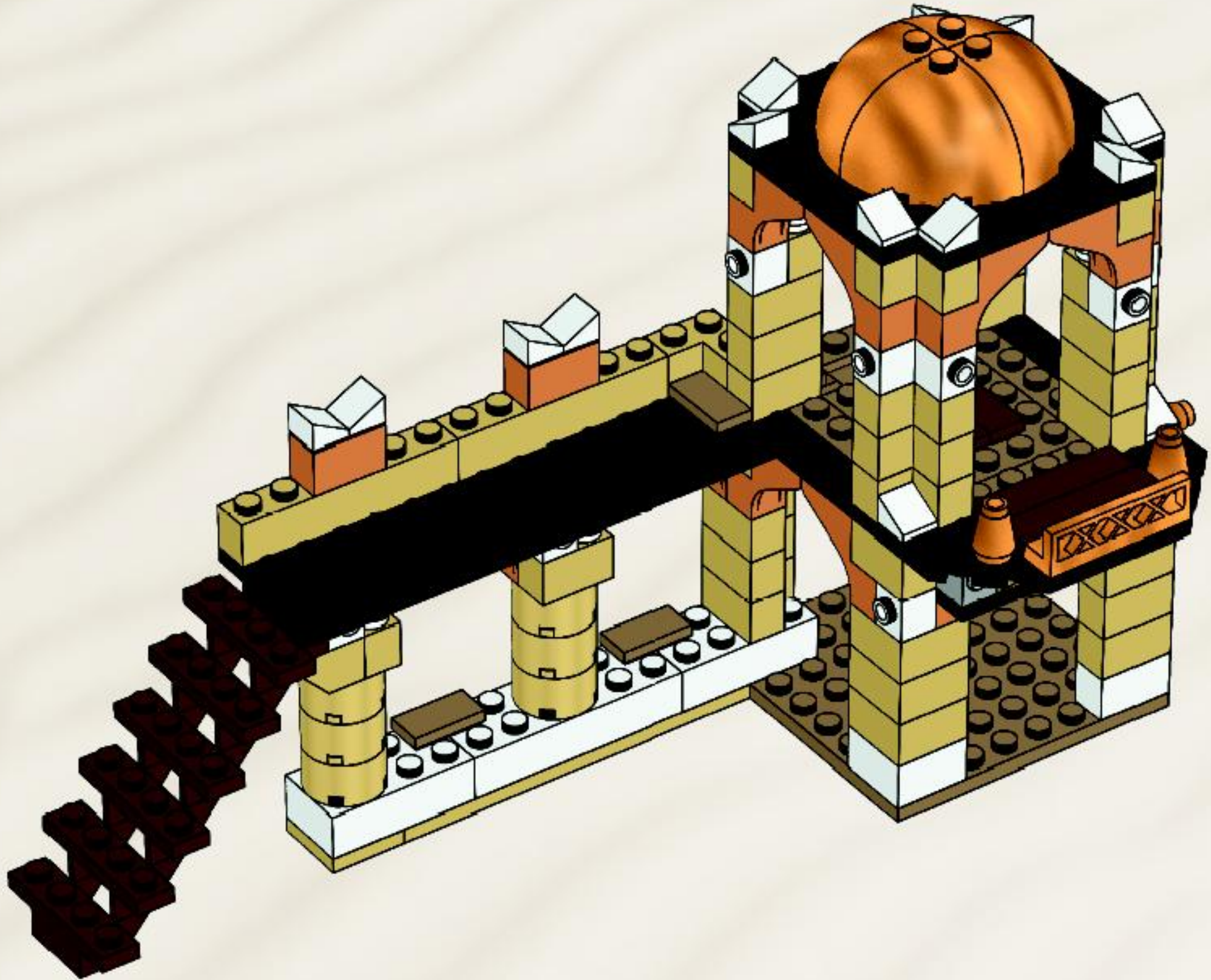





32

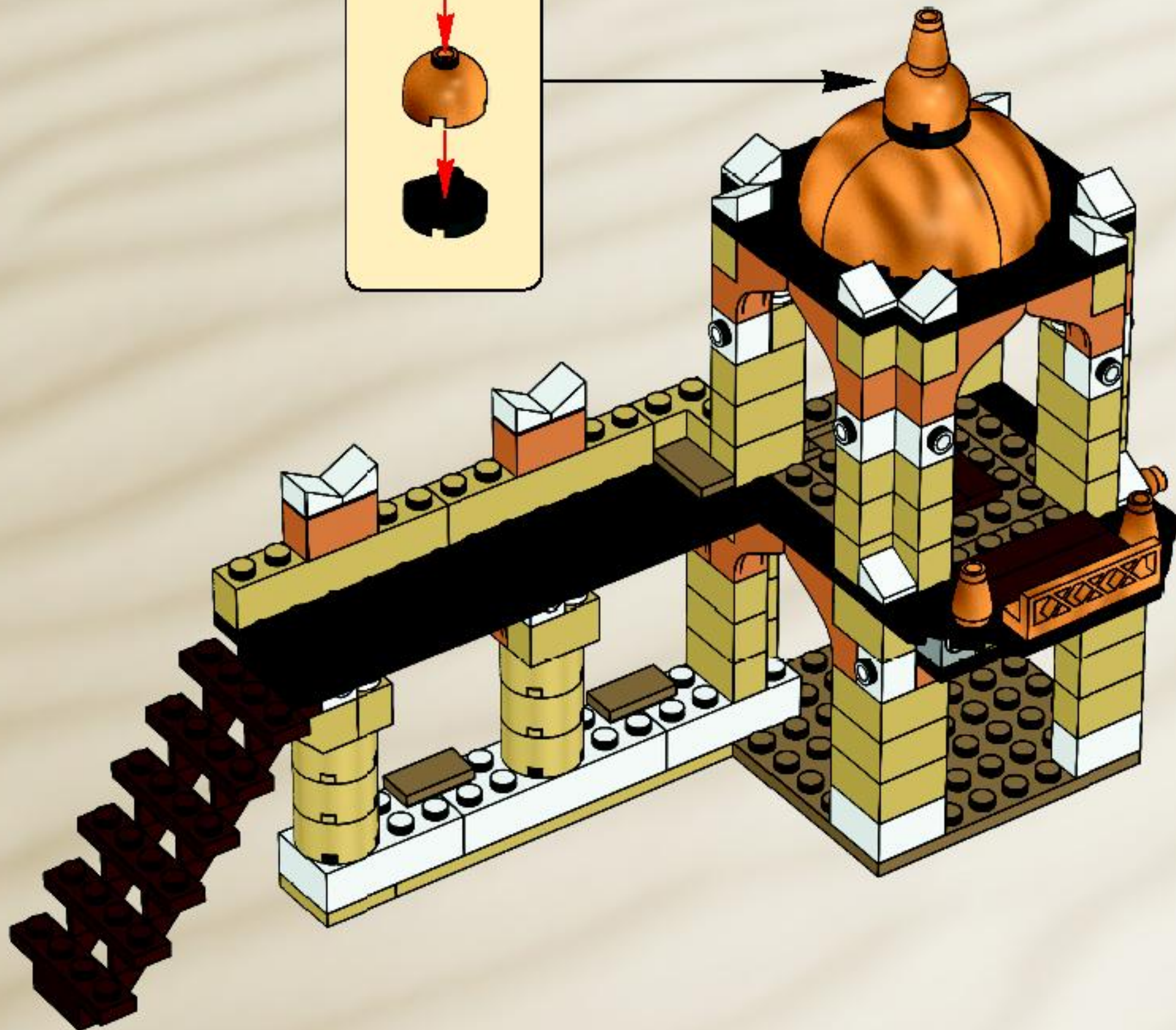
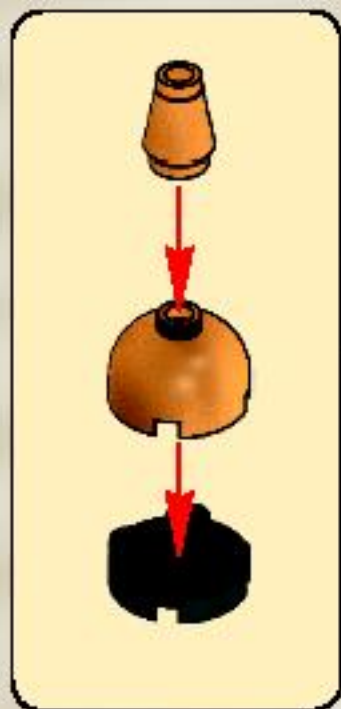



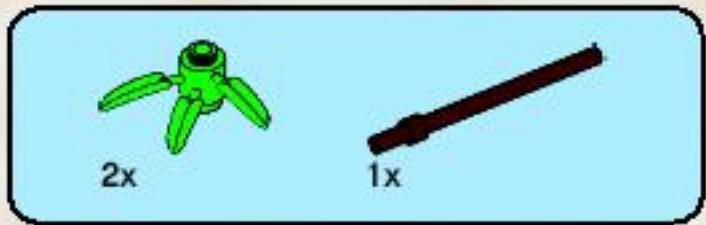

33

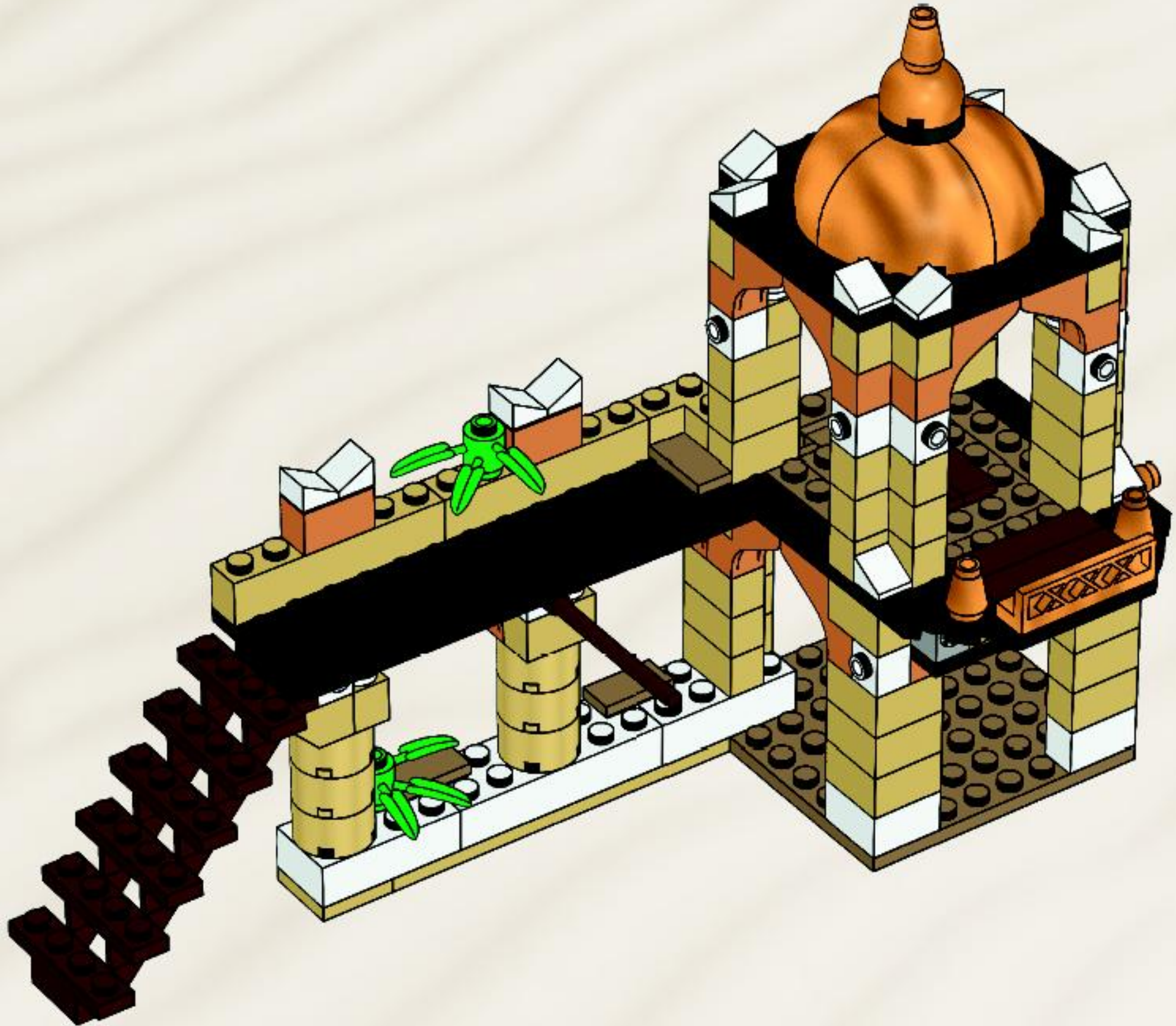



			
1x	1x	2x	2x

# 34

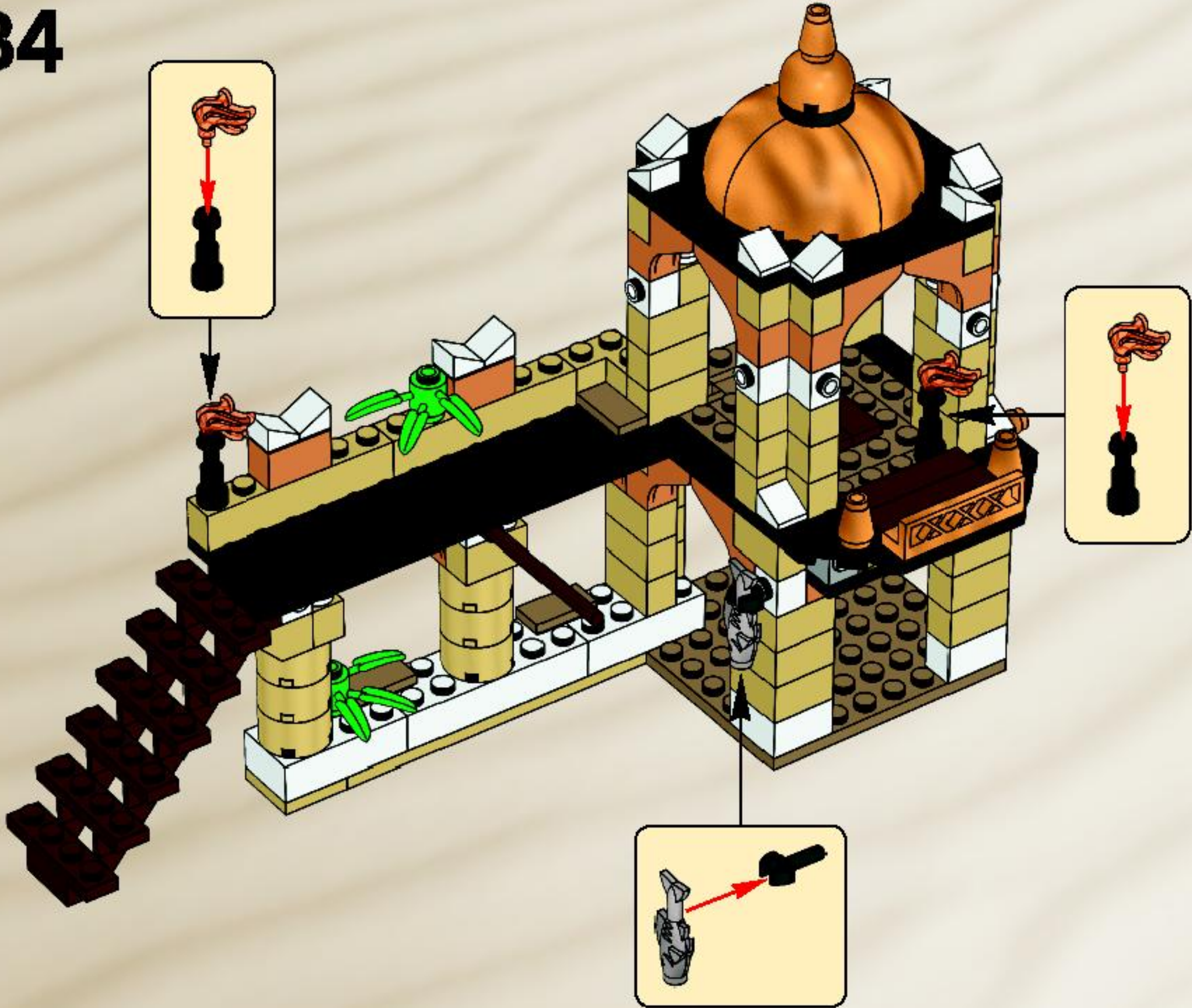



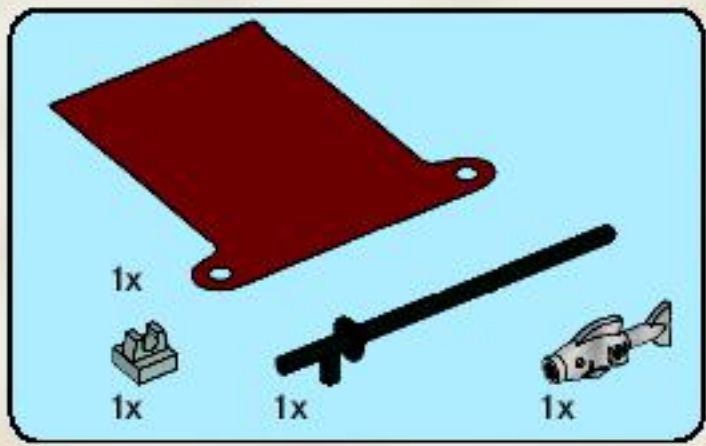

35

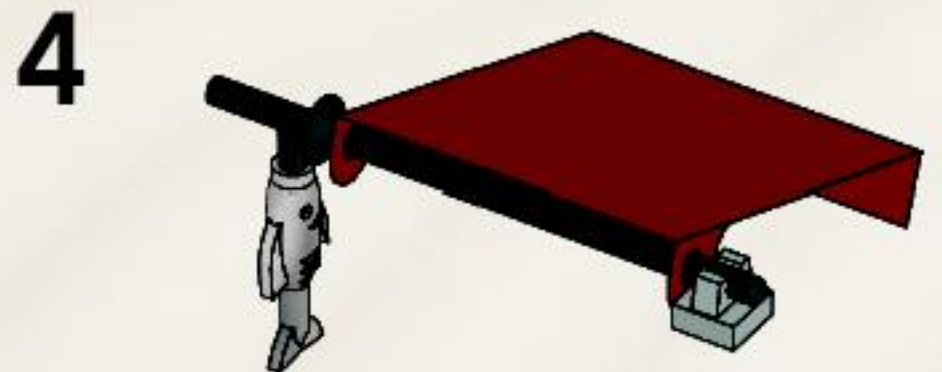
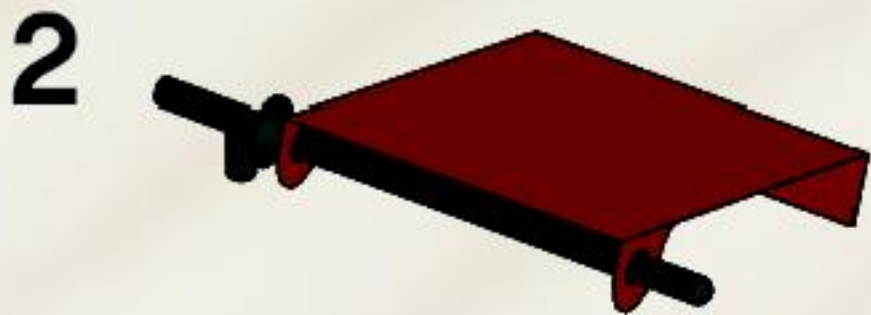

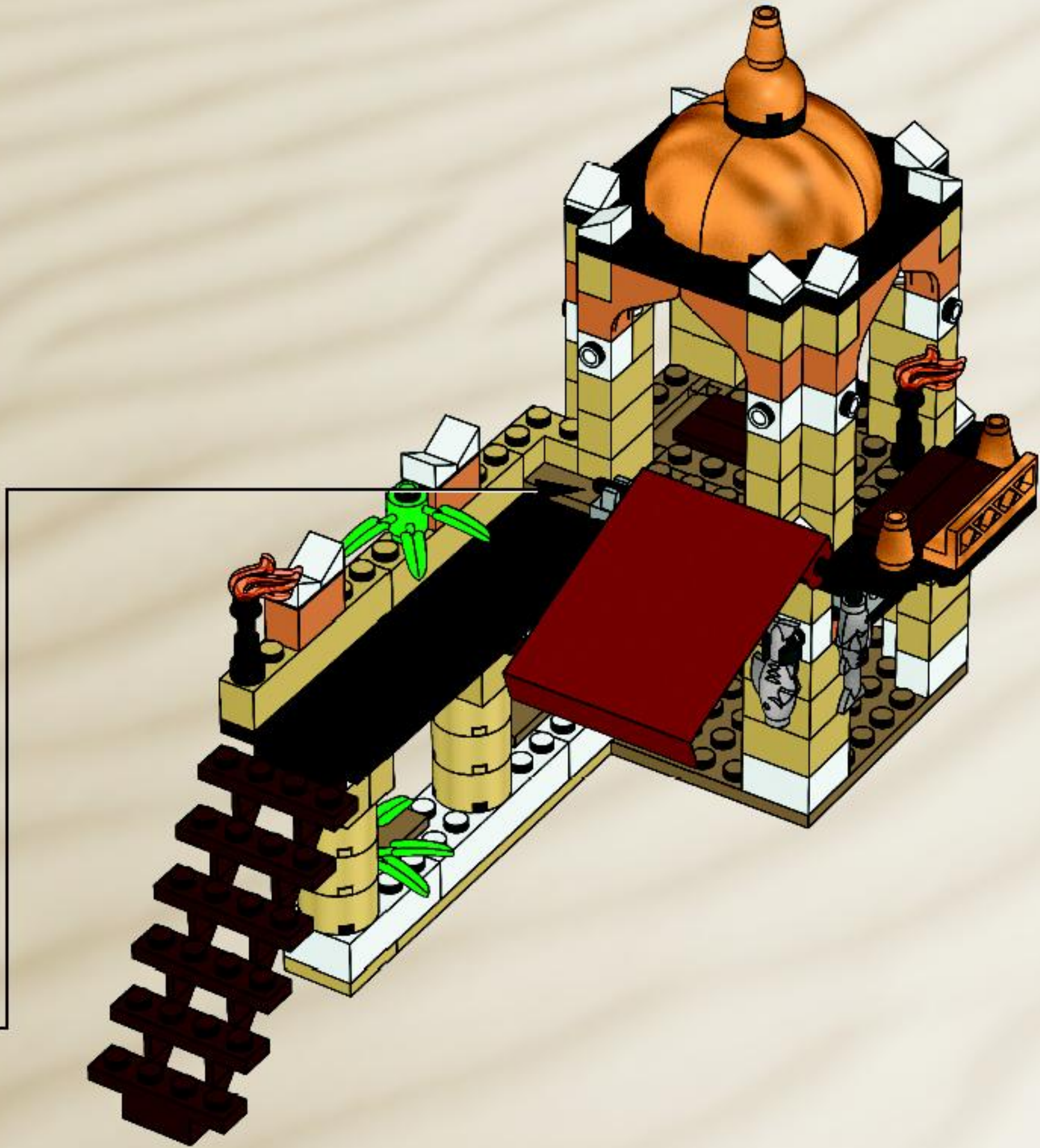













Customer Service  
Kundenservice  
Service Consommateurs  
Servicio Al Consumidor

[www.lego.com/service](http://www.lego.com/service) or dial





FREE! GRATIS! GRATUIT!



www.LEGOclub.com



00800 5346 5555\*

1-866-534-6258 • 1-877-518-5346  
US & Canada only Canada seulement



VISIT THE WORLD'S  
BIGGEST LEGO® SHOP!

[www.LEGOshop.com](http://www.LEGOshop.com)

\* Free phone. Mobile charges may apply. \* Numéro sans frais. Des frais peuvent s'appliquer avec les téléphones cellulaires. \* Gebührenfrei, Kosten für Anrufe aus Mobilfunknetzen können anfallen.  
\* Gratis telefonnummer vând vase bije. \* Deter est gratis număr, dar din rețea Pro Postbelgie. \* Det är gratis, utifrån Ringfri och Post telefoni.





7569



7570



7571



7573



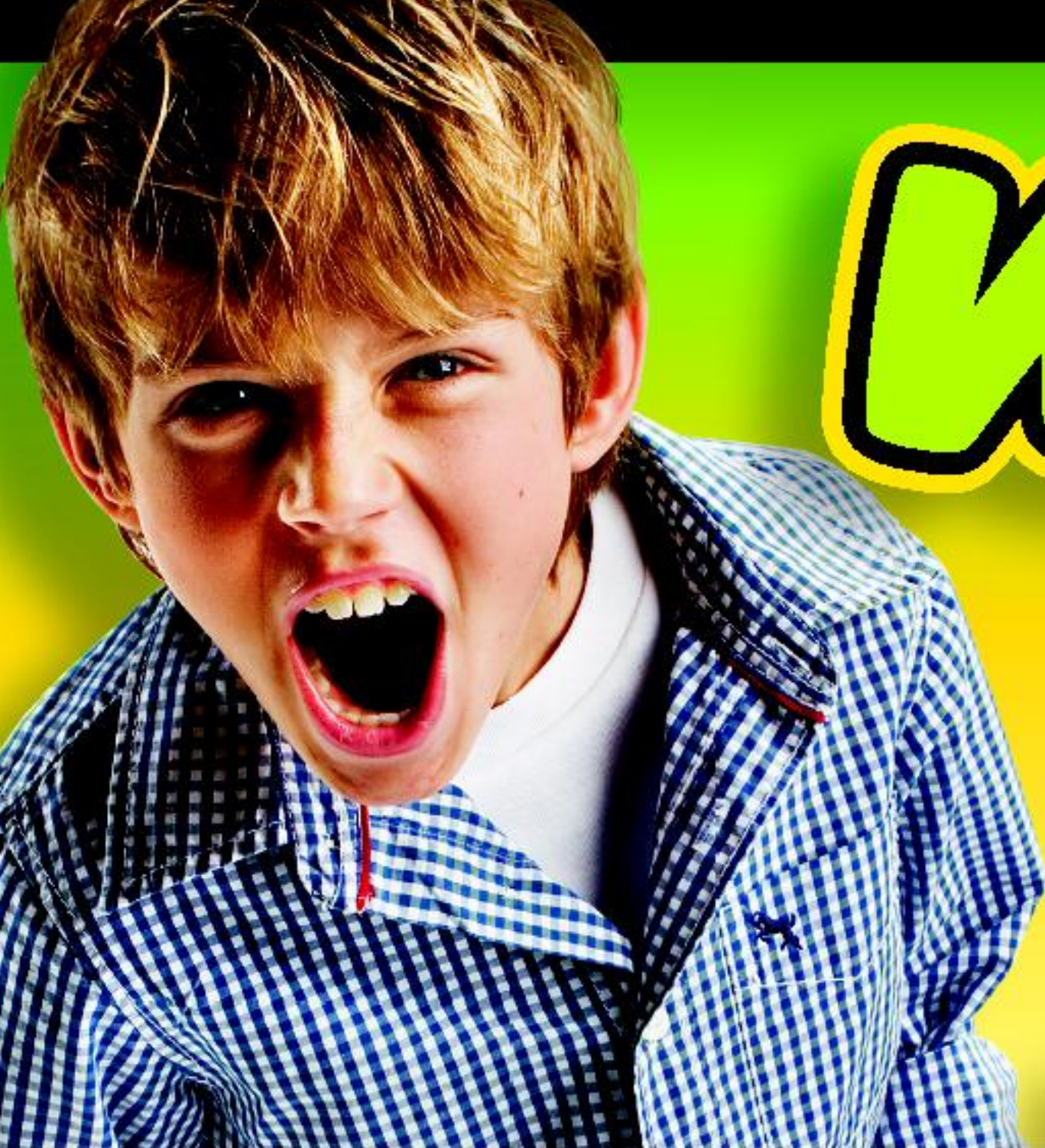

# WIN!

Go to [www.nielsen.com/LEGO](http://www.nielsen.com/LEGO) to fill out a survey for a chance to win a cool LEGO® Product.

No purchase necessary.

Open to all residents where not prohibited.



[www.LEGO.com](http://www.LEGO.com)



# [www.nielsen.com/LEGO](http://www.nielsen.com/LEGO)

## GEWINNE! WIN!

Nimm an der Umfrage auf [www.nielsen.com/LEGO](http://www.nielsen.com/LEGO) teil und hab die Chance ein cooles LEGO® Produkt zu gewinnen!

Die Teilnahme am Gewinnspiel führt zu keinerlei Kaufverpflichtungen. Teilnahme in allen nicht ausgeschlossenen Ländern möglich.

Ga naar [www.nielsen.com/LEGO](http://www.nielsen.com/LEGO), vul een enquêteformulier in en maak kans op een cool LEGO® product.

Geen aankoopverplichting. Iedereen mag deelnemen, uitgezonderd ingezetenden van landen waar een enquêteverbod geldt.

## GAGNE! 当てよう!

Visite [www.nielsen.com/LEGO](http://www.nielsen.com/LEGO) pour répondre à un questionnaire et avoir une chance de gagner un produit LEGO® très cool!

Aucune obligation d'achat. Ouvert à tous les résidents des pays autorisés.

[www.nielsen.com/LEGO](http://www.nielsen.com/LEGO)にアクセスして、アンケートにご記入ください。当選者にはレゴ製品を差し上げます。

お買い上げの必要はありません。禁止されていない限り、すべての年齢にご利用いただけます。