



AVATAR™

75573



4

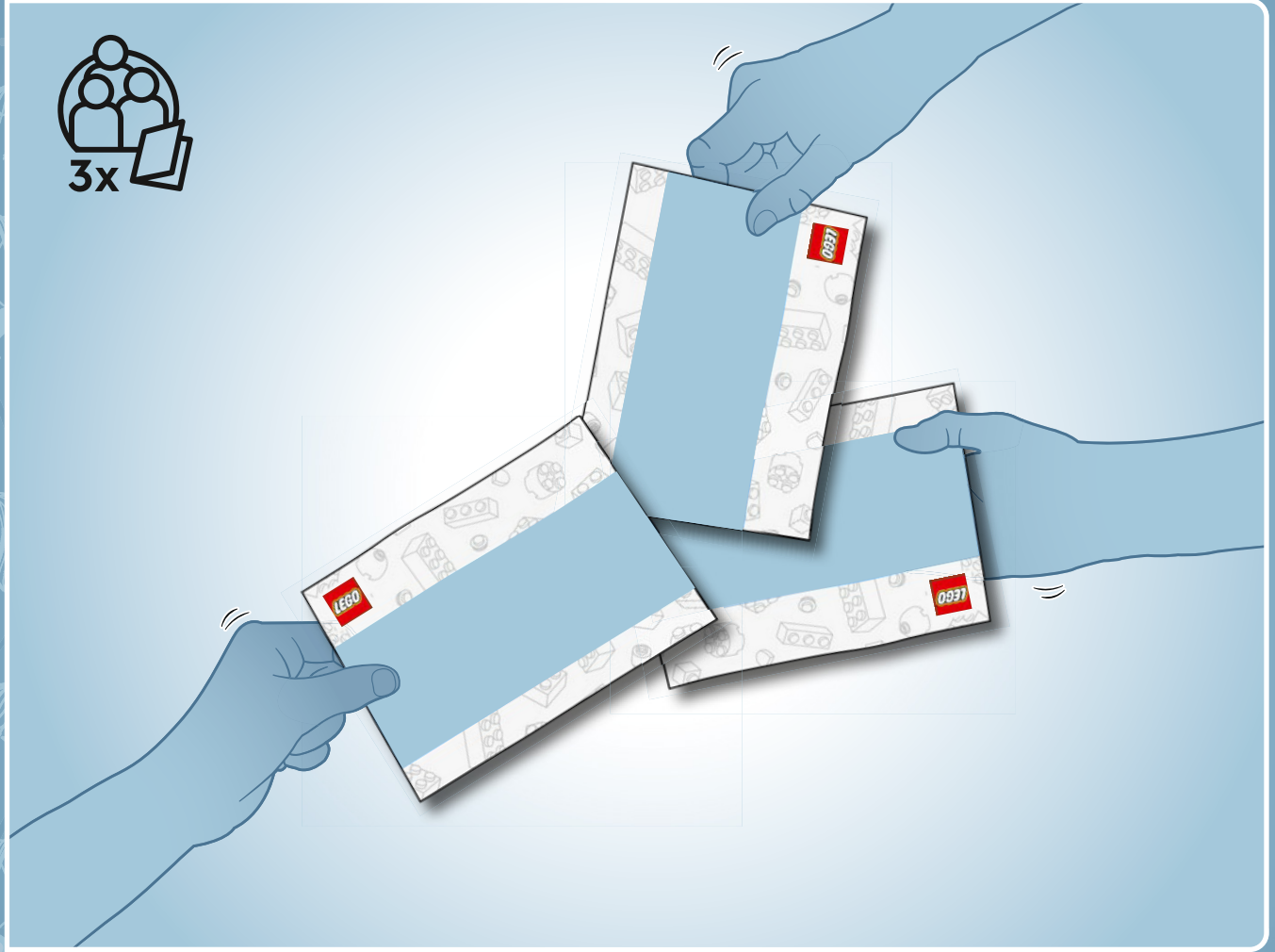

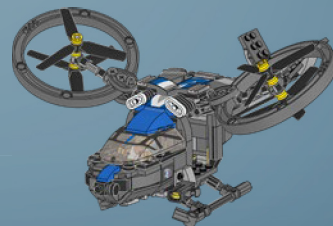
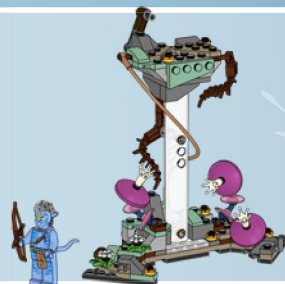

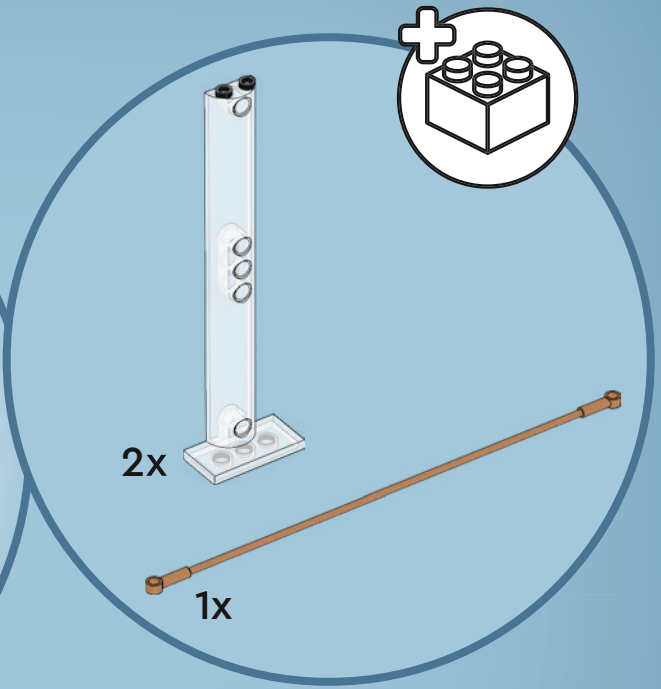

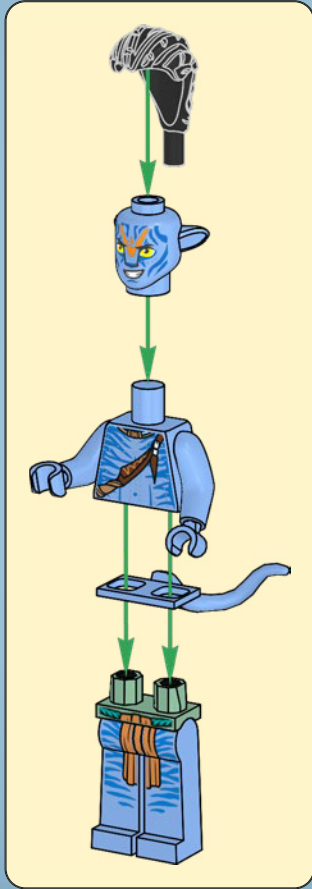

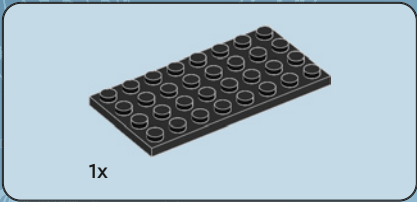

1

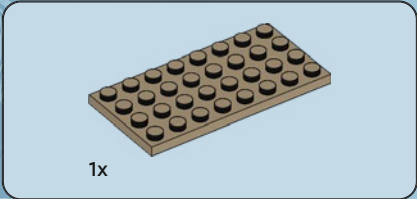
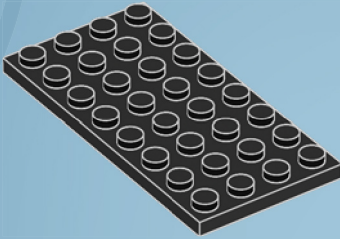

2

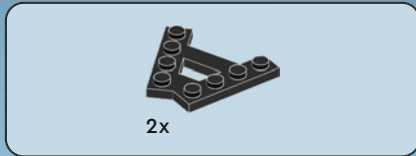
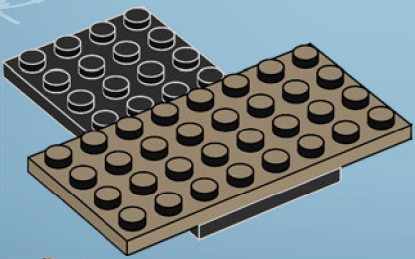

3

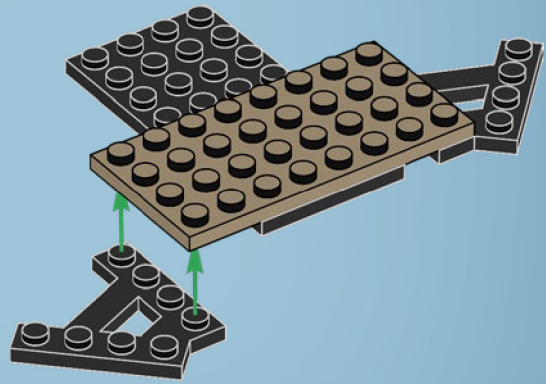

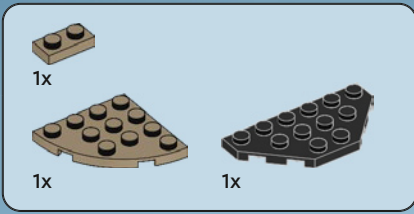

4

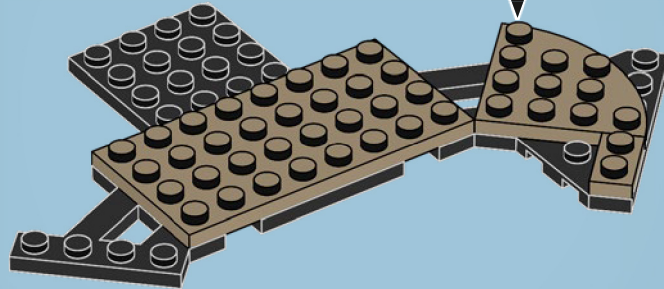
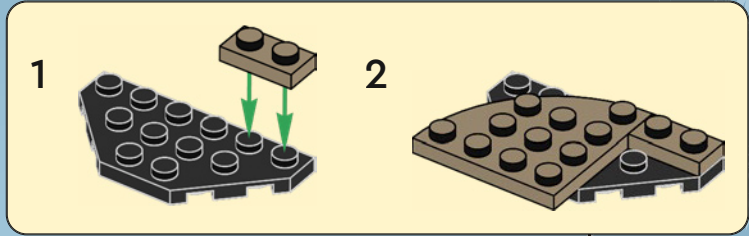

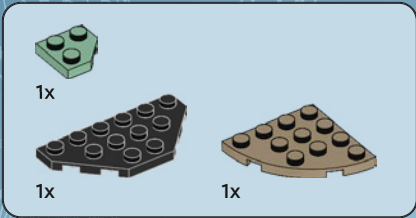

5

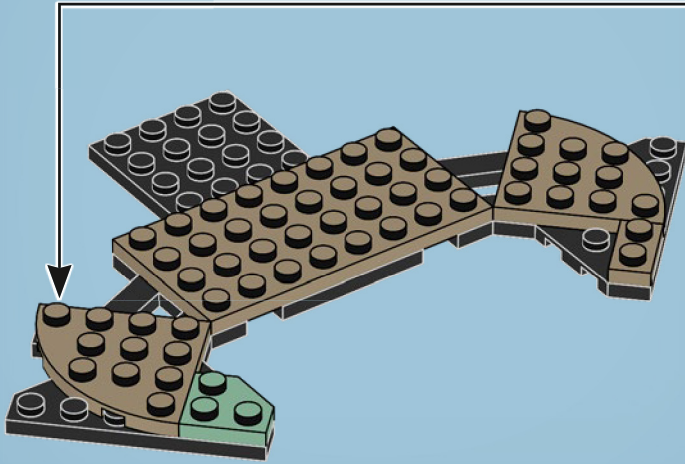
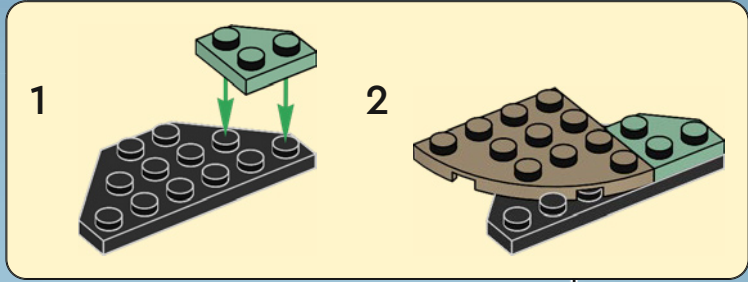



2x

6

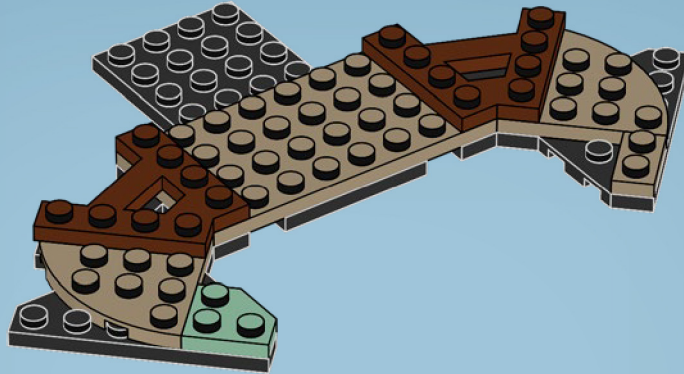

2x

7

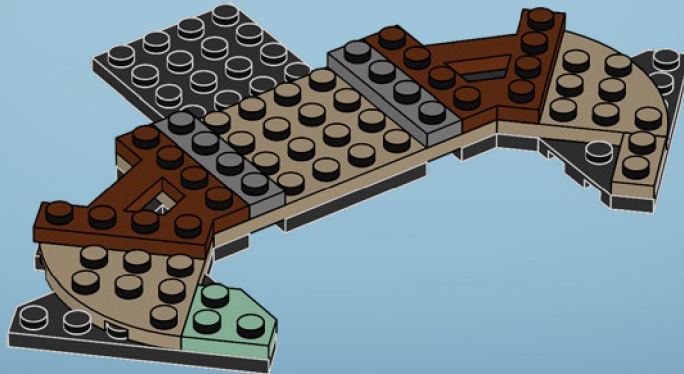



1x



1x



1x



1x

8



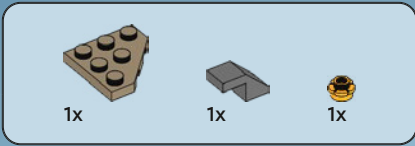

9



10





2x



1x

11





1x



1x



2x

12



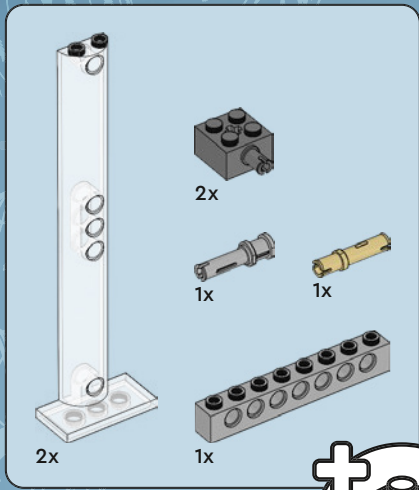

13

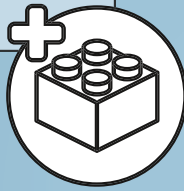

1

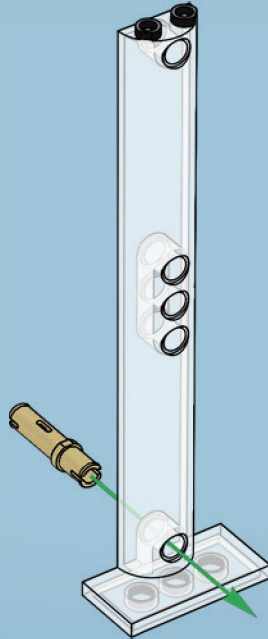

2

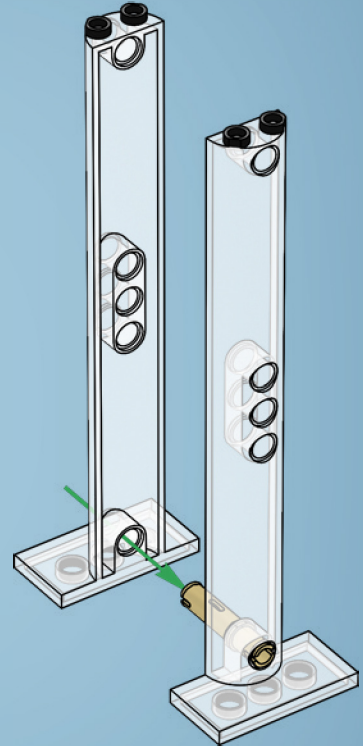

3

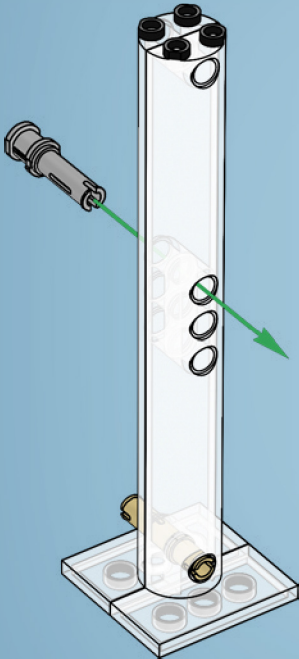

4

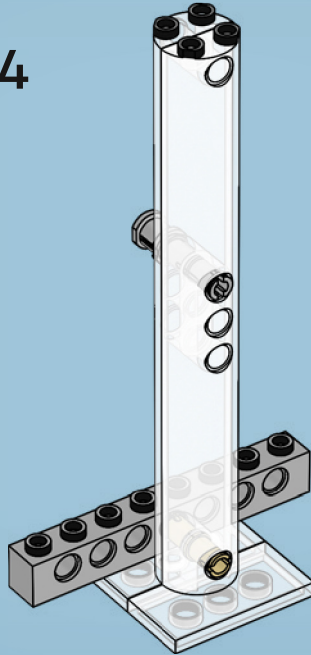

5

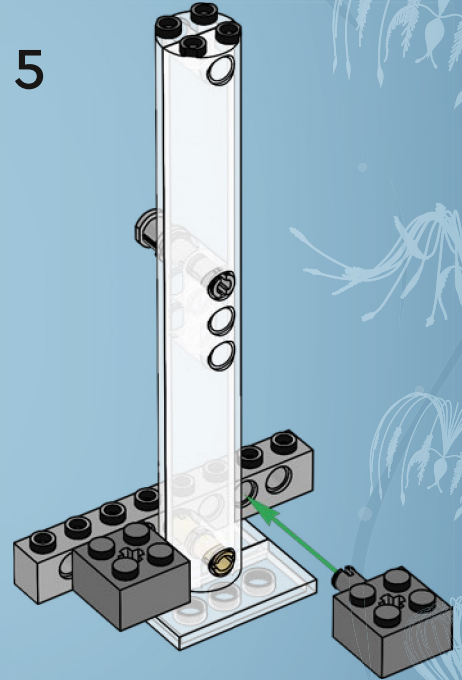

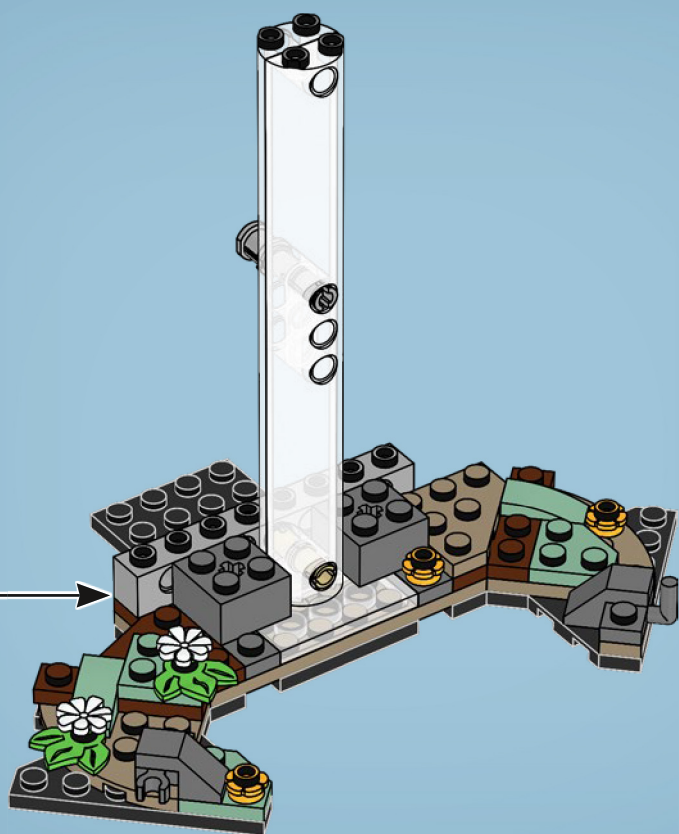



1x

14

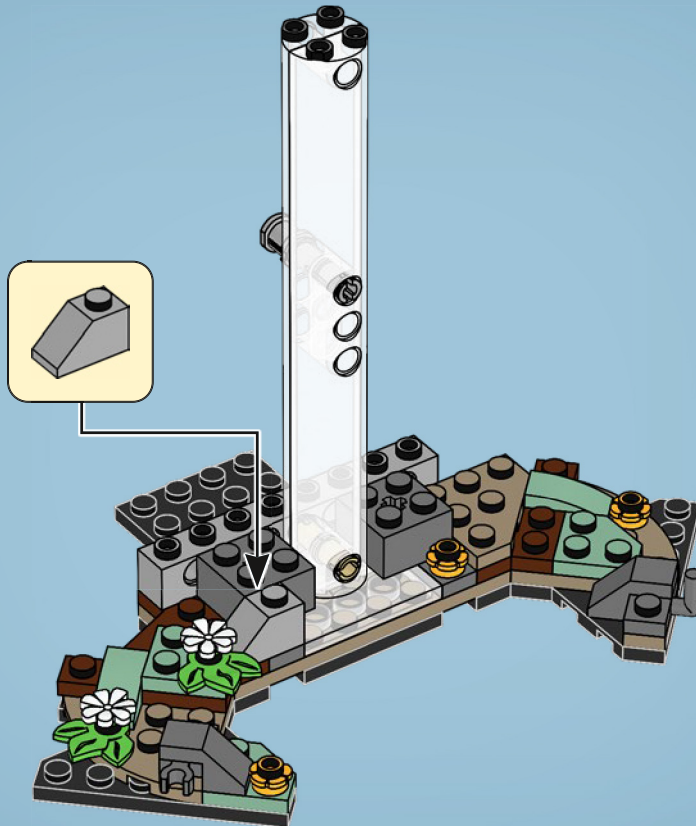



2x

15

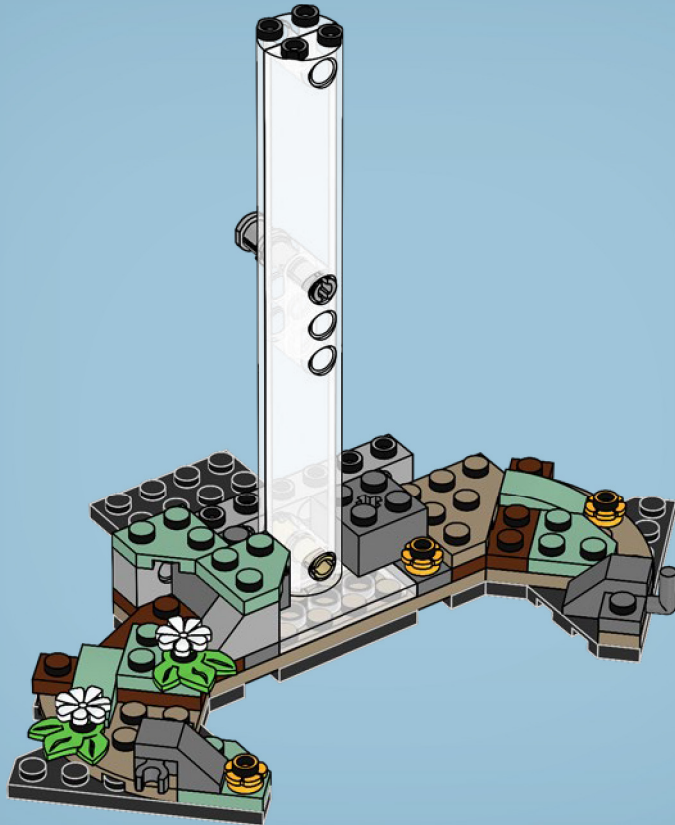



16

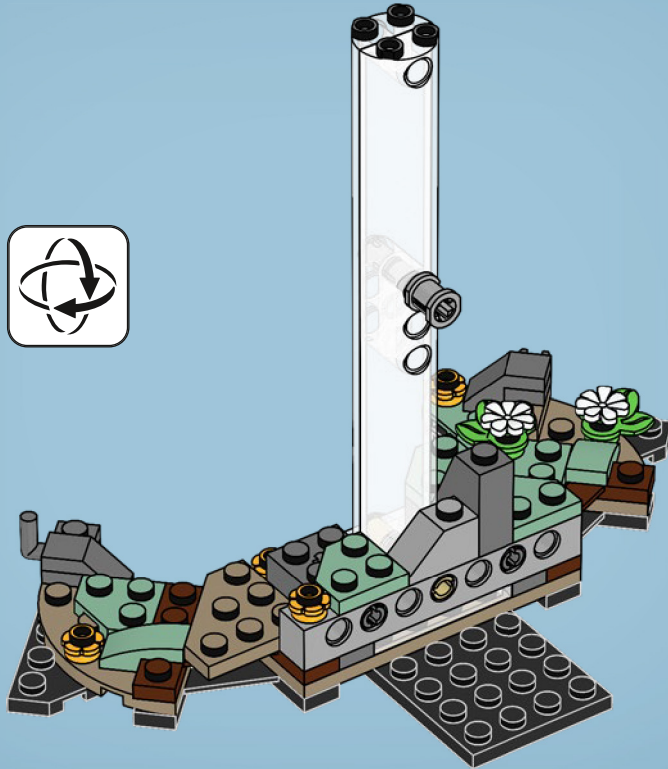

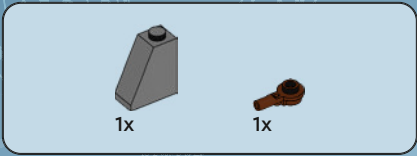

17

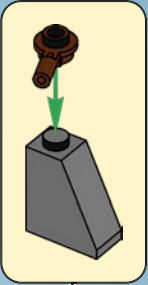
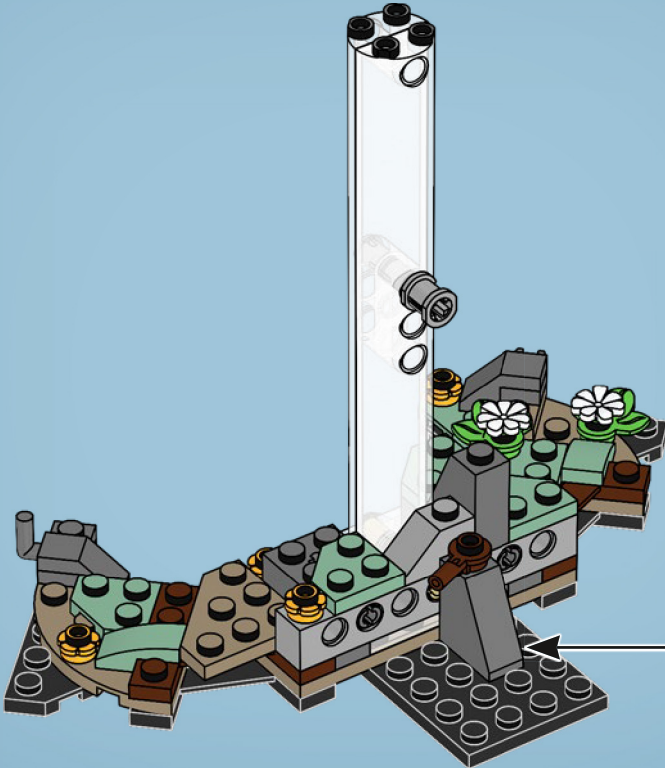



2x

18

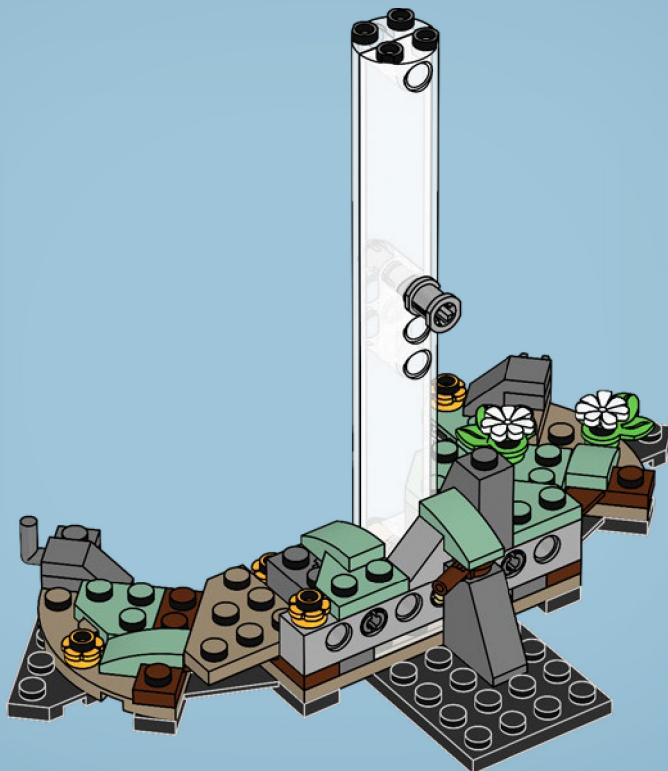



1x

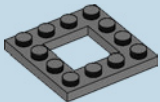

1x

19

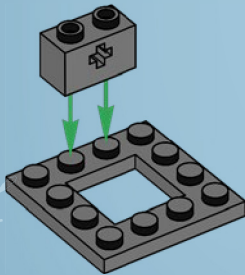

2x



1x

20

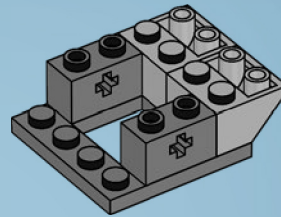

2x



1x

21

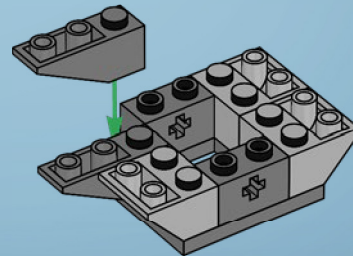



2x

22

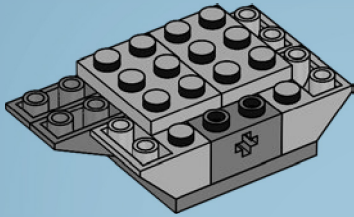

2x

23

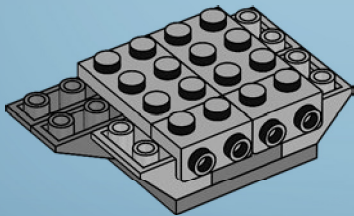

3x

24

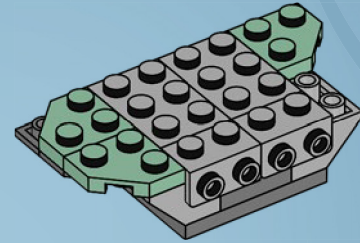

1x



1x

25

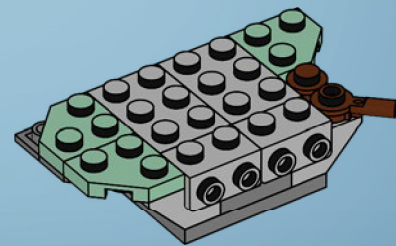



2x



1x

26

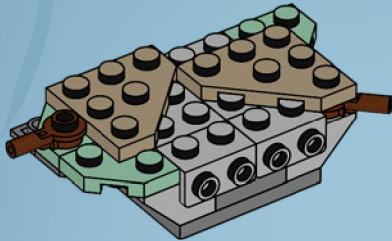

2x



1x

27

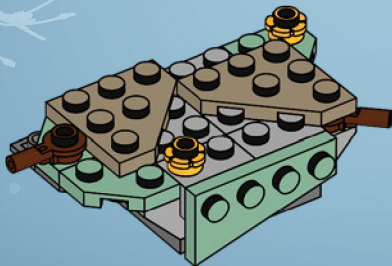

2x

28

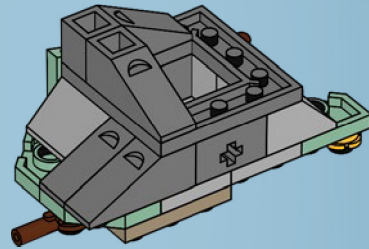

29

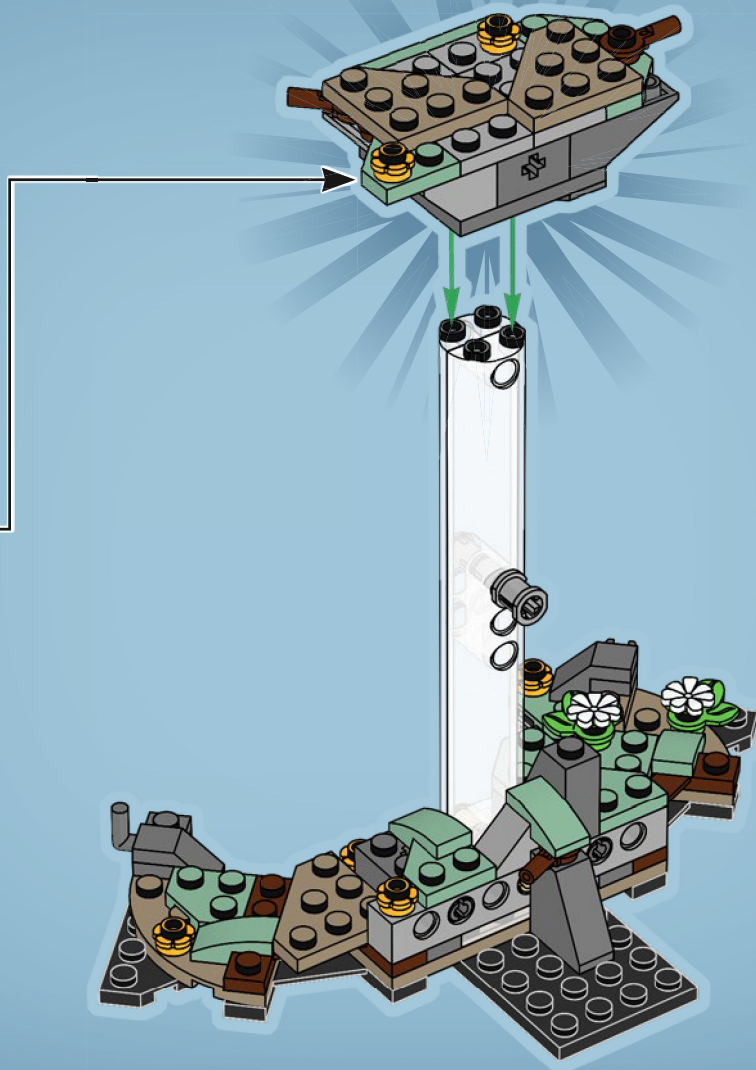



1x



1x

30

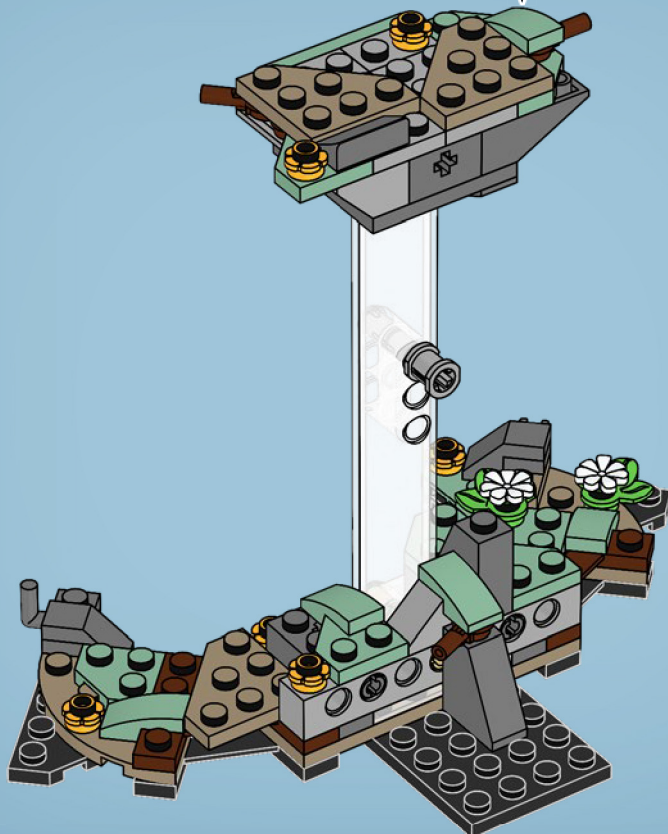



1x

31

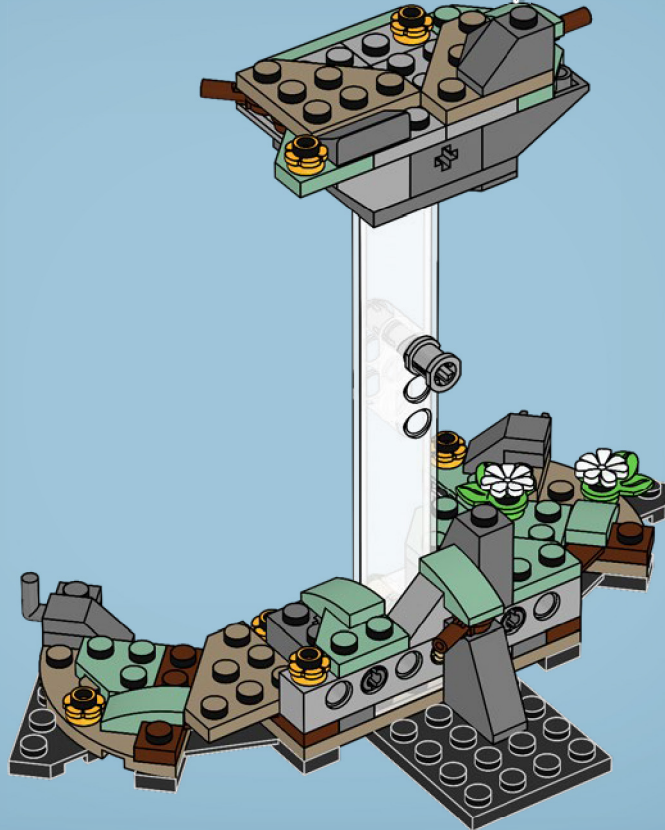

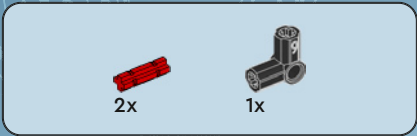

32

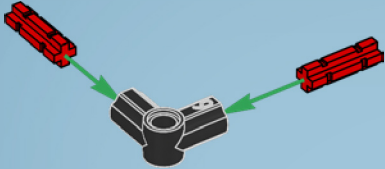

33

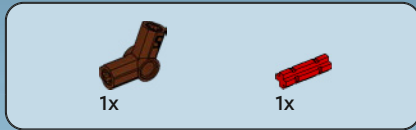
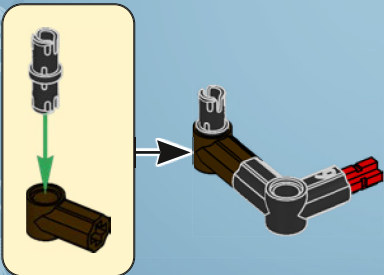

34

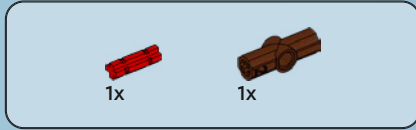
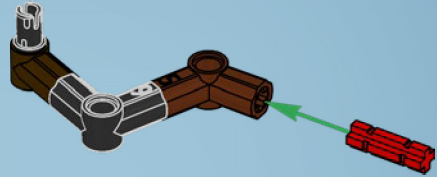

35





1x

36

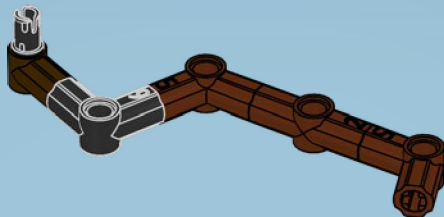

1x



1x

37

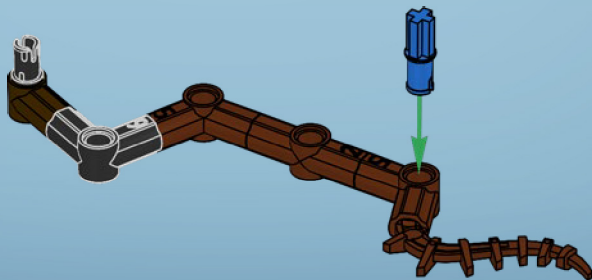

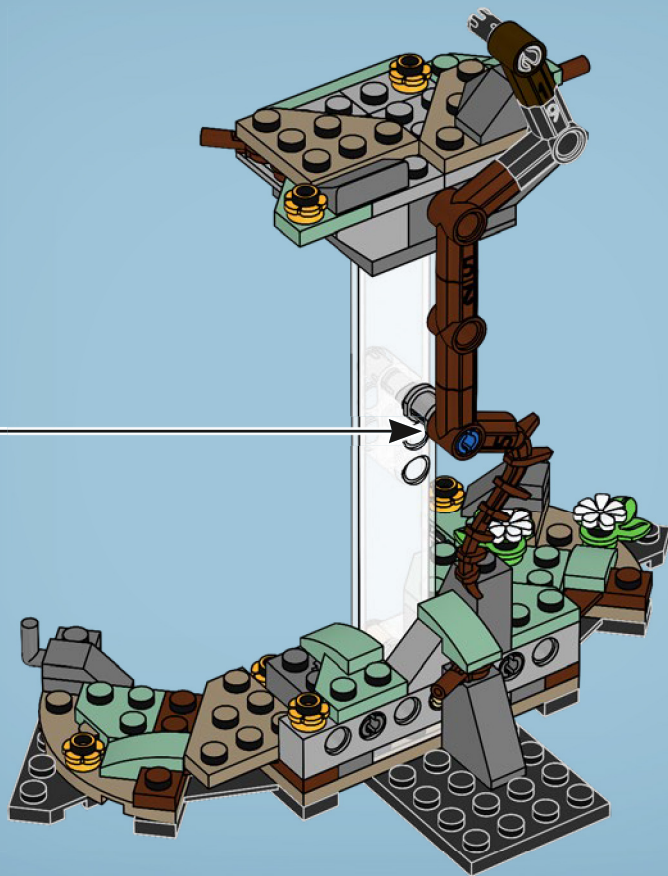

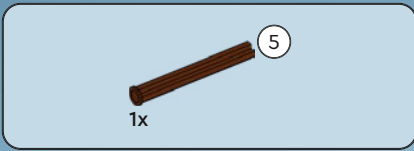

39

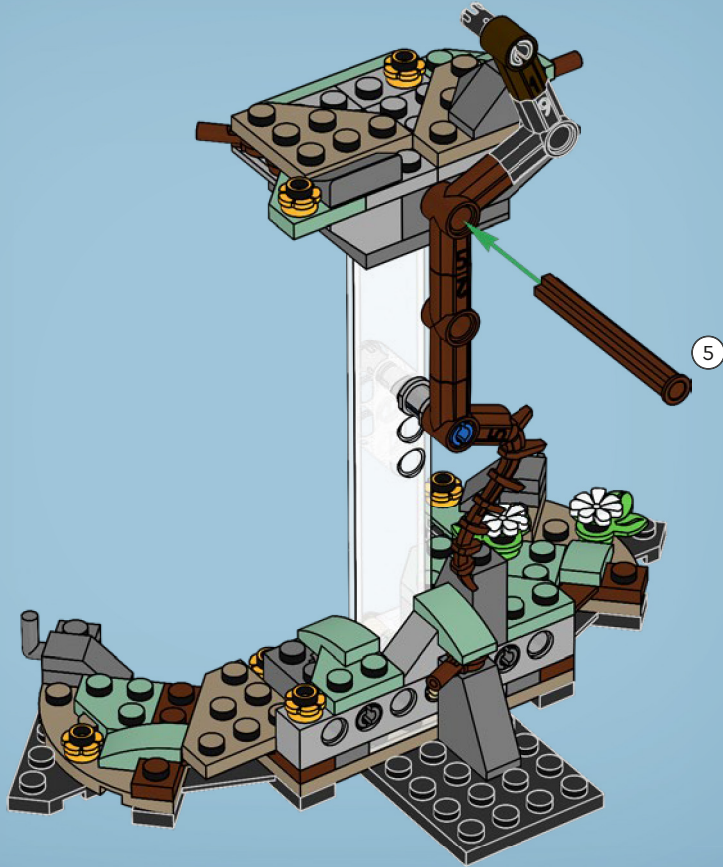

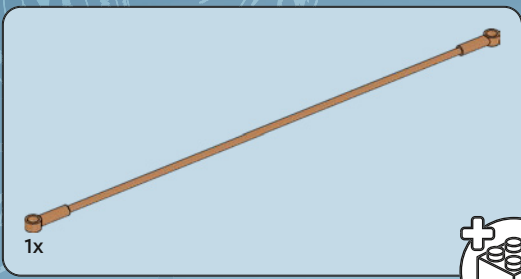

40

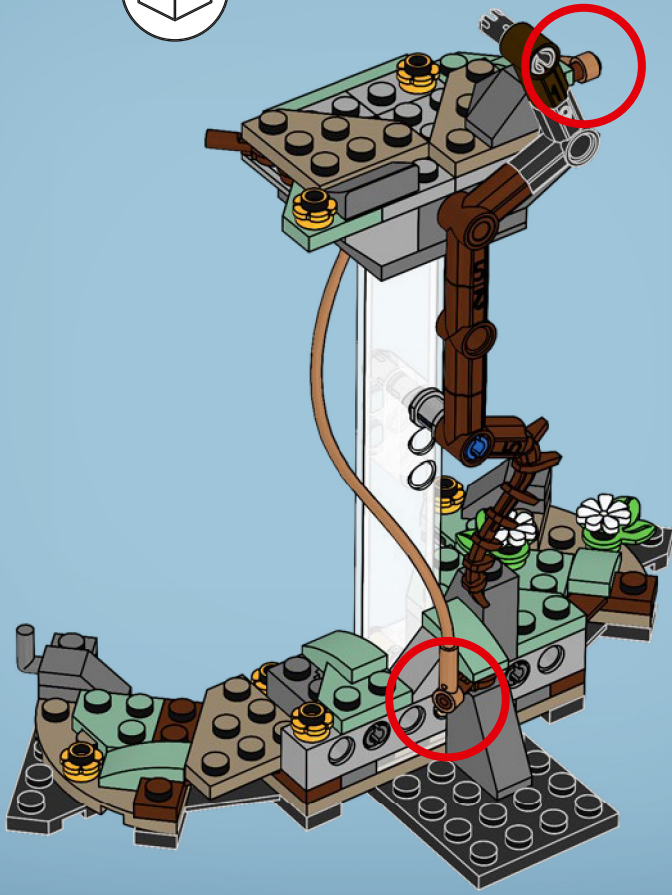

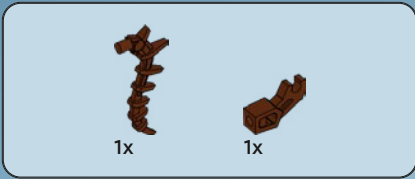

41

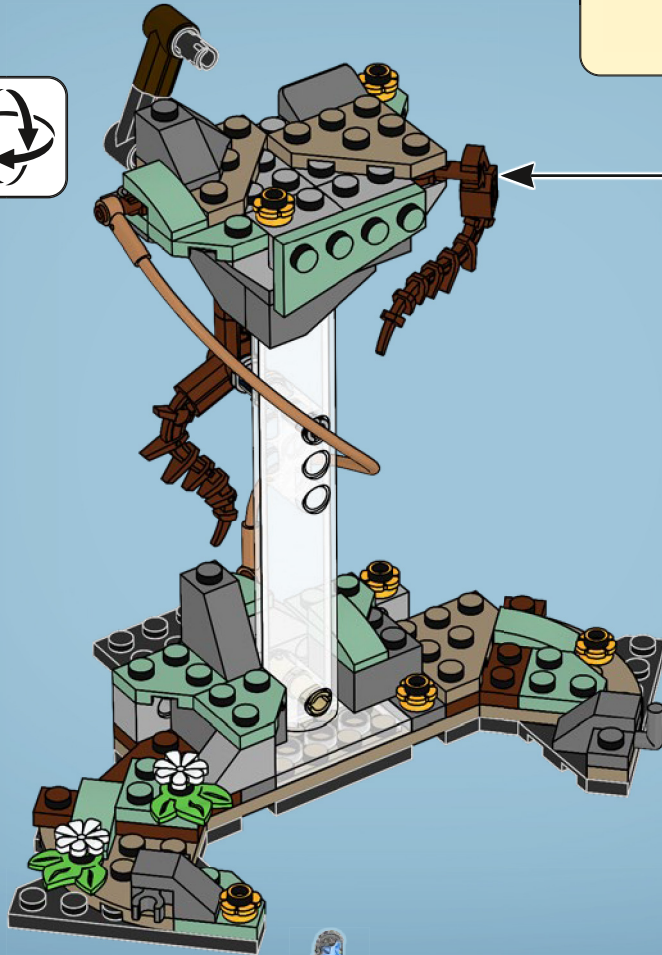





3x

42

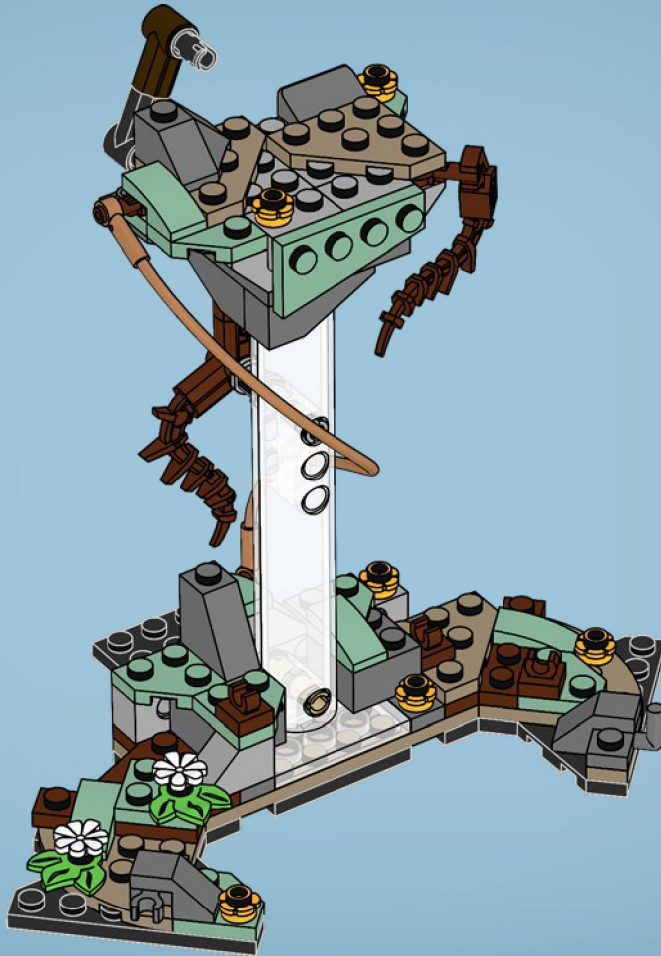



43

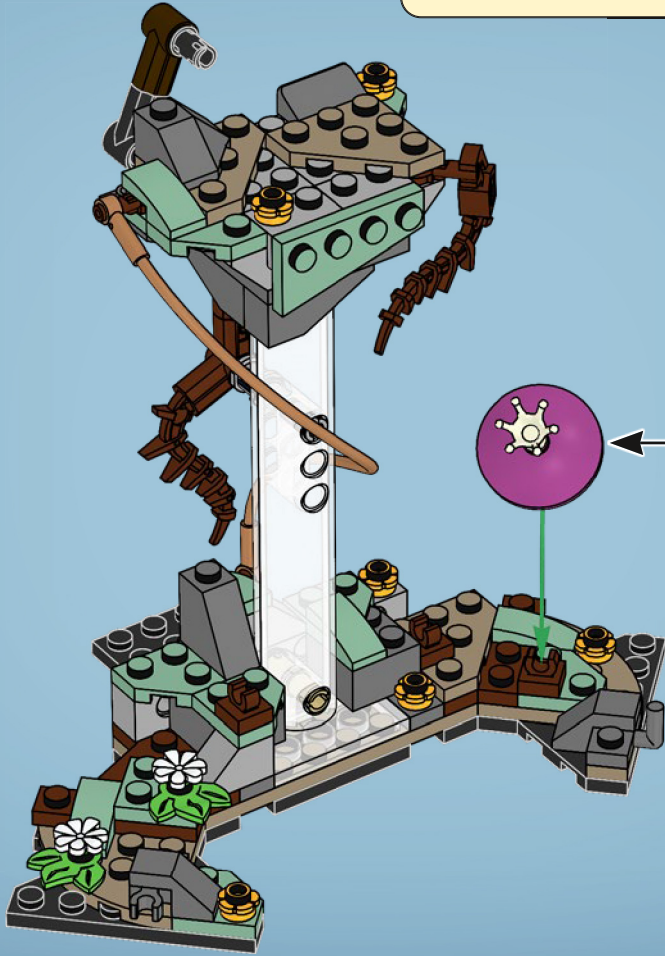
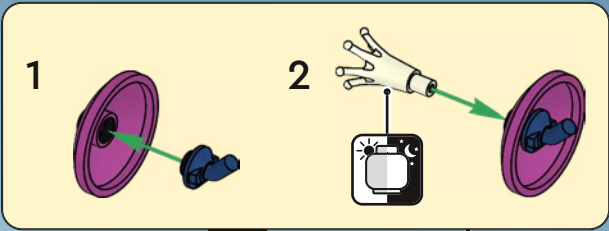

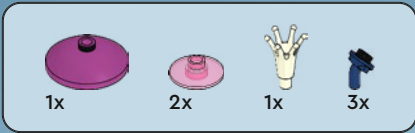

44

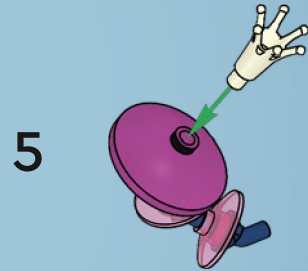
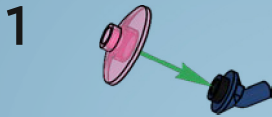

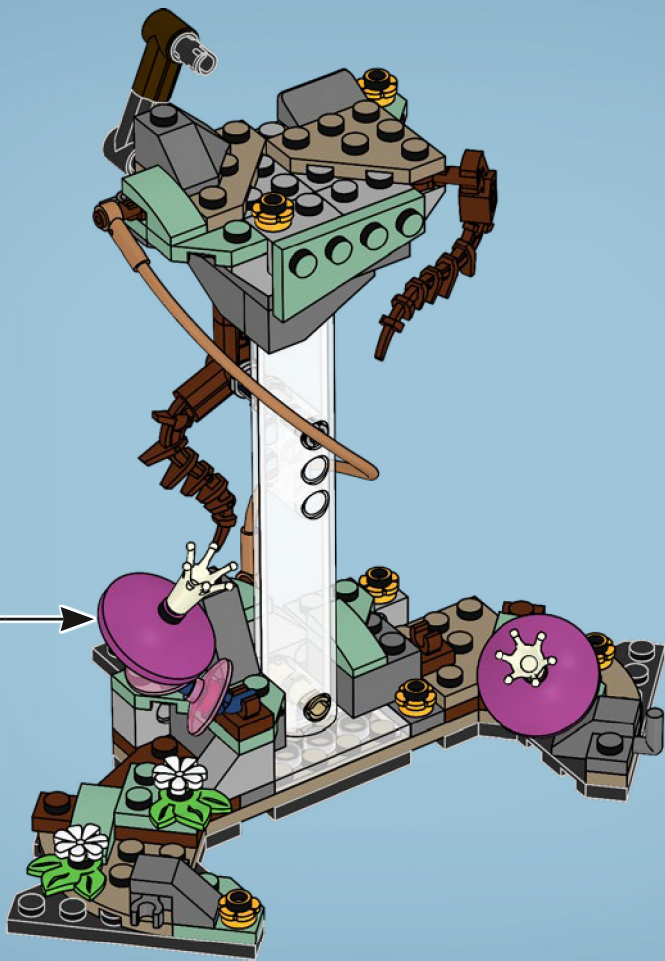

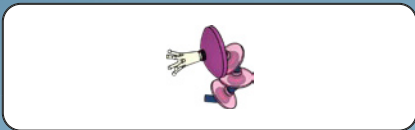

45

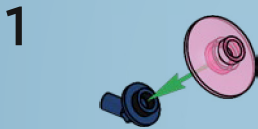

3



4



5



6



7

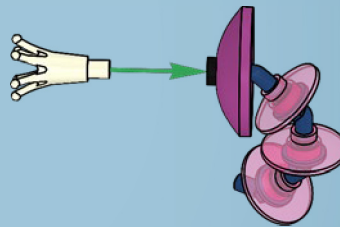

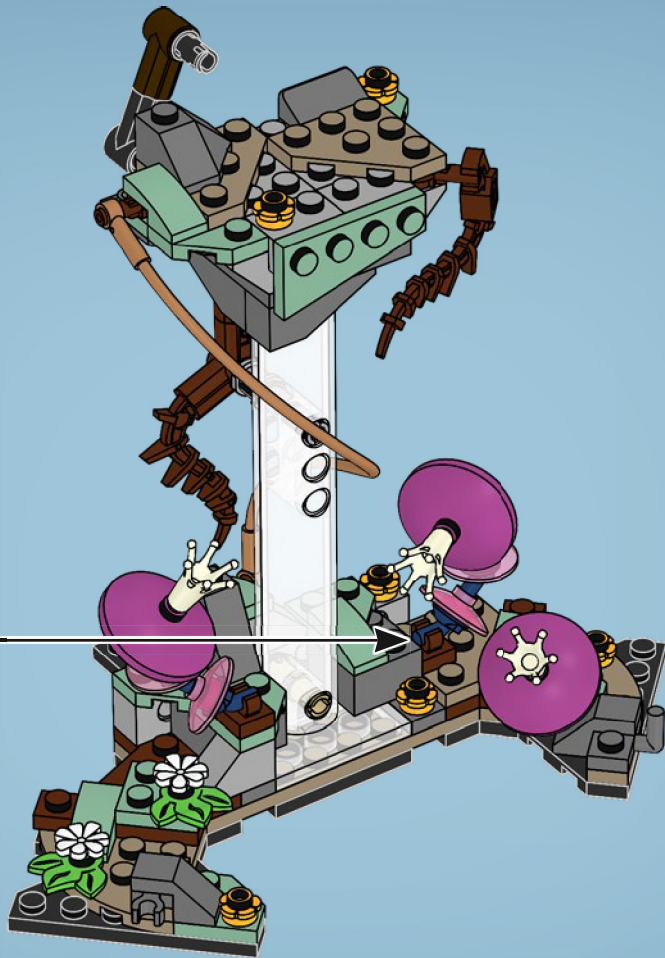



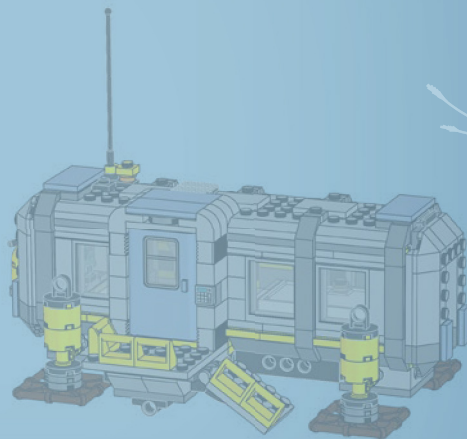
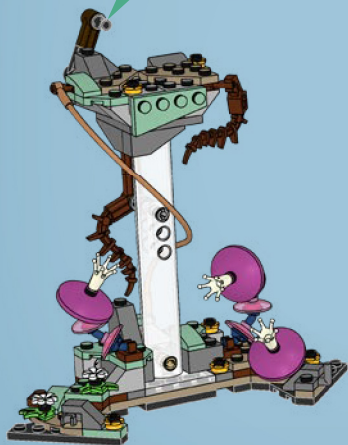
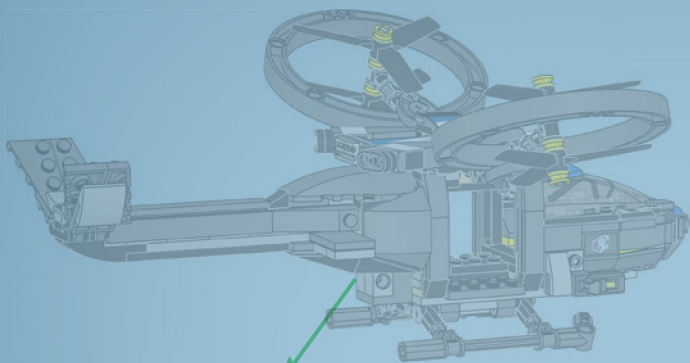



AVATAR™

LEGO and the LEGO logo are trademarks of the/son des marques de commerce du/
son marcas registradas de LEGO Group. ©2022 The LEGO Group.



TM & © 20th Century Studios

6452101