



# STAR WARS™

75378



Q LEGO® Builder



### **Get excited about our new packaging!**

We're switching from plastic to paper-based packaging. That's why you might find a mix of paper and plastic in our boxes!

### **Nos nouveaux emballages vous emballeront !**

Nous passons des emballages en plastique aux emballages à base de papier. C'est pourquoi vous pourriez trouver un mélange de papier et de plastique dans nos boîtes !

### **¡Te presentamos nuestros nuevos empaques!**

Estamos sustituyendo las bolsas de plástico por bolsas con base de papel. ¡Por eso, puedes encontrar una mezcla de papel y de plástico en nuestras cajas!

**[LEGO.com/sustainable-packaging](https://www.lego.com/sustainable-packaging)**



Q LEGO® Builder

# BUILDER



Apple and the Apple logo are trademarks of Apple Inc., registered in the U.S. and other countries and regions. App Store is a service mark of Apple Inc. Google Play and the Google Play logo are trademarks of Google LLC. Tencent and the Tencent logo are trademarks of Tencent Inc.

Q [LEGO.com/devicecheck](https://LEGO.com/devicecheck)

**EN** Ask parents' permission before going online | **DE** Eltern um Erlaubnis bitten, bevor du online gehst | **FR** Demande l'autorisation d'un parent avant d'aller en ligne | **IT** Chiedi il permesso ai tuoi genitori prima di andare online | **ES** Pídeles permiso a tus papás antes de conectarte a Internet | **PT** Pede autorização aos pais antes de acederes online | **ZH** 上网前应先征得父母的同意 | **PL** Poproś rodziców o zgodę, zanim wejdiesz do Internetu | **CS** Než půjdeš na internet, požádej rodiče o svolení | **SK** Skôr než pôjdeš na internet, vypýtaj si povolenie od rodičov | **HU** Kérj szülői engedélyt, mielőtt online csatlakoznál! | **RO** Cere permisiunea părinților înainte de a te conecta online | **BG** Поискайте разрешение от родител, преди да влезете онлайн | **LV** Pirms došanās tiešsaistē palūdz atļauju vecākiem | **ET** Enne Interneti kasutamist küsi vanematelt luba | **LT** Prieš prisijungdami prie interneto, atsiklauskite tėvų



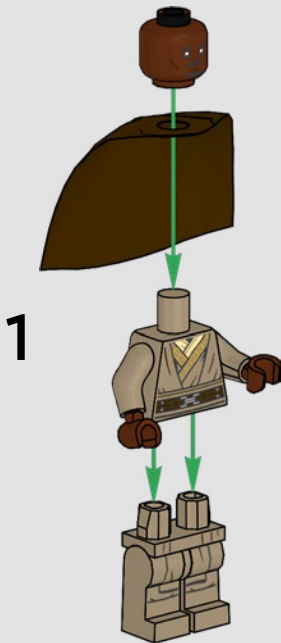



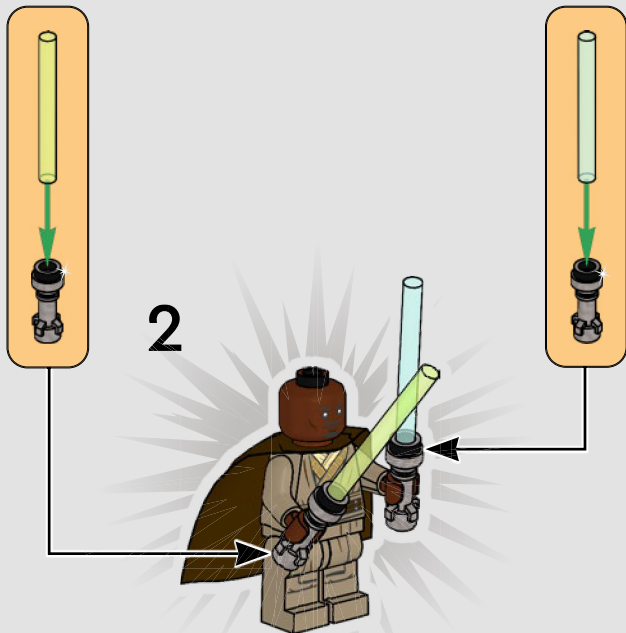

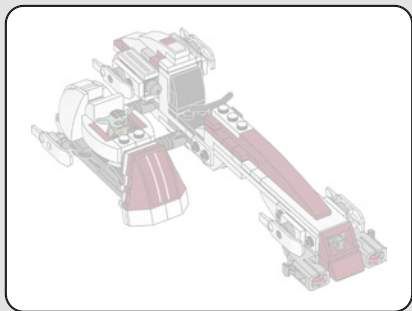

1x

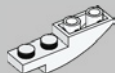

1x

1

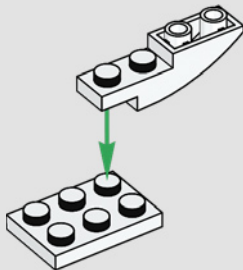



1x

2

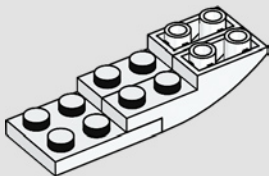

1x

3

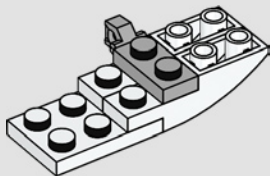



2x



4x

4

1

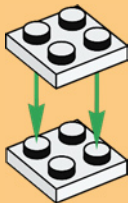

2

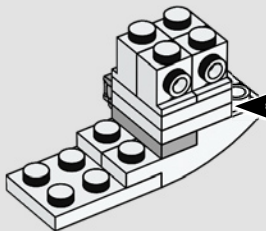
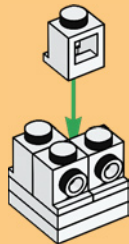





1x



1x

7

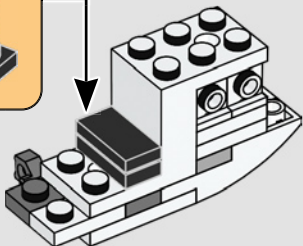
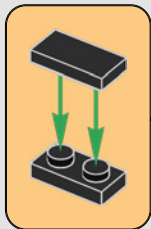

8



1x

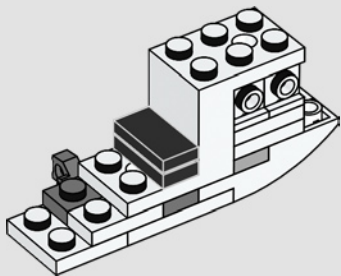



2x

9

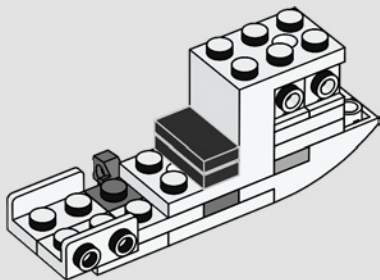

2x

10

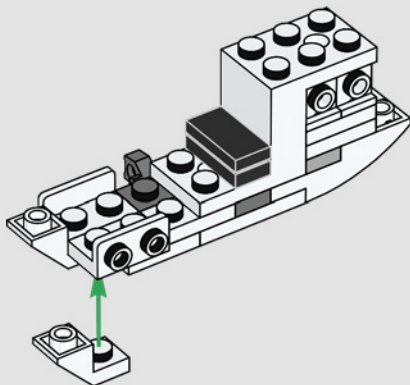



1x

11

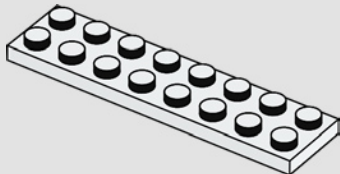

12



2x

12

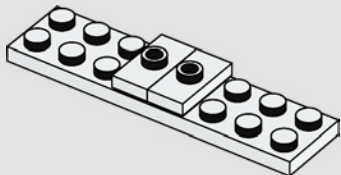





1x

13

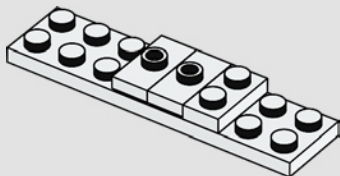

1x

14

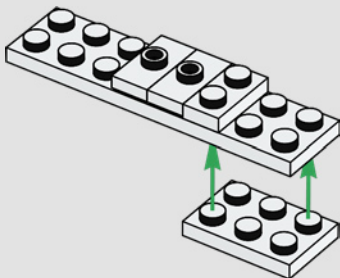

15

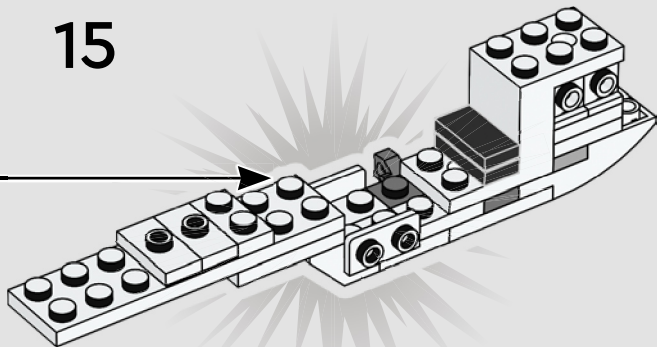

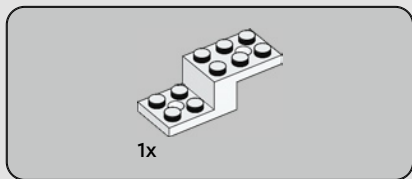

16

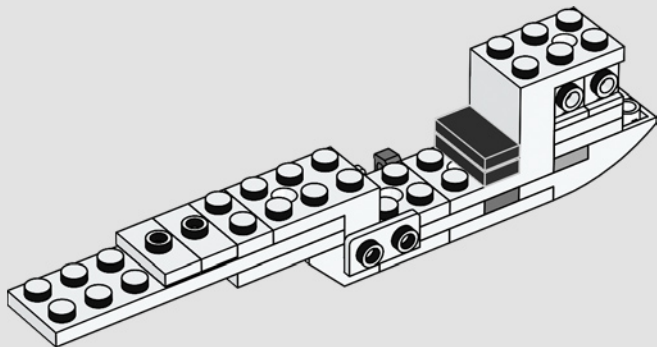

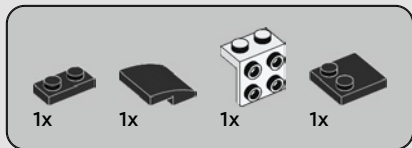

17

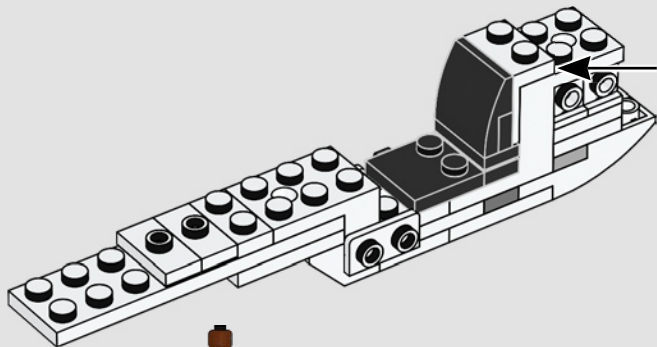
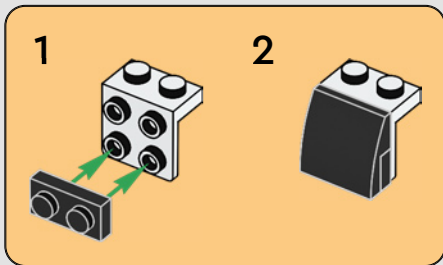

16



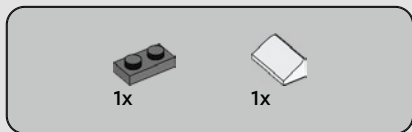

18

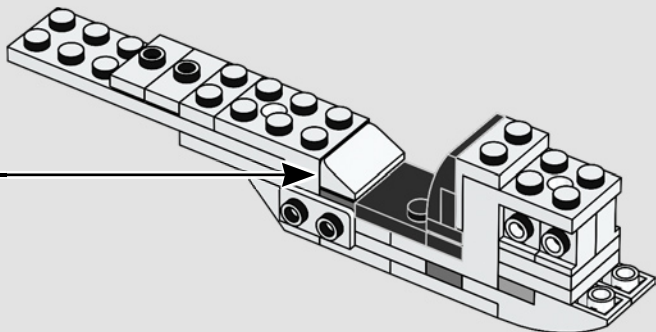
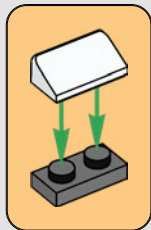

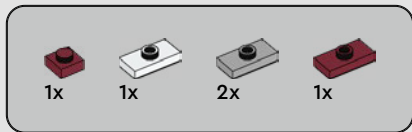

19

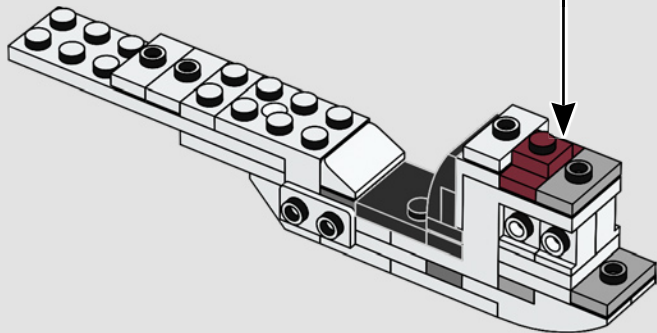
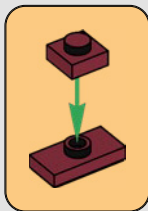

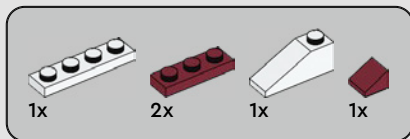

# 20

1

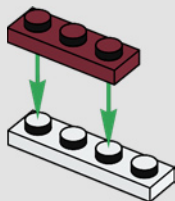

2

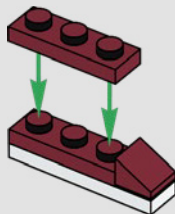

3

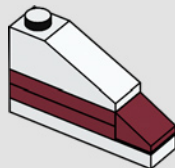

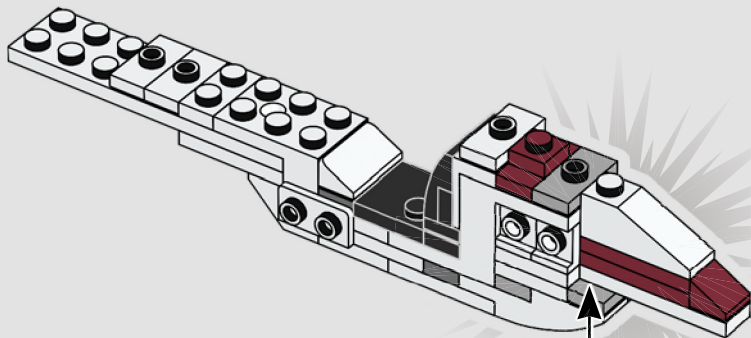



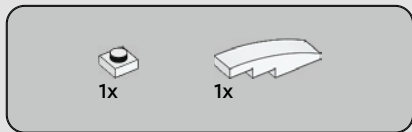

21

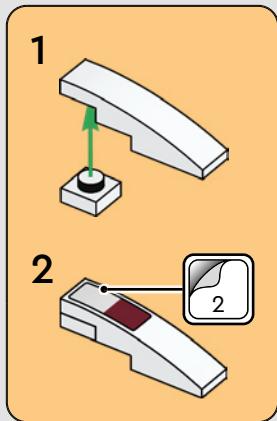
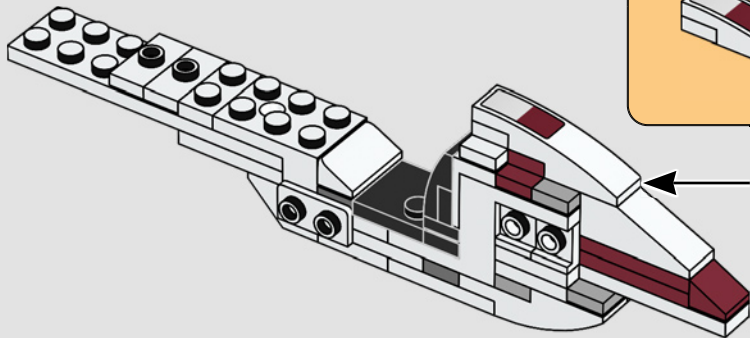



3x

22

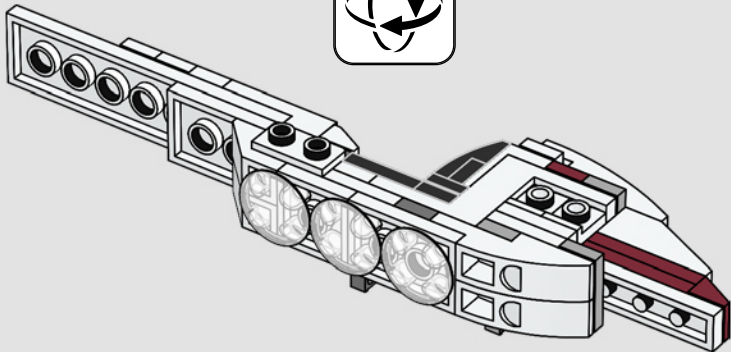

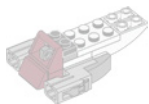

1x



1x

# 23

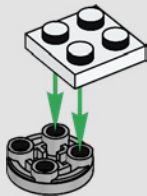

1x

# 24





2x

25

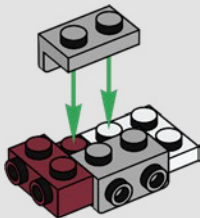

2x

26

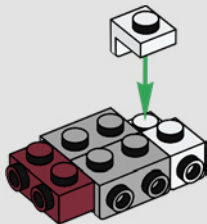



1x

27

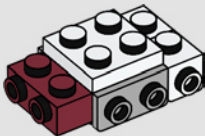

1x



1x

28

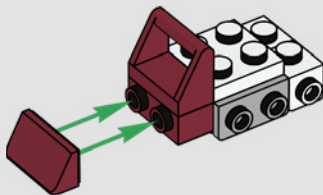



1x



1x

# 29

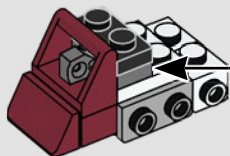
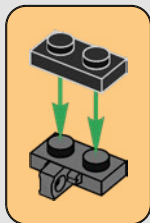



2x

30

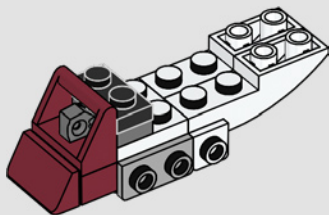

1x

31

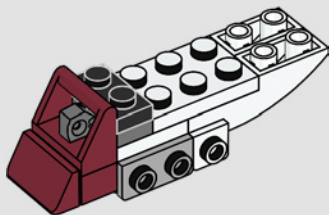

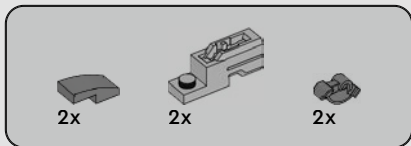

# 32

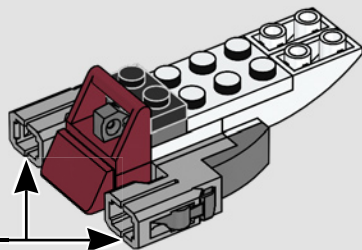
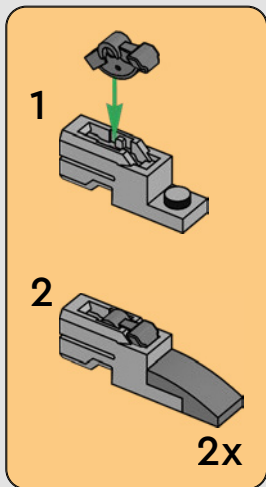



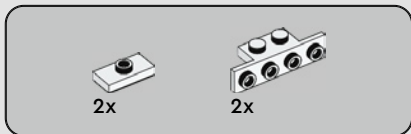

33

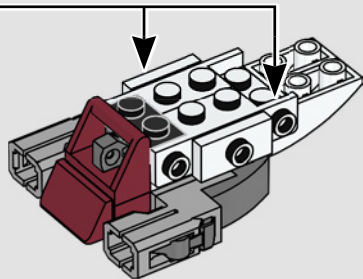
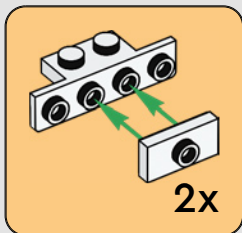



34

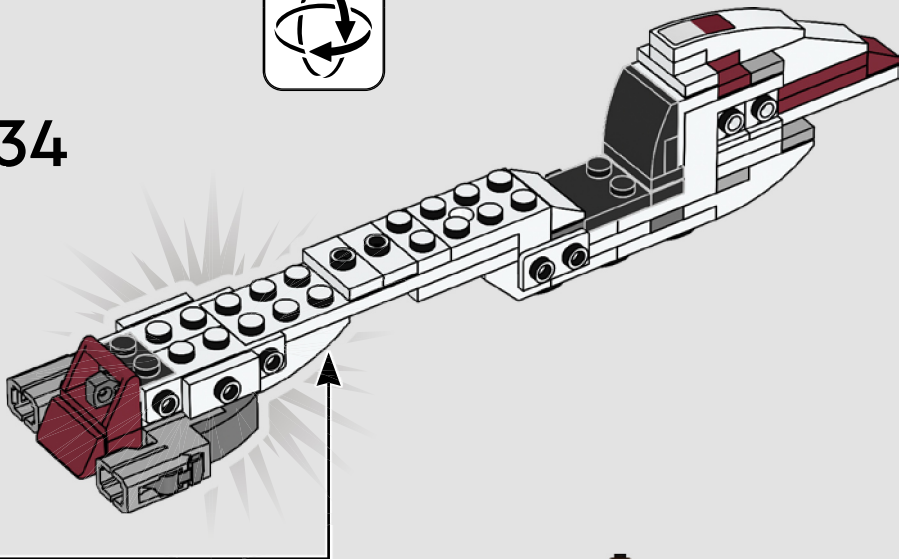

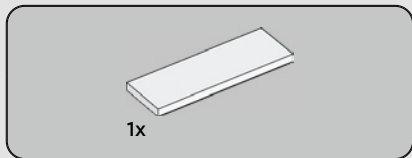

35

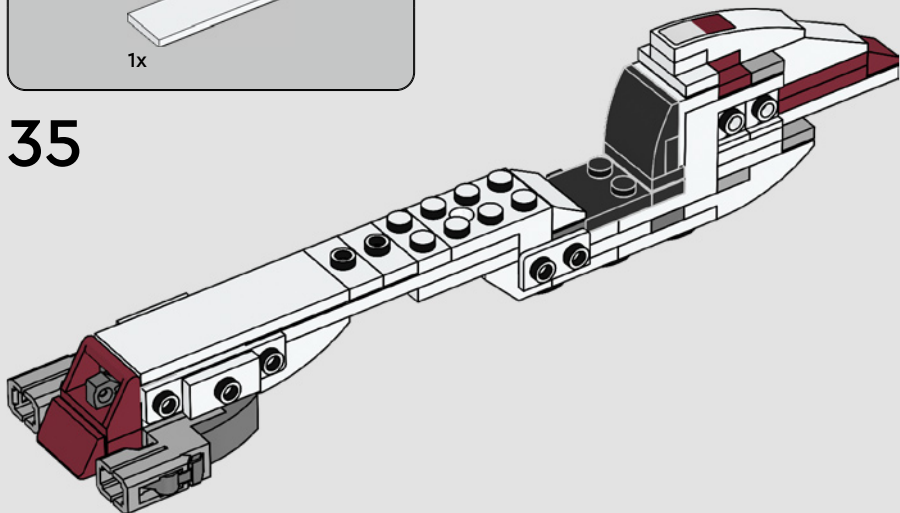



1x



1x

# 36

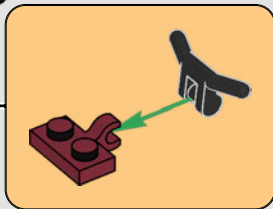
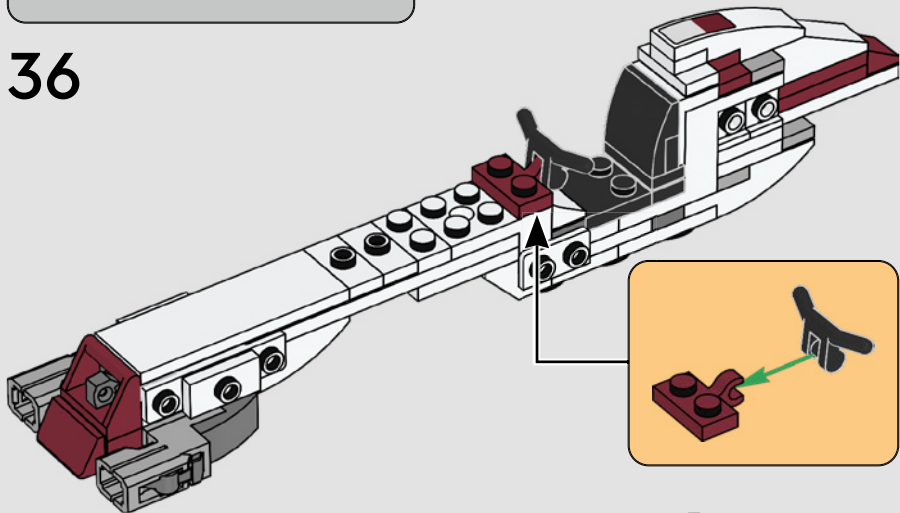



1x



4x

37

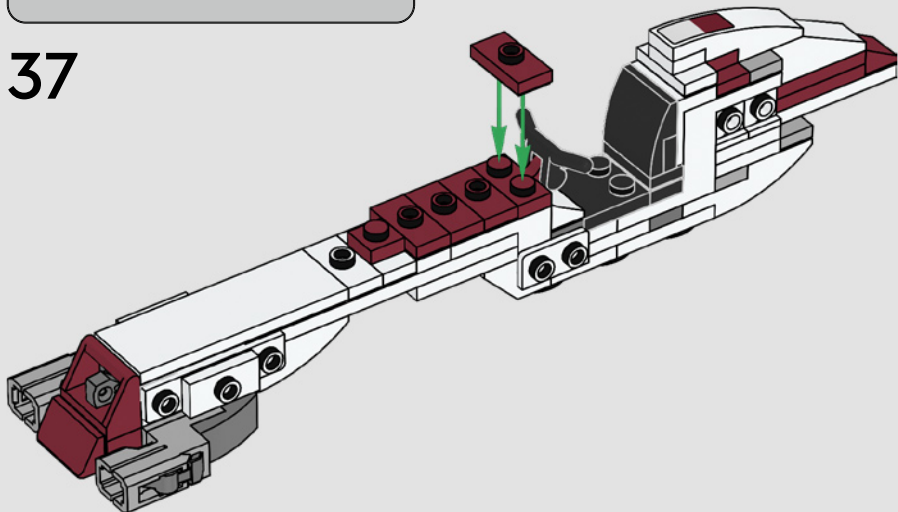

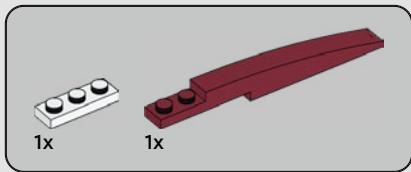

38

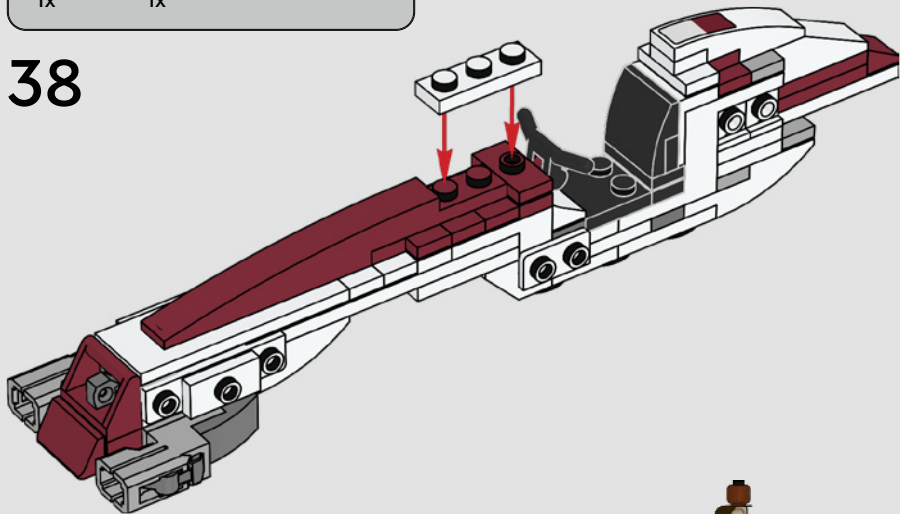

34





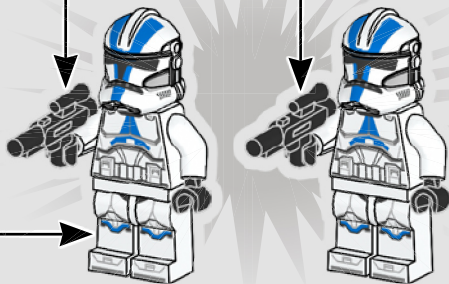
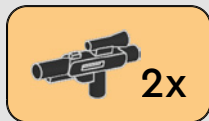
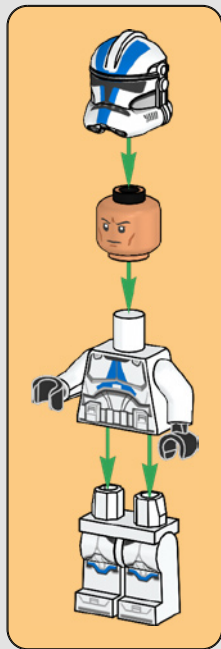



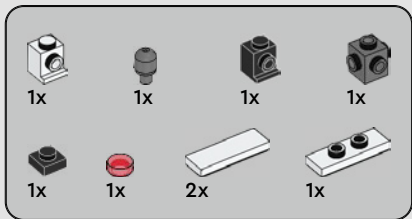
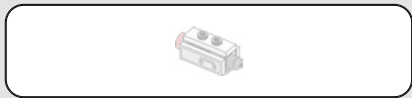

39

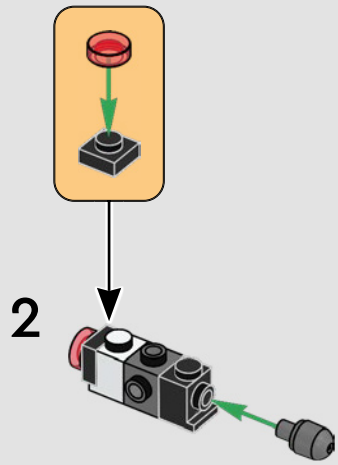
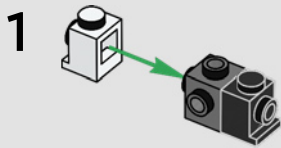

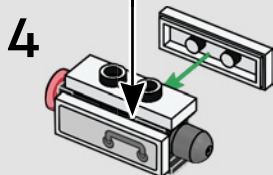
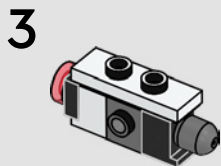
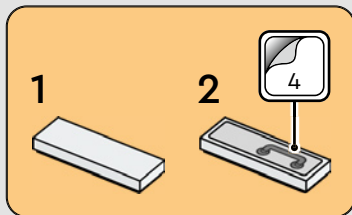

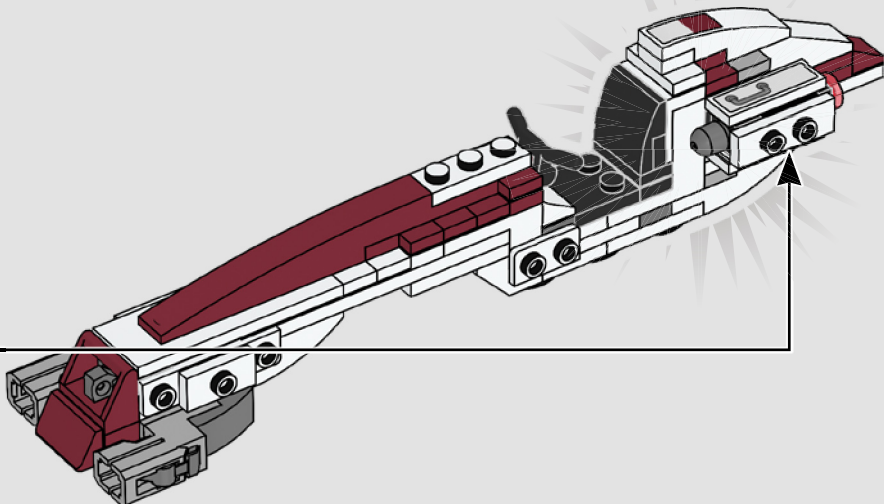



3

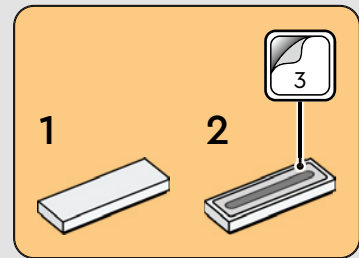
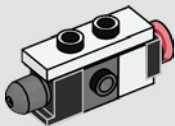

4

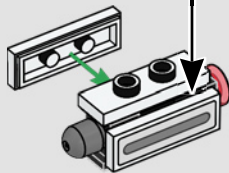

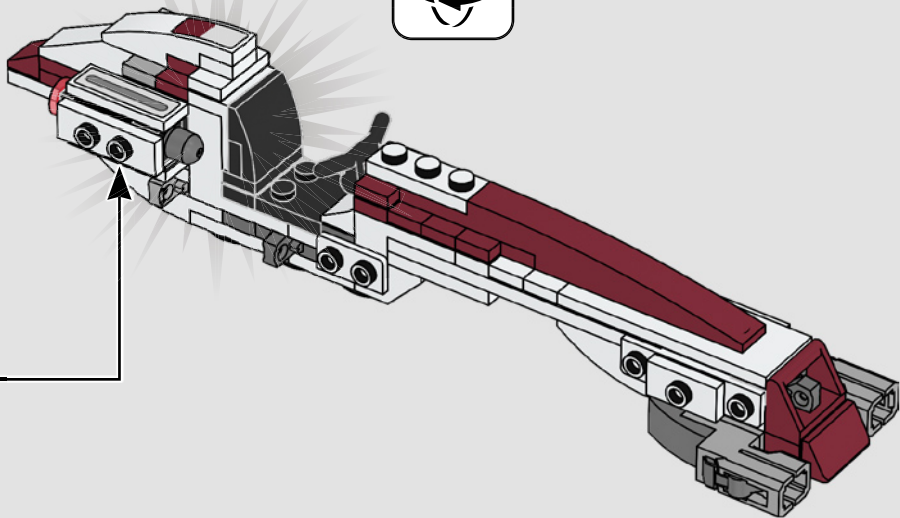

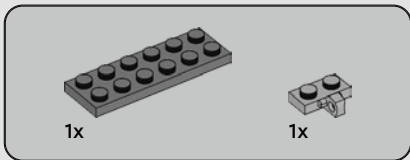
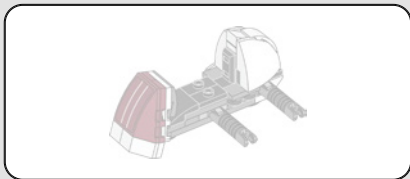

41

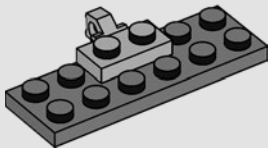



1x

42

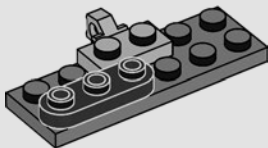

1x



1x

43

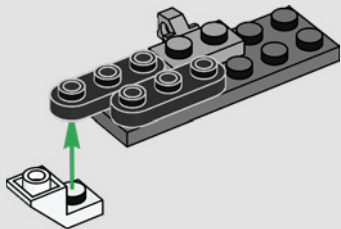



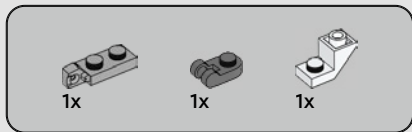

44

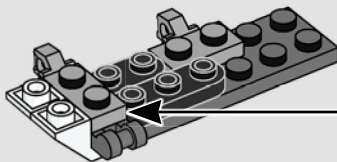
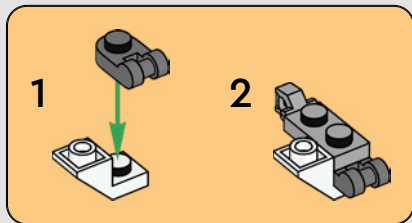





1x

47

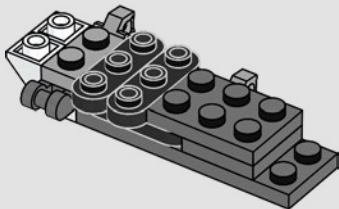

2x



1x

48

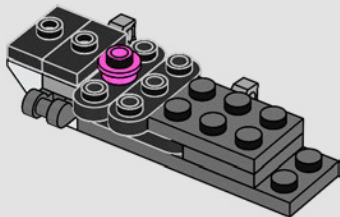



1x



2x

# 49

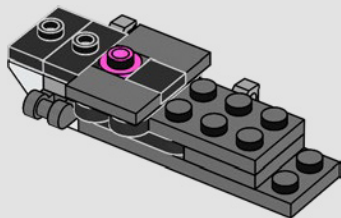

2x

# 50

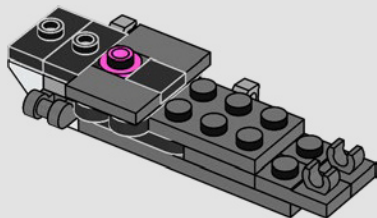



1x



2x

# 51

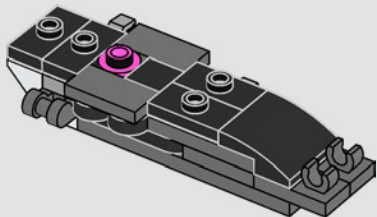

1x

# 52

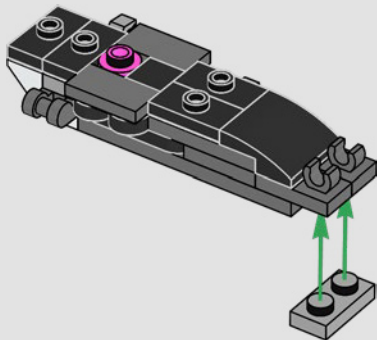



1x



1x

# 53

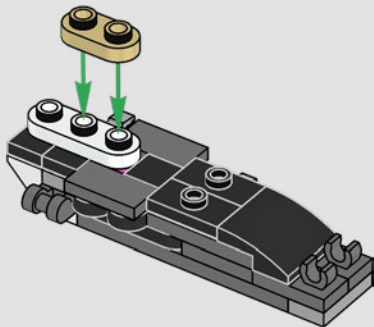

1x

# 54

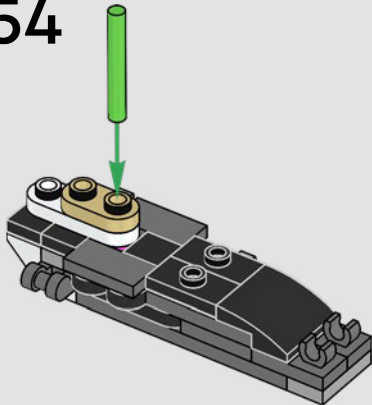



1x



1x

# 55

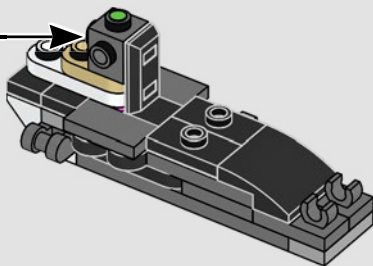
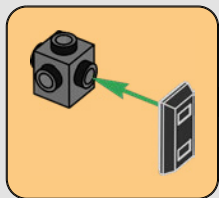

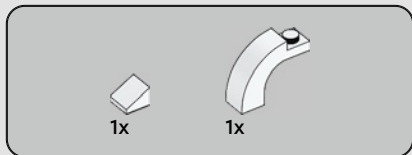

56

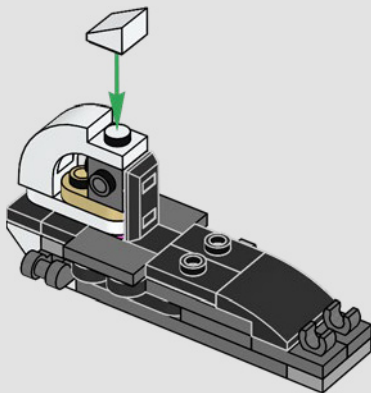



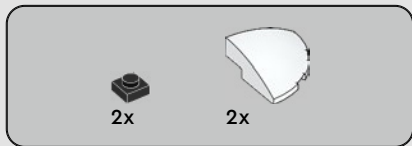

57

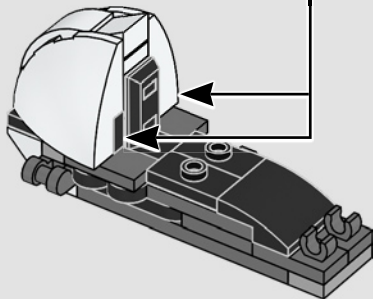
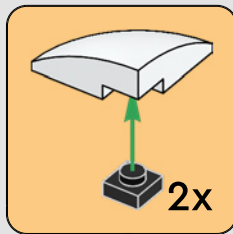



1x



1x

# 58

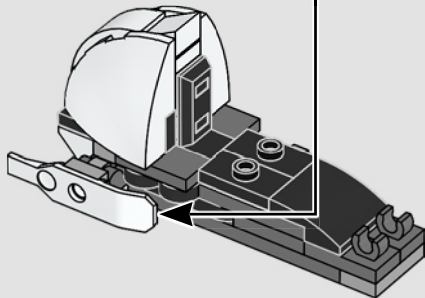
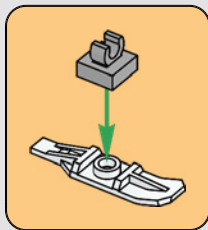



2x

59

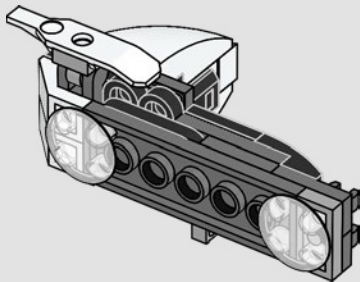



1x

60

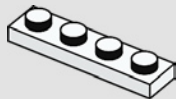

1x

61

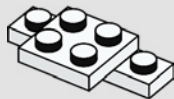



1x



1x

# 62



1x

# 63

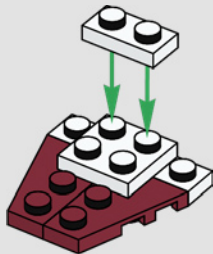



2x

64

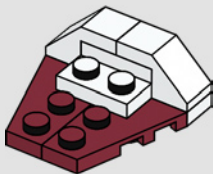

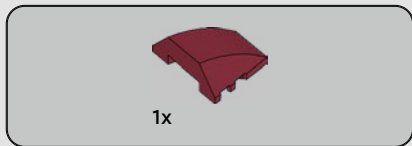

65

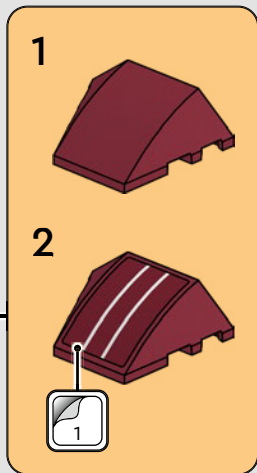
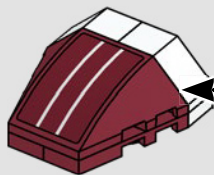



1x

66

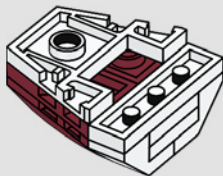





1x

67

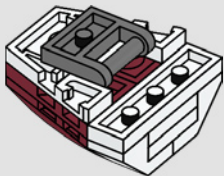

1x

68

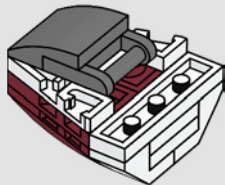

69

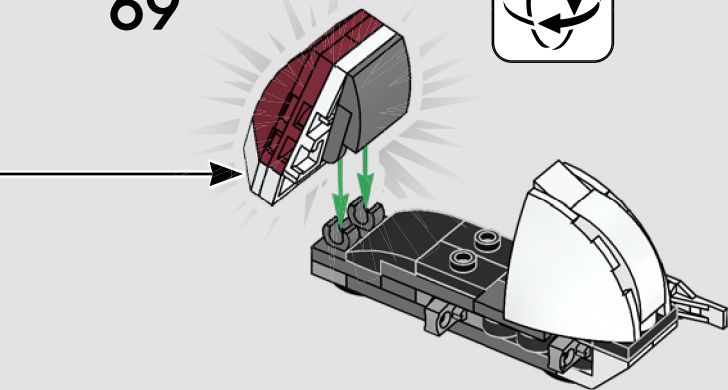

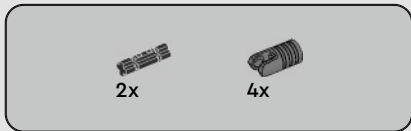

70

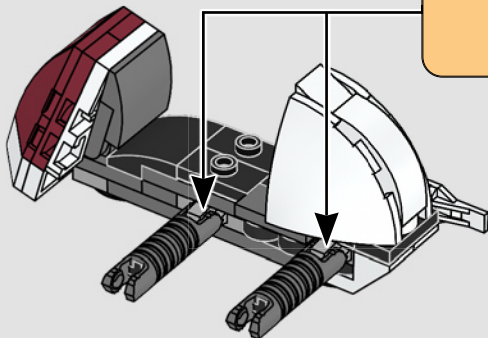
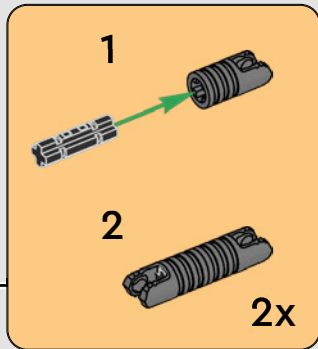

71

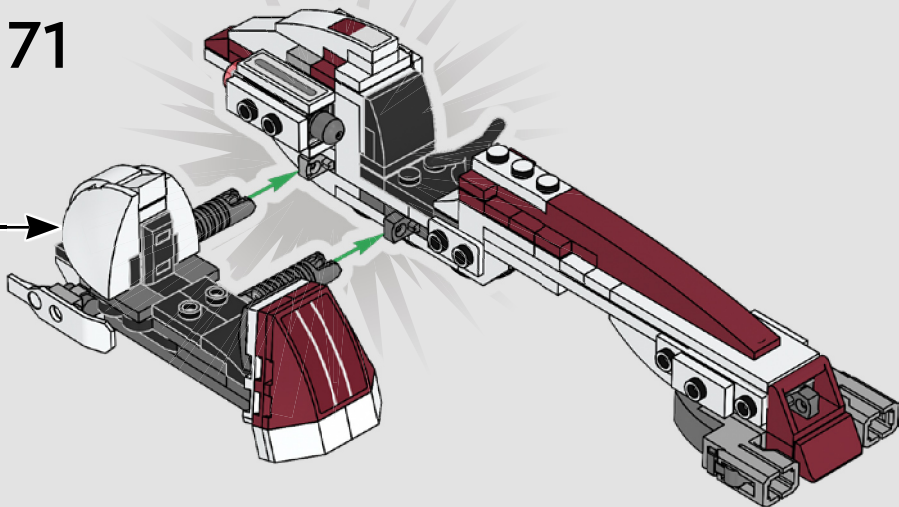



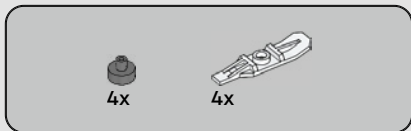

72

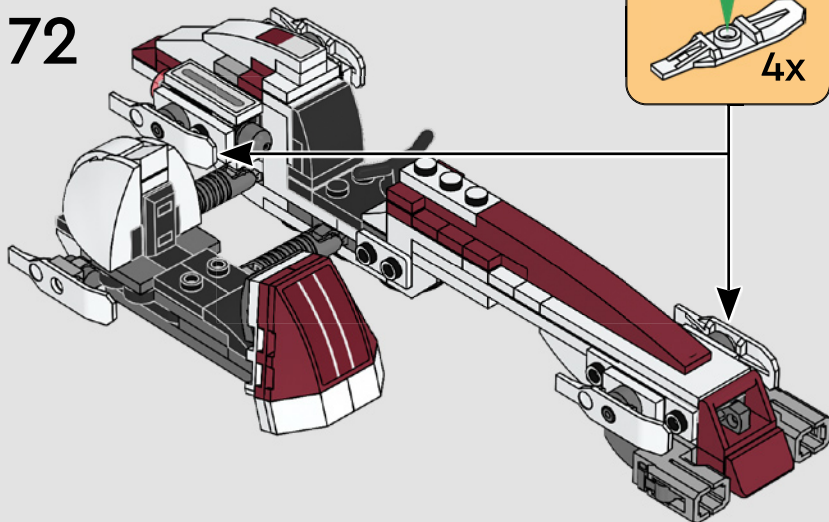



1x



1x

# 73

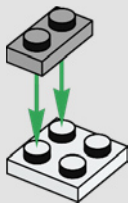

1x

# 74

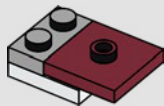



1x

75



4x

76

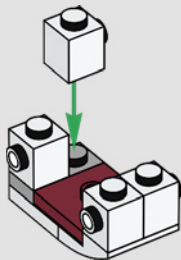



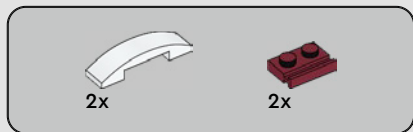

77

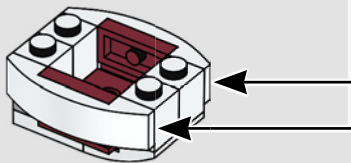
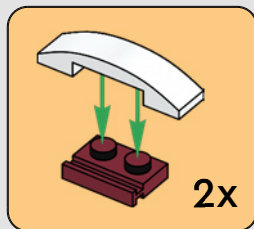



1x

78

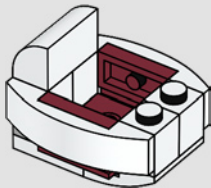

1x



1x

79

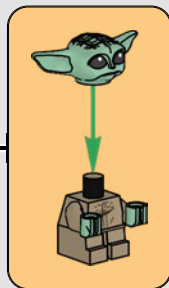

80

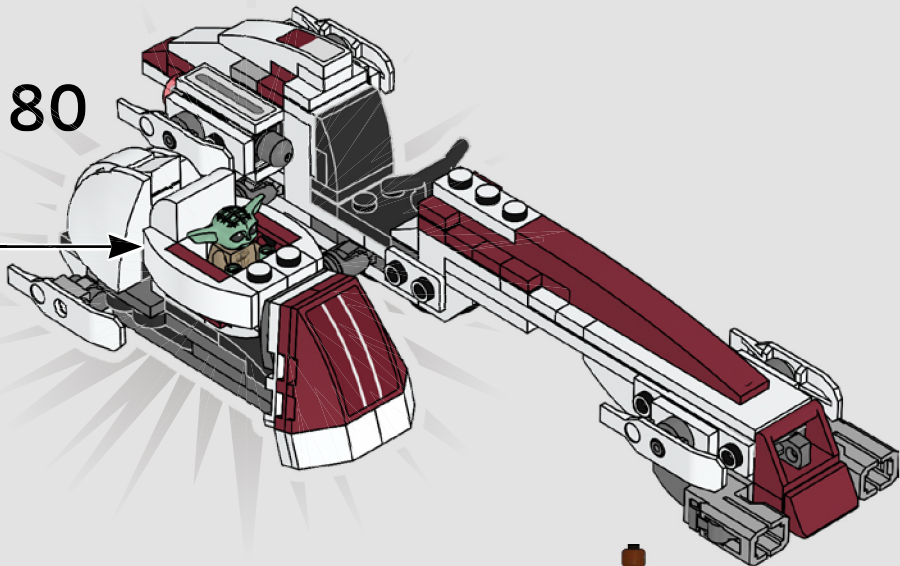



4x



81

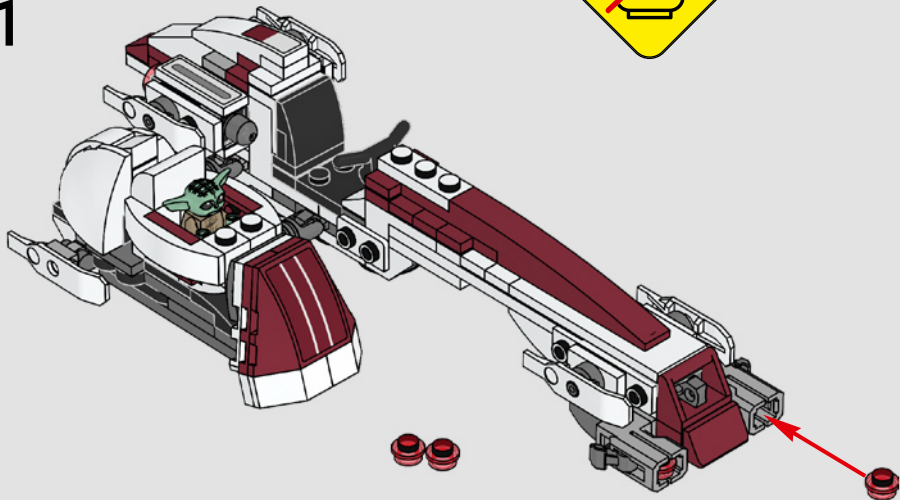

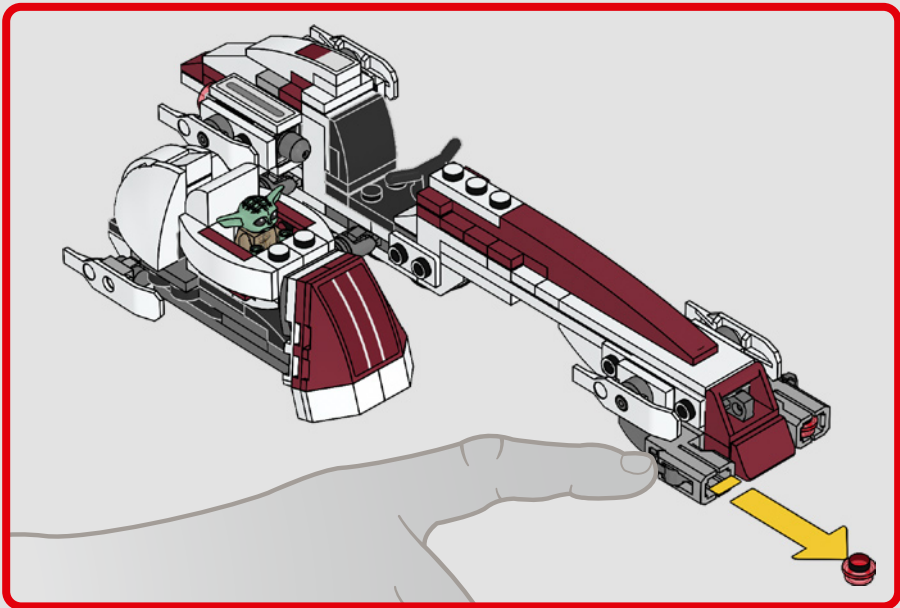



1x

82

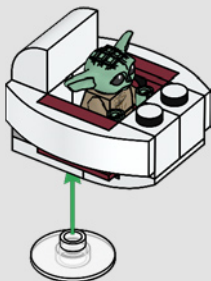

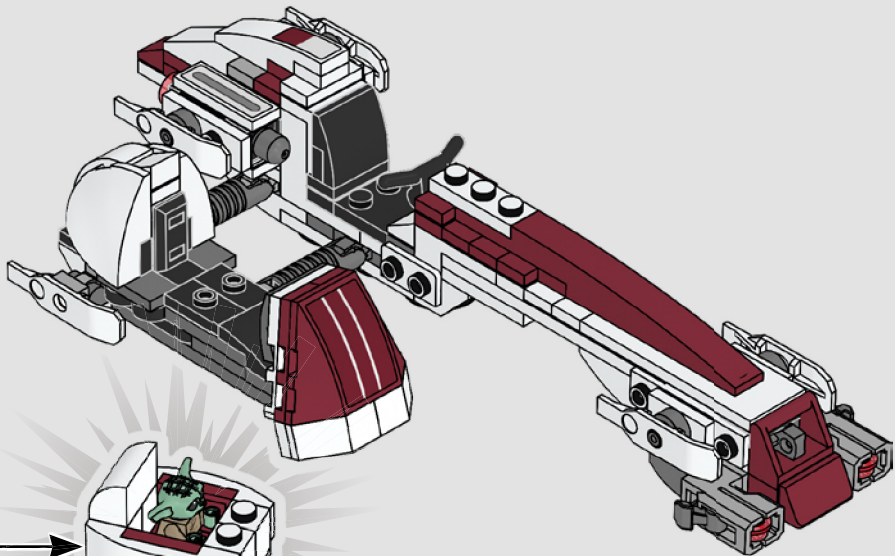



1x



1x

1

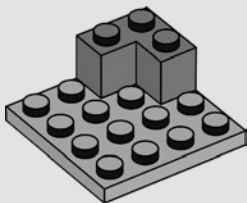

1x



1x

2

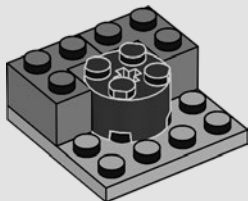





2x

3

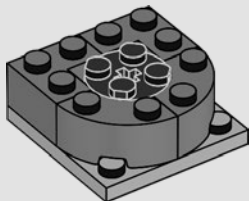

2x



2x

4

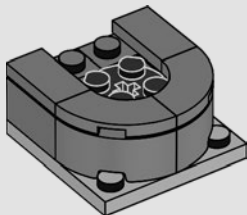



1x



1x

5

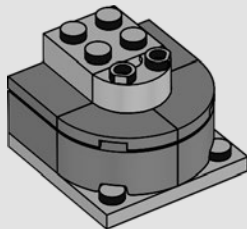

1x



1x

6

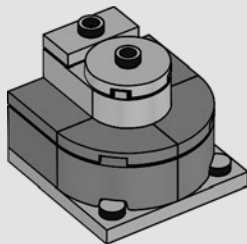

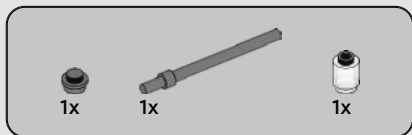

7

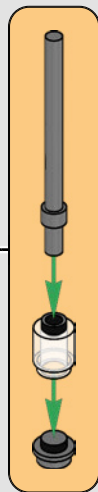
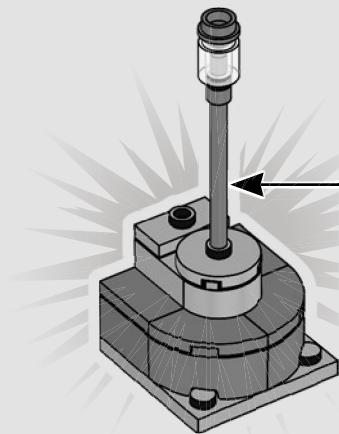

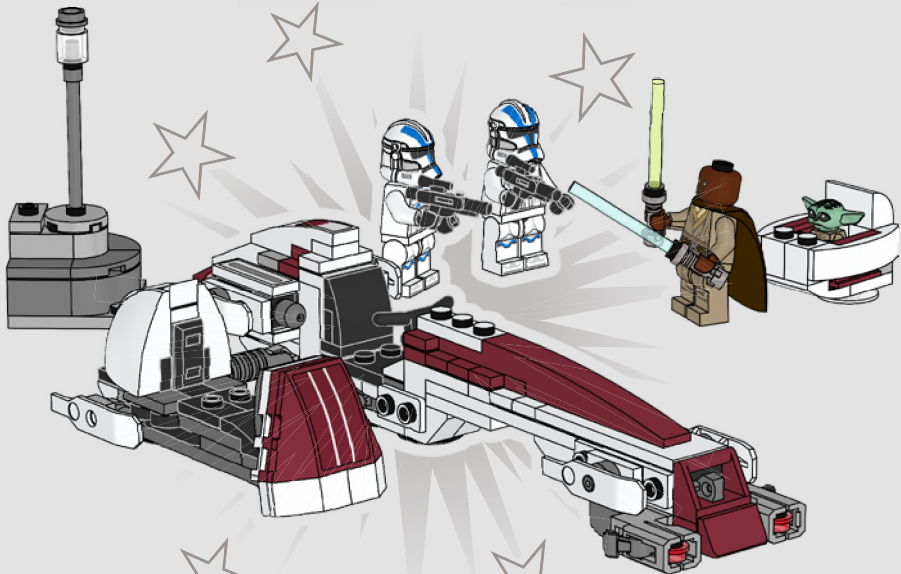



6x  
407001



1x  
302401



4x  
4558952



1x  
4504369



2x  
6296132



2x  
6380146



1x  
4547489



2x  
6308127



3x  
302301



5x  
6051511



4x  
6458097



1x  
6248827



2x  
6166894



2x  
6070698



1x  
6117940



1x  
6450820



7x  
302201



1x  
6210385



2x  
6334524



2x  
6195371



4x  
4558168



1x  
362301



1x  
6429913



1x  
428601



2x  
6311398



2x  
6168618



3x  
302101



5x  
6484391



4x  
6034675



1x  
6045936



2x  
371001



1x  
6170524



1x  
6053026



1x  
6310374



1x  
6332042



1x  
303401



2x  
6023806



1x  
6212758



2x  
6308125



2x  
407026



4x  
302426

















































1x  
307026



2x  
4109810



1x  
614326

 3x 302326	 2x 6053077	 1x 6472377	 1x 6083977	 5x 6092597	 1x 6508097
 1x 306926	 1x 6161772	 1x 6488937	 1x 6313126	 1x 6470185	 3x 6066097
 4x 6092585	 1x 6223655	 1x 6510467	 1x 6484390	 2x 4539076	 1x 6266251
 1x 6156991	 1x 6245306	 2x 4539114	 2x 6186005	 1x 6472375	 2x 4211398
 1x 3003126	 5x 6163901	 1x 4531415	 1x 4613761	 1x 6311384	 2x 4654582
 2x 4498713	 4x 6208450	 2x 6267490	 1x 6175314	 1x 6183782	 2x 6266231
 4x 6428168	 2x 6258607	 1x 6267492	 1x 6293875	 1x 6308012	 1x 4211387
 1x 6192346	 1x 6507882	 1x 6483616			
	 1x 6483616				



2x  
6360382

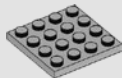

1x  
4243797



2x  
6344216



1x  
4210633



4x  
6271752



3x  
4210700



2x  
6360675



1x  
6388119



4x  
6271538



4x  
4211052



2x  
4211063



2x  
6266248



2x  
6029948



2x  
6344754



1x  
6146321



2x  
6265306



2x  
4211109



1x  
4210635



2x  
6360619



1x  
6344820



1x  
4211043



1x  
6170420



1x  
4211002



1x  
6230582



1x  
6492810



1x  
6507884



2x  
6051389



LEGO.com/service

YOU COULD

WIN

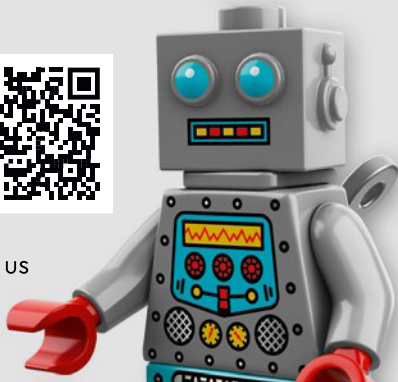

Scan this QR code or go to  
**LEGO.COM/PRODUCTFEEDBACK** and give us  
your short feedback about this LEGO® set  
for a chance to win a cool LEGO prize.

Terms and Conditions apply\*

**EN: YOU COULD WIN.** Terms and Conditions apply\* **DE: Du könntest GEWINNEN.** Es gelten die Teilnahmebedingungen\* **FR: Tu pourrais GAGNER.** Des conditions s'appliquent\* **IT: Potresti VINCERE tu.** Termini e condizioni sono applicabili\* **ES: Puedes GANAR.** Aplican términos y condiciones\* **PT: Poderá GANHAR.** Aplicam-se termos e condições\* **ZH: 轻松获奖.** 条款和条件适用\* **PL: Szansa na WYGRANĄ.** Obowiązują warunki korzystania\* **CS: Máte šanci VYHRÁT.** Platí všeobecné smluvní podmínky\* **SK: Máte šancu VYHRÁT.** Platia všeobecné zmluvné podmienky\* **HU: TE IS NYERHETSZ.** Felhasználási feltételek érvényesek\* **RO: Ai putea CÂȘTIGA.** Se aplică termenii și condiții\* **BG: Можете да СПЕЧЕЛИТЕ.** Има определени правила и условия\* **LV: Tu vari LAIMĒT.** Ir spēkā noteikumi un nosacījumi.\* **ET: Sul on võimalus VÕITA.** Kehtivad tingimused\* **LT: Jūs galite LAIMĖTI.** Taikomos sąlygos\*

\*[LEGO.com/productfeedback-terms](https://www.lego.com/productfeedback-terms)

LEGO and the LEGO logo are trademarks of the/son des marques de commerce du/  
son marcas registradas de LEGO Group. ©2024 The LEGO Group.

© & ™ Lucasfilm Ltd.

6515730