



STAR WARS

ULTIMATE COLLECTOR SERIES
SÉRIE DE COLLECTION SUPRÊME



75192

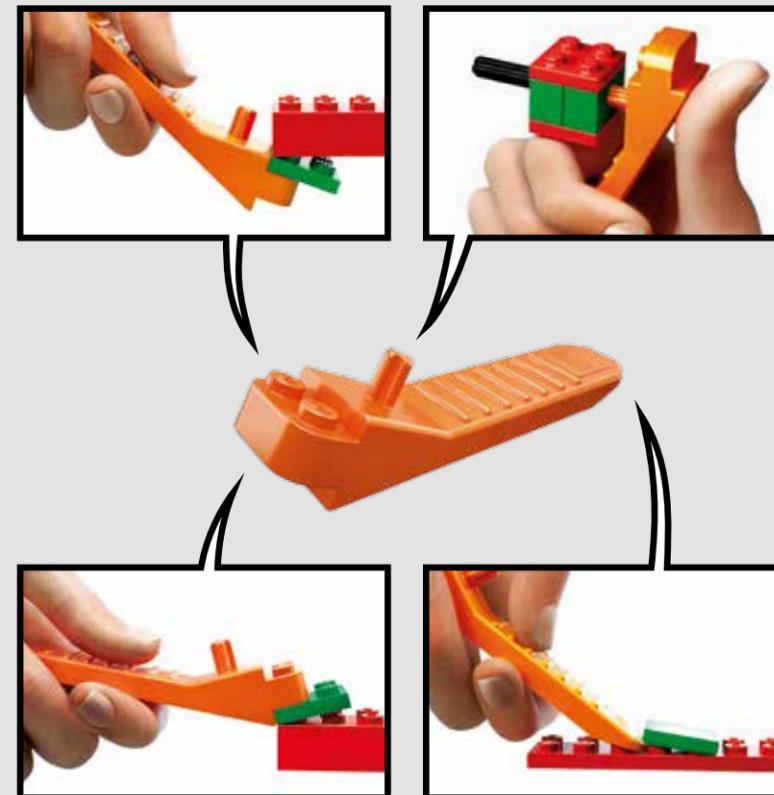

LEGO.com/brickseparator

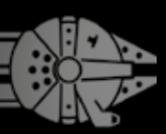

ABOUT THE LEGO® STAR WARS TEAM

LEGO® *Star Wars* started in 1999, and we have made new models for the product line every year since then. The LEGO *Star Wars* design team consists of eleven model designers and four graphic designers. The team is a mix of brand-new designers with new fresh ideas, and experienced LEGO *Star Wars* designers with many models under their belts.

This is an ideal team for creating new, innovative LEGO *Star Wars* models, as well as revising and improving previous LEGO versions of classic and iconic *Star Wars* ships. The focus of our main LEGO *Star Wars* product line is to make cool, fun, and inspiring LEGO *Star Wars* models for children.

For LEGO Direct we have the opportunity to make even bigger, more challenging models with special attention to accuracy and details. These models are fun and exciting to develop, but also a huge challenge! We always do our very best, and hope you will enjoy building them.

Happy building!

Jens Kronvold Frederiksen
Design Director LEGO® *Star Wars*™





© & ™ Lucasfilm Ltd.

ABOUT THE MILLENNIUM FALCON™

Hauling thousands of tons of cargo across the endless void of space is a tough task, and among the most famous vehicles invented for these heavy-duty jobs was the Corellian YT-1300 light freighter. One of these freighters in particular became infamous for hauling contraband and stolen goods. Piloted by intergalactic smuggler Han Solo and his right-hand Wookiee, Chewbacca, this special light freighter became known as the *Millennium Falcon*™.

The original name for this vehicle was YT-1300 492727ZED, and it was owned by the human gambler Lando Calrissian, who is said to have made several customizations to the power core and deflector shields, among other changes. During this time, the vehicle gained the name *Millennium Falcon*, but the ship didn't stay long with Lando, who is rumored to have quickly lost the ship to the aforementioned Han Solo during a high-stakes game of sabbac.

Despite the aged appearance and out-of-style vehicle design, the *Millennium Falcon* was a fierce ship, even though the shape of the chassis was one of the only remaining original aspects of the vehicle. Lando, Han Solo, and numerous other owners upgraded, customized, and improvised numerous

modifications to create a freighter that was unlike any other in history. In addition to a customized hyperdrive system, the freighter was also touted to be the fastest ship in the galaxy. Han Solo also outfitted the *Millennium Falcon* with multiple weapons systems and updated the hull armor with Duralloy plates salvaged from an Imperial cruiser. All of these modifications, as well as its sublight speed and maneuverability, made the *Millennium Falcon* competitive against the fastest starfighters produced by both the Rebellion and the Empire. Additionally, Han Solo included custom-built sensor-proof smuggling compartments, which later aided in the rescue of Princess Leia Organa from Imperial Stormtroopers.

Present for some of the largest conflicts during the Galactic Civil War, the *Millennium Falcon* was instrumental in the destruction of both of the Death Stars, and was an invaluable part of the Rebellion's fleet. Some years after the Battle of Endor, the *Millennium Falcon* was stolen from Han Solo, ended up in the hands of such characters as Ducaim and the Irving boys, and finally ended up on the junkyard planet Jakku, where it sat unused for years, collecting dust. The infamous ship soon reclaimed its former glory, however, as the mechanically shrewd Rey, the astromech droid BB-8, and deserter stormtrooper Finn used the ship to escape an attack from the First Order.



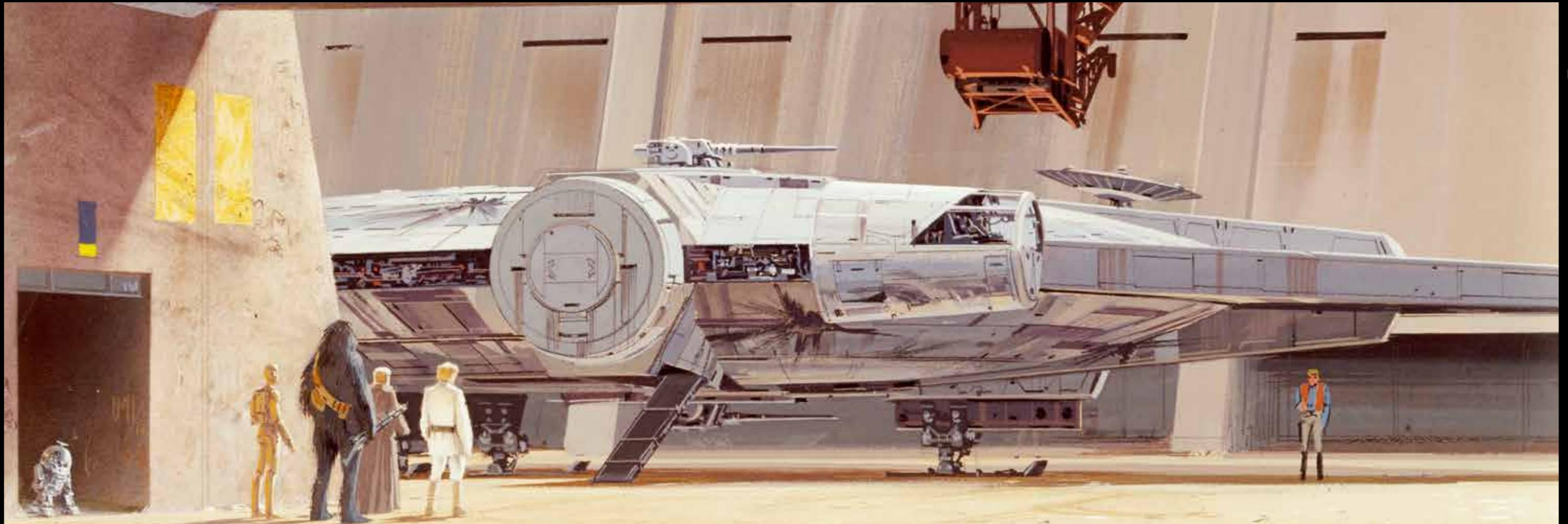
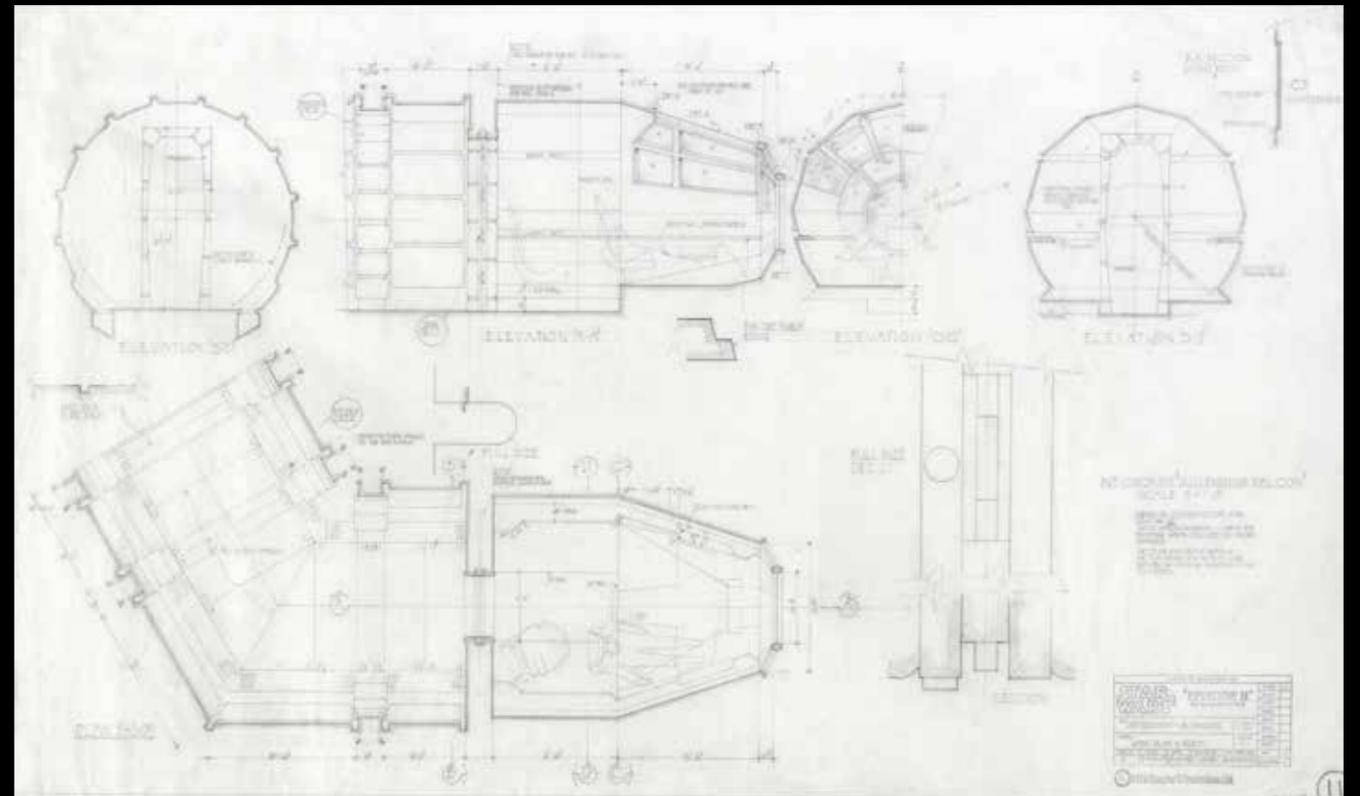
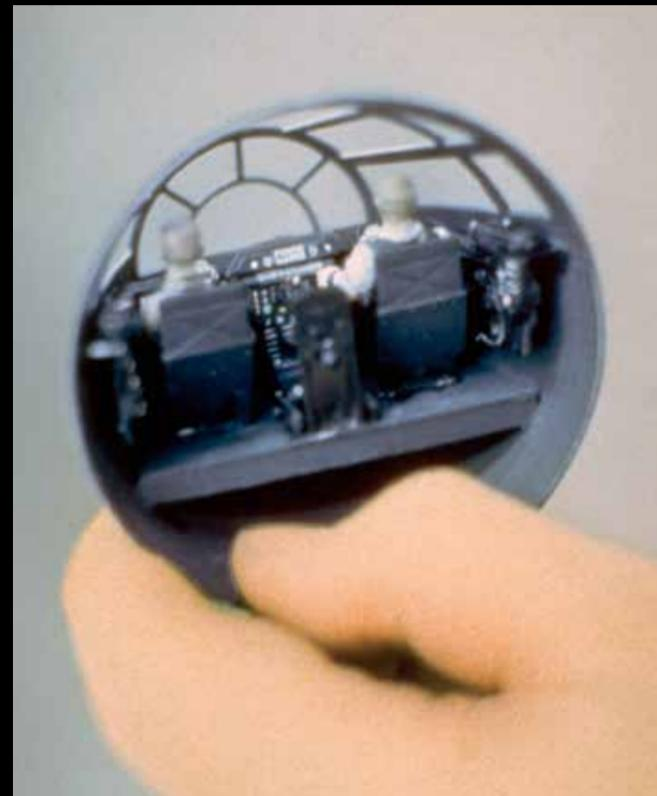
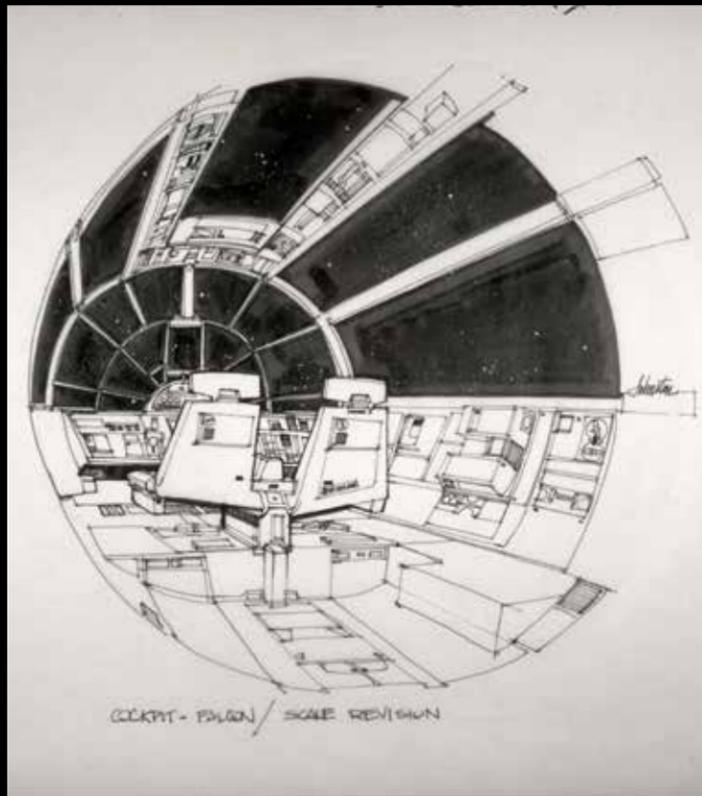



BUILDING BEHIND THE SCENES: MILLENNIUM FALCON™

In the second draft of the *A New Hope* film script written in 1975, George Lucas described a “pirate ship” that Han Solo served aboard, along with fellow crewmate Chewbacca. Subsequent rewrites made Han Solo the owner of this pirate ship, while in the fourth draft of the script, the ship was finally given a name: the *Millennium Falcon*.

Early designs of what would become one of the most famous spaceships in science-fiction history were similar to stereotypical rocket ships. Huge engine exhaust ports were added to give the ship a racecar feel and the cockpit was rounded out. The design had too many parallels to other spaceships, however, and Lucas began thinking of ways to differentiate the *Millennium Falcon* and give the vehicle a truly unique look. It is believed that he was inspired by the saucer-shape design of classic UFOs and the idea of a hamburger with a bite taken out of it. Thus, the famous rounded shape of the *Millennium Falcon* was born.

Construction began on the models for the movie set. Materials used included items as disparate as novelty chance dice and parts from a Ferrari sports car. Several complete models were constructed for various scenes throughout the film, ranging in size from seven inches to over four feet. A near full-size exterior measuring almost sixty feet long was built for *A New Hope* and featured in the famous escape scene in the Death Star hangar. The completed exterior set had a functional landing gear as well as a structural support disguised as a fuel line. Internally, the set featured the starboard ring corridor, boarding ramp, a cockpit access tunnel, gun turret ladder, various secret compartments, and the forward hold. Interestingly, the cockpit was constructed separately so that it could be rocked to simulate movement as it traveled through space and battled the Imperial Fleet. The built set was simply too big to move, so rather than breaking it down and rebuilding it for various scenes, the film crew changed the sets around the ship. For the film *The Empire Strikes Back*, another near full-size replica of the ship's exterior was built.



© & ™ Lucasfilm Ltd.



© & ™ Lucasfilm Ltd.

Despite multiple sets and models being created to depict the *Millennium Falcon* throughout the movie universe, several scenes make use of matte paintings produced by Ralph McQuarrie to show the *Millennium Falcon* in its complete glory. One such scene is when Princess Leia, played by actress Carrie Fisher, sees the *Millennium Falcon* for the first time in *A New Hope*. Similarly, when Han Solo asks Lando Calrissian to promise not to damage the *Millennium Falcon* in *Return of the Jedi*, the ship shown is a backdrop painting.

When filming began on *The Empire Strikes Back*, a new and smaller miniature model was created to supplement the full-size *Millennium Falcon*. This smaller version allowed for more intricate in-flight rolls and pitches that were impossible with a five-foot model. Measuring approximately thirty-two inches in length, the new model included more detailed surface features, and updated landing gear and cockpit details,

which expanded the number of shots the film crew could now include. The model was then mounted on a gimbal and used to simulate the ship's movements: for example, when escaping from an oncoming group of TIE fighters. This model is also renowned for being the version most familiar to *Star Wars* fans, as the design was used most often for toys, model kits, promotional materials, and art for the *Star Wars* universe. This same model was later reused for *The Return of the Jedi*.

Another unmistakable feature of the *Millennium Falcon* were the sounds that accompanied the amazing visuals. Almost all of the space-faring vehicles in the *Star Wars* universe featured sound effects that were based on real planes. For the *Millennium Falcon*, sound designer Ben Burtt used the slowed-down engine sound of the North American P-51 Mustang fighter airplane from World War II. He then added a thunderclap or a lion's roar to accentuate the speed and size of the ship when it passed close to the camera. To create the sound of the *Millennium Falcon* jumping to hyperspace, Burtt combined the sound of a Douglas DC-3 with an echo effect, and the film crew's motion-control cameras as they moved along their tracks.

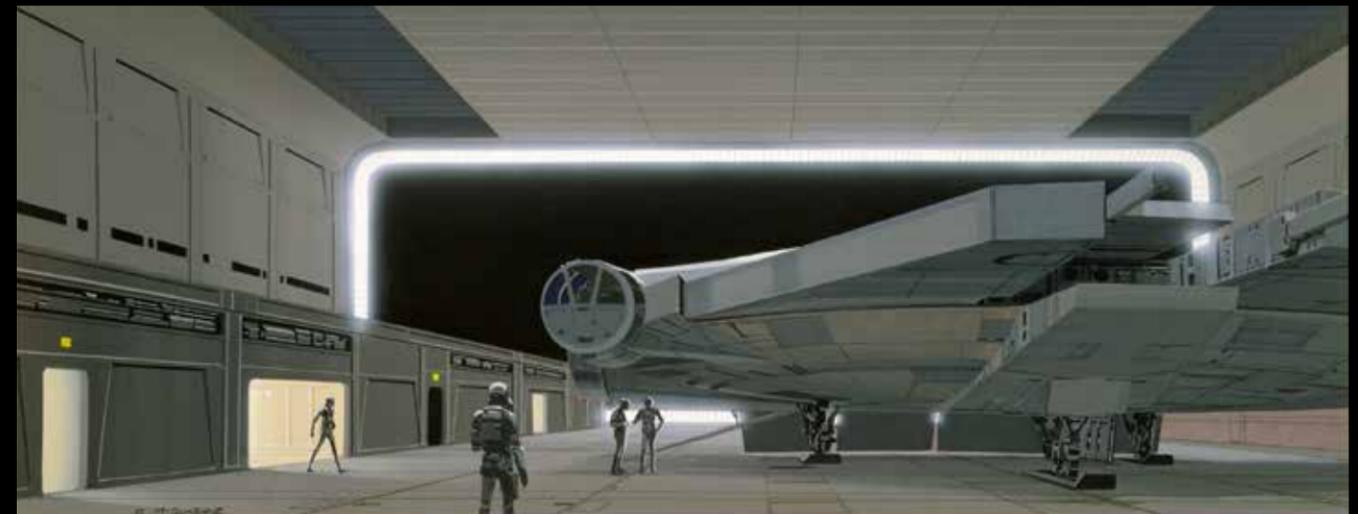
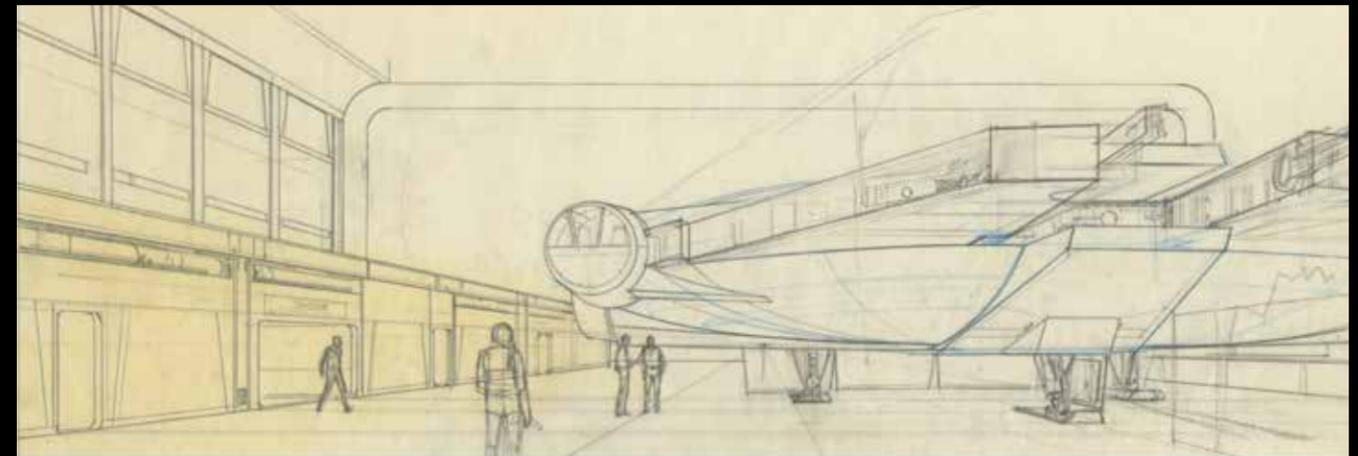



HISTORY OF THE LEGO MILLENNIUM FALCON

Jens Kronvold Frederiksen

Q: The *Millennium Falcon* is probably the most iconic vehicle from the entire *Star Wars* saga. When approaching a new model with this much history, what were some of the first steps taken when designing the first LEGO brick version of the *Millennium Falcon*?

A: Well, that was many years ago. The first LEGO *Millennium Falcon* launched in 2000. But I do remember that we had a lot of discussion about how to design this model. It is round, and therefore not that simple to create with LEGO bricks and elements!

But we decided to use some circular elements from a LEGO Space UFO theme for the main body of the ship. We also created a new canopy element for the cockpit, but today this model looks very dated. More recent versions of the LEGO *Millennium Falcon* are much closer to the real design!



Jens Kronvold Frederiksen

Q: With over eight versions of the model in the LEGO set library, were there any versions that contained dramatic changes from the previous incarnation?

A: The next *Millennium Falcon*, created in 2004, was minifigure scale. This was a huge upgrade from the first version. We made the 12x3 stud triangular plate to create the main body in a completely new and more accurate way. We also created a more accurate transparent element for the cockpit canopy.

Q: The unique rounded shape of the *Millennium Falcon* is a defining characteristic of the spaceship. Was this a challenge to communicate with LEGO bricks?

A: A round shape is difficult with LEGO bricks, but the way we did it in the first version, 4504 *Millennium Falcon*, is the best way! Currently, the latest version, 75105 *Millennium Falcon*, uses the same triangular elements.

On a large-scale version like this UCS version, it is much more complicated! I remember from when I designed the first UCS version *Millennium Falcon* 10179. It was about making a sturdy frame, and then covering it up with panels in many different shapes, created from a lot of different LEGO elements!

Q: Were there any elements of previous versions that have been significantly updated for this newest interpretation of the *Millennium Falcon*?

A: The model you have here is by far the most detailed LEGO *Millennium Falcon* ever done! More or less all details have been upgraded on this latest version of the ship.

A very noticeable new detail is of course the cockpit canopy. A vast improvement from the 10179 *Millennium Falcon*, which only had the framing on the canopy, and no glass!

Q: What type of visual resources are used when designing a LEGO set based on a vehicle from a movie? Film screenshots? Online schematics? Something else?

A: When designing models, we always use official reference material. For this *Millennium Falcon* we used the movies, including *Star Wars: The Force Awakens*, and pictures of studio models.

Q: What sets the *Millennium Falcon* apart from other LEGO *Star Wars* sets?

A: First of all, it is the most iconic and popular ship in the *Star Wars* films. For that reason, there have been many different versions and sizes of the LEGO *Millennium Falcon* build.

Q: Are there any parts of the new set that improve functionality, stability, or appearance in any significant ways?

A: More or less everything has been improved. The basic inner frame is probably the part that come closest to the previous 10179 *Millennium Falcon*. When we create a new version of a model, we always start by going through consumer feedback on the previous version, to find areas for improvement. Visually, this version is also much more accurate and detailed.

Q: How accurate is the LEGO *Millennium Falcon* compared to the real in-universe vehicle?

A: Very accurate! The only major difference is that the *Millennium Falcon* in the movies is missing the LEGO studs!

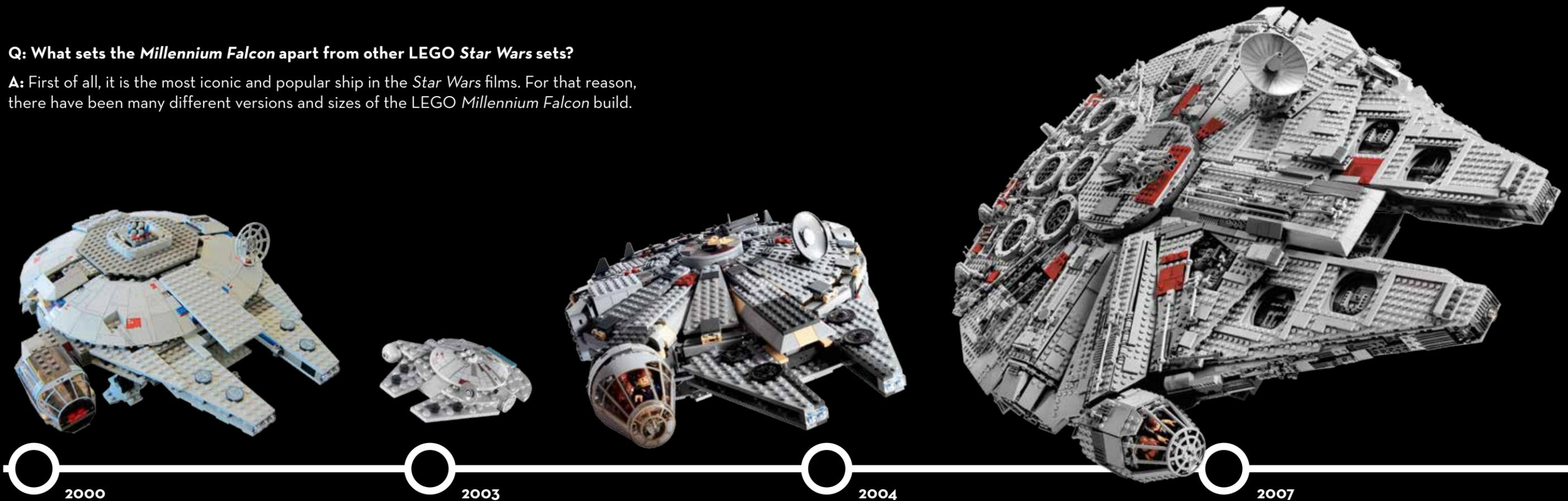

7190: Millennium Falcon™

659 pieces

The very first incarnation of the LEGO *Millennium Falcon* is created. Measures over 2" (6 cm) high, 21" (53 cm) long, and 17" (42 cm) wide. Includes six minifigures: Han Solo, Chewbacca, Princess Leia Organa, Luke Skywalker, R2-D2, and C-3PO.

4488: MINI Millennium Falcon™

87 pieces

First miniversion of the *Millennium Falcon*. Measures over 2" (4 cm) high, 5" (14 cm) long, and 5" (14 cm) wide. No minifigures included. Set contains additional parts to build a Y-Wing Starfighter when also using additional parts from sets 4489, 4490, and 4491.

4504: Millennium Falcon™ (Episode V)

985 pieces

Original Trilogy Edition. All-new LEGO brick plates are created to help build the unique shape. Measures over 4" (9 cm) high, 22" (57 cm) long, and 15" (38 cm) wide. Includes five minifigures: Han Solo, Chewbacca, Princess Leia Organa, C-3PO, and a snowtrooper.

10179: Ultimate Collector's Millennium Falcon™

5,197 pieces

The biggest version so far of the iconic ship lands on shelves everywhere. Measures over 8" (21 cm) high, 33" (84 cm) long, and 22" (56 cm) wide! Includes five minifigures: Han Solo, Chewbacca, Obi-Wan Kenobi, Luke Skywalker, and Princess Leia Organa.

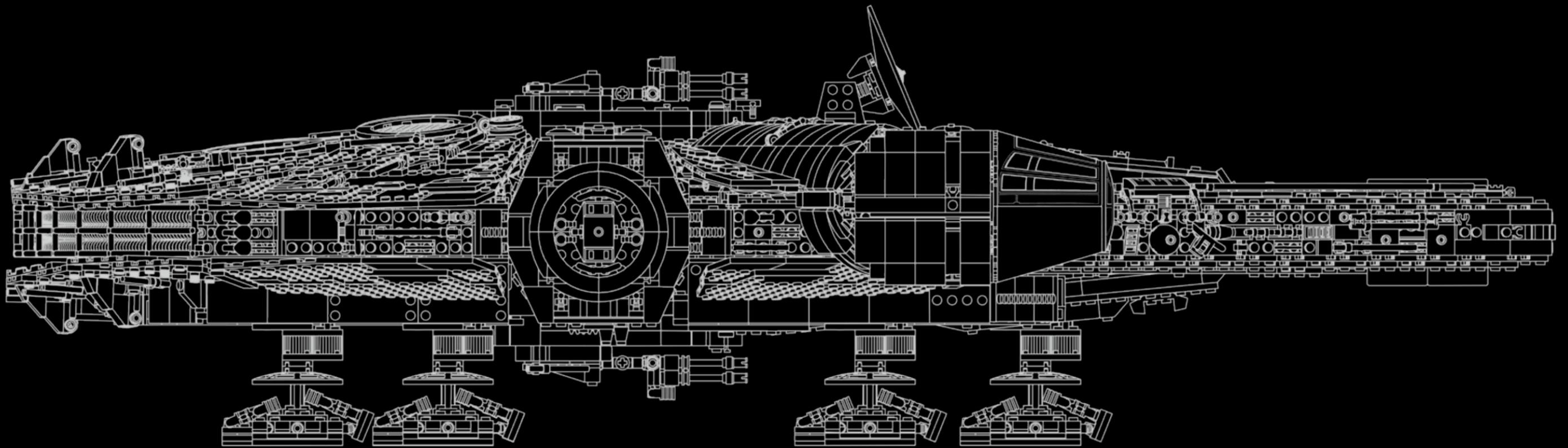

2009

7778: Midi-scale Millennium Falcon™

356 pieces
A midi-scale version of the *Millennium Falcon*. Measures over 3" (8 cm) high, 9" (24 cm) long, and 7" (17 cm) wide. No minifigures included.



2011

7965: Millennium Falcon™

1,254 pieces
Measures over 4" (10cm) high, 23" (58cm) long, and 15" (38cm) wide. Includes six minifigures: Han Solo, Luke Skywalker, Chewbacca, Ben Kenobi, Princess Leia Organa, and Darth Vader.



2014

75030: Millennium Falcon™ Microfighters

94 pieces
A Microfighters version of the *Millennium Falcon*, which still incorporates the recognizable and famous round shape with two flick missiles and a minicockpit on top for Han Solo to sit in. Measures over 2" (6 cm) high, 3" (8 cm) long, and 3" (8 cm) wide.



2015

75105: Millennium Falcon™ (Episode VII)

1,329 pieces
Episode VII Edition. Measures over 5" (14 cm) high, 18" (47 cm) long, and 12" (32 cm) wide. Includes six minifigures: Rey, Finn, Han Solo, Chewbacca, Tasu Leech and a Kanjiklub Gang Member, plus a BB-8 astromech droid.



MEET THE MODEL DESIGNER

Hans Burkhard Schlömer

Q: There are many legendary vehicles in the *Star Wars* Universe, but the *Millennium Falcon* stands apart as an iconic creation that helped define one of the most memorable movies of all time. With so much at stake, what were your first thoughts when sitting down to design the ultimate LEGO *Millennium Falcon*?

A: Designing any set of this size certainly is a daunting task in its own right. Even more so when the set in question is the *Millennium Falcon*! I've never built the older set before, so this was the perfect opportunity to do what is every LEGO *Star Wars* fan's dream: build the huge 10179 *Millennium Falcon*!

This exercise helped me understand how the internal support structure works, how the model is divided into segments, and how they all connect to the frame. In short, how everything goes together! When I realized that the basic design principle is still sound and would also provide the sturdiness an even more detailed and heavier model would require, I just kept running with it.



© & ™ Lucasfilm Ltd.



Hans Burkhard Schlömer

Q: You have designed LEGO *Star Wars* sets before — how was the *Millennium Falcon* different from other models you have created?

A: After designing the play theme version of *Star Wars: The Force Awakens Millennium Falcon*, LEGO set 75105, I was already quite familiar with the look of the ship. After creating the 10179 *Millennium Falcon* in the digital program we use here, I disassembled the model on my screen and was able to lay out all the subsections side by side.

However, every time I made more than just cosmetic changes digitally, I had to make sure the parts still fit the rest of the model, or make necessary changes to other parts as well. These also had to be checked on a physical copy and then altered as well. Many of those subbuilds were redesigns, while others were brand new and had to find a place on the model.

In order to test how the model will perform under stress we always heat up the whole set. But we don't have an oven large enough for the *Falcon* at the LEGO office — so we booked the sauna at the public bath in Billund, Denmark, just for this occasion. Sneaking the top-secret model into the building and back again was a little like being in a spy movie, and definitely a change from design routine!

Q: Were there special challenges when it came to making the model look like the real *Star Wars* Millennium Falcon?

A: The *Falcon* is most certainly not the easiest shape to re-create with LEGO elements at any scale. But the previous 10179 model already did much of the work for me, allowing me to focus on details that really could use a facelift after ten years — like areas that were built using angled plates and panels before, when they really should be round or curved. For example, the top center with the guns, the corridor leading to the cockpit, or the airlocks on the sides of the ship.

The top panels for the front mandibles required a total redesign to achieve the look I wanted, with correctly sized and placed holes, and dark-gray elements to bring out the detailing on one side. I added a bit of dark tan all over the model for a more weathered look, and swapped out plates for tiles for a better balance between studs and flat surfaces. Early on it was also decided to develop a new windshield element for the cockpit for a really spot-on look and to be in line with other current LEGO *Star Wars* products.

Q: The original *Millennium Falcon* movie model went through several design changes before the shape was decided on. Typically, how many sketch versions of a LEGO model are there before the final version is reached?

A: A typical sight in LEGO design areas is a dozen or more slightly different prototypes of the same model — representing design stages — sitting on or behind designers' desks. But on LEGO *Star Wars* this is usually not how I personally work. With proper reference material on hand and the ability to go through early iterations quickly with our digital programs, the first physical copy I build is usually very close to the final version in terms of look and size. I didn't have room for a fleet of slightly different



© & ™ Lucasfilm Ltd.

Falcons anyway. If you are reading this before building your own *Falcon*, it is B-I-G! Never did I have more than one or maybe two copies of the complete model in my work space — all changes were done digitally and then checked on and applied to the one physical copy I had room for. Being able to base this new version of the *Millennium Falcon* on 10179 was also a great help. I knew the support structure would not fail me and trigger a disastrous cascade of design changes at some later point.

Q: Are there key features you wanted to include when designing the interior details of the ship?

A: It was decided early on that this version of the ultimate *Millennium Falcon* was going to have some interior. There were just two problems: The interior sets we see in the movie would not be able to fit into the ship as seen on screen. On top of that, the LEGO *Millennium Falcon* is already pretty much filled with LEGO Technic beams in order to provide the required sturdiness and structural stability. There is even less space to put anything else into it!

The first step was then to make room by altering the internal support structure to determine how much space I would have available to work with. As it turned out it wasn't much, but enough to put in all the important features I could find, with a few extras on top — like the hatches leading to the escape pods, which are themselves missing, as reported by Imperial Stormtroopers searching the ship in *Episode IV*.

Finally, I wanted the *Falcon* to still look good and complete even when the top is taken off to showcase the interior. Only the panels right on top of the interior have to be removed, keeping the rest of the model with its structural beams and off-color pieces well covered.



Q: What was your favorite part of the design process?

A: The first phase of LEGO set development is always very exciting for a designer — this is when shaping and detailing of a model happens. Later I spend most of my time fixing issues and finding solutions for various design aspects like model stability, functions, product safety, or building flow.

My favorite part, however, is when I finally receive a bag of bricks and a pile of loose building instructions based on the steps that I developed — in this case, a very large pile! At this point my work is mostly done and my colleagues take over creating the design and completing the final elements of the set, like creating the box art or generating lists of elements for the factory.

Q: Were there features or functions of the movie version of the *Millennium Falcon* that were, in your opinion, essential to have in the final design?

A: In my mind, this new *Millennium Falcon* would HAVE to be the *Episode V* version. *The Empire Strikes Back* is where the *Falcon* really shines, develops character, and becomes part of the cast with the last-second escape from Hoth, the chase through the asteroid field, meeting the space slug, hugging a Star Destroyer, visiting Bespin, and finally even taking on a Super Star Destroyer! However, apart from the

necessary spaceship functions, the *Millennium Falcon* is not really heavy on out-of-the-ordinary features — or so Han Solo certainly wants you to believe! One of the new gadgets is the “Ground Buzzer” blaster cannon — a nasty surprise for Imperial troops, as seen in *Episode V* in the rebel base!

Since the *Millennium Falcon* also appears in *Episode VII* and *VIII*, adding the new rectangular sensor dish was essential, so you can choose between making the classic or new trilogy version of the *Falcon*.

Q: What are the differences between the original trilogy *Millennium Falcon*, and the *Falcon* as seen in *Episode VII: The Force Awakens*?

A: It takes a detailed study of reference material to realize that the new sensor dish is not the only change to the *Episode VII Falcon*, just the most obvious one. While even more aged and beaten up, many of the hull details of the ship have been cleaned up or altered. For practical reasons I went for a middle ground while still keeping some of the removed details — such as the metal cage covers on the sides of the mandibles (one is right next to the cockpit). They are not present on the *Episode VII Falcon* anymore, but I kept them because they are great details to have on any version of the *Falcon* and blend in nicely. Two other small gadgets sitting right on top of the ship’s front were a different matter though. They are a bit more obvious so I made them removable.

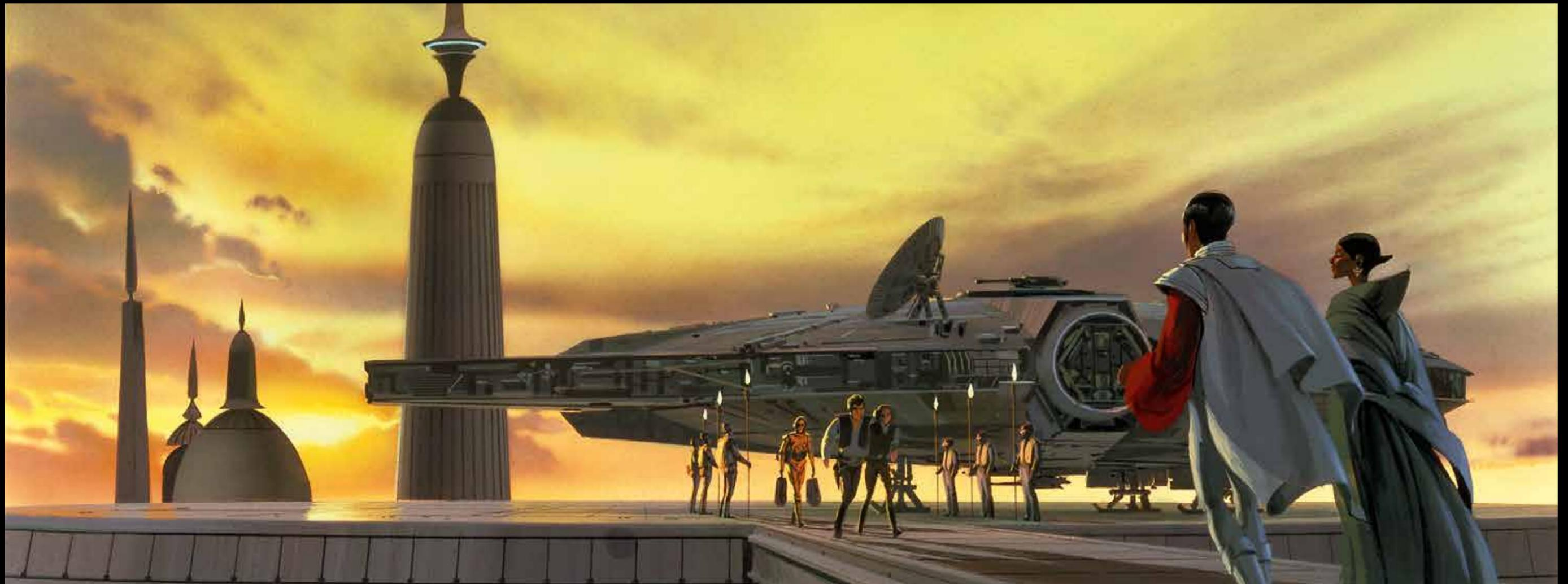



MEET THE GRAPHIC DESIGNER

Madison O'Neil

Q: Were there special challenges when it came to making the model look like the real *Star Wars Millennium Falcon*?

A: The most challenging aspect of the graphic design on this model had to be the stickers of the corridors inside the *Millennium Falcon*. It was important to capture a feeling of depth looking down the circular hallways and create the illusion that your minifigures could walk from the common area to the cockpit or the hyperdrive. The interior of the *Falcon* can be quite complex, with all its missing panels, flashing controls, and exposed wires. I did my best to simplify these details down to the essentials to maintain the LEGO DNA.

Q: The original *Millennium Falcon* movie model went through several design changes before the shape was decided on. Typically, how many sketch versions of a LEGO product are there before the final version is reached?

A: The design of any LEGO minifigure or decoration is likely to go through several rounds of revisions before being finalized and sent to Lucasfilm for approval. In certain special cases you can end up doing more than ten versions, all with small distinct features or color changes. With a limited color palette it can often be a unique challenge to match the reference.

Q: What was your favorite part of the design process?

A: I always enjoy starting a new project and developing the graphical needs of the product with the model designer. That discussion will usually lead to me combing through the reference folders to find clear images of extremely specific pieces of a ship, or taking a few minutes to re-watch certain parts of the movies to get inspired (or just for fun). It's also very rewarding when you finally receive the first test print of a decorated element. For me, that marks the end of a cycle, when the design that has only lived on the computer screen until this point becomes something you can play with.



Madison O'Neil

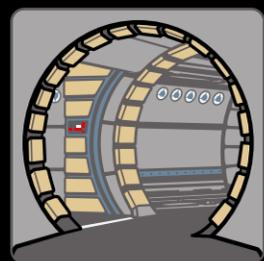

Corridors

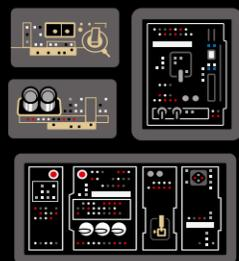
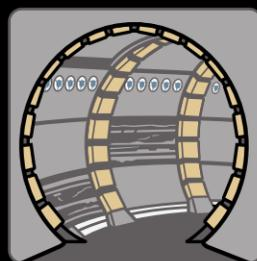

Control Panels



Dejarik Board



Han Solo



Chewbacca



Princess Leia

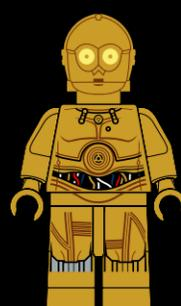

C-3PO



Q: Were there features or functions of the movie version of the *Millennium Falcon* that were, in your opinion, essential to have in the final design?

A: Well you can't have a *Millennium Falcon* without a good Dejarik Board! It was also exciting and essential to re-create the iconic radar dish, gunnery windows, and cockpit.

Q: Were there characters related to the various appearances of the *Millennium Falcon* that were, in your opinion, essential to have in the final design?

A: We wanted this *Millennium Falcon* to be a little more versatile than the previous version, giving you the freedom to decide between the classic *Falcon* or the version from *The Force Awakens*. As such, we knew we had to include two crews, and the crew from *The Empire Strikes Back* seemed the best complement to *The Force Awakens* crew. We also took this opportunity to create some alternate face designs for Han and Leia. This is the only set where they are wearing the breathing masks that they use to explore the belly of the giant space slug in *The Empire Strikes Back*. Mynocks beware! My favorite new character in this set is the adorable birdlike creature that we are told lives on the island shown at the end of *The Force Awakens*, the same island where Rey discovers Luke. I can't wait to see what part they play in *Episode VIII*!



Blueprint and Concept Sketches

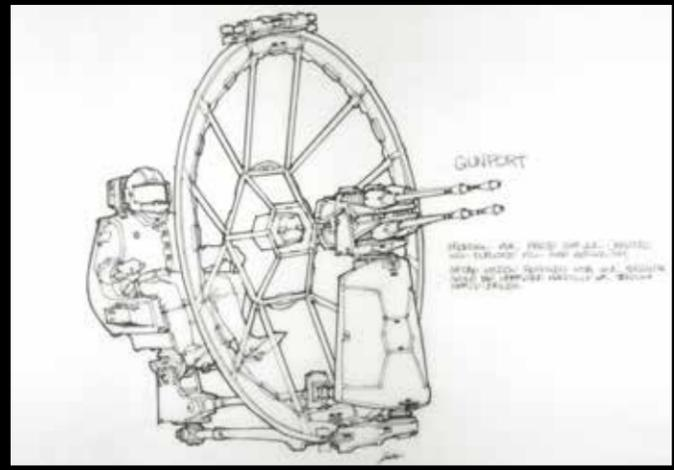
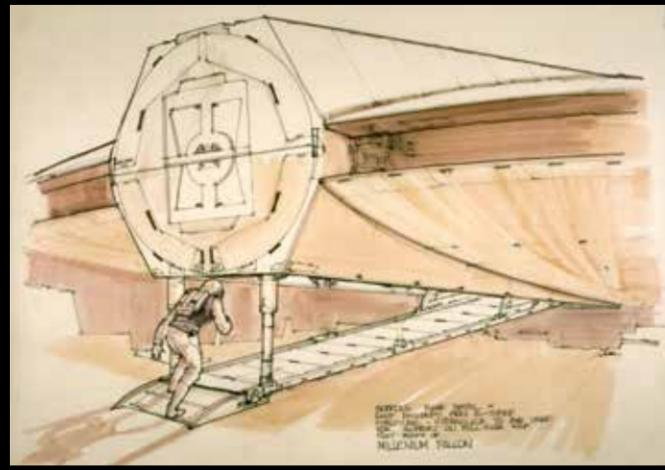
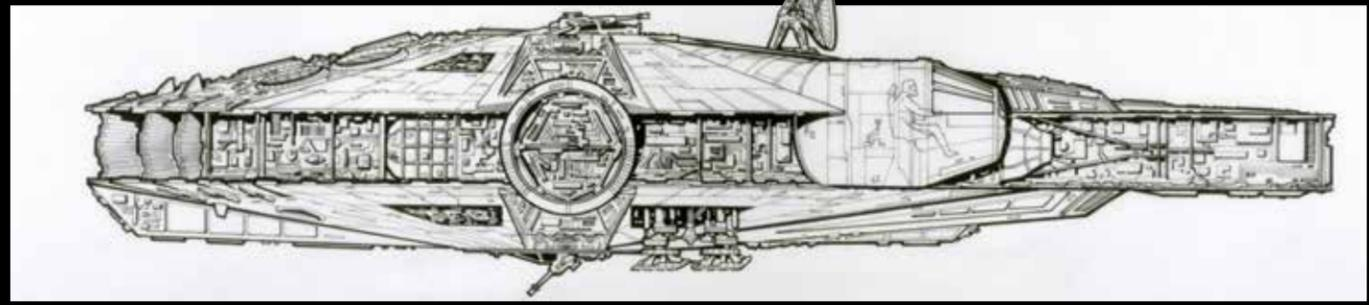
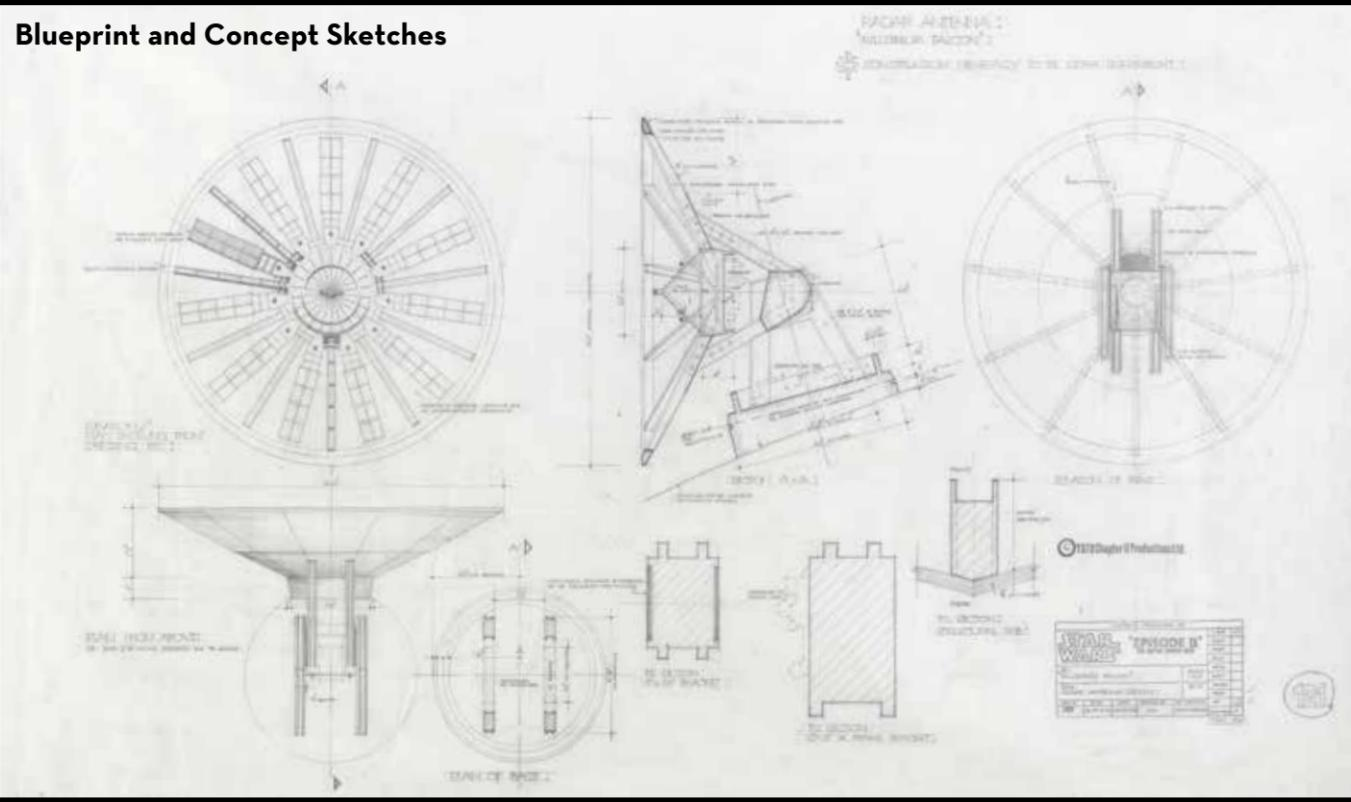



À PROPOS DE L'ÉQUIPE LEGO® STAR WARS

L'aventure LEGO® *Star Wars* a commencé en 1999 et nous avons depuis conçu chaque année de nouveaux modèles pour cette gamme de produits. L'équipe de design LEGO *Star Wars* est composée de onze créateurs de modèles et de quatre graphistes. Elle regroupe de nouveaux designers avec des idées originales et des designers LEGO *Star Wars* expérimentés ayant de nombreux modèles à leur actif.

Il s'agit de l'équipe idéale pour créer de nouveaux modèles LEGO *Star Wars* innovants et pour améliorer les versions LEGO antérieures des célèbres vaisseaux cultes. L'objectif de notre gamme principale de produits LEGO *Star Wars* est de créer des modèles cool, amusants et stimulants pour les enfants.

Pour LEGO Direct, nous avons la possibilité de créer des modèles encore plus grands et plus complexes, en prêtant une attention particulière à la précision et aux détails. Ces modèles sont amusants et fascinants à concevoir, mais ils constituent aussi un énorme défi ! Nous donnons toujours le meilleur de nous-mêmes, et nous espérons que vous les apprécierez autant que nous.

Bonne construction !

Jens Kronvold Frederiksen
Directeur du design, LEGO® *Star Wars*™





© & ™ Lucasfilm Ltd.

À PROPOS DU MILLENNIUM FALCON™

Transporter des tonnes de marchandises à travers le vide sidéral est une tâche ingrate, qui requiert des vaisseaux spécifiquement conçus pour ce genre de voyages, tels que le cargo léger YT-1300F de la Corporation Technique Corellienne. Et le plus célèbre d'entre eux est sans aucun doute le *Millennium Falcon*™. Piloté par le hors-la-loi intergalactique Han Solo et son bras droit Chewbacca, il s'est fait connaître en transportant des marchandises volées et de contrebande.

Le précédent propriétaire du « YT-1300 492727ZED », Lando Calrissian, y apporta quelques modifications, en améliorant les boucliers déflecteurs et en poussant la puissance des réacteurs. Le vaisseau, renommé *Millennium Falcon*, ne resta cependant pas longtemps en la possession de Lando puisque celui-ci, joueur invétéré, le perdit contre son vieil ami Han Solo lors d'une partie de sabbac.

En dépit de son apparence extérieure usée et désuète – l'un des rares éléments encore d'origine étant son châssis – le *Millennium Falcon* était alors un vaisseau redoutable. Les modifications, améliorations et autres réparations improvisées par Lando, Han Solo et bien d'autres en firent un cargo unique en son genre. Grâce à son système personnalisé d'hyperpropulsion, il était présenté comme le vaisseau le plus

rapide de toute la galaxie. Han Solo a également renforcé le système d'armement du *Millennium Falcon* et amélioré la coque avec des plaques de duracier récupérées sur un croiseur impérial. Grâce à toutes ces modifications, à son incroyable vitesse et à sa grande maniabilité, le *Millennium Falcon* rivalisait avec les chasseurs stellaires les plus rapides de l'Alliance Rebelle et de l'Empire. Sans oublier les compartiments secrets aménagés par Han Solo, qui permirent plus tard de sauver la Princesse Leia Organa des Stormtroopers impériaux.

Impliqué dans plusieurs opérations majeures de la Flotte Rebelle lors de la Guerre Civile Galactique, le *Millennium Falcon* a joué un rôle clé dans la destruction des deux Étoiles de la Mort. Quelque temps après la bataille d'Endor, le *Millennium Falcon* fut dérobé à Han Solo par un certain Ducain, qui se le fit voler à son tour par les frères Irving, pour finalement atterrir sur la planète désertique de Jakku, où il resta immobilisé à prendre la poussière. Ce n'est que des années plus tard que le cargo refit surface, permettant à un trio composé d'une pilleuse d'épaves et mécano talentueuse nommée Rey, d'un Stormtrooper en fuite du nom de Finn et d'un droïde astromech BB-8 d'échapper au Premier Ordre.



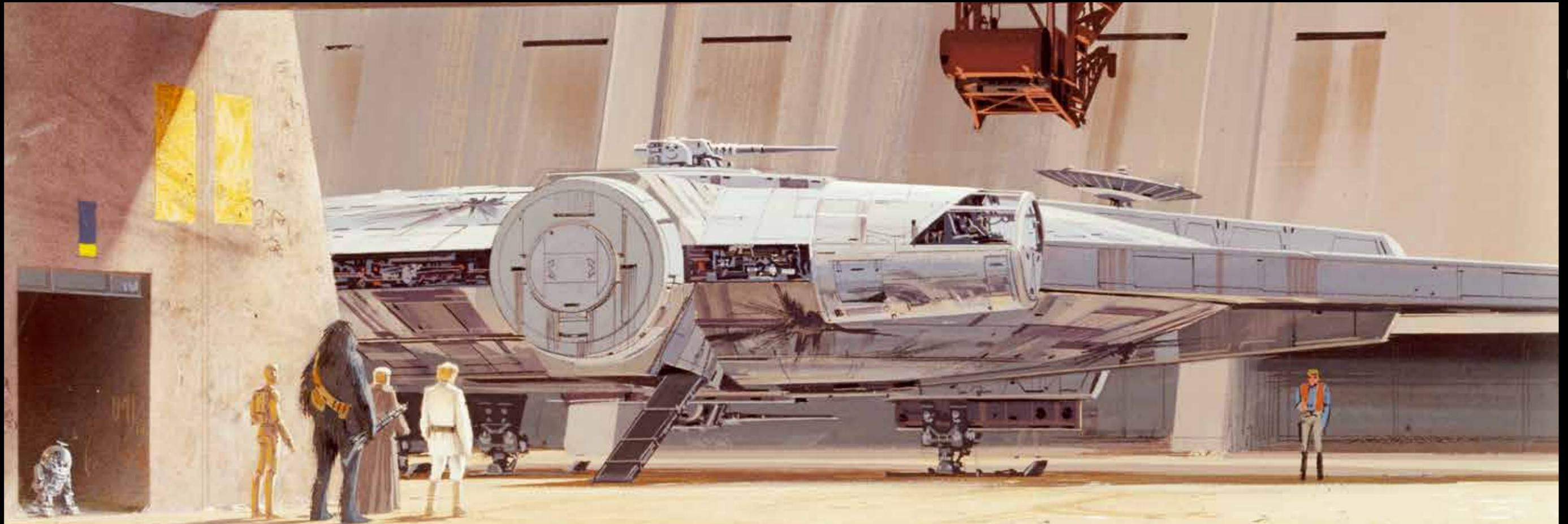
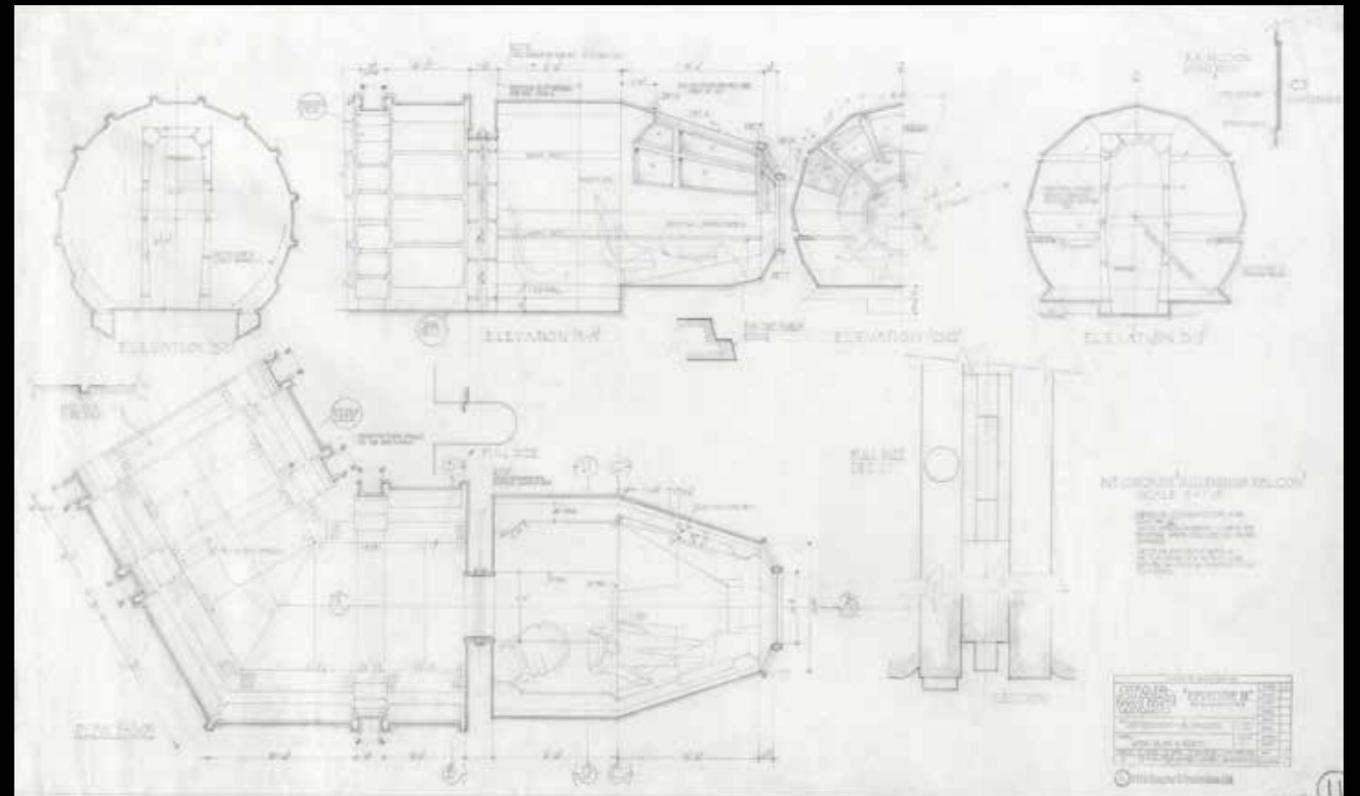
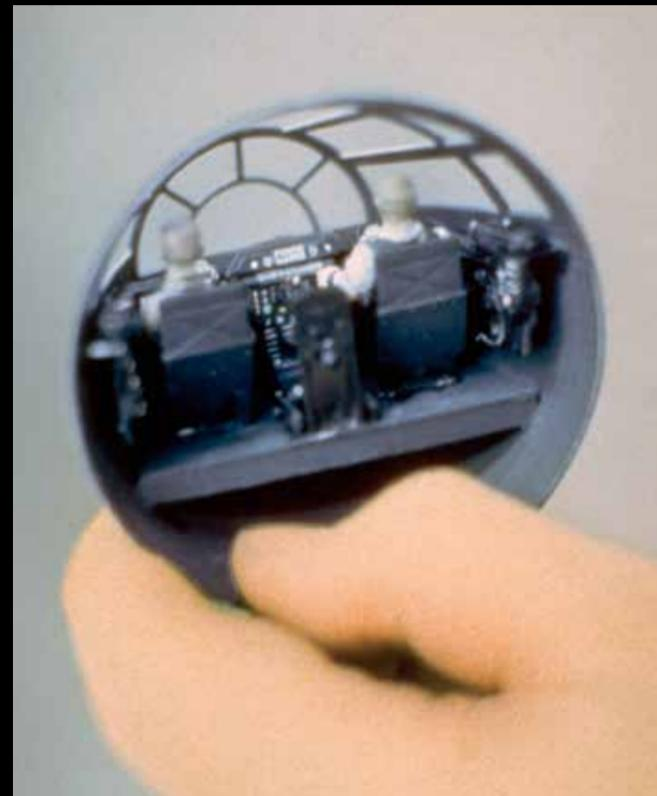
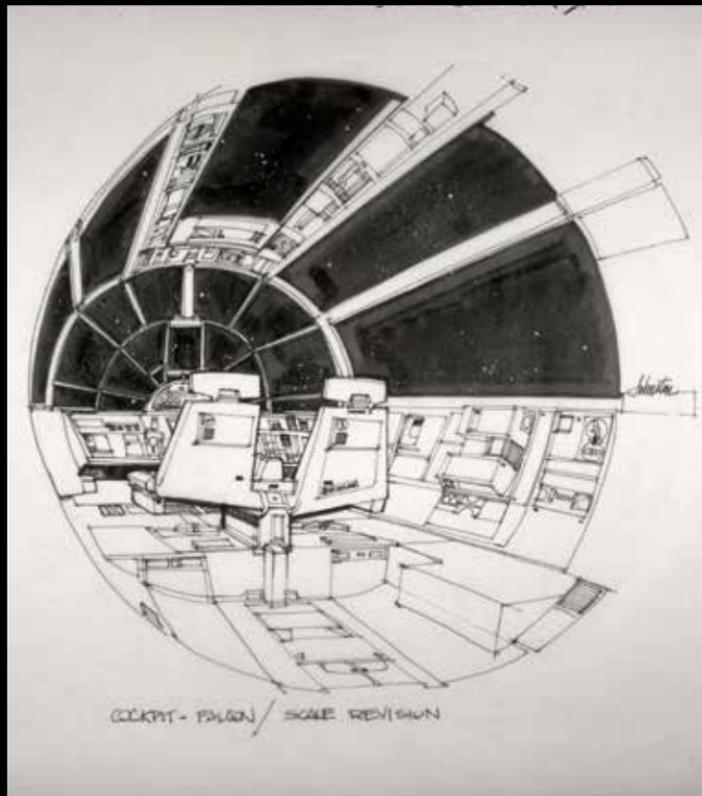



L'ENVERS DU DÉCOR : LE MILLENNIUM FALCON™

La deuxième ébauche du scénario du film *Un nouvel espoir*, écrit en 1975 par George Lucas, mentionne un « vaisseau pirate » avec à son bord un certain Han Solo accompagné de son fidèle coéquipier et ami, Chewbacca. Ce n'est que par la suite que Han Solo devint le propriétaire de ce vaisseau pirate, et il a fallu attendre la quatrième mouture du scénario pour qu'il obtienne le nom qu'on lui connaît aujourd'hui : le *Millennium Falcon*.

Les premières esquisses de ce qui deviendrait l'un des engins spatiaux les plus célèbres de toute l'histoire de la science-fiction ressemblaient plus ou moins à une fusée. Lucas décida alors d'ajouter de larges ports d'échappement moteur pour lui donner un aspect plus agressif, et le poste de pilotage fut arrondi. Mais il ressemblait encore trop aux autres vaisseaux, et Lucas voulait absolument que le *Millennium Falcon* soit unique. Il aurait trouvé l'inspiration en associant la forme d'une soucoupe volante à l'idée d'un hamburger dans lequel on aurait pris une bouchée. Voilà comment le *Millennium Falcon* aurait obtenu sa célèbre forme arrondie.

Vint ensuite l'étape de fabrication des modèles, avec des matériaux aussi hétéroclites que des dés pour rétroviseur ou des éléments empruntés à une Ferrari. Plusieurs modèles complets furent construits pour répondre à tous les besoins du tournage, allant de moins de 20 cm à plus de 1 m. Un modèle « quasi » grandeur nature de plus de 18 m de long fut également réalisé spécialement pour filmer l'extérieur du vaisseau, notamment pour la fameuse scène d'évasion du hangar de l'Étoile de la Mort dans *Un nouvel espoir*. Ce modèle incluait un train d'atterrissage fonctionnel ainsi qu'un support structurel dissimulé en conduite de carburant. Plusieurs décors ont également été fabriqués pour les scènes à l'intérieur du vaisseau : le couloir tribord, la rampe d'embarquement, le tunnel d'accès au poste de pilotage, l'échelle menant à la tourelle, plusieurs compartiments secrets et la soute avant. Fait intéressant, le poste de pilotage a dû être construit séparément afin de pouvoir simuler les déplacements du vaisseau à travers l'espace et lors des affrontements contre la Flotte Impériale. Le modèle complet était trop volumineux pour pouvoir être déplacé. Plutôt que de devoir le désassembler et le remonter entre chaque scène, l'équipe de tournage changeait tout simplement le décor autour. Une deuxième réplique du vaisseau à échelle réelle fut ensuite construite pour *L'Empire contre-attaque*.



© & ™ Lucasfilm Ltd.



© & ™ Lucasfilm Ltd.

Bien que plusieurs décors et modèles aient été créés pour les besoins du film, plusieurs scènes ont été tournées à l'aide de décors peints réalisés par Ralph McQuarrie afin de présenter le *Millennium Falcon* sous son meilleur jour. C'est le cas, par exemple, de la scène dans laquelle la Princesse Leia, incarnée par l'actrice Carrie Fisher, voit le *Millennium Falcon* pour la première fois dans *Un nouvel espoir*. Idem pour la scène dans laquelle Han Solo demande à Lando Calrissian de lui promettre de ne pas endommager le *Millennium Falcon* dans *Le retour du Jedi*, il s'agit là encore d'une toile peinte.

Le tournage de *L'Empire contre-attaque* a quant à lui nécessité la création d'un modèle réduit en complément de la version en taille réelle du *Millennium Falcon*. Cette miniature a notamment permis de réaliser des manœuvres de vol plus délicates, qui étaient tout simplement impossibles avec un vaisseau de 1,50 m. Mesurant près de 80 cm de long, ce nouveau modèle incluait davantage de détails,

un nouveau train d'atterrissage et un poste de pilotage plus travaillé, ce qui a permis à l'équipe de tourner davantage de scènes. Cette version miniature fut ensuite montée sur une perche afin de pouvoir simuler les mouvements du vaisseau, par exemple pour échapper à des chasseurs TIE. Ce modèle est également connu pour être la version la plus populaire auprès des fans de *Star Wars*, puisque c'est celle qui a été la plus utilisée pour les jouets, les maquettes, le matériel promotionnel et de nombreuses œuvres d'art dérivées de l'univers de la saga. À noter que ce même modèle fut par la suite réutilisé pour *Le retour du Jedi*.

Mais le *Millennium Falcon* se démarque également par les effets sonores qui accompagnent les visuels. Presque tous les engins spatiaux de la saga *Star Wars* empruntent le bruit de véritables avions. Pour le *Millennium Falcon*, l'ingénieur du son Ben Burtt a ralenti le bruit d'un moteur de P-51 Mustang, un avion de chasse américain de la Seconde Guerre mondiale. Il y a ensuite ajouté un coup de tonnerre ou le rugissement d'un lion pour accentuer l'impression de vitesse et de puissance du vaisseau lors de son passage à proximité de la caméra. Pour les sauts en hyperspace, il combina cette fois-ci le son d'un Douglas DC-3 avec un effet d'écho, associé au déplacement de la caméra.

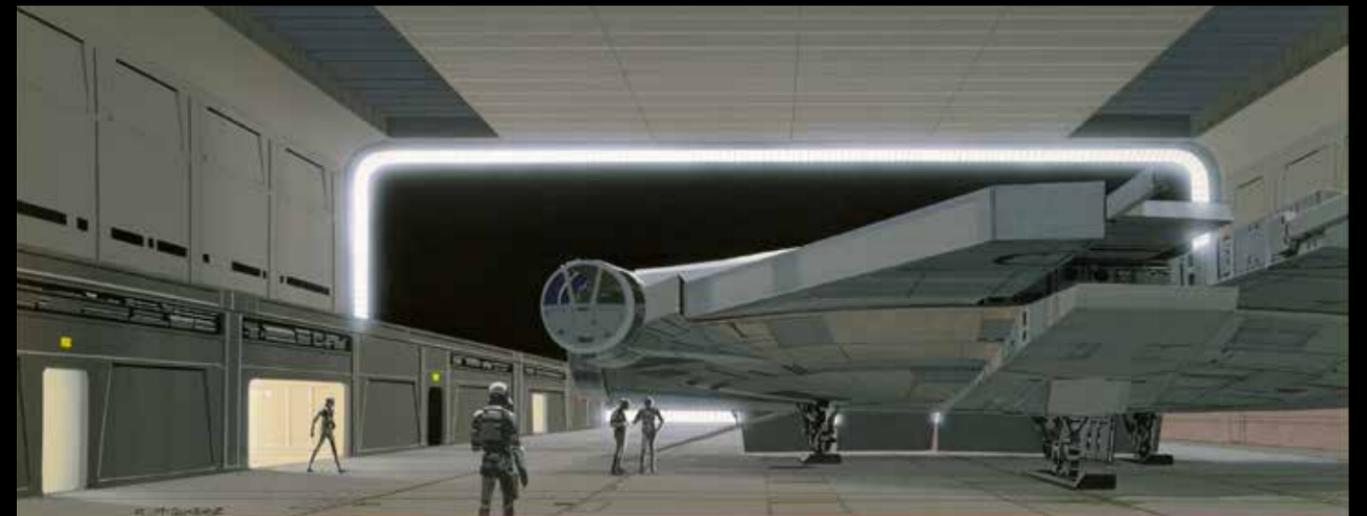
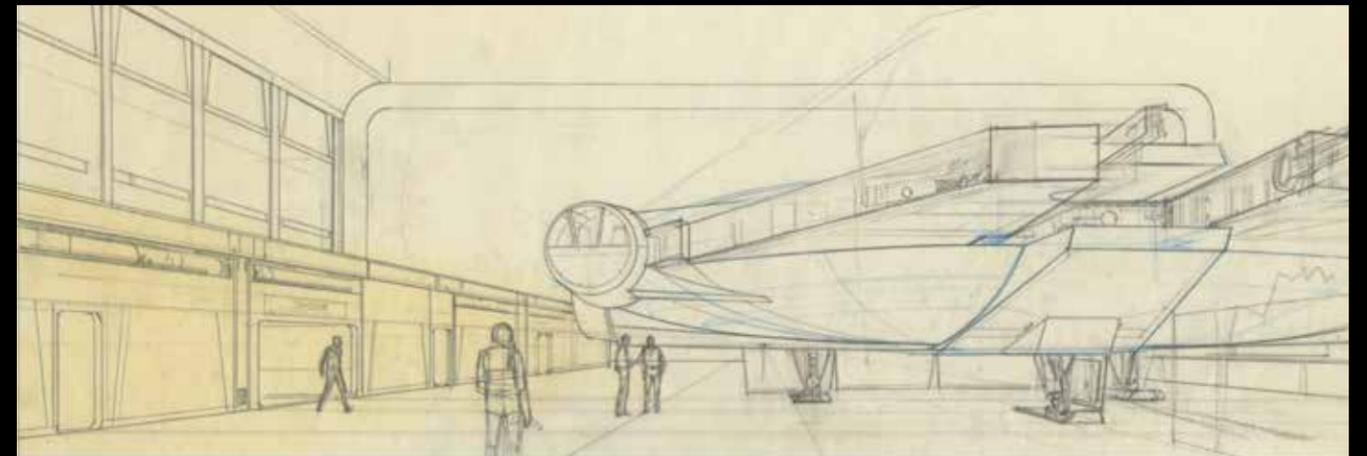



HISTOIRE DU MILLENNIUM FALCON LEGO

Jens Kronvold Frederiksen

Q : Le *Millennium Falcon* est sans doute le vaisseau le plus emblématique de toute la saga *Star Wars*. Il ne doit pas être évident de s'attaquer à un tel « monument » du cinéma. Par quoi commence-t-on lorsque l'on conçoit la toute première version en briques LEGO du *Millennium Falcon* ?

R : Eh bien, c'était il y a de nombreuses années. Le premier *Millennium Falcon* LEGO est sorti en 2000. Mais je me souviens que nous avons beaucoup discuté sur la façon de concevoir ce modèle. Il a une forme arrondie, il n'est donc pas évident à reproduire avec des briques et éléments LEGO !

Nous avons finalement décidé d'utiliser des éléments circulaires provenant d'une soucoupe volante du thème LEGO Espace pour la structure principale du vaisseau. Nous avons également créé un élément spécifique pour le poste de pilotage. Mais ce modèle semble aujourd'hui complètement dépassé. Les dernières versions du *Millennium Falcon* LEGO sont bien plus proches du vaisseau original !

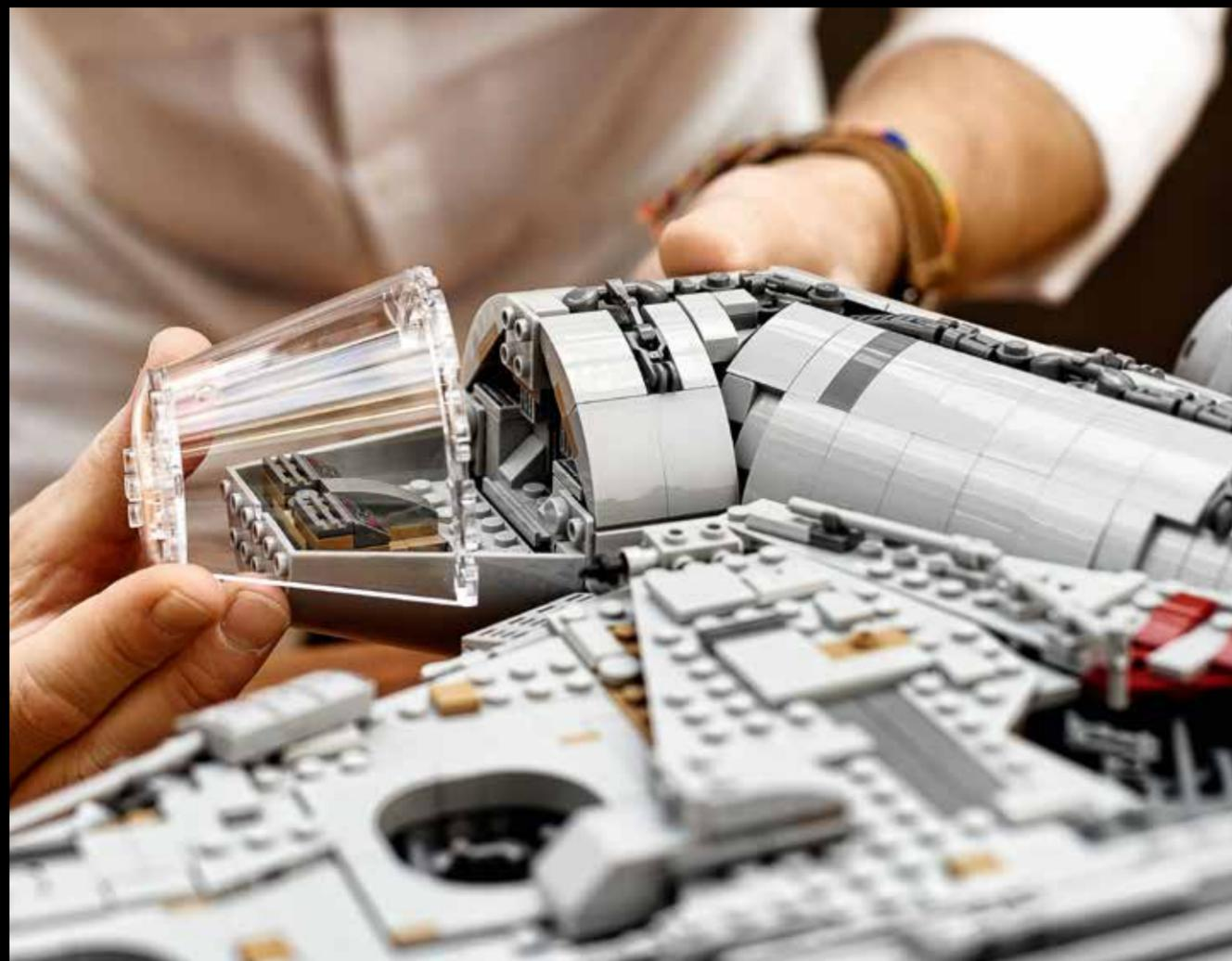

Jens Kronvold Frederiksen

Q : Avec plus de huit versions du modèle dans la collection LEGO, y en a-t-il qui ont impliqué des modifications majeures par rapport à la précédente ?

R : Le second *Millennium Falcon*, créé en 2004, était à l'échelle des figurines. Ça a été une véritable révolution par rapport à la version précédente. Nous avons fabriqué une plaque triangulaire de 12 tenons sur 3 pour créer une toute nouvelle structure, plus réaliste. Nous avons aussi créé un nouvel élément, transparent et davantage travaillé, pour la verrière du poste de pilotage.

Q : La forme arrondie inimitable du *Millennium Falcon* est l'une des principales caractéristiques du vaisseau. J'imagine que ça n'a pas été simple de la reproduire en briques LEGO ?

R : Il est toujours difficile de reproduire un élément arrondi avec des briques LEGO, mais la solution que nous avons adoptée pour la première version, le *Millennium Falcon* 4504, est sans aucun doute la meilleure ! En fait, le dernier modèle, le 75105, reprend les mêmes éléments triangulaires.

Sur un modèle grand format comme cette version de la série de collection suprême, c'est beaucoup plus compliqué ! Je me souviens de l'époque où j'ai conçu l'ensemble 10179, le premier modèle du vaisseau de la série de collection suprême. Le défi était de créer un cadre robuste, puis de le recouvrir avec des panneaux de toutes formes, créés à partir d'une multitude d'éléments LEGO différents !

Q : Y a-t-il des éléments des versions précédentes qui ont dû être complètement retravaillés pour cette nouvelle interprétation du *Millennium Falcon* ?

R : Ce modèle est de loin la version LEGO du *Millennium Falcon* la plus aboutie ! Nous avons pratiquement tout revu.

L'amélioration la plus évidente est bien sûr la verrière du poste de pilotage. C'est un changement important par rapport à la version 10179, qui n'avait qu'un simple cadre, sans la partie vitrée !

Q : Sur quelles ressources visuelles vous basez-vous pour concevoir un ensemble LEGO dérivé d'un film ? Des captures d'écran, des schémas en ligne ?

R : Lorsque nous imaginons de nouveaux modèles, nous nous basons toujours sur le matériel de référence officiel. Pour ce *Millennium Falcon*, nous avons bien sûr exploité les films, y compris l'*Épisode VII : Le Réveil de la Force*, ainsi que des photos de modèles studio.

Q : Qu'est-ce qui fait du *Millennium Falcon* une pièce résolument à part dans l'univers LEGO *Star Wars* ?

R : Il faut bien garder à l'esprit que c'est le vaisseau le plus célèbre et le plus populaire de toute la saga. C'est ce qui explique qu'il existe autant de versions LEGO différentes du *Millennium Falcon*, en termes de design mais aussi de taille.

Q : Y a-t-il des pièces de ce nouvel ensemble qui ont permis de véritablement améliorer la fonctionnalité, la stabilité ou l'apparence du vaisseau ?

R : Tout a été plus ou moins amélioré. La structure intérieure est probablement l'élément qui a le moins changé par rapport au *Millennium Falcon* 10179. Lorsque nous créons une nouvelle version d'un modèle, nous commençons toujours par passer en revue les commentaires de nos clients sur la version précédente, afin d'identifier les points à améliorer. Visuellement, cette version est également bien plus aboutie et détaillée.

Q : Dans quelle mesure ce *Millennium Falcon* LEGO ressemble-t-il à l'original ?

R : C'est quasiment une copie conforme ! La seule grosse différence, c'est que le *Millennium Falcon* des films n'a pas nos tenons LEGO !



2000

7190 : Millennium Falcon™

659 pièces
Tout premier modèle LEGO du *Millennium Falcon*. Mesure 6 cm de haut, 53 cm de long et 42 cm de large. Inclut 6 figurines : Han Solo, Chewbacca, Princesse Leia Organa, Luke Skywalker, R2-D2 et C-3PO.



2003

4488 : MINI Millennium Falcon™

87 pièces
Première version miniature du *Millennium Falcon*. Mesure plus de 4 cm de haut, 14 cm de long et 14 cm de large. Aucune figurine incluse. Contient des pièces supplémentaires permettant de construire un bombardier Y-Wing en association avec les pièces supplémentaires des ensembles 4489, 4490 et 4491.



2004

4504 : Millennium Falcon™ (Épisode V)

985 pièces
Modèle de la trilogie originale. Inclut de toutes nouvelles briques LEGO spécialement créées pour pouvoir reproduire la forme unique du vaisseau. Mesure plus de 9 cm de haut, 57 cm de long, et 38 cm de large. Inclut 5 figurines : Han Solo, Chewbacca, Princesse Leia Organa, C-3PO et un Snowtrooper.

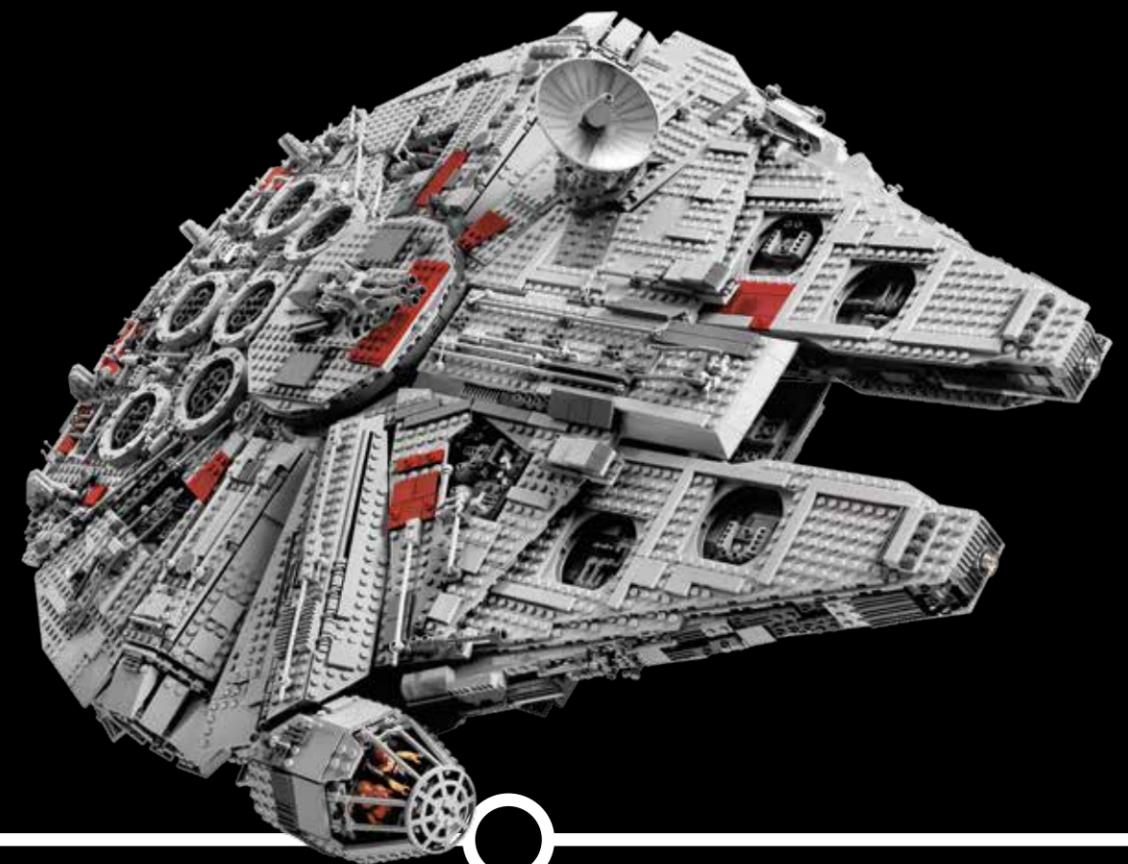

2007

**10179 : Millennium Falcon™
Série de collection suprême**

5 197 pièces
Plus grand modèle LEGO de ce vaisseau de légende commercialisé à ce jour. Mesure plus de 21 cm de haut, 84 cm de long et 56 cm de large. Inclut 5 figurines : Han Solo, Chewbacca, Obi-Wan Kenobi, Luke Skywalker et Princesse Leia Organa.

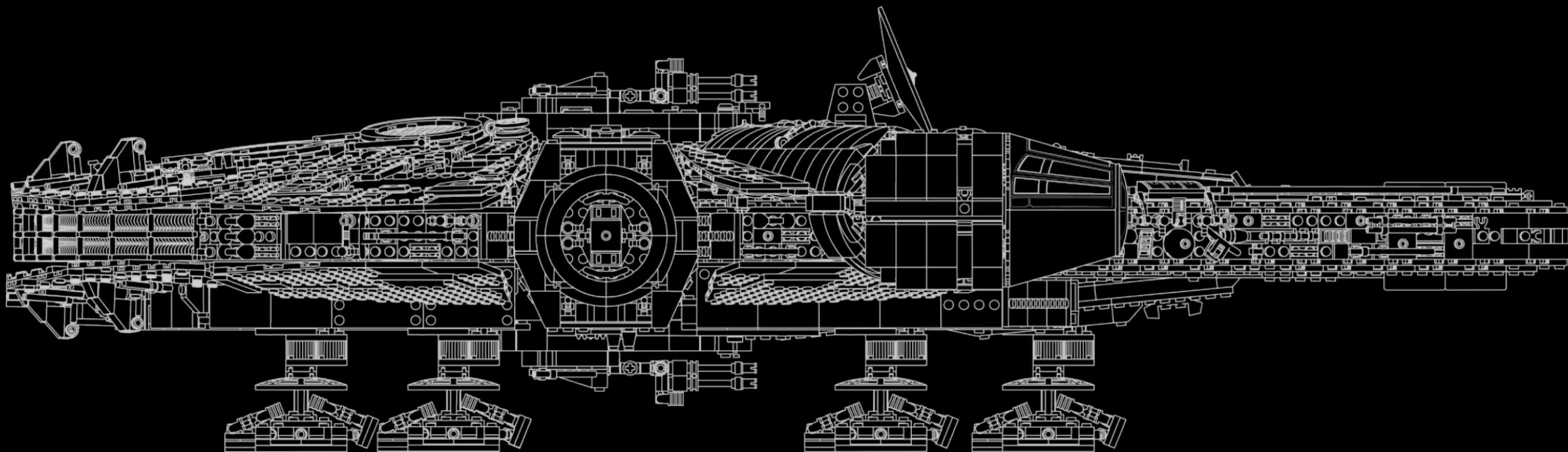

2009

7778 : Millennium Falcon™ Édition spéciale
356 pièces
Version taille moyenne du *Millennium Falcon*.
Mesure plus de 8 cm de haut, 24 cm de long et
17 cm de large. Aucune figurine incluse.



2011

7965 : Millennium Falcon™
1 254 pièces
Mesure plus de 10 cm de haut, 58 cm de long
et 38 cm de large. Inclut 6 figurines : Han Solo,
Luke Skywalker, Chewbacca, Ben Kenobi,
Princesse Leia Organa et Darth Vader.



2014

75030 : Micro-vaisseau Millennium Falcon™
94 pièces
Version micro-vaisseau du *Millennium Falcon*,
reprenant sa forme arrondie caractéristique avec
2 missiles rapides et un mini poste de pilotage
pour pouvoir accueillir la figurine Han Solo.
Mesure plus de 6 cm de haut, 8 cm de long et
8 cm de large.



2015

75105 : Millennium Falcon™ (Épisode VII)
1 329 pièces
Modèle du vaisseau de l'Épisode VII. Mesure plus
de 14 cm de haut, 47 cm de long et 32 cm de large.
Inclut 6 figurines : Rey, Finn, Han Solo, Chewbacca,
Tasu Leech et un membre du gang Kanjiklub, plus
un droïde astromech BB-8.

RENCONTRE AVEC LE DESIGNER DU MODÈLE

Hans Burkhard Schlömer

Q : L'univers *Star Wars* compte un grand nombre de véhicules de légende, mais le *Millennium Falcon* est un véritable symbole, qui a sans nul doute contribué au succès de l'un des films les plus cultes de tous les temps. Avec de tels enjeux, comment avez-vous appréhendé la conception de ce modèle LEGO du *Millennium Falcon* ?

R : La conception d'un ensemble de cette importance, quel qu'il soit, est un défi colossal en soi. Mais c'est encore plus vrai lorsqu'il s'agit du *Millennium Falcon* ! Je n'avais encore jamais monté aucun des ensembles précédents, ça a donc été pour moi l'excuse idéale pour réaliser le rêve de n'importe quel fan de LEGO *Star Wars* : construire le *Millennium Falcon* 10179 !

Cet exercice m'a aidé à comprendre comment fonctionne la structure interne, comment le modèle a été segmenté, et comment chaque section est reliée au cadre. En bref, comment tout tient ensemble ! Lorsque j'ai réalisé que le principe de conception fondamental restait valable et que la structure serait suffisamment solide pour un modèle encore plus détaillé et plus lourd, j'ai simplement continué sur ma lancée.

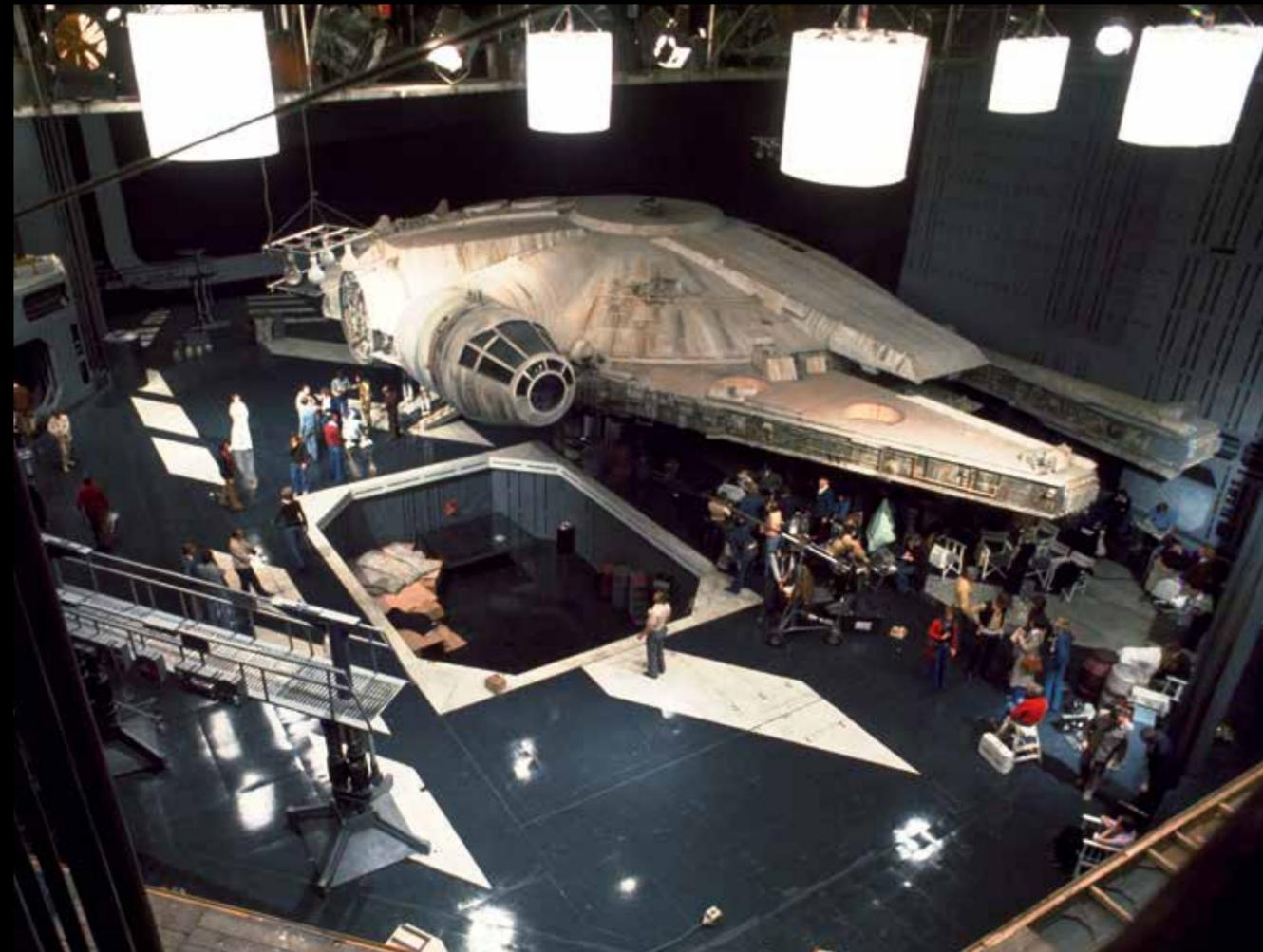

© & ™ Lucasfilm Ltd.



Hans Burkhard Schlömer

Q : Vous avez imaginé d'autres ensembles LEGO *Star Wars*. En quoi le *Millennium Falcon* est-il différent de ces autres modèles ?

R : J'avais déjà pu me familiariser avec l'aspect général du vaisseau avec le *Millennium Falcon* du thème *Star Wars : Le Réveil de la Force*, l'ensemble LEGO 75105. Une fois la version numérique du *Millennium Falcon* 10179 terminée, j'ai désassemblé le modèle à l'écran afin de pouvoir placer les différentes sous-sections les unes à côté des autres.

Cependant, après chaque modification importante, je devais m'assurer que tout s'imbriquait encore parfaitement. Et modifier les autres pièces en conséquence dans le cas contraire. Je validais ensuite ces modifications à l'aide de la copie physique du vaisseau. Un grand nombre de ces sous-sections ont simplement été retravaillées, mais on en a également ajouté de nouvelles, qui n'avaient pas encore leur place.

Nous avons ensuite dû tester le comportement du modèle sous la contrainte, en le soumettant à une forte chaleur. Le problème, c'est que nous ne disposons pas d'un four assez grand pour le *Millennium Falcon* dans nos locaux. Nous avons donc loué le sauna des bains publics de Billund, au Danemark. Il a fallu transporter ce modèle ultra-secret en toute discrétion, comme dans les films d'espionnage. Ça a été un moment épique !

Q : Avez-vous rencontré des difficultés pour reproduire le Millennium Falcon le plus fidèlement possible ?

R : De par sa forme arrondie, le *Millennium Falcon* n'est clairement pas le sujet le plus facile à reproduire en briques LEGO, et ce, quelle que soit l'échelle. Mais le plus gros du travail avait déjà été fait avec la version 10179. J'ai donc pu me concentrer sur des éléments qui avaient besoin d'un bon coup de jeune après 10 ans, comme les sections construites à l'aide de plaques et de panneaux coudés qui auraient plutôt nécessité des briques arrondies ou incurvées. Le centre supérieur avec les canons, le couloir menant au poste de pilotage ou les sas latéraux, par exemple.

J'ai dû entièrement retravailler les panneaux supérieurs des mandibules avant pour pouvoir obtenir le résultat que je souhaitais, avec des éléments gris foncé de taille et de forme appropriées, pour faire ressortir les détails sur le côté. J'ai aussi ajouté quelques touches de beige foncé afin de conférer au vaisseau un aspect plus authentique, et remplacé les plaques par des tuiles pour un meilleur équilibre entre les surfaces lisses et les tenons. On avait également décidé de développer une nouvelle verrière pour le poste de pilotage, pour un rendu plus réaliste et par souci de cohérence avec les autres produits de la gamme LEGO *Star Wars*.

Q : Le modèle original du Millennium Falcon, utilisé pour le tournage, est passé par un certain nombre de modifications avant d'aboutir à l'aspect qu'on lui connaît aujourd'hui. En général, combien de versions préliminaires réalisez-vous avant de valider la version finale d'un modèle LEGO ?

R : On retrouve généralement sur ou derrière les bureaux des designers, au minimum une douzaine de prototypes légèrement différents d'un même modèle, qui correspondent aux différentes étapes de conception. Mais pour le thème LEGO *Star Wars*, je ne travaille pas de cette façon. Comme je dispose de tout le matériel de référence nécessaire et que je peux rapidement réaliser des premières esquisses numériques, la première copie physique est généralement assez proche de la version finale pour ce qui est



© & ™ Lucasfilm Ltd.

de l'aspect général et de la taille. Je n'aurais pas la place nécessaire pour toute une flotte de *Millennium Falcon* de toute façon. Si vous lisez ceci avant de construire votre propre *Millennium Falcon*, préparez-vous, il est énoooooorme ! En fait, je n'avais jamais plus d'un ou deux exemplaires complets en même temps. Je réalisais les modifications sur ordinateur, avant de les transposer sur la copie physique pour validation. Le fait d'avoir l'ensemble 10179 à ma disposition m'a également beaucoup aidé. Je savais que la structure interne était fiable et que je n'aurais pas à effectuer toute une série de modifications de conception par la suite.

Q : Y a-t-il des caractéristiques clés de l'intérieur du vaisseau que vous vouliez absolument inclure ?

R : Nous avons décidé assez tôt que cette version du *Millennium Falcon* aurait un intérieur. Mais il était absolument impossible de reproduire l'intégralité de l'équipement que l'on peut voir dans le film. Il faut déjà un grand nombre de barres LEGO Technic pour assurer la solidité et la stabilité de la structure du *Millennium Falcon*. Il est vraiment compliqué d'ajouter quoi que ce soit d'autre !

On a donc commencé par dégager de l'espace en modifiant la structure interne. Comme vous pouvez l'imaginer, l'espace restait limité, mais cela a suffi pour insérer l'essentiel et même un peu plus, comme les trappes d'accès aux capsules de sauvetage - pourtant absentes si l'on en croit les Stormtroopers impériaux qui fouillent le vaisseau dans l'Épisode IV.

Enfin, je tenais à ce que le *Millennium Falcon* ait de l'allure et reste immédiatement identifiable une fois la section supérieure retirée. Je me suis donc débrouillé pour qu'il soit possible de découvrir l'intérieur en retirant uniquement les panneaux supérieurs, afin que la structure et les briques internes restent parfaitement invisibles.



Q : Quelle est votre étape préférée du processus de conception ?

R : La première phase de développement d'un ensemble LEGO est une étape toujours très excitante pour un designer - c'est là que la forme et les détails d'un modèle prennent vie. Après, je passe surtout mon temps à tenter de résoudre des problèmes et à tester de nouvelles solutions pour la stabilité du modèle, les différentes fonctions, la sûreté du produit ou la procédure de montage.

Mais ce que je préfère avant tout, c'est lorsque je vois arriver un sachet de briques et une montagne de pages d'instructions basés sur mon travail - et je peux vous dire que dans ce cas, il y en avait une tonne ! À ce stade, mon travail est quasiment terminé et je passe le relais à mes collègues pour la finalisation de l'ensemble, comme le visuel de la boîte ou la liste des pièces pour l'usine.

Q : Y a-t-il des fonctions ou des caractéristiques du Millennium Falcon du film qu'il était, selon vous, essentiel d'inclure dans la version finale ?

R : Dans mon esprit, ce nouveau modèle DEVAIT correspondre à la version de l'Épisode V. C'est dans *L'Empire contre-attaque* que le *Millennium Falcon* prend toute sa place, qu'il se révèle véritablement, pour finalement devenir le vaisseau culte que l'on connaît, avec notamment l'évasion in extremis de la planète Hoth, la poursuite dans le champ d'astéroïdes, la rencontre avec la limace de l'espace, l'attente derrière le destroyer stellaire, la halte sur Bespin et, finalement, l'affrontement avec un super destroyer stellaire ! Cependant, le *Millennium Falcon* ne présente pas tellement de caractéristiques exceptionnelles - ou du

moins c'est ce que Han Solo veut laisser croire ! Il y a en particulier un nouveau canon blaster, une petite surprise à l'intention des troupes impériales, comme on peut le voir dans la scène de la base rebelle de l'Épisode V !

Et puisque le *Millennium Falcon* apparaît également dans les Épisodes VII et VIII, il était évident pour moi qu'il fallait ajouter le nouveau radar rectangulaire du vaisseau, afin que chacun puisse choisir la trilogie de son choix.

Q : Quelles différences y a-t-il entre le Millennium Falcon de la trilogie originale et celui de l'Épisode VII : Le Réveil de la Force ?

R : Il faut véritablement se plonger dans le matériel de référence pour réaliser que le nouveau radar n'est pas la seule modification apportée au *Millennium Falcon* dans l'Épisode VII, mais seulement la plus évidente. Bien que la coque du vaisseau soit plus fatiguée, un grand nombre des détails ont été éliminés ou modifiés. Pour des raisons pratiques, j'ai décidé de faire un compromis en maintenant certains de ces détails, comme les grilles métalliques situées sur le côté des mandibules (il y en a une juste à côté du poste de pilotage). Elles n'existent plus sur le *Millennium Falcon* de l'Épisode VII, mais j'ai décidé de les conserver parce que j'estime qu'elles apportent un cachet unique au vaisseau, et qu'elles s'intègrent parfaitement. Cela a été un peu plus compliqué pour les deux « gadgets » situés à l'avant du vaisseau. On ne peut clairement pas les manquer, c'est pourquoi ils sont amovibles.

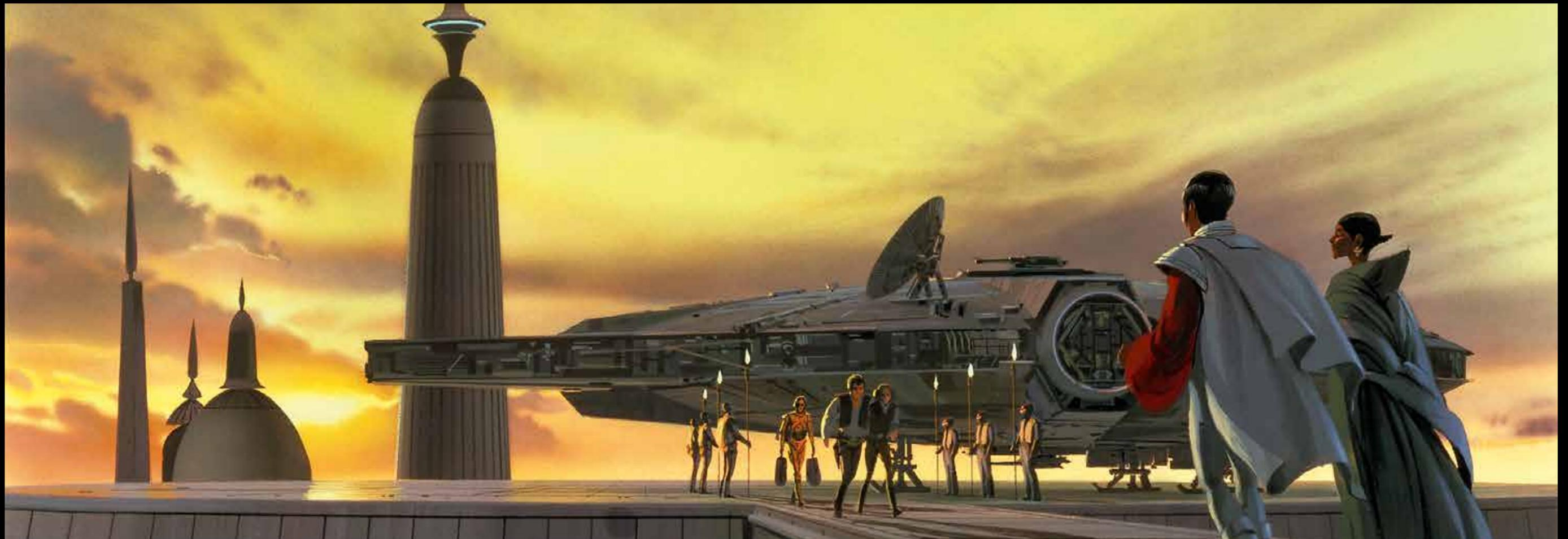



RENCONTRE AVEC LE GRAPHISTE

Madison O'Neil

Q : Avez-vous rencontré des difficultés pour reproduire le *Millennium Falcon* le plus fidèlement possible ?

R : L'aspect le plus difficile de la conception graphique sur ce modèle est sans conteste le travail sur les autocollants des couloirs du *Millennium Falcon*. Il était important de rendre un effet de profondeur et de donner l'impression de pouvoir faire passer les figurines de la zone commune au poste de pilotage ou à l'hyperpropulsion. L'intérieur du *Millennium Falcon* est assez complexe, avec tous ses panneaux manquants, ses voyants clignotants et ses fils dénudés. J'ai fait de mon mieux pour simplifier au maximum tous ces détails afin de conserver l'esprit LEGO.

Q : Le modèle original du *Millennium Falcon*, utilisé pour le tournage, est passé par un certain nombre de modifications avant d'aboutir à l'aspect qu'on lui connaît aujourd'hui. En général, combien de versions préliminaires réalisez-vous avant de valider la version finale d'un produit LEGO ?

R : La conception de n'importe quelle figurine ou de n'importe quel décor LEGO implique forcément plusieurs révisions avant la finalisation du graphisme et son envoi à Lucasfilm pour approbation. Il peut arriver que l'on réalise plus d'une dizaine de versions impliquant des changements distincts ou des coloris différents. Avec une palette de couleurs limitée, cela s'avère souvent un véritable défi de bien reproduire la référence.

Q : Quelle est votre étape préférée du processus de conception ?

R : J'ai toujours aimé démarrer un nouveau projet et discuter des besoins graphiques d'un produit avec le designer du modèle. En général, je me retrouve rapidement à farfouiller dans le matériel de référence à la recherche d'images nettes d'éléments très spécifiques d'un vaisseau, ou à regarder des scènes des films pour m'en inspirer (ou juste pour le plaisir). La toute première épreuve d'un élément fini est également un moment incroyable. Pour moi, cela marque la fin d'un cycle. On passe d'une version numérique à un objet que l'on peut manipuler.



Madison O'Neil

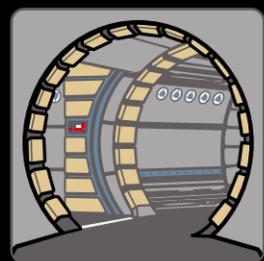

Couloirs

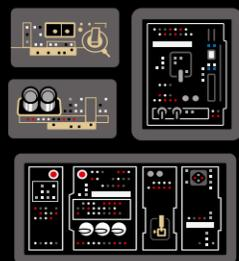
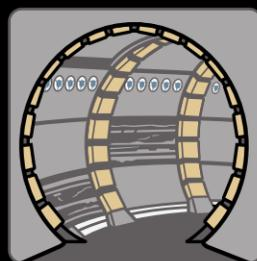

Panneaux de commande



Jeu de Dejarik



Han Solo



Chewbacca



Princesse Leia

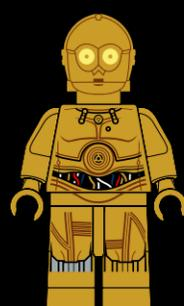

C-3PO



Q : Y a-t-il des fonctions ou des caractéristiques du *Millennium Falcon* du film qu'il était, selon vous, essentiel d'inclure dans la version finale ?

R : Eh bien, le *Millennium Falcon* ne serait pas le *Millennium Falcon* sans un Dejarik à son bord ! Il était également absolument essentiel de reproduire le célèbre radar du vaisseau, les tourelles et le poste de pilotage.

Q : Y a-t-il des personnages qu'il était, selon vous, essentiel d'inclure dans la version finale ?

R : Nous voulions que ce *Millennium Falcon* offre davantage de possibilités que la version précédente, afin de pouvoir choisir entre le vaisseau classique ou la version du *Réveil de la Force*. Nous devions donc inclure deux équipages, et celui de *L'Empire contre-attaque* nous a paru être le meilleur choix pour compléter celui du *Réveil de la Force*. Nous en avons également profité pour créer de nouveaux visages pour Han Solo et la Princesse Leia. C'est le seul ensemble où ces personnages disposent de masques respiratoires, tirés de la scène de l'exploration dans l'atmosphère viciée du ventre d'un exogorth dans *L'Empire contre-attaque*. Prenez garde aux mynocks ! Mon personnage favori de ce nouvel ensemble est cette « adorable » créature ailée peuplant l'île filmée à la fin du *Réveil de la Force*, celle-là même où Rey rencontre Luke. J'ai hâte de découvrir l'Épisode VIII !



ACERCA DEL EQUIPO LEGO® STAR WARS

La línea LEGO® *Star Wars* comenzó a venderse en 1999 y se ha ido expandiendo con nuevos modelos cada año desde entonces. El equipo de diseño de LEGO *Star Wars* se compone de once diseñadores de modelos y cuatro diseñadores gráficos. El grupo combina nuevos diseñadores con ideas frescas y diseñadores con mucha experiencia en el universo LEGO *Star Wars* y un gran número de modelos realizados.

Es un equipo ideal para la creación de nuevos e ingeniosos modelos LEGO *Star Wars* y la revisión y mejora de las antiguas versiones LEGO de las naves más clásicas y emblemáticas. El principal objetivo de la línea LEGO *Star Wars* es hacer llegar a los niños modelos divertidos, modernos e inspiradores basados en este universo.

Para LEGO Direct, es una magnífica oportunidad de crear modelos más grandes y complicados, con especial atención a la precisión y los detalles. Son modelos divertidos y emocionantes para desarrollar, ¡pero también son un gran reto! Siempre nos esforzamos al máximo. ¡Esperamos que disfrutes de la experiencia de construirlos!

¡Feliz construcción!

Jens Kronvold Frederiksen
Director de diseño de LEGO® *Star Wars*™





© & ™ Lucasfilm Ltd.

ACERCA DEL MILLENNIUM FALCON™

Transportar miles de toneladas de mercancía a través del infinito vacío del espacio es una dura tarea, y entre los más famosos vehículos inventados para desempeñar labores como esta destaca el carguero ligero Corelliano YT-1300f. Uno de ellos en particular se hizo de mala reputación por transportar artículos robados y prohibidos. Piloteado por el contrabandista intergaláctico Han Solo y Chewbacca, su fiel compañero Wookiee, este carguero ligero tan especial acabó por adoptar el nombre de *Millennium Falcon*™.

El nombre original de la nave era YT-1300 492727ZED y pertenecía al apostador humano Lando Calrissian, de quien se dice que modificó partes del núcleo generador y los escudos deflectores, entre otros aspectos del vehículo. Fue durante esa época cuando el carguero cambió su nombre por el de *Millennium Falcon*, pero Lando no sería su propietario durante mucho tiempo, pues se rumora que pronto lo perdió durante un arriesgado juego de Sabbac siendo Han Solo el ganador.

A pesar del envejecido aspecto y el anticuado diseño del vehículo, el *Millennium Falcon* es una nave poderosa, incluso aunque la forma del chasis es una de las pocas cosas que conserva del vehículo original. Lando, Han Solo y otros muchos mejoraron, personalizaron e improvisaron numerosas

modificaciones en la nave con objeto de crear un carguero como ningún otro. Además de tener un sistema de hipervelocidad hecho a la medida, el carguero también tenía fama de ser la nave más rápida de la galaxia. Han Solo equipó además el *Millennium Falcon* con diferentes sistemas de armamento y recubrió el blindaje del casco con placas de Duralloy recuperadas de un crucero imperial. Todas estas modificaciones, sumadas a su velocidad sublumínica y su gran maniobrabilidad, hicieron del *Millennium Falcon* un digno competidor de los cazas estelares más veloces fabricados por la Rebelión y el Imperio. Han Solo incluyó también compartimentos de contrabando a prueba de sensores que más tarde permitieron rescatar a la princesa Leia Organa de los Stormtroopers imperiales.

Presente durante algunos de los más grandes conflictos de la Guerra Civil Galáctica, el *Millennium Falcon* fue decisivo para la destrucción de ambas Estrellas de la Muerte y parte invaluable de la flota de la Rebelión. Años después de la batalla de Endor, a Han Solo le fue robado el *Millennium Falcon*, que pasó por las manos de personajes como Ducain y los chicos Irving. Finalmente, acabó en el planeta-deshuesadero Jakku, donde permaneció sin uso durante años, acumulando polvo. La infame nave recuperó su antigua gloria cuando la ingeniosa Rey, el droide astromecánico BB-8 y Finn, un Stormtrooper desertor, la usaron para huir de un ataque de la Primera Orden.



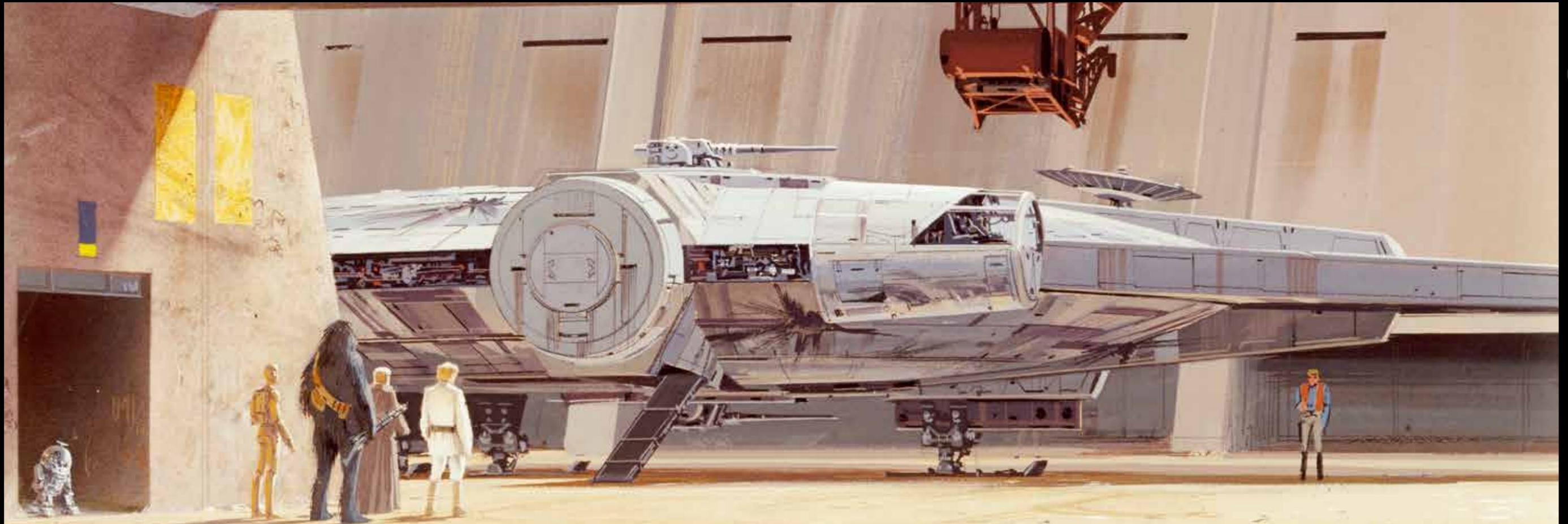
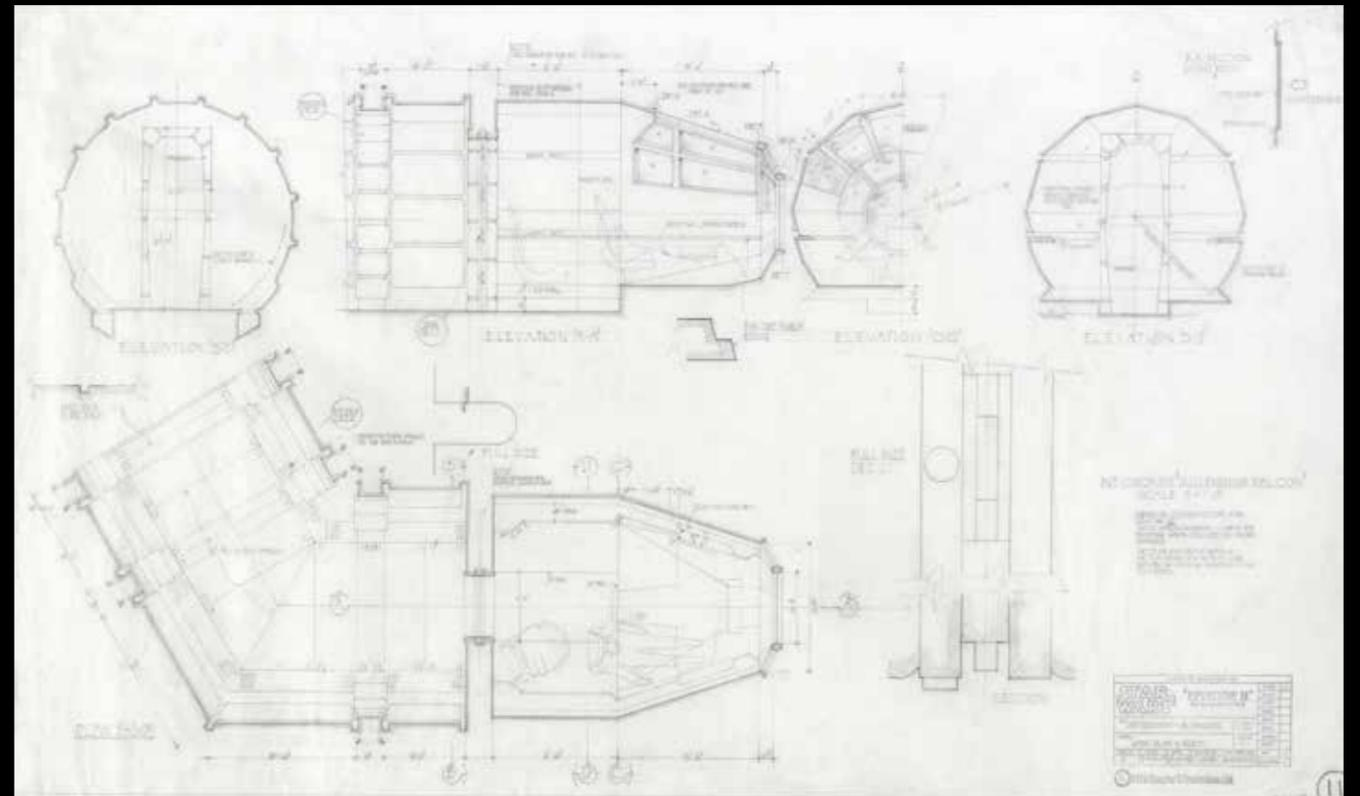
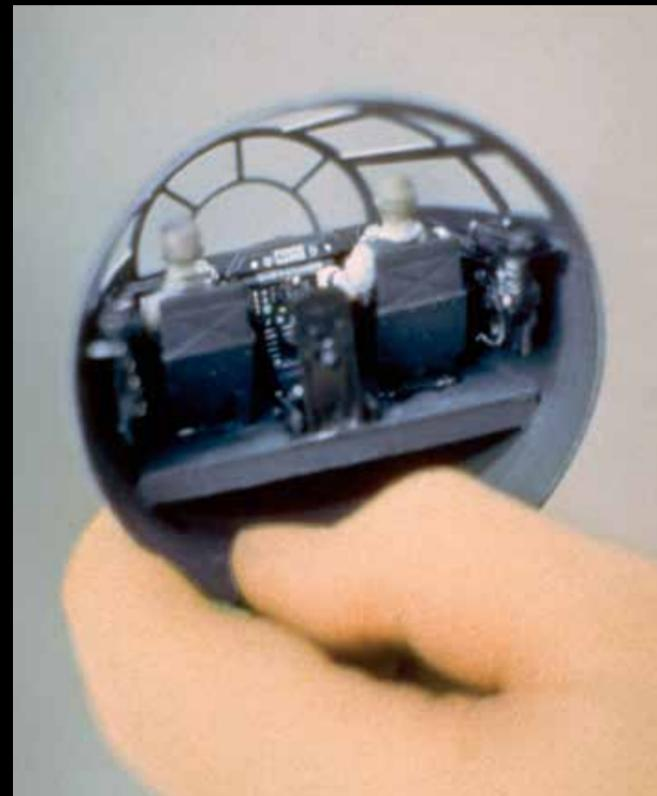
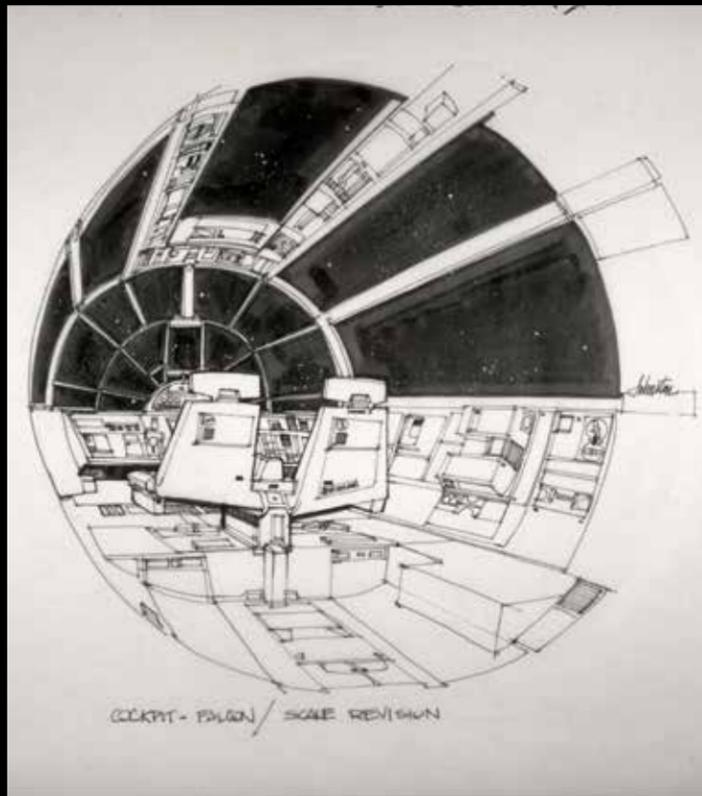



DETRÁS DEL MODELO: MILLENNIUM FALCON™

En el segundo borrador del guion de *Una nueva esperanza*, redactado en 1975, George Lucas describía una “nave pirata” pilotada por Han Solo con un solo tripulante más, llamado Chewbacca. En versiones posteriores, Han Solo se convirtió en el propietario de la nave pirata; en el cuarto borrador del guion, la nave recibió por fin un nombre: *Millennium Falcon*.

Los primeros diseños de lo que se convertiría en una de las naves espaciales más famosas de la historia de la ciencia ficción se parecían al estereotipo de un cohete. Se agregaron grandes ductos de escape para darle un aspecto más veloz a la nave y la cabina se redondeó. El diseño guardaba demasiados paralelismos con otras naves, así que Lucas comenzó a pensar en maneras de diferenciar el *Millennium Falcon* y dar al vehículo un aspecto verdaderamente único. Se cree que se inspiró en la clásica forma de platillo volador de los ovnis y la idea de una hamburguesa mordida. Esa es, pues, la historia del nacimiento de la forma redonda del *Millennium Falcon*.

Comenzó entonces la construcción de los modelos para la película. Para ello se usaron materiales tan distintos como un par de dados de la suerte o diferentes piezas de un Ferrari. Se construyeron varios modelos completos para las diferentes escenas, con tamaños que iban desde unos 17 cm hasta más de 1,2 m. Para *Una nueva esperanza* se construyó también un exterior a escala prácticamente real que medía casi 18 m de longitud; el modelo apareció en la famosa escena de la huida en el hangar de la Estrella de la Muerte. El exterior completo incluía un tren de aterrizaje móvil y un soporte estructural que se camufló como una manguera de combustible. Por dentro, la nave contaba con el corredor circular de estribor, la rampa de abordaje, un túnel de acceso a la cabina, la escalera de acceso a la torreta, varios compartimentos secretos y la bodega delantera. Curiosamente, la cabina se construyó por separado para que fuera más fácil de balancear y simular así los movimientos de la nave al viajar a través del espacio y luchar contra la flota imperial. El modelo completo era demasiado grande como para moverlo, así que, en vez de desarmarlo y volverlo a armar para las diferentes escenas, el equipo de rodaje decidió cambiar las escenografías alrededor de la nave. Para *El Imperio contraataca*, se construyó otra réplica a escala casi real del exterior de la nave.



© & ™ Lucasfilm Ltd.



© & ™ Lucasfilm Ltd.

A pesar de los muchos escenarios y modelos creados para representar el *Millennium Falcon* en el vasto universo cinematográfico, algunas de las escenas requirieron el trabajo del artista Ralph McQuarrie para mostrar el *Millennium Falcon* en toda su gloria. Una de tales escenas tiene lugar en *Una nueva esperanza*, cuando la princesa Leia, interpretada por la actriz Carrie Fisher, ve por primera vez el *Millennium Falcon*. De igual manera, cuando Han Solo hace prometer a Lando Calrissian que no le hará daño al *Millennium Falcon* en *El retorno del Jedi*, la nave que aparece es una pintura.

Cuando comenzó el rodaje de *El Imperio contraataca*, se creó una nueva versión en miniatura como complemento del *Millennium Falcon* a tamaño real. Las menores dimensiones de la nueva versión permitieron reproducir acrobacias más complejas y hacer tomas que eran imposibles con un modelo de más de 1,5 m. Con unos 81 cm de longitud, el nuevo modelo contaba con una superficie más detallada,

un tren de aterrizaje más realista y detalles en la cabina, gracias a lo cual el equipo de rodaje pudo incluir la nave en un mayor número de escenas. El modelo se montó en un mecanismo que se usó para simular los movimientos de la nave (por ejemplo, al escapar de un grupo de TIE Fighters). Este modelo es renombrado también por ser la versión más conocida entre los fans de *Star Wars*, ya que su diseño fue el más utilizado para fabricar juguetes, maquetas, materiales promocionales y representaciones gráficas relacionadas con el universo *Star Wars*. Este mismo modelo se reutilizó más tarde para el rodaje de *El retorno del Jedi*.

Otra característica inconfundible del *Millennium Falcon* son los sonidos que acompañaban a los asombrosos efectos visuales. Casi todos los vehículos espaciales del universo *Star Wars* contaban con efectos de sonido basados en aviones reales. Para el *Millennium Falcon*, el ingeniero acústico Ben Burtt usó el sonido del motor desacelerado de un caza Mustang P-51 norteamericano de la Segunda Guerra Mundial. Después agregó un trueno o el rugido de un león para acentuar la velocidad y el tamaño de la nave al pasar cerca de la cámara. Para crear el sonido del *Millennium Falcon* al saltar al hiperespacio, Burtt combinó el ruido del motor de un Douglas DC-3 con un efecto de eco y el de las cámaras de control de movimiento del equipo de rodaje al desplazarse por los rieles.

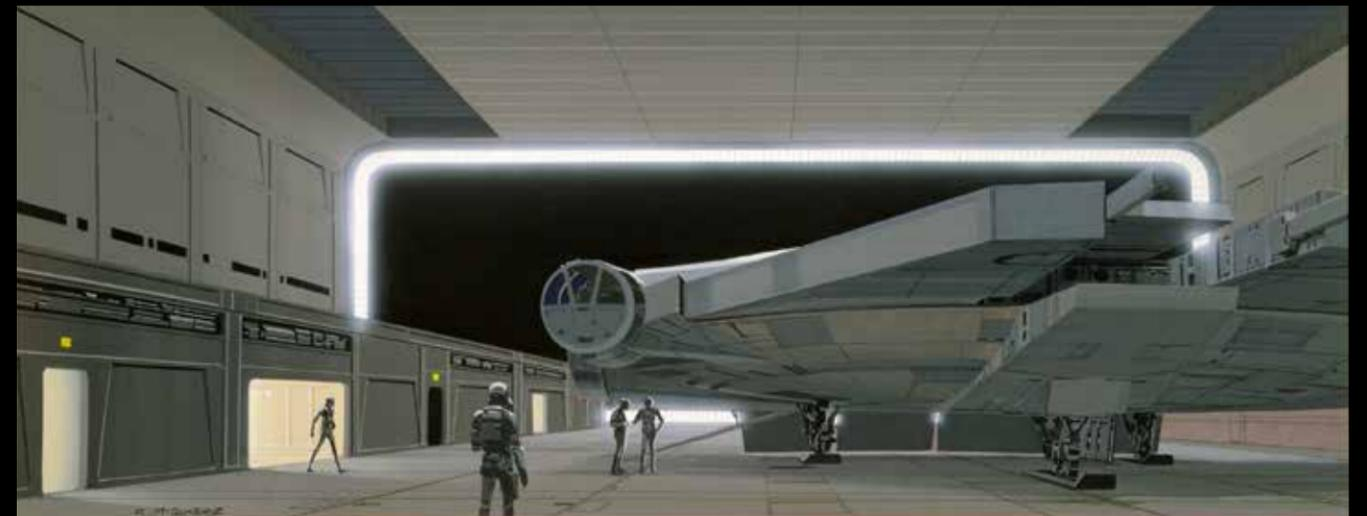
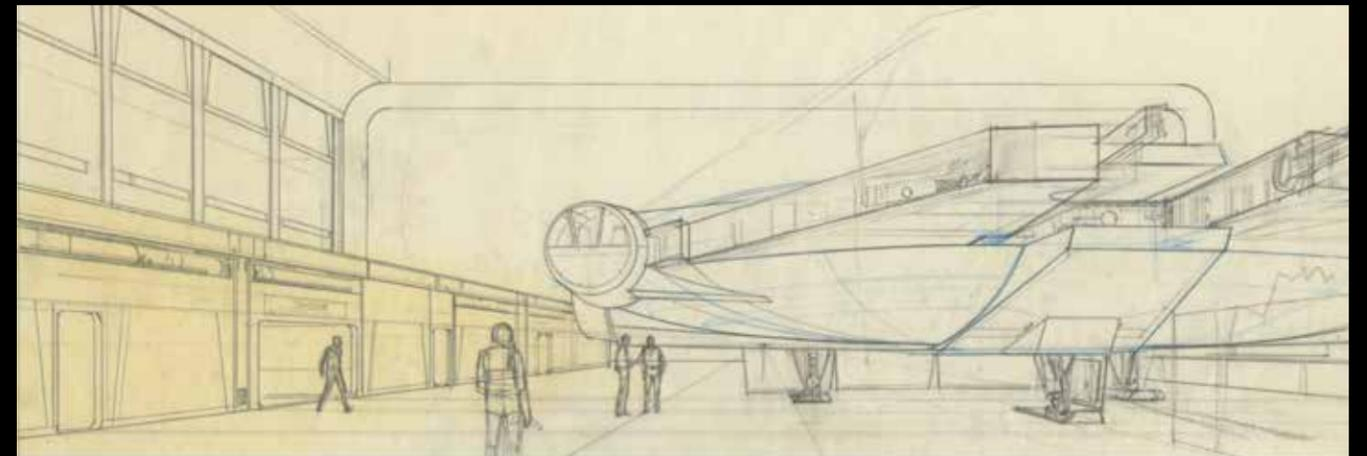



HISTORIA DEL MILLENNIUM FALCON LEGO

Jens Kronvold Frederiksen

P: Puede que el *Millennium Falcon* sea el vehículo más emblemático de toda la saga *Star Wars*. Considerando que se trataba de un nuevo modelo basado en una nave con tanta historia, ¿cuáles fueron los primeros pasos al diseñar la versión original LEGO del *Millennium Falcon*?

R: Bueno, de eso hace ya muchos años. LEGO lanzó al mercado el primer *Millennium Falcon* en 2000. Pero recuerdo que tuvimos muchos debates sobre el diseño del modelo. Es redondo, ¡así que no era fácil de recrear usando bricks y elementos LEGO!

Al final decidimos usar algunos elementos circulares del tema LEGO Space UFO para la estructura principal de la nave. También creamos una cubierta nueva para la cabina, ¡aunque hoy el modelo parece muy antiguo! ¡Las versiones LEGO más recientes del *Millennium Falcon* son mucho más fieles al diseño real!

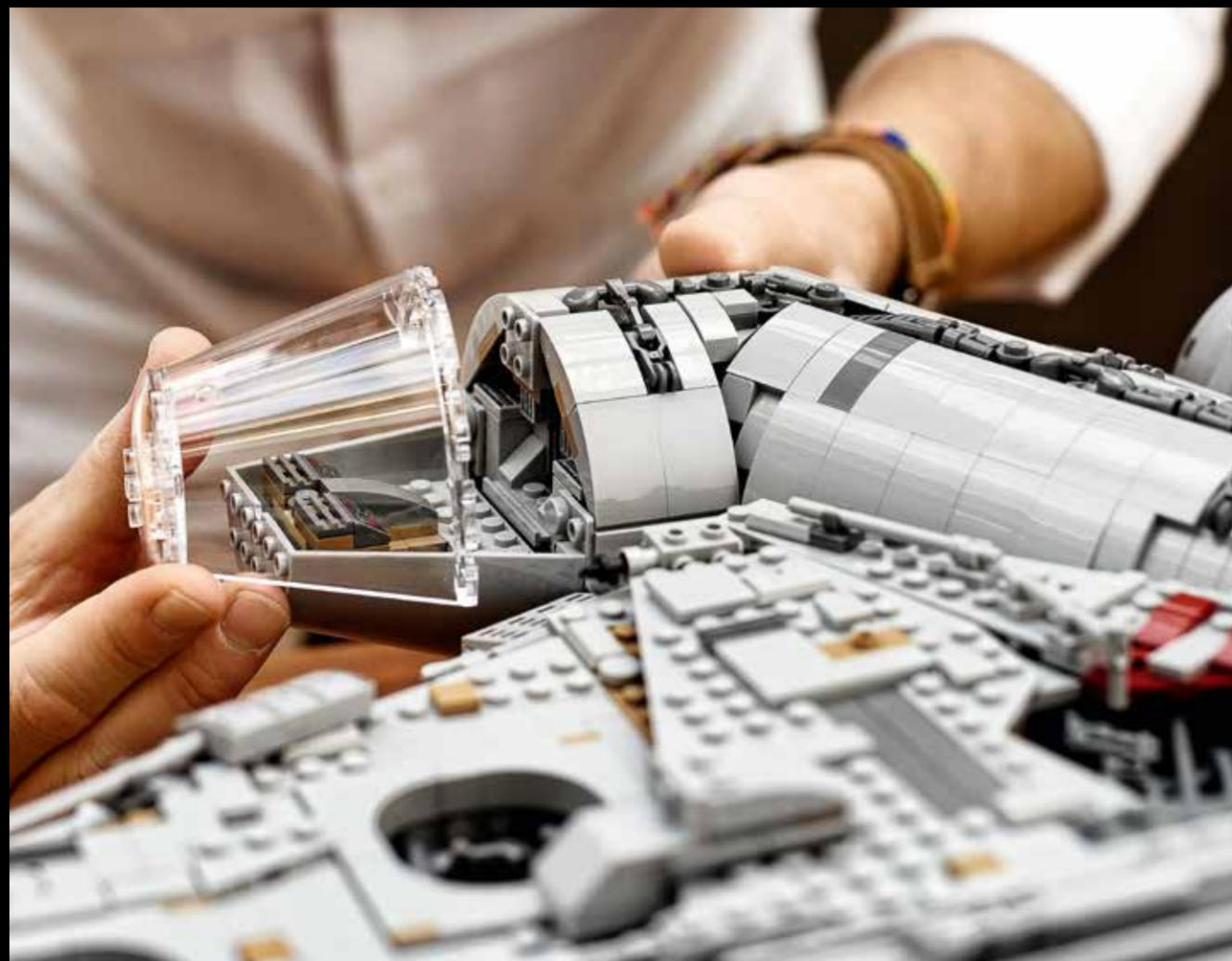

Jens Kronvold Frederiksen

P: Con más de ocho versiones del modelo en la biblioteca de sets LEGO, ¿hubo alguna versión que introdujera cambios drásticos en relación con la anterior?

R: El siguiente *Millennium Falcon*, de 2004, se hizo a escala de minifigura. Fue una versión muy mejorada en comparación con la primera. Introdujimos la placa triangular de 12x3 espigas para recrear la estructura principal de un modo completamente nuevo y más preciso. También creamos un elemento transparente más fiel al original para la cubierta de la cabina.

P: La exclusiva forma redonda del *Millennium Falcon* es una característica que define al vehículo. ¿Fue un reto comunicarla usando bricks LEGO?

R: Cualquier forma redonda es difícil de recrear usando bricks LEGO, ¡pero el modo en que lo hicimos en la primera versión del *Millennium Falcon* (4504) es la mejor! La versión más reciente del *Millennium Falcon* (75105) usa los mismos elementos triangulares.

En una versión a gran escala, como esta versión UCS, ¡es mucho más complicado! Aún recuerdo cuando diseñé el primer set UCS del *Millennium Falcon* (10179). ¡La idea era construir una estructura sólida y cubrirla con paneles de formas muy diferentes, creados a partir de muchos elementos LEGO distintos!

P: ¿Hay alguna parte de las versiones anteriores que haya recibido una mejora notable en esta última interpretación del *Millennium Falcon*?

R: El modelo que tenemos aquí es, por mucho, la versión LEGO del *Millennium Falcon* más detallada hasta hoy. Más o menos, se han retocado todos los detalles en esta última versión de la nave.

Uno de los más notables es, por supuesto, la cubierta de la cabina. Se trata de una gran mejora en comparación con el *Millennium Falcon* (10179), que sólo tenía el marco de la cubierta, ¡sin cristal!

P: ¿Qué tipo de recursos visuales se usan para diseñar un set LEGO basado en un vehículo de una película? ¿Cuadros de la película? ¿Planos bajados de Internet? ¿Otras cosas?

R: Al diseñar este tipo de modelos, siempre recurrimos a los materiales de referencia oficiales. Para esta versión del *Millennium Falcon* usamos las películas (incluida *Star Wars: El despertar de la Fuerza*) e imágenes de los modelos de estudio.

P: ¿Qué diferencia al *Millennium Falcon* de otros sets LEGO *Star Wars*?

R: En primer lugar, es la nave más emblemática y popular de la saga *Star Wars*. Esa es la razón por la que han existido tantas versiones LEGO del *Millennium Falcon* de diferentes tamaños.

P: ¿Hay alguna parte del nuevo set que mejore notablemente las funciones, la estabilidad o el aspecto del modelo?

R: Más o menos, lo hemos mejorado todo. La estructura interior básica es, probablemente, la parte que más se acerca al anterior *Millennium Falcon* (10179). Cuando trabajamos en una nueva versión de un modelo, siempre empezamos analizando la respuesta de los consumidores a la versión anterior para determinar lo que se puede mejorar. Visualmente, esta versión es también mucho más precisa y detallada.

P: ¿Qué grado de precisión alcanza el *Millennium Falcon* LEGO en comparación con el auténtico vehículo de la saga?

R: ¡Uno muy alto! La única gran diferencia es que el *Millennium Falcon* de las películas no tiene espigas LEGO.



2000

7190: Millennium Falcon™

659 piezas

Se crea la primera versión LEGO del *Millennium Falcon*. Mide más de 6 cm de altura, 53 cm de longitud y 42 cm de ancho. Incluye 6 minifiguras: Han Solo, Chewbacca, princesa Leia Organa, Luke Skywalker, R2-D2 y C-3PO.



2003

4488: MINI Millennium Falcon™

87 piezas

Primera versión en miniatura del *Millennium Falcon*. Mide más de 4 cm de altura, 14 cm de longitud y 14 cm de ancho. No incluye minifiguras. El set contiene piezas adicionales para construir un Y-Wing Starfighter usando también piezas de los sets 4489, 4490 y 4491.



2007

10179: Ultimate Collector's Millennium Falcon™

5.197 piezas

La versión más grande hasta la fecha de la emblemática nave aterriza en todas las tiendas. ¡Mide más de 21 cm de altura, 84 cm de longitud y 56 cm de ancho! Incluye 5 minifiguras: Han Solo, Chewbacca, Obi-Wan Kenobi, Luke Skywalker y princesa Leia Organa.

4504: Millennium Falcon™ (Episodio V)

985 piezas

Edición original de la trilogía. Se crean nuevas placas LEGO para recrear con mayor fidelidad la forma característica de la nave. Mide más de 9 cm de altura, 57 cm de longitud y 38 cm de ancho. Incluye 5 minifiguras: Han Solo, Chewbacca, princesa Leia Organa, C-3PO y un Snowtrooper.

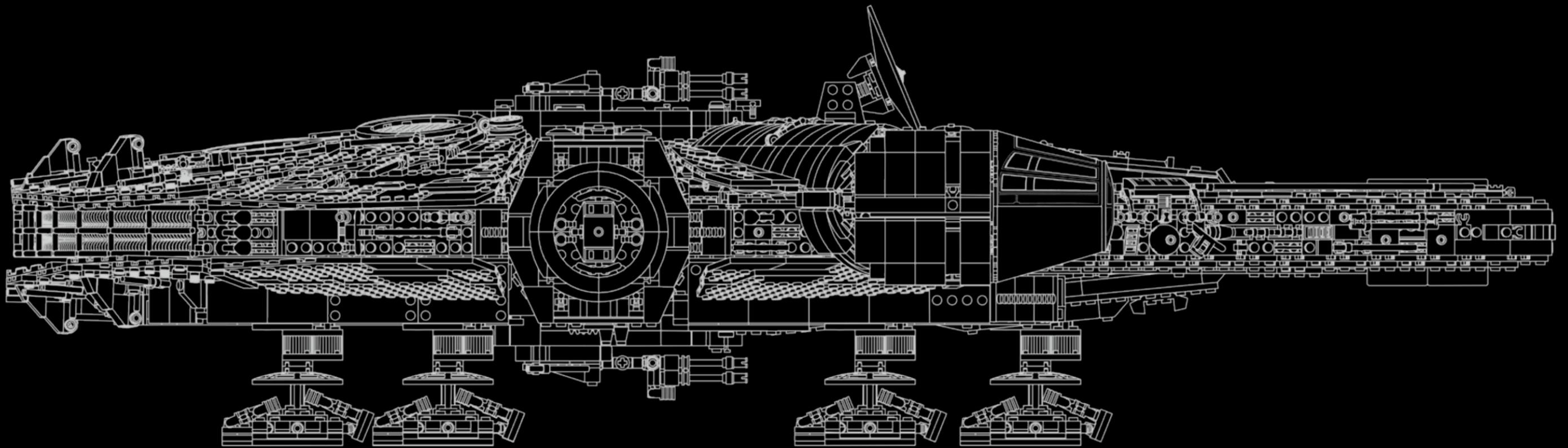

2009

778: Midi-scale Millennium Falcon™

356 piezas
Una versión del *Millennium Falcon* a media escala. Mide más de 8 cm de altura, 24 cm de longitud y 17 cm de ancho. No incluye minifiguras.

2011

7965: Millennium Falcon™

1.254 piezas
Mide más de 10 cm de altura, 58 cm de longitud y 38 cm de ancho. Incluye 6 minifiguras: Han Solo, Luke Skywalker, Chewbacca, Ben Kenobi, princesa Leia Organa y Darth Vader.

2014

75030: Millennium Falcon™ Microfighters

94 piezas
Versión Microfighters del *Millennium Falcon*. Mantiene la característica y popular forma redonda y cuenta con 2 lanzamisiles y una minicabina en la que puede sentarse Han Solo. Mide más de 6 cm de altura, 8 cm de longitud y 8 cm de ancho.

2015

75105: Millennium Falcon™ (Episodio VII)

1.329 piezas
Edición del Episodio VII. Mide más de 14 cm de altura, 47 cm de longitud y 32 cm de ancho. Incluye 6 minifiguras: Rey, Finn, Han Solo, Chewbacca, Tasu Leech y un miembro de los Kanjiklub; incluye también el droide astromecánico BB-8.



CONOCE AL DISEÑADOR DEL MODELO

Hans Burkhard Schlömer

P: En el universo *Star Wars* existen numerosos vehículos legendarios, pero el *Millennium Falcon* es sin duda uno de los más emblemáticos y ha contribuido a definir una de las sagas cinematográficas más memorables de todos los tiempos. Con una carta de presentación como esta, ¿qué fue lo primero que pensaste al sentarte a diseñar la versión LEGO definitiva del *Millennium Falcon*?

R: Diseñar un set de este tamaño es siempre una tarea muy complicada. ¡Y lo es todavía más cuando el set en cuestión es el *Millennium Falcon*! No llegué a construir nunca el set antiguo, así que esta era la oportunidad perfecta de hacer realidad el sueño de cualquier fan de LEGO *Star Wars*: ¡construir el enorme *Millennium Falcon* (10179)!

Hacerlo me ayudó a comprender cómo funciona la estructura de soporte interior, los segmentos en los que se divide el modelo y el modo en el que se conectan a la estructura. En resumen, ¡cómo todo va unido! Cuando comprobé que el principio básico de diseño seguía siendo válido y aún proporcionaba la resistencia que requeriría un modelo todavía más detallado y pesado, decidí conservarlo.



© & ™ Lucasfilm Ltd.



Hans Burkhard Schlömer

P: Ya habías diseñado sets LEGO *Star Wars* antes: ¿en qué se diferenció el diseño del *Millennium Falcon* de los demás modelos que has creado?

R: Trabajé en el diseño de la versión LEGO del *Millennium Falcon* de *Star Wars: El despertar de la Fuerza* (75105), así que ya estaba bastante familiarizado con la nave. Después de trasladar el *Millennium Falcon* (10179) al programa digital que usamos aquí, lo desarmé en mi pantalla y pude colocar todas las subsecciones una junto a la otra.

No obstante, cuando los cambios digitales iban más allá de una mera alteración estética, tenía que asegurarme de que las partes siguieran concordando con el resto del modelo o aplicar también los cambios necesarios a las demás. Todo eso había que comprobarlo también con un modelo físico, lo cual dio lugar a nuevos cambios. Muchos de esos submodelos respondían a nuevas versiones del diseño, mientras que otros eran completamente nuevos y todavía tenían que encontrar su lugar.

Para comprobar el comportamiento del modelo bajo presión, siempre calentamos el set completo. En esta ocasión, no obstante, no teníamos un horno lo suficientemente grande para el *Falcon* en la sede de LEGO, así que reservamos el sauna del baño público de Billund (Dinamarca) para hacerlo. Entrar desapercibidos con un modelo altamente secreto al edificio y luego sacarlo de igual manera fue un poco como actuar en una película de espías, ¡y algo que definitivamente está fuera de nuestra rutina de diseño!

P: ¿Tuviste que afrontar algún reto en particular para que el aspecto del modelo fuera fiel al auténtico *Millennium Falcon* de *Star Wars*?

R: Desde luego, el *Falcon* no tiene la forma más fácil de recrear con elementos LEGO a cualquier escala. Sin embargo, el modelo anterior (10179) ya había cargado con buena parte del trabajo y me permitió concentrarme en detalles que necesitaban una revisión después de 10 años, como las áreas que se construían usando placas y paneles en ángulo y que, en realidad, tenían que ser redondas o curvas. Por ejemplo, el extremo superior central con los cañones, el pasillo que conduce a la cabina o las compuertas herméticas a los lados de la nave.

Tuve que rediseñar por completo los paneles superiores de las quijadas delanteras para lograr el aspecto que buscaba, con los orificios en las posiciones y los tamaños correctos y elementos gris oscuro para dar protagonismo a los detalles de un lado. Agregué un poco de café oscuro en todo el modelo para lograr un aspecto más desgastado e intercambié placas por cubiertas para equilibrar mejor las superficies con espigas y las lisas. En las primeras etapas se decidió también desarrollar un nuevo parabrisas para la cabina que aportara un aspecto atractivo y estuviera a la altura de los demás productos LEGO *Star Wars* actuales.

P: El modelo original del *Millennium Falcon* basado en las películas pasó por varios cambios en el diseño antes de que se eligiera la forma definitiva. Normalmente, ¿cuántas versiones preliminares de un modelo LEGO se crean antes de llegar a la versión final?

R: En los departamentos de diseño de LEGO, es común encontrar una docena de prototipos ligeramente diferentes de un mismo modelo (resultado de las distintas etapas de diseño) en la mesa de un diseñador; en ocasiones, incluso más. Sin embargo, en el caso de LEGO *Star Wars*, no es así como yo acostumbro trabajar. Con los materiales de referencia adecuados y la posibilidad de efectuar las primeras iteraciones del diseño con ayuda de nuestros programas digitales, la primera copia física que construyo suele ser muy parecida a la versión final en términos de aspecto y tamaño. De todas formas, tampoco tengo



© & ™ Lucasfilm Ltd.

espacio para una flota de *Falcons* ligeramente diferentes entre sí. Si estás leyendo esto antes de construir tu propio *Falcon*, ¡ES REALMENTE GRANDE! No llegué a tener más de una, o quizá dos, copias del modelo completo en mi área de trabajo; hacía los cambios digitalmente y luego los revisaba y aplicaba a la copia física para la que tenía espacio. Poder basar esta nueva versión en el anterior *Millennium Falcon* (10179) fue también de gran ayuda. Sabía que la estructura de soporte no me fallaría resultando en una desastrosa cascada de cambios de diseño en el último momento.

P: ¿Había alguna característica clave que quisieras incluir en el diseño del interior de la nave?

R: Desde el principio sabíamos que esta versión del *Millennium Falcon* definitivo iba a tener algún tipo de interior. Sólo había dos problemas: los escenarios interiores que se ven en las películas no caben en la nave tal y como se ve en la pantalla. Además, el *Millennium Falcon* LEGO tiene numerosas vigas LEGO Technic que le dan la resistencia y estabilidad estructural necesarias, ¡así que tiene aún menos espacio para ponerle algo adentro!

Lo primero que hice fue alterar la estructura interna de soporte para determinar cuánto espacio tenía para trabajar. Resultó no ser mucho, pero suficiente para incluir todas las características que pude encontrar y algún que otro extra, como las escotillas que conducen a las cápsulas de escape, que en realidad no están, como descubrieron los Stormtroopers imperiales cuando registraron la nave en el Episodio IV.

Por último, quería que el *Falcon* mantuviera la estética y no pareciera incompleto al levantar la parte superior para ver el interior. Sólo hay que quitar los paneles que se ubican encima del interior, manteniendo el resto del modelo bien cubierto, con sus vigas estructurales y piezas de otros colores fuera de la vista.



P: ¿Qué parte del proceso de diseño te gustó más?

R: La primera etapa del desarrollo de un set LEGO siempre es emocionante para un diseñador: es cuando el modelo y los detalles toman forma. Más adelante, paso la mayor parte del tiempo resolviendo problemas y buscando soluciones para diferentes aspectos del diseño, como la estabilidad del modelo, las funciones, la seguridad del producto o el flujo de construcción.

Mi parte favorita, no obstante, es cuando por fin recibo una bolsa de bricks y un montón de instrucciones de construcción sueltas basadas en los pasos que he desarrollado. En este caso, ¡el montón era muy grande! Cuando llega ese punto, mi trabajo casi ha terminado: mis compañeros toman el relevo del diseño y afinan los últimos detalles del set, como las ilustraciones de la caja o las listas de elementos para la fábrica.

P: ¿Alguna característica o función de la versión cinematográfica del *Millennium Falcon* tenía, en tu opinión, que ser necesariamente parte del diseño final?

R: Según mi criterio, este nuevo *Millennium Falcon* TENÍA que ser el del Episodio V. Es en *El Imperio contraataca* donde el *Falcon* brilla en todo su esplendor, desarrolla su personalidad y se convierte en parte del reparto con la huida de Hoth en el último momento, la persecución por el campo de asteroides, el encuentro con la babosa espacial, el aterrizaje en un destructor estelar, la visita a Bespin, ¡e incluso el enfrentamiento contra un superdestructor estelar! No obstante, aparte de las funciones necesarias para cualquier nave espacial, el *Millennium Falcon* no destaca particularmente por poseer funciones fuera de lo

normal... ¡o eso quiere Han Solo que creamos! Uno de los nuevos artefactos es el cañón bláster “Ground Buzzer”: una desagradable sorpresa para las tropas imperiales, ¡como demuestra su aparición en la escena de la base rebelde del Episodio VI!

Como el *Millennium Falcon* aparece también en los Episodios VII y VIII, agregar la nueva antena rectangular era imprescindible para ofrecer la oportunidad de elegir entre la versión clásica del *Falcon* y la de la nueva trilogía.

P: ¿Qué diferencias hay entre el *Millennium Falcon* de la trilogía original y el *Falcon* que aparece en el Episodio VII: *El despertar de la Fuerza*?

R: Hace falta estudiar con atención los materiales de referencia para darse cuenta de que la nueva antena no es el único cambio del *Falcon* del Episodio VII, sino sólo el más obvio. Aunque ahora es más viejo y ha librado más batallas, muchos de los detalles del casco de la nave se han limpiado o alterado. Por razones prácticas, decidí mantener un término medio, conservando algunos de los detalles eliminados, como las jaulas metálicas a los lados de las quijadas (una de las cuales está justo junto a la cabina). El *Falcon* del Episodio VII ya no las tiene, pero las conservé porque son detalles fantásticos para cualquier versión del *Falcon* y quedan muy bien. Hay otros dos pequeños dispositivos sobre el extremo delantero de la nave que no son tan discretos. Estos llamaban más la atención, así que hice que fueran removibles.

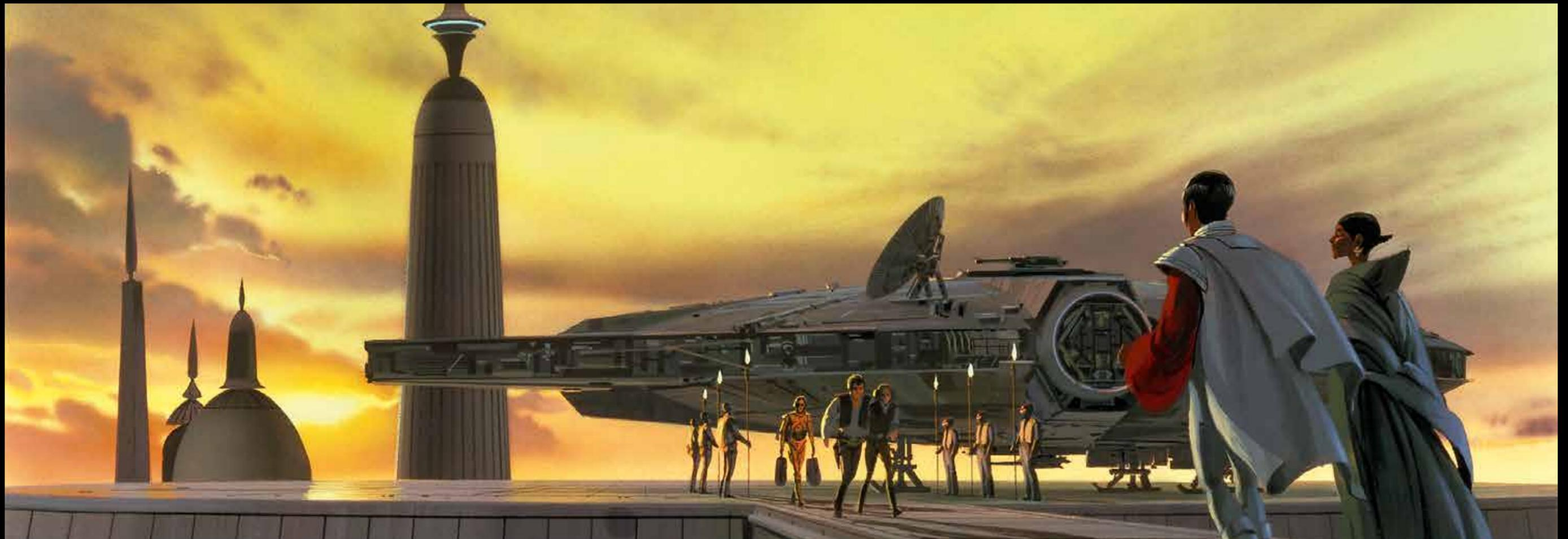



CONOCE AL DISEÑADOR GRÁFICO

Madison O'Neil

P: ¿Tuviste que afrontar algún reto en particular para que el aspecto del modelo fuera fiel al auténtico *Millennium Falcon* de *Star Wars*?

R: El mayor reto del diseño gráfico para este modelo fueron las calcomanías de los pasillos interiores del *Millennium Falcon*. Era importante dar sensación de profundidad al mirar por los corredores circulares y crear la ilusión de que las minifiguras podrían caminar por el área común de la cabina o el hiperimpulsor. El interior del *Falcon* puede ser bastante complejo, con tantos paneles que faltan, controles que parpadean y cables a la vista. Me esforcé por simplificar los detalles, reduciéndolos a lo básico, sin perder el ADN de LEGO.

P: El modelo original del *Millennium Falcon* basado en las películas pasó por varios cambios en el diseño antes de que se eligiera la forma definitiva. Normalmente, ¿cuántas versiones preliminares de un producto LEGO se crean antes de llegar a la versión final?

R: El diseño de cualquier minifigura o decoración LEGO pasa por varias rondas de revisiones antes de considerarse completo y remitirse a Lucasfilm para su aprobación. En casos muy especiales llegan a crearse más de 10 versiones, todas con pequeñas diferencias o cambios de color. Con una paleta de colores limitada, a menudo es todo un reto respetar las referencias.

P: ¿Qué parte del proceso de diseño te gustó más?

R: Disfruto mucho cuando empiezo un nuevo proyecto y también al desarrollar los requisitos gráficos del producto con el diseñador del modelo. Ese debate con frecuencia me lleva a peinar las carpetas de referencias en busca de imágenes y partes muy específicas de una nave o pasar algunos minutos volviendo a ver escenas de las películas para inspirarme (o sólo por diversión). También es muy gratificante recibir por fin la primera prueba de impresión de un elemento decorado. Para mí, marca el final de un ciclo, cuando el diseño que hasta entonces sólo vivía en la pantalla de una computadora se convierte en algo con lo que puedes jugar.

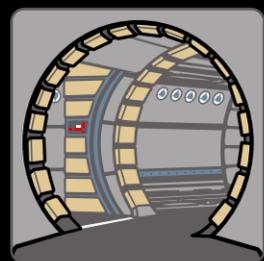

Corredores

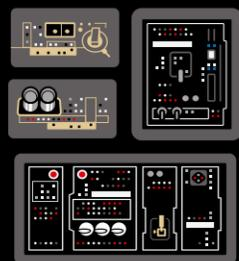
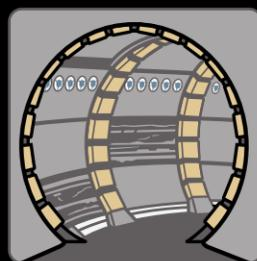

Paneles de control



Tablero de Dejarik



Han Solo



Chewbacca



Princesa Leia



C-3PO



Madison O'Neil

P: ¿Alguna característica o función de la versión cinematográfica del *Millennium Falcon* tenía, en tu opinión, que ser necesariamente parte del diseño final?

R: ¿Qué sería de un *Millennium Falcon* sin un buen tablero de Dejarik? También fue muy emocionante y fundamental recrear la emblemática antena de radar, las ventanas de artillería y la cabina.

P: ¿Algún personaje relacionado con las distintas apariciones del *Millennium Falcon* tenía, en tu opinión, que ser parte del diseño final necesariamente?

R: Queríamos que este *Millennium Falcon* fuera un poco más versátil que la versión anterior y ofreciera cierta libertad al elegir entre el *Falcon* clásico y la versión de *El despertar de la Fuerza*. Para lograrlo, sabíamos que teníamos que incluir dos tripulaciones, y la de *El Imperio contraataca* parecía ser la que mejor complementaba a la de *El despertar de la Fuerza*. También aprovechamos la oportunidad para crear algunas caras alternativas para Han y Leia. Este es el único set en el que llevan las máscaras que usan para explorar el vientre de la babosa espacial en *El Imperio contraataca*. ¡Cuidado con los Mynocks! Mi personaje favorito de los que incluye este set es la adorable criatura voladora que vive en la isla que aparece al final de *El despertar de la Fuerza*; la misma donde Rey descubre a Luke. ¡Ya quiero ver el papel que interpretan en el Episodio VIII!



Plano y borradores conceptuales

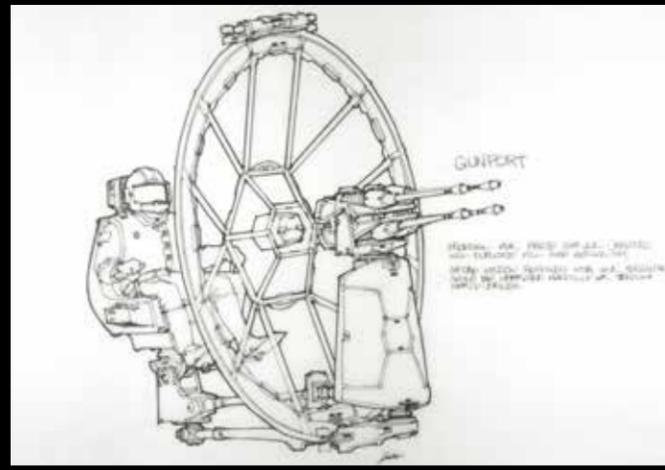
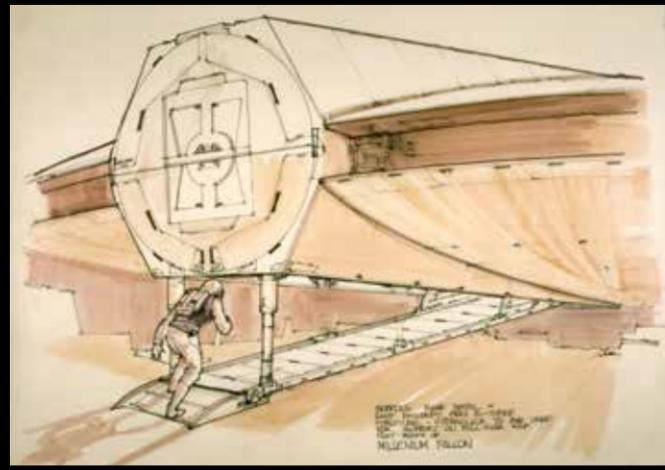
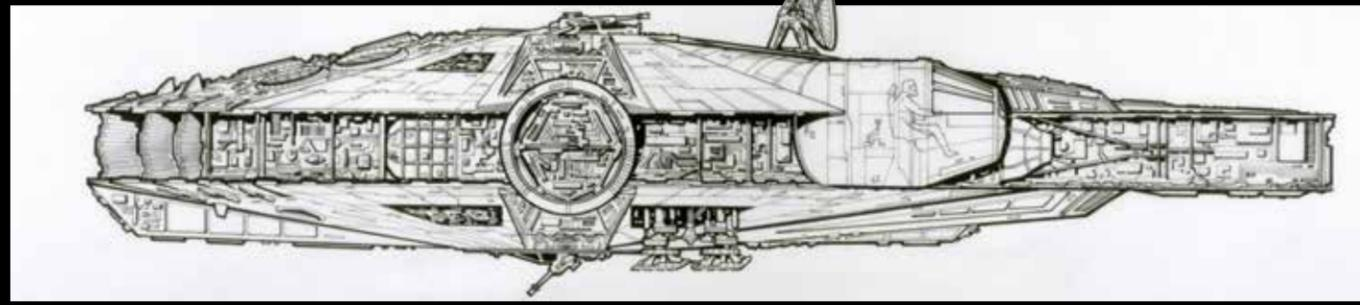
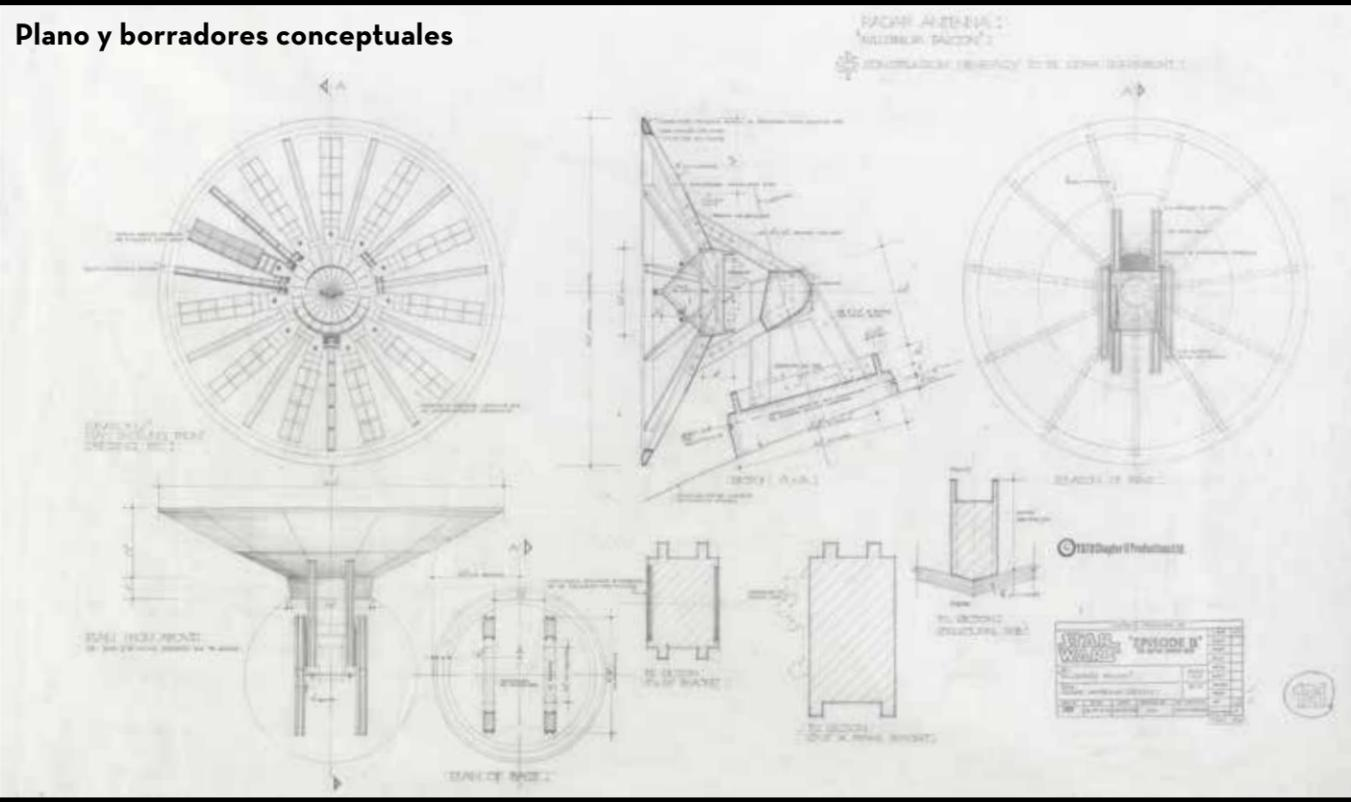

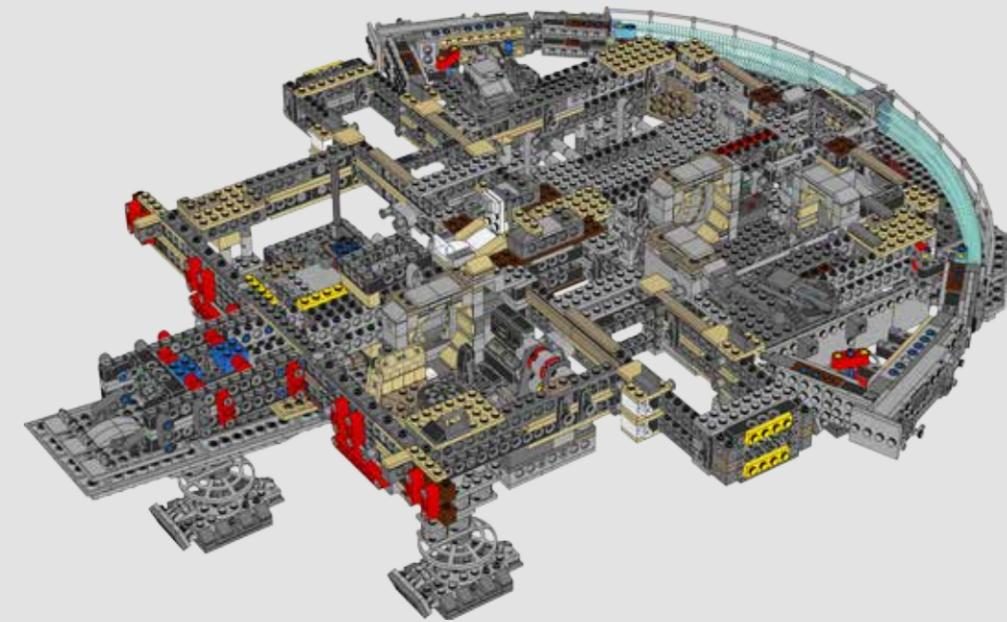
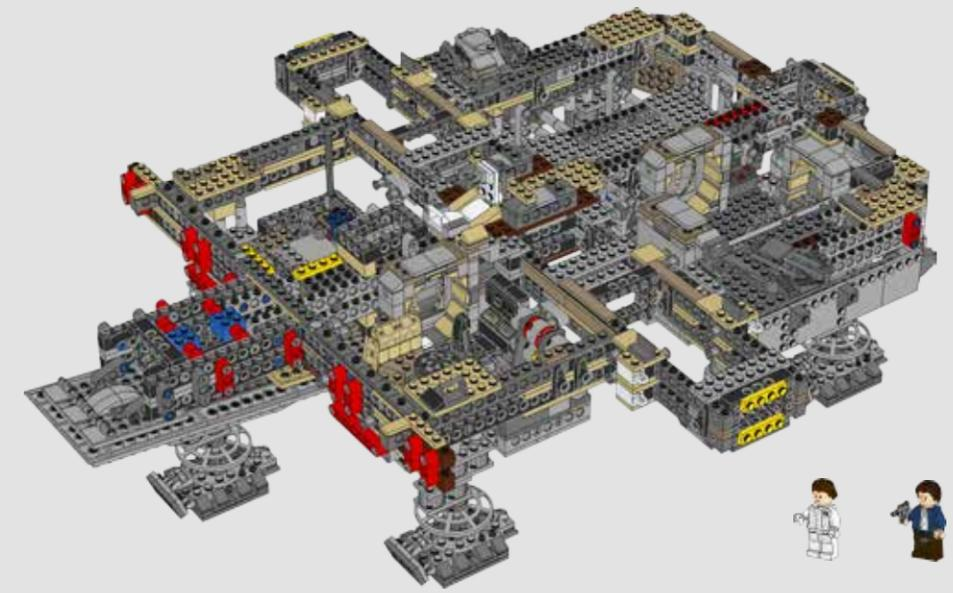
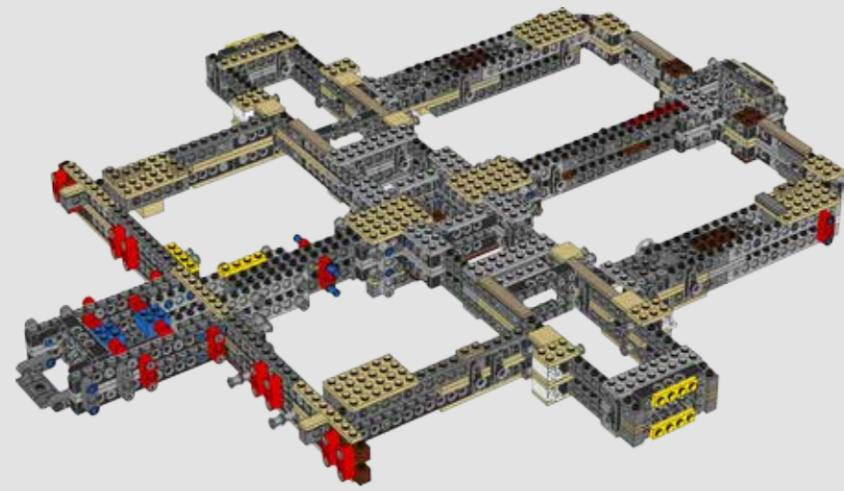



7

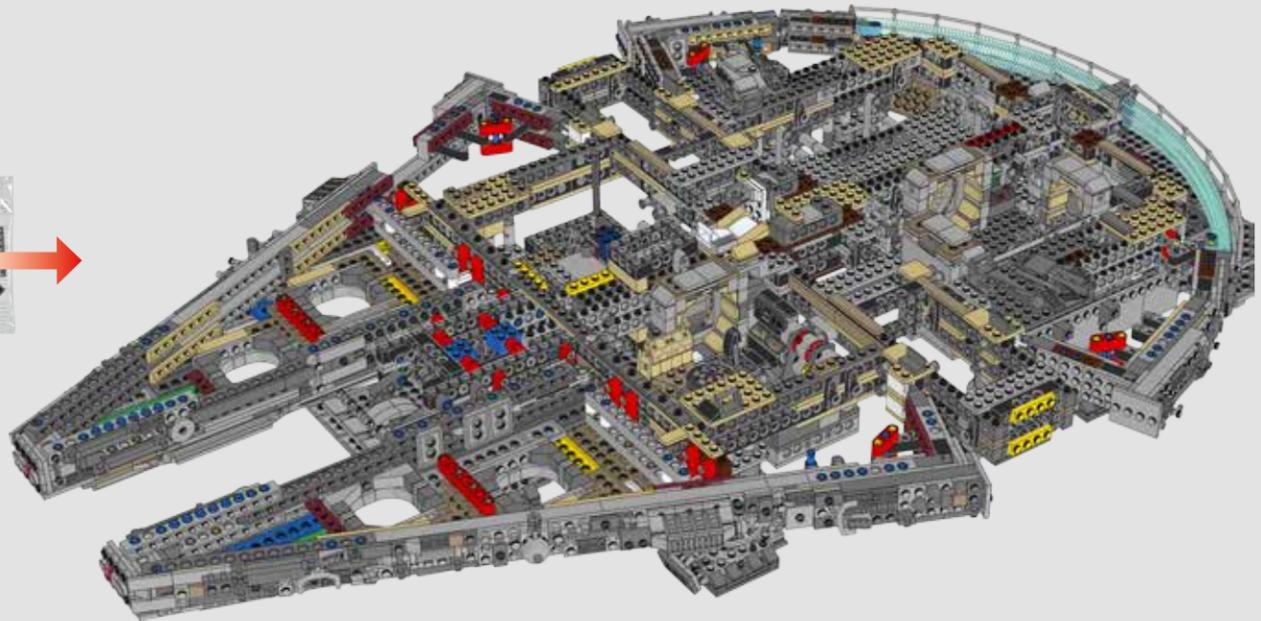

8

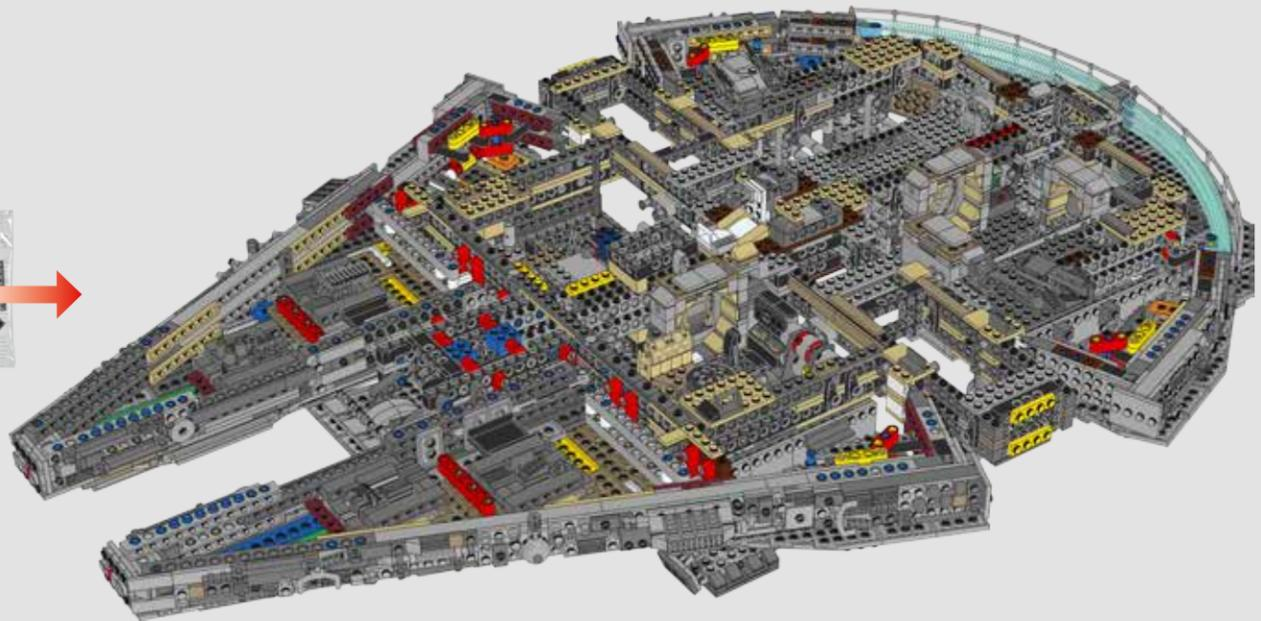

9

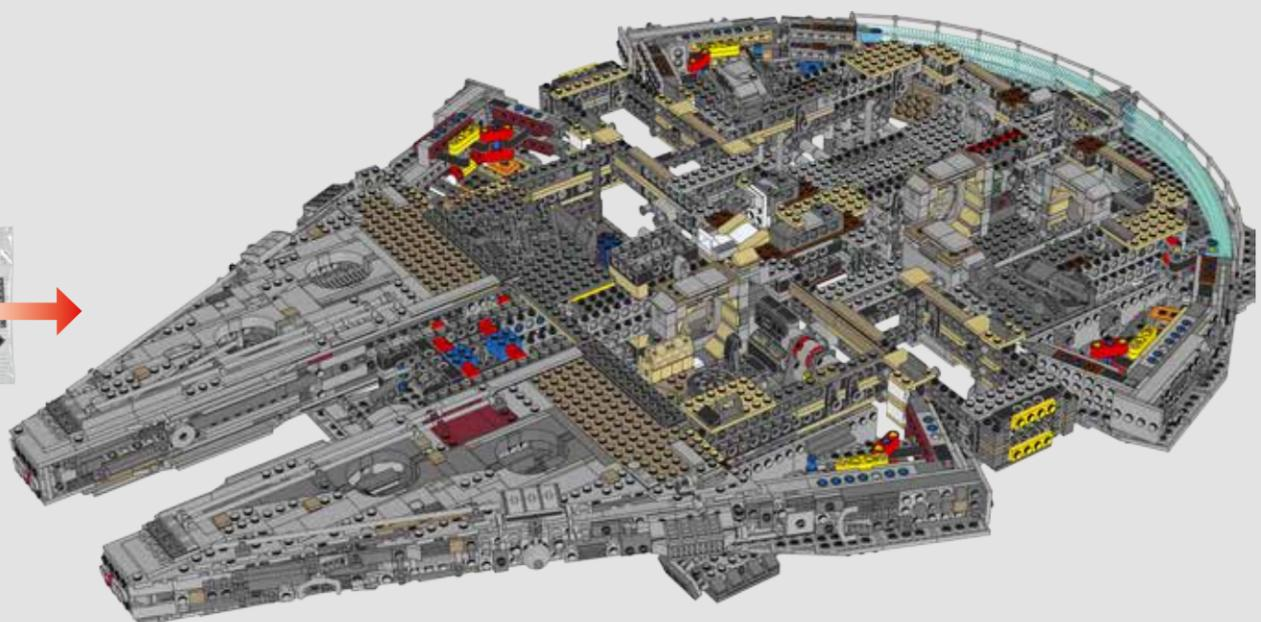

10

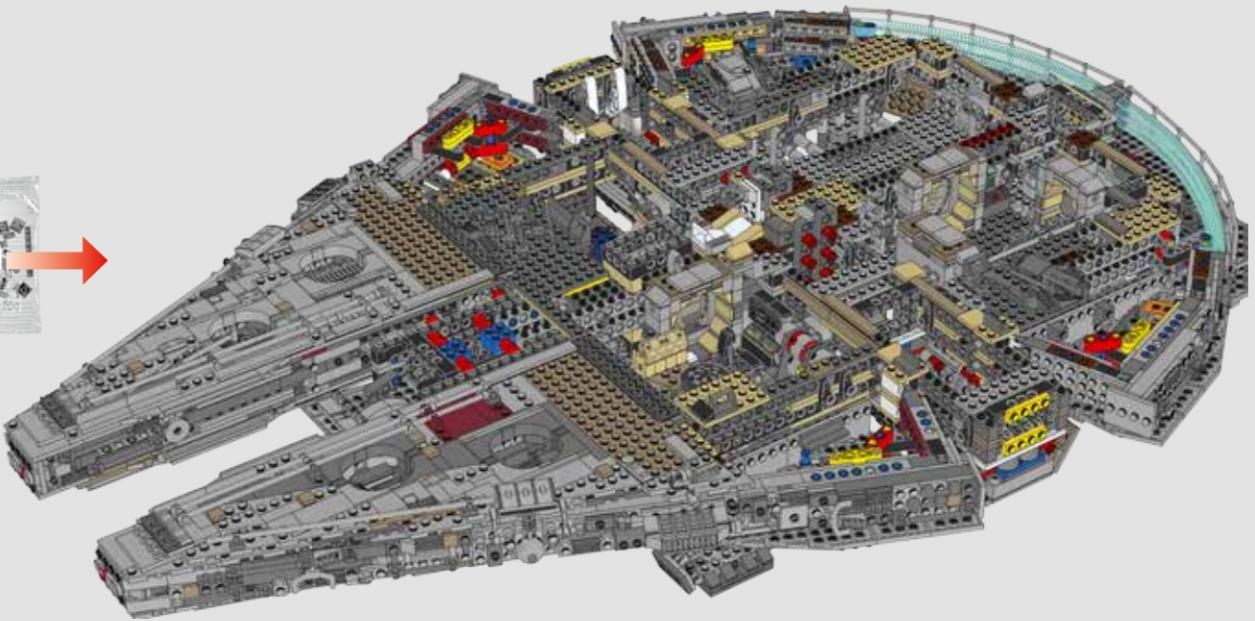

11

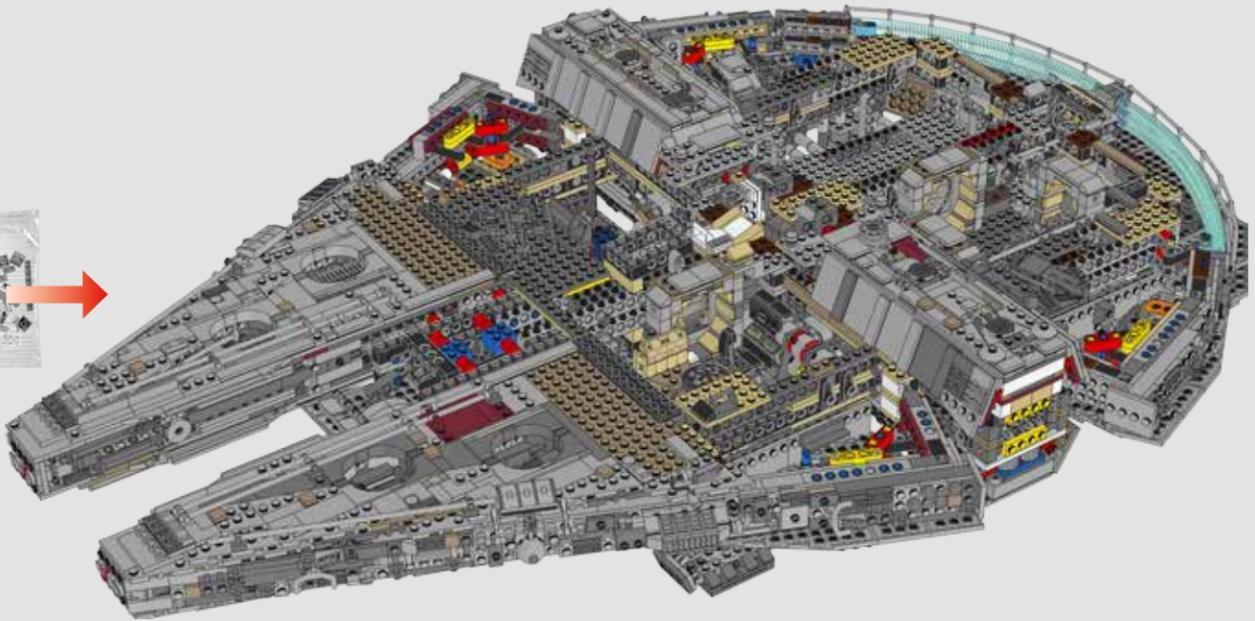

12





13

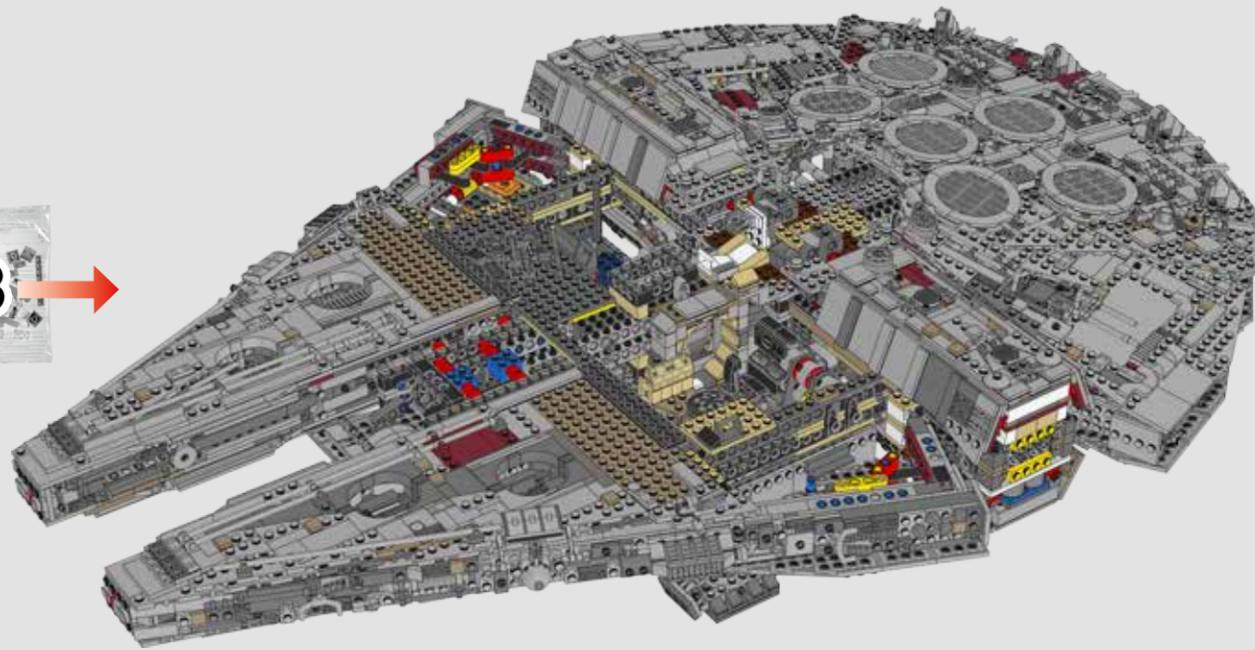

14

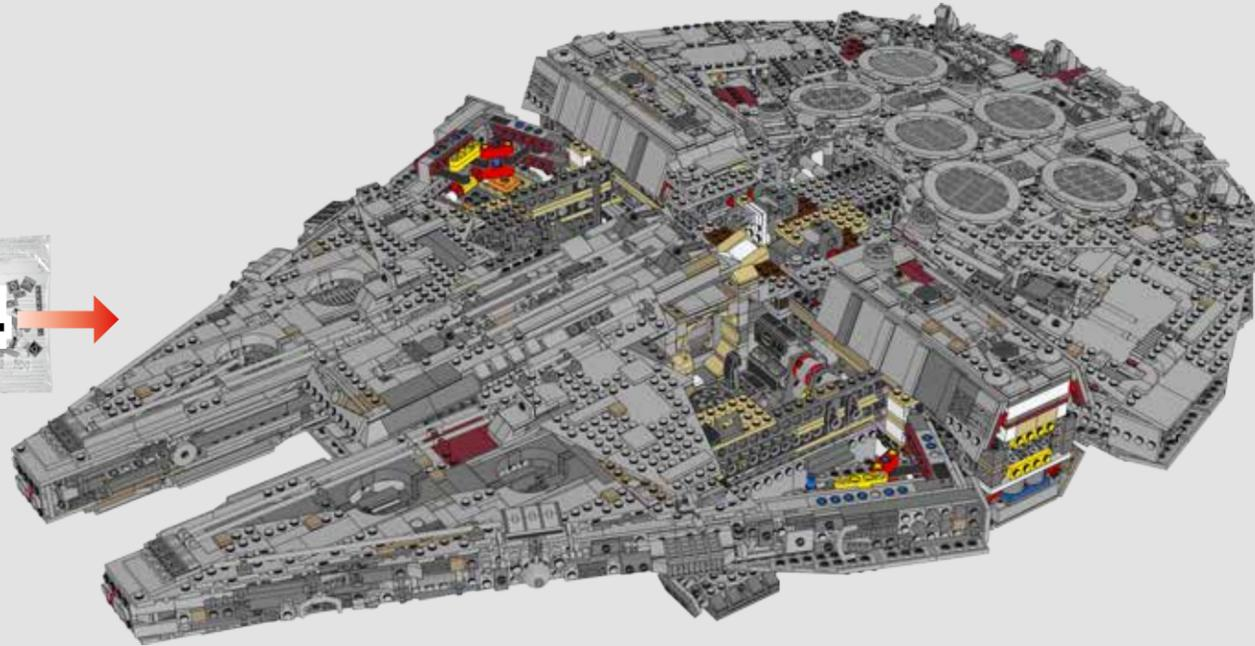

15

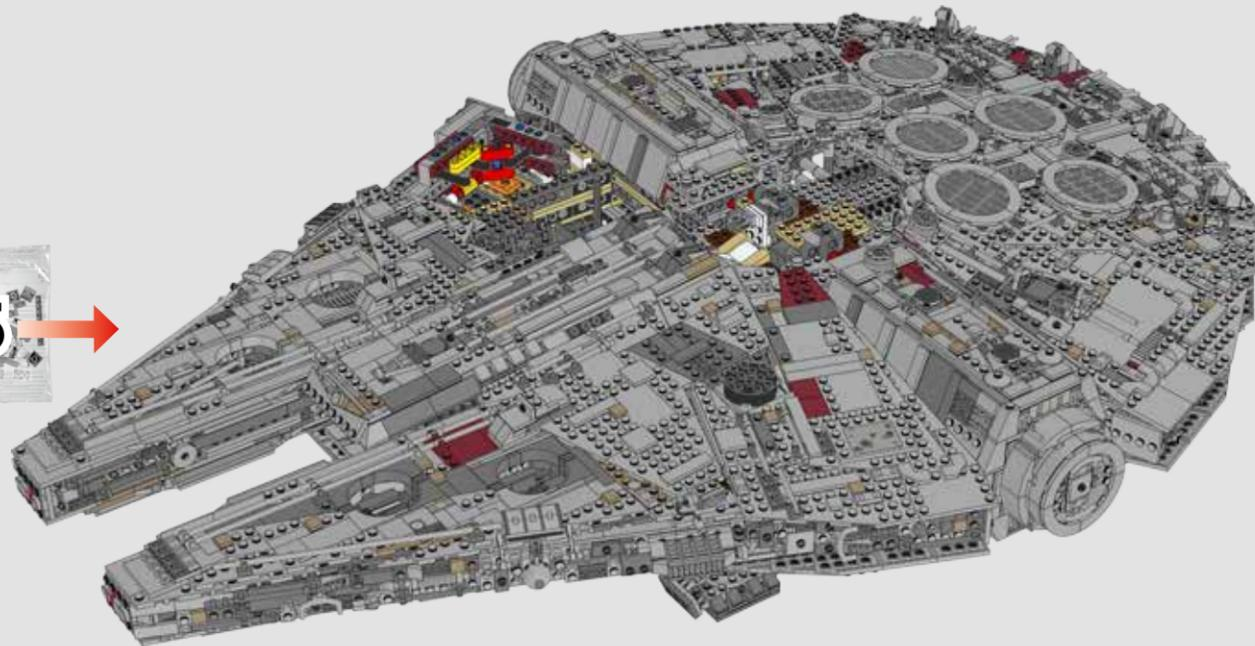

16

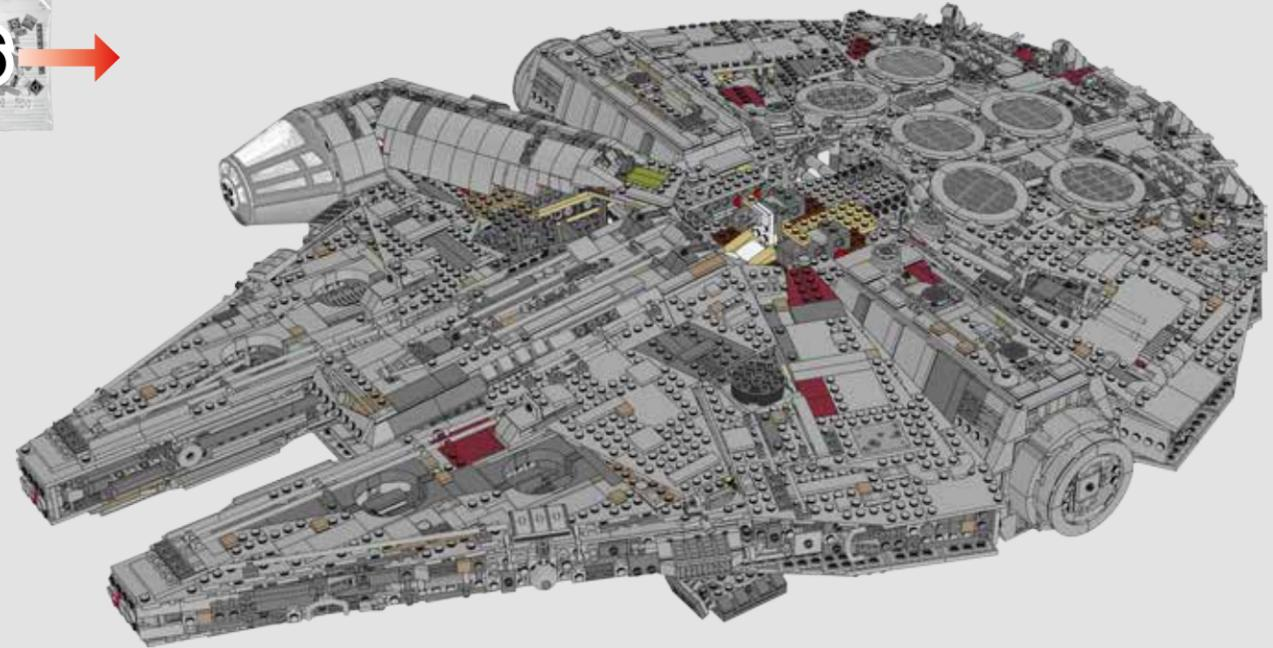

17

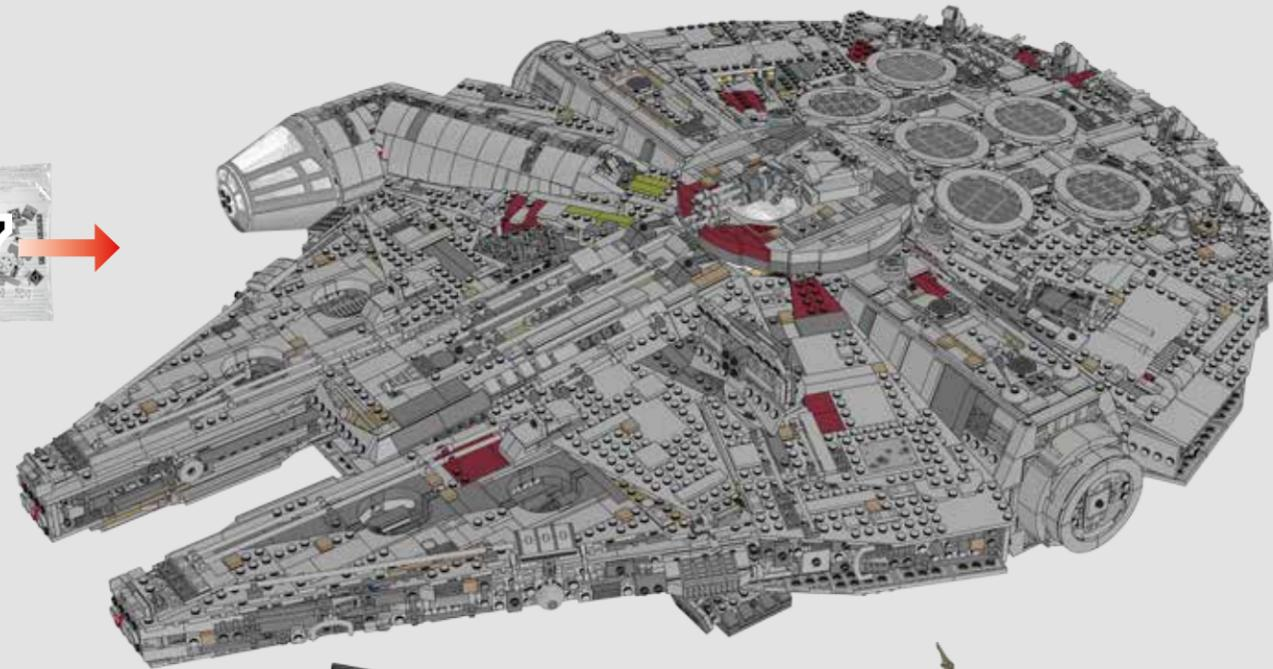

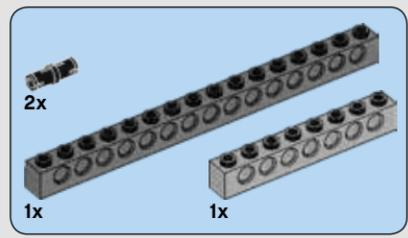
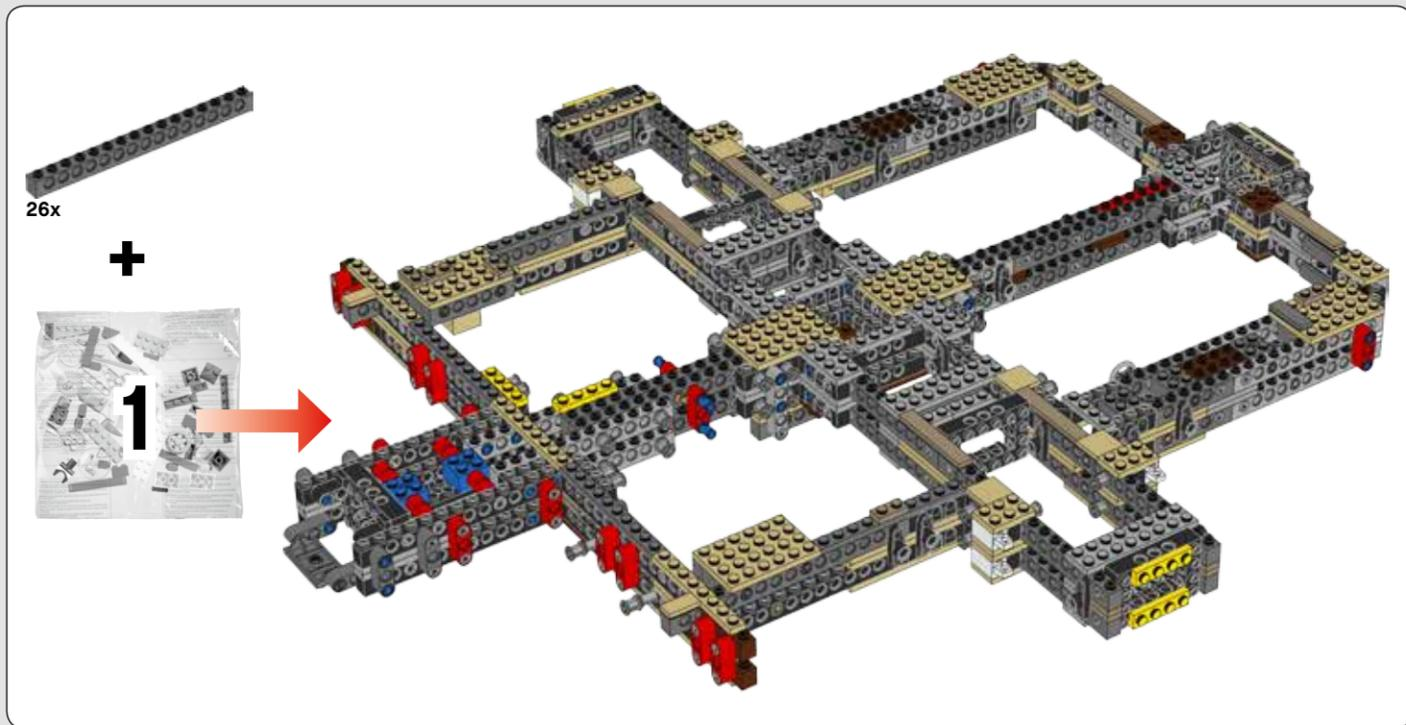

3

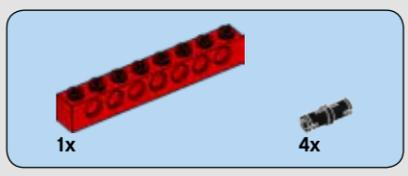
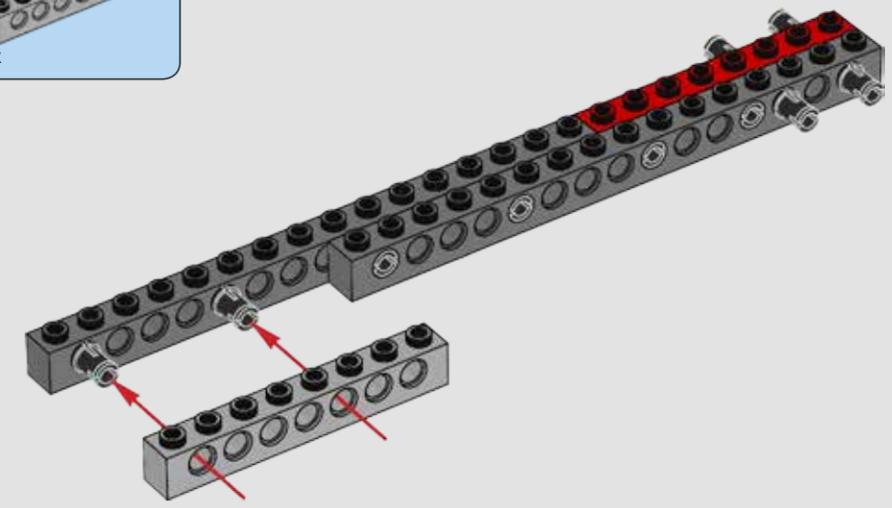

1

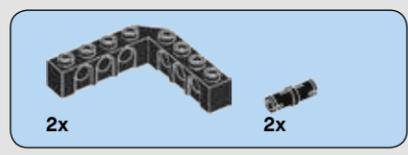
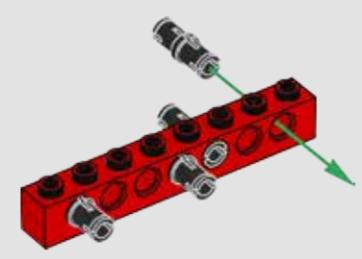

4

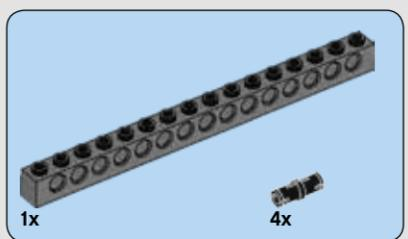
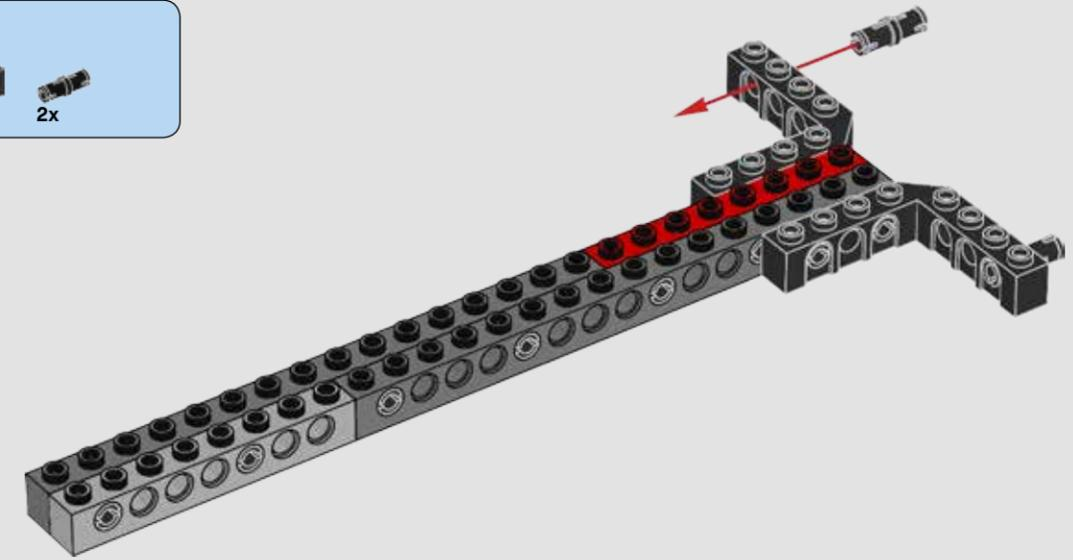

2

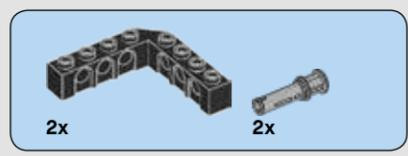

5

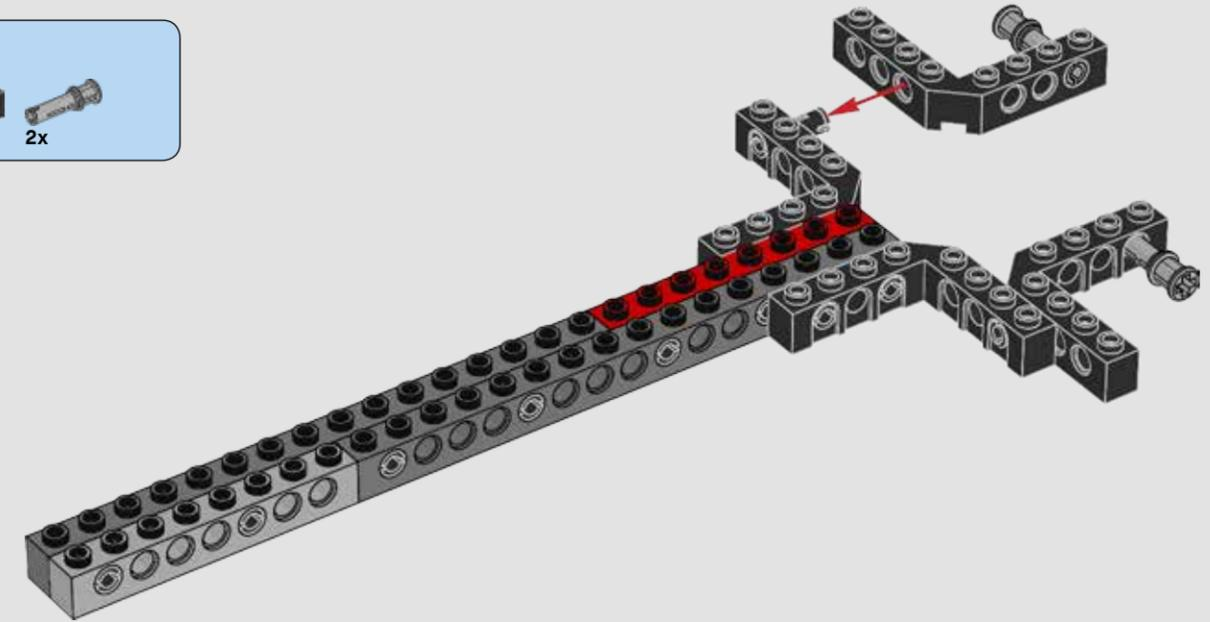

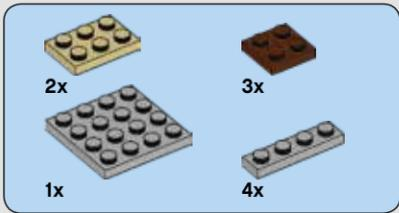

6

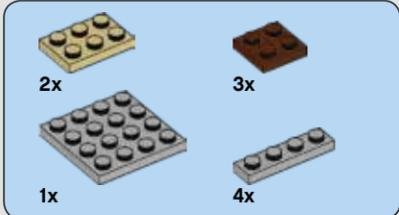
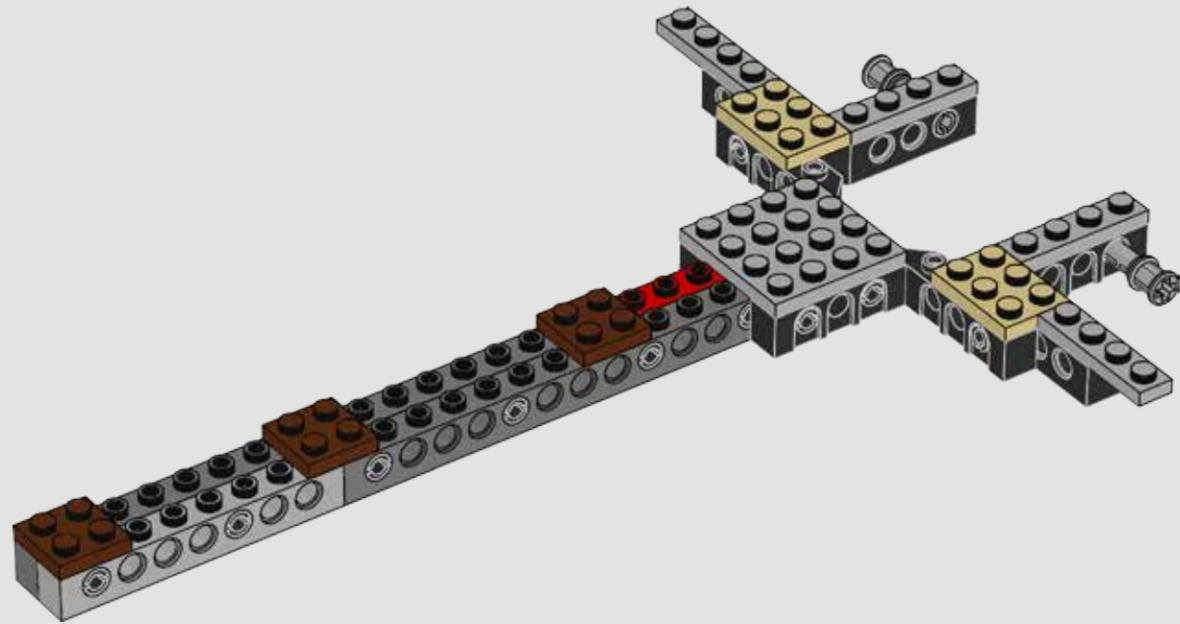

7

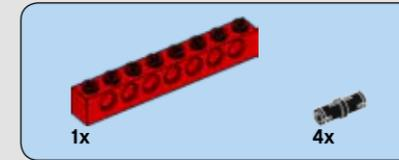
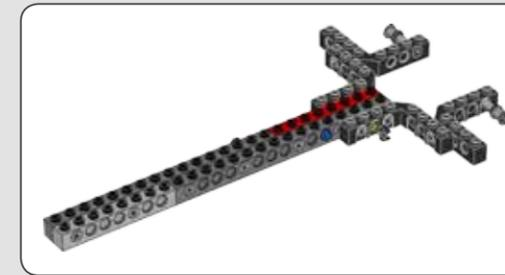
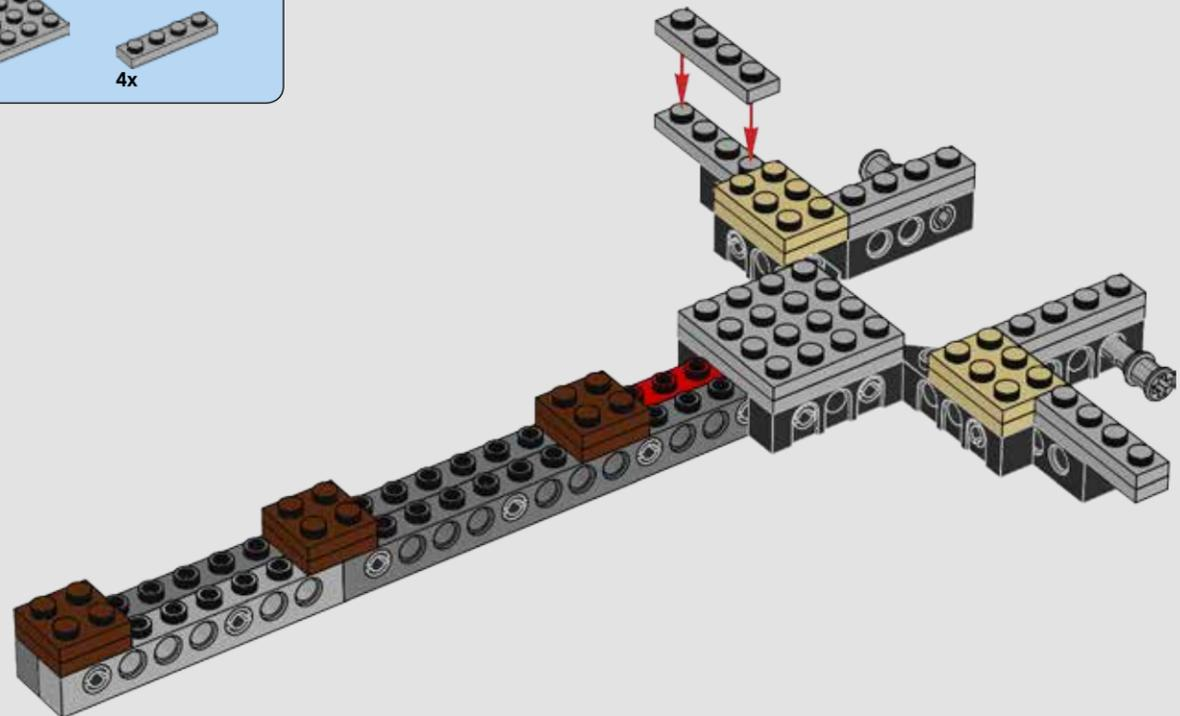

8

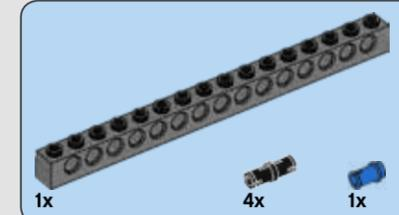

9

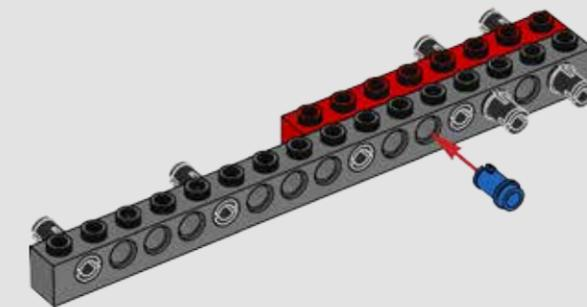

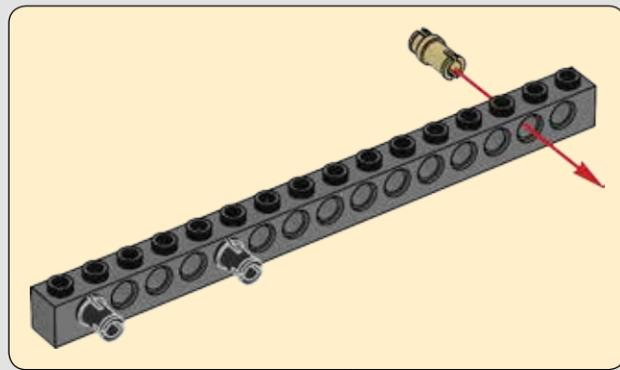
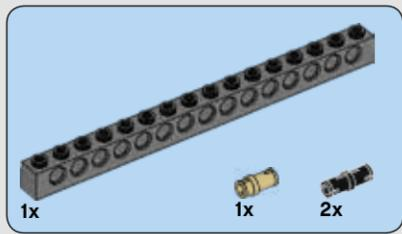

10

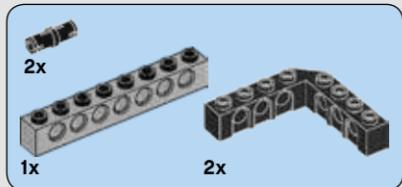
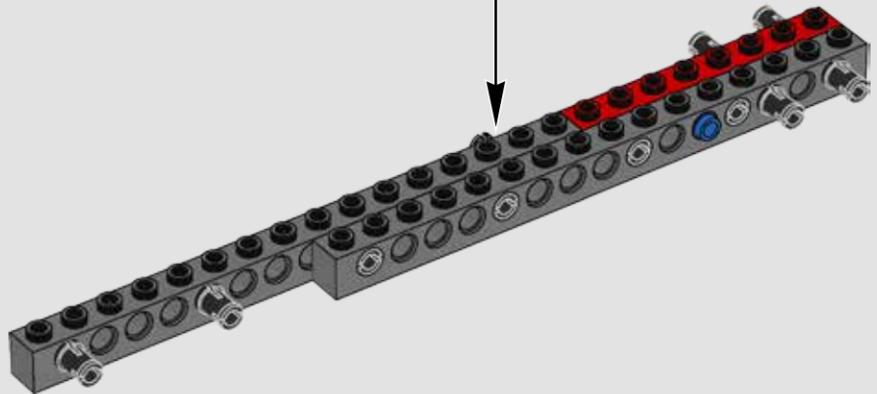

11

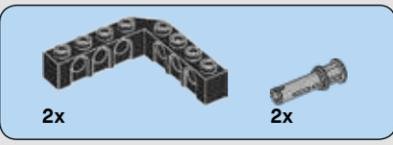
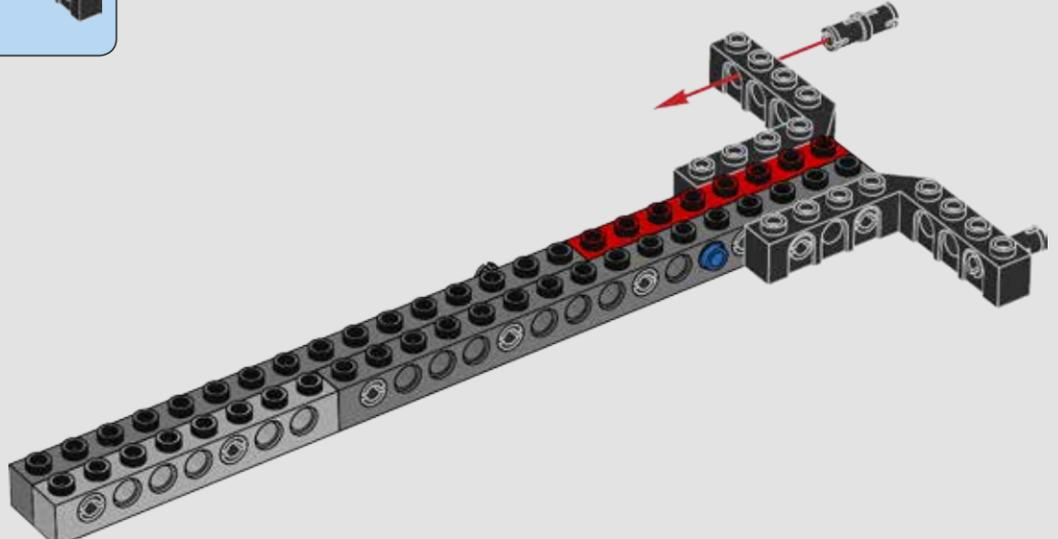

12

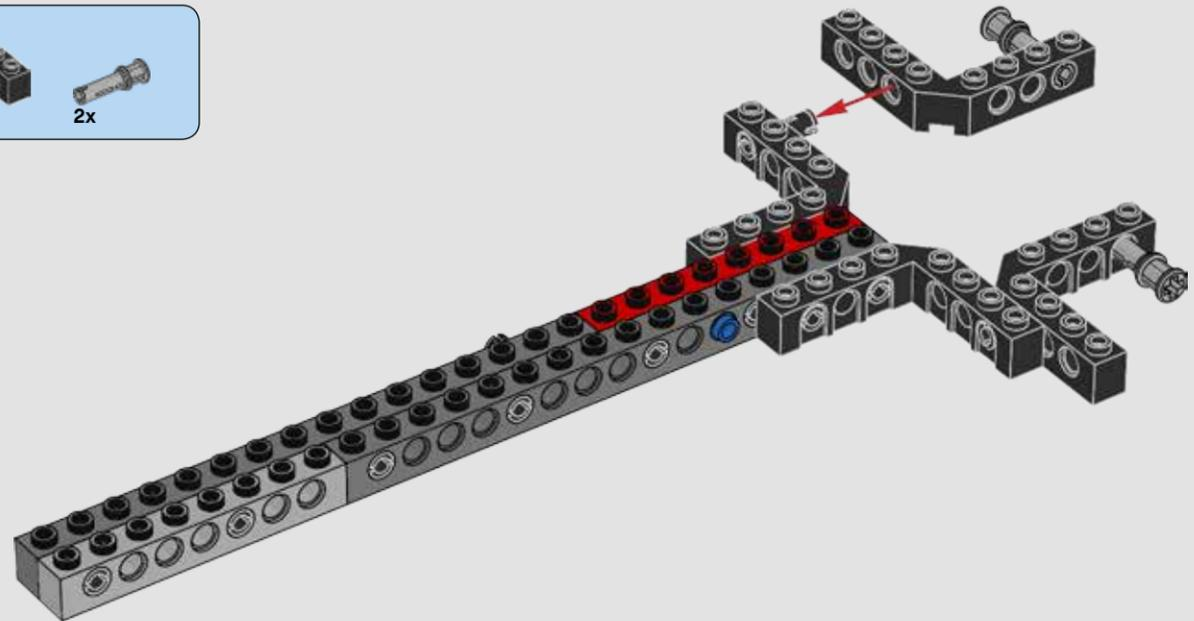

13

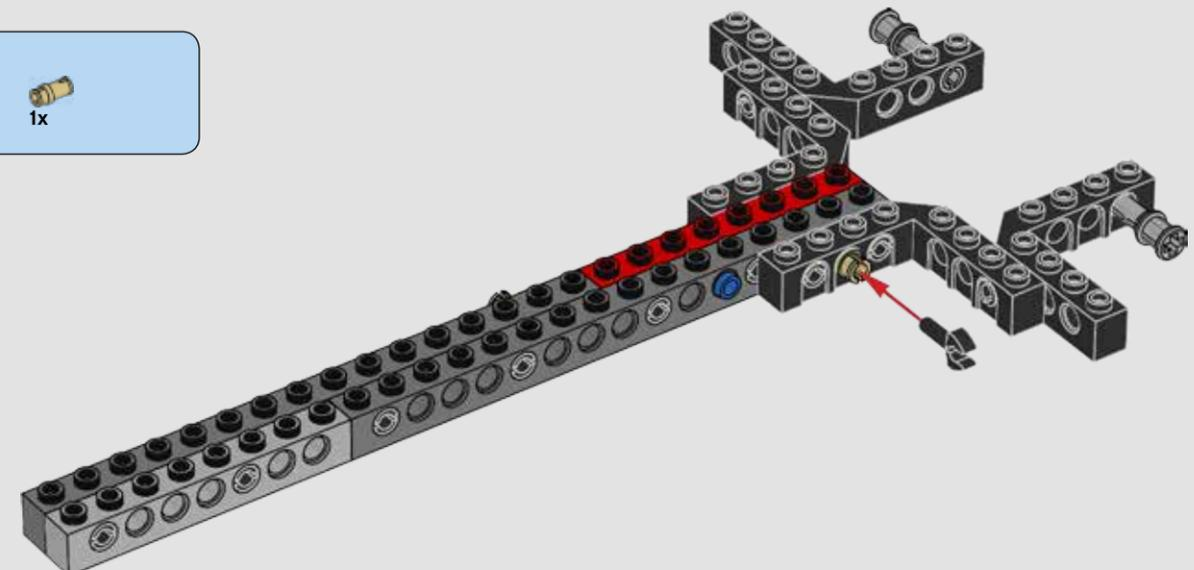

14

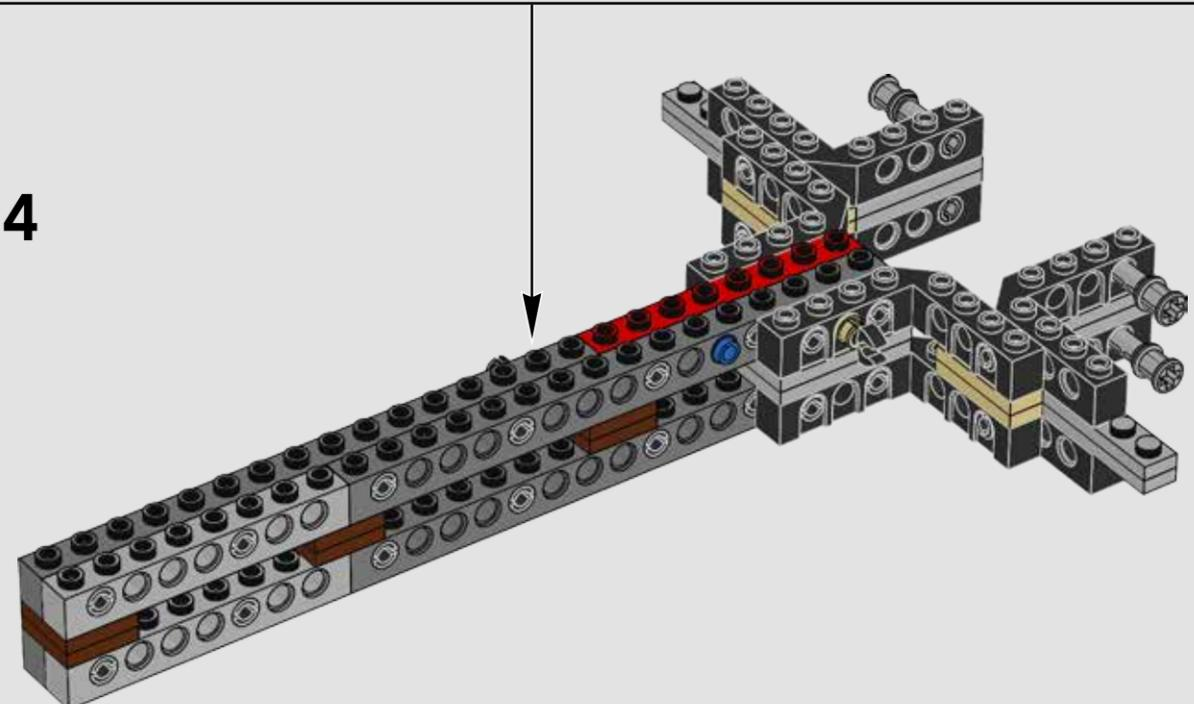

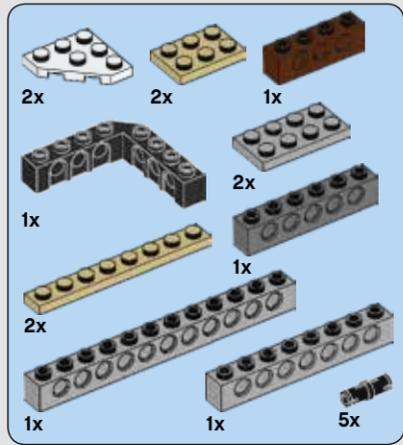

1

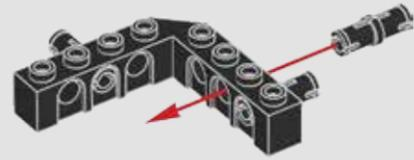

15

2

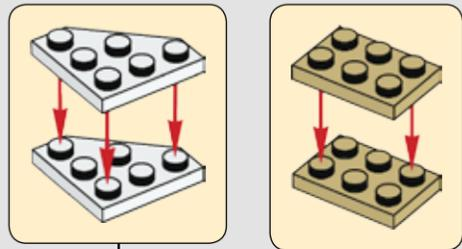
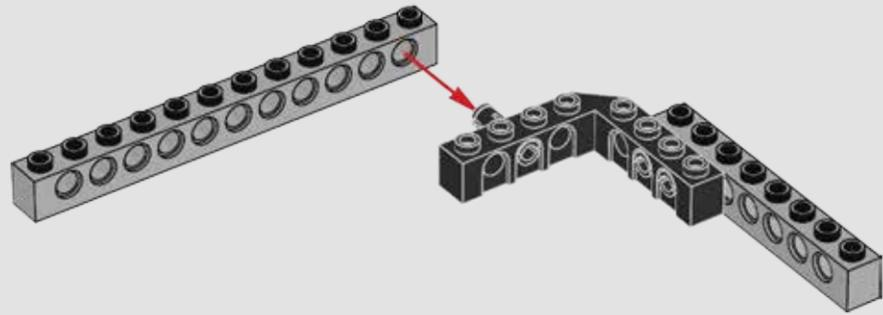

3

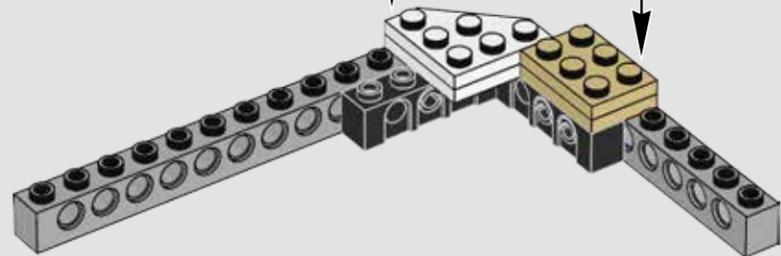

4

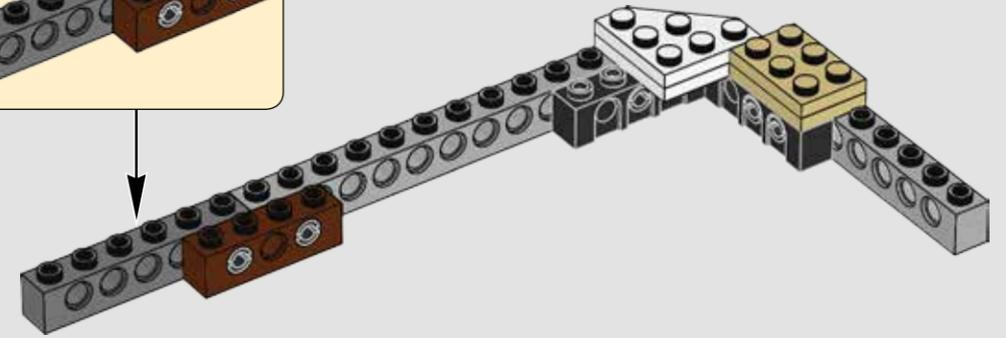
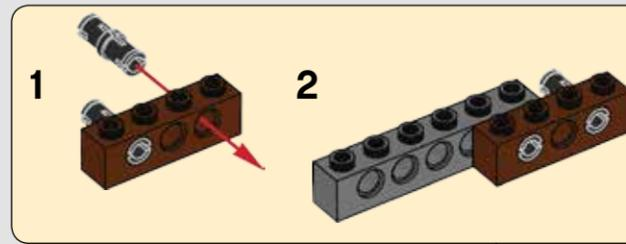

5

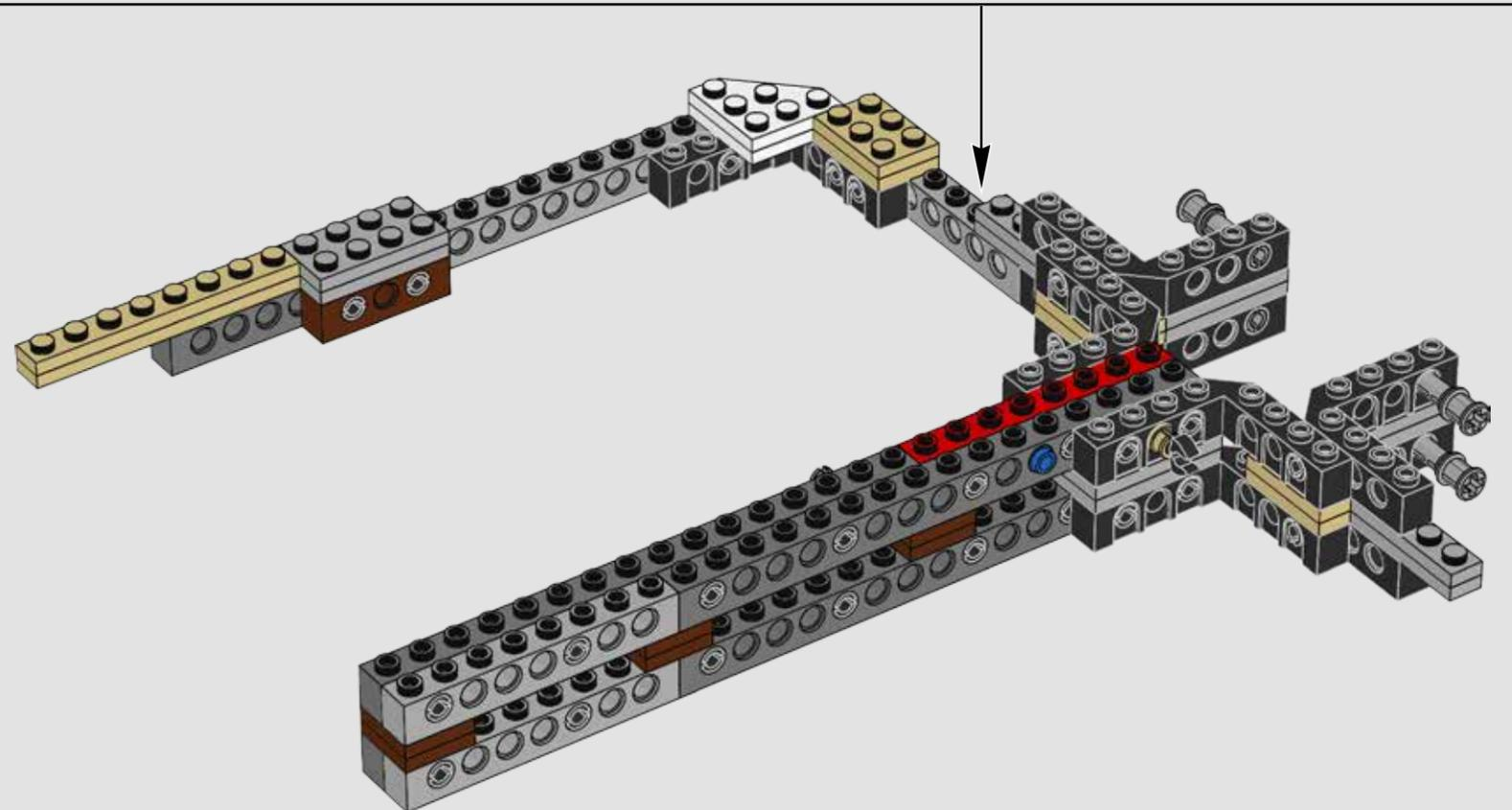
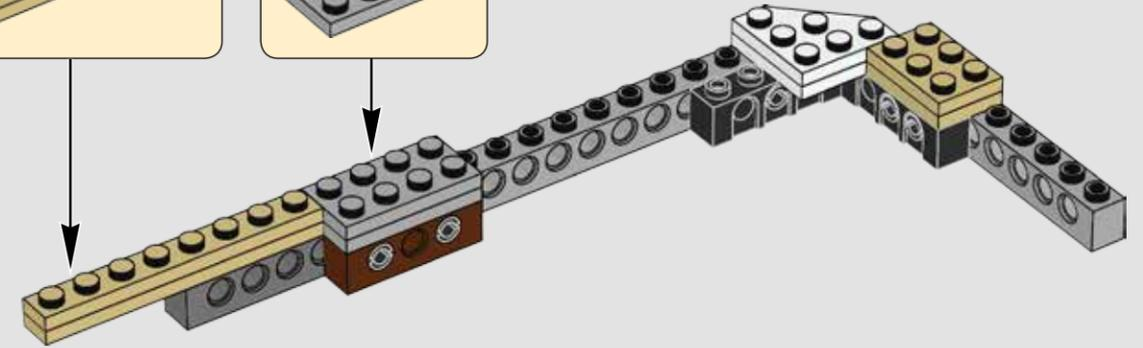
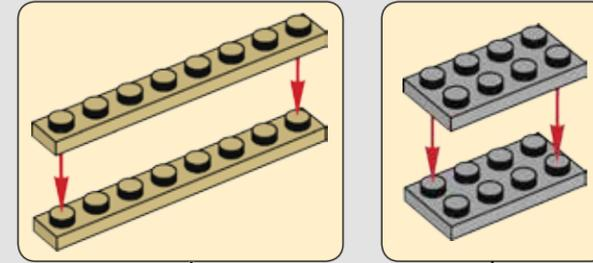

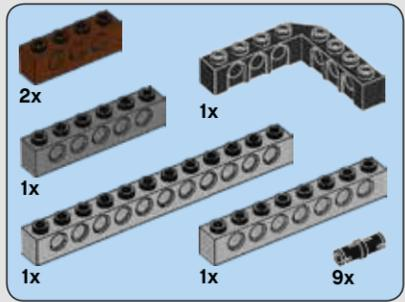

16

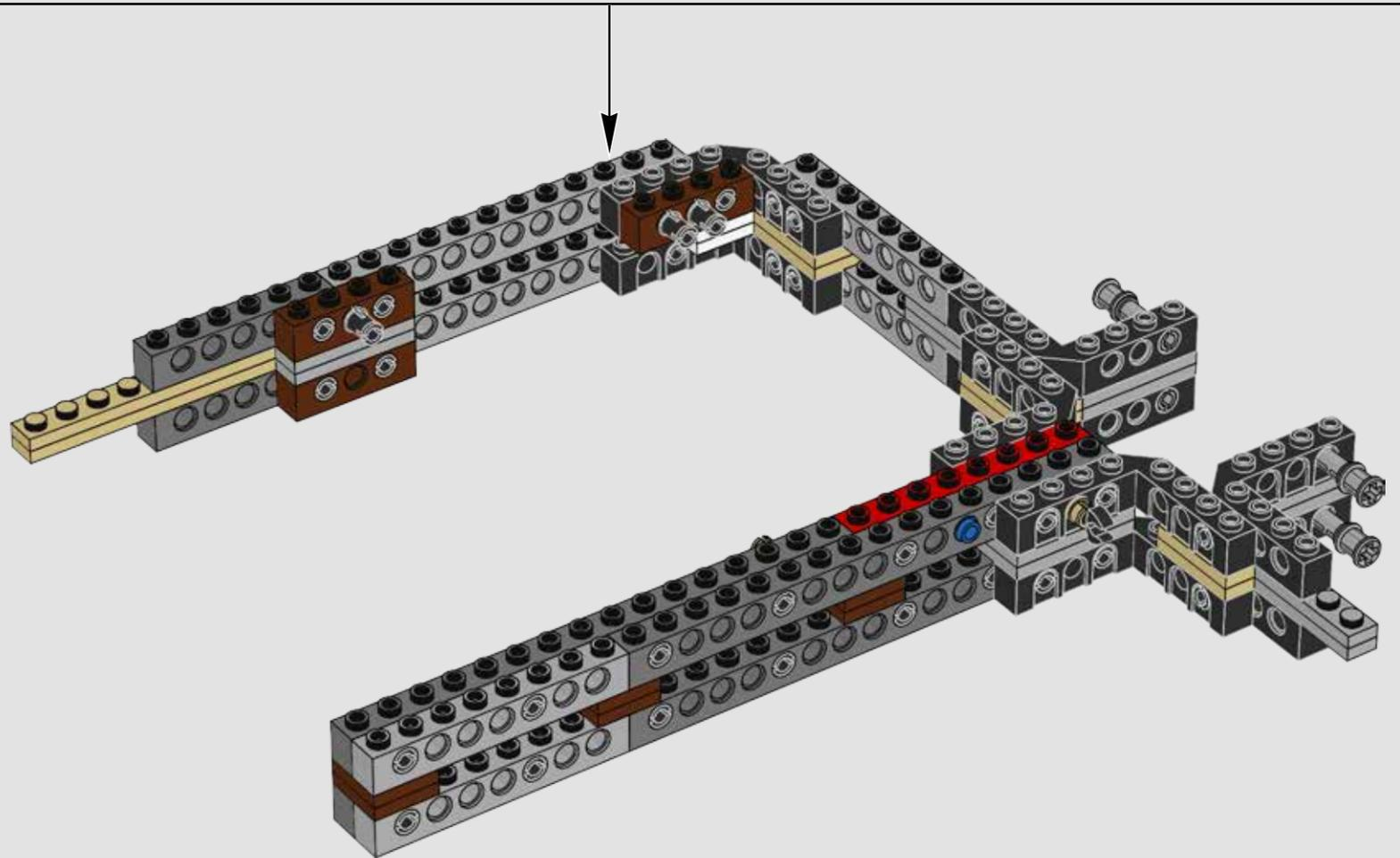
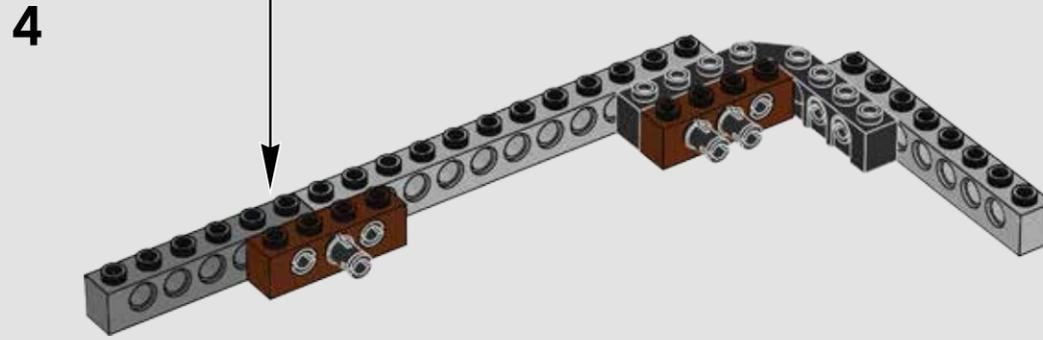
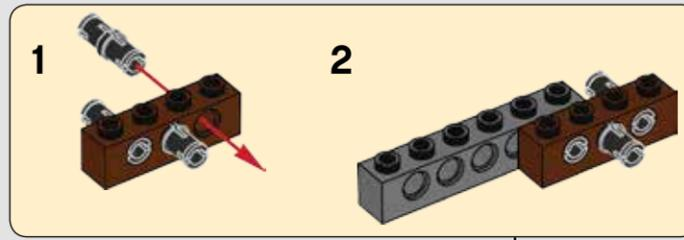
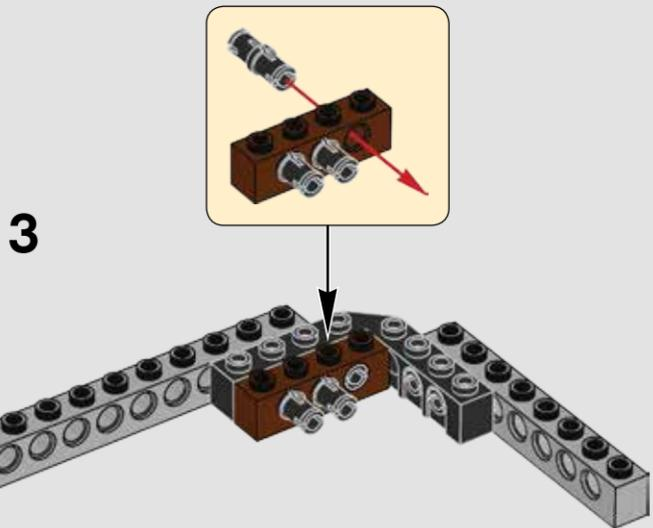
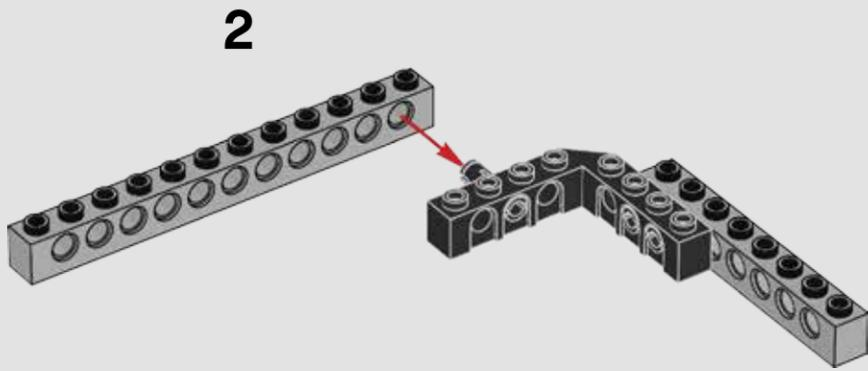
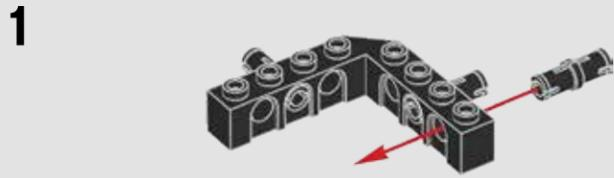

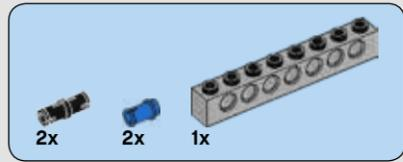
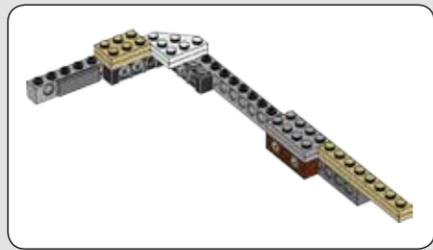

17

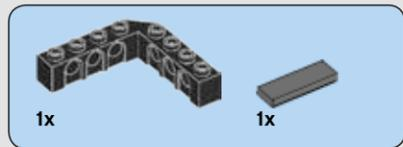
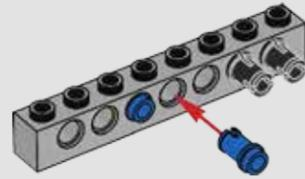

18

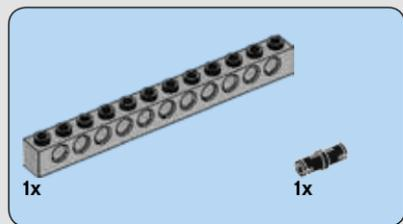
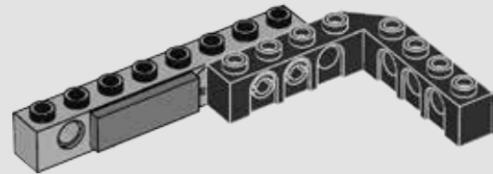

19

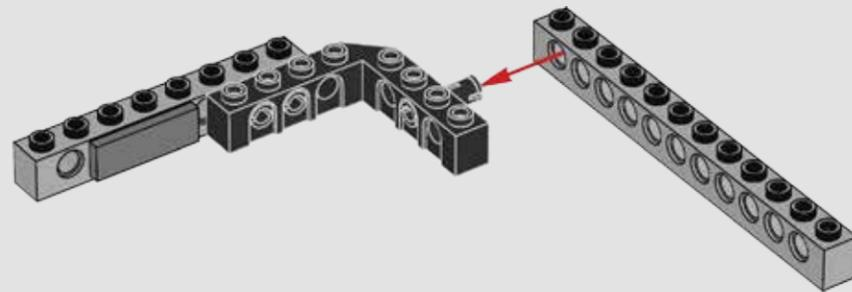

20

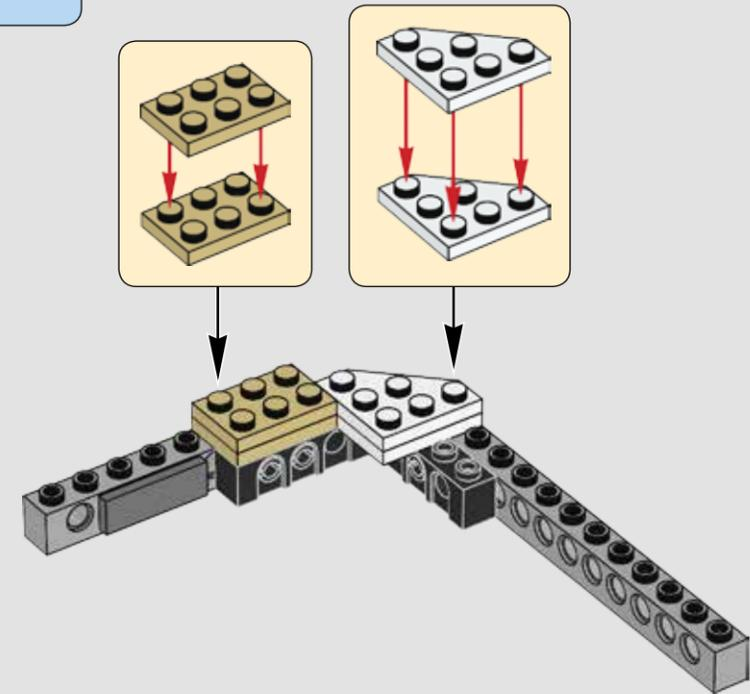

21

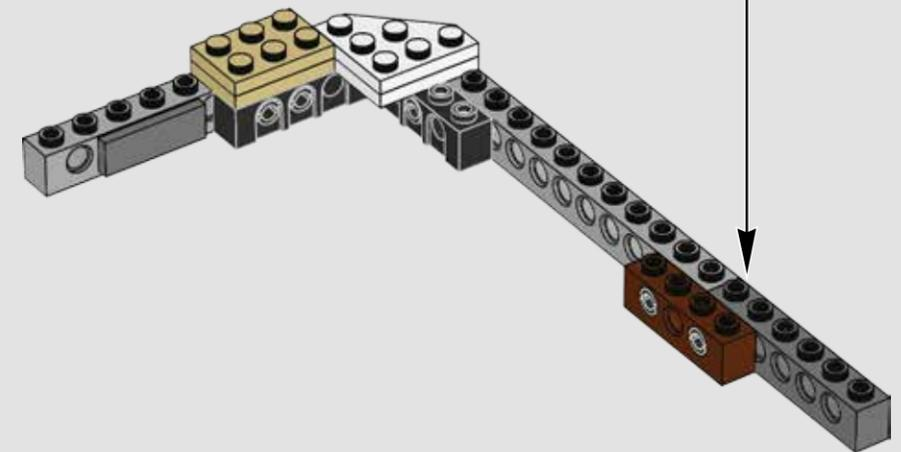
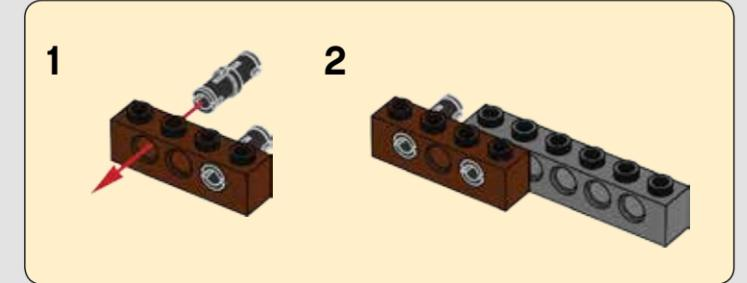

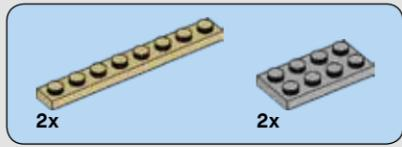

22

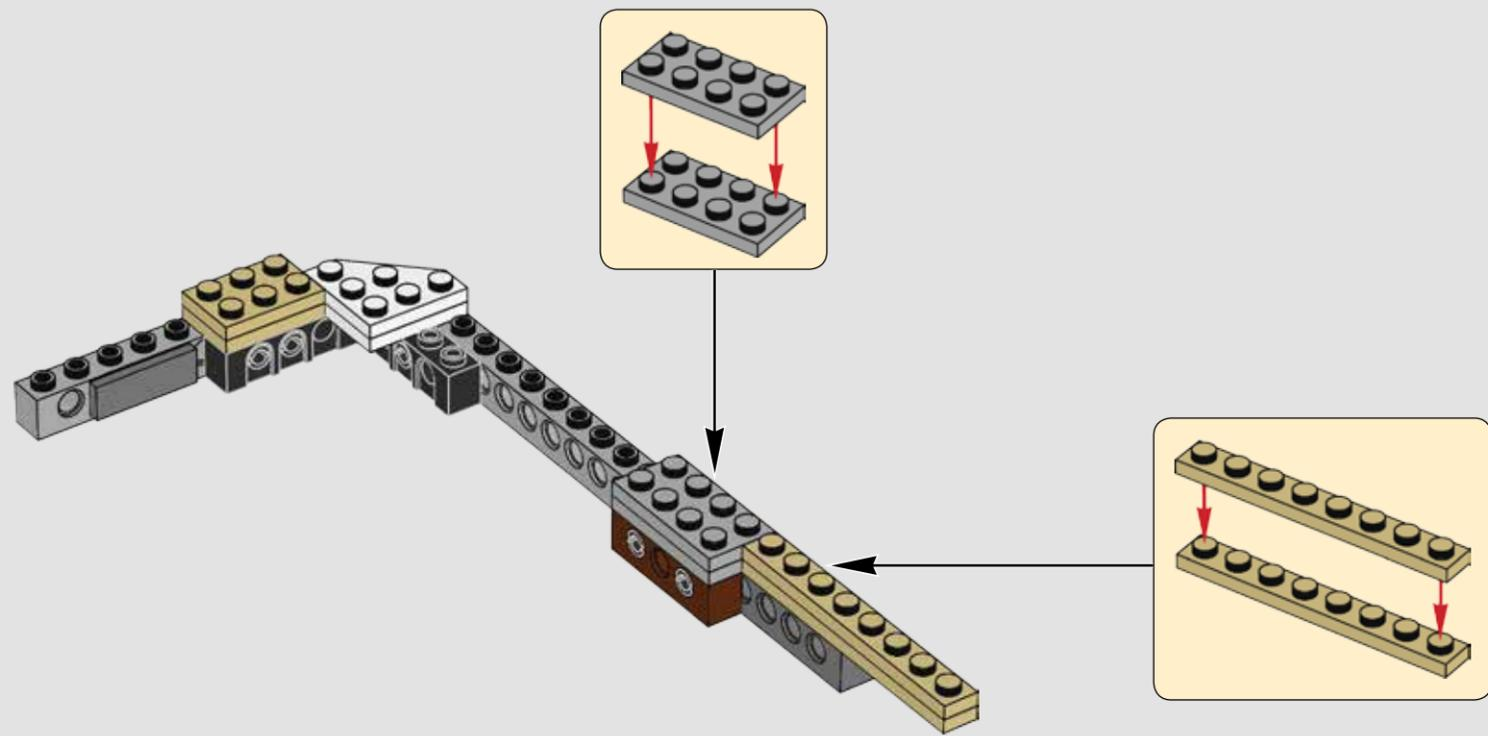

23

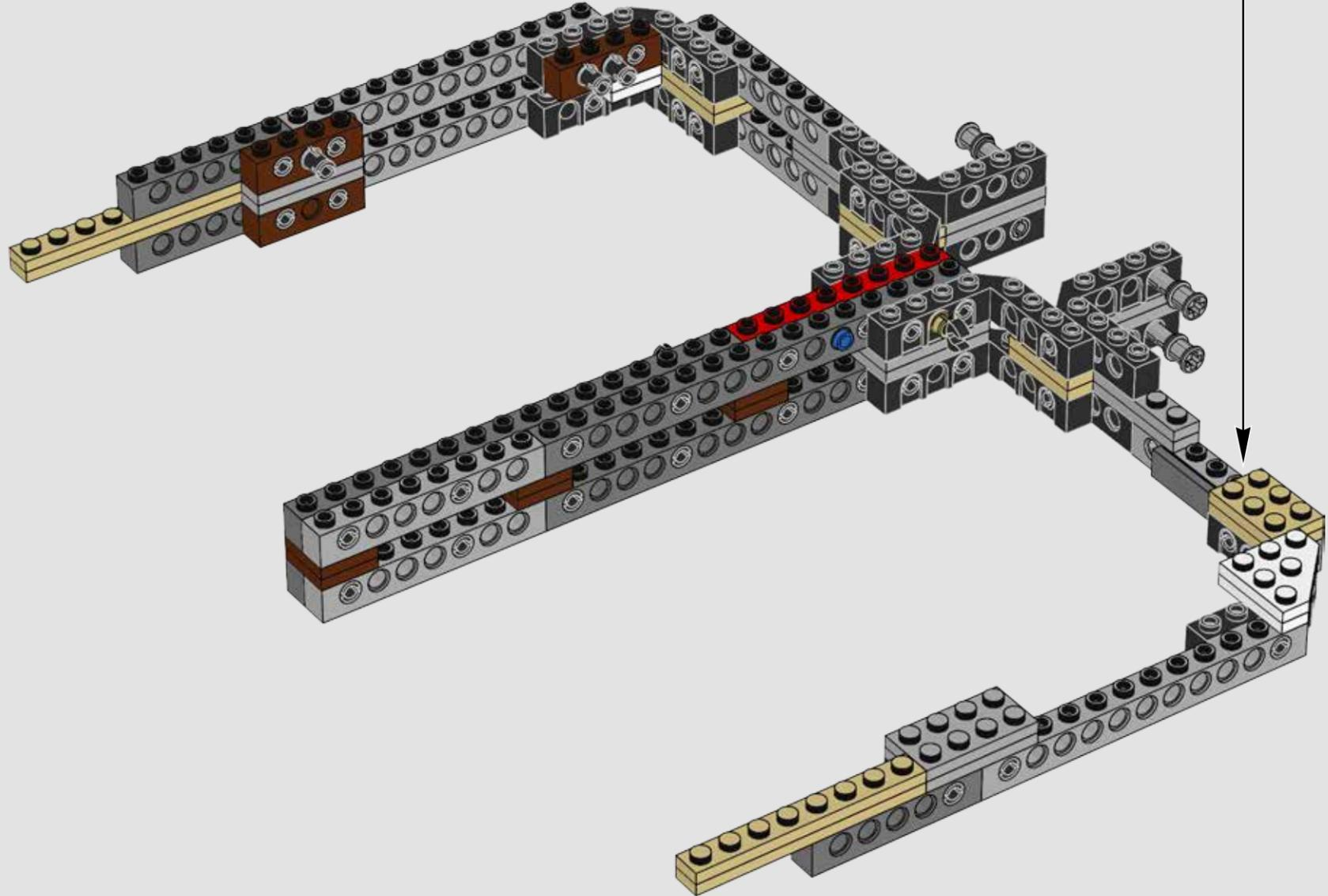

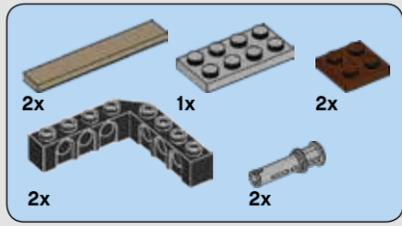

25

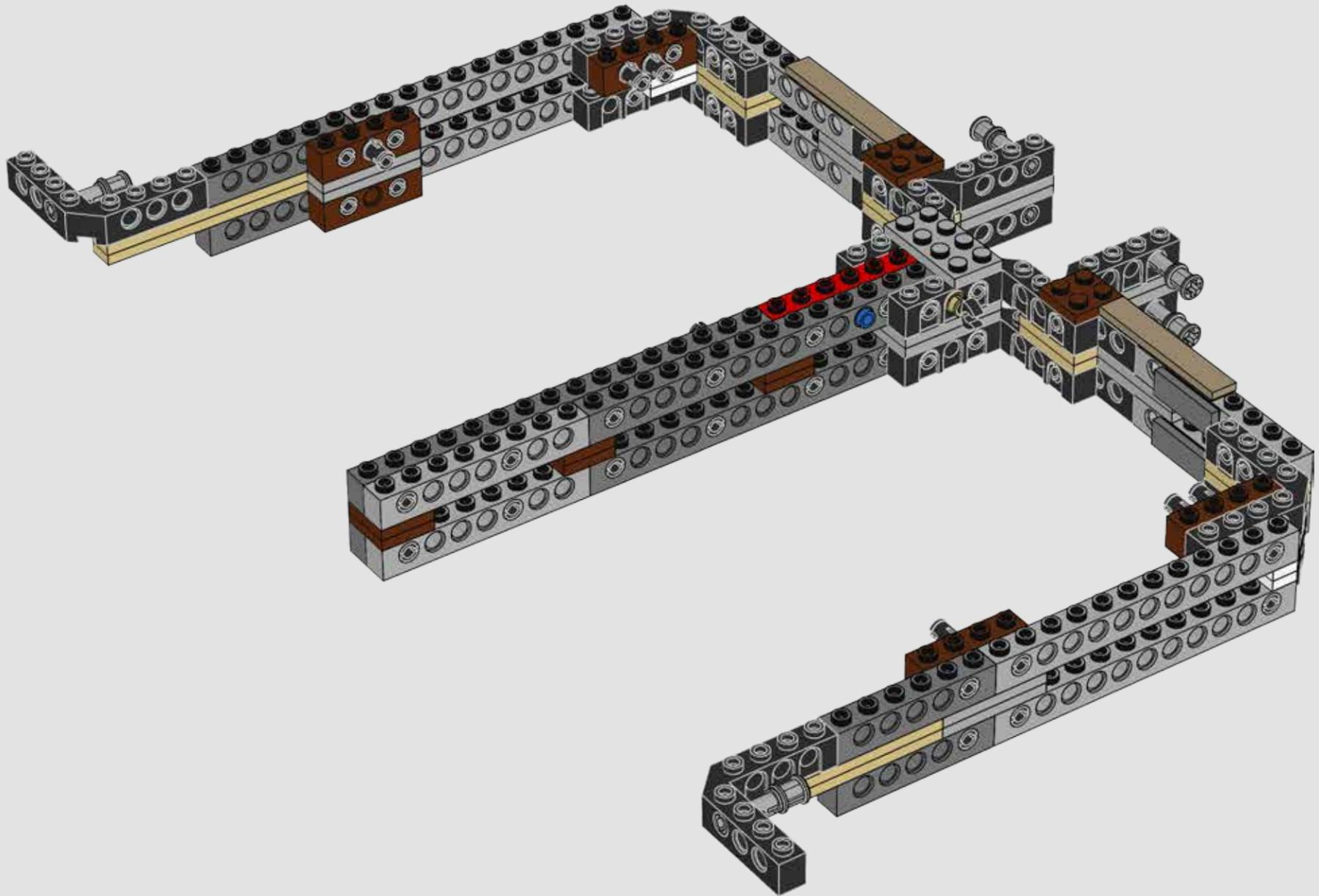

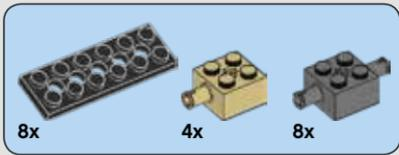

26

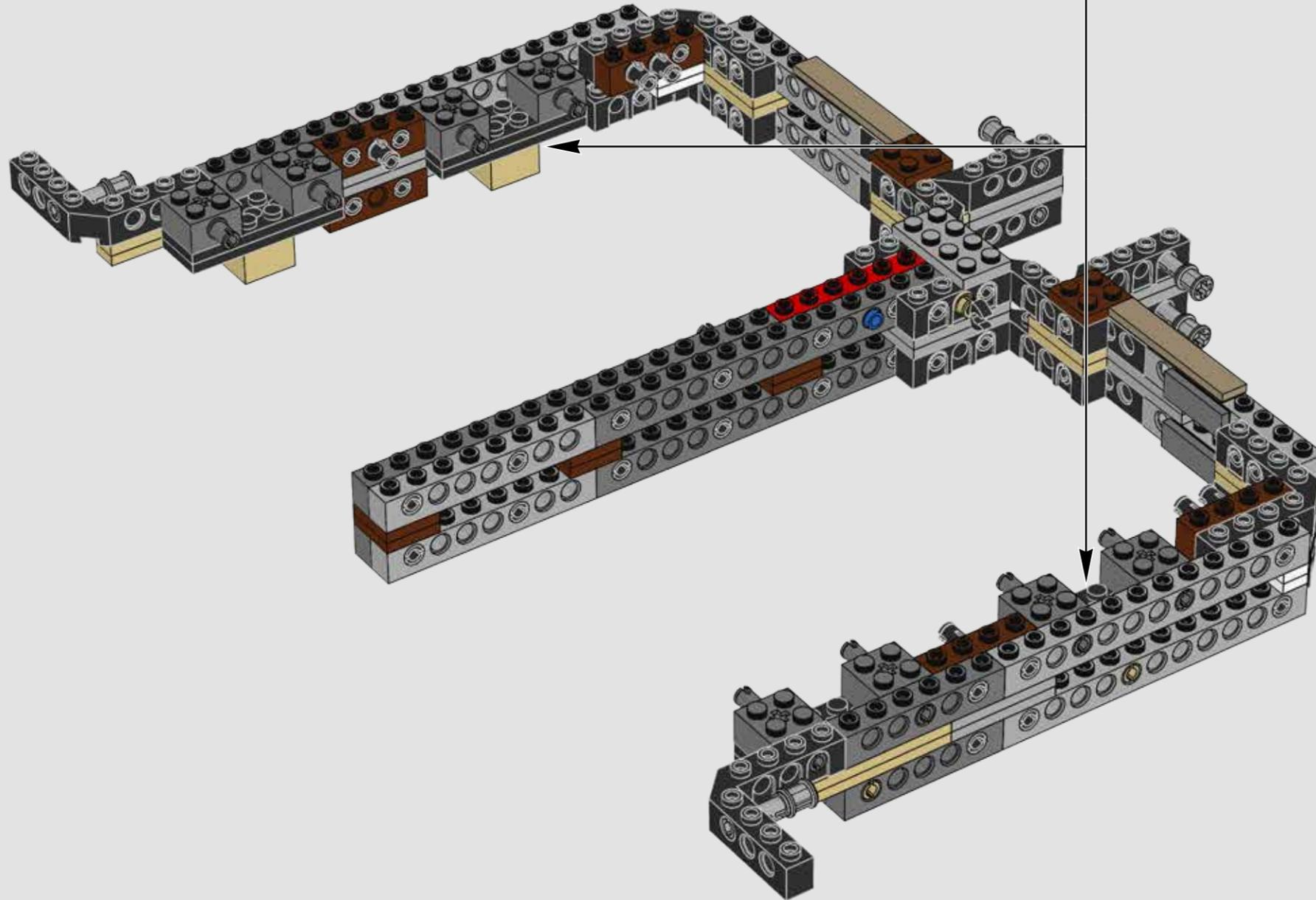
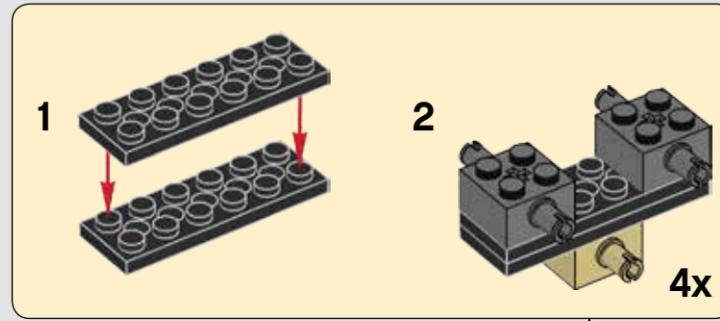

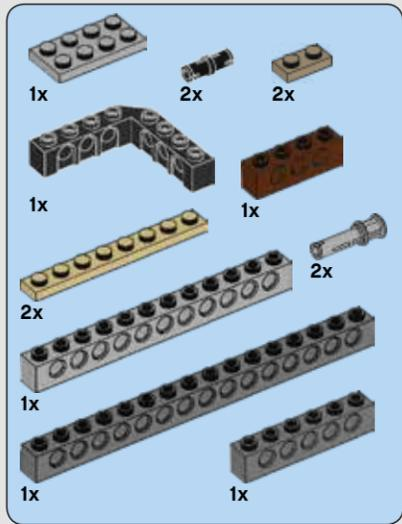

27

1

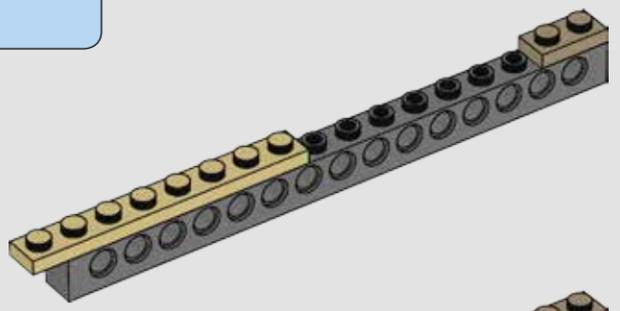

2

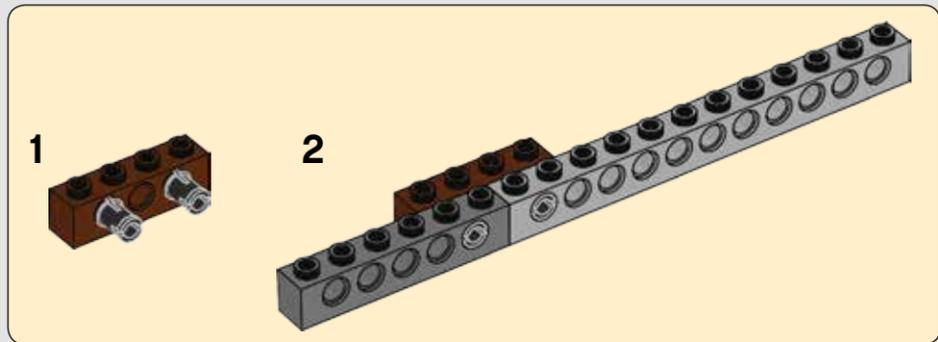
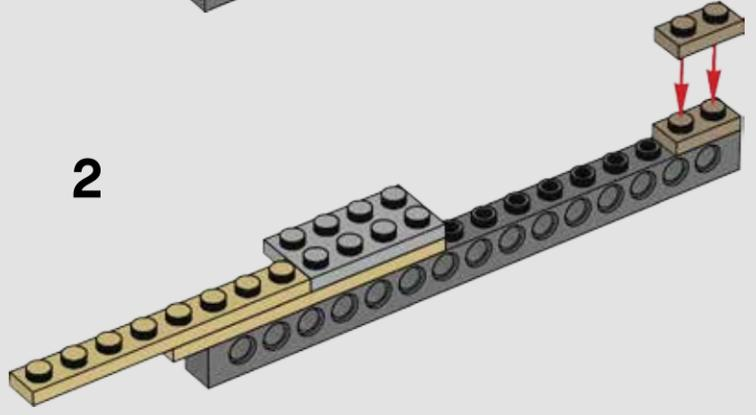

3

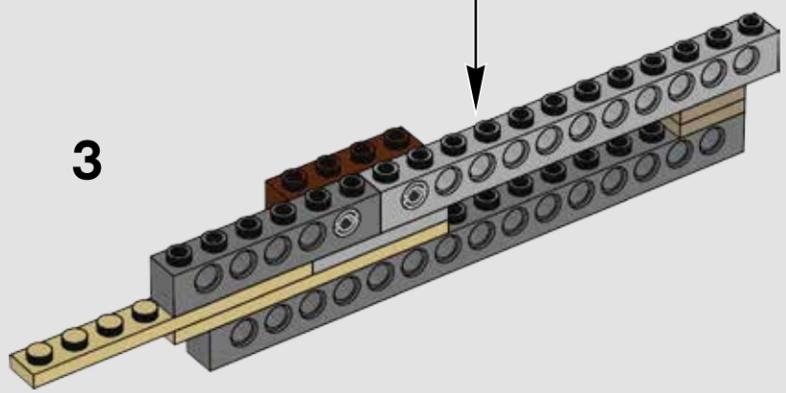

4

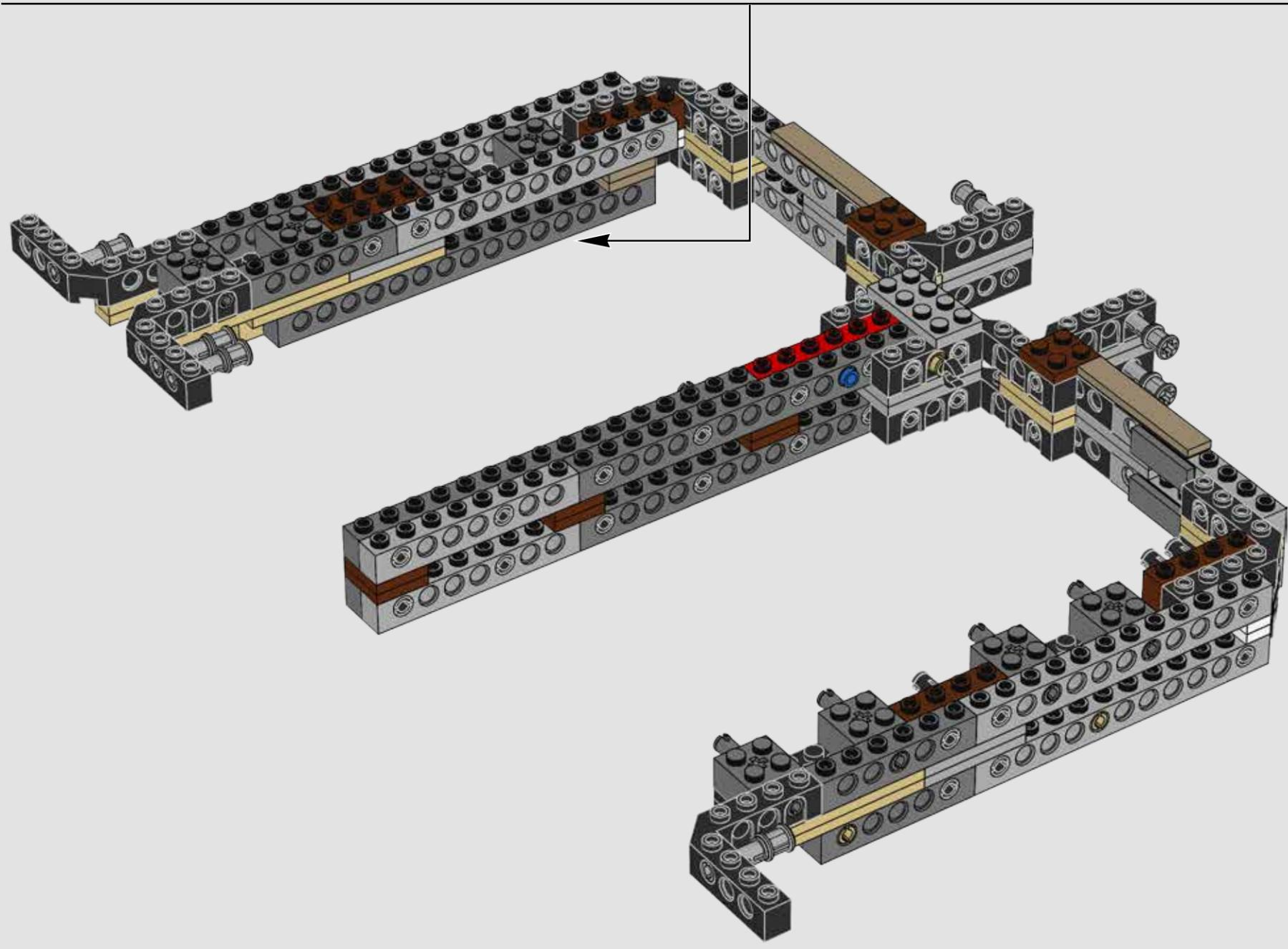
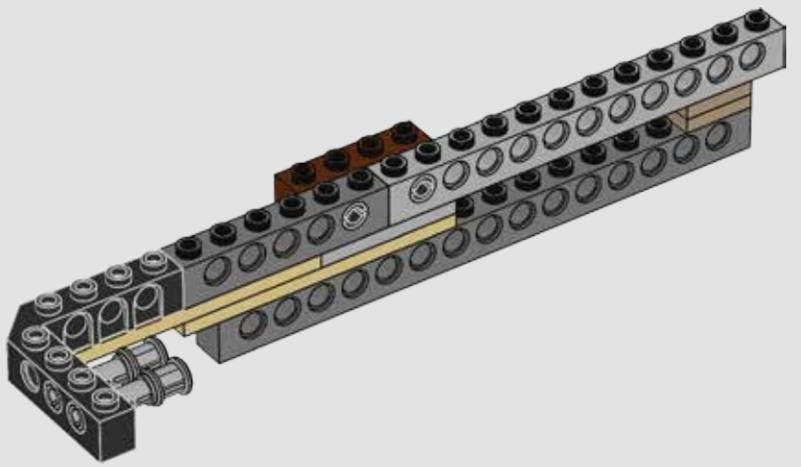

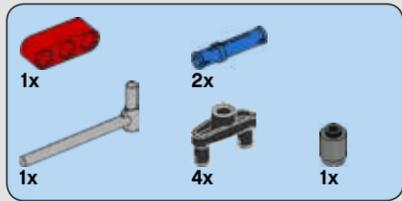

29

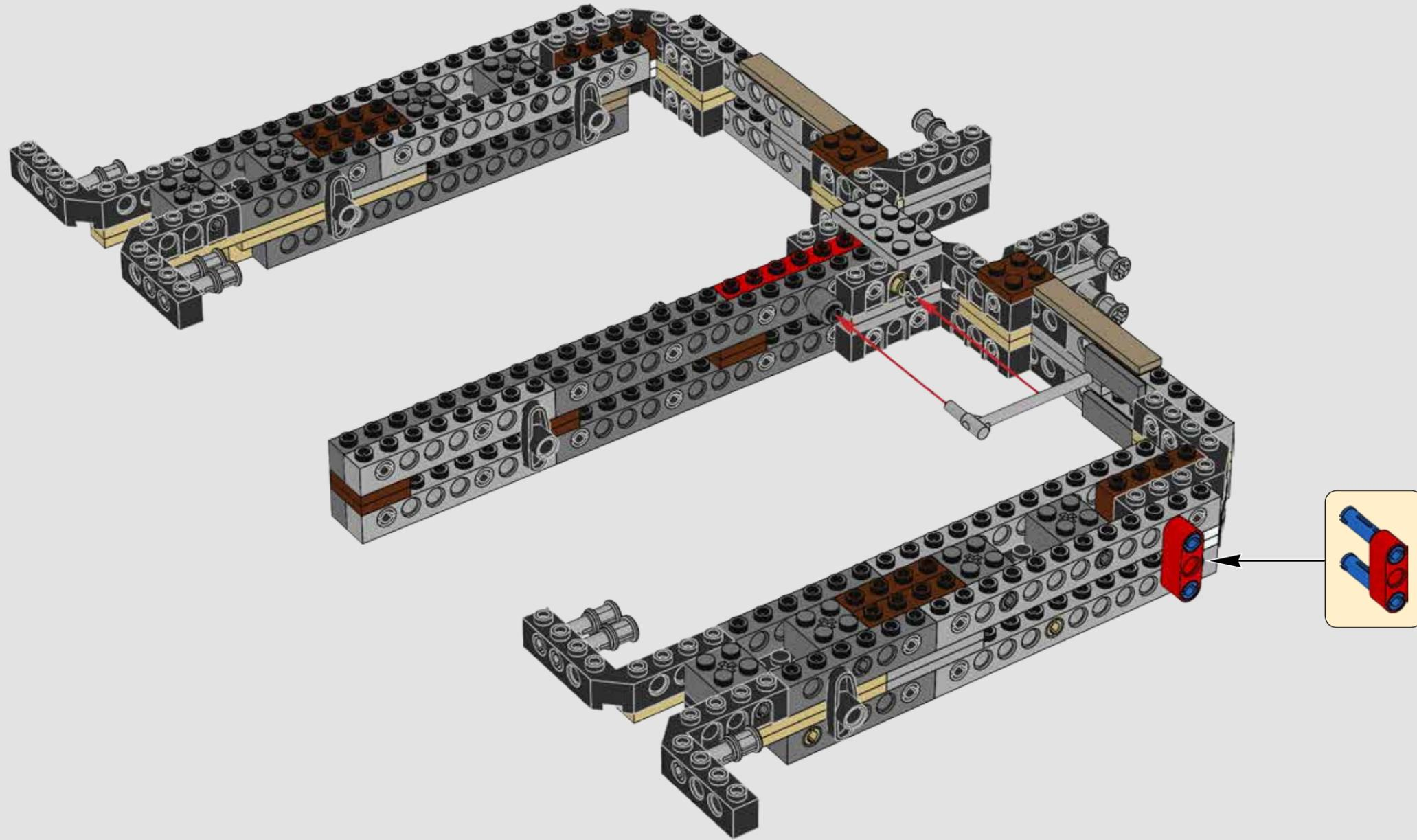

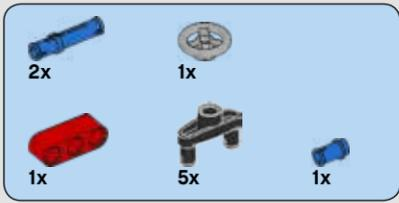

30

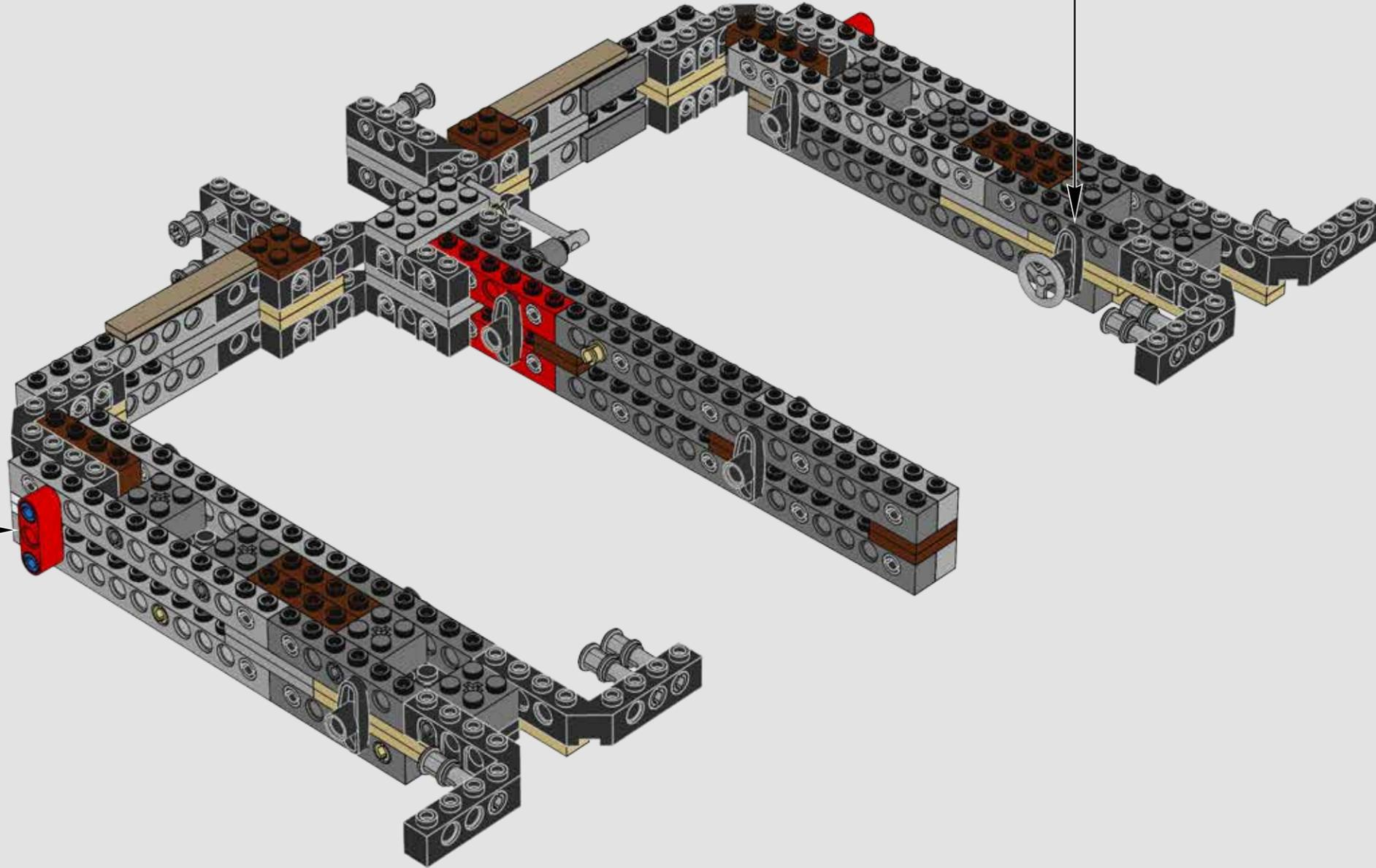
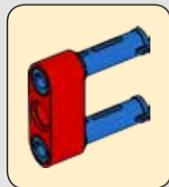
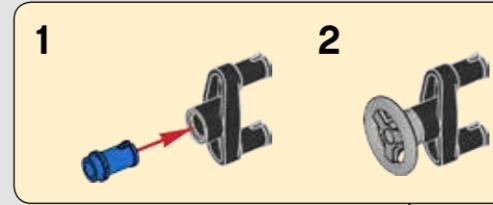

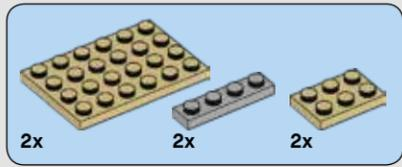

31

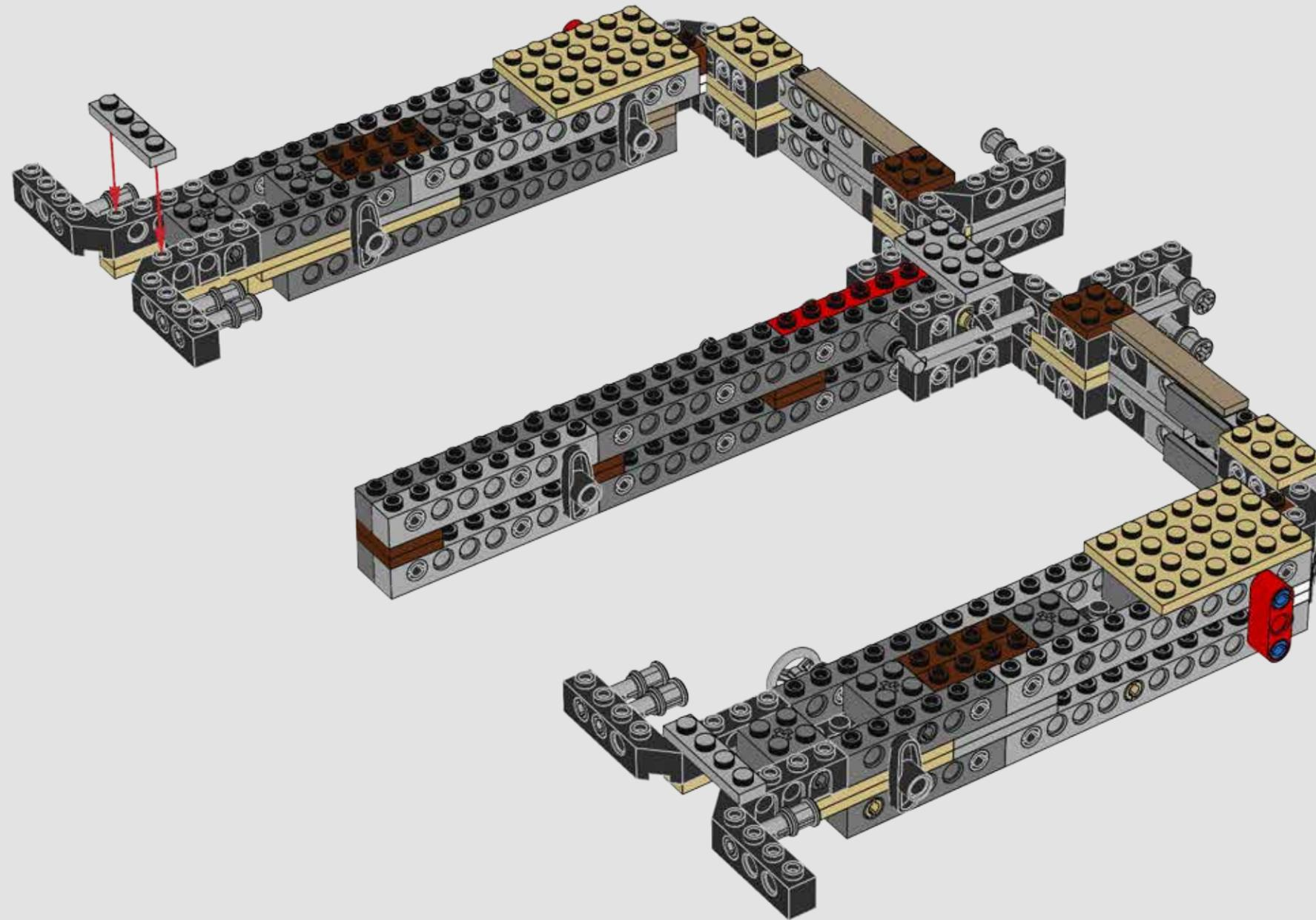

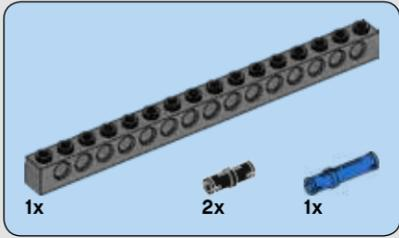
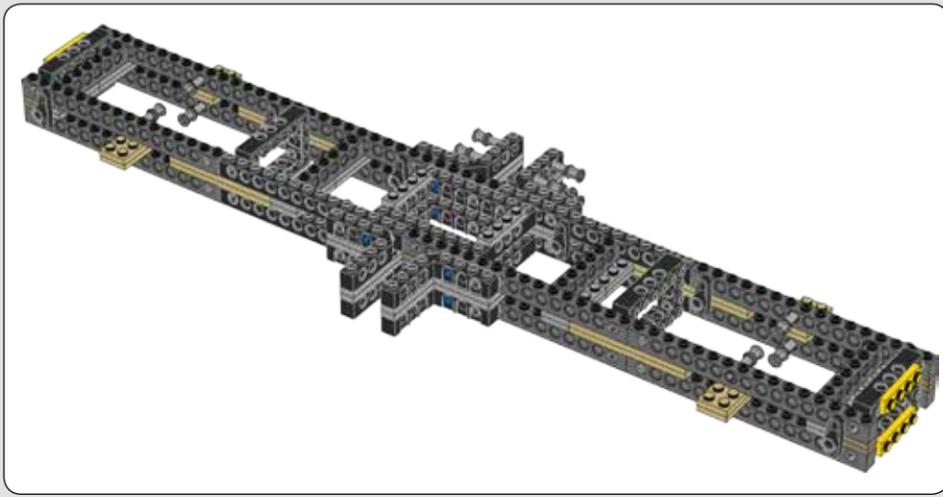

32

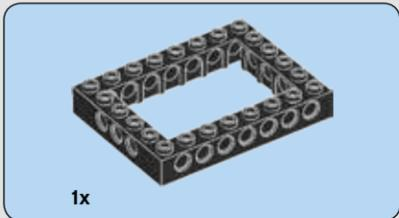
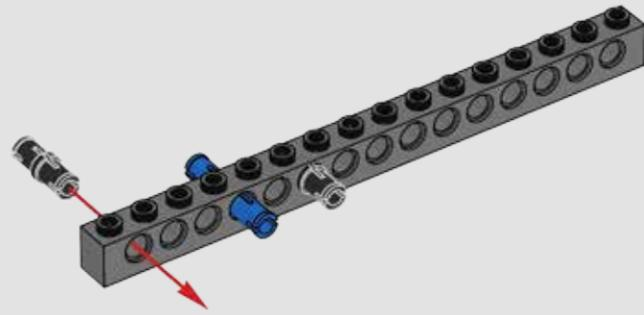

33

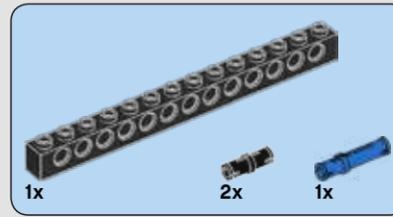
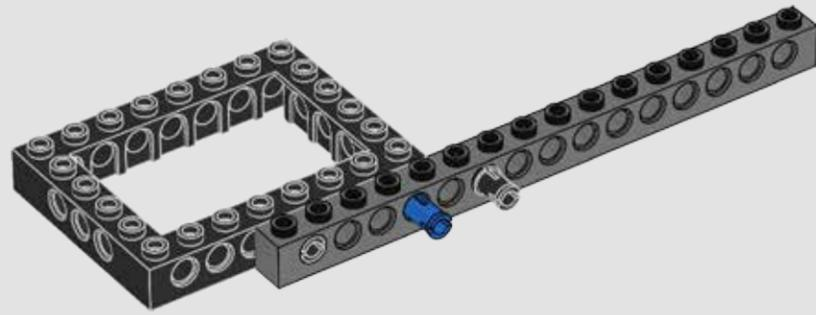

34

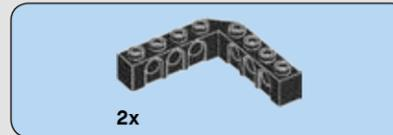
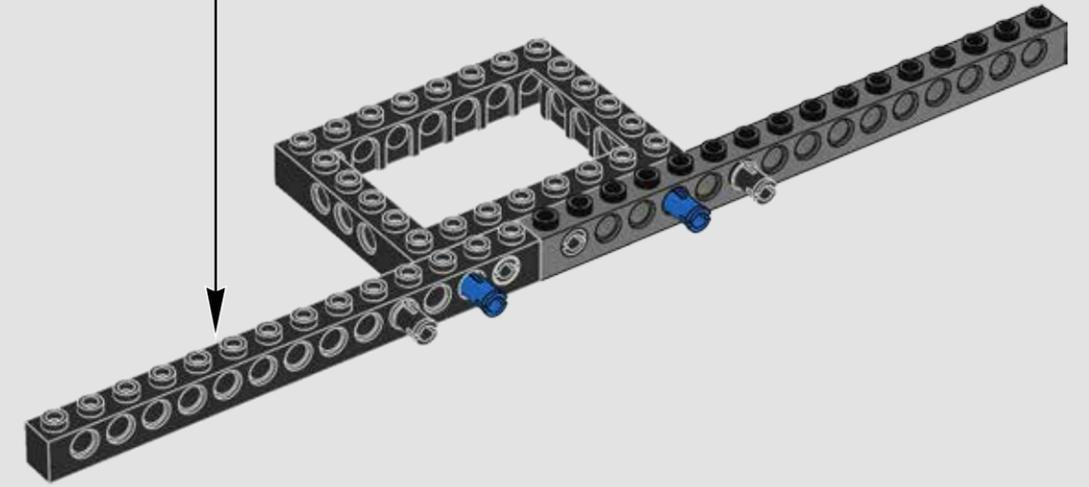
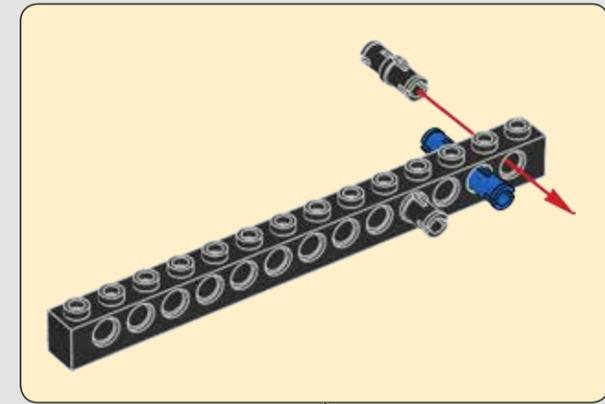

35

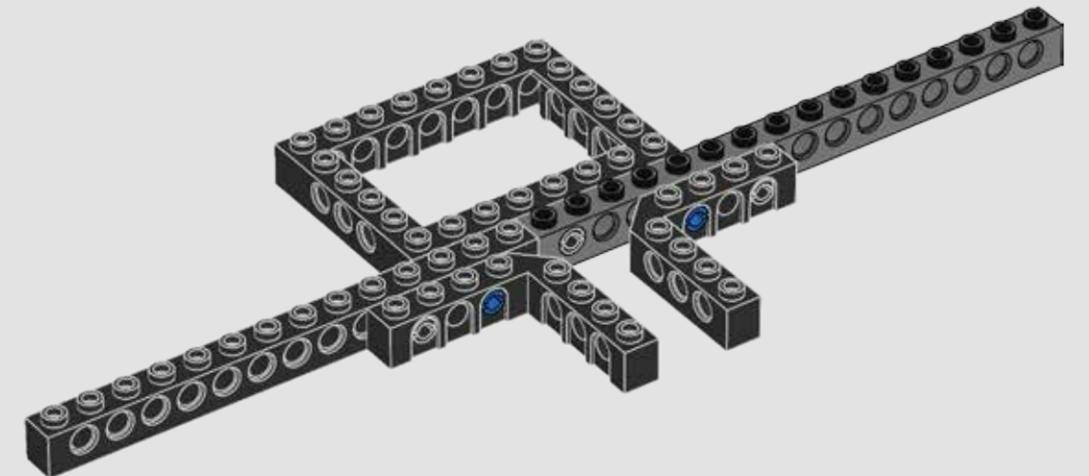

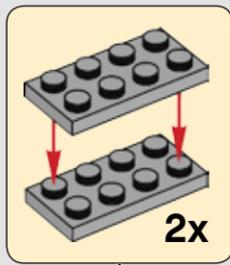
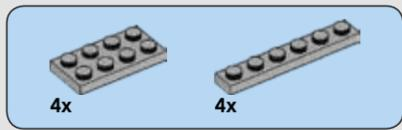

36

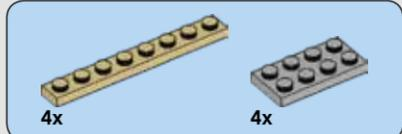
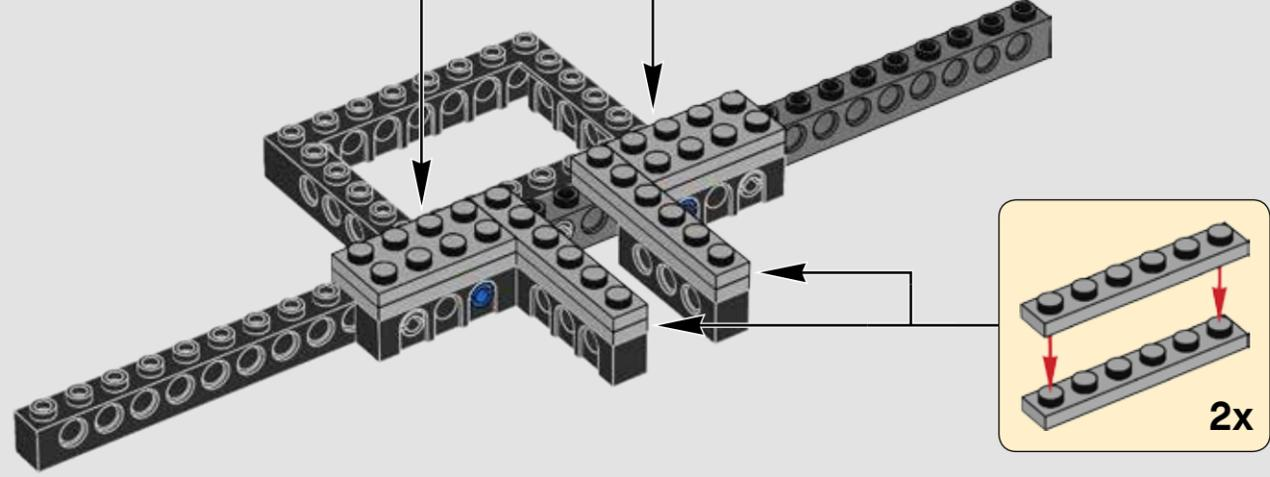

37

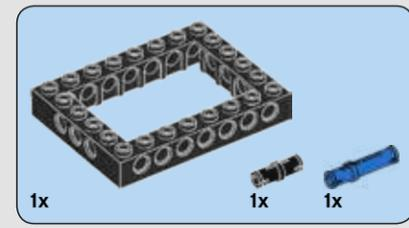
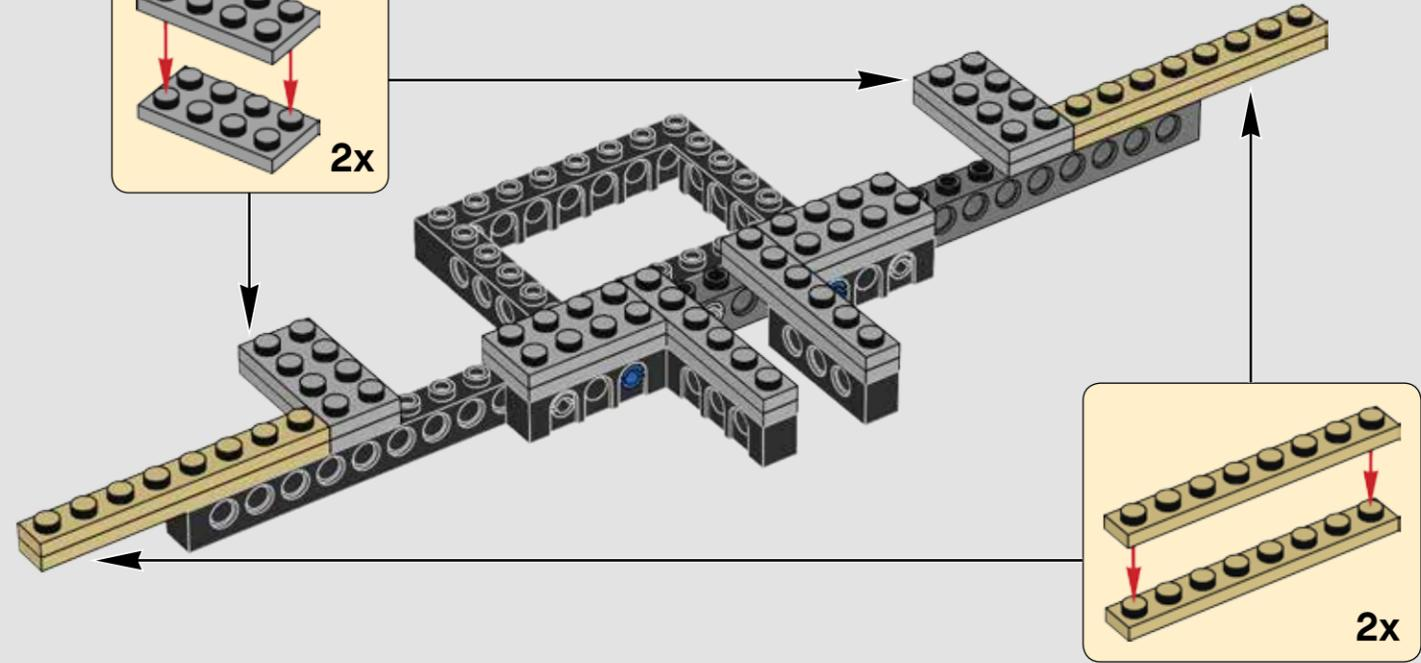
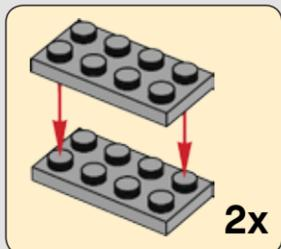

38

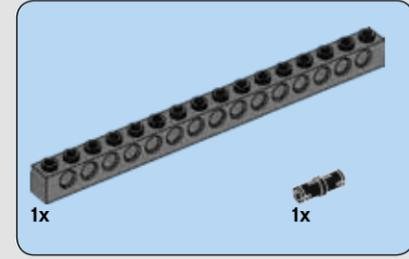
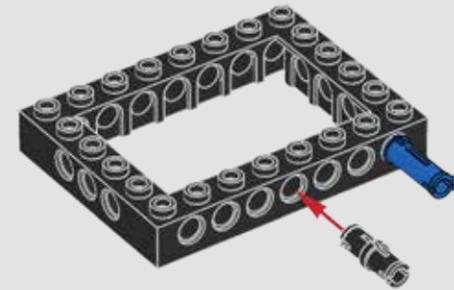

39

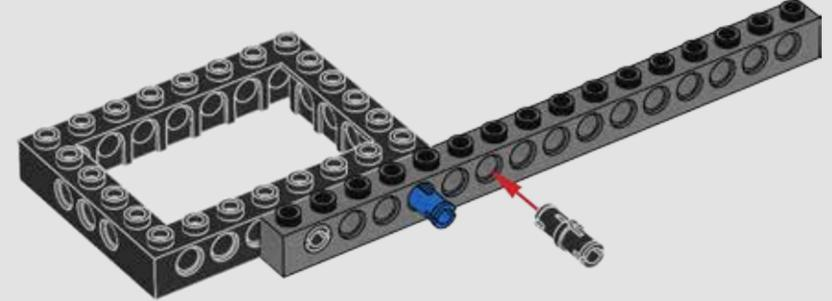

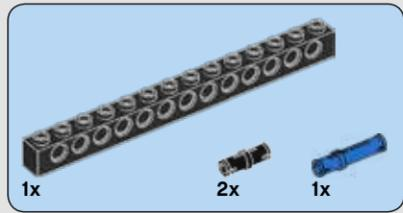

40

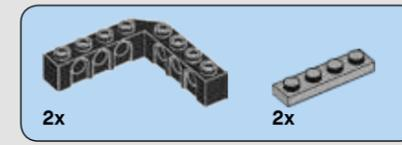
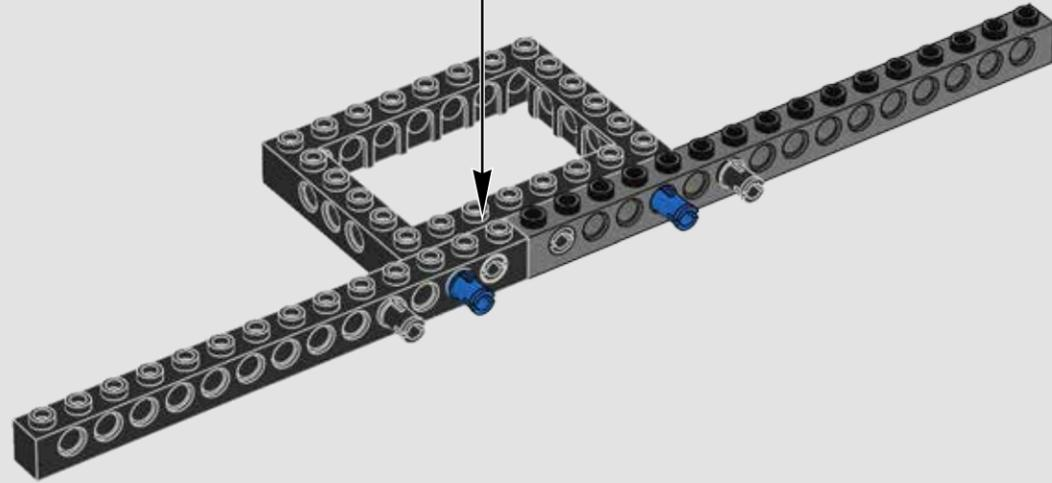
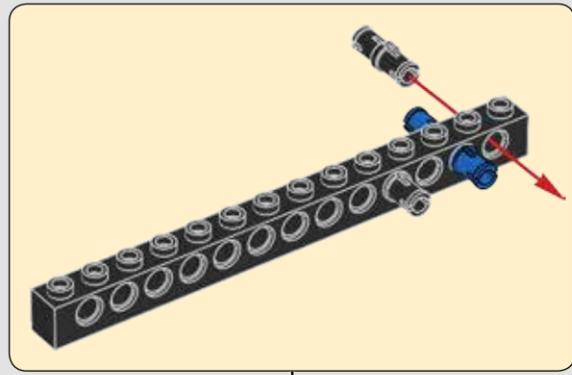

41

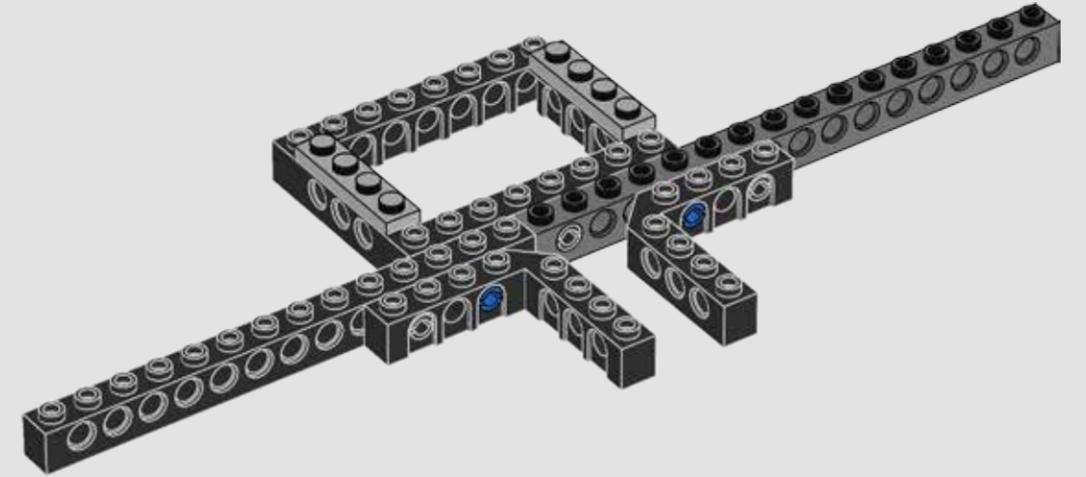

42

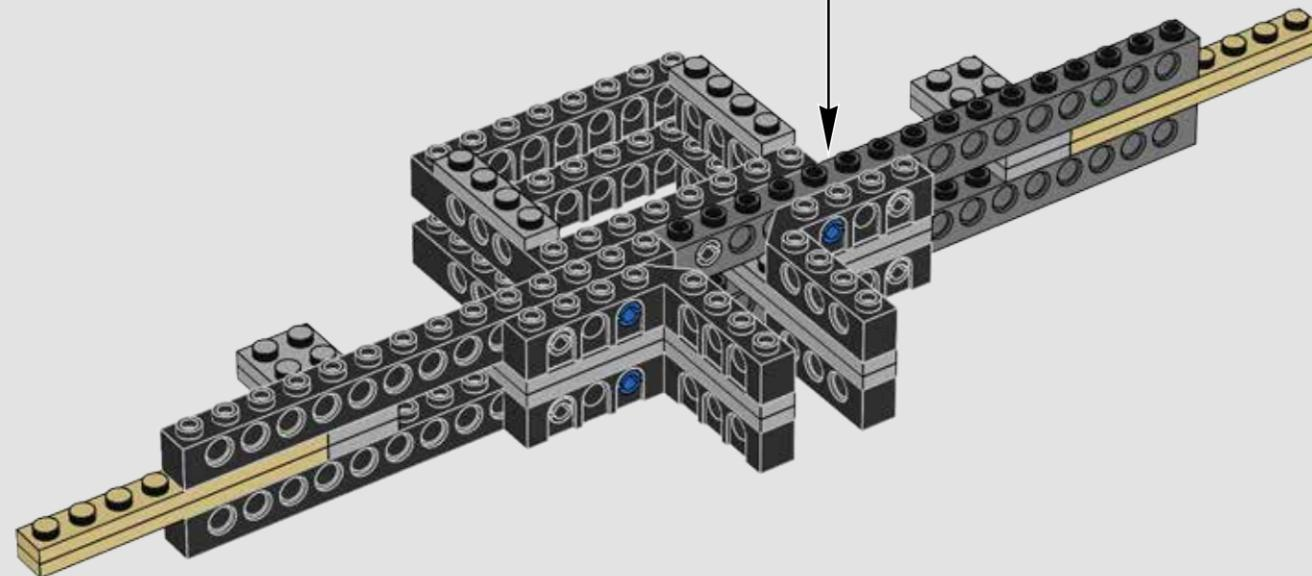



43

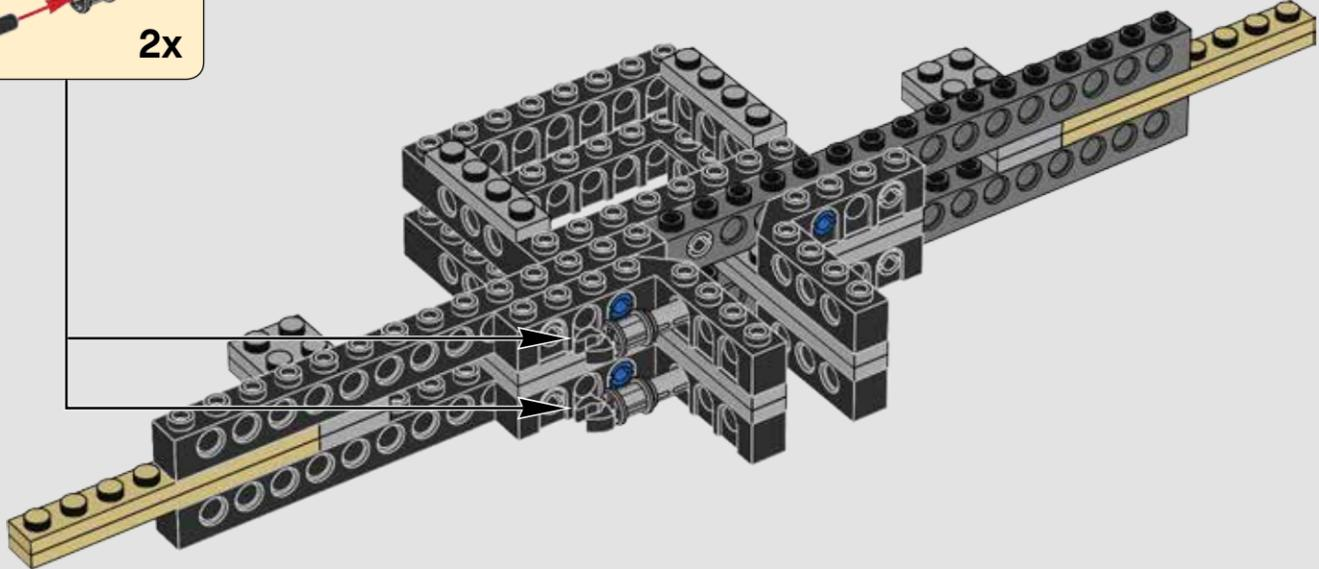
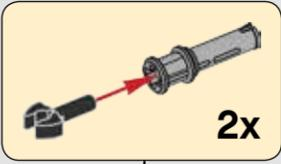

44

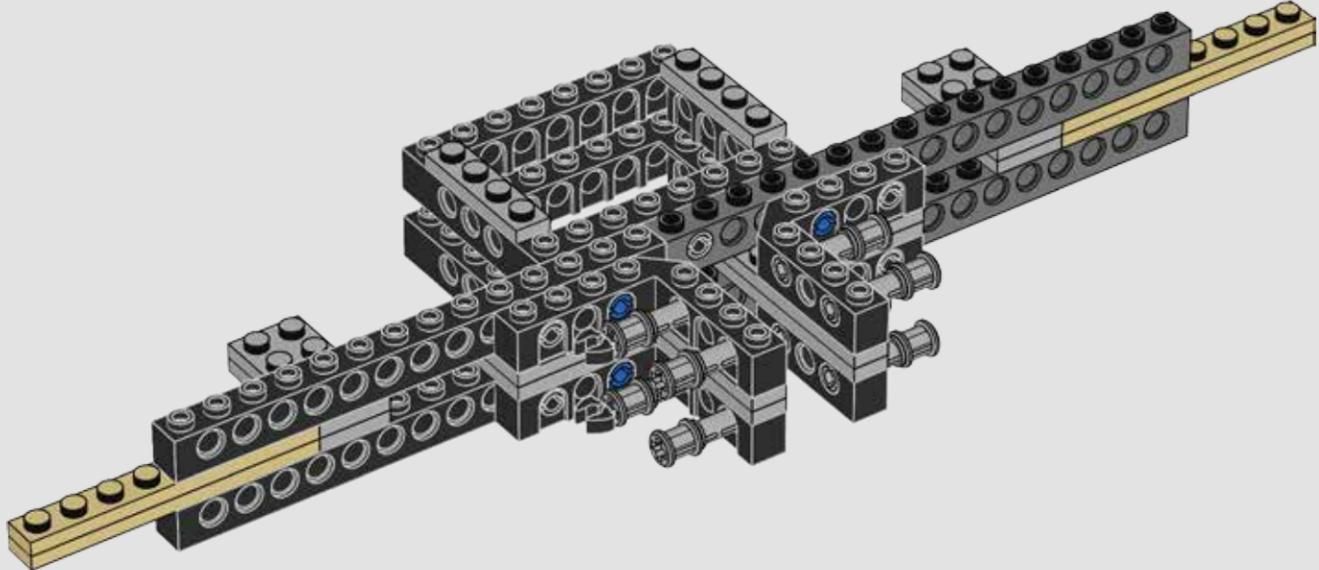

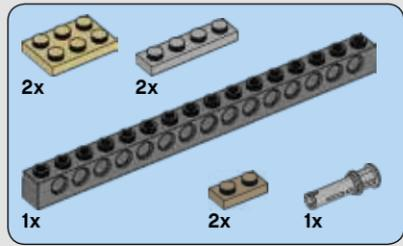

45

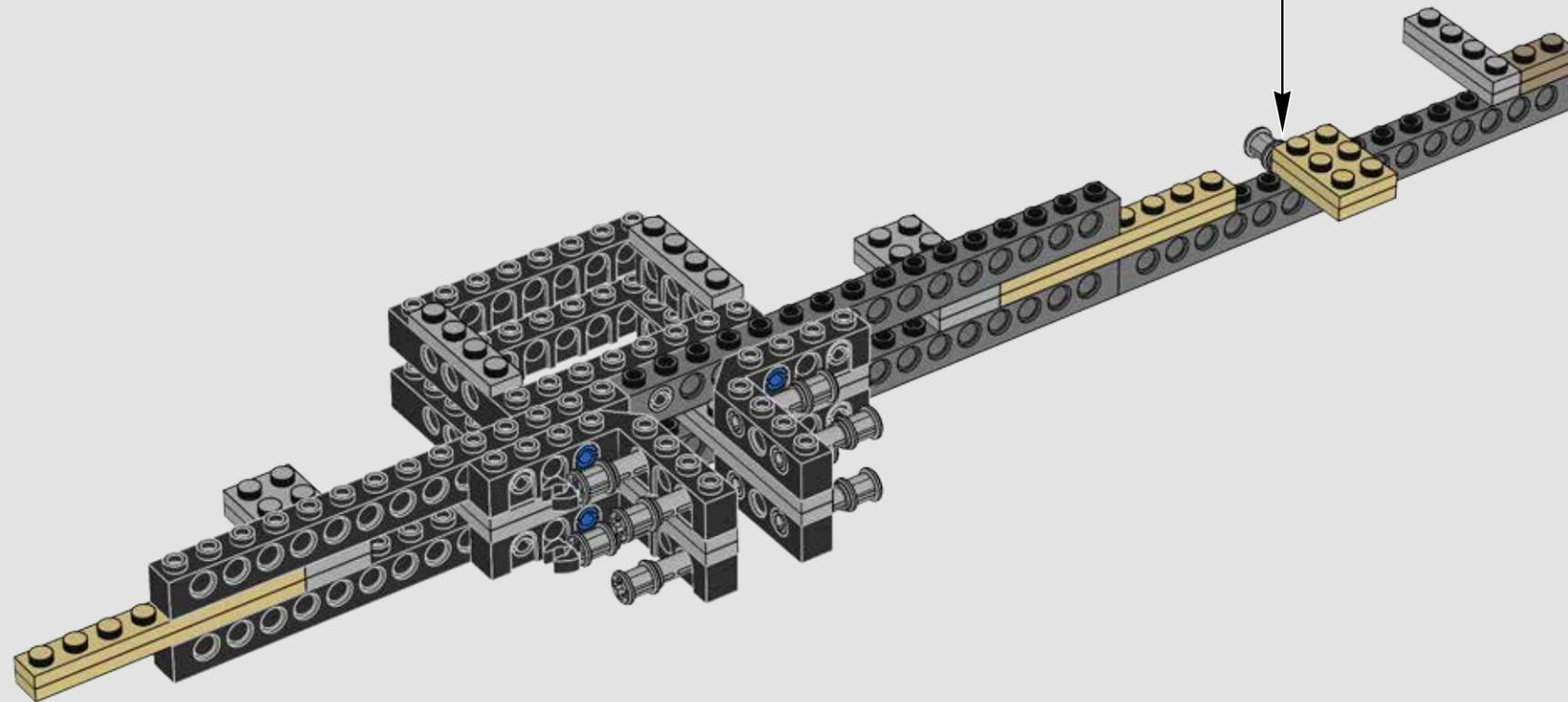
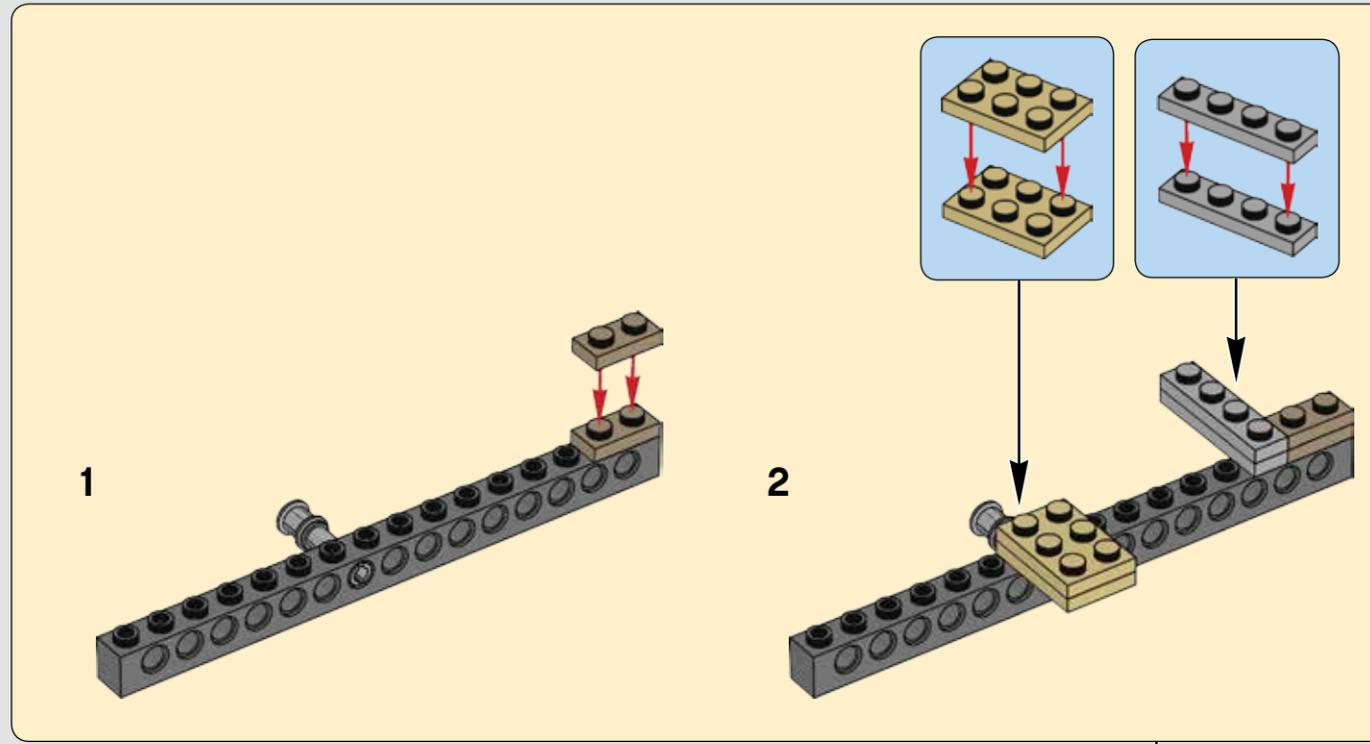

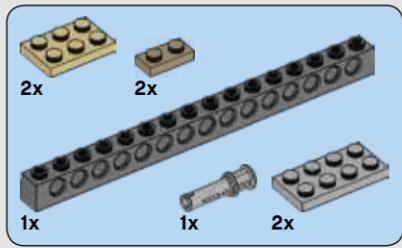

46

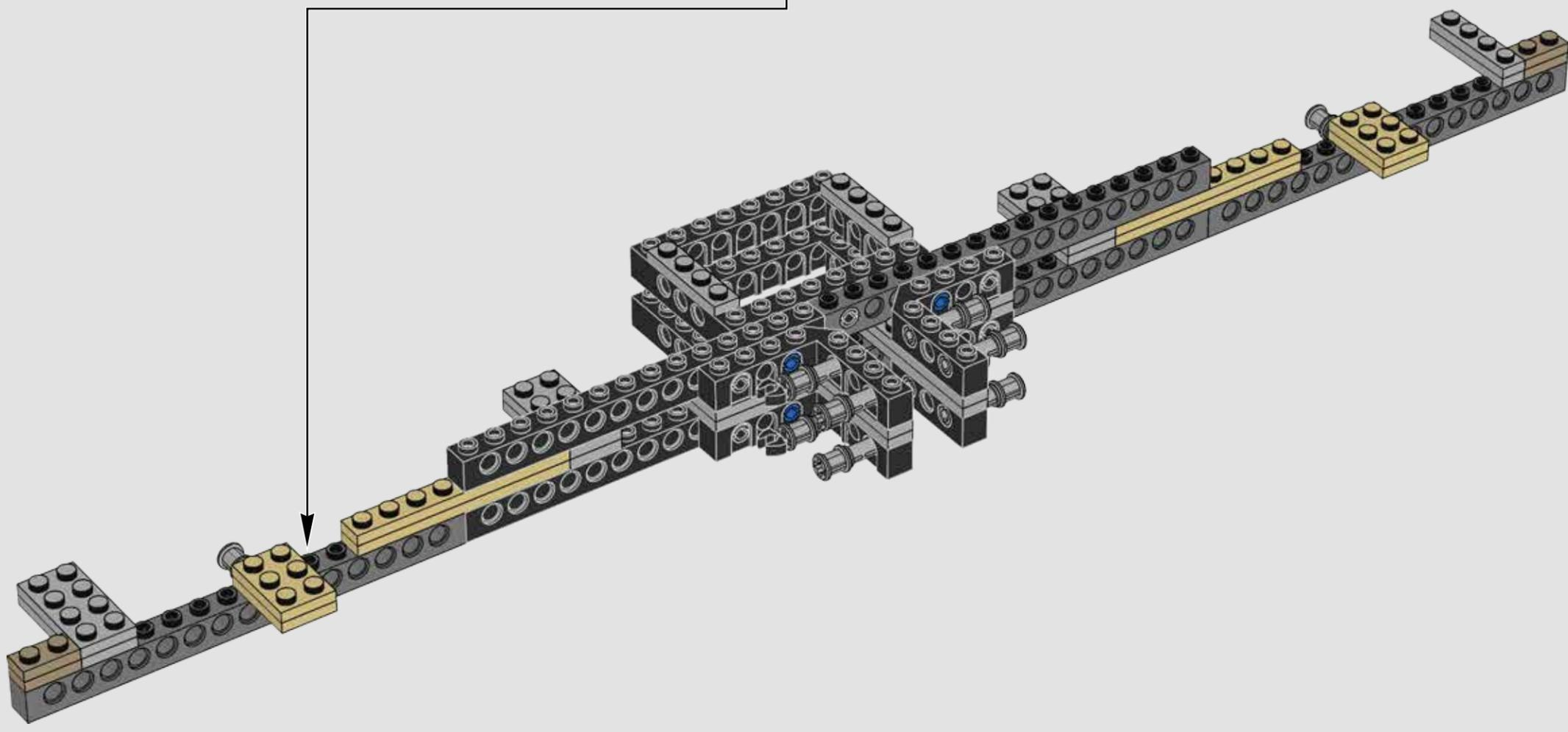
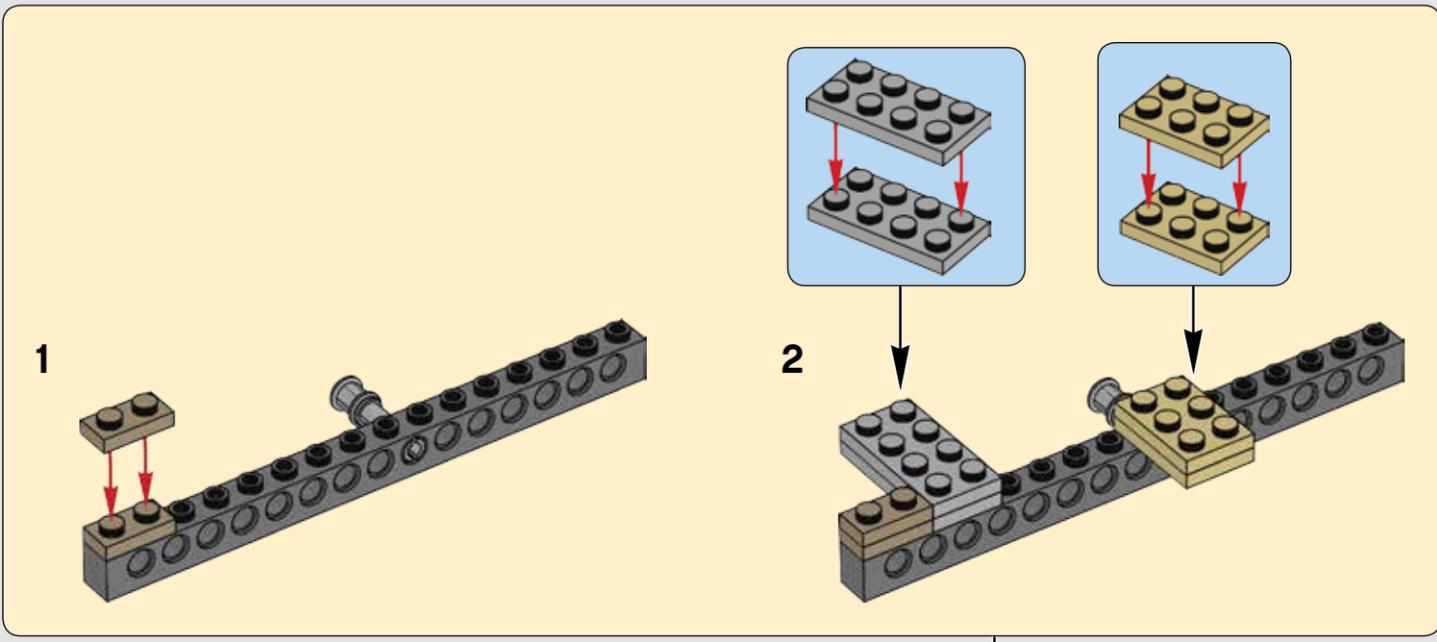

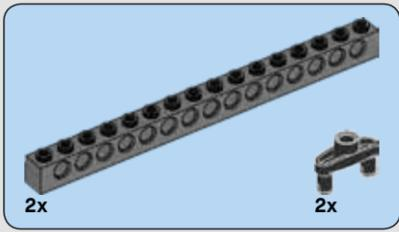

47

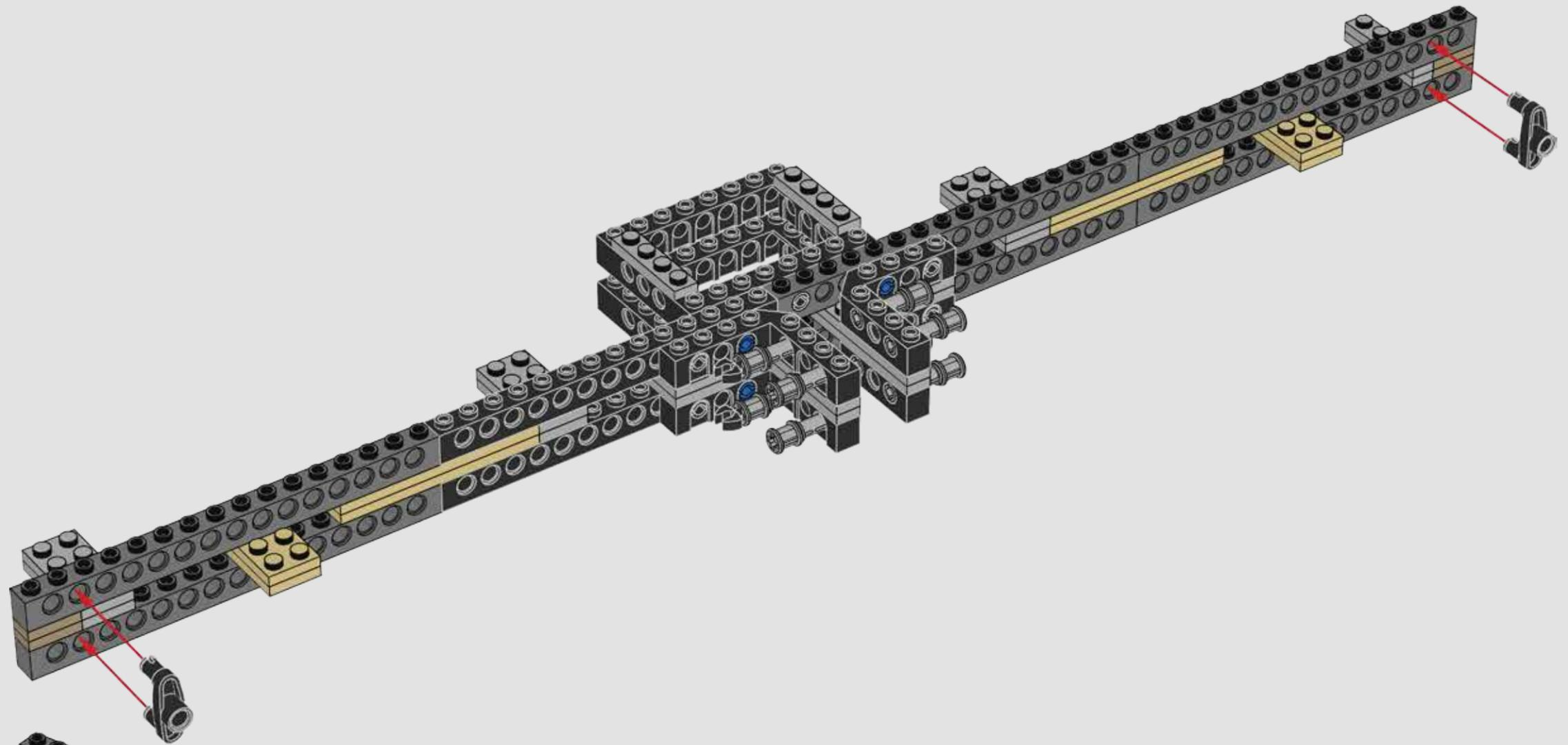

48

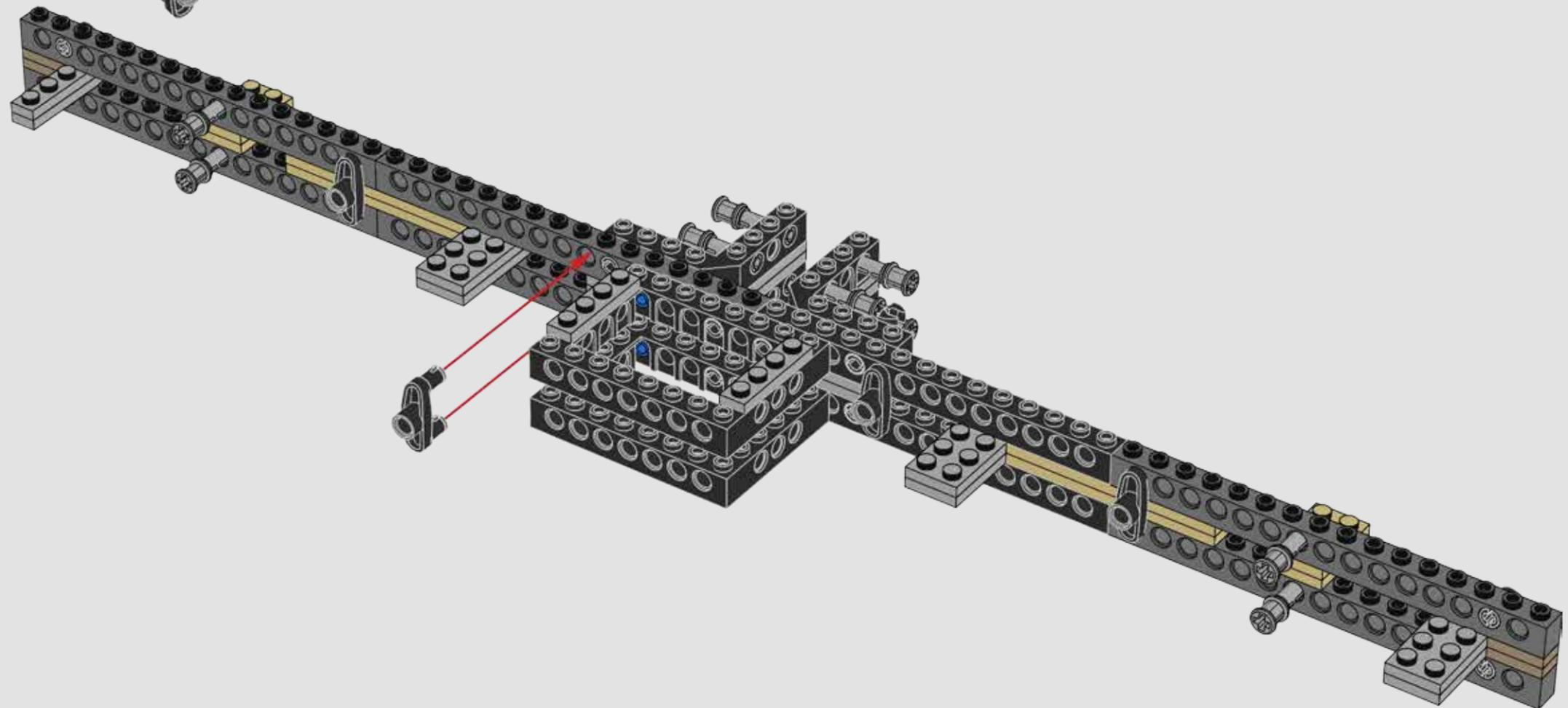

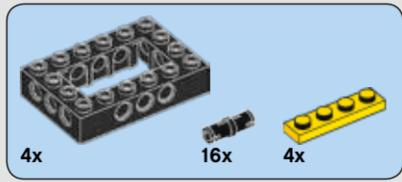

49

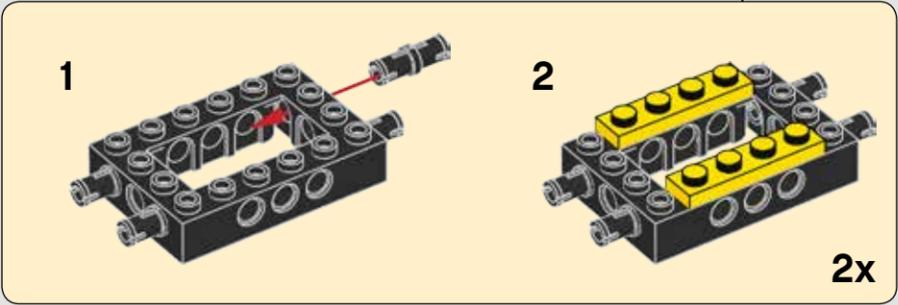
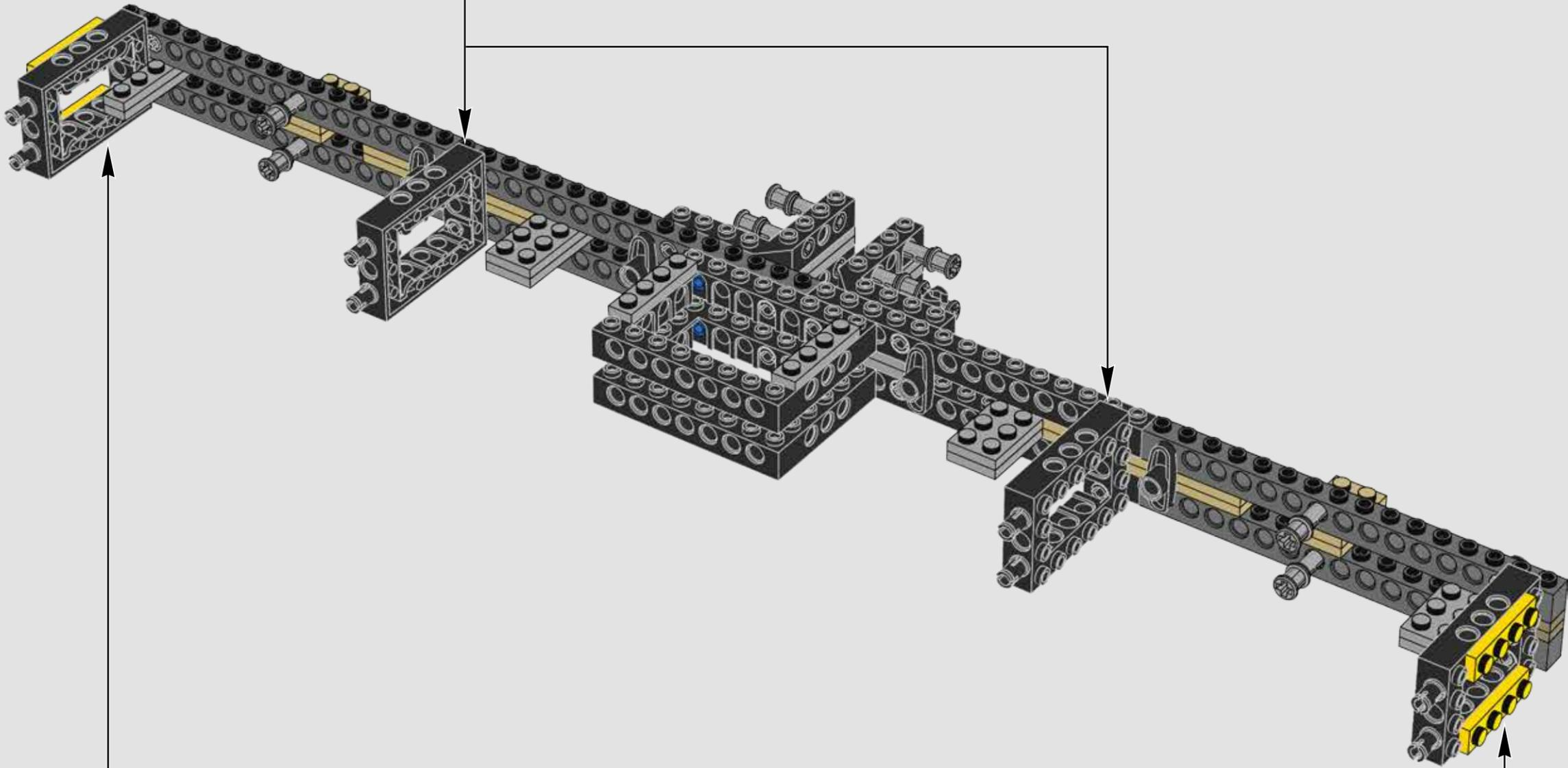
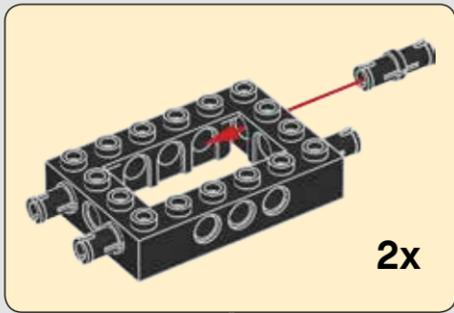

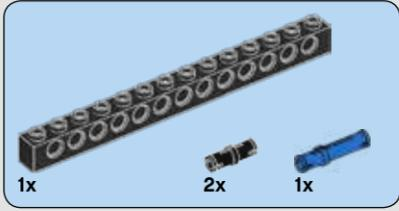
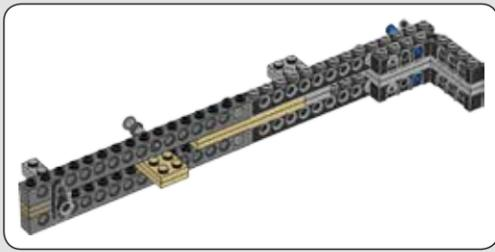

50

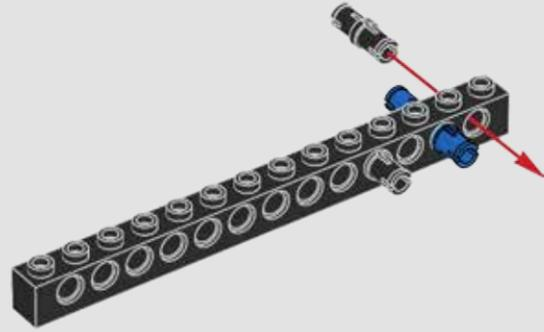

51

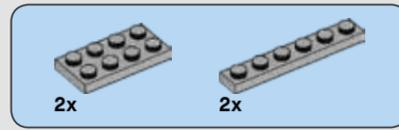
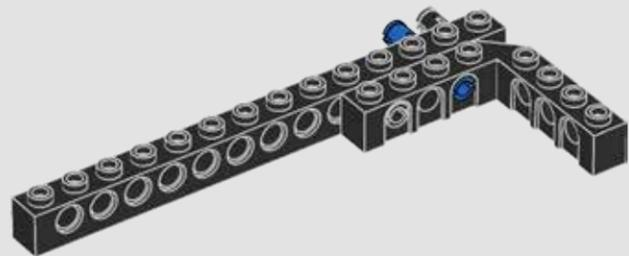

52

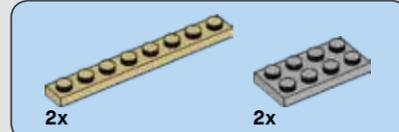
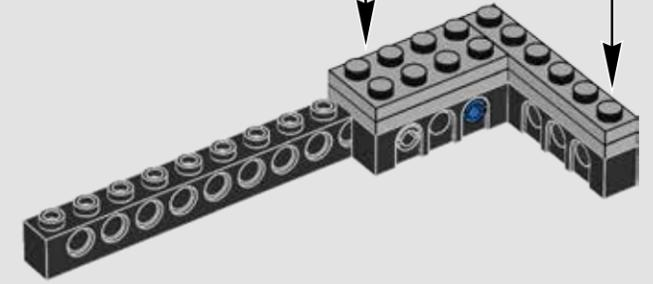
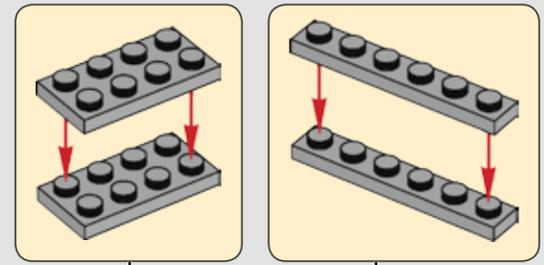

53

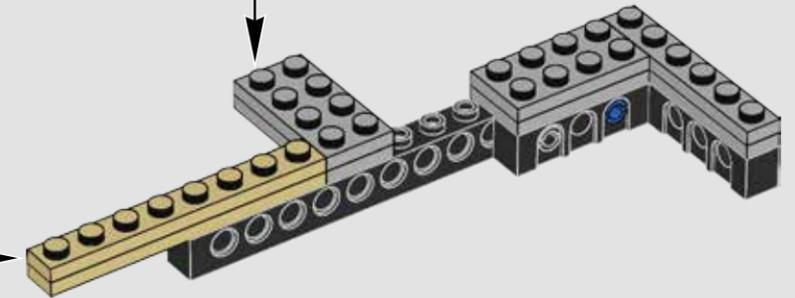
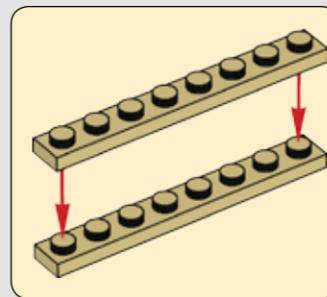
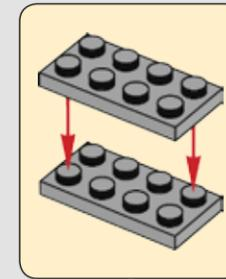

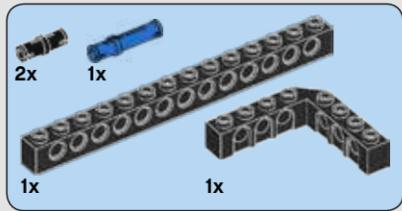

54

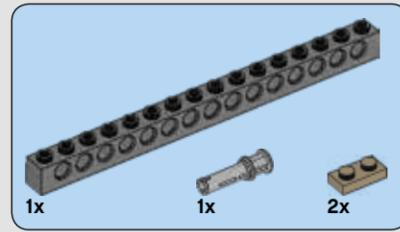
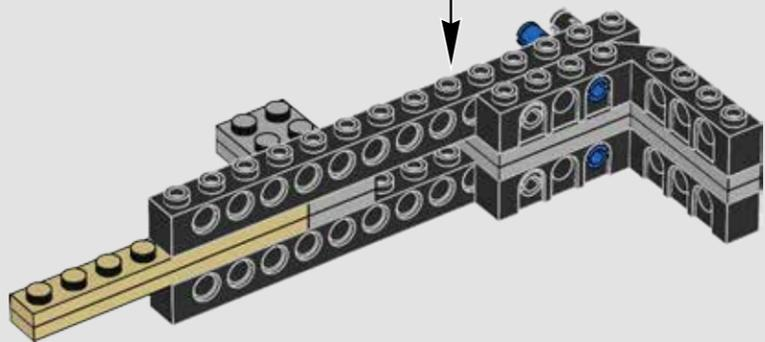
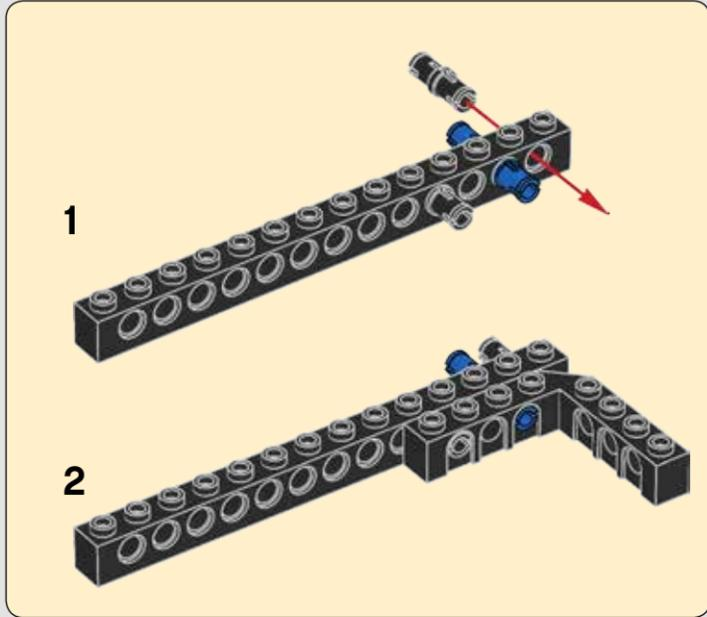

55

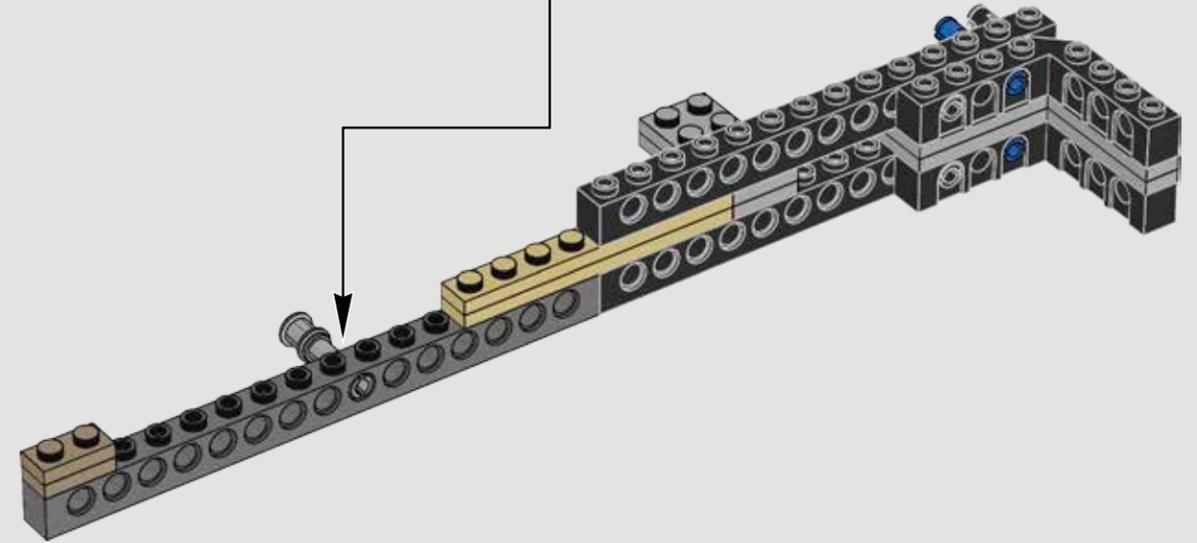
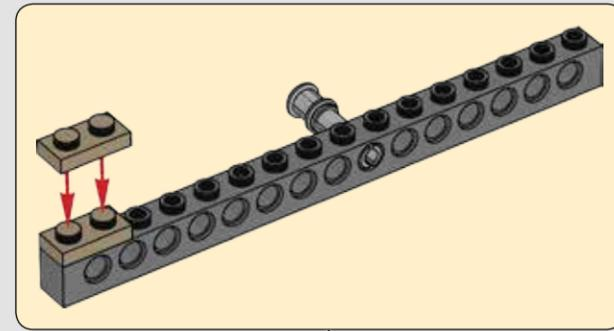

56

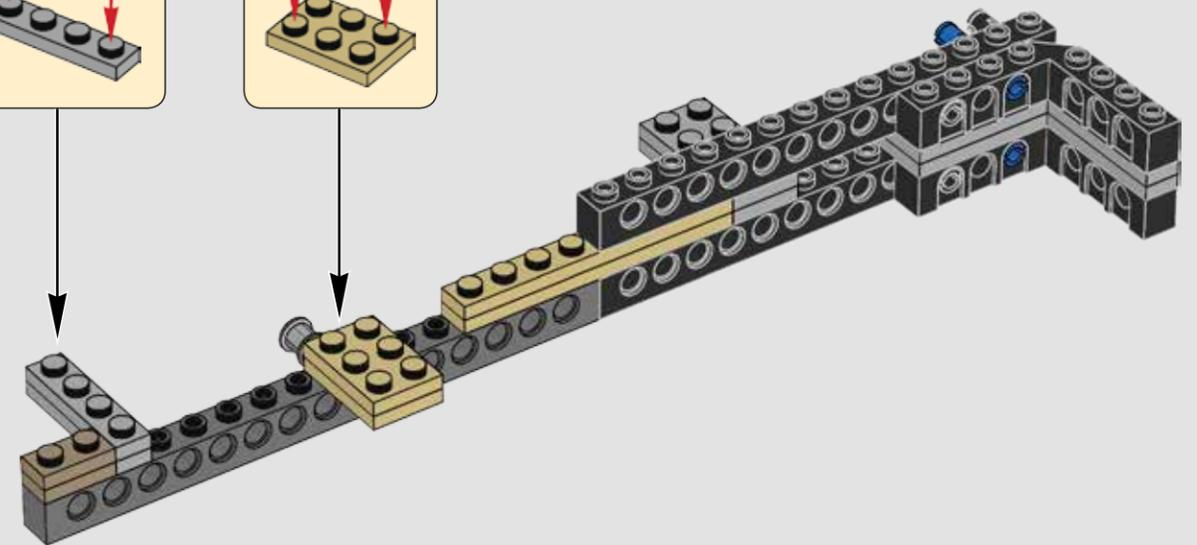
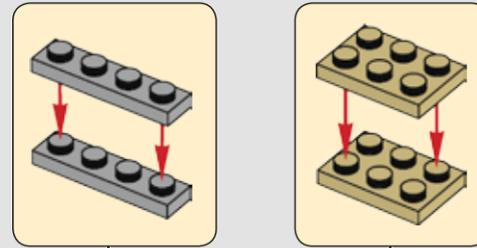

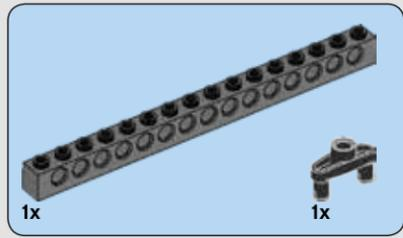

57

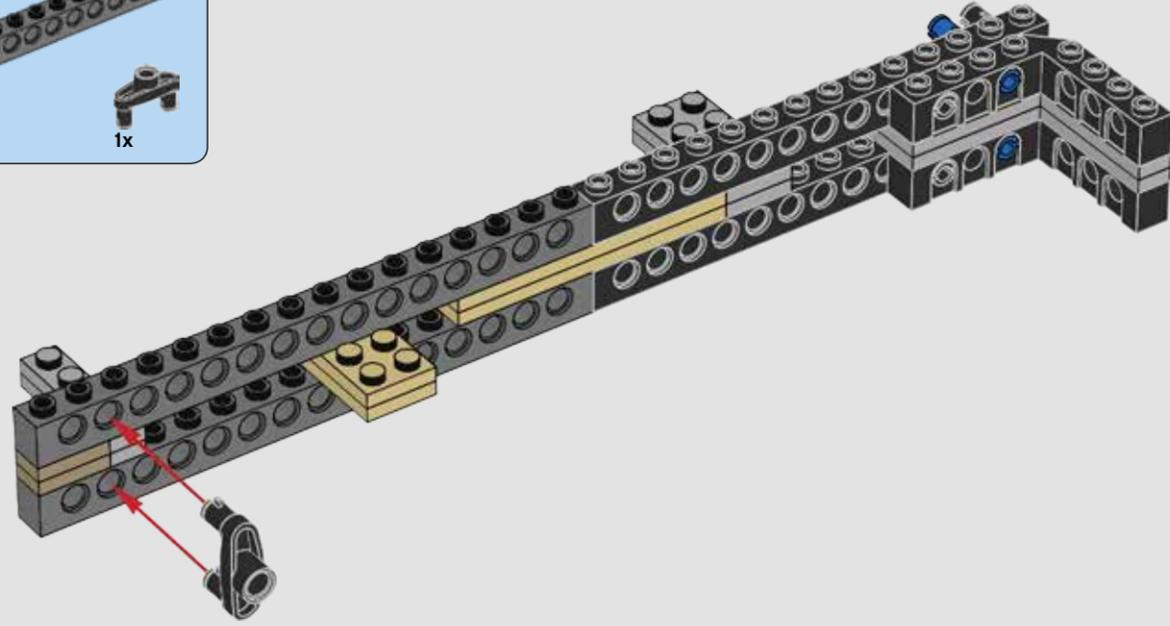

58

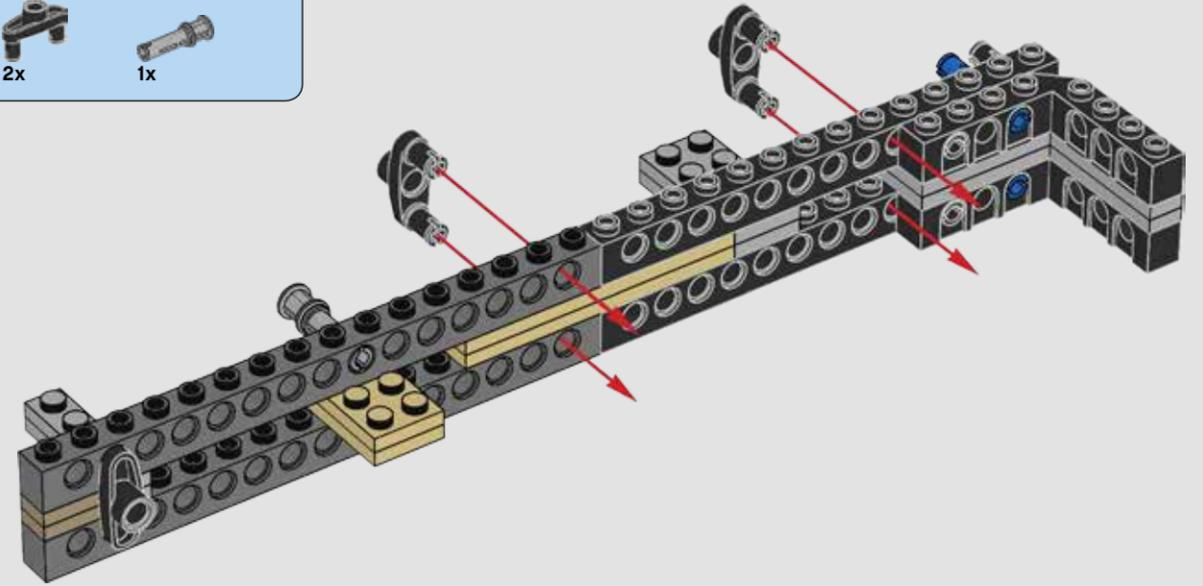

59

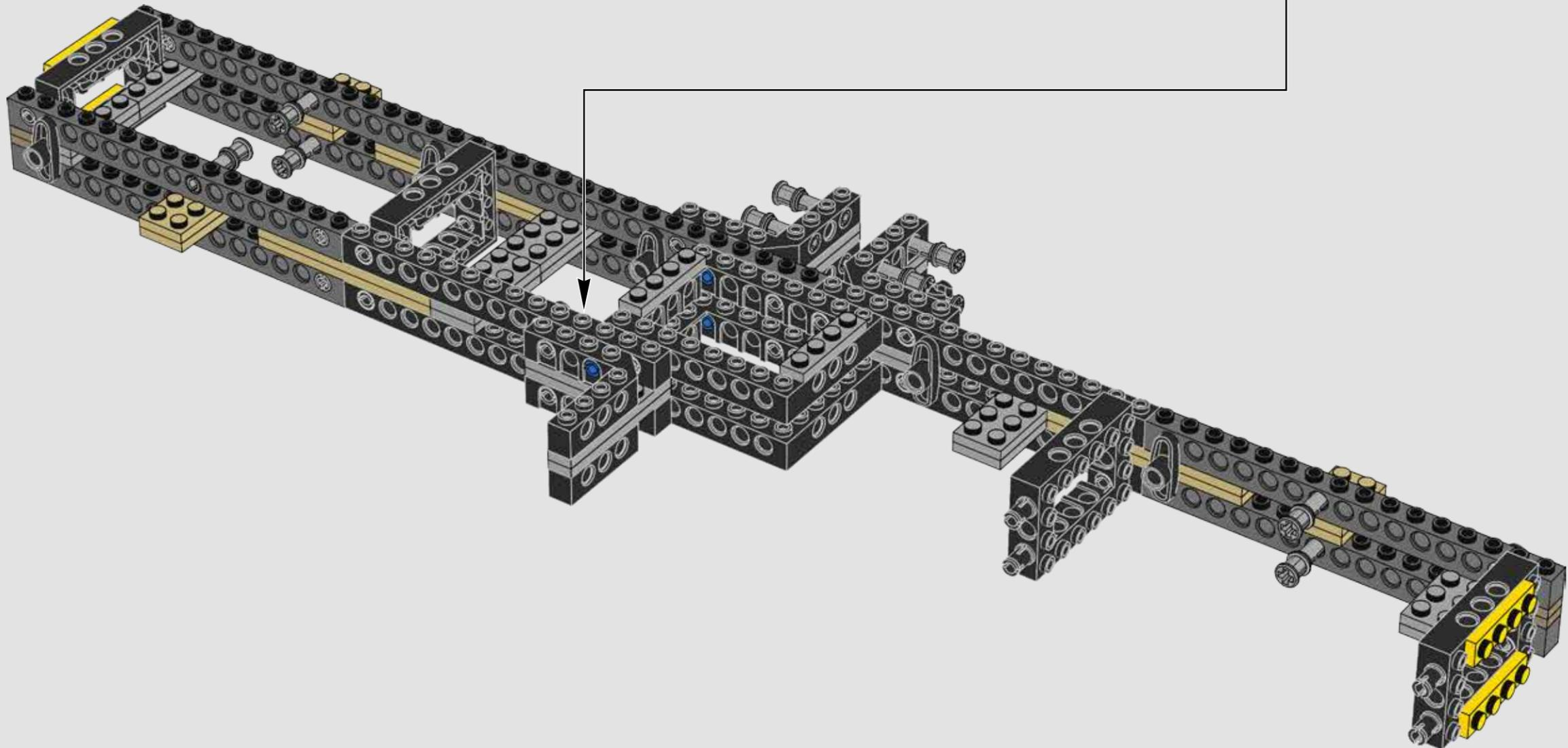

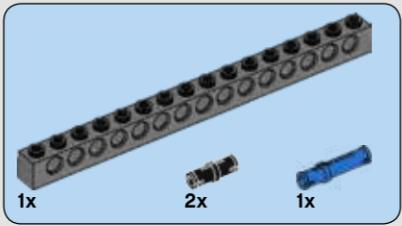
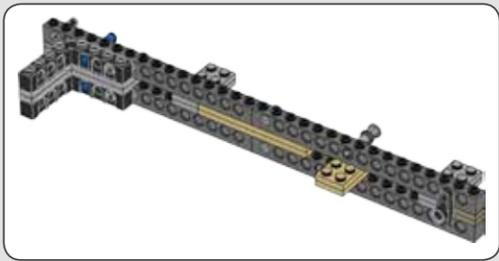

60

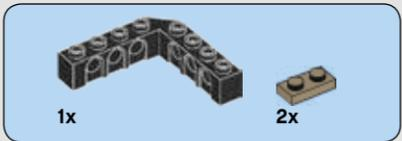
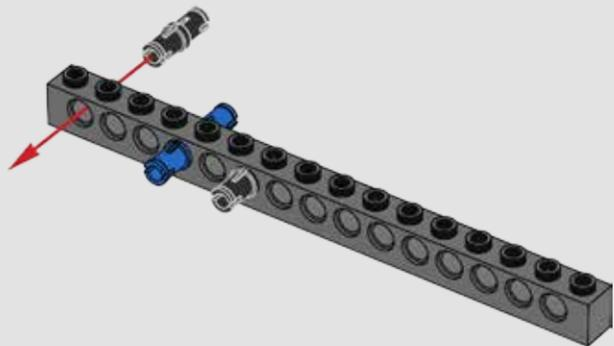

61

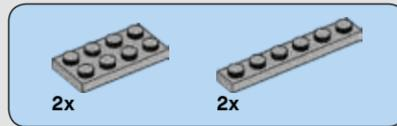
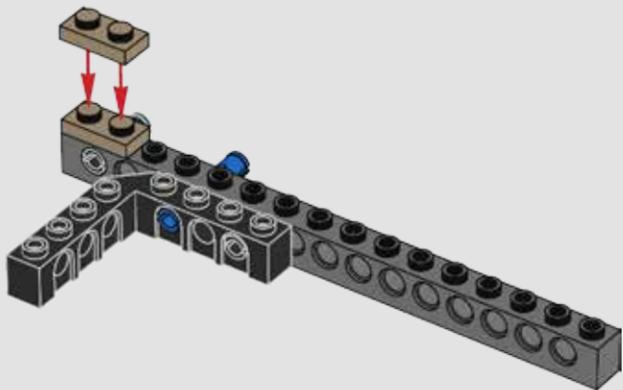

62

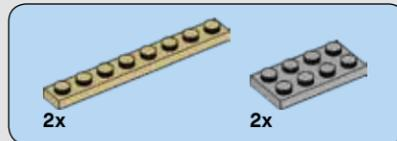
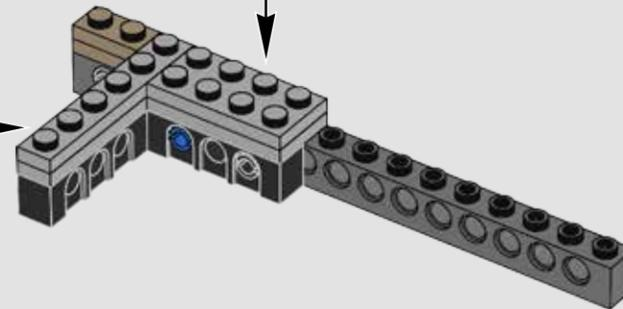
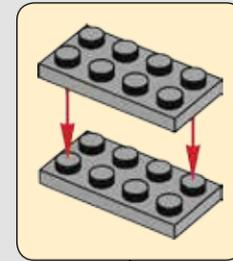
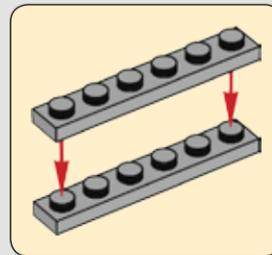

63

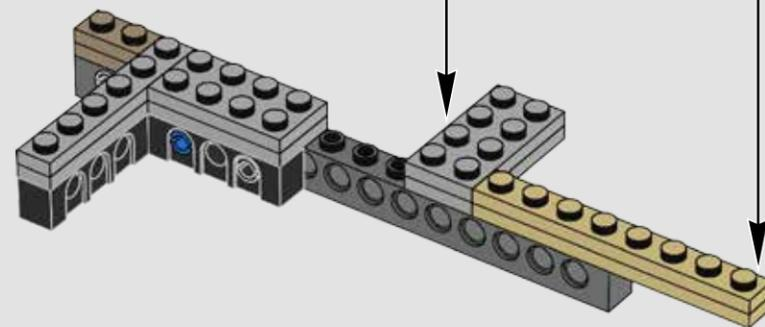
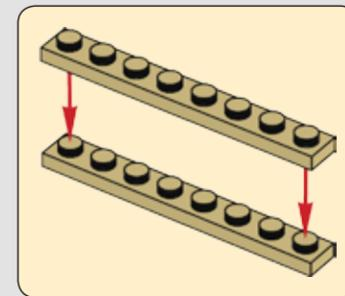
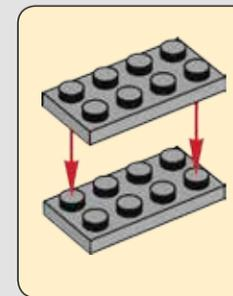

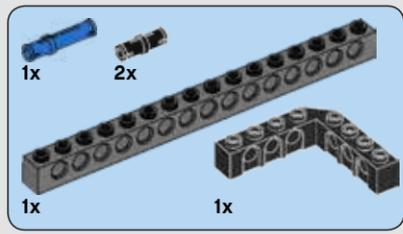

64

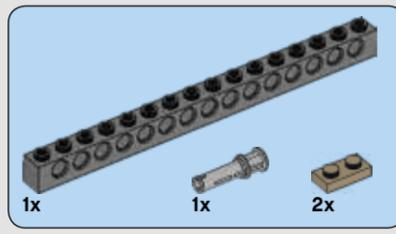
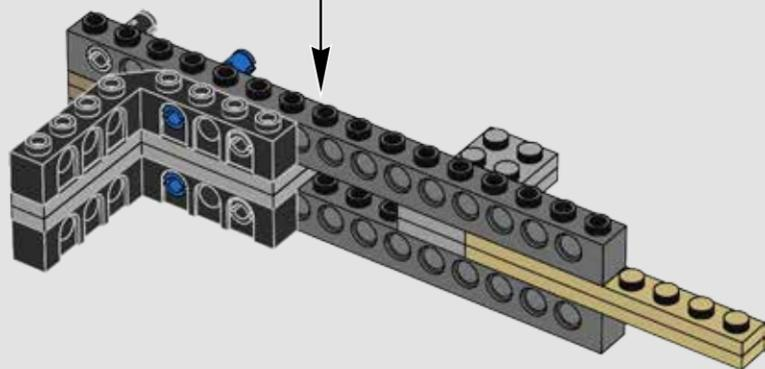
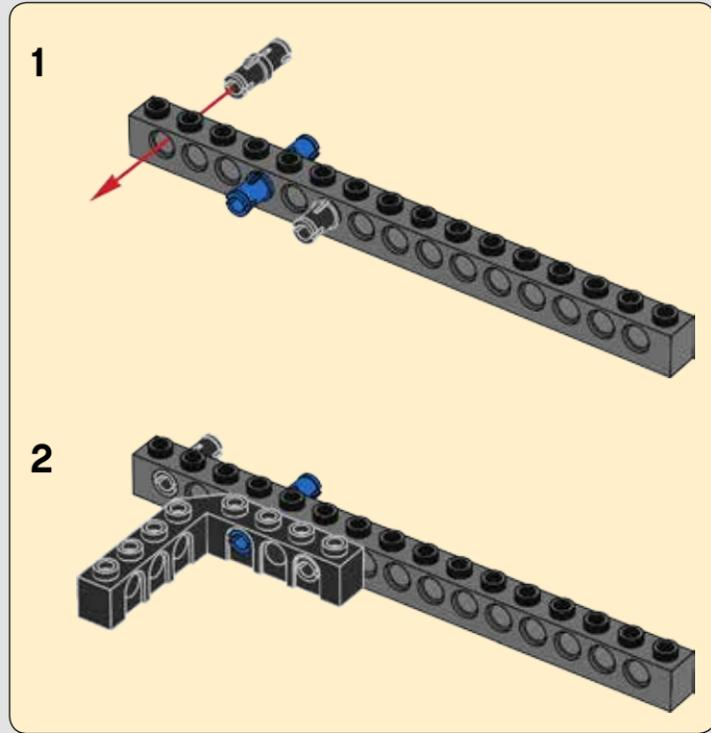

65

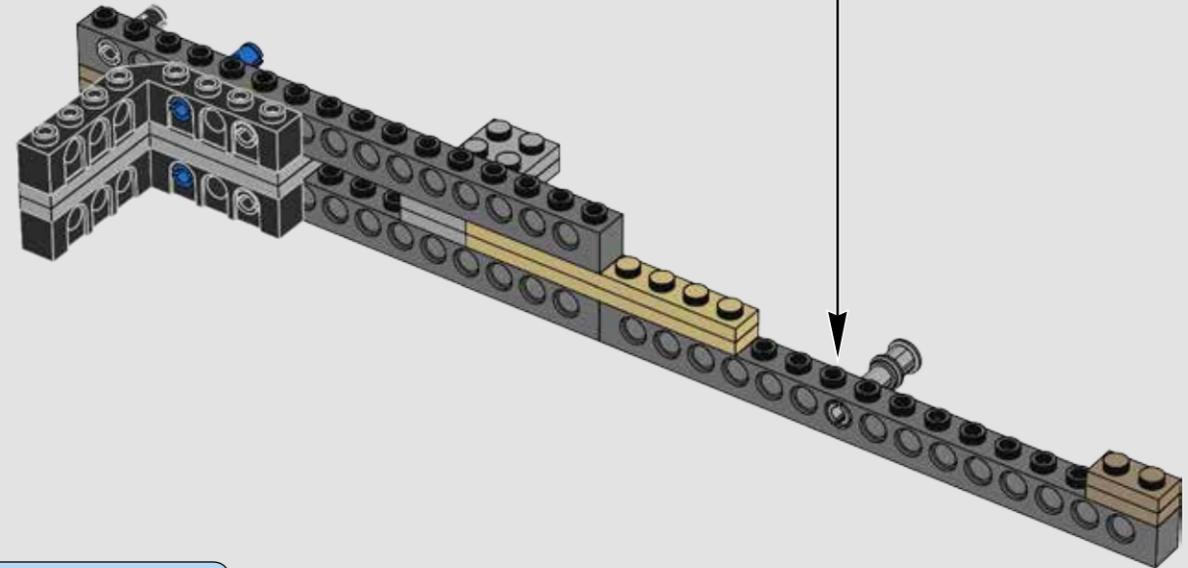
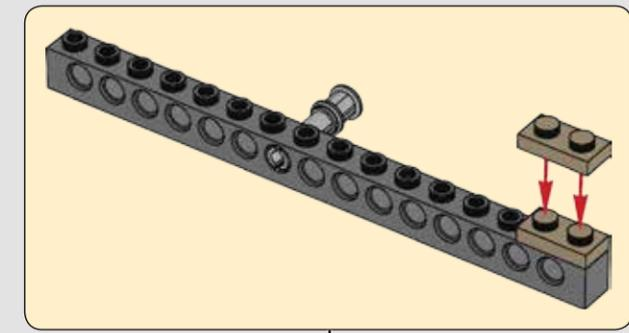

66

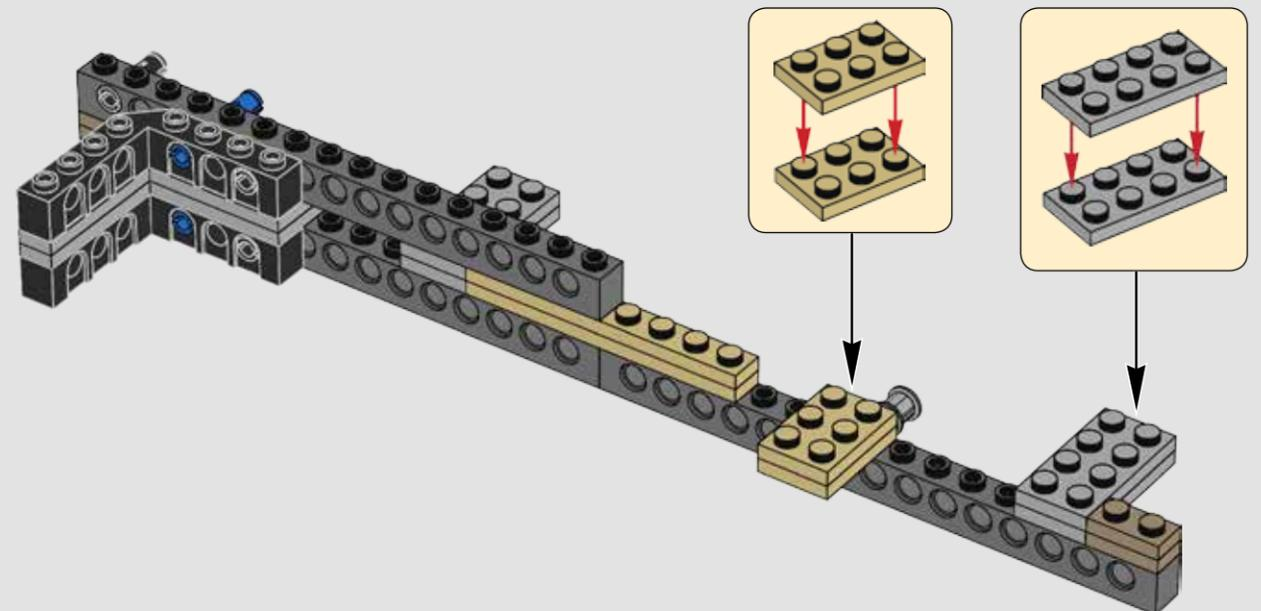

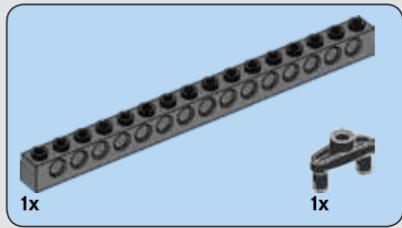

67

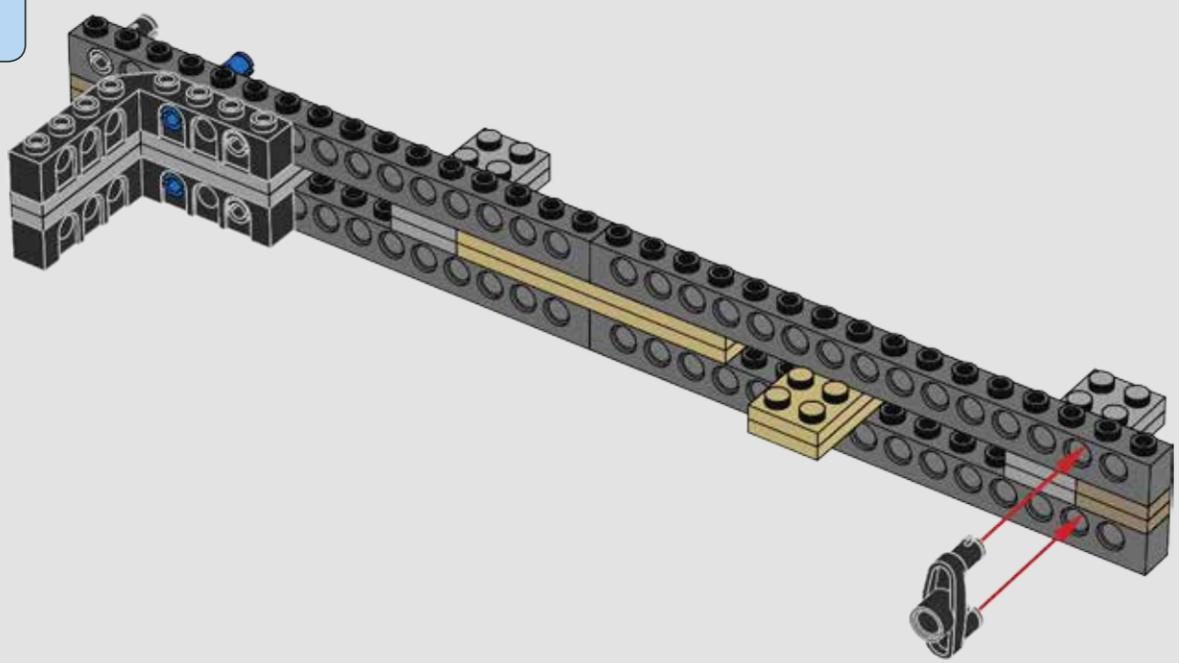

68

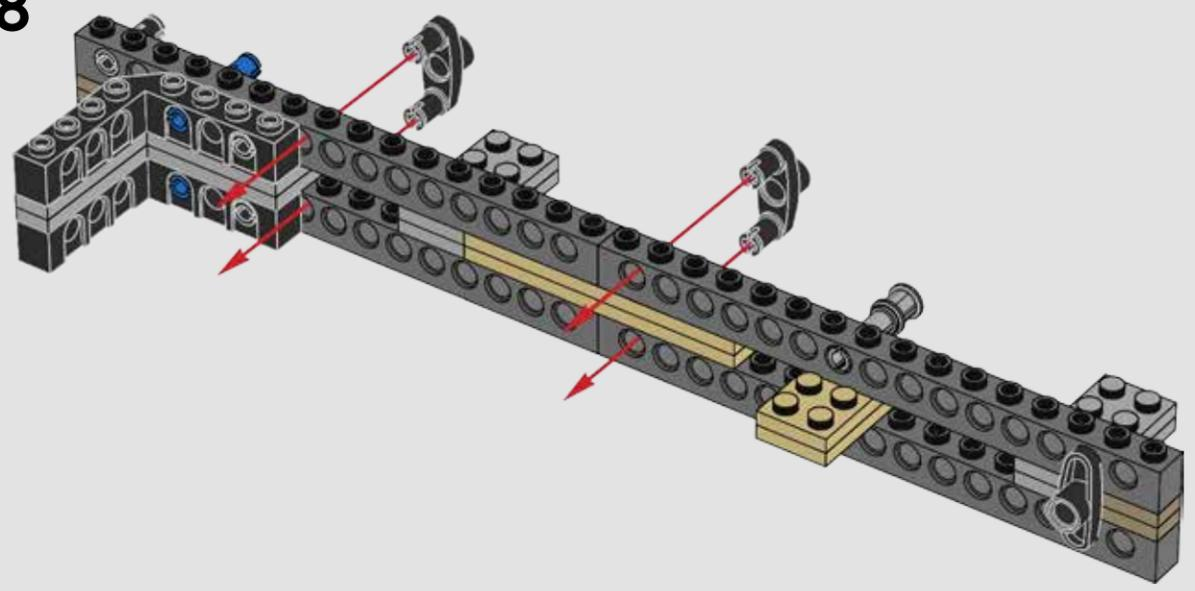

69

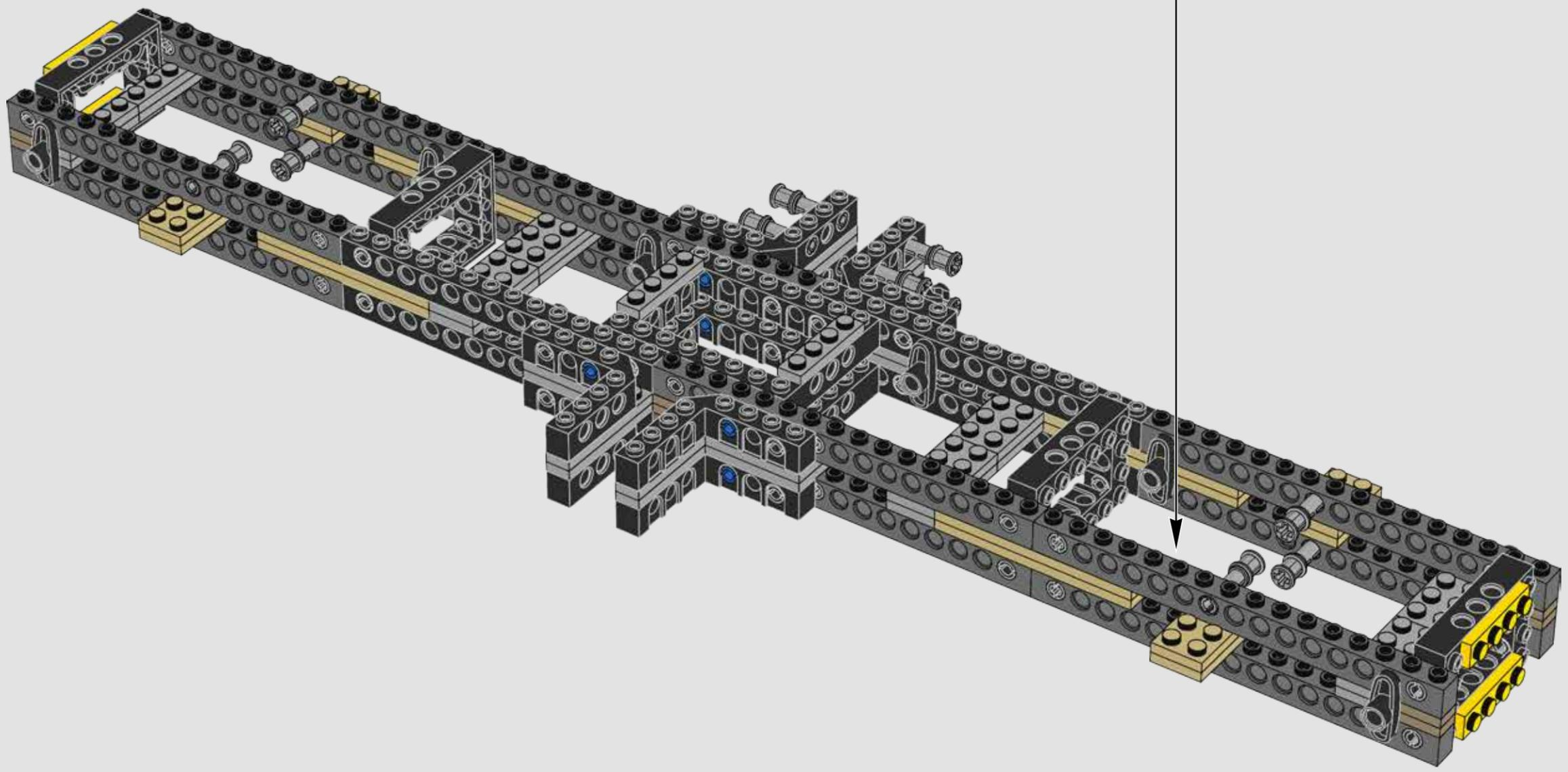

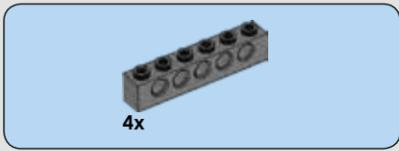

70

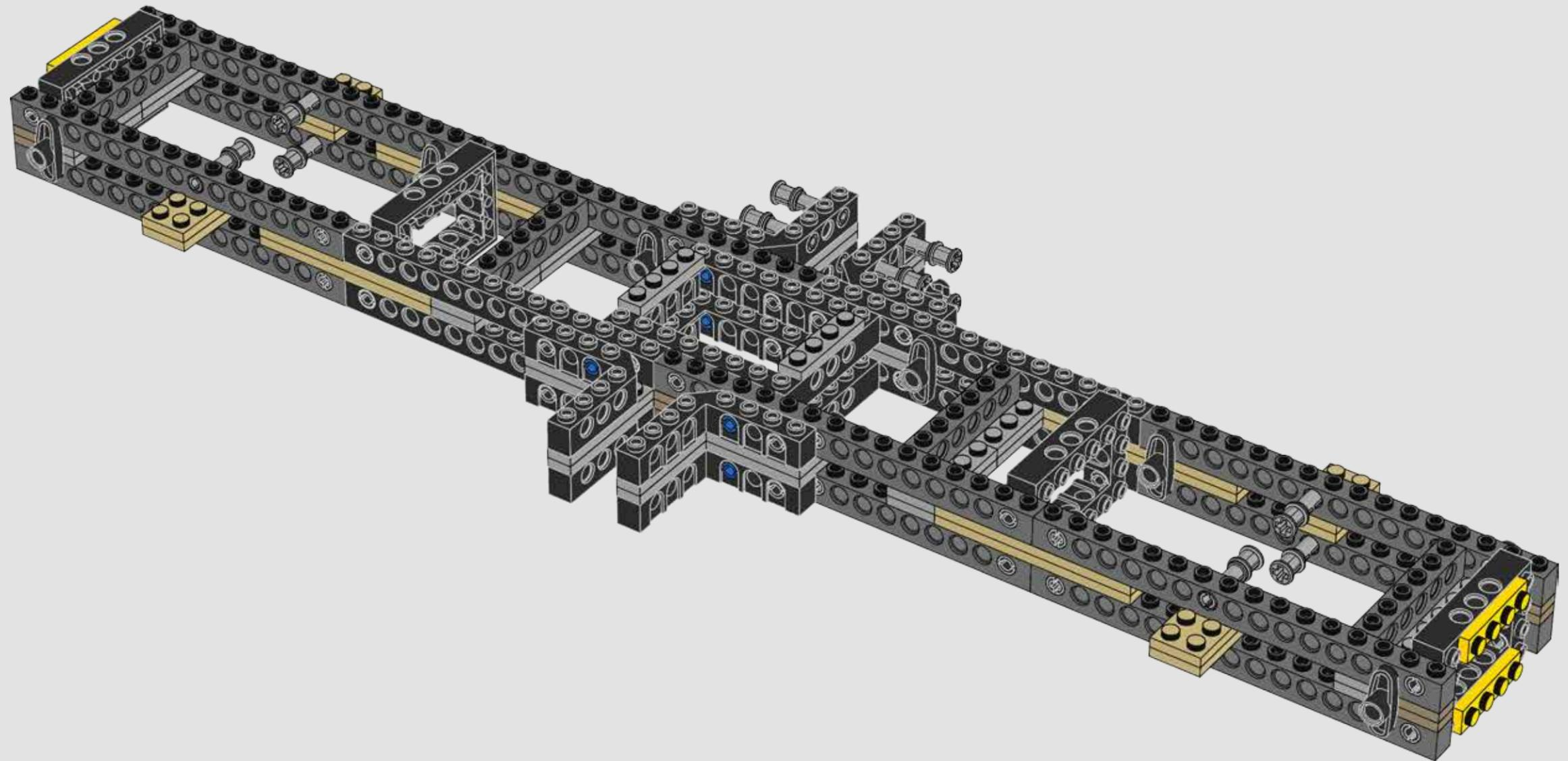

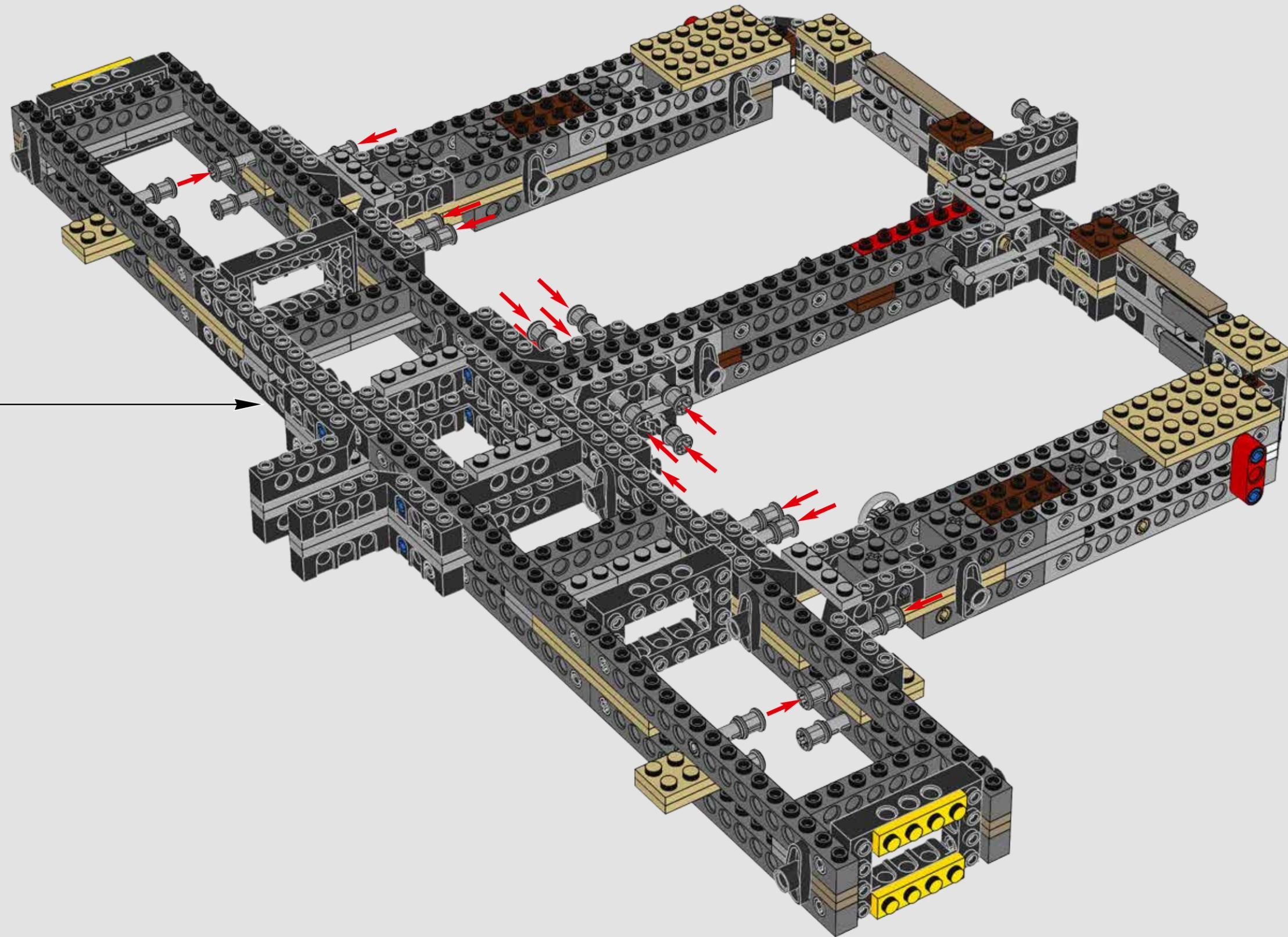

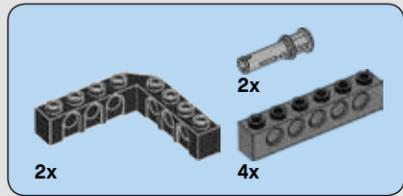

72

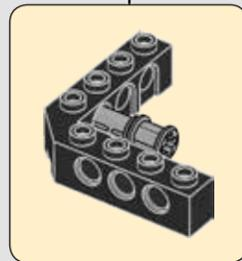
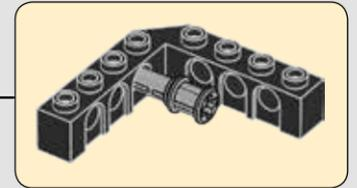
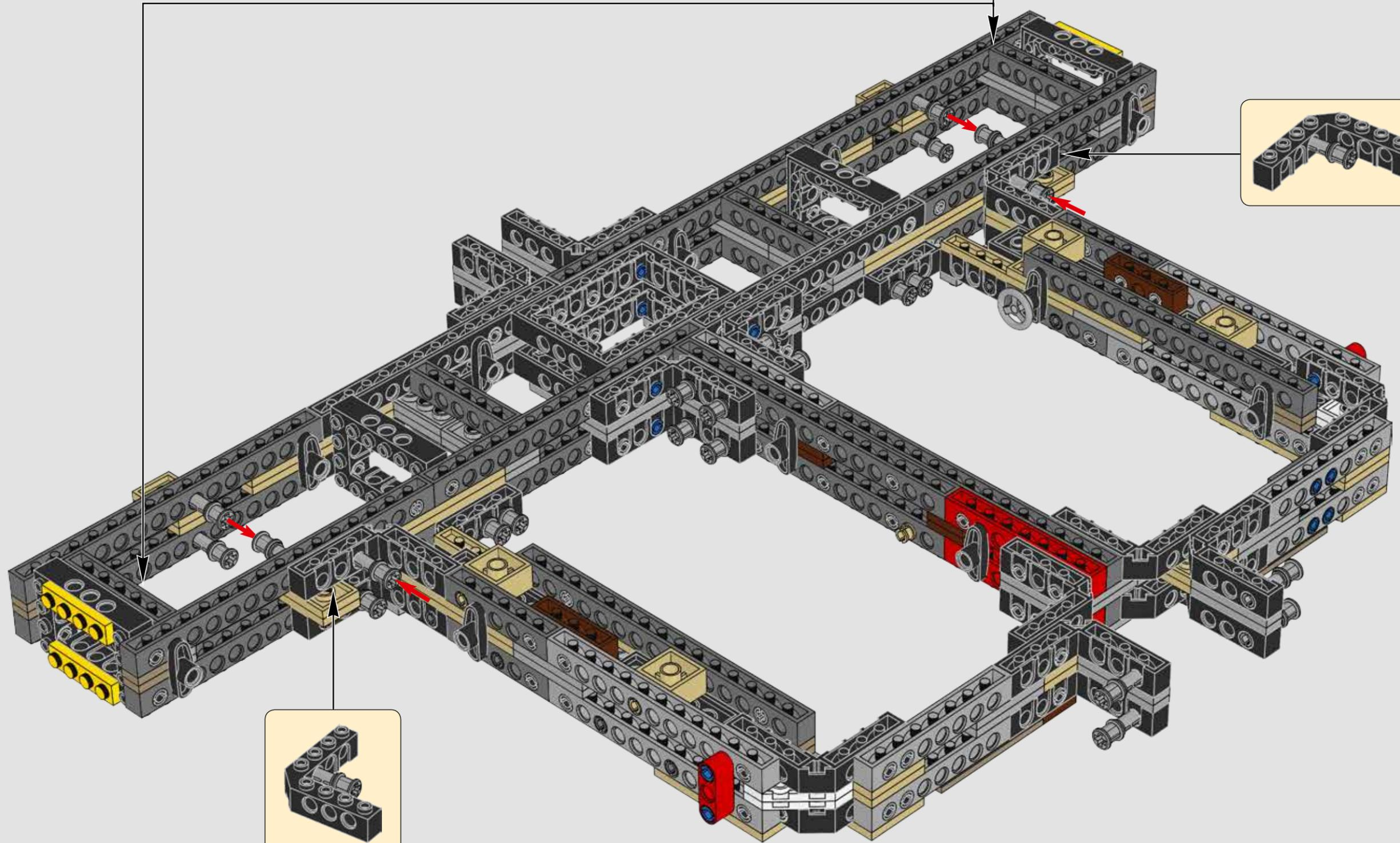
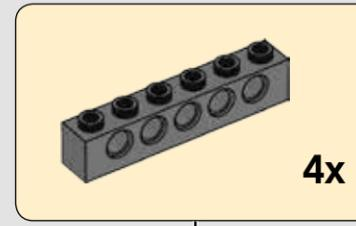

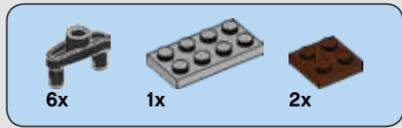

73

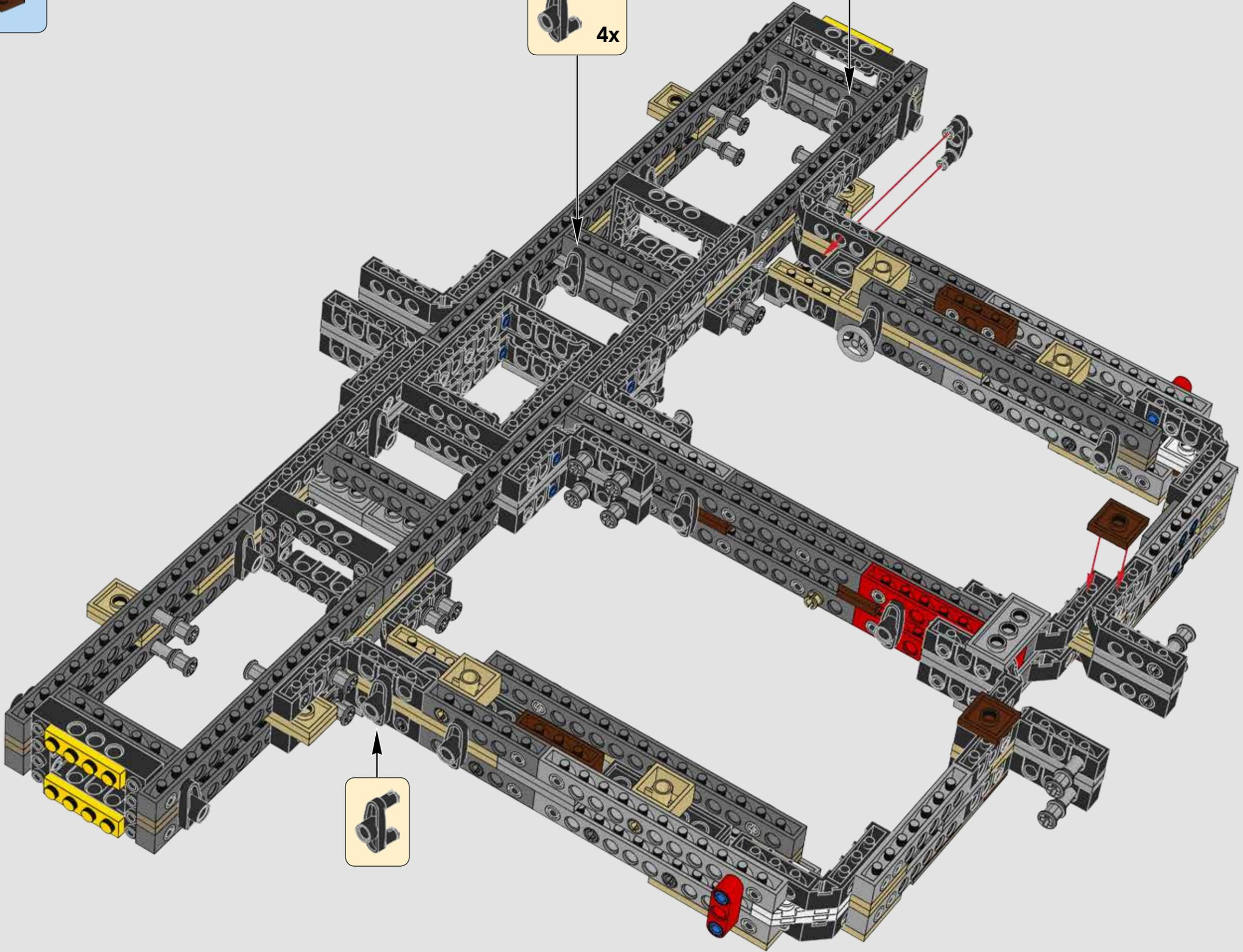

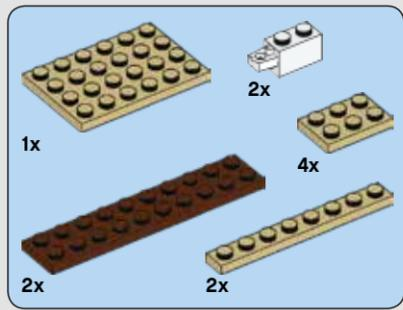

74

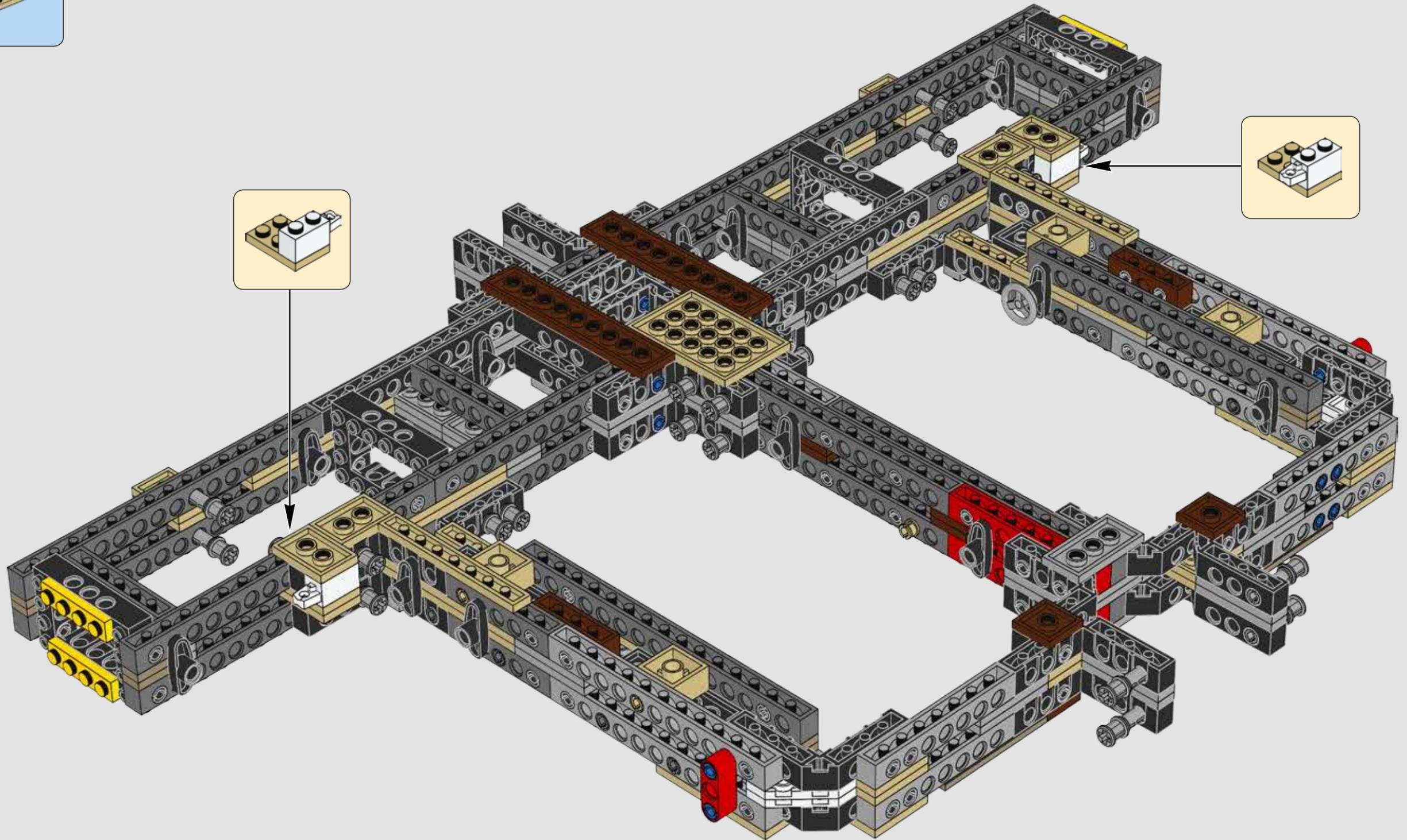

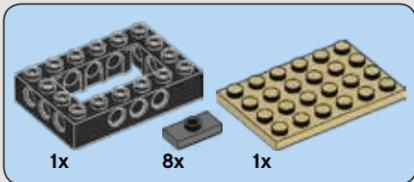

75

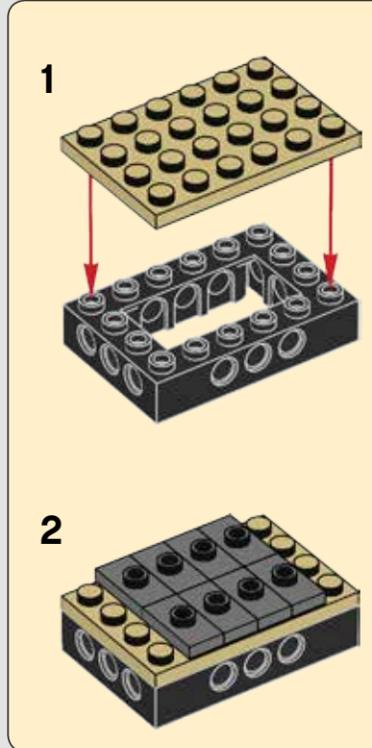
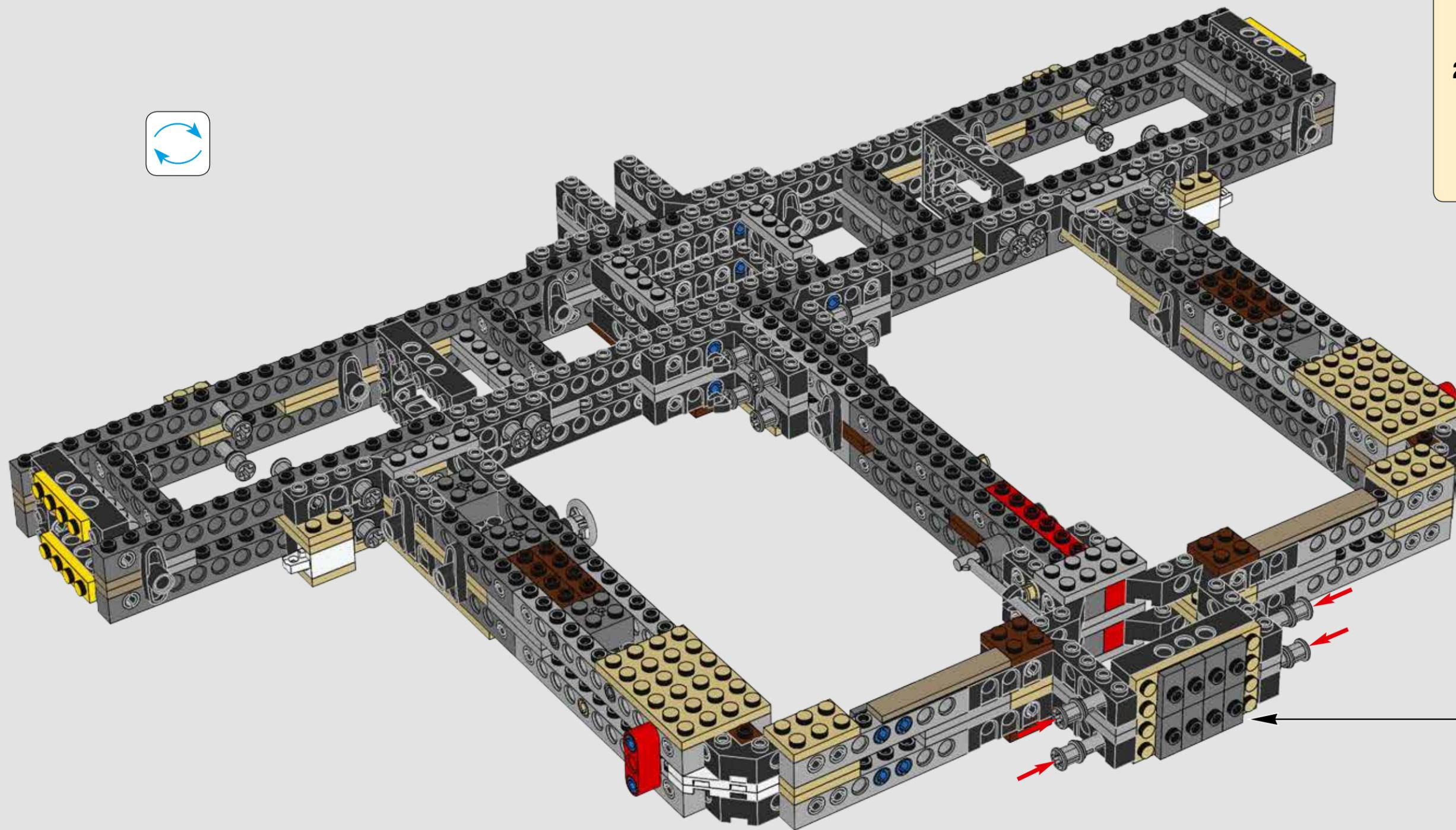

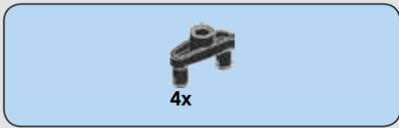

76

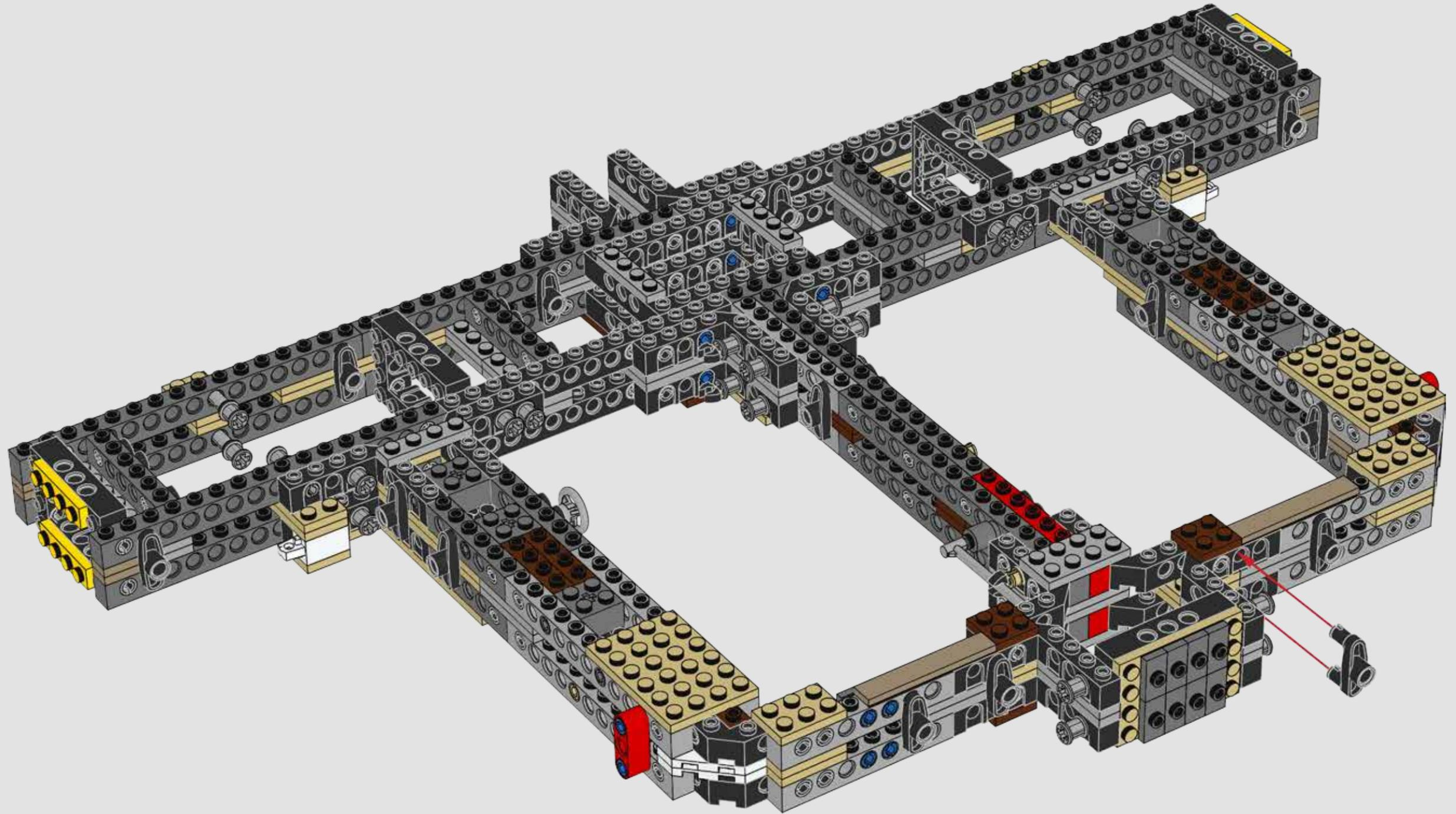

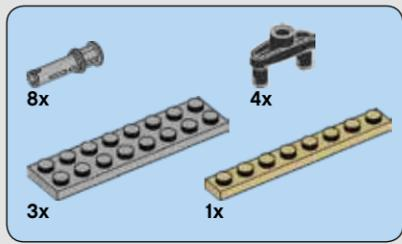

77

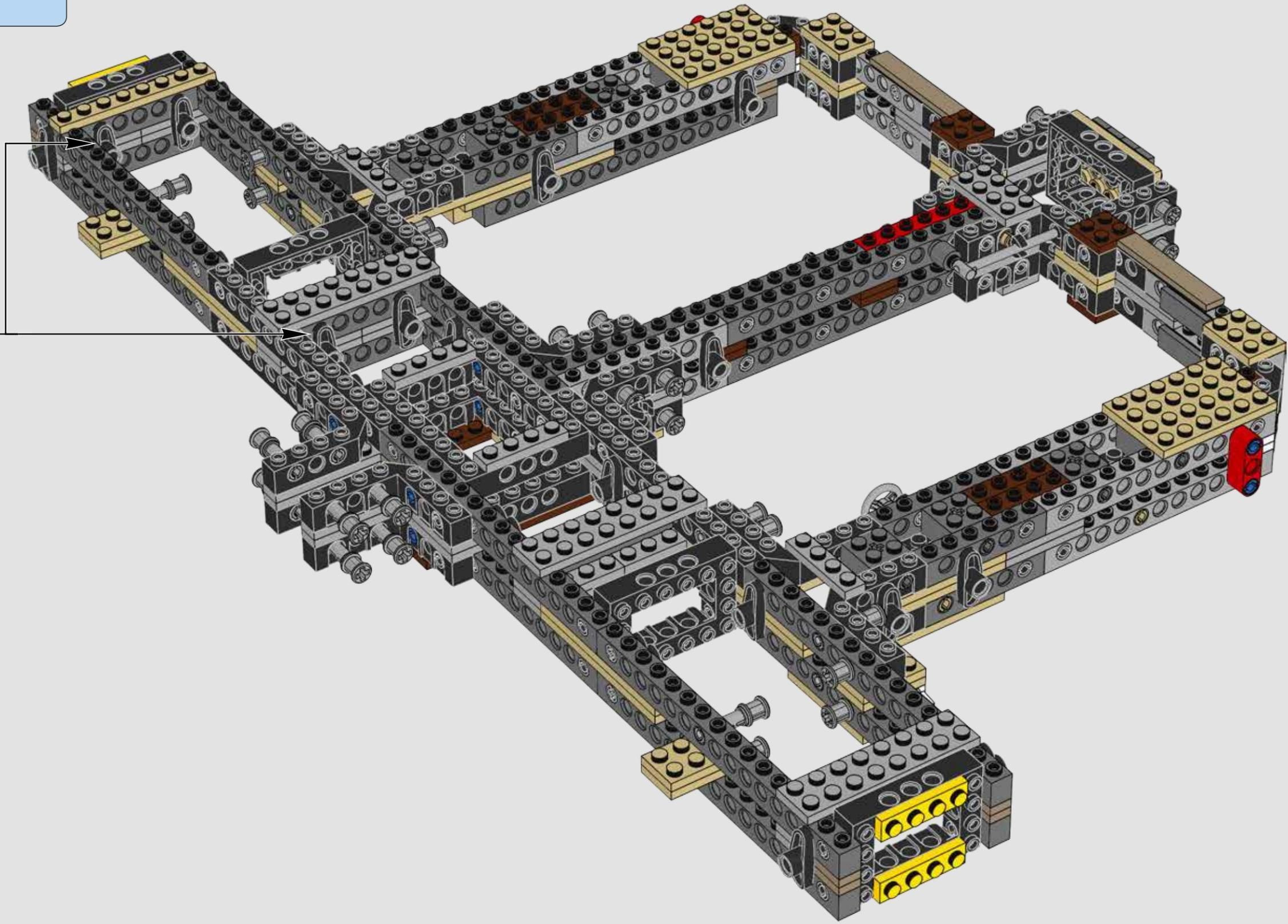

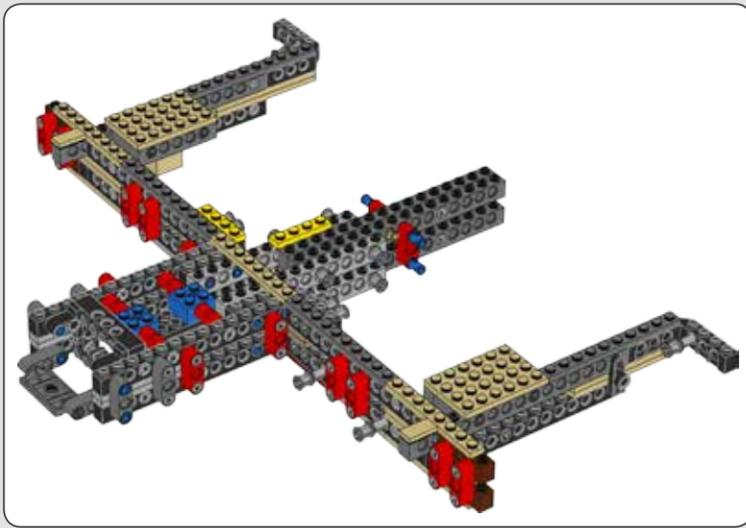

78

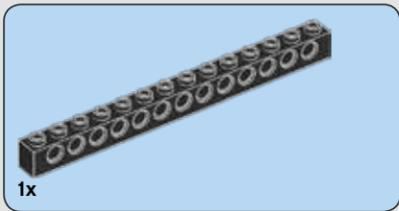

79

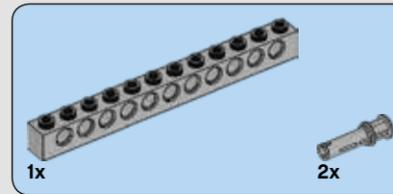
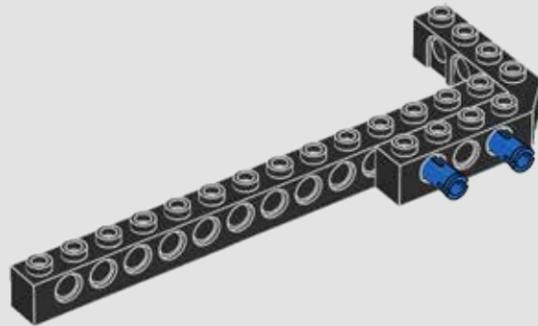

80

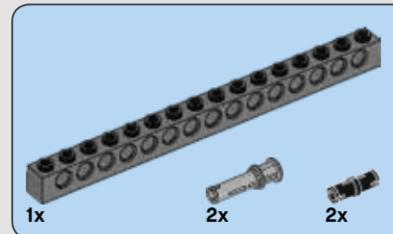
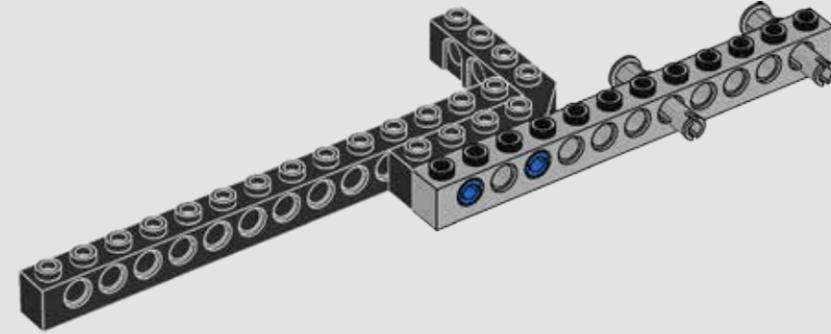

81

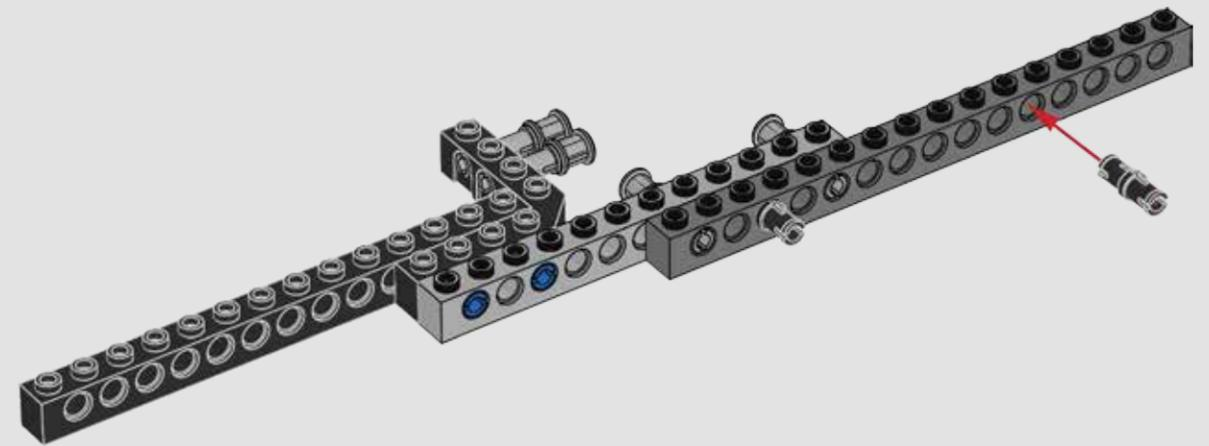

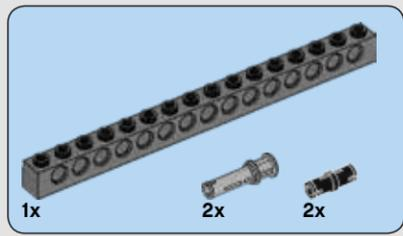

87

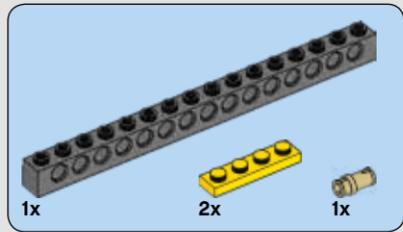
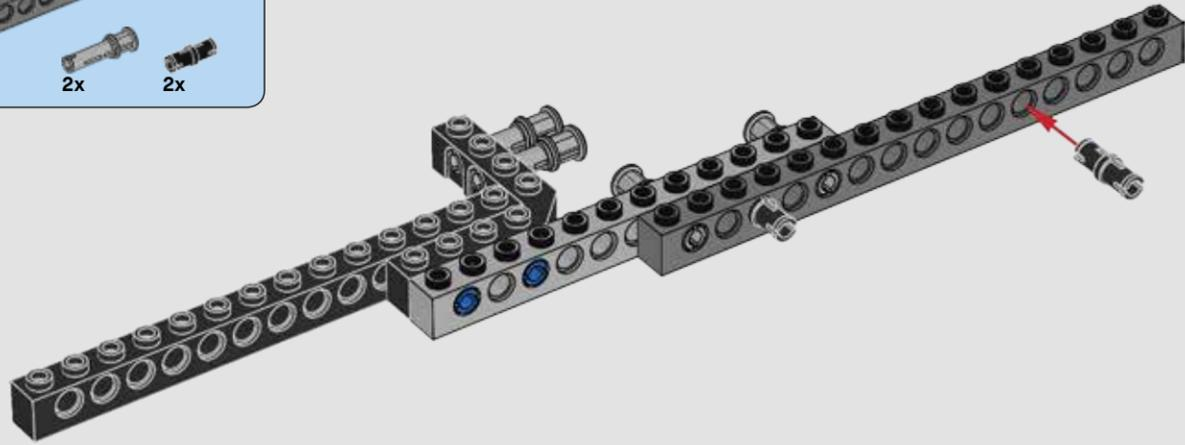

88

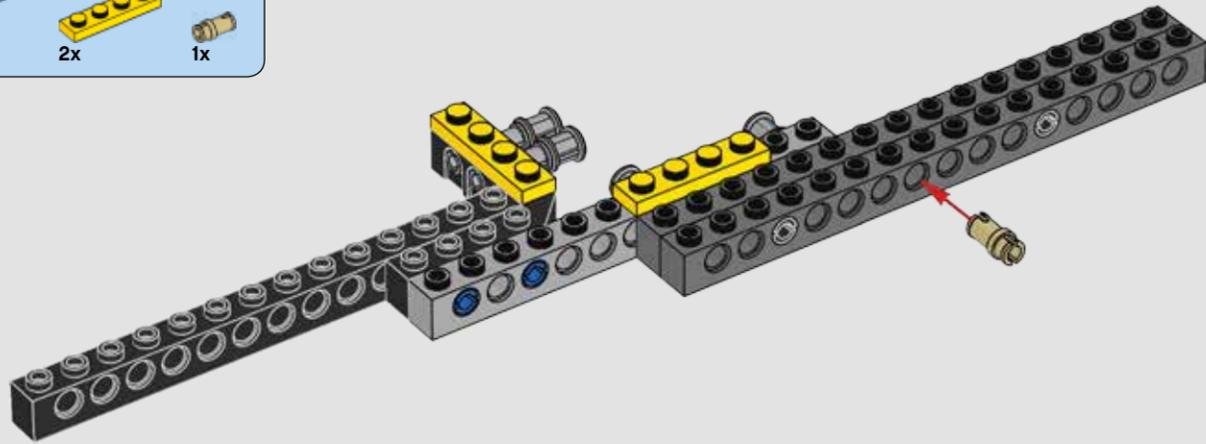

89

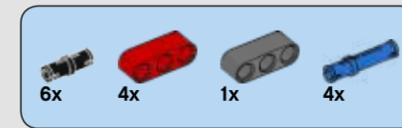
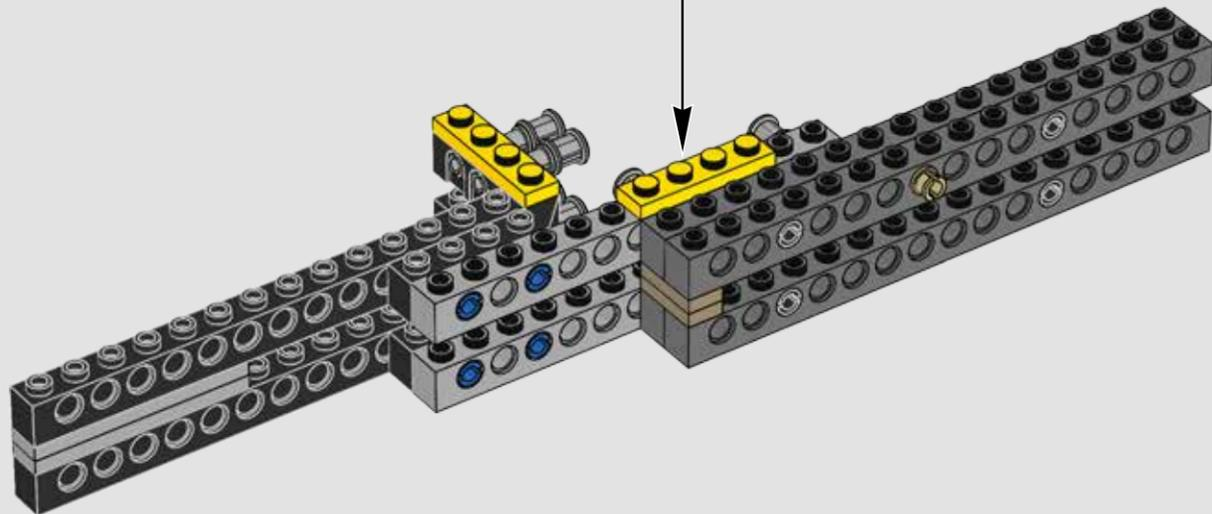

90

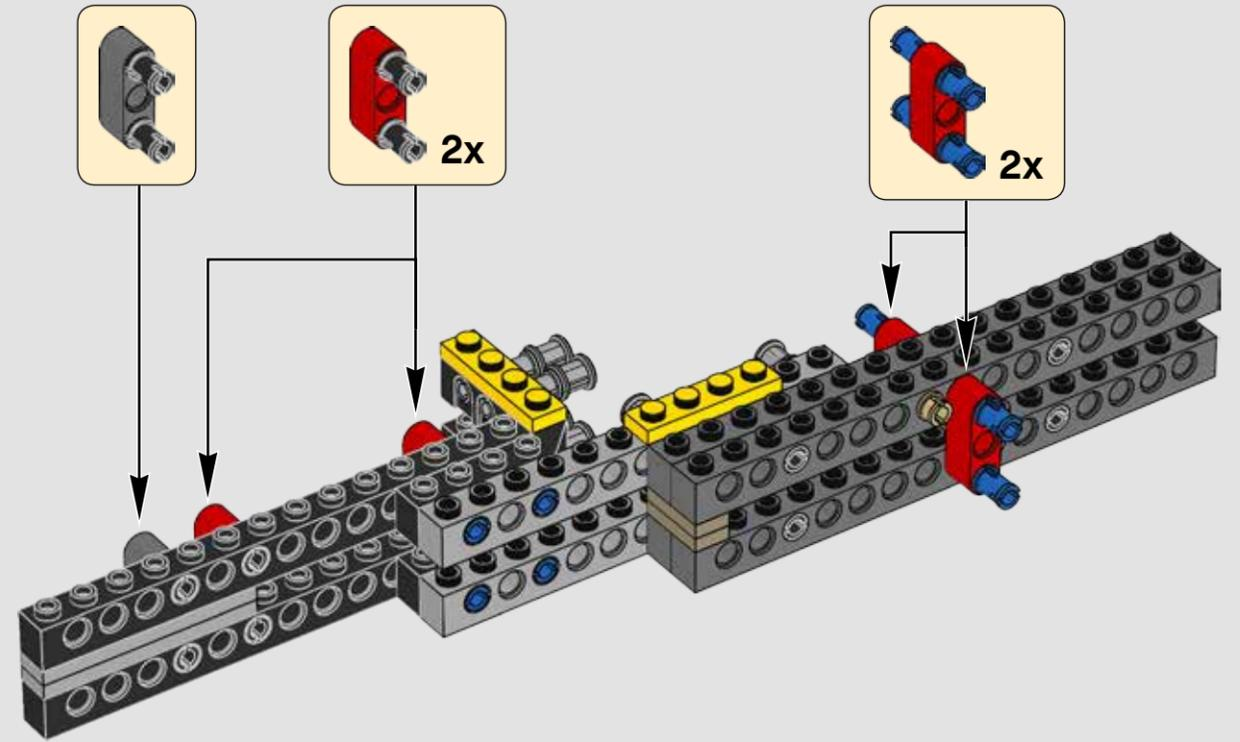

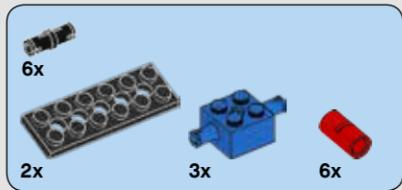

91

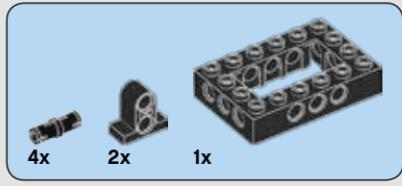
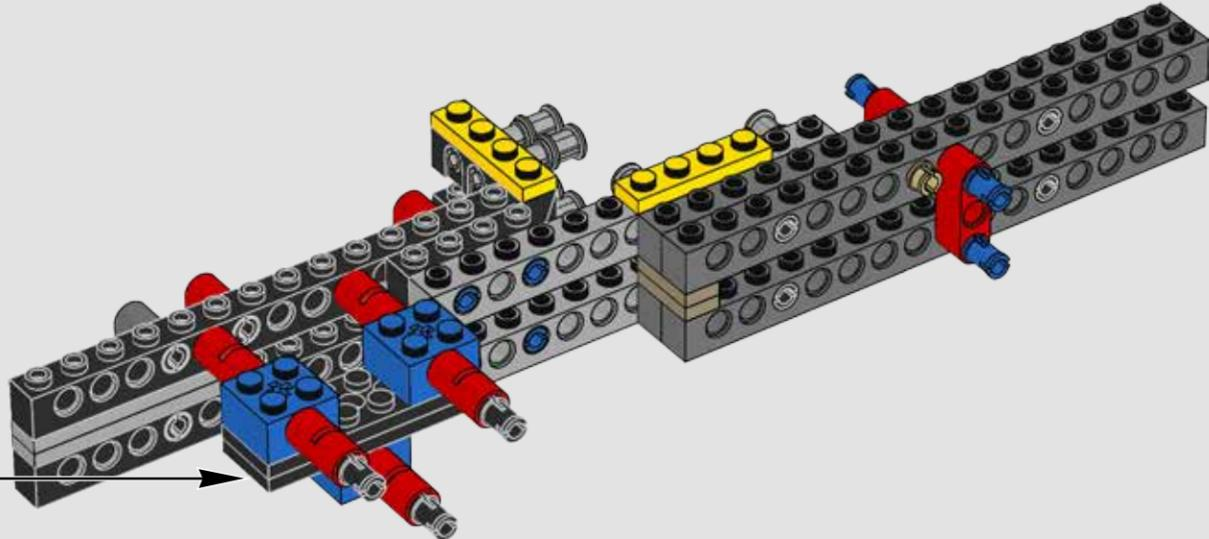
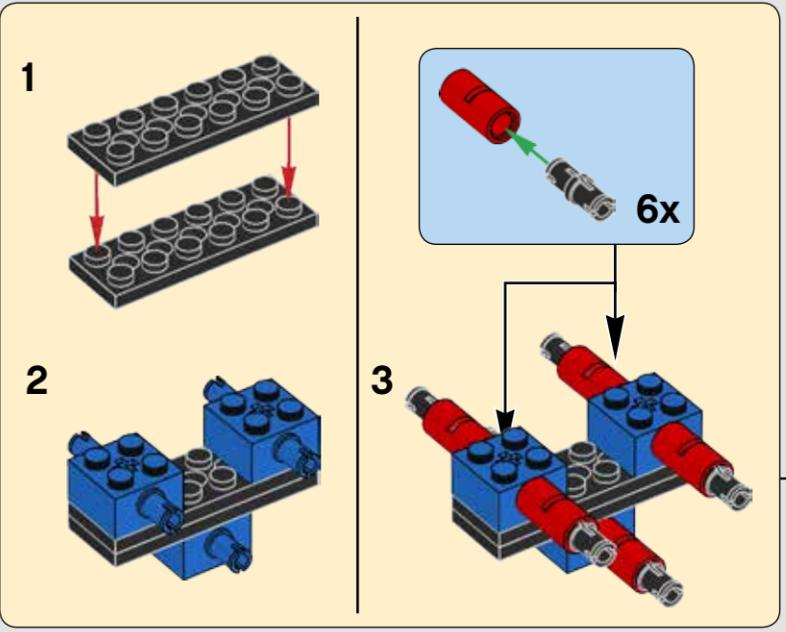

92

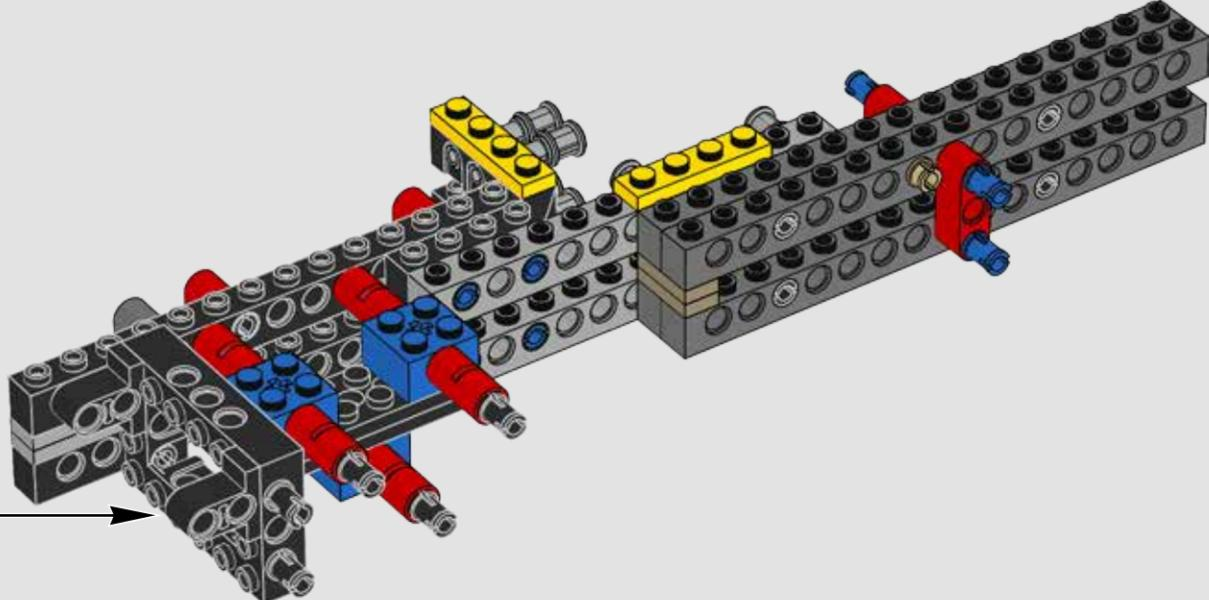
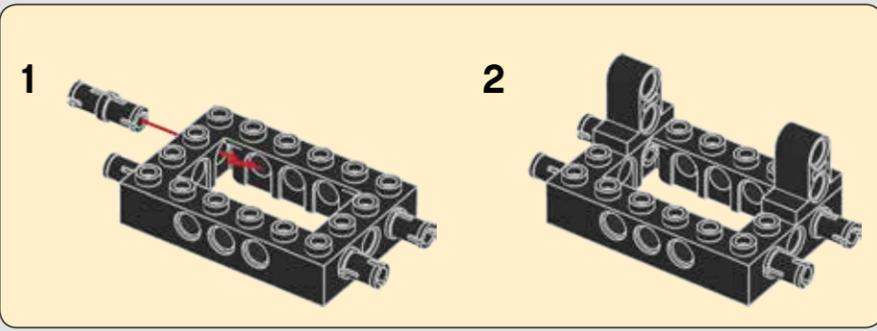



93

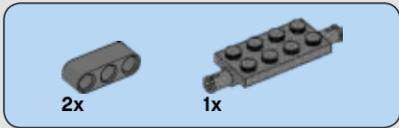
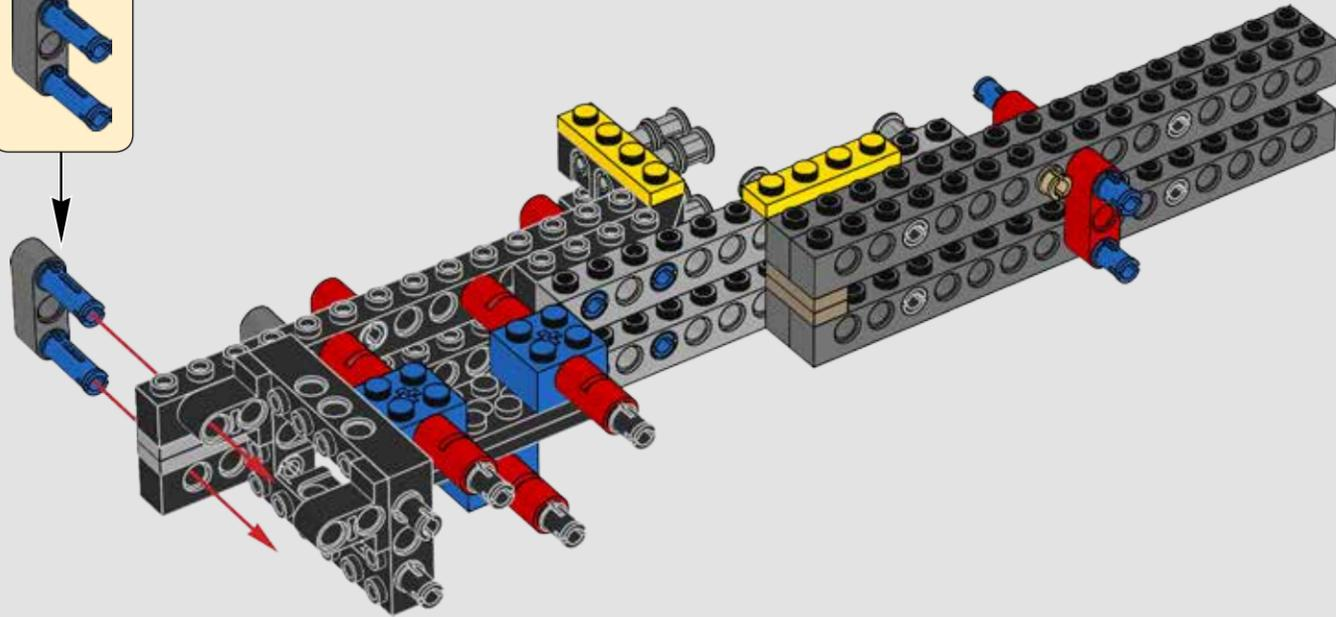
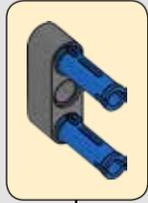

94

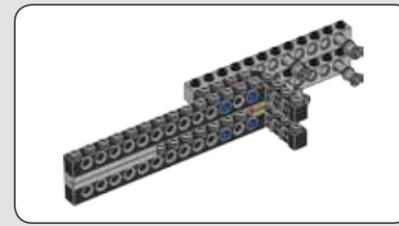
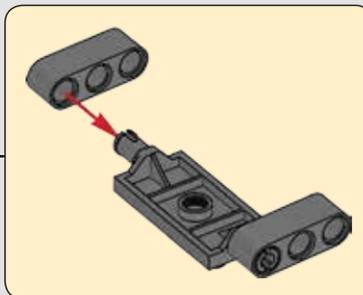
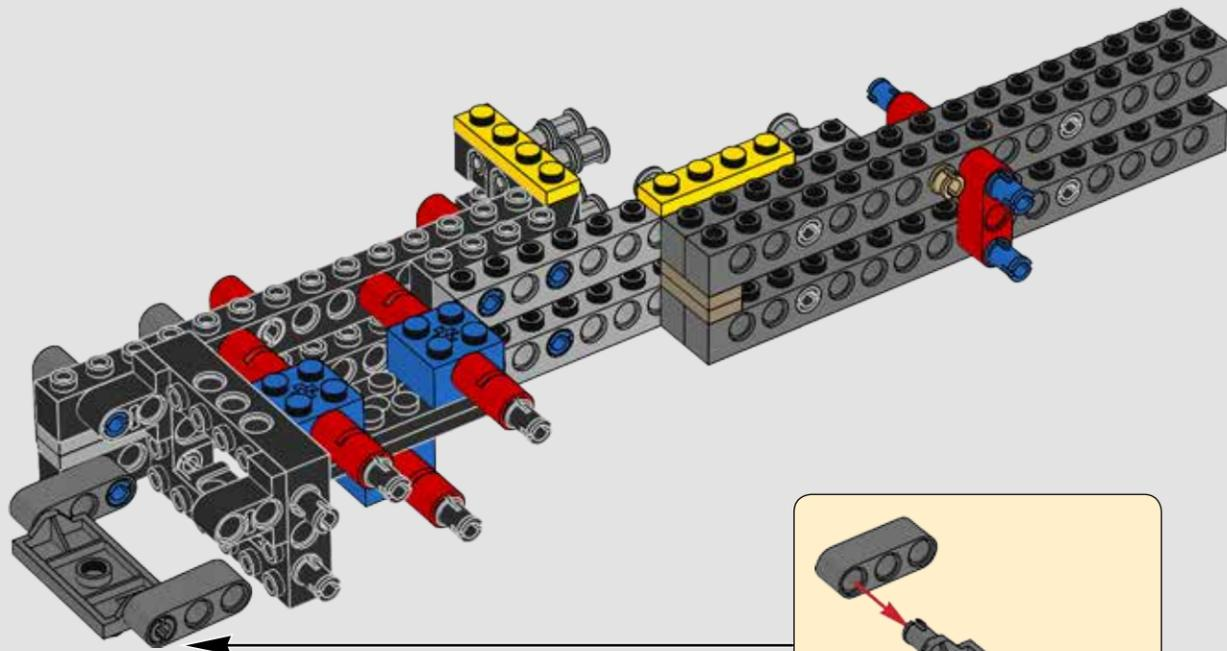

95

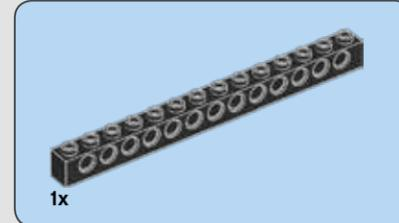
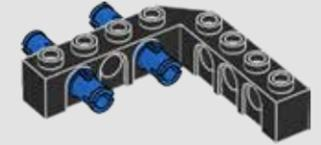
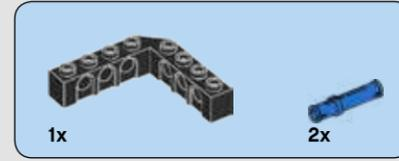

96

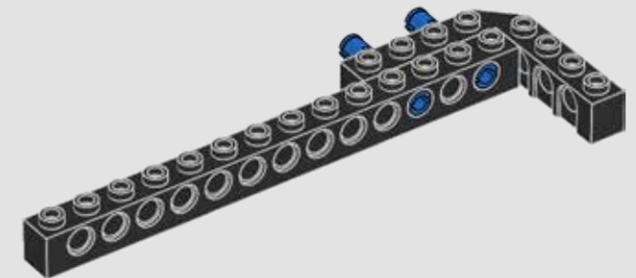

100

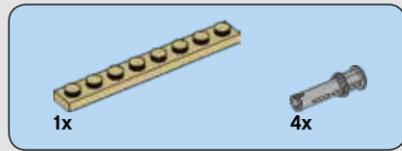
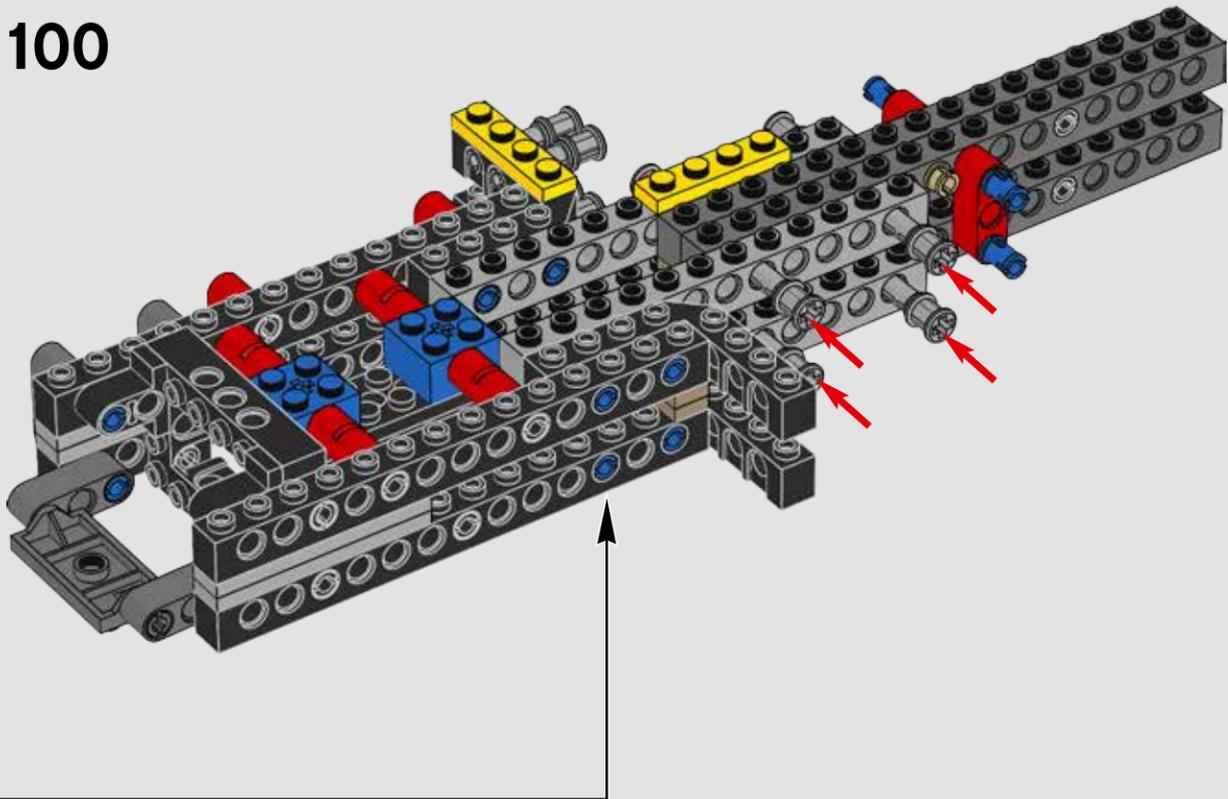

101

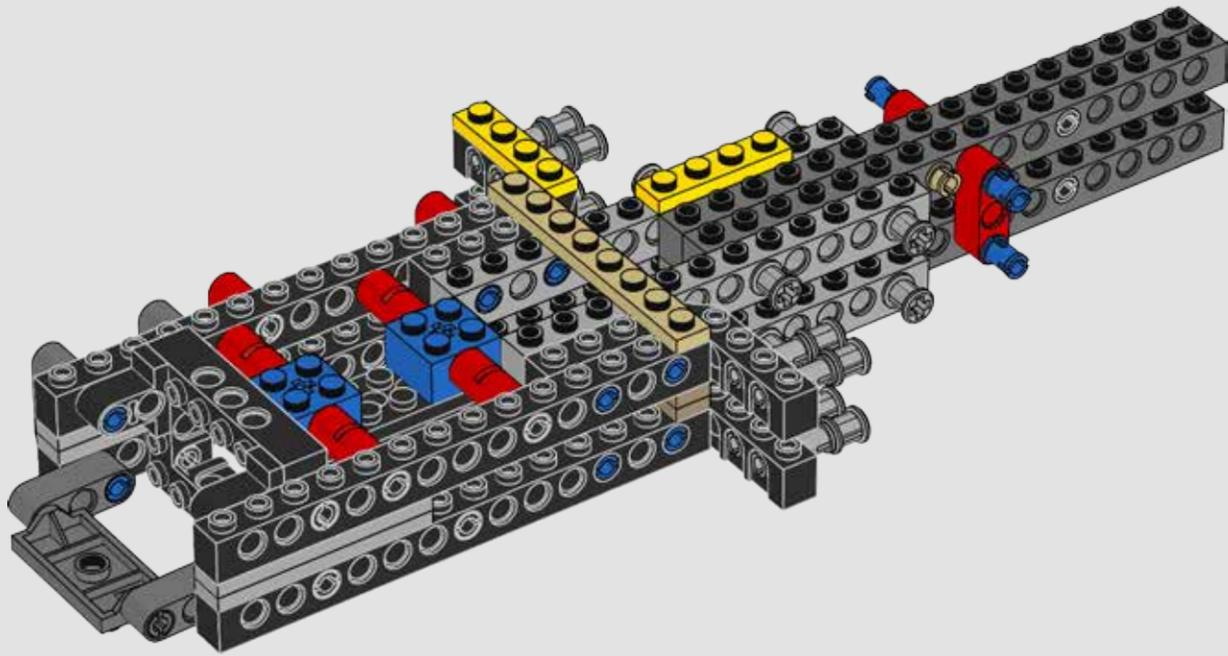



102

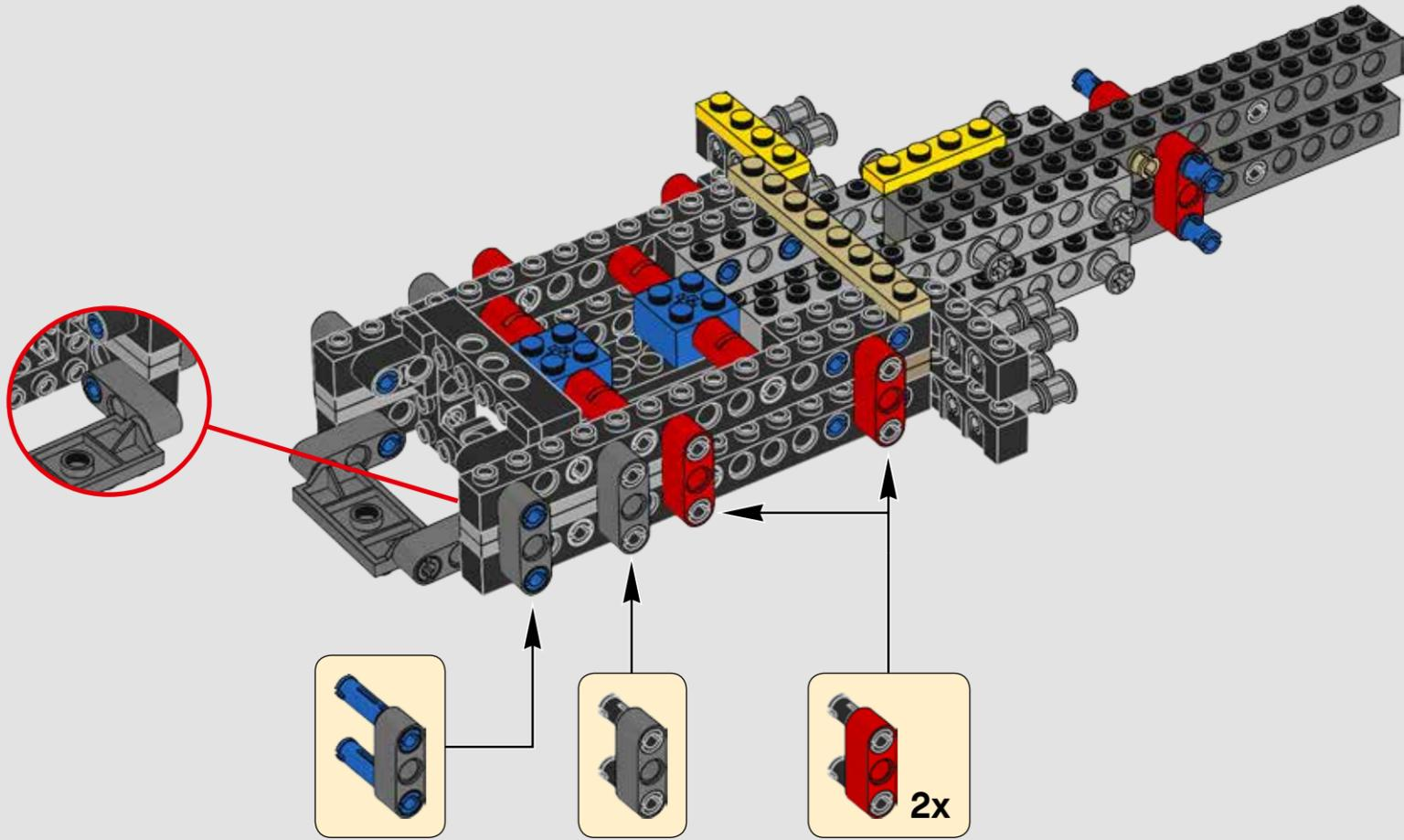

103

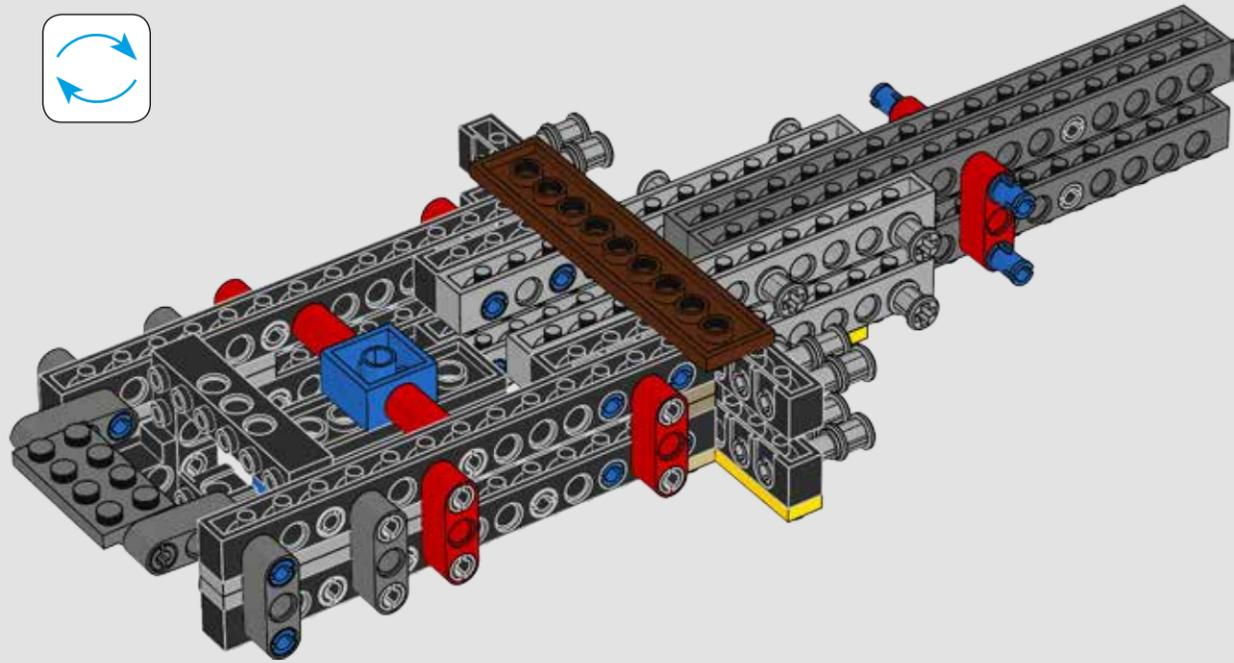

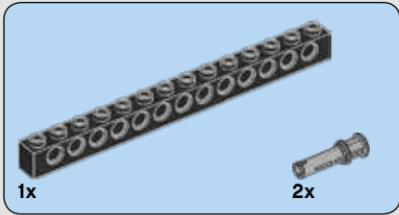
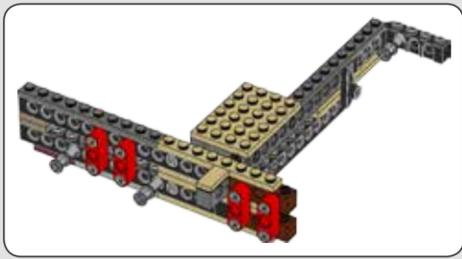

104

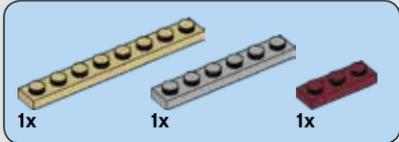
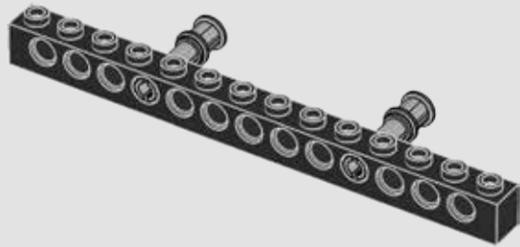

105

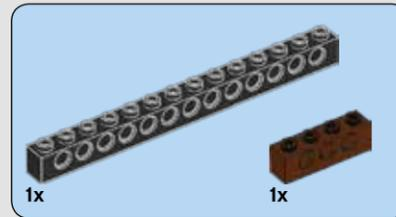
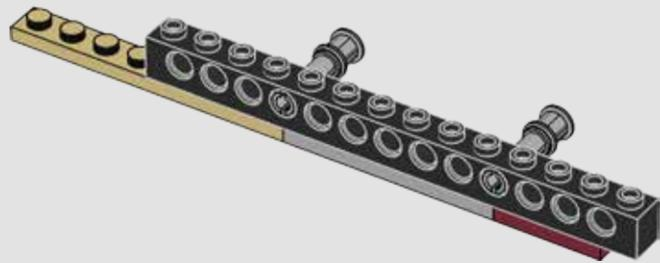

106

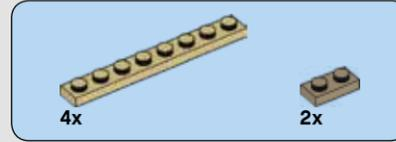
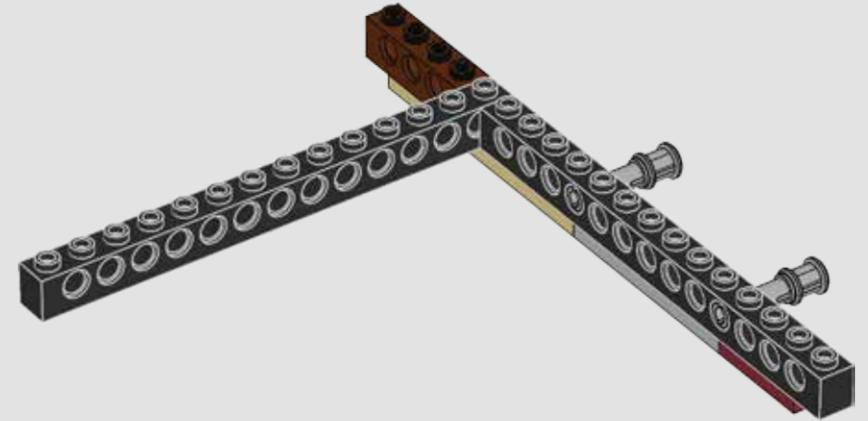

107

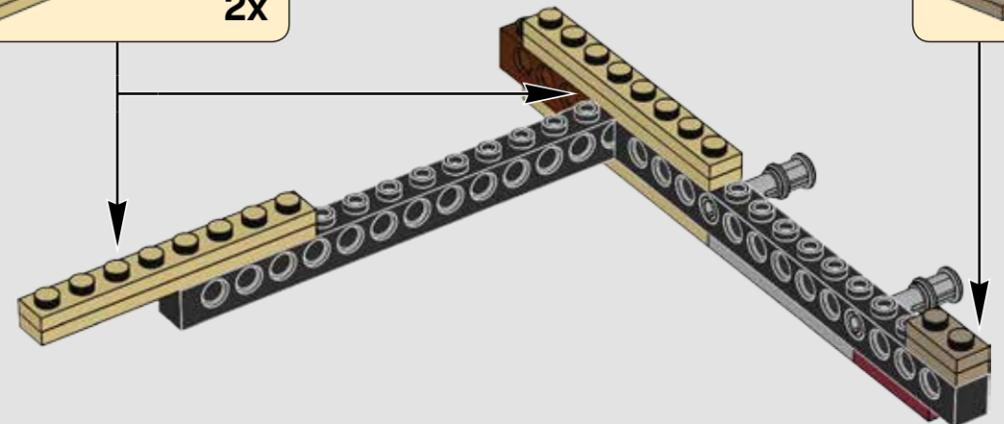
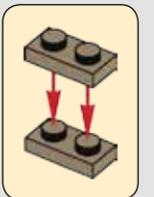
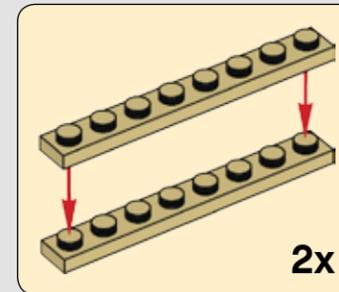

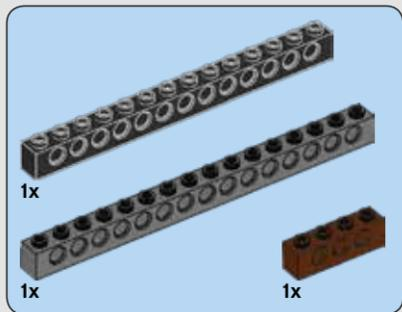

108

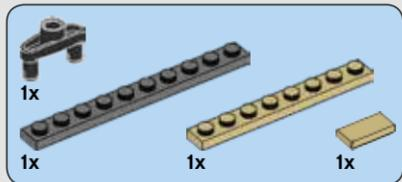
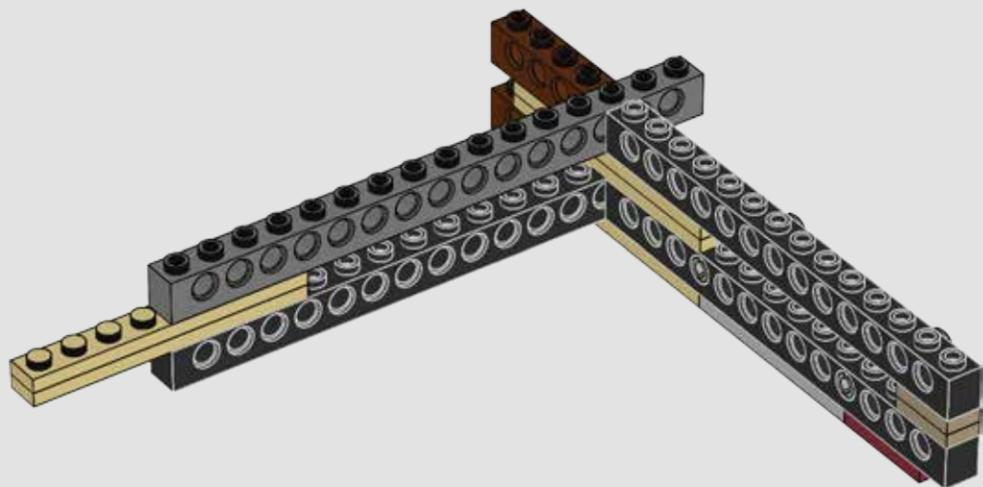

109

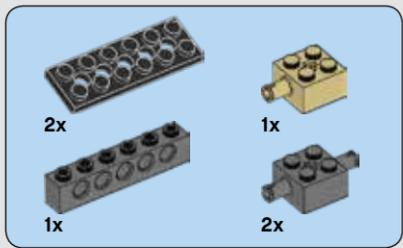
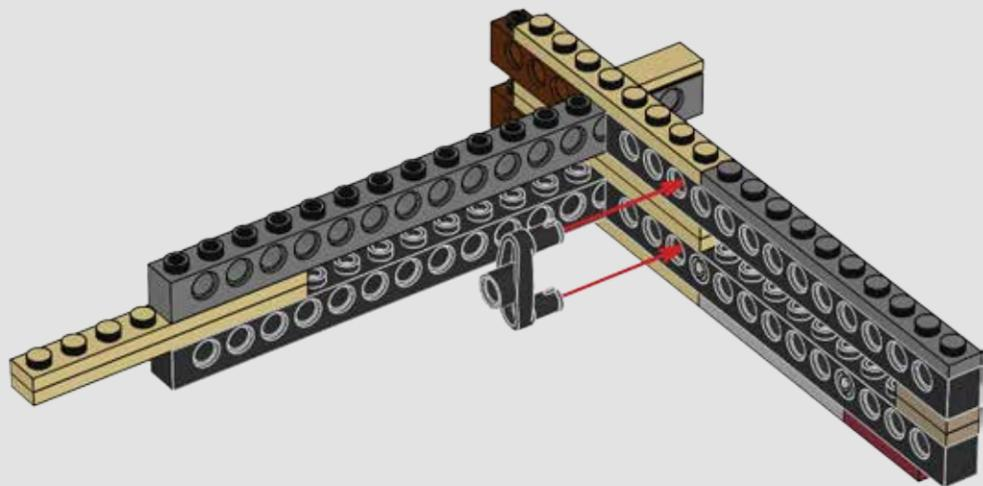

110

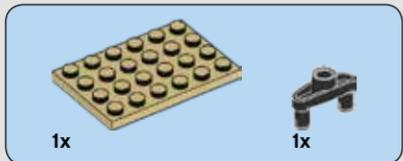
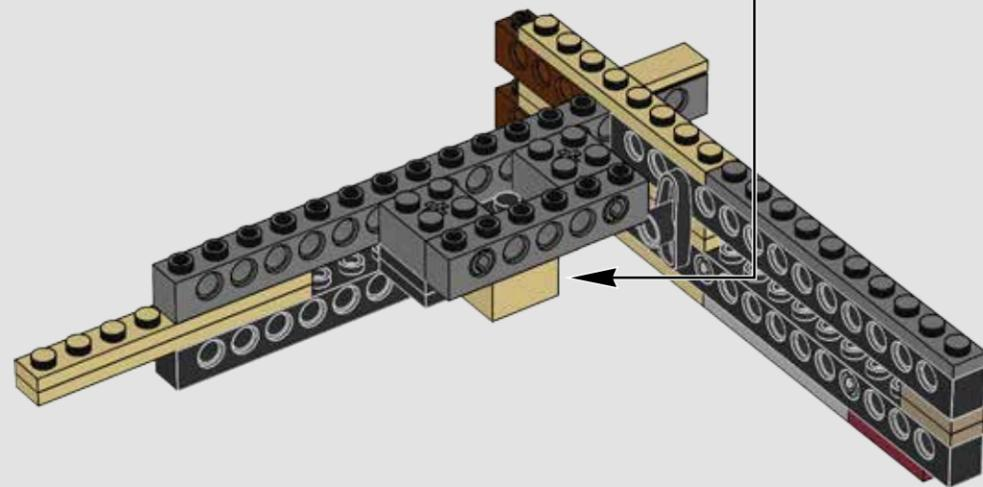
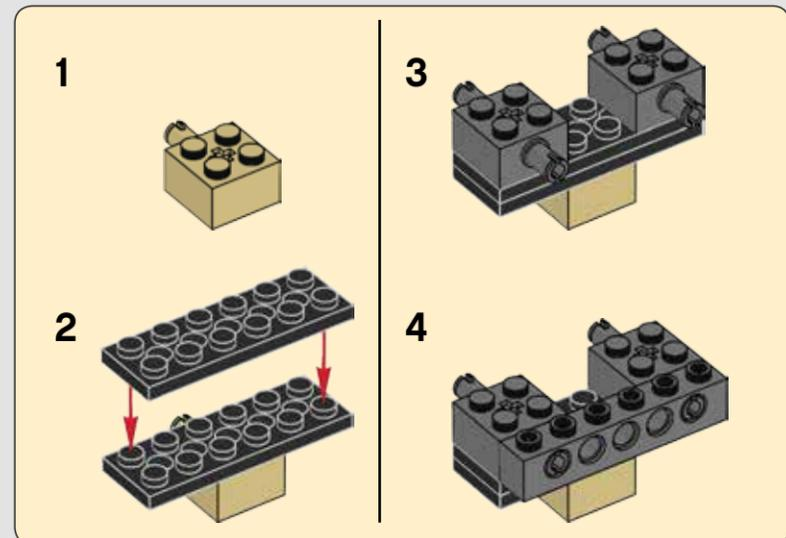

111

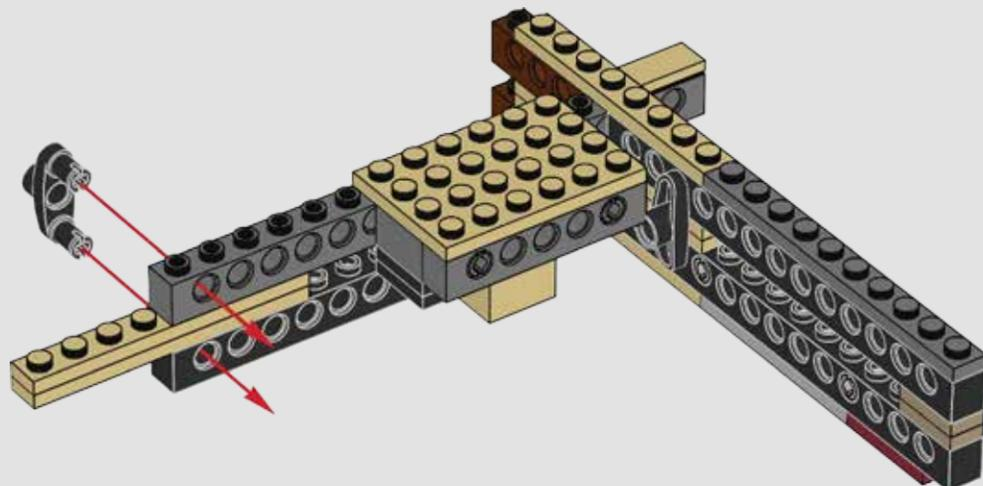

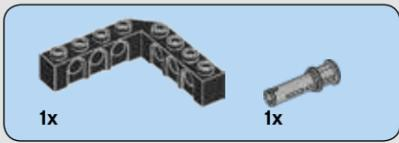

112

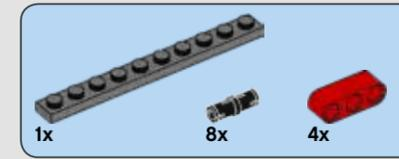
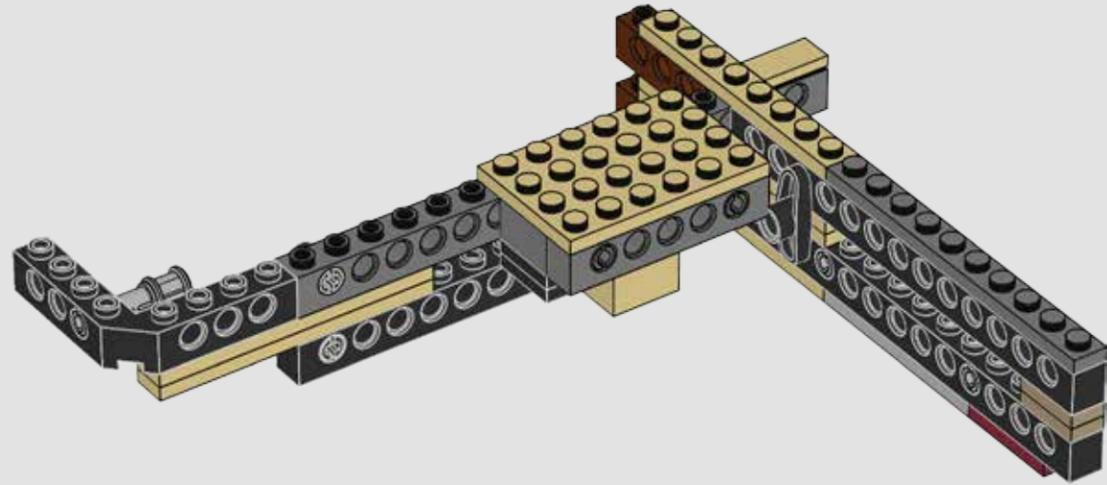

113

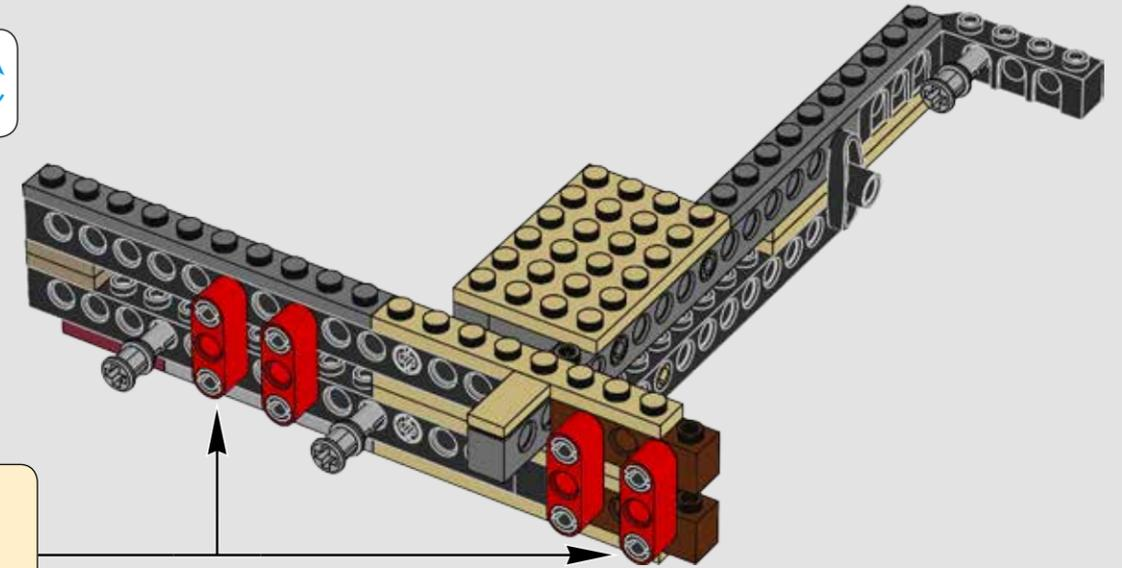

114

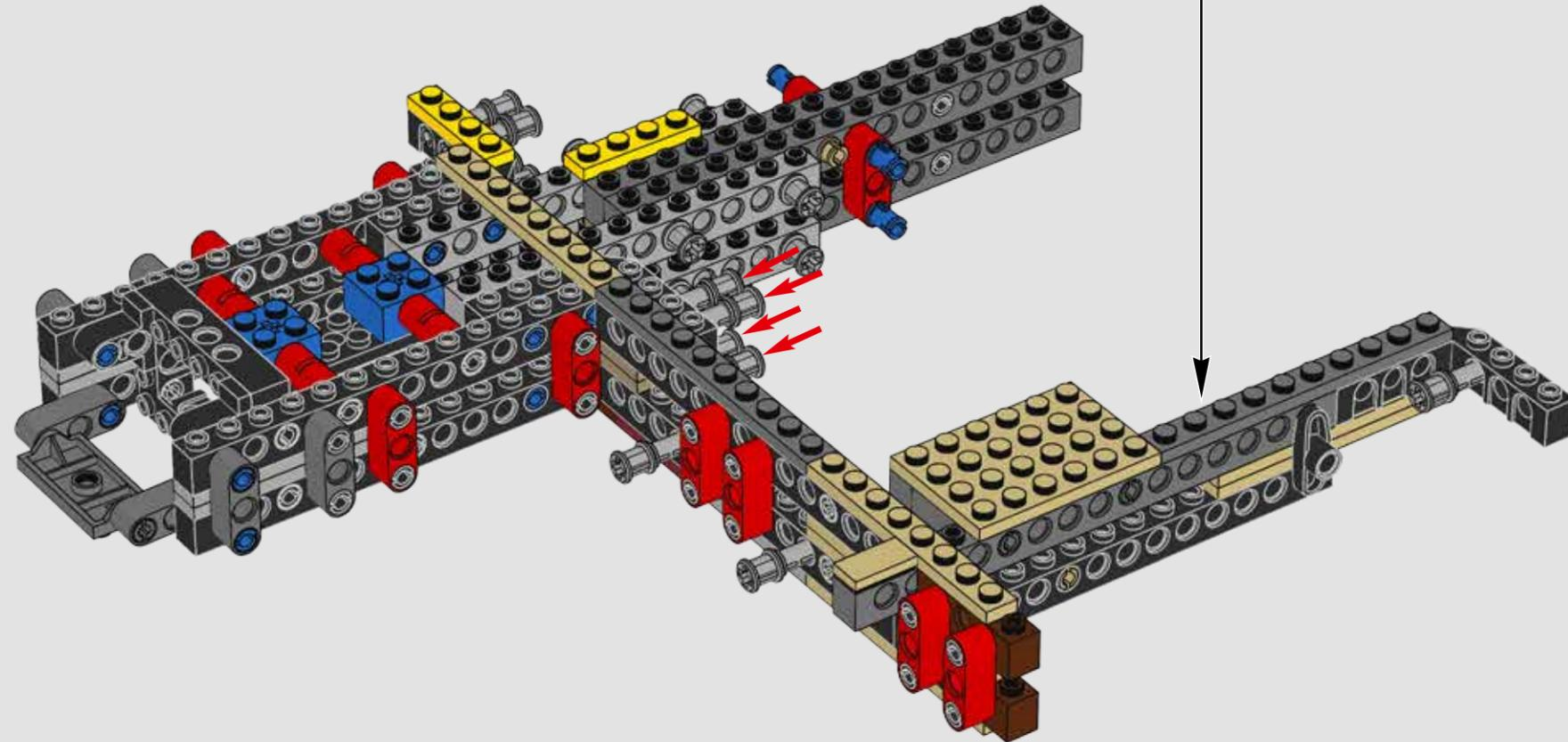

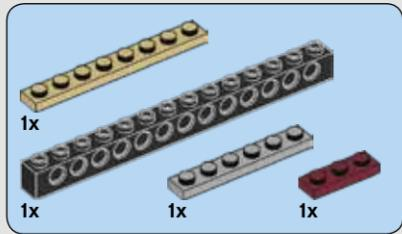
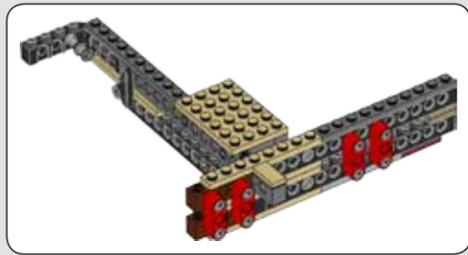

115

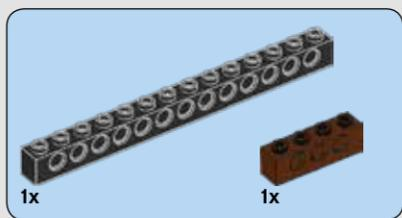
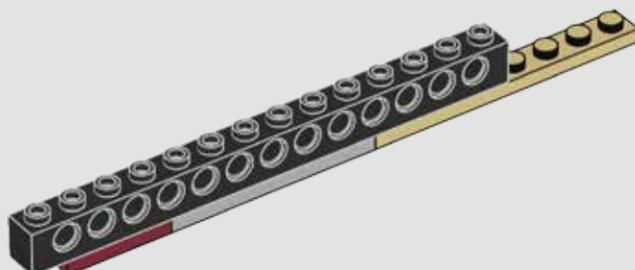

116

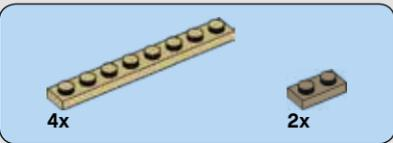
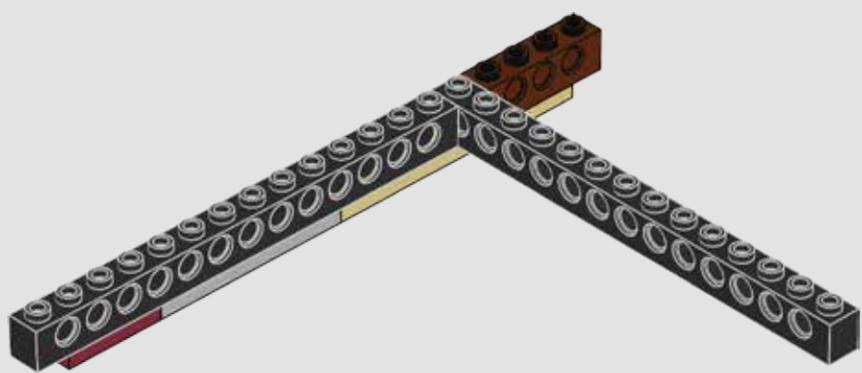

117

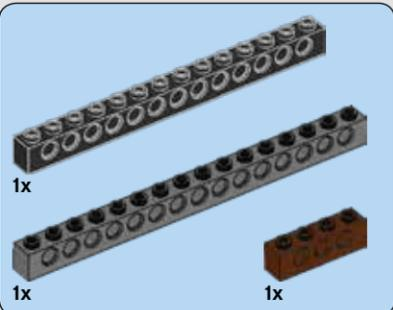
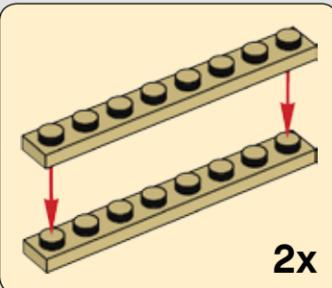
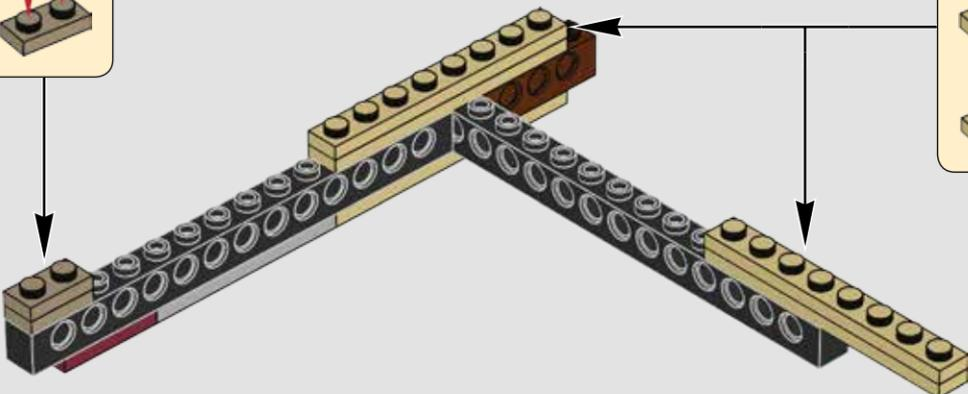
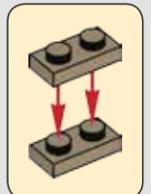

118

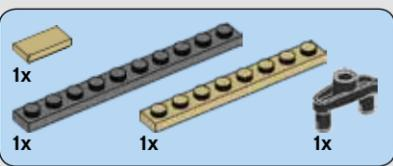
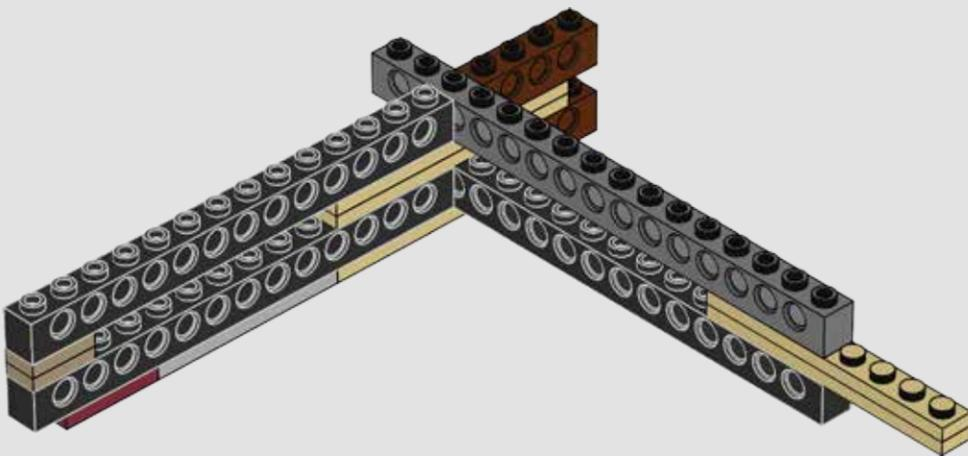

119

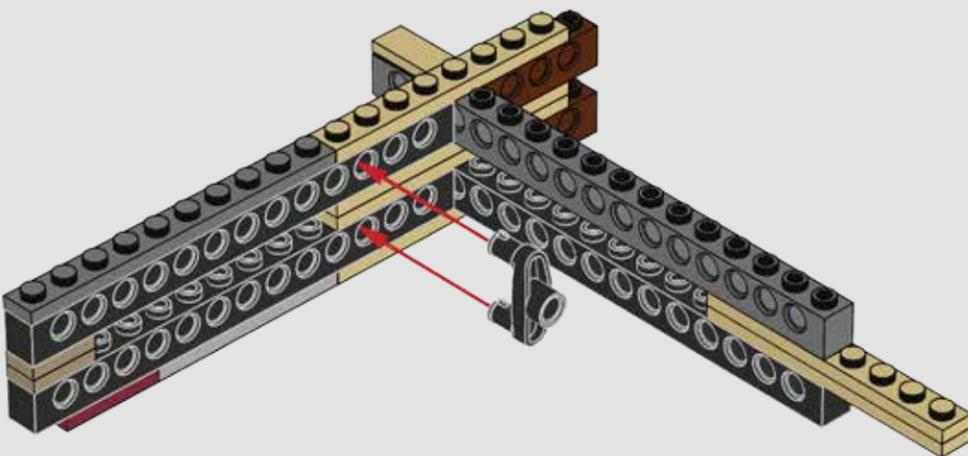

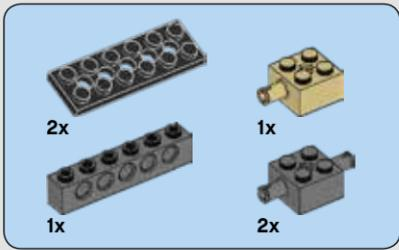

120

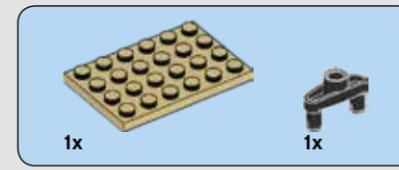
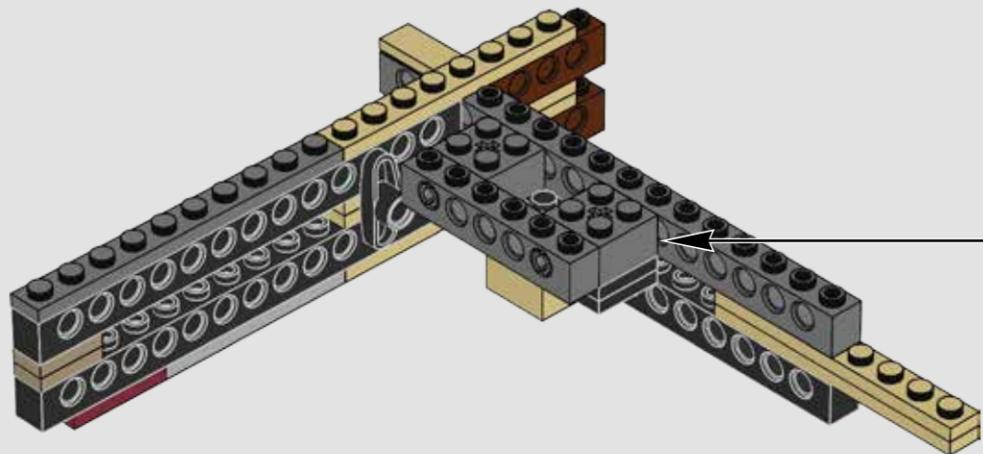
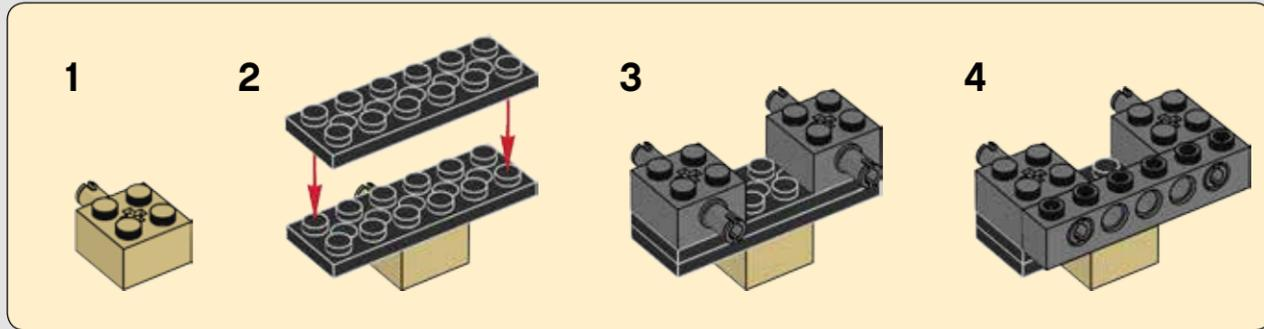

121

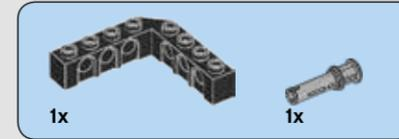
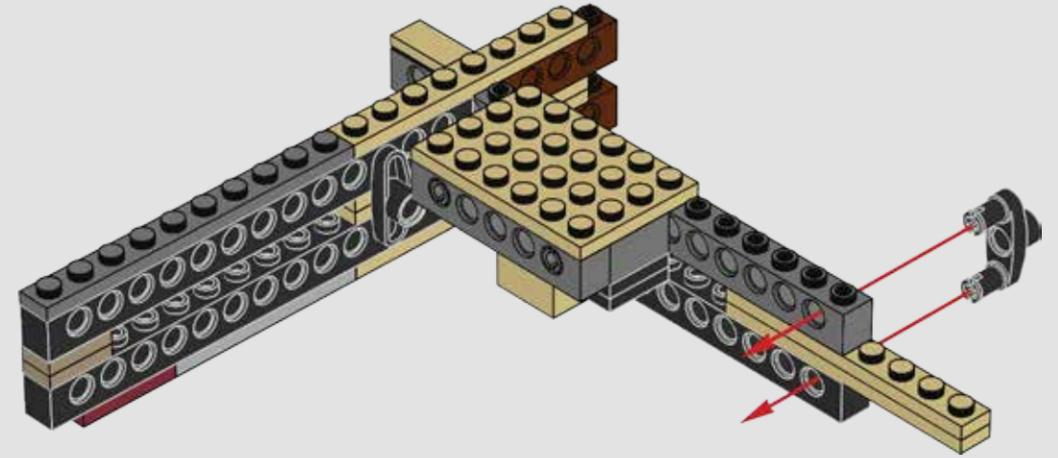

122

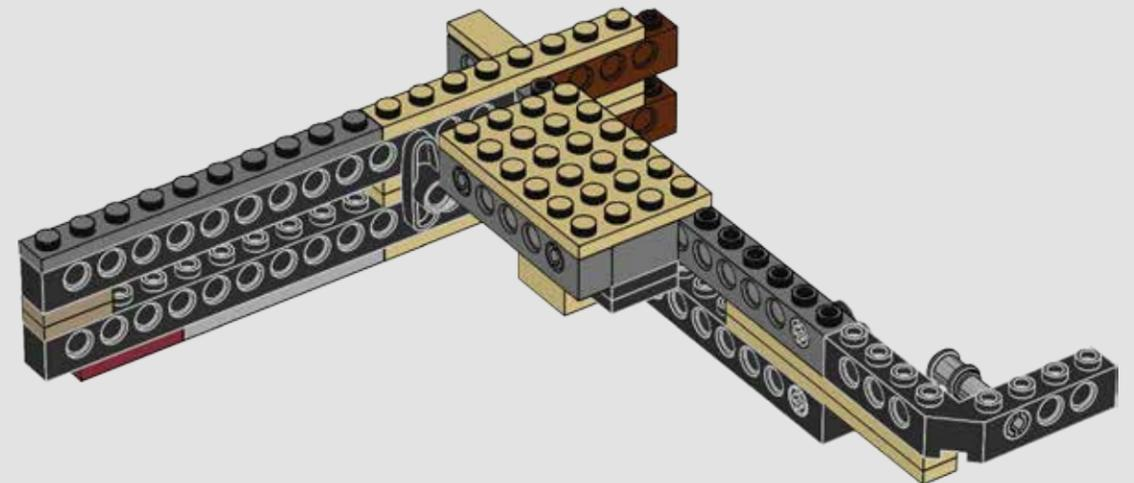

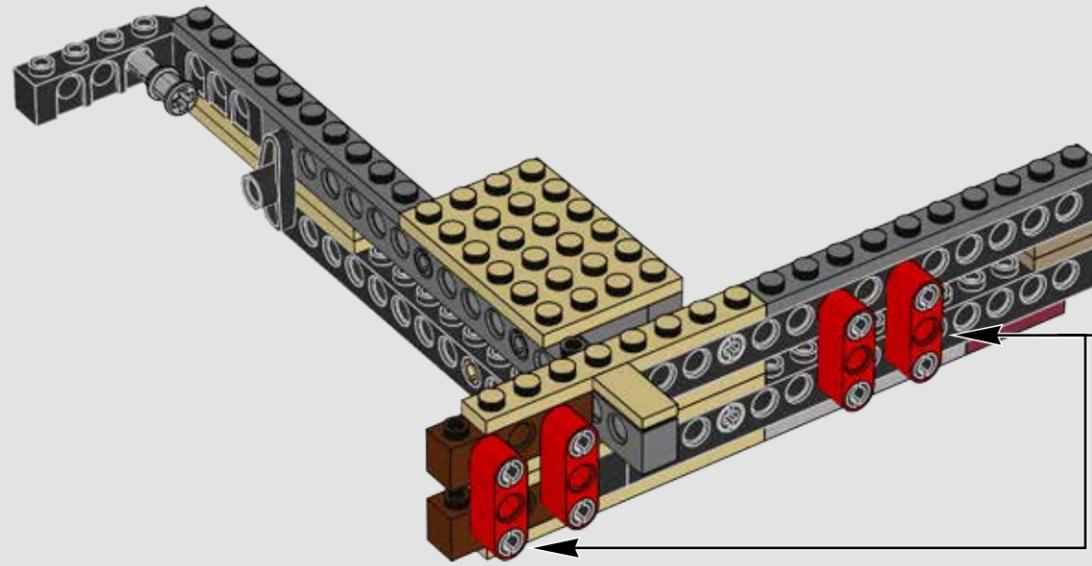
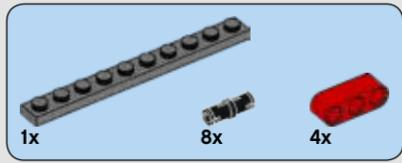

123

124

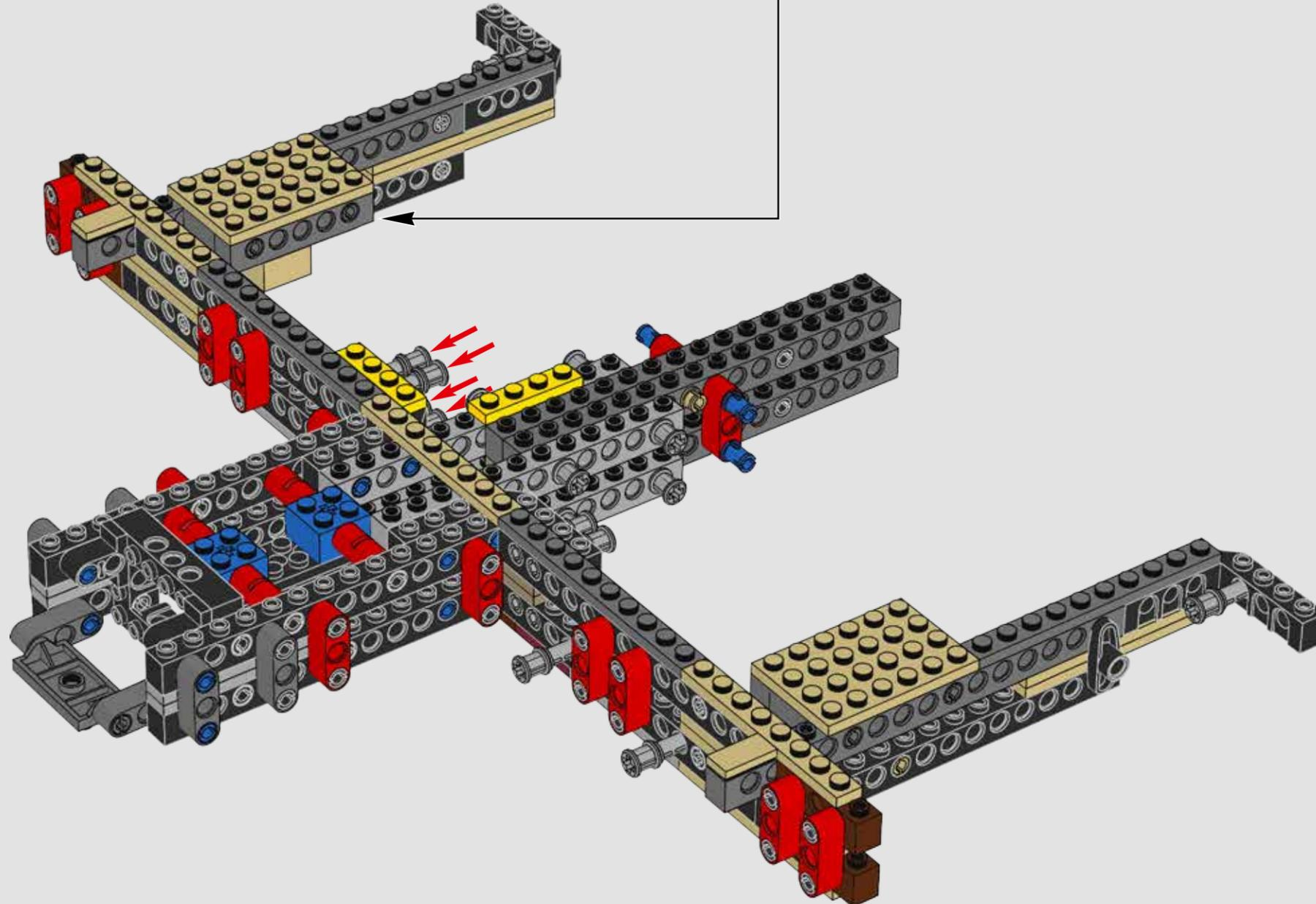

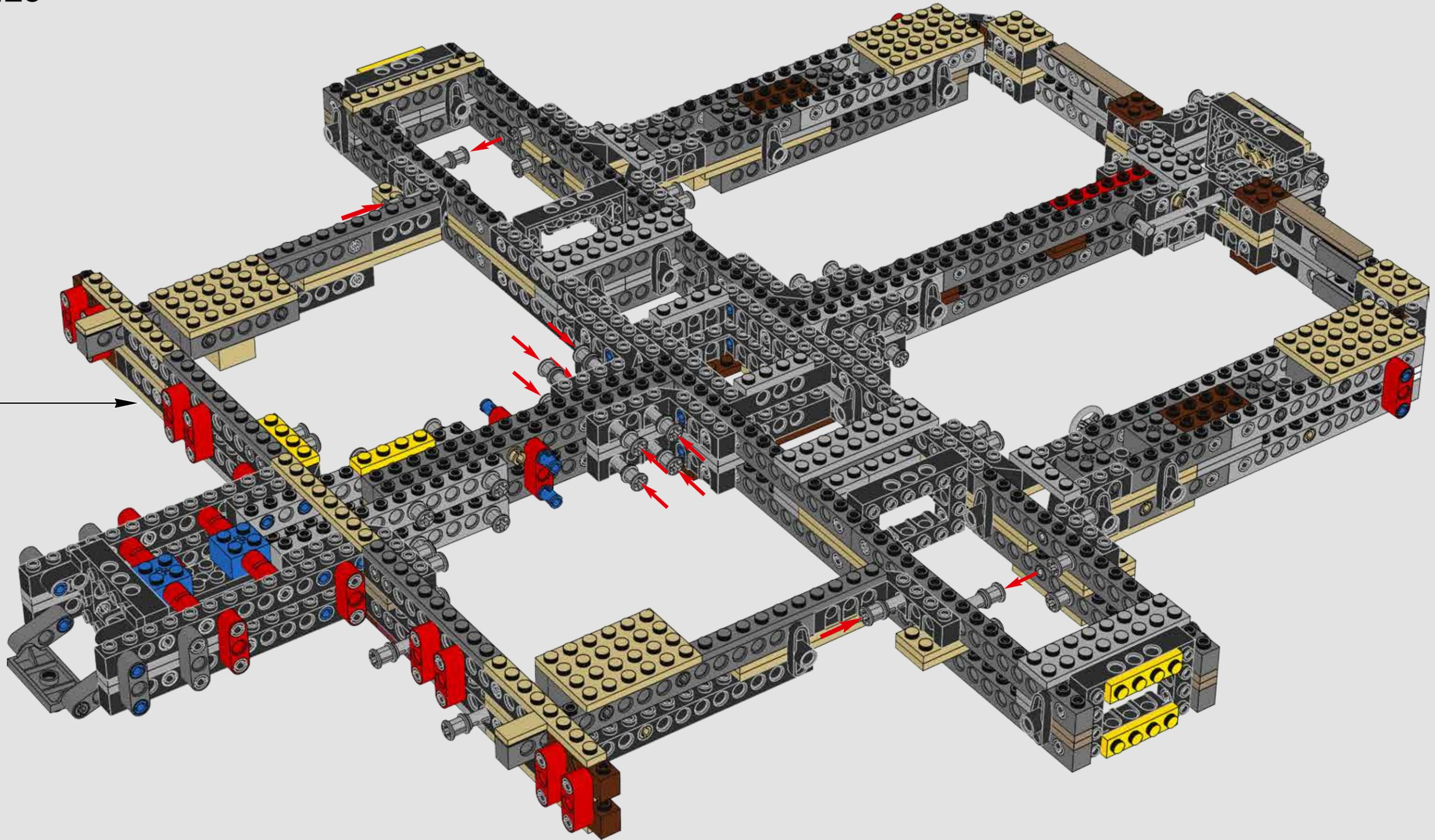

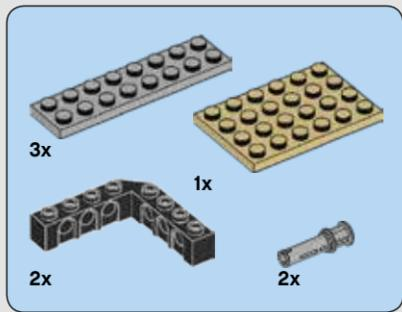

126

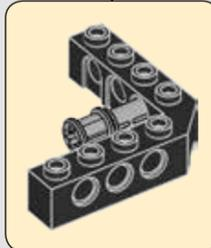
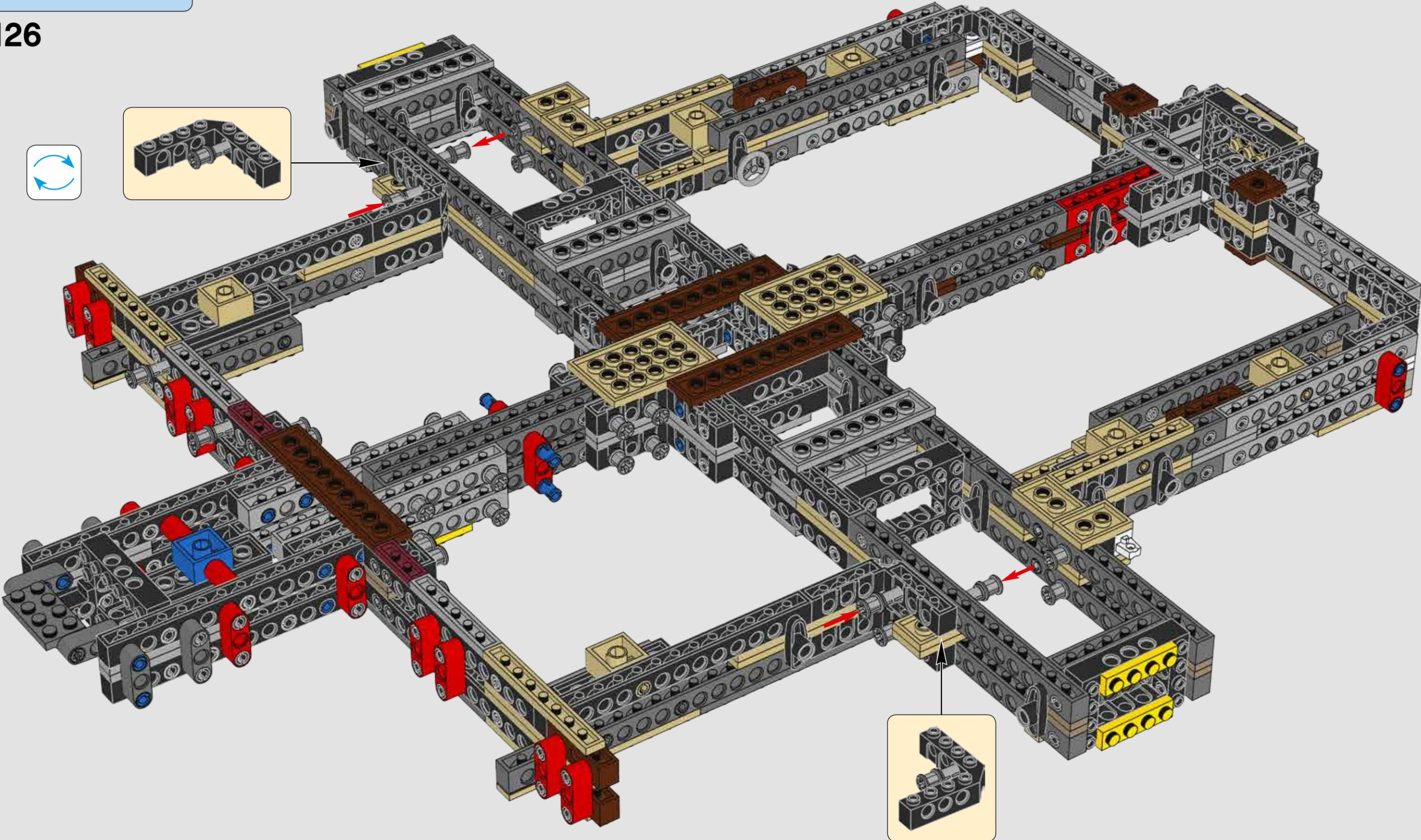
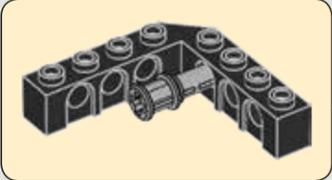

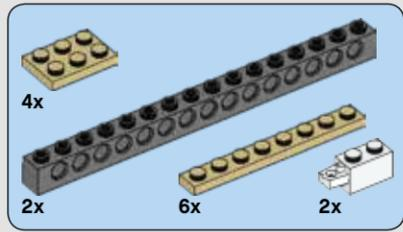

127

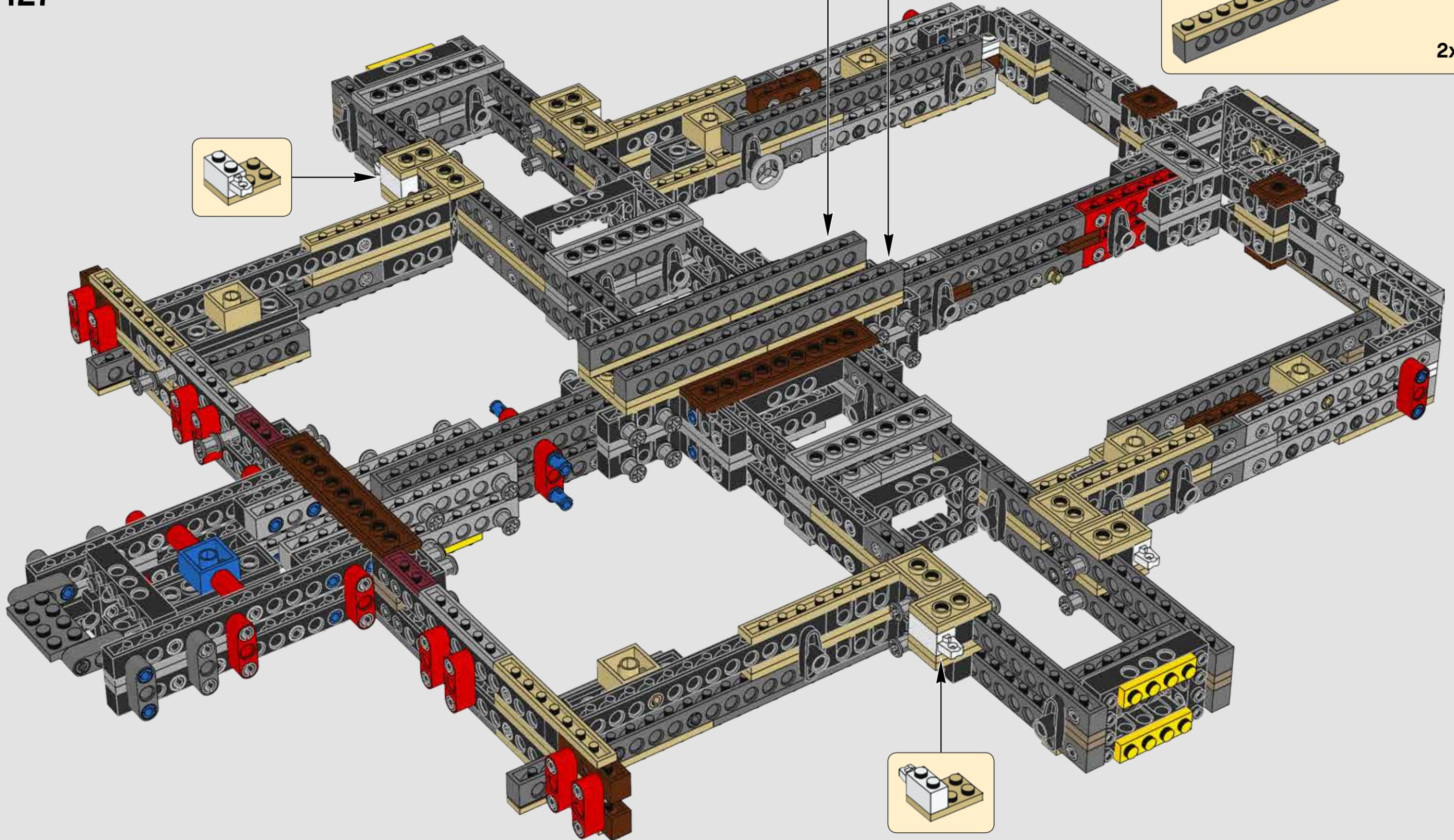
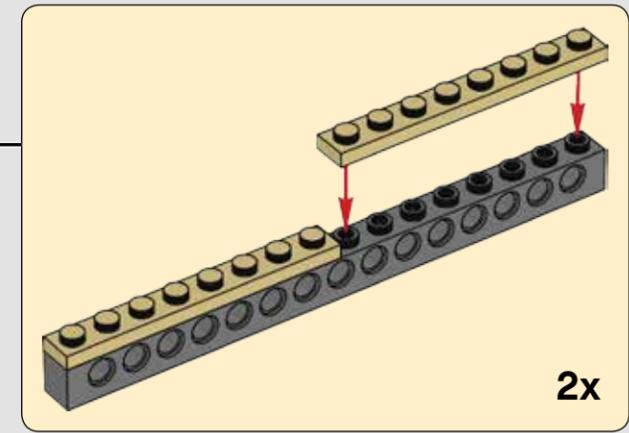

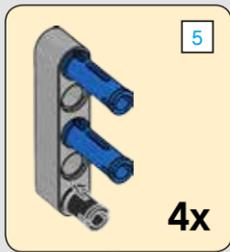
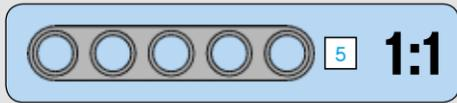

128

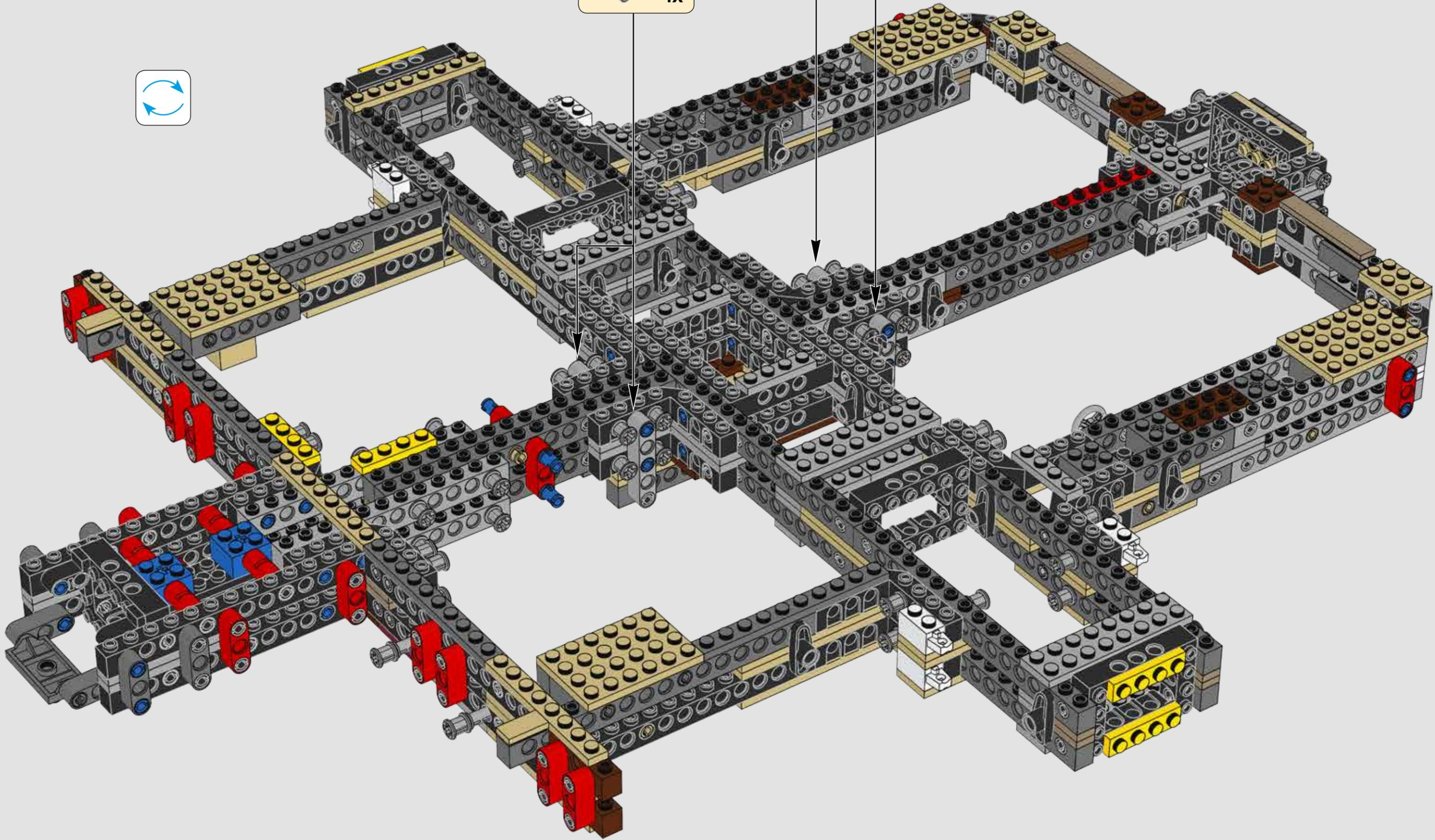

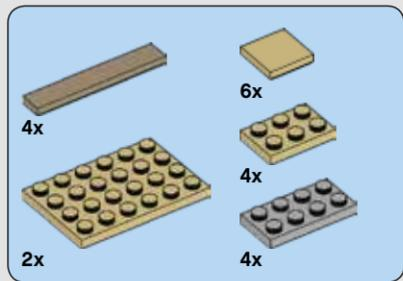

129

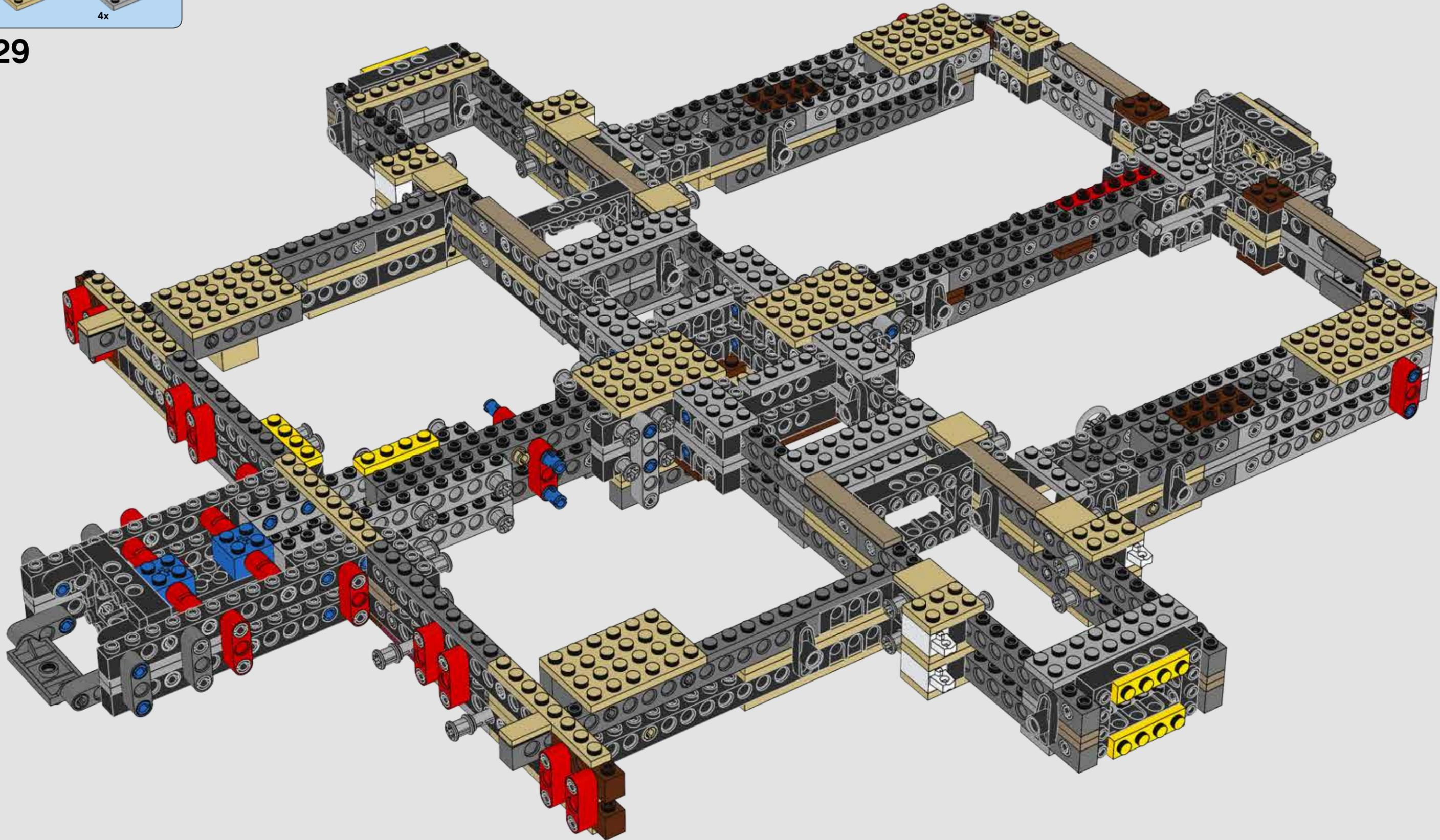

5x 1x 2x

130

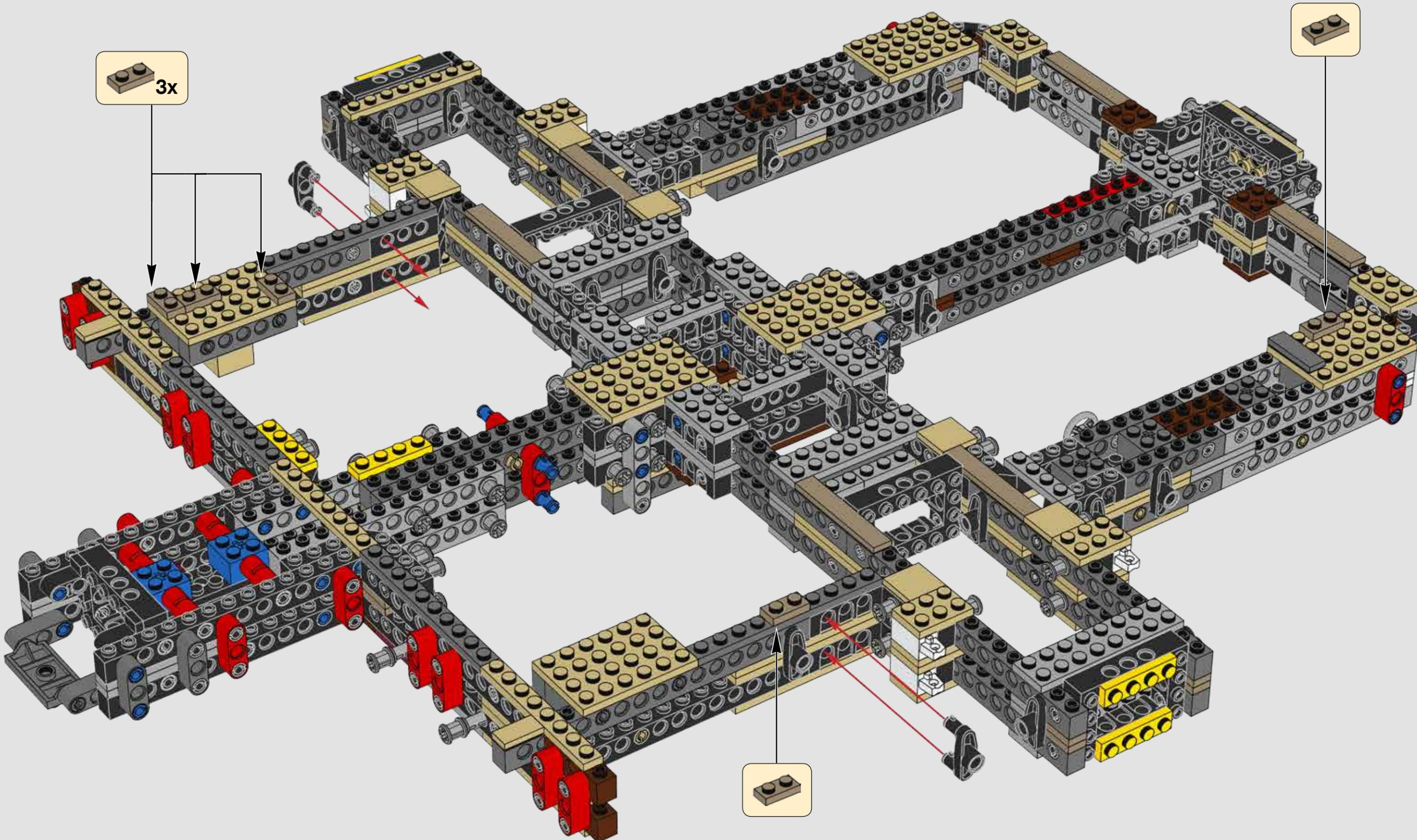

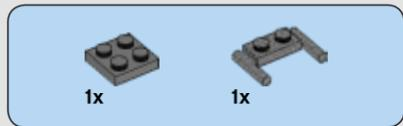
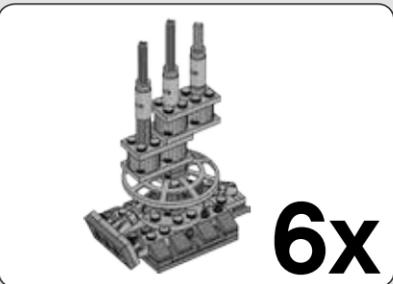
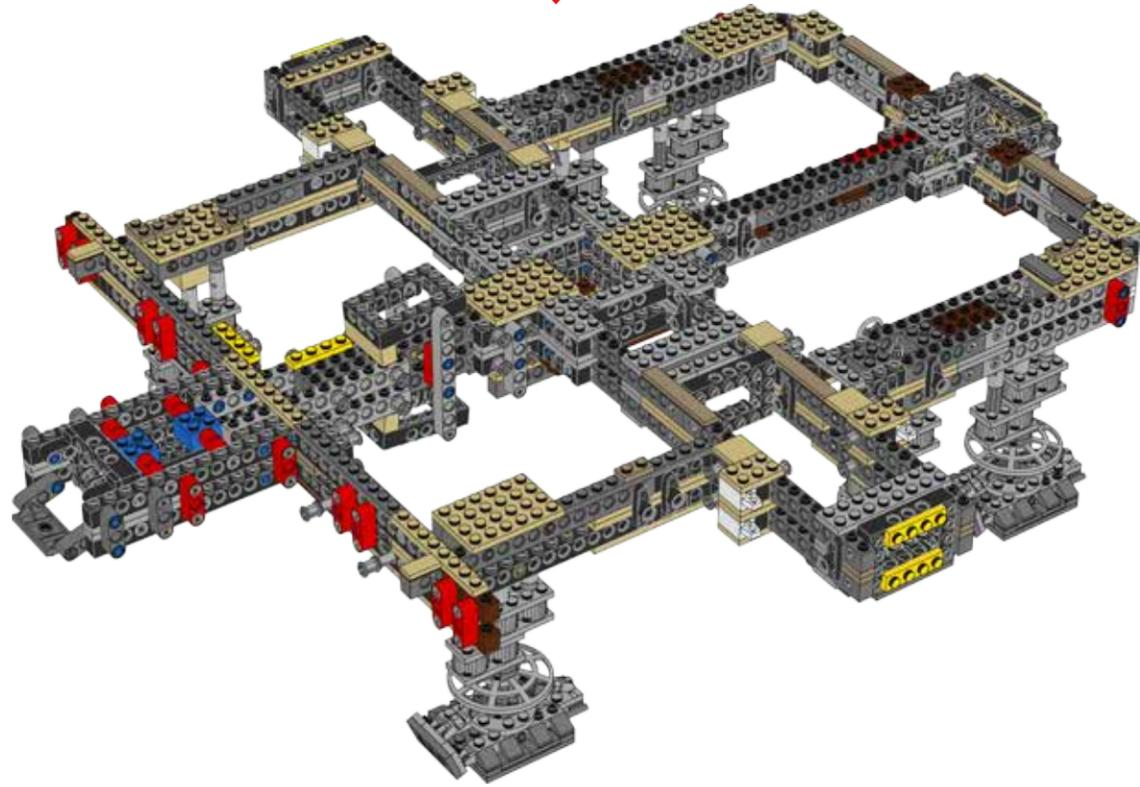

131

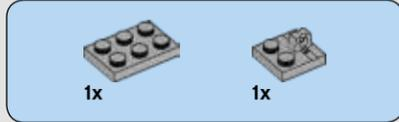
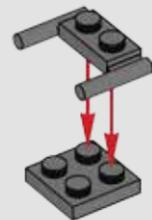

132

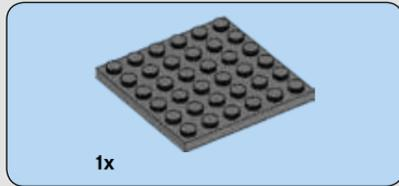
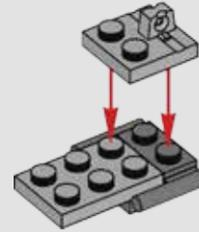

133

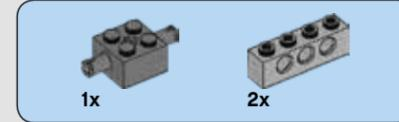

135

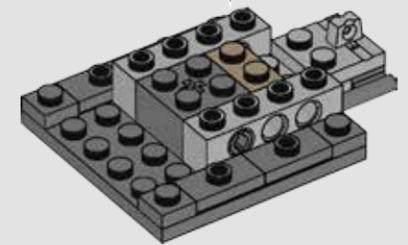
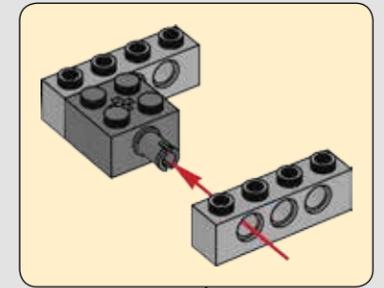

134

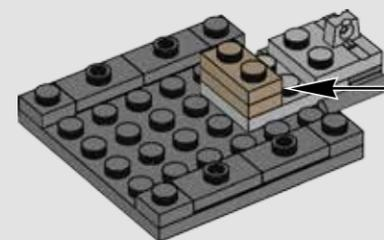
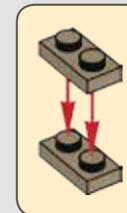

136

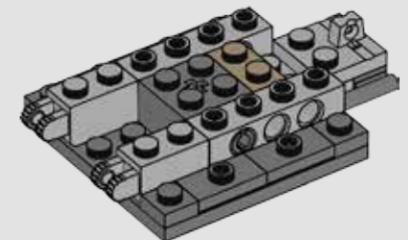



137

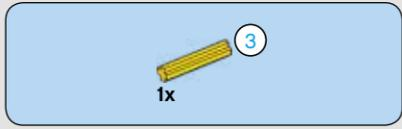
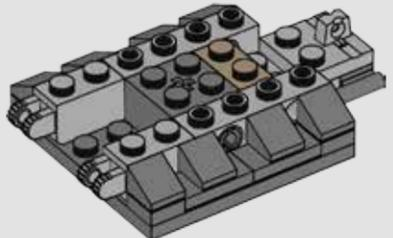

138

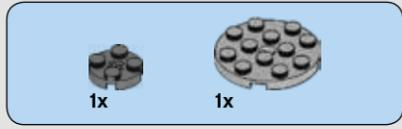
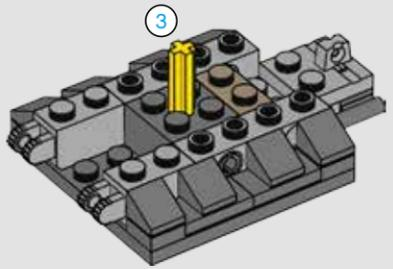

139

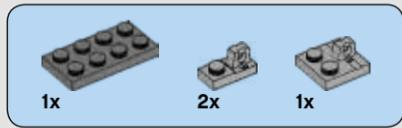

140

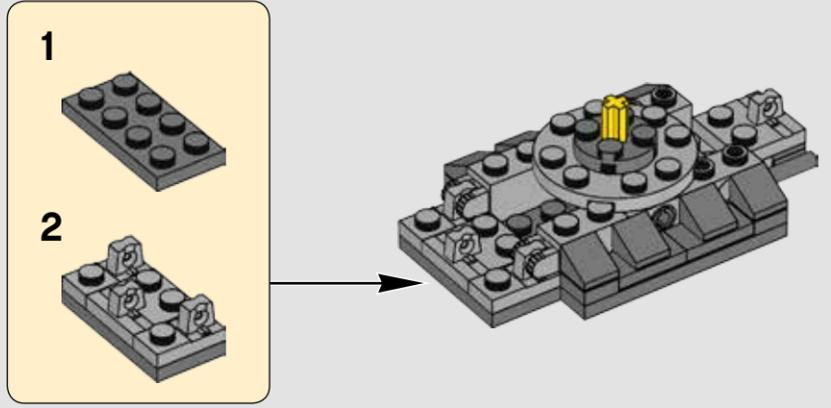

141

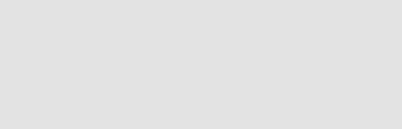
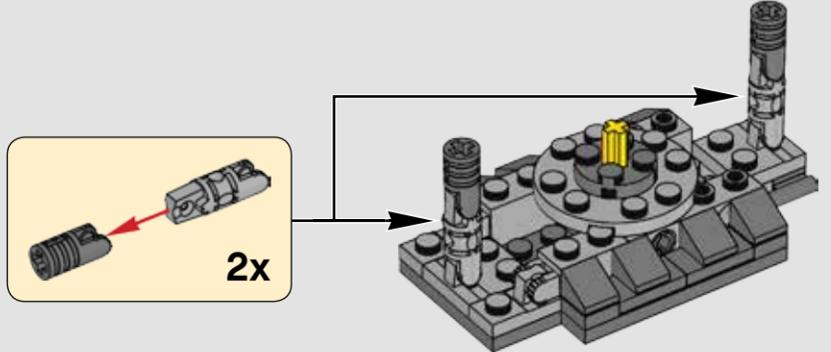

142

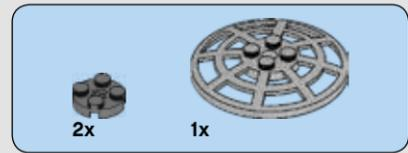
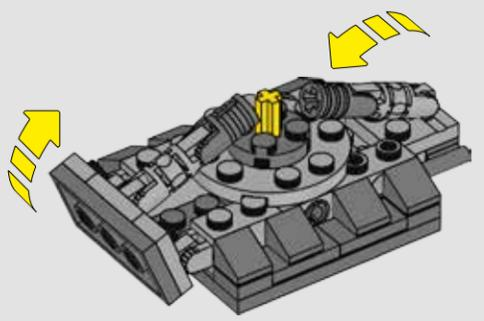

143

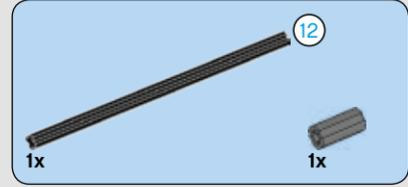
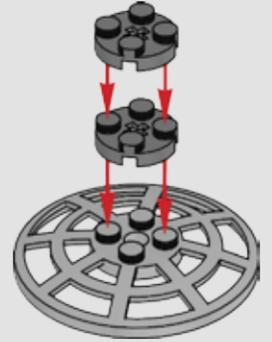

144

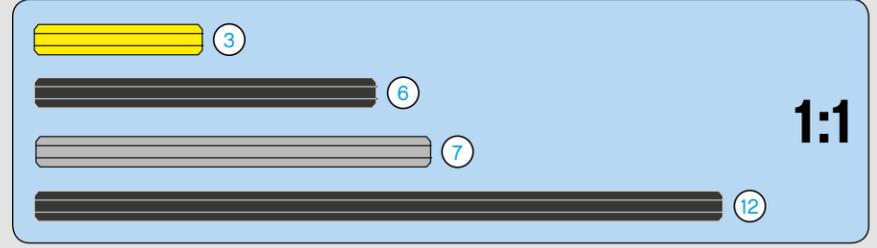
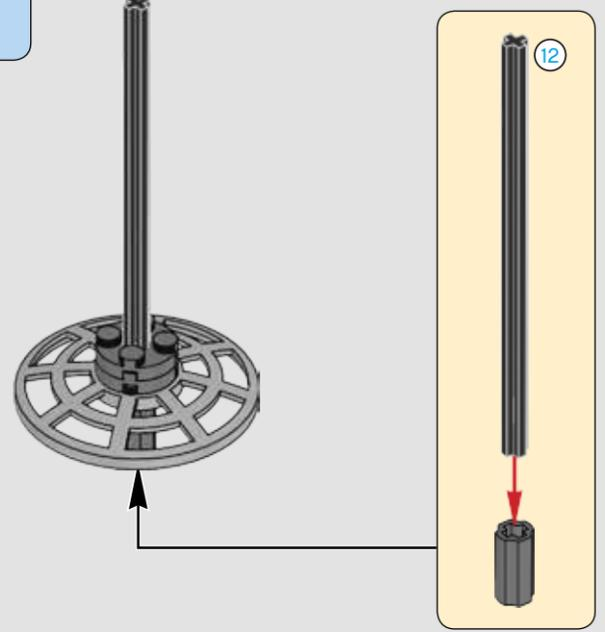



145

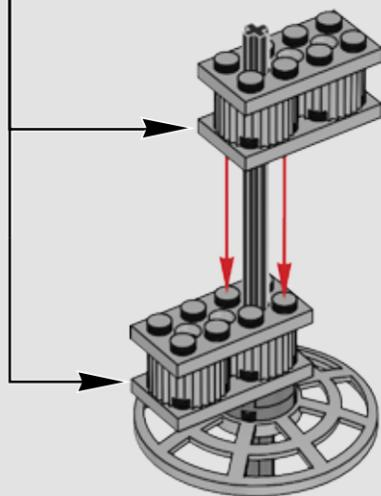
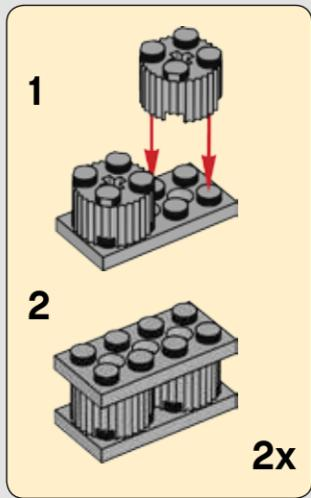

146

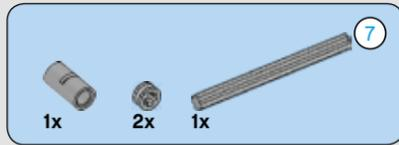
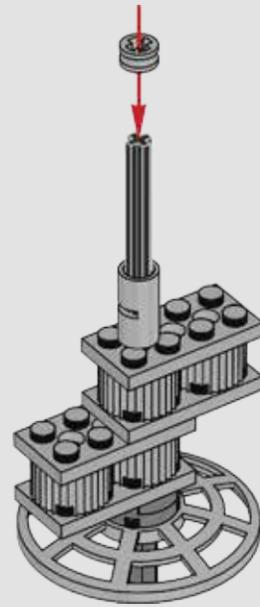

147

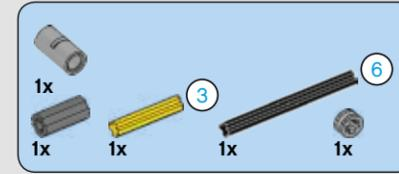
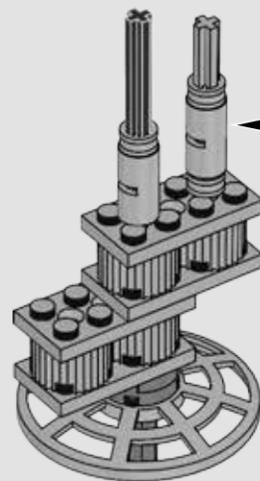
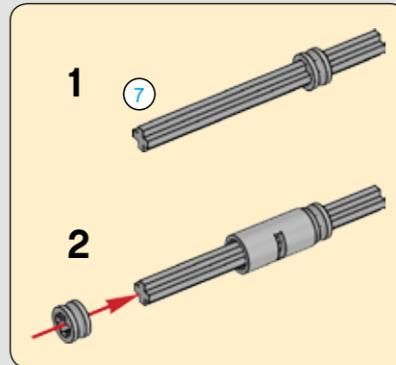

148

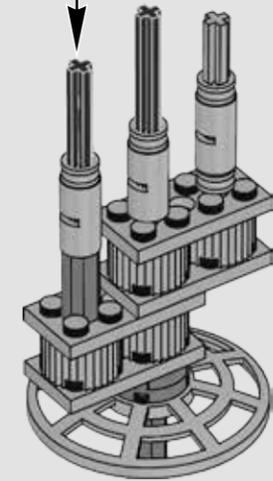
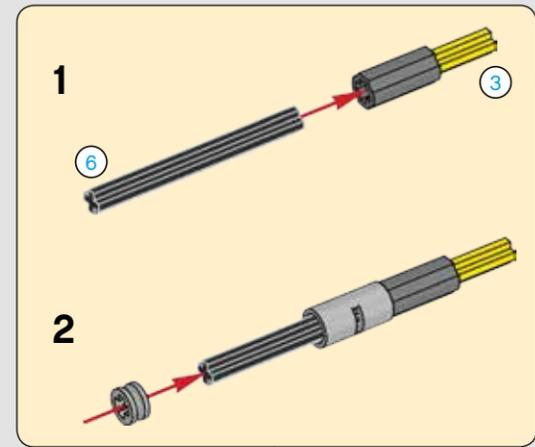

149

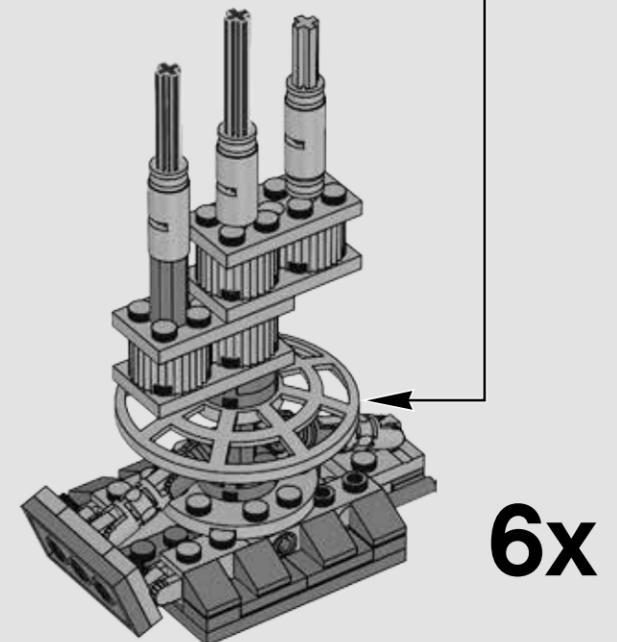

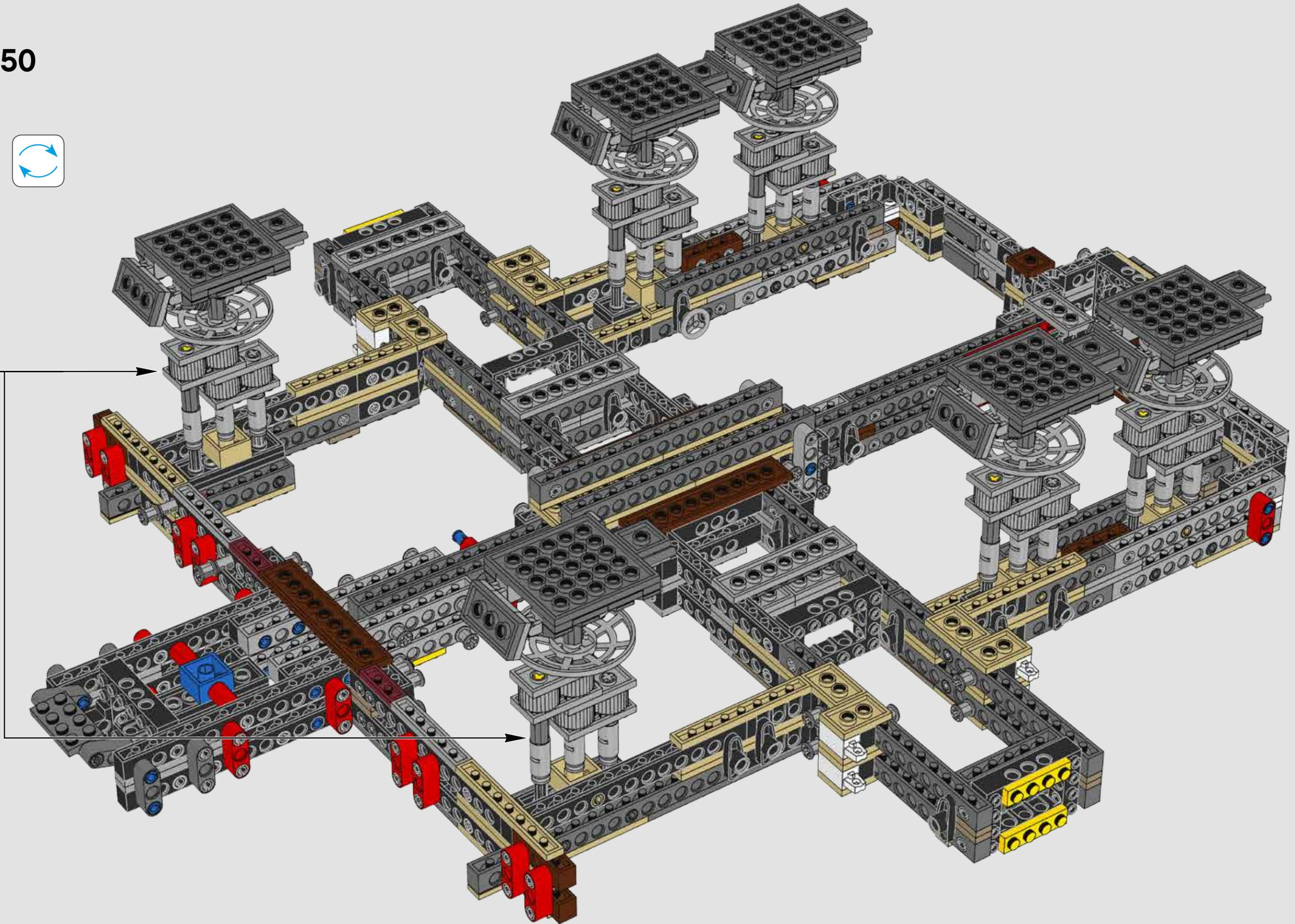

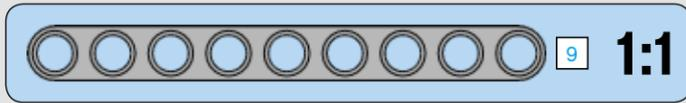
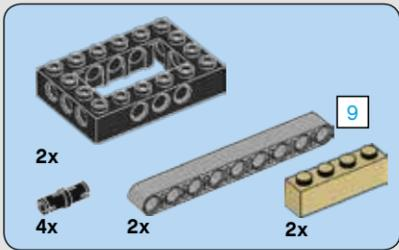

151

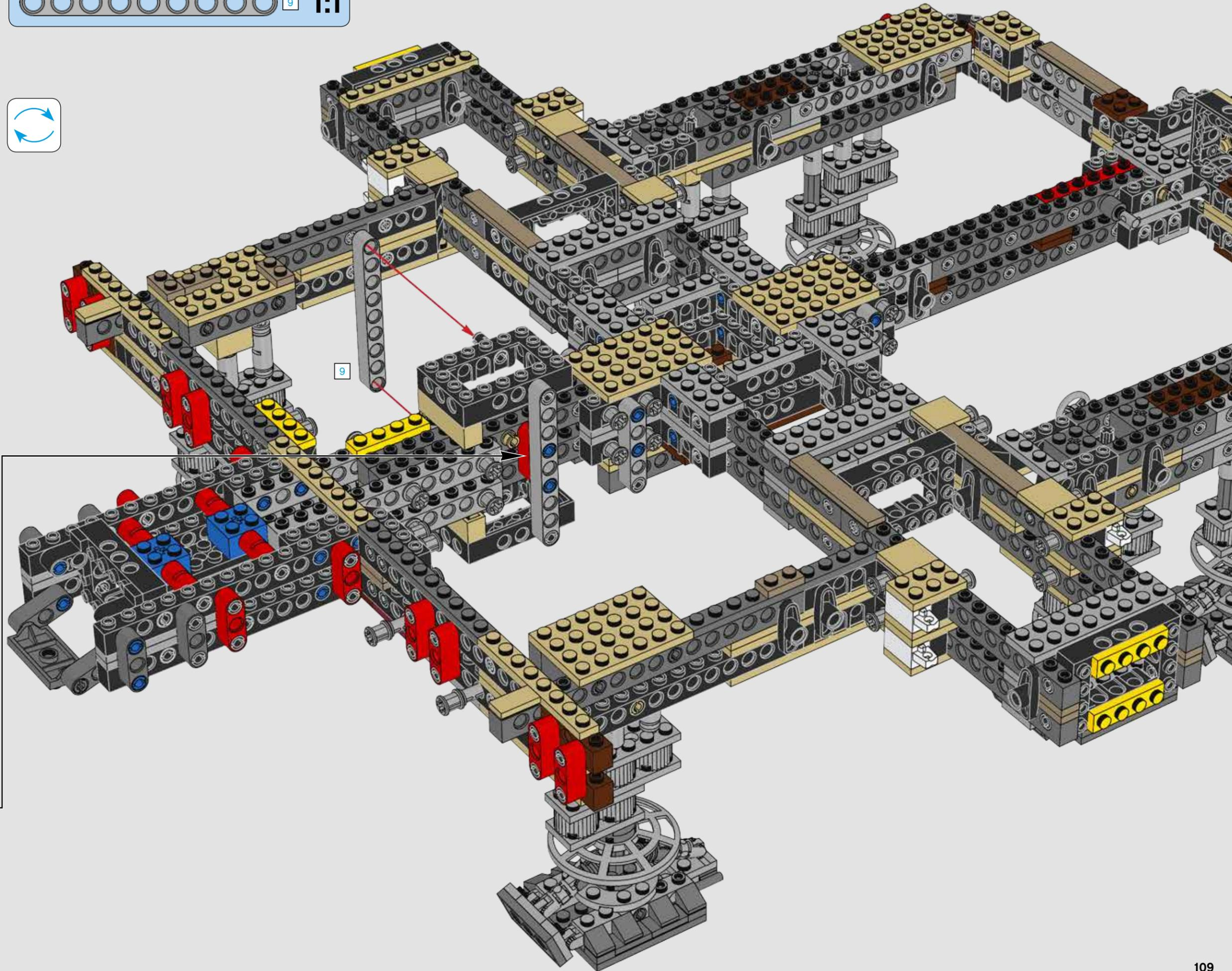
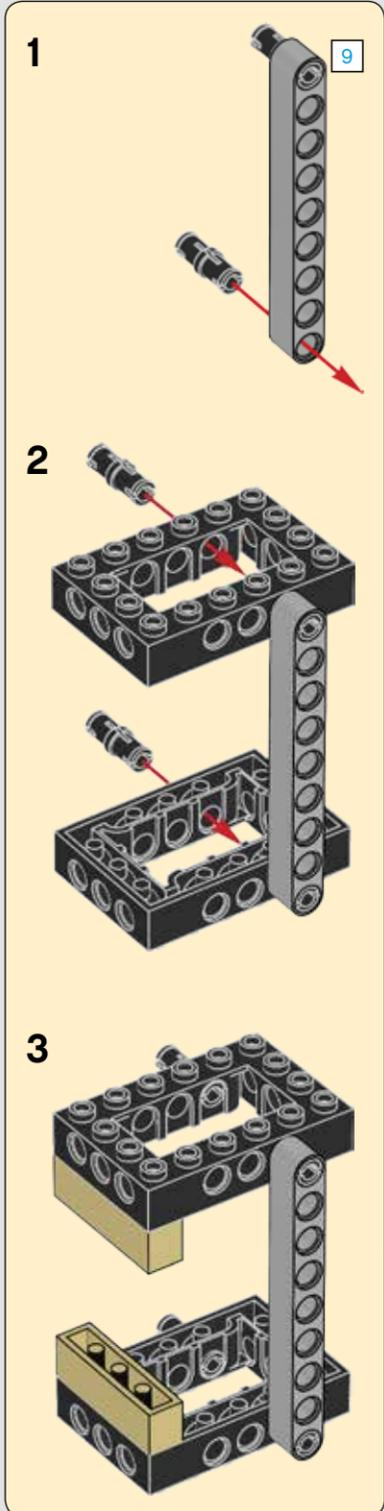

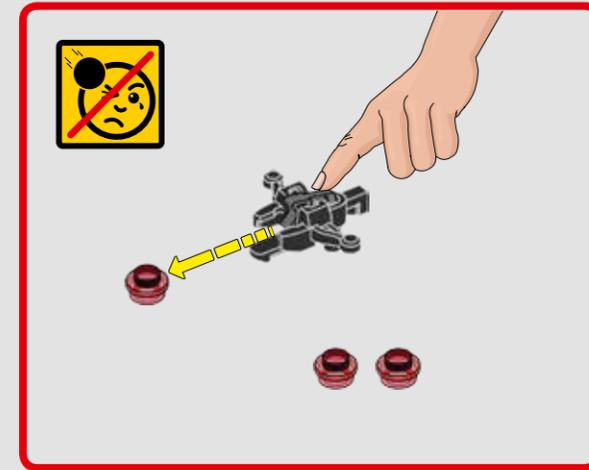
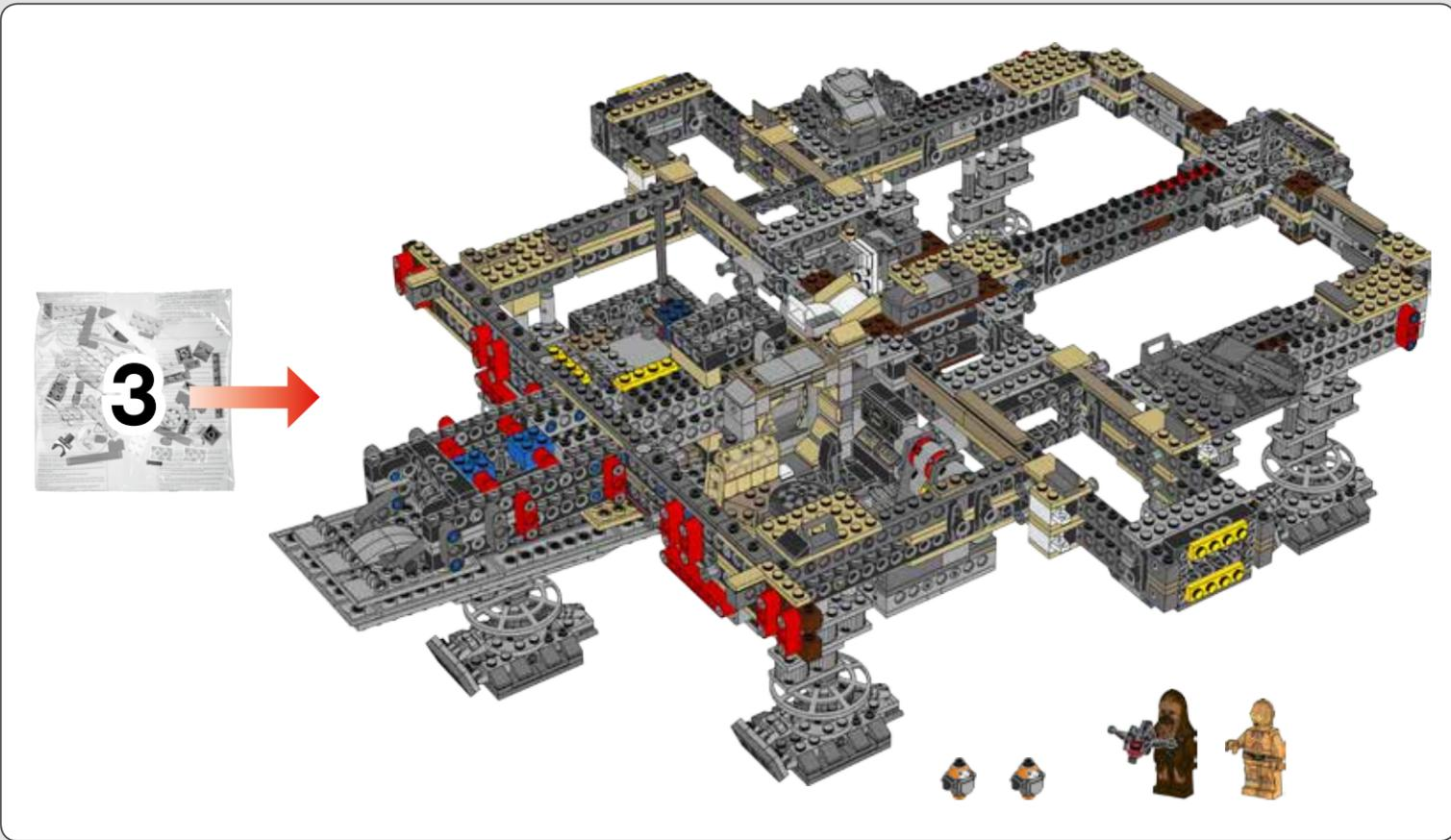

152

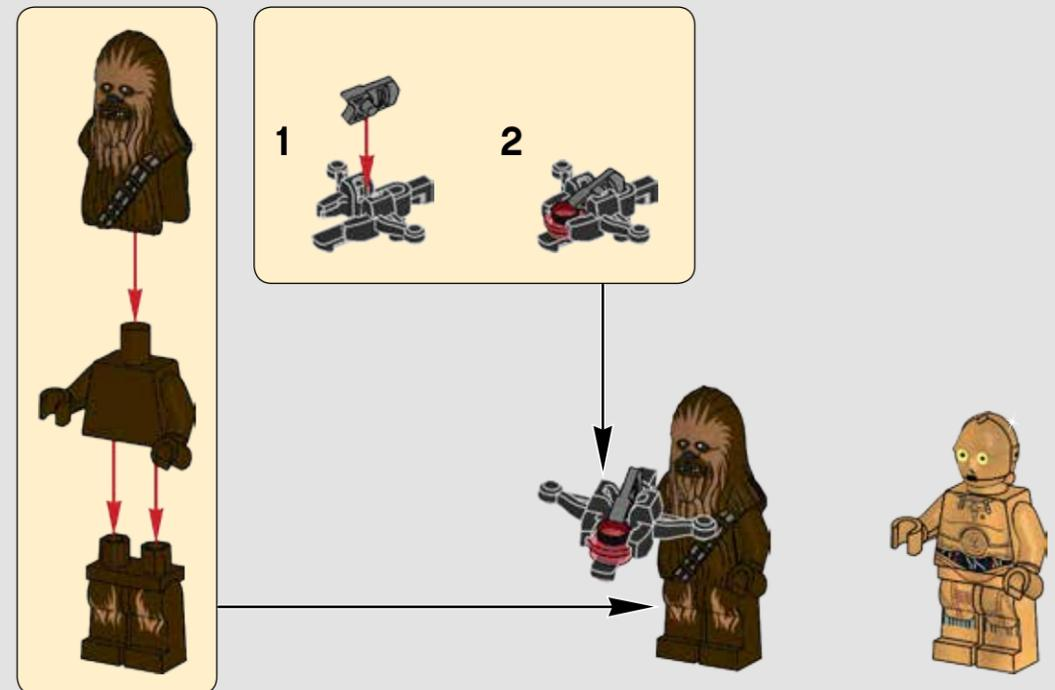
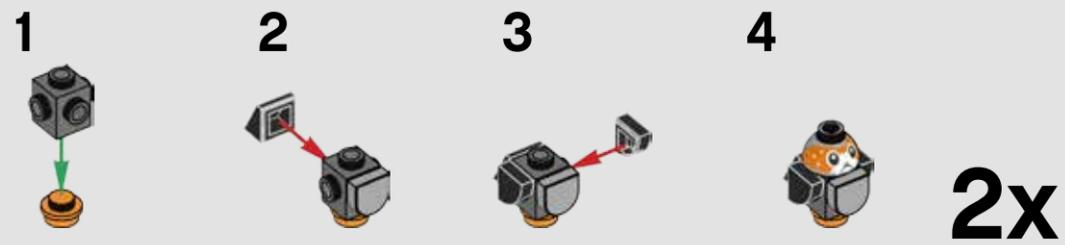

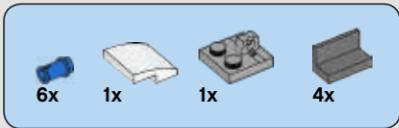

153

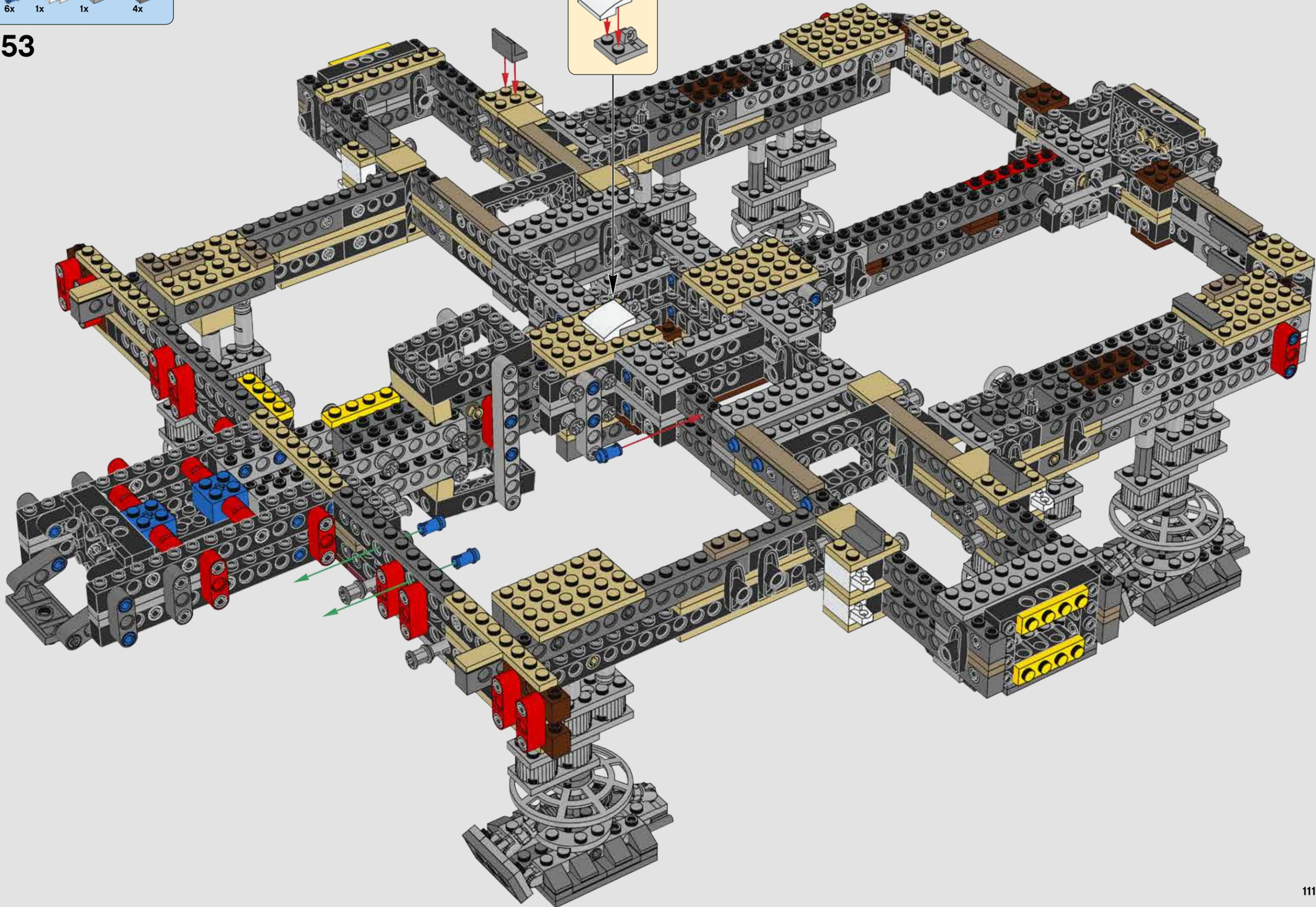
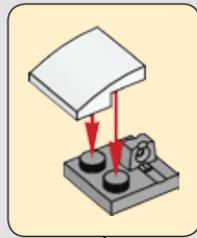

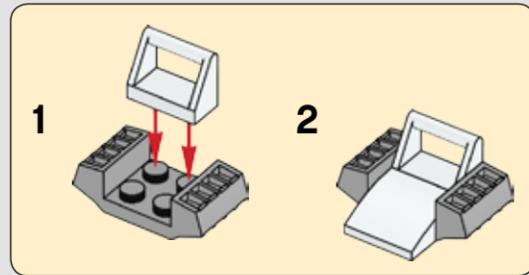
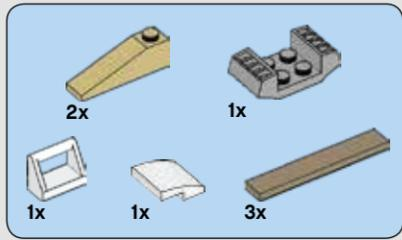

154

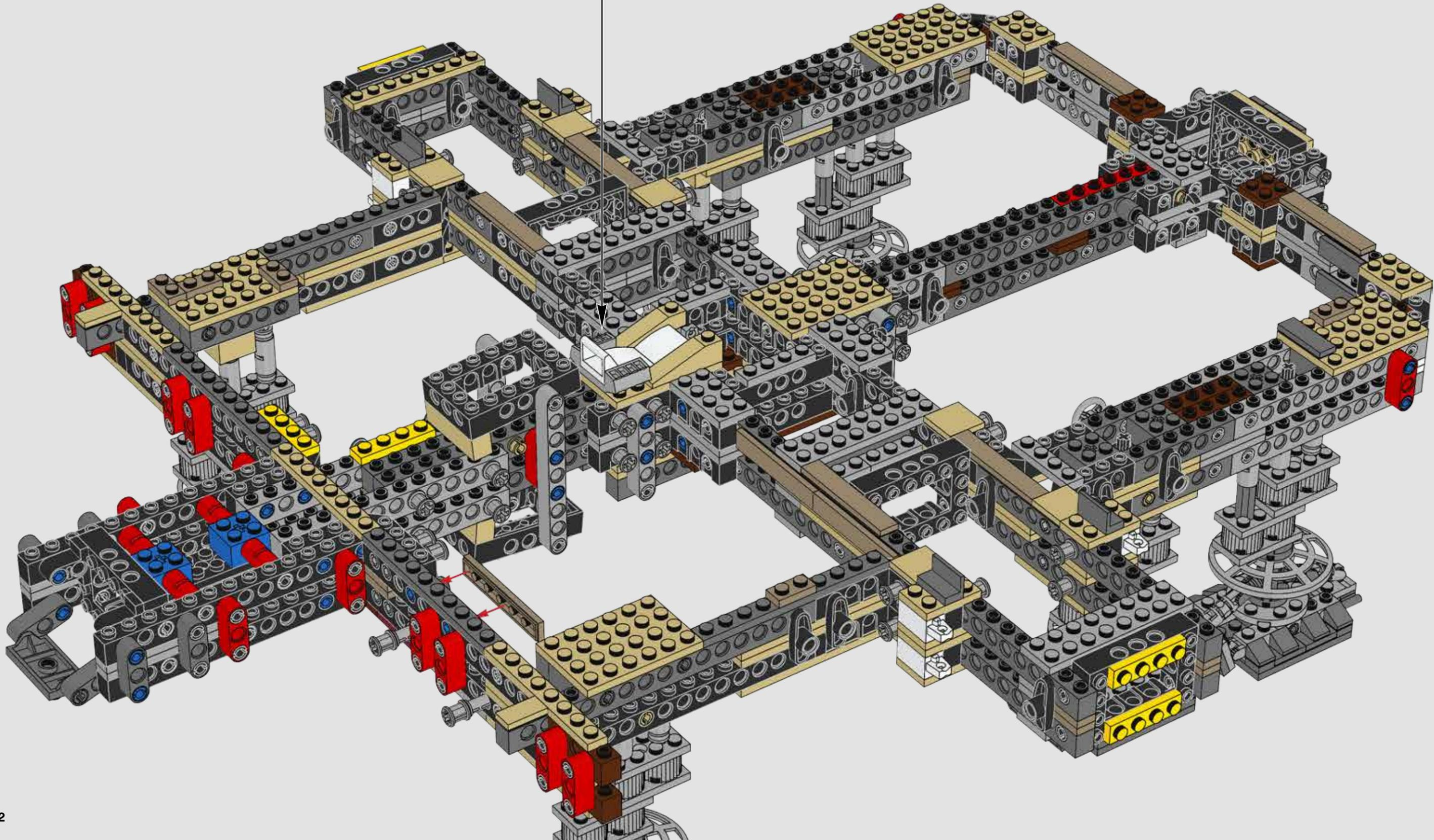

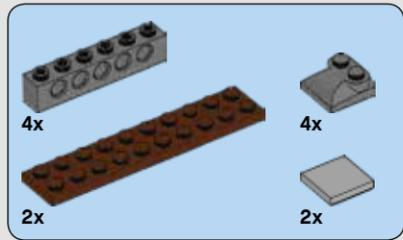

155

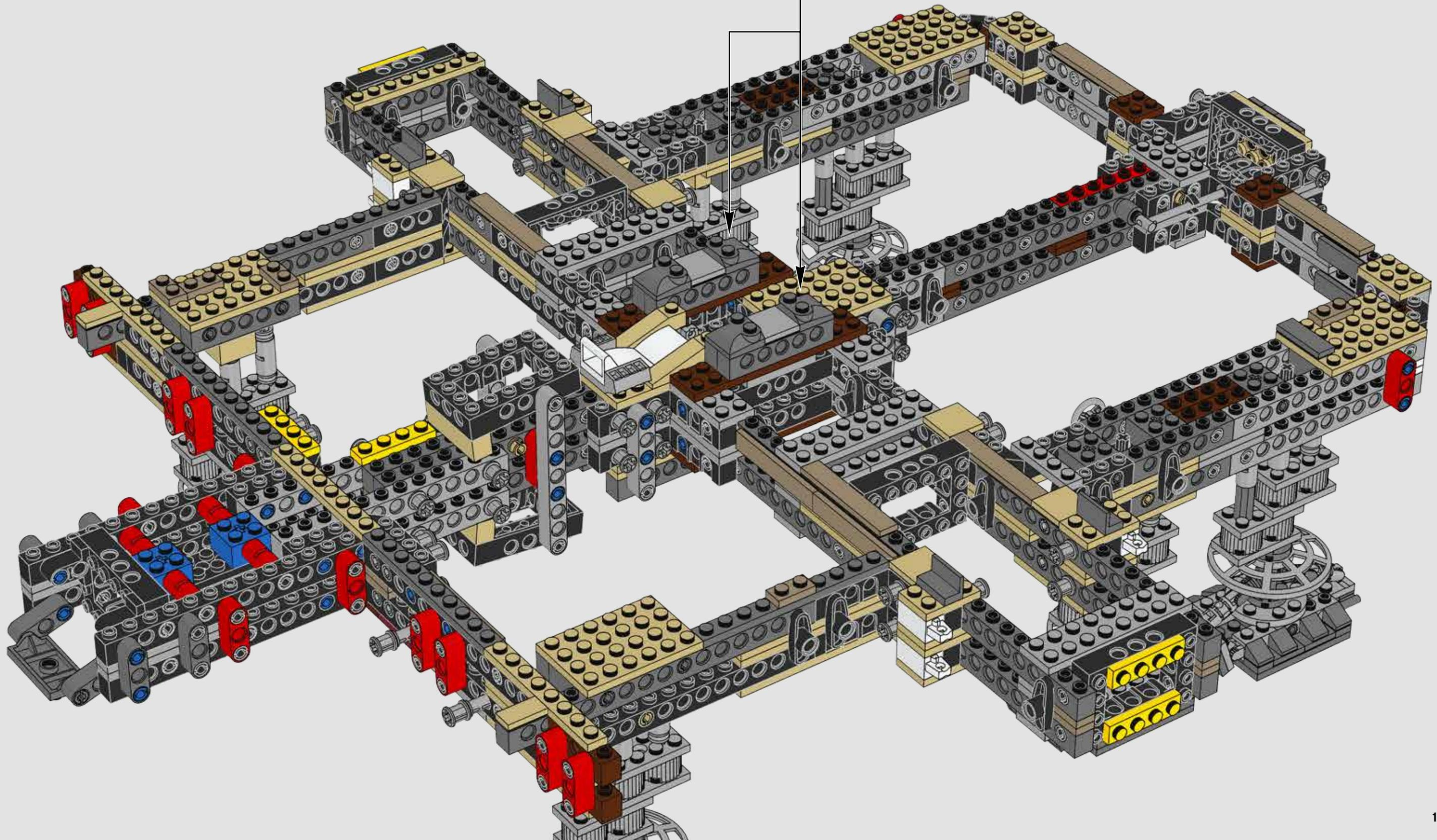
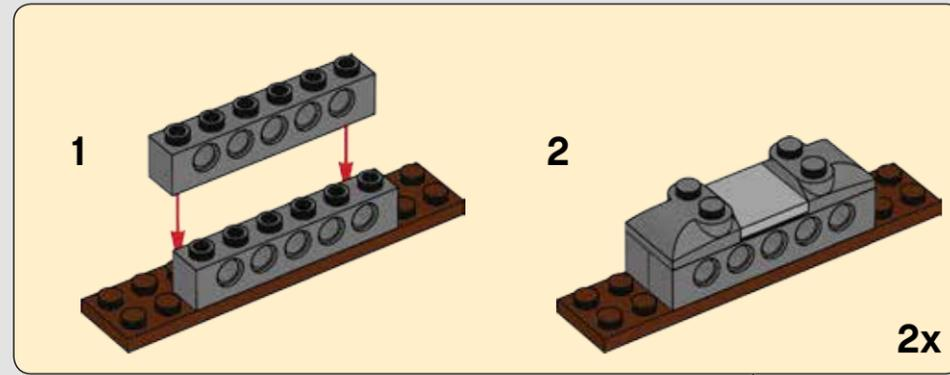

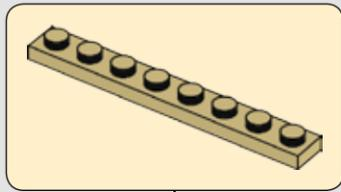
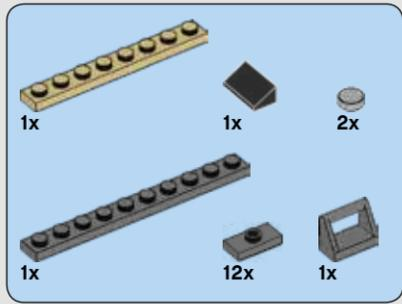

156

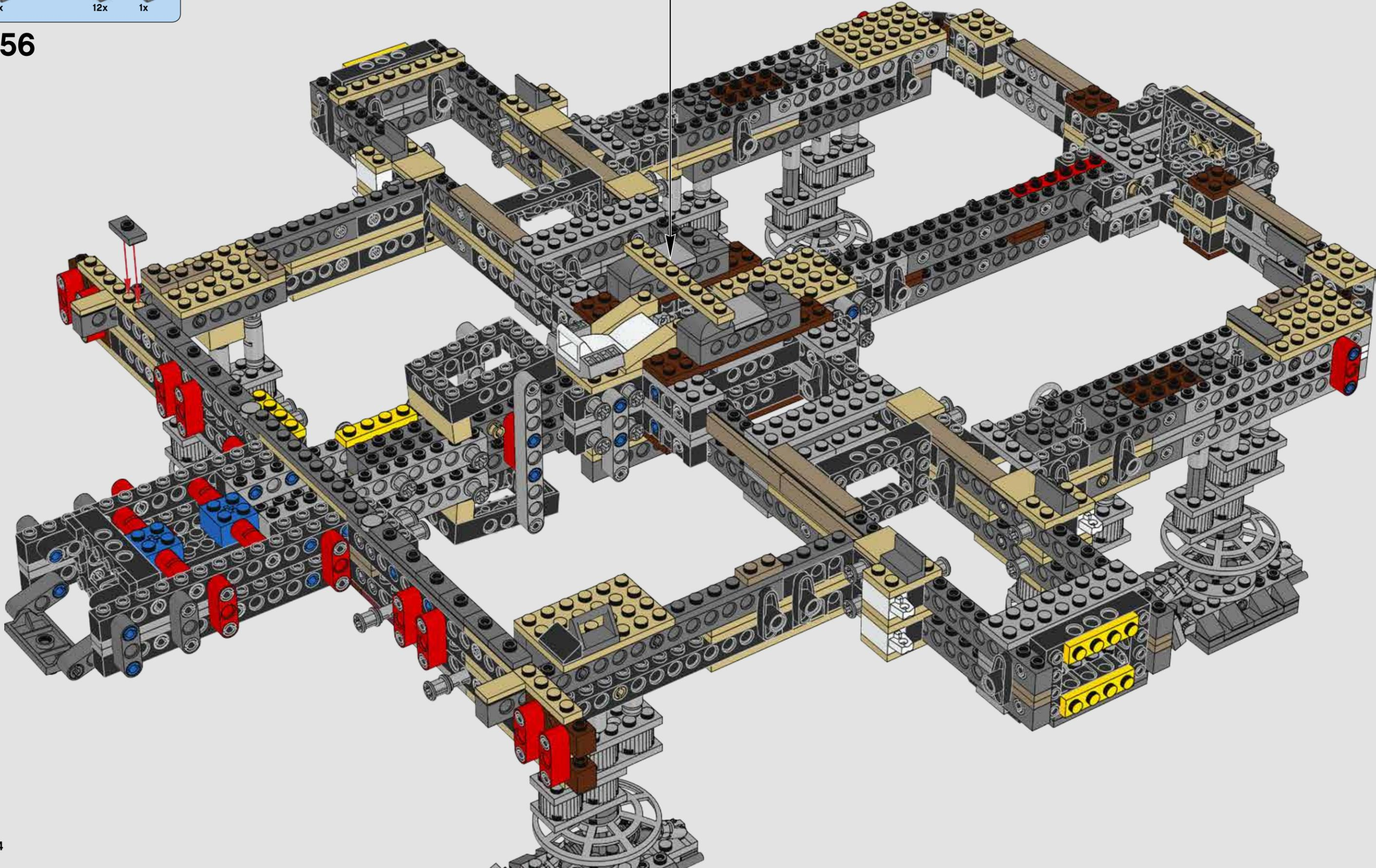

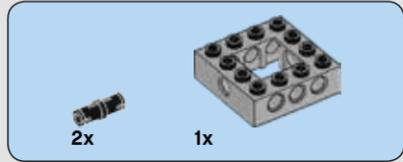
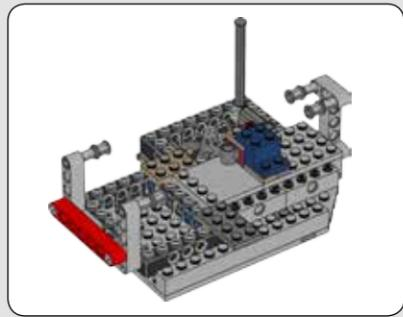

157

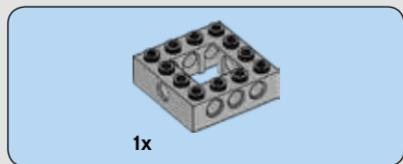
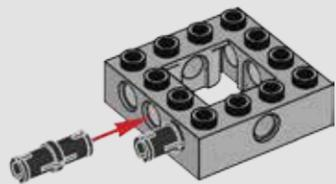

158

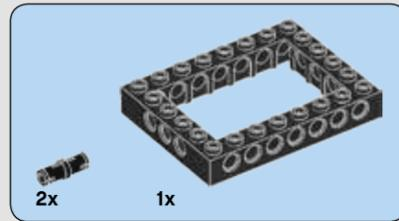
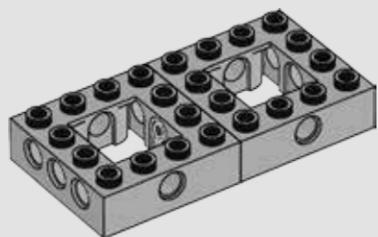

159

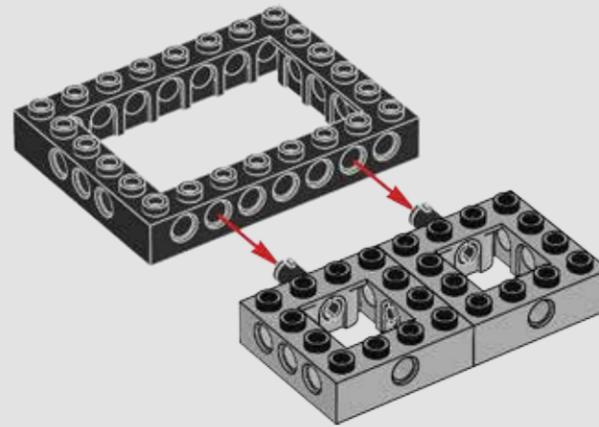

160

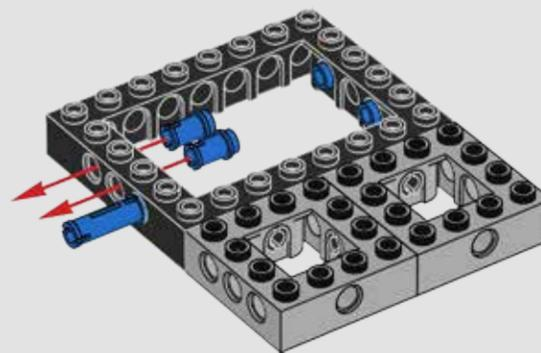

161

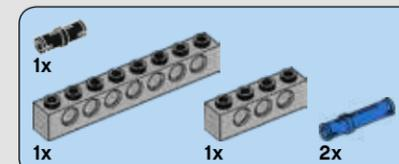
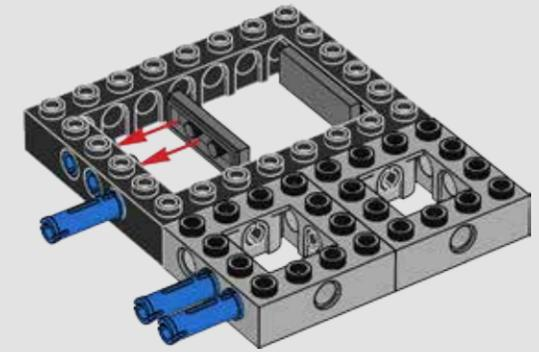

162

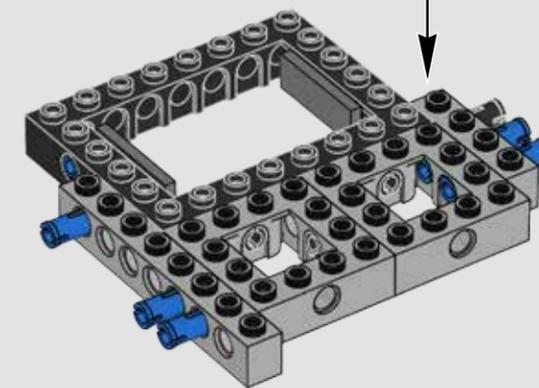
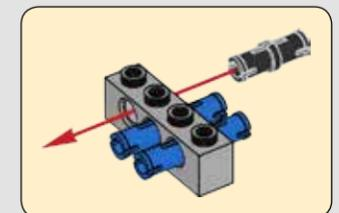

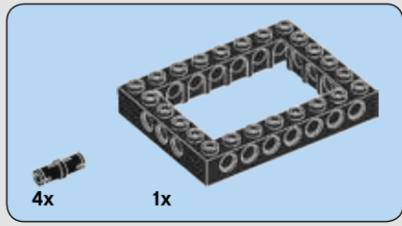

163

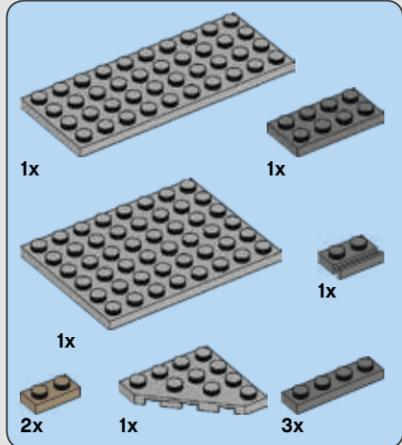
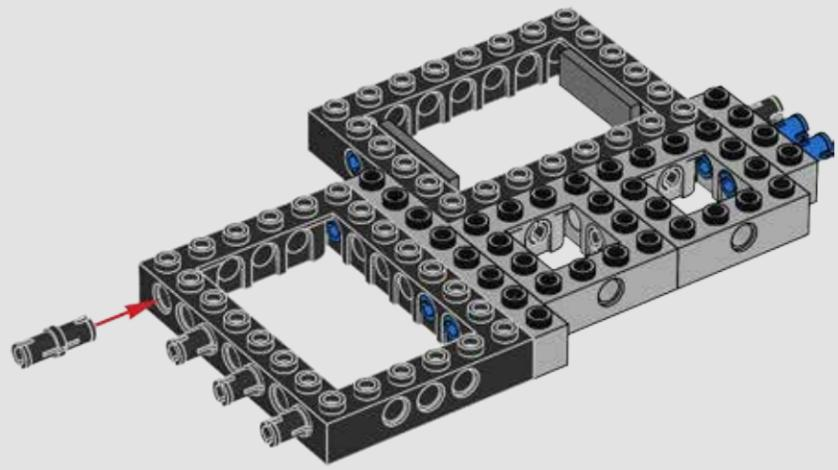

164

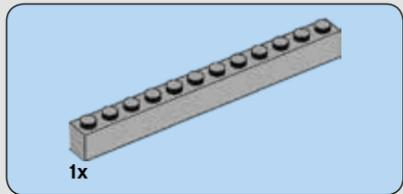
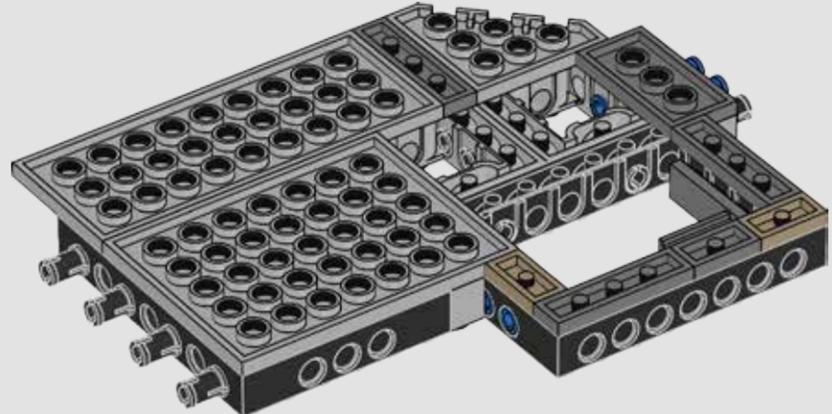

165

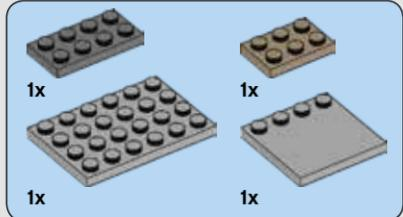
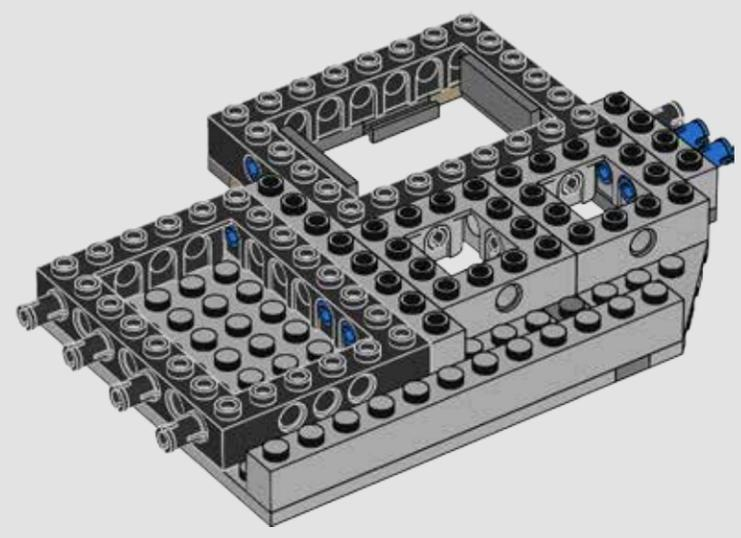

166

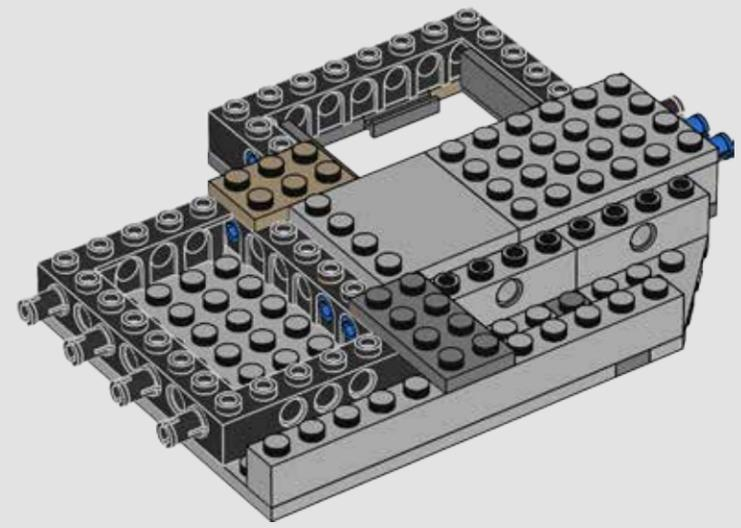

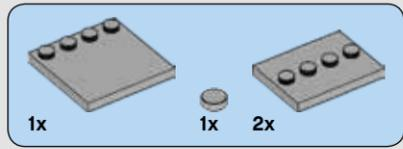

167

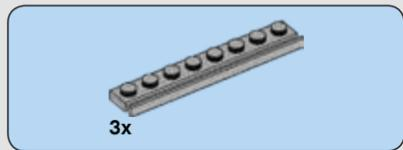
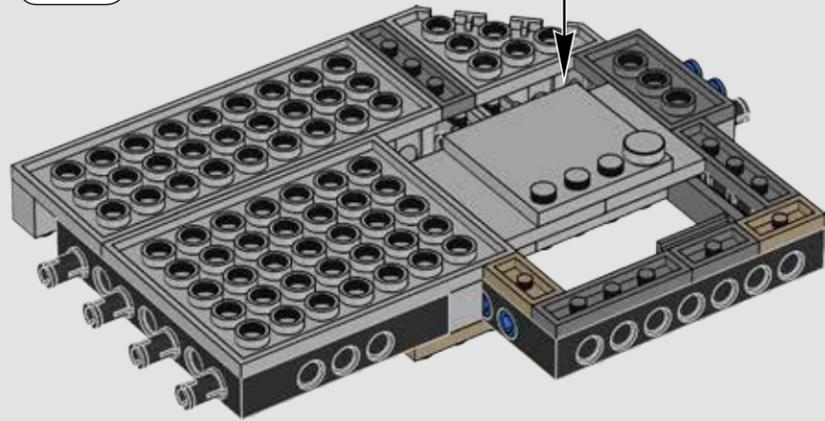
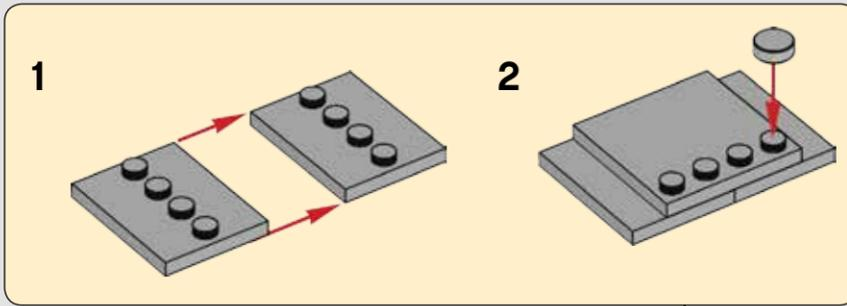

168

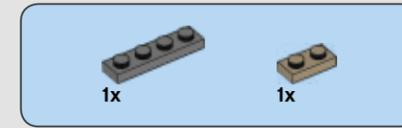
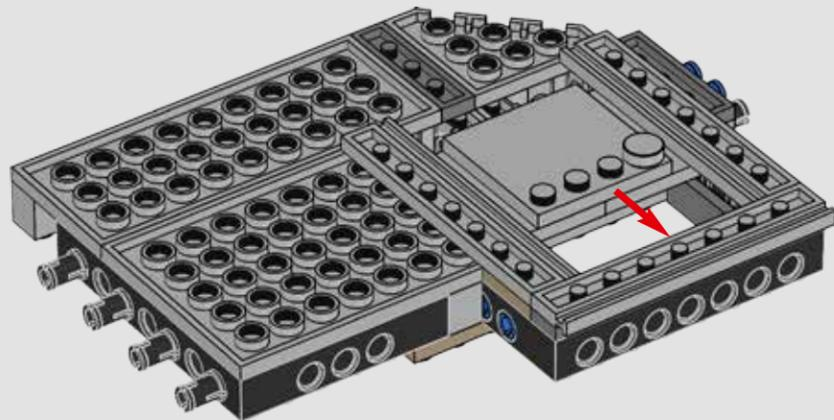

169

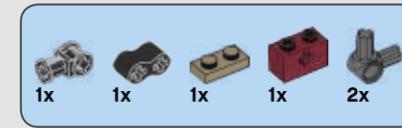
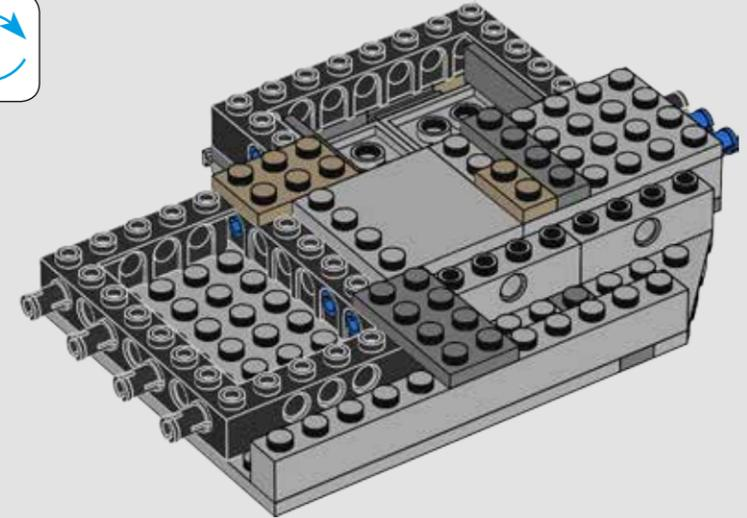

170

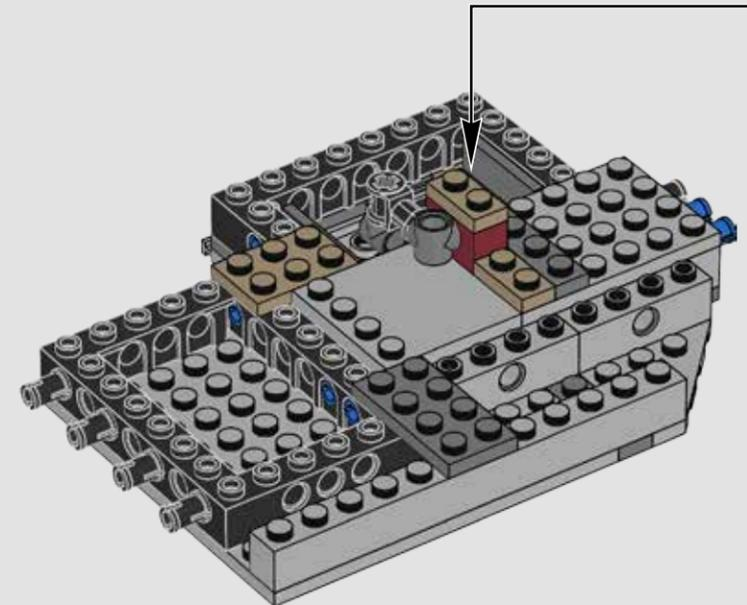
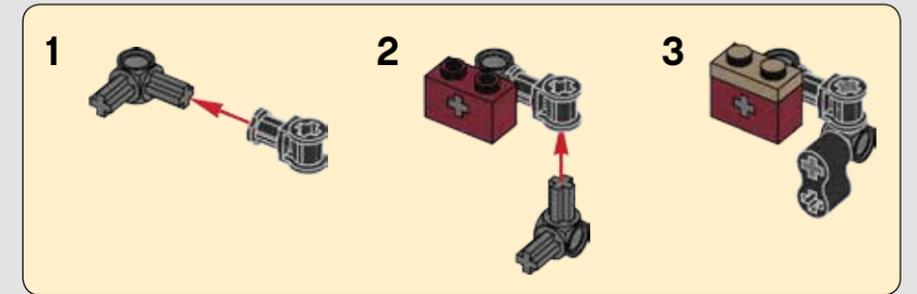

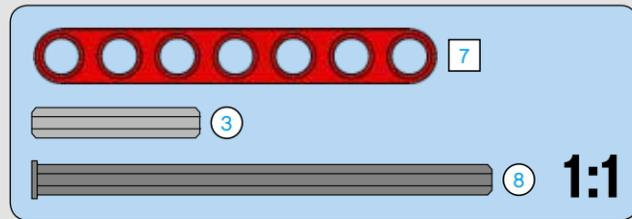
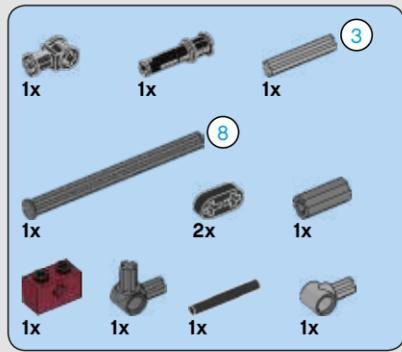

171

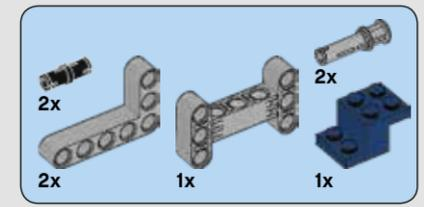
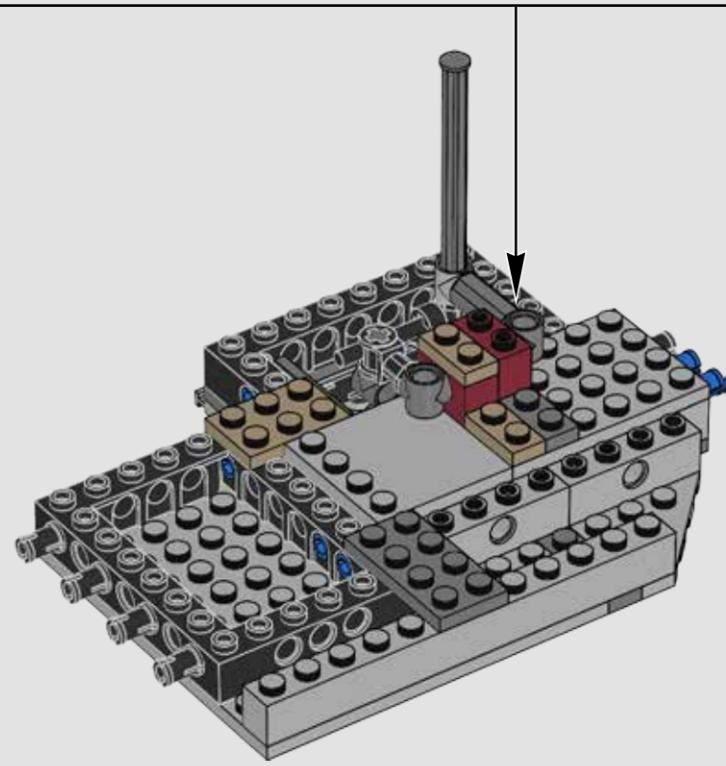
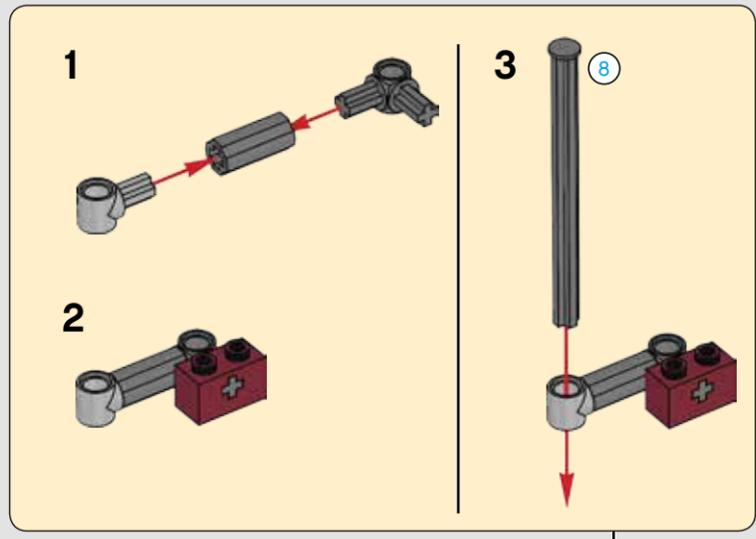
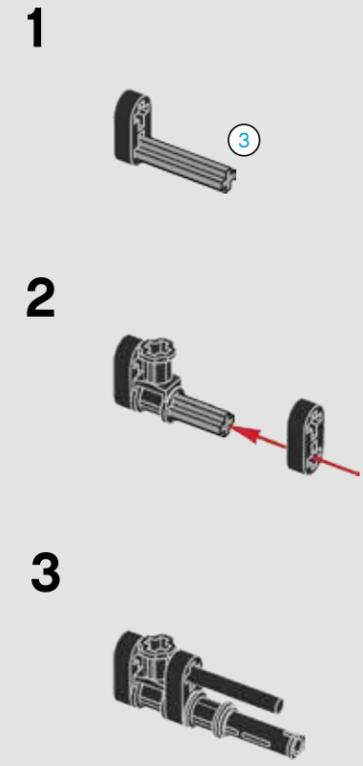

172

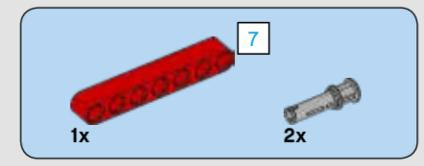
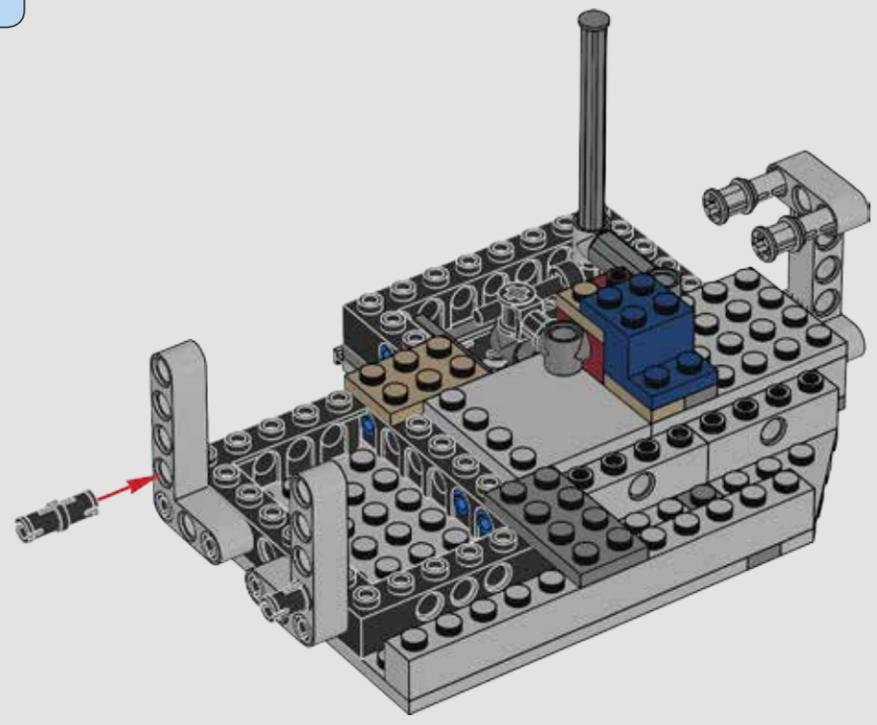

173

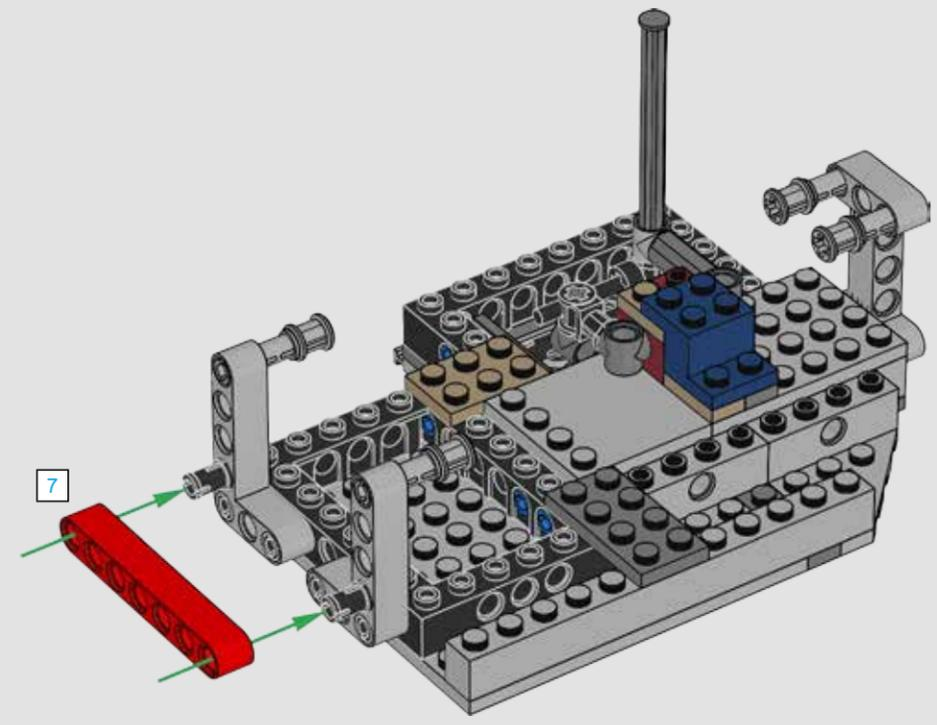

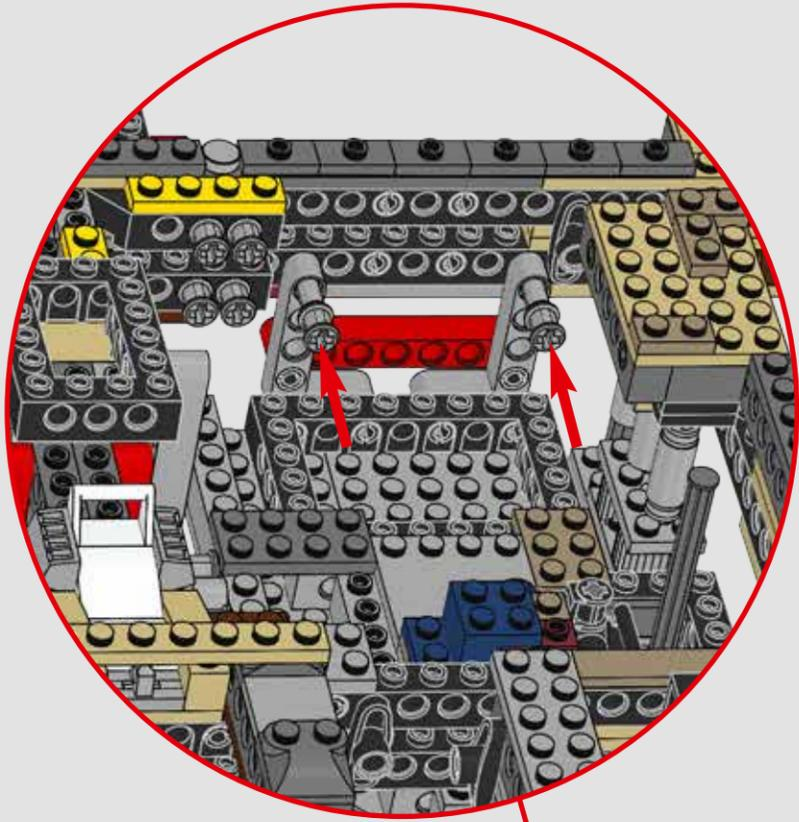

174

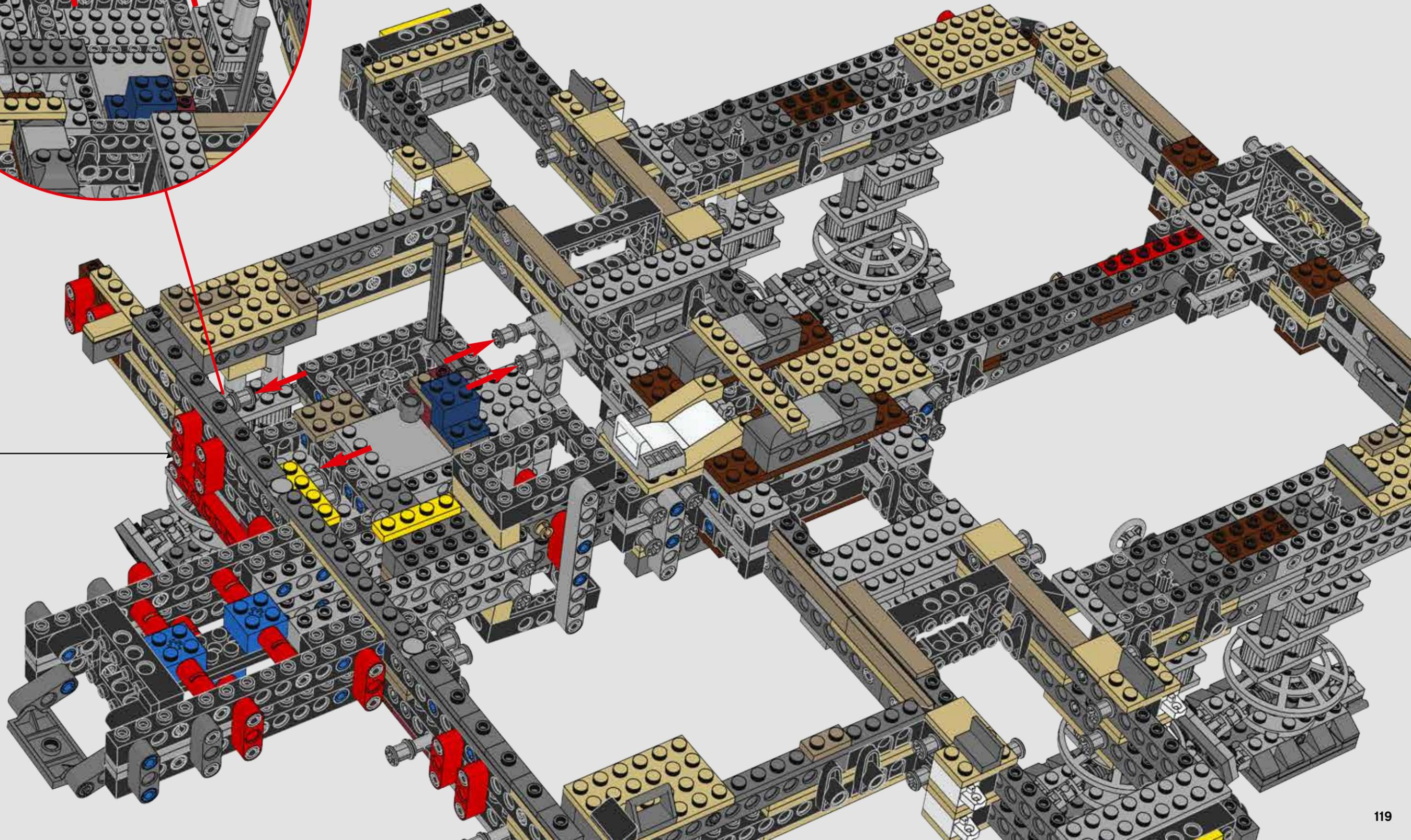

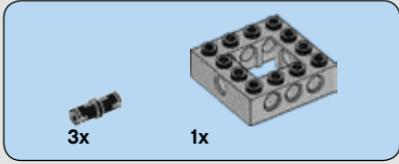
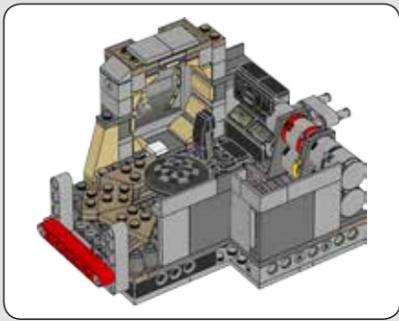

175

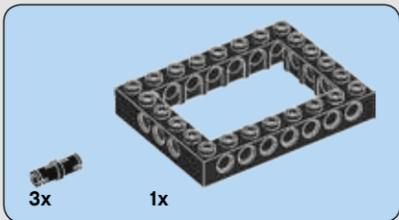
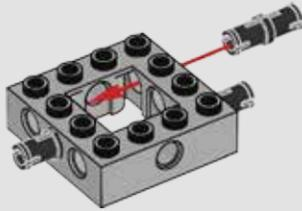

176

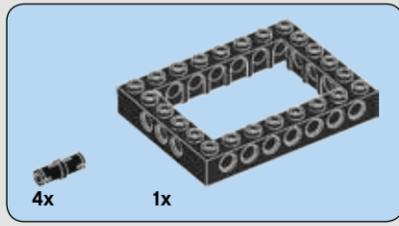
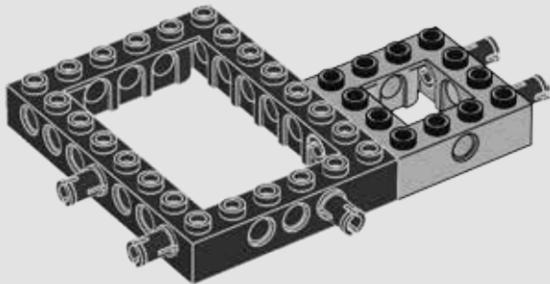

177

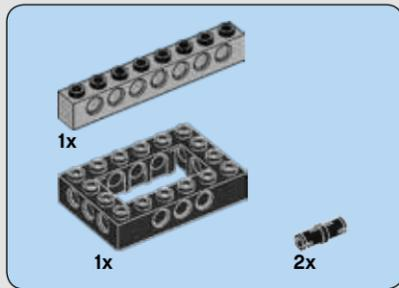
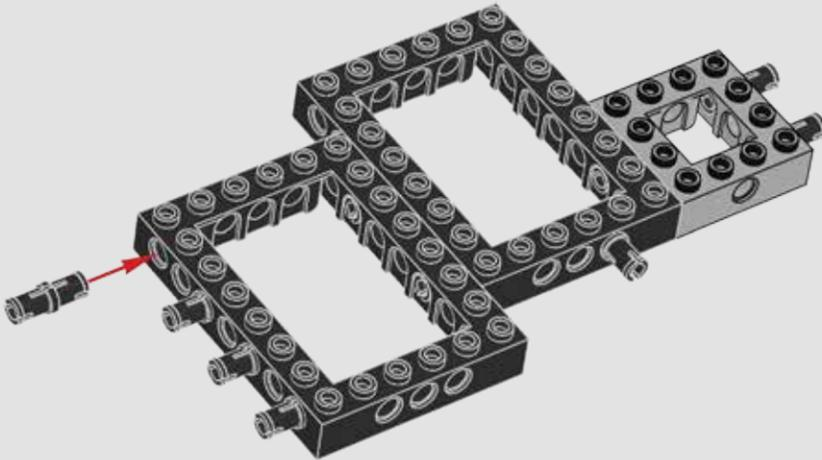

178

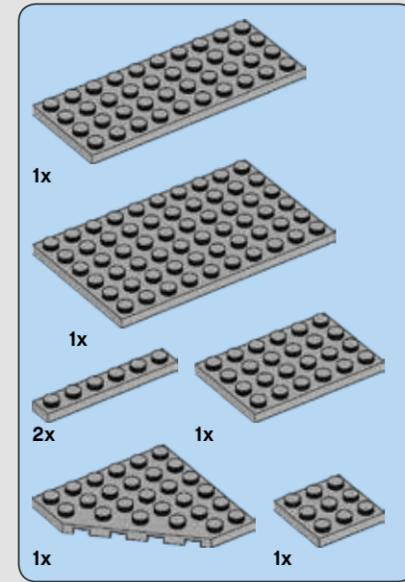
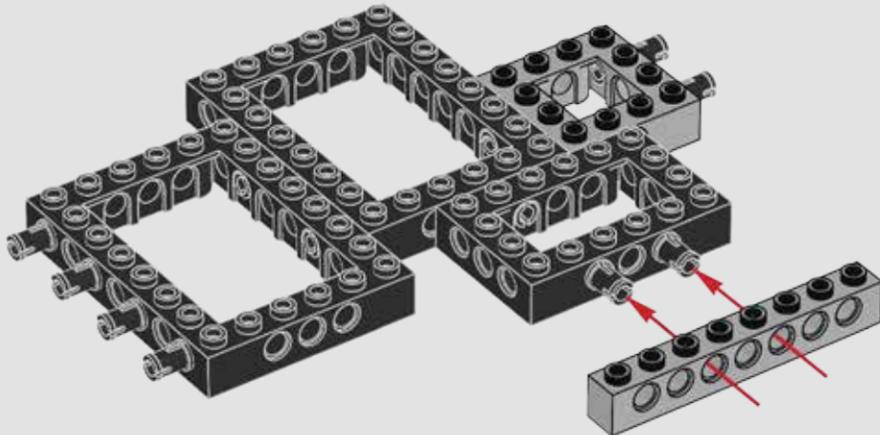

179

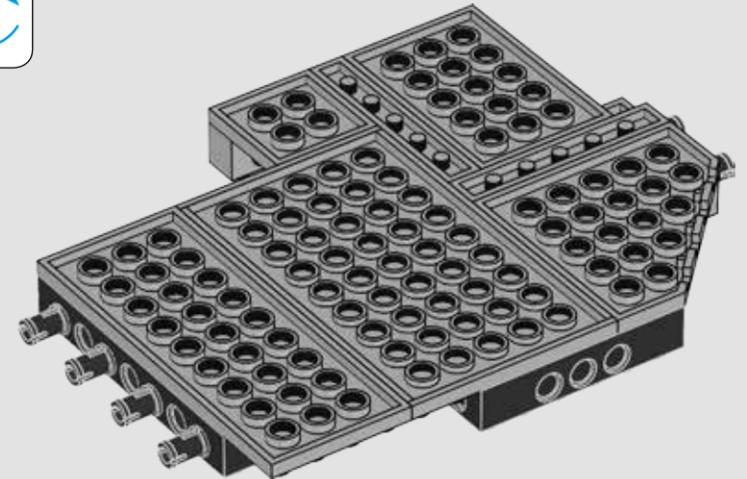

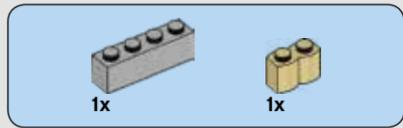

180

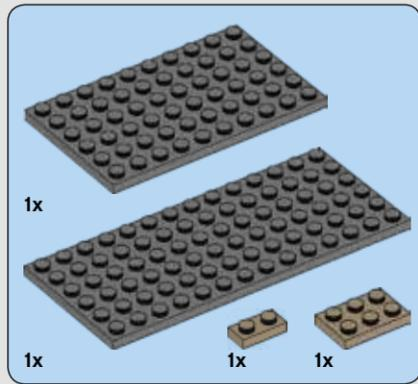
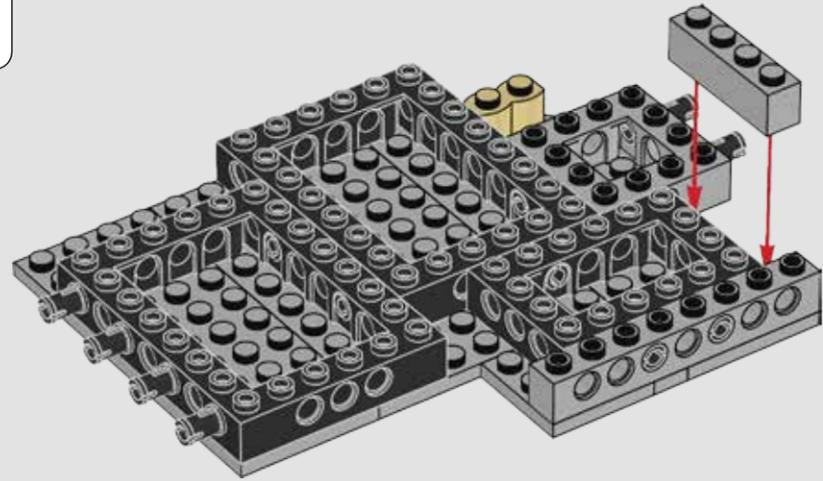

181

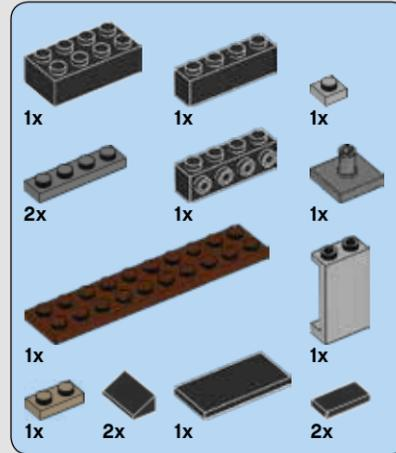
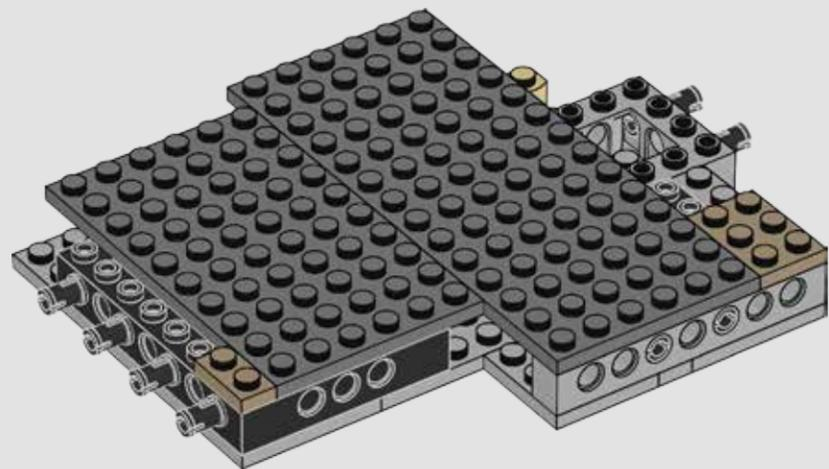

182

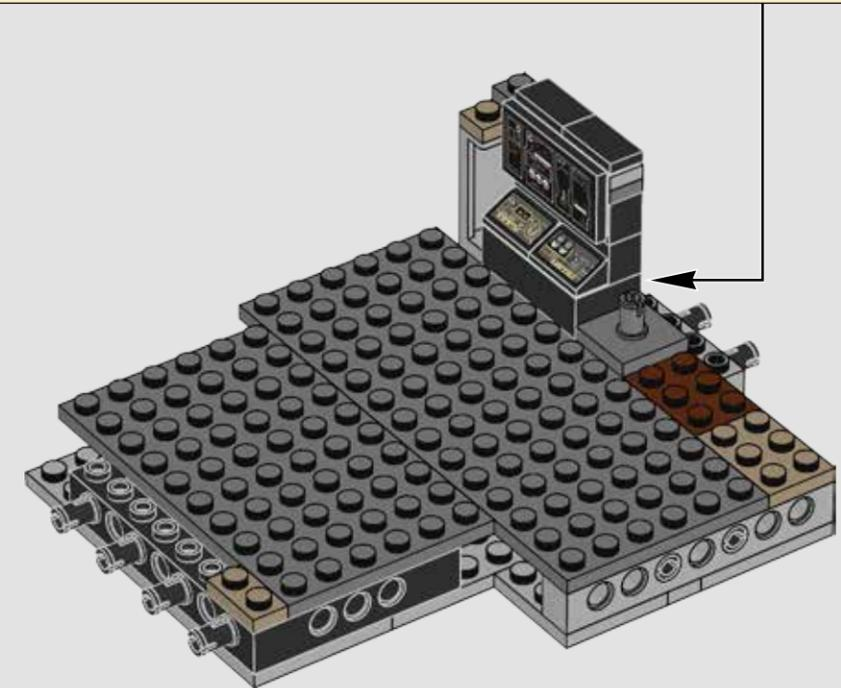
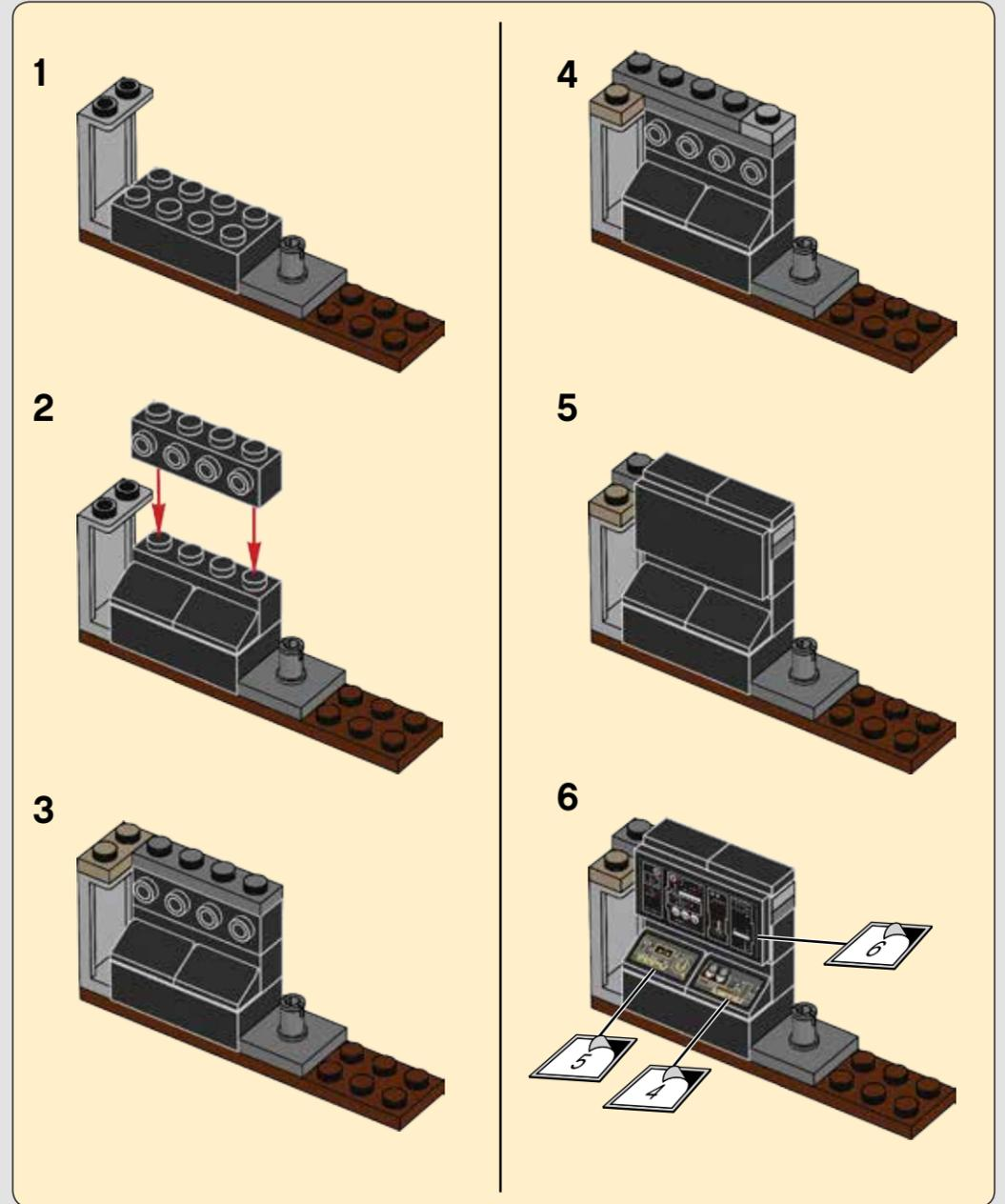

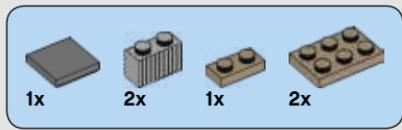

183

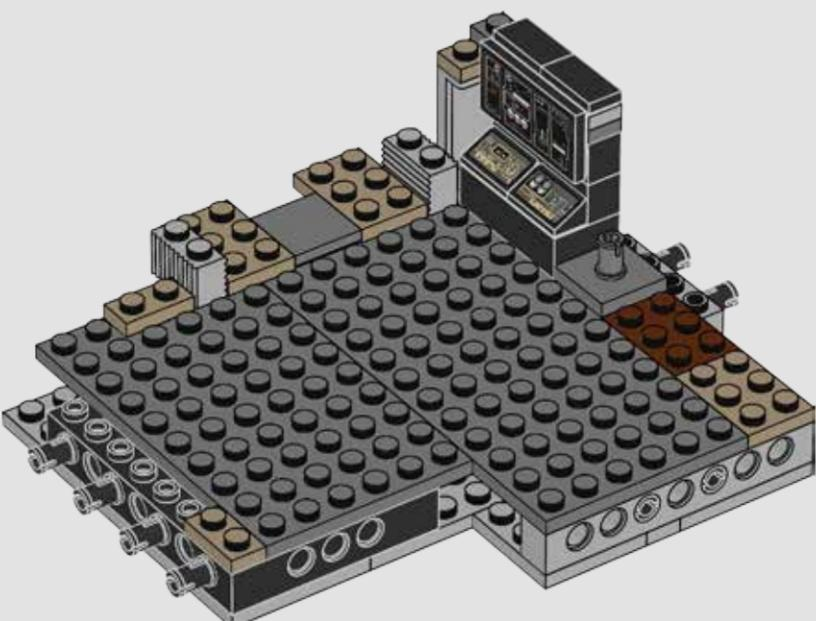

184

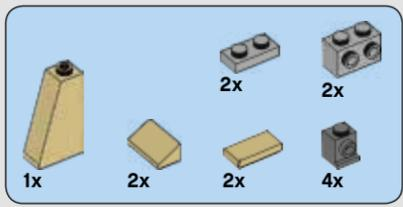
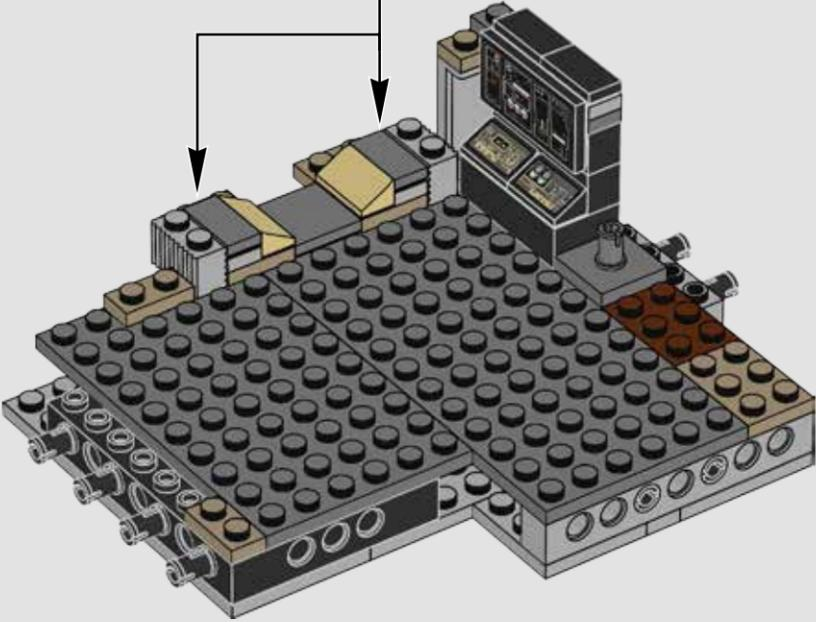
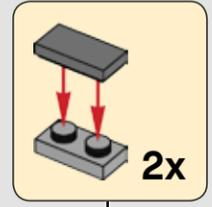

185

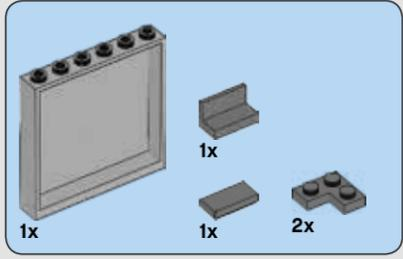
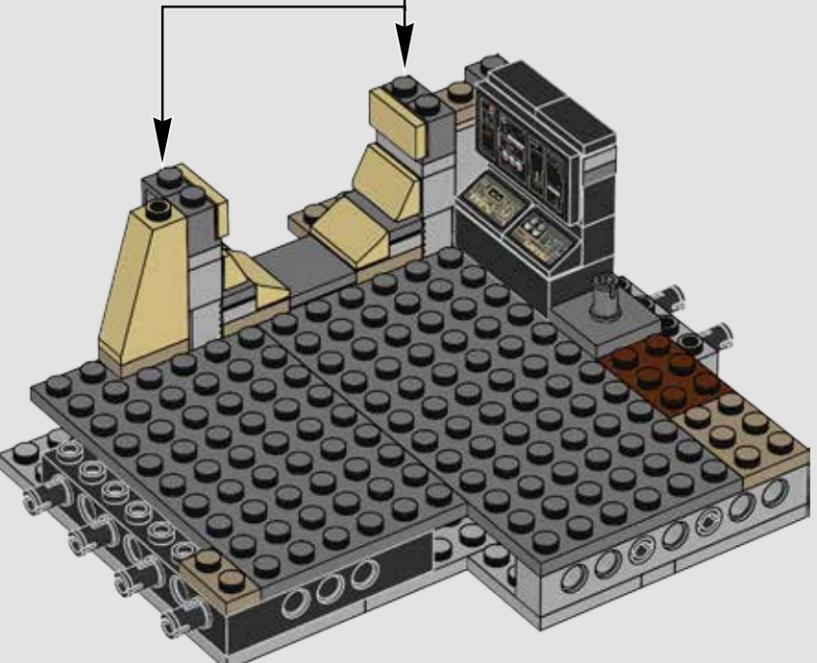
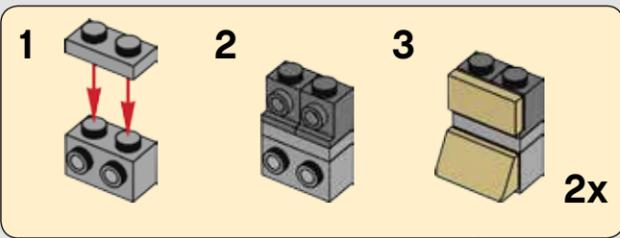

186

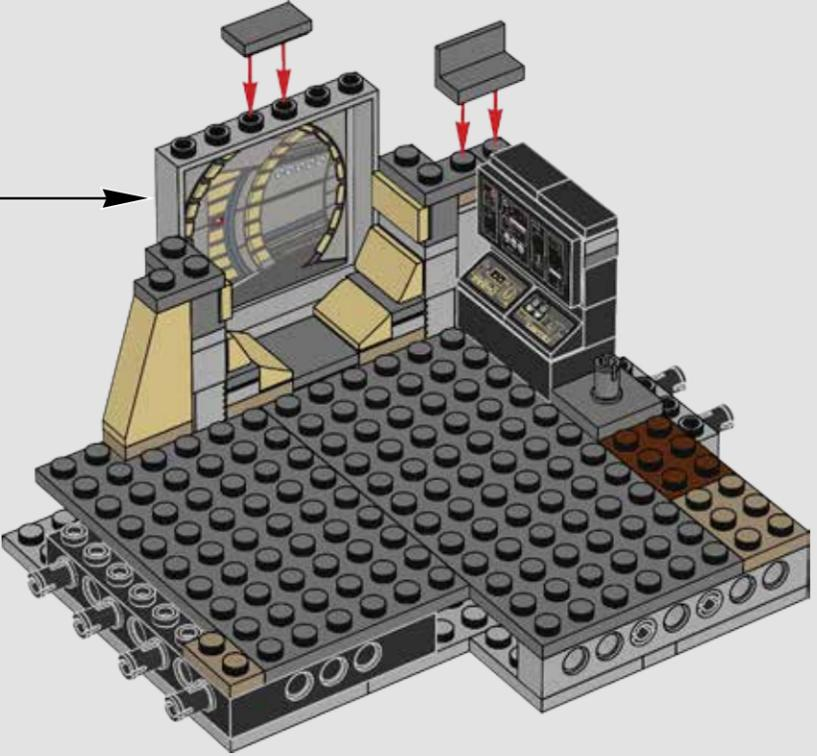
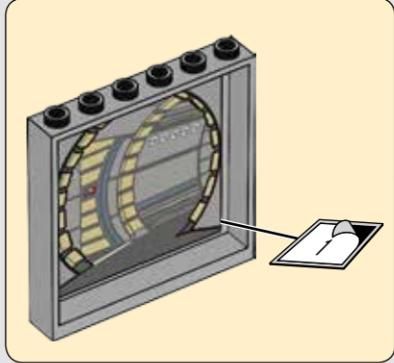

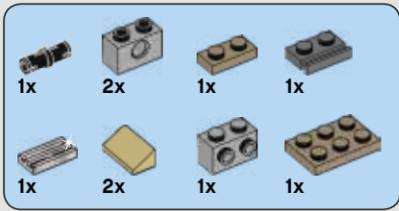

187

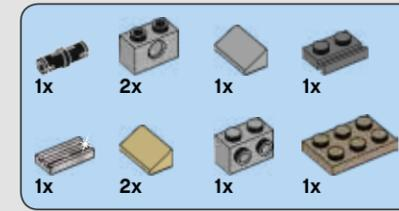
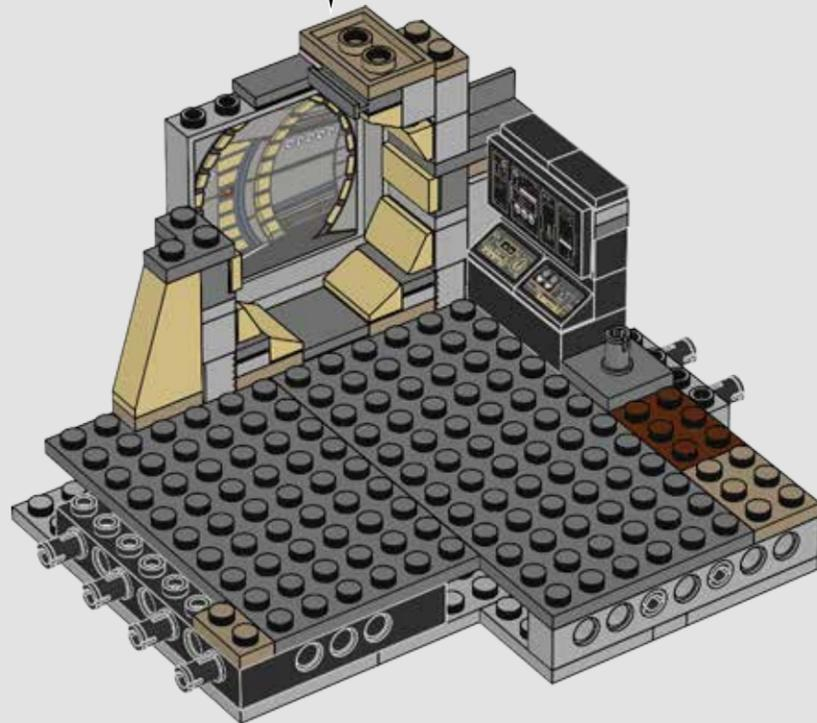
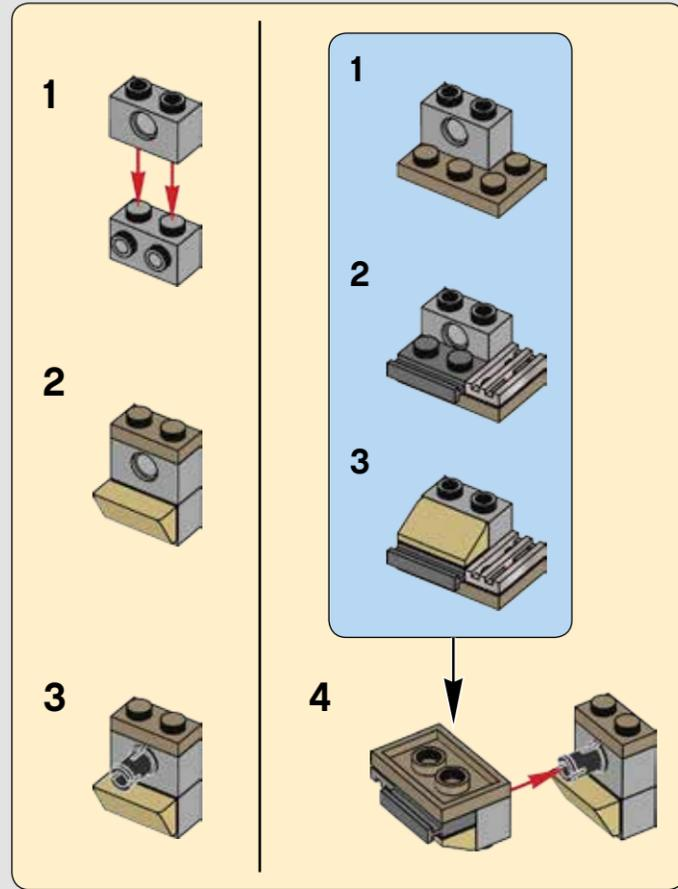

188

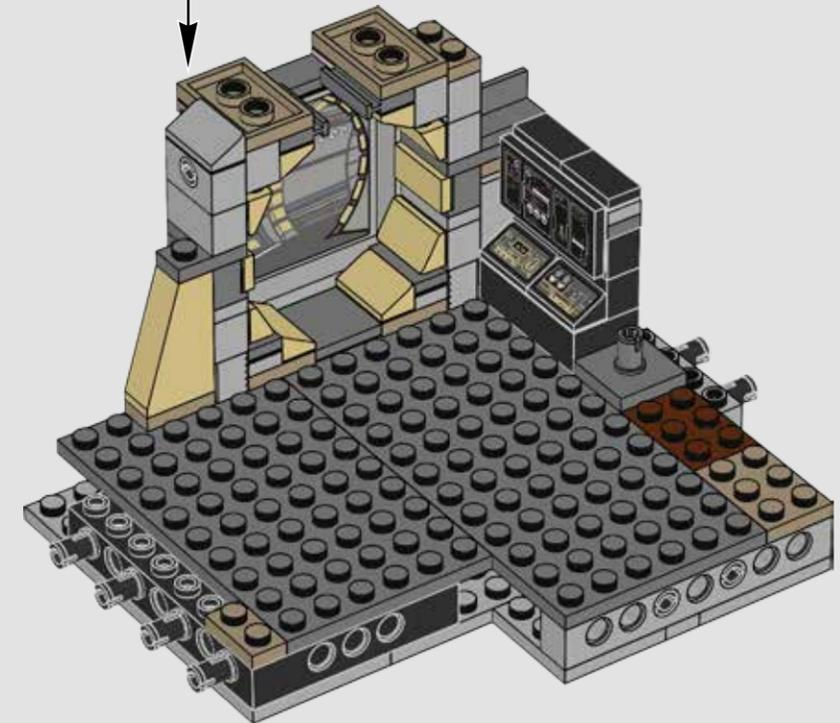
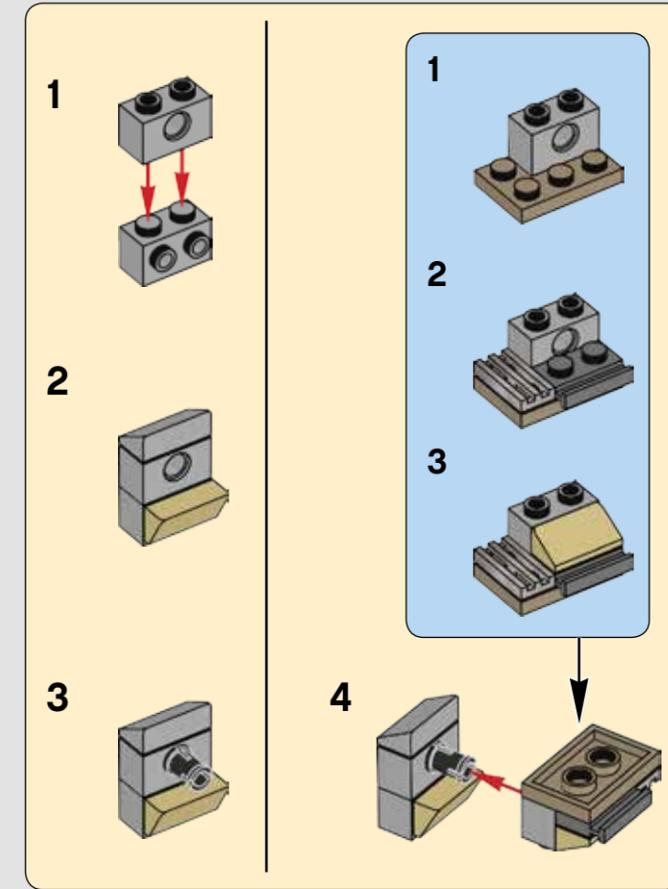

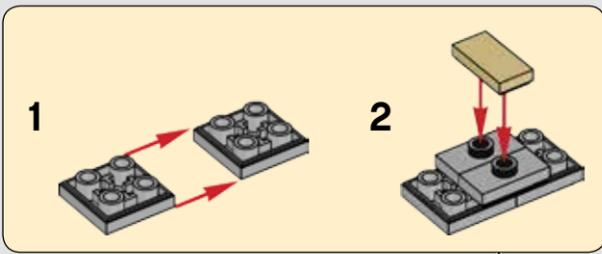

189

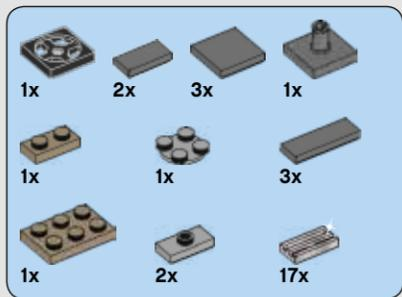
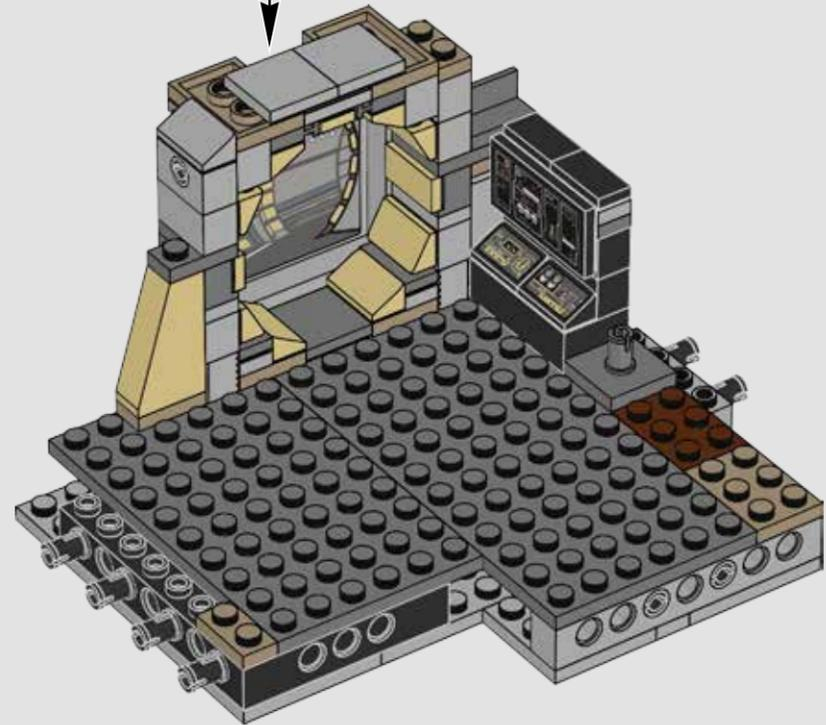

190

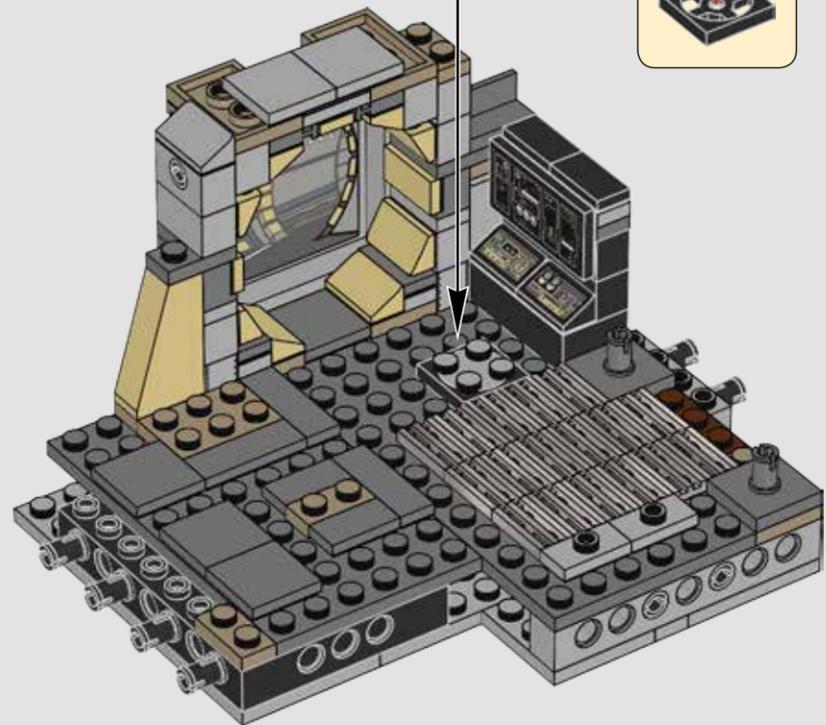

191

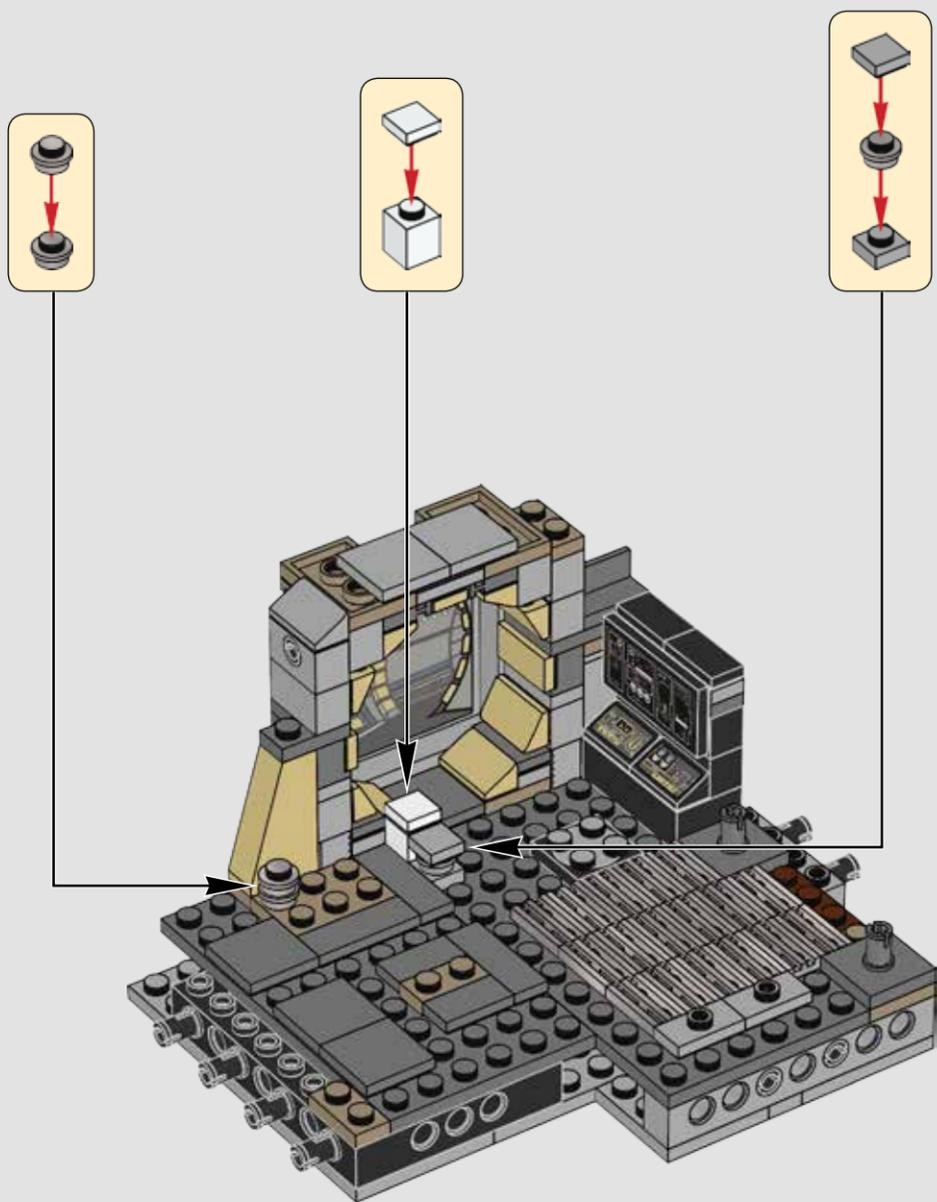

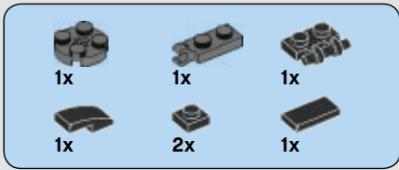

192

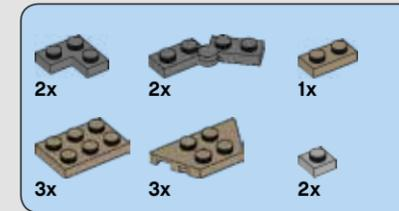
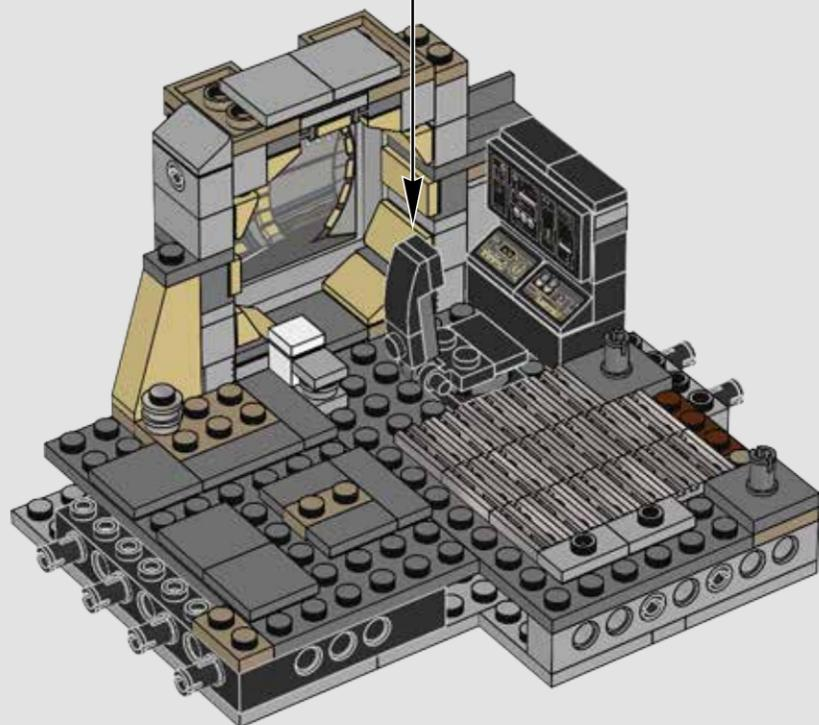
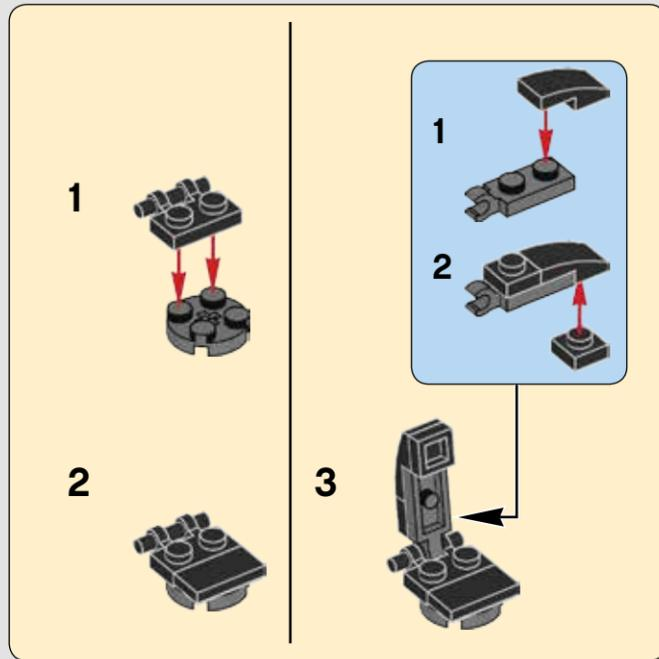

193

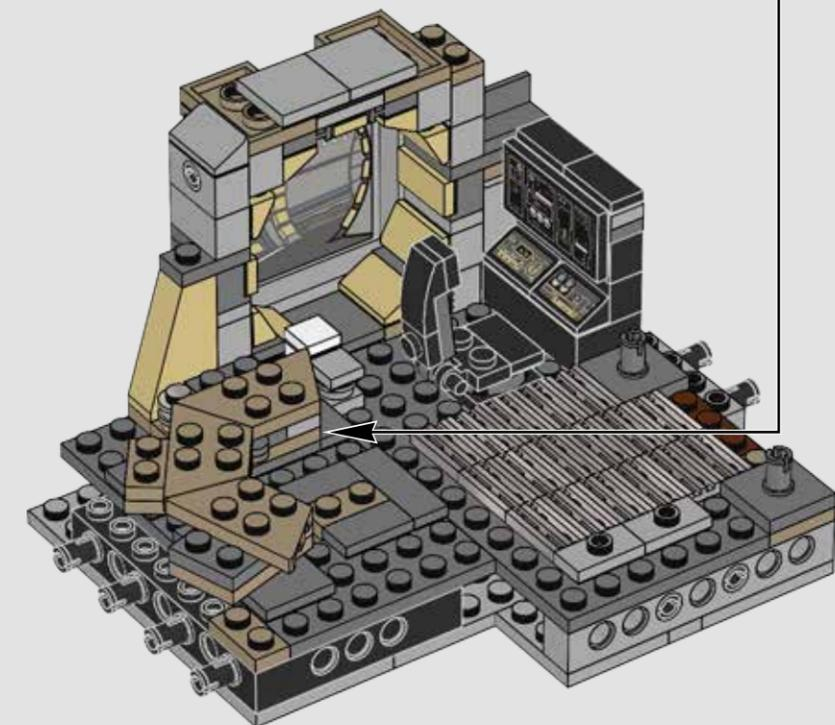
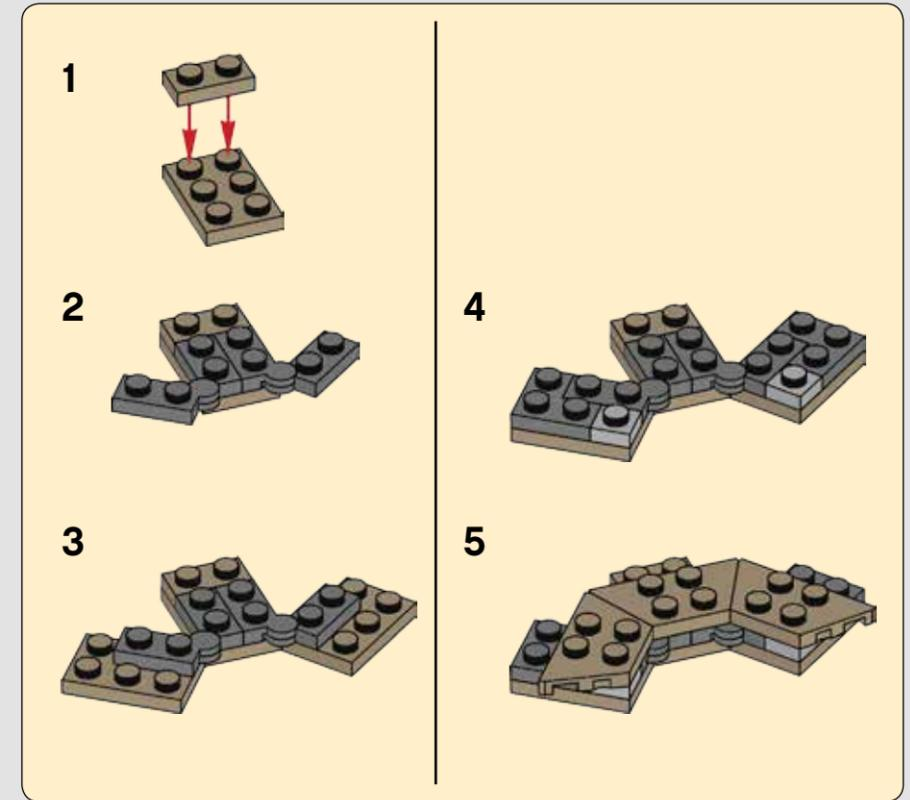

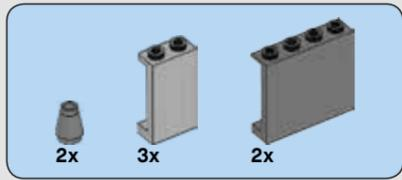

194

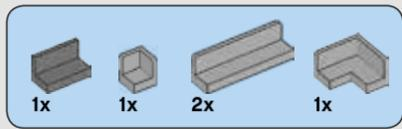
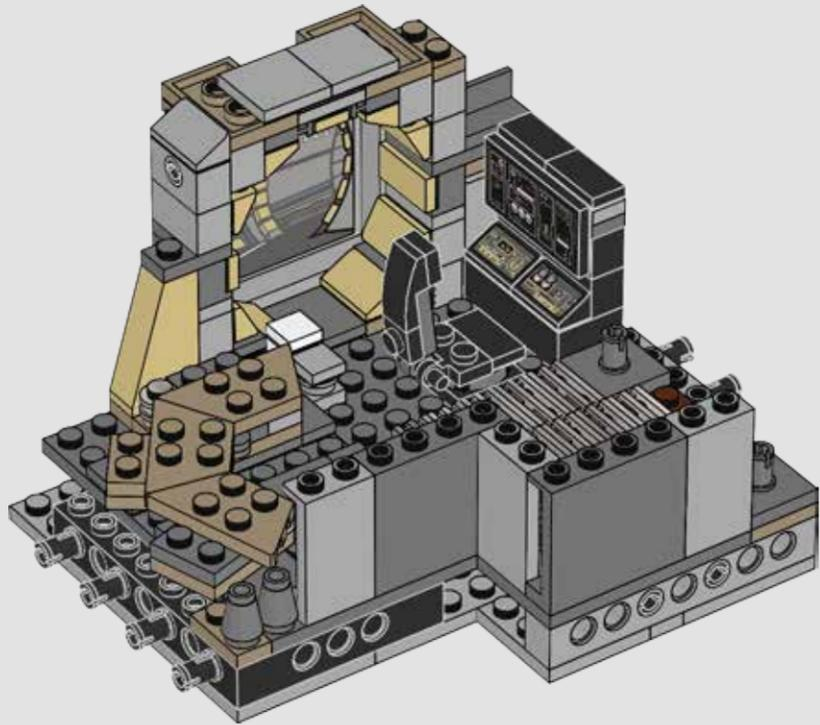

195

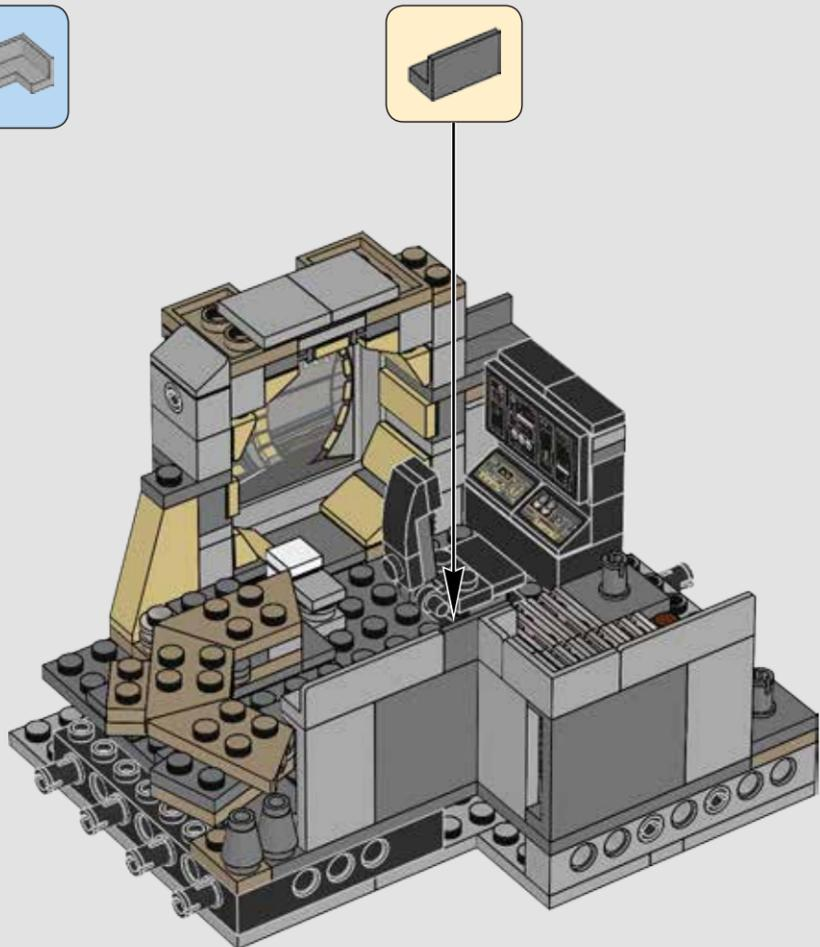

196

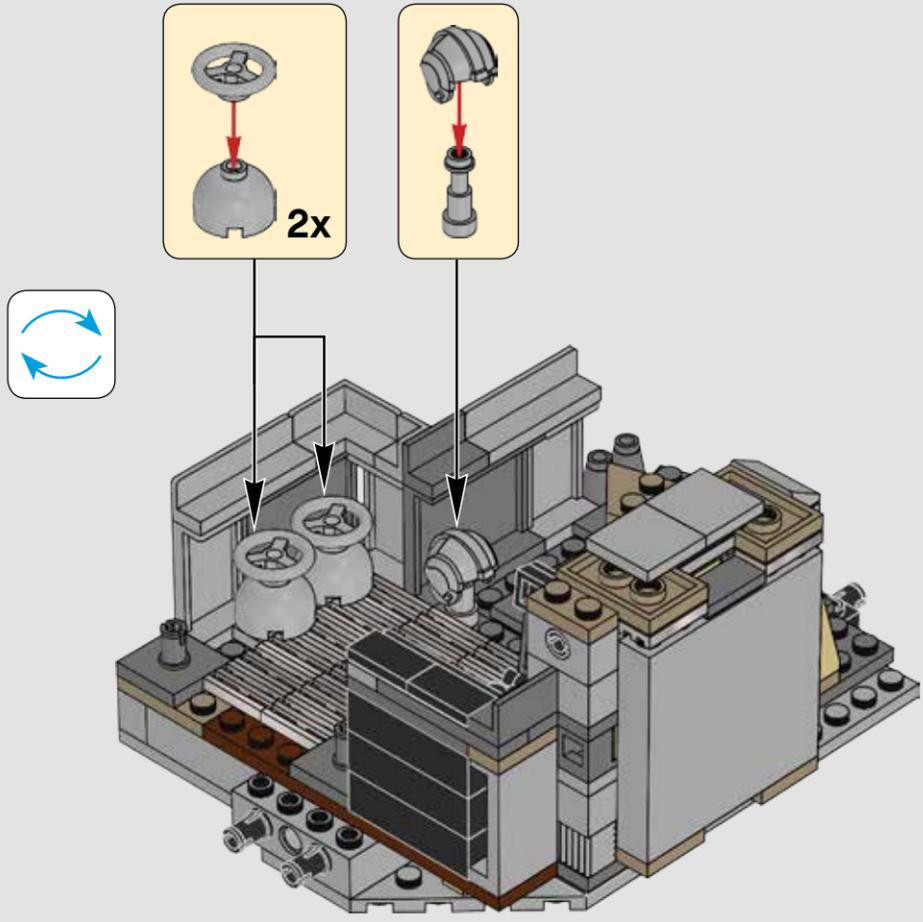

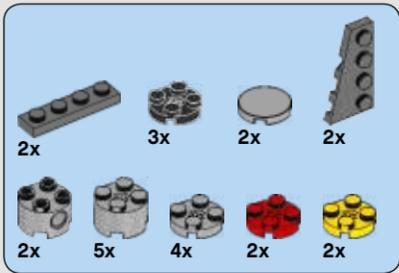

197

1

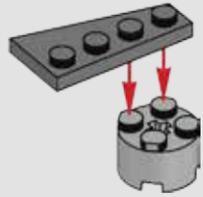

2



3

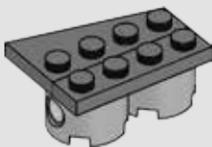

4

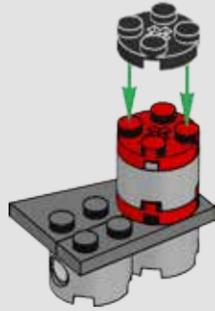

5

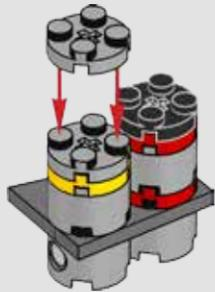

6

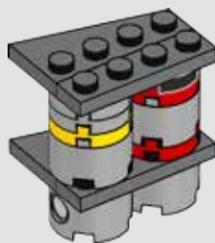

7

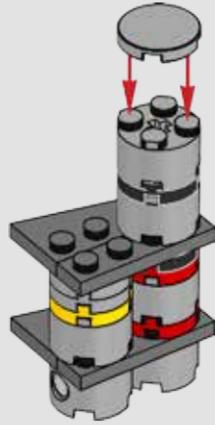

8

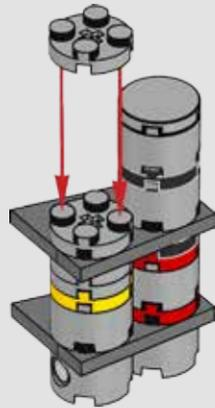

9

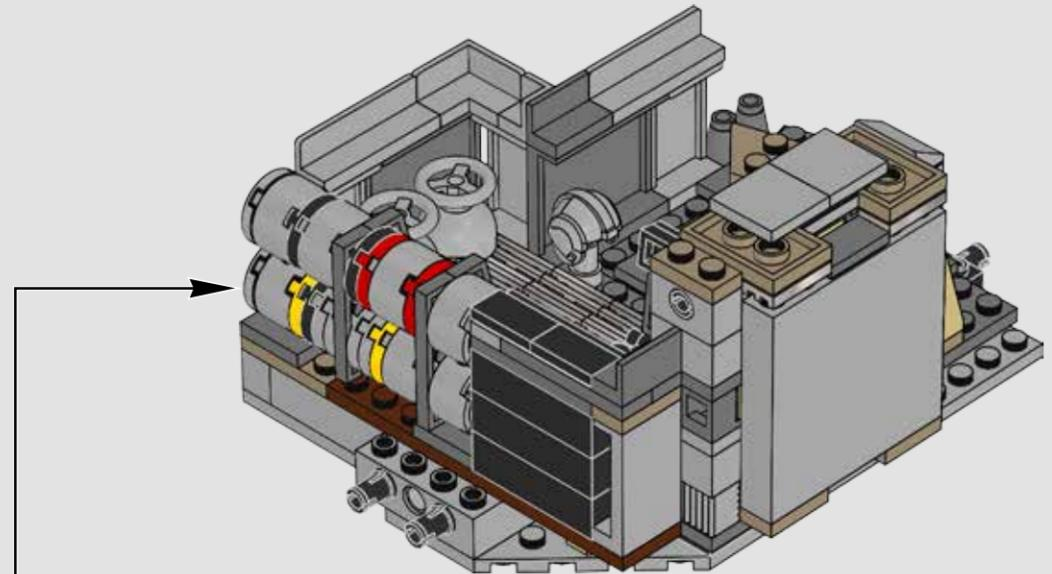
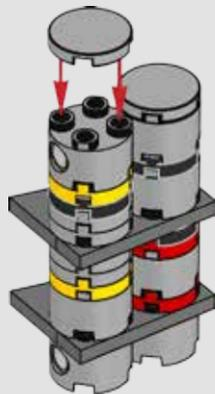

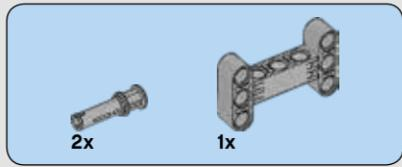

198

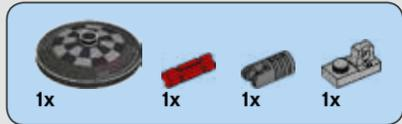
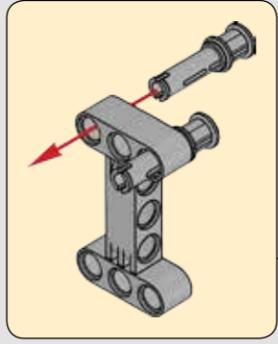
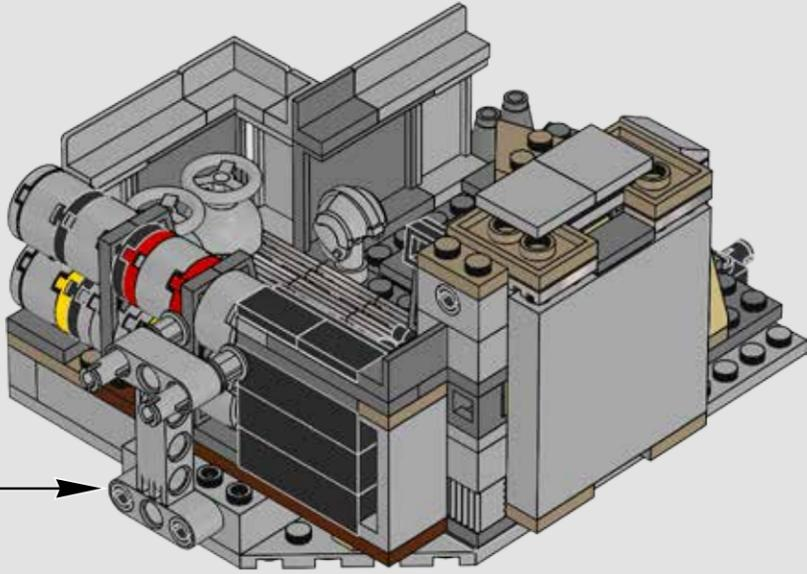

199

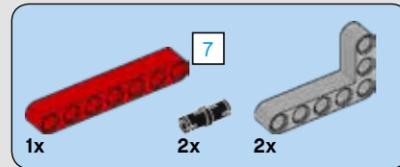
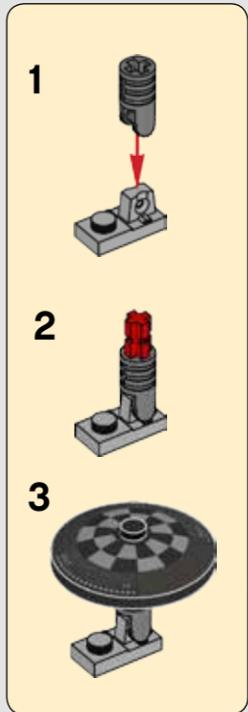
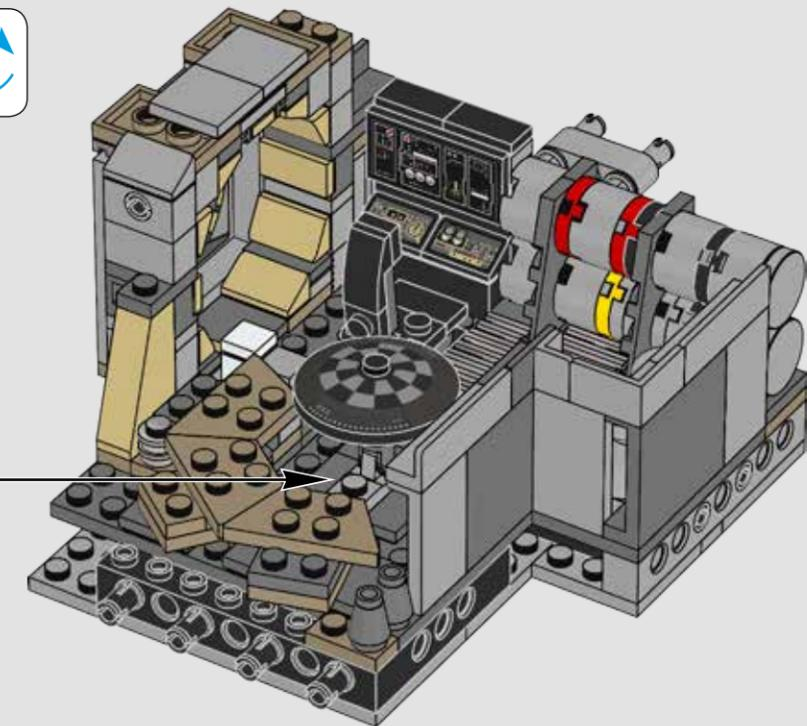

200

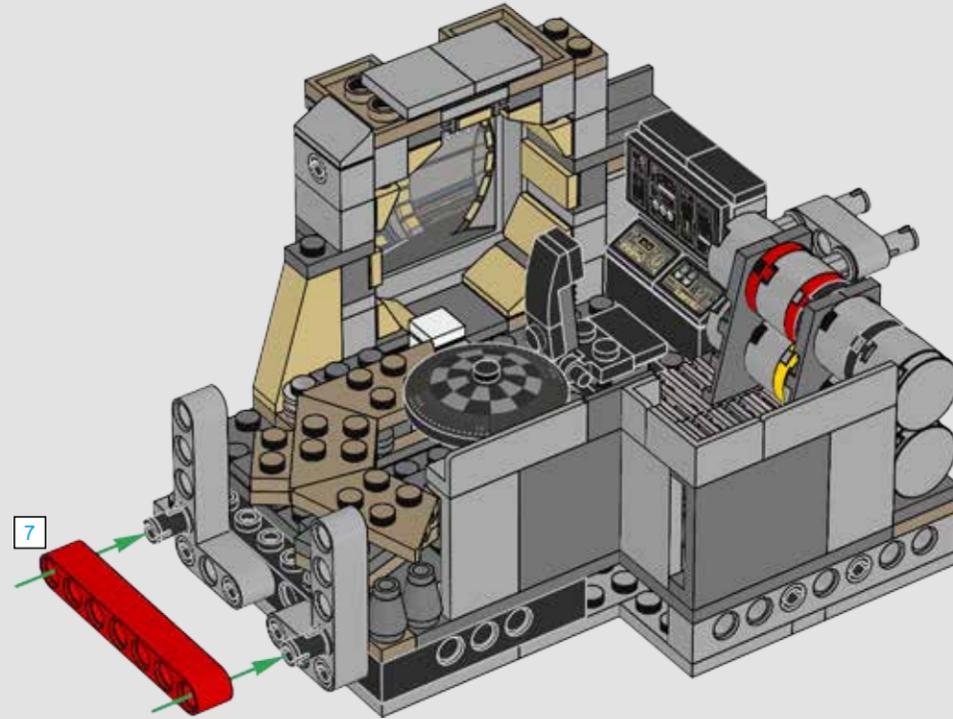
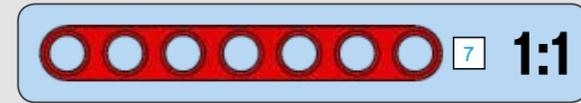

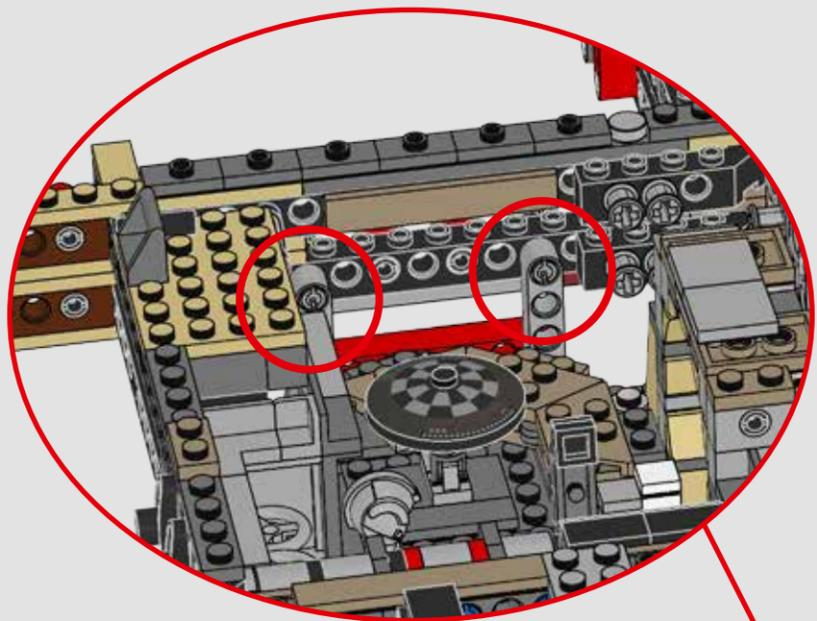

201

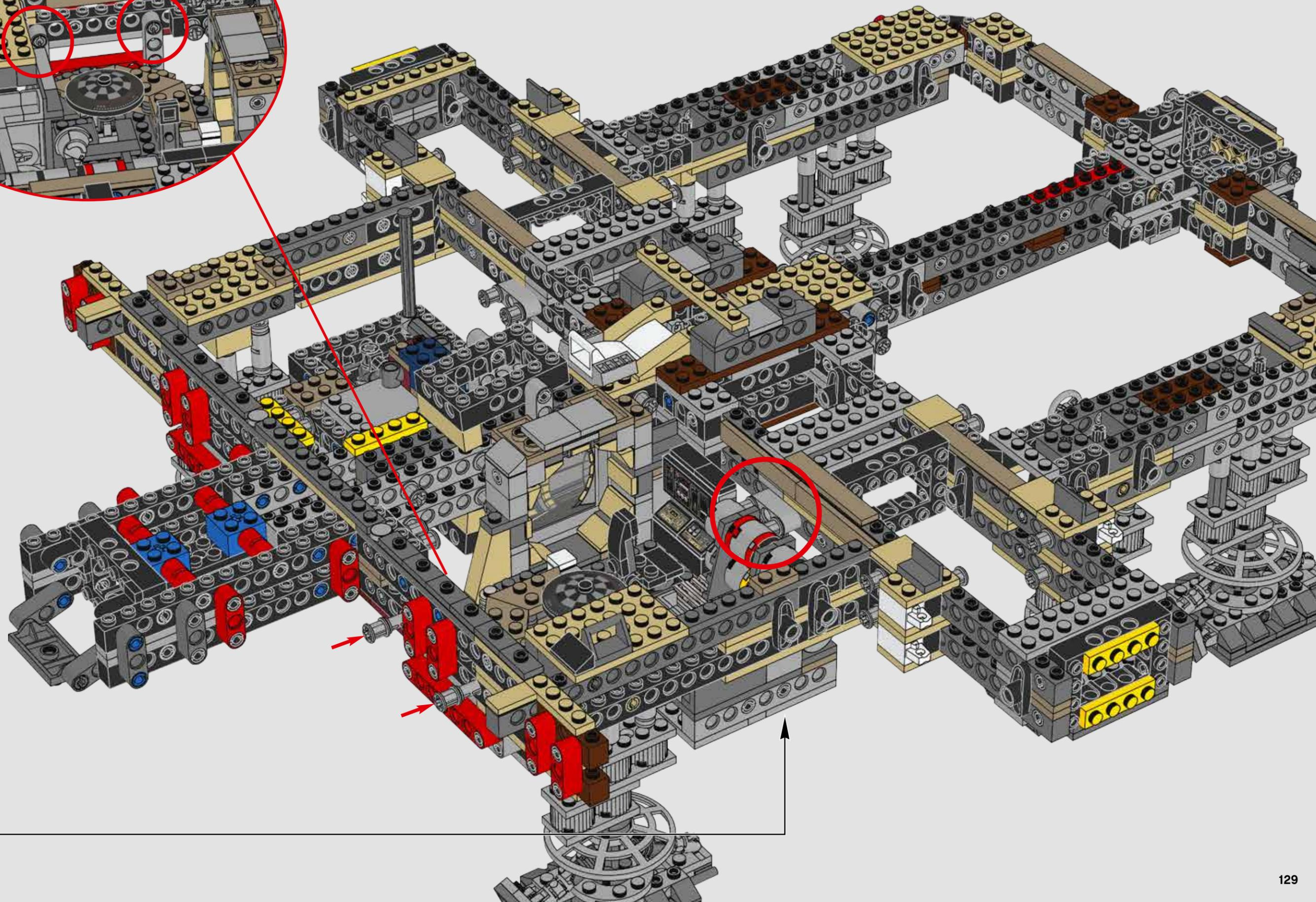

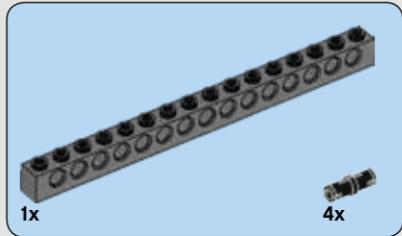
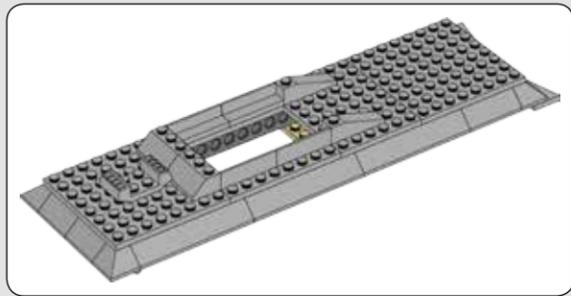

202

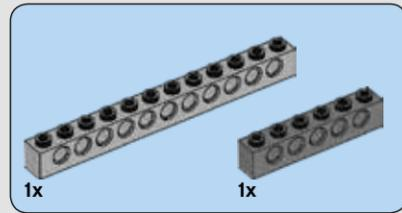
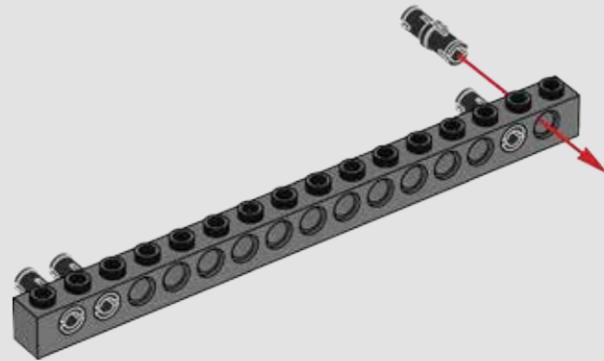

203

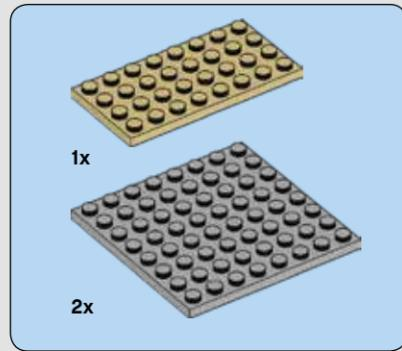
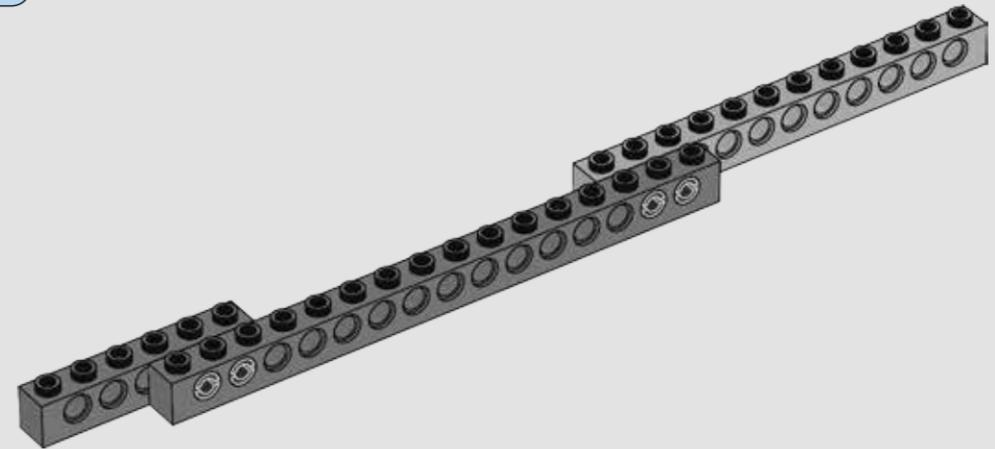

204

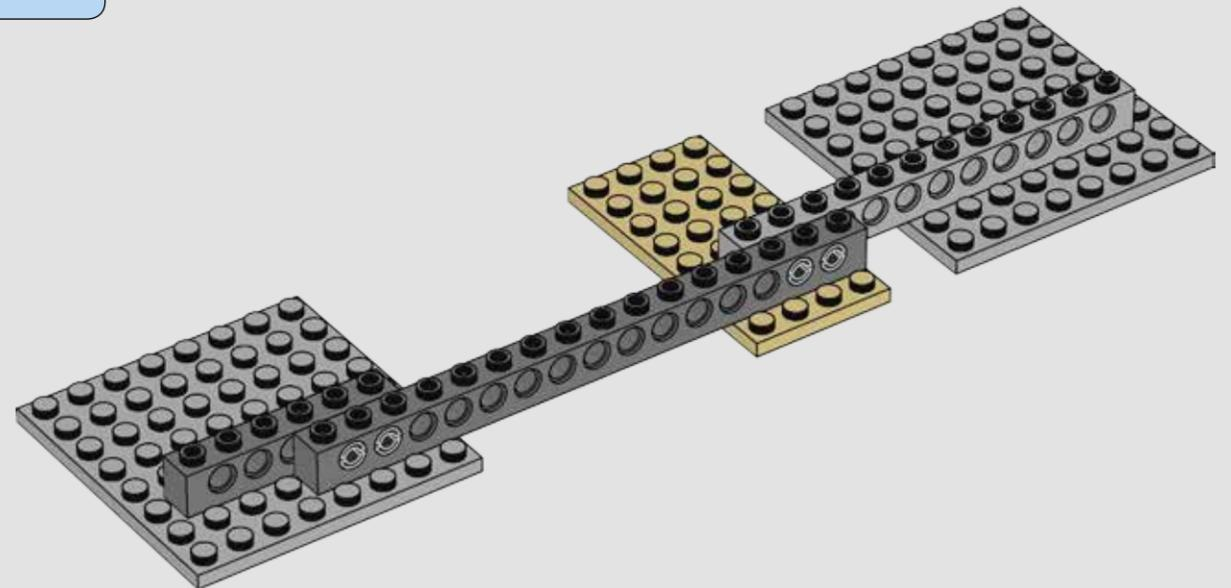

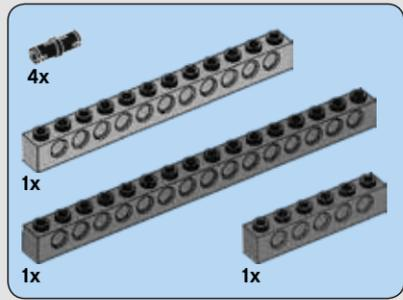

205

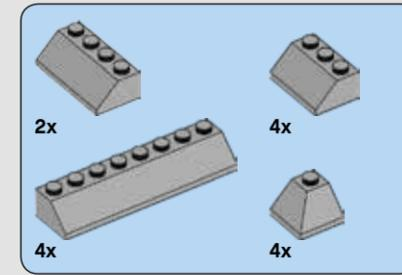
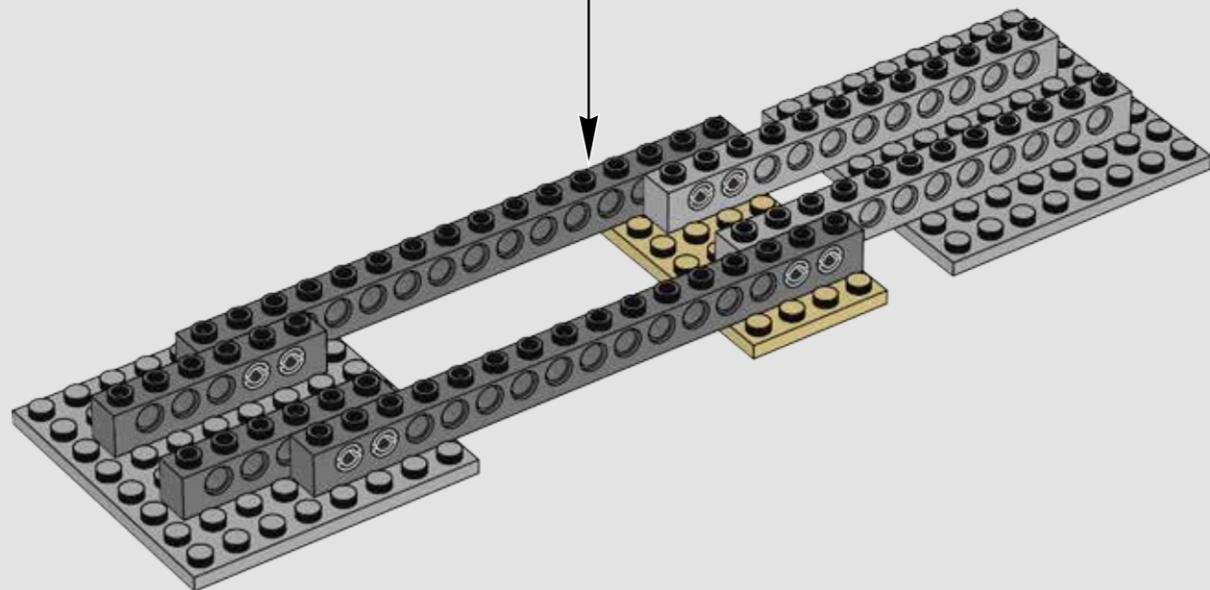
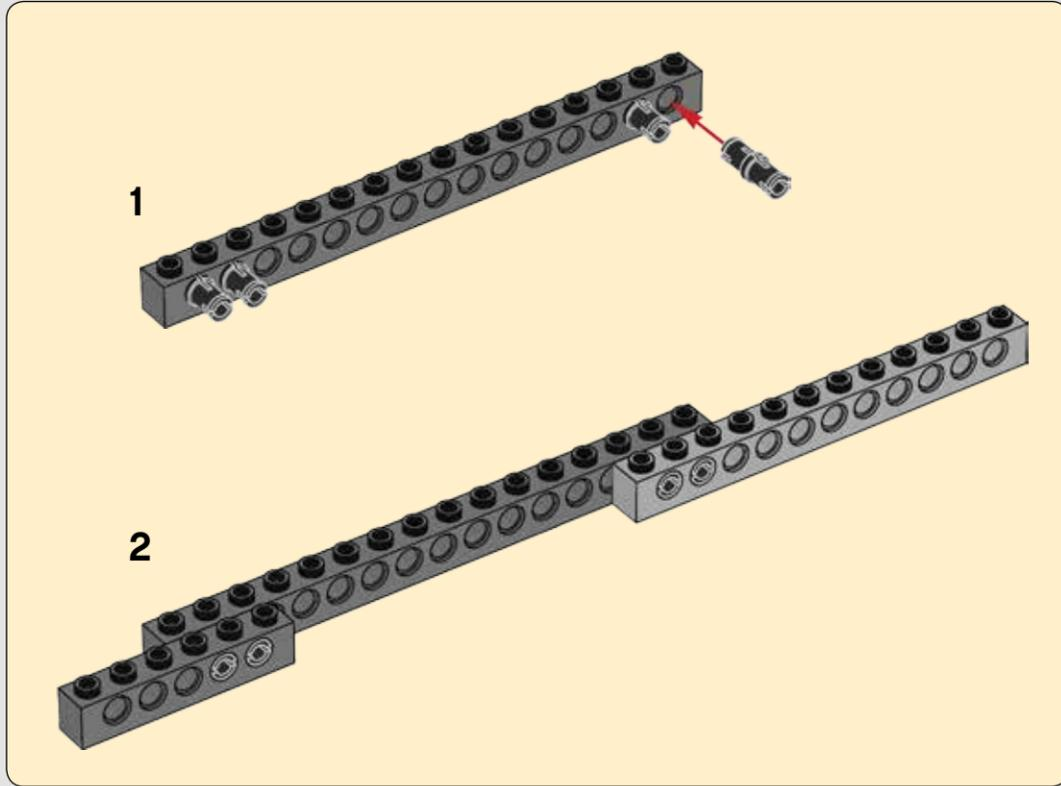

206

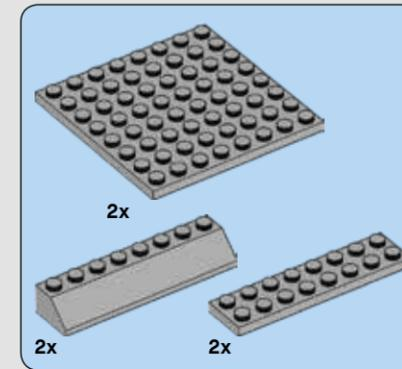
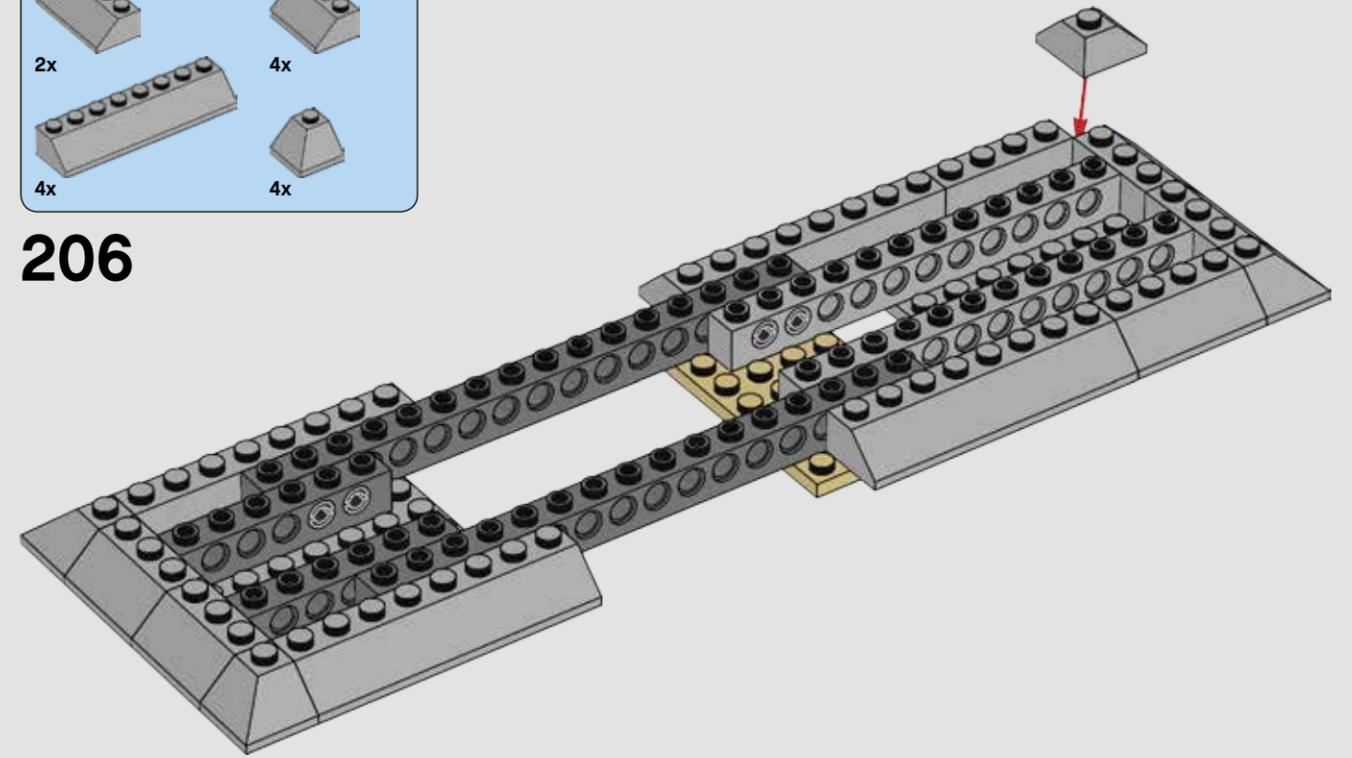

207

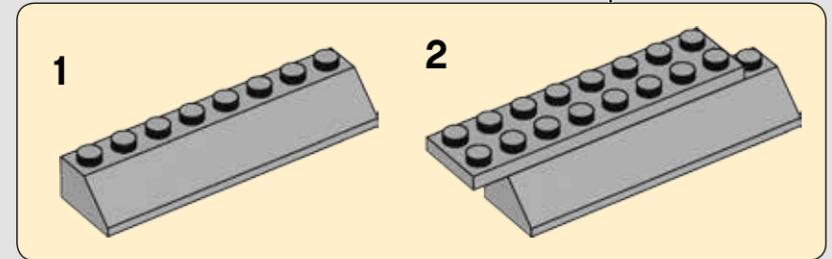
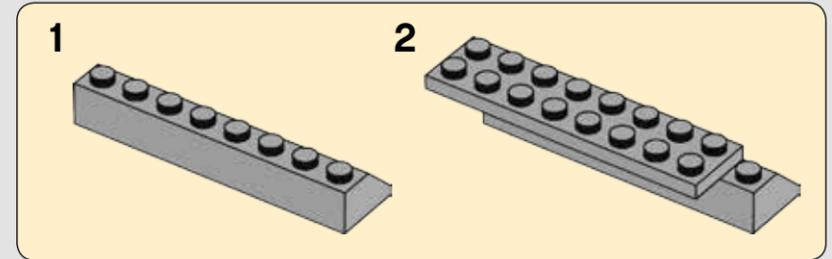
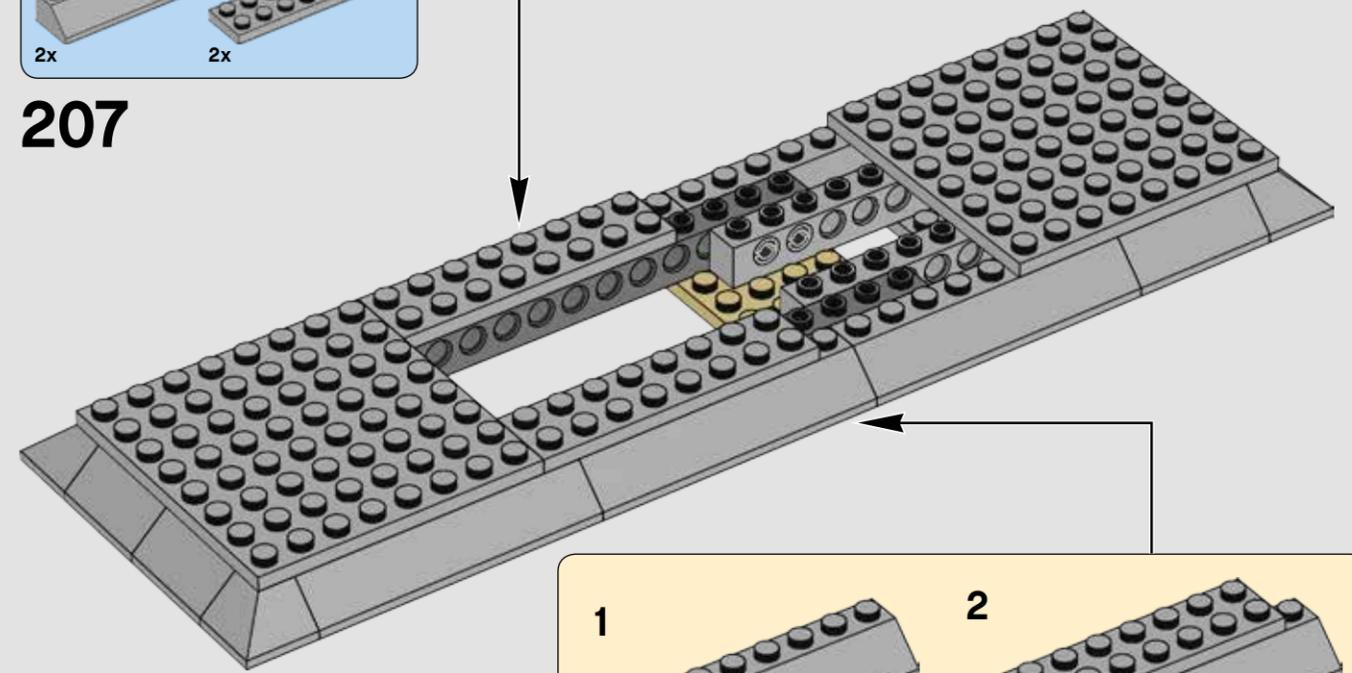

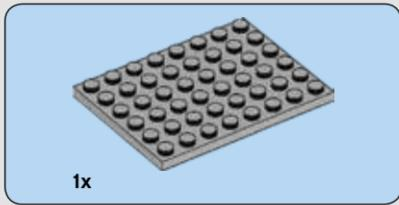

208

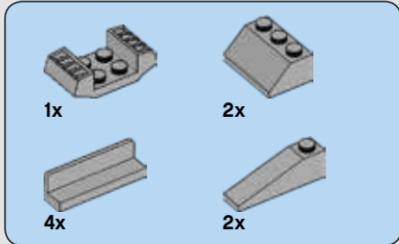
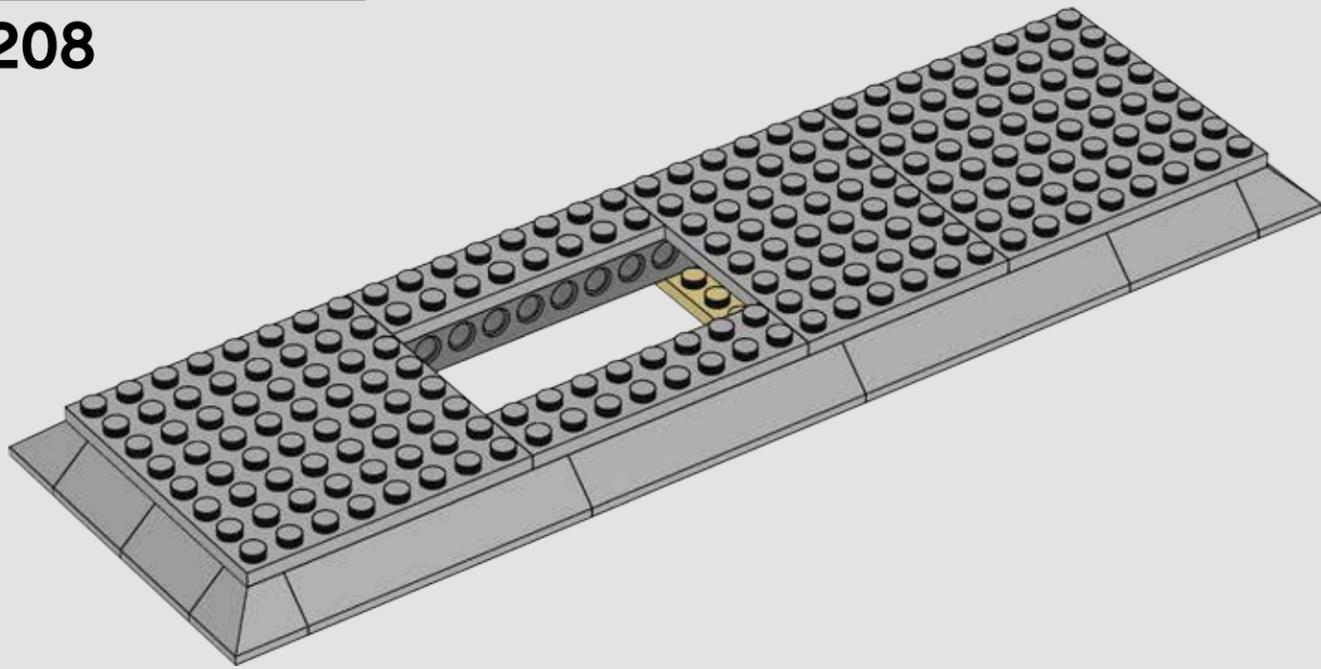

209

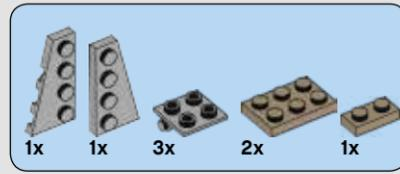
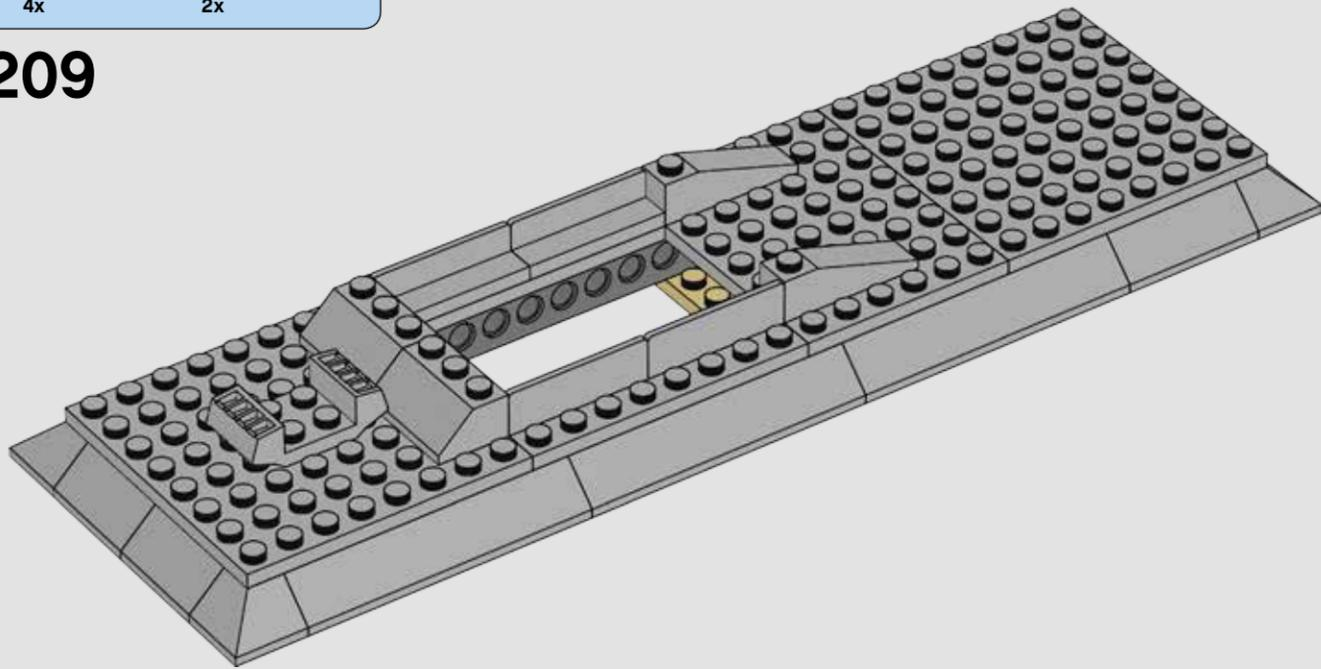

210

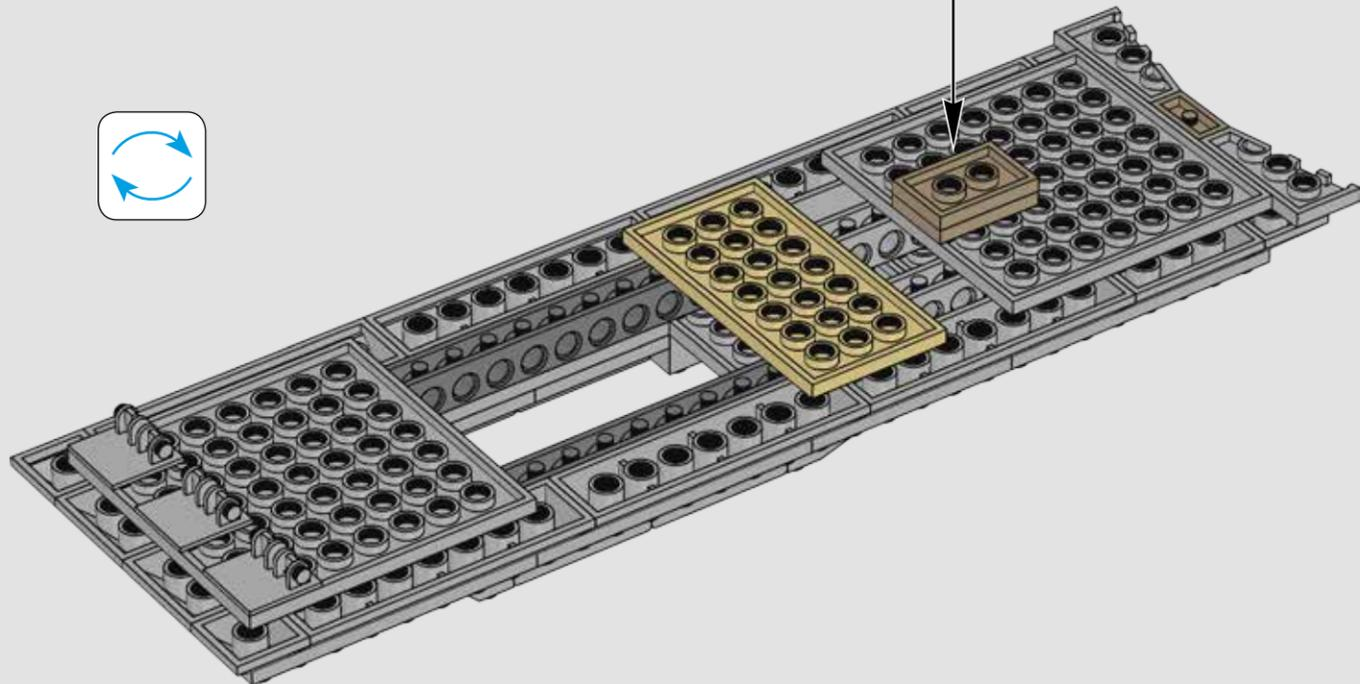
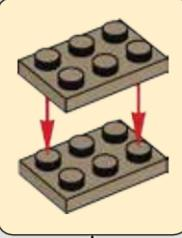



211

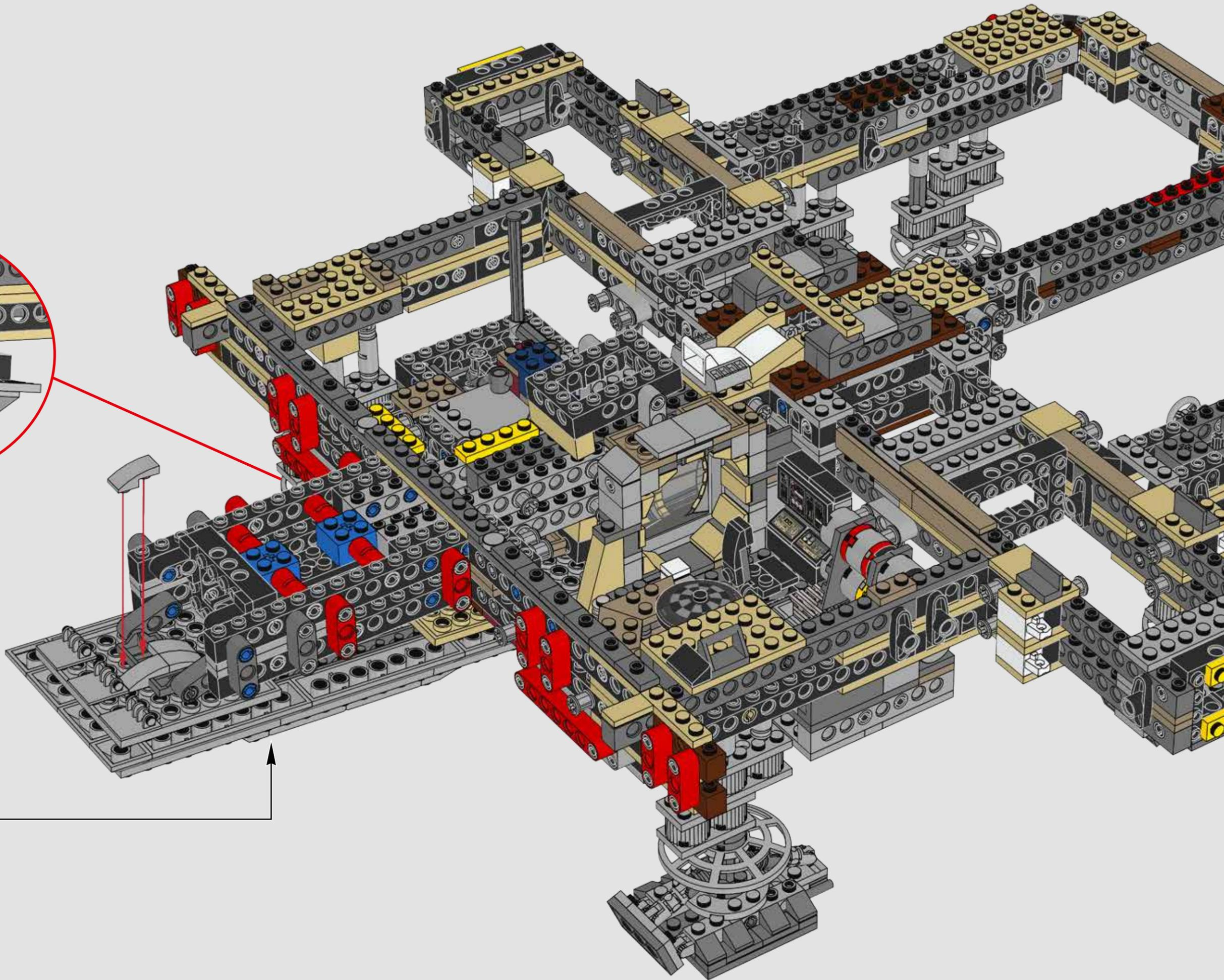
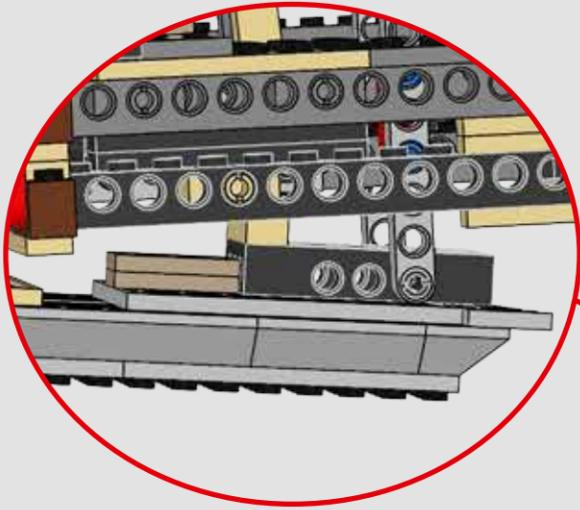

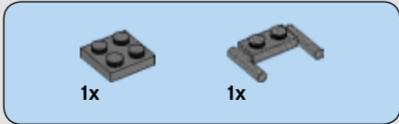
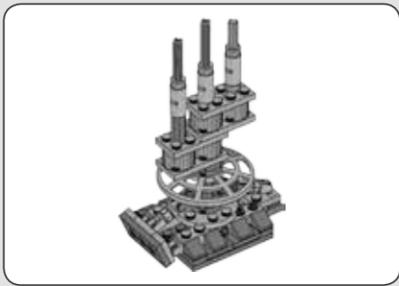

212

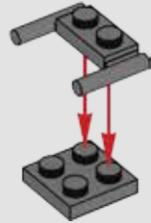

213

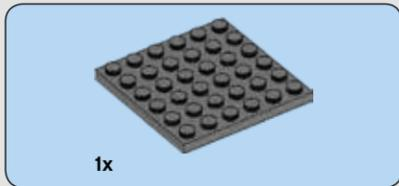
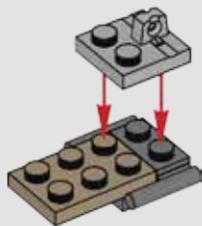

214

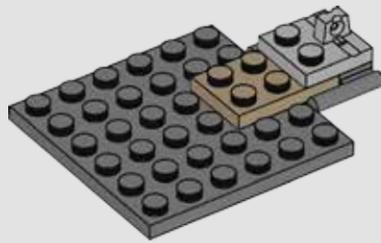

215

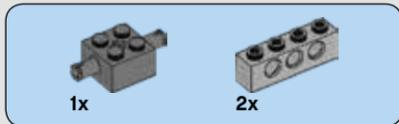
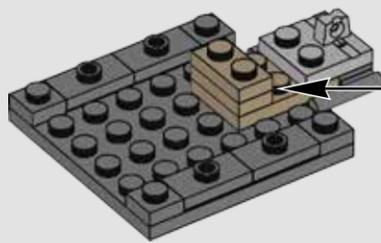
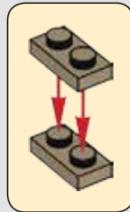

216

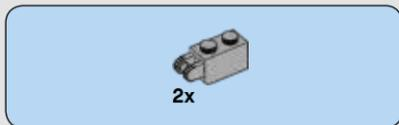
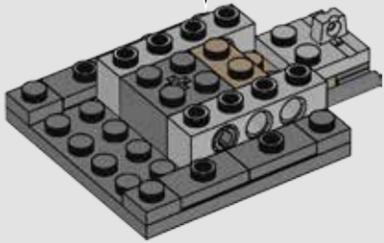
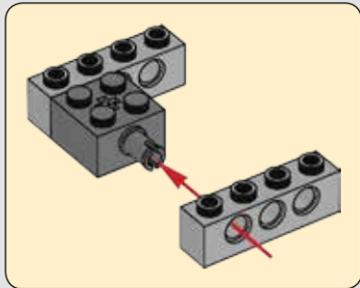

217

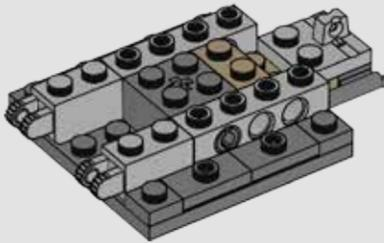



218

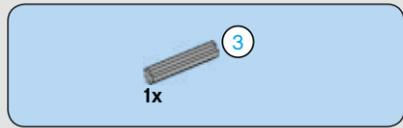
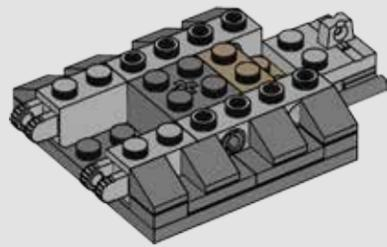

219

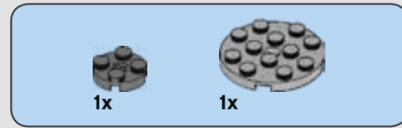
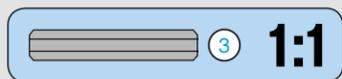
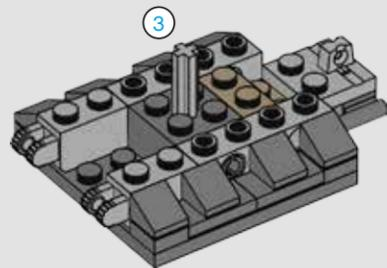

220

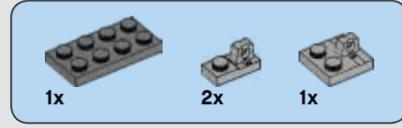
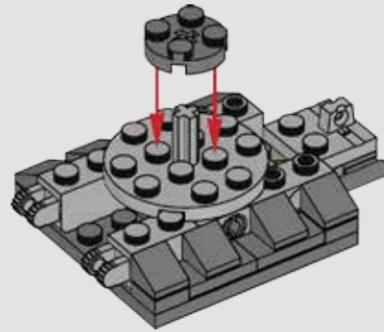

221

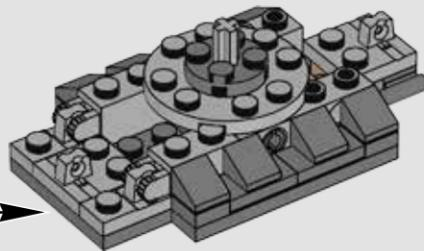
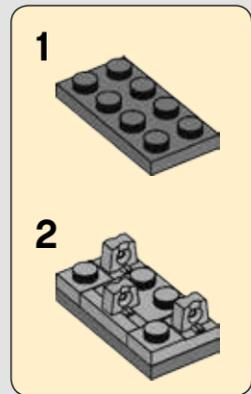

222

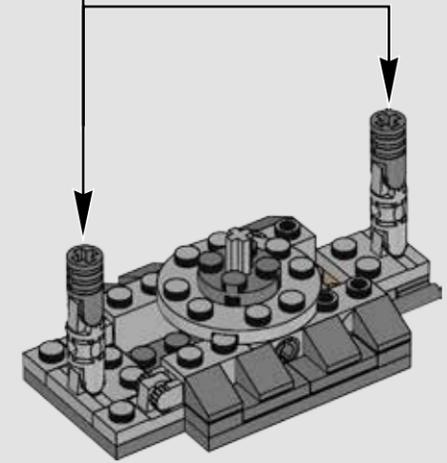
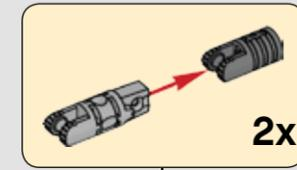

223

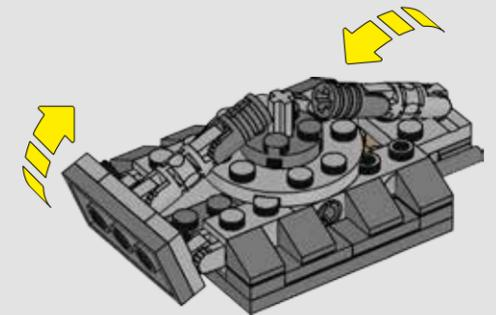

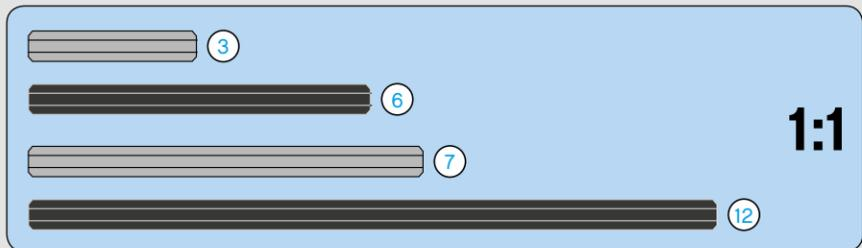

1:1

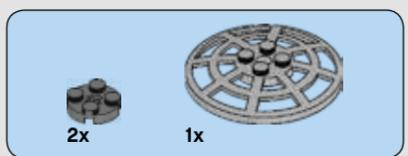

224

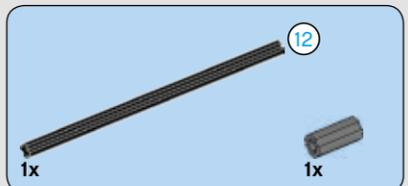
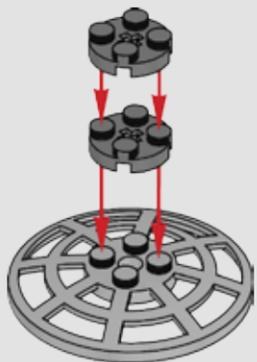

225

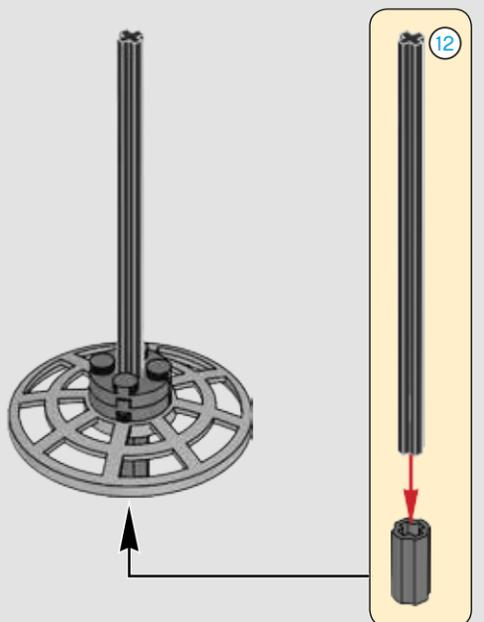

226

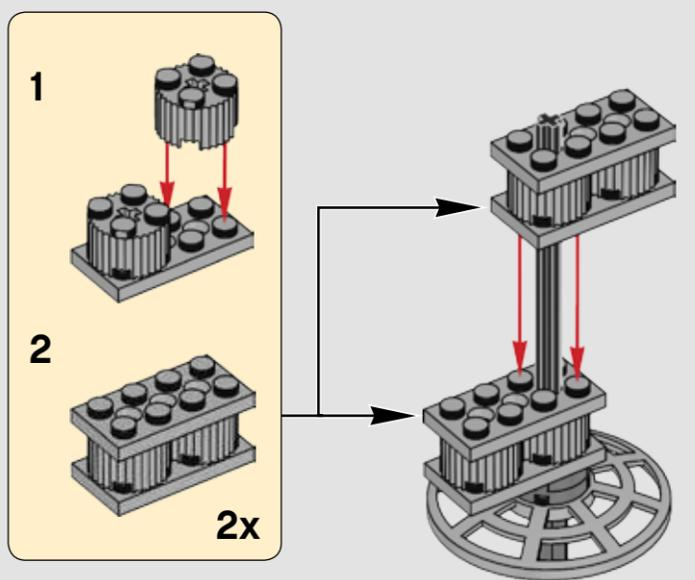

227

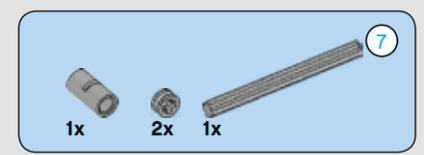
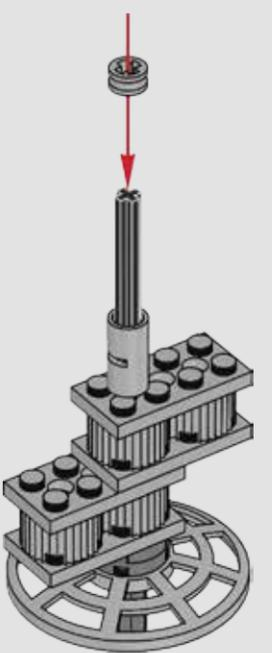

228

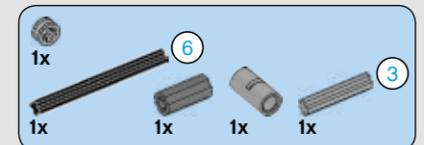
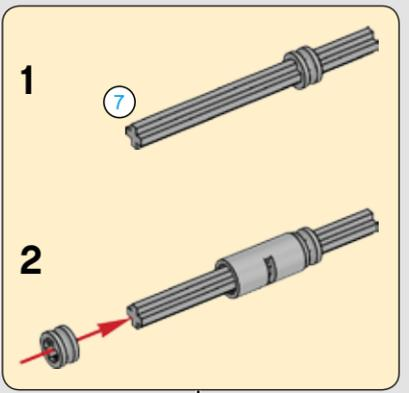
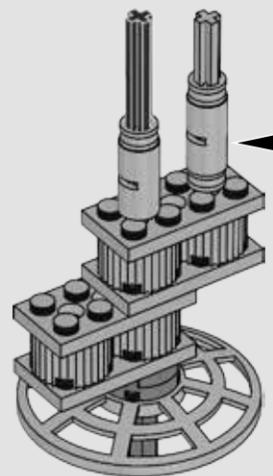

229

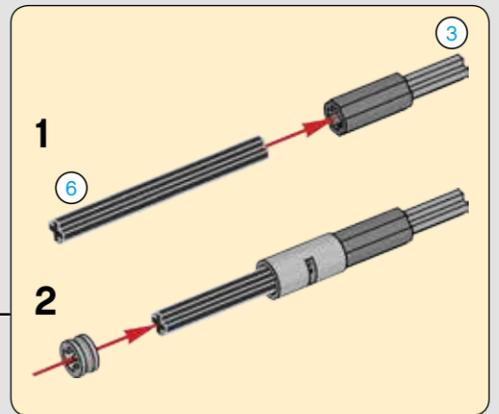
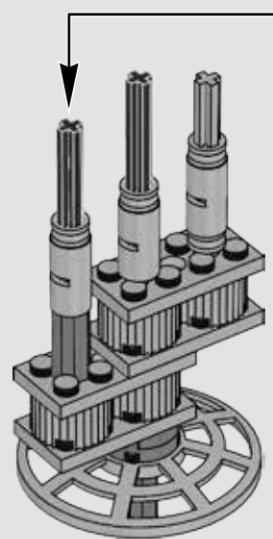

230

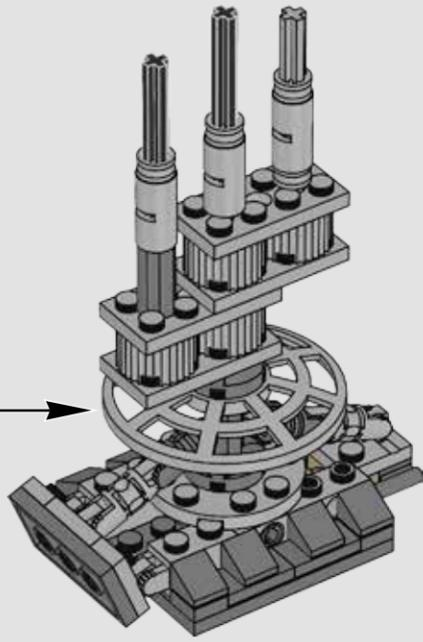

231

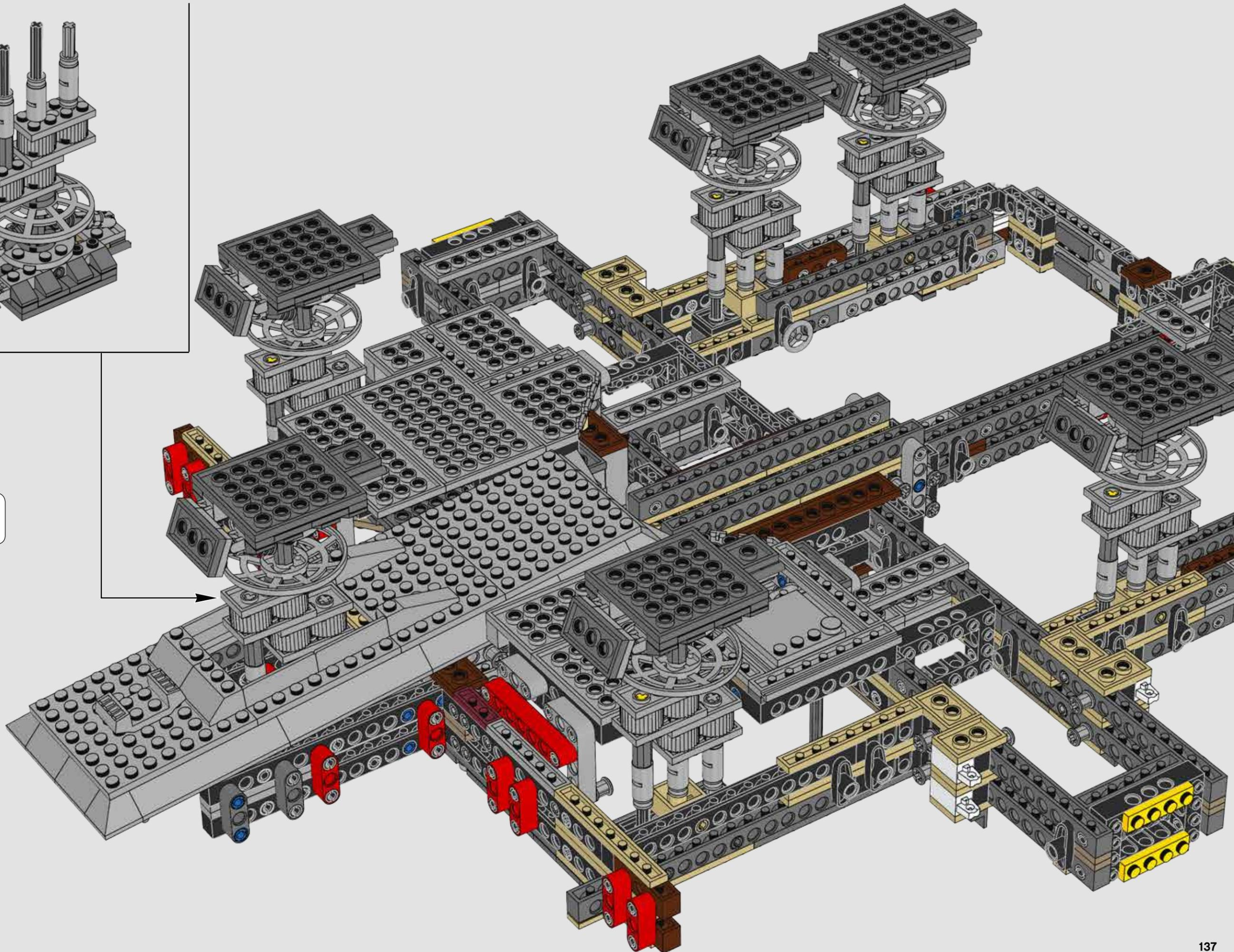



232

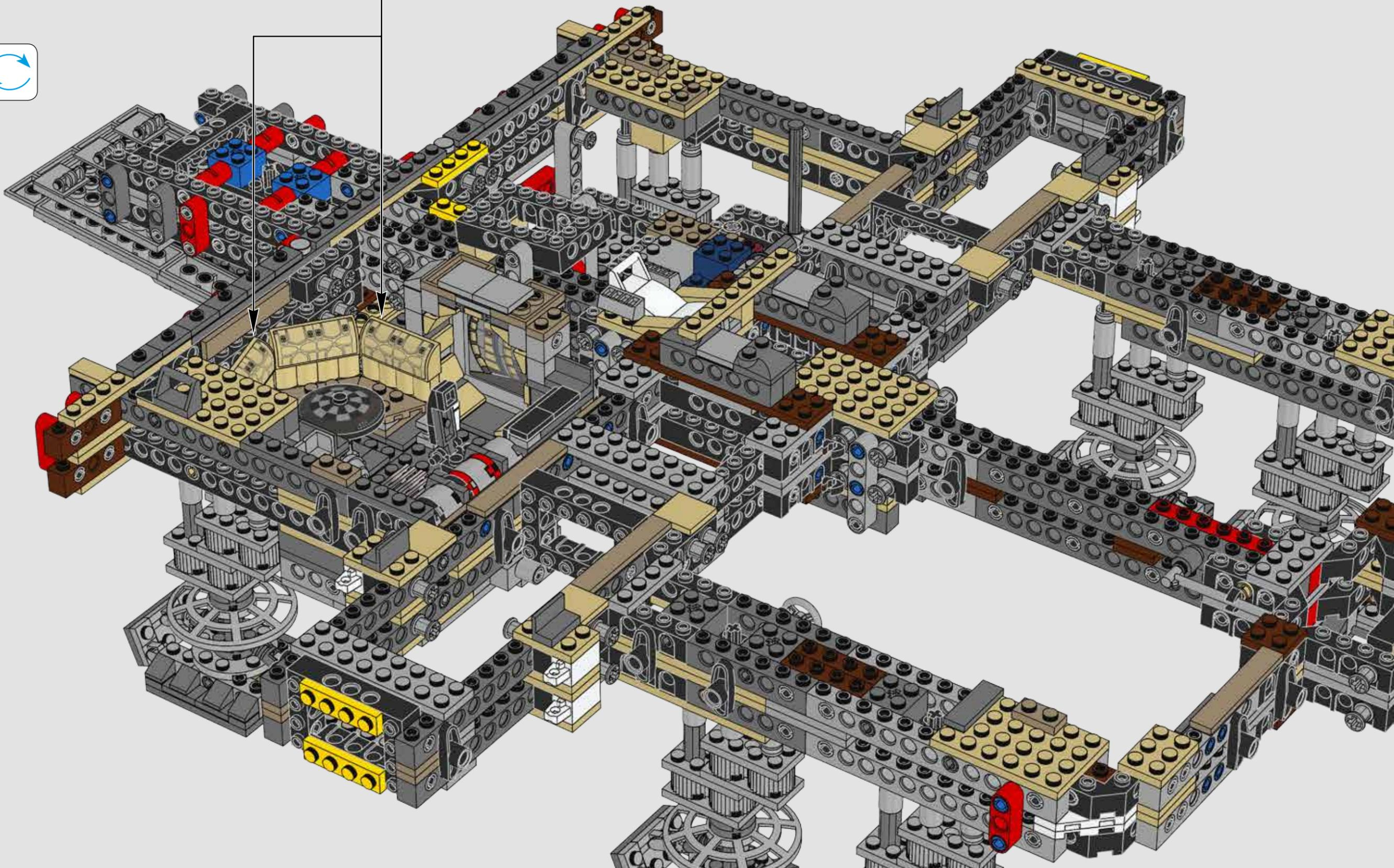
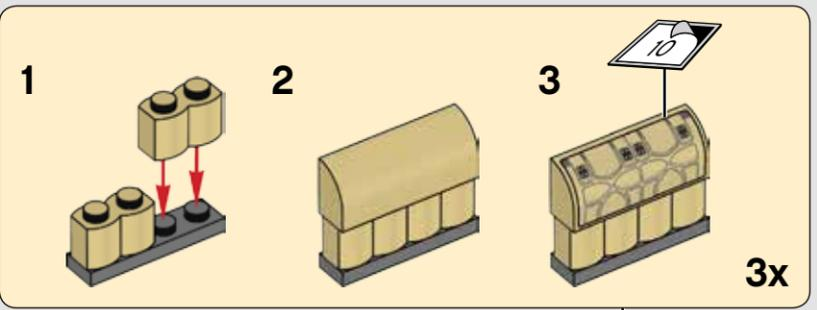

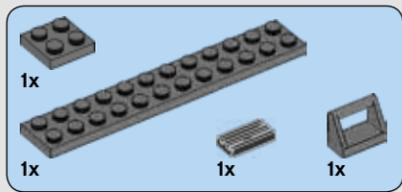

234

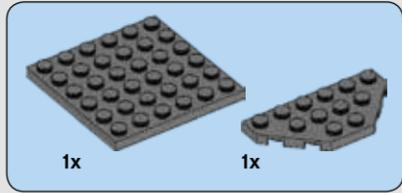
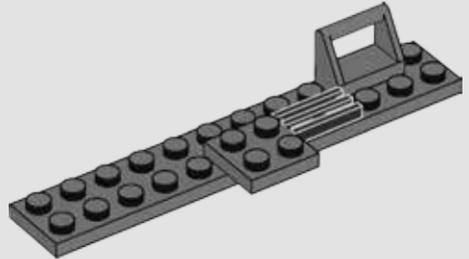

235

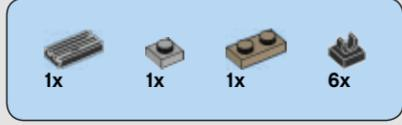
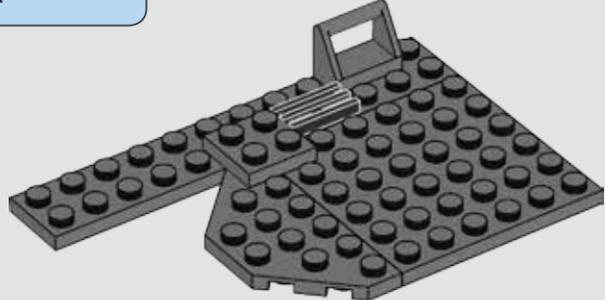

236

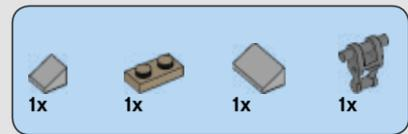

237

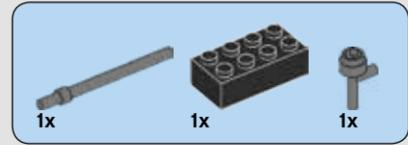
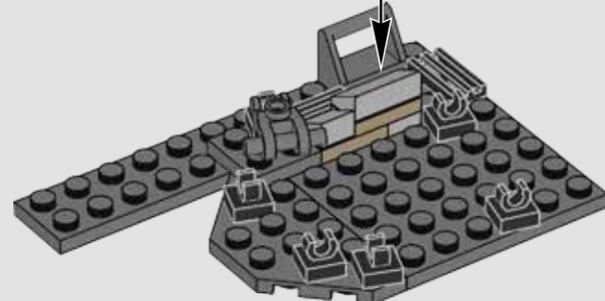
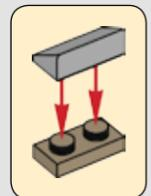

238

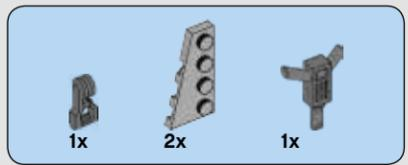
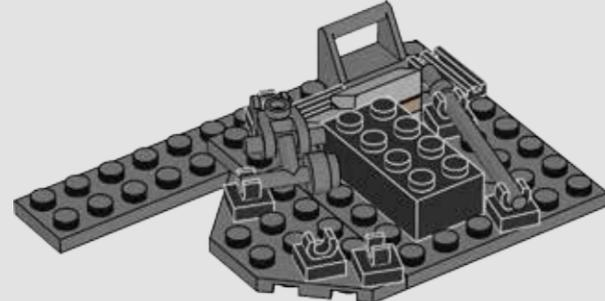

239

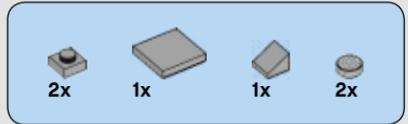
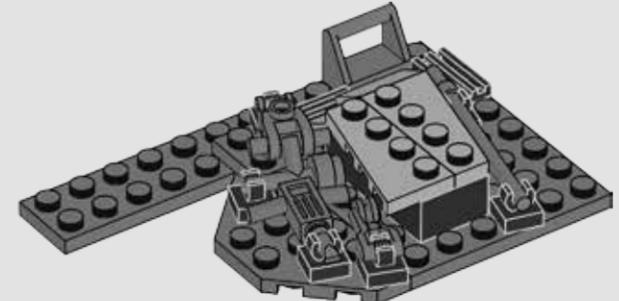

240

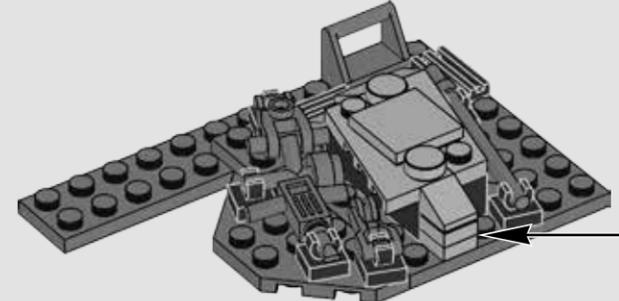
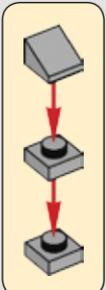

241

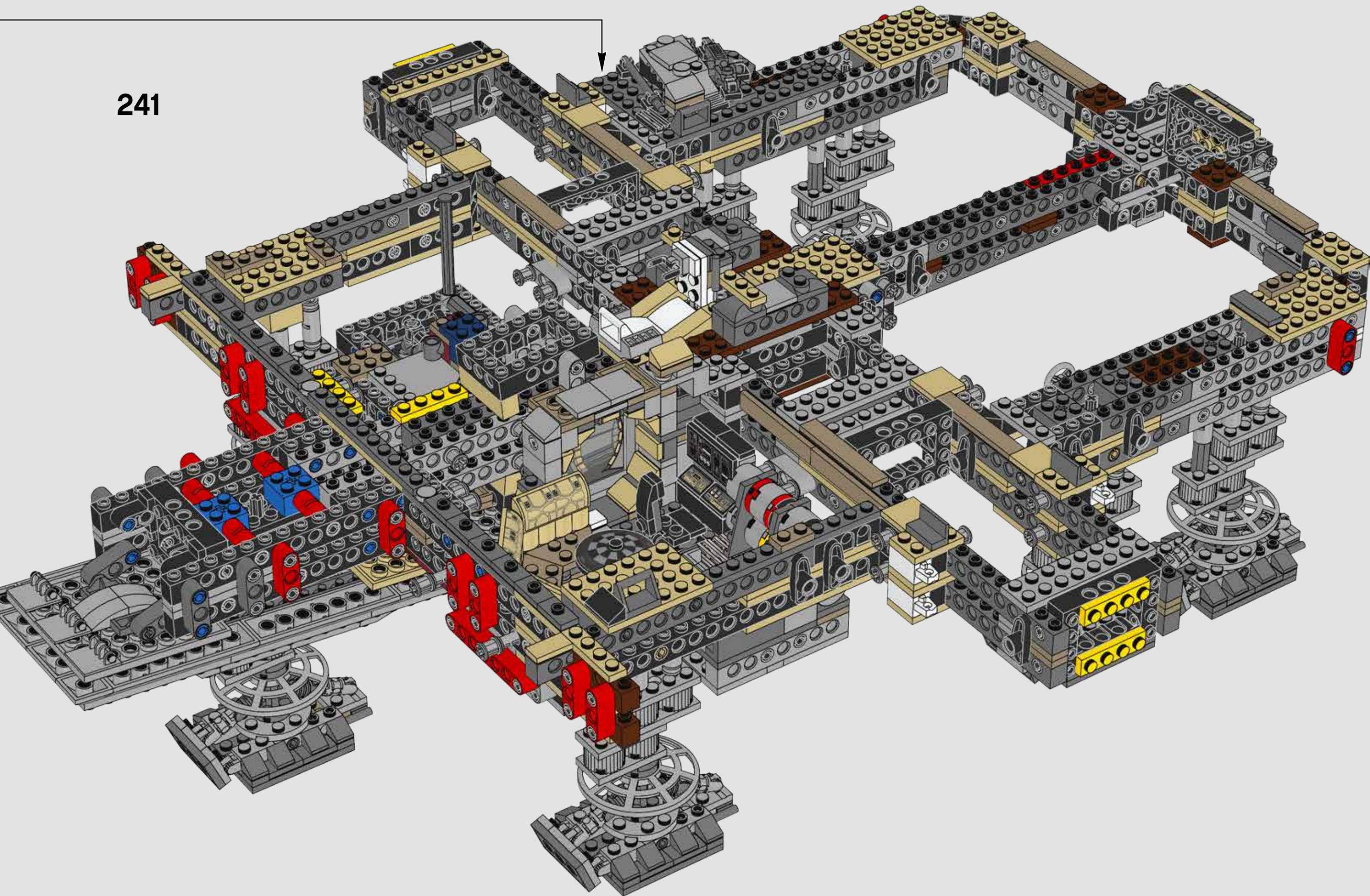

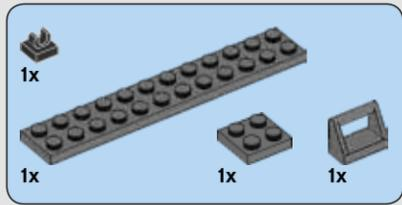

242

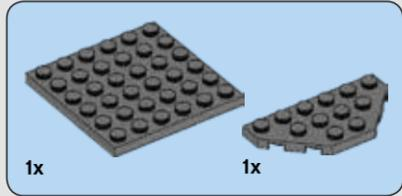
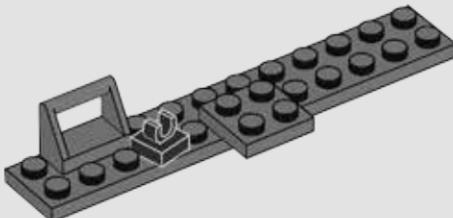

243



244

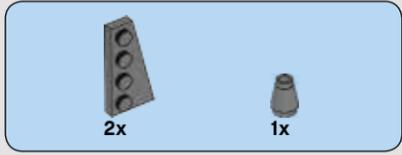
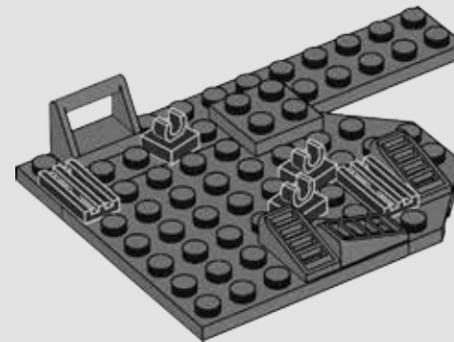

245

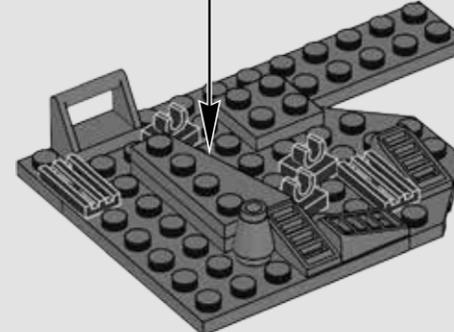
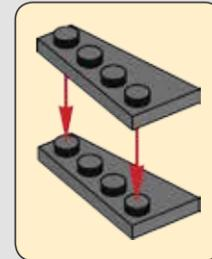

246

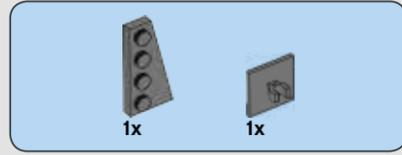
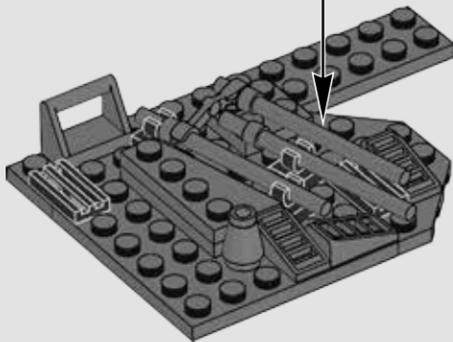
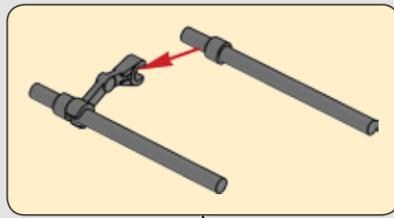

247

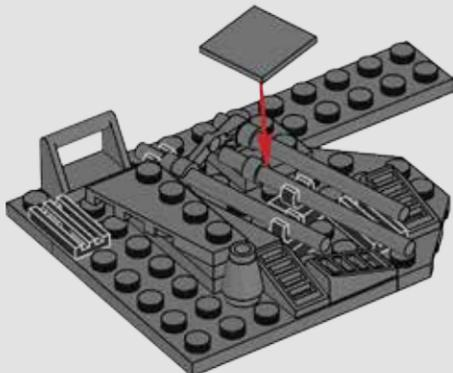

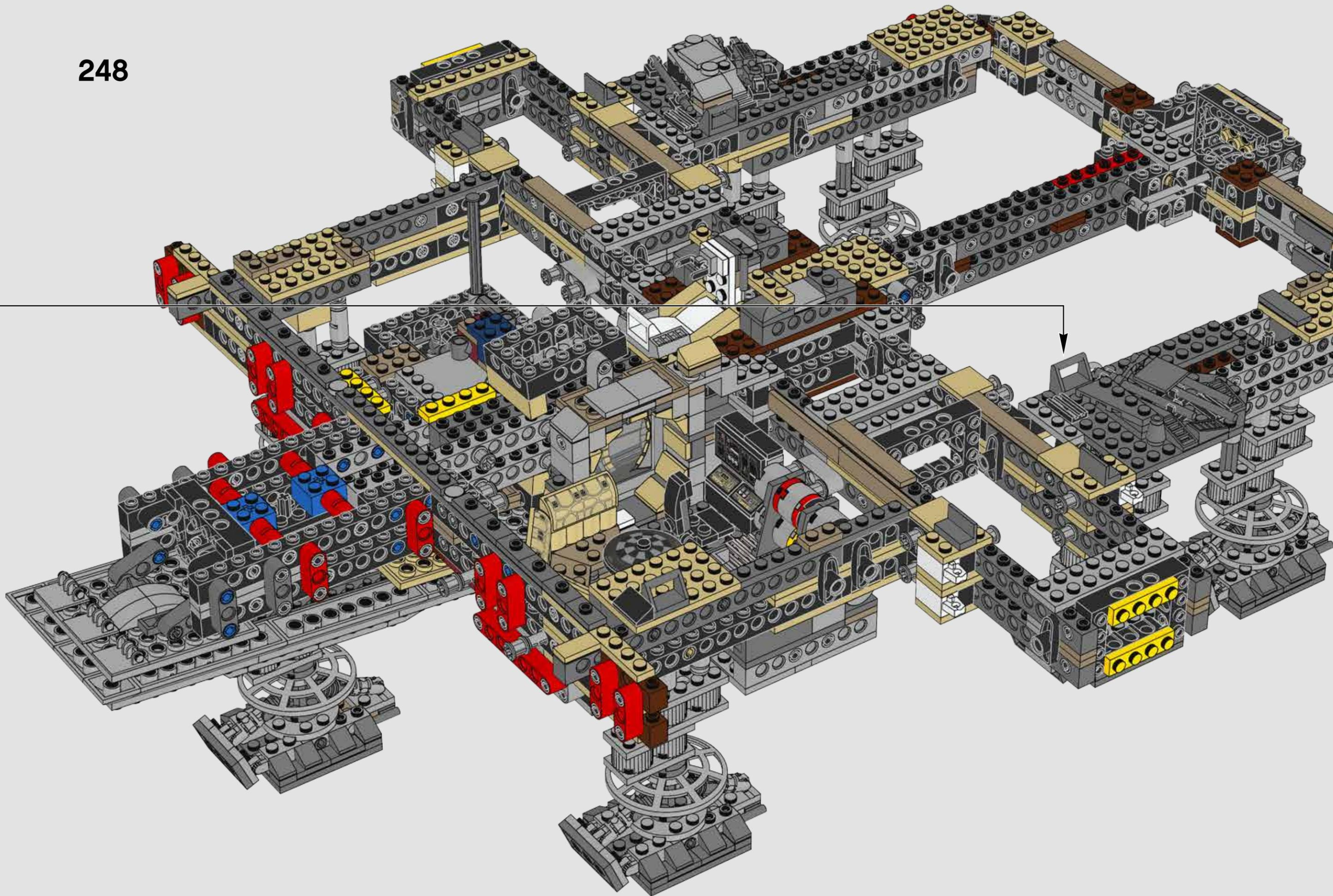



2x

+

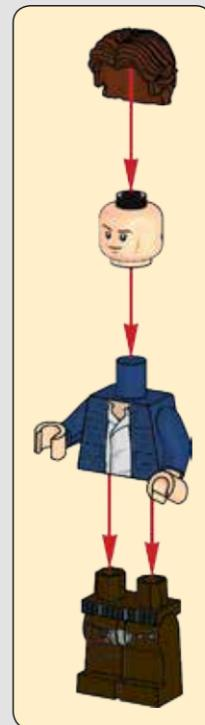
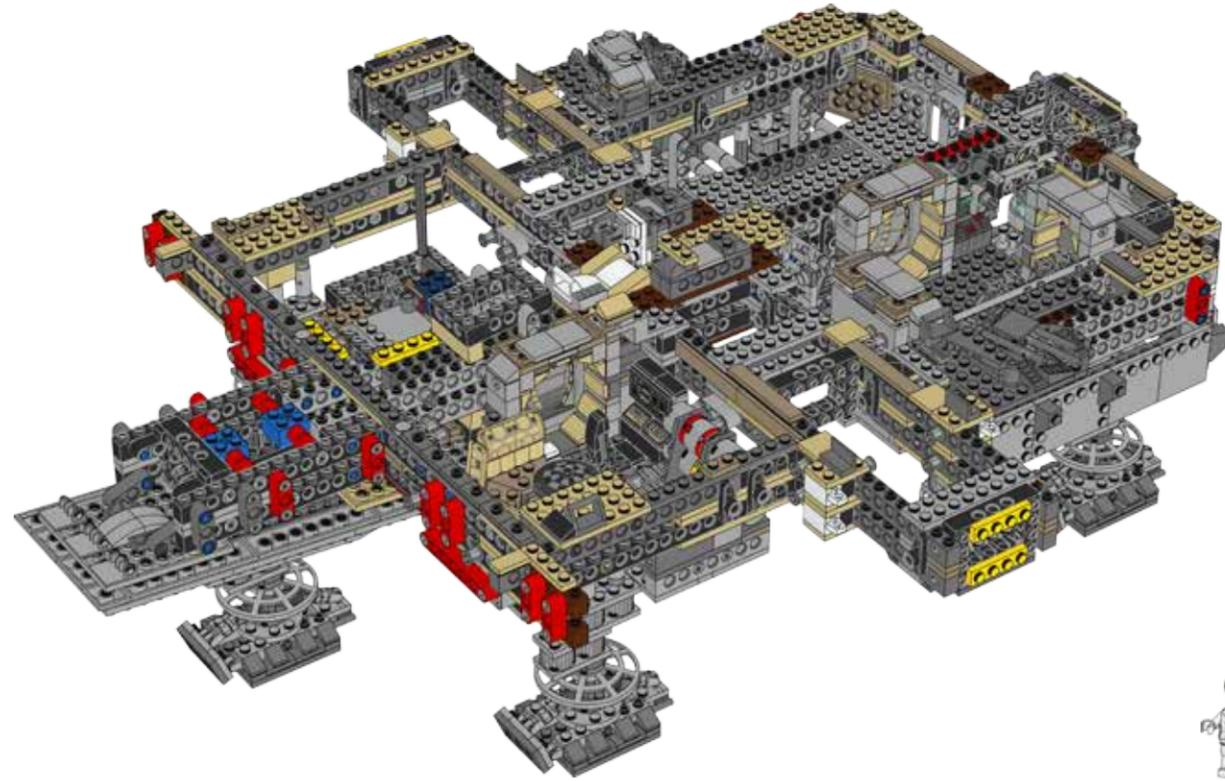

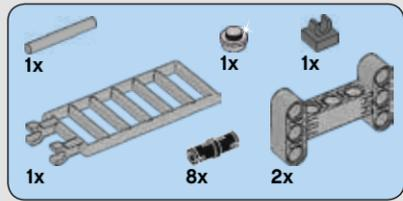

249

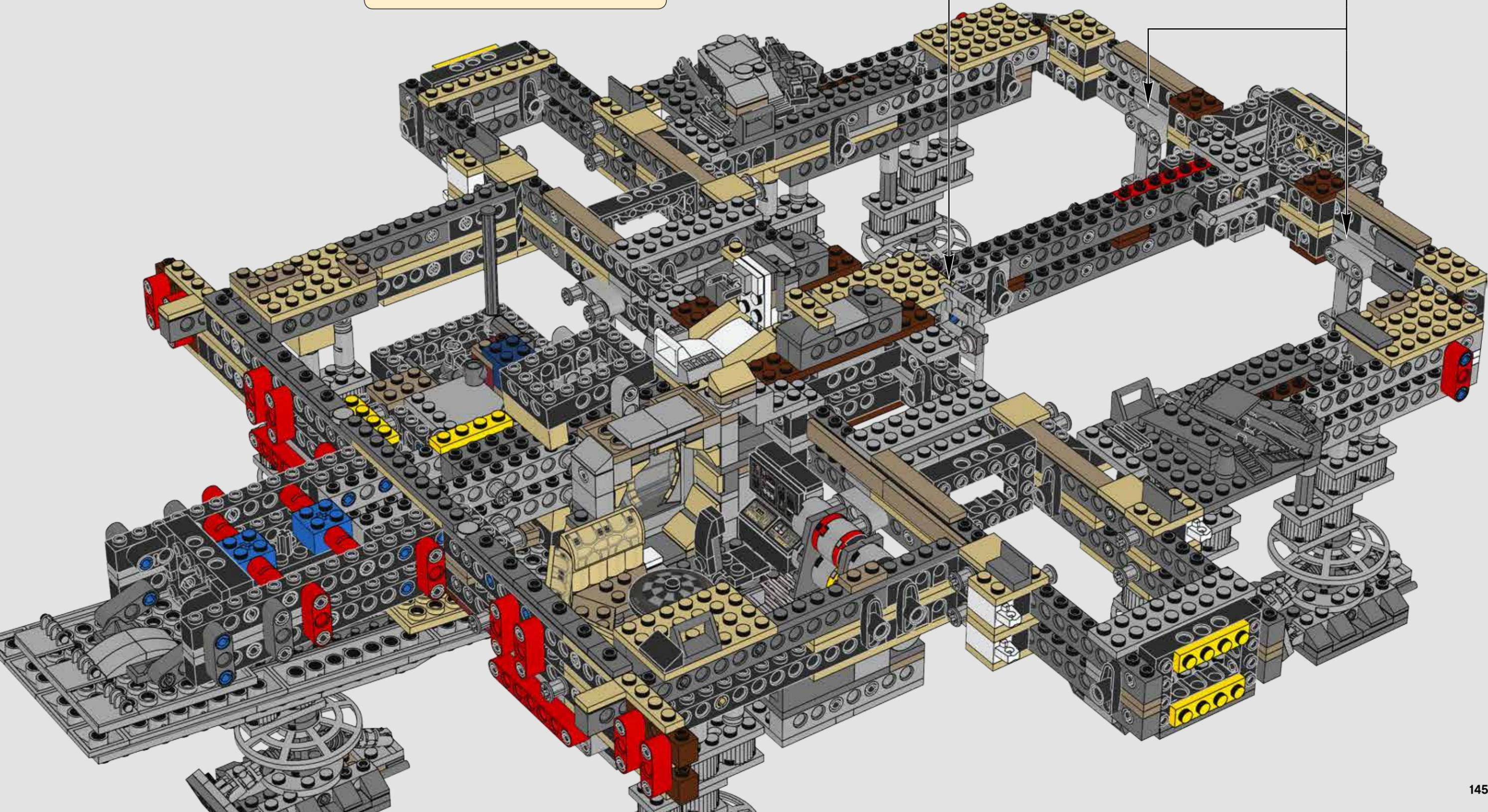
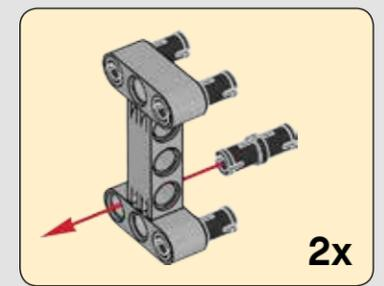
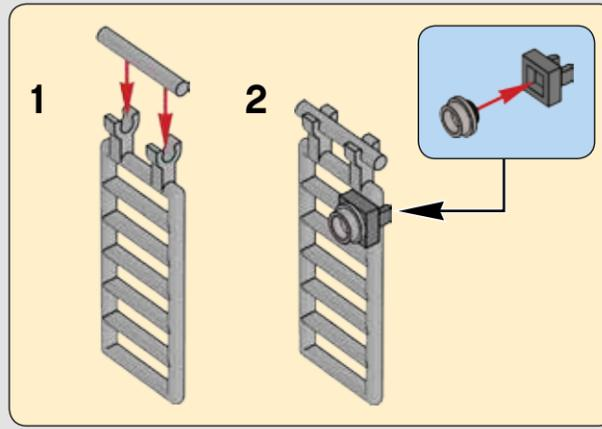

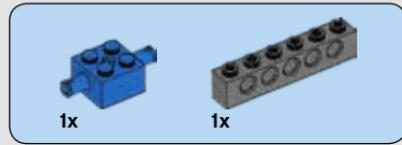
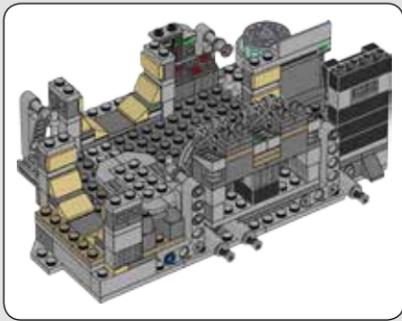

250

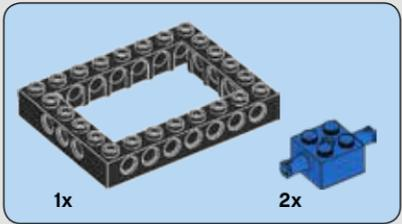
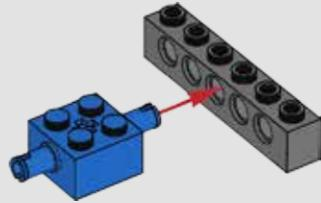

251

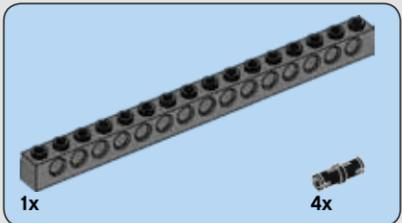
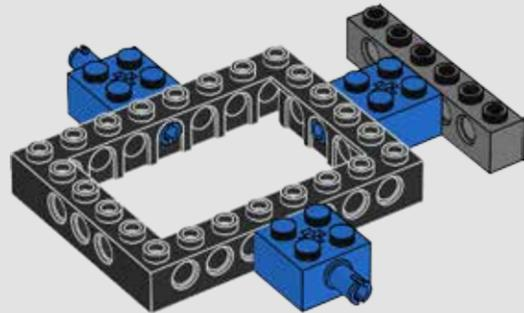

252

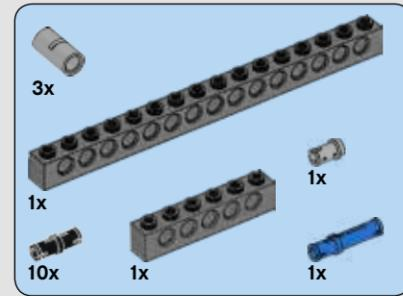
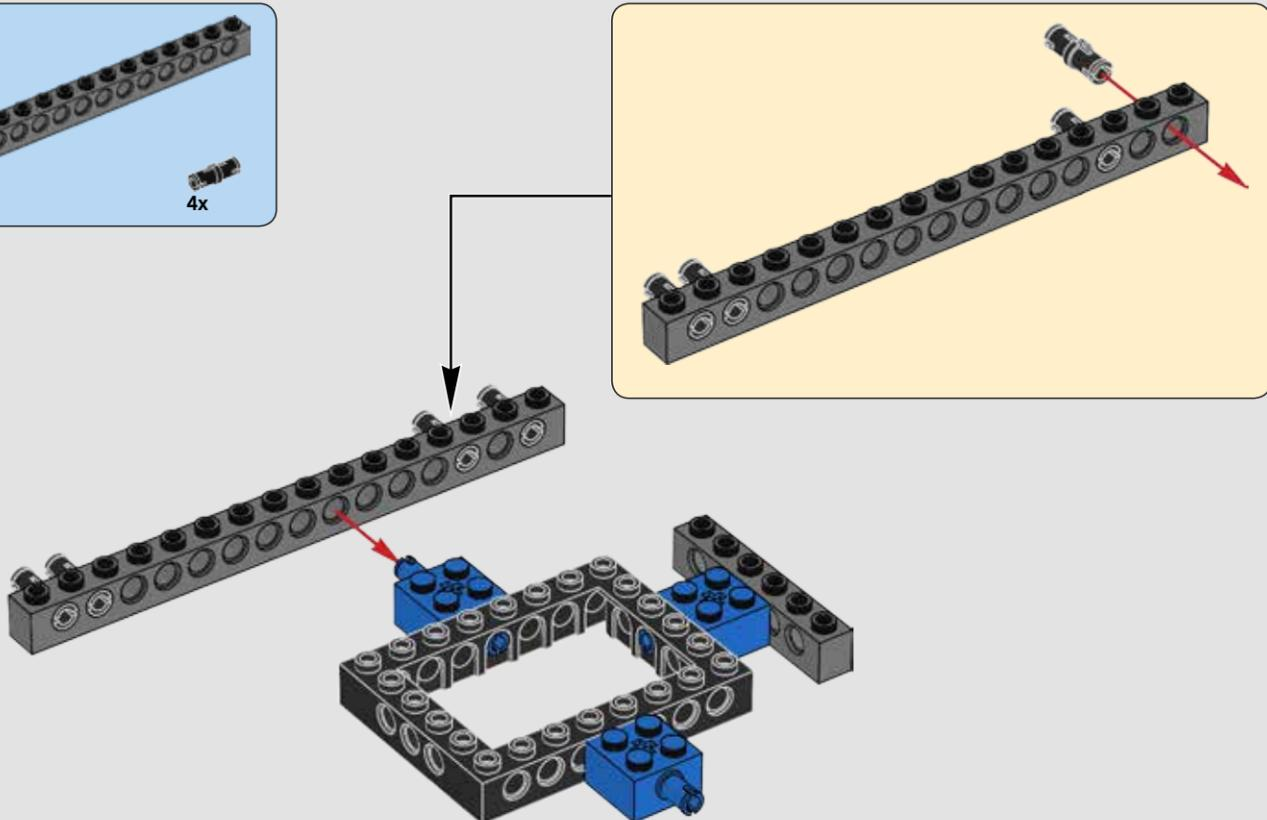

253

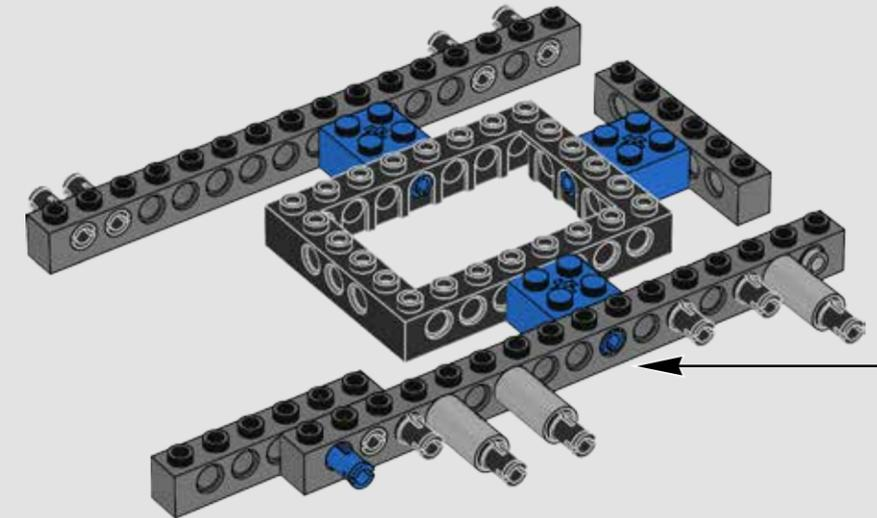
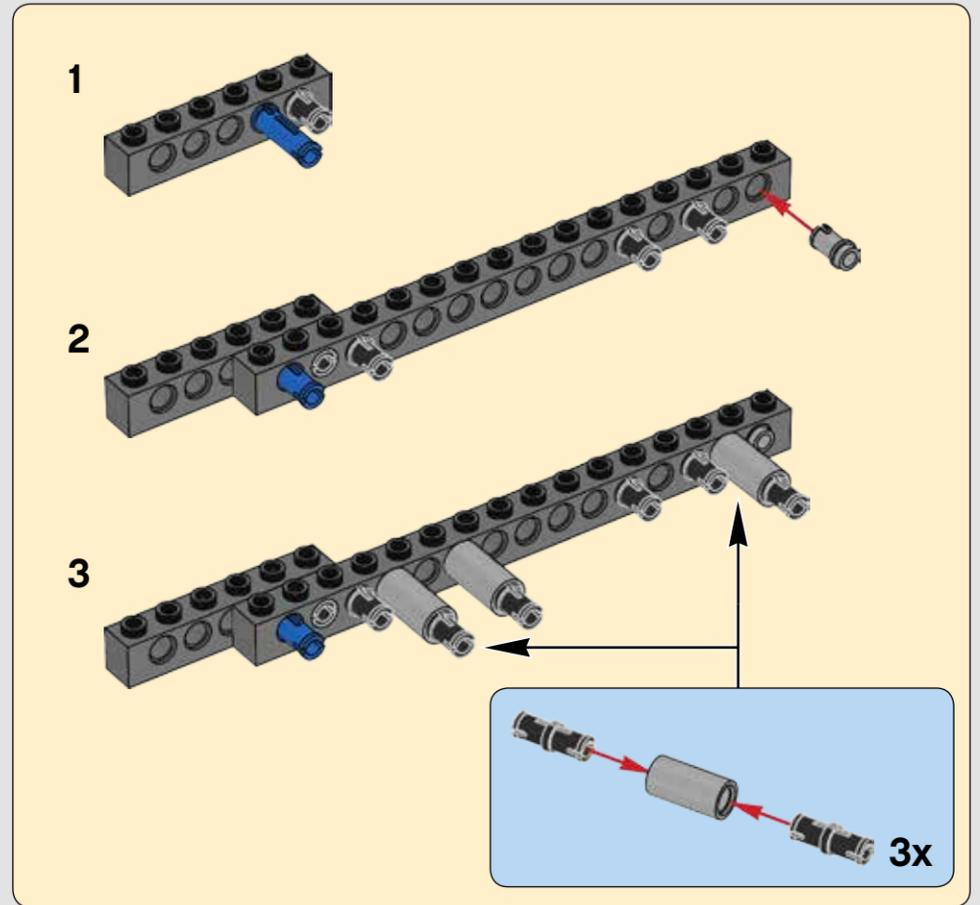

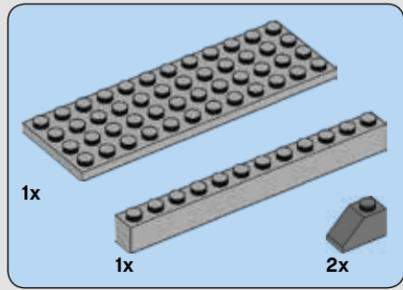

254

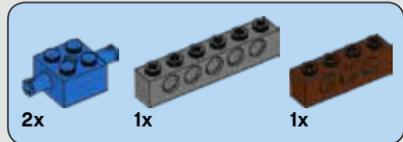
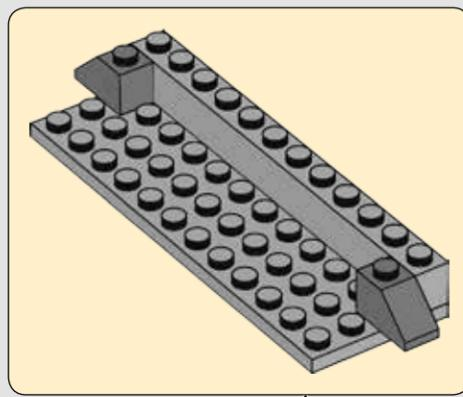
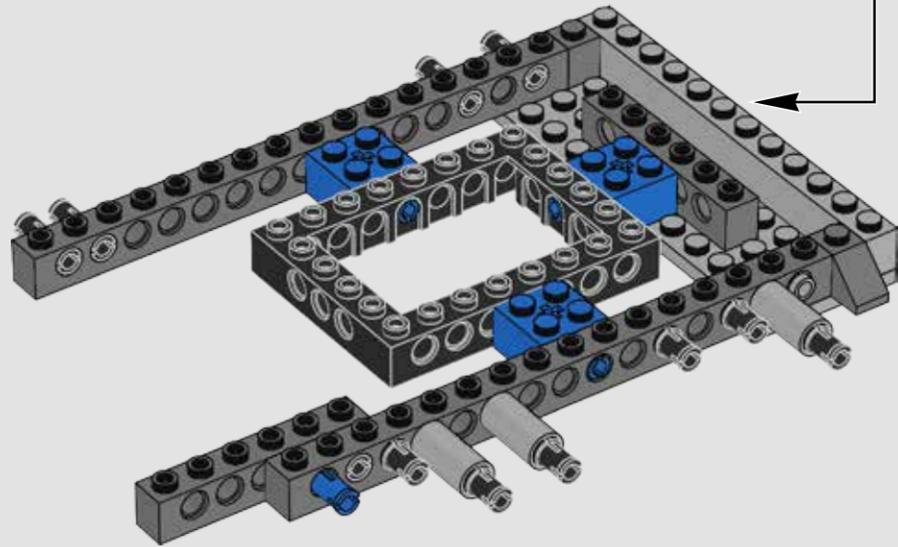

255

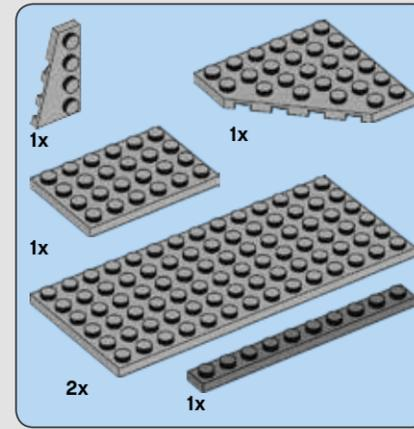
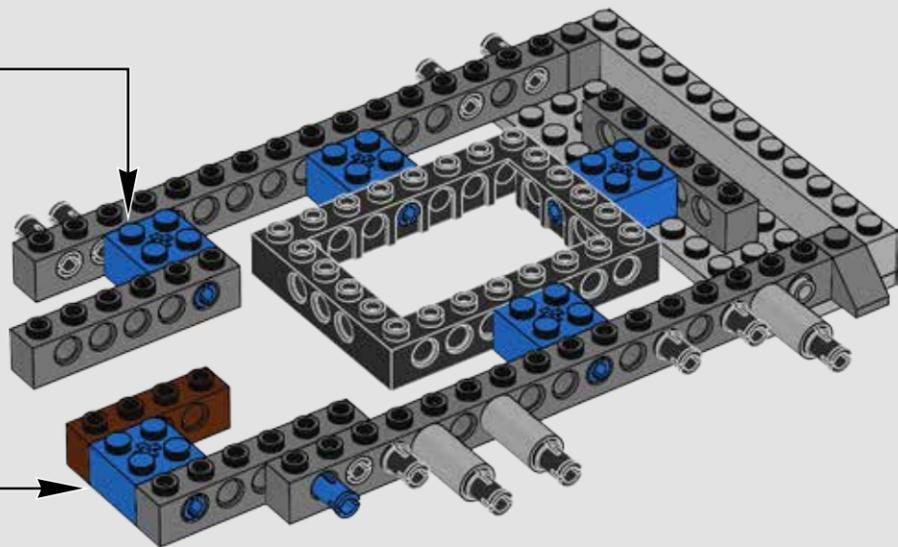
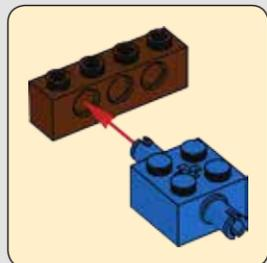
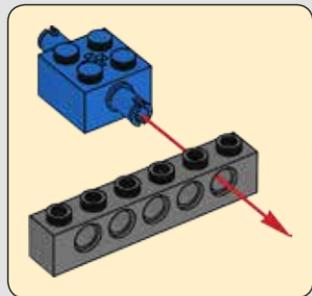

256

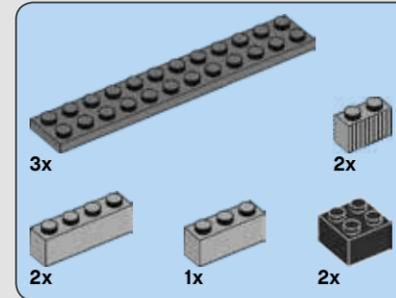
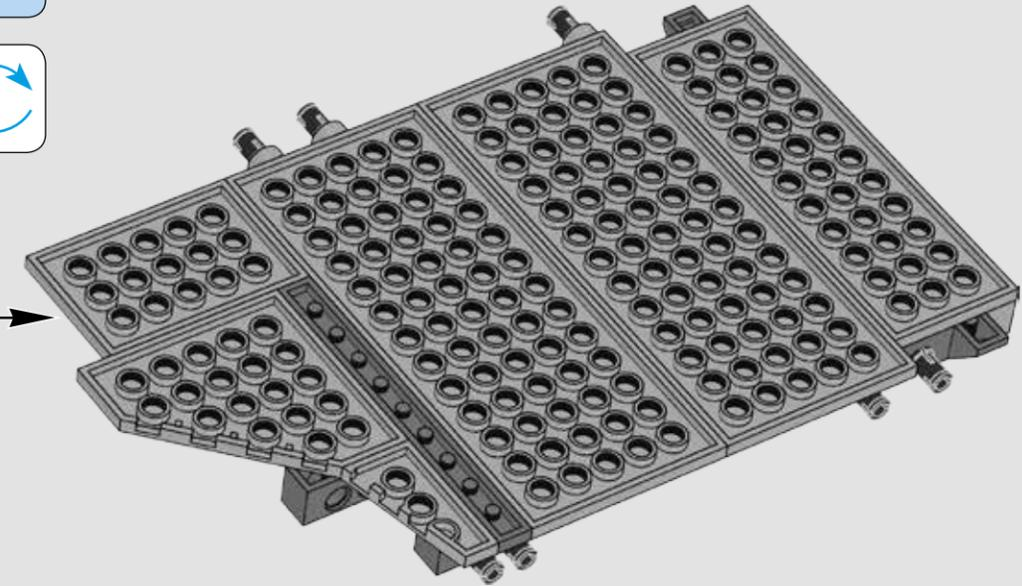
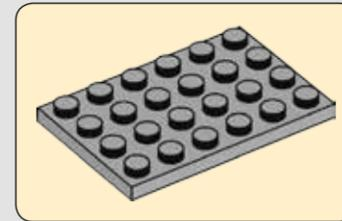

257

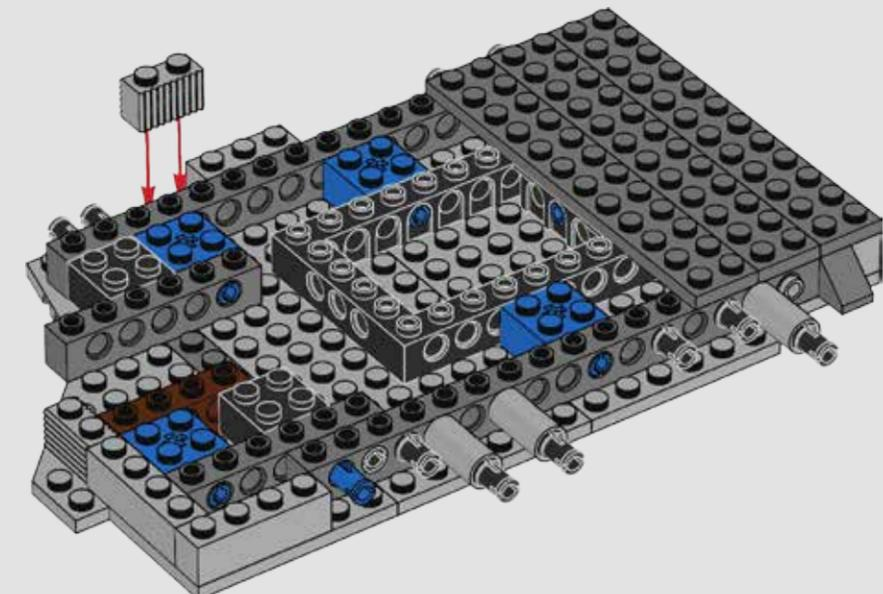

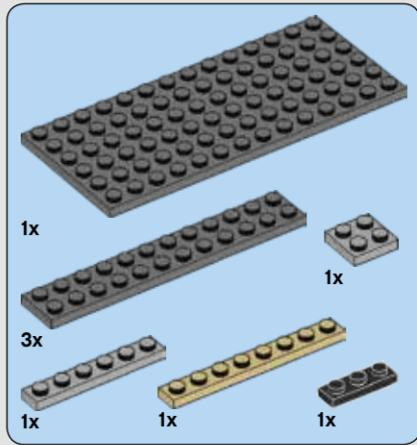

258

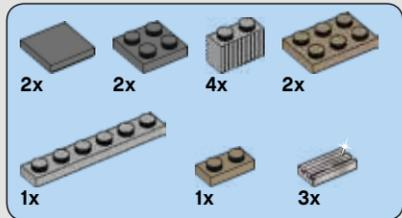
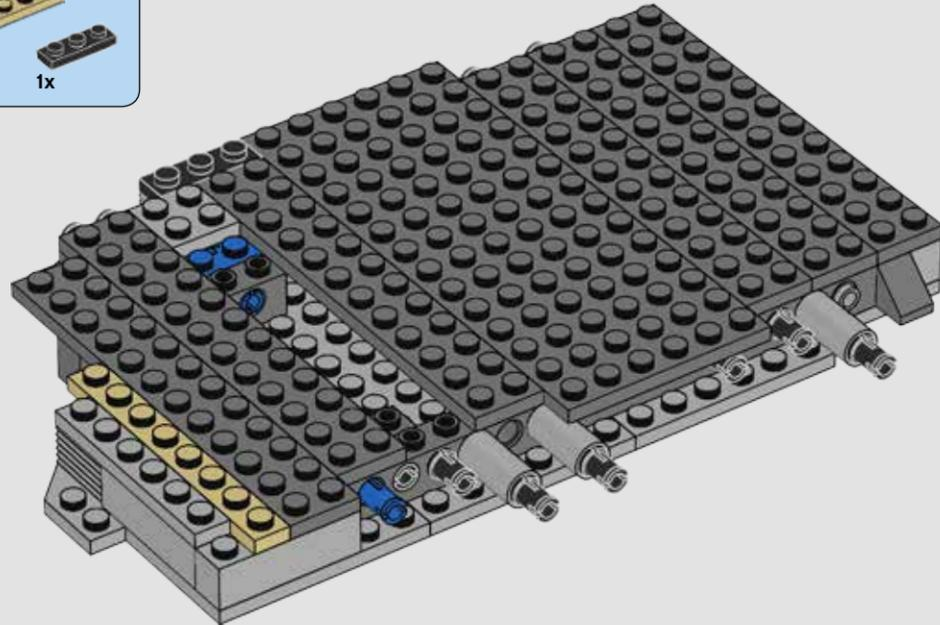

259

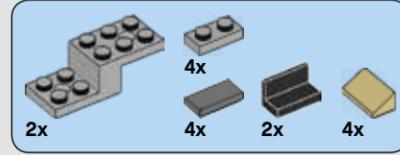

260

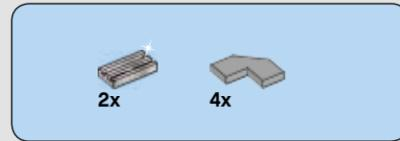
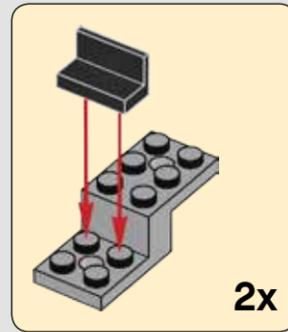

261

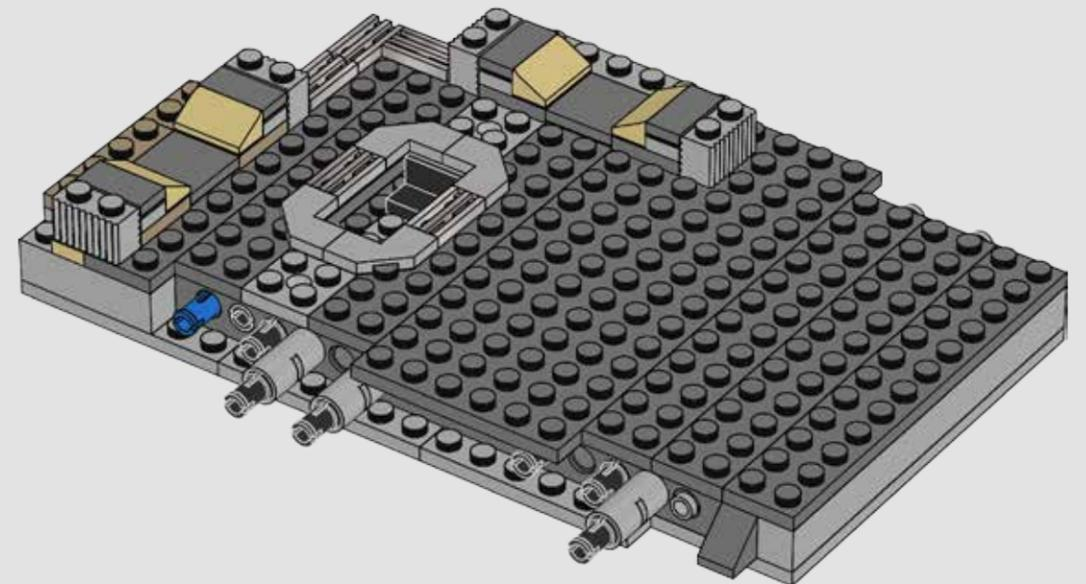
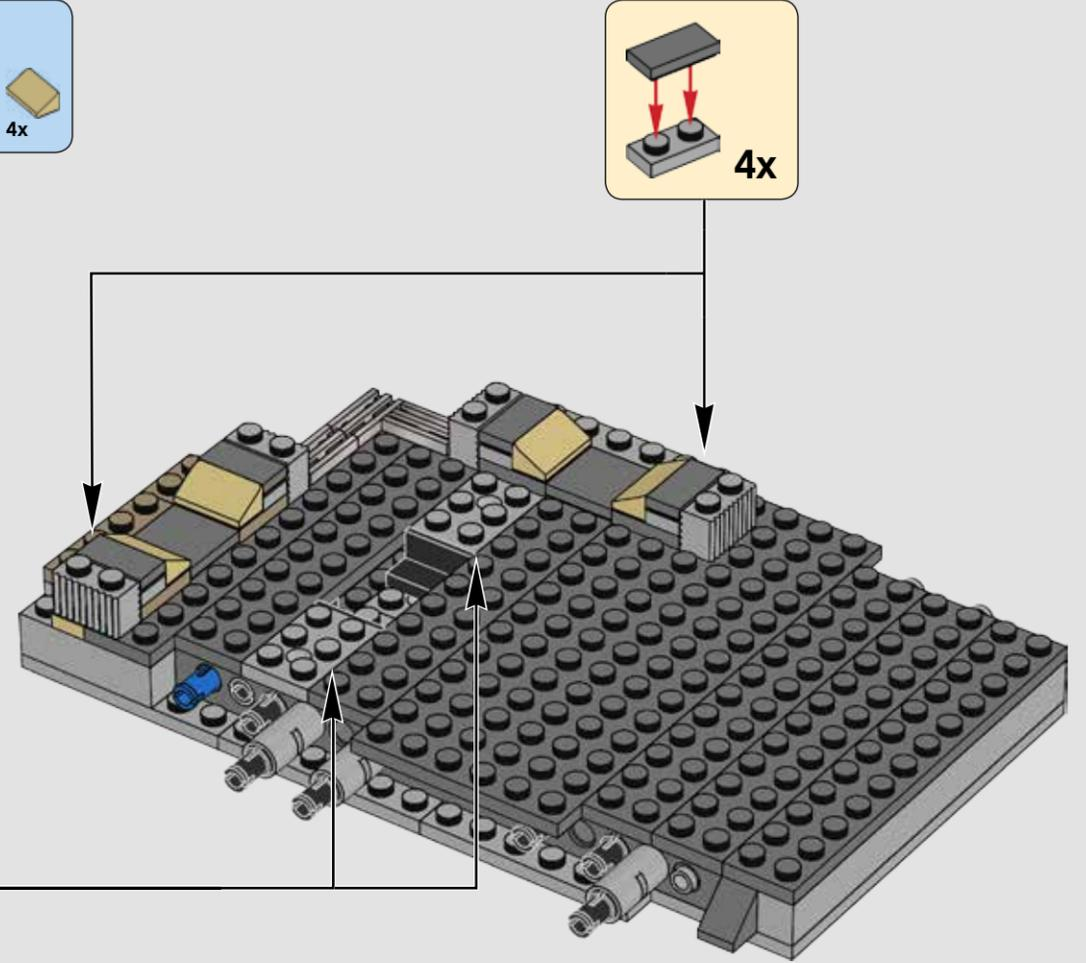

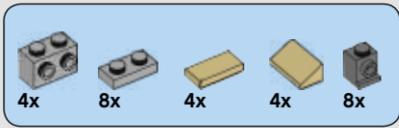

262

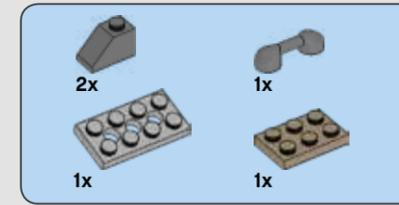
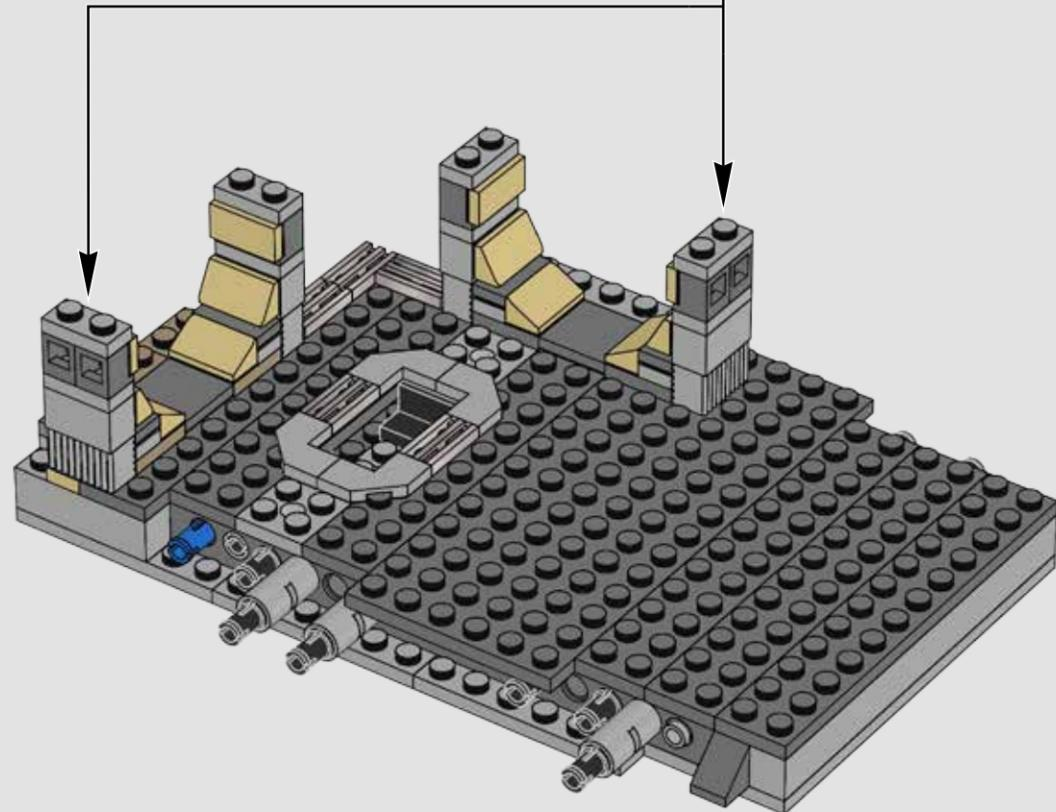
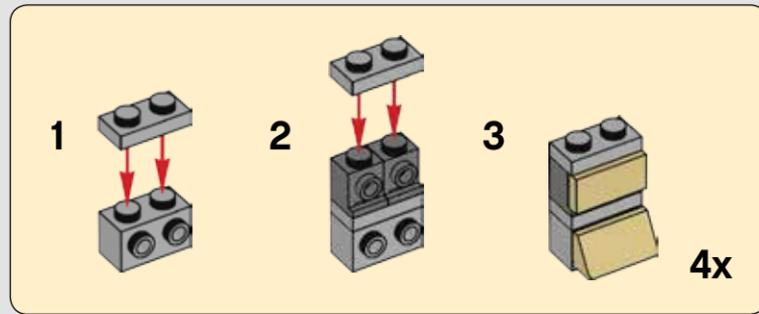

263

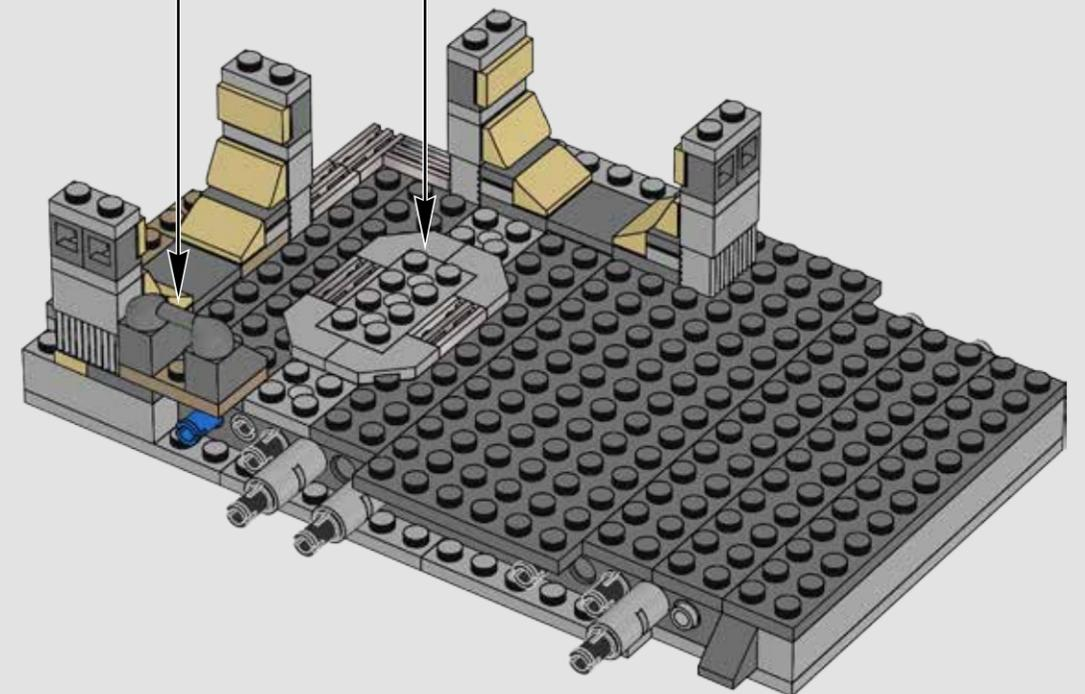
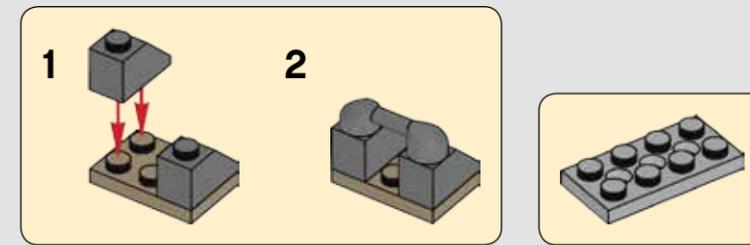

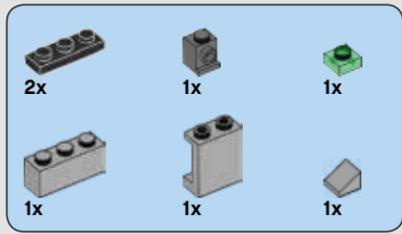

264

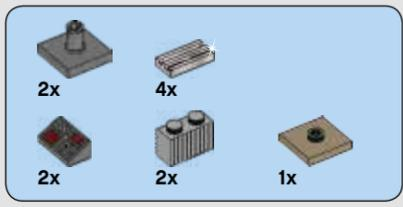
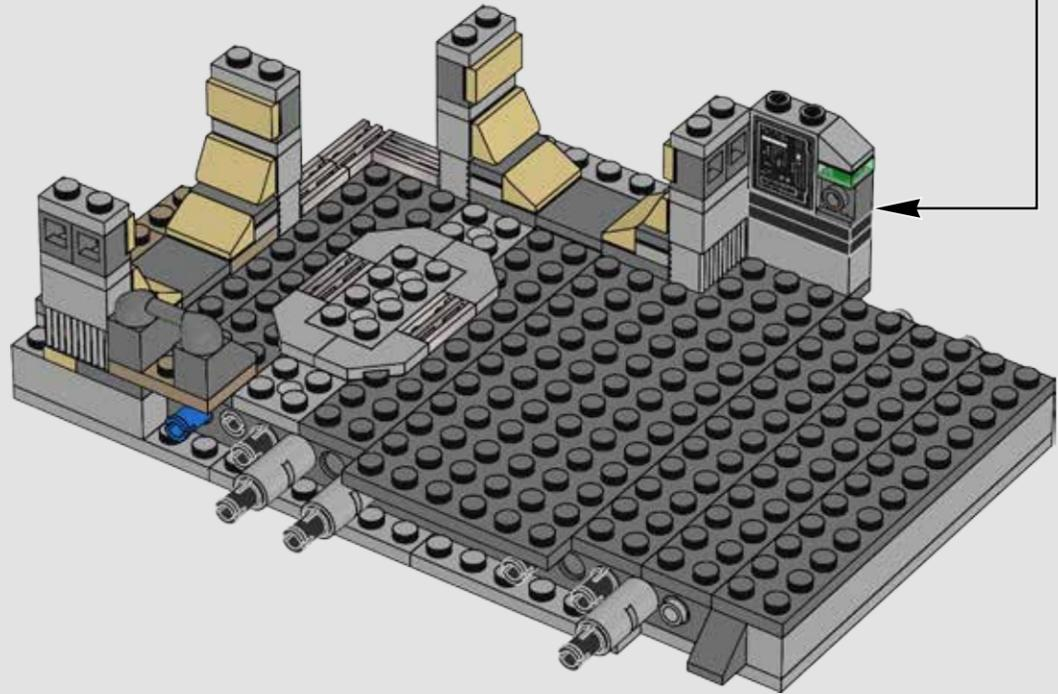
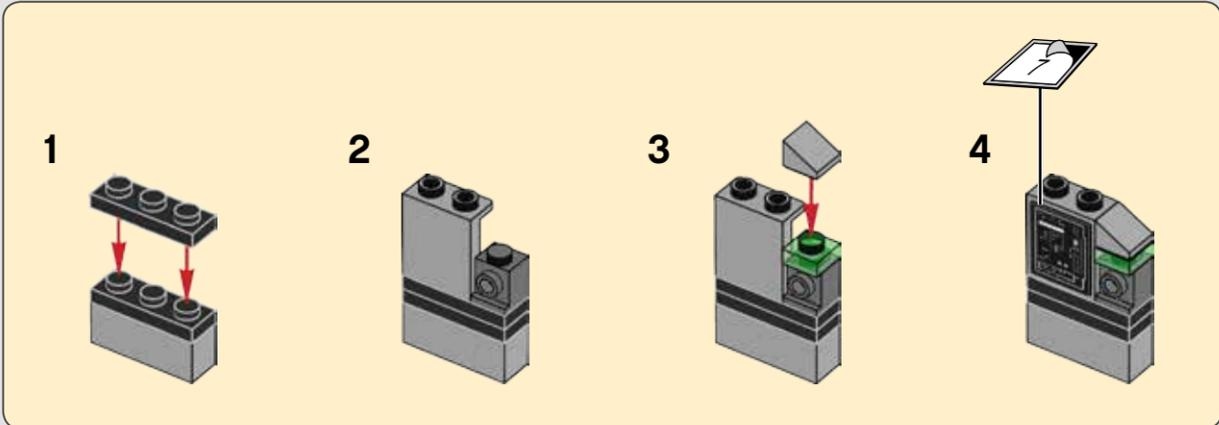

265

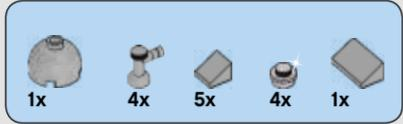
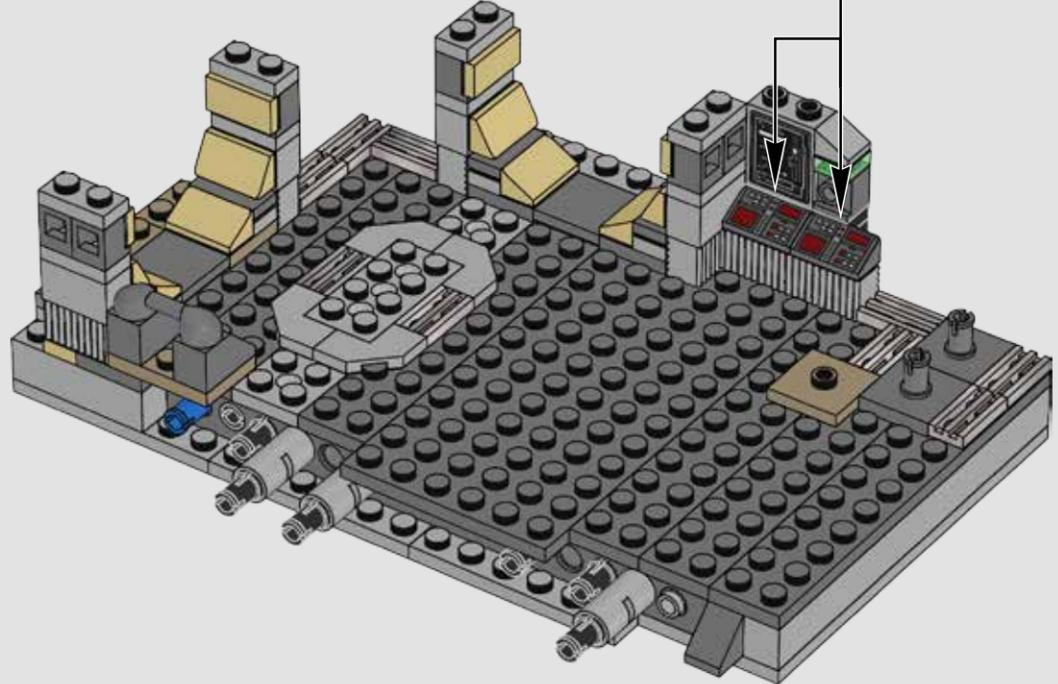

266

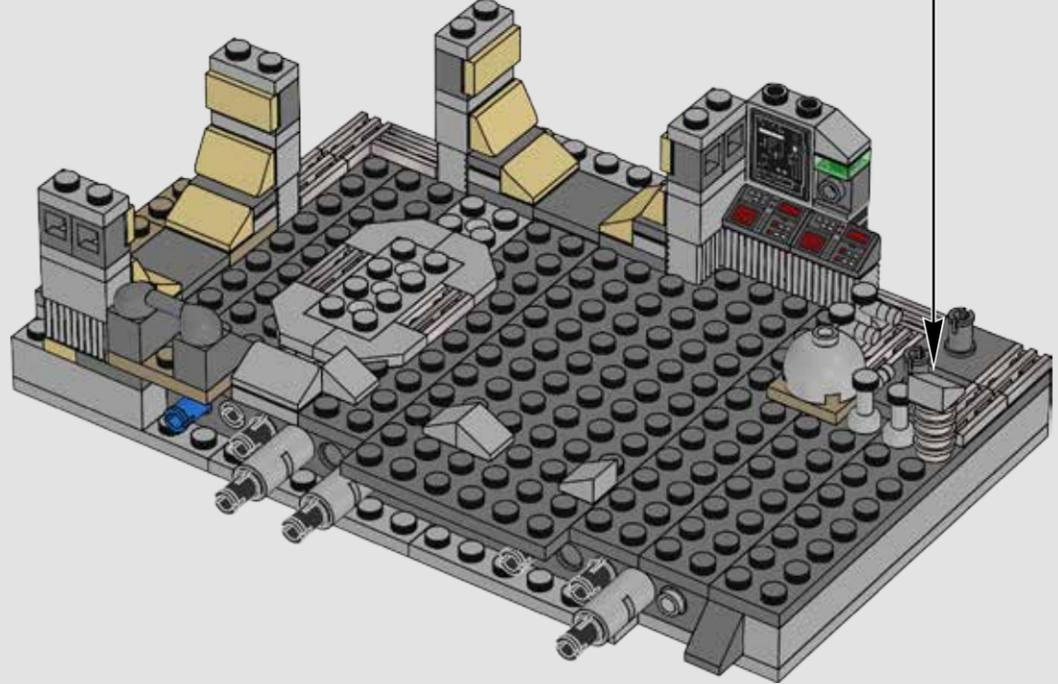
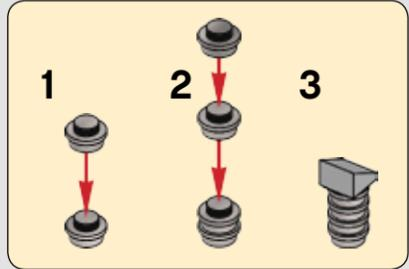

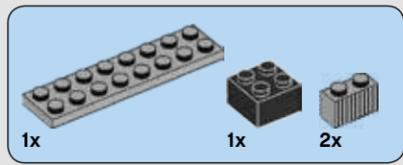

267

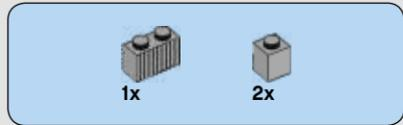
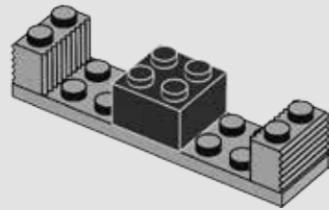

268

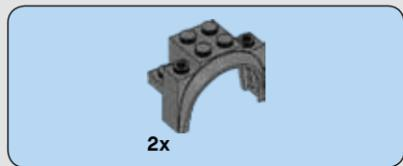
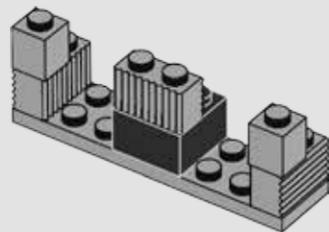

269

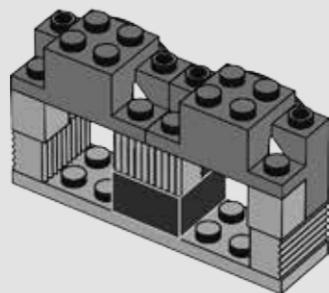

270

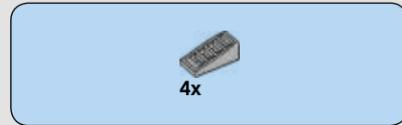
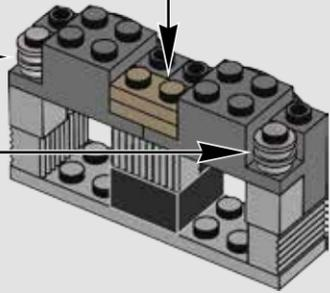
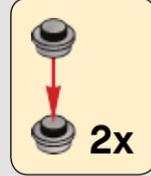
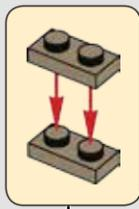

271

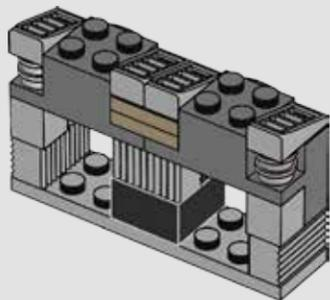

272

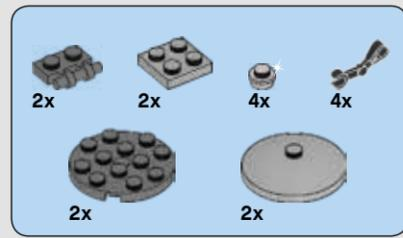
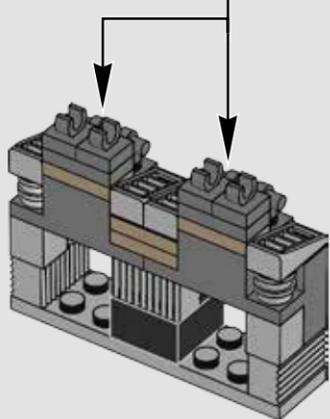
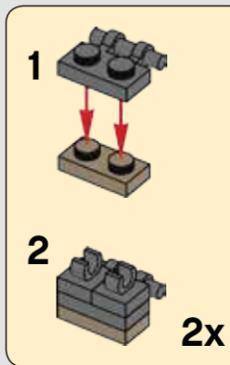

273

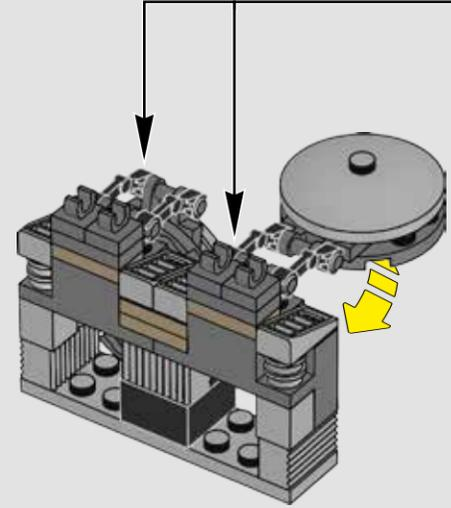

274

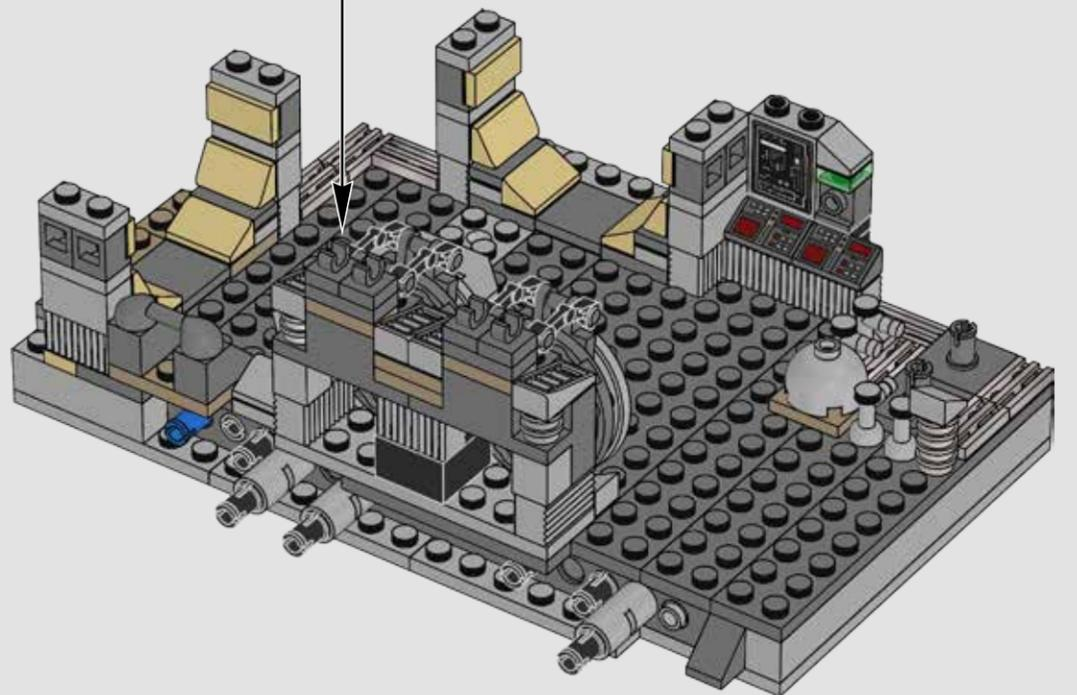

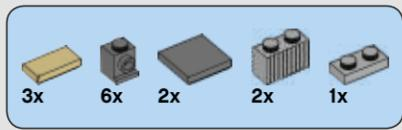

275

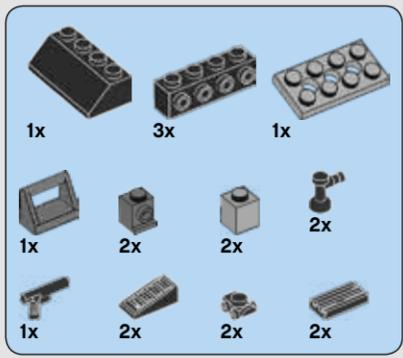
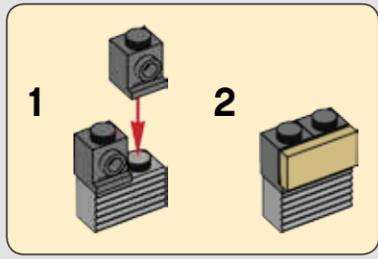
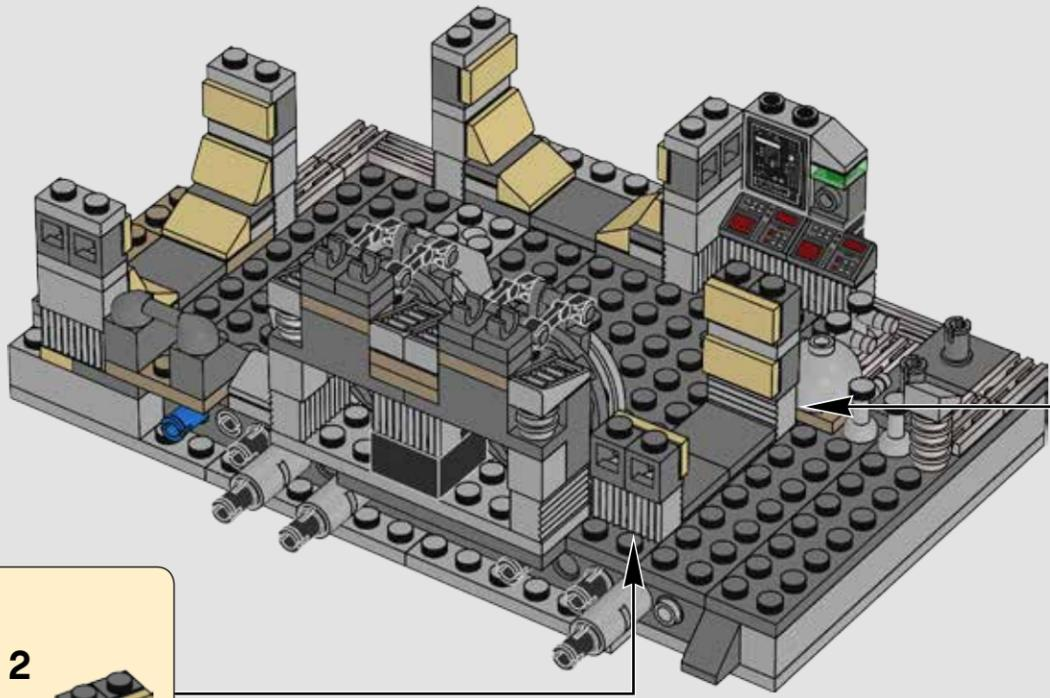
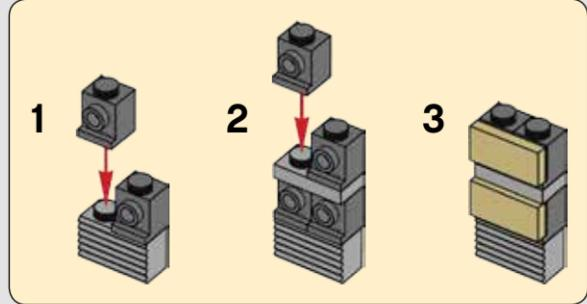

276

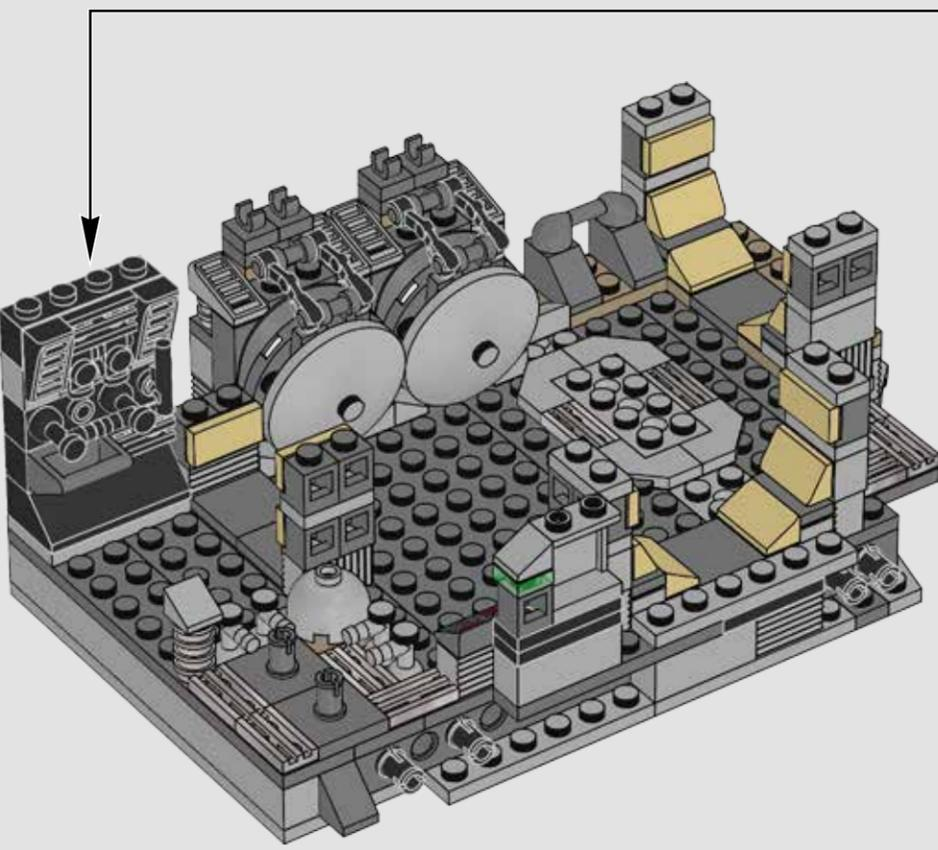
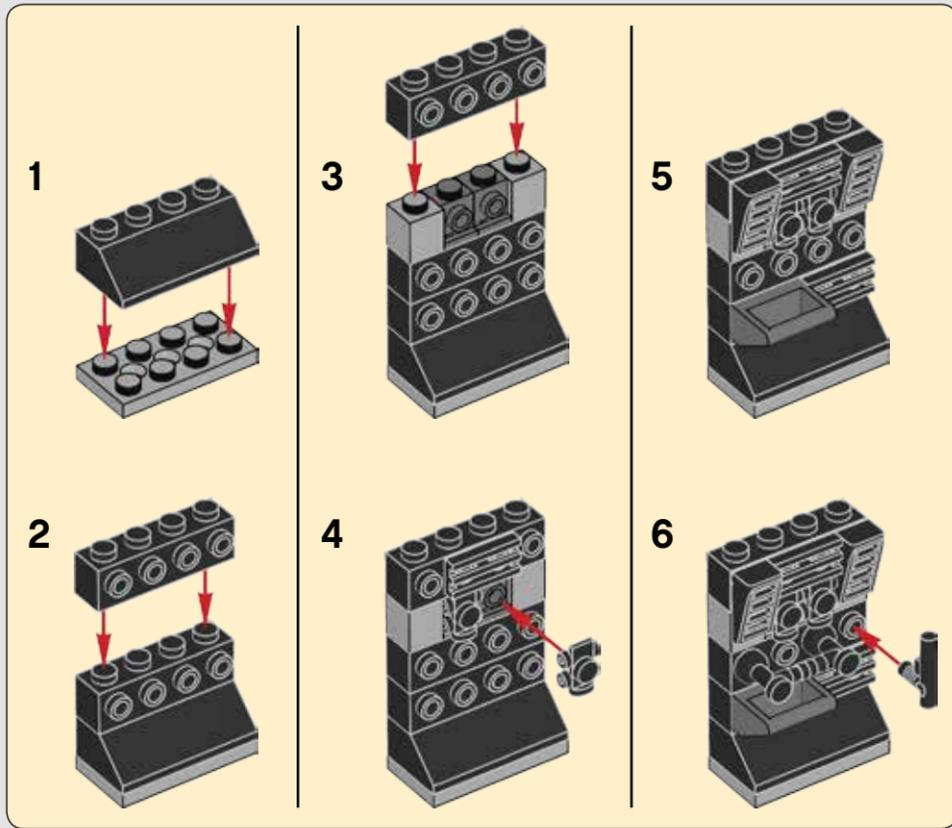

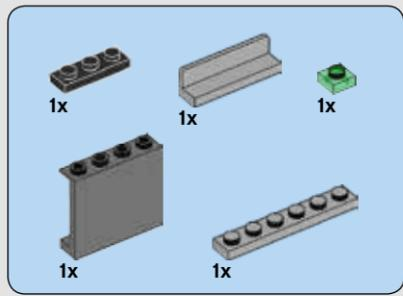

277

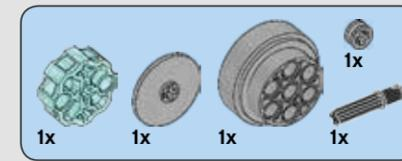
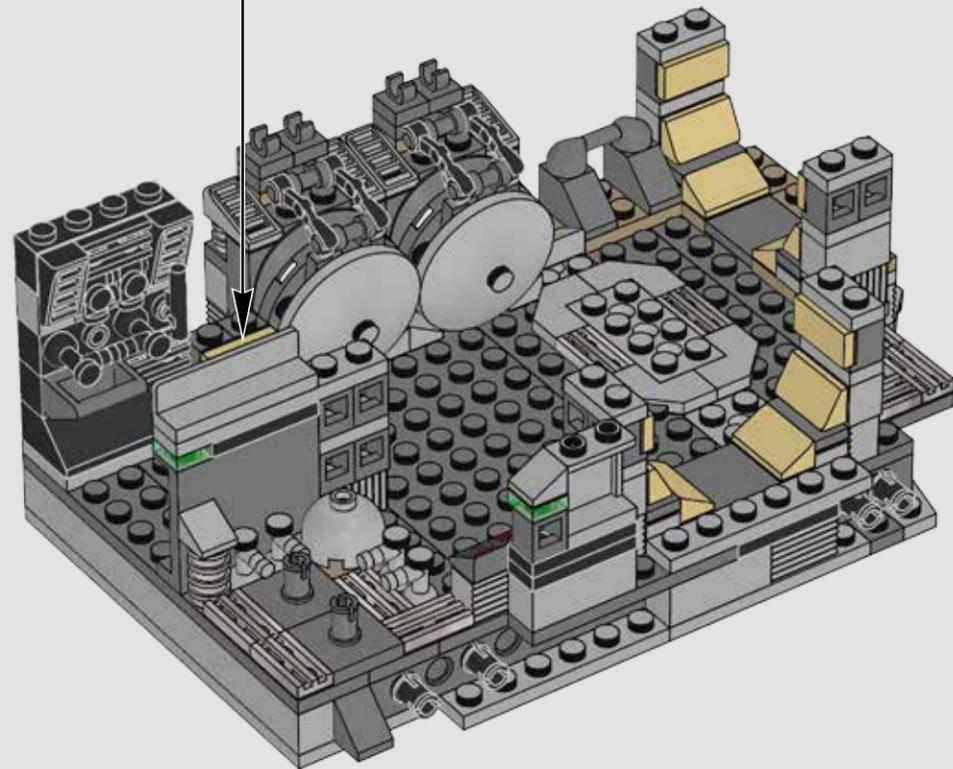
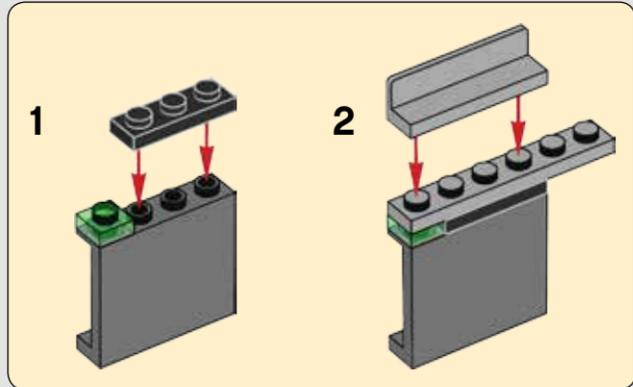

278

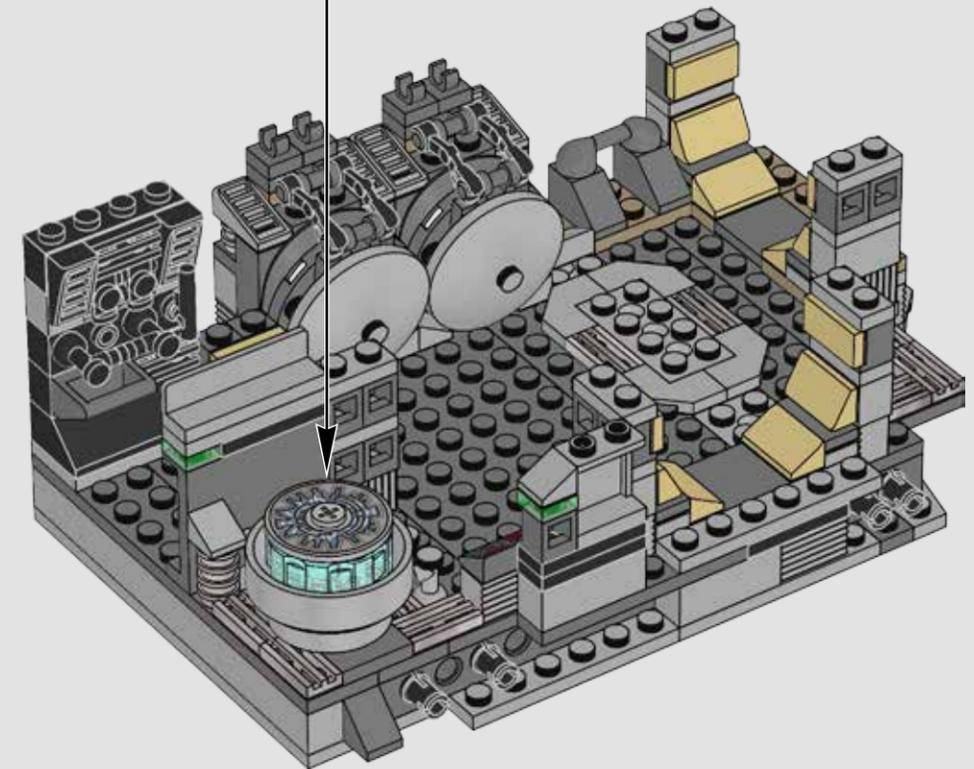
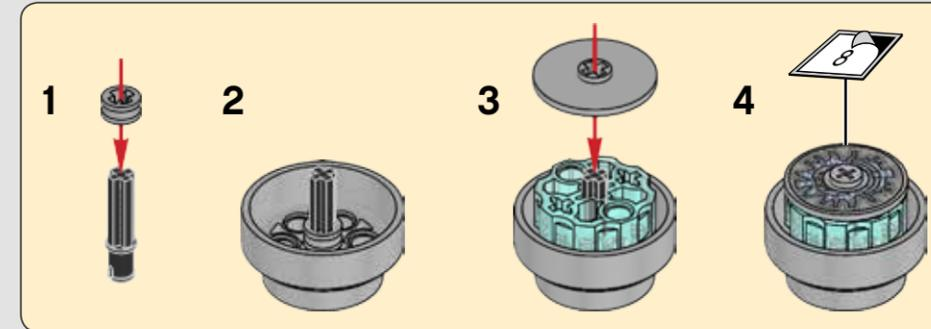

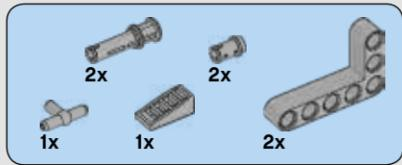

279

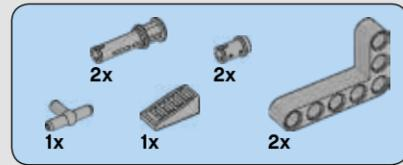
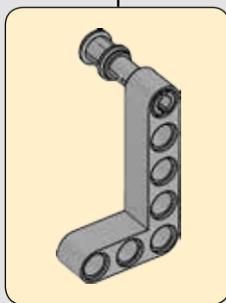
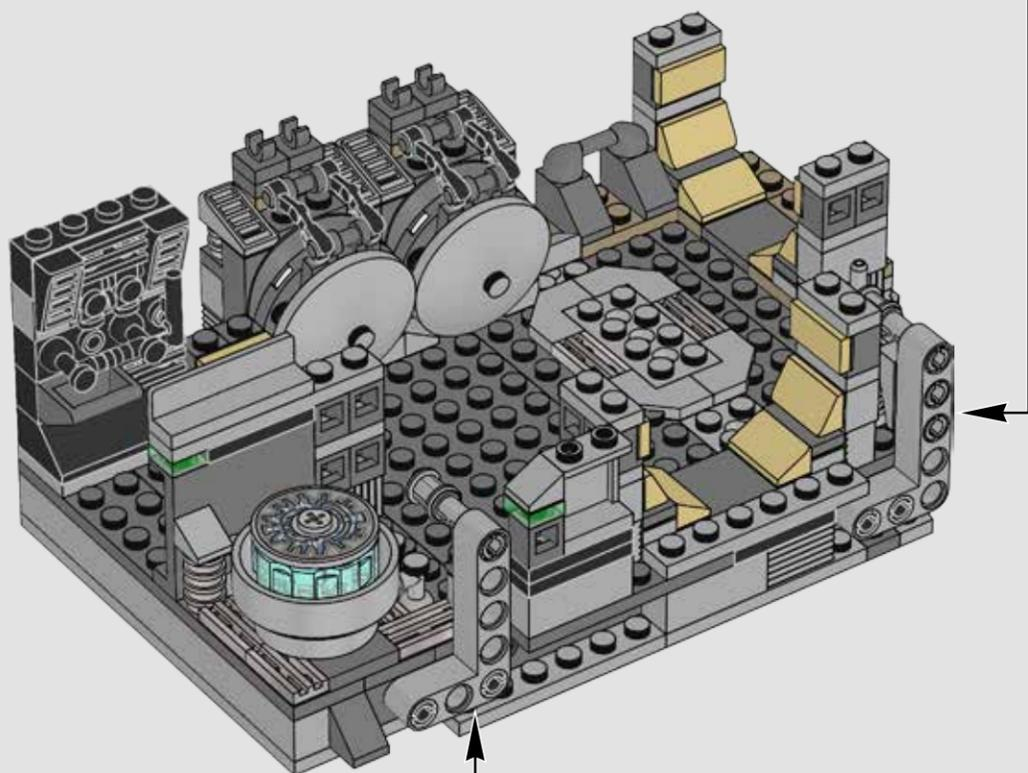
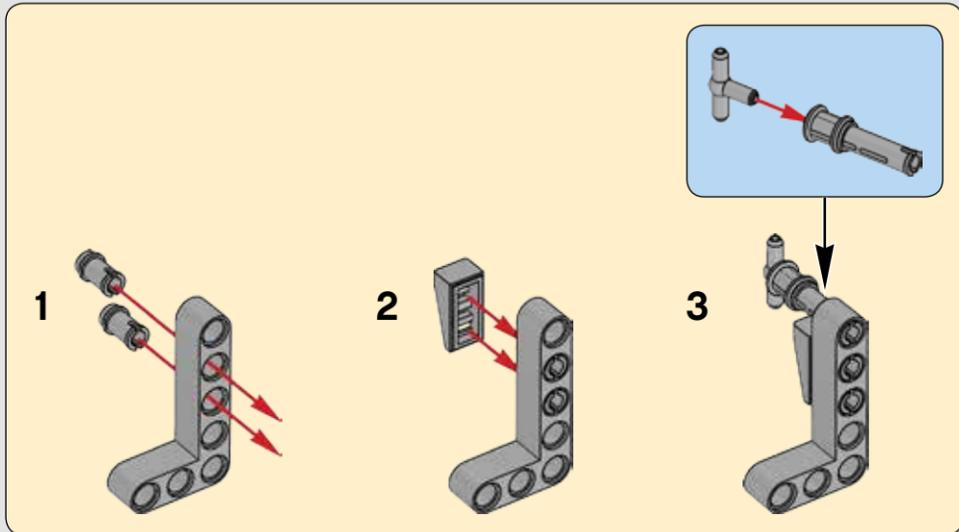

280

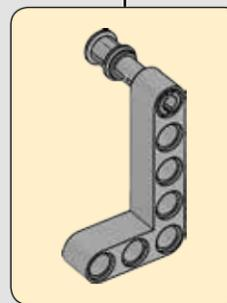
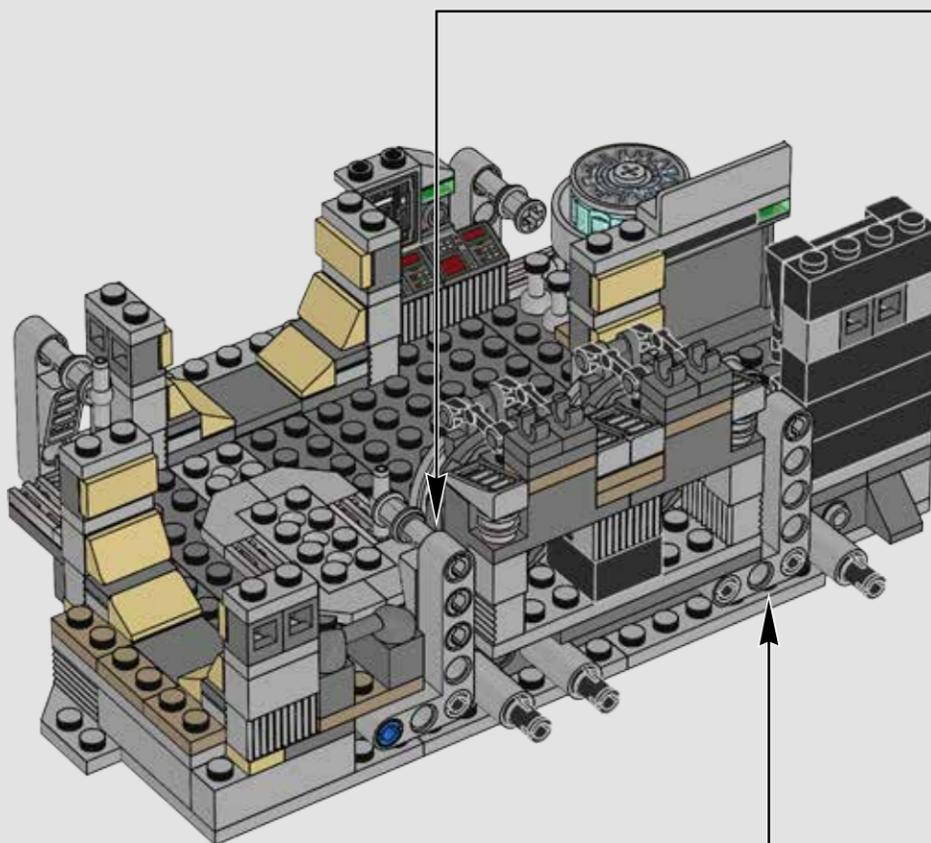
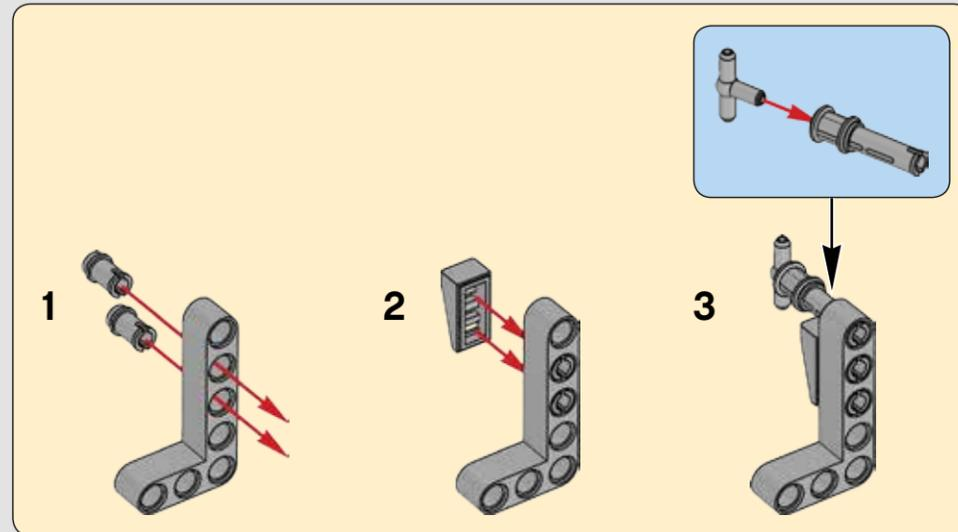

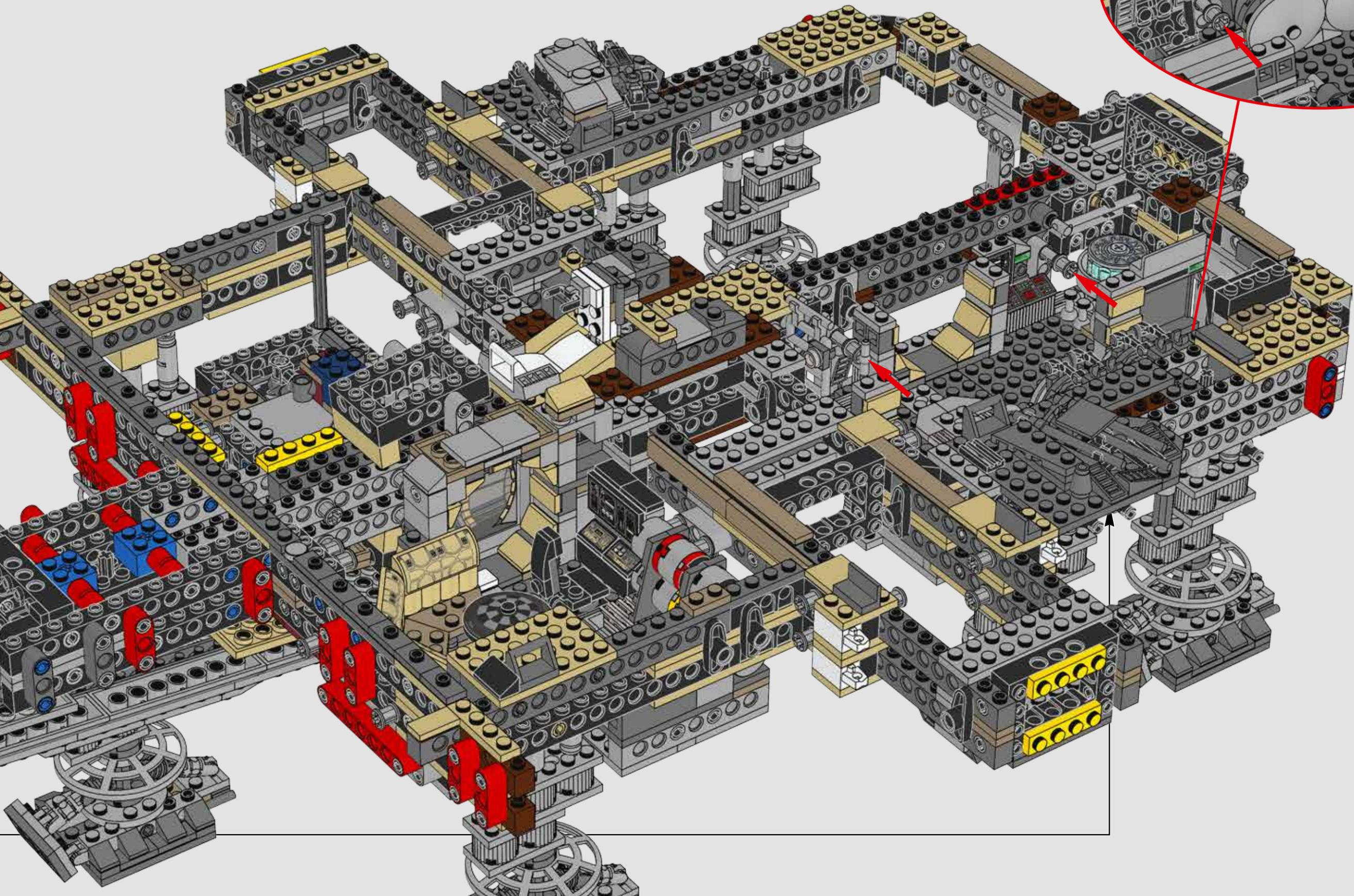

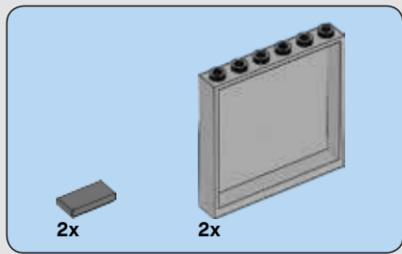

282

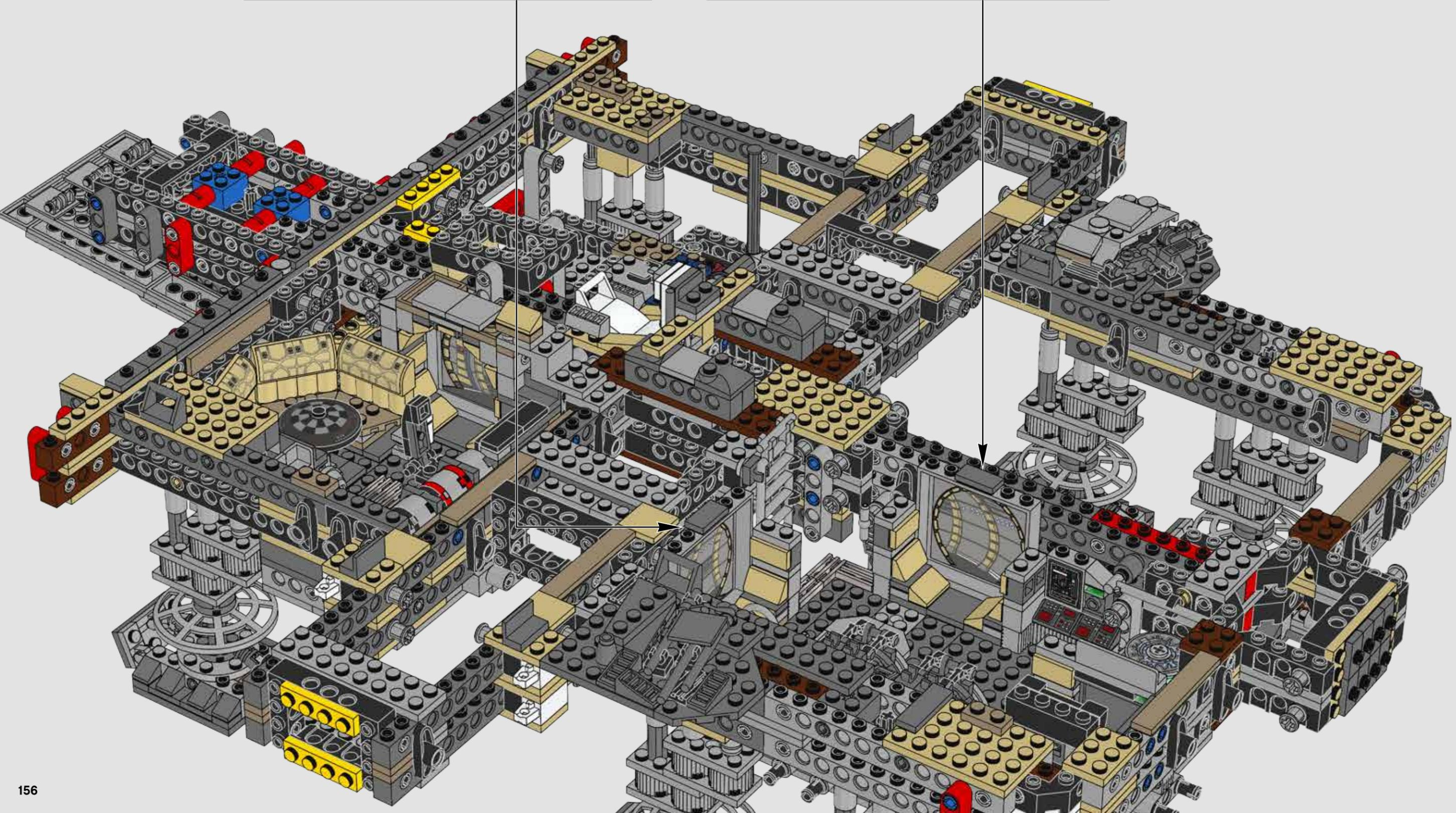
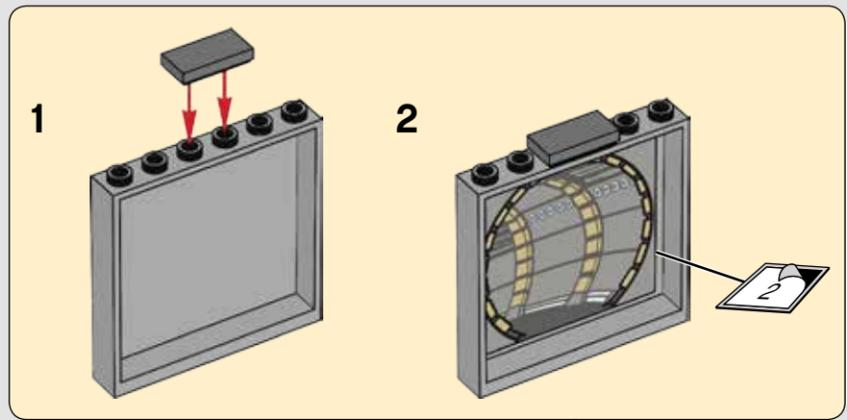
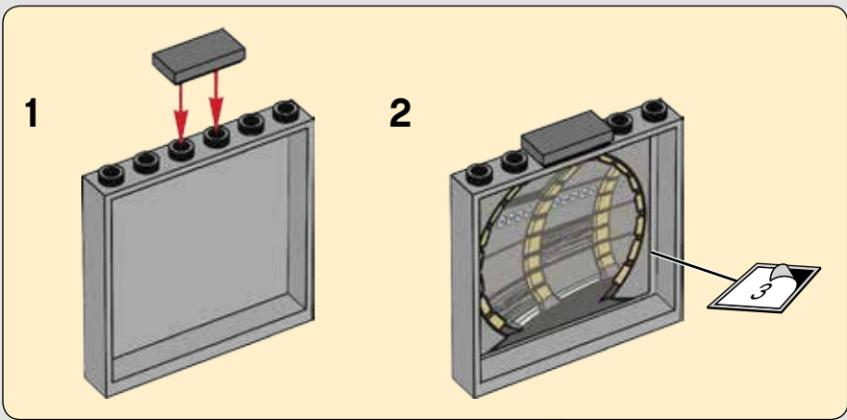

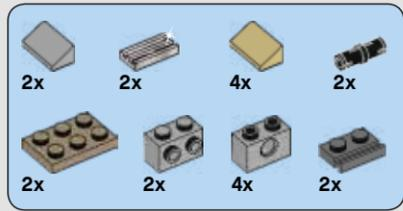

283

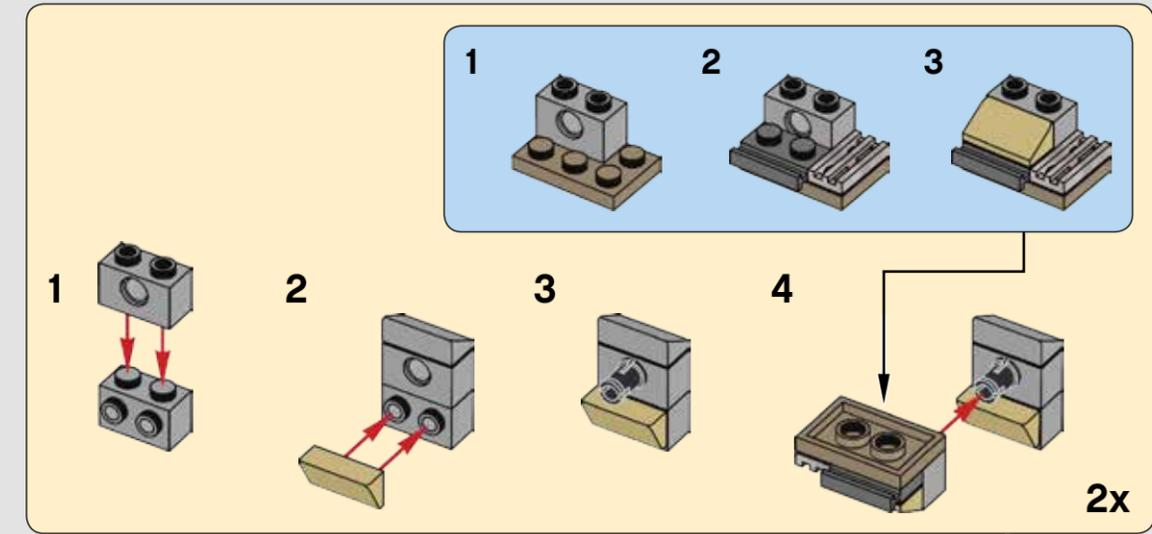

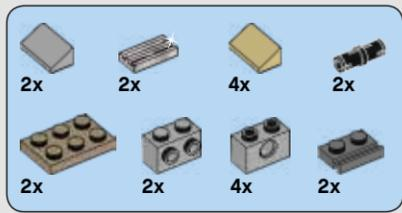

284

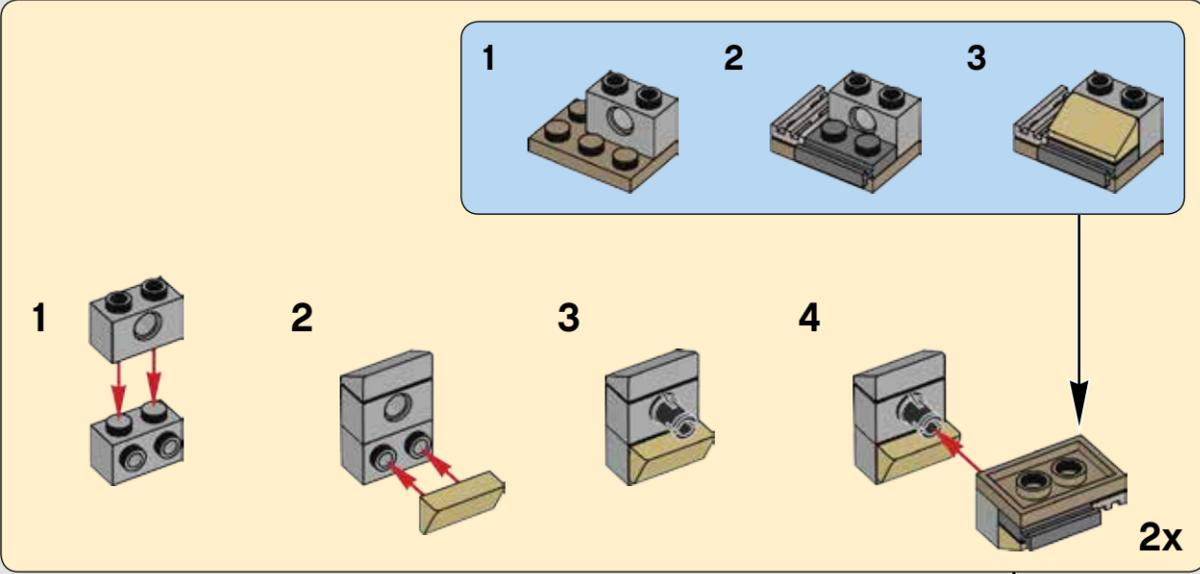

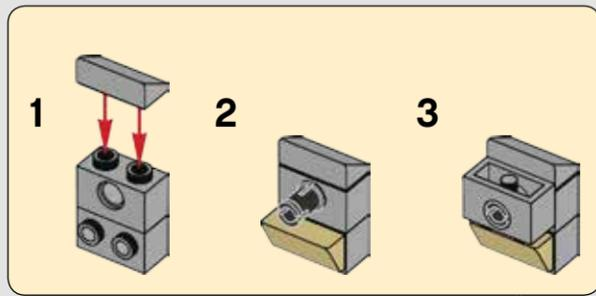
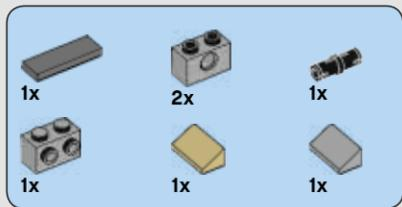

286

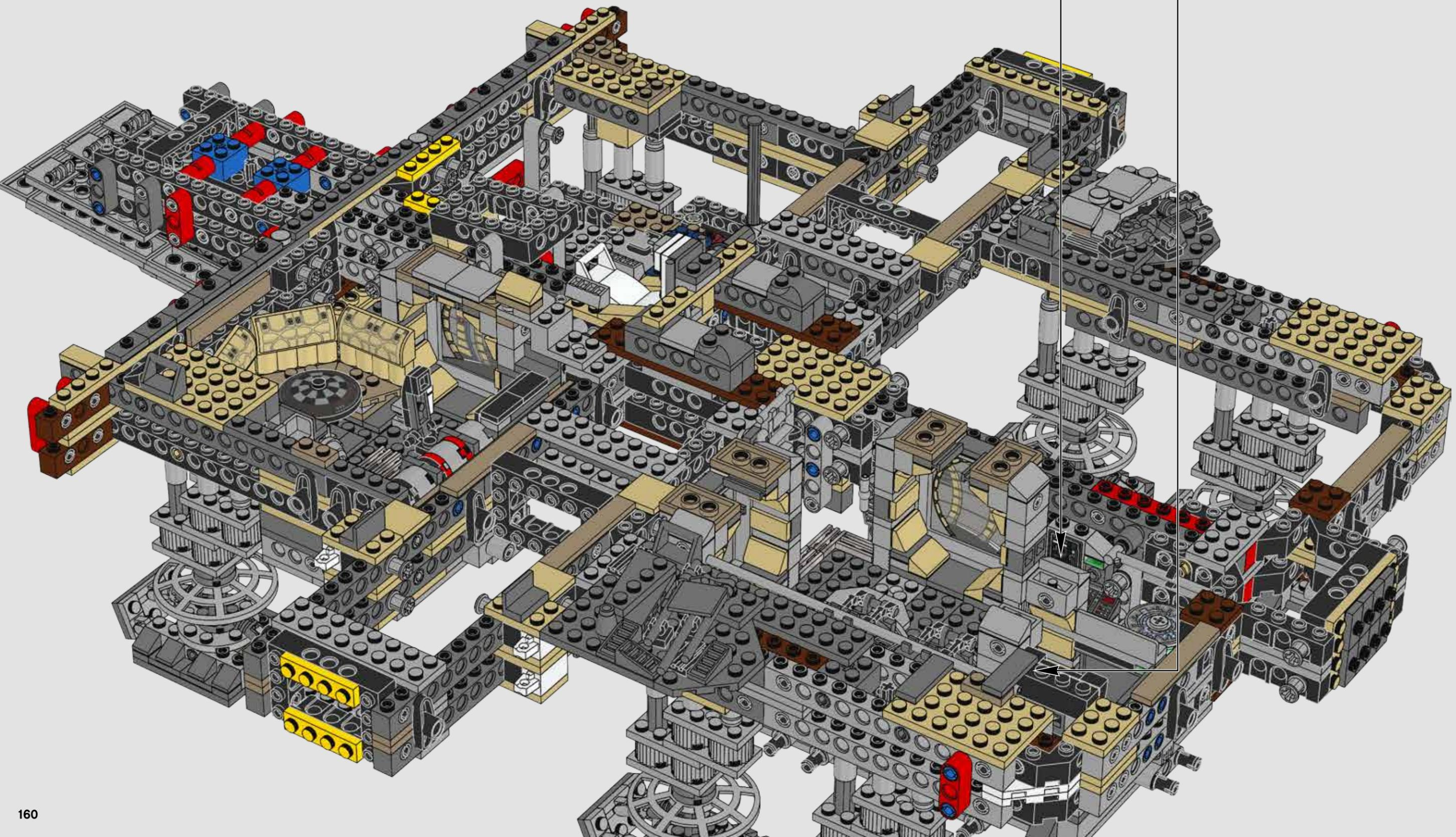

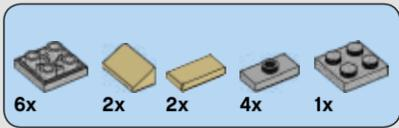

287

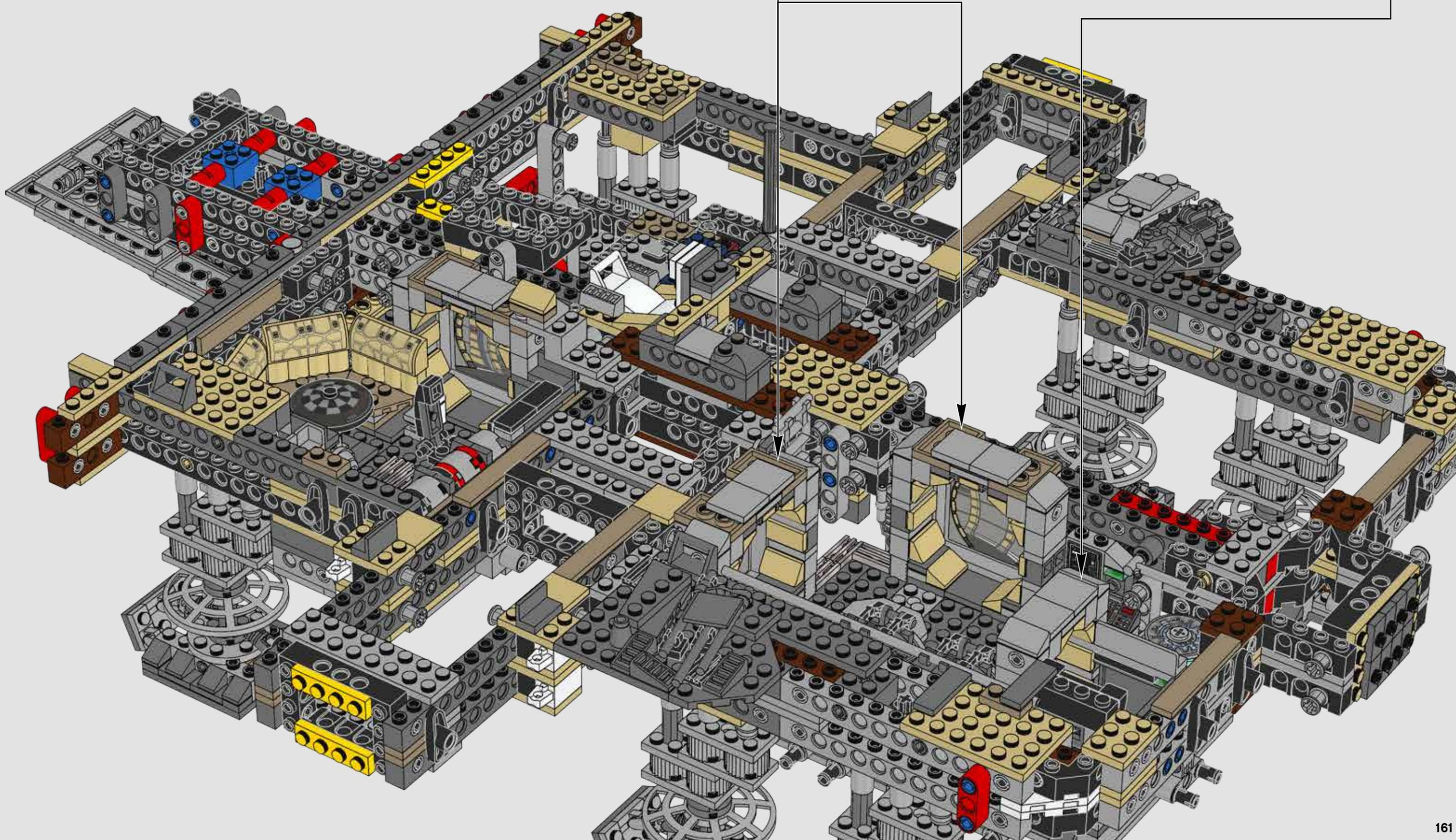
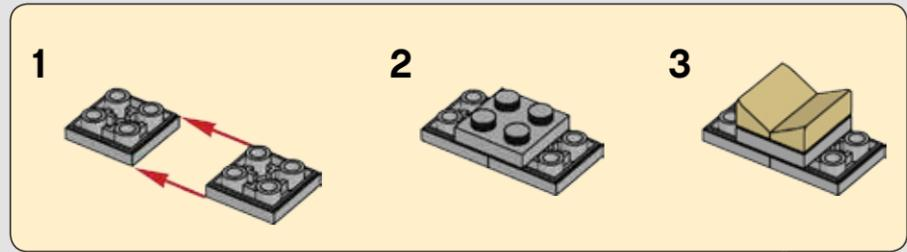
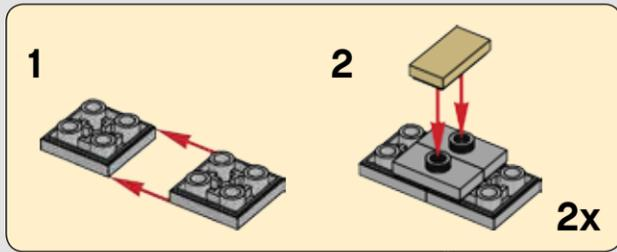

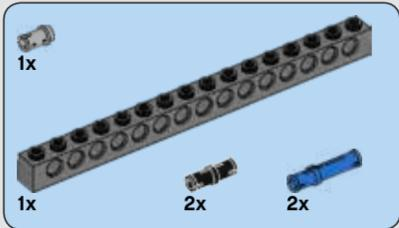
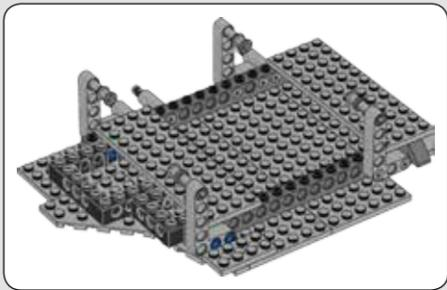

288



289

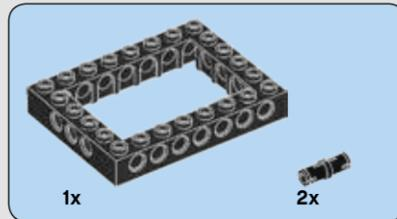
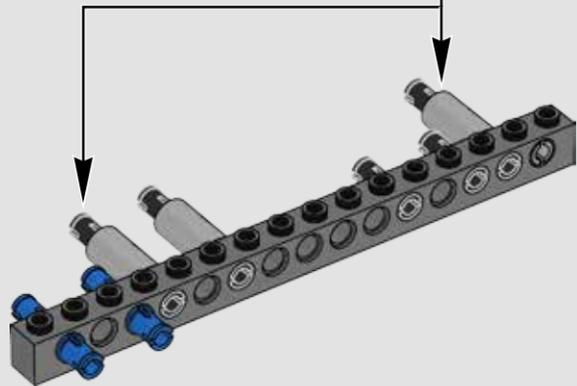
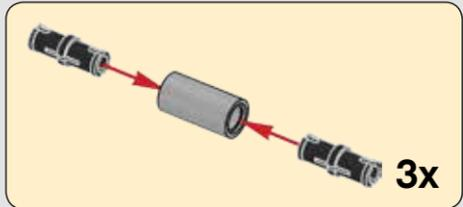

290

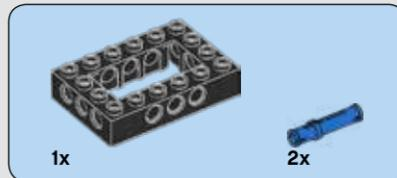
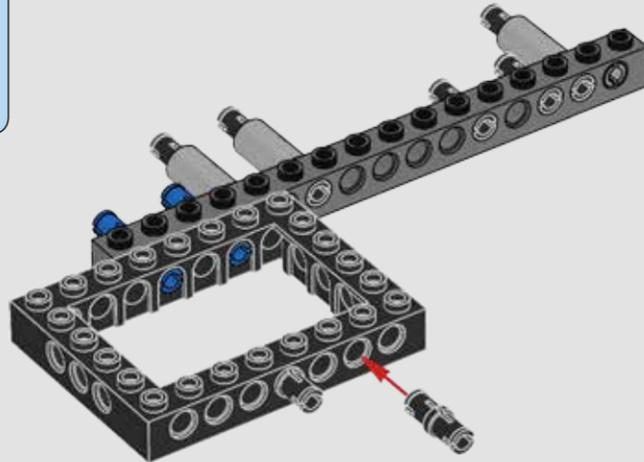

291

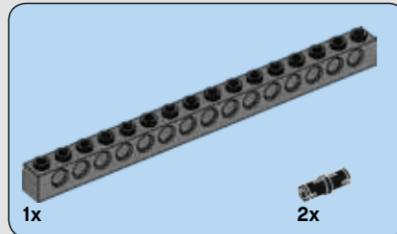
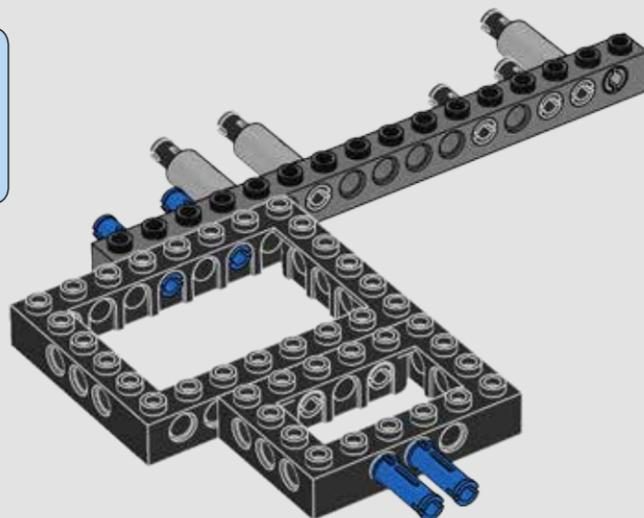

292

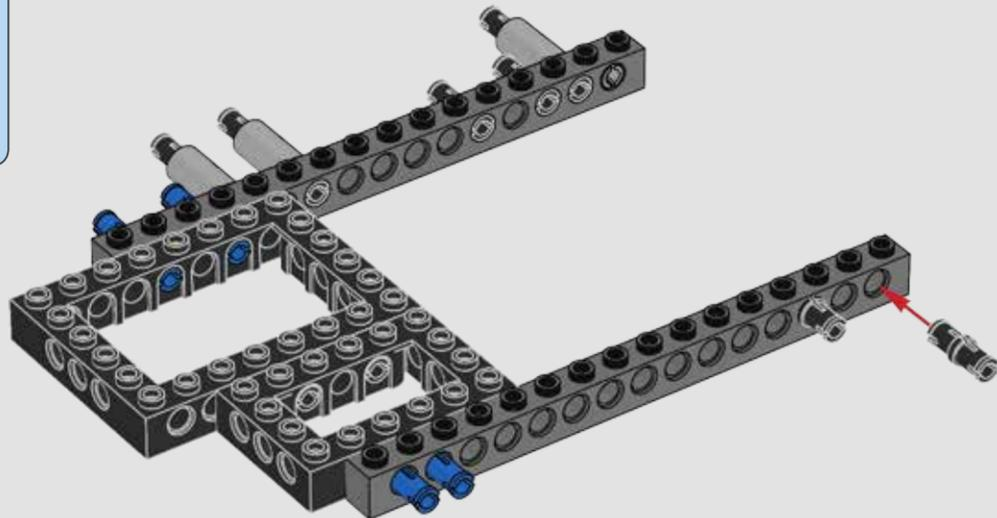

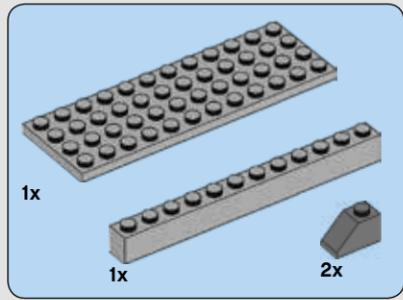

293

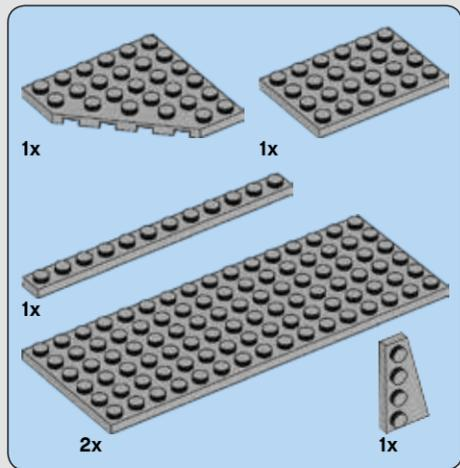
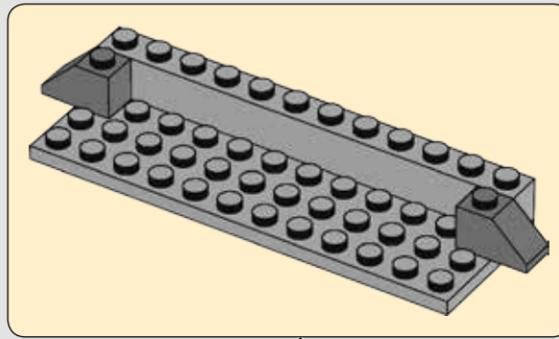
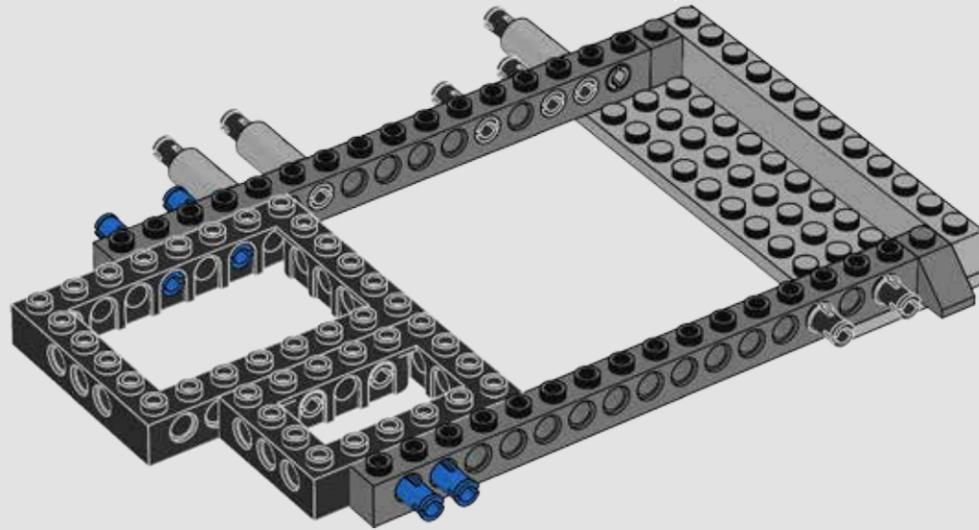

294

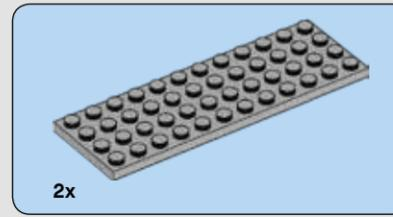
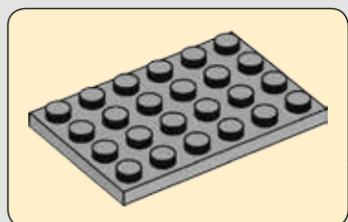
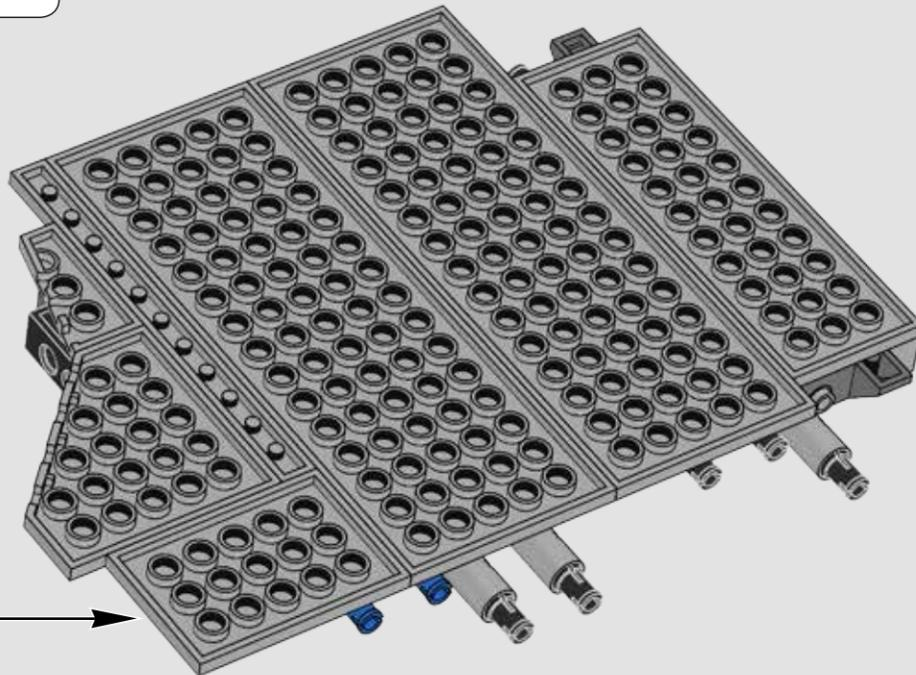

295

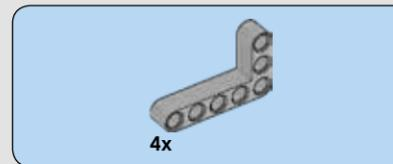
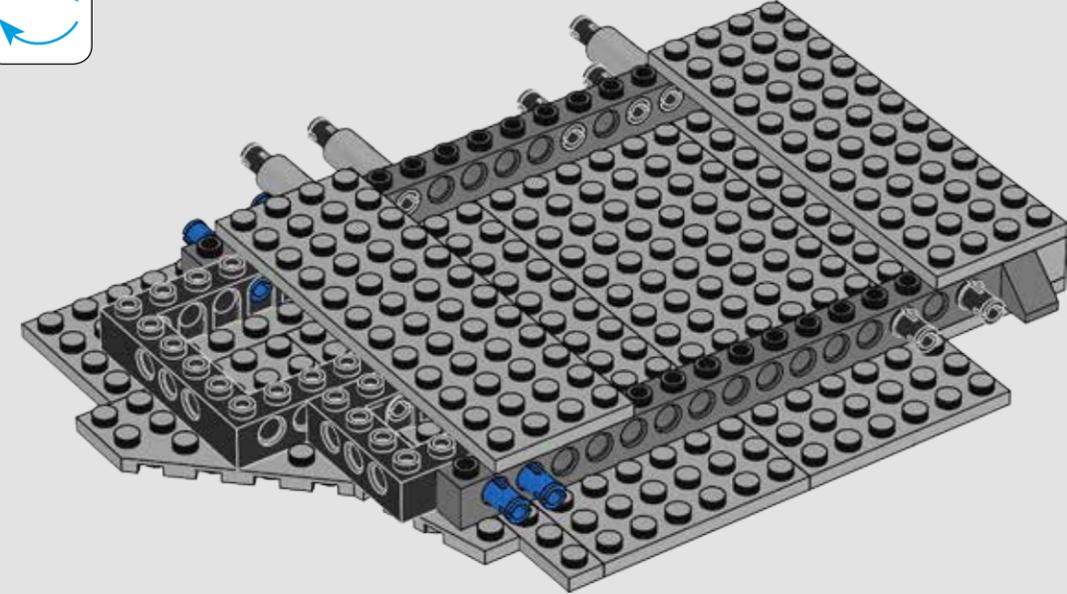

296

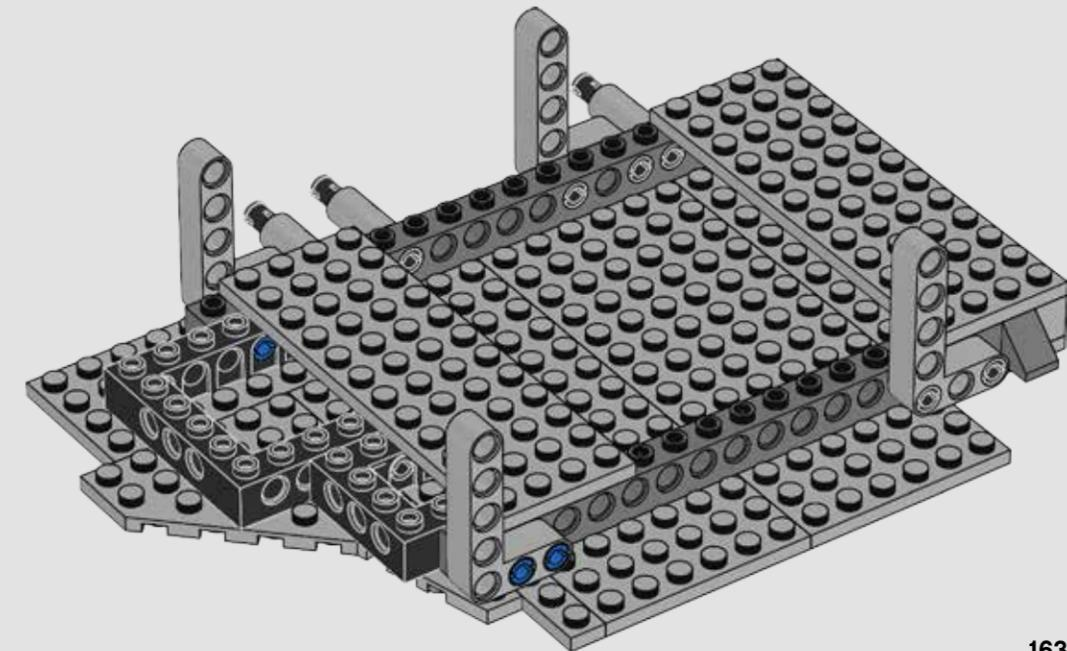

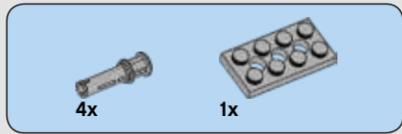

297

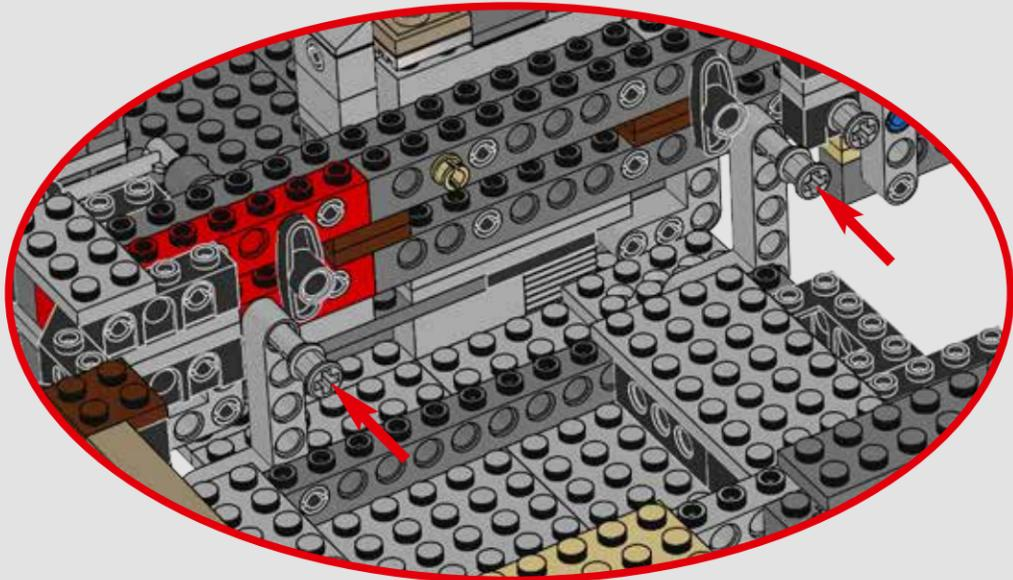
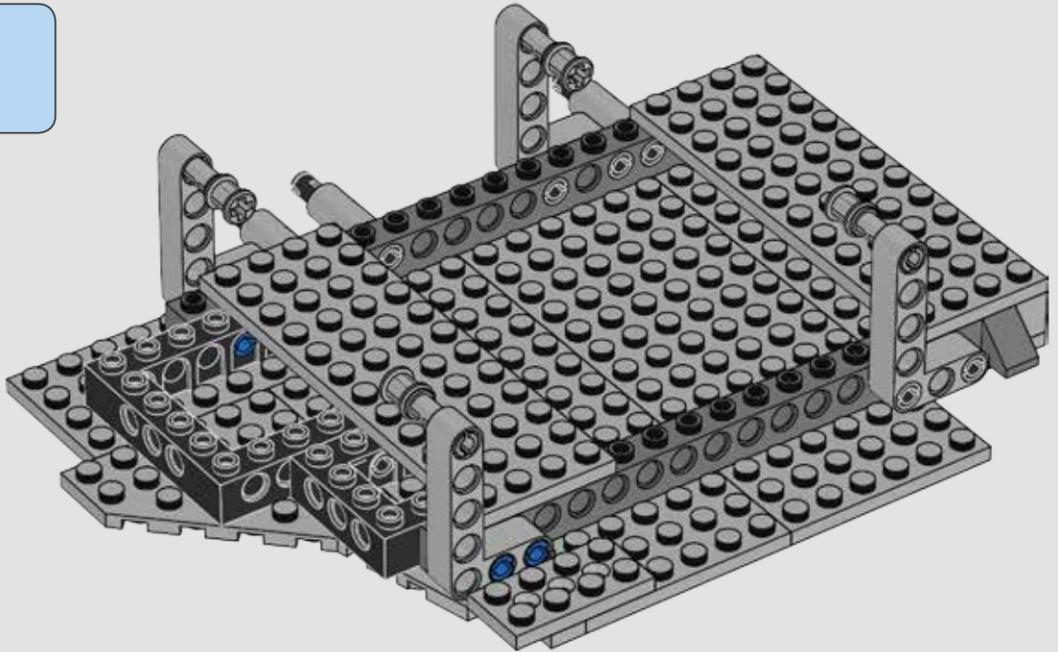

298

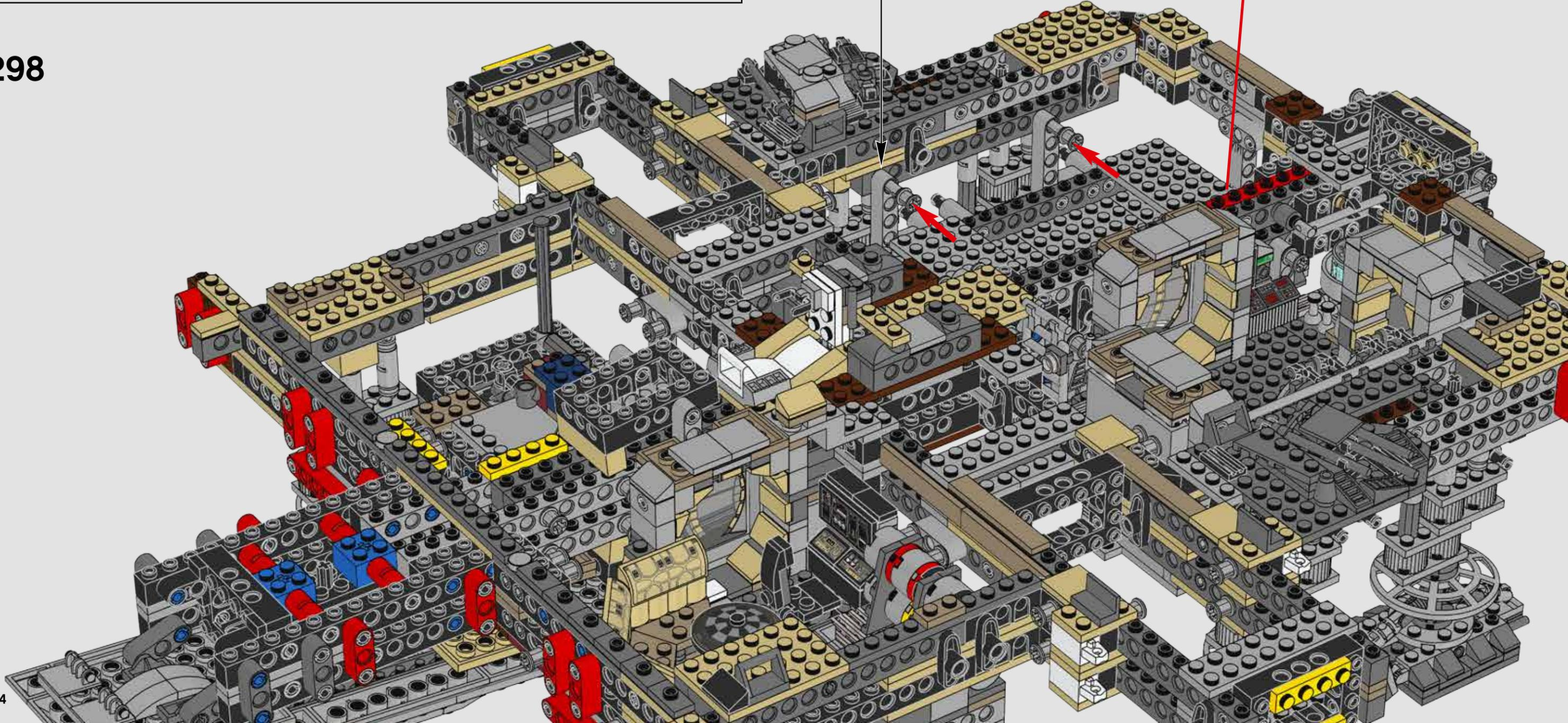

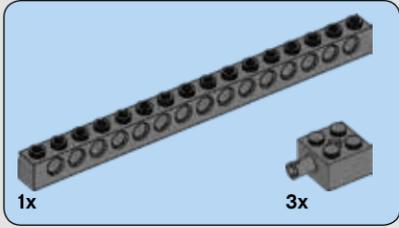
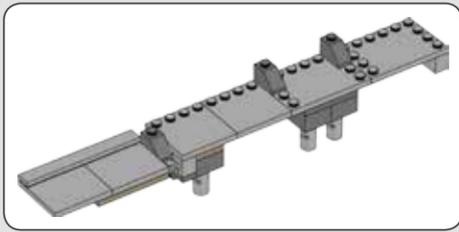

299

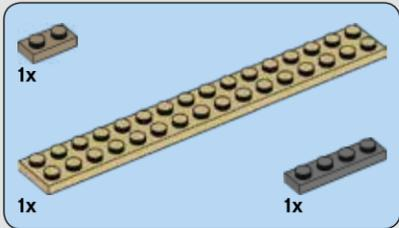
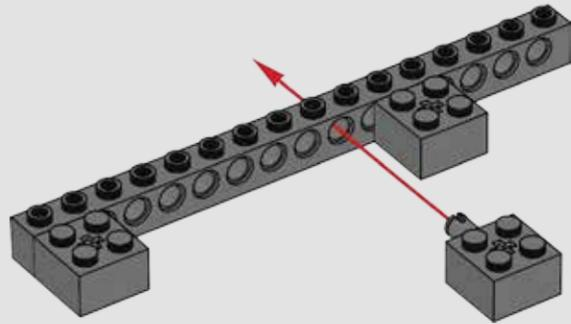

300

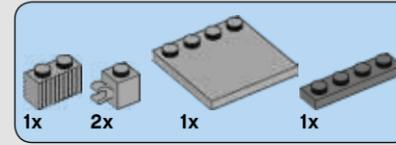
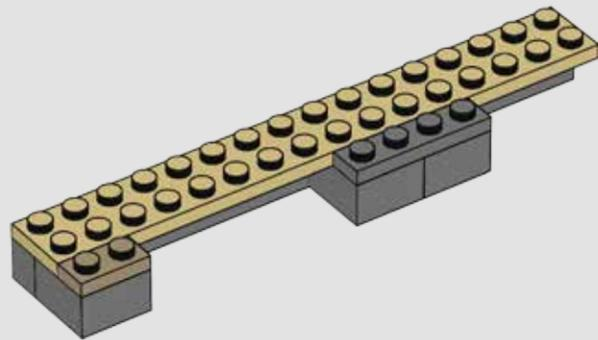

301

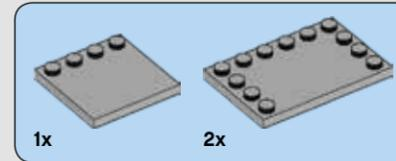
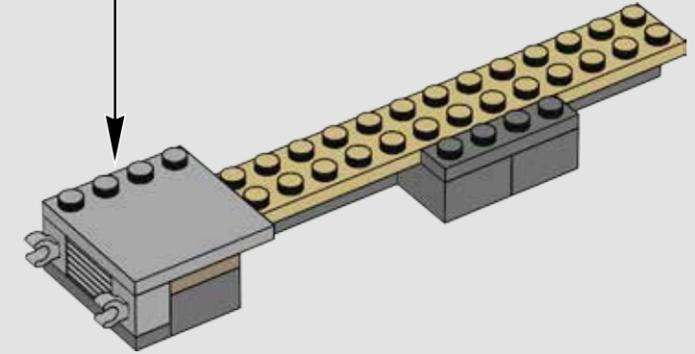
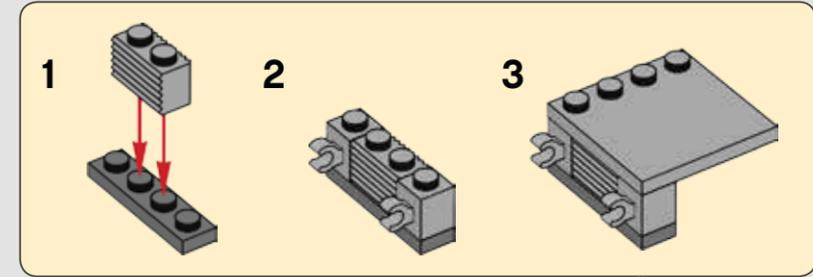

302

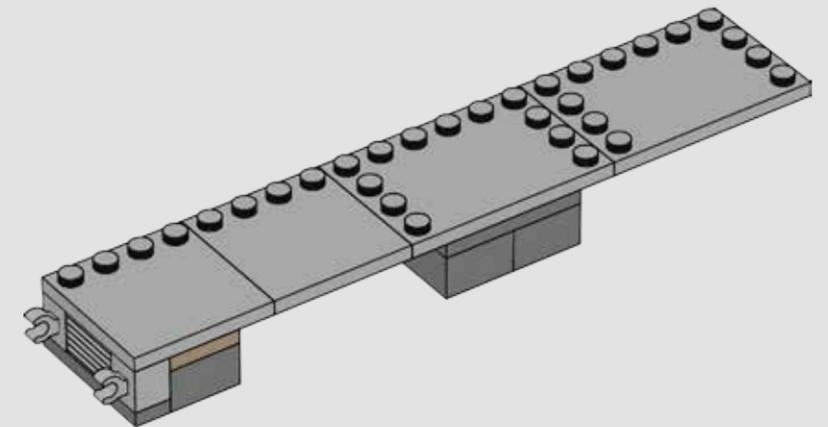

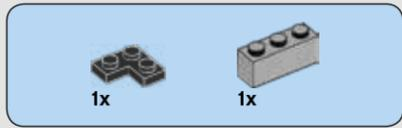

303

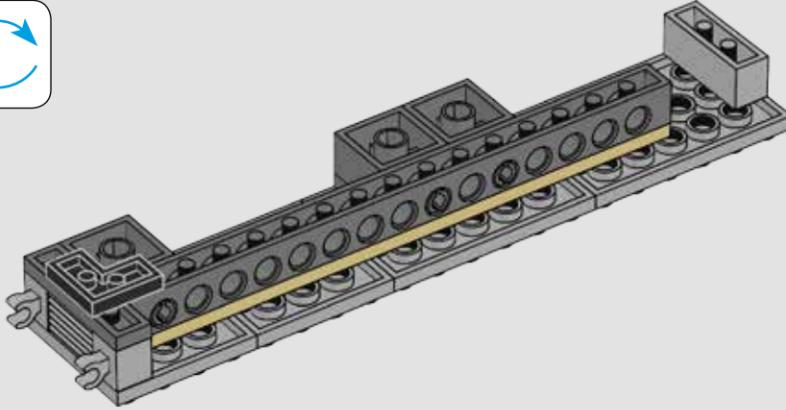

304

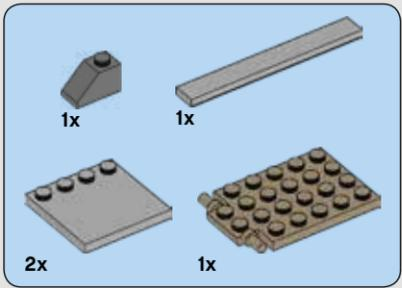
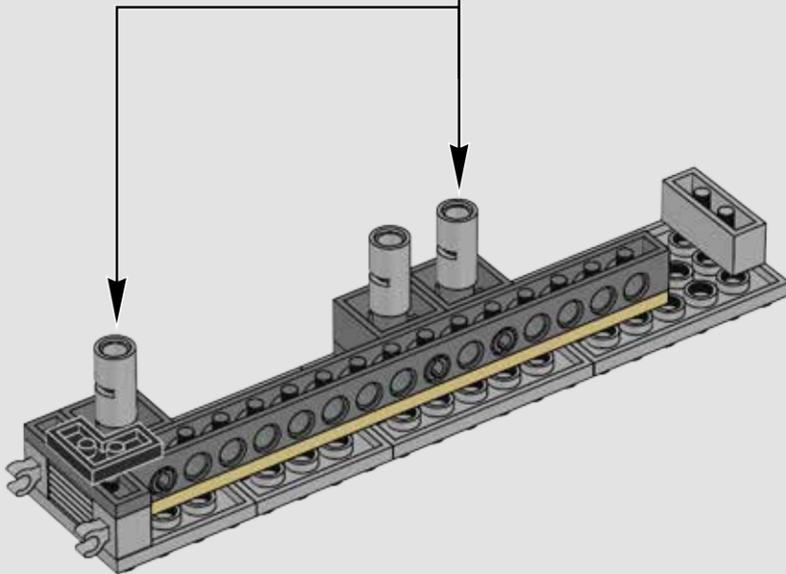
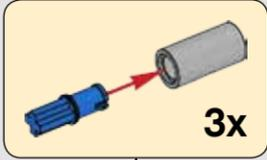

305

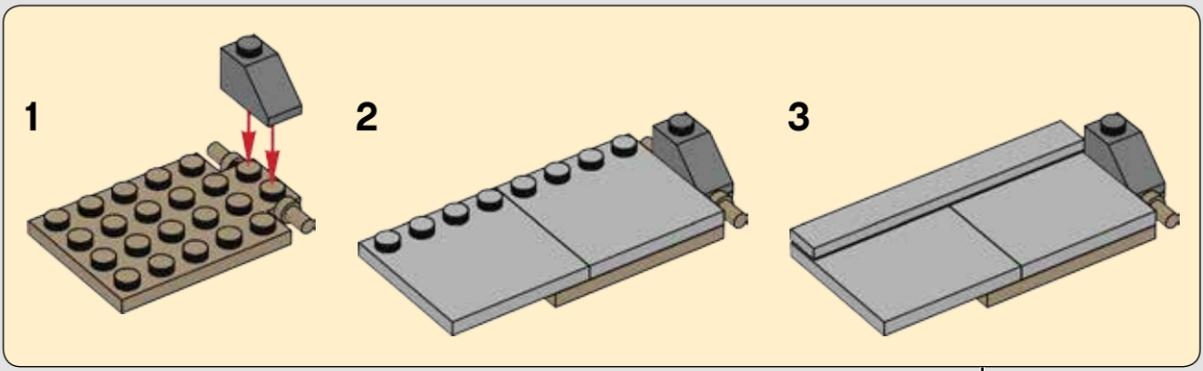
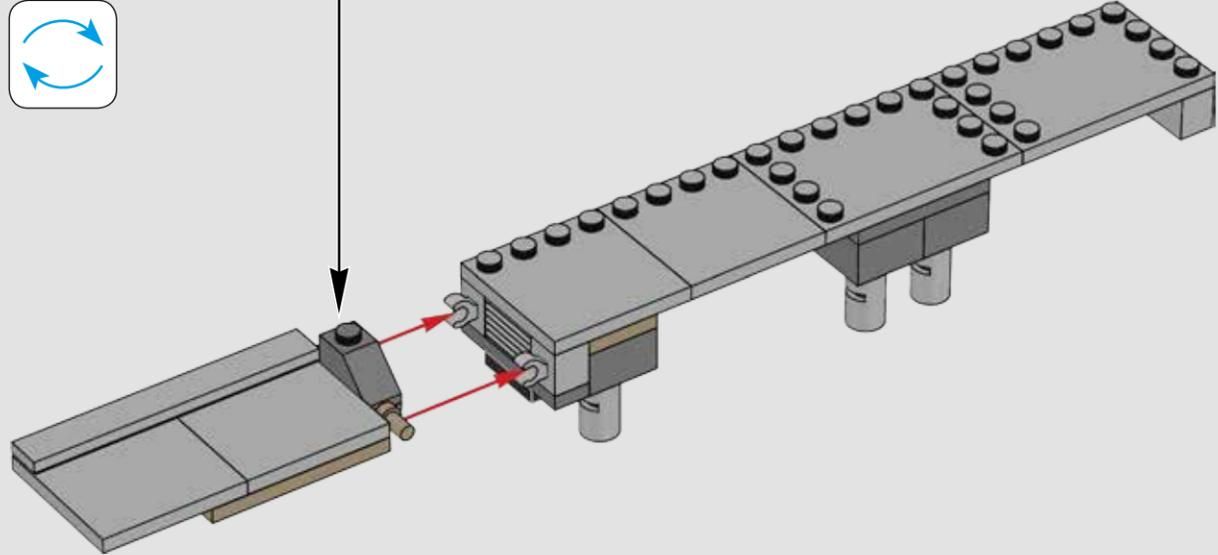

306

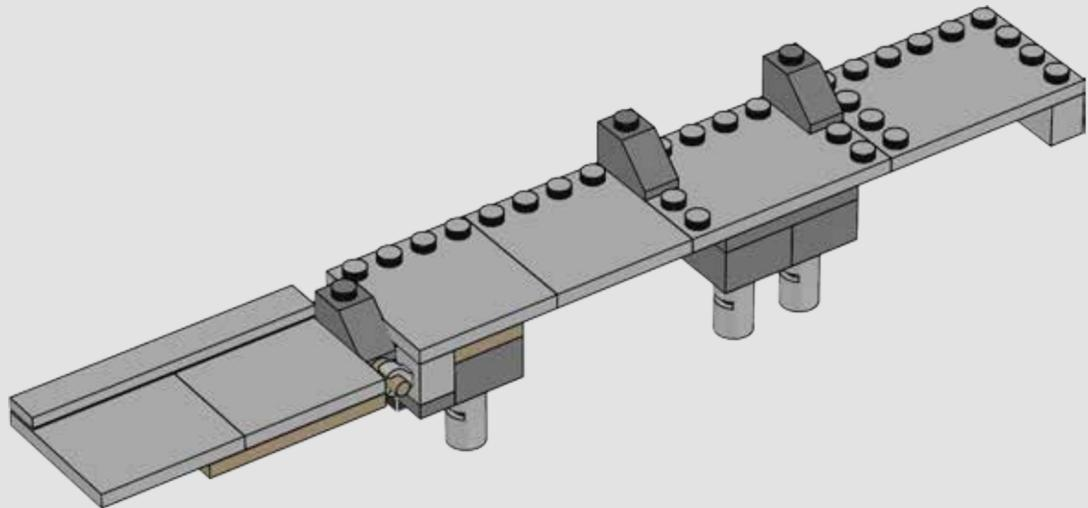

307

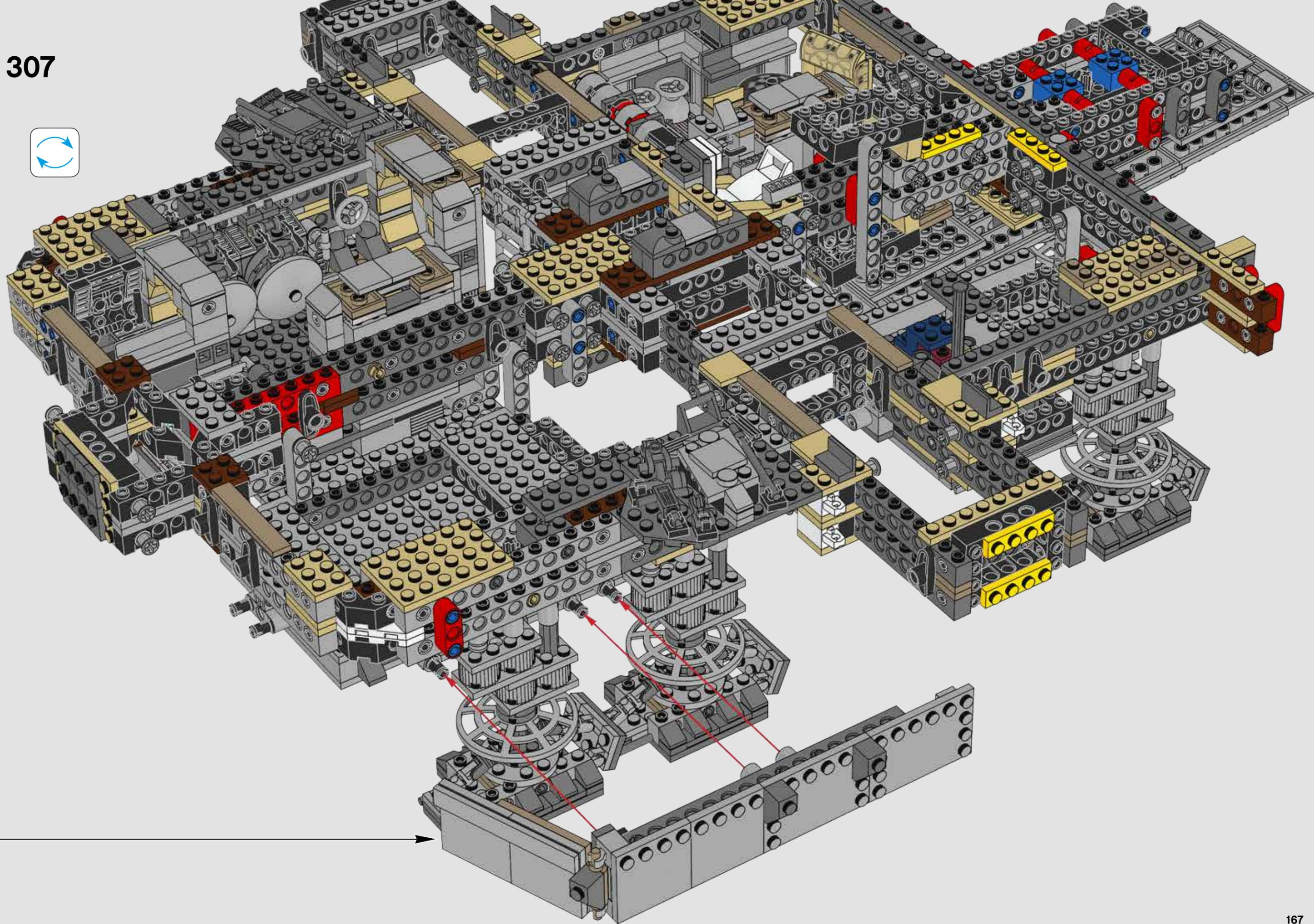

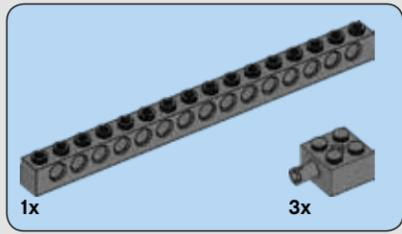

308

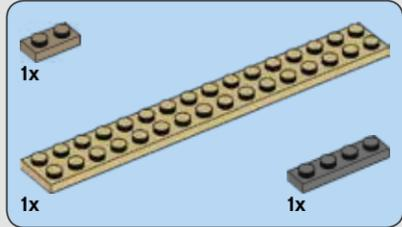
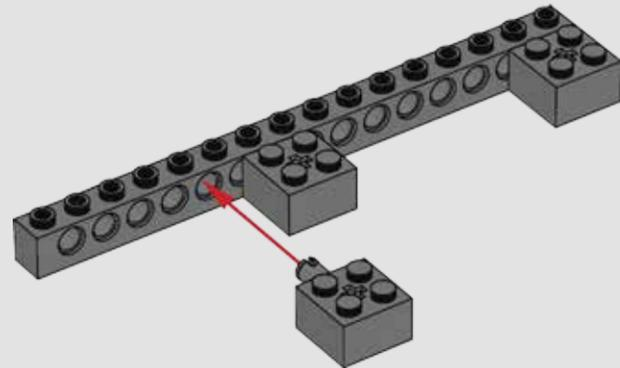

309

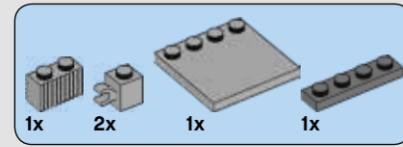
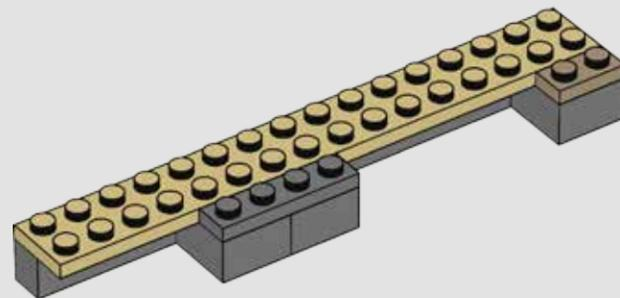

310

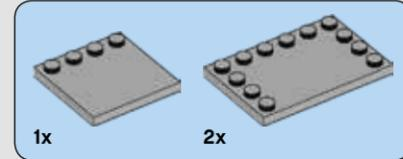
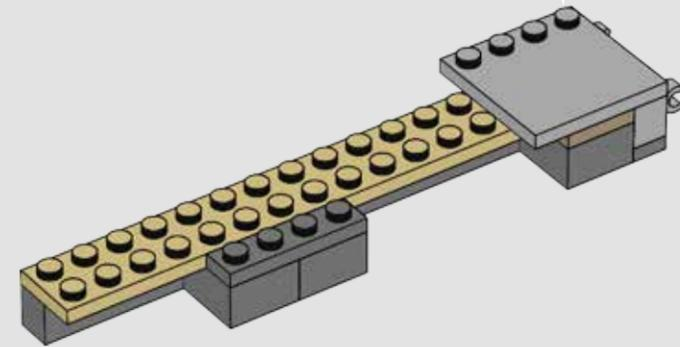
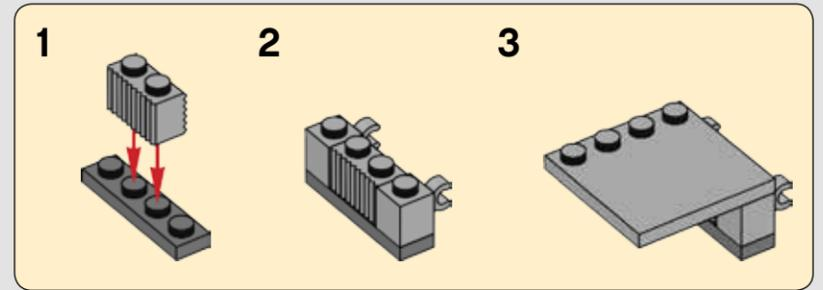

311

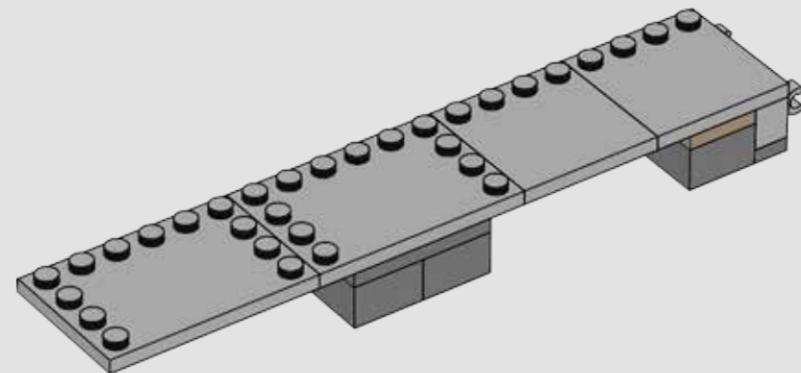

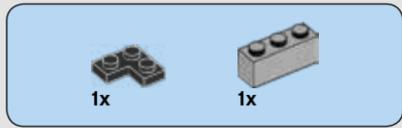

312

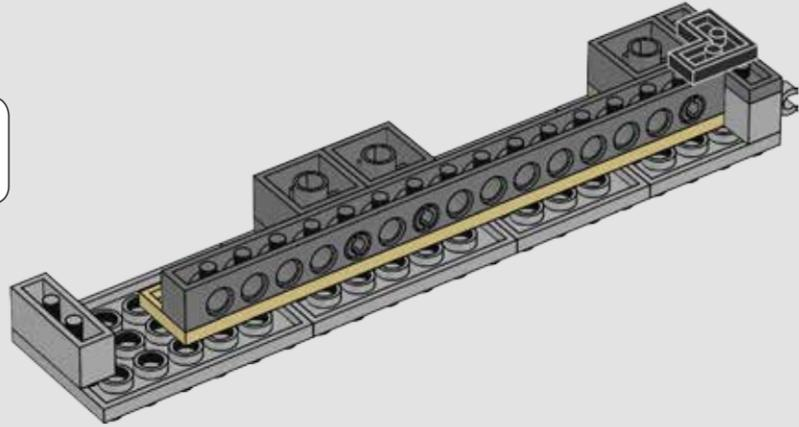

313

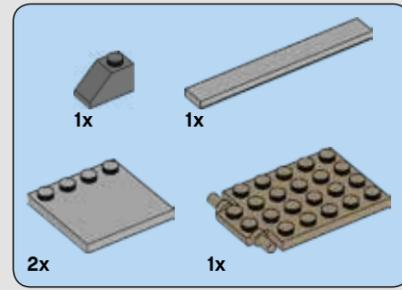
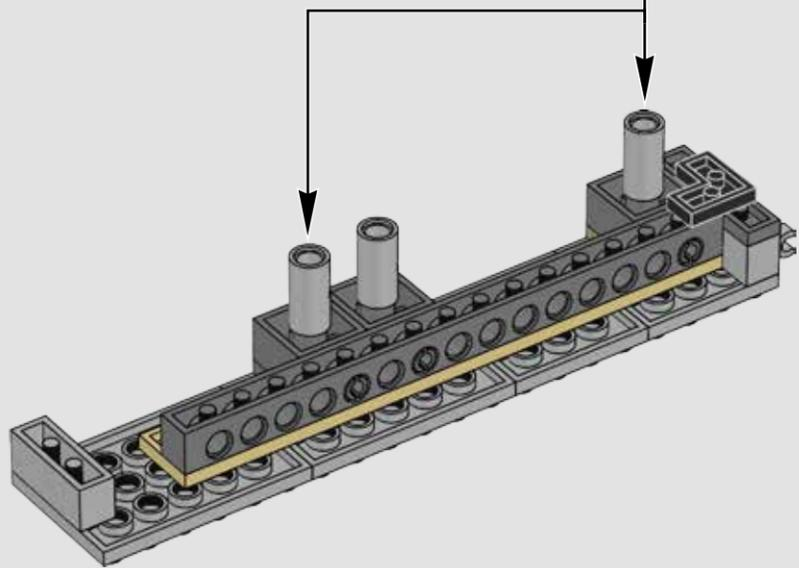
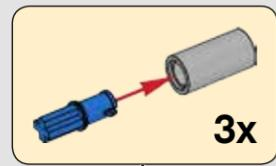

314

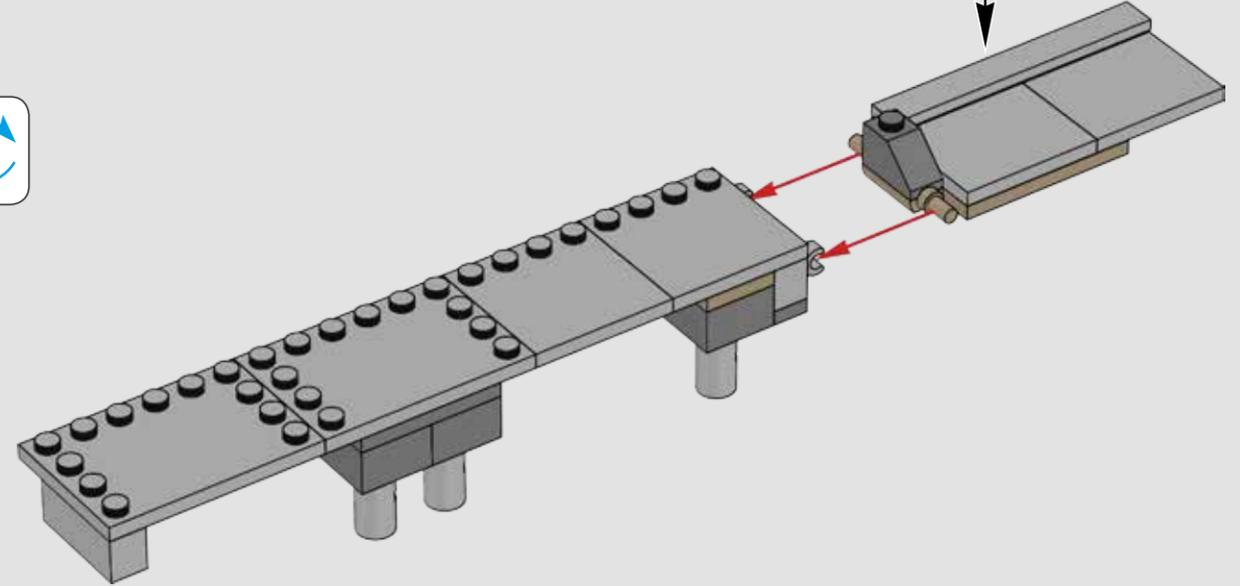

315

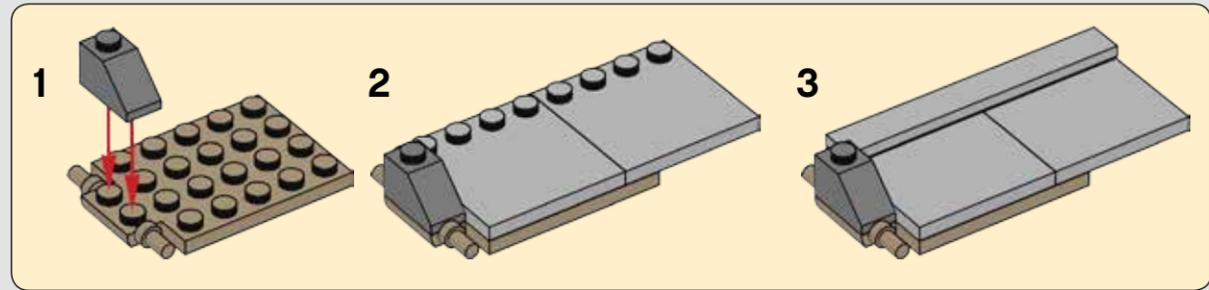
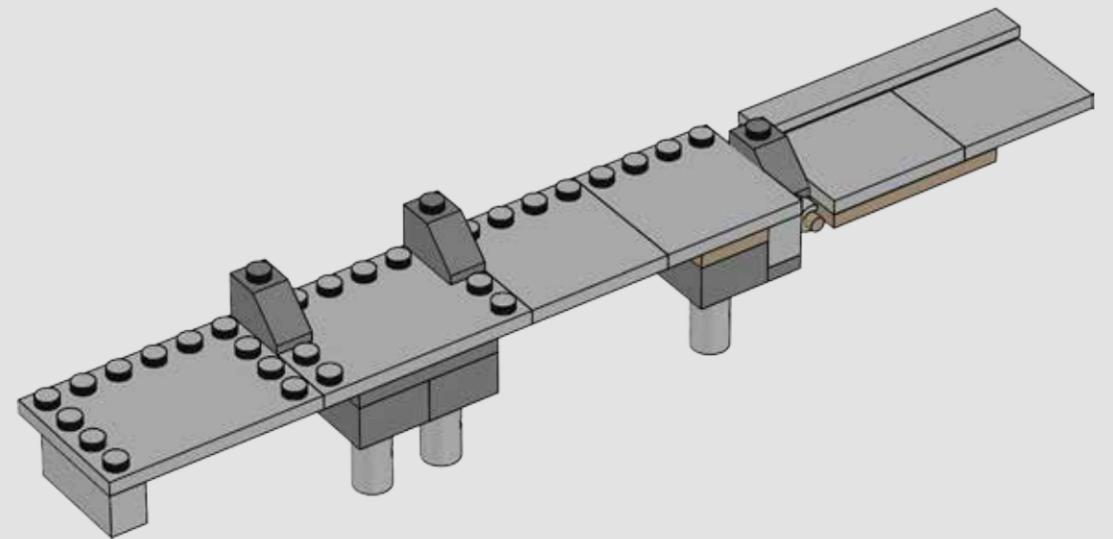

1

2

3

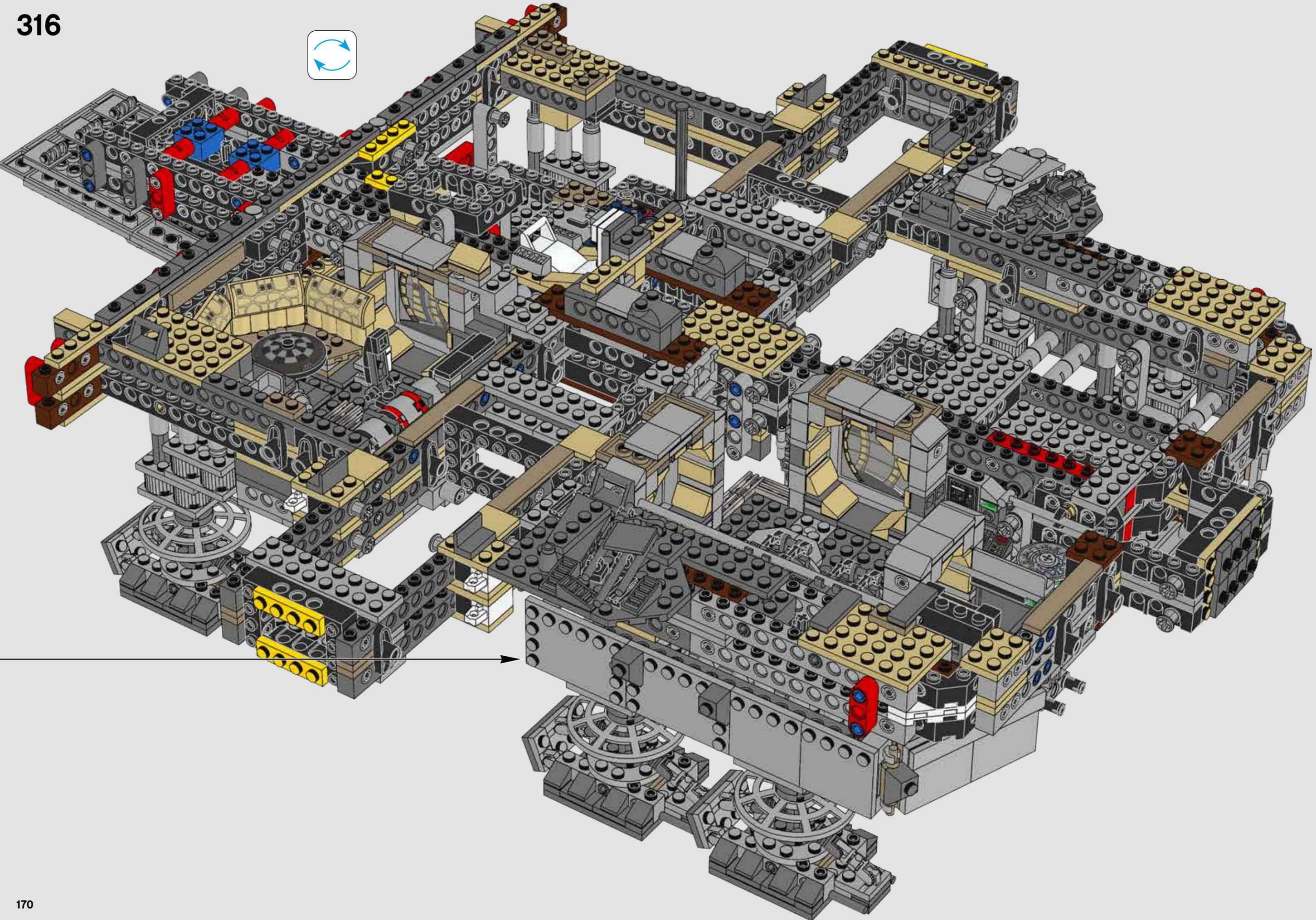

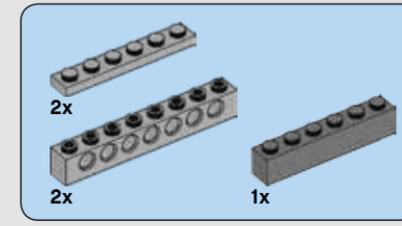
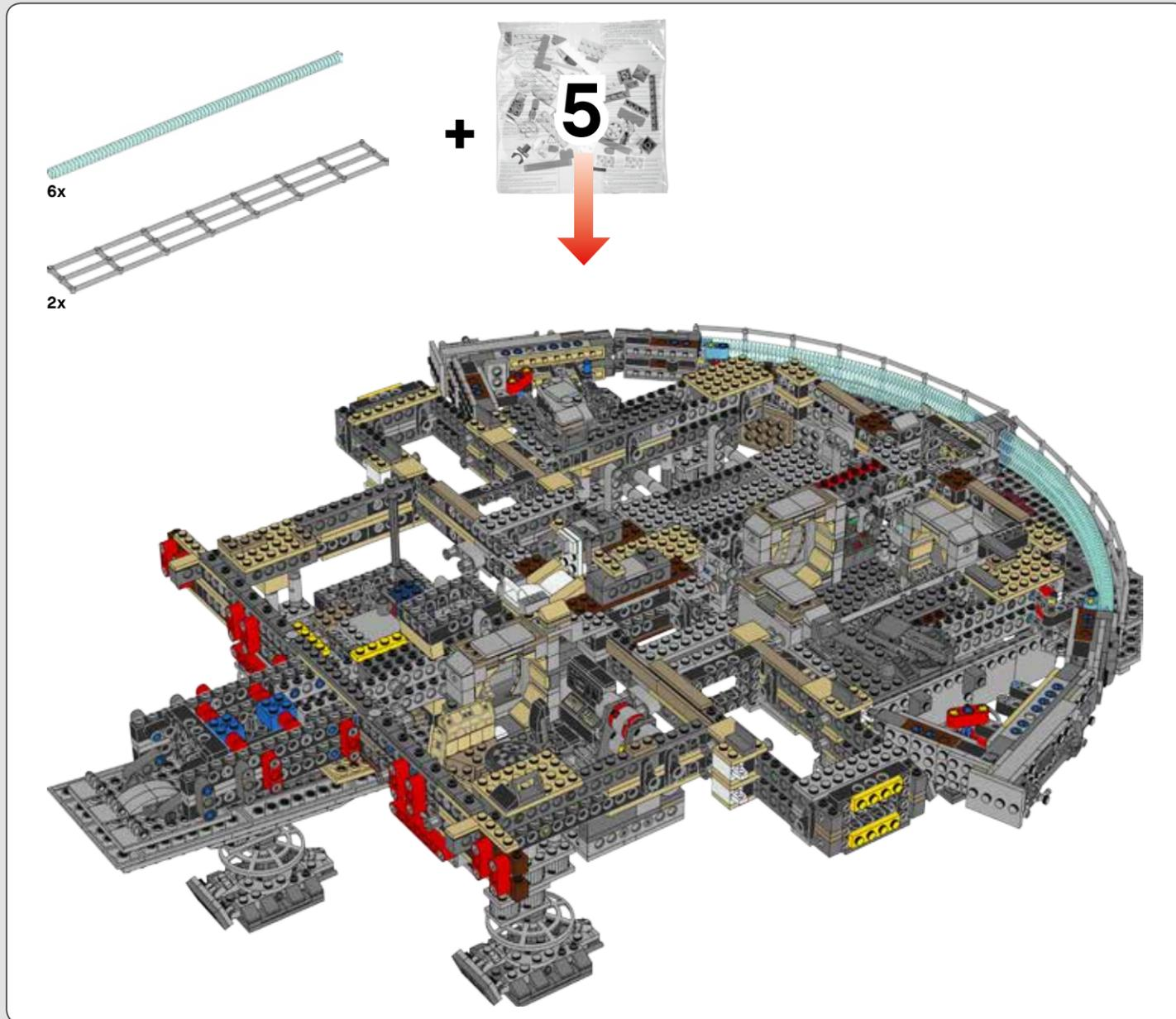

318

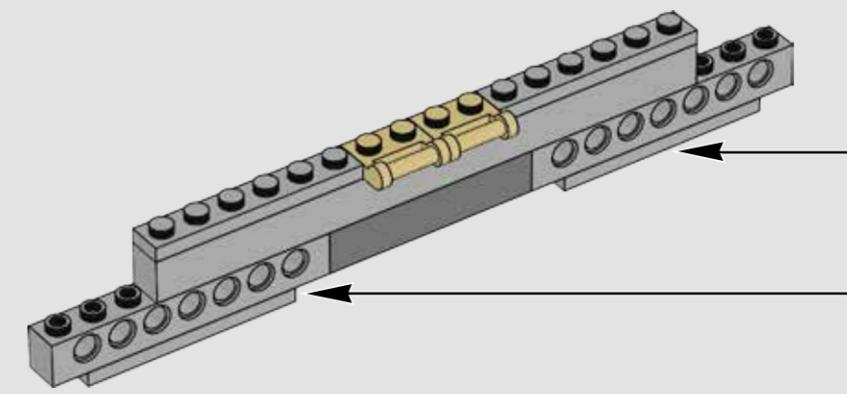
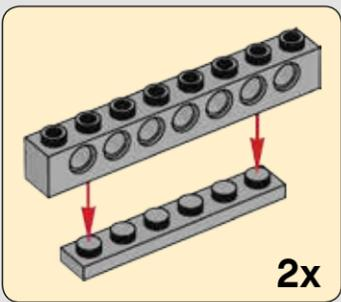

319

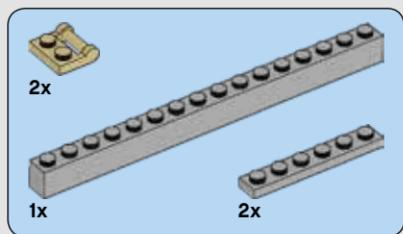
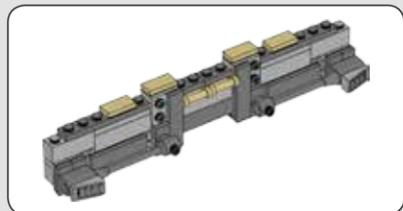

317

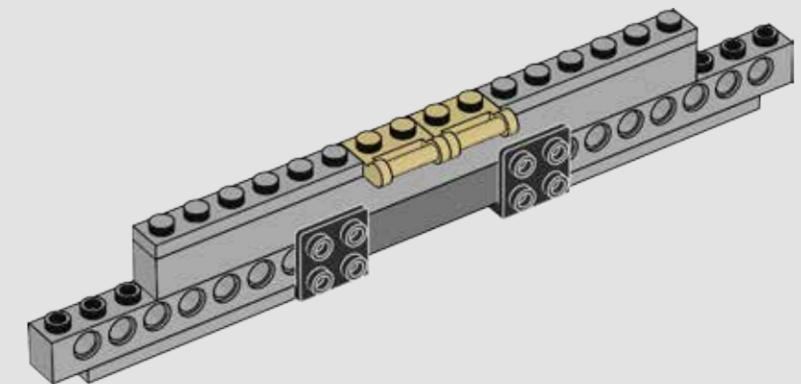
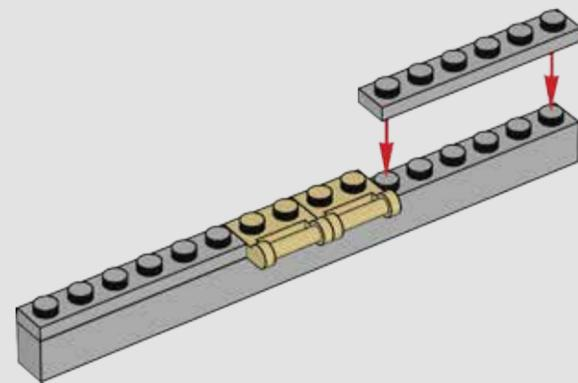

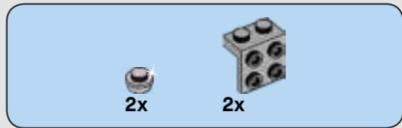

320

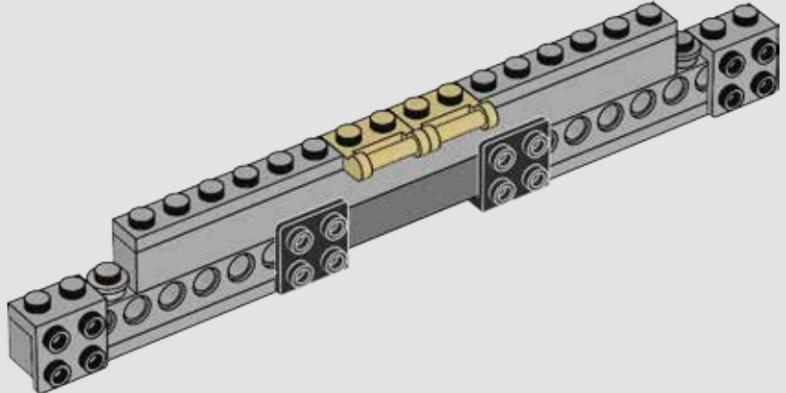

321

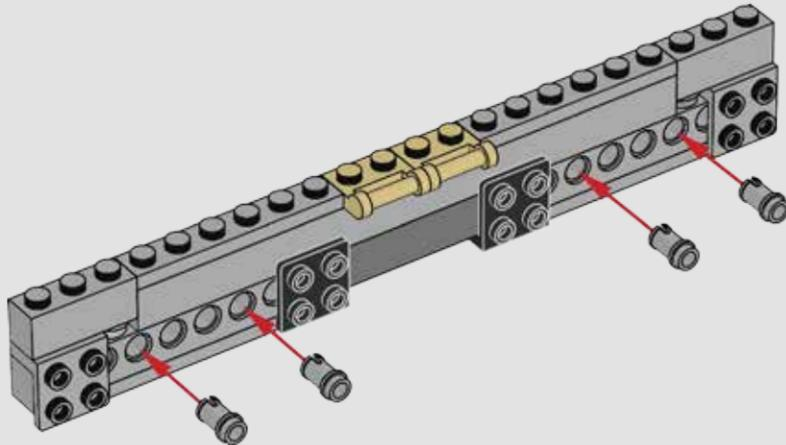

322

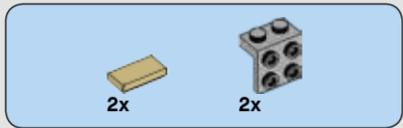
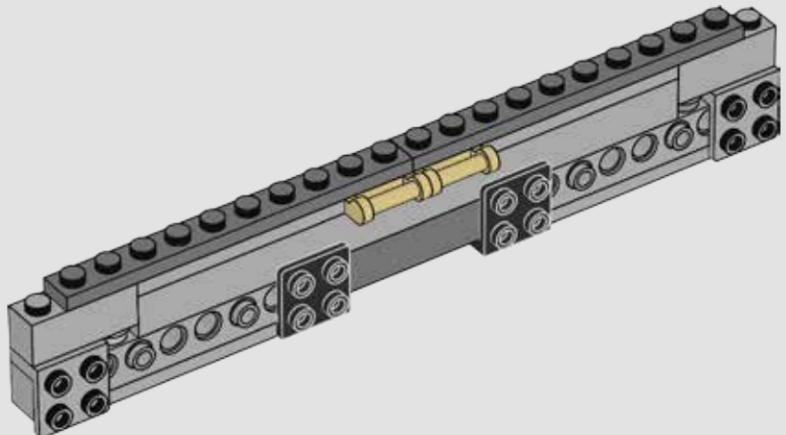

323

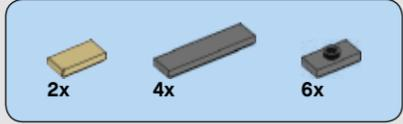
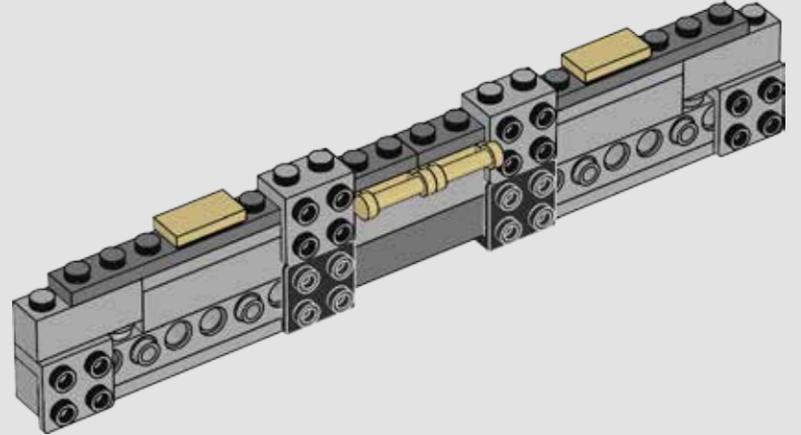

324

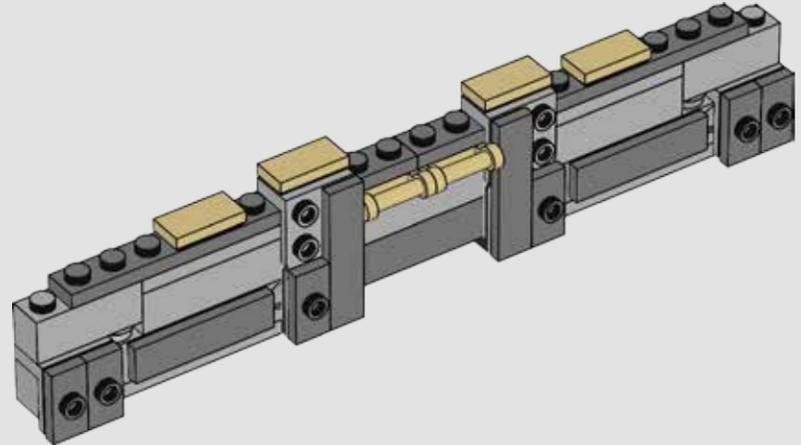

325

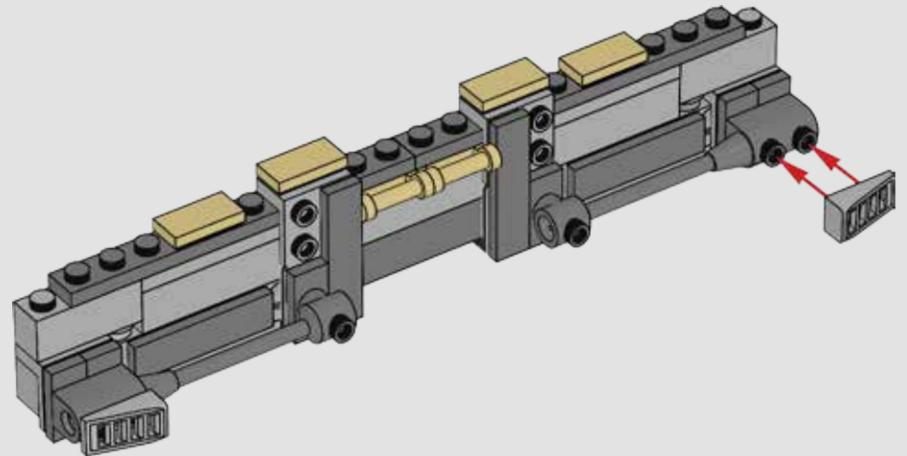

326

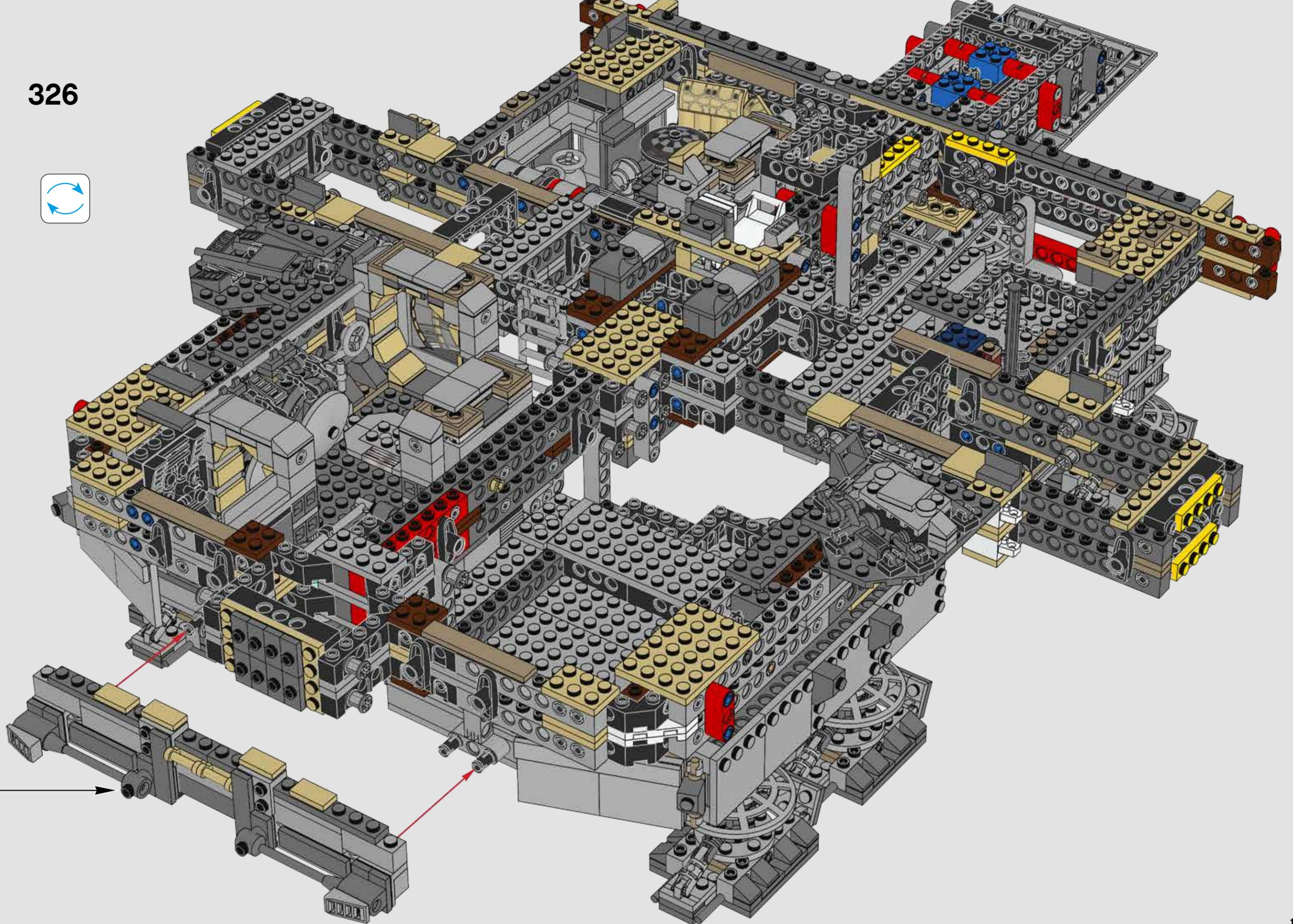

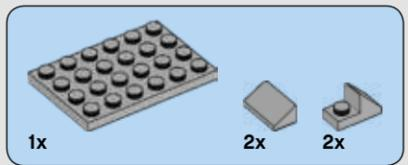

327

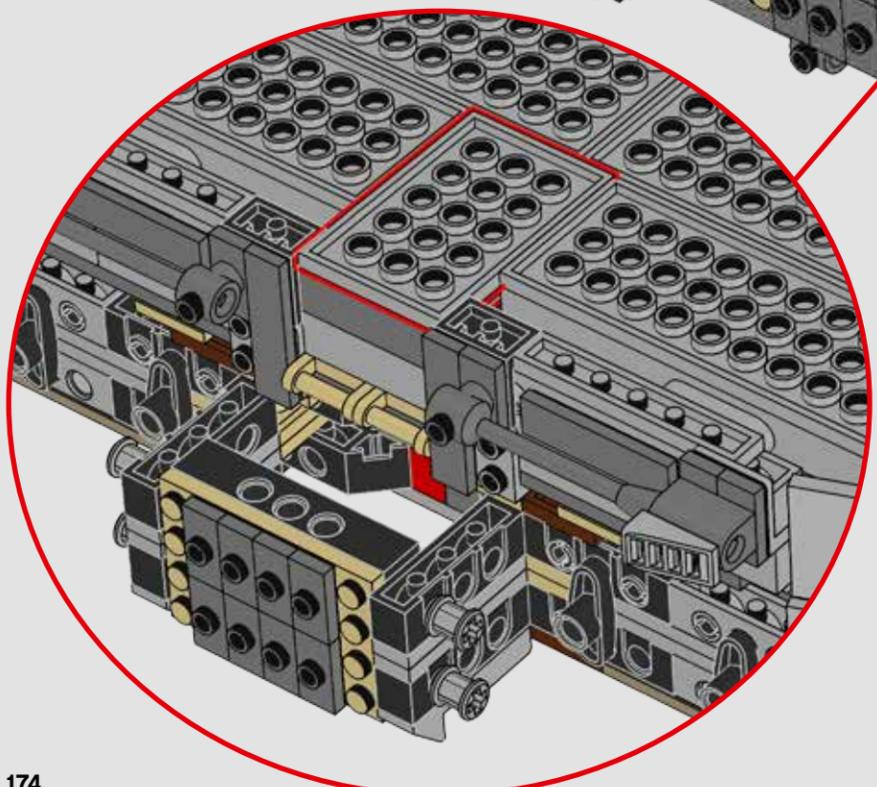
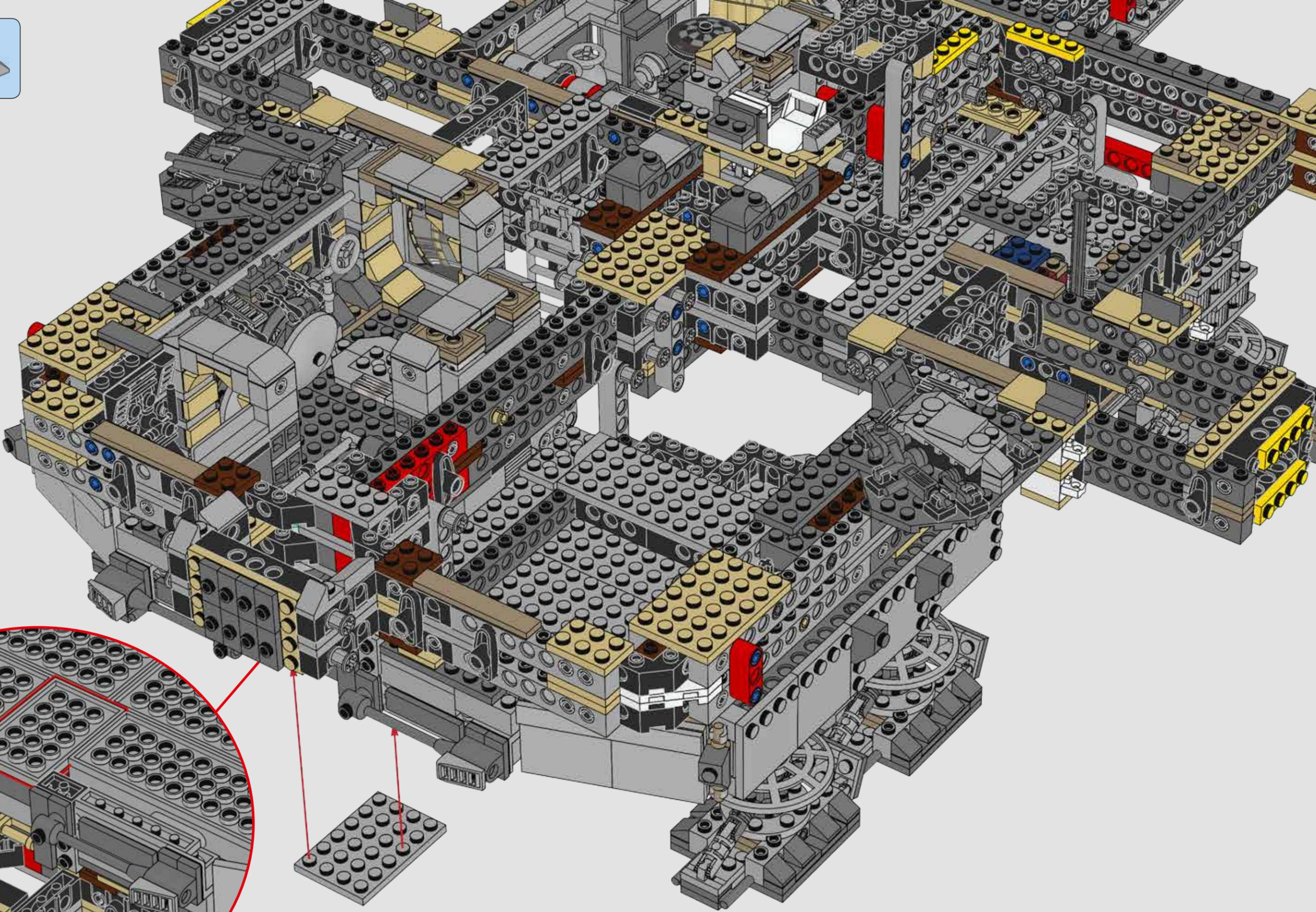

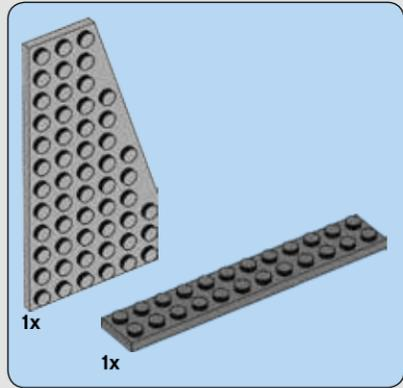
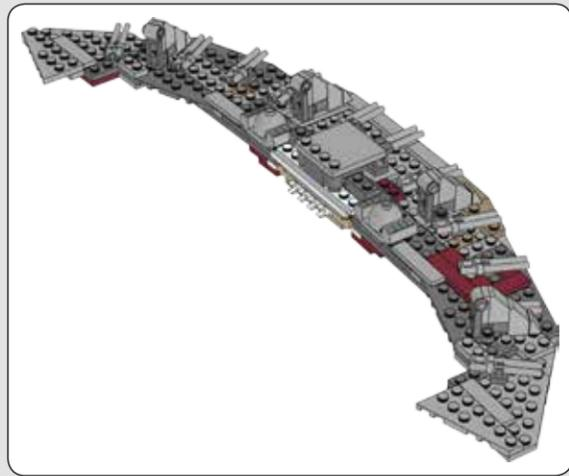

328

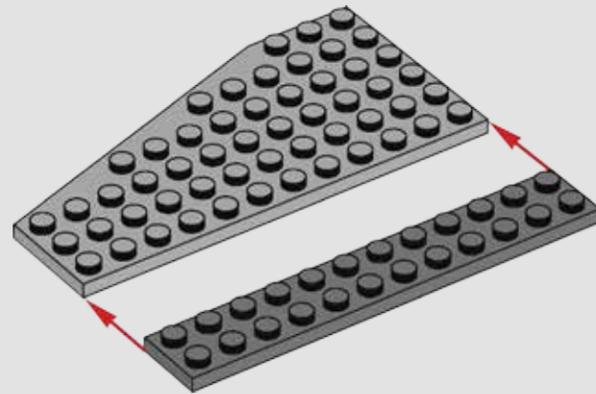

329

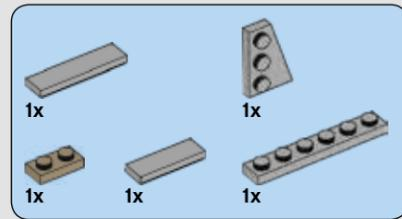
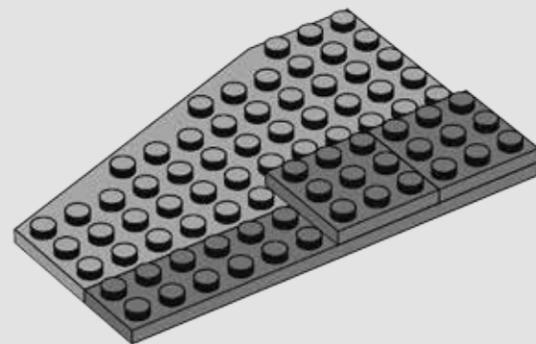

330

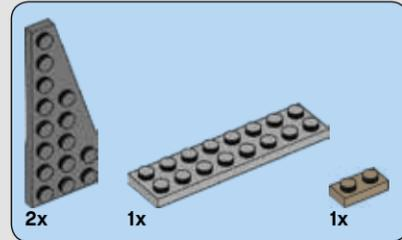
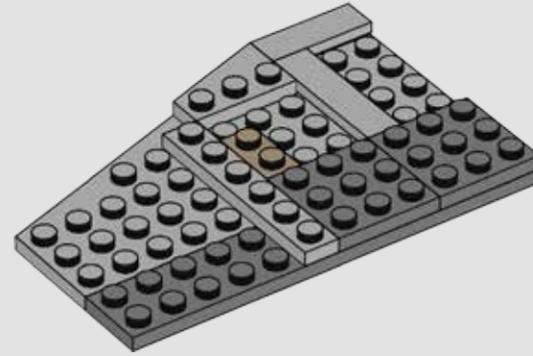

331

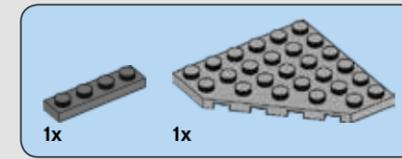
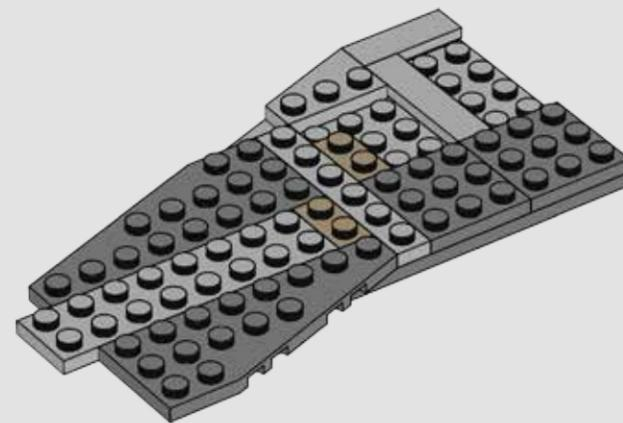

332

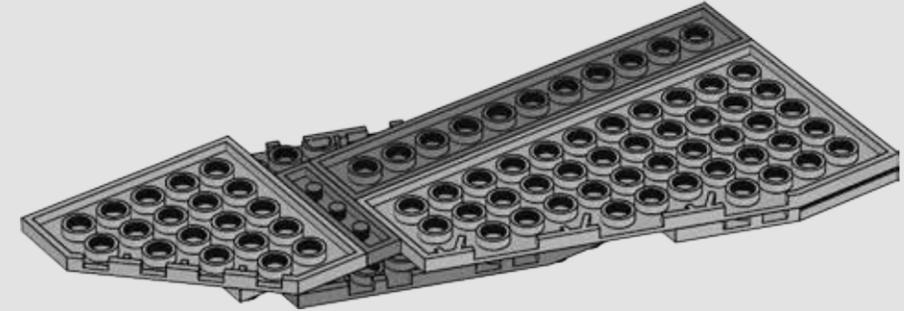

333

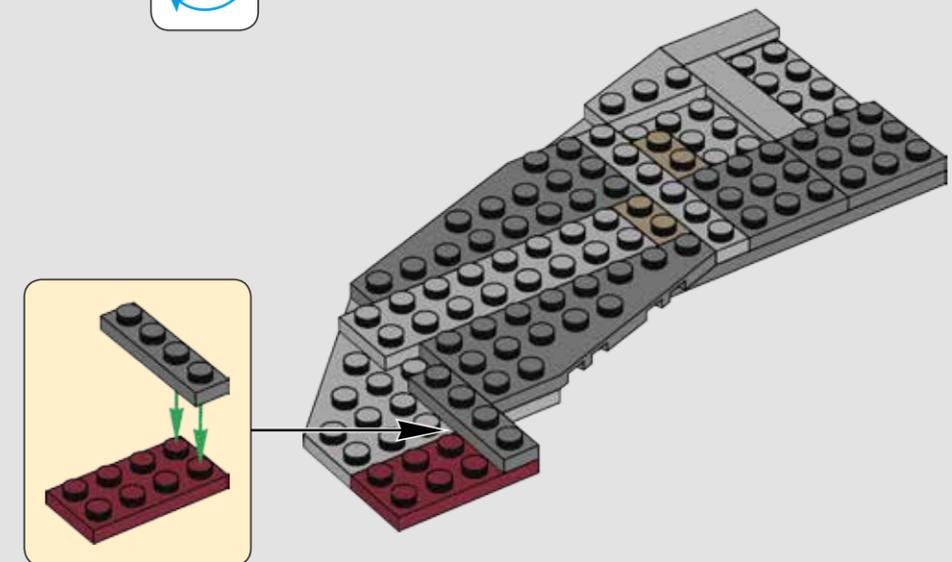

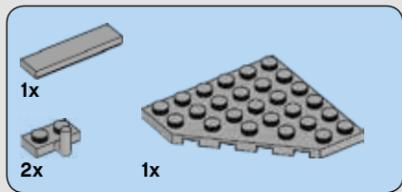

334

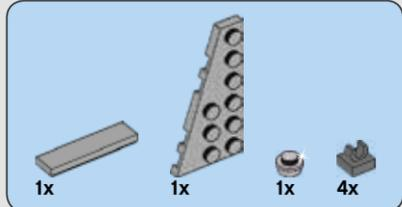
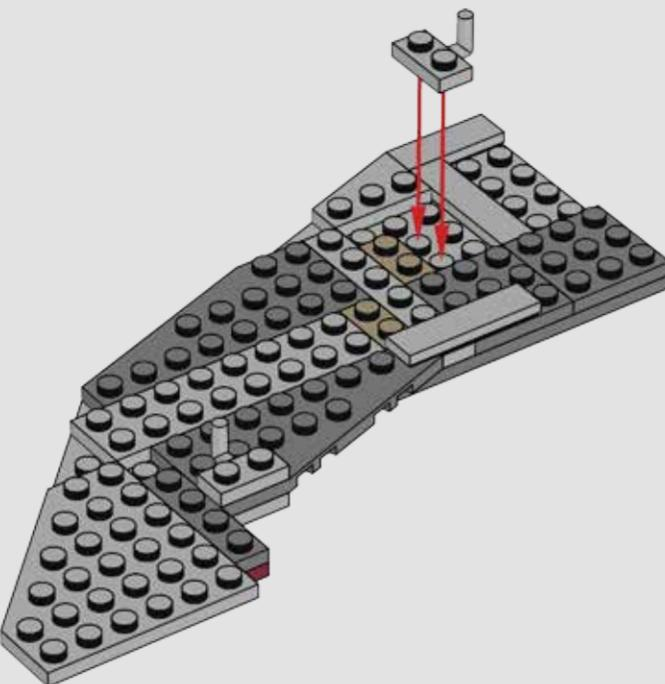

335

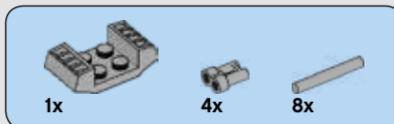
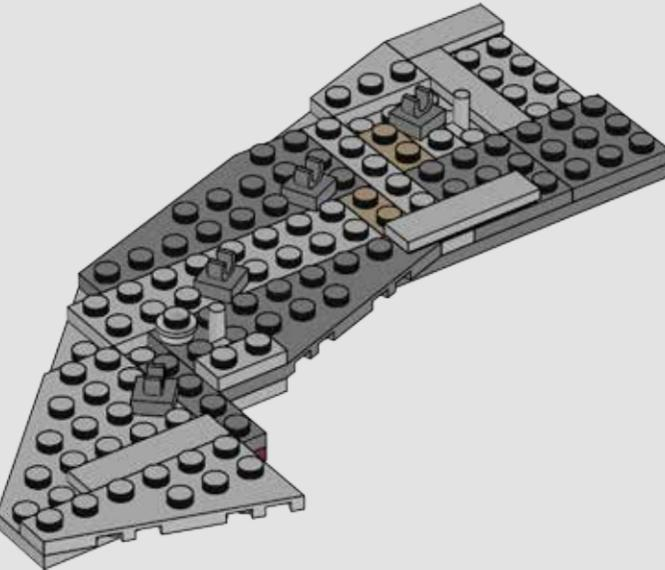

336

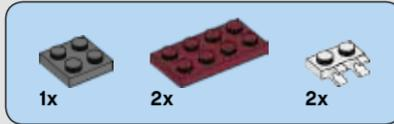
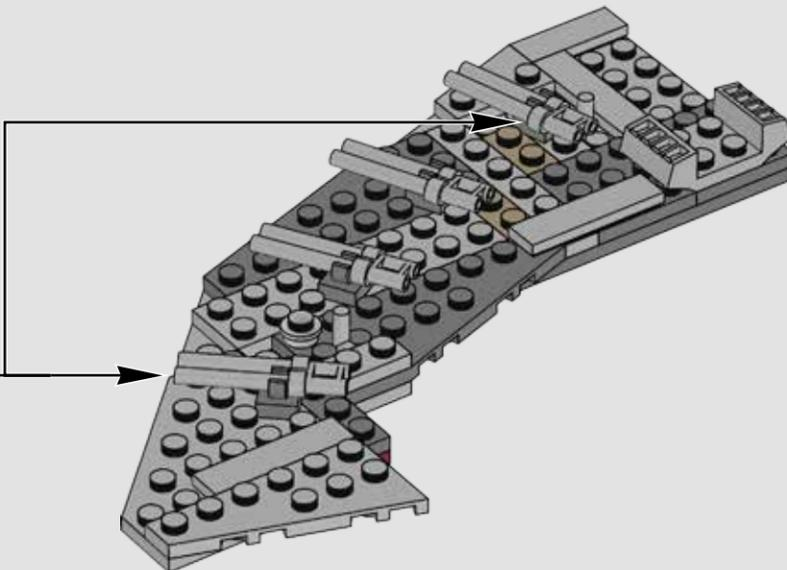
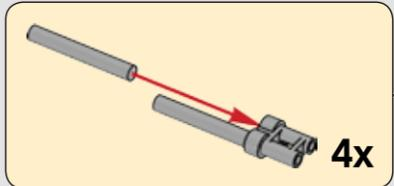

337

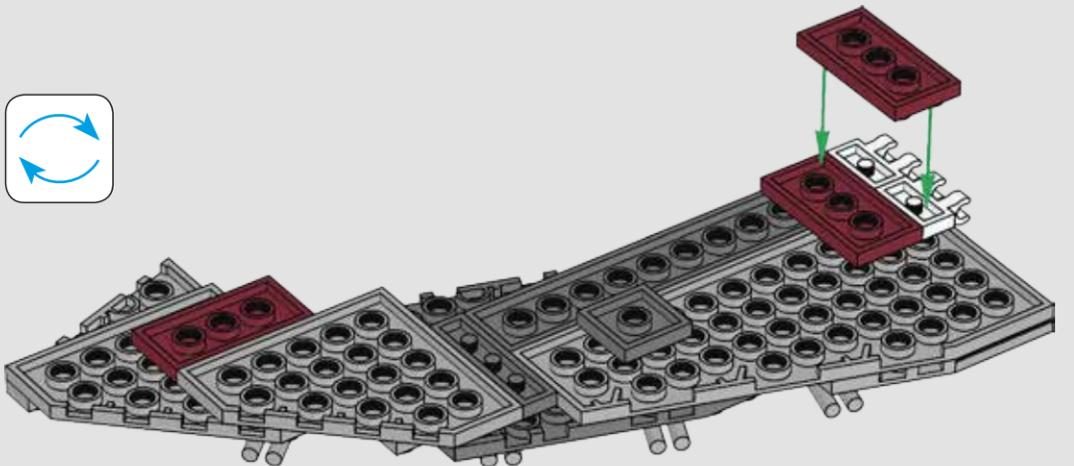

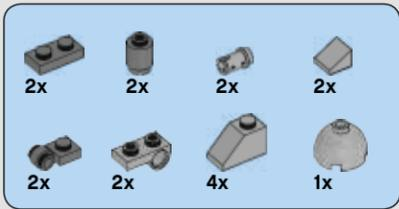

338

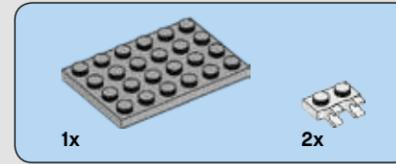
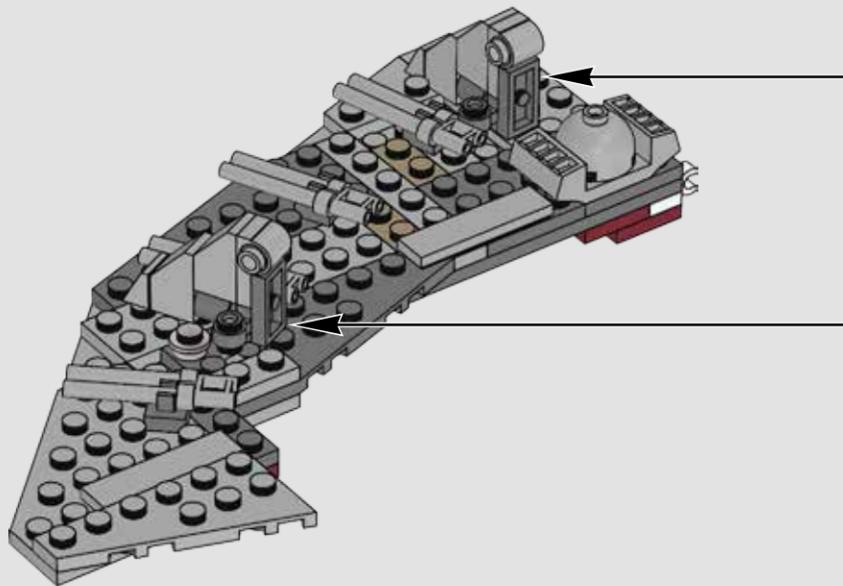
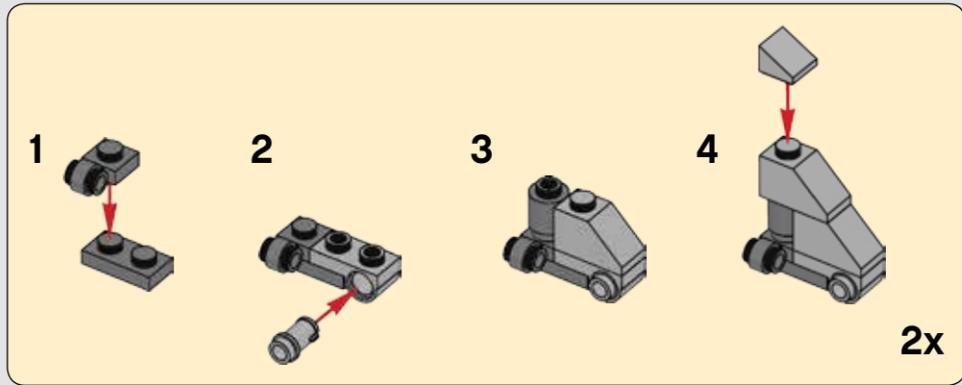

339



340

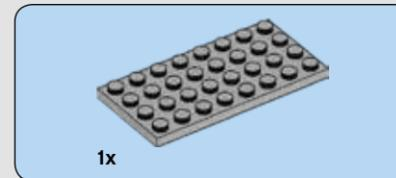
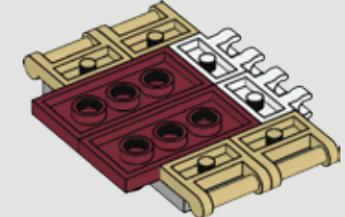

341

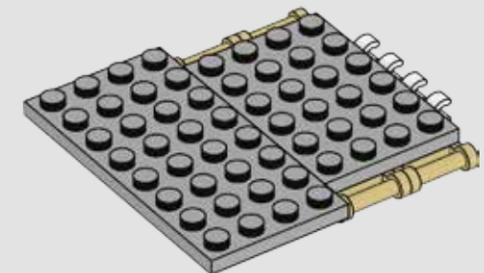

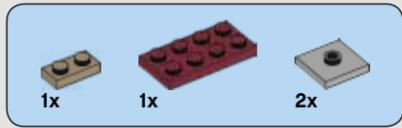

342

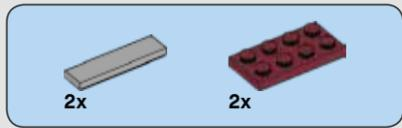
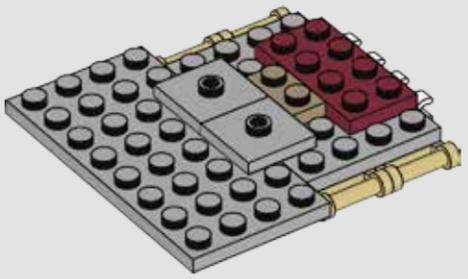

343

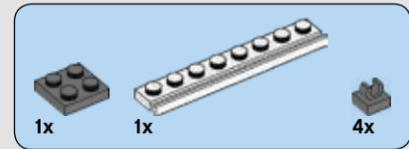
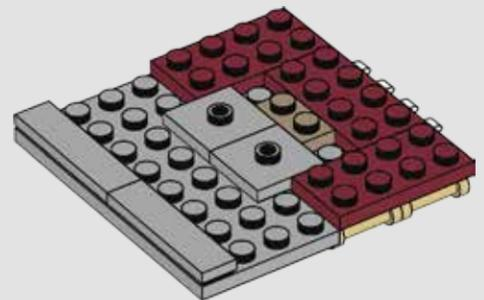

344

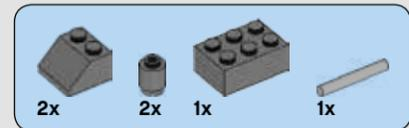
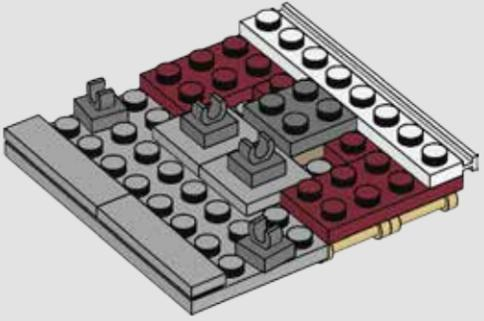

345

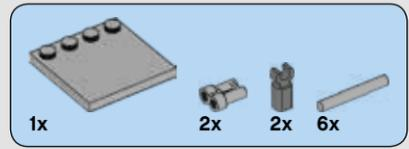
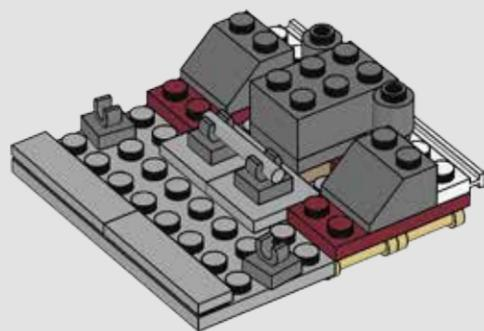

346

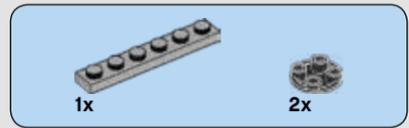
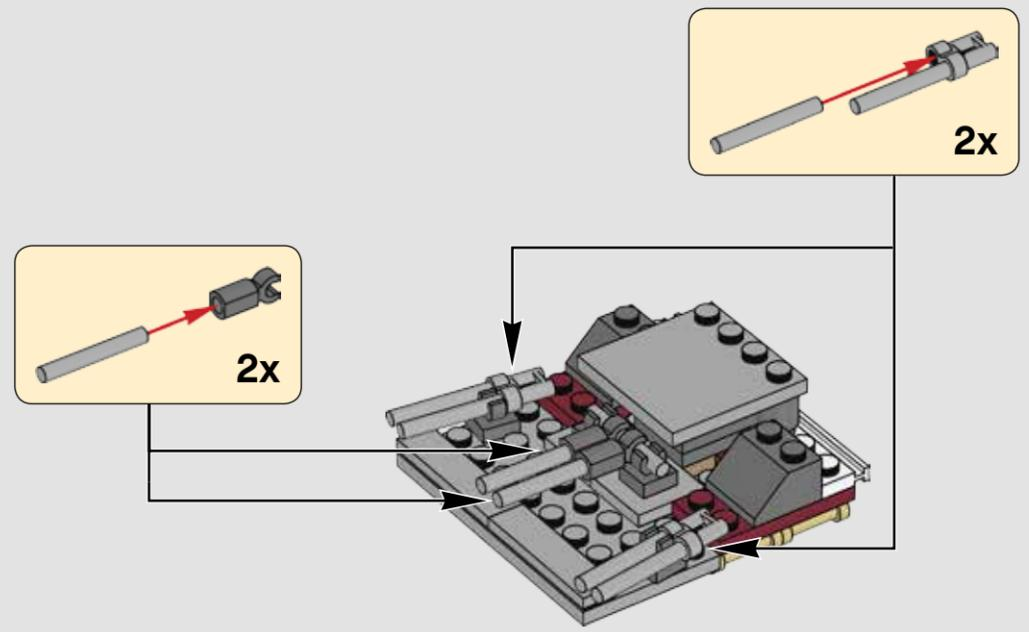

347

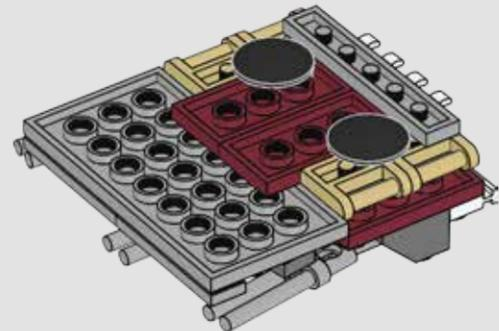

348

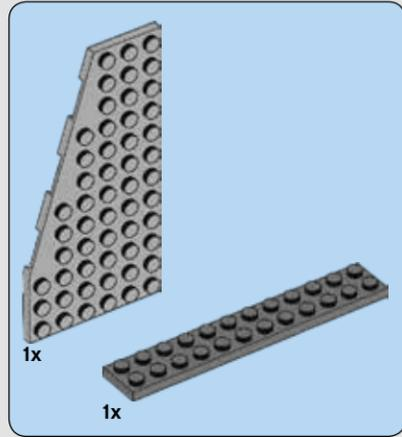
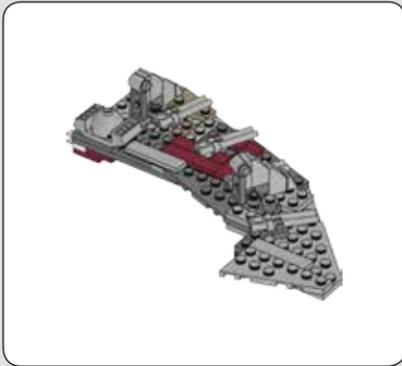
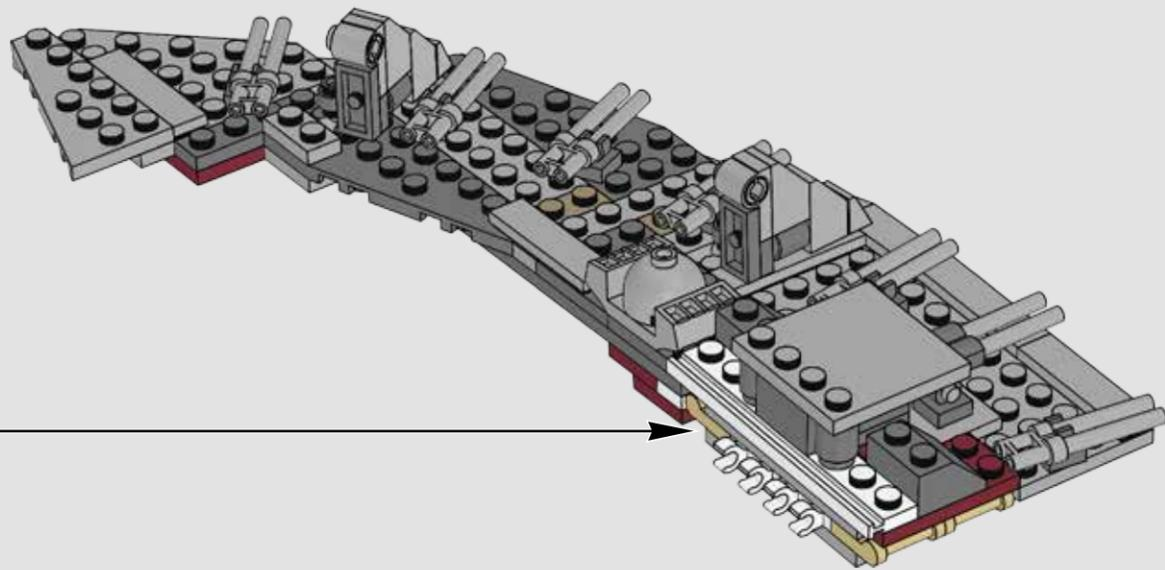

349

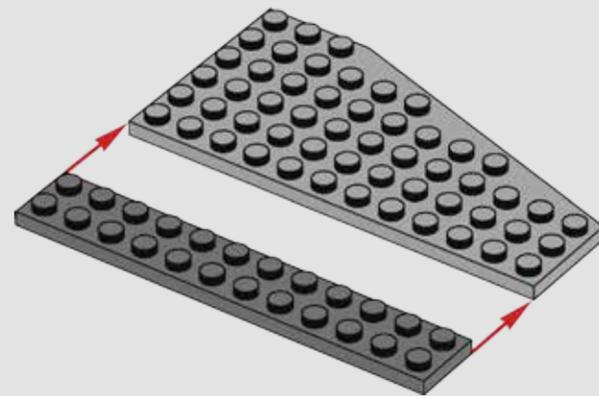

350

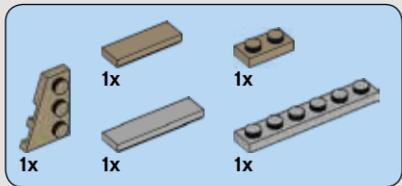
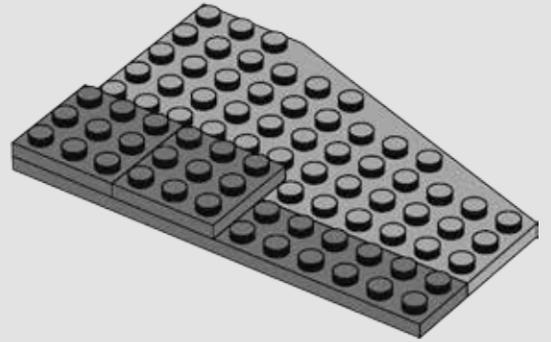

351

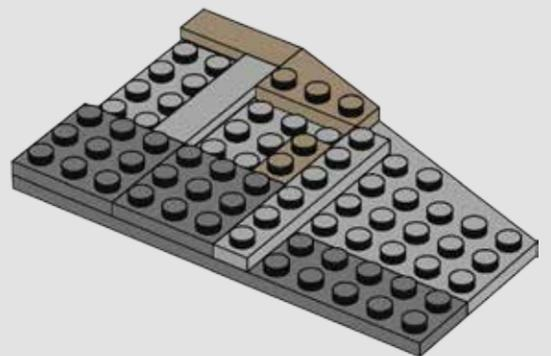

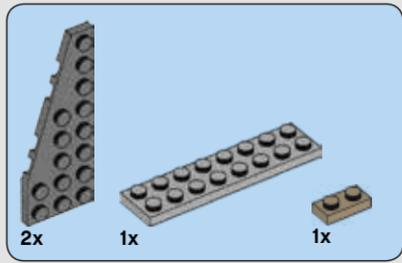

352

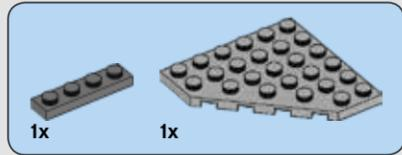
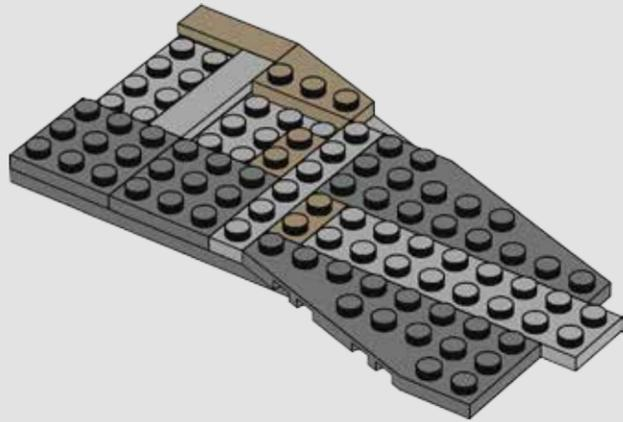

353

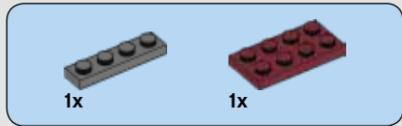
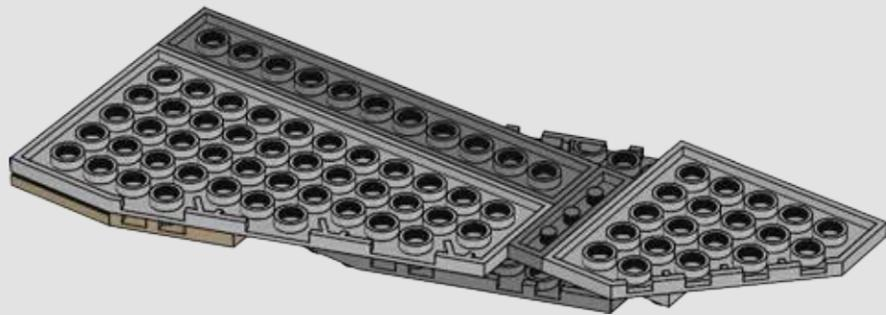

354

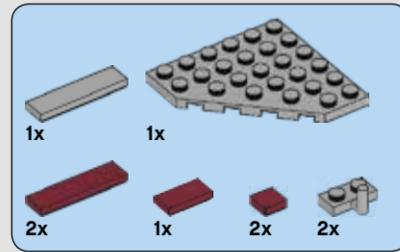
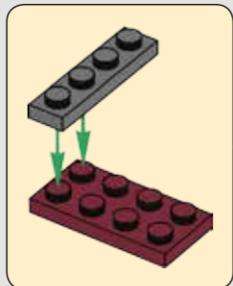
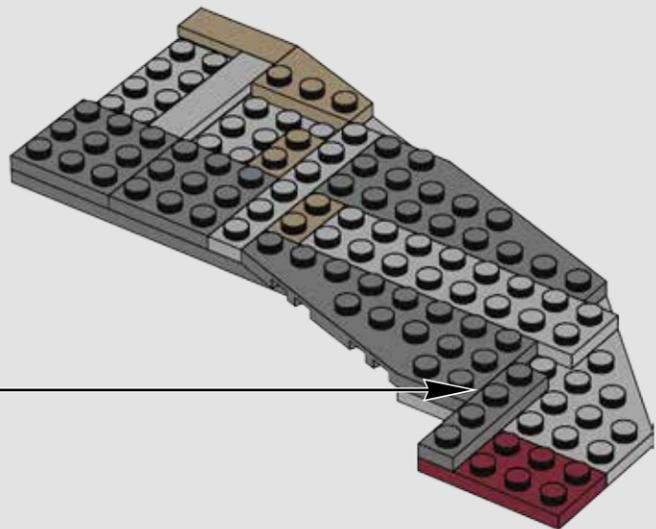

355

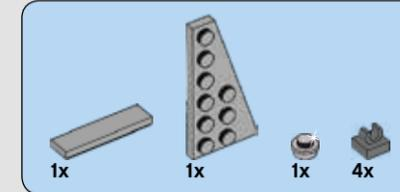
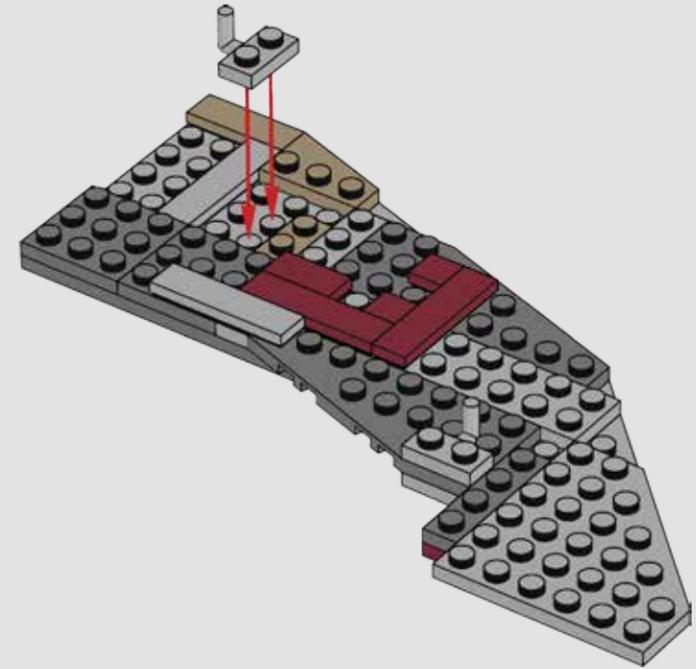

356

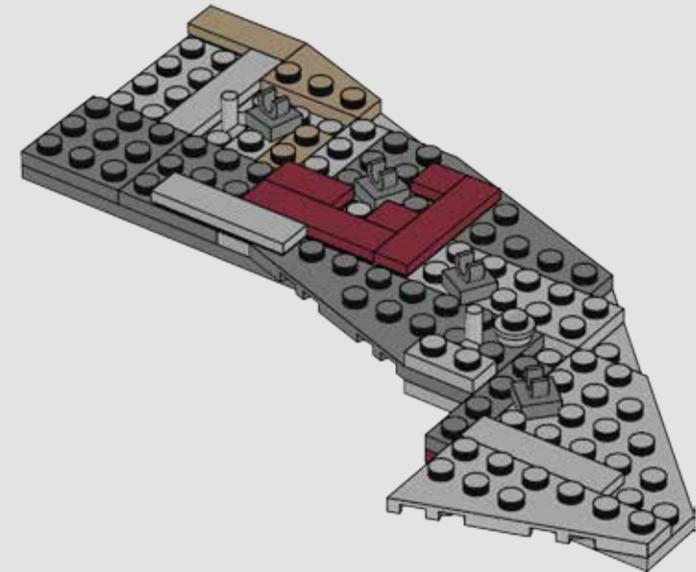

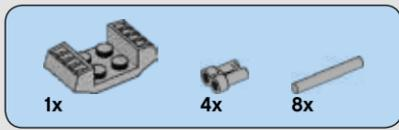

357

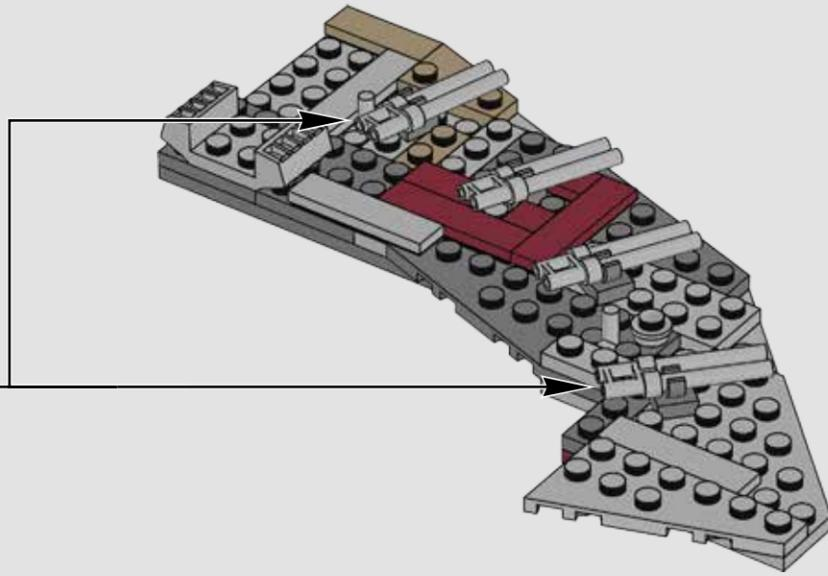
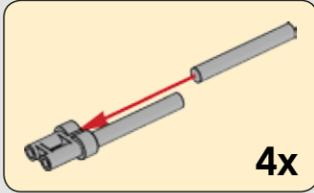

358

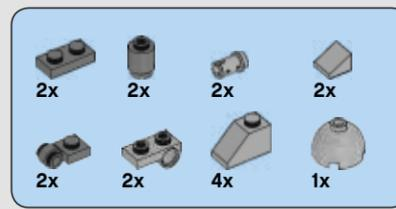
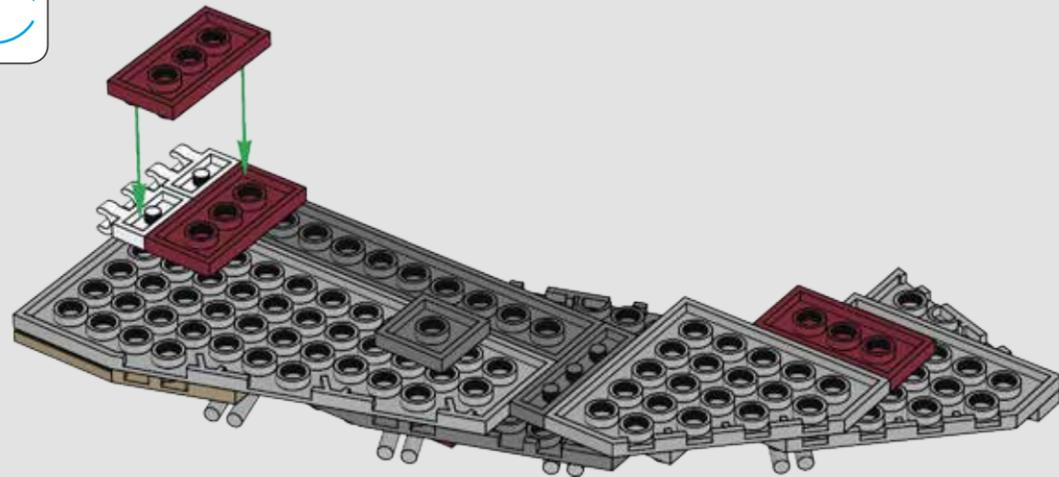

359

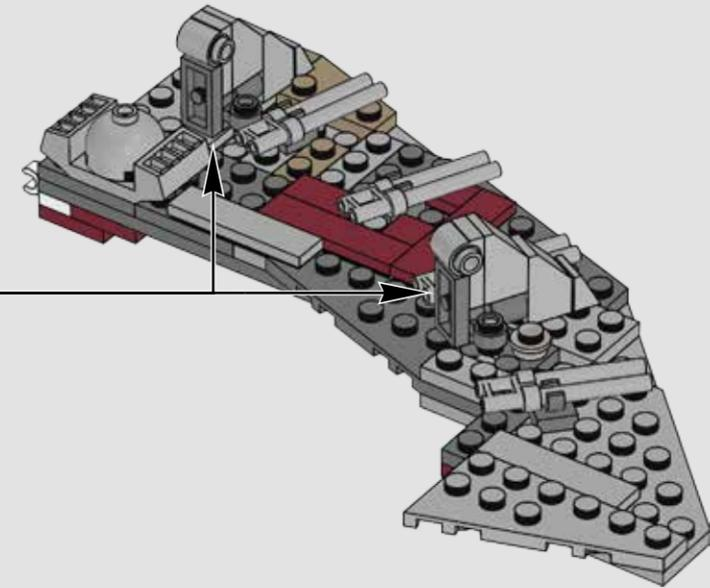
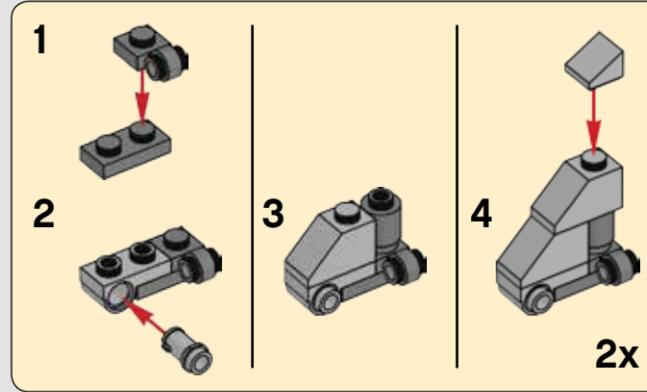

360

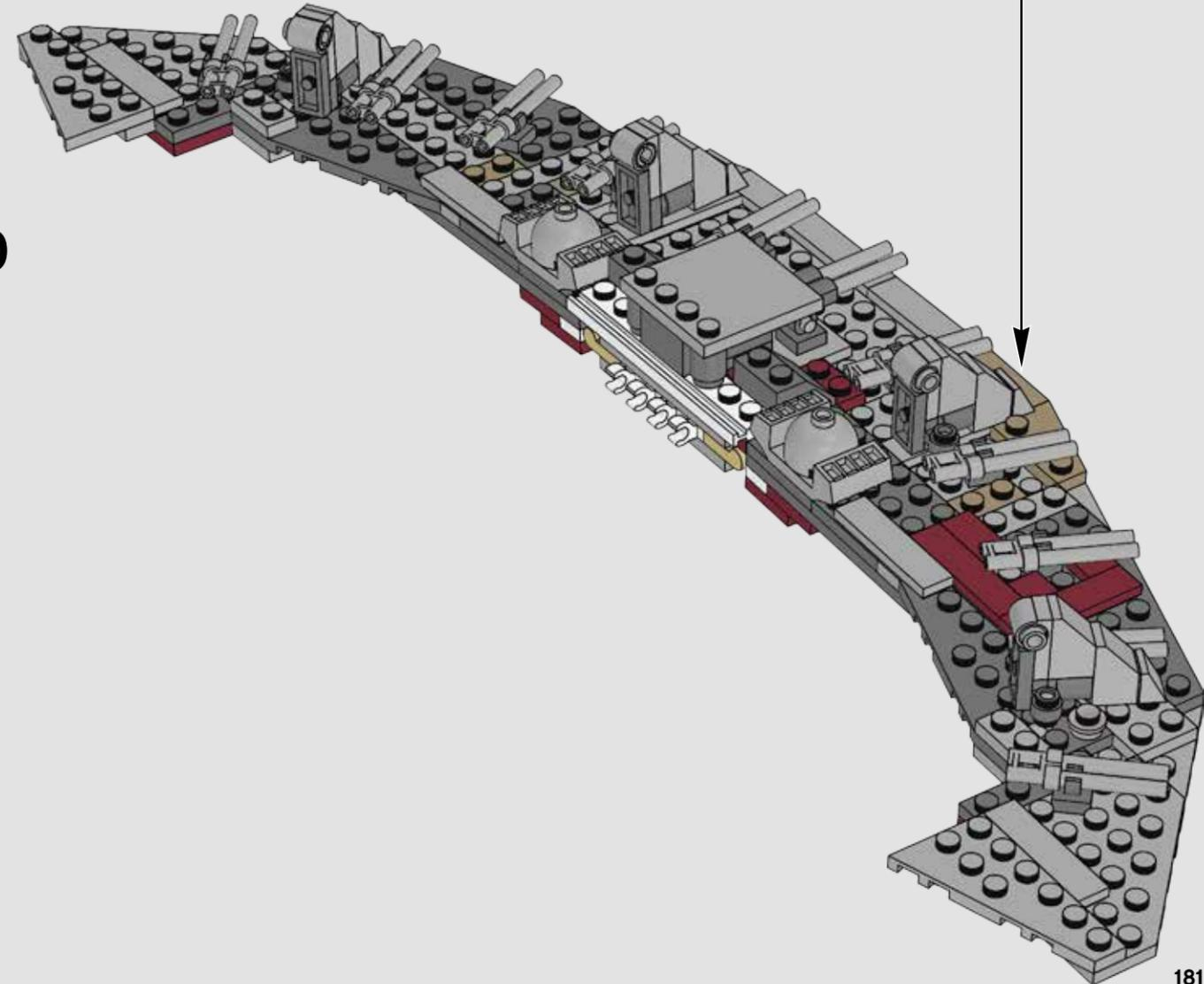

361

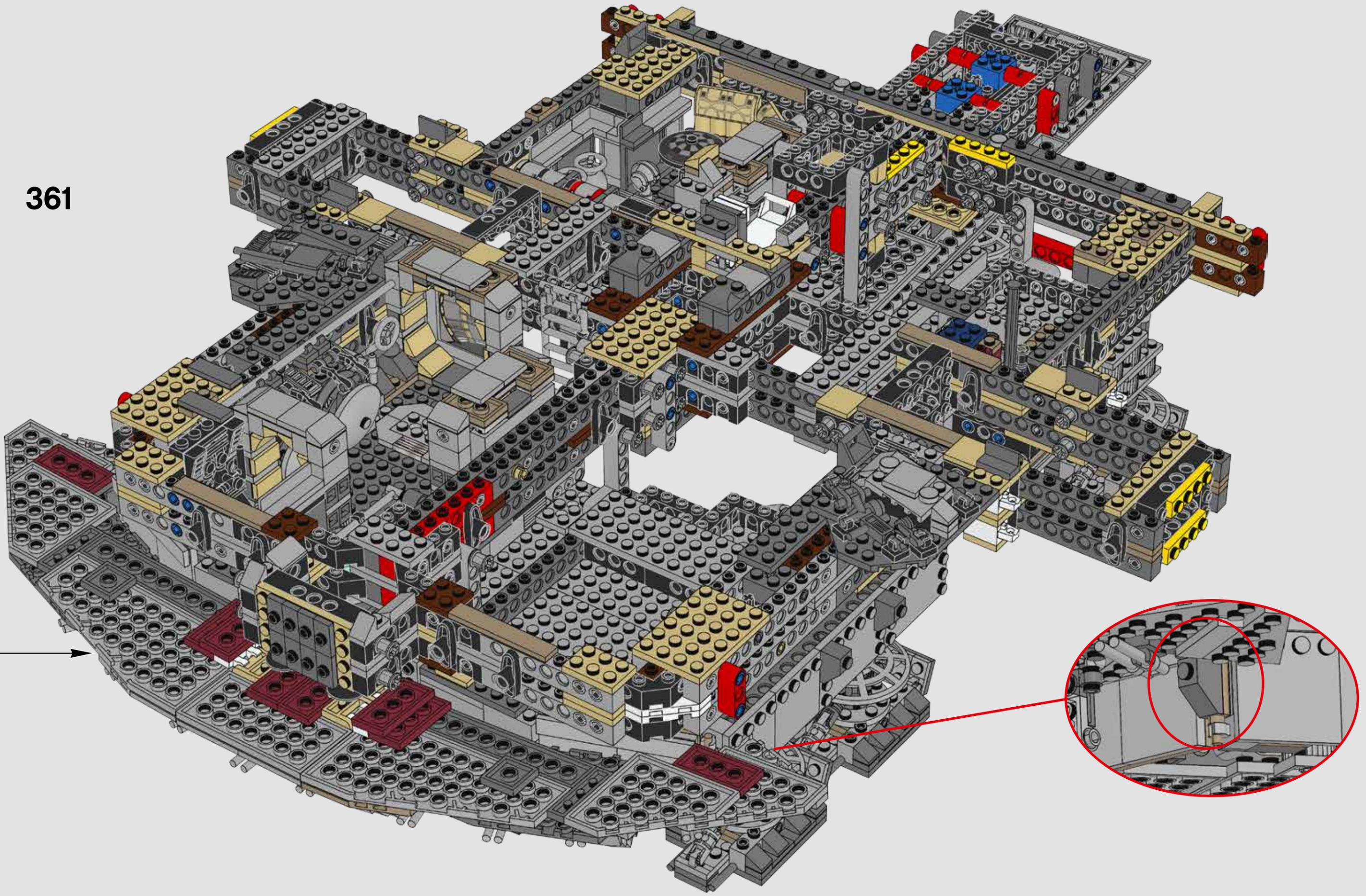

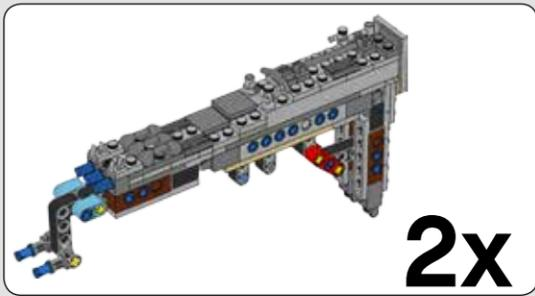

2x

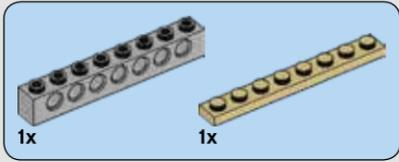

362

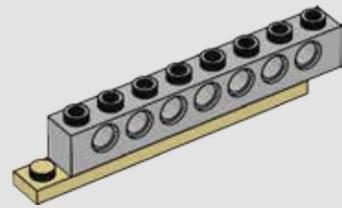

363

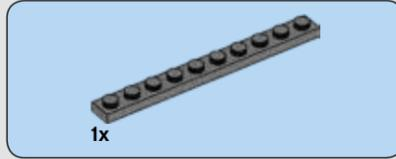
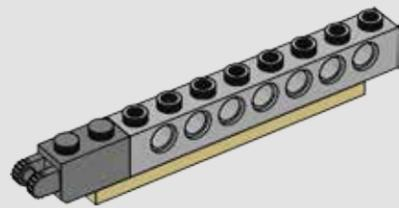

364

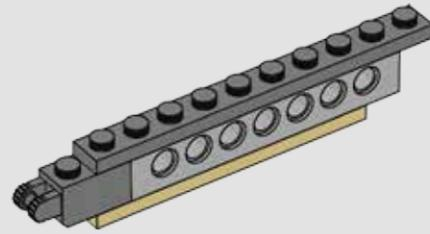

365

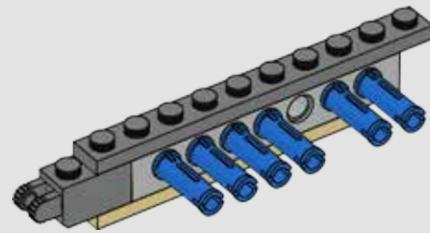

366

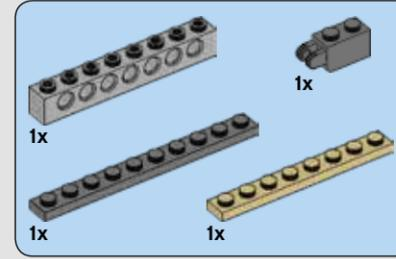
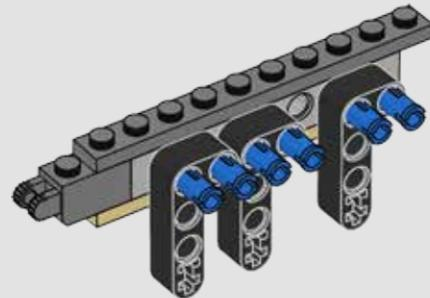

367

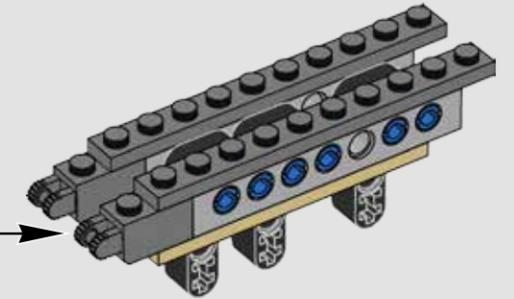
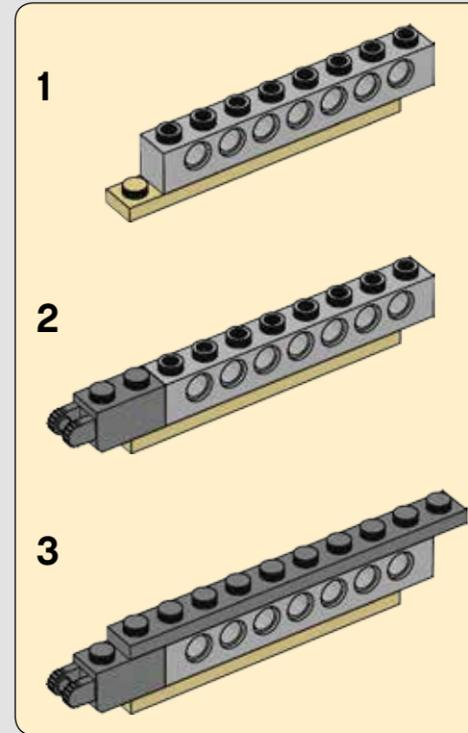

368

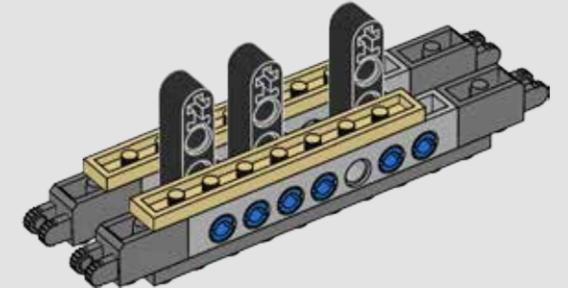



369

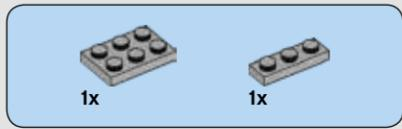
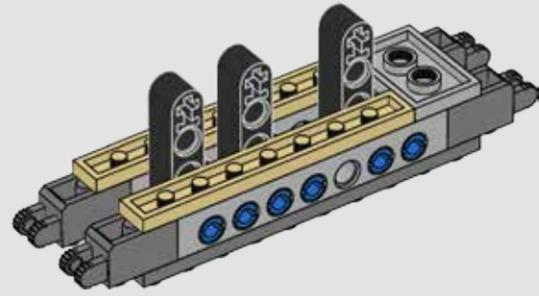

370

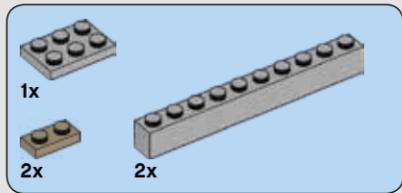
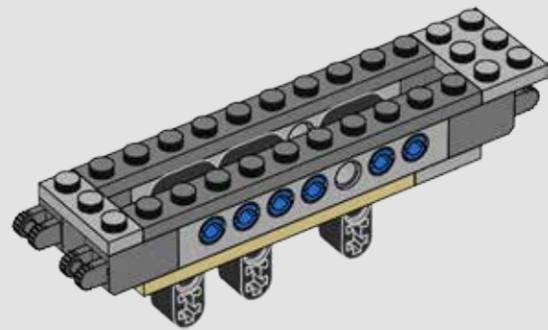

371

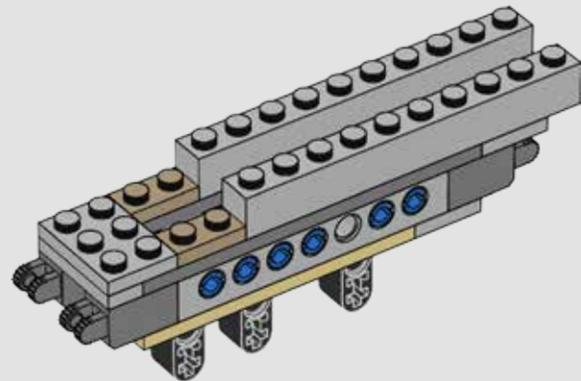

372

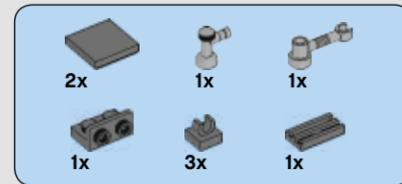
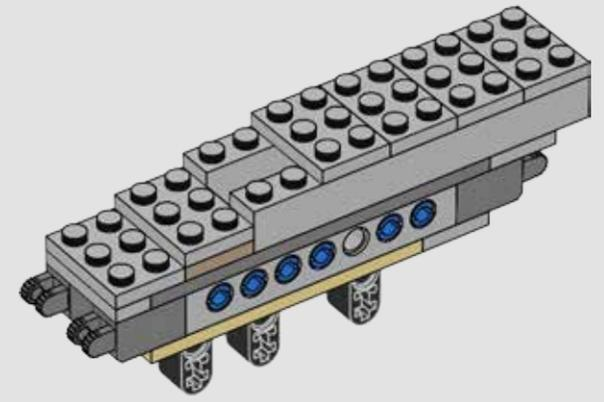

373

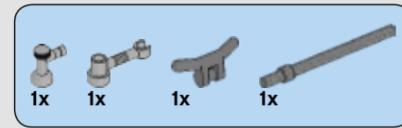
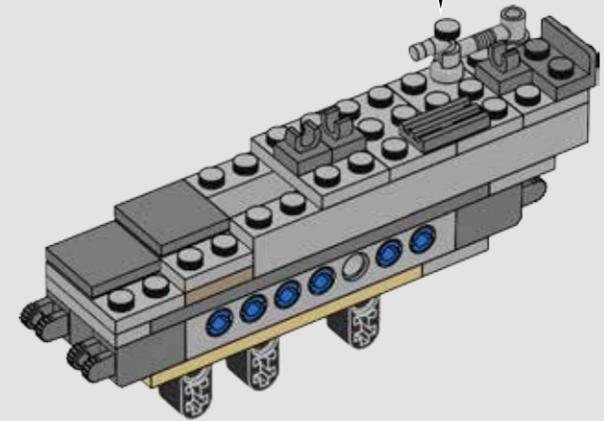
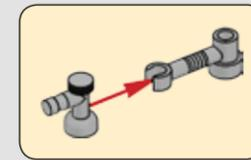

374

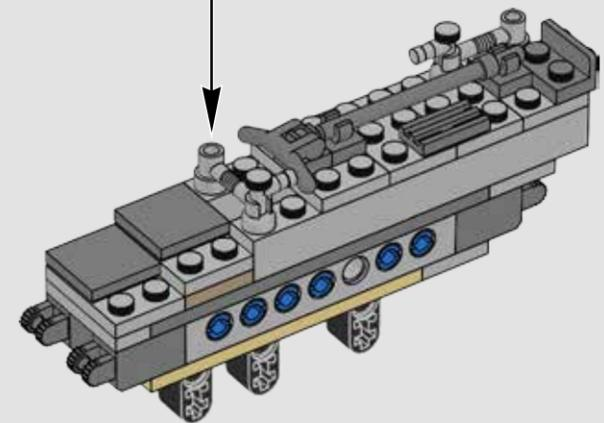
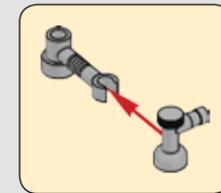

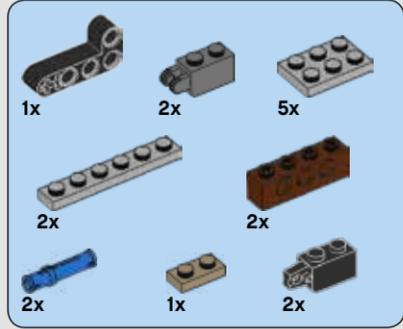

375

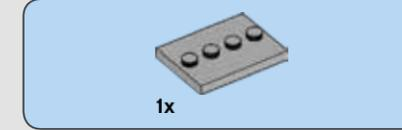
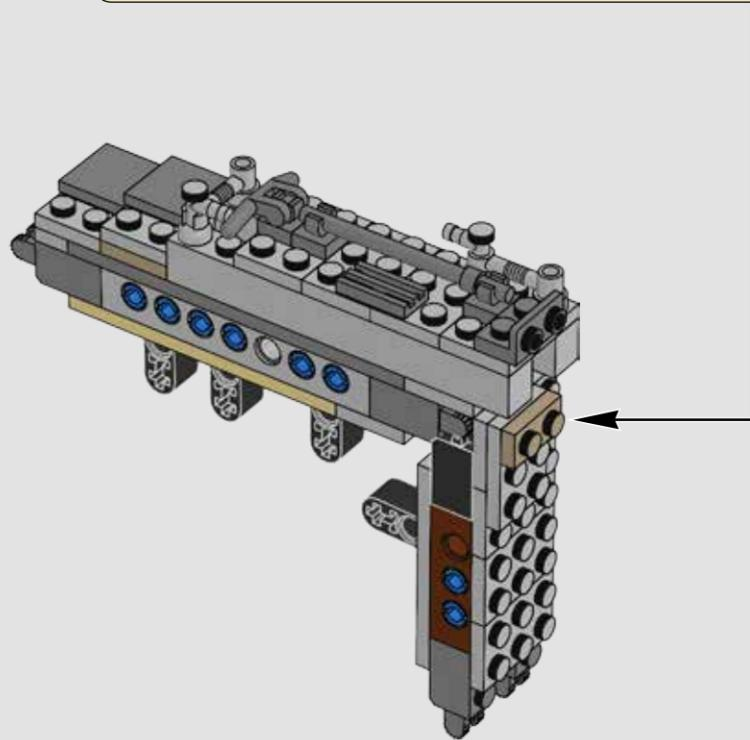
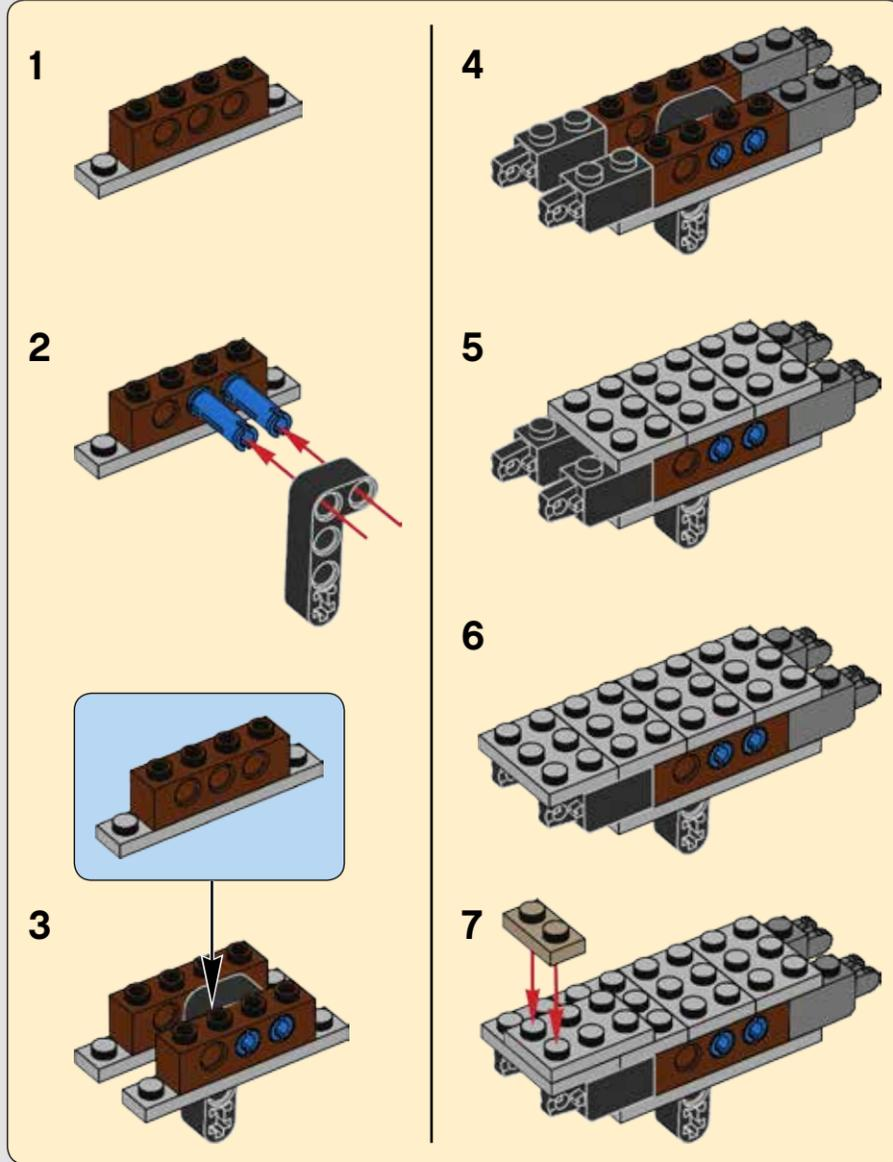

376

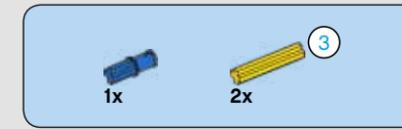

377

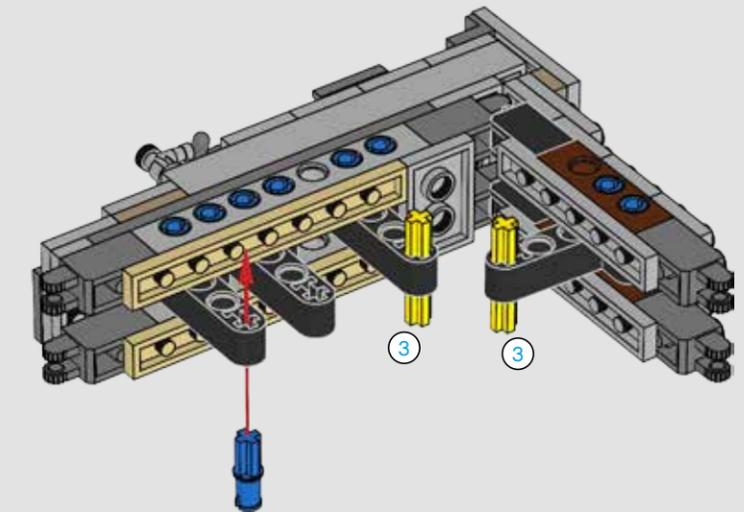

378

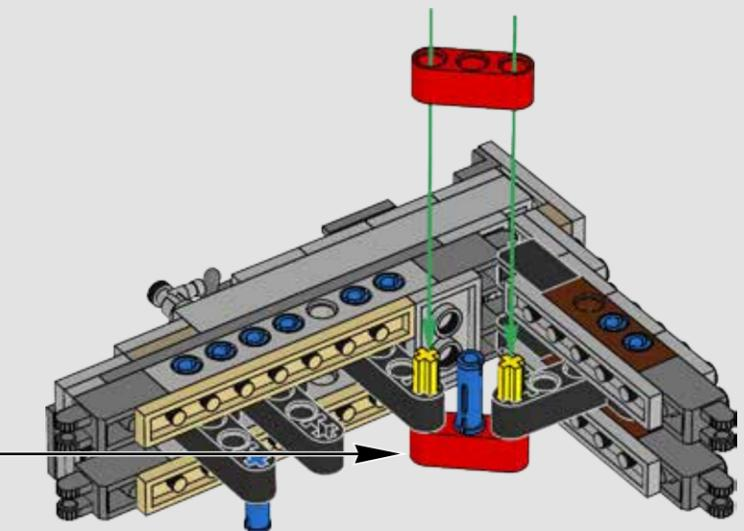
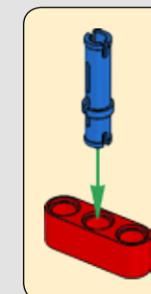



379

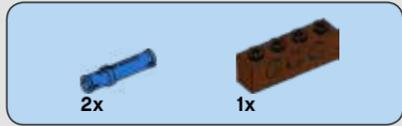
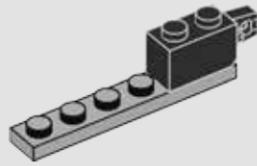

380

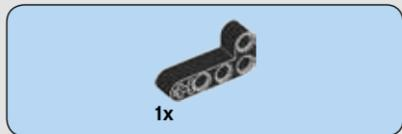
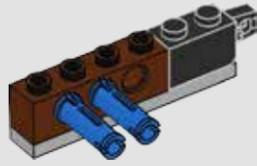

381

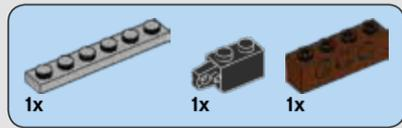
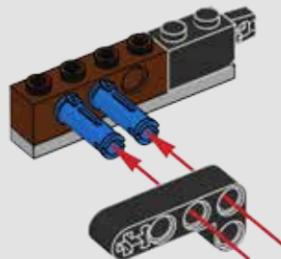

382

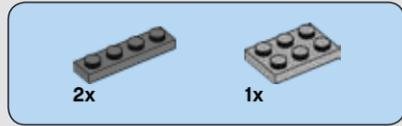
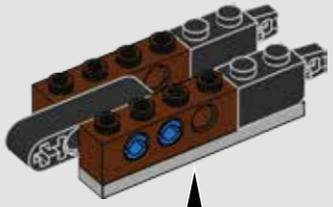
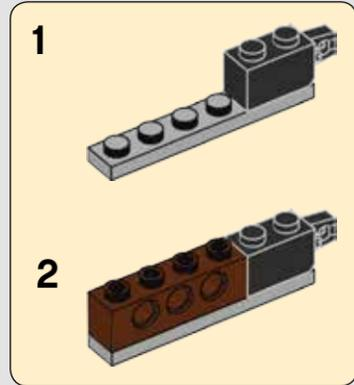

383

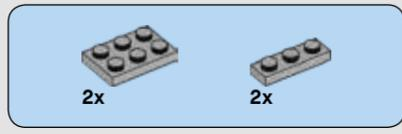
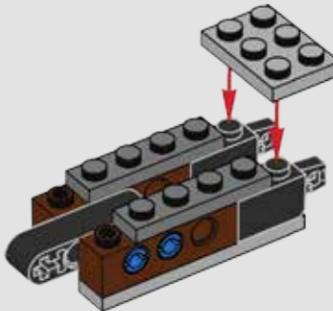

384

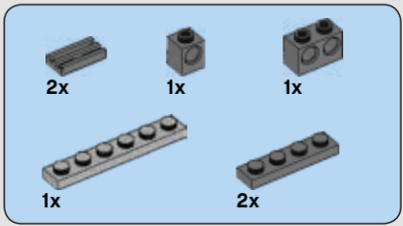
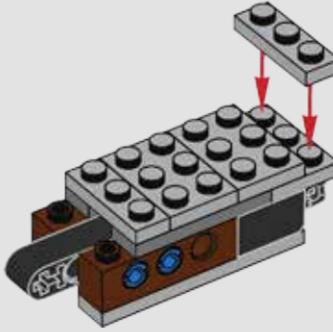

385

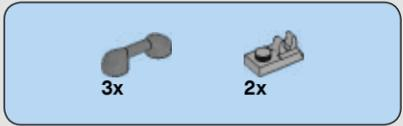
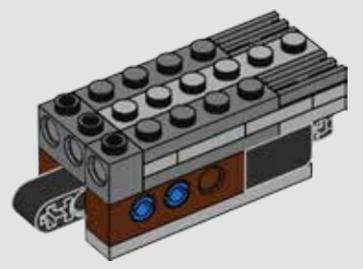

386

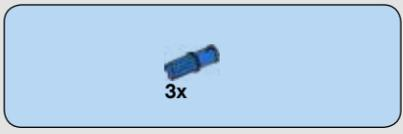
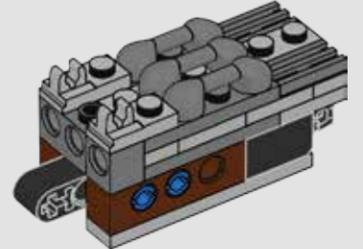

387

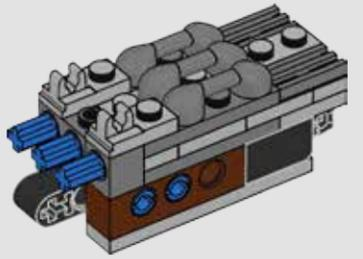

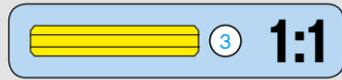
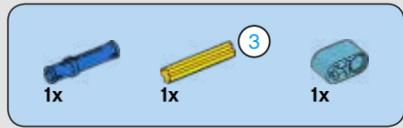

388

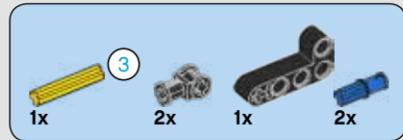
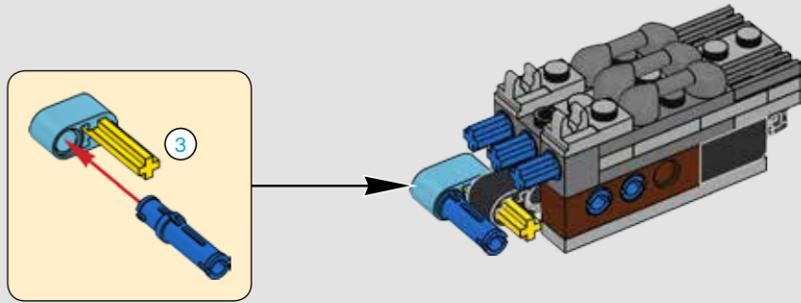

389

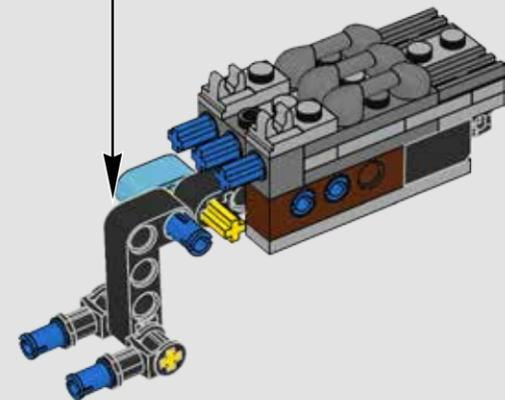
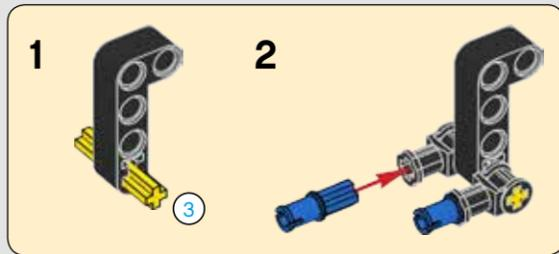

390

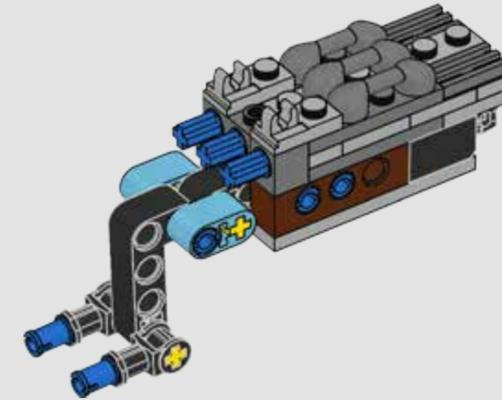

391

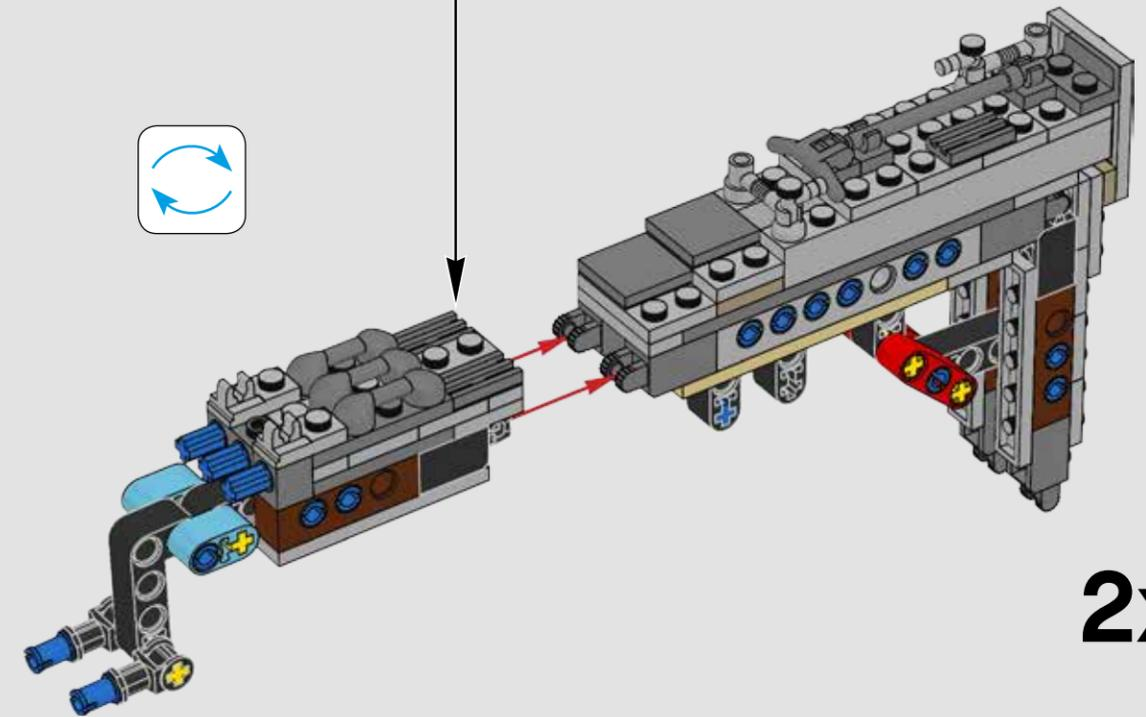

2x

392

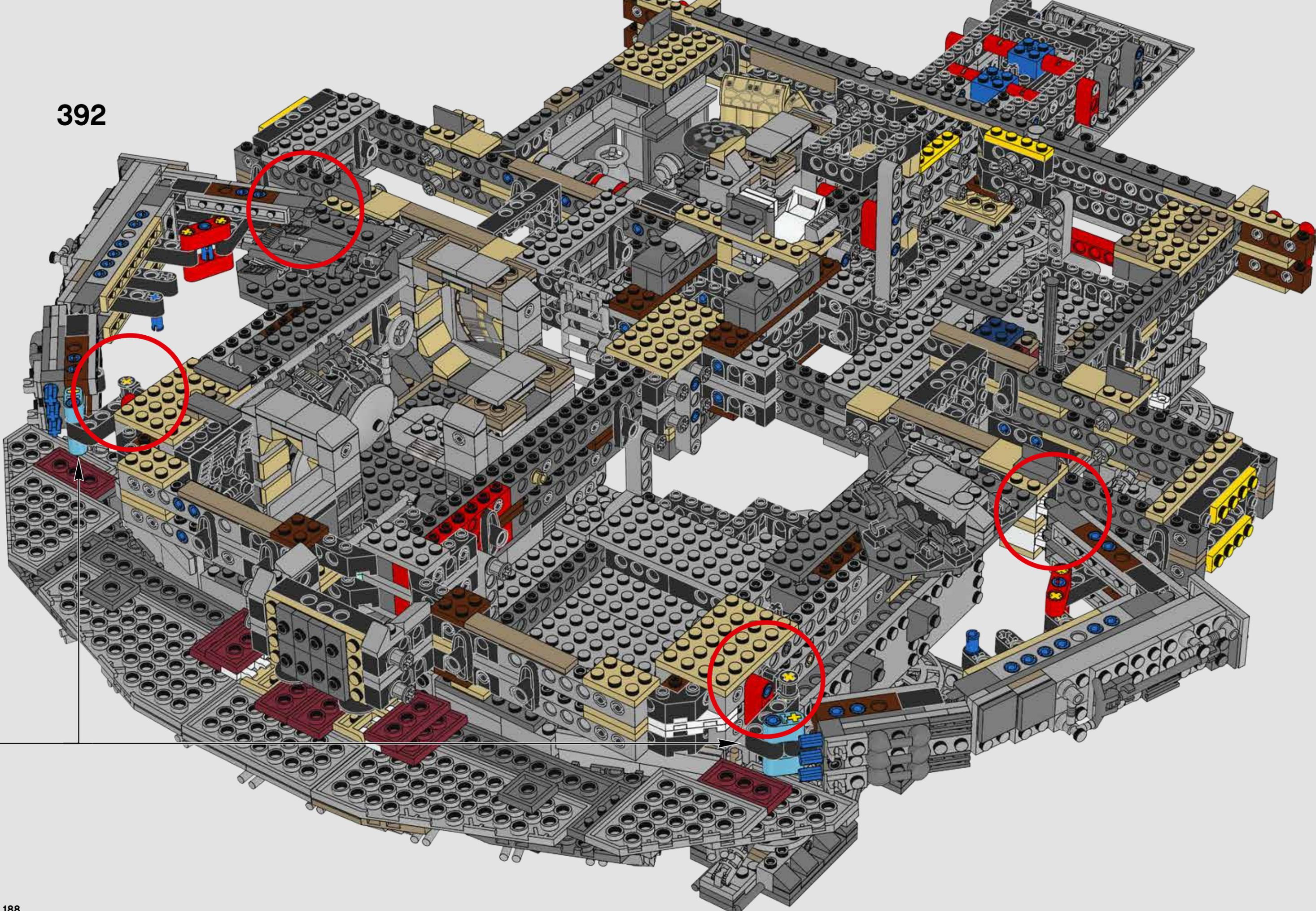

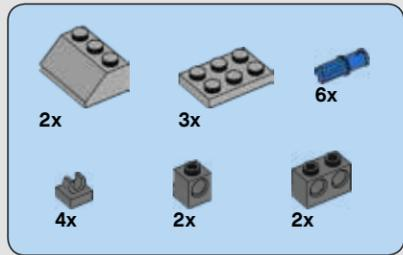

393

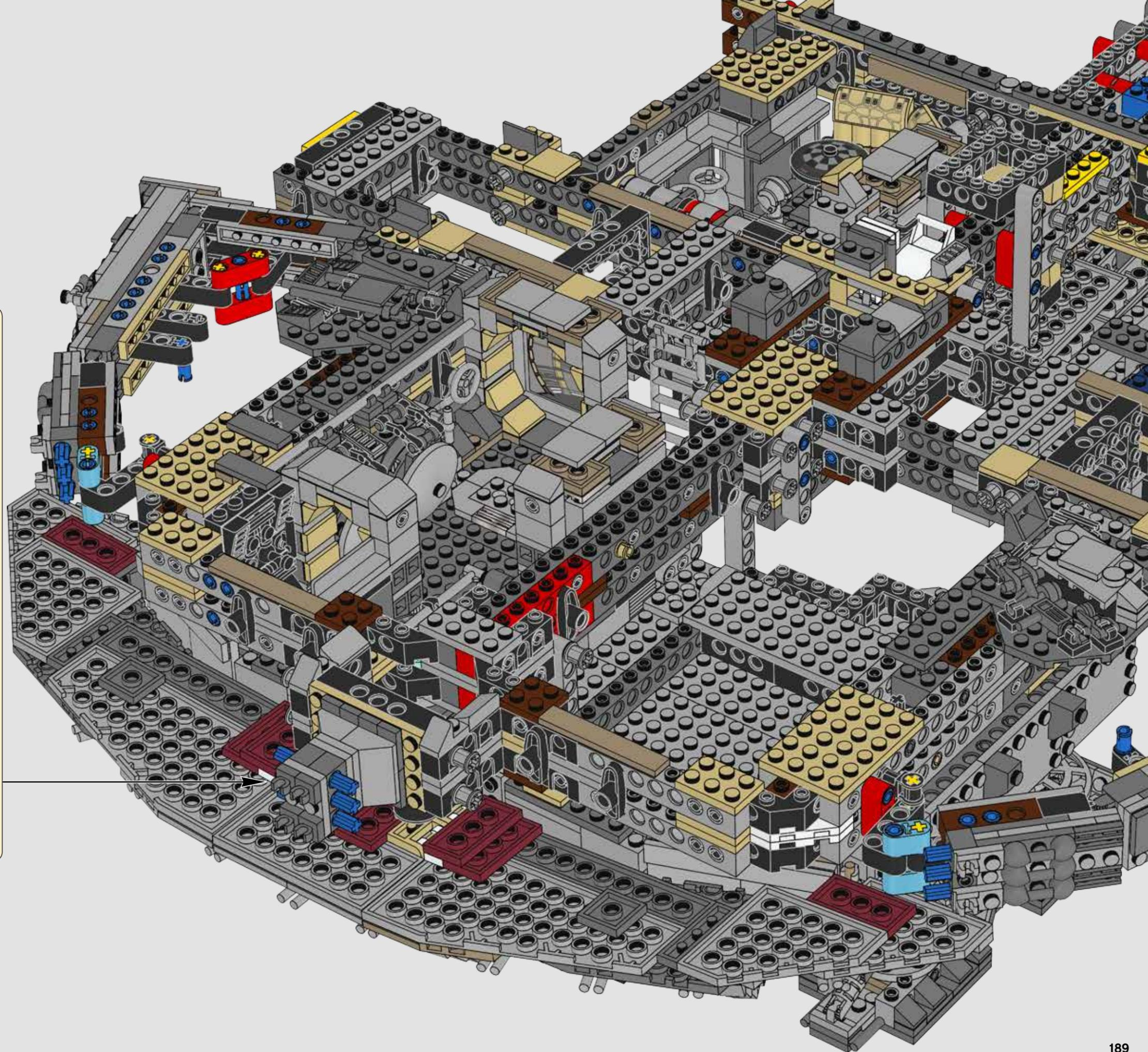
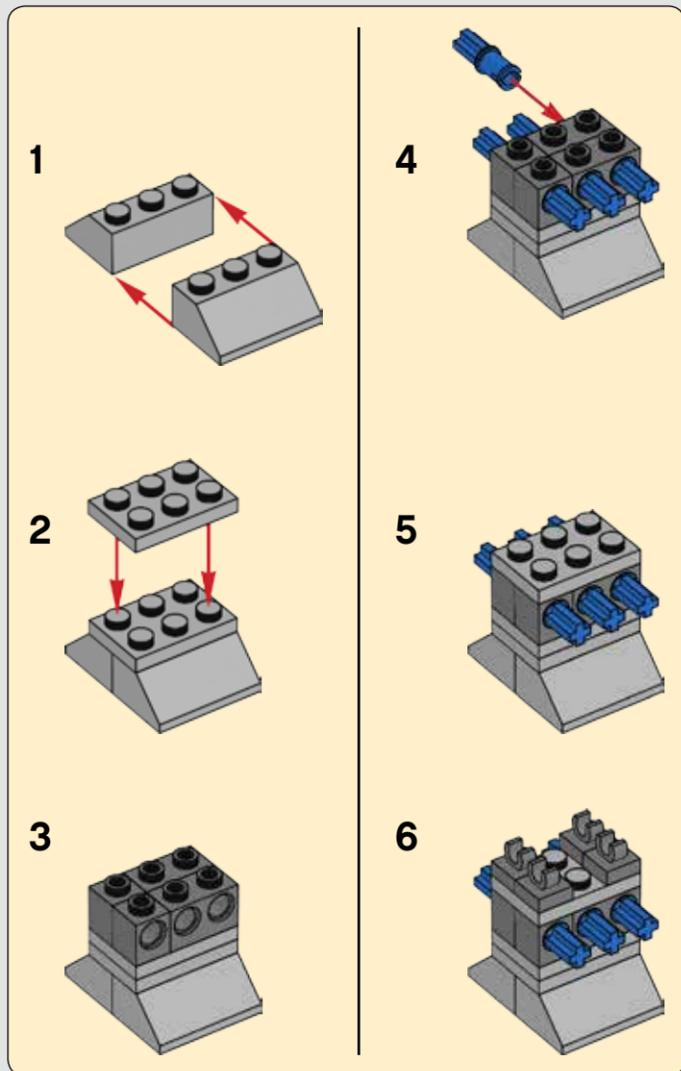

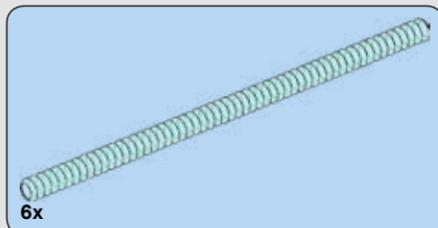

394

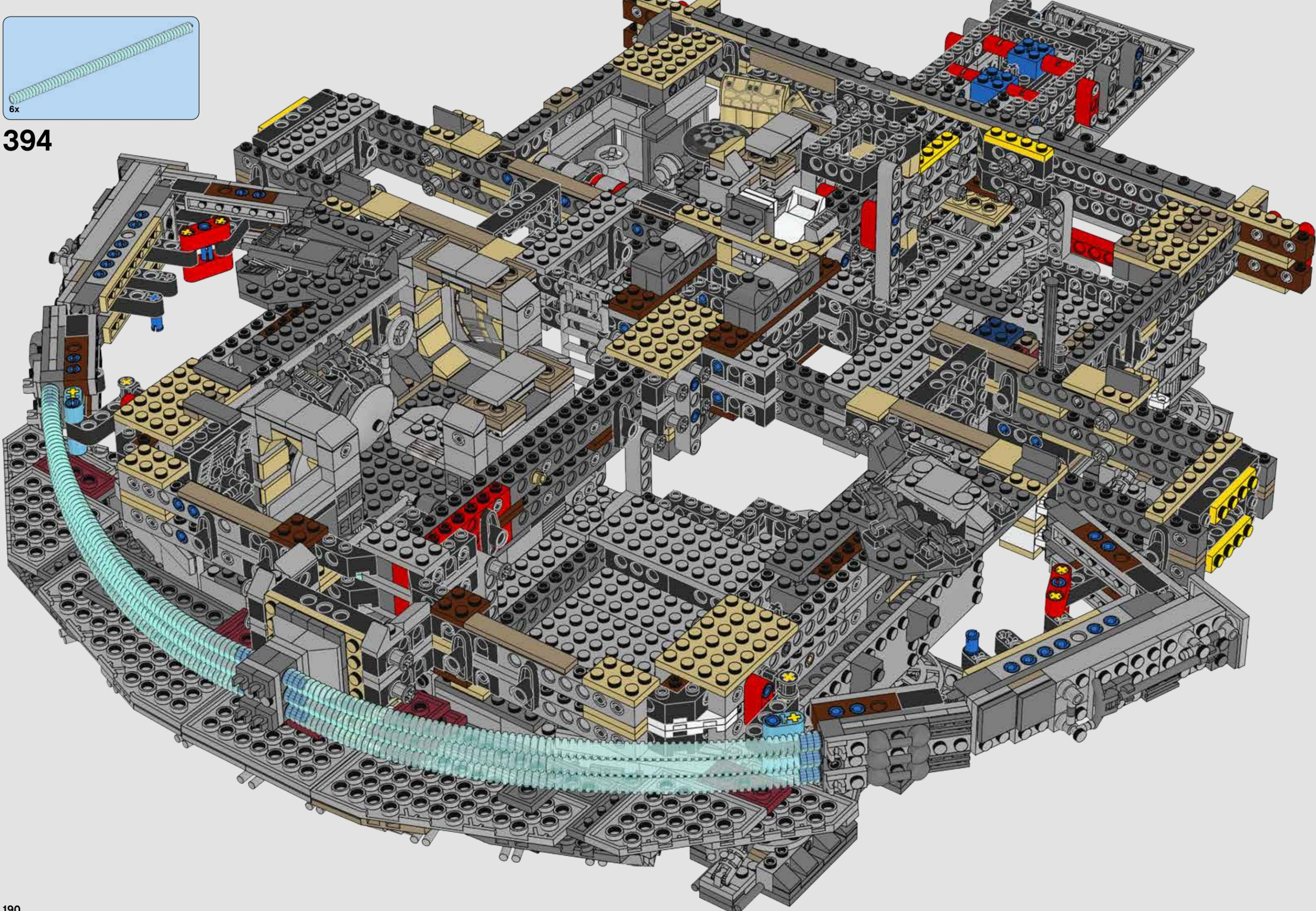

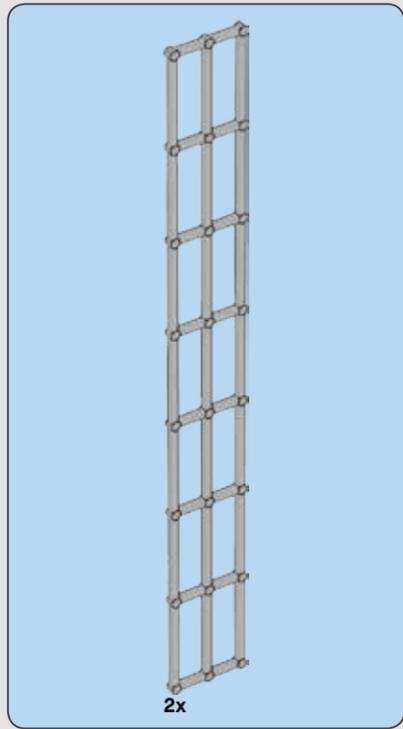

395



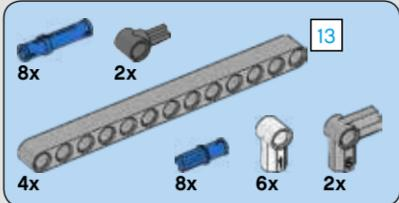
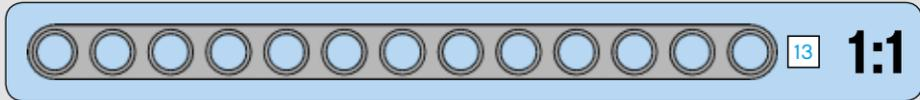
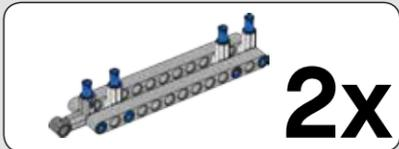
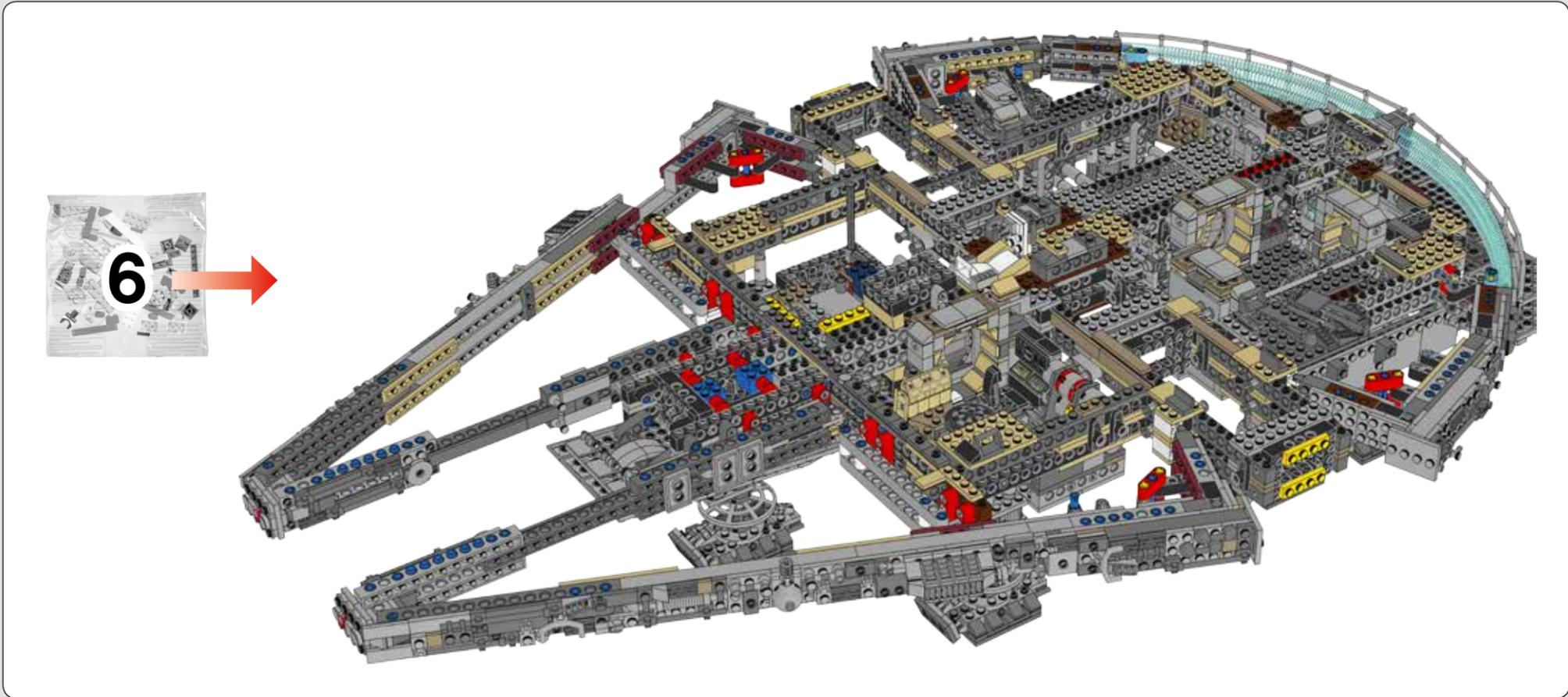

396

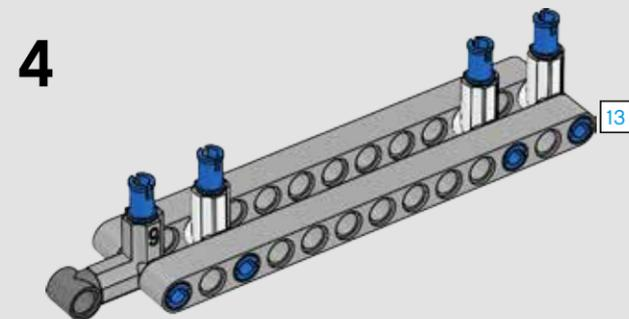
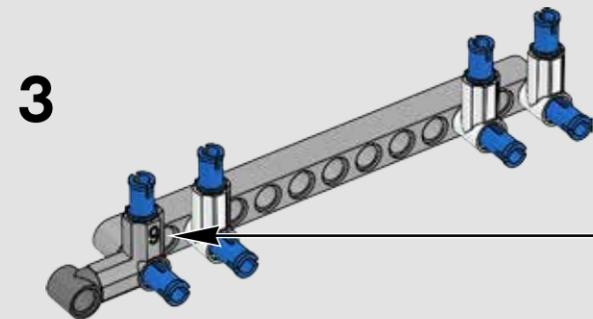
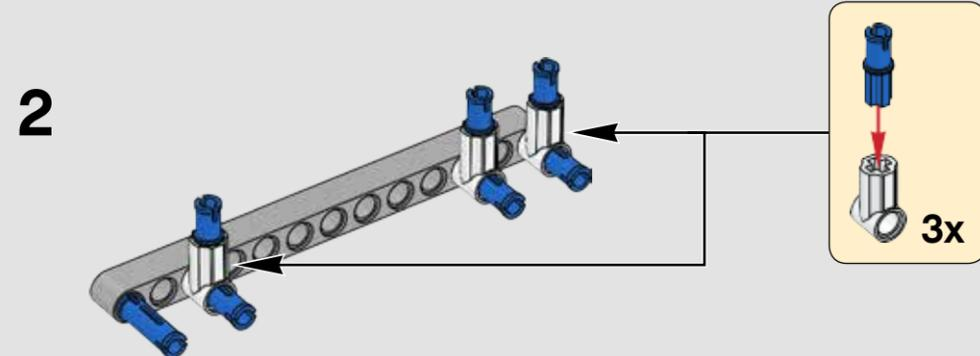
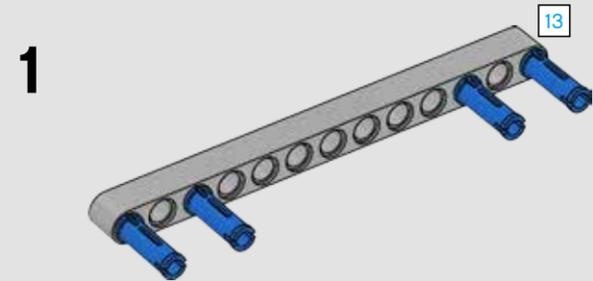

2x

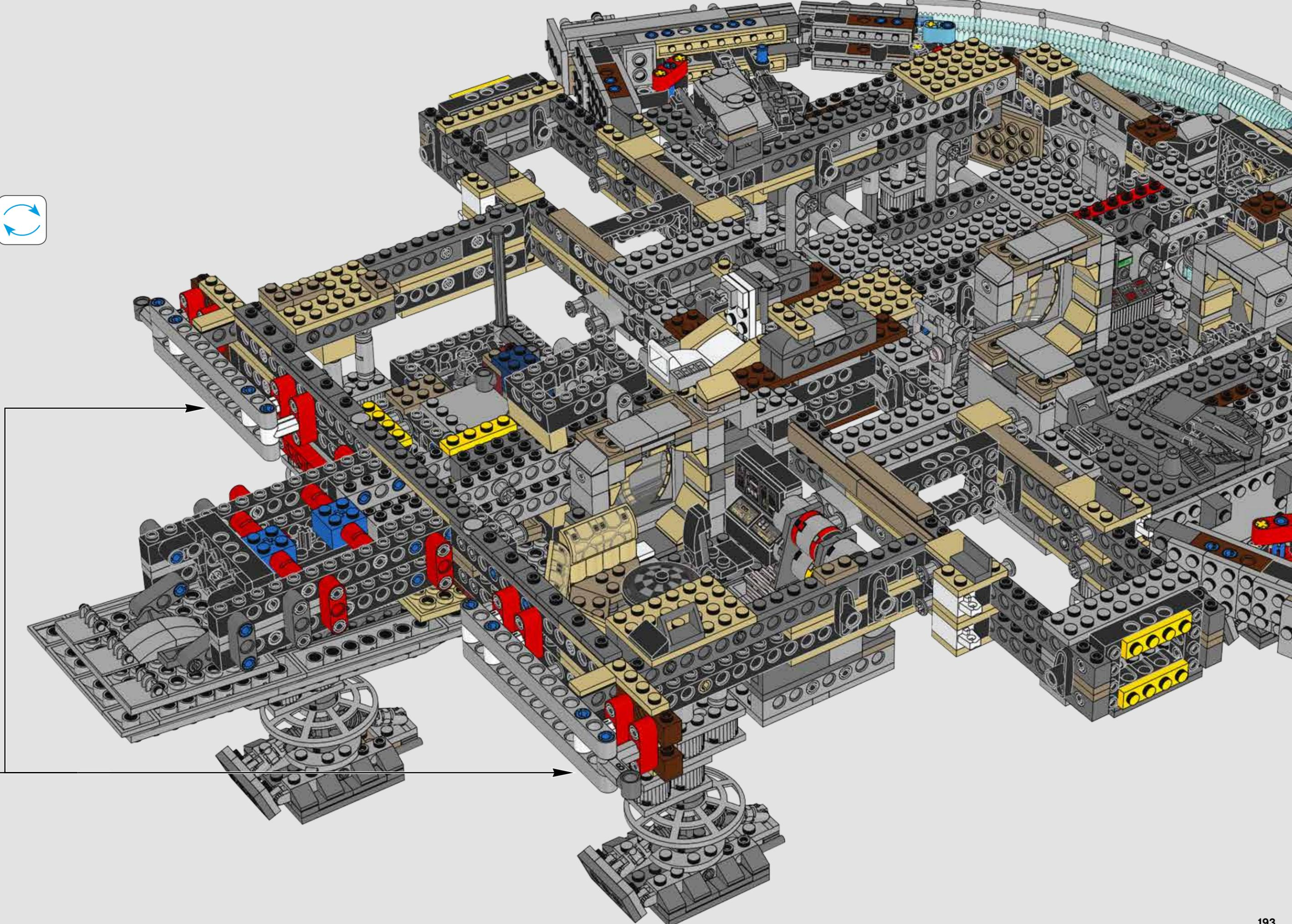

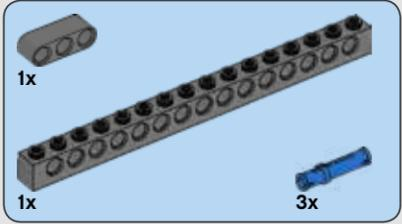
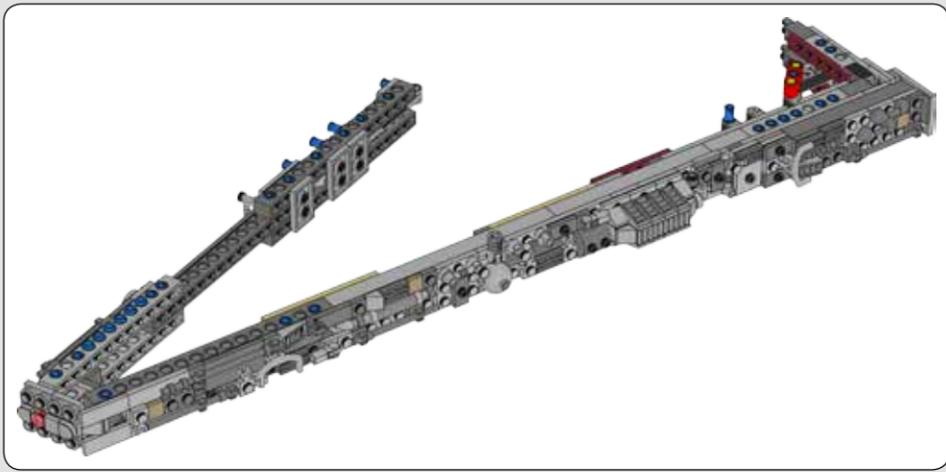

397

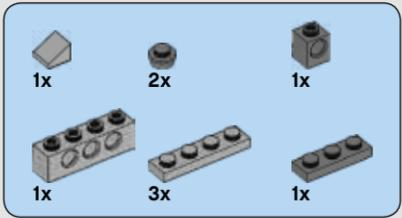
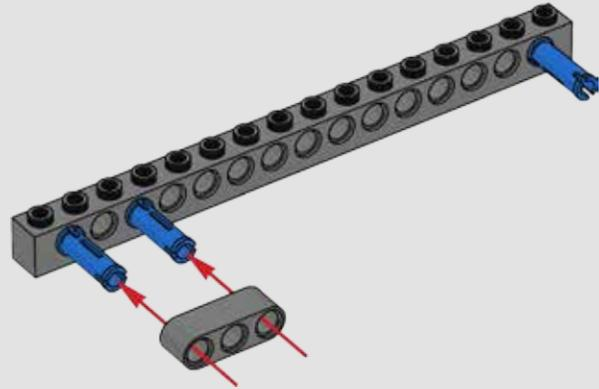

398

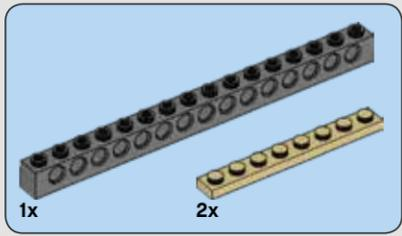
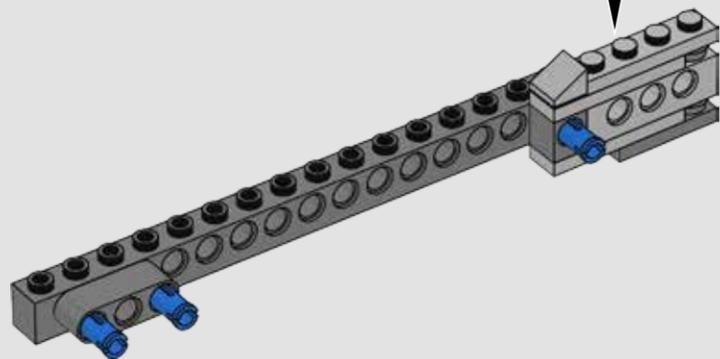
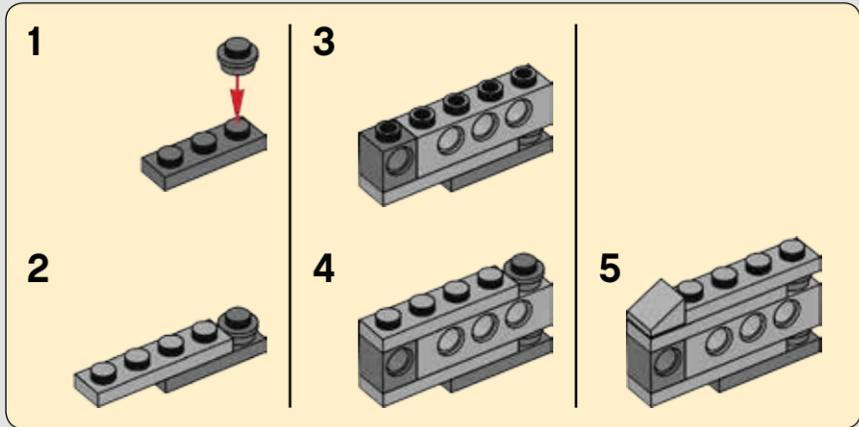

399

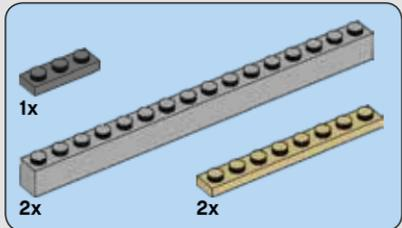

400

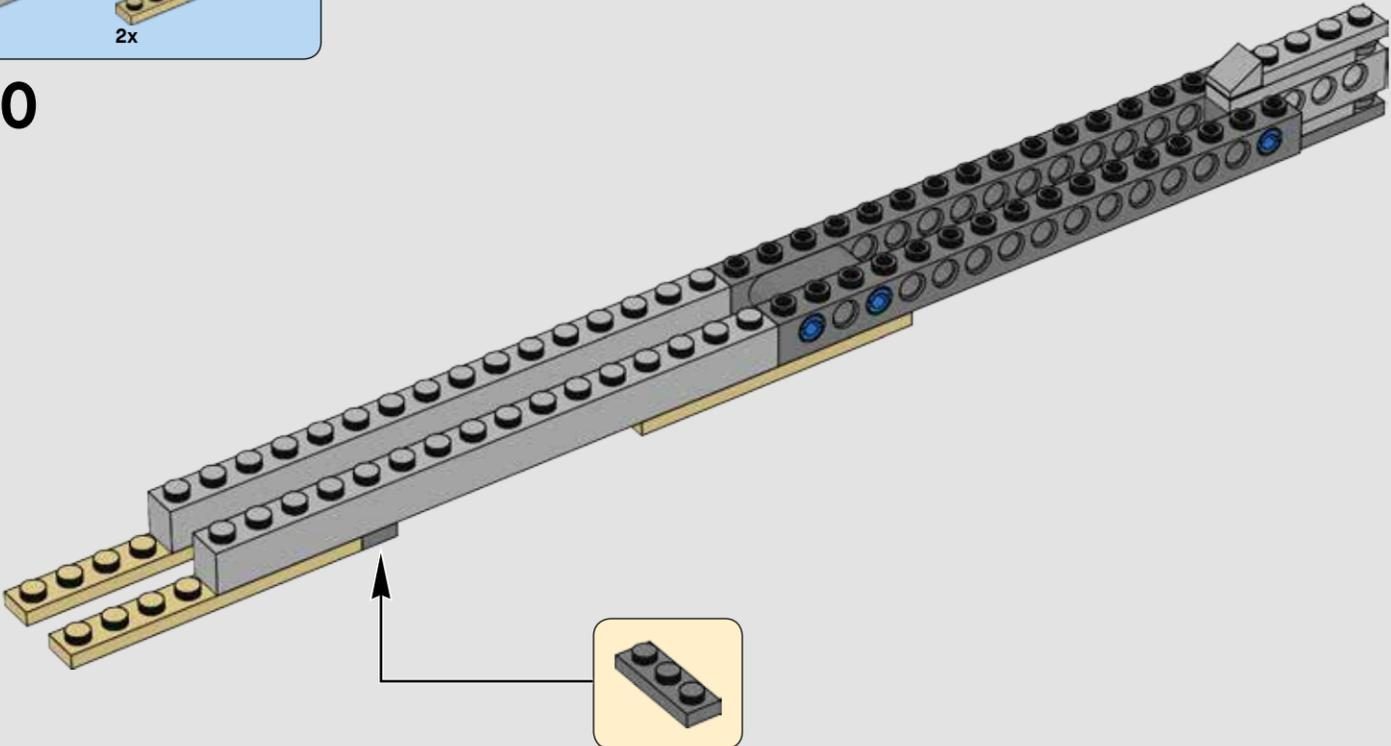

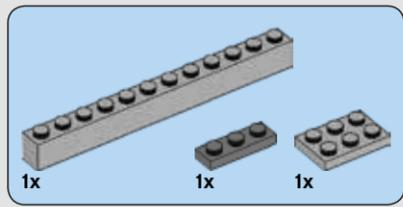

401

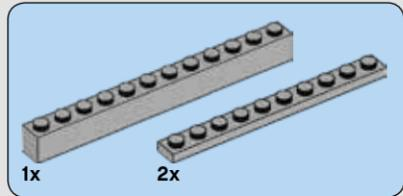
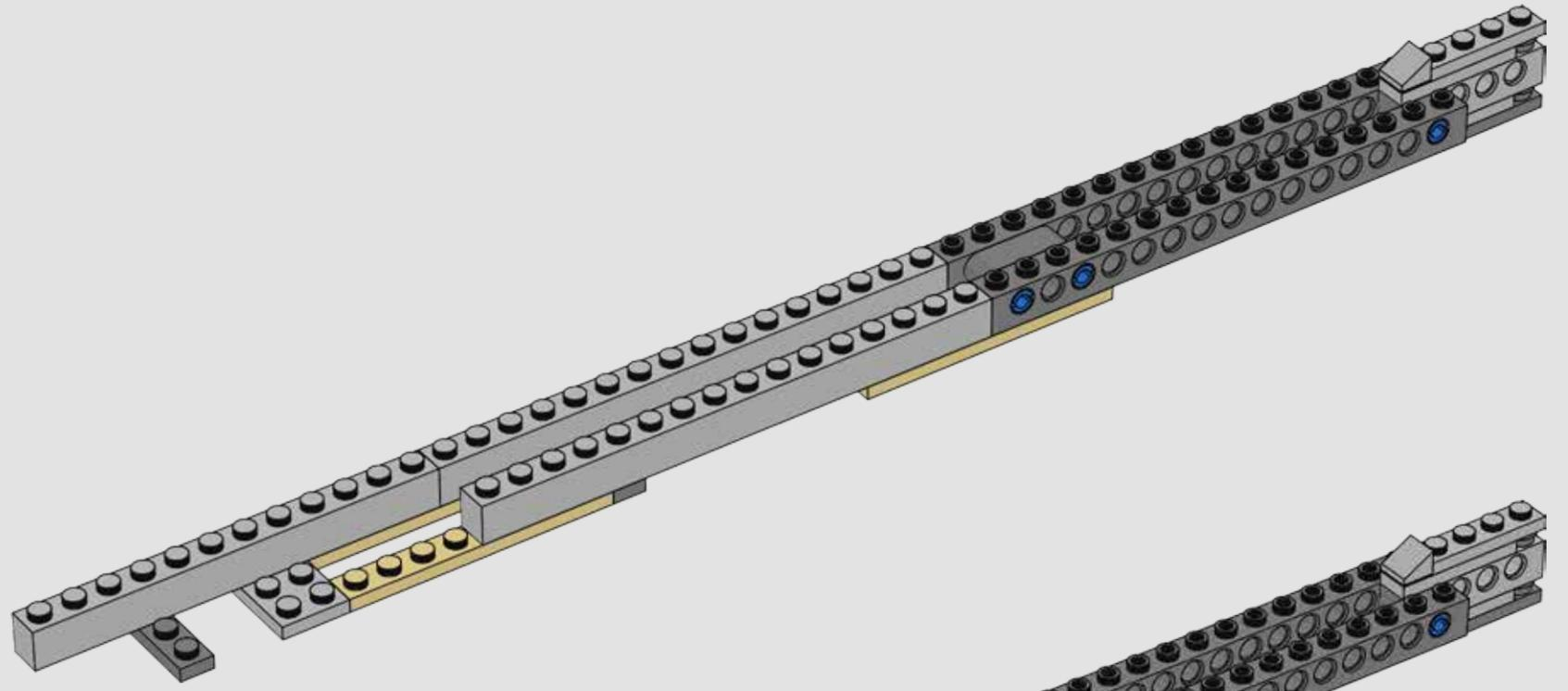

402

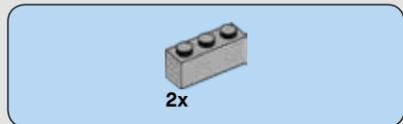
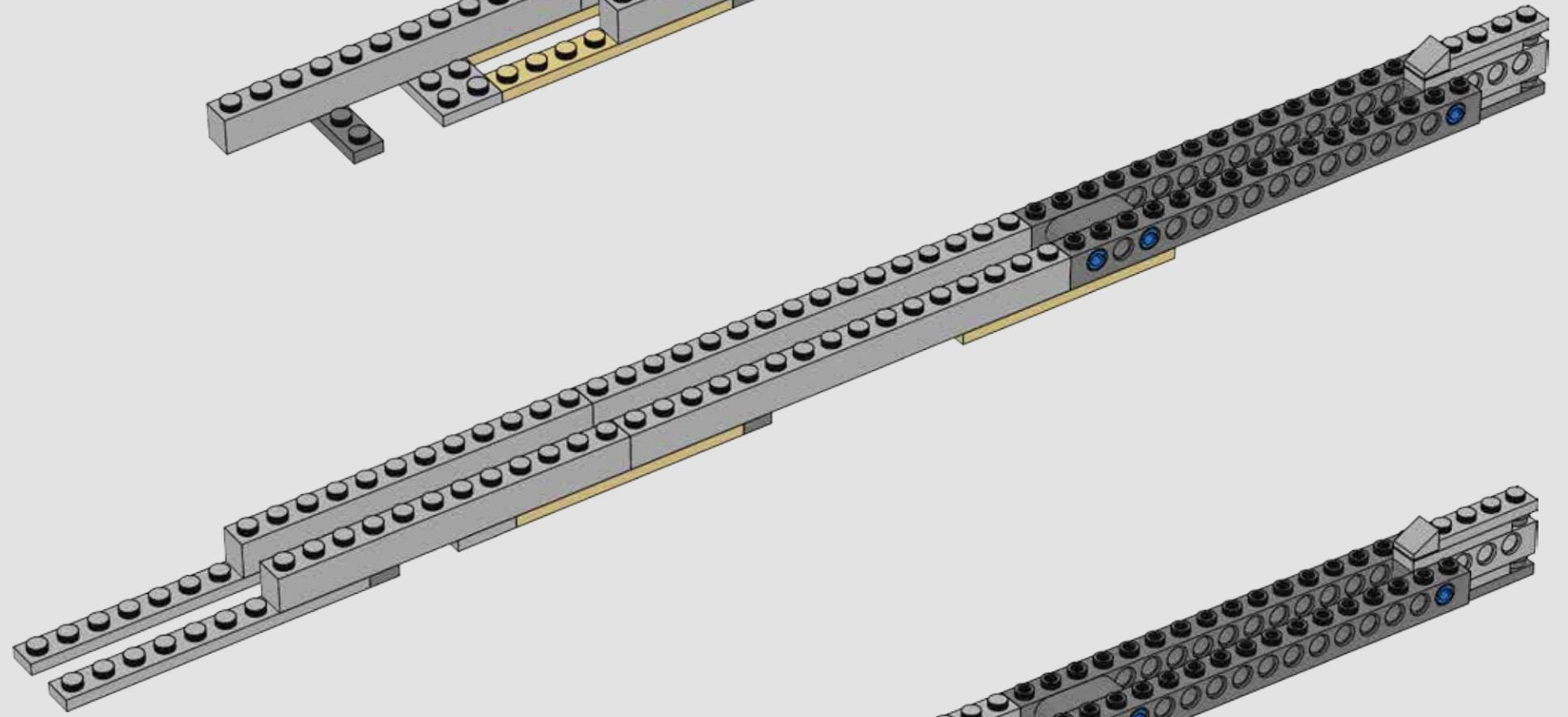

403

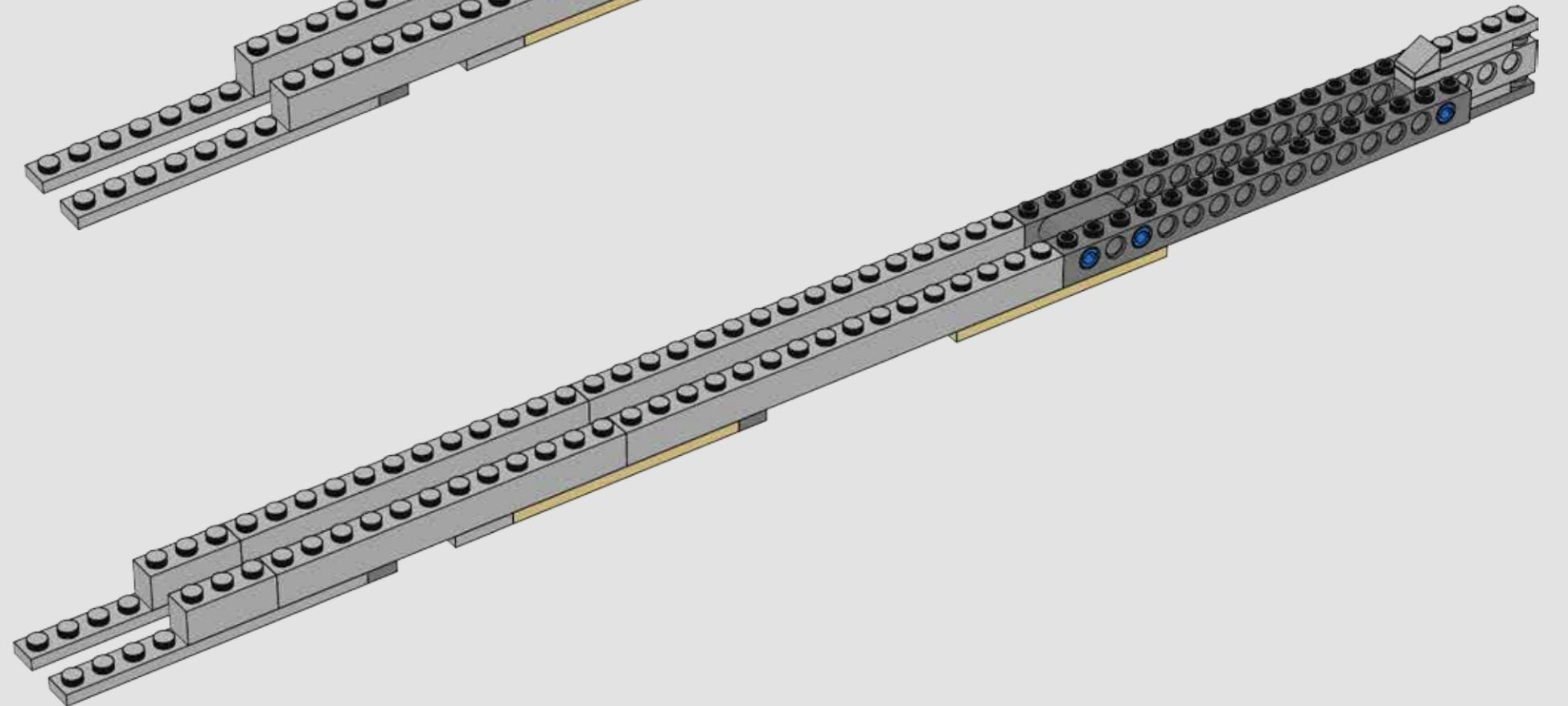

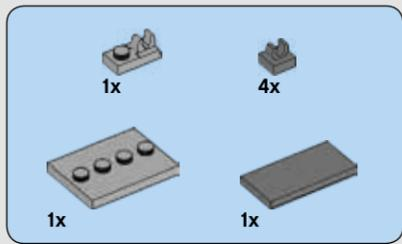

404

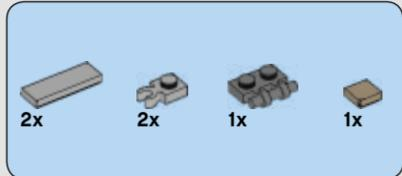
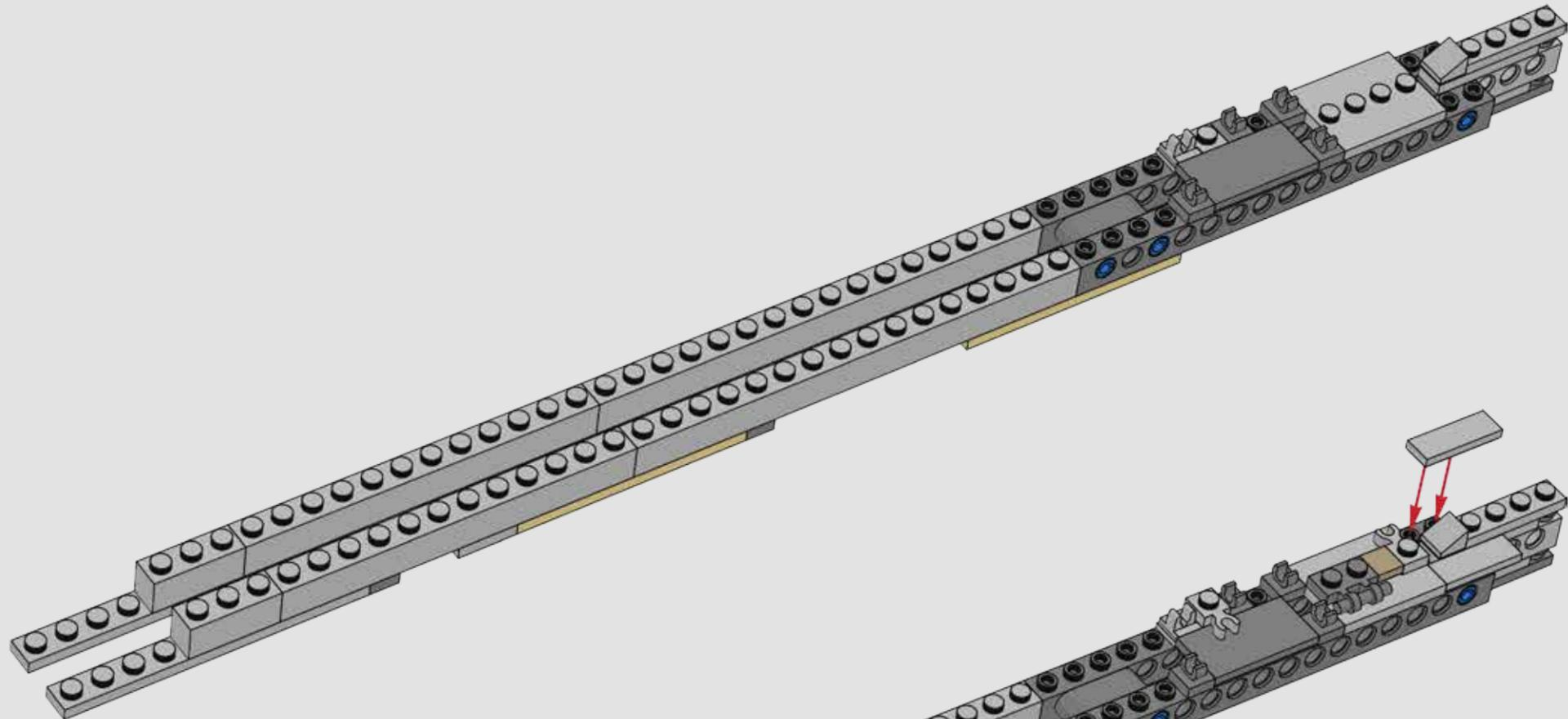

405

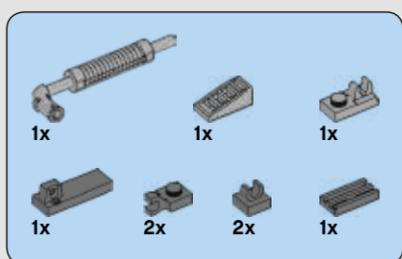
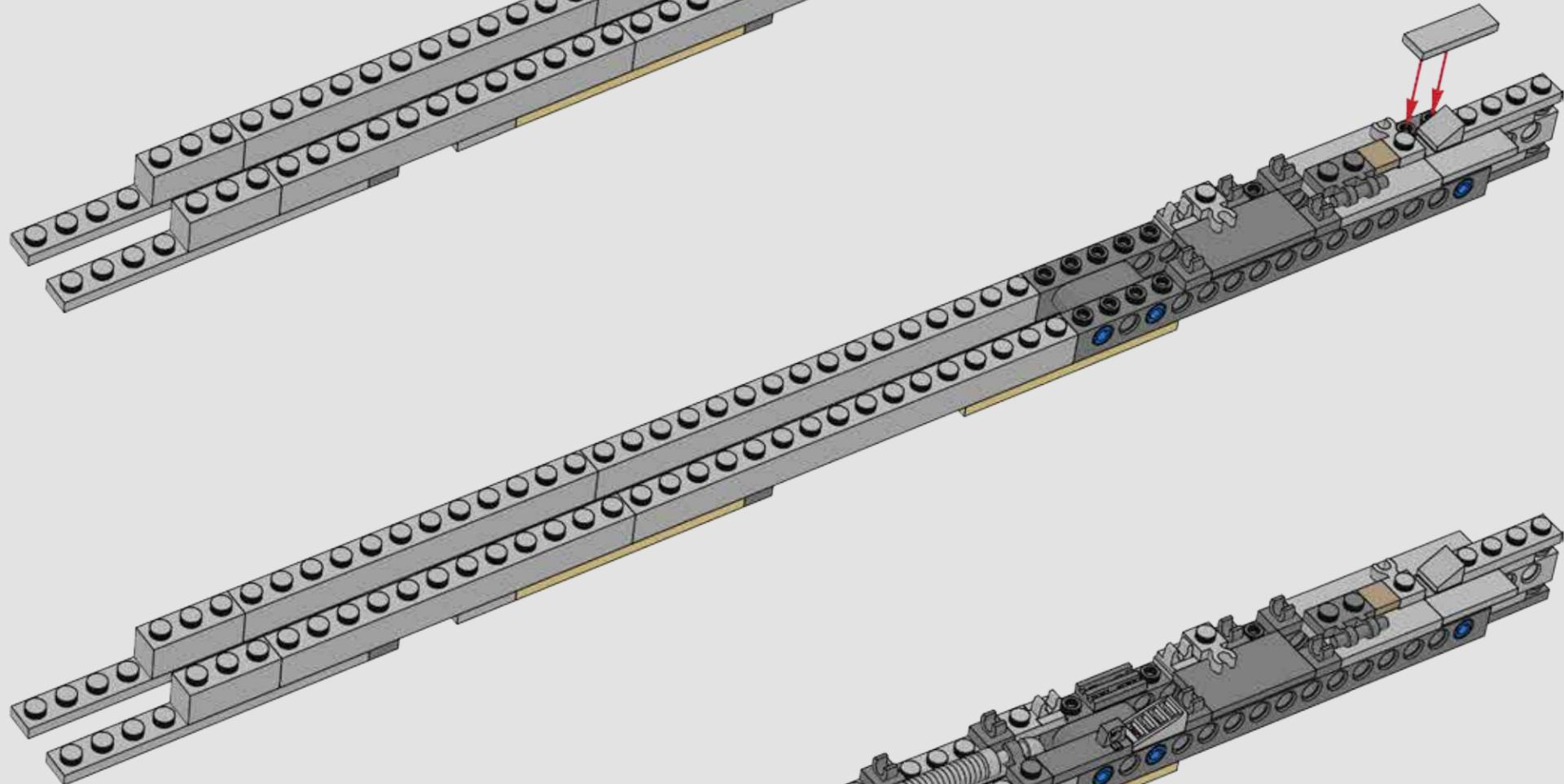

406

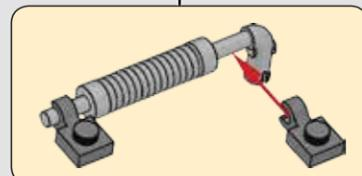
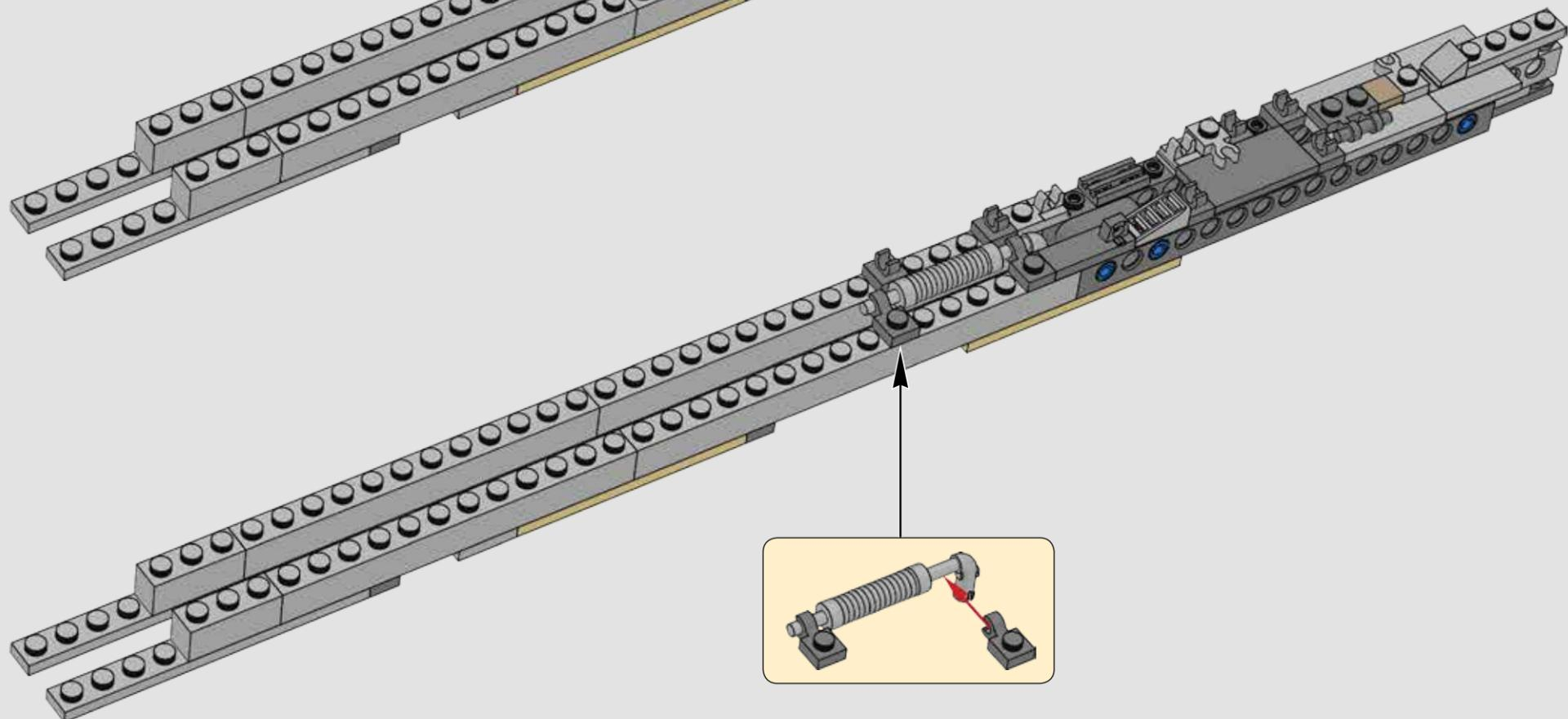

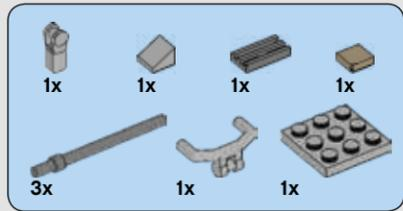

407

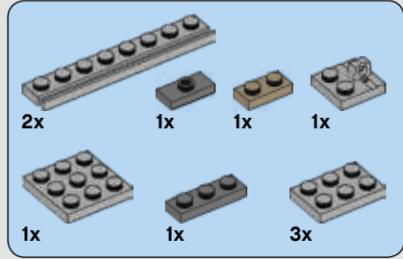
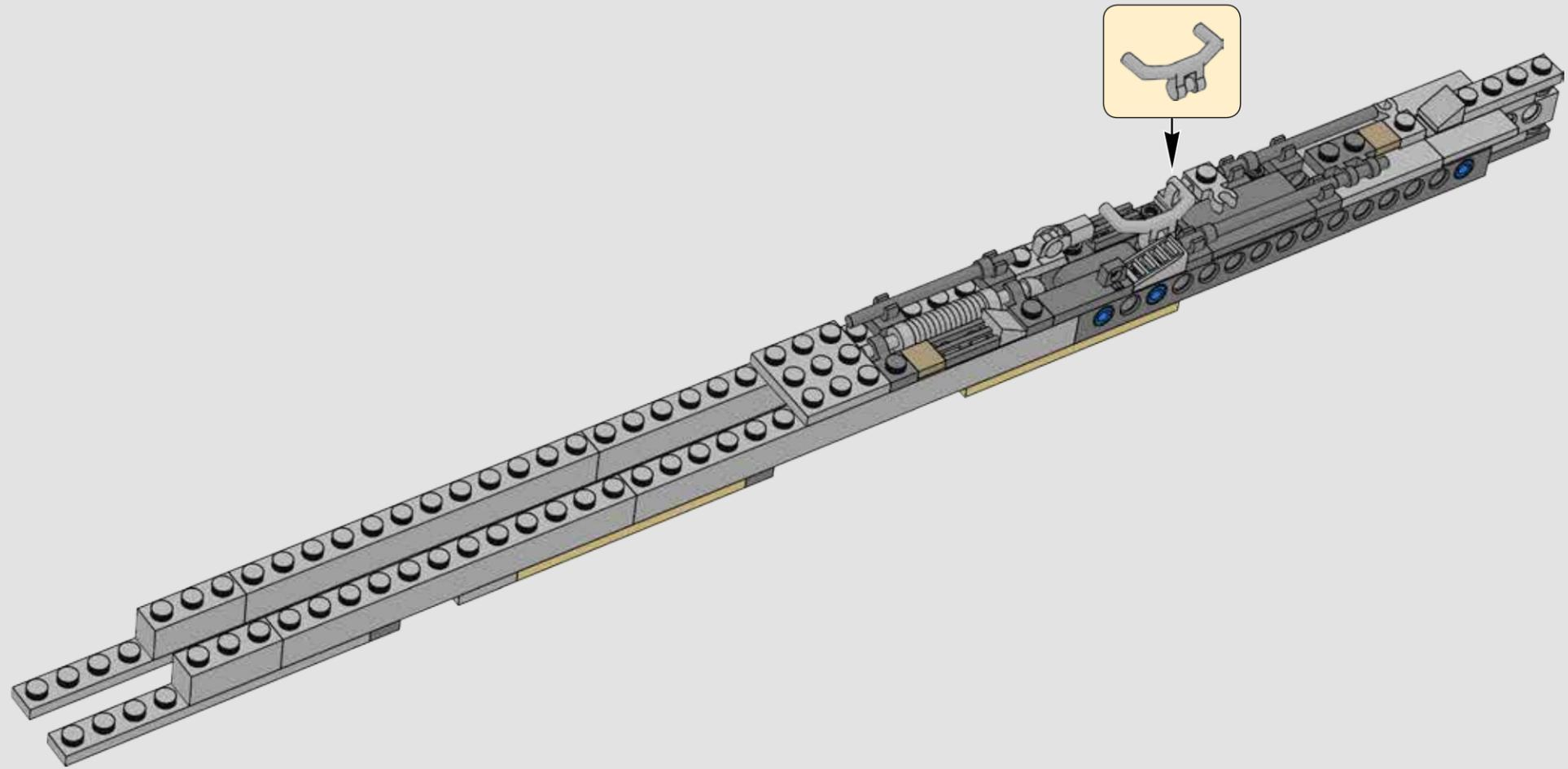

408

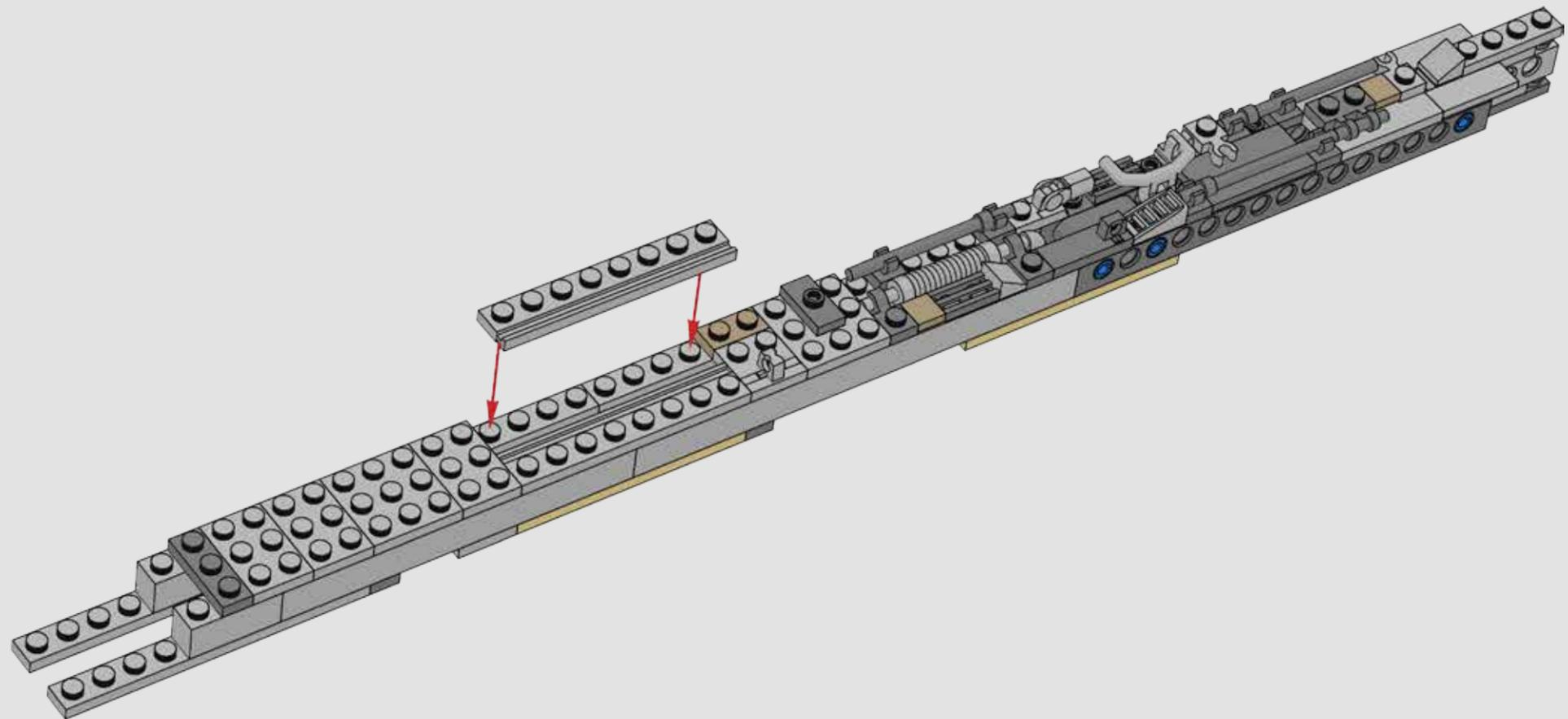

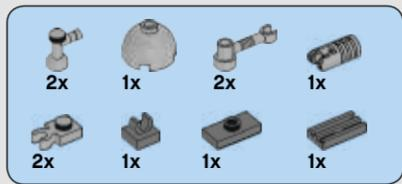

409

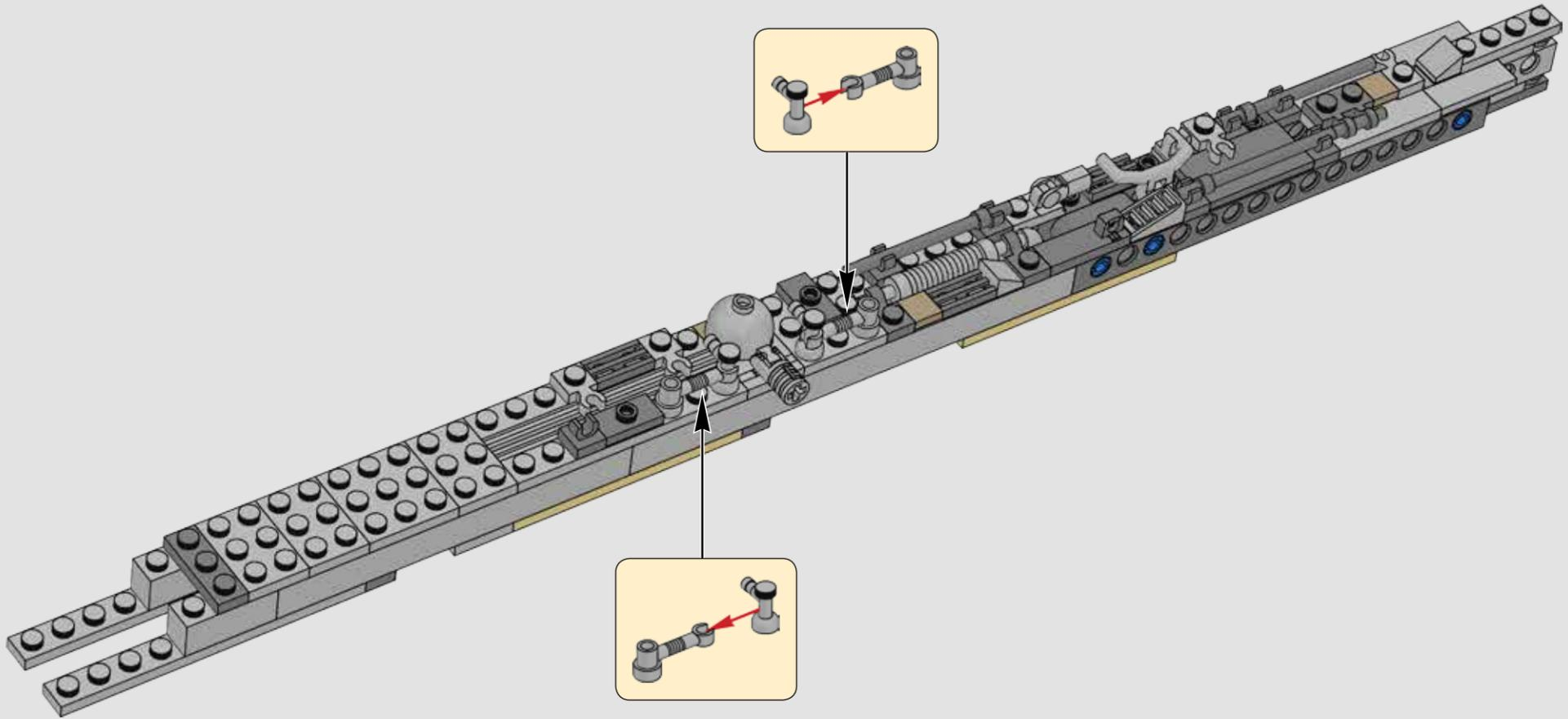

410

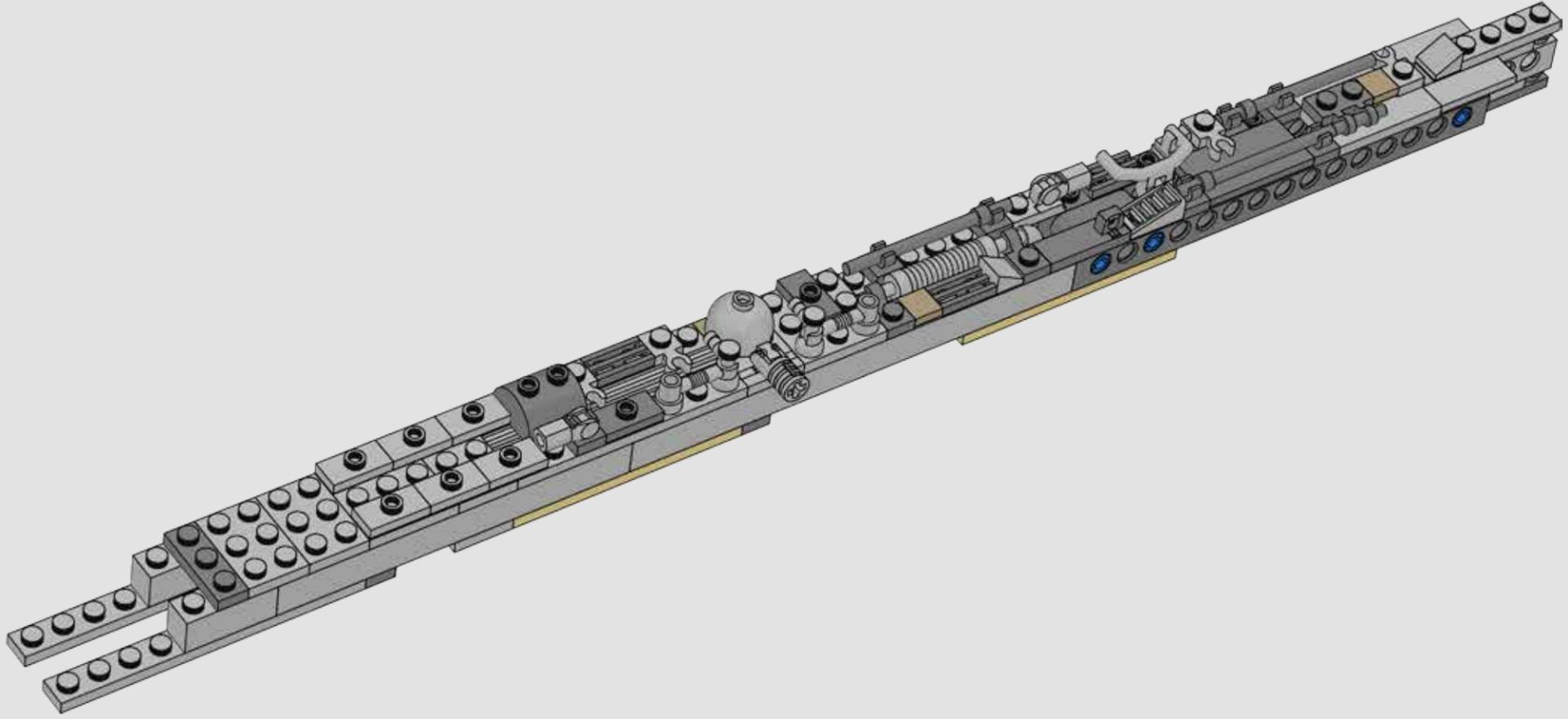

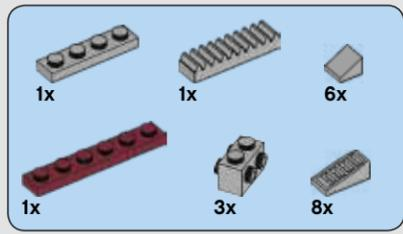

411

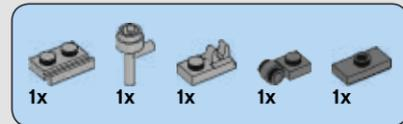
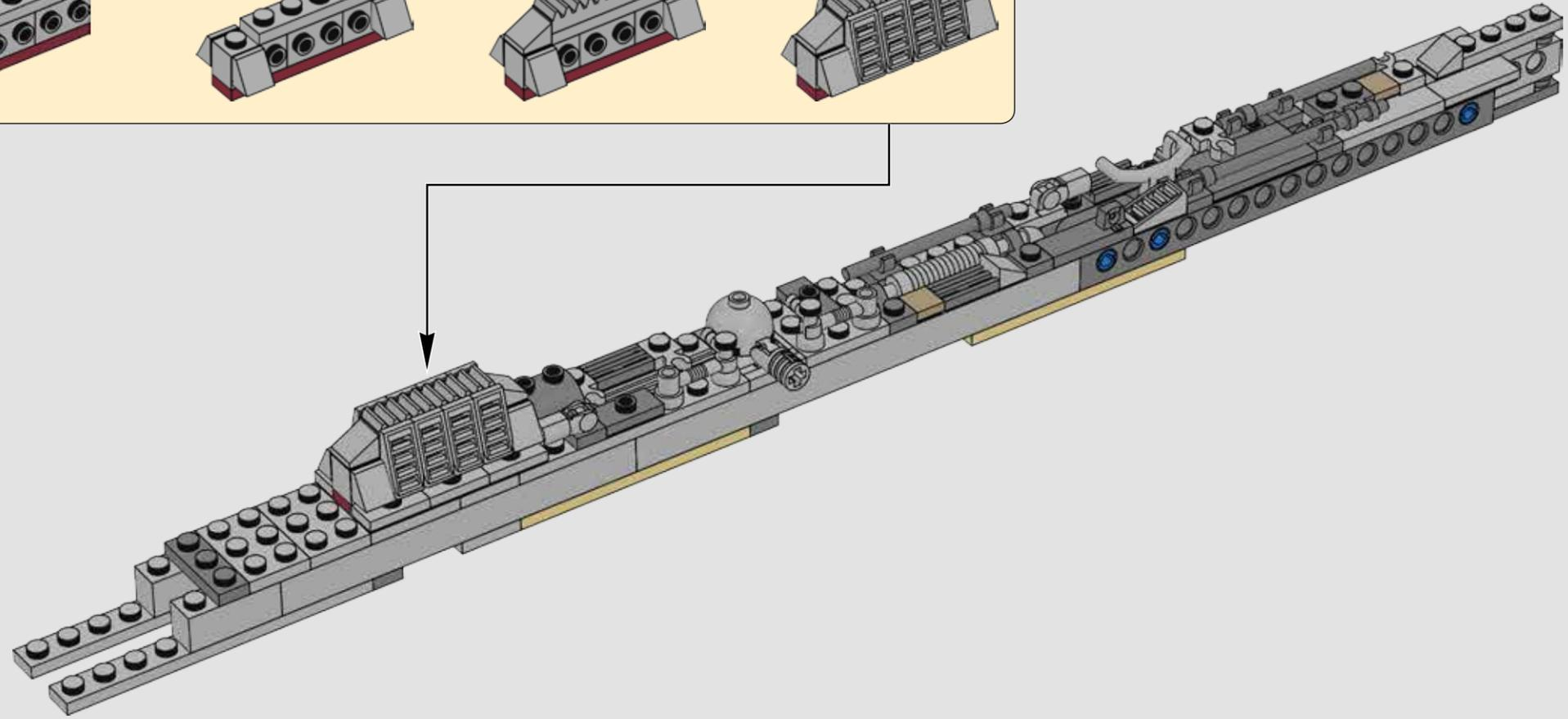
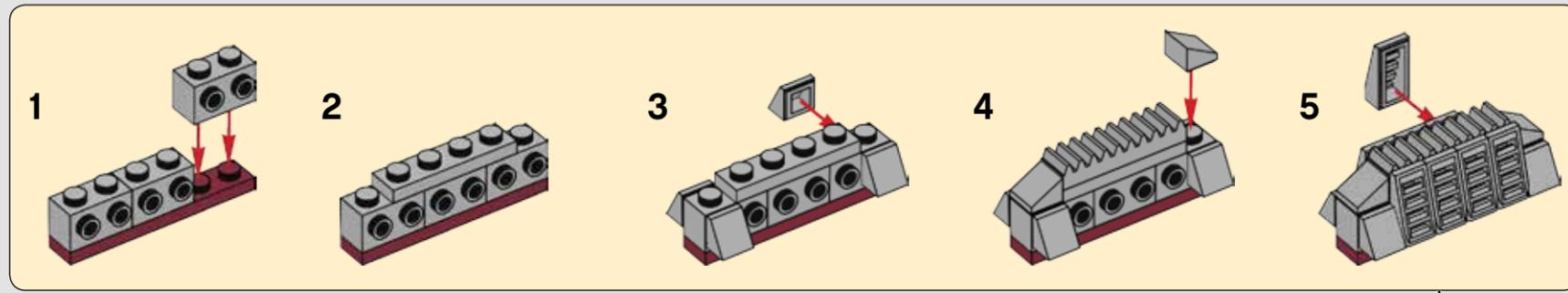

412

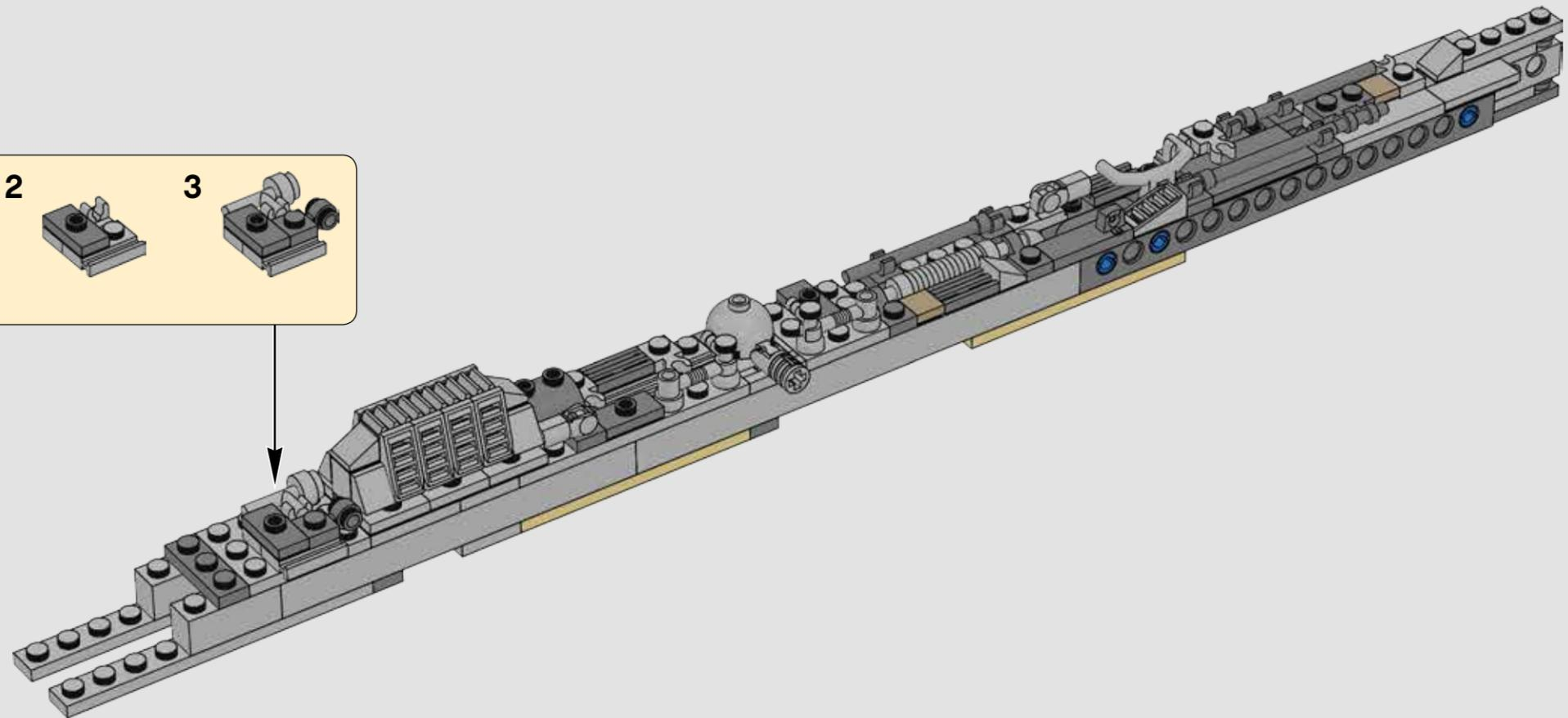
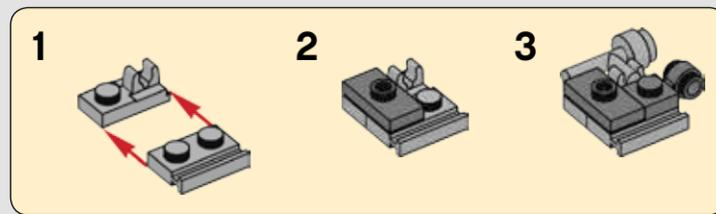

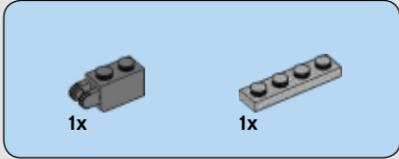

413

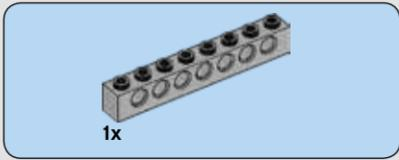
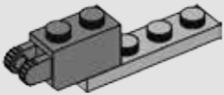

414

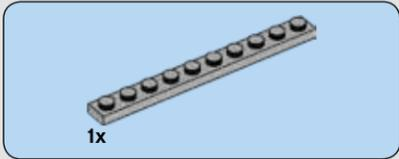
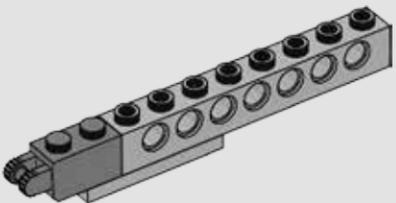

415

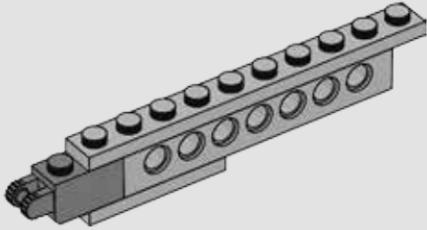

416

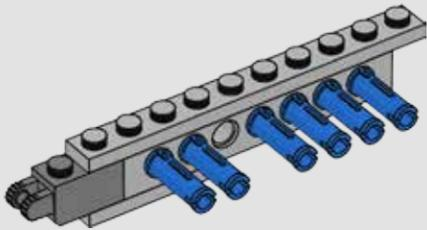

417

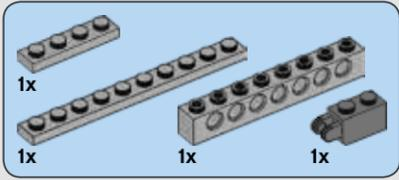
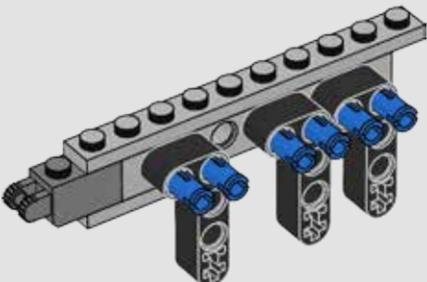

418

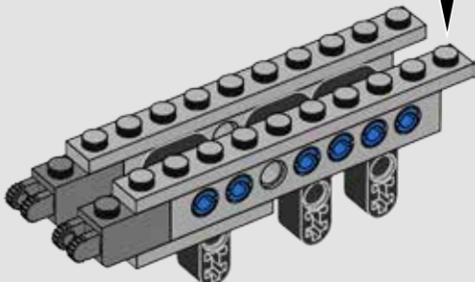
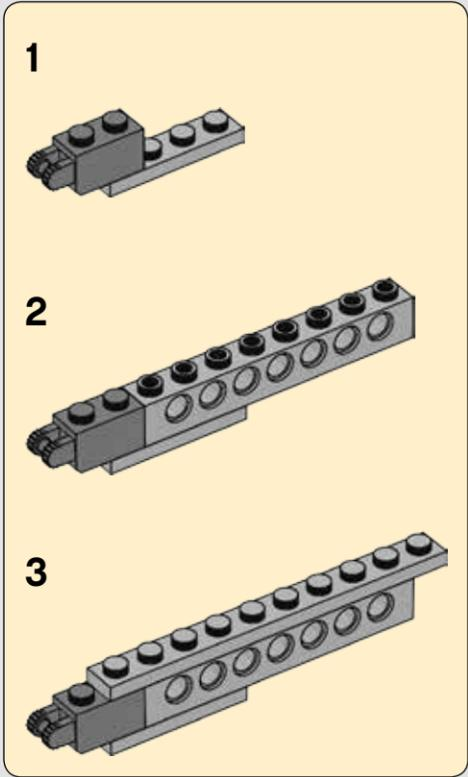

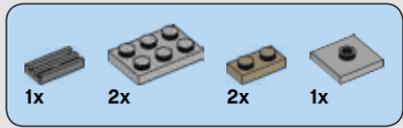

419

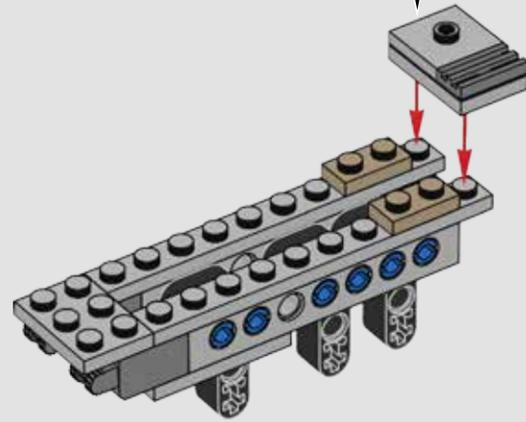
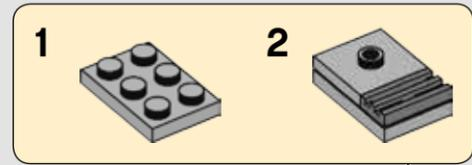

420

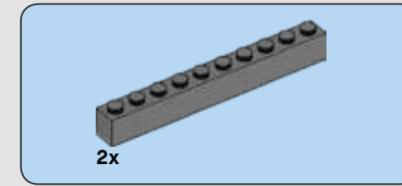
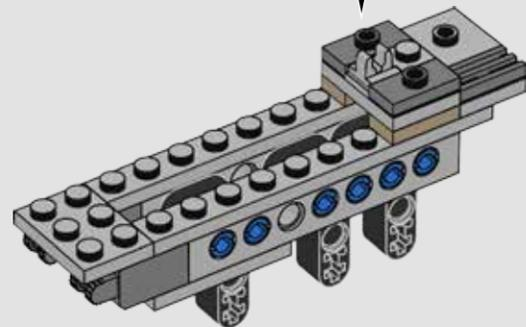
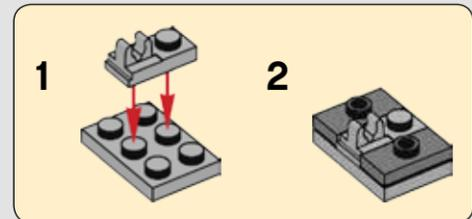

421

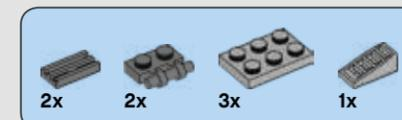
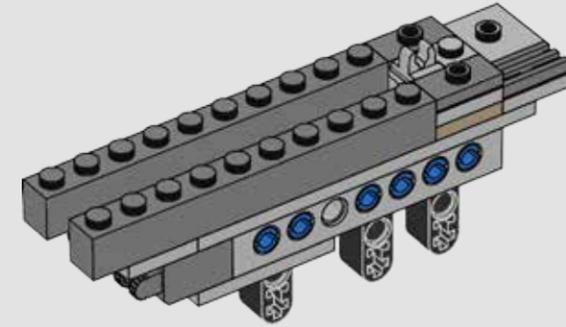

422

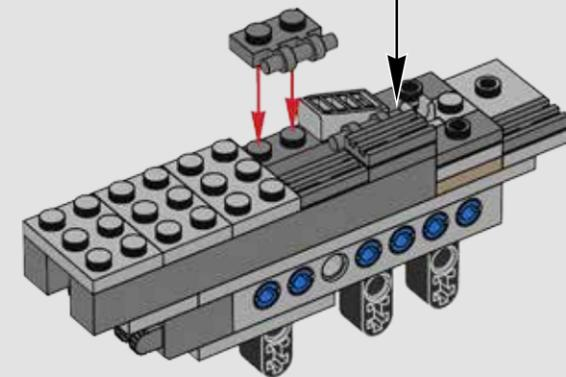
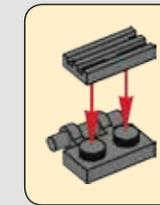

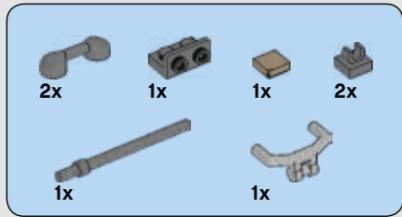

423

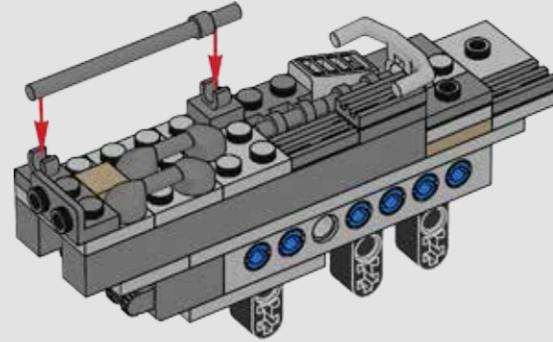

424

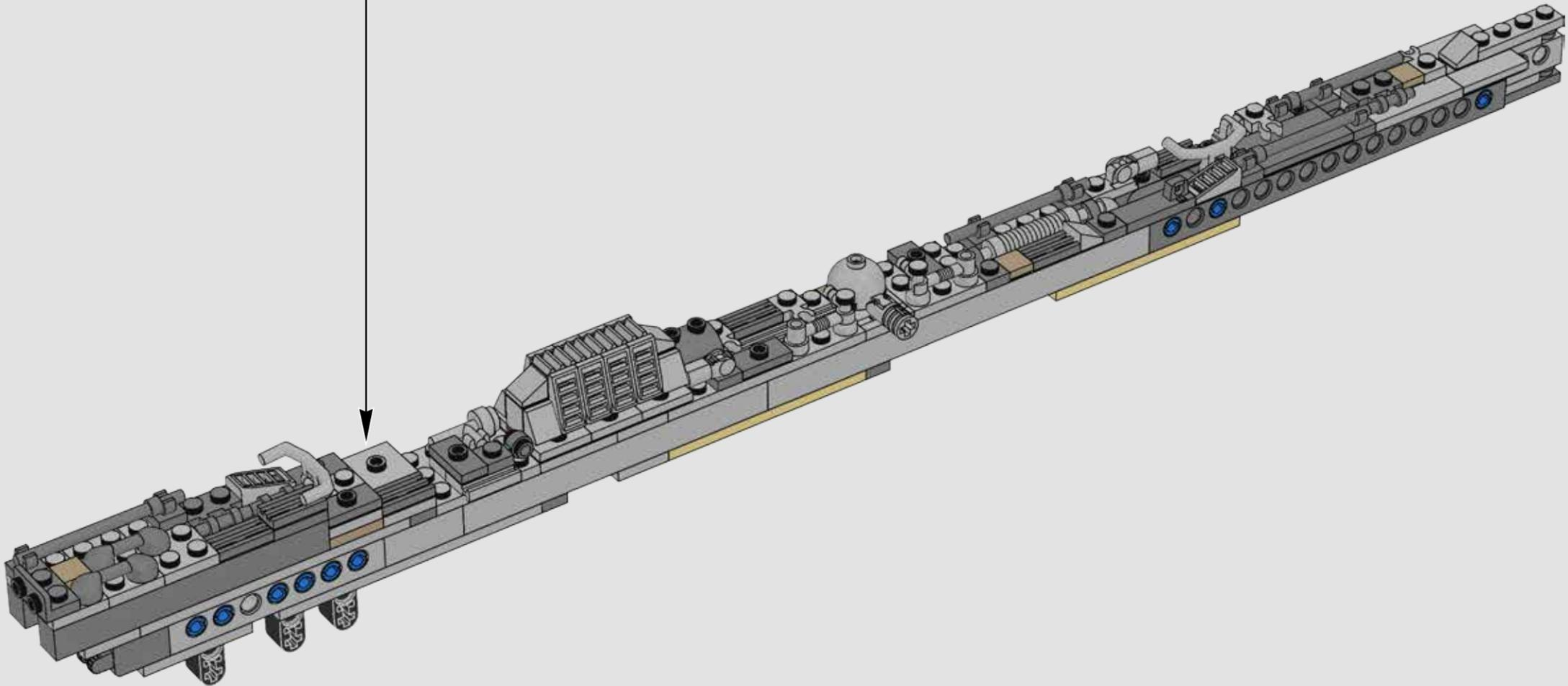

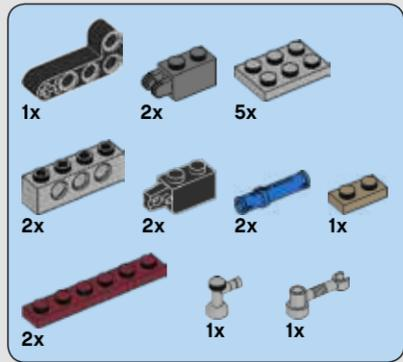

425

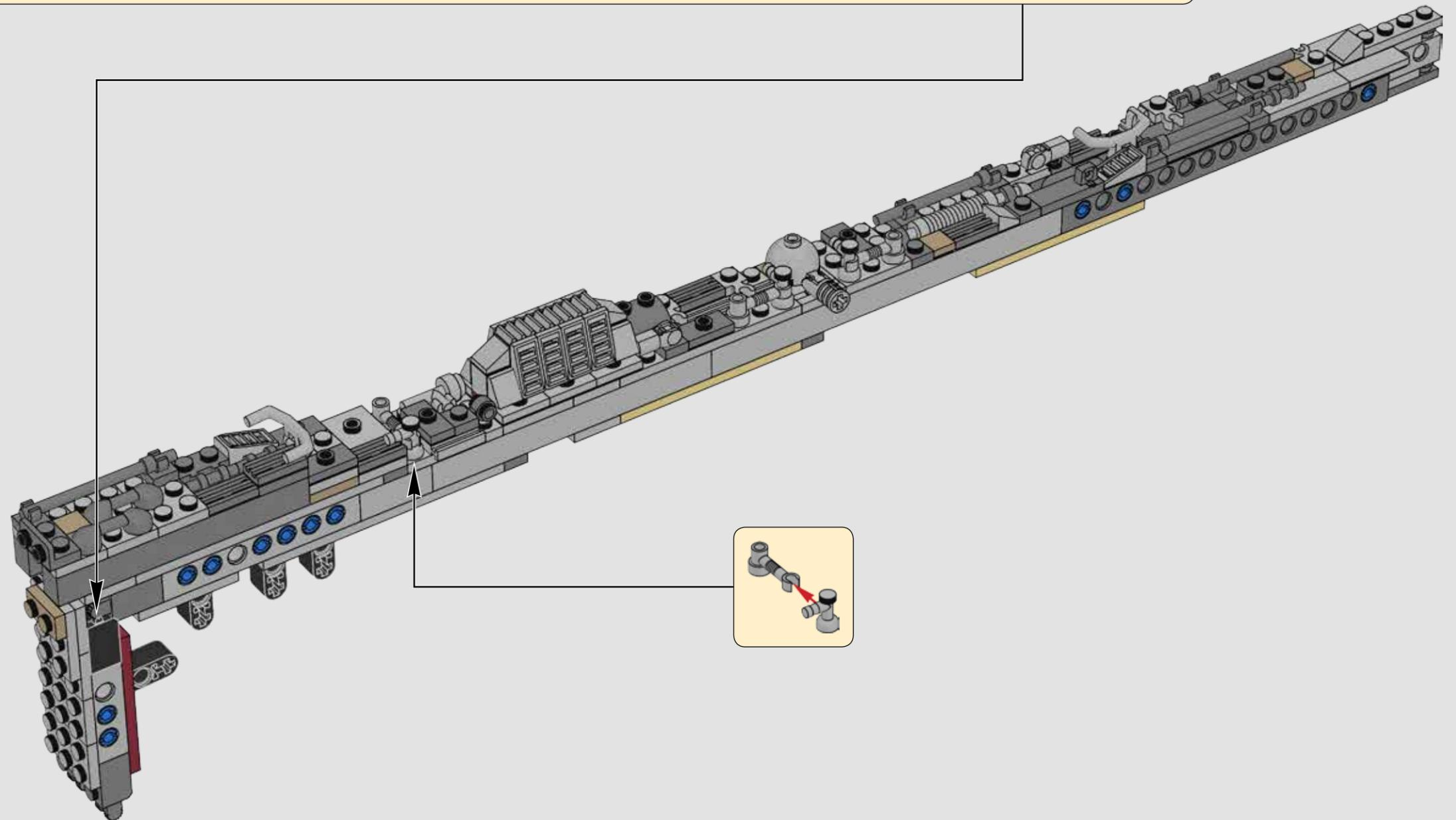
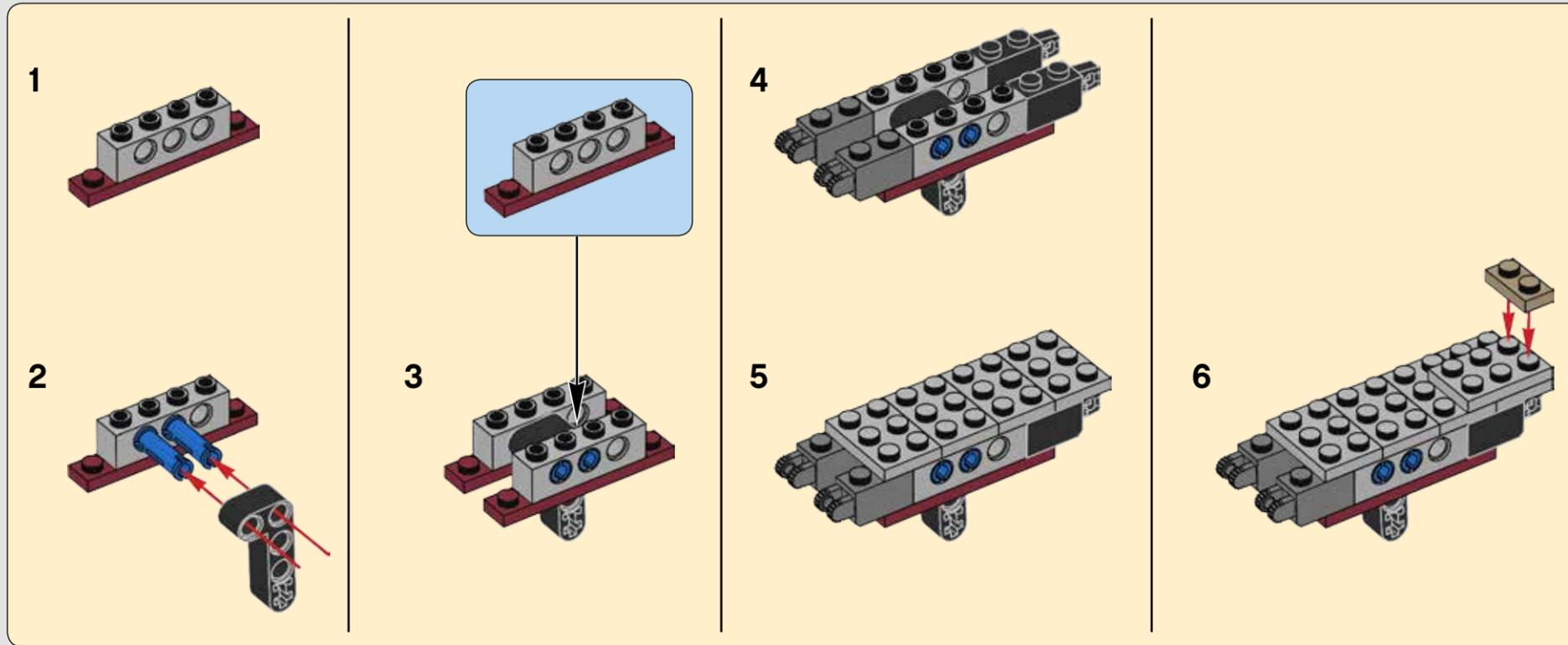

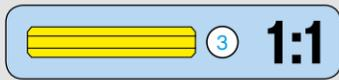
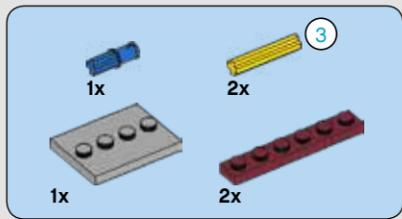

426

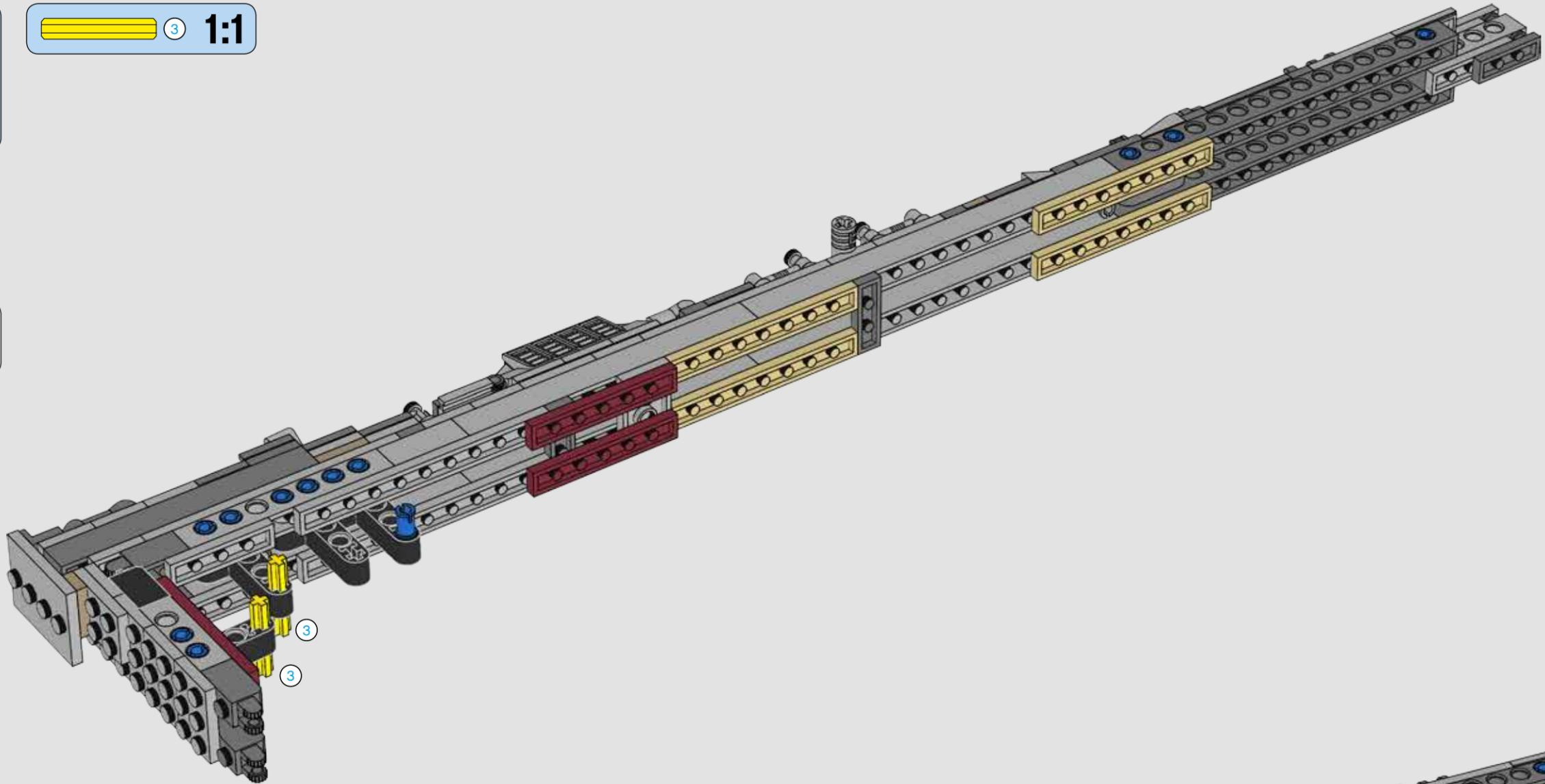

427

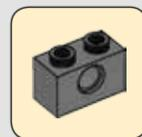
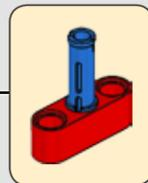
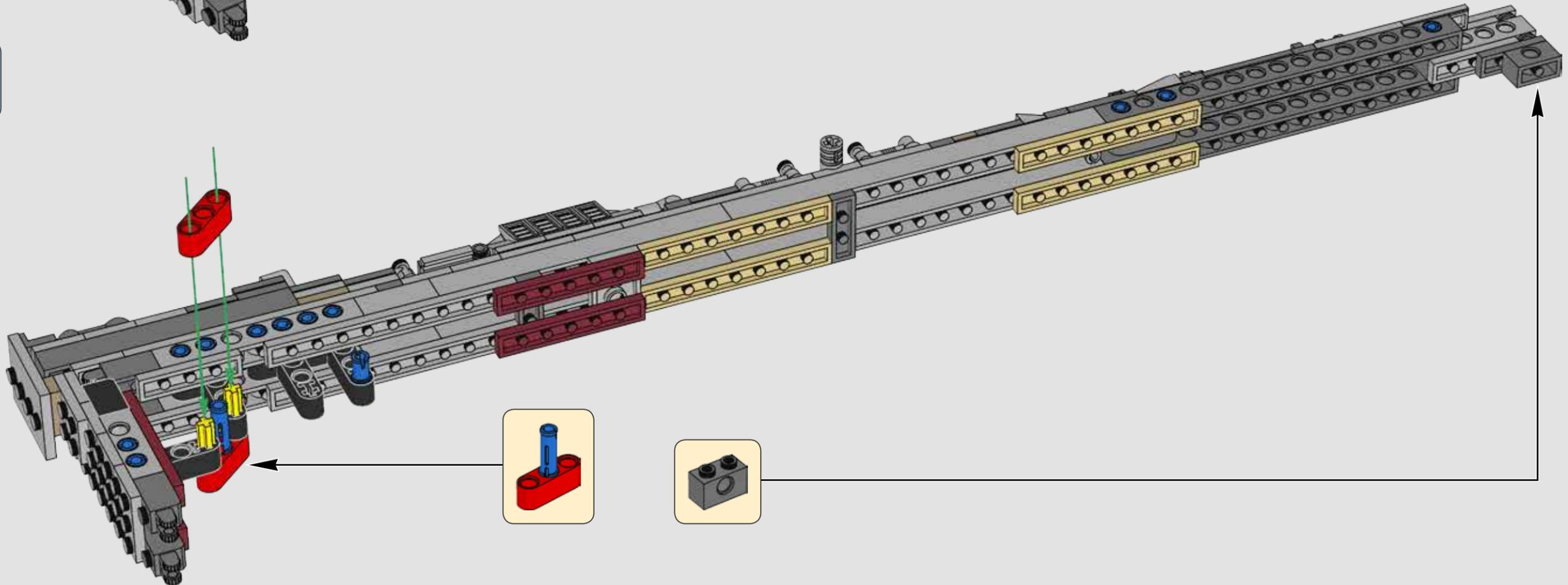

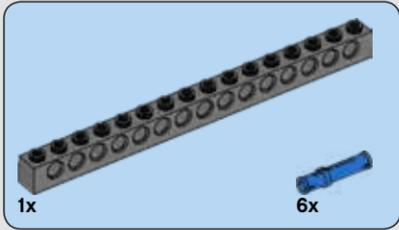
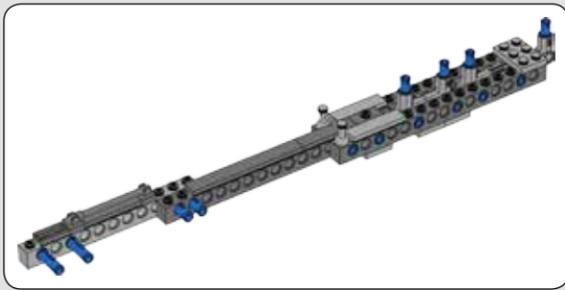

428



429

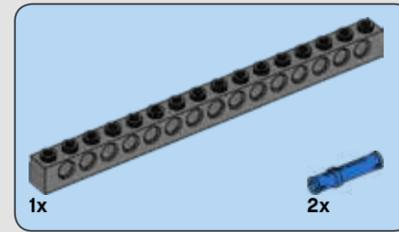
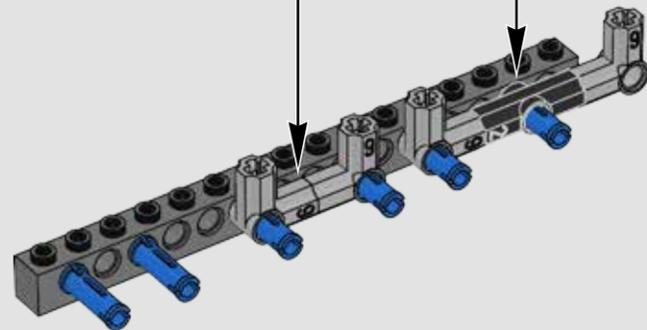
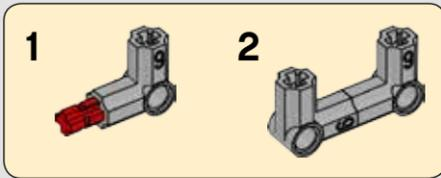
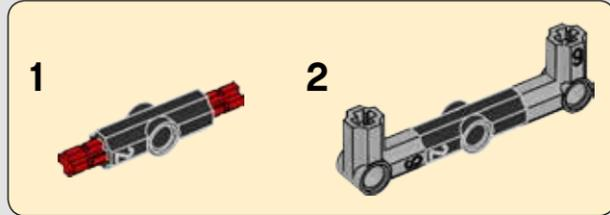

430

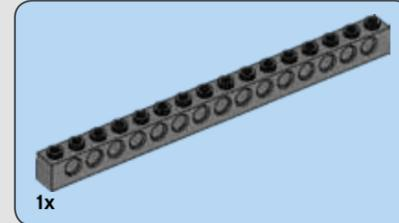
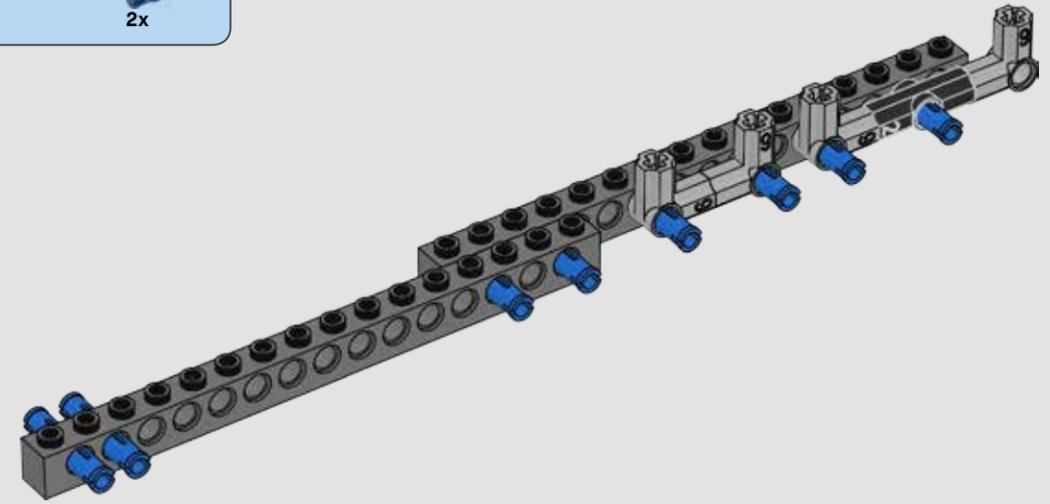

431

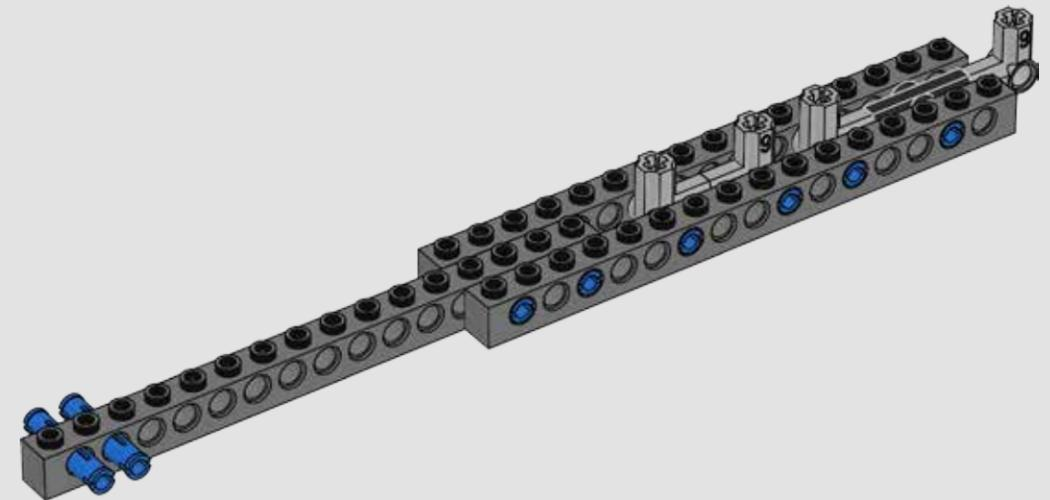

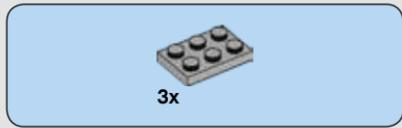

432

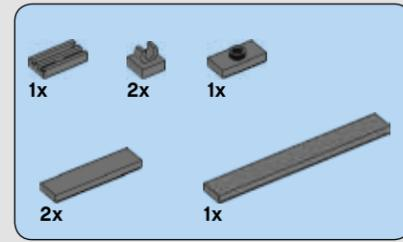
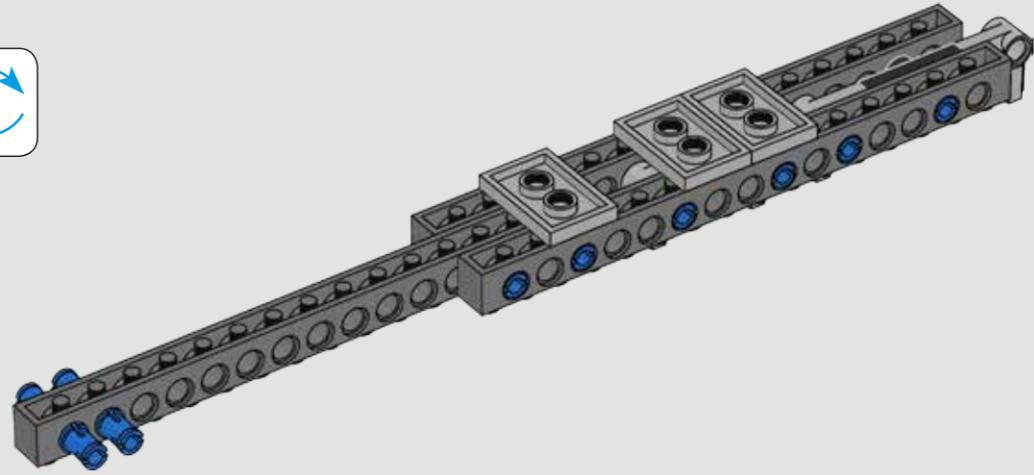

434

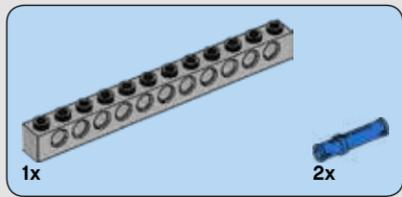
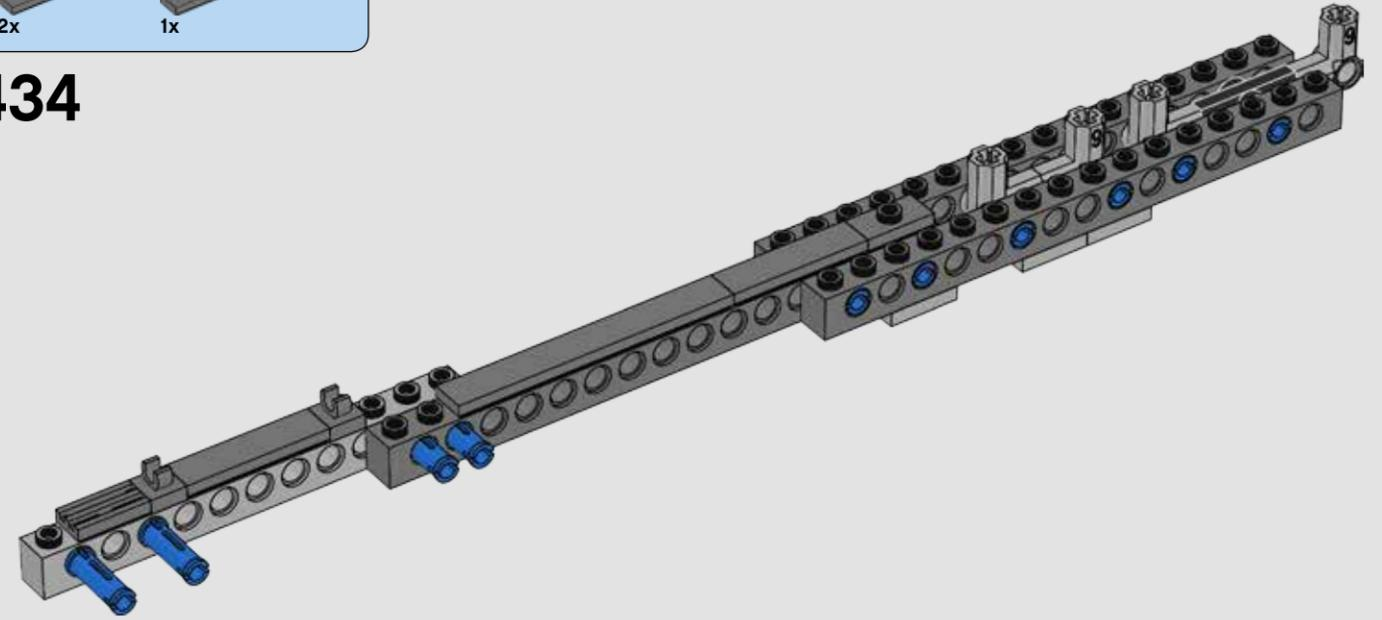

433

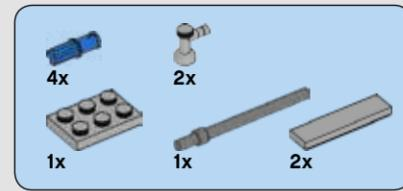
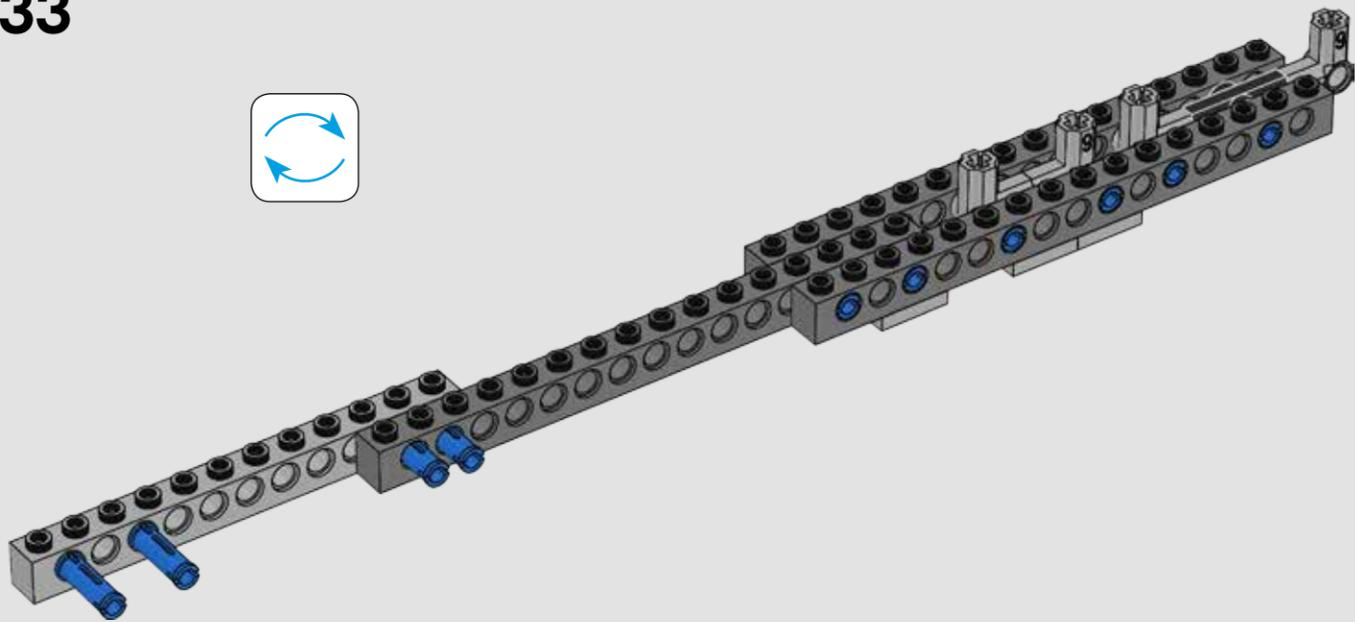

435

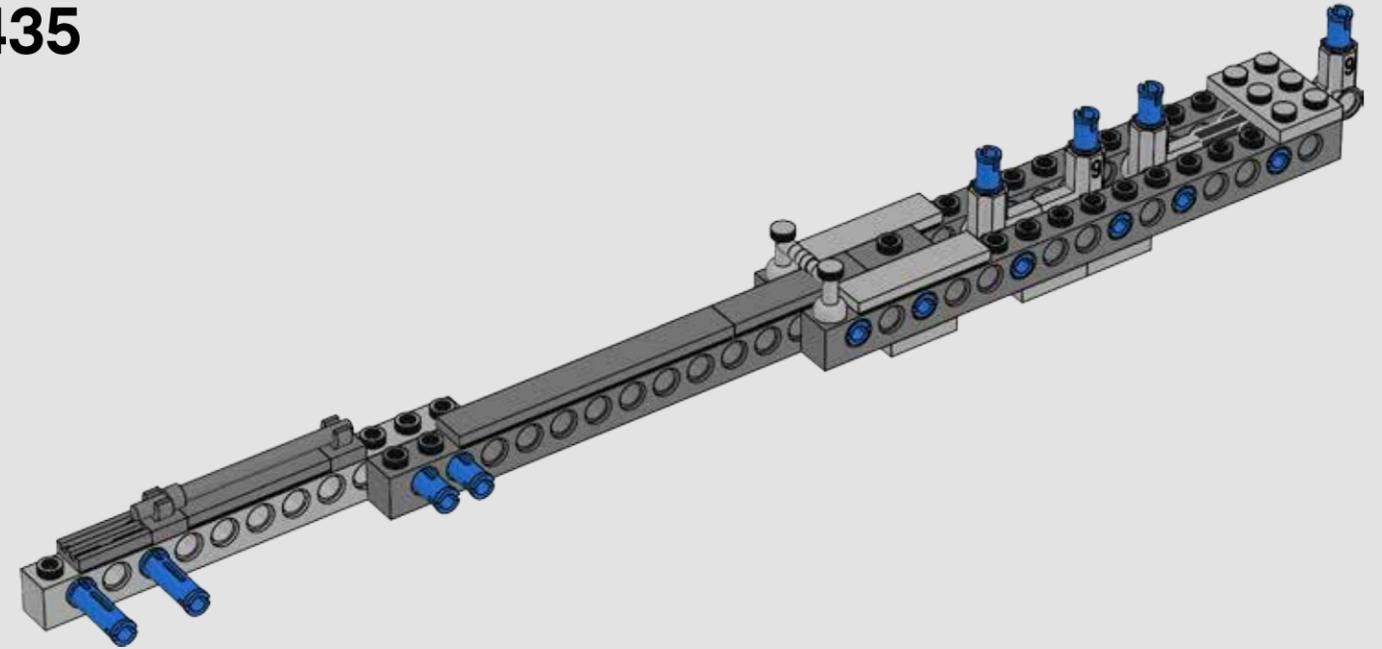

436

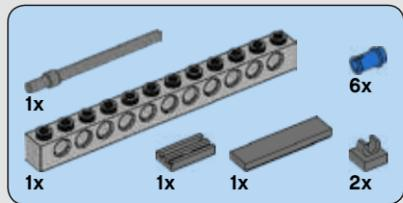
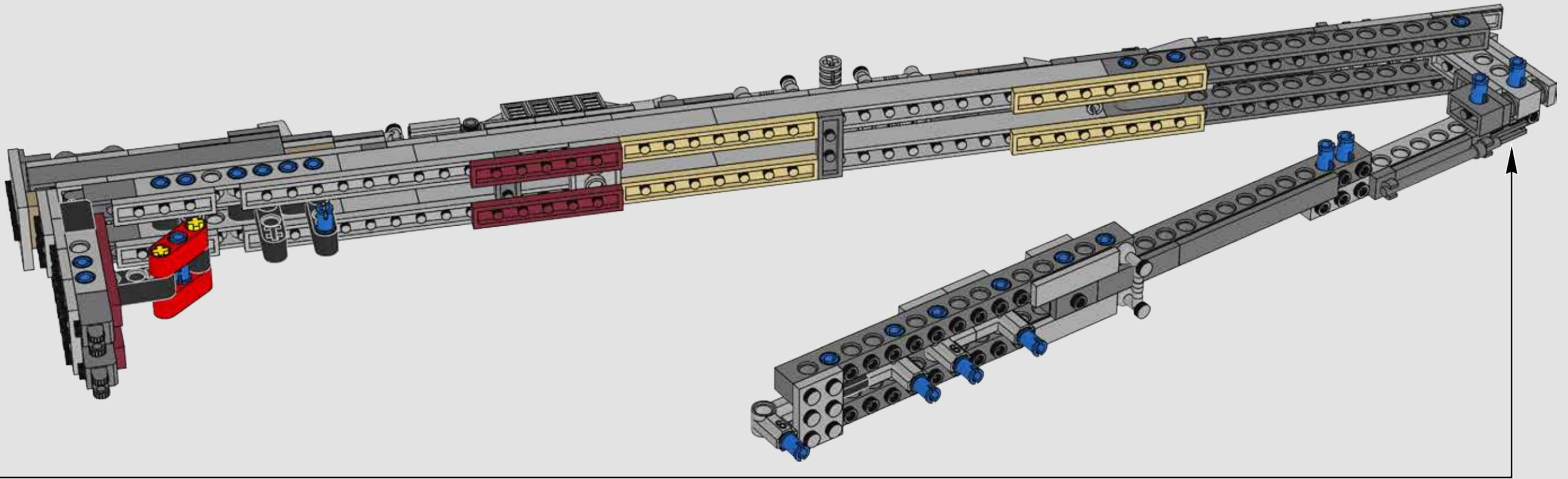

437

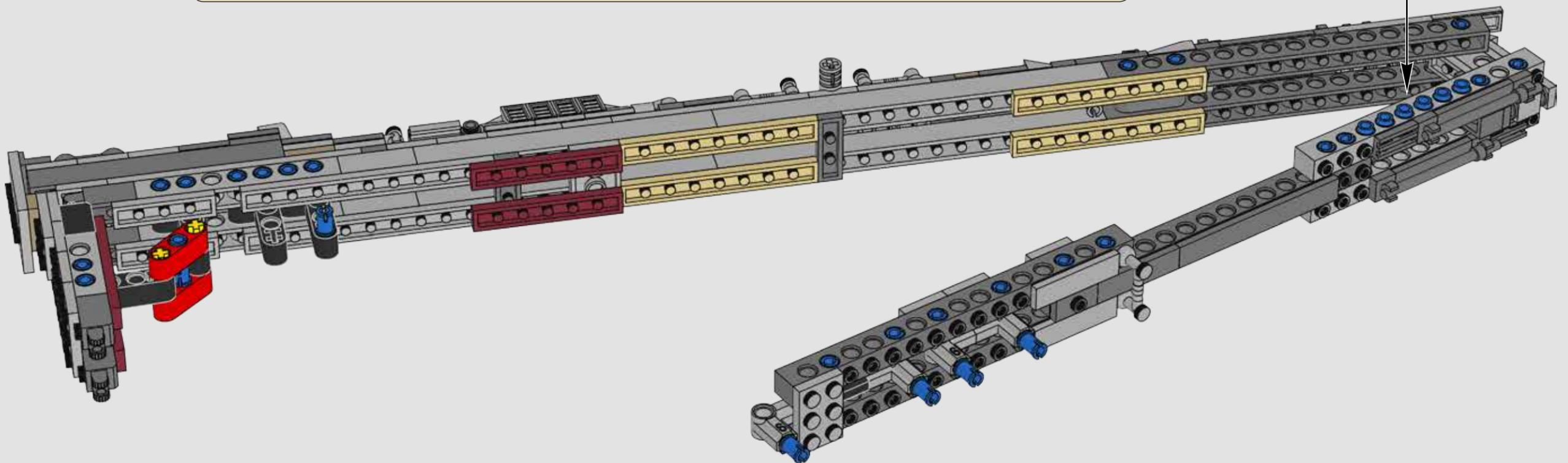
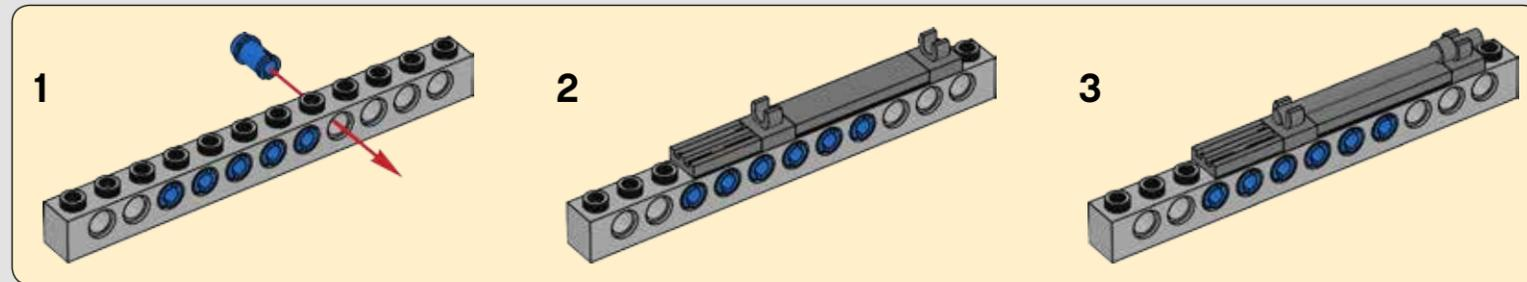

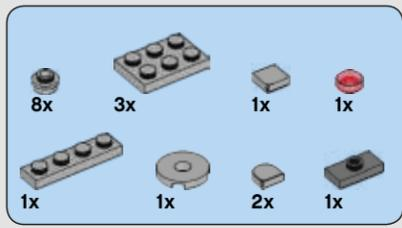

438

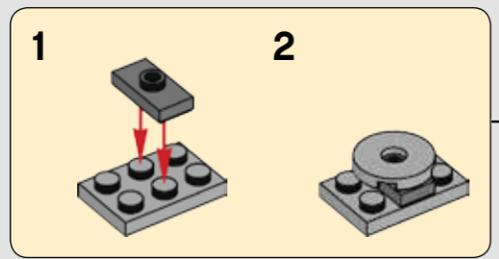
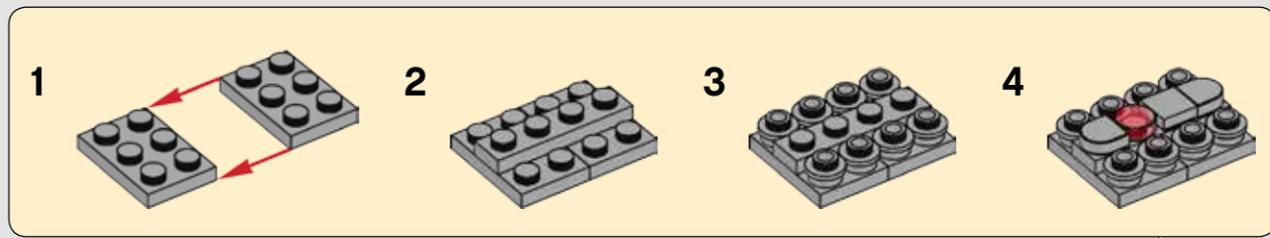
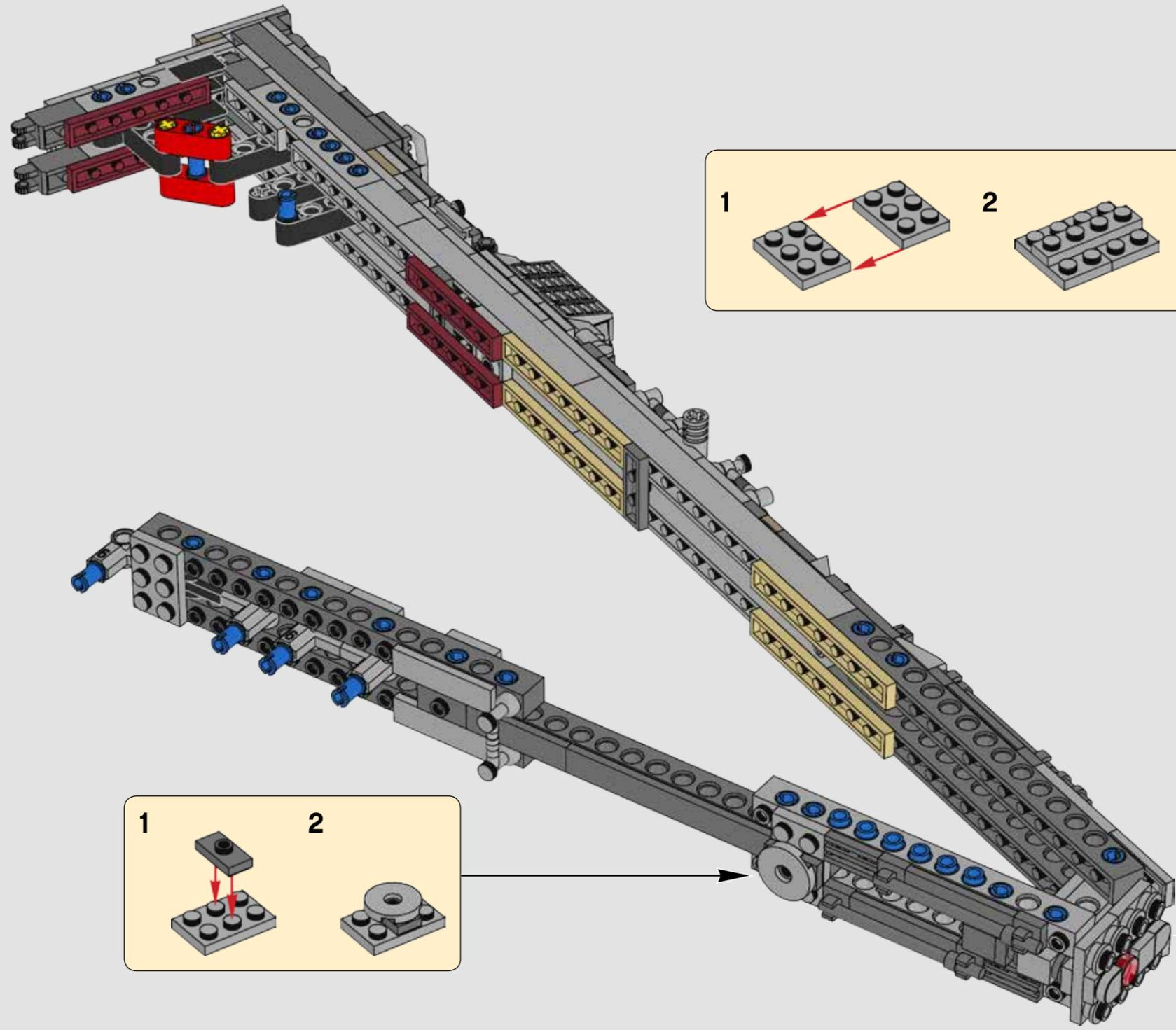

439

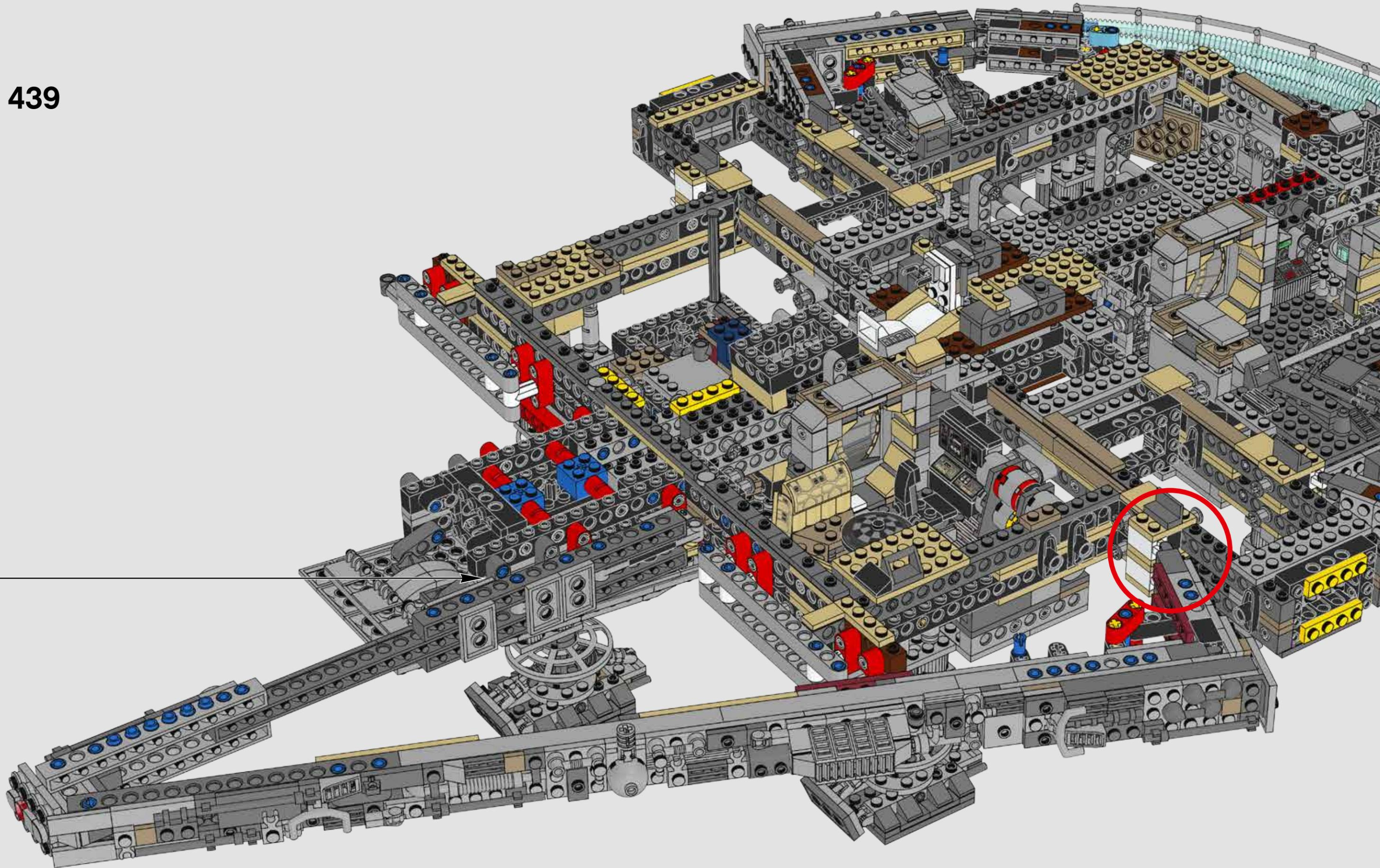

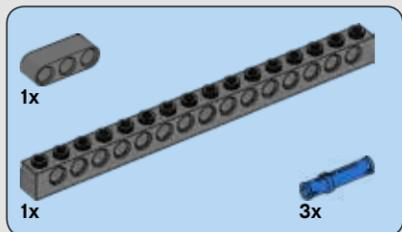
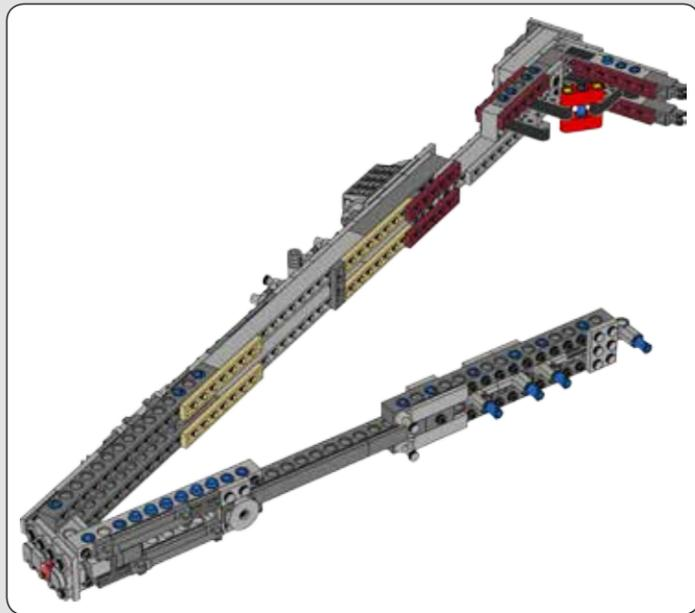

440

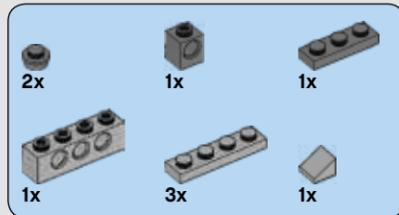
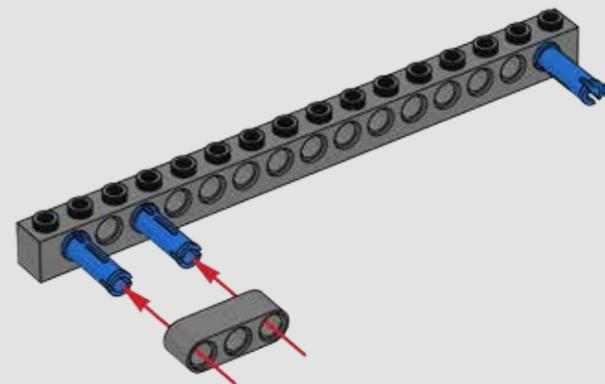

441

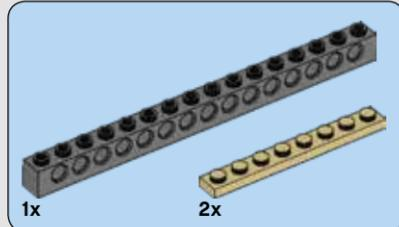
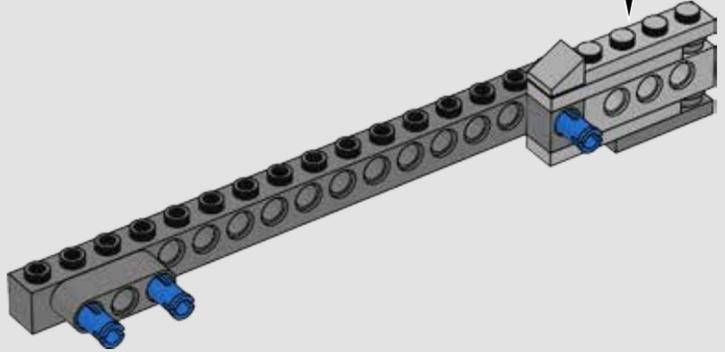
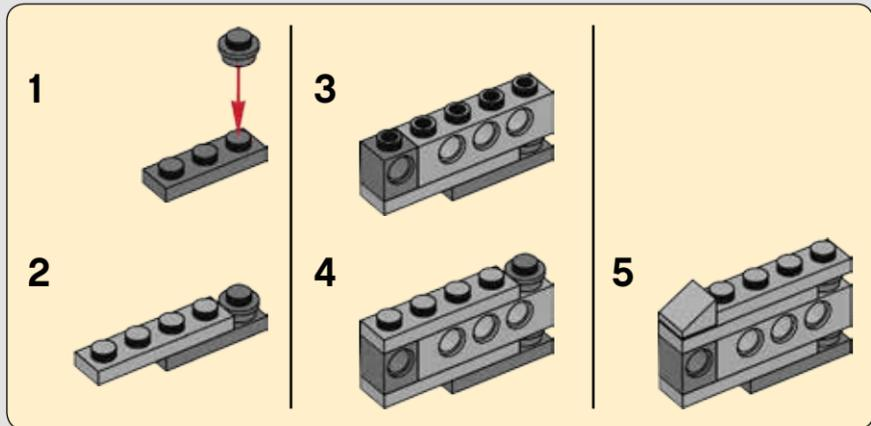

442

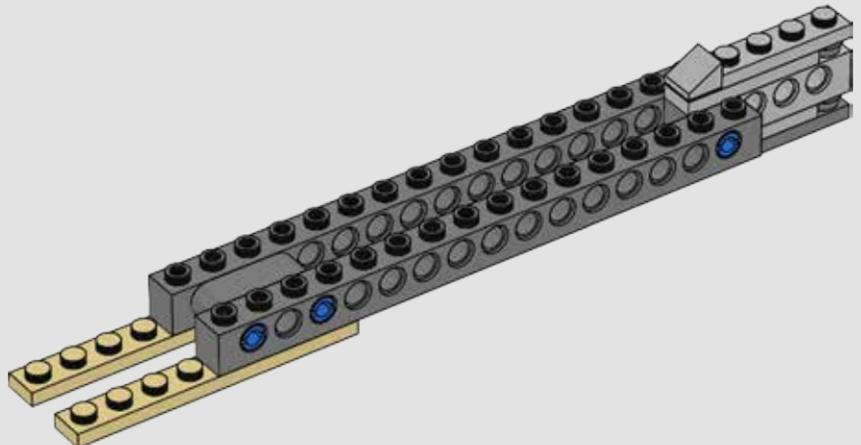

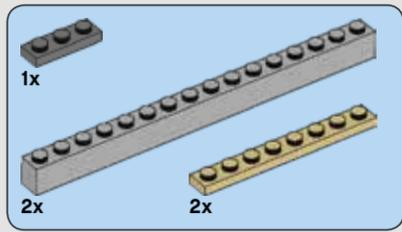

443

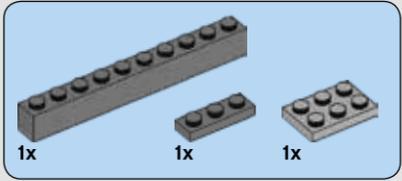
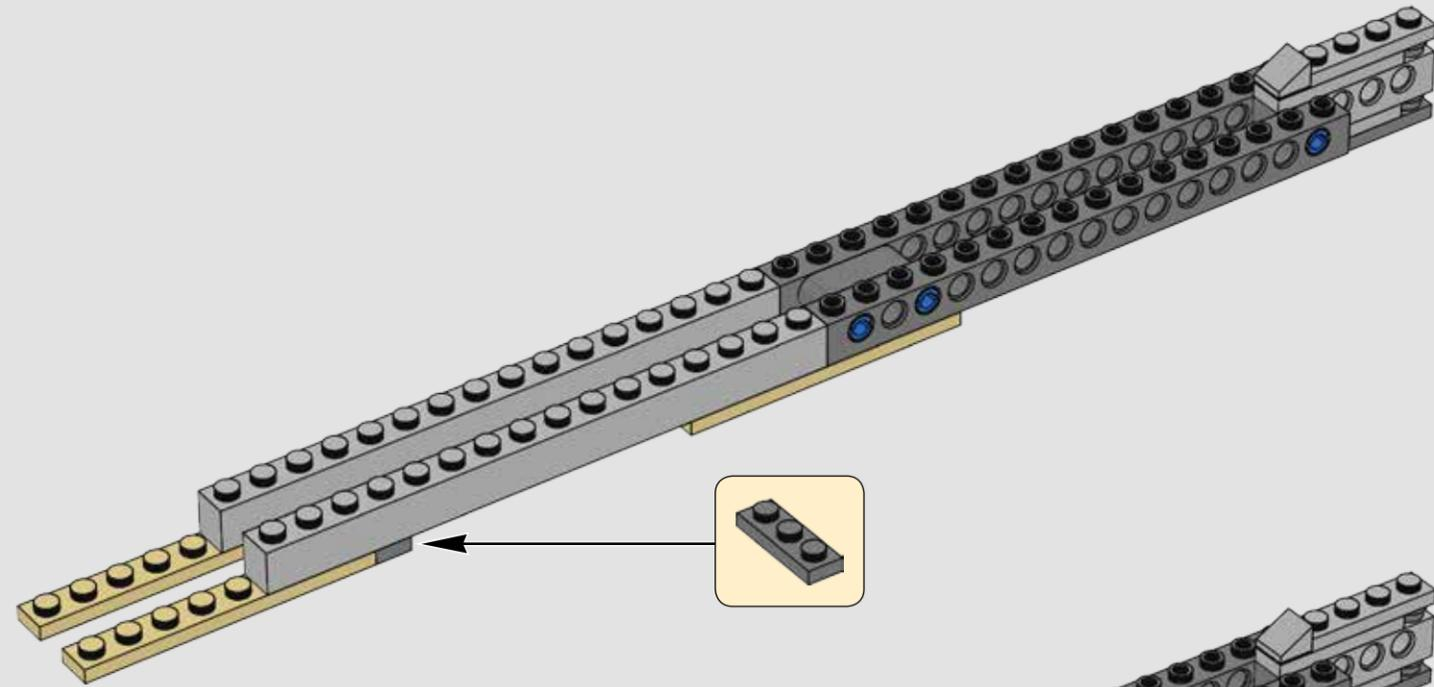

444

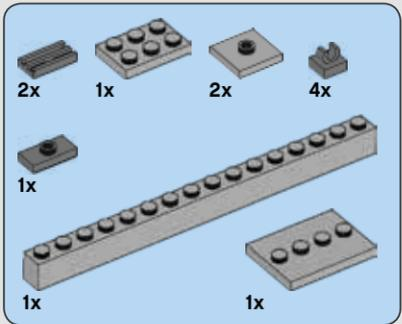
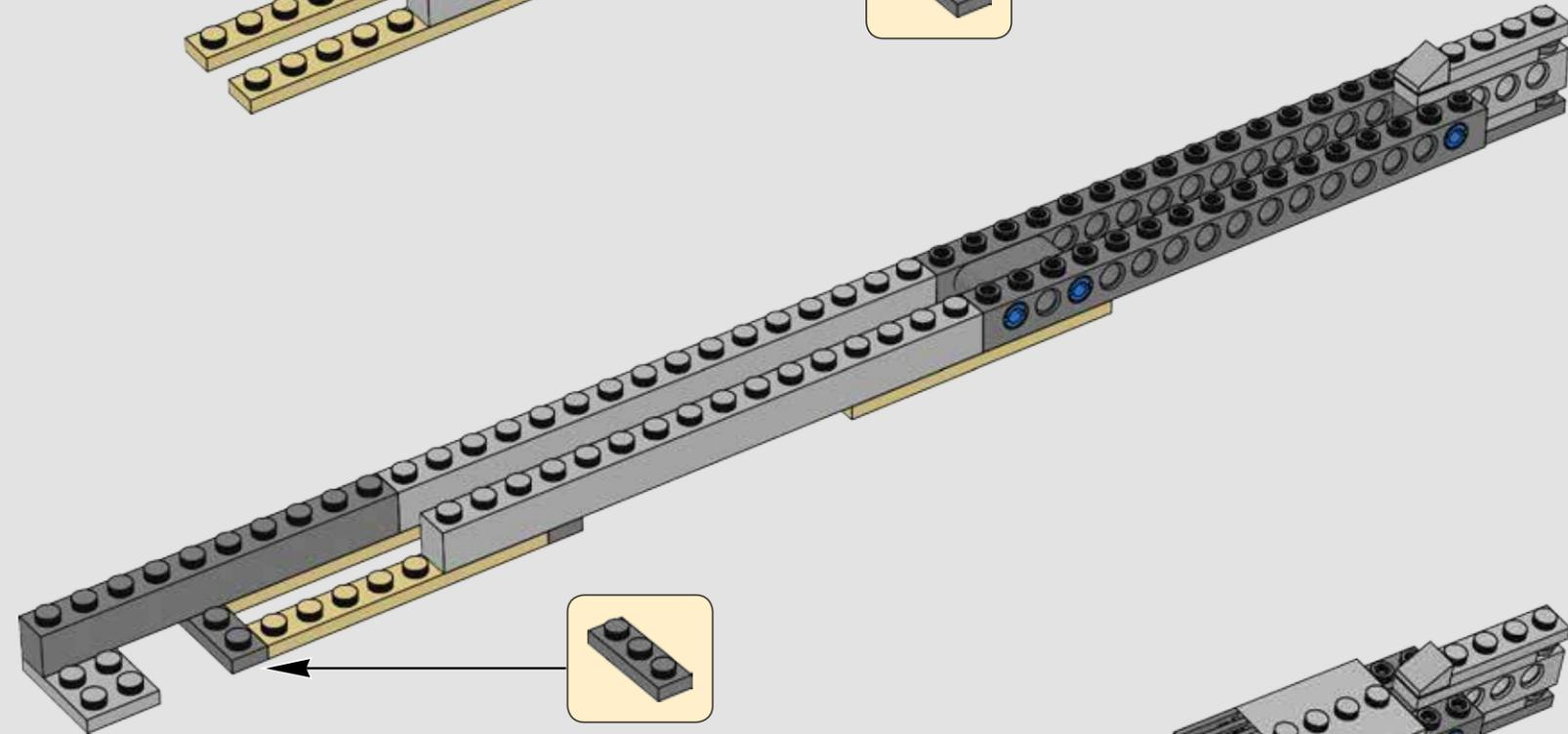

445

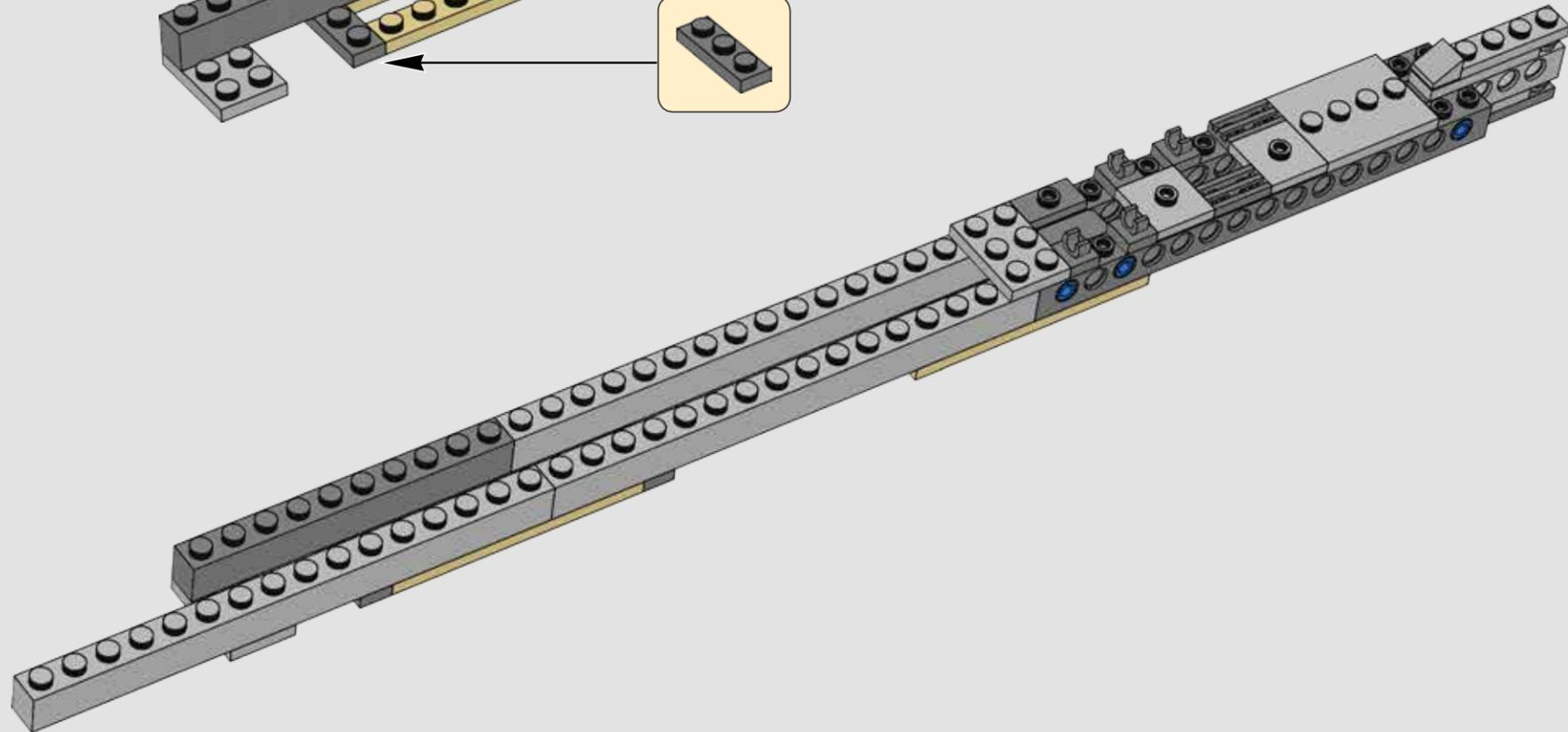

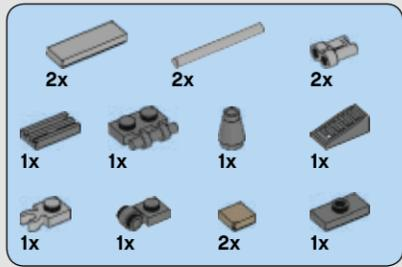

446

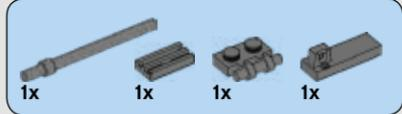
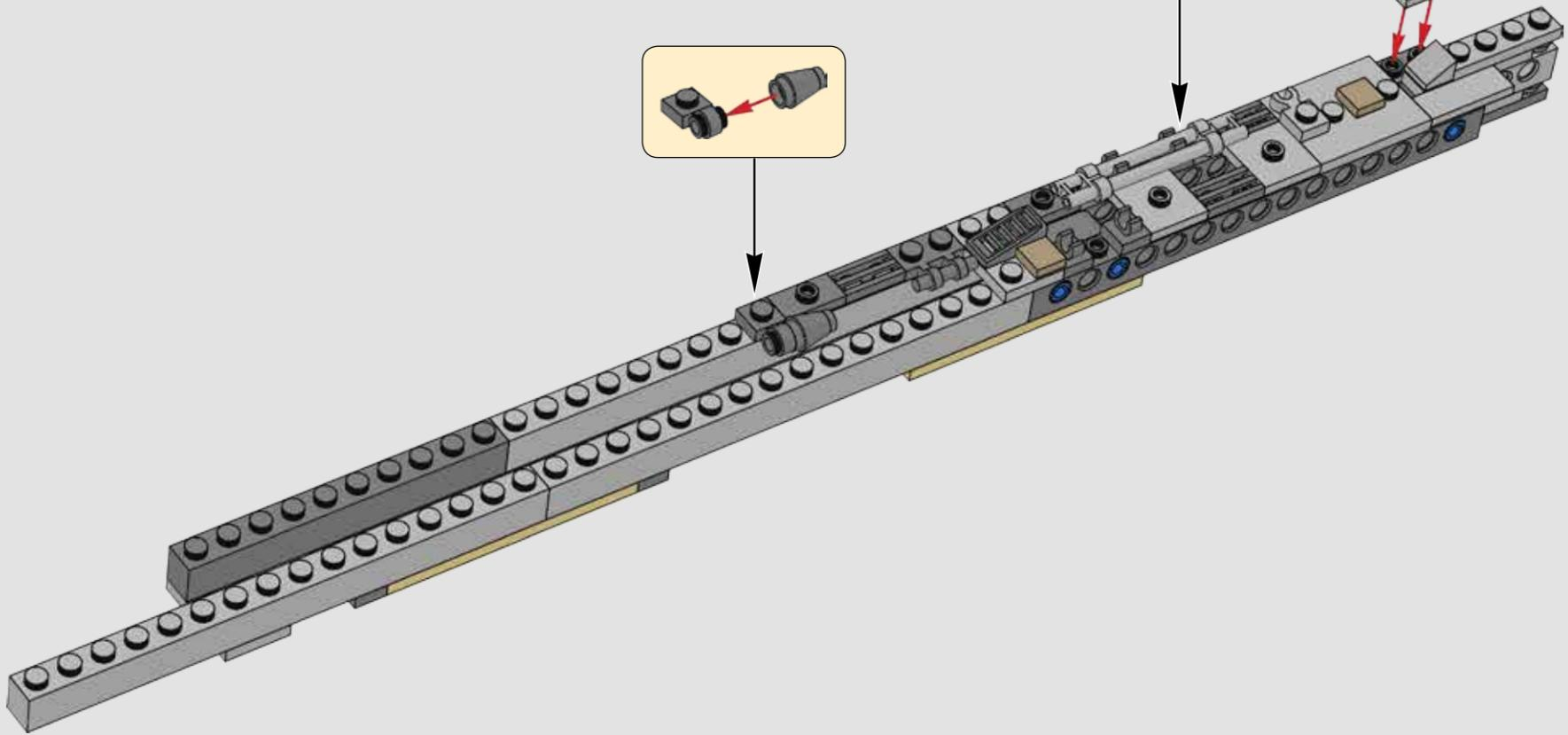
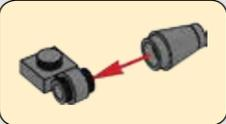
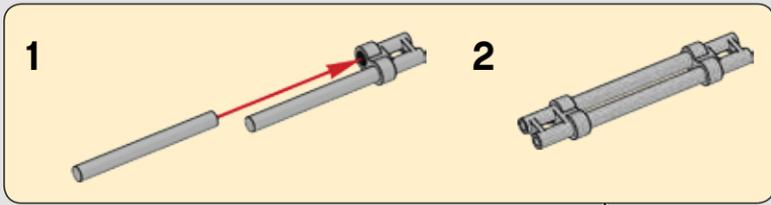

447

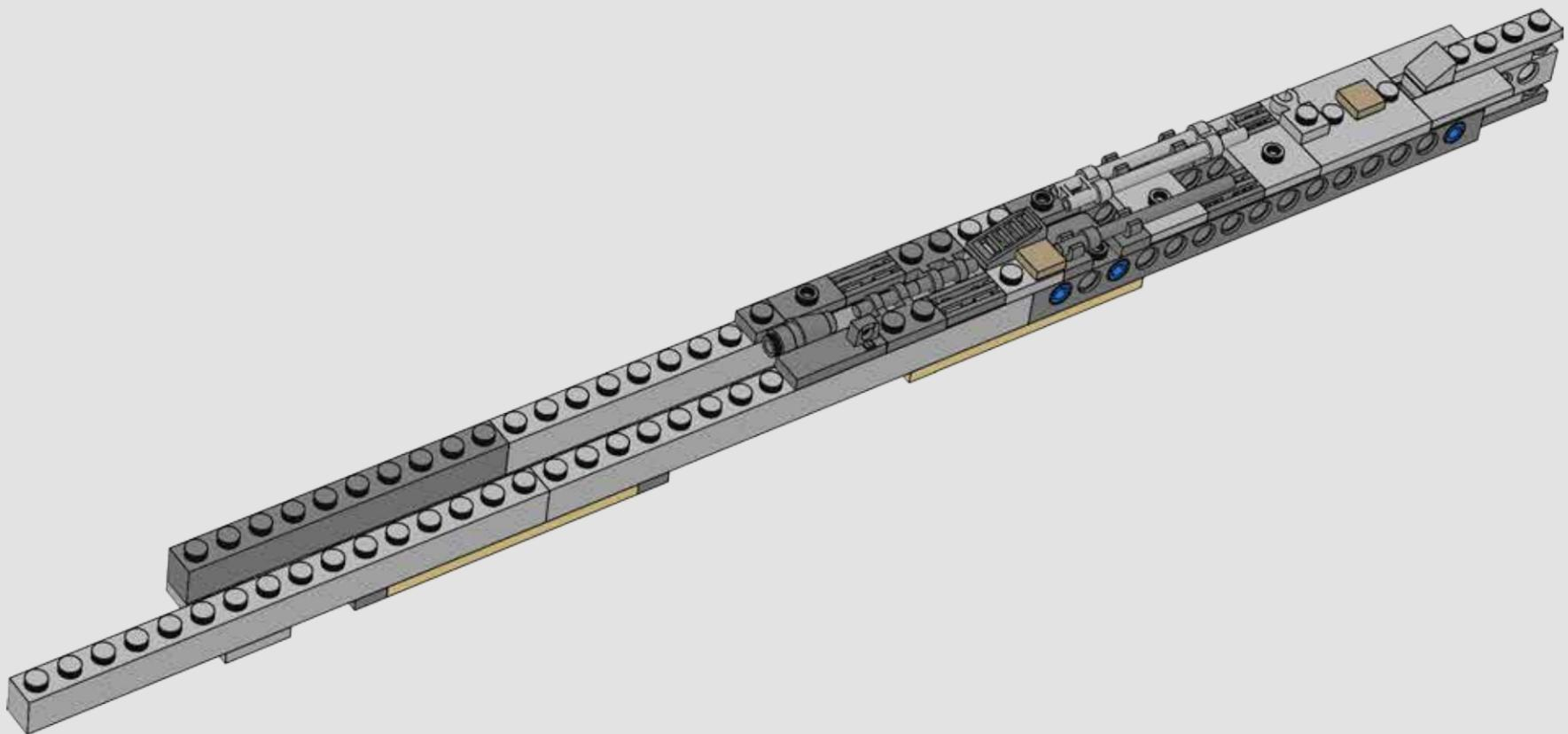

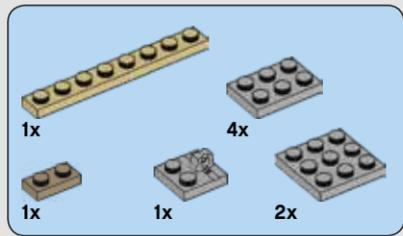

448



449

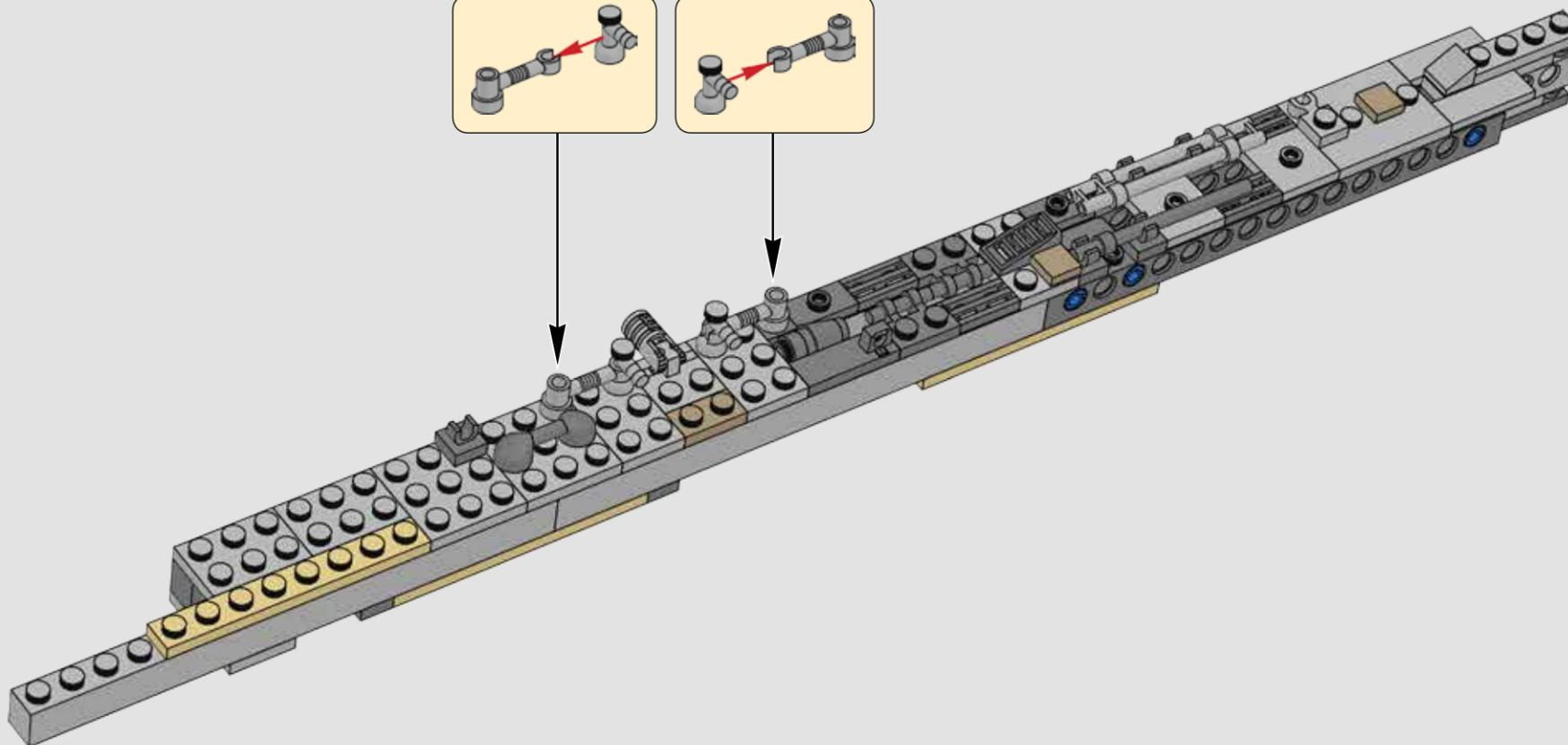
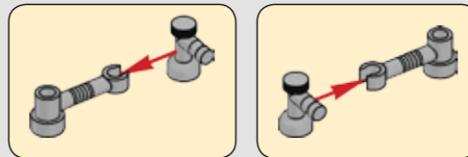

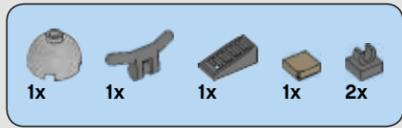

450

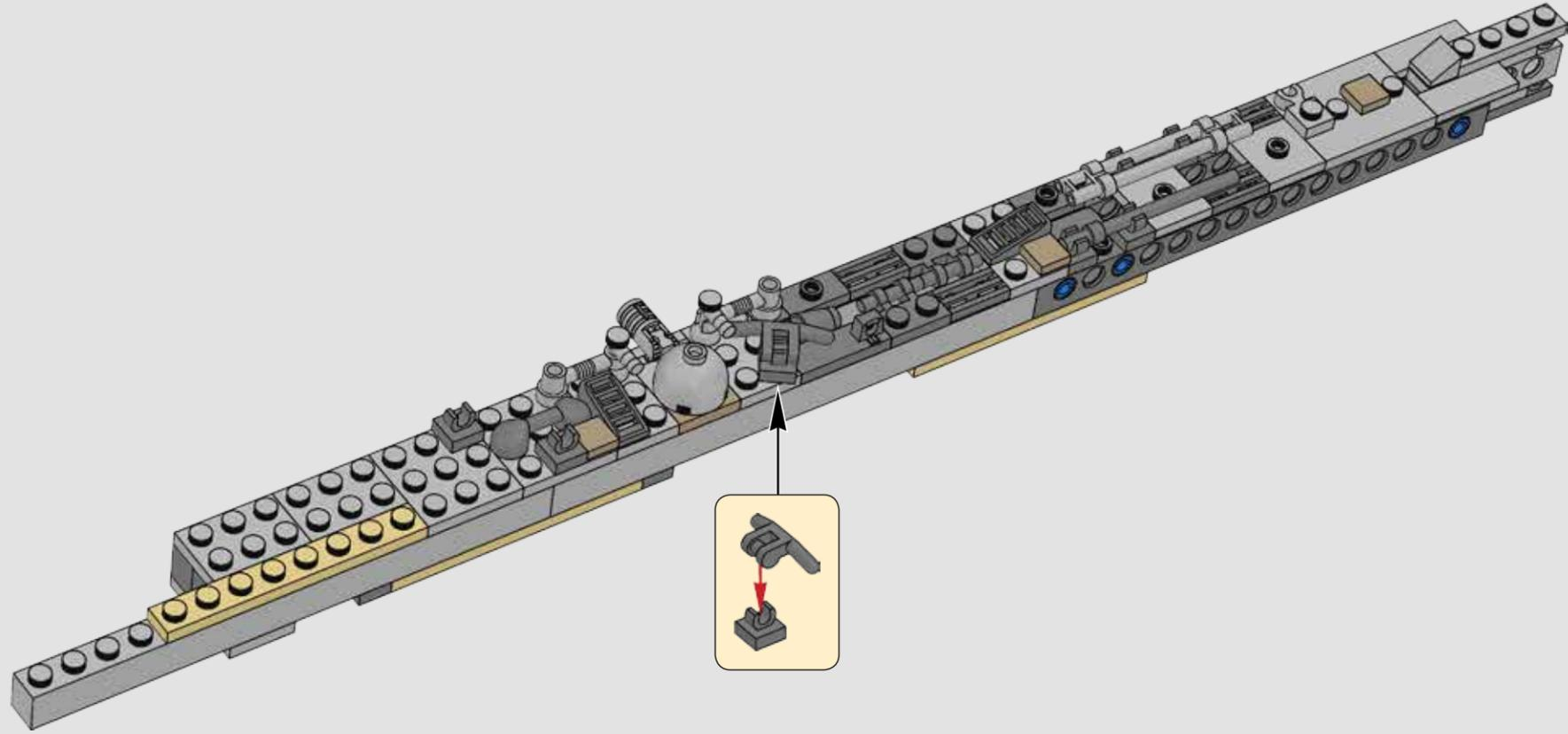

451

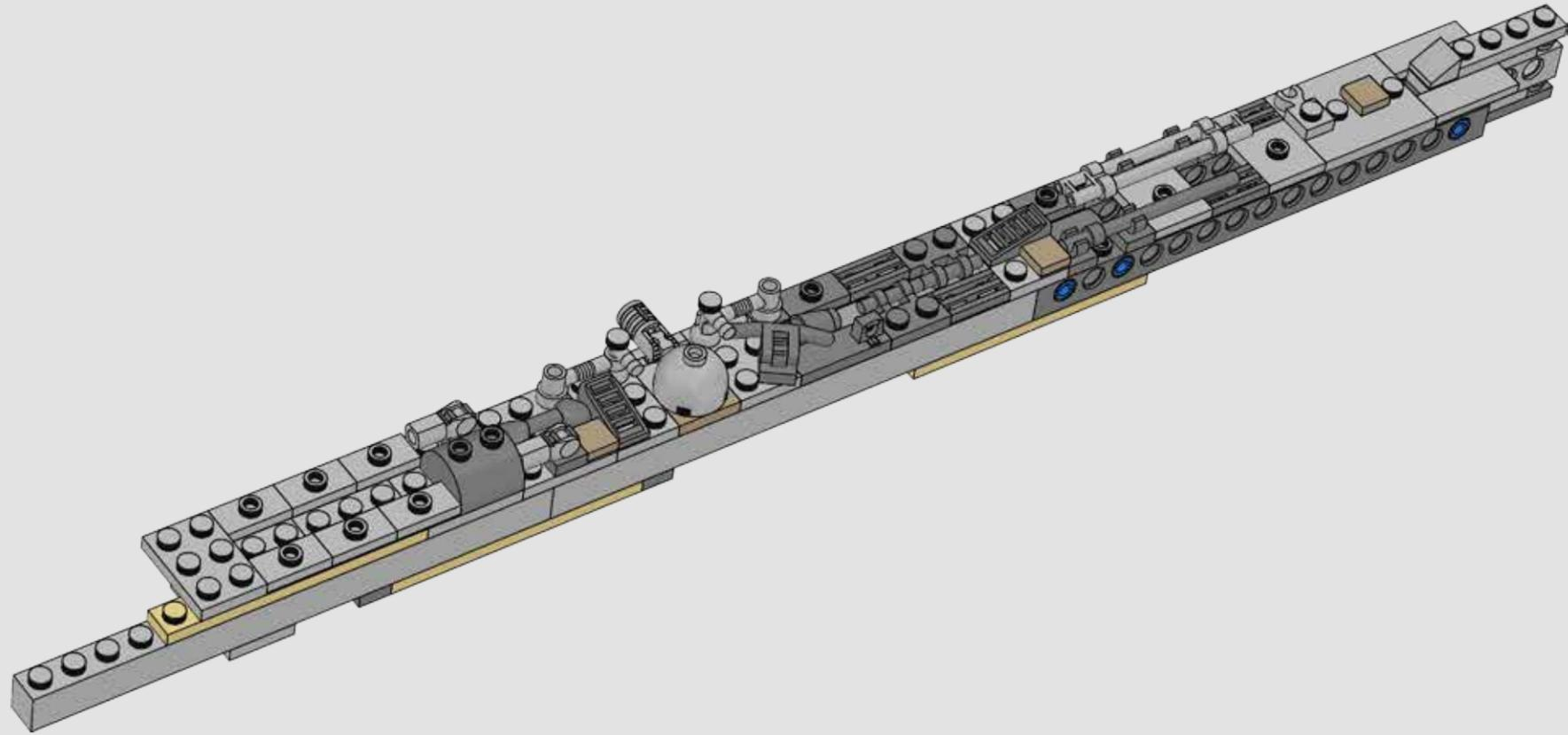

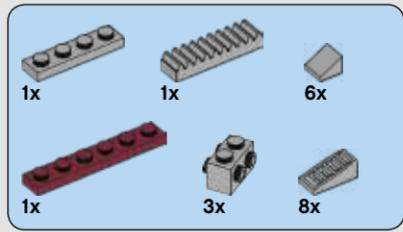

452

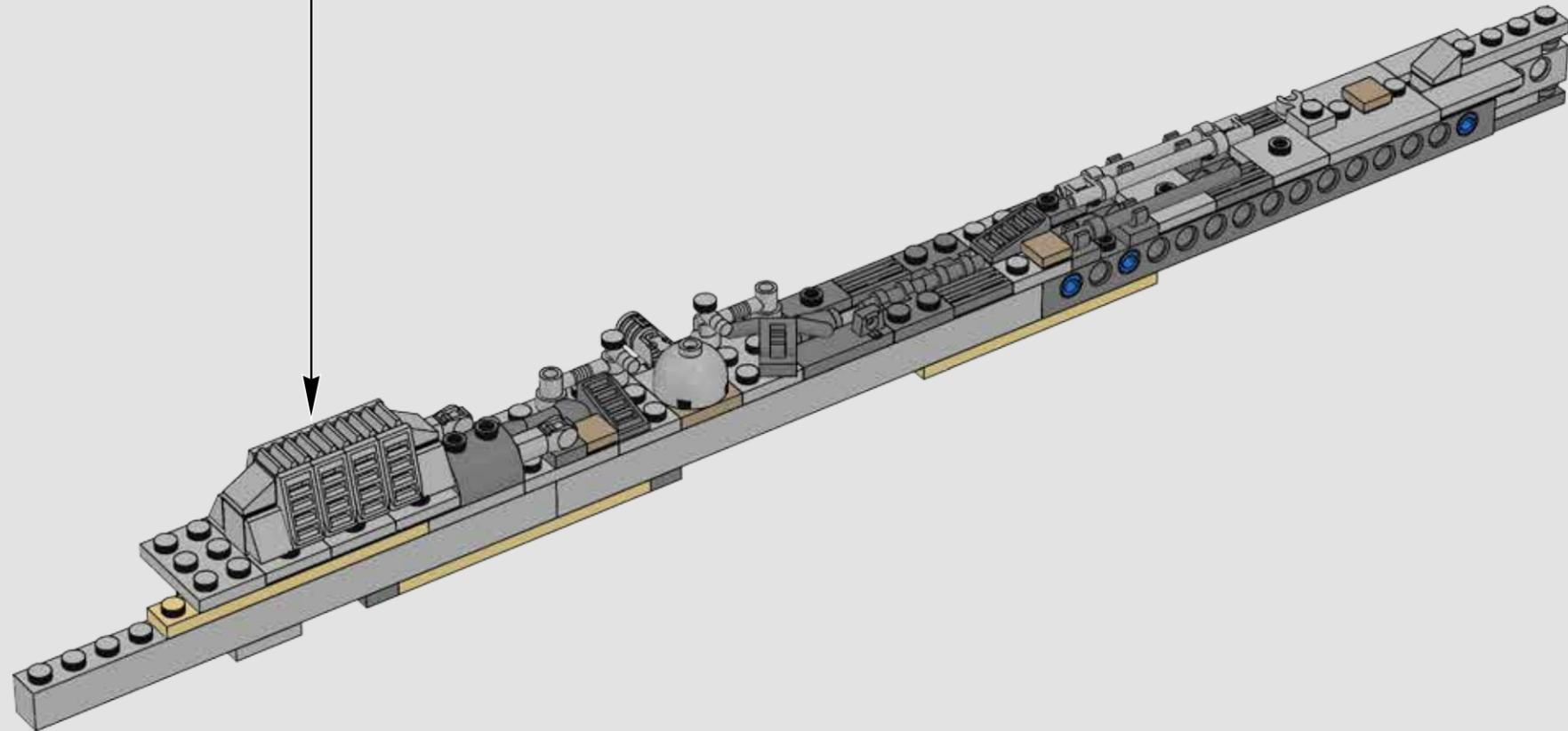
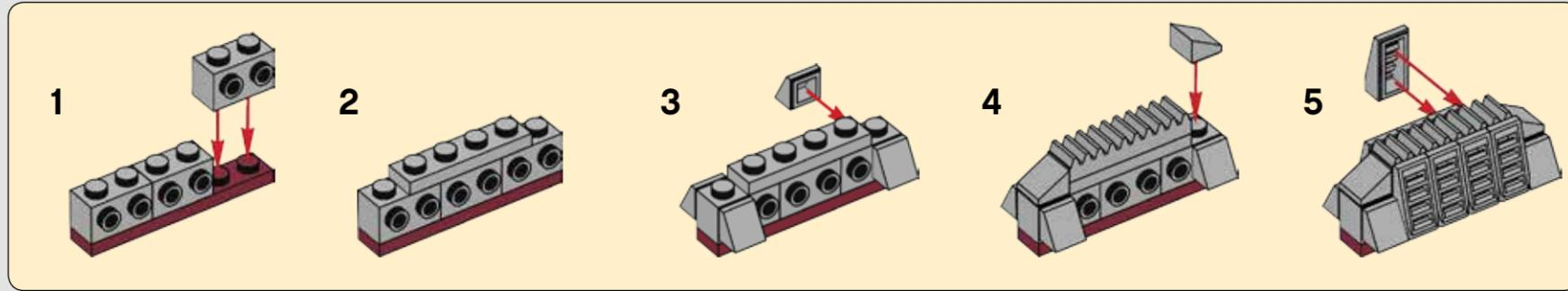

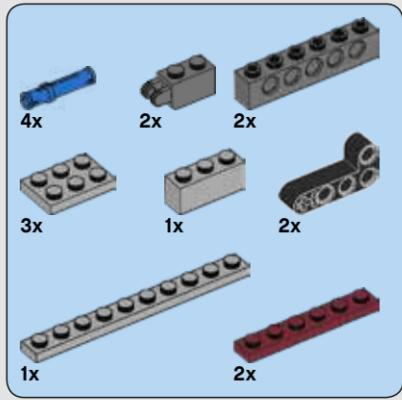

453

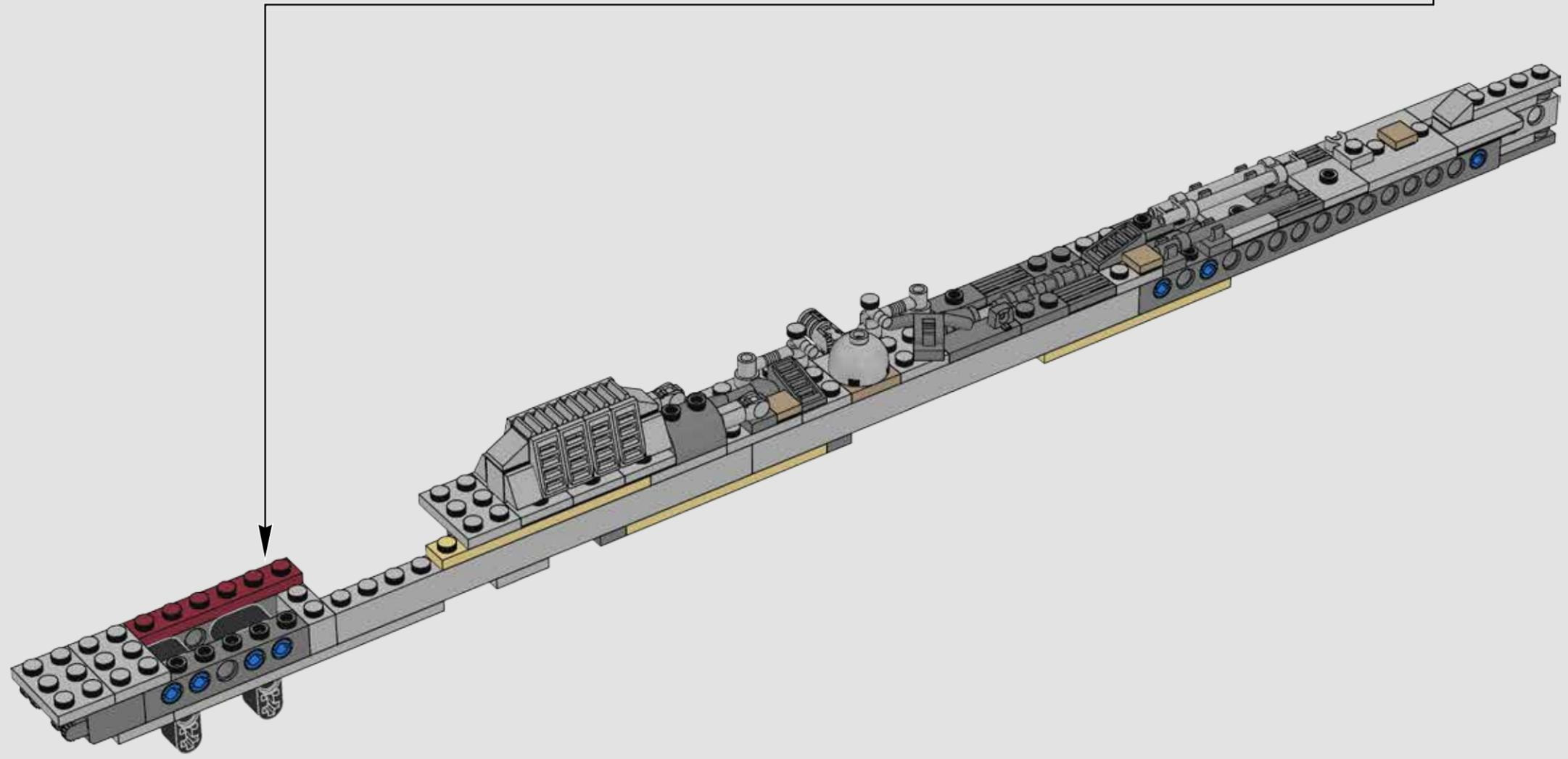
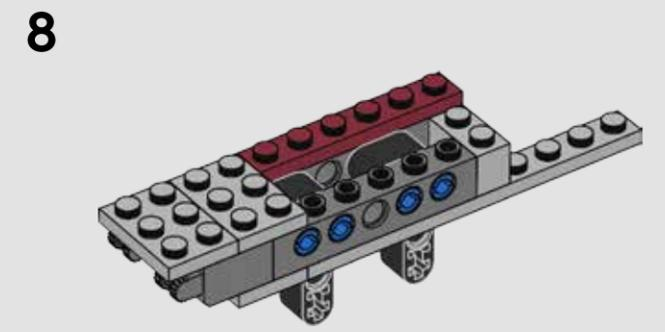
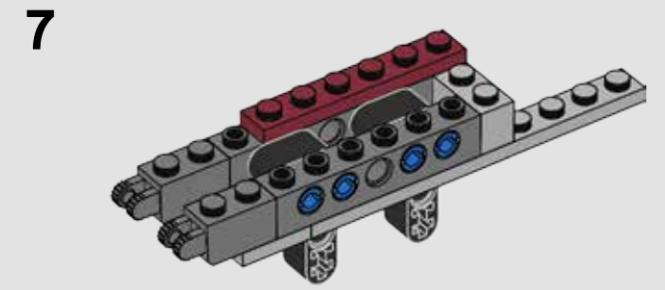
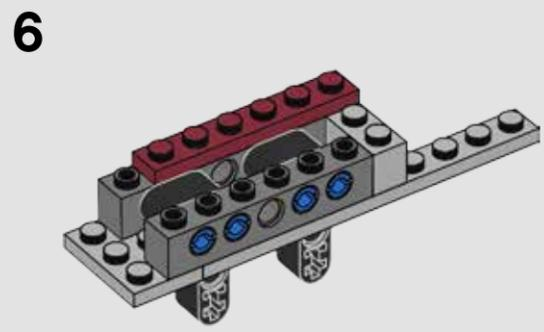
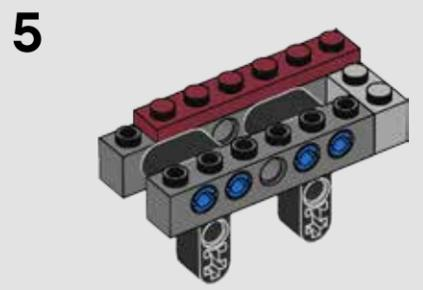
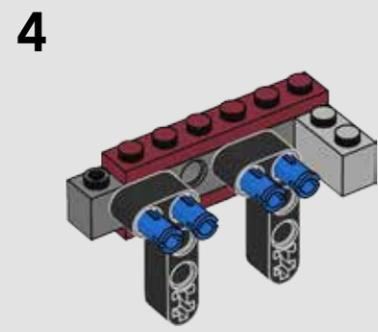
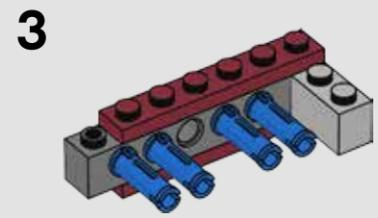
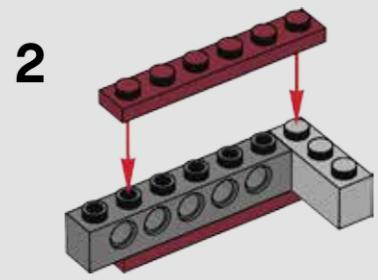

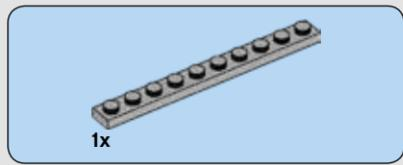

1x

454

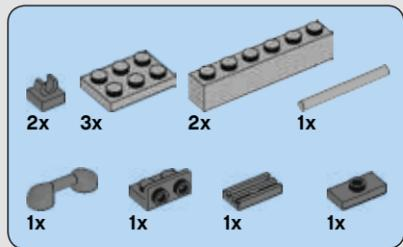
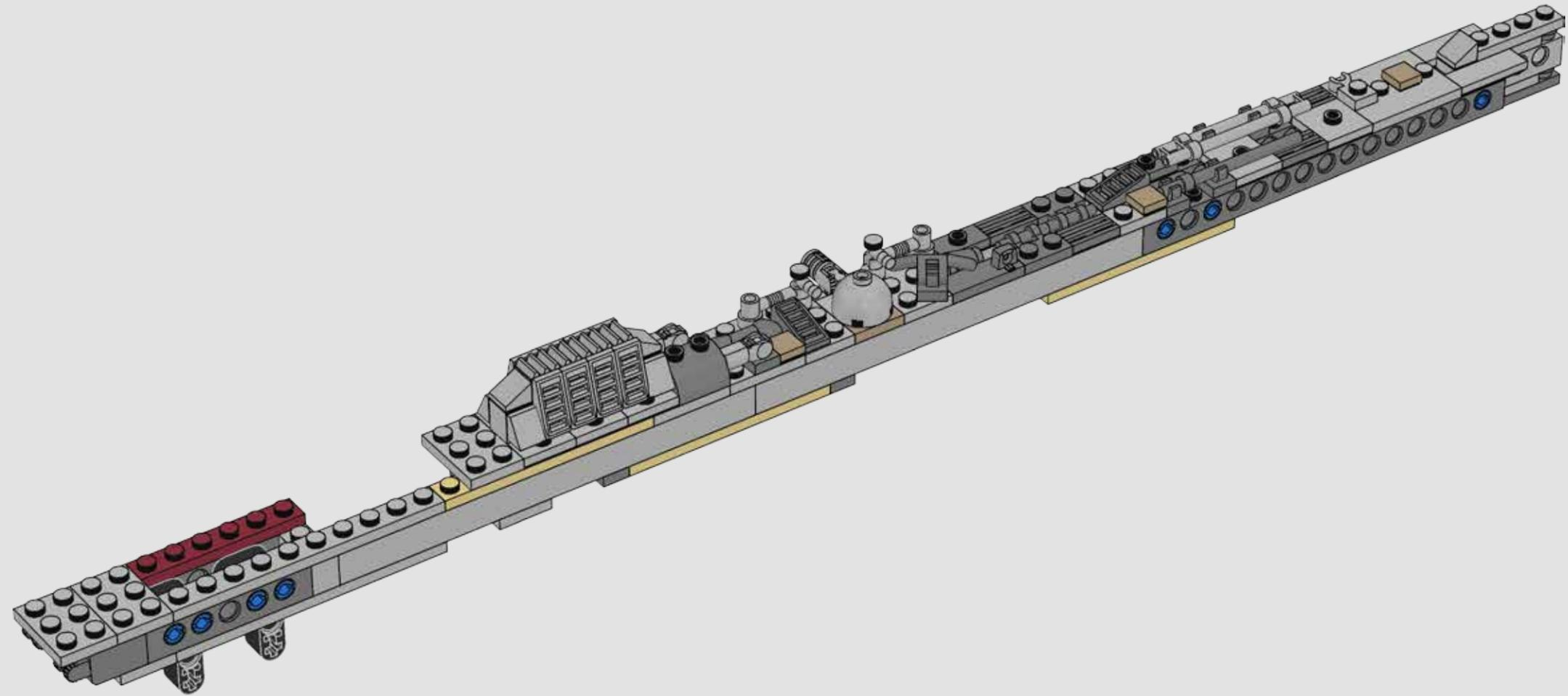

455

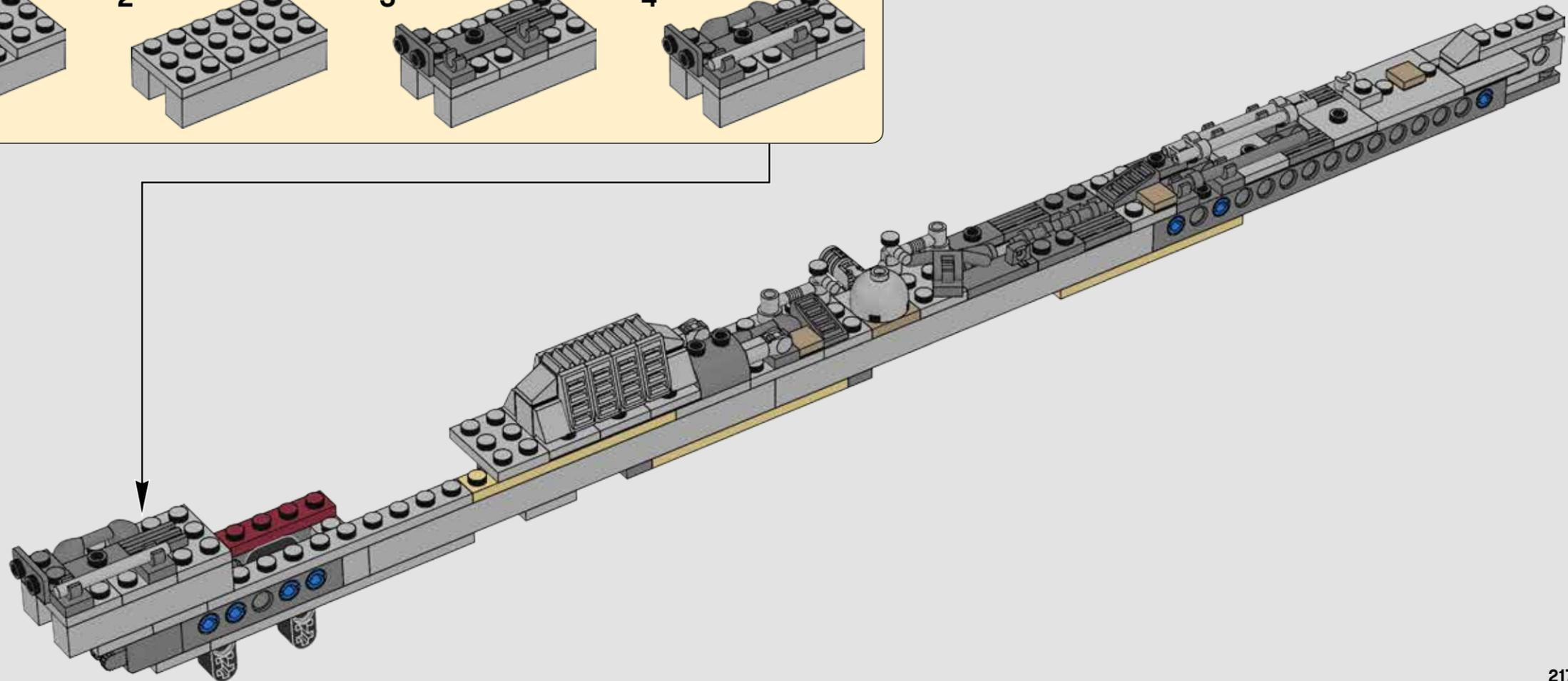
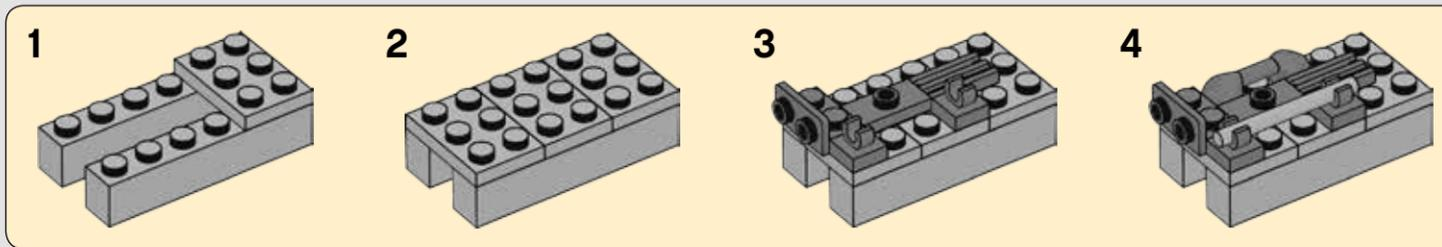

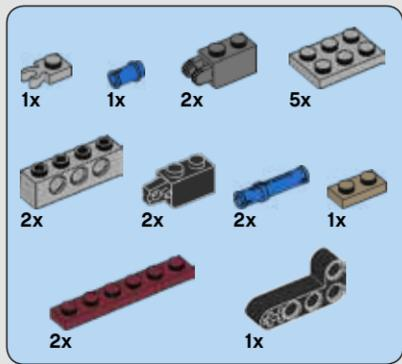

456

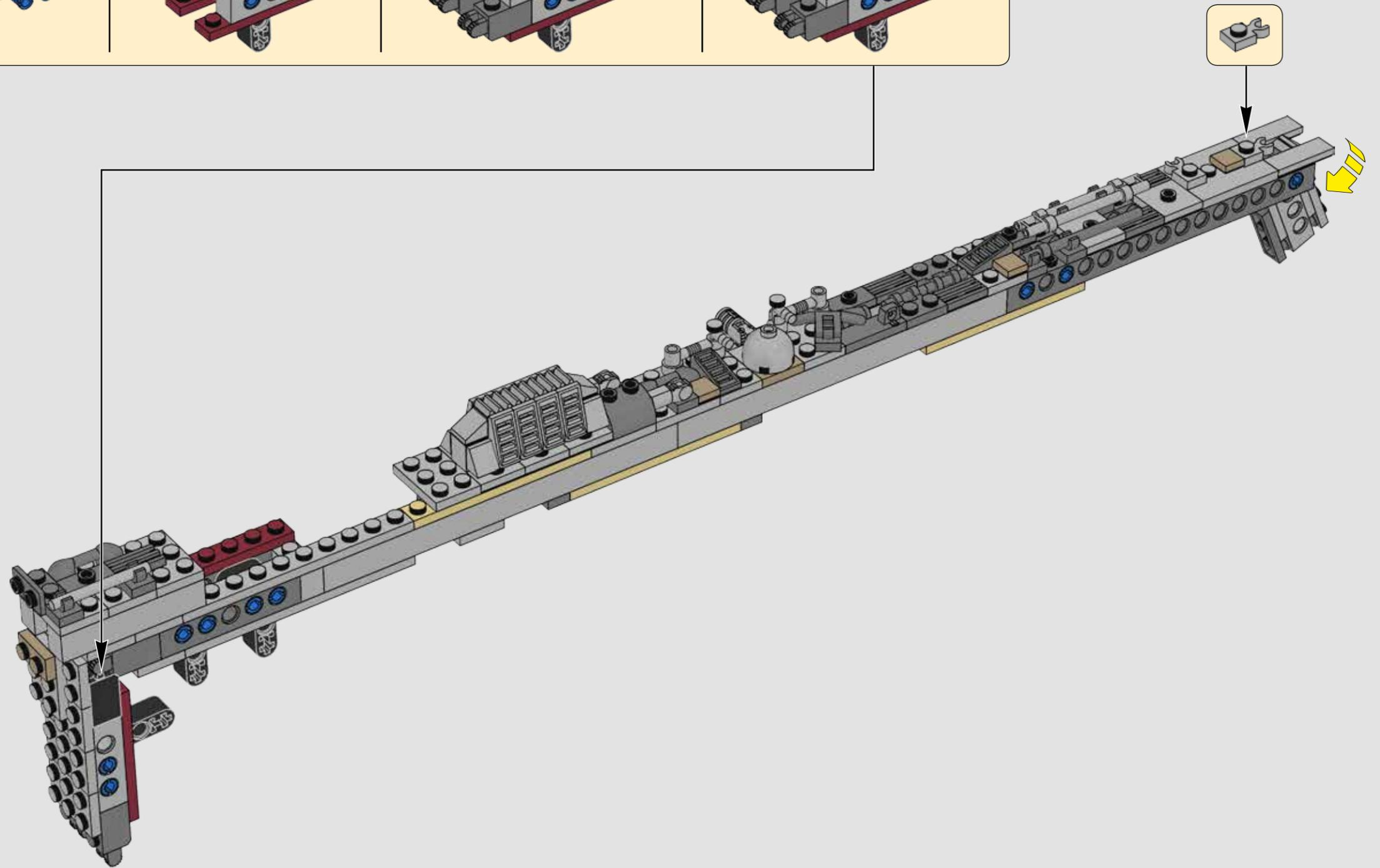
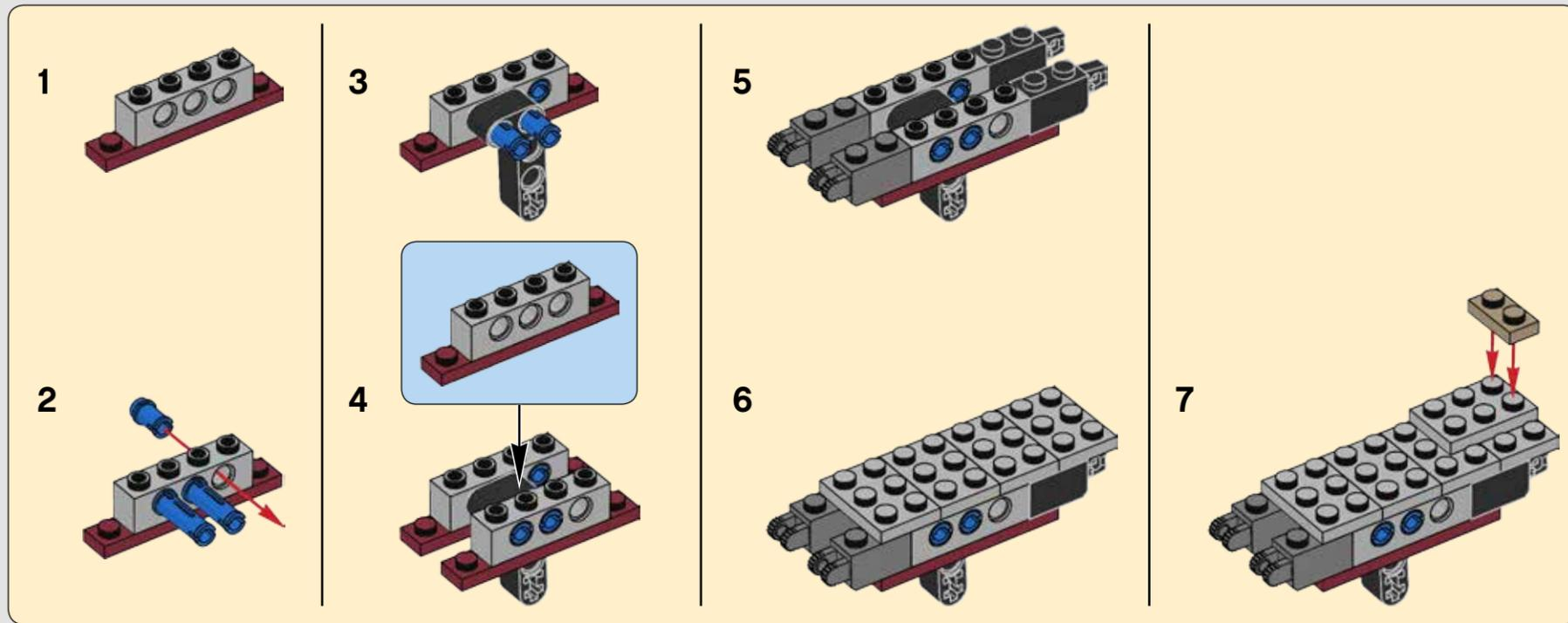

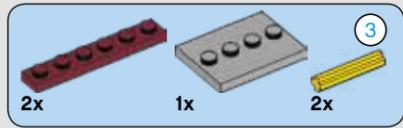

457

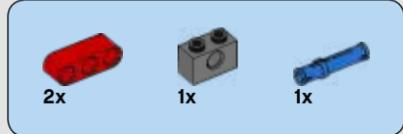

458

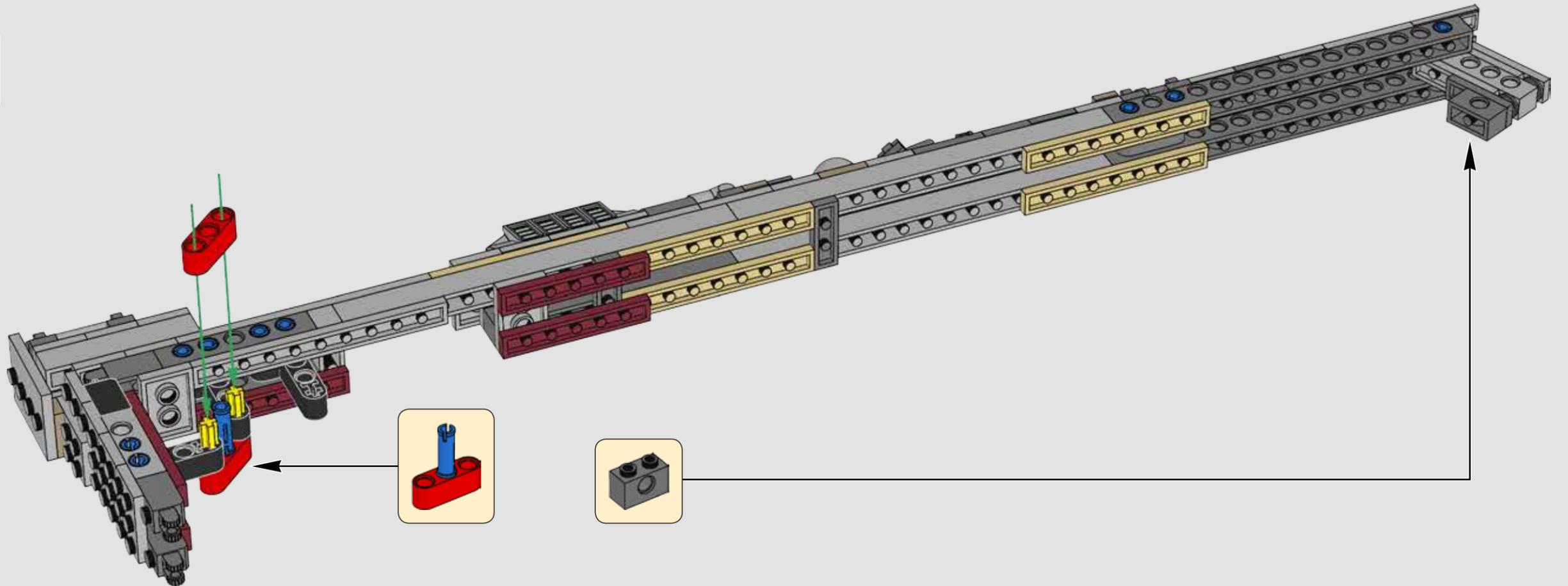

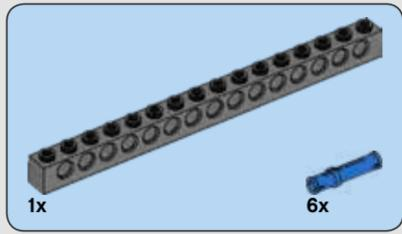

459



460

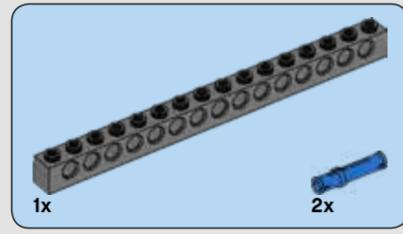
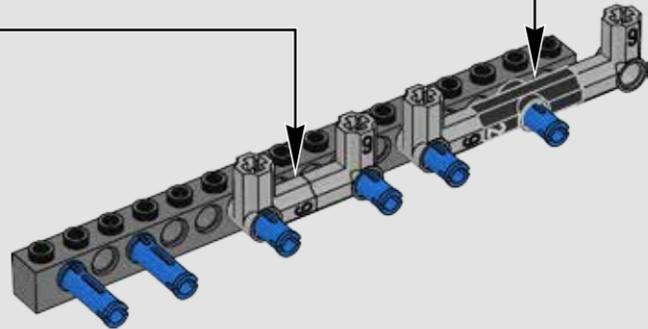
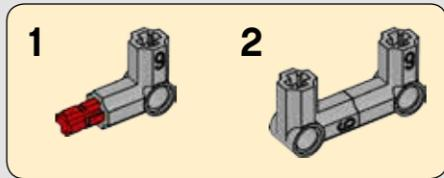
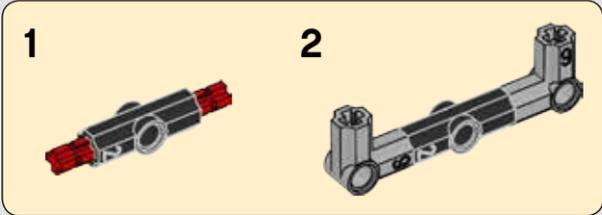

461

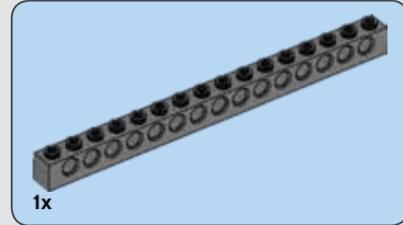
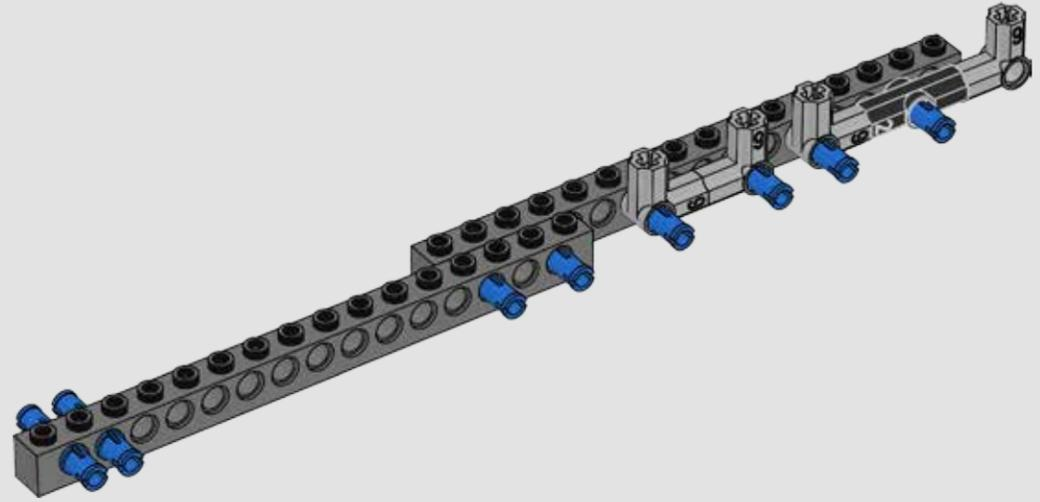

462

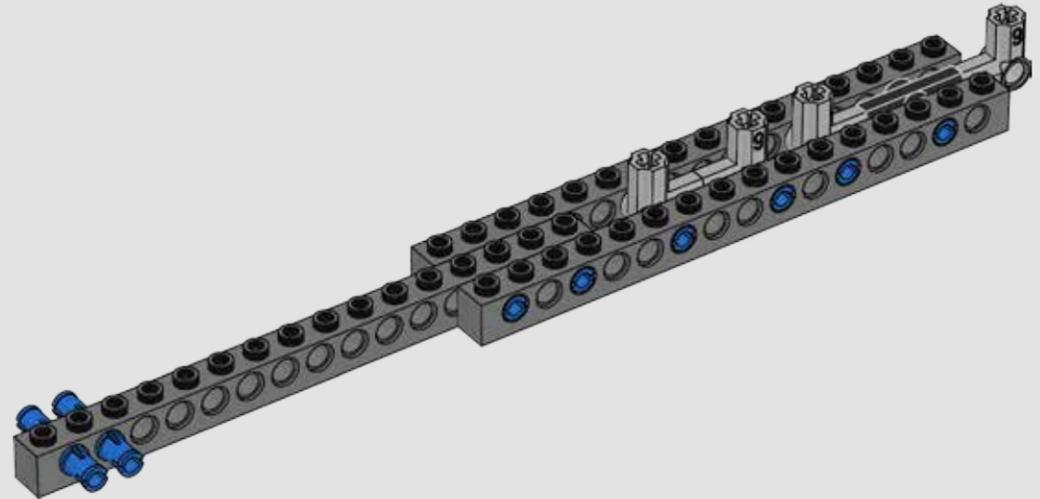

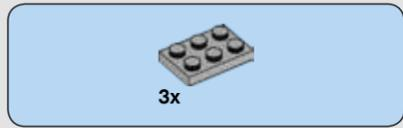

463

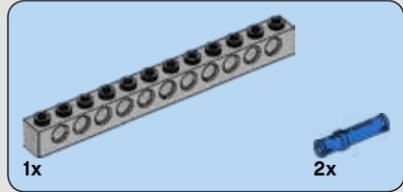
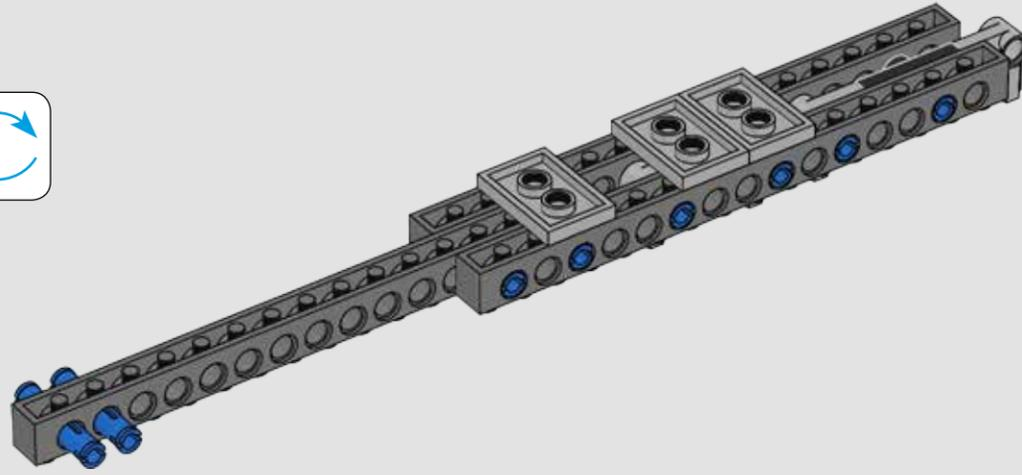

464

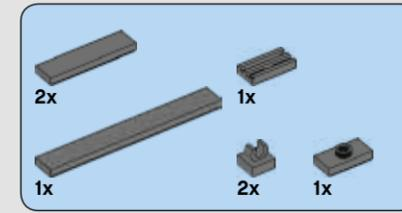
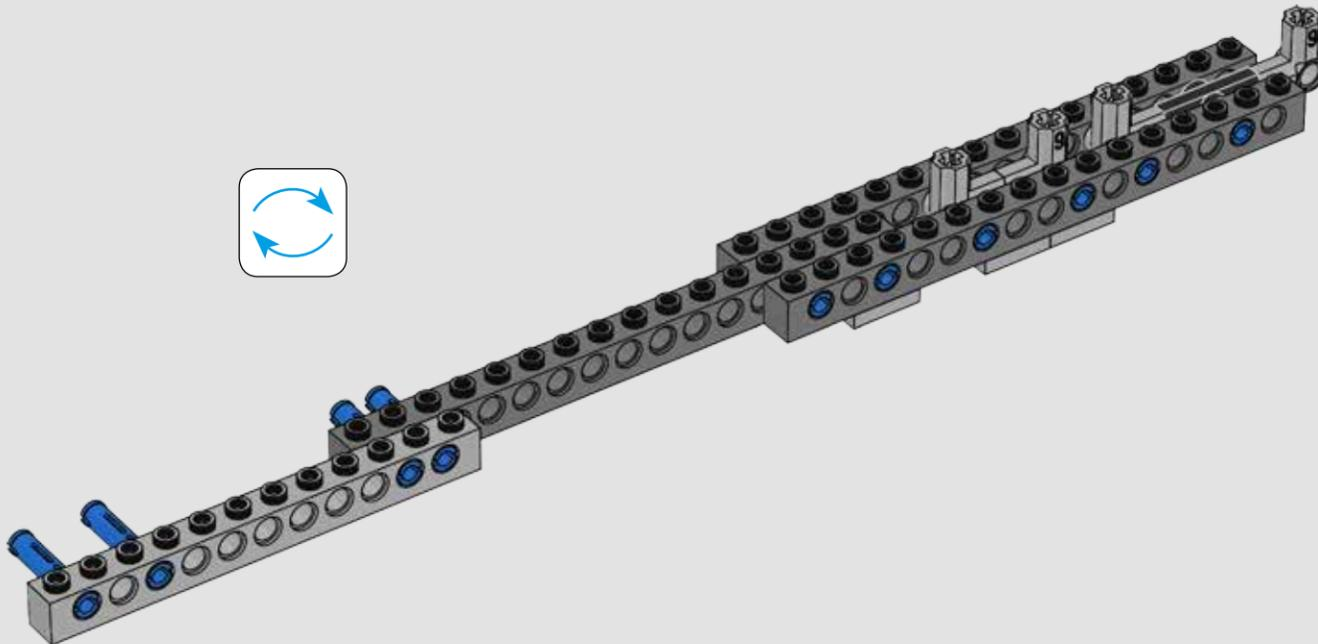

465

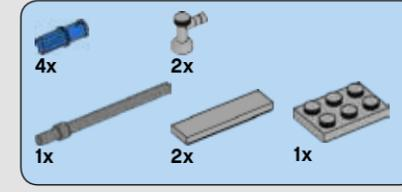
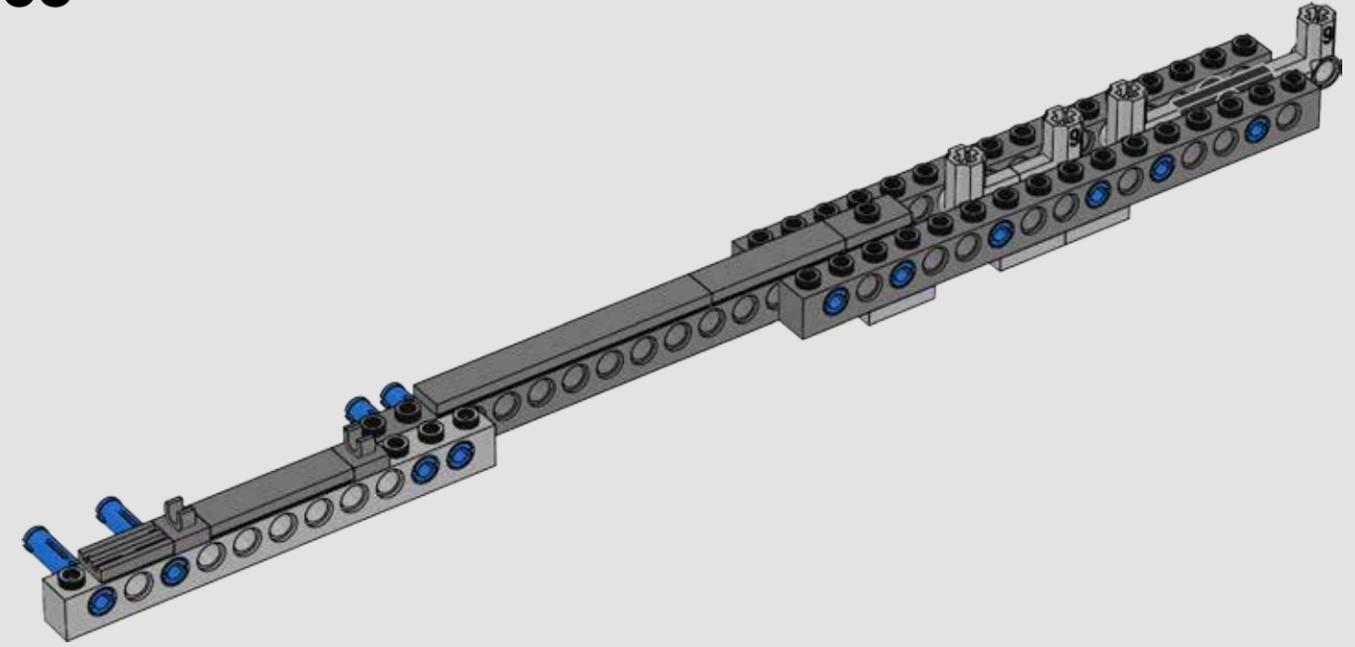

466

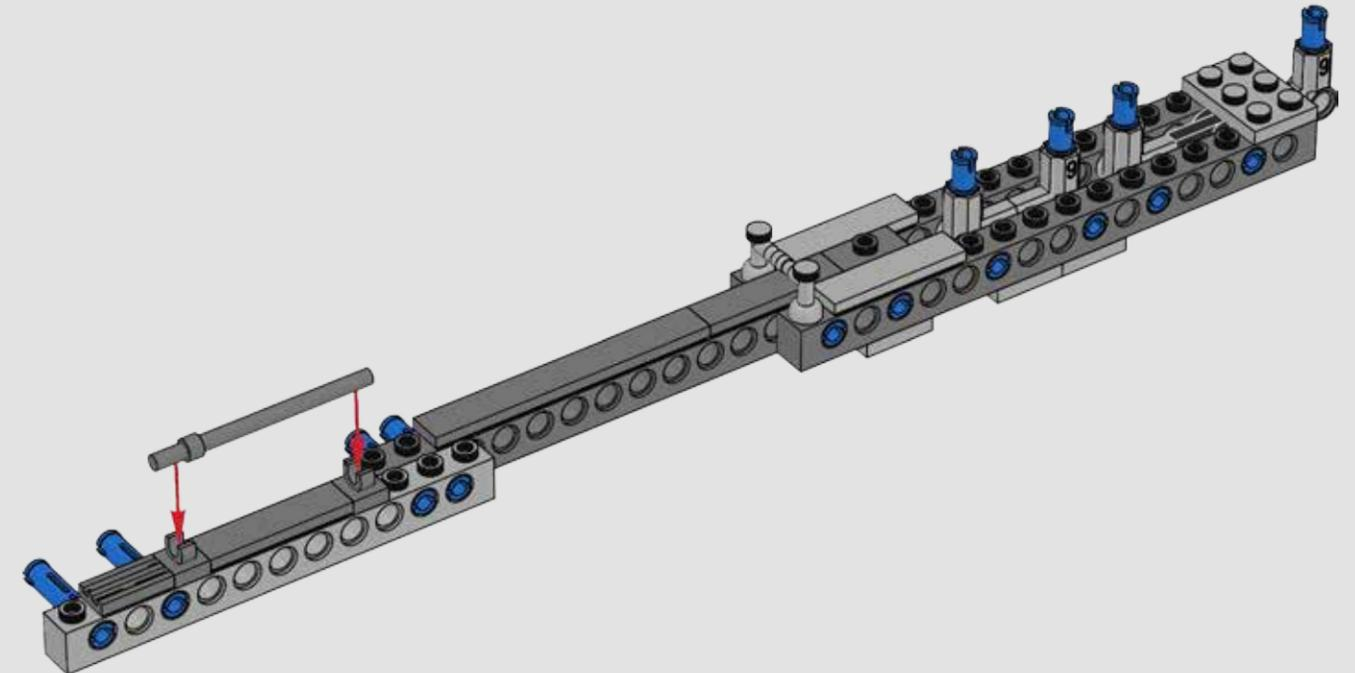

467

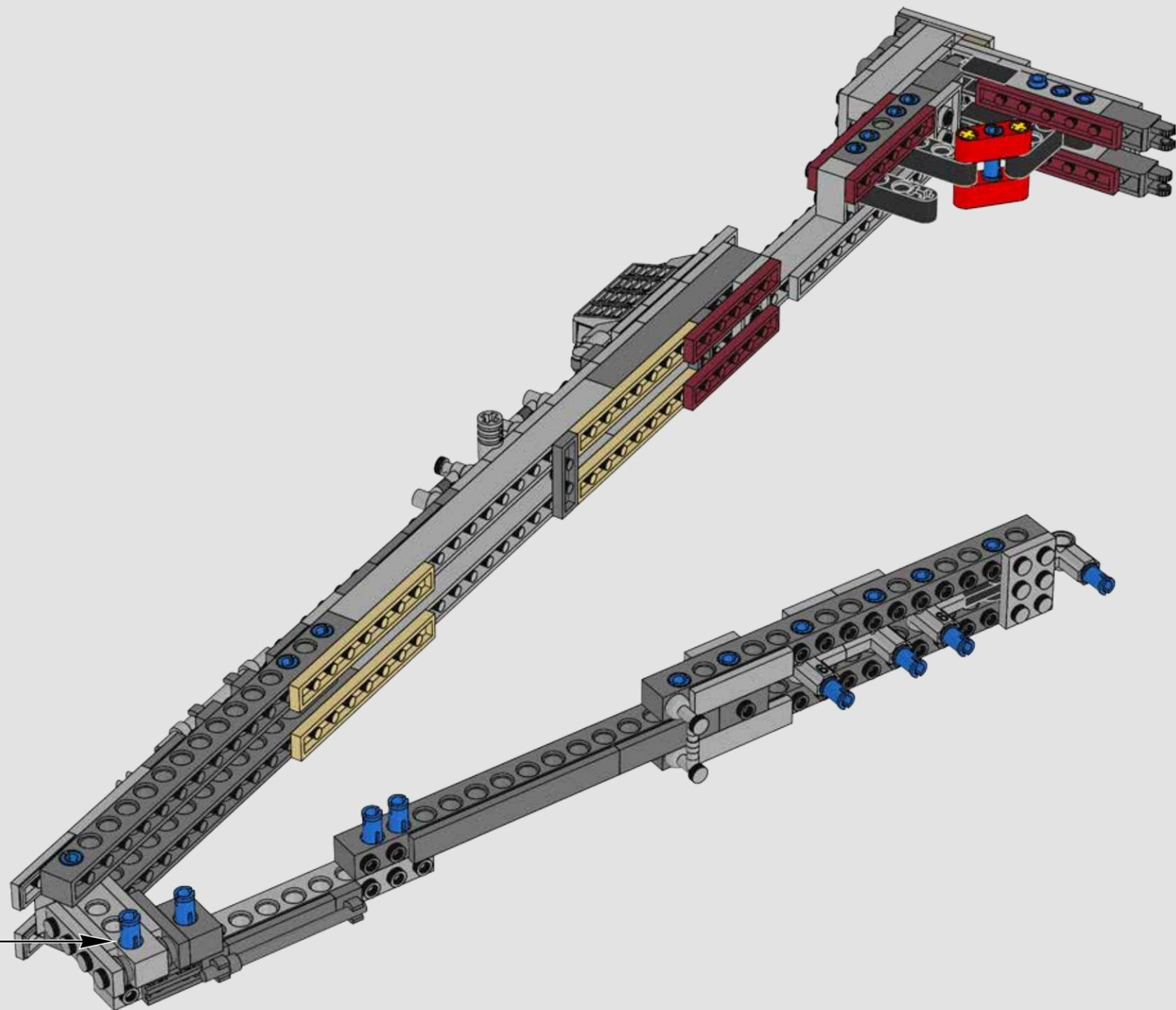

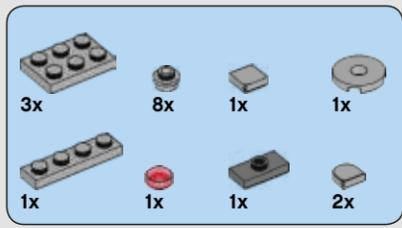

469

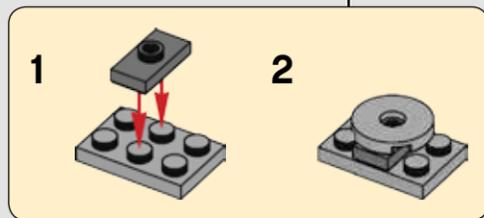
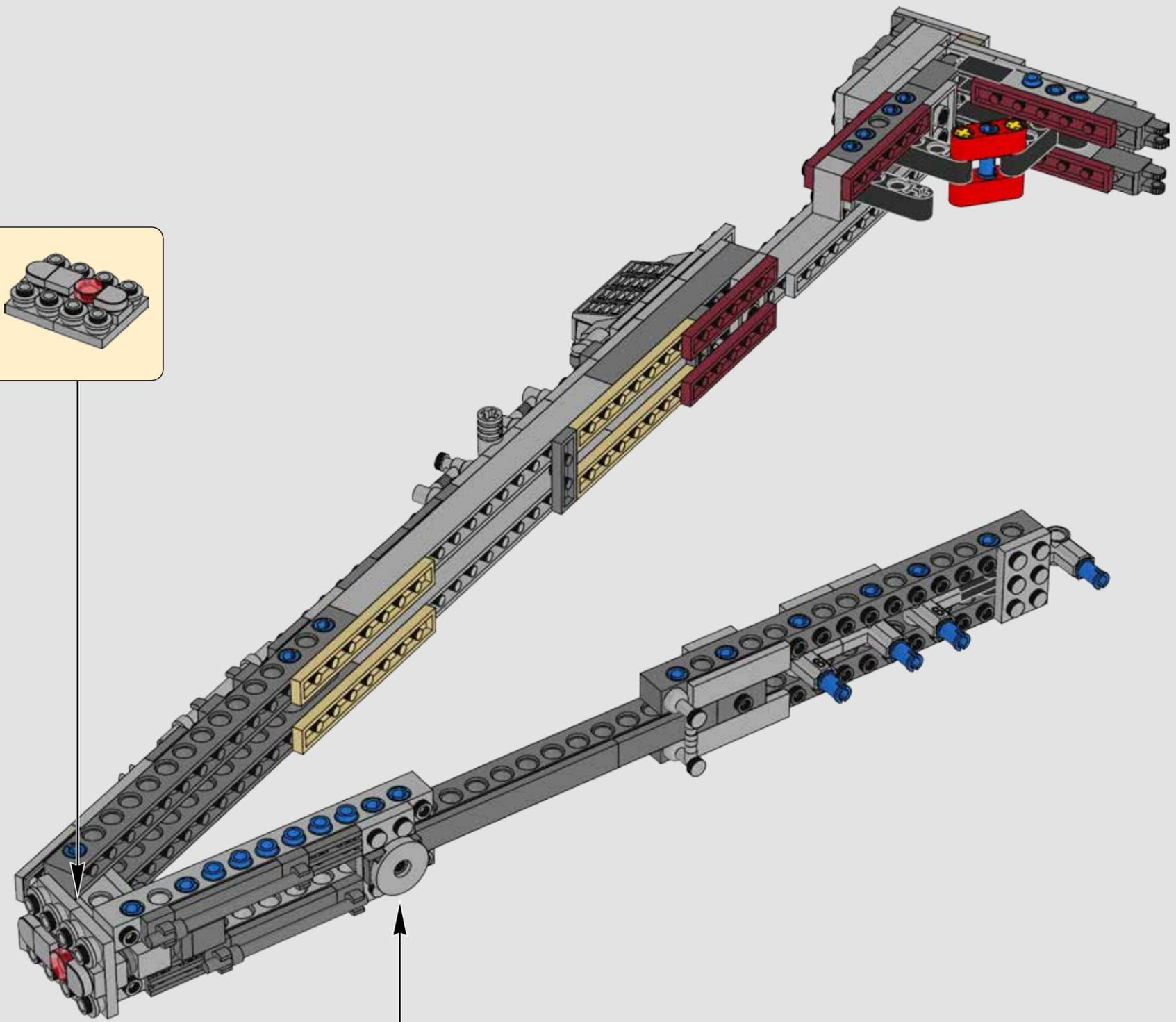
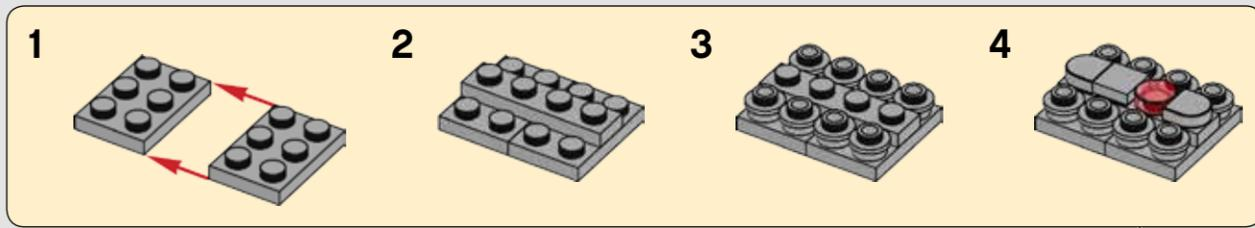

470

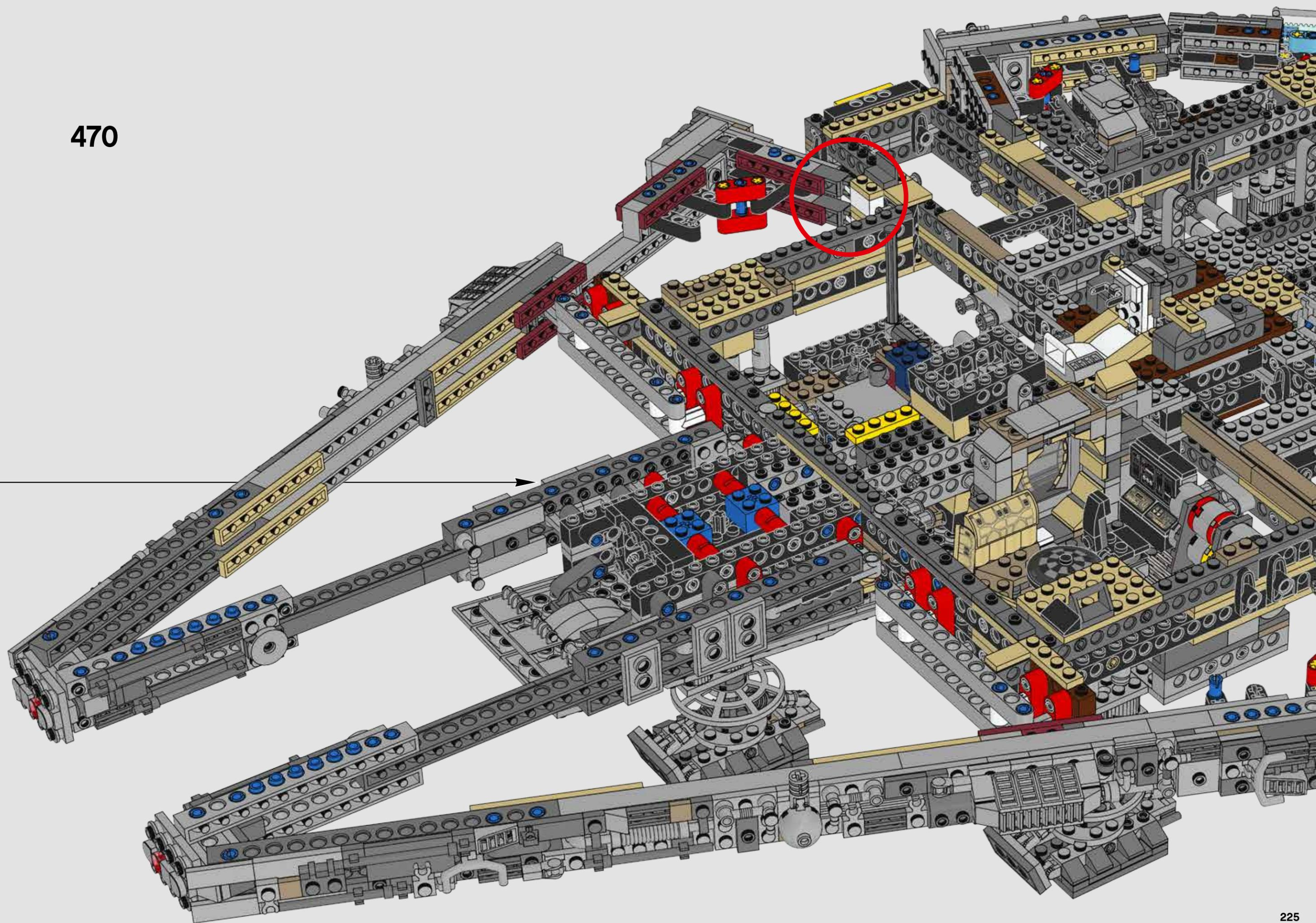



7

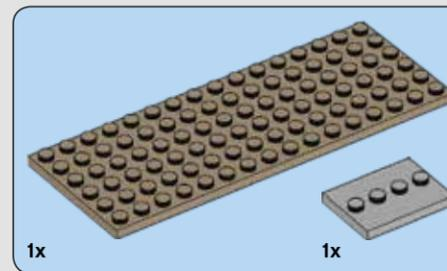
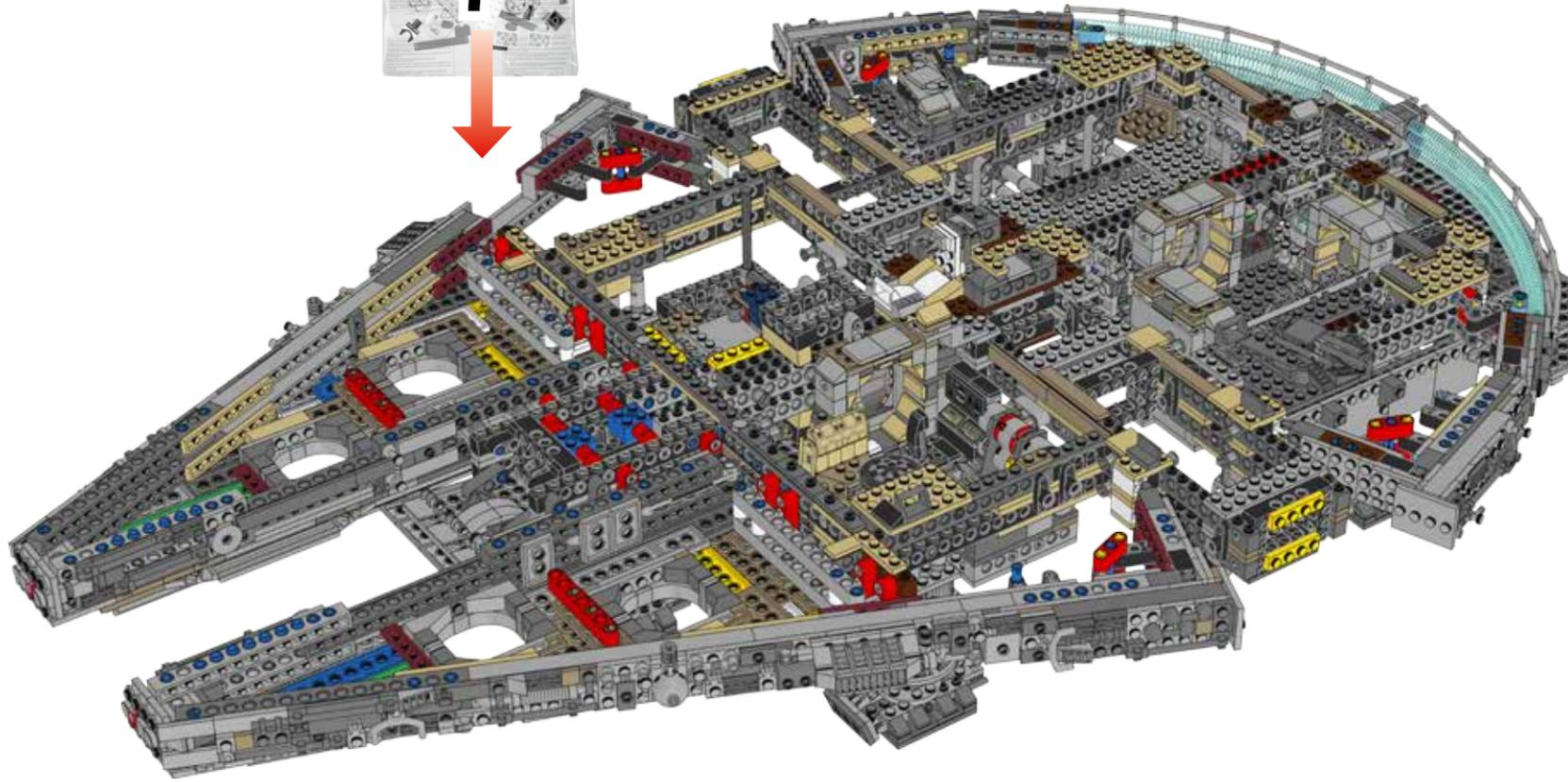

472

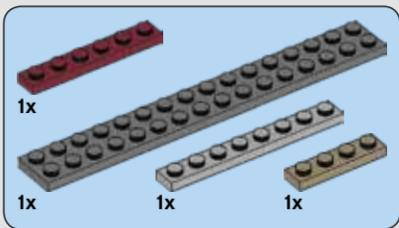
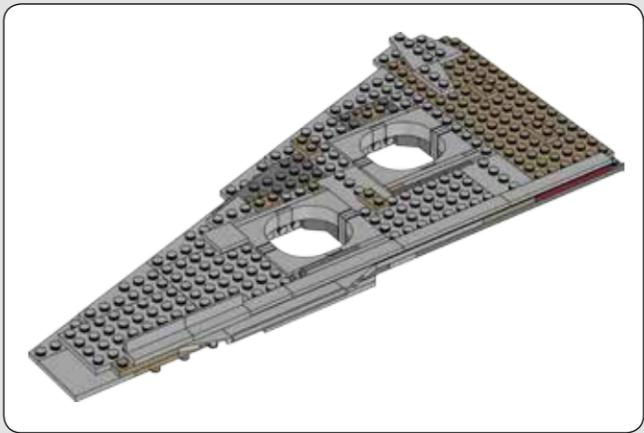
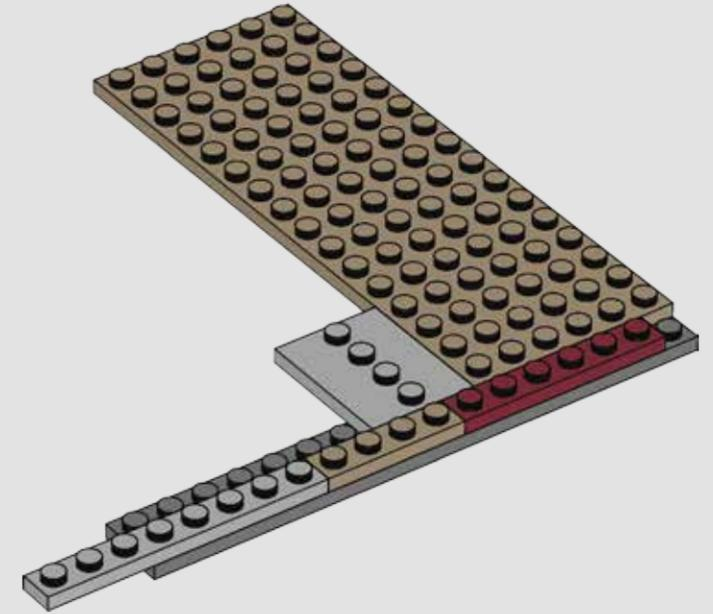

471

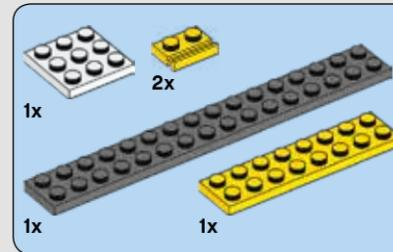
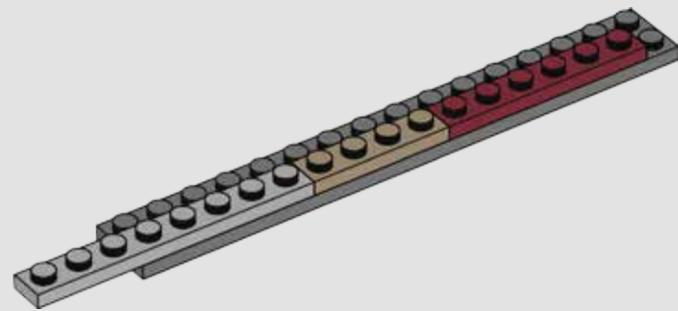

473

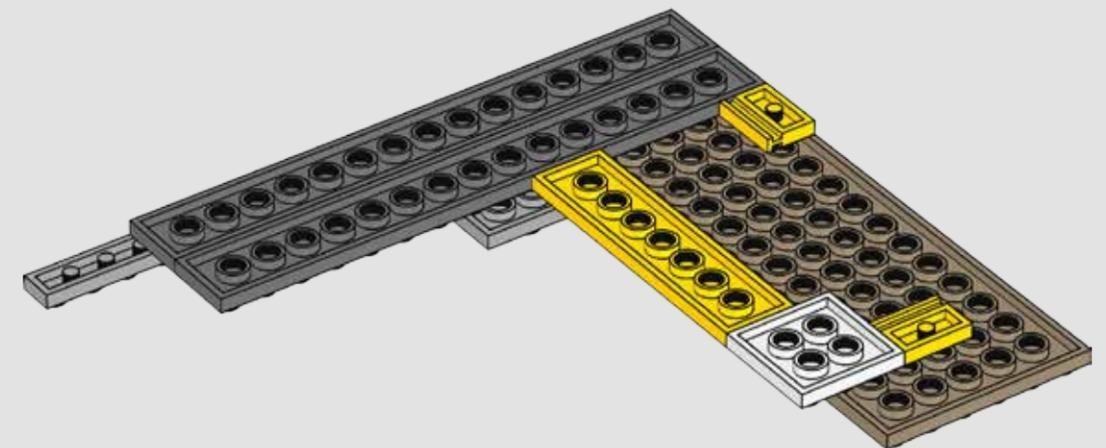

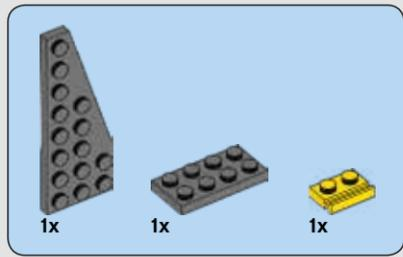

474

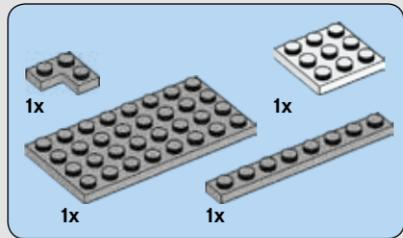

475

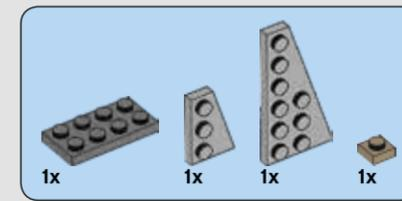
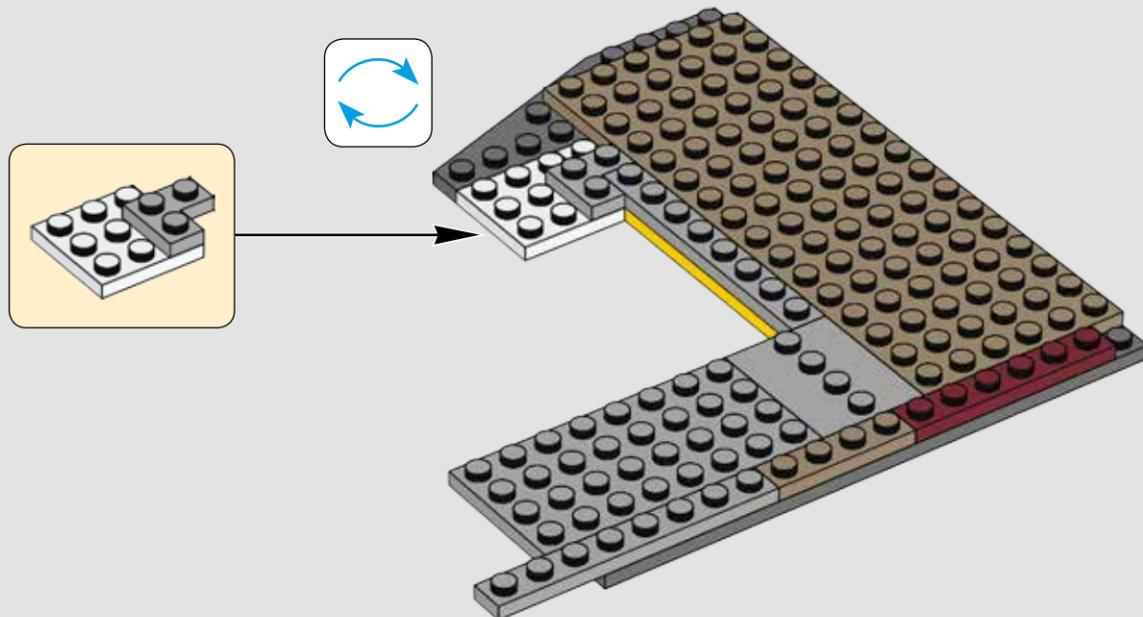

476

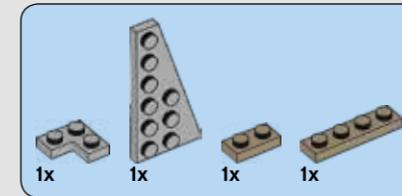
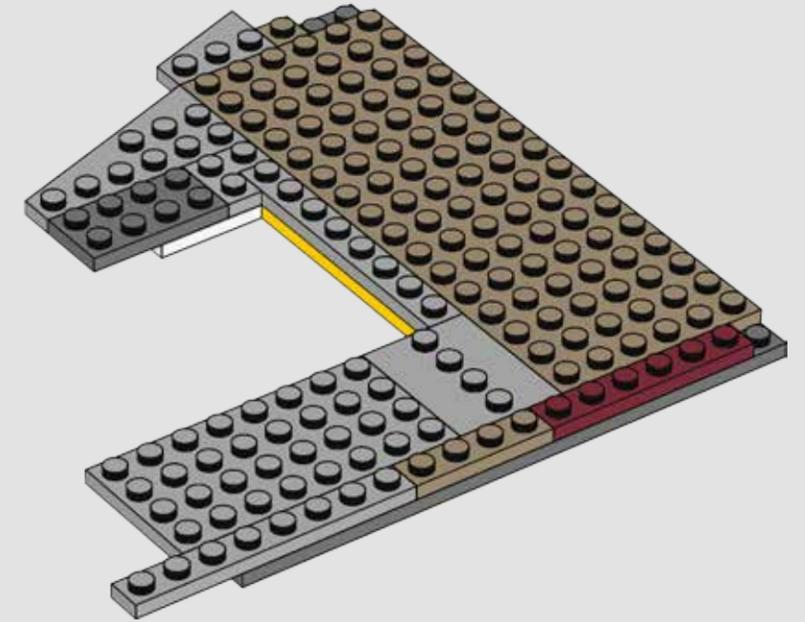

477



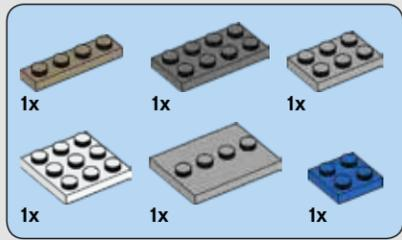

478

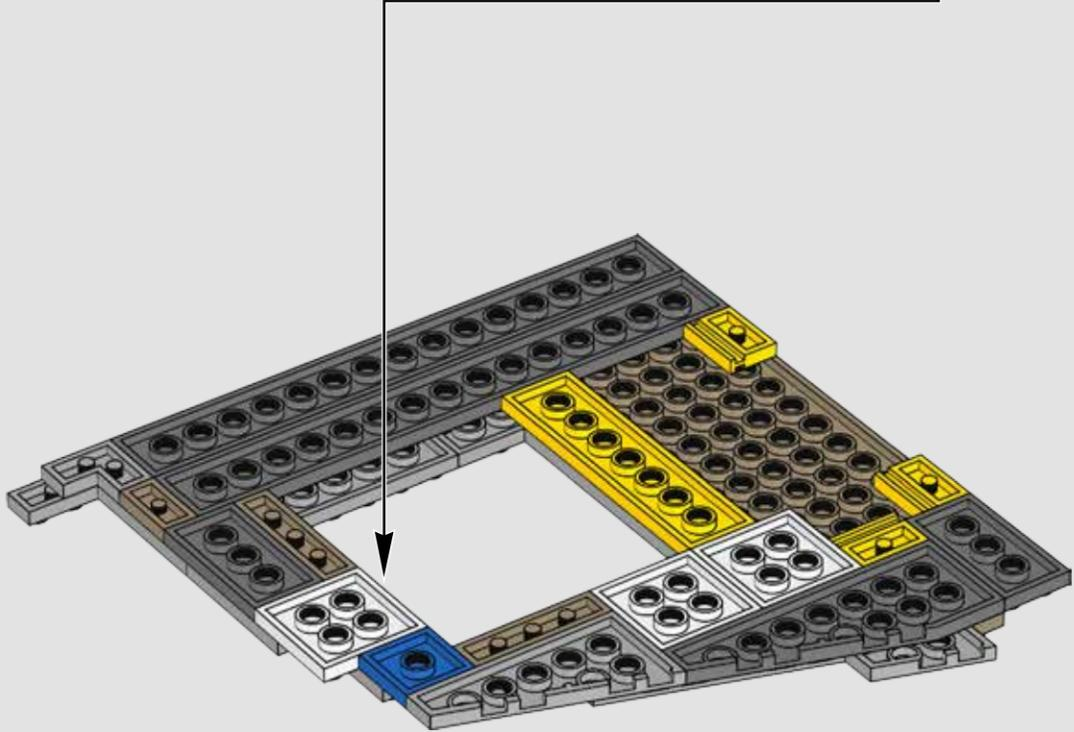
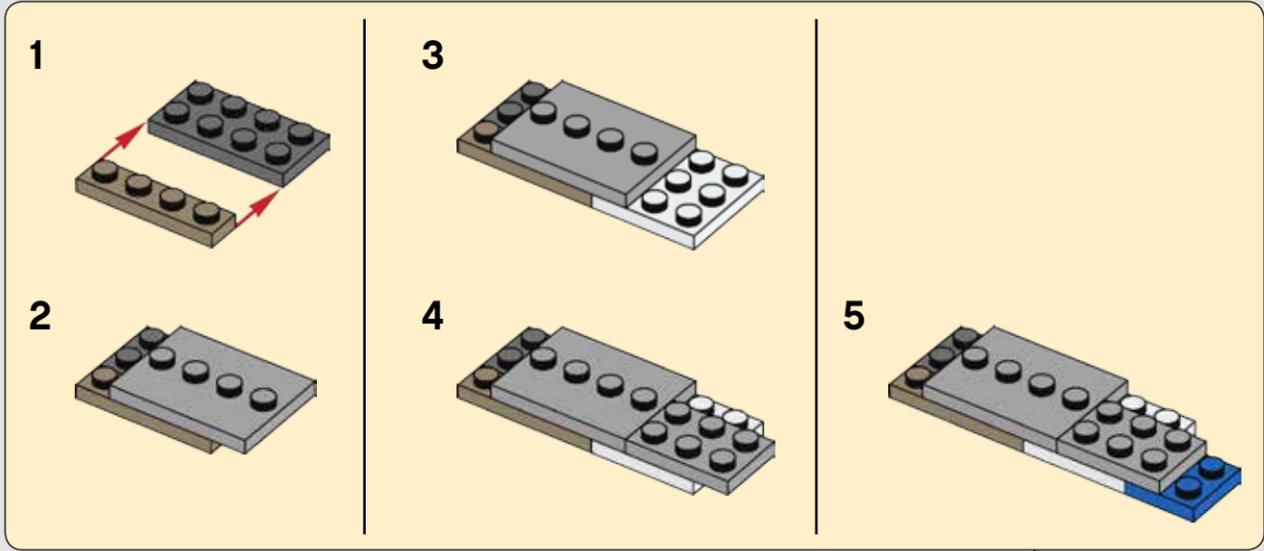

479

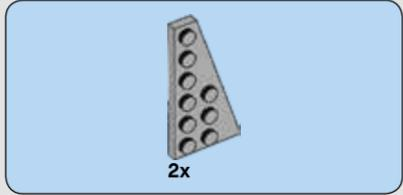
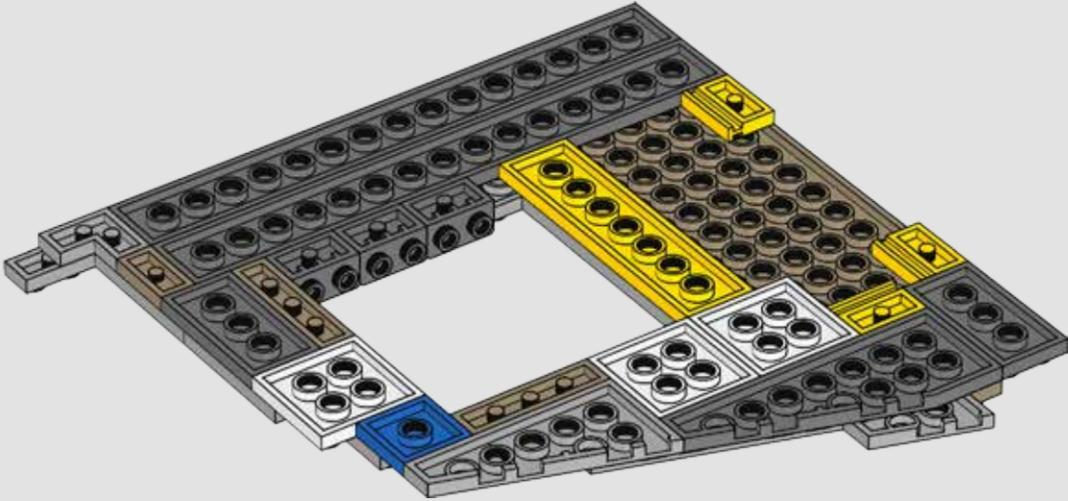

480

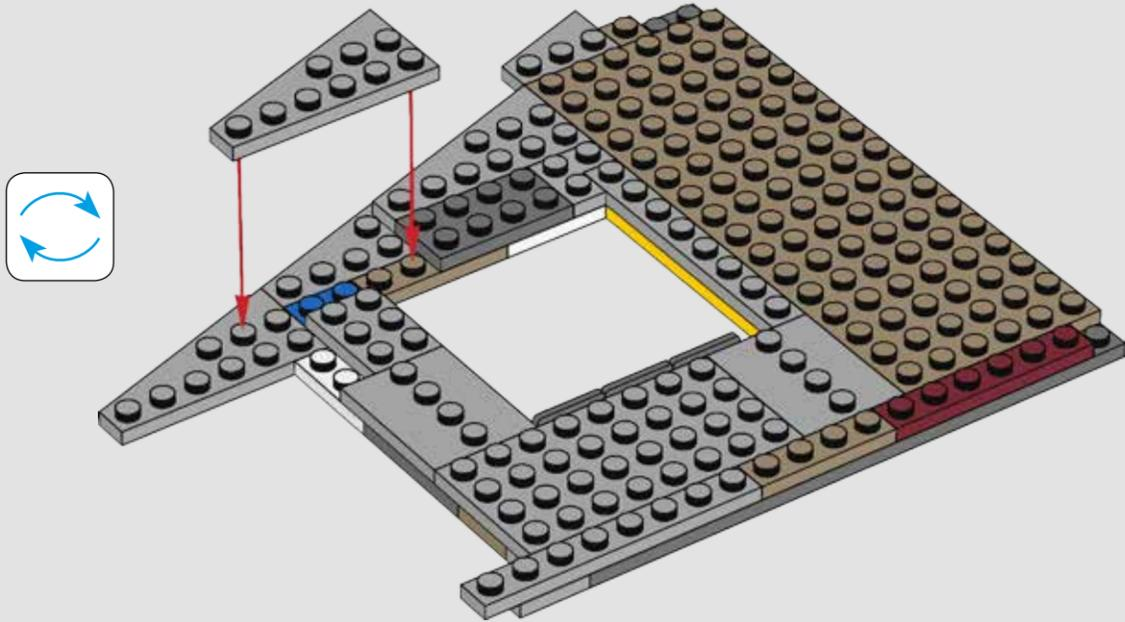

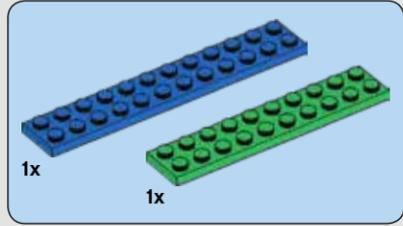
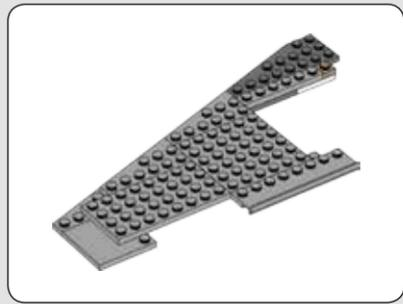

481

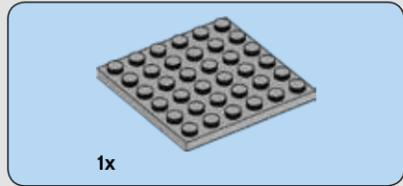
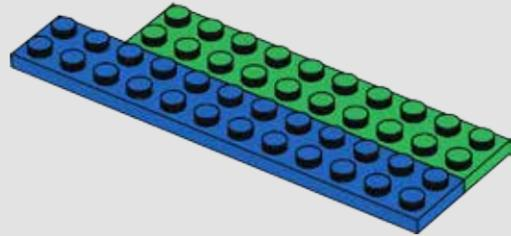

482

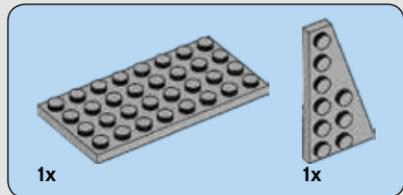
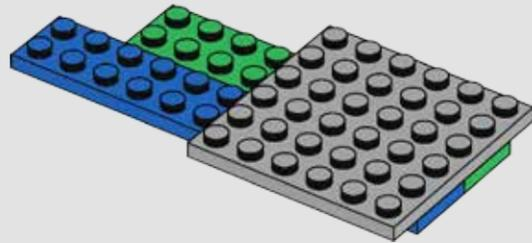

483

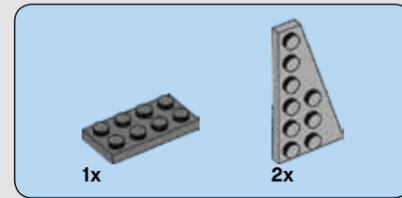
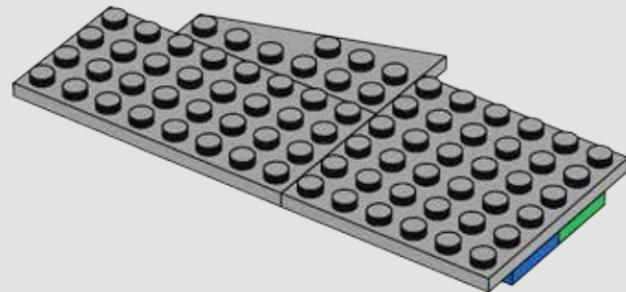

484

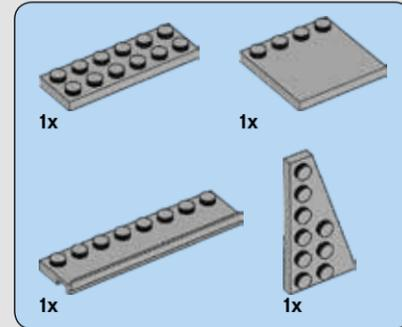
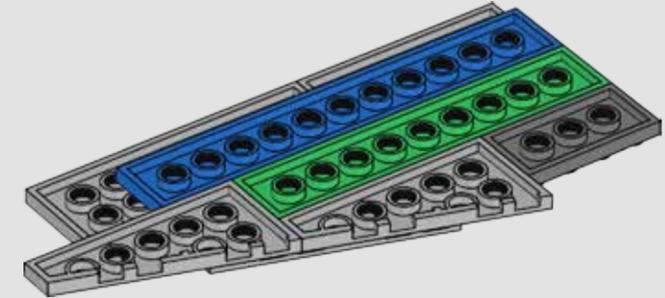

485

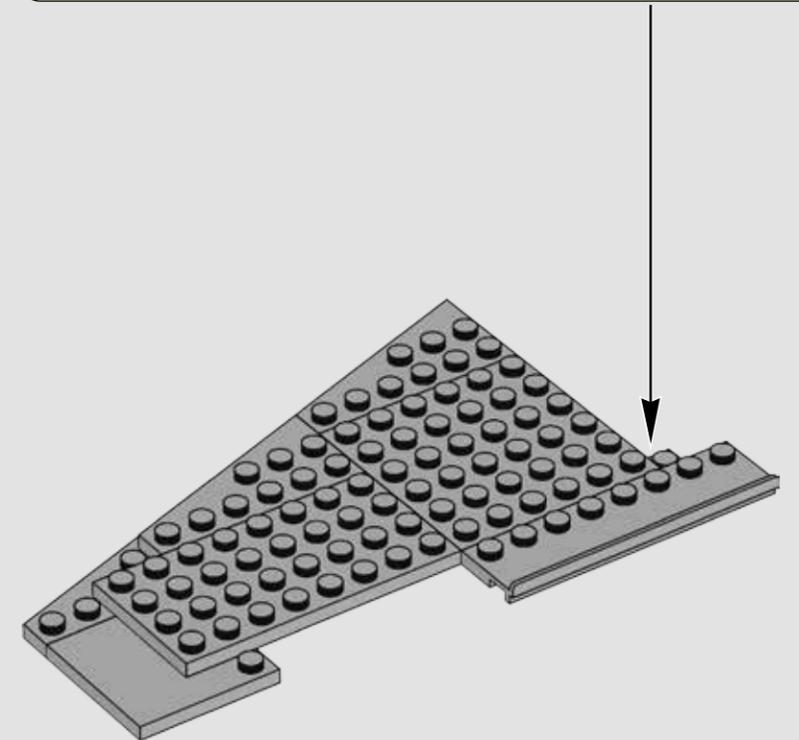
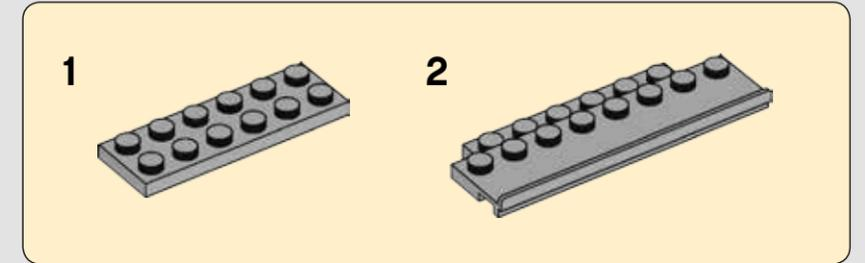

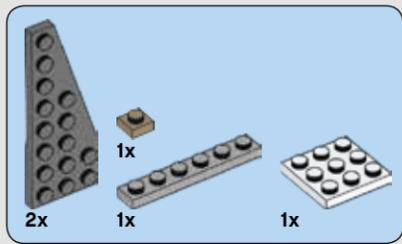

486

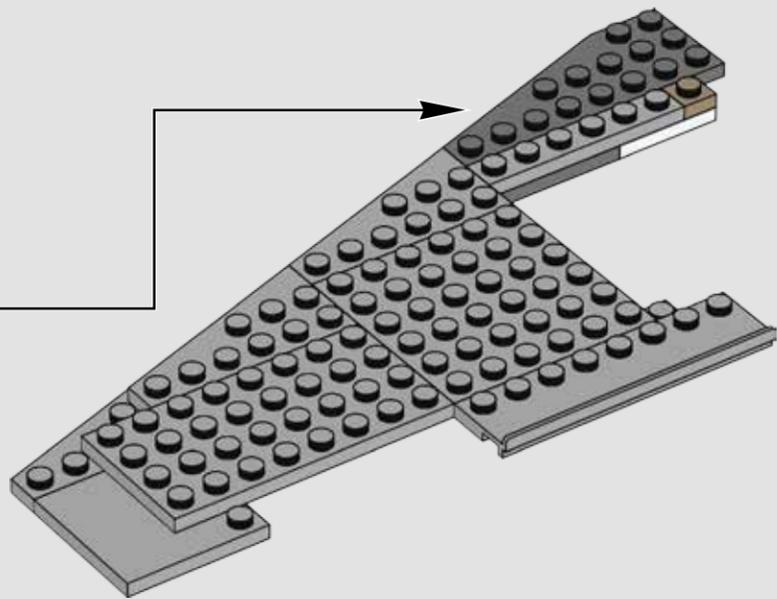
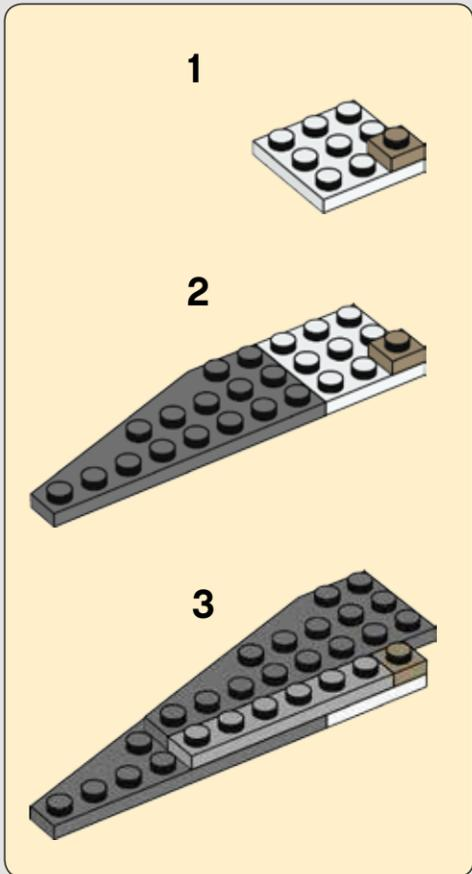

487

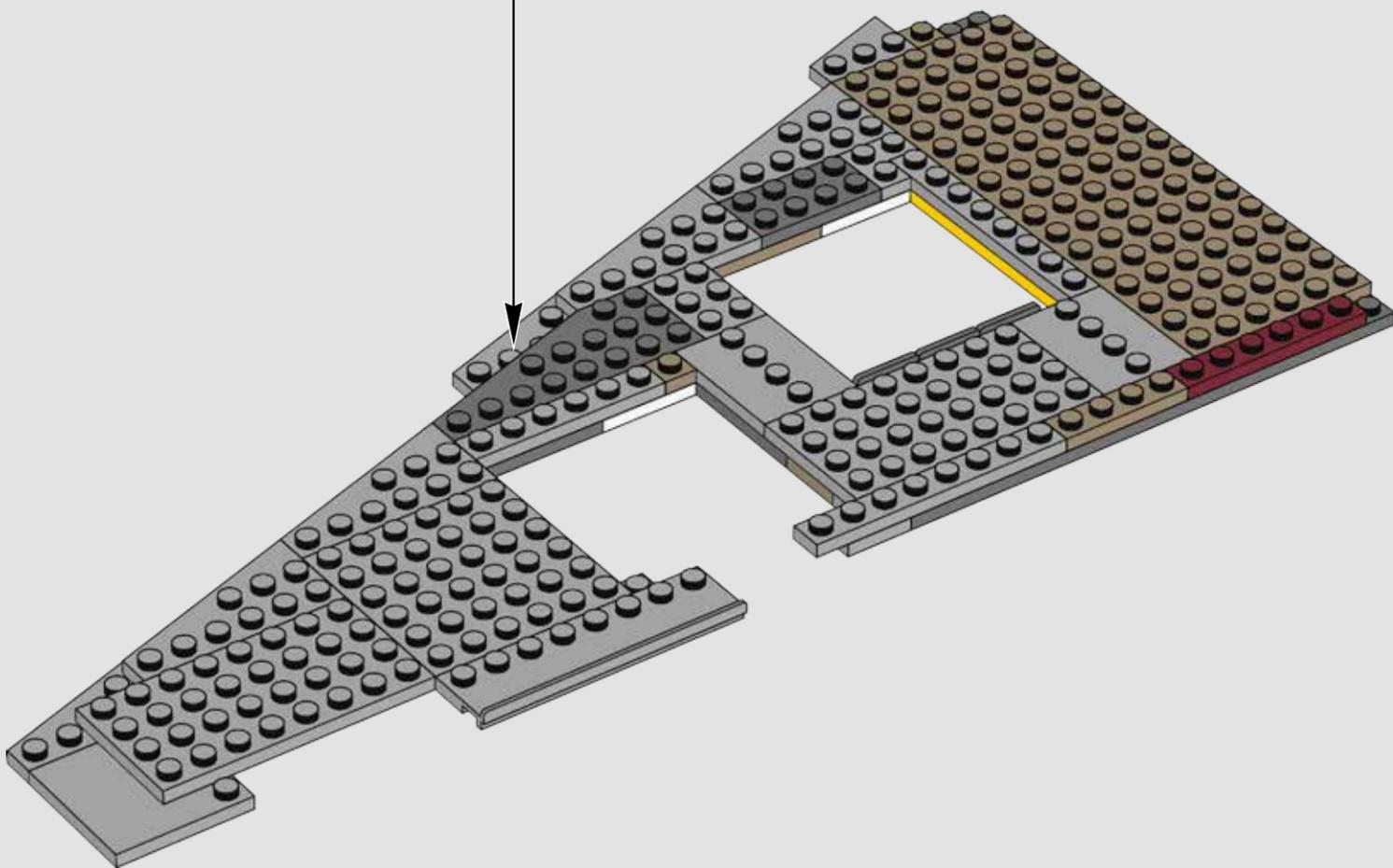

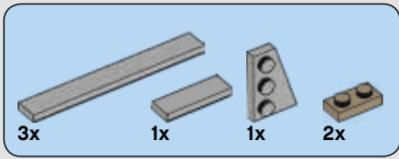

488

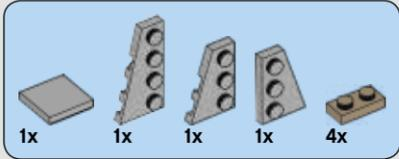
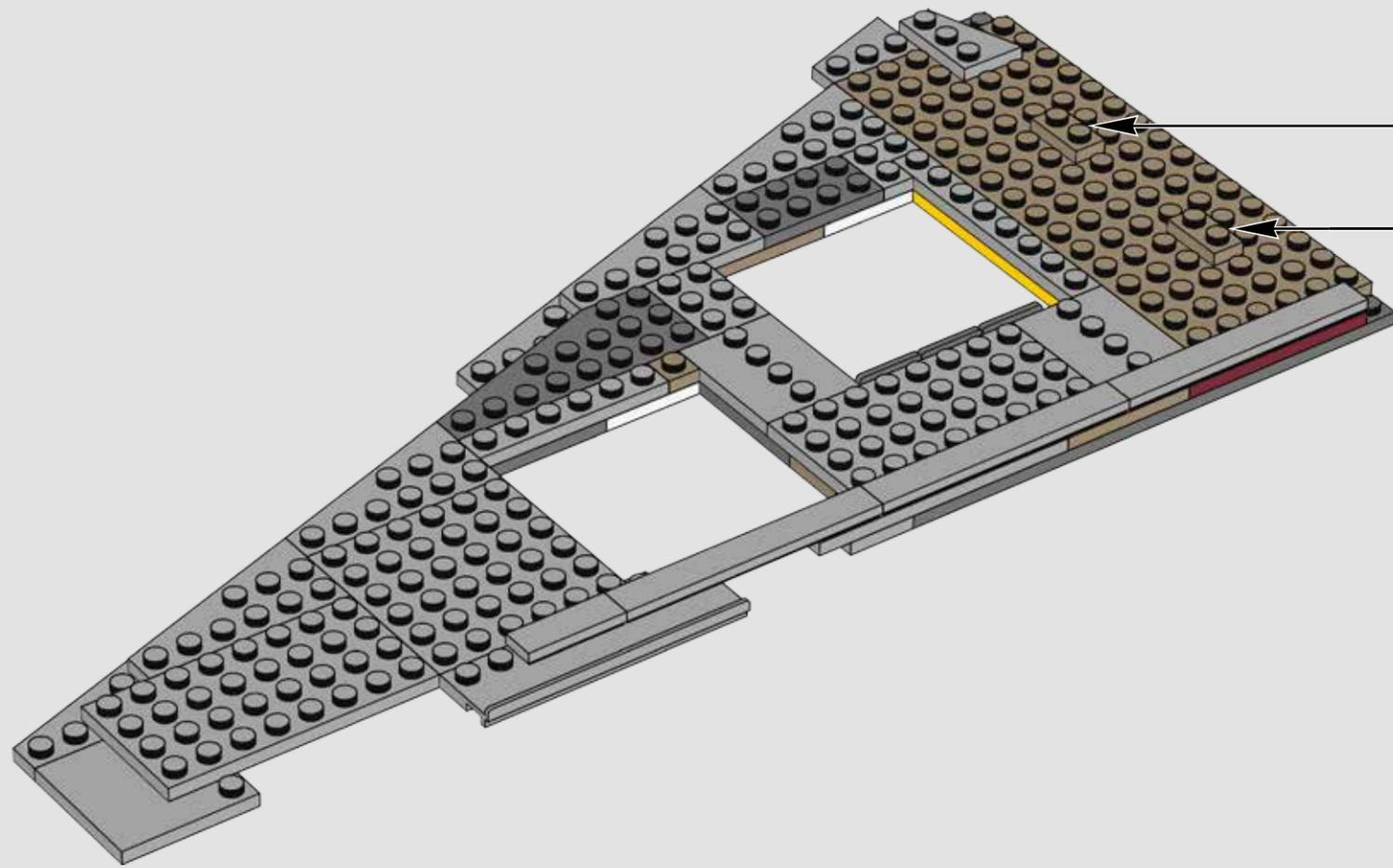

489

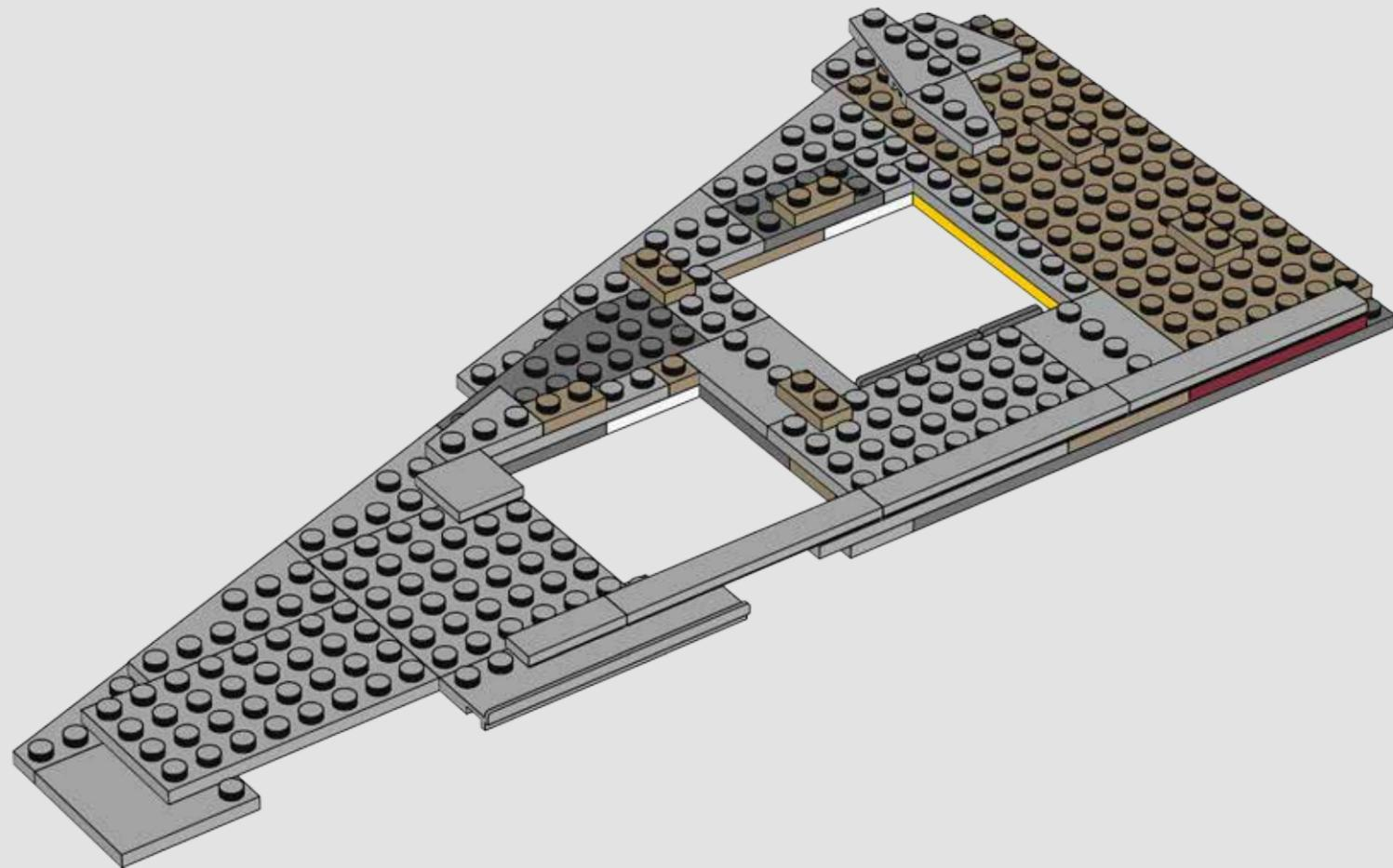

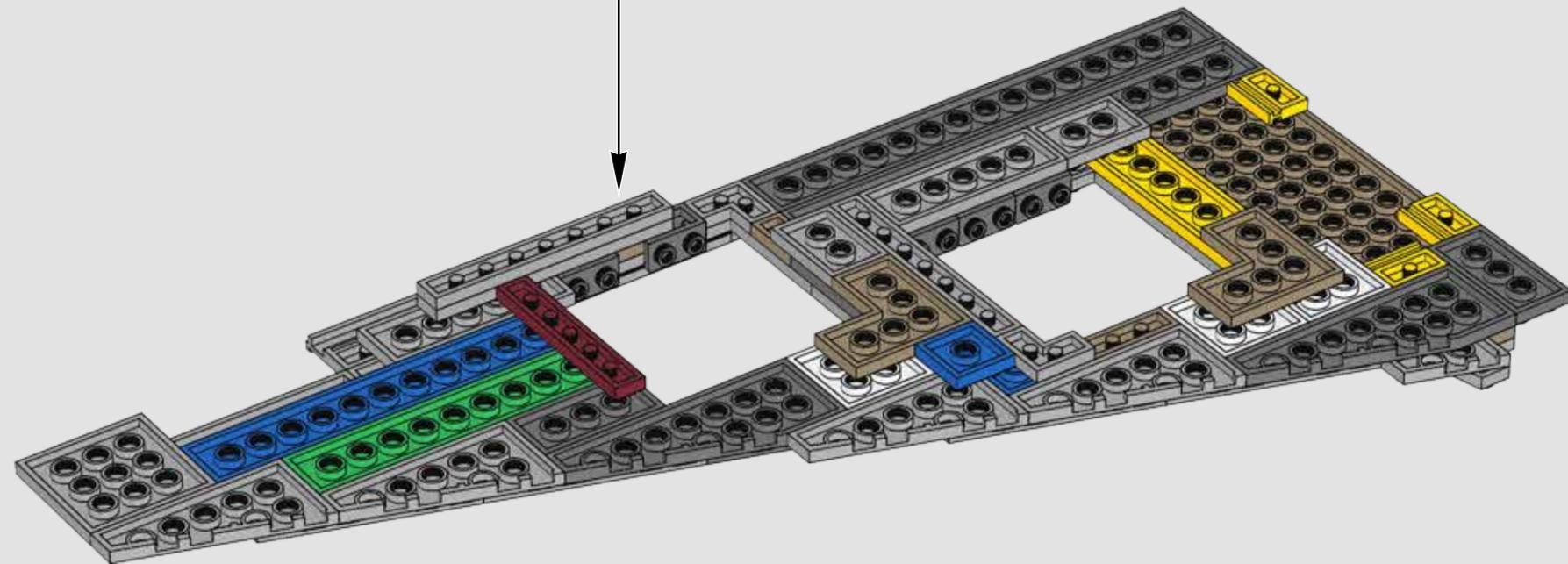
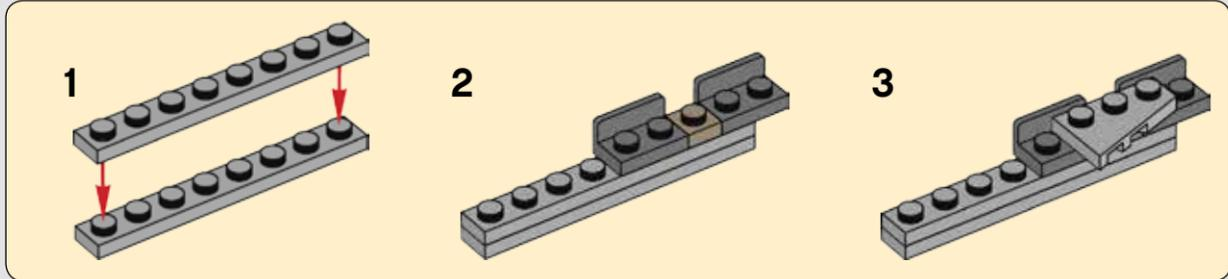
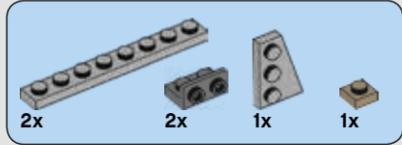
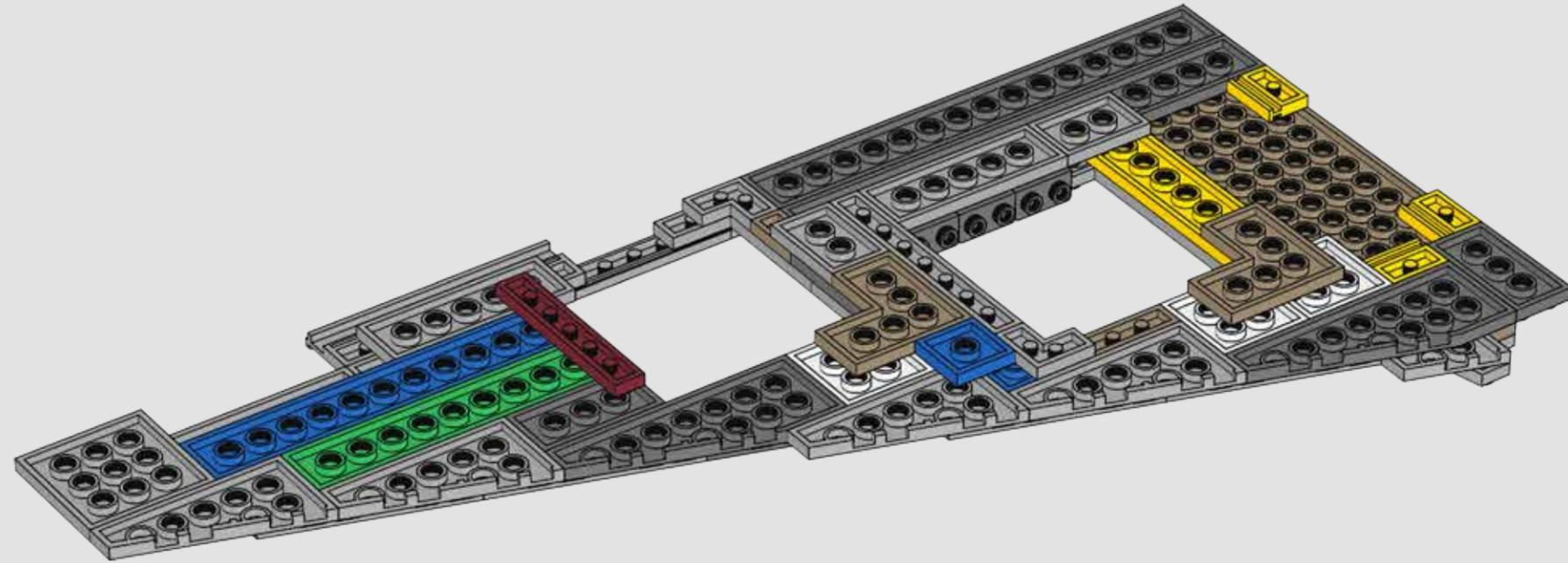
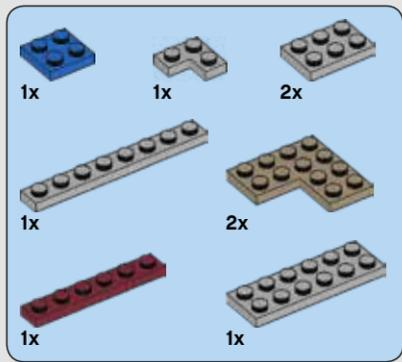

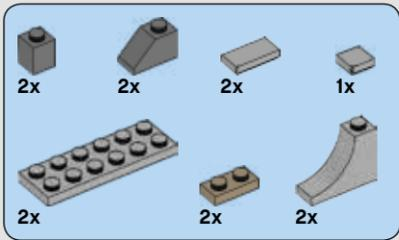

492

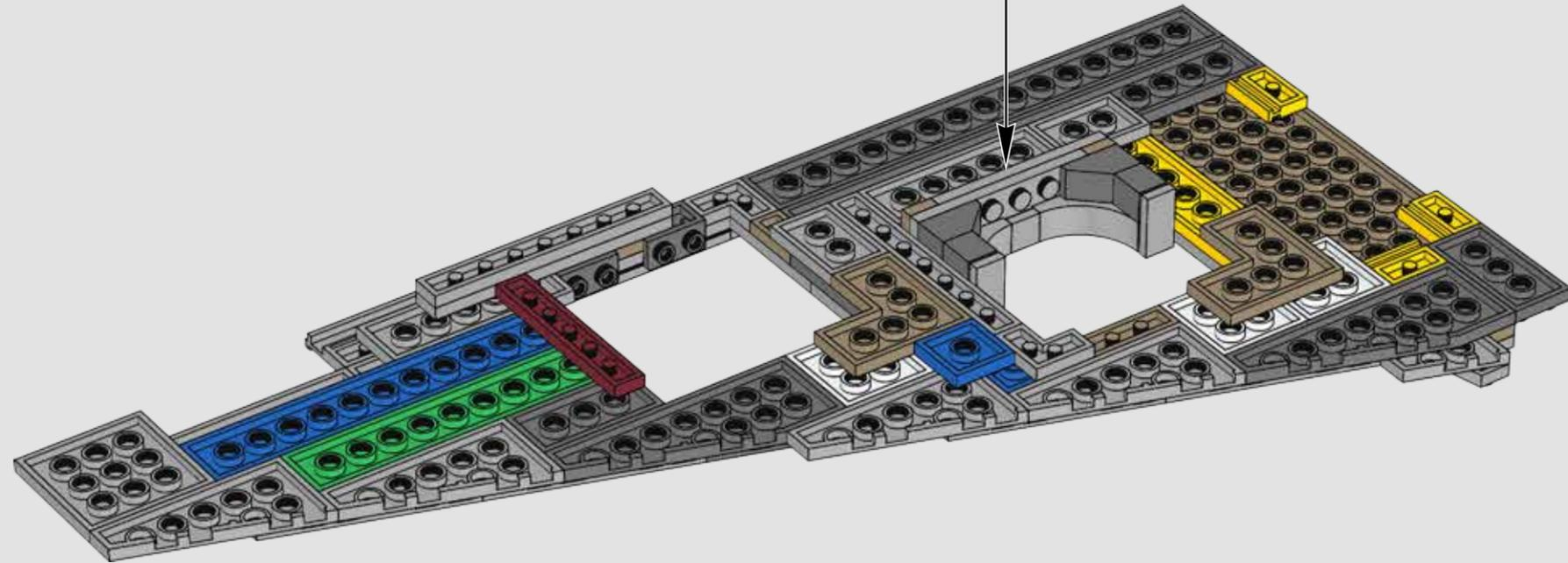
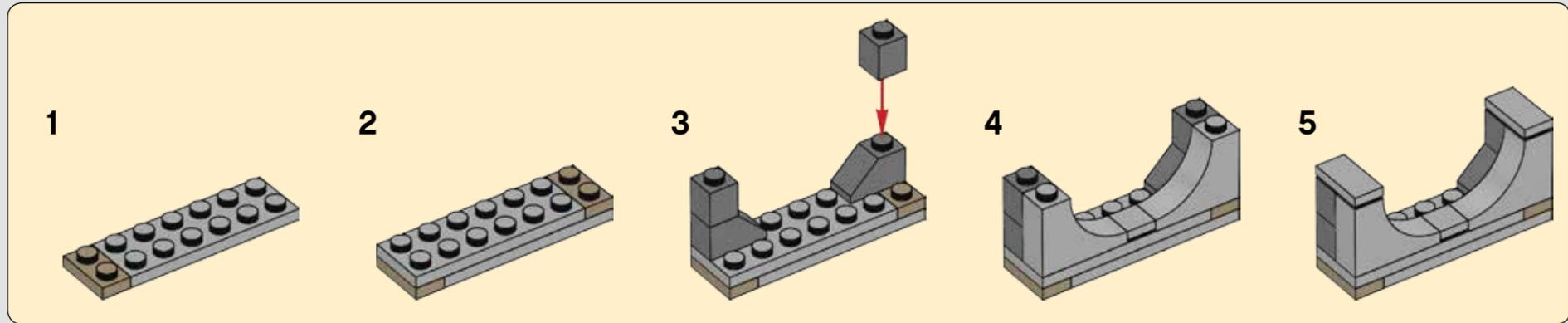

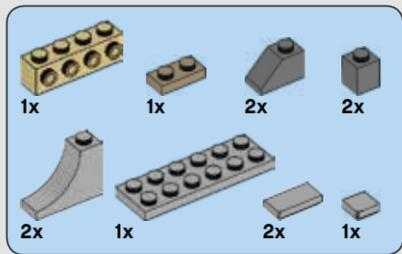

493

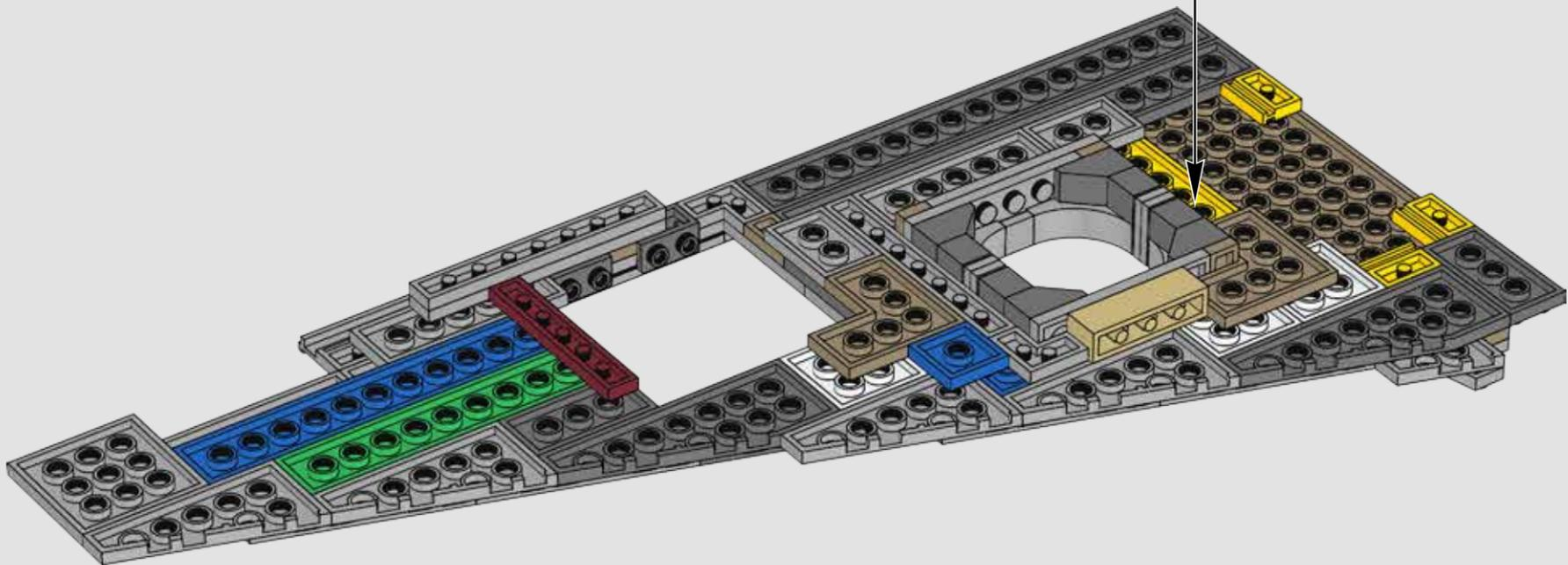
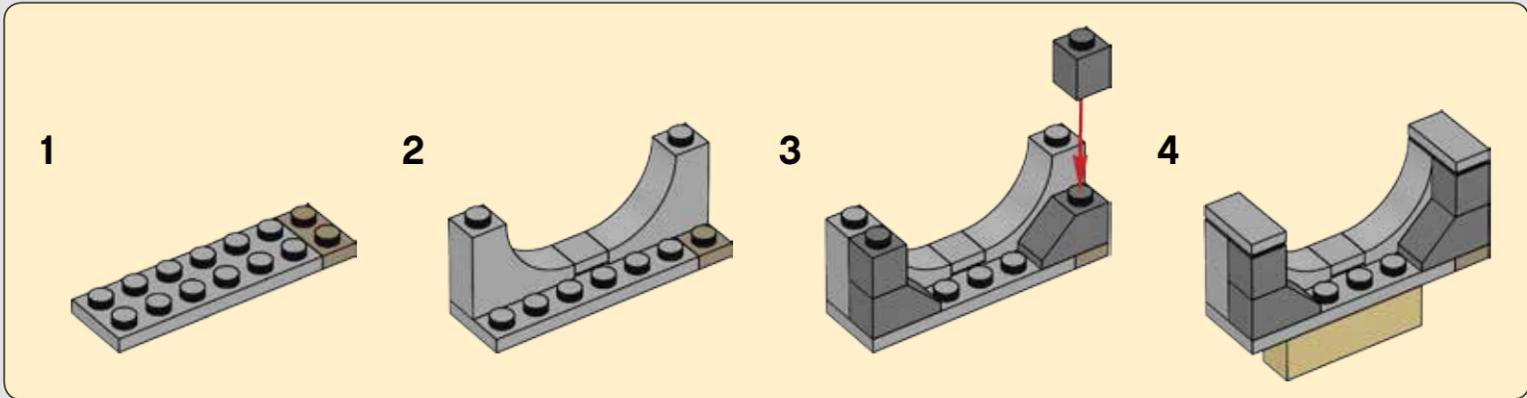

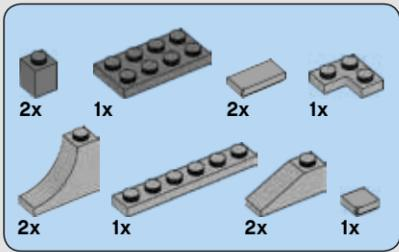

494

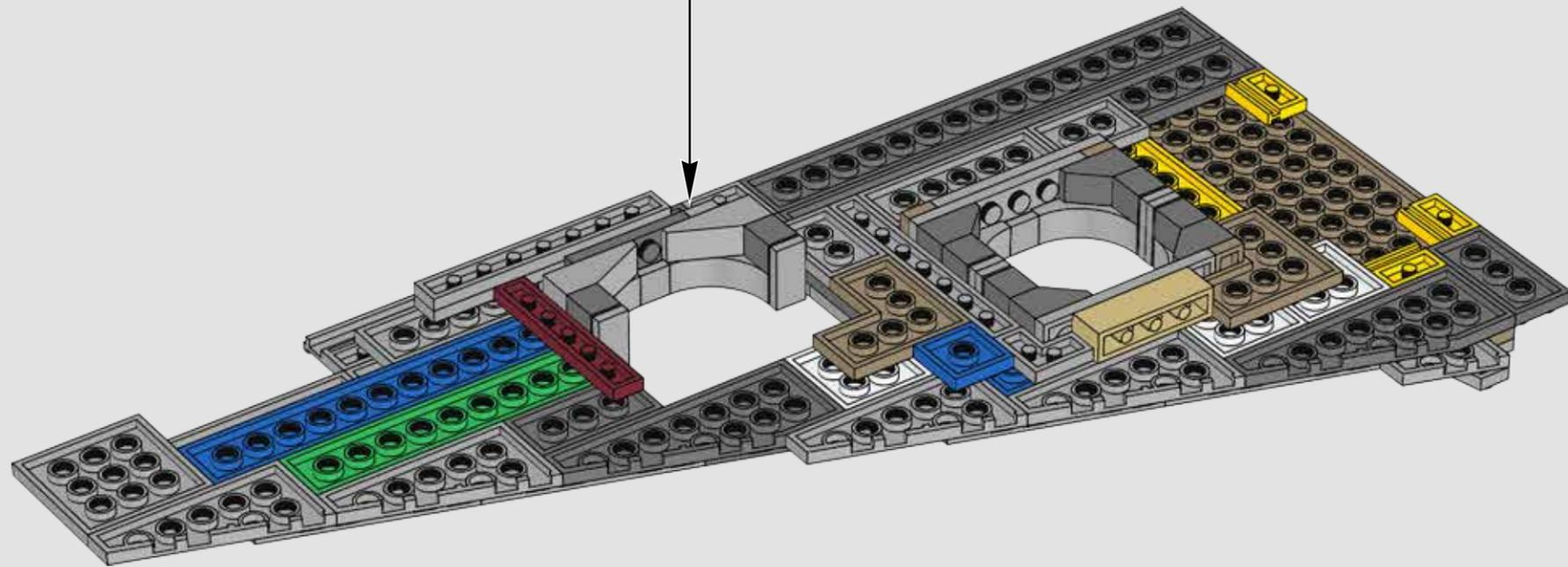
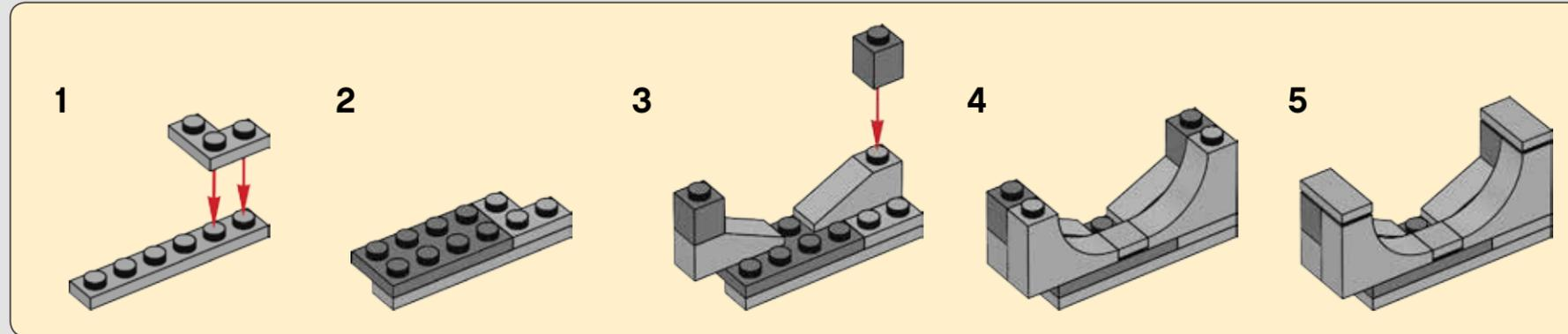

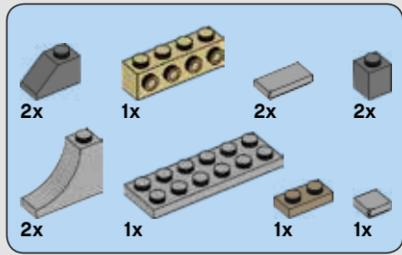

495

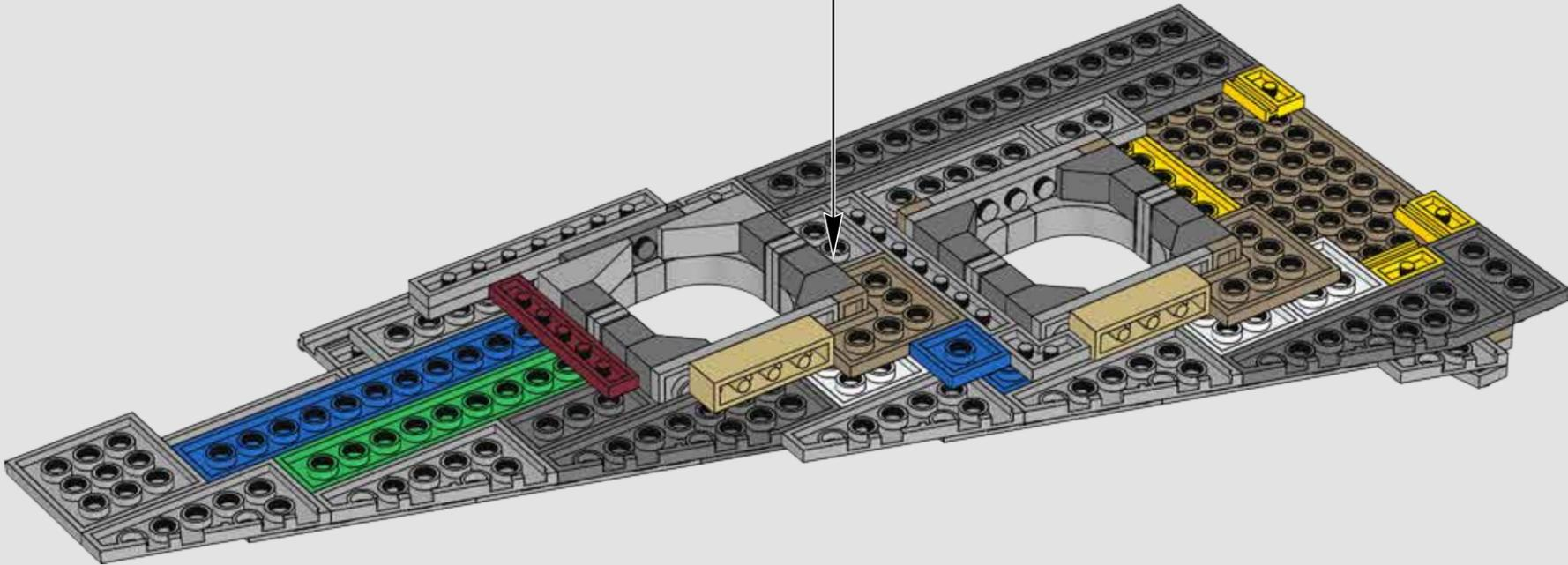
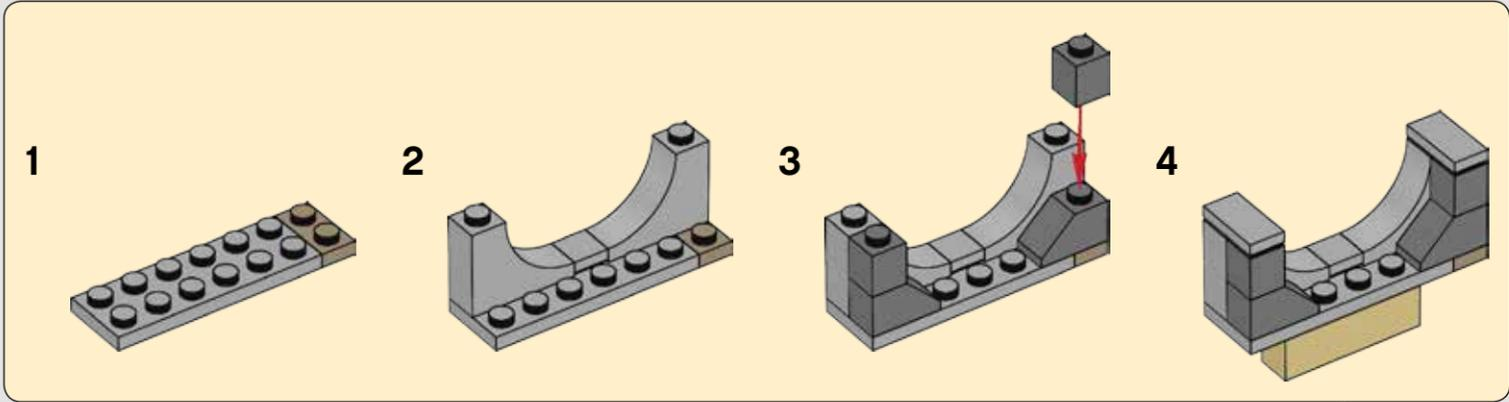

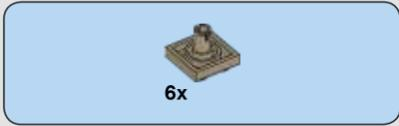

496

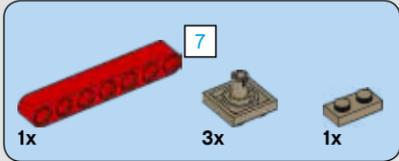
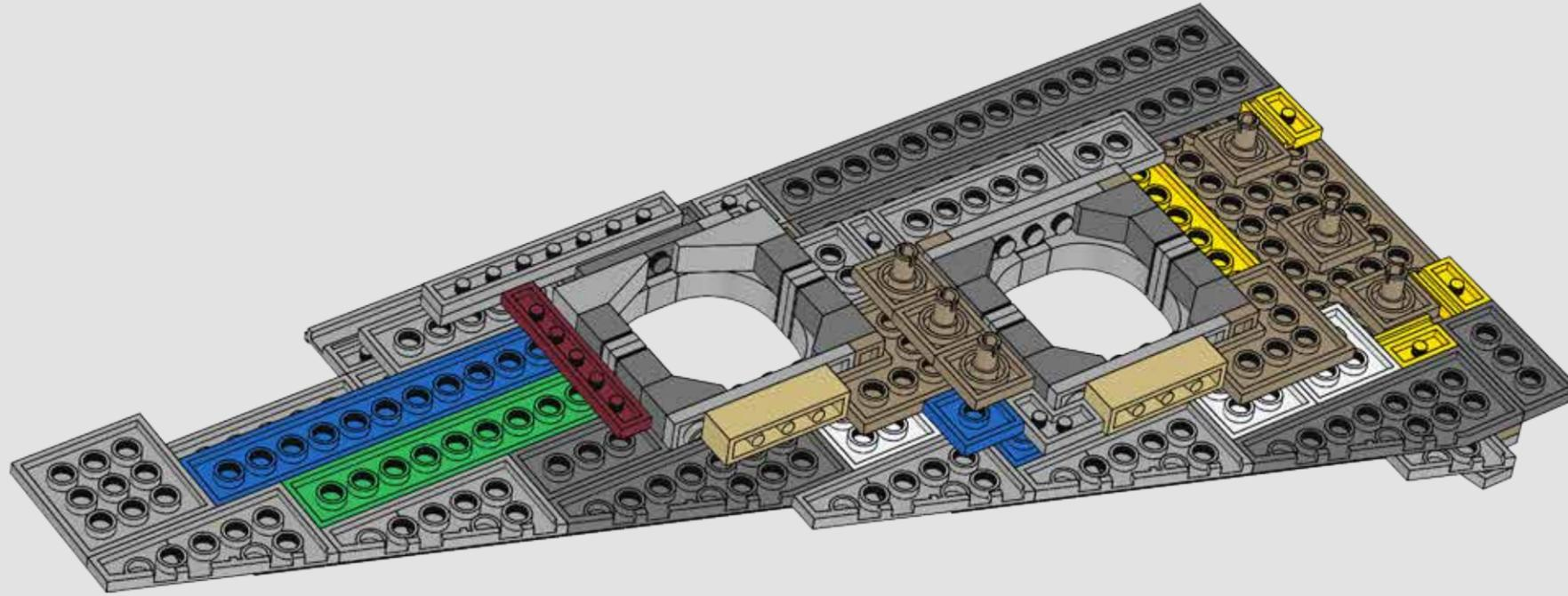

497

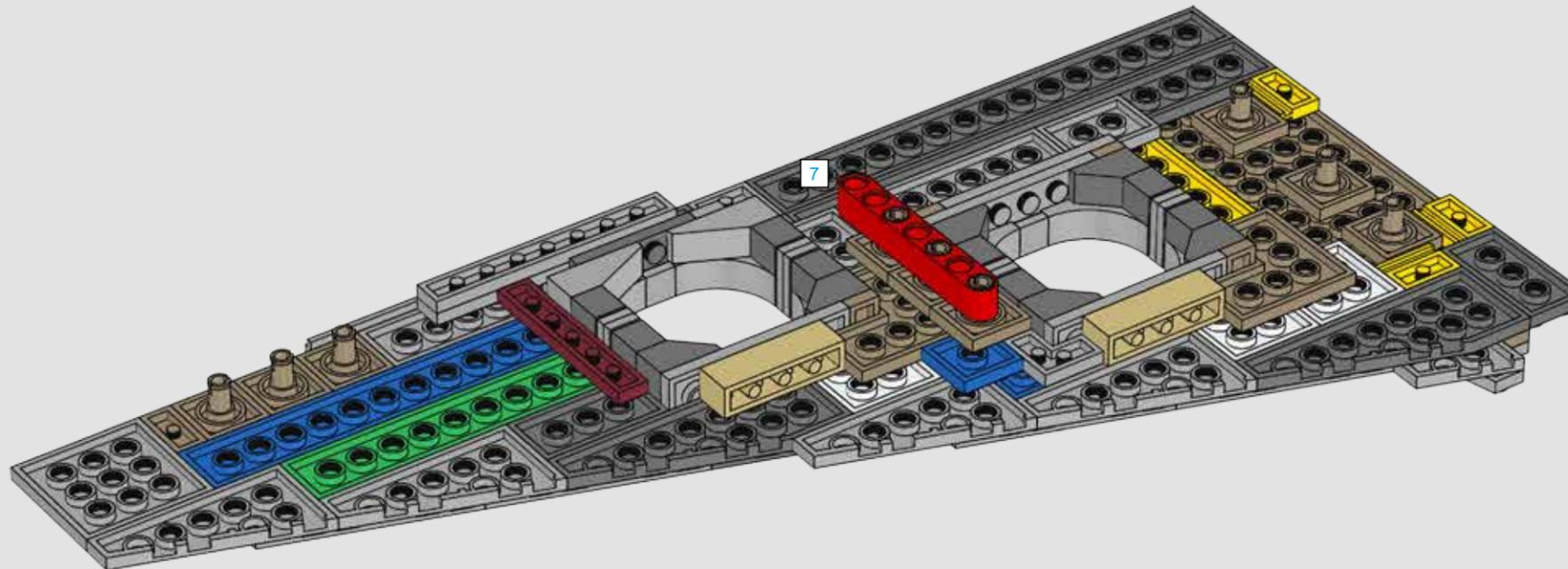
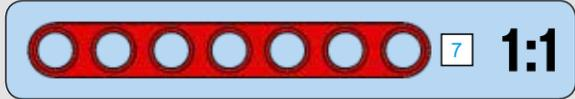

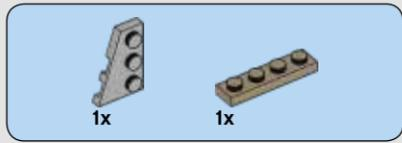

498

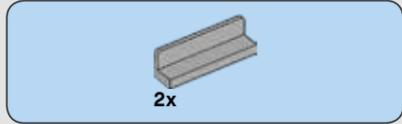
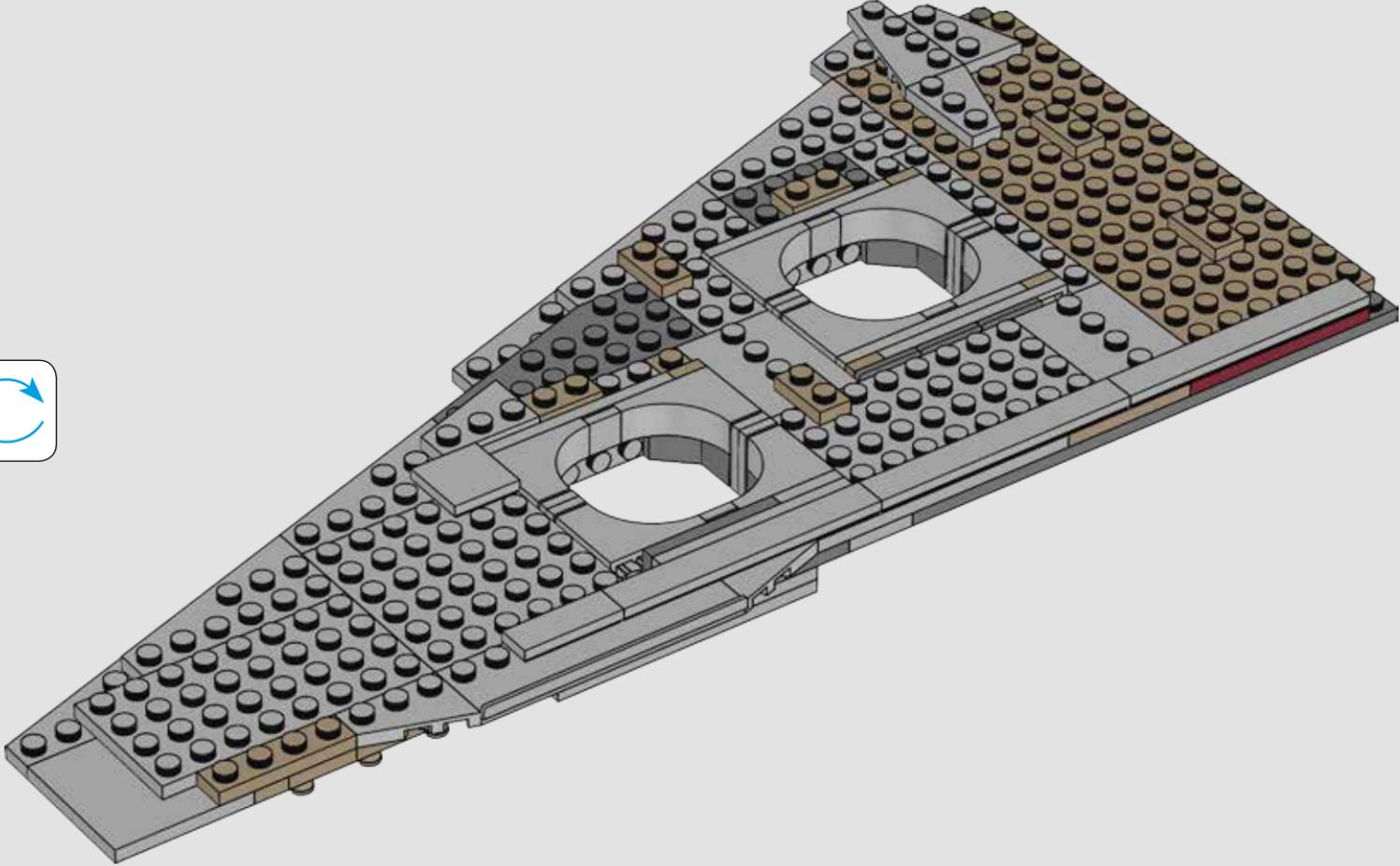

499

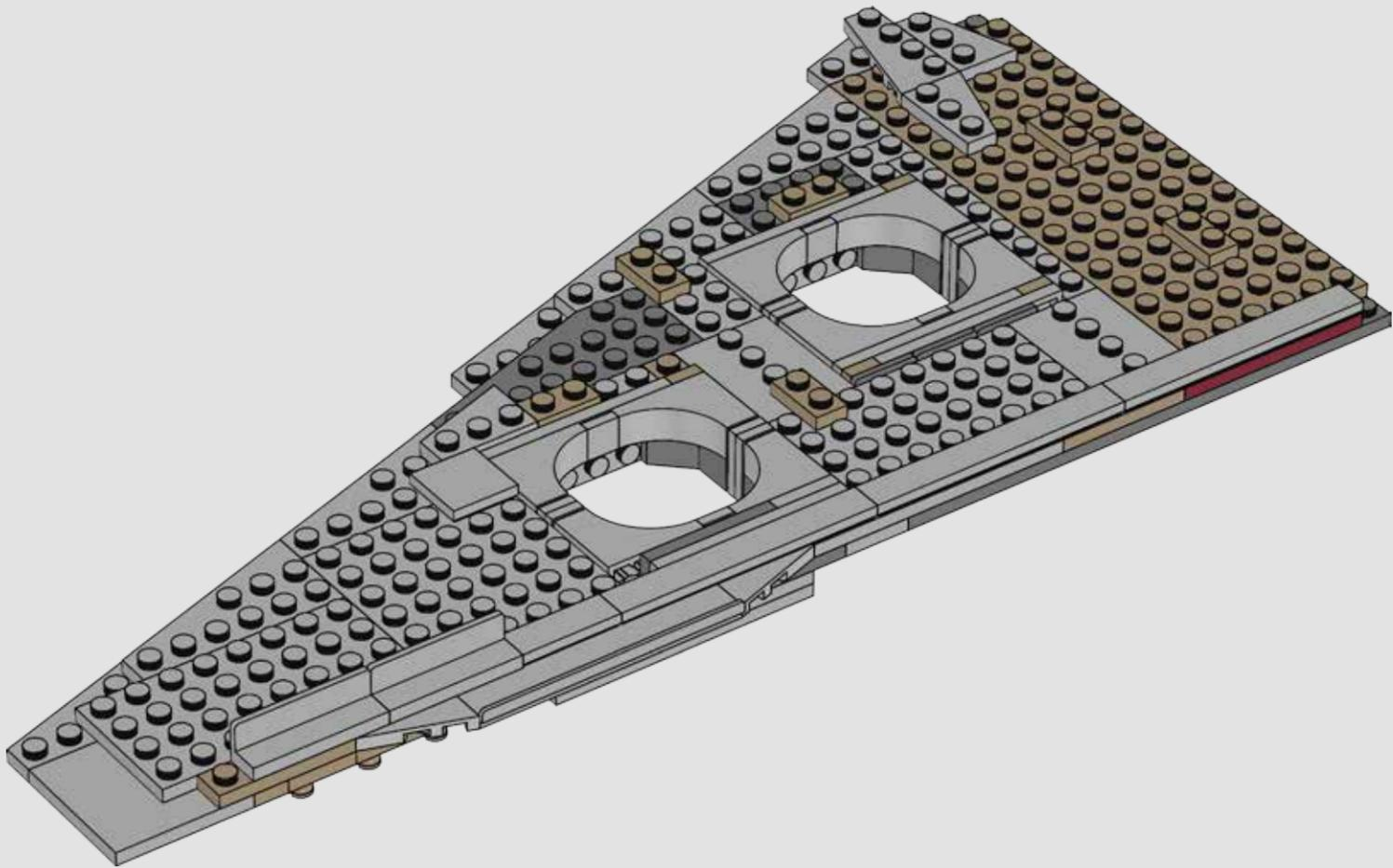

500

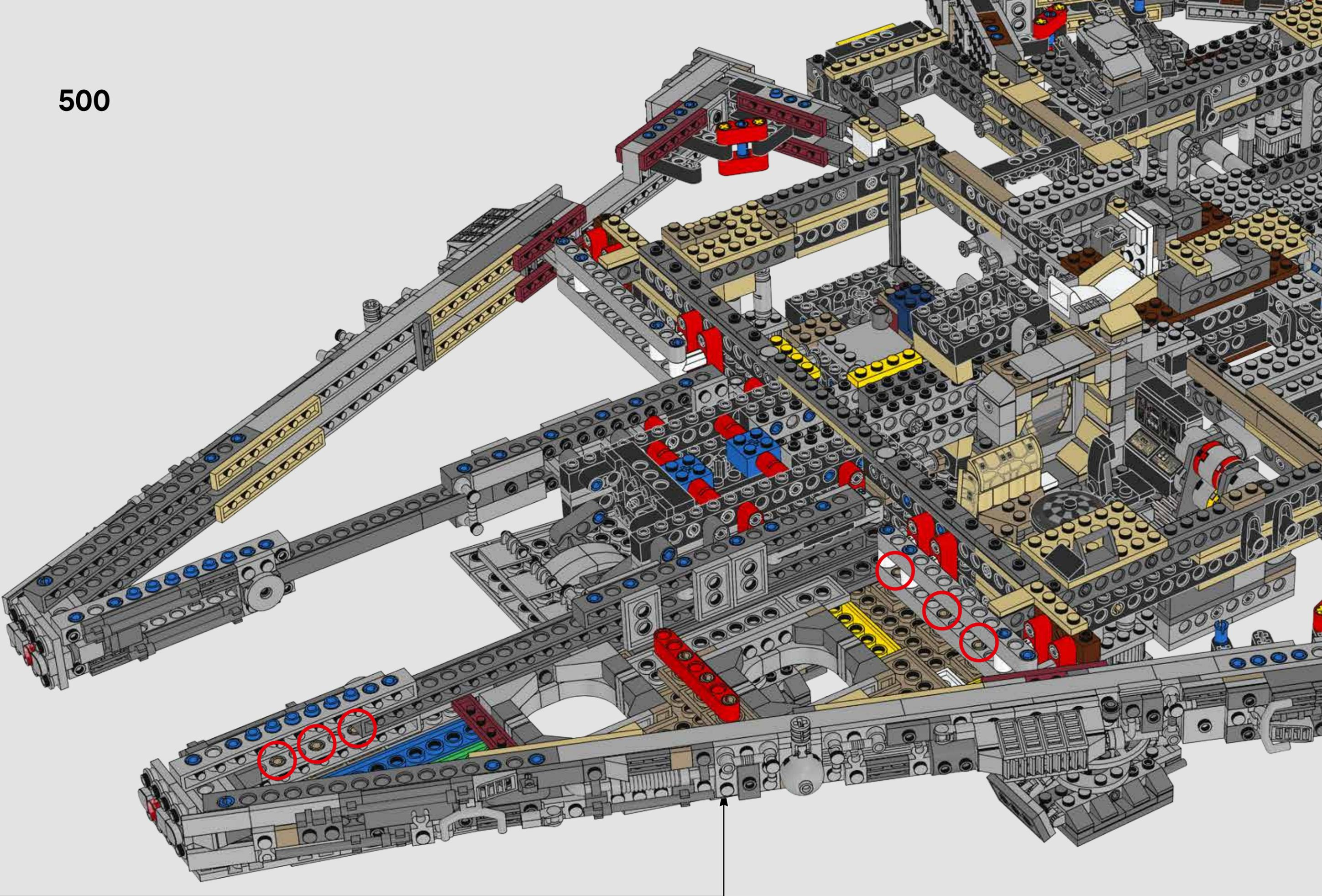

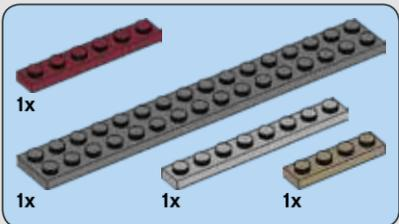
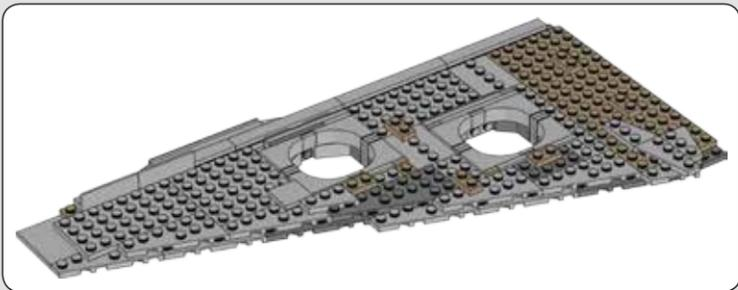

501

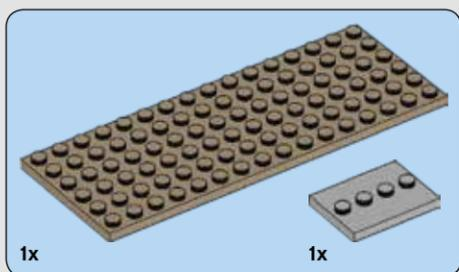
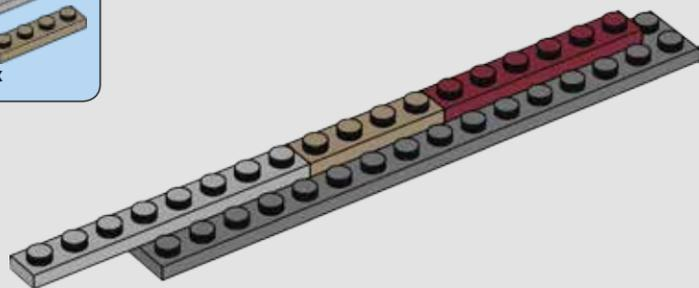

502

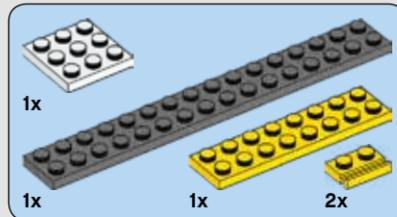
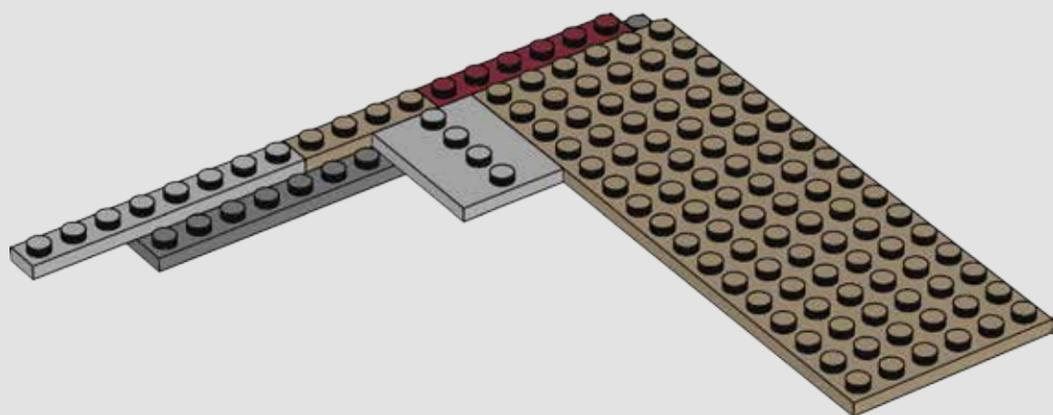

503

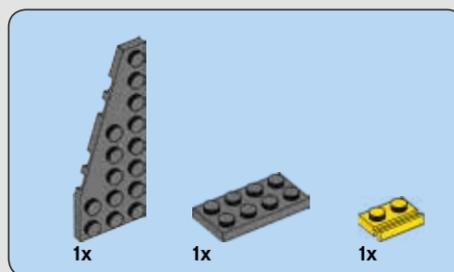

504

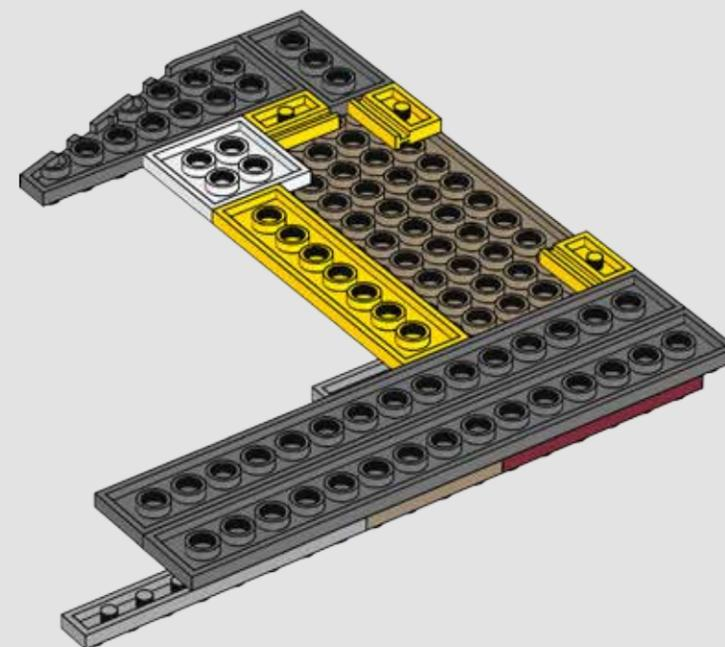

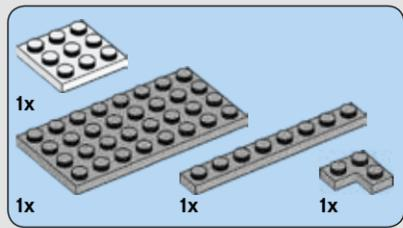

505

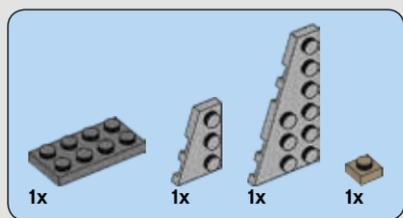
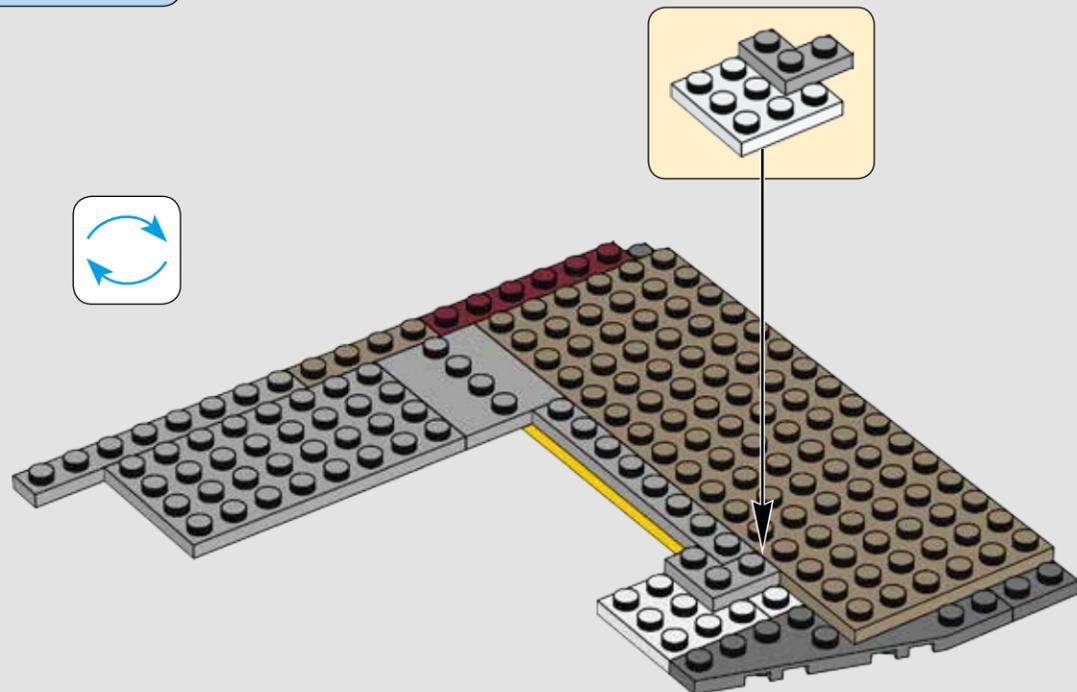

506

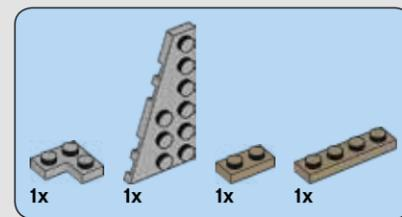
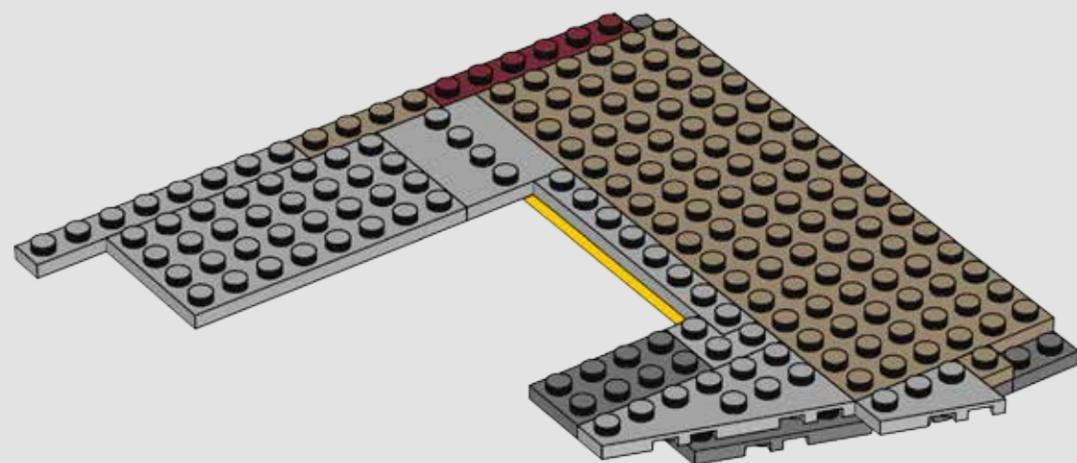

507

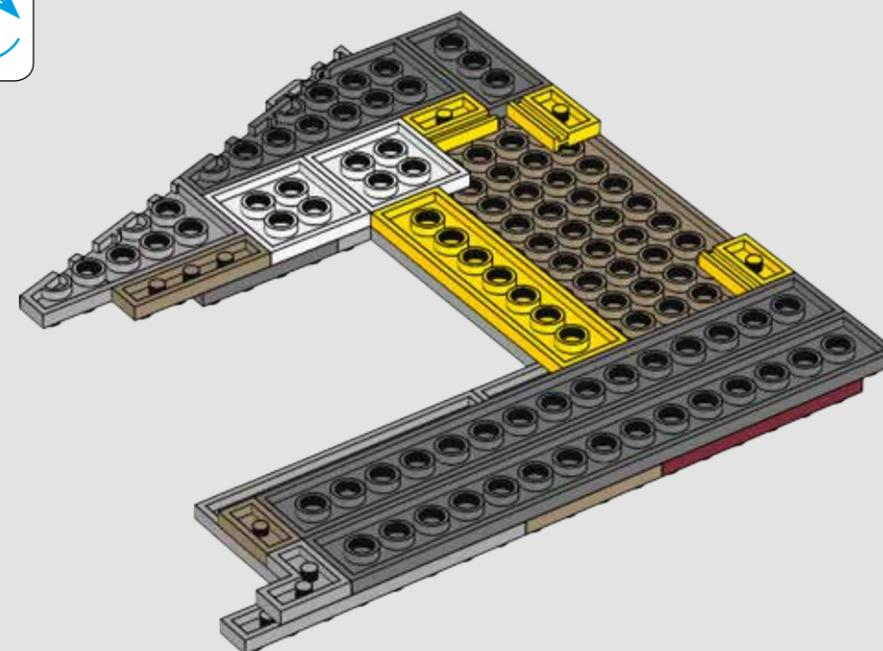

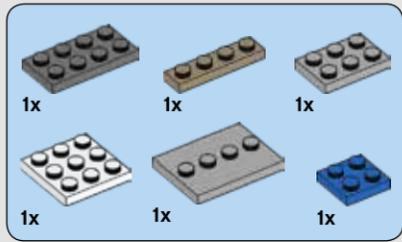

508

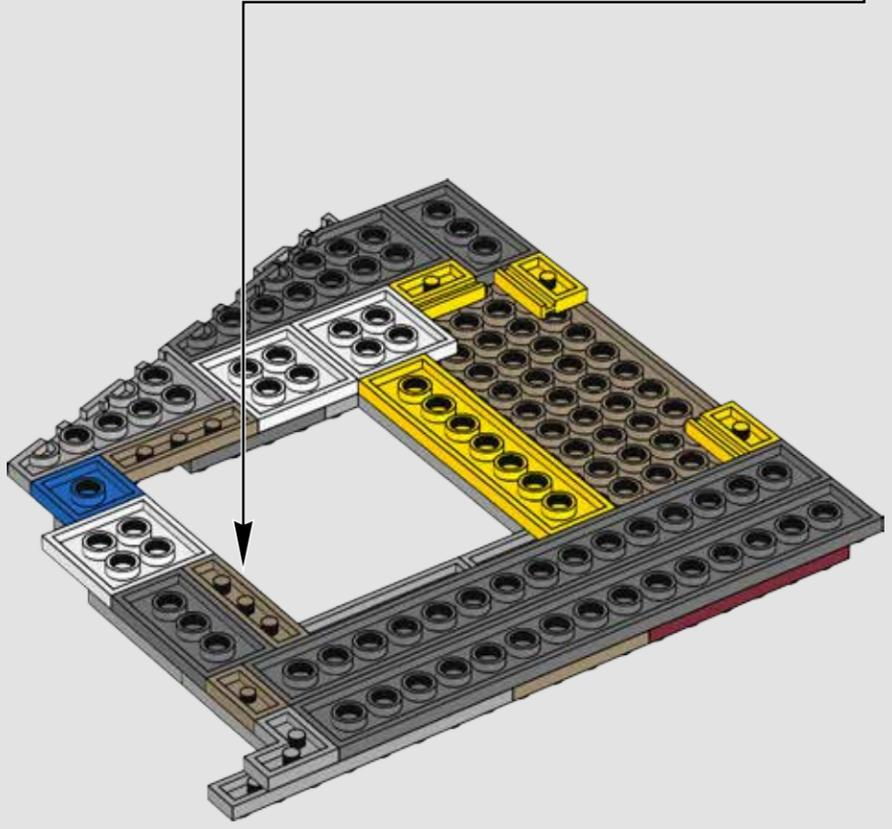
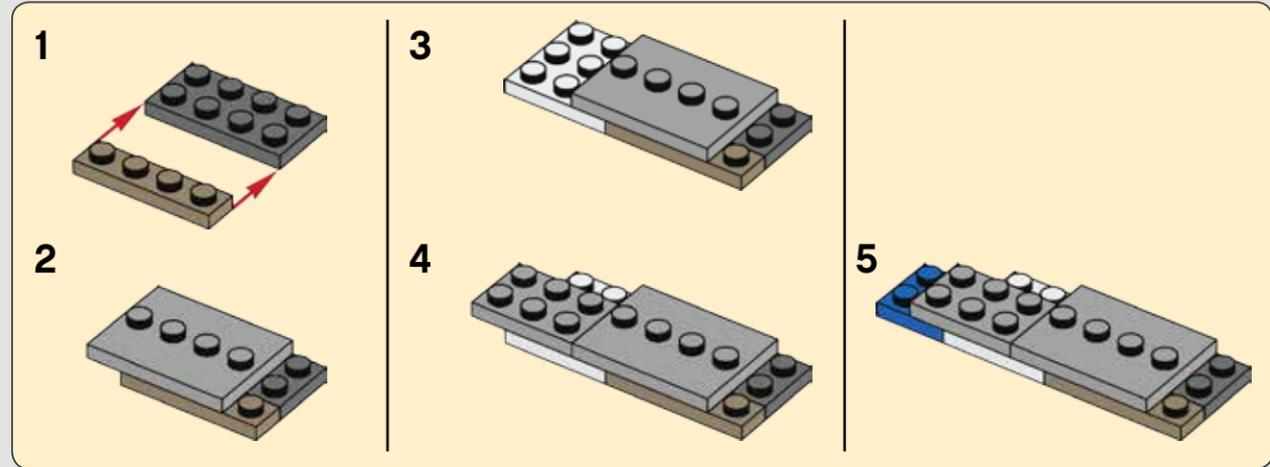

509

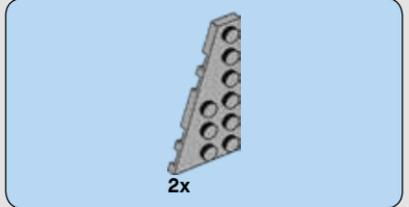
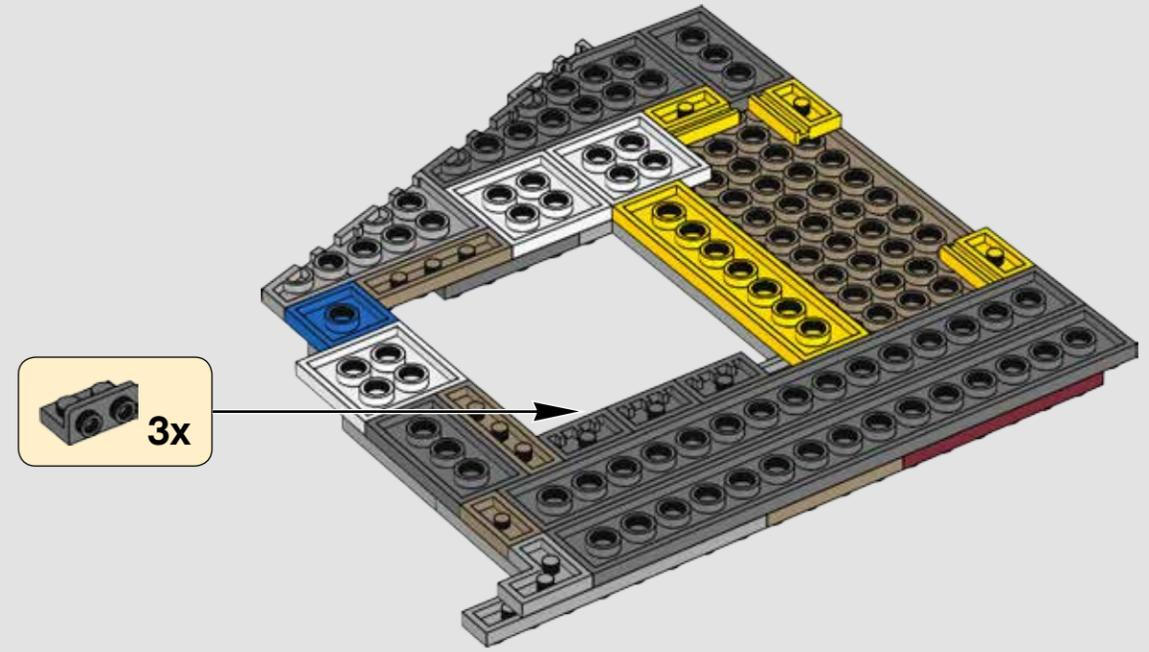

510

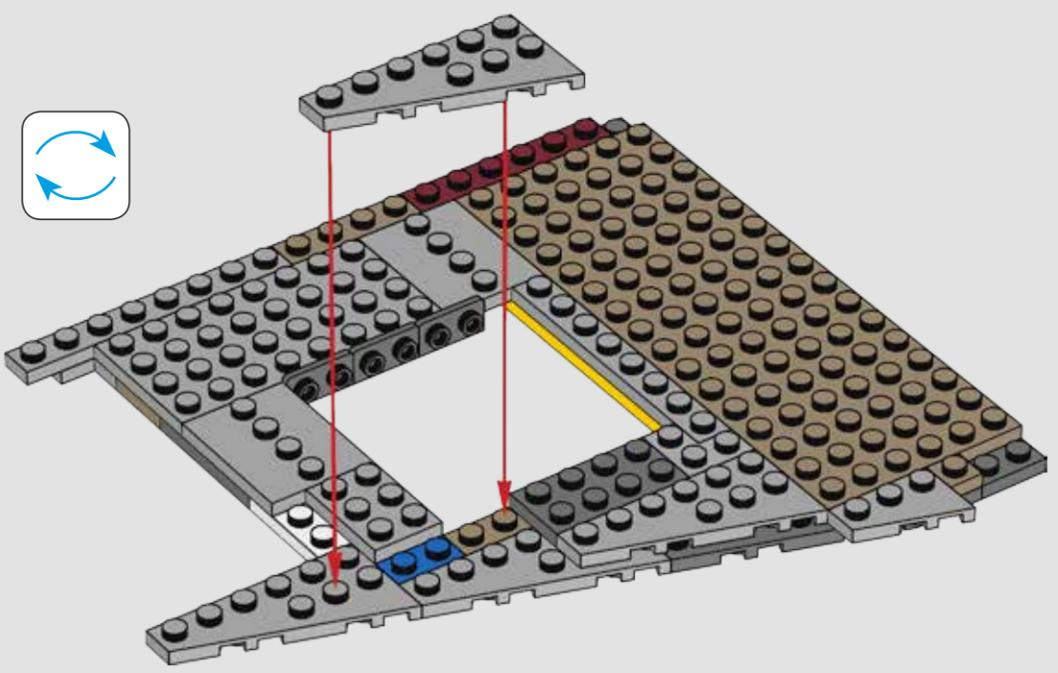

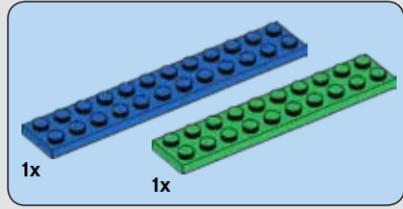
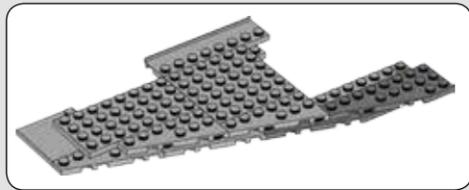

511

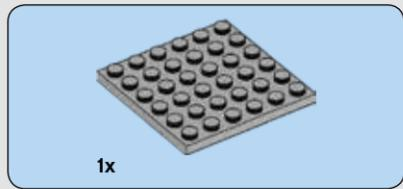
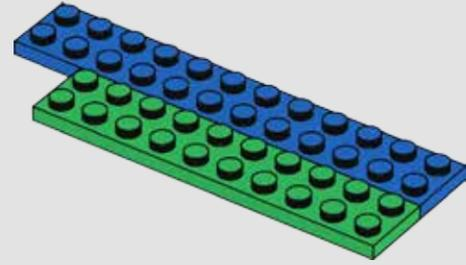

512

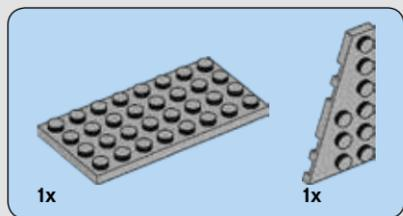
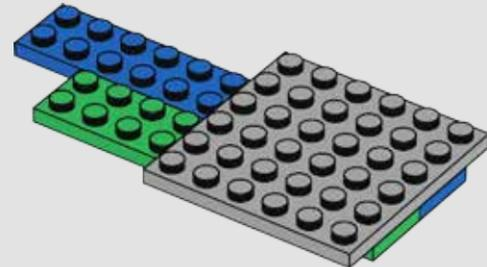

513

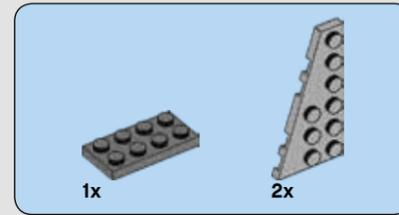
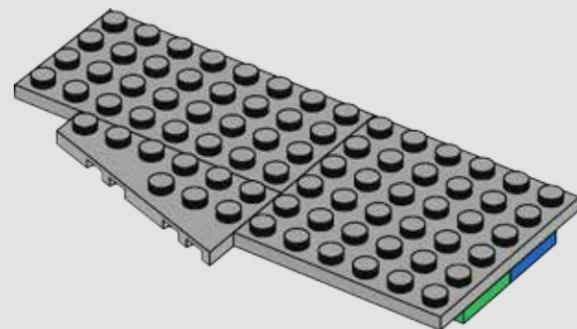

514

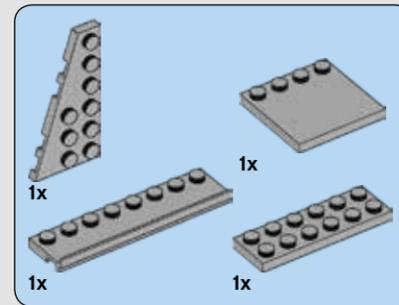
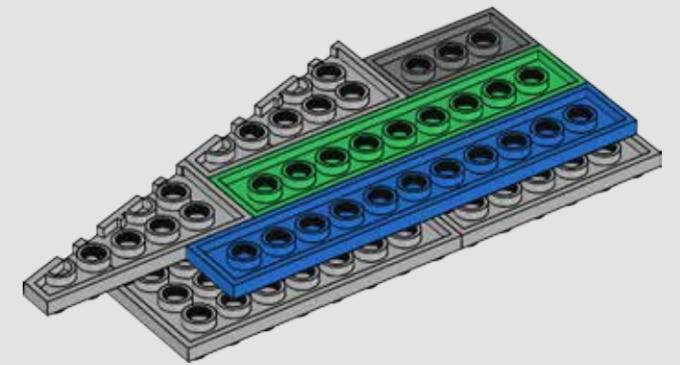

515

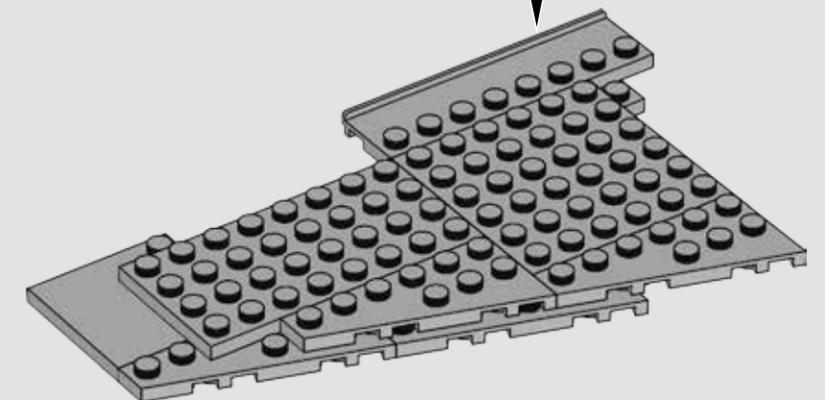
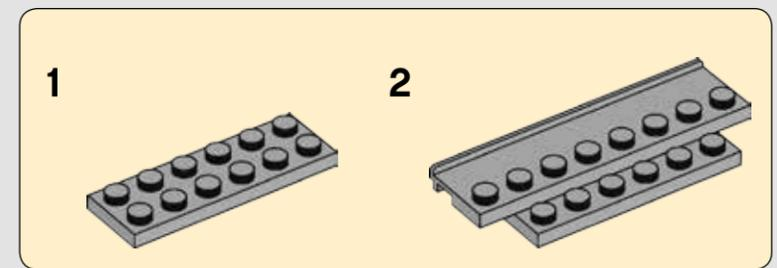

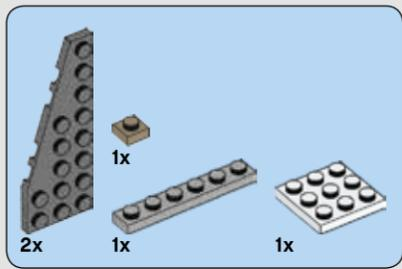

516

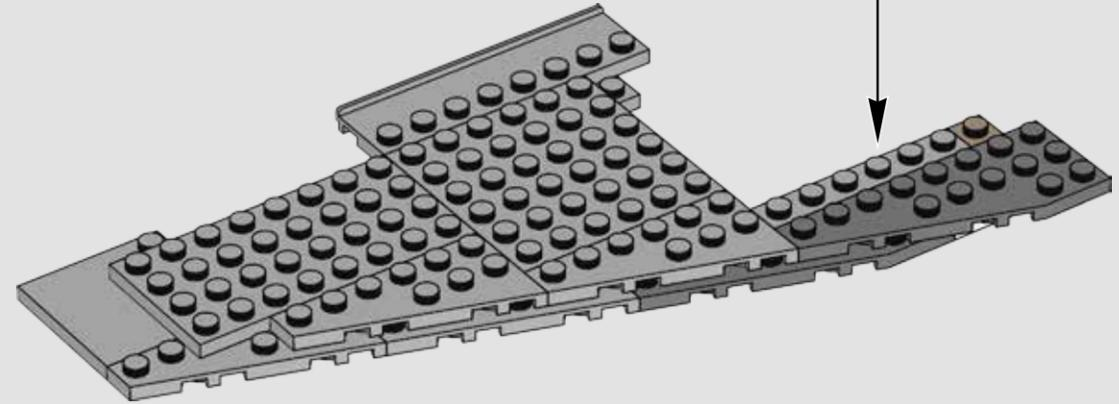
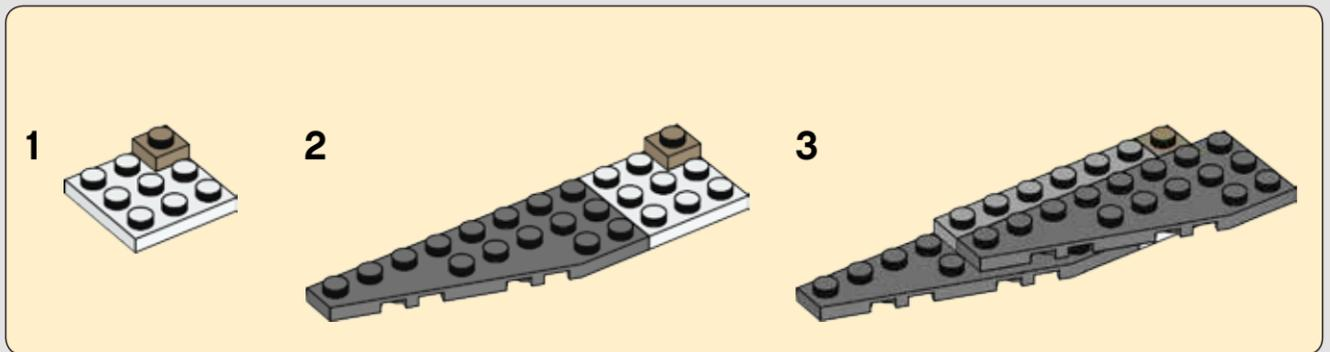

517

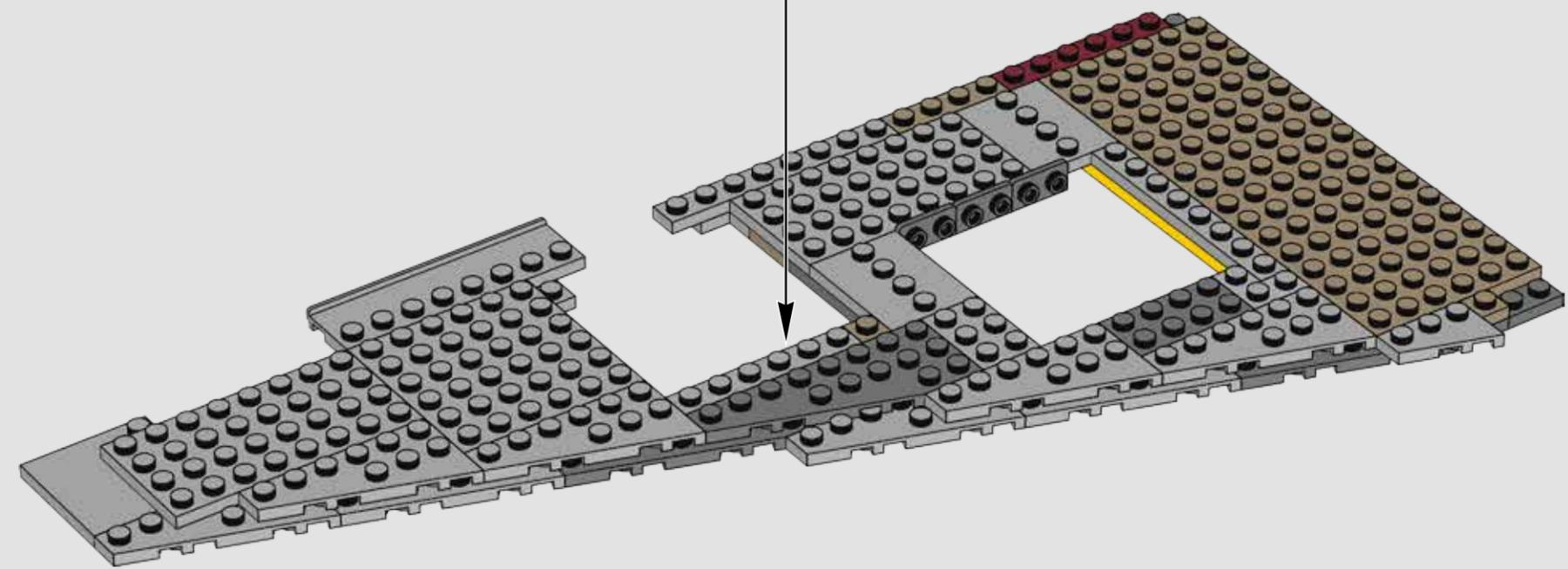

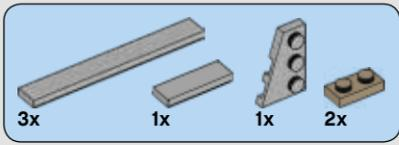

518

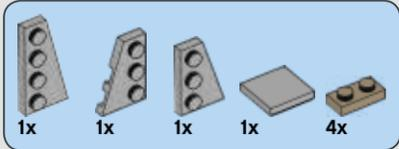
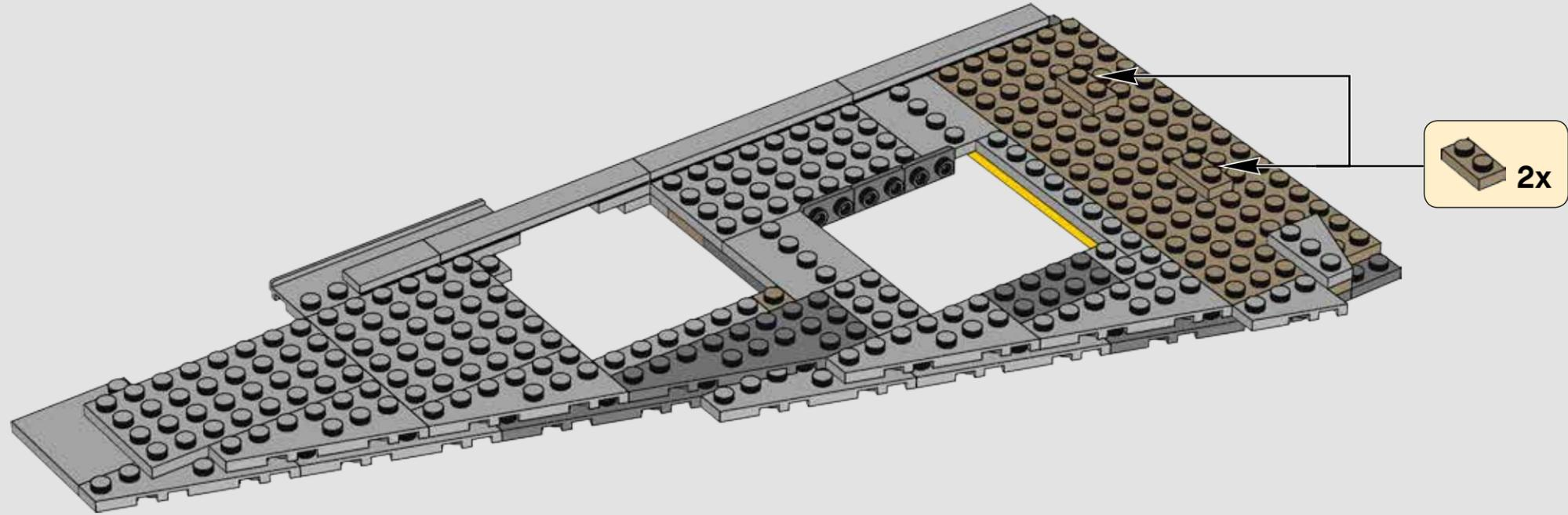

519

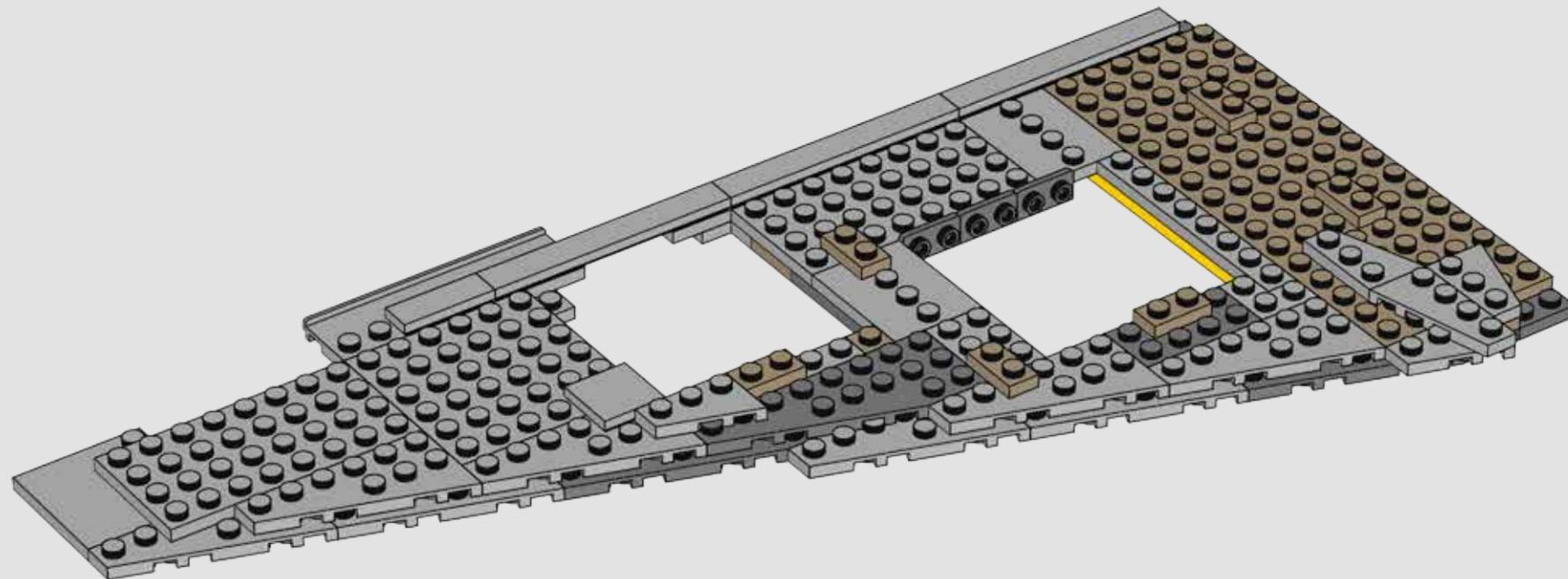

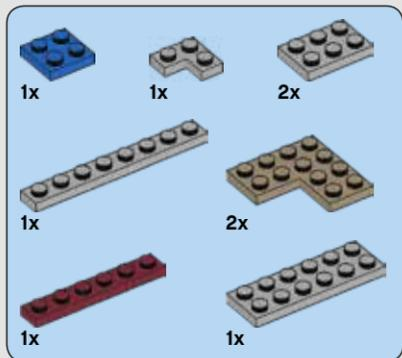

520

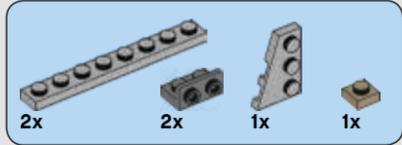
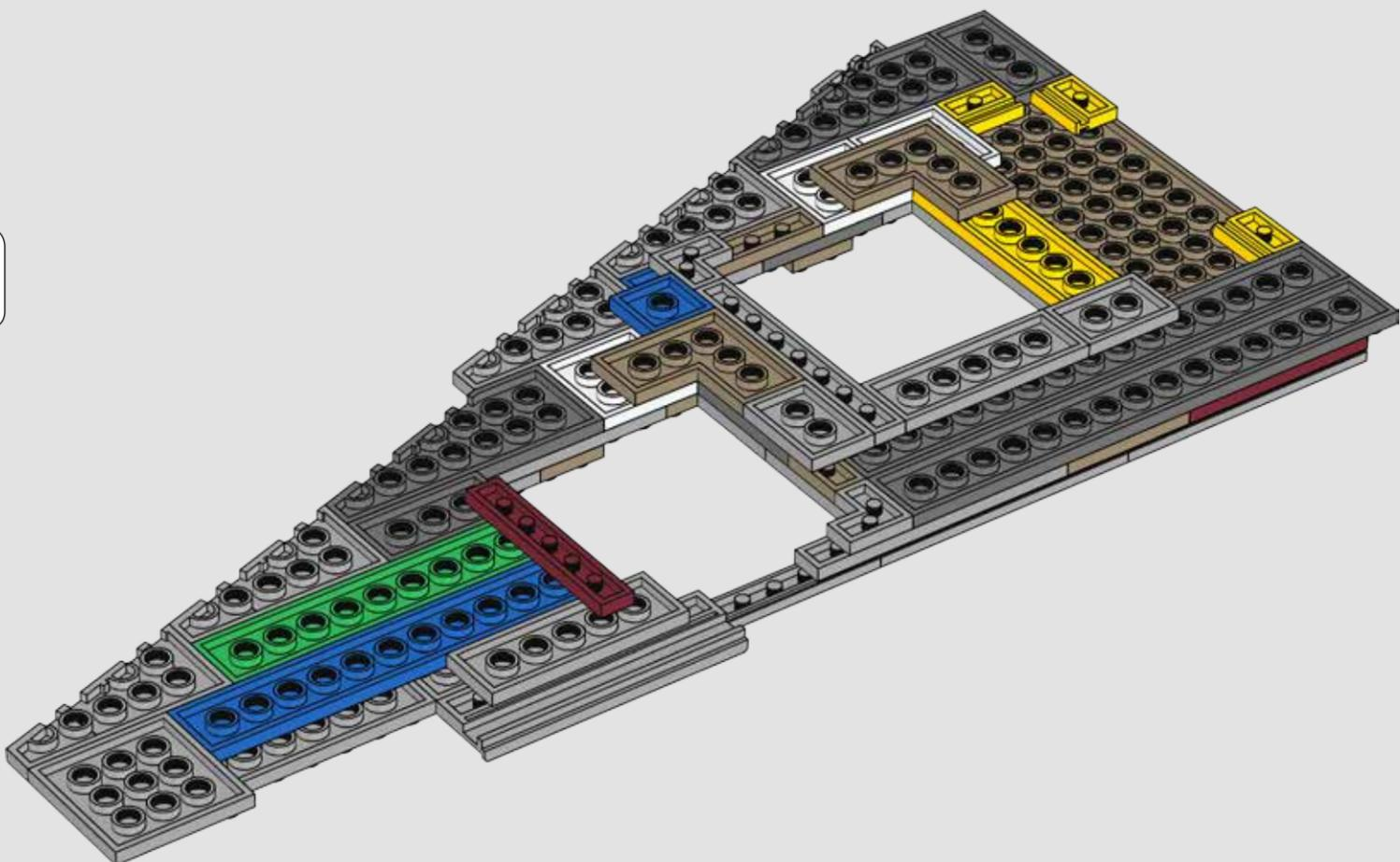

521

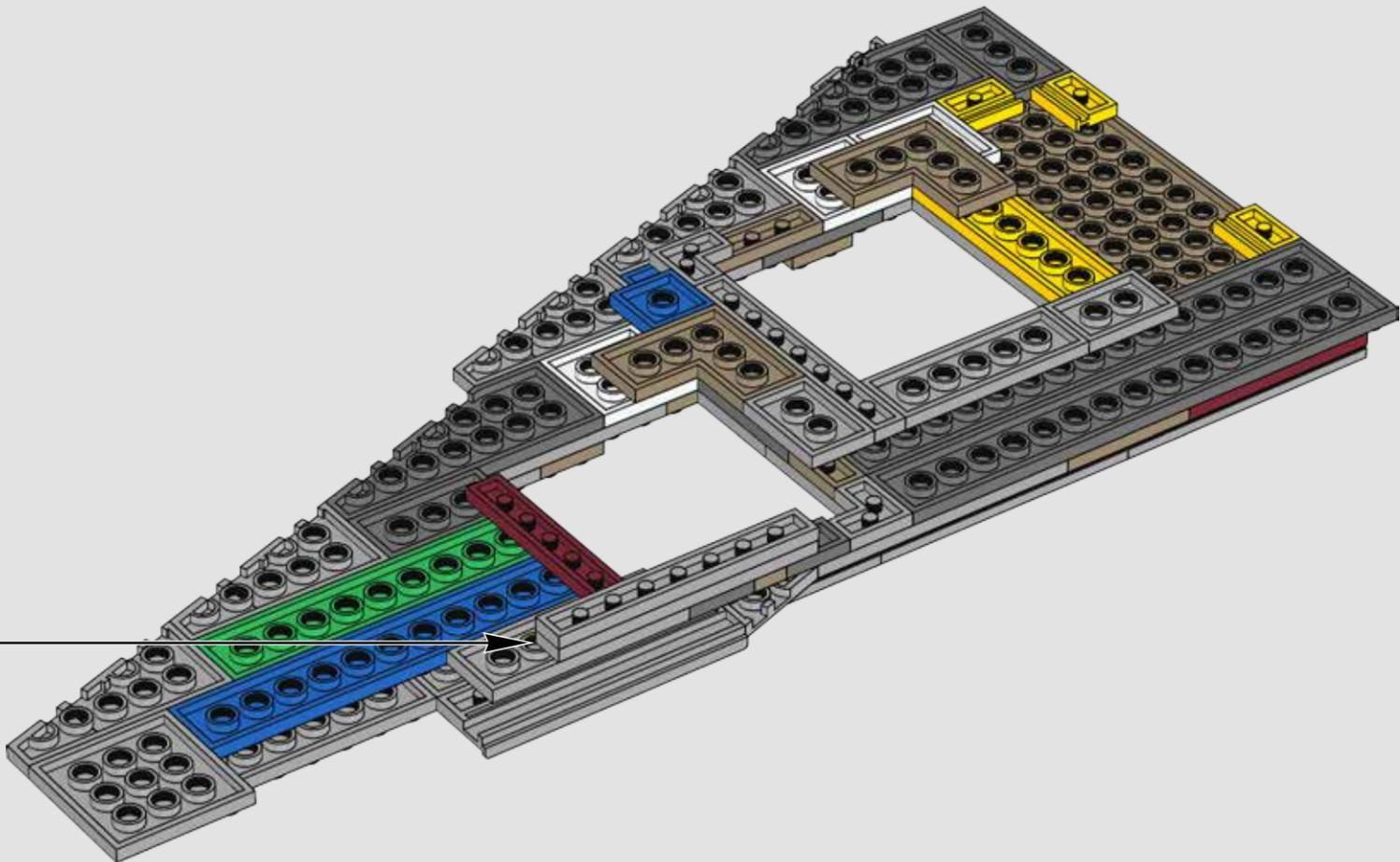
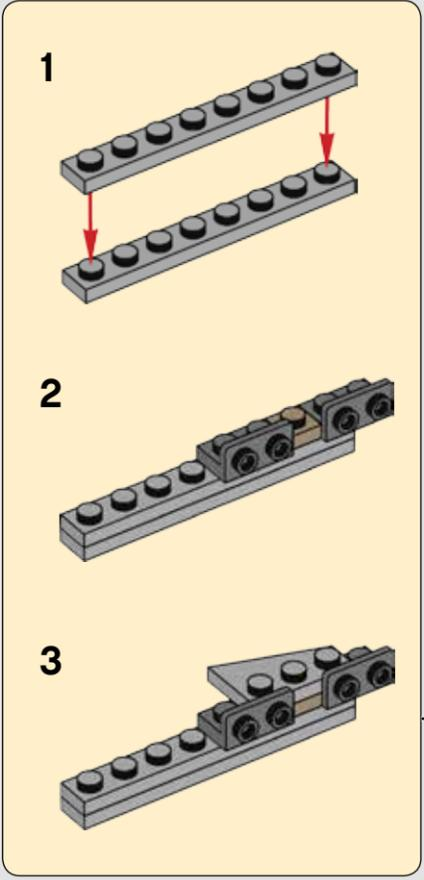

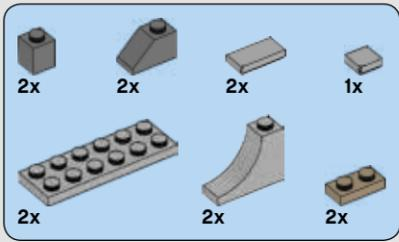

522

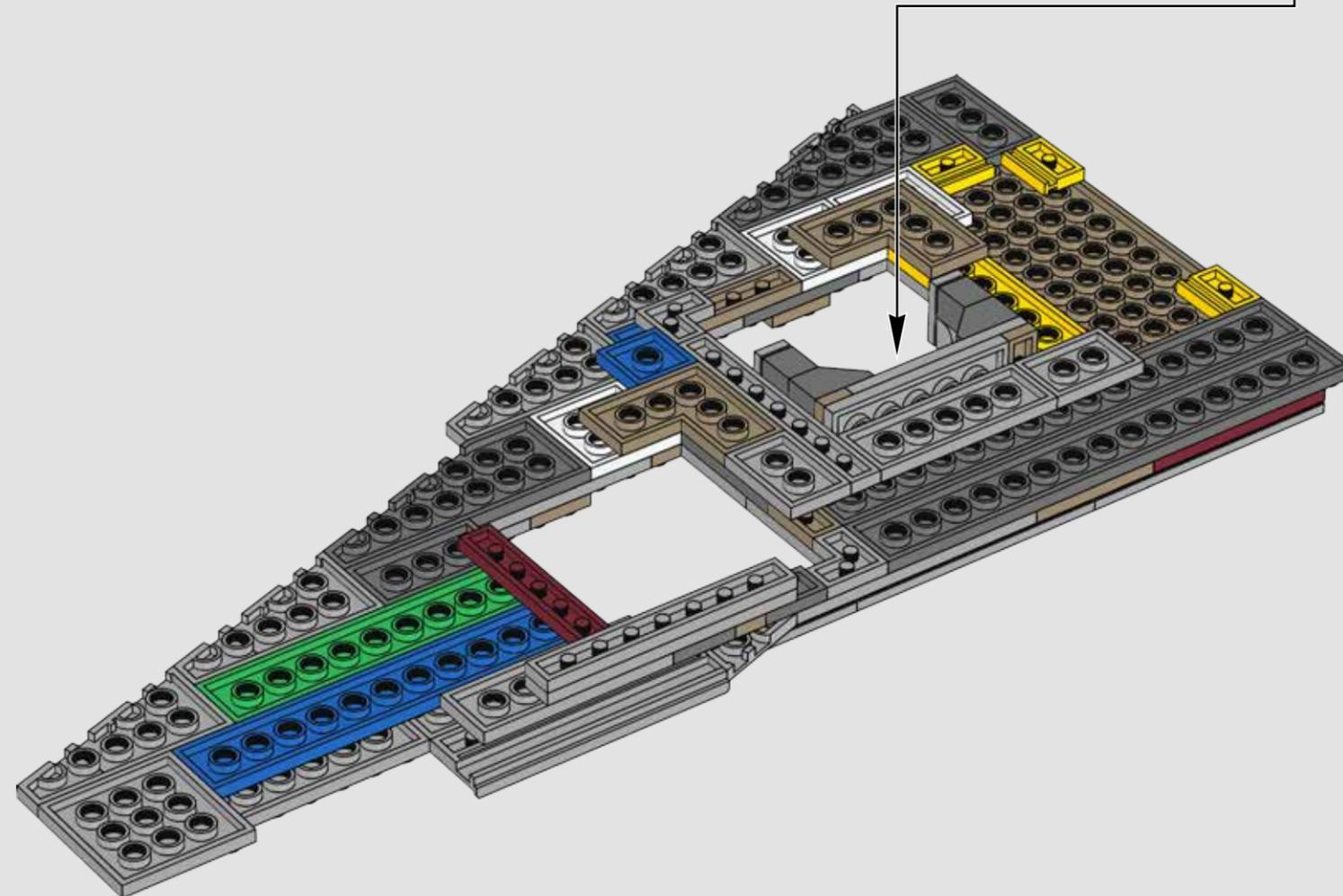
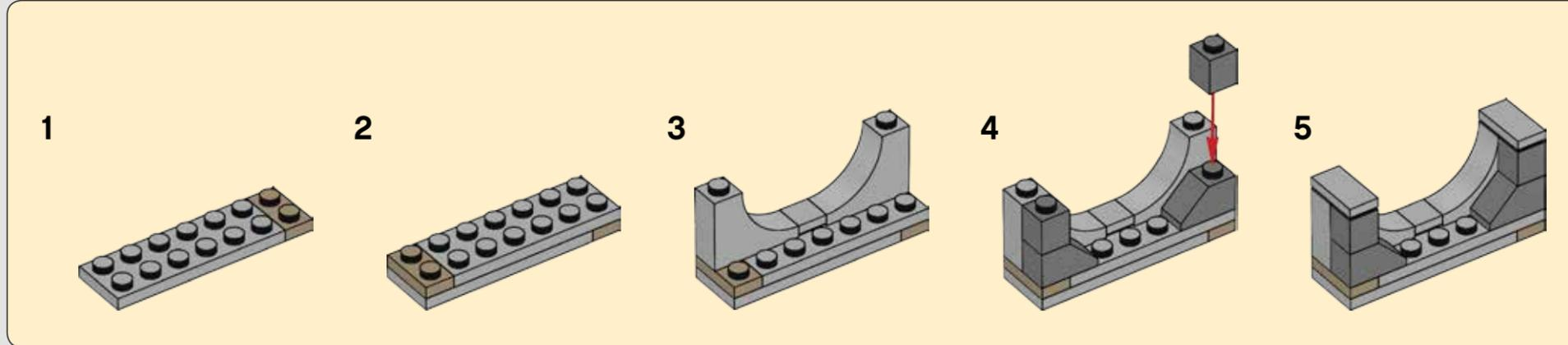

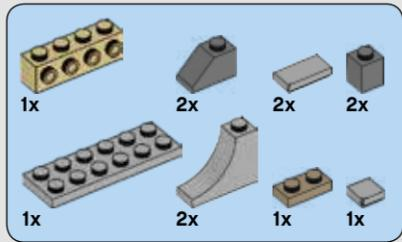

523

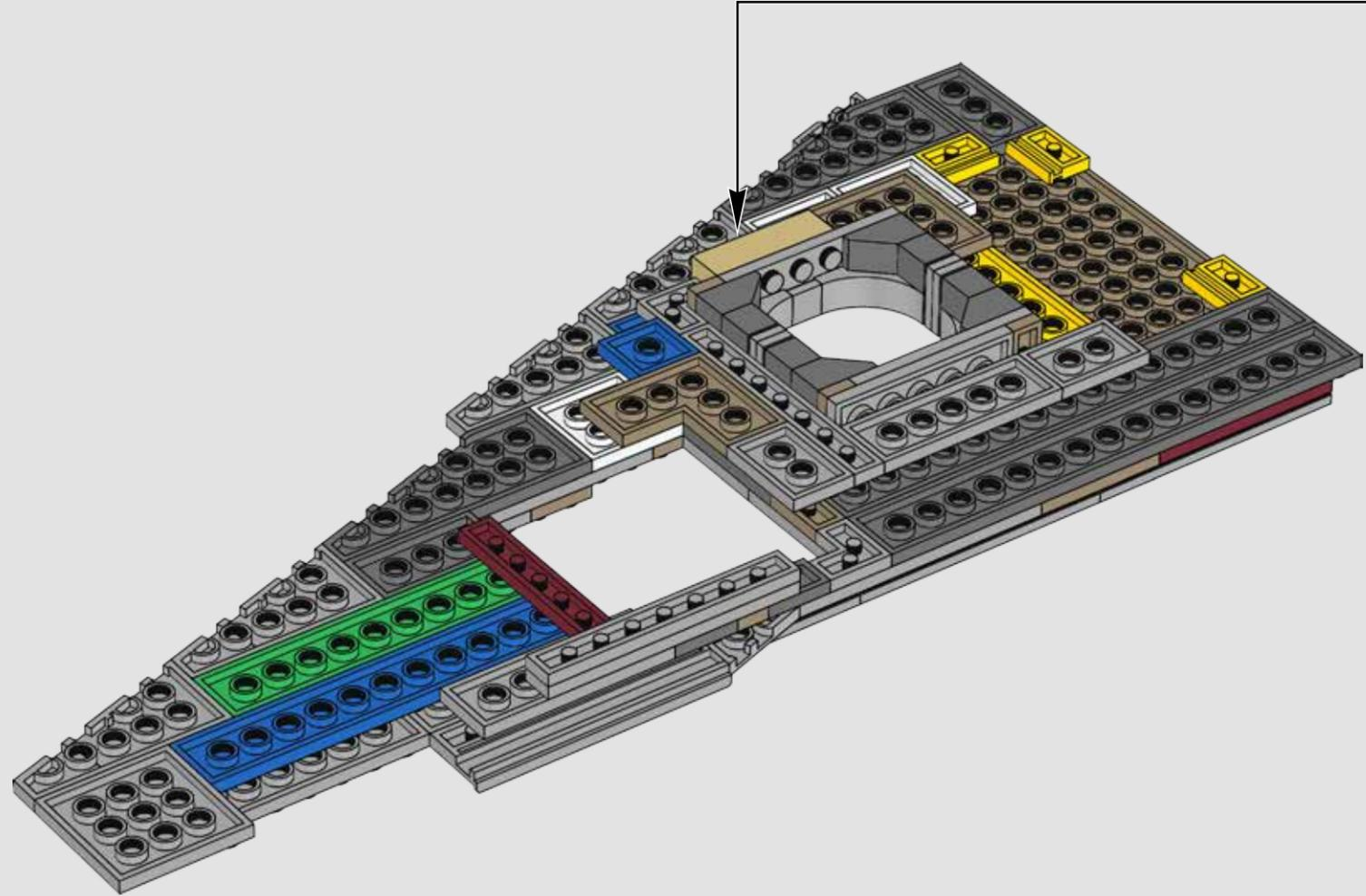
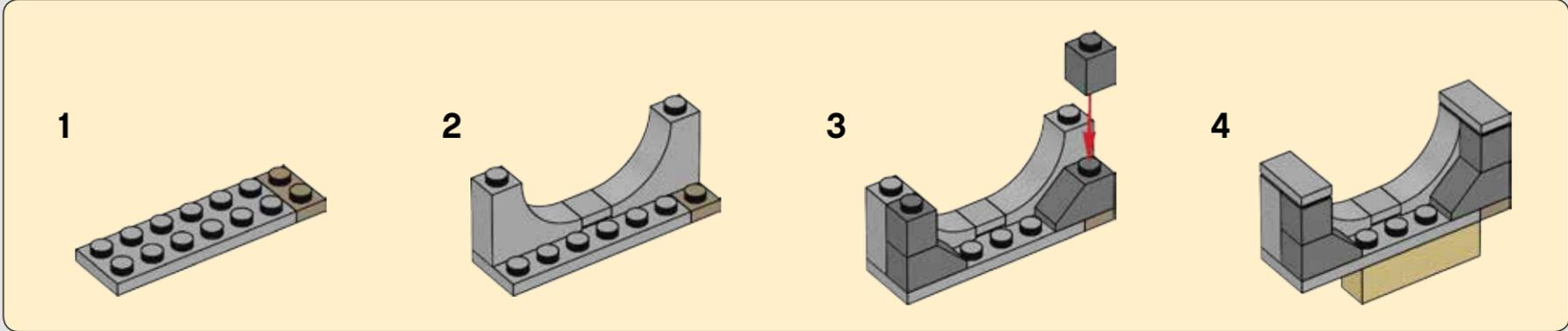

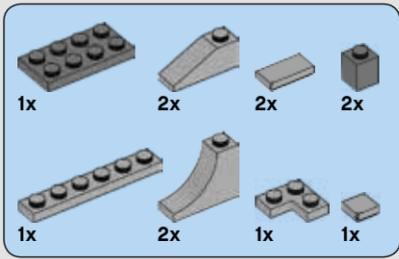

524

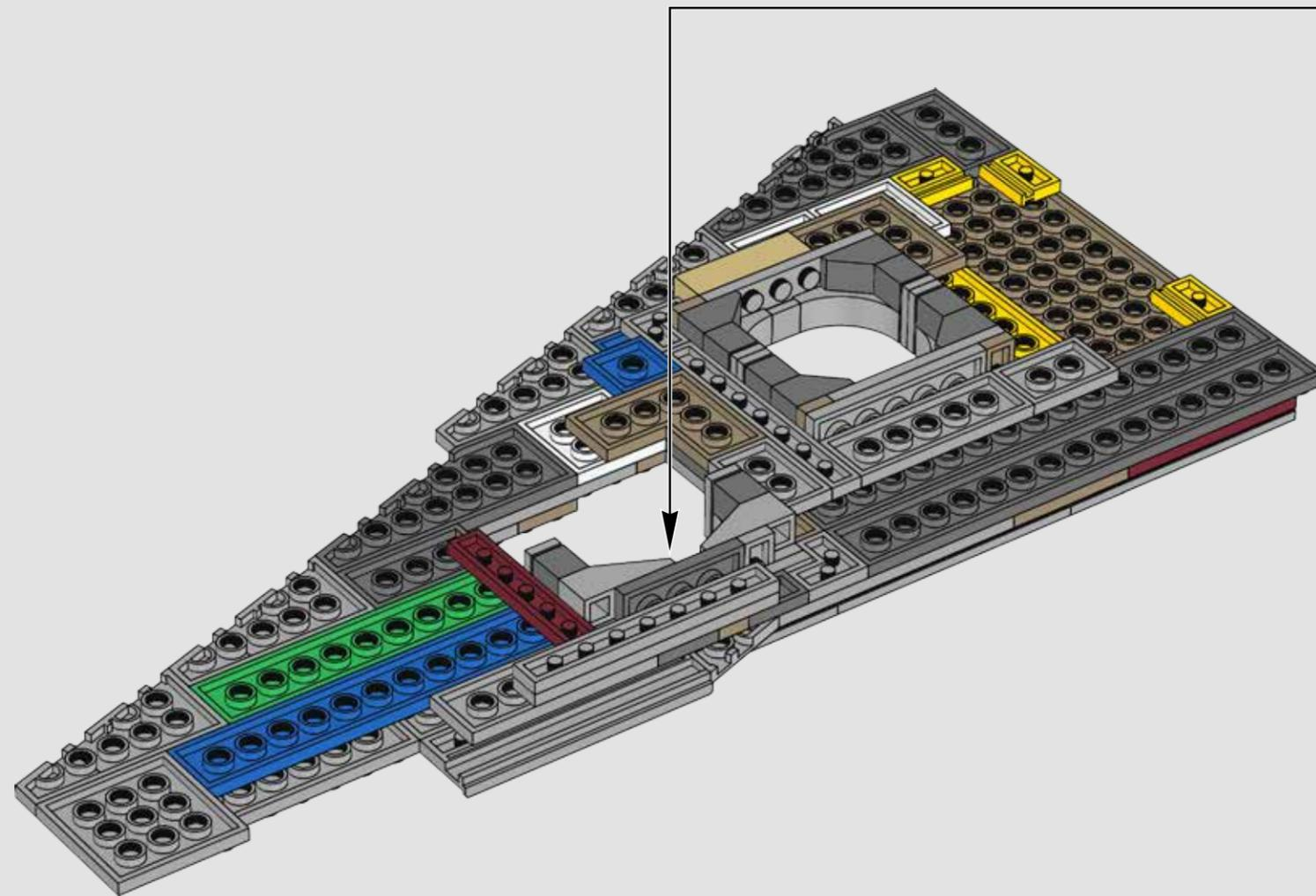
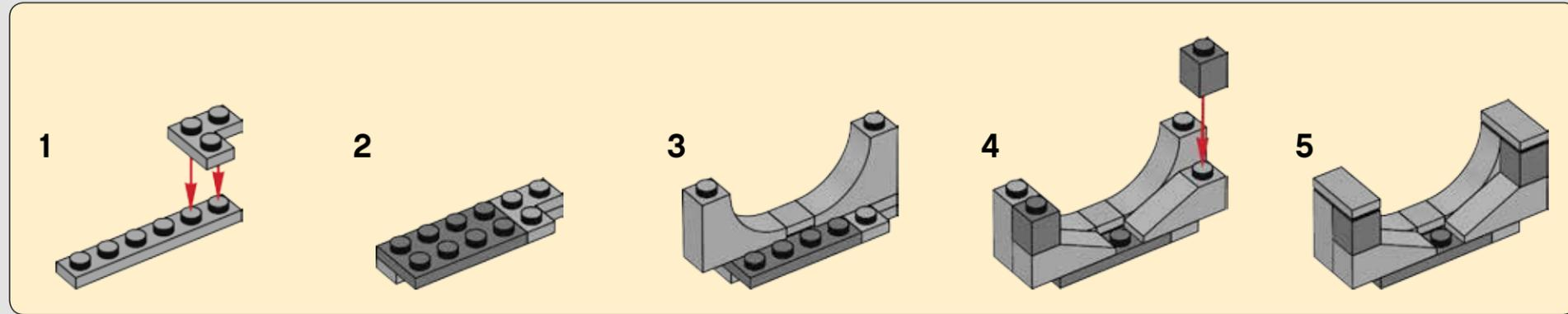

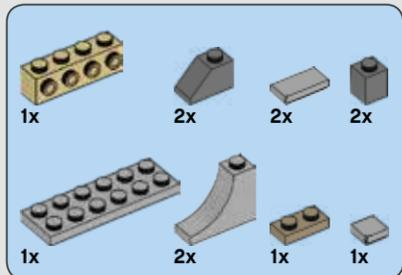

525

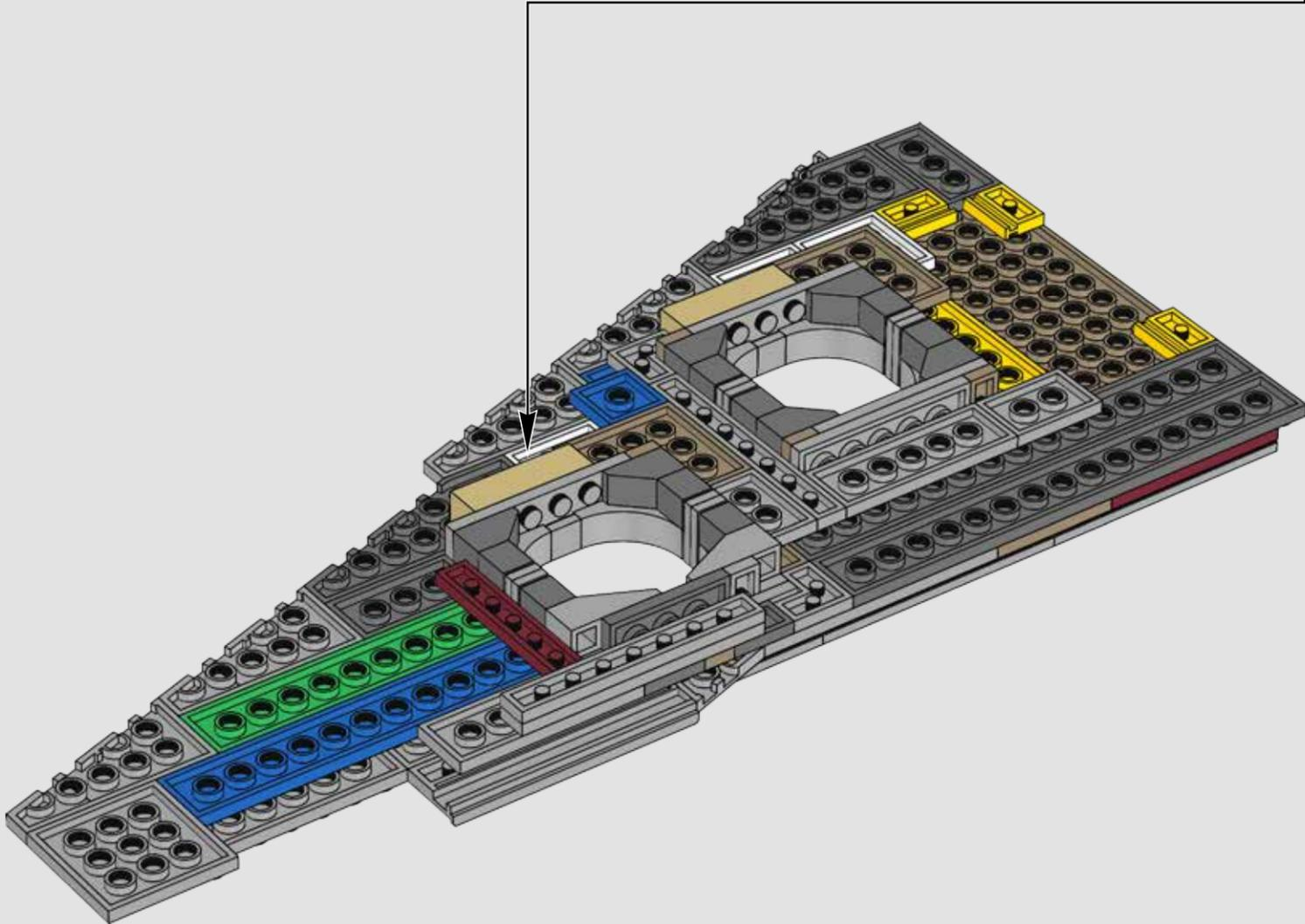
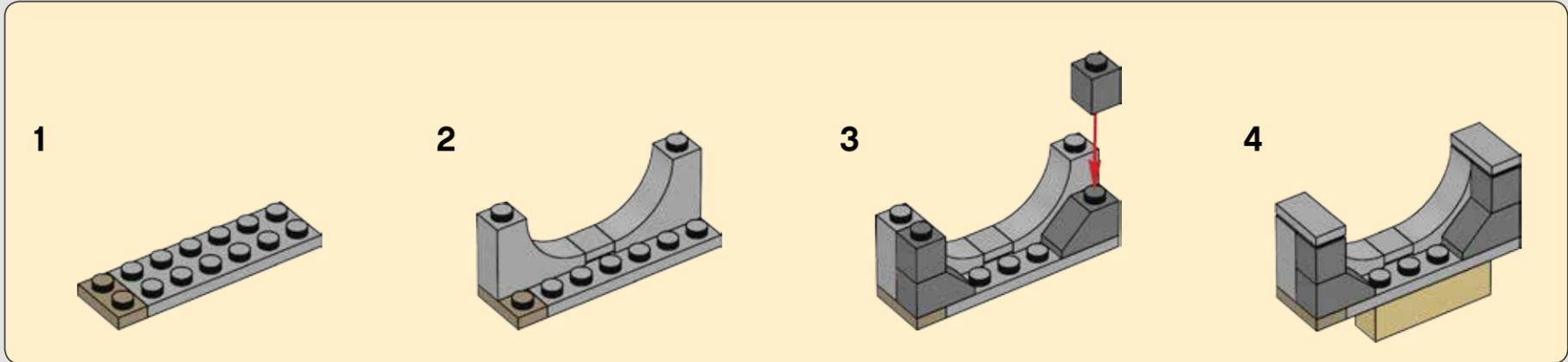



526

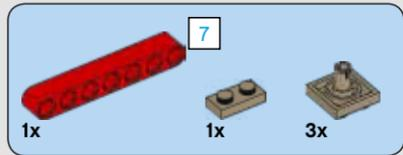
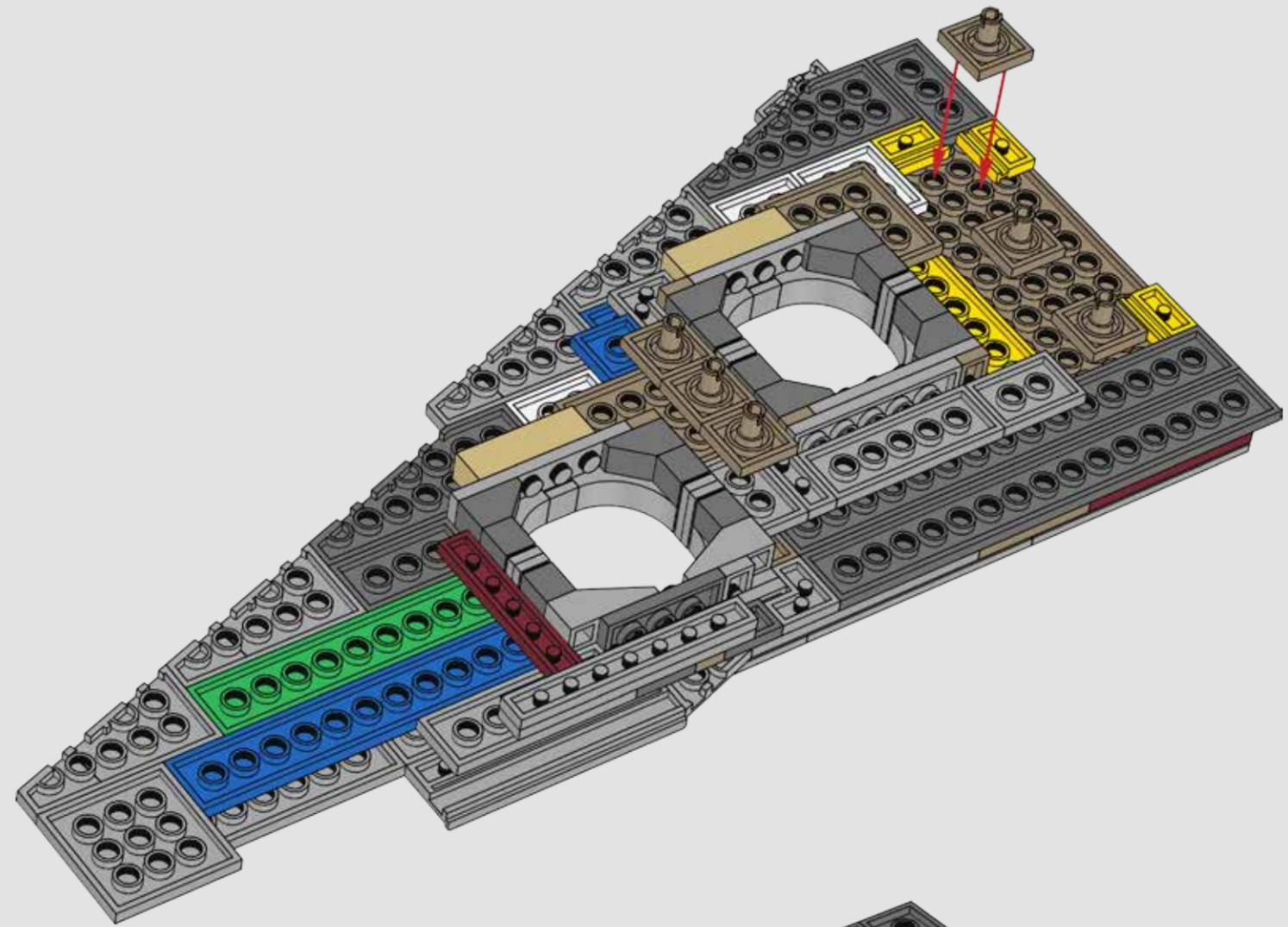

527

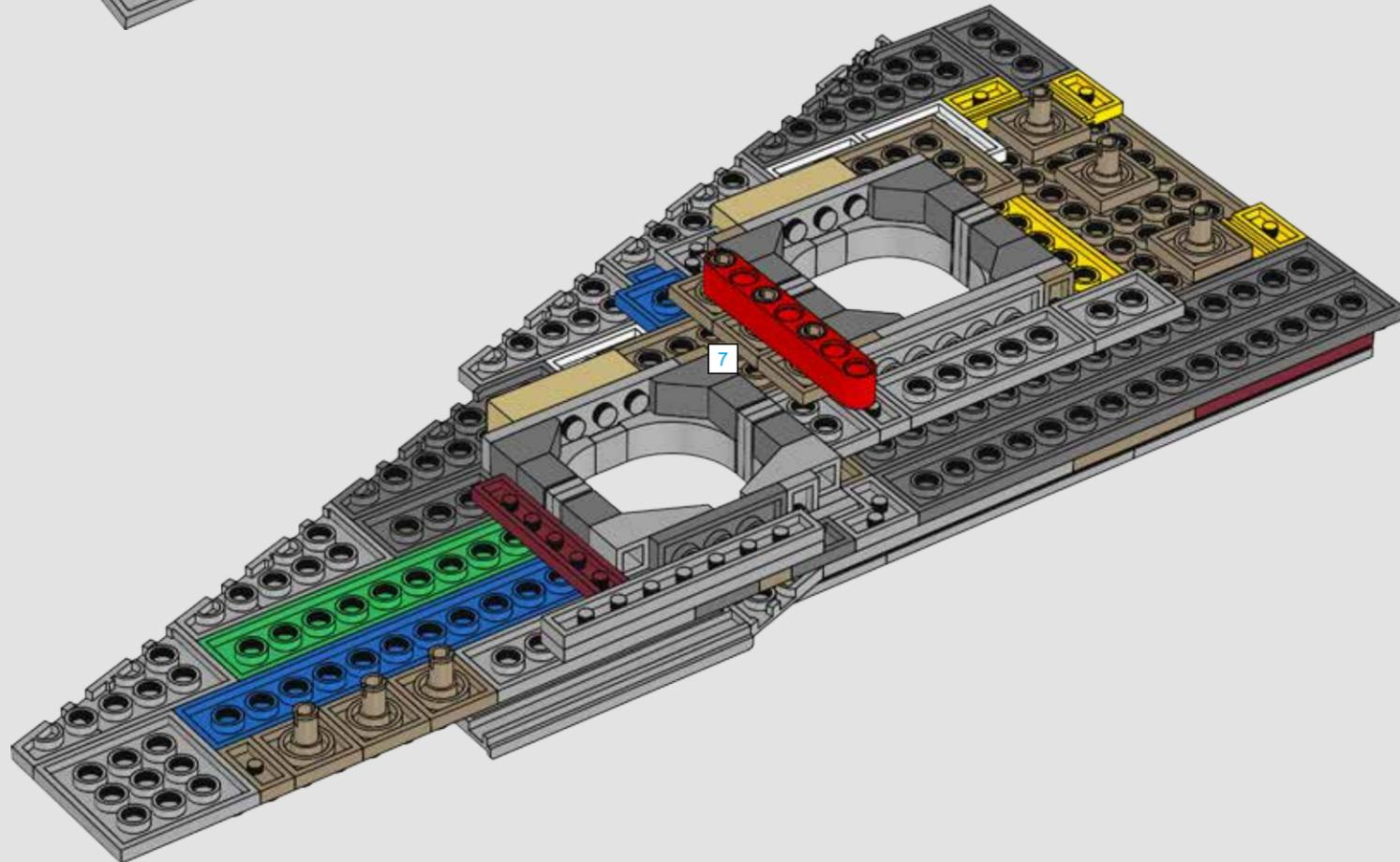
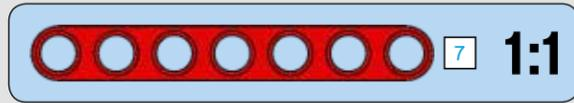

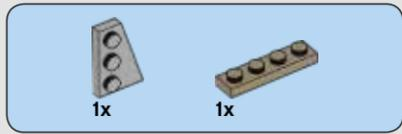

528

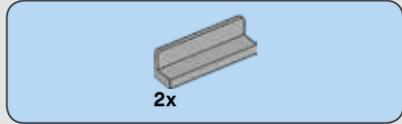
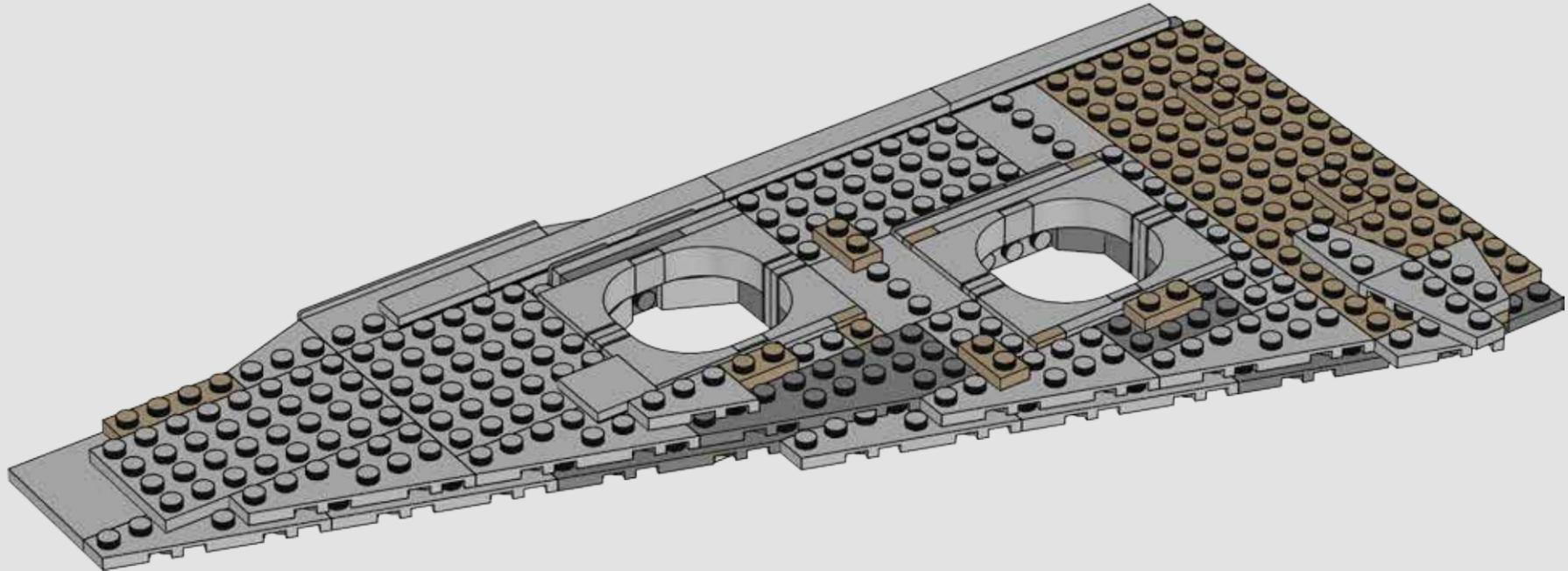

529

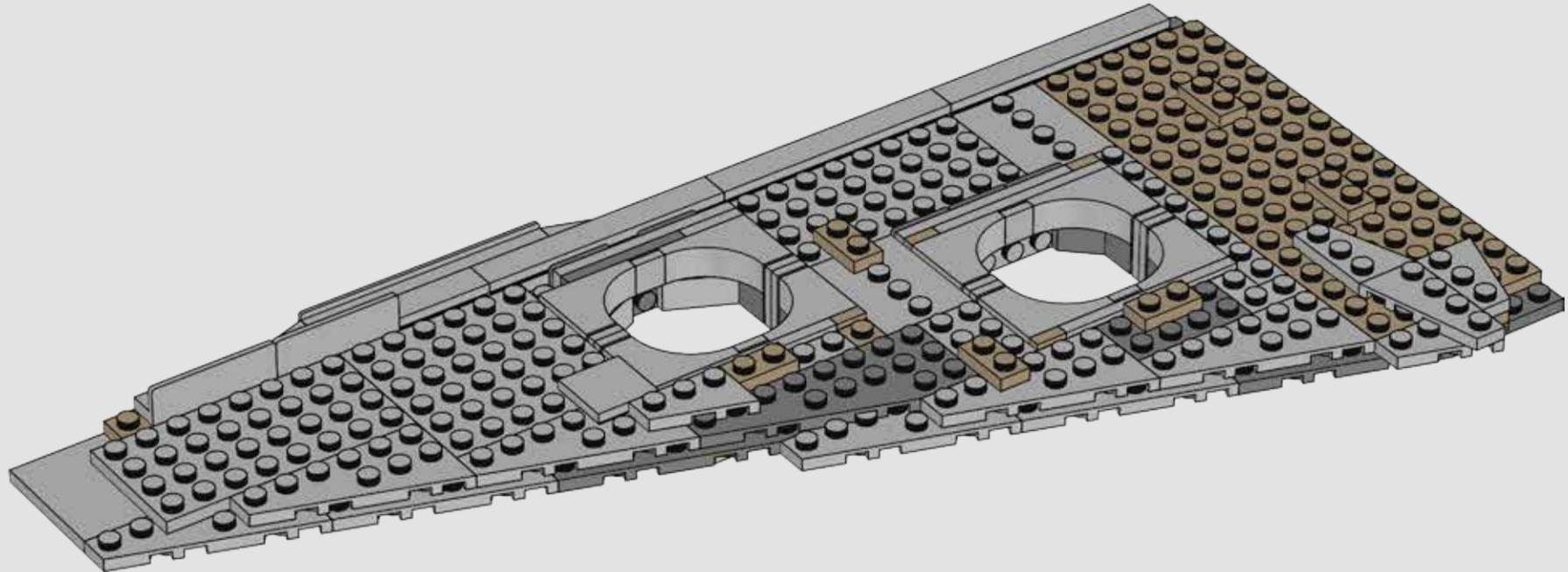

530

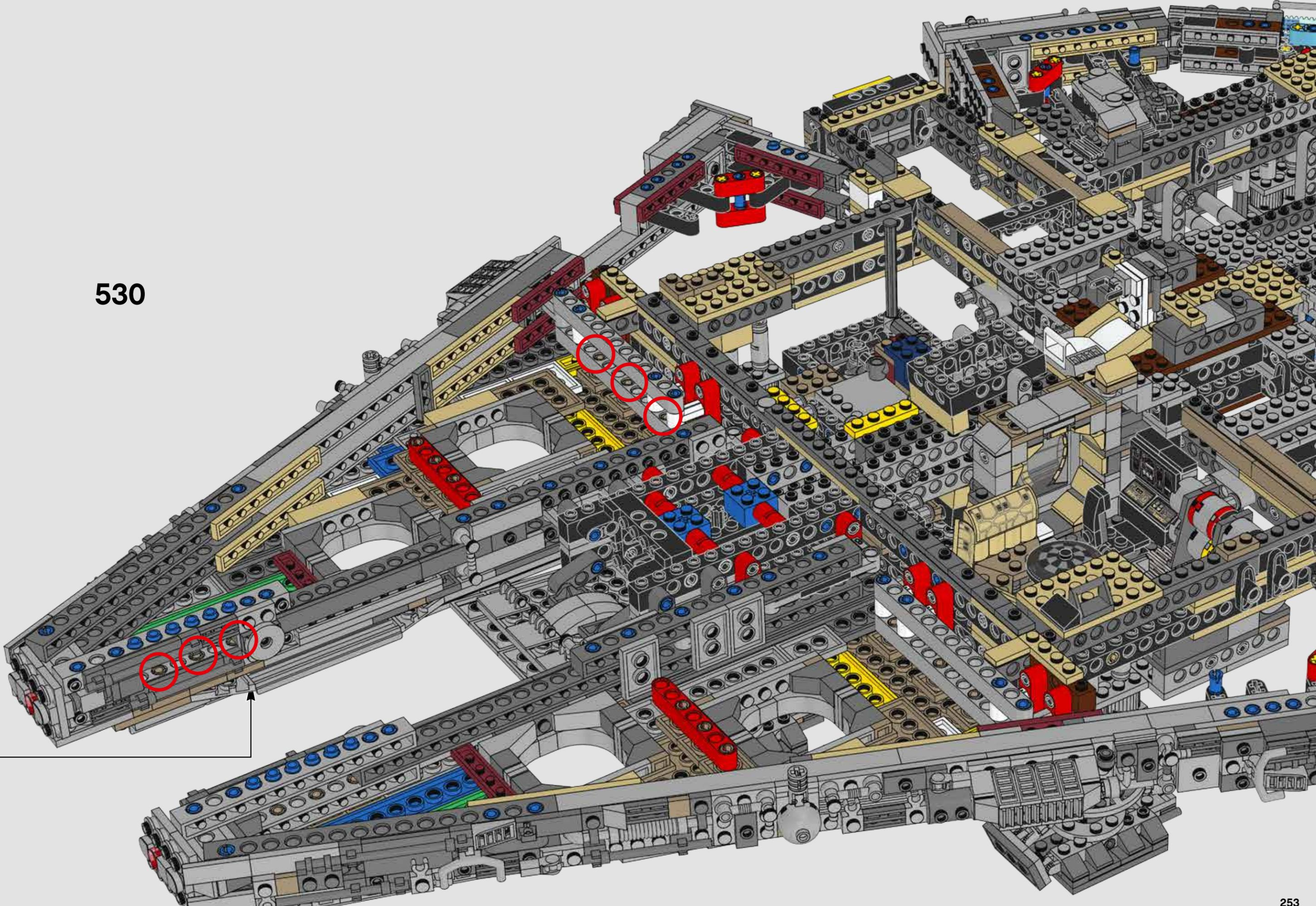



8

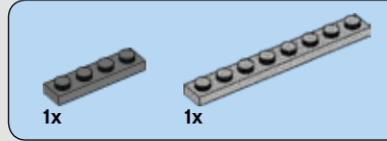
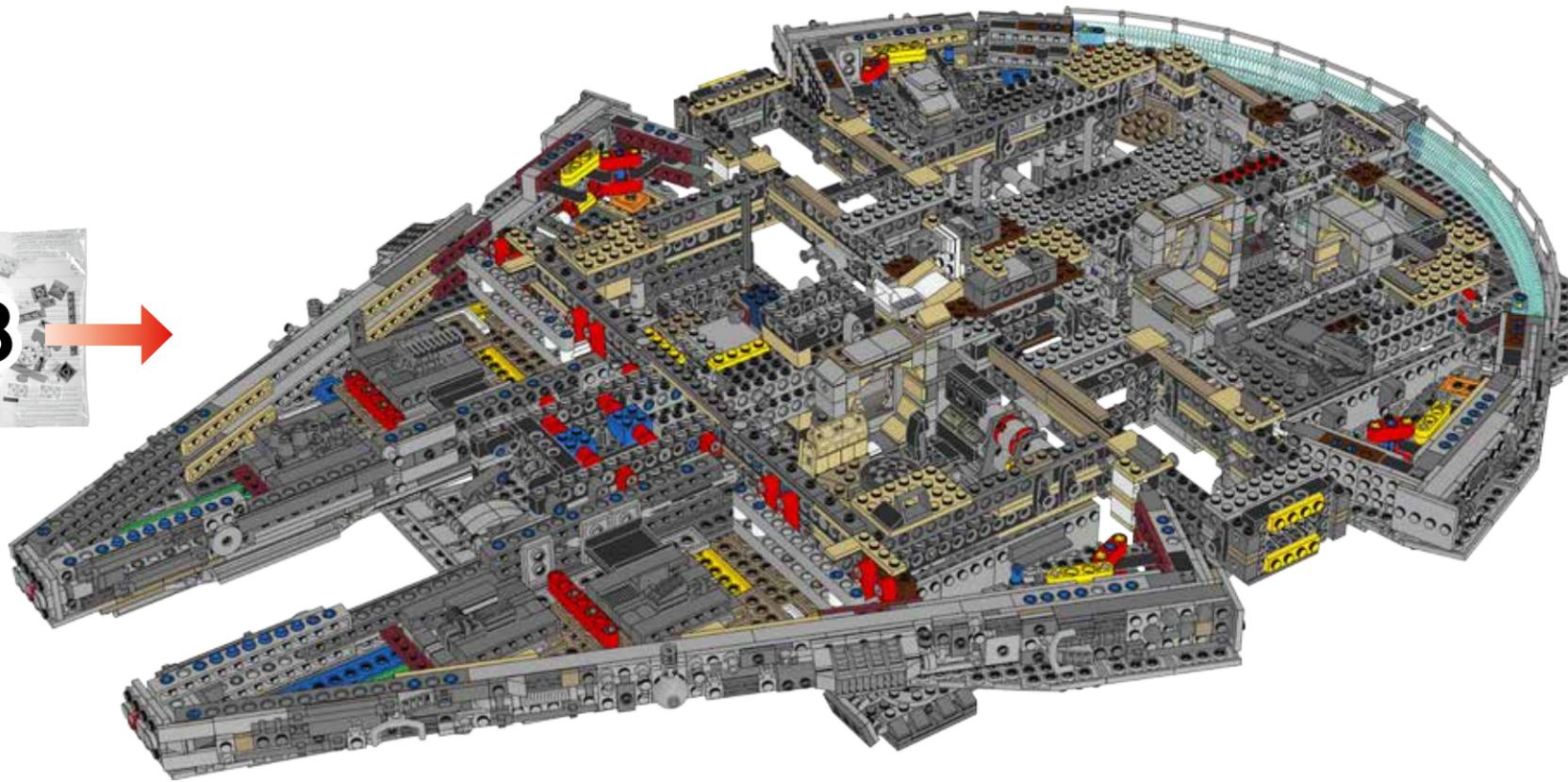

533

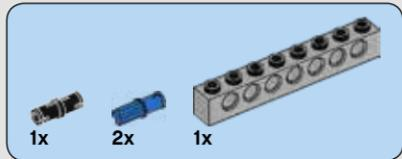
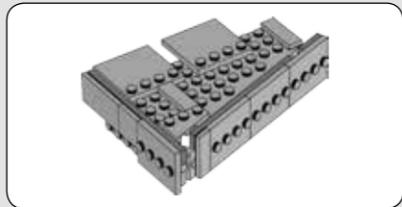
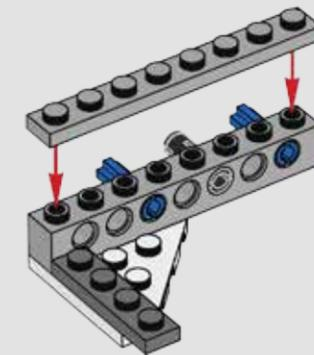

531

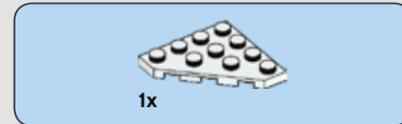
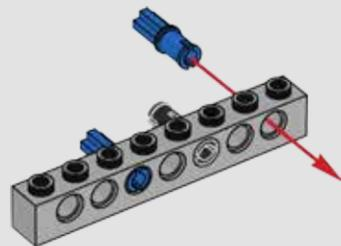

532

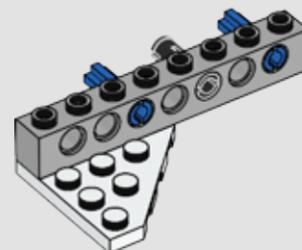

534

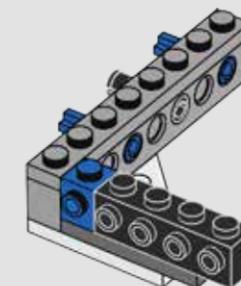

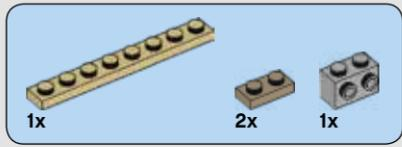

535

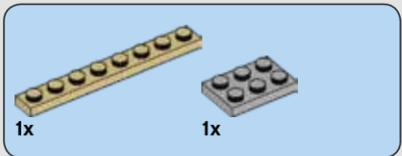
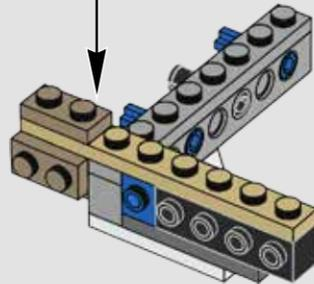
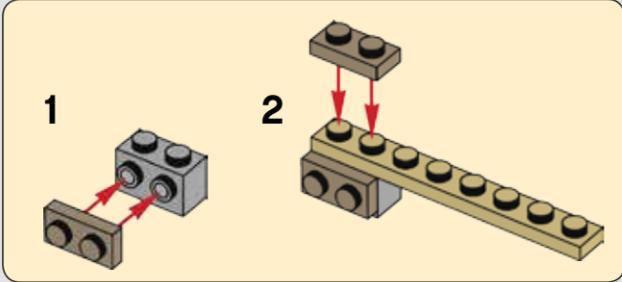

536

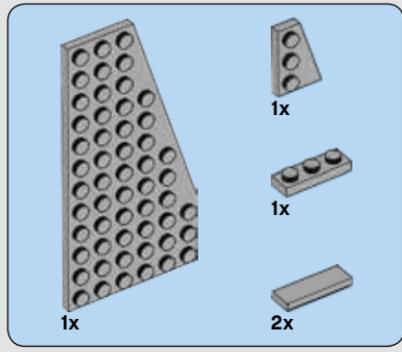
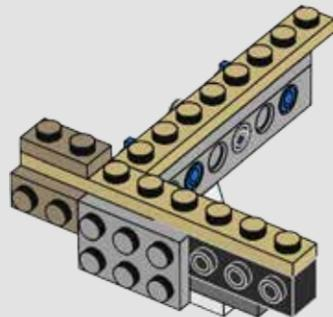

537

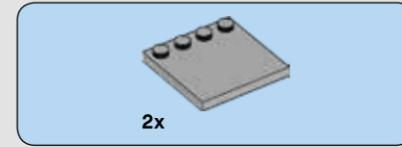
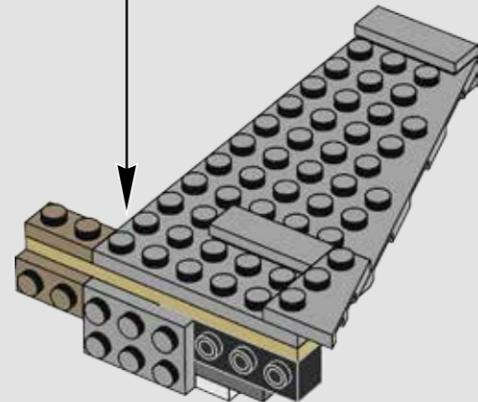
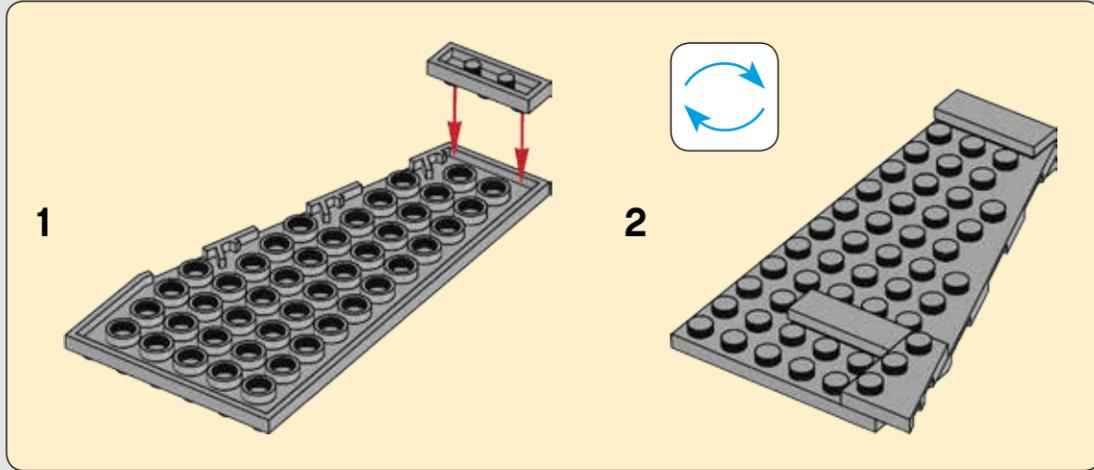

538

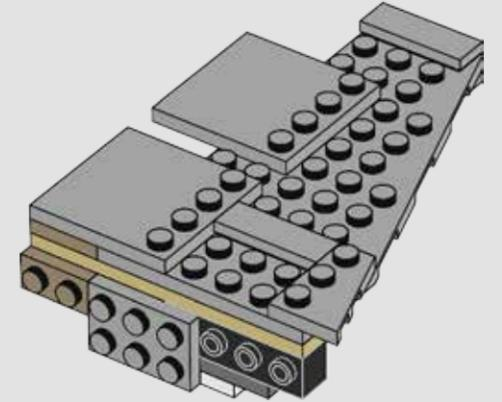

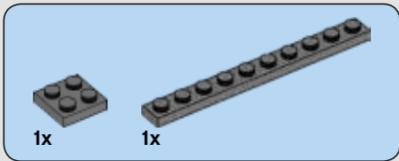

539

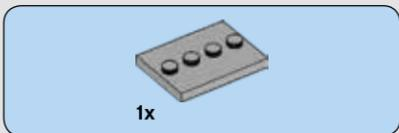
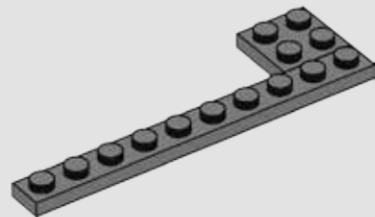

540

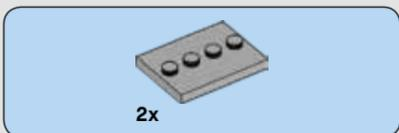
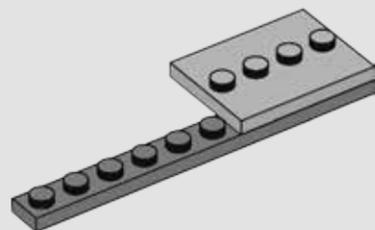

541

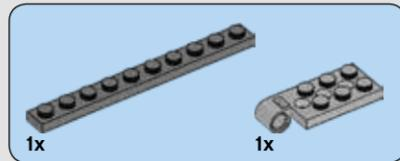
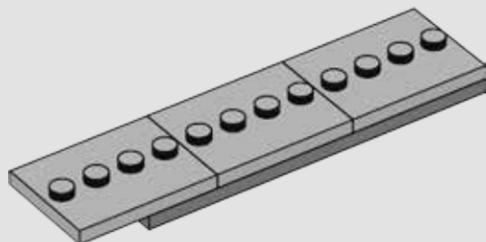

542

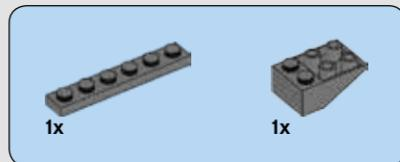
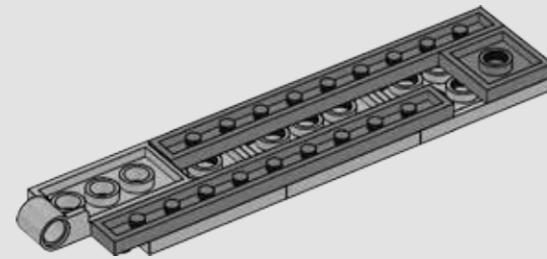

543

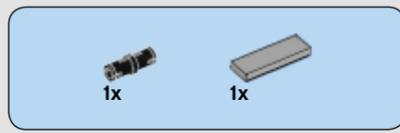
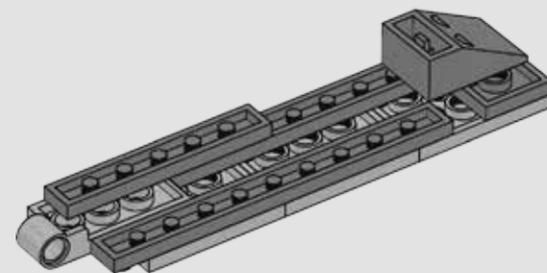

544

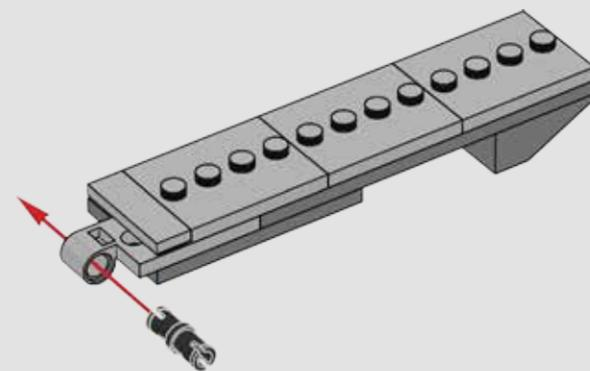

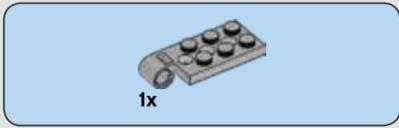

545

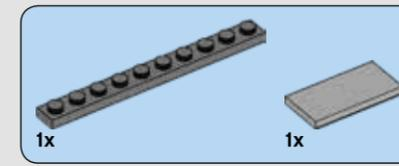
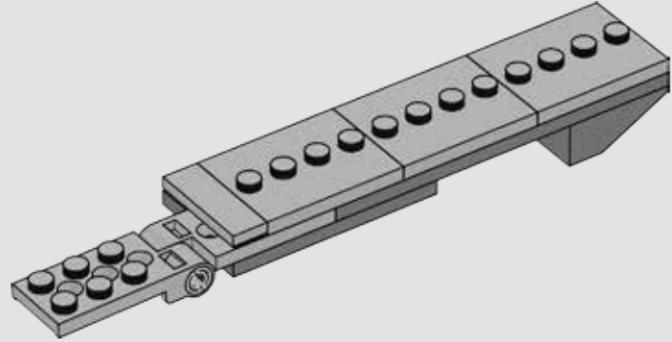

547

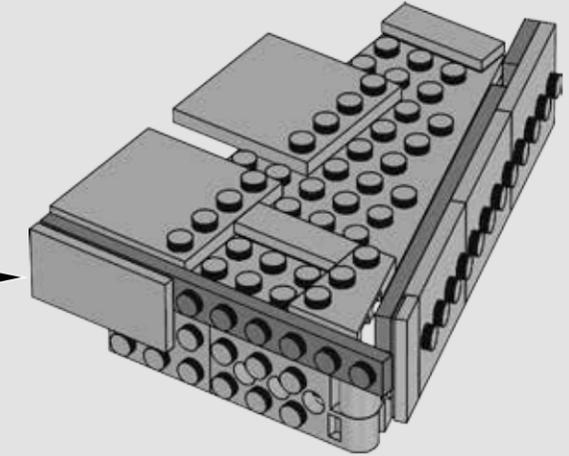
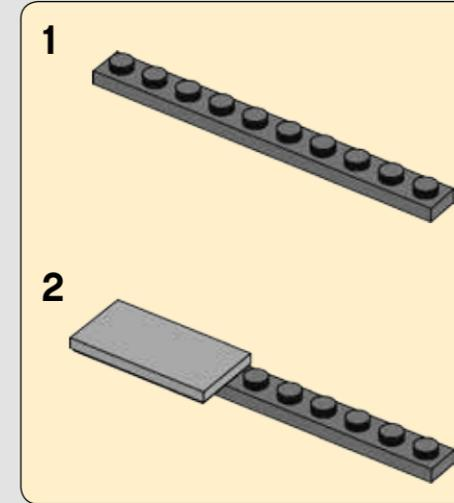

546

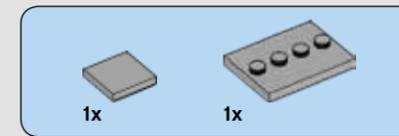
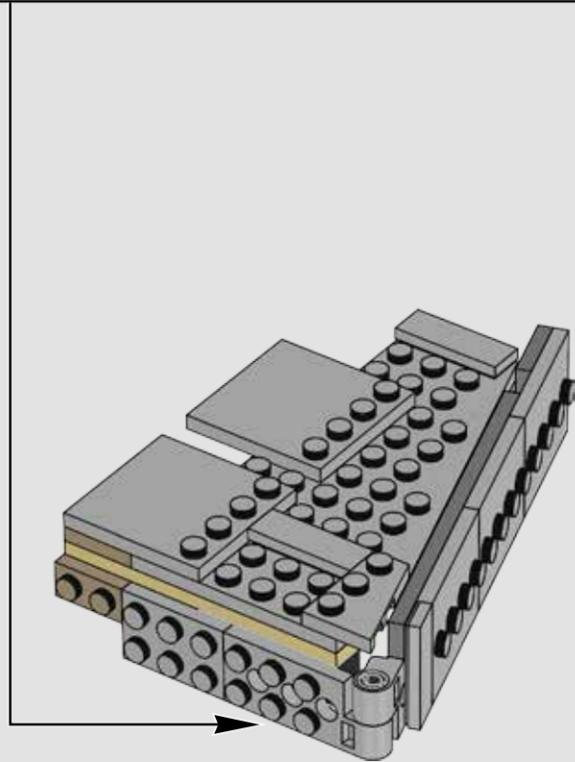

548

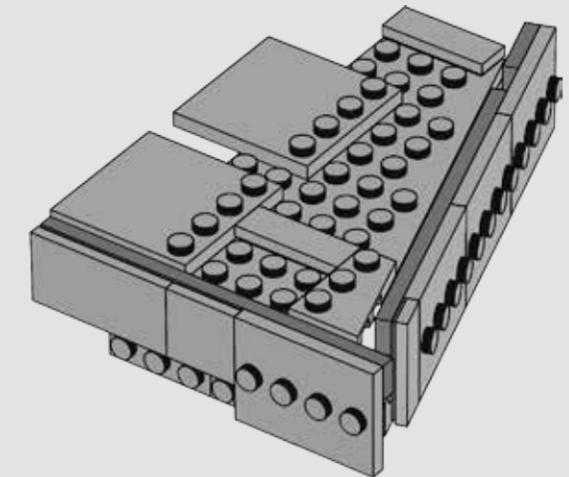

549

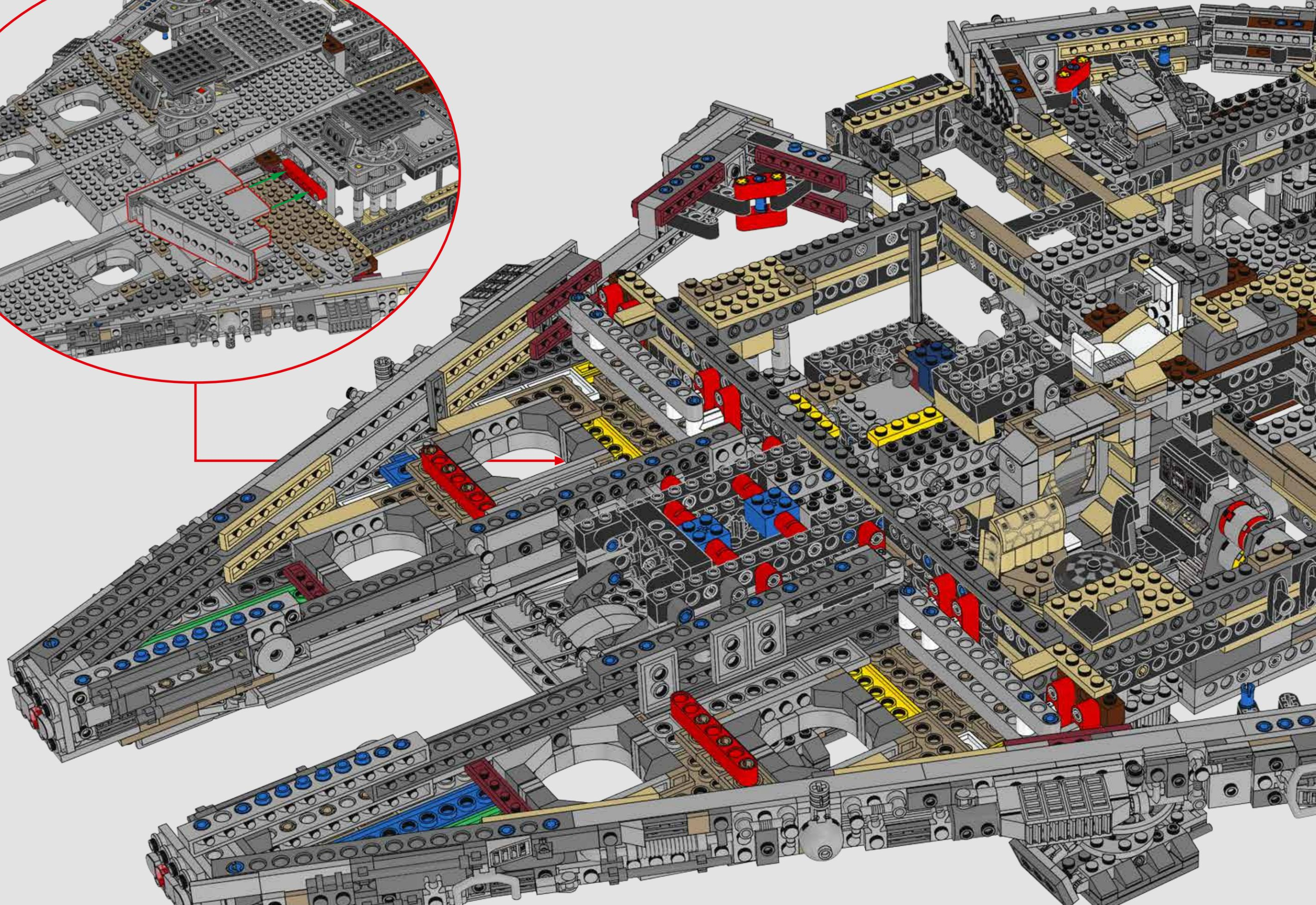

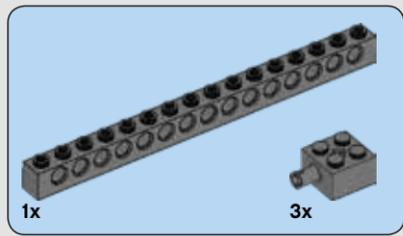

550

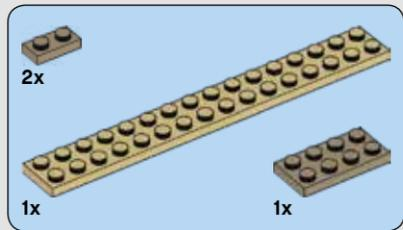
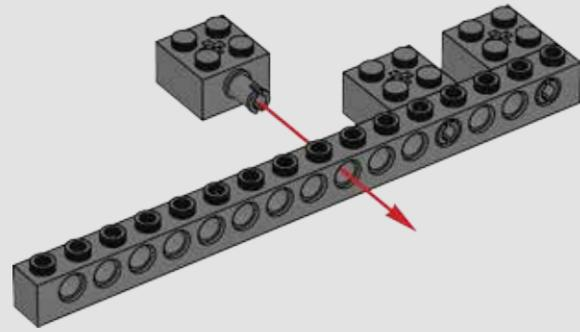

551

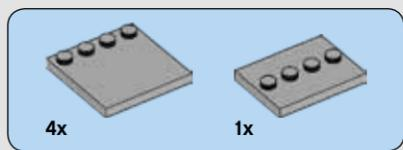
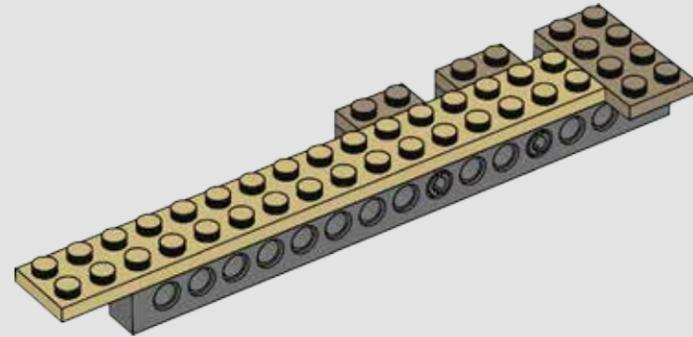

552

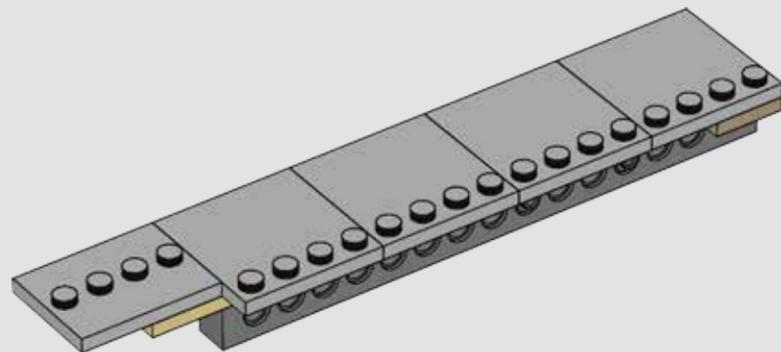

553

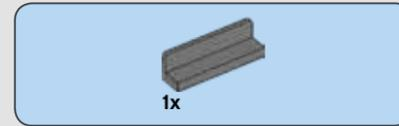
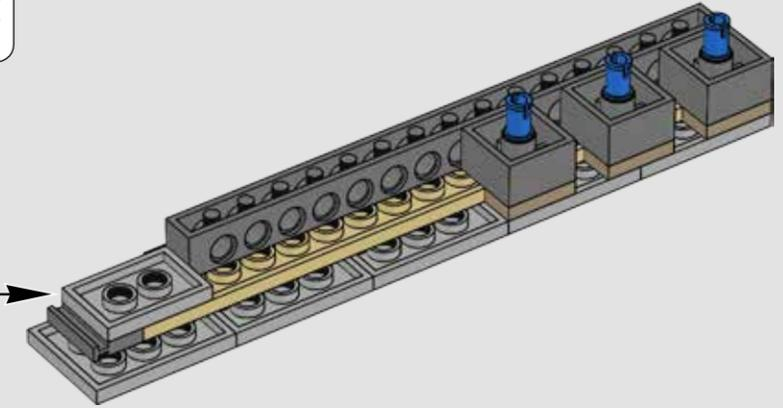
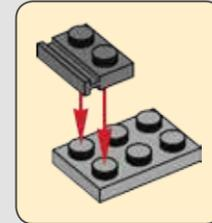

554

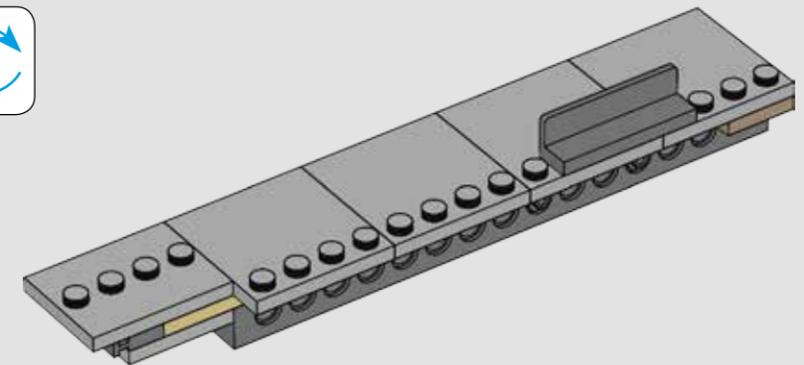

555

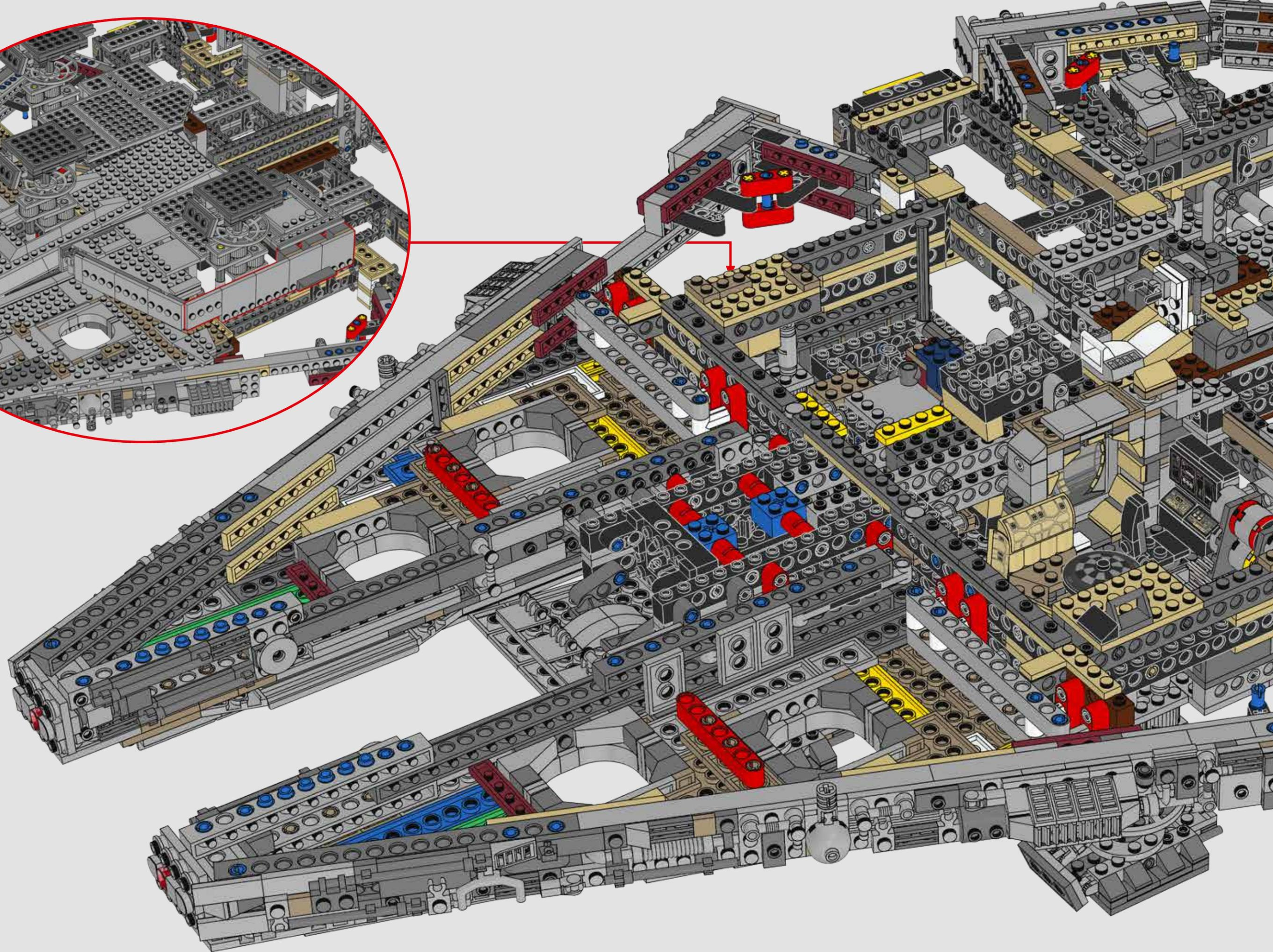
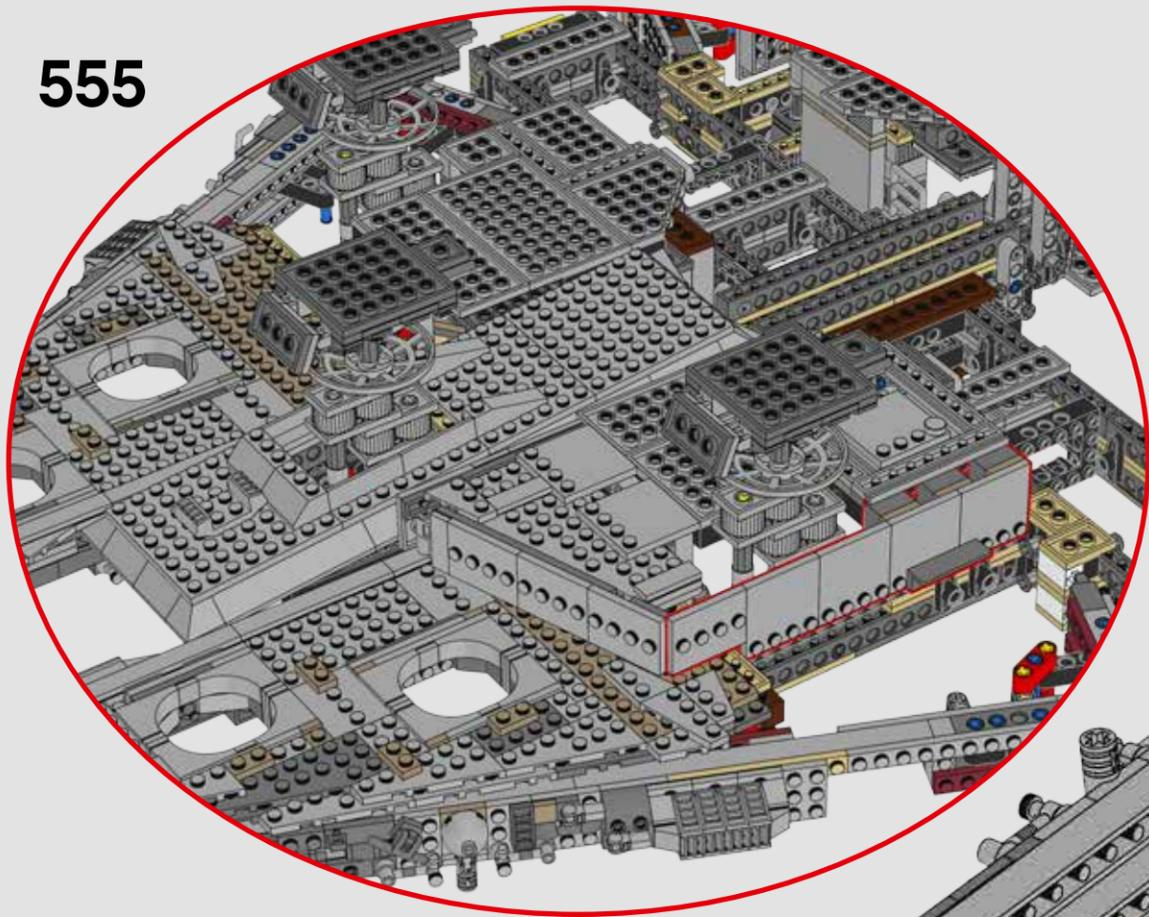

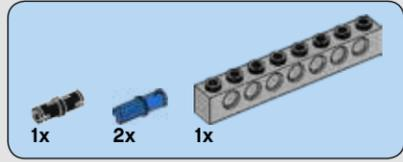
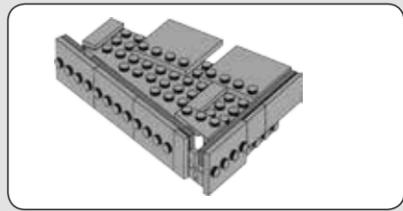

556

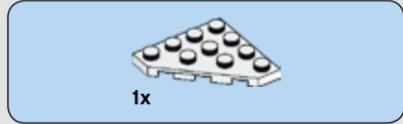
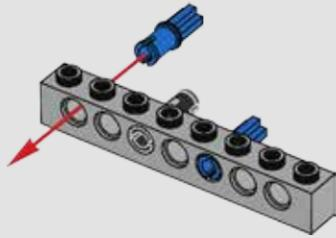

557

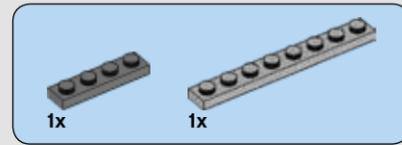
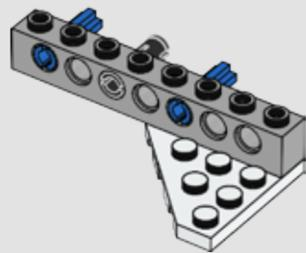

558

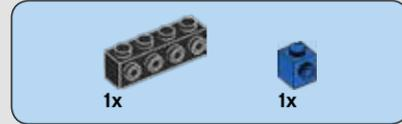
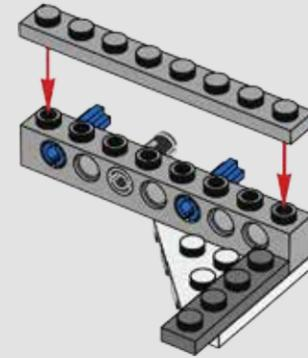

559

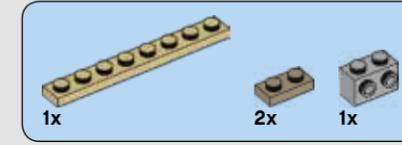
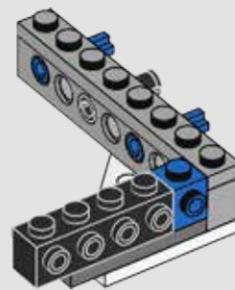

560

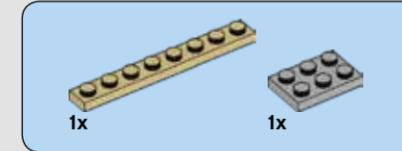
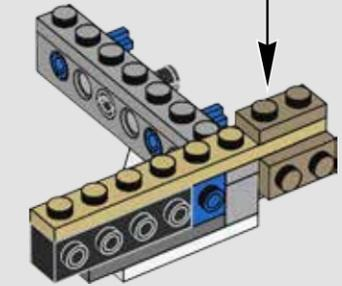
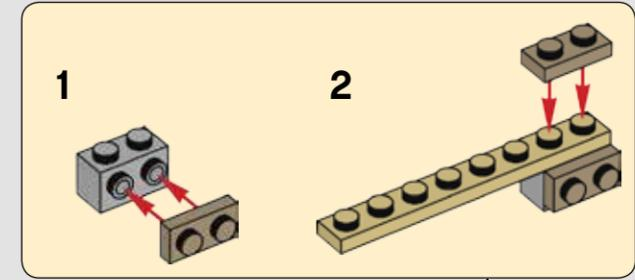

561

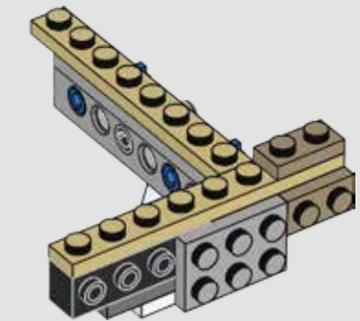

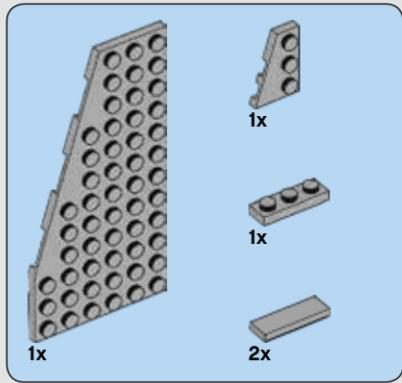

562

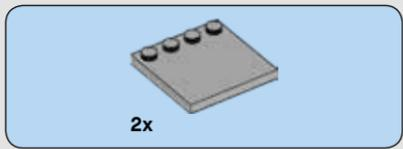
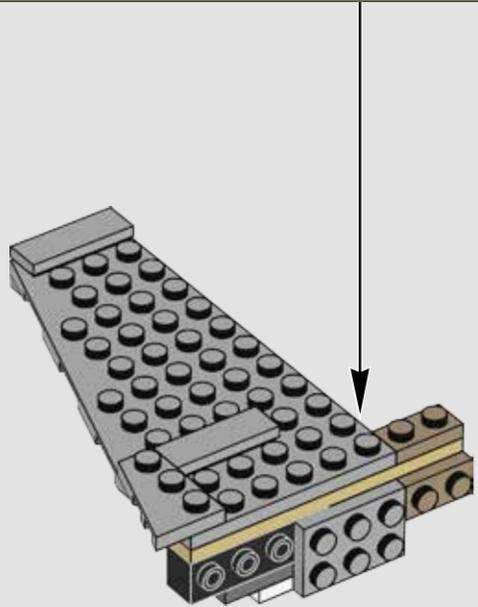
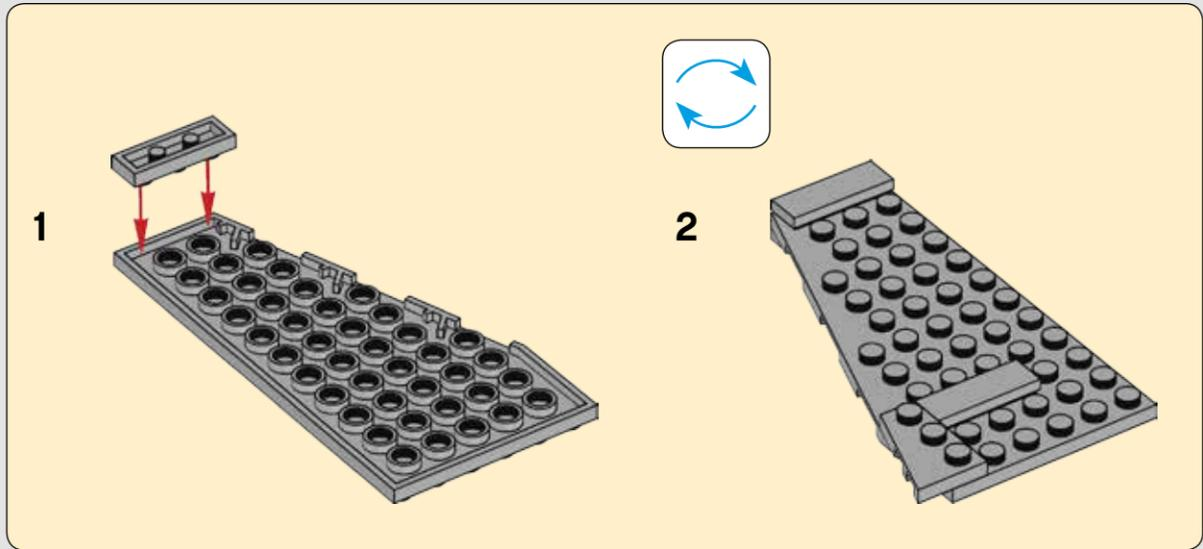

563

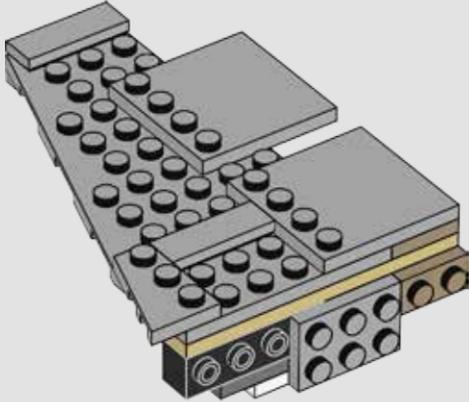

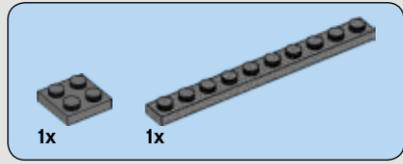
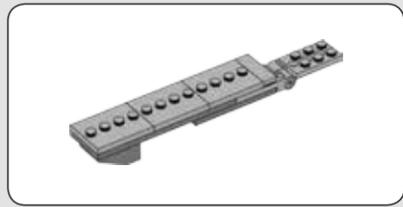

564

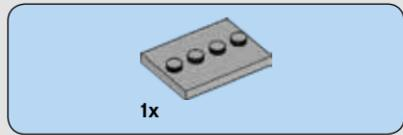
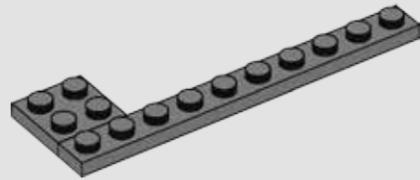

565

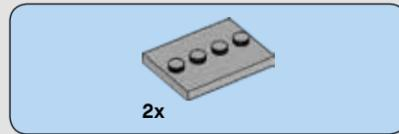
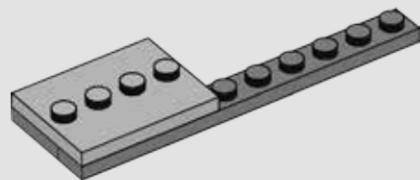

566

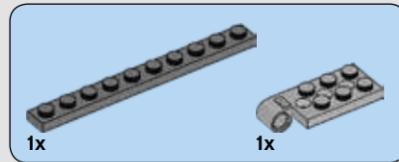
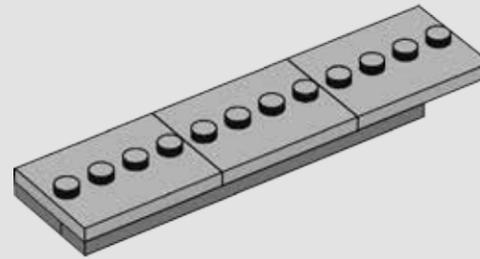

567

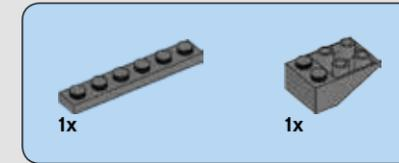
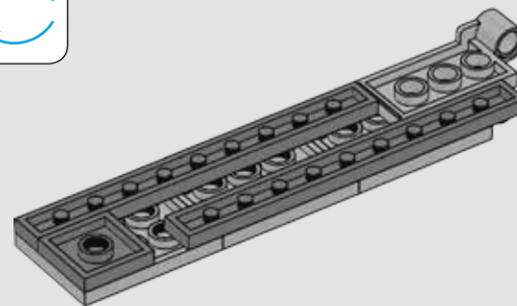

568

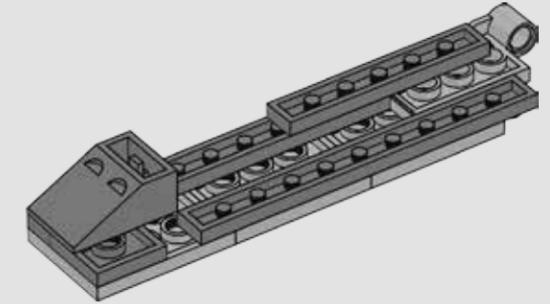

569

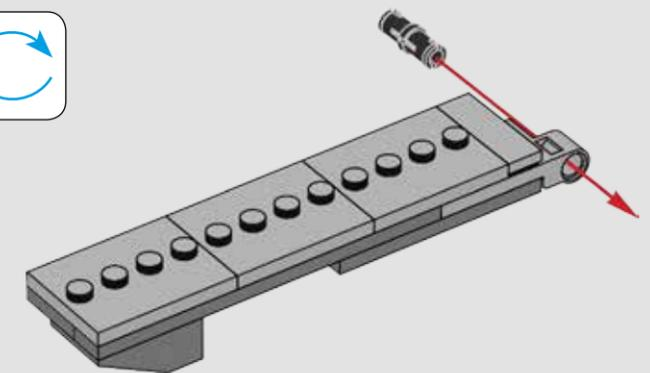

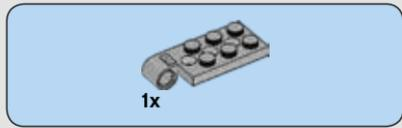

570

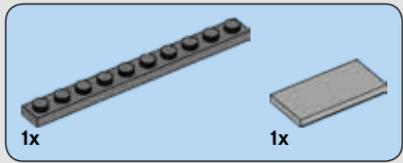
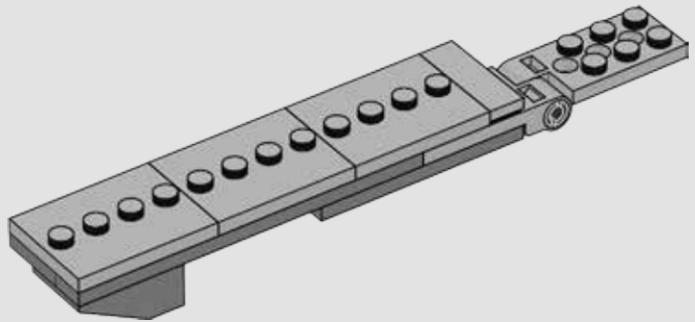

572

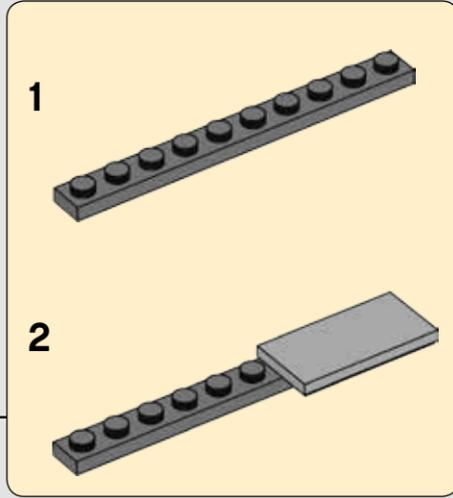
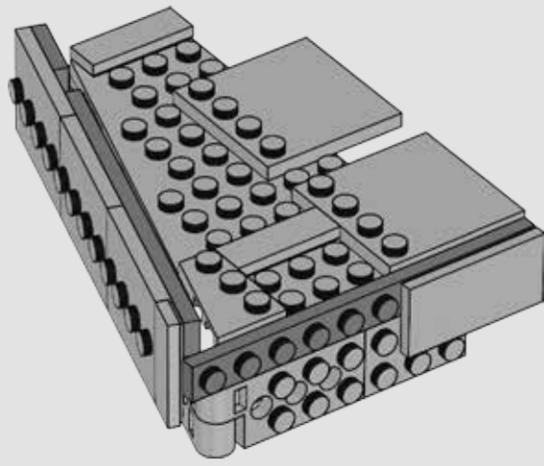

571

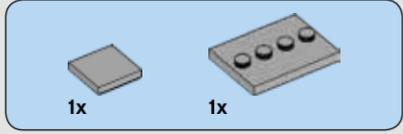
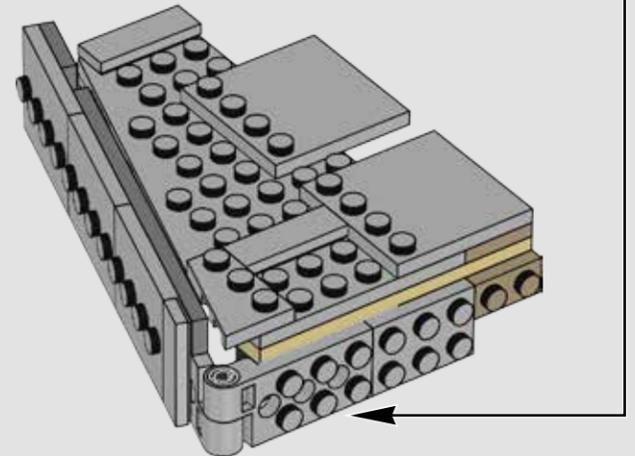

573

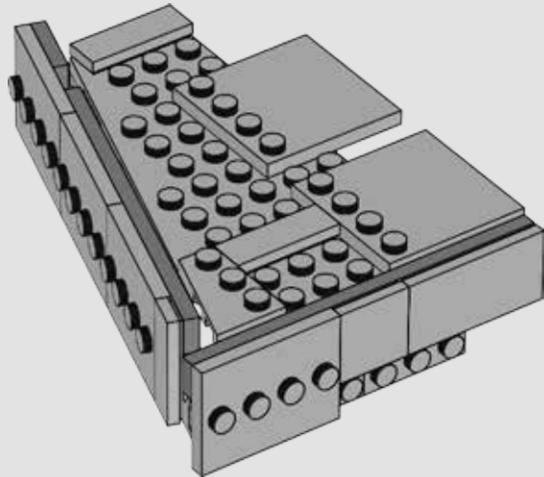

574

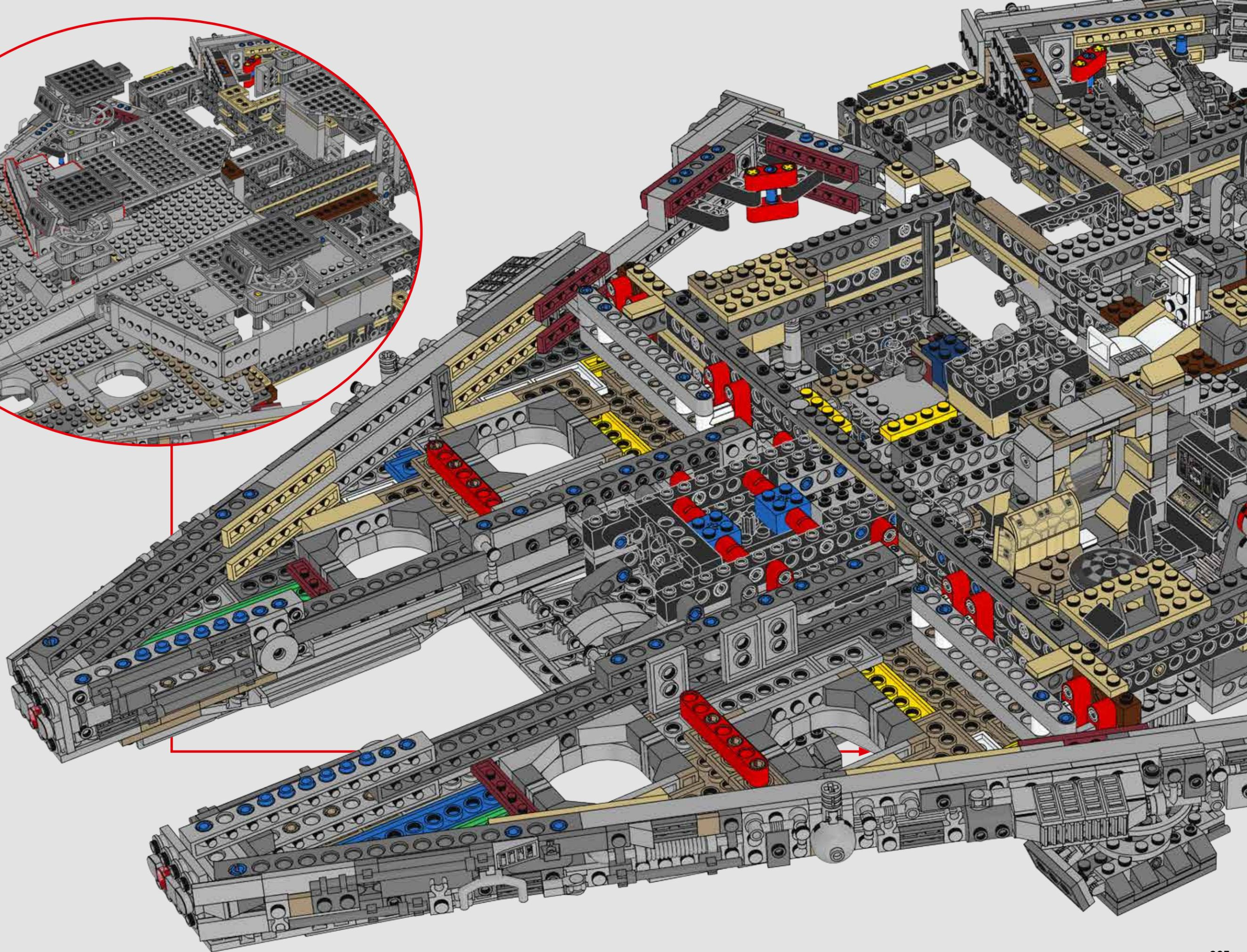
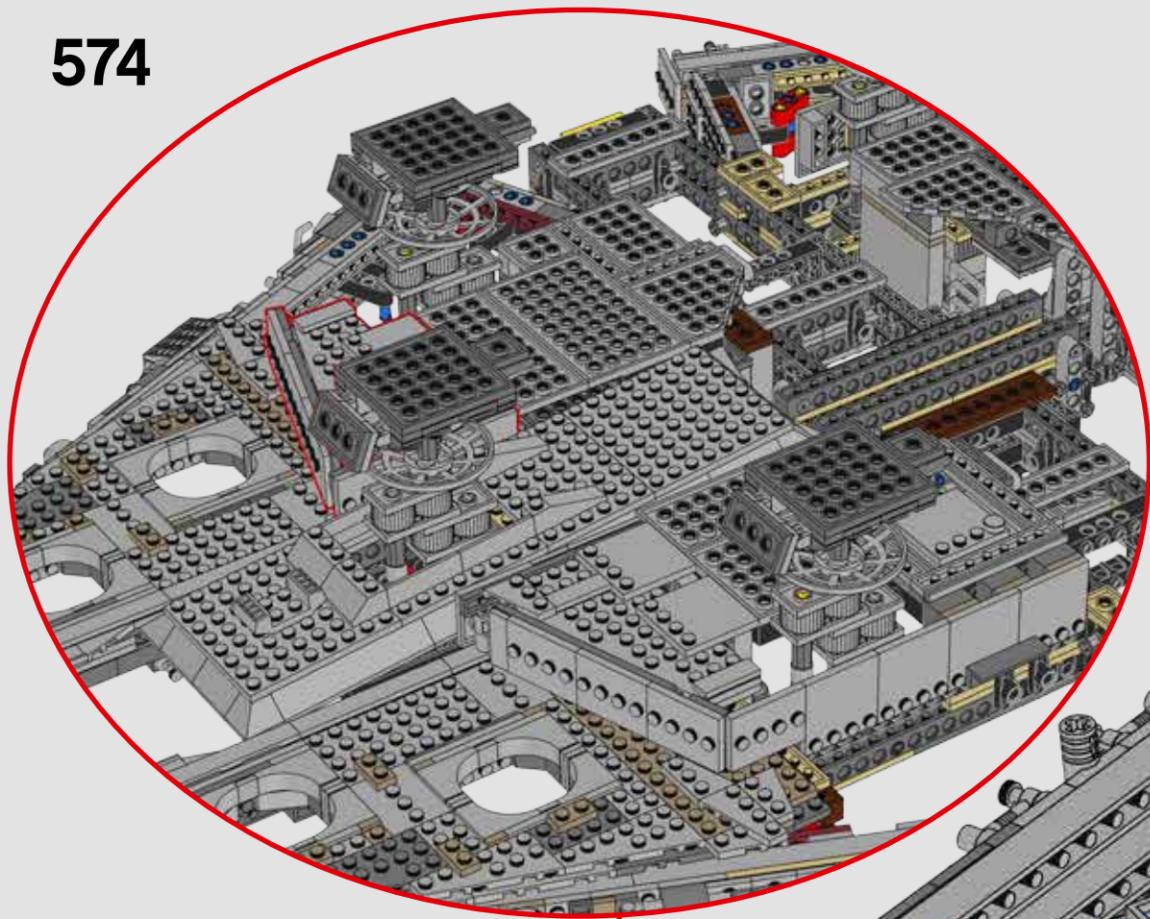

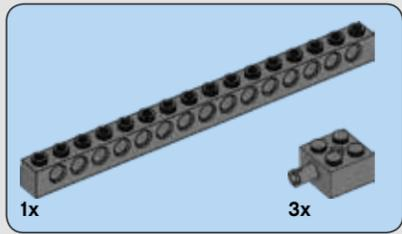

575

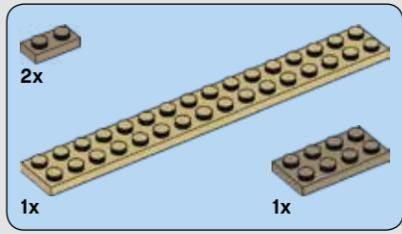
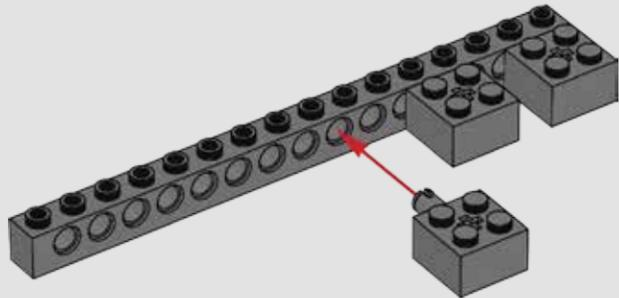

576

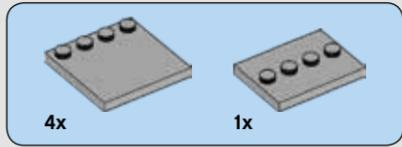
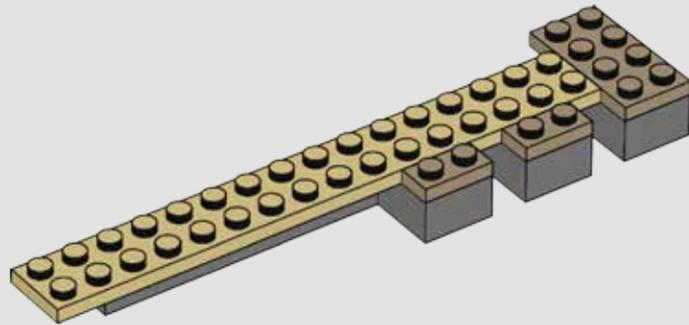

577

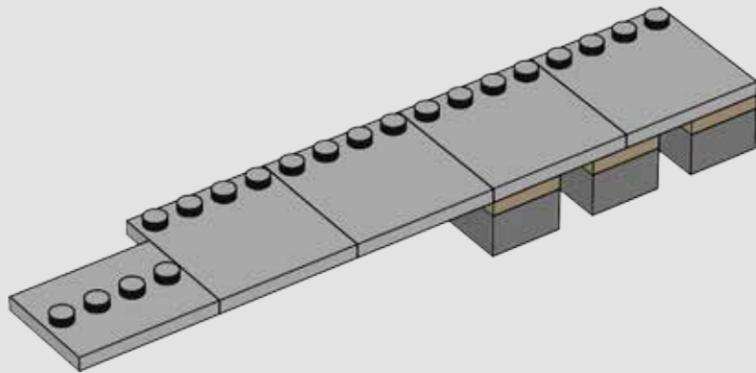

578

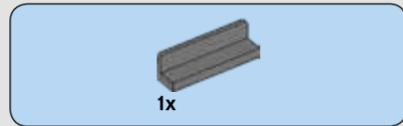
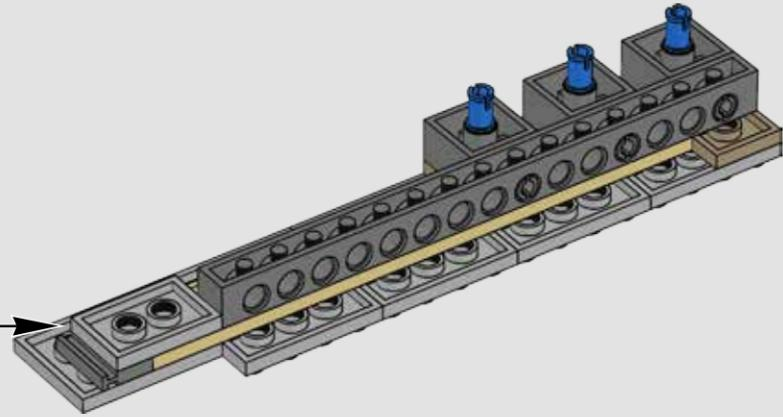
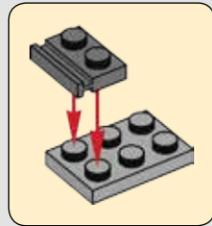

579

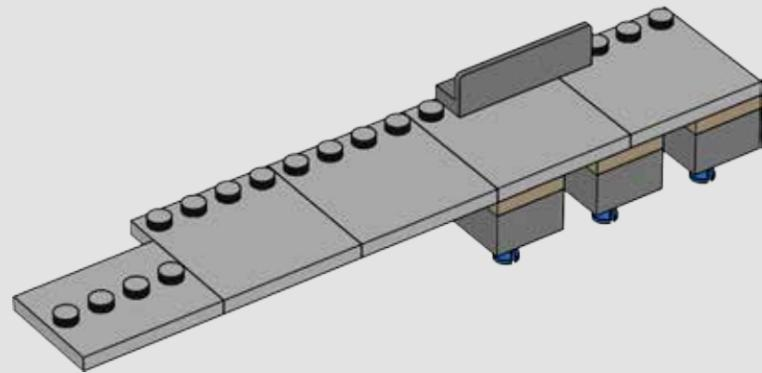

580

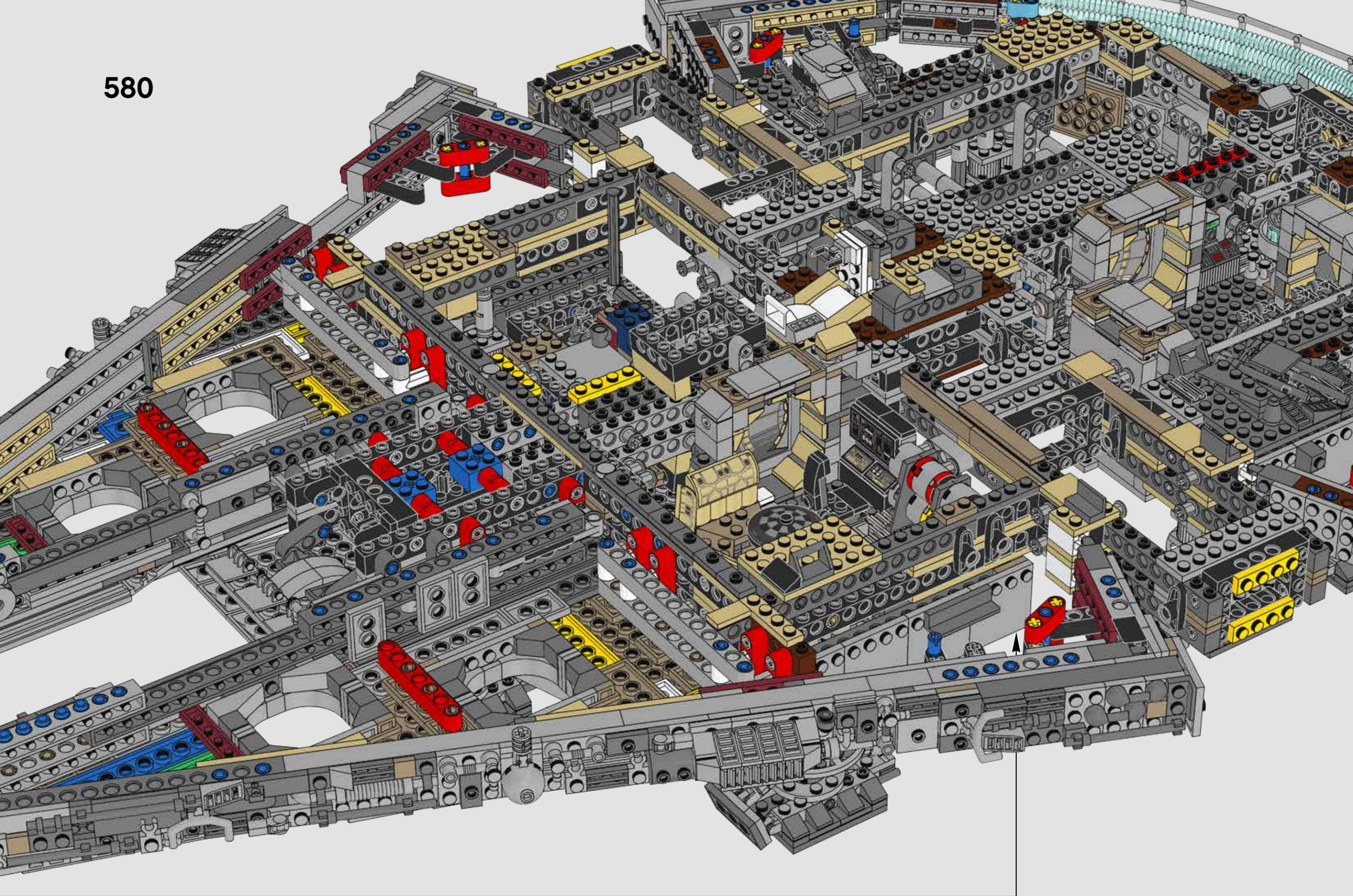

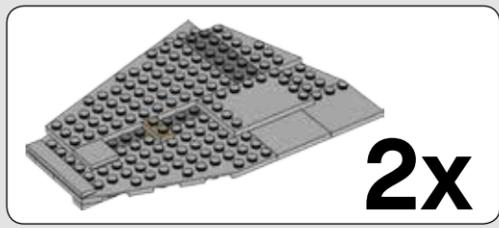

2x

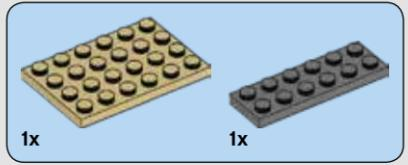

581

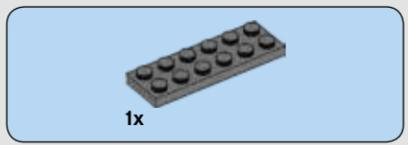
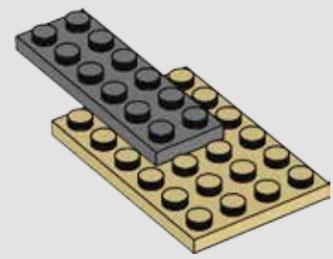

582

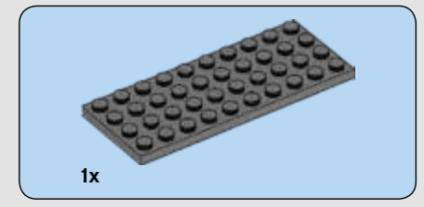
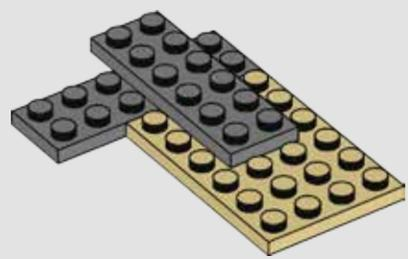

583

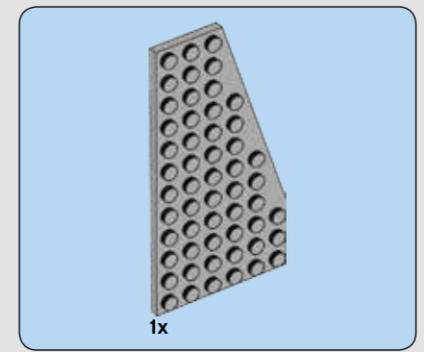
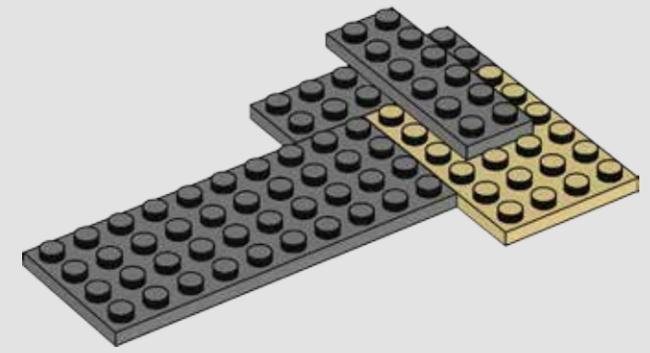

584

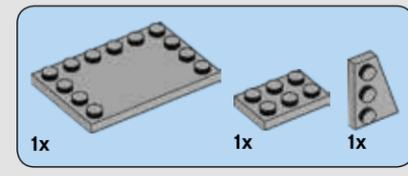
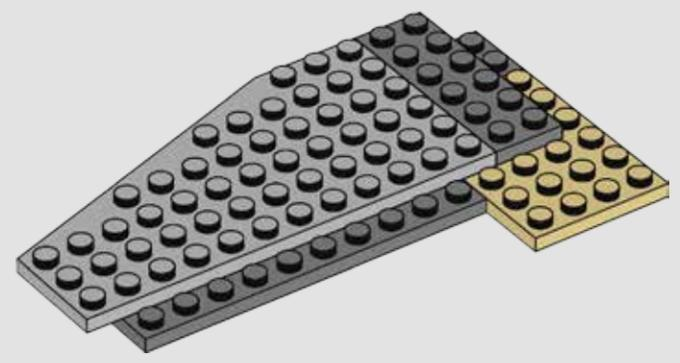

585

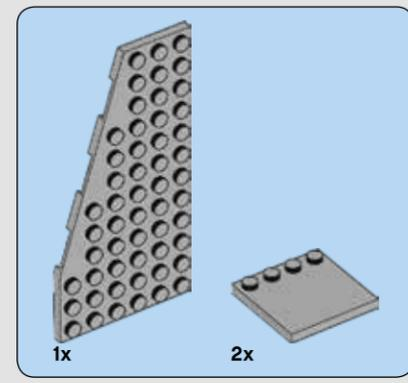
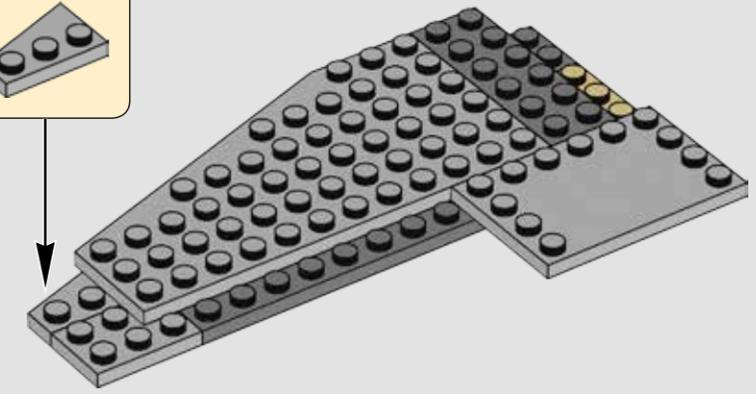
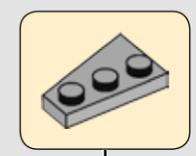

586

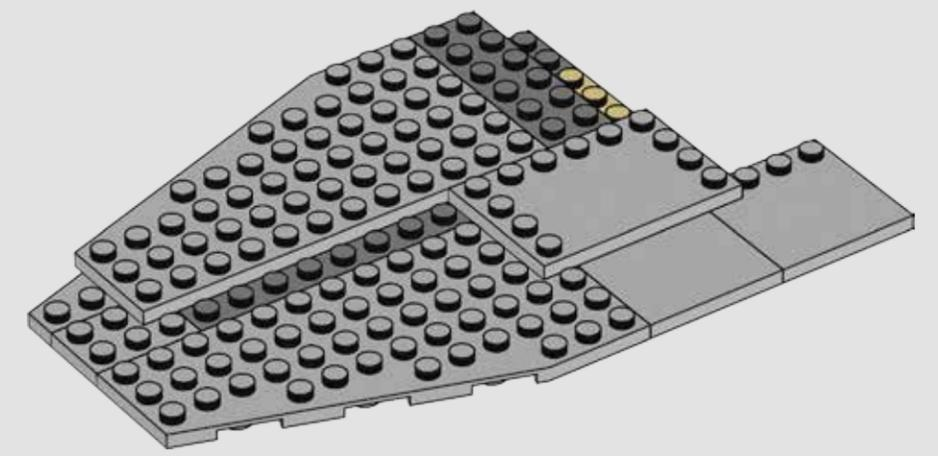

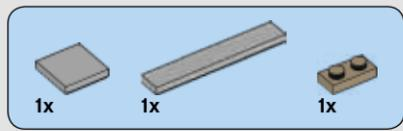

587

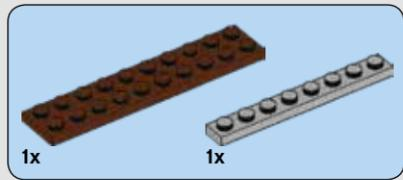
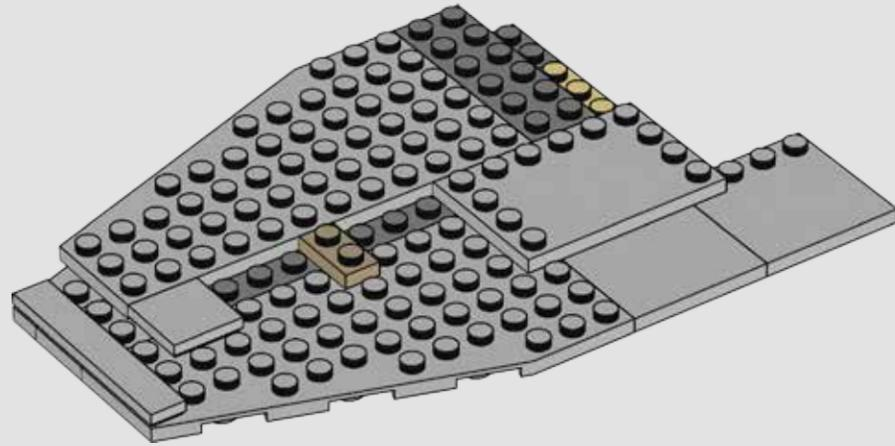

588

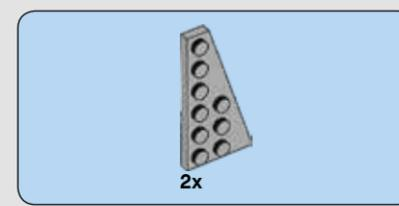
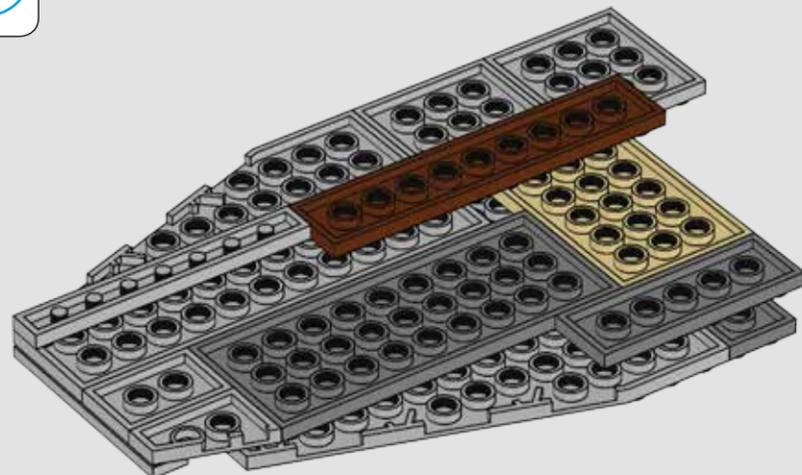

589

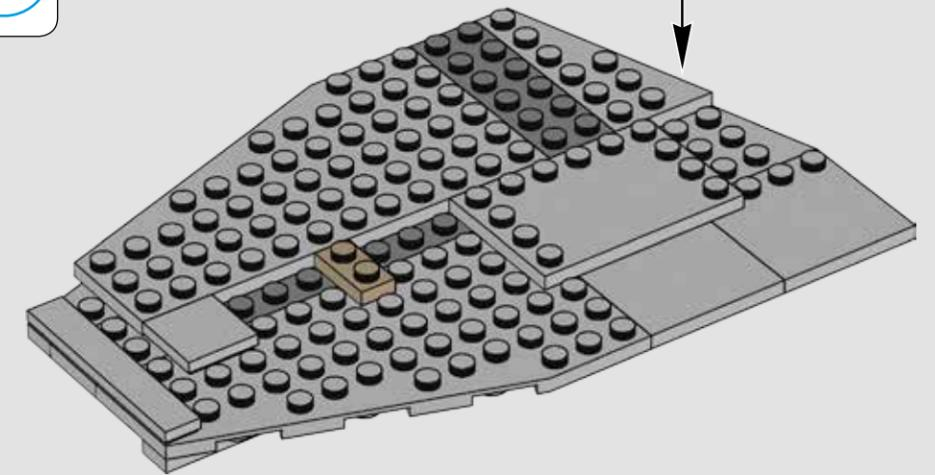
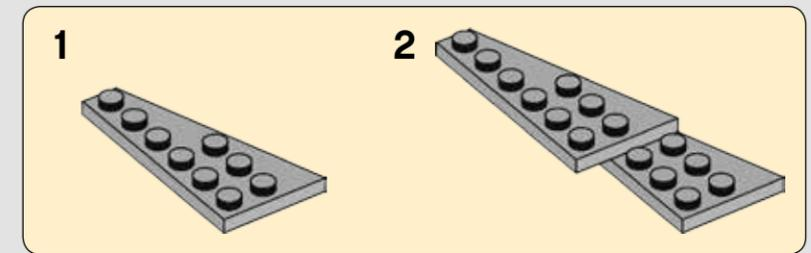

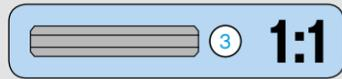
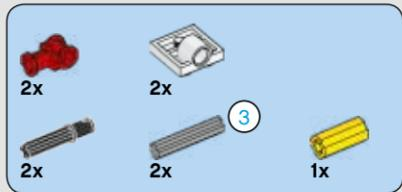

590

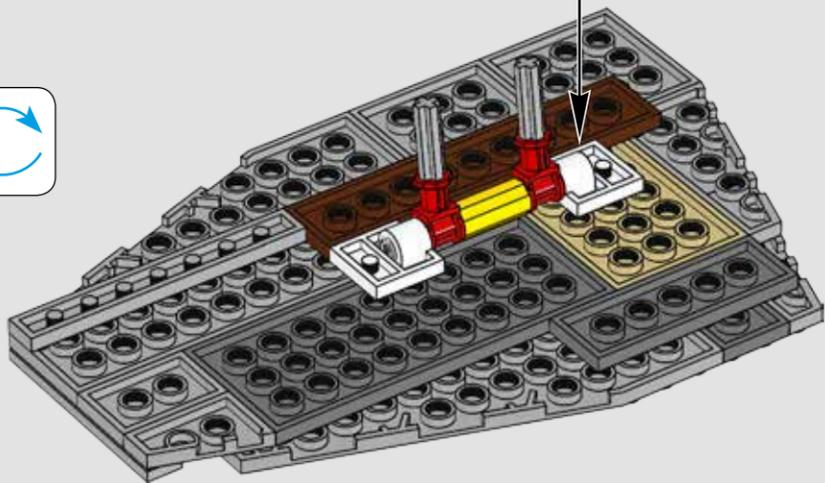
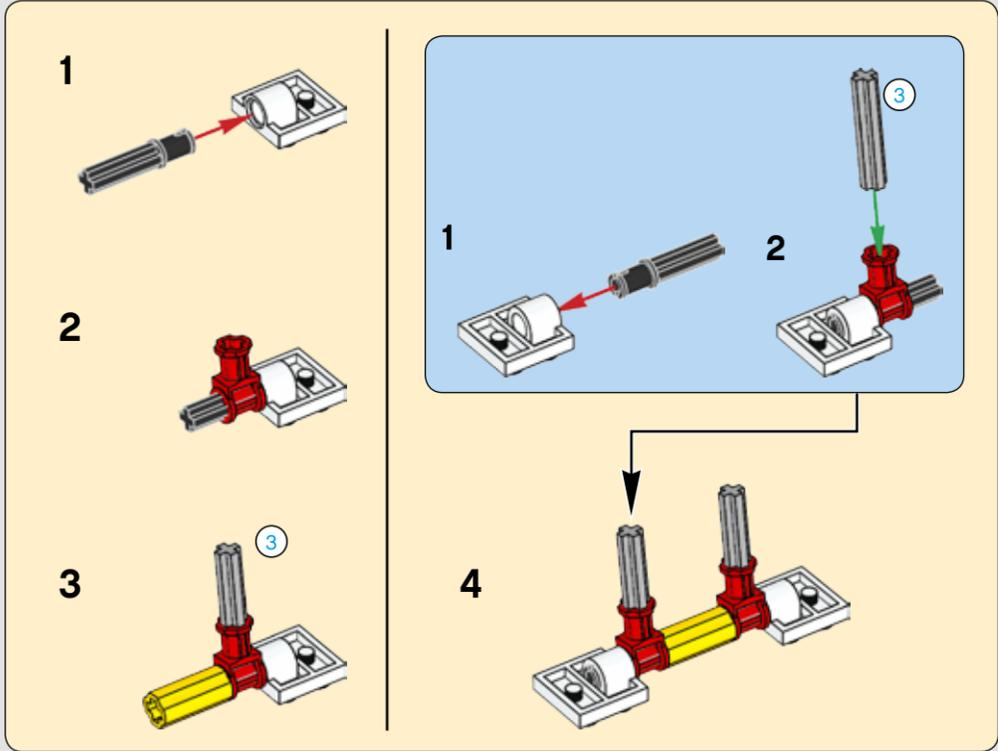

591

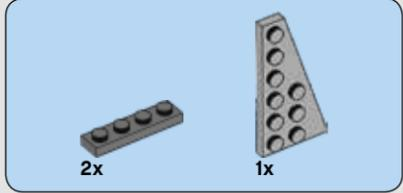
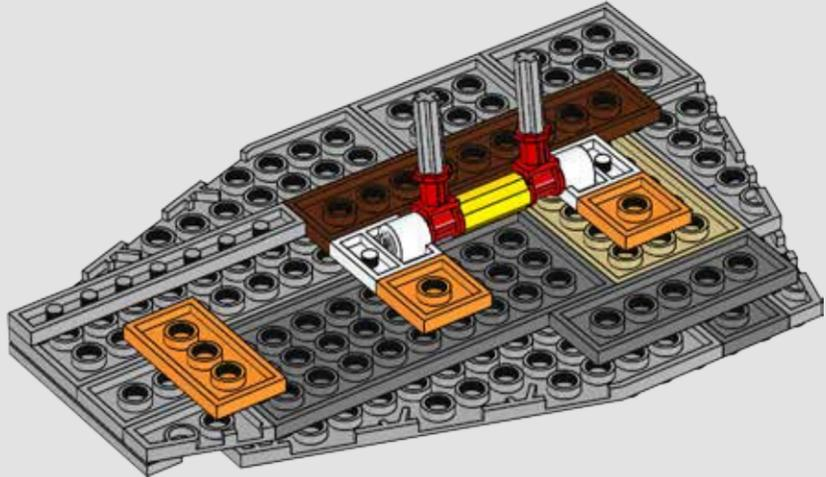

592

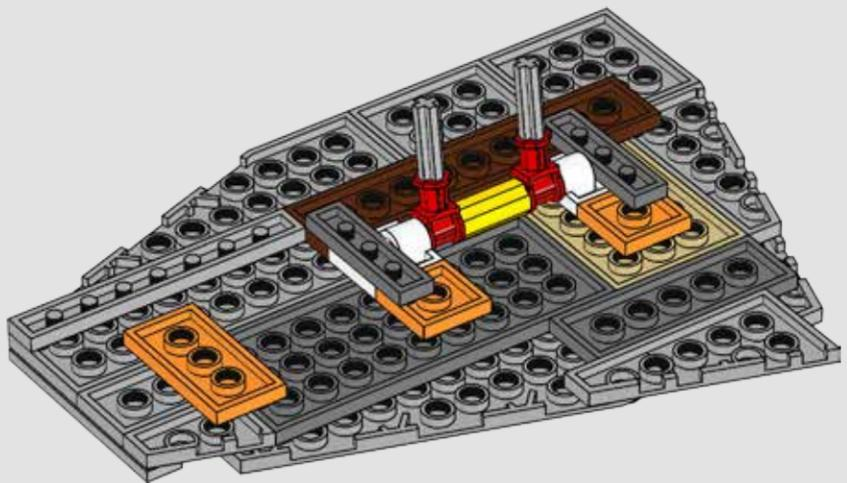

2x

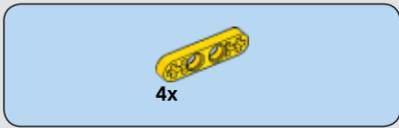

593

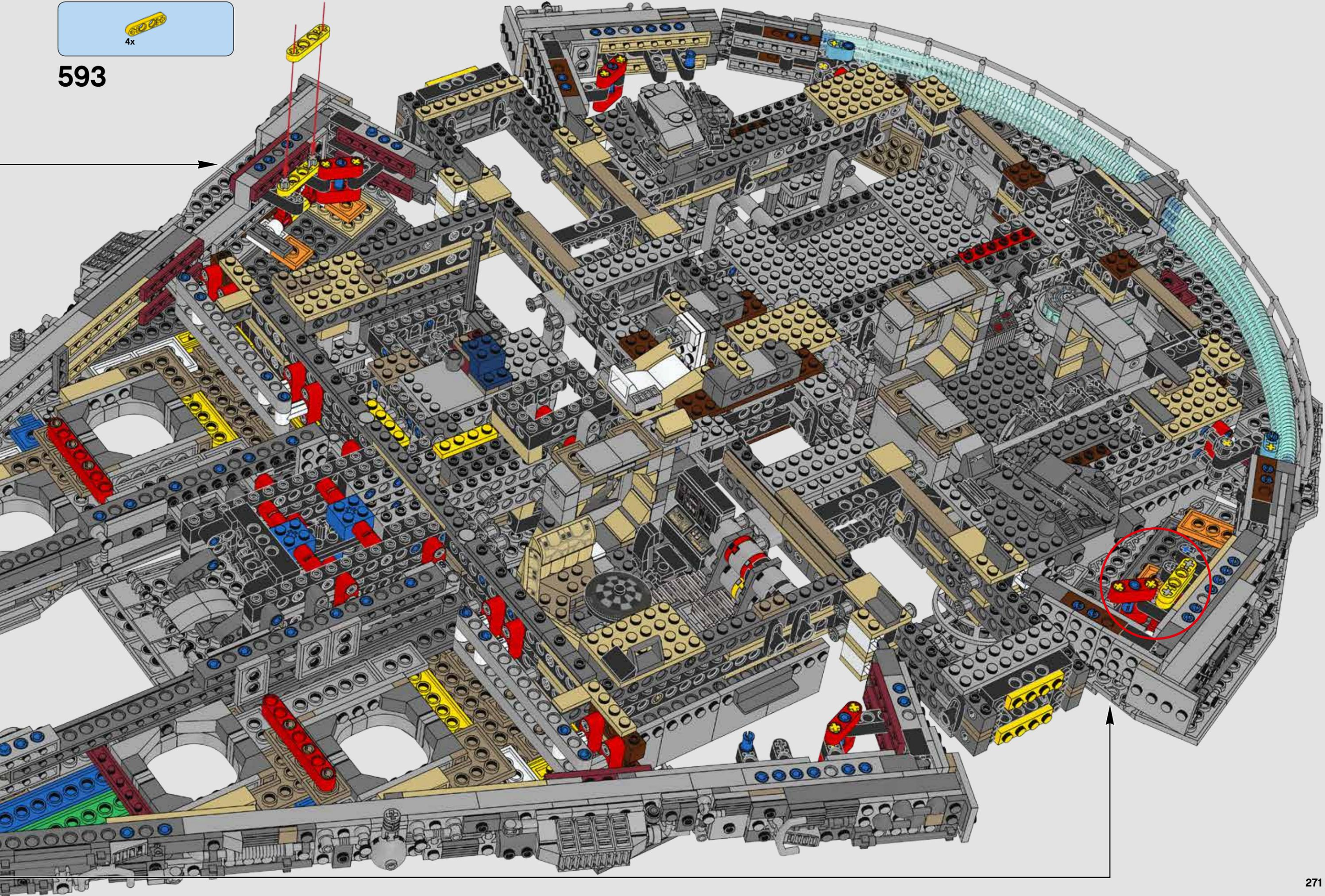

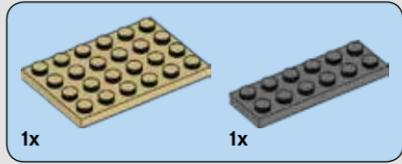
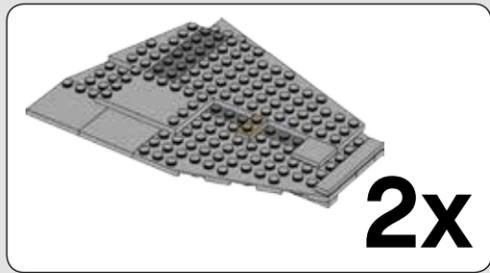

594

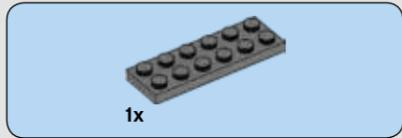
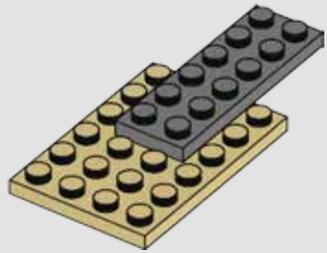

595

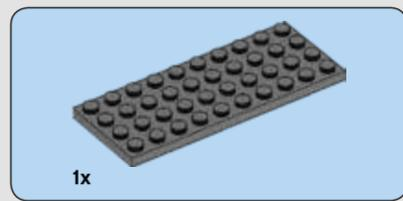
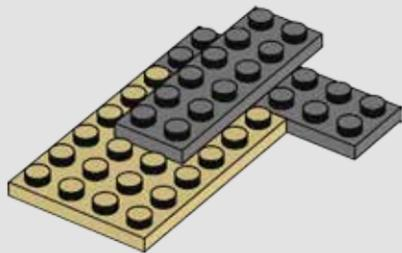

596

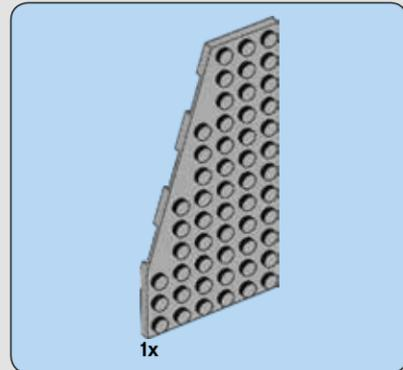
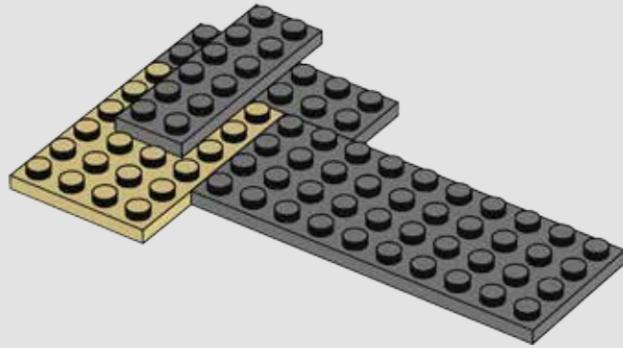

597

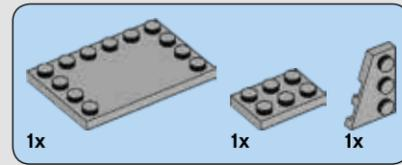
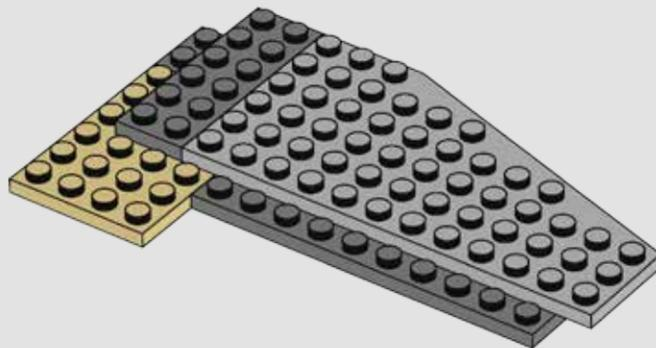

598

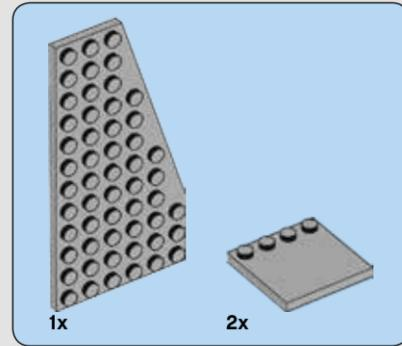
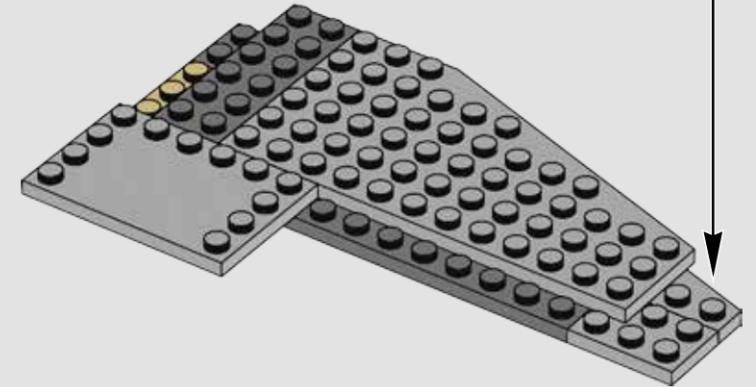

599

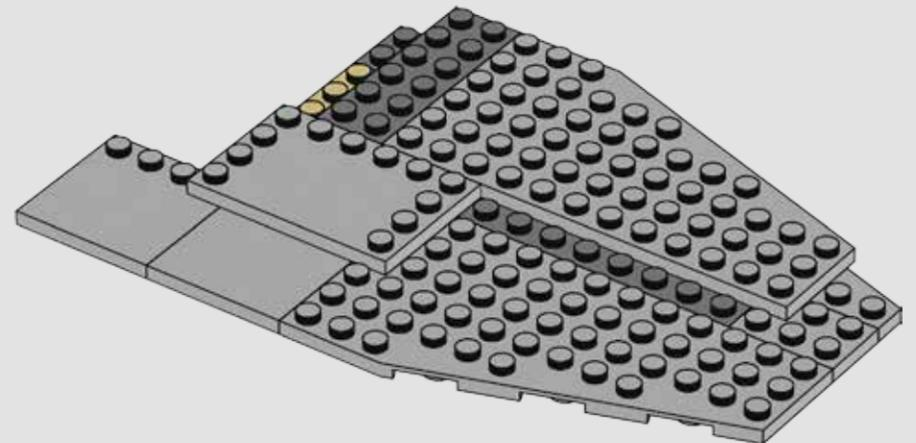

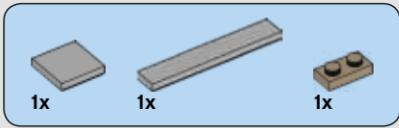

600

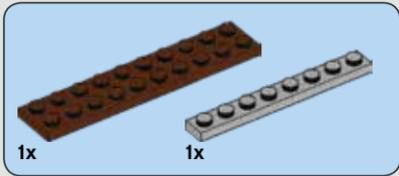
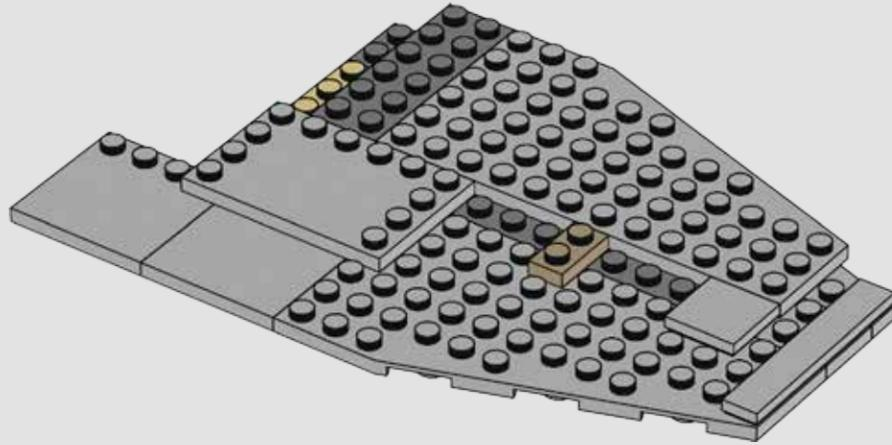

601

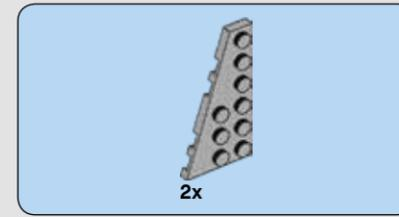
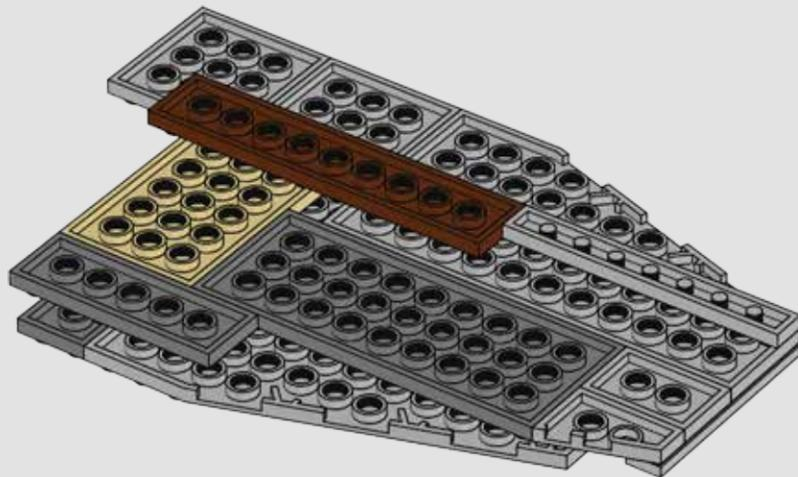

602

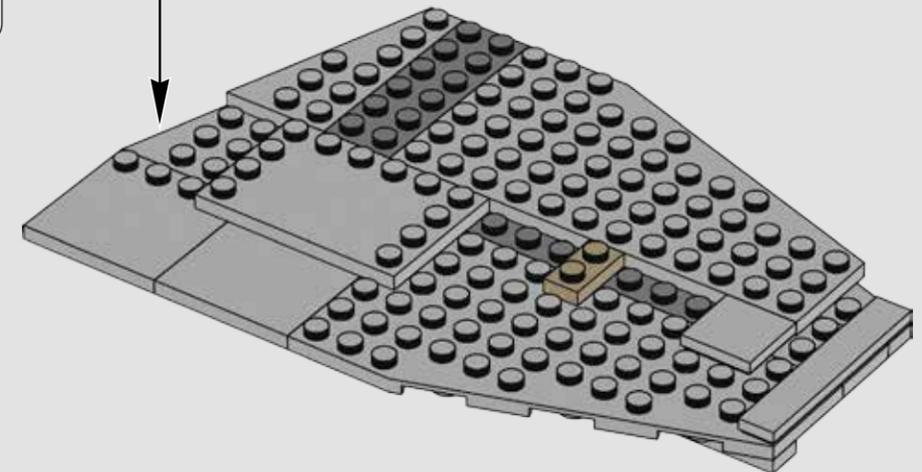
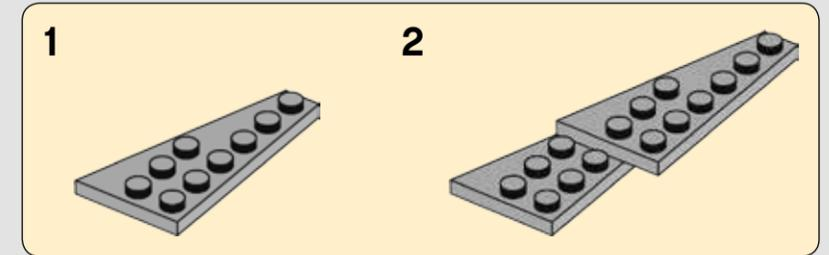

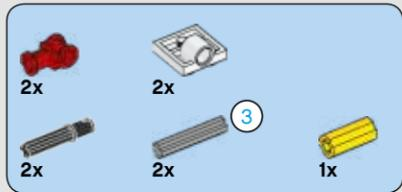

603

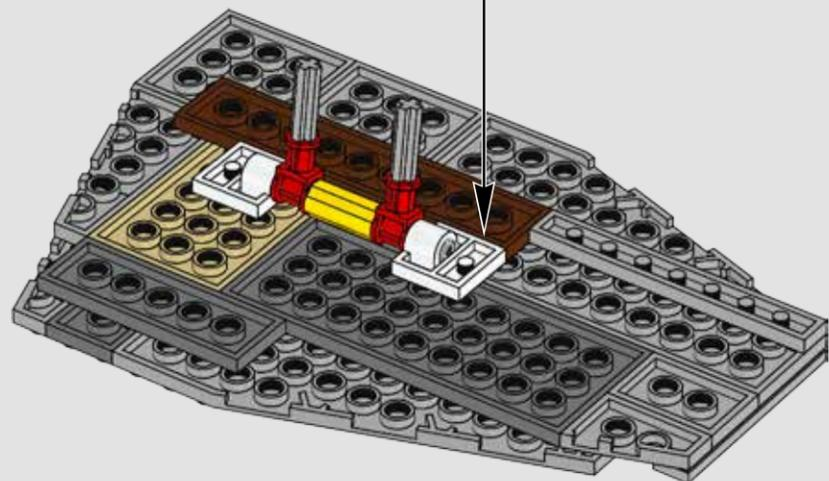
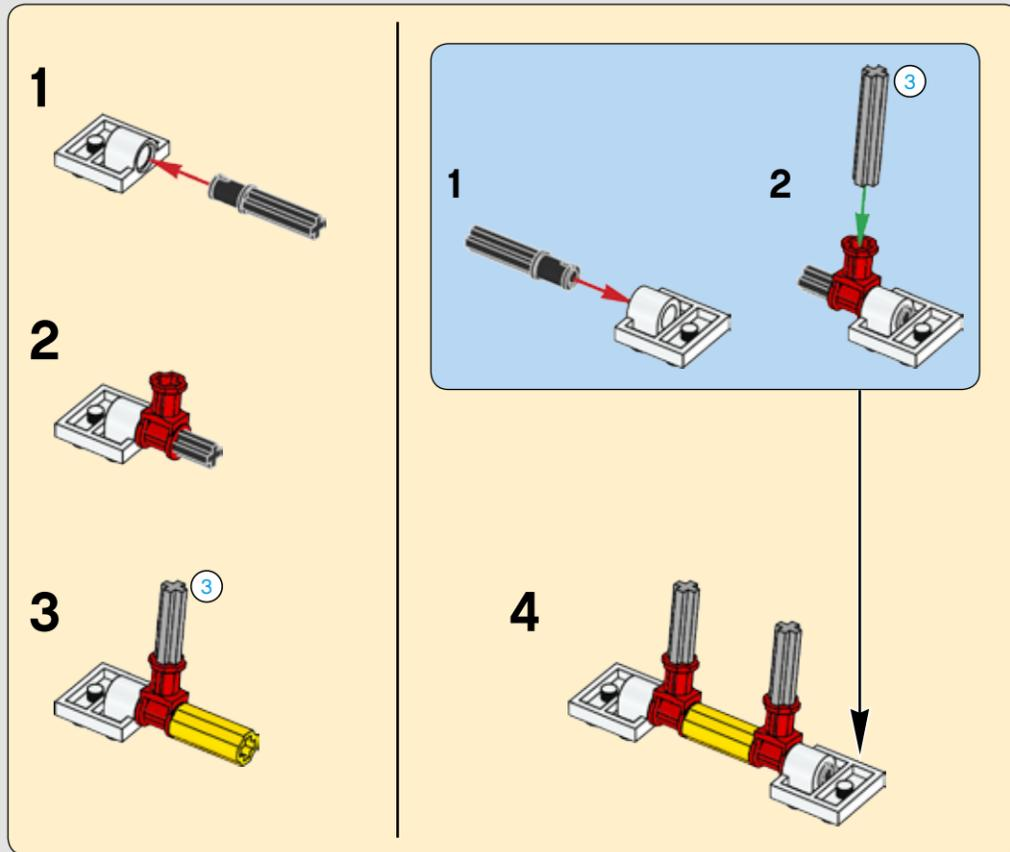

604

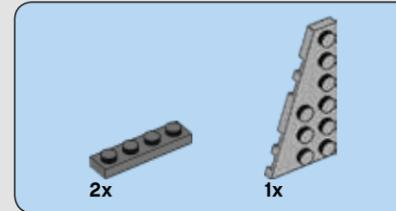
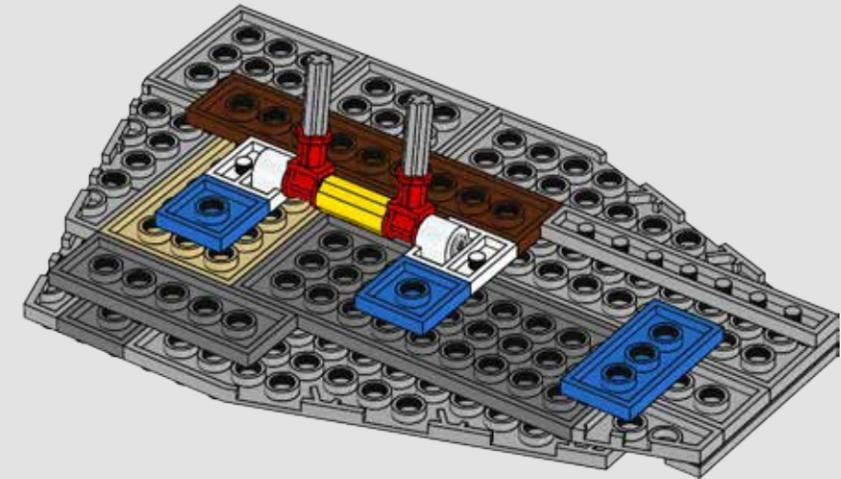

605

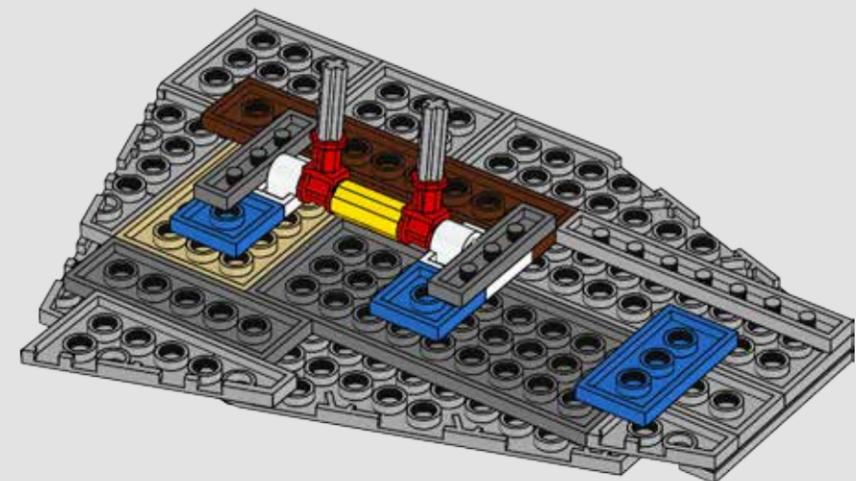

2x

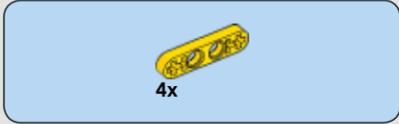

606

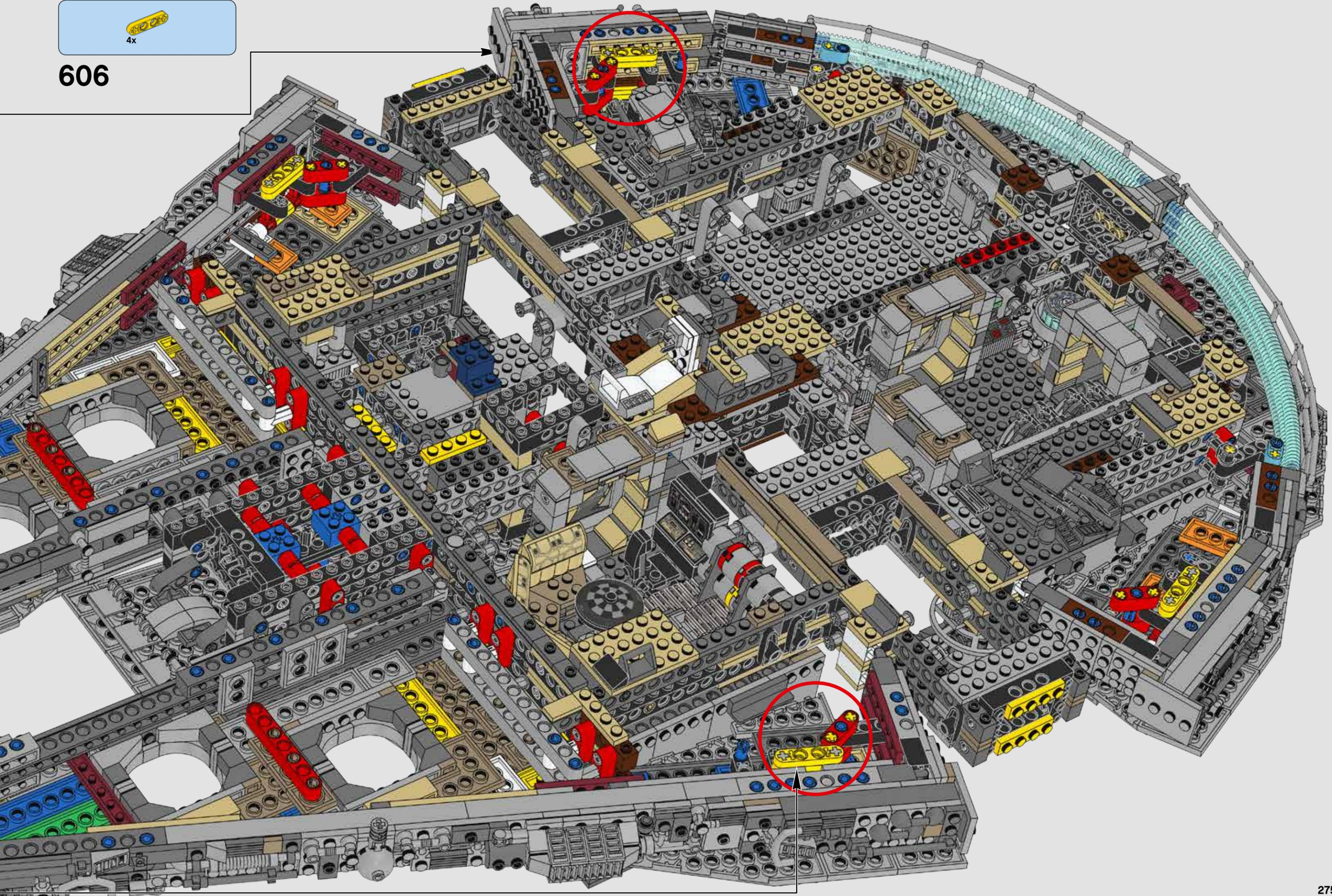

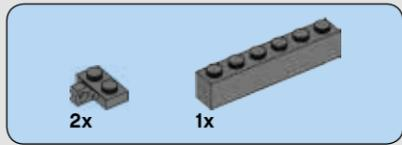

607

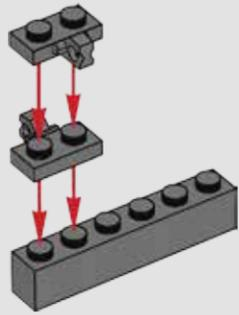

608

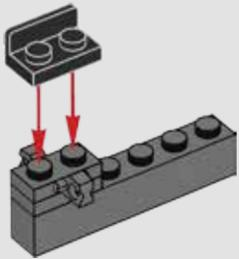

609

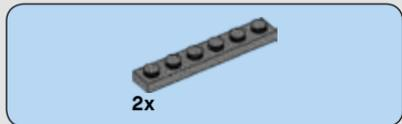
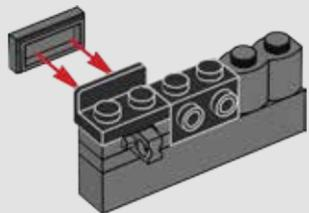

610

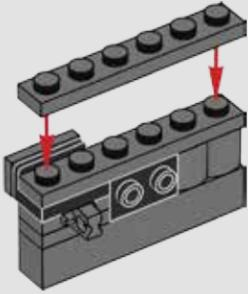

611

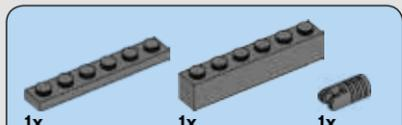
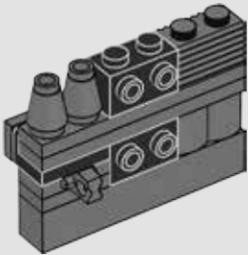

612

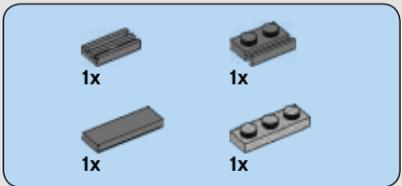
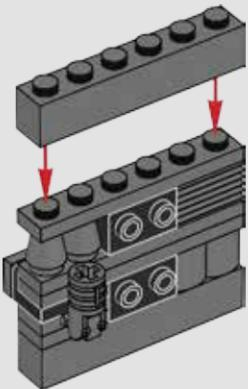

613

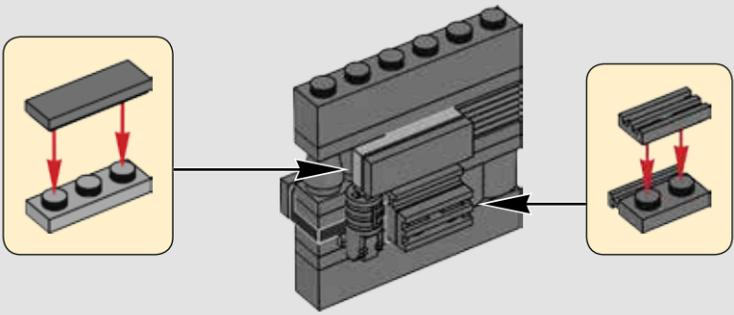

614

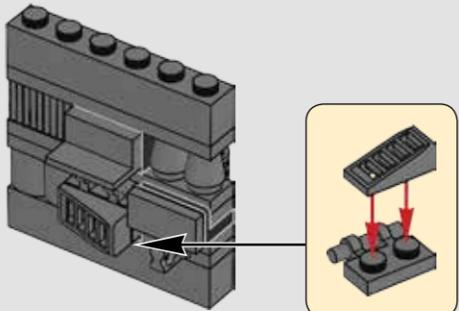

615

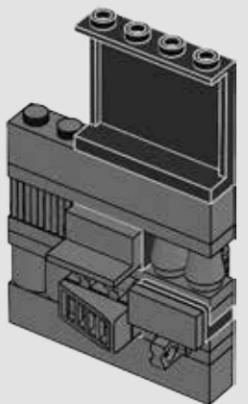

616

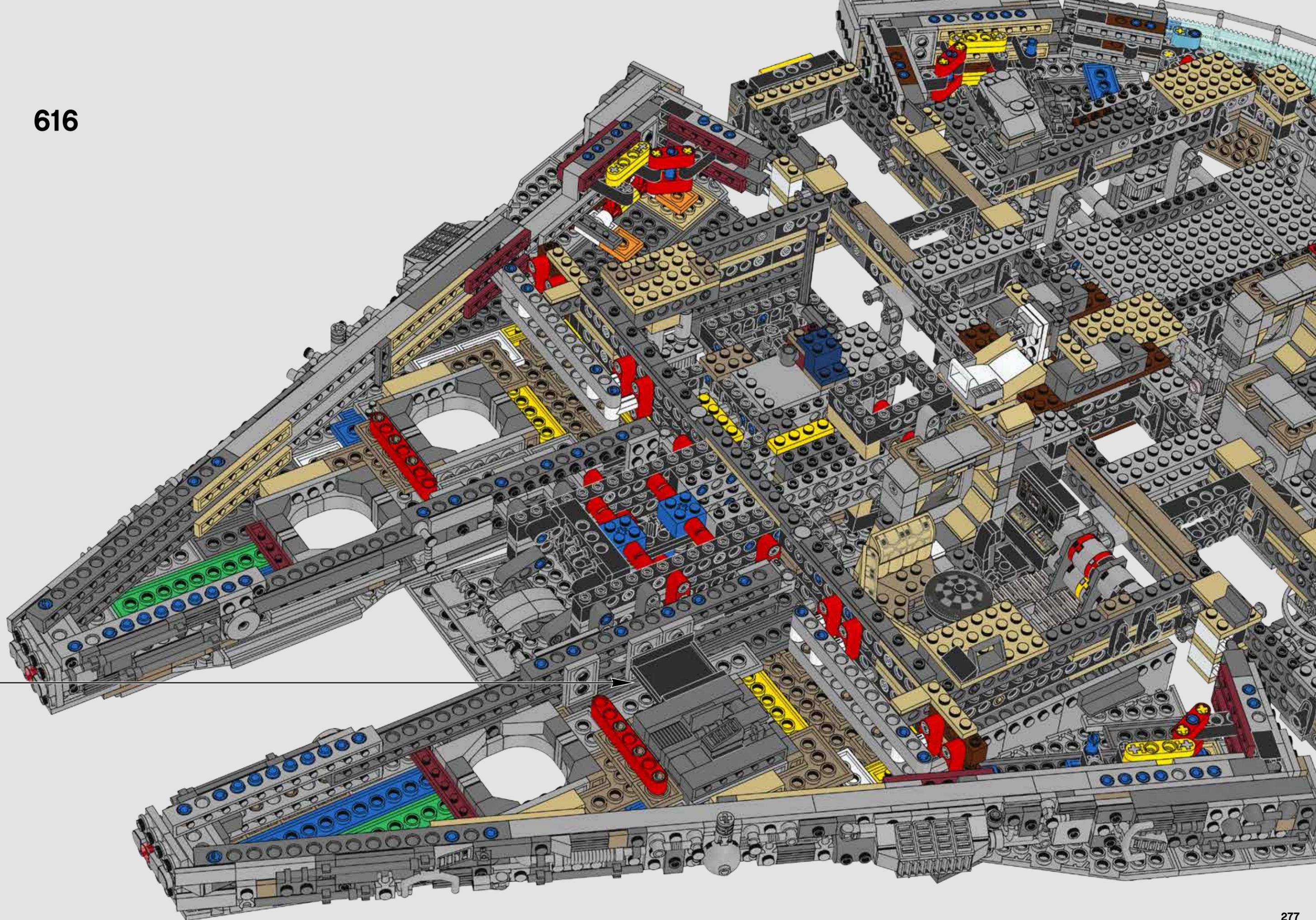

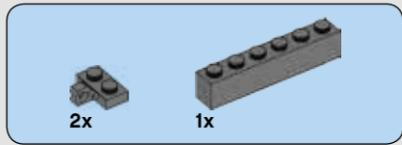

617

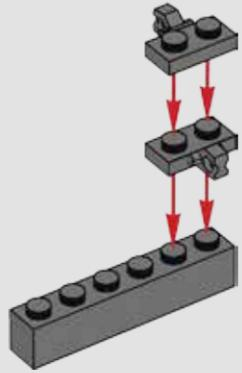

618

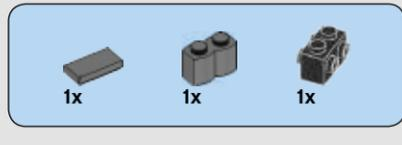
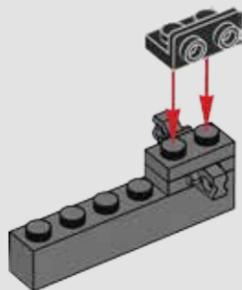

619

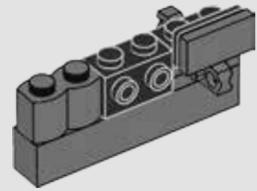

620

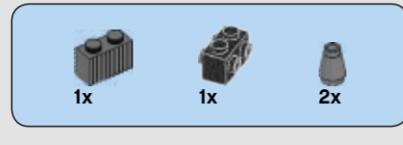
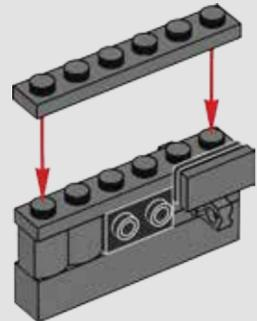

621

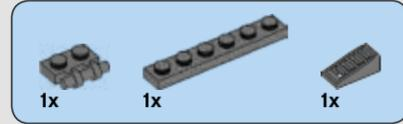
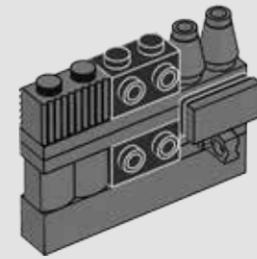

622

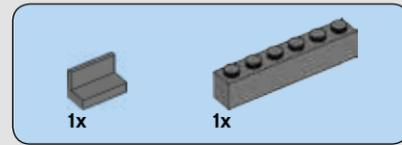
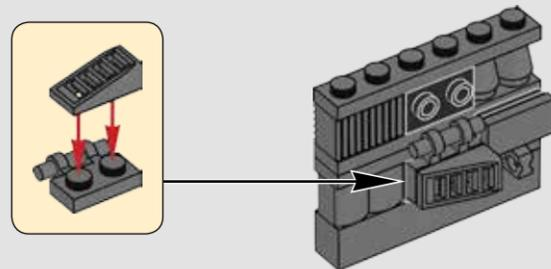

623

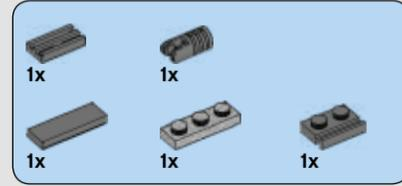
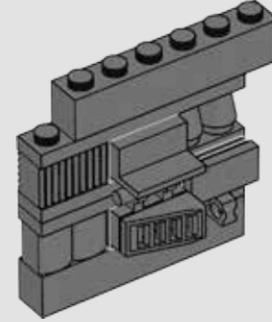

624

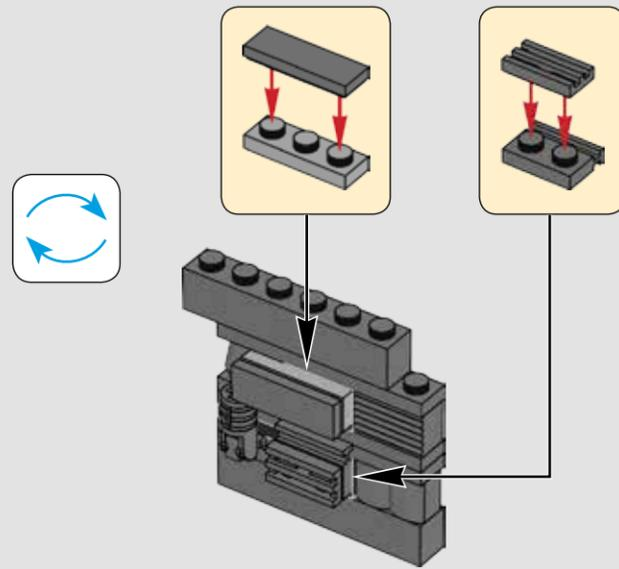

625

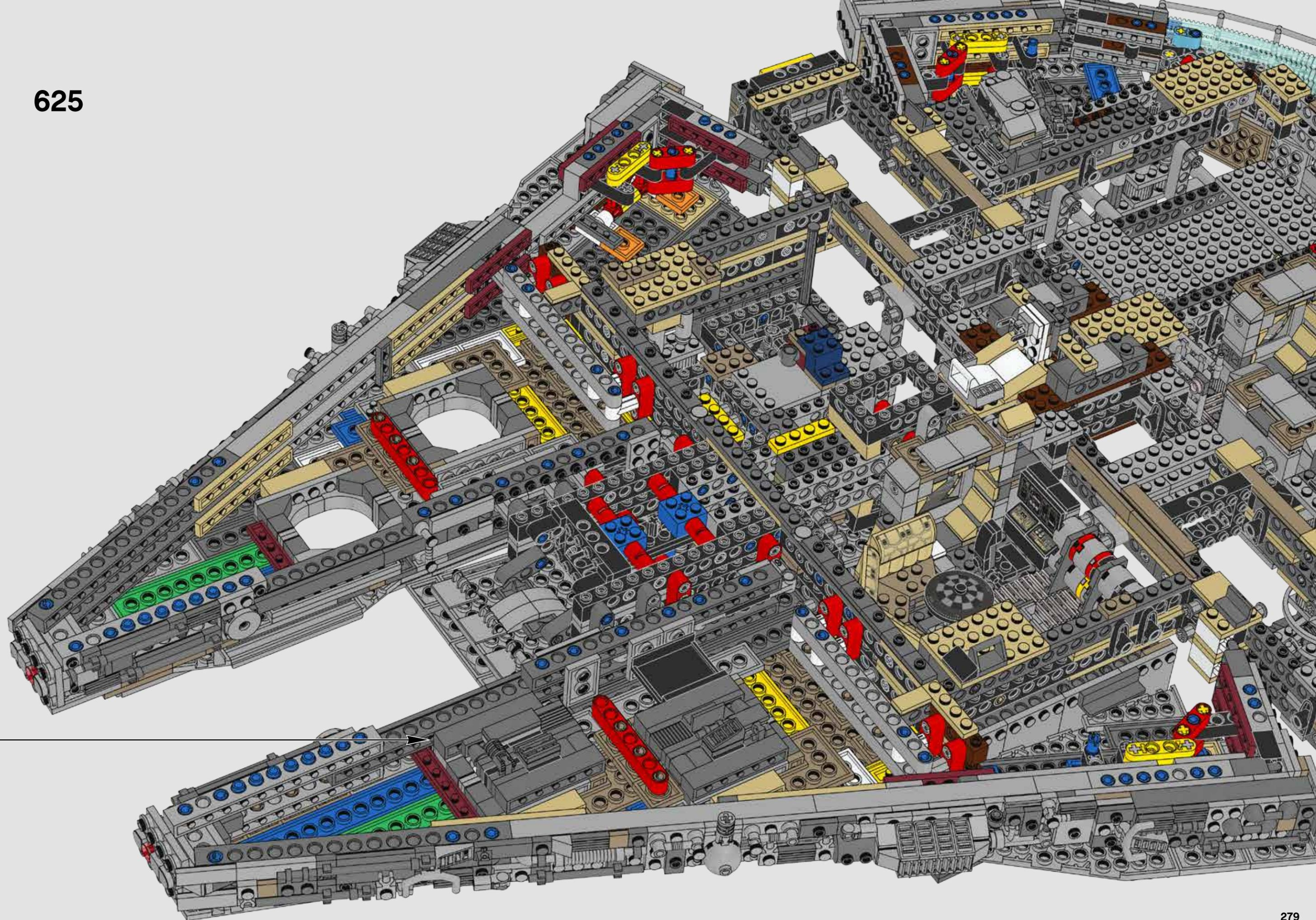

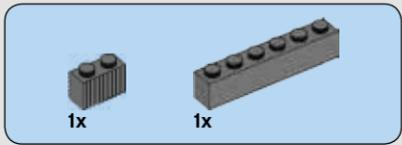

626

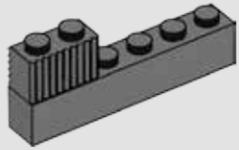

627

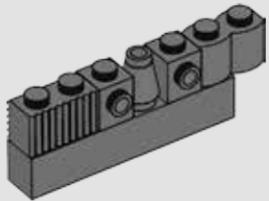

628

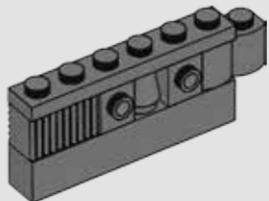

629

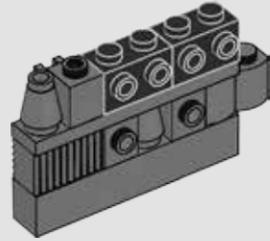

630

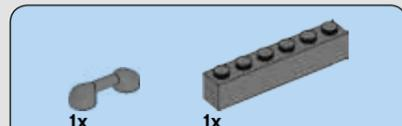
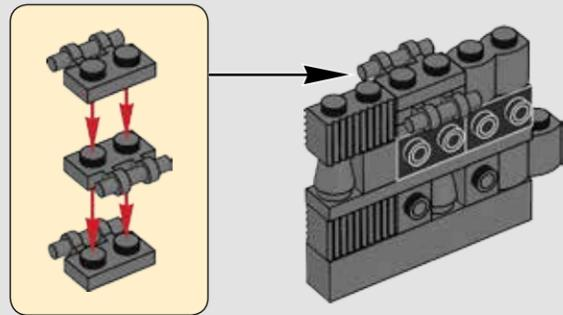

631

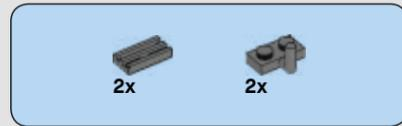
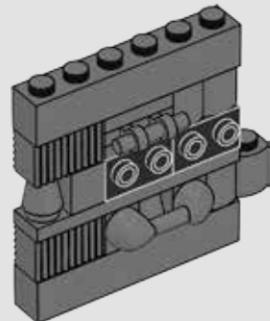

632

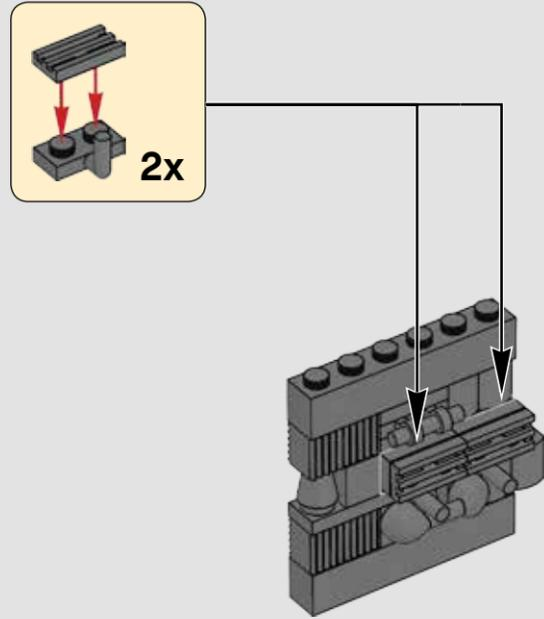

633

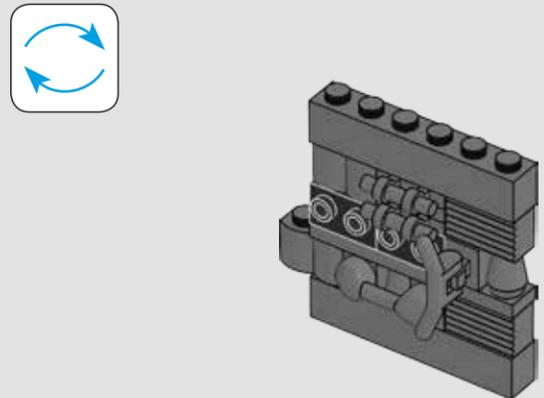

634

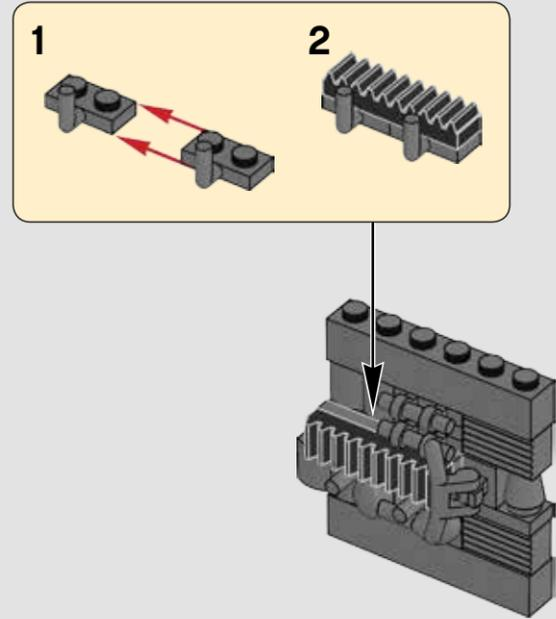

635

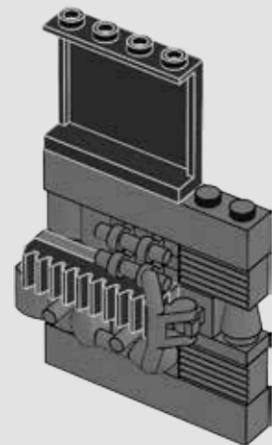

636

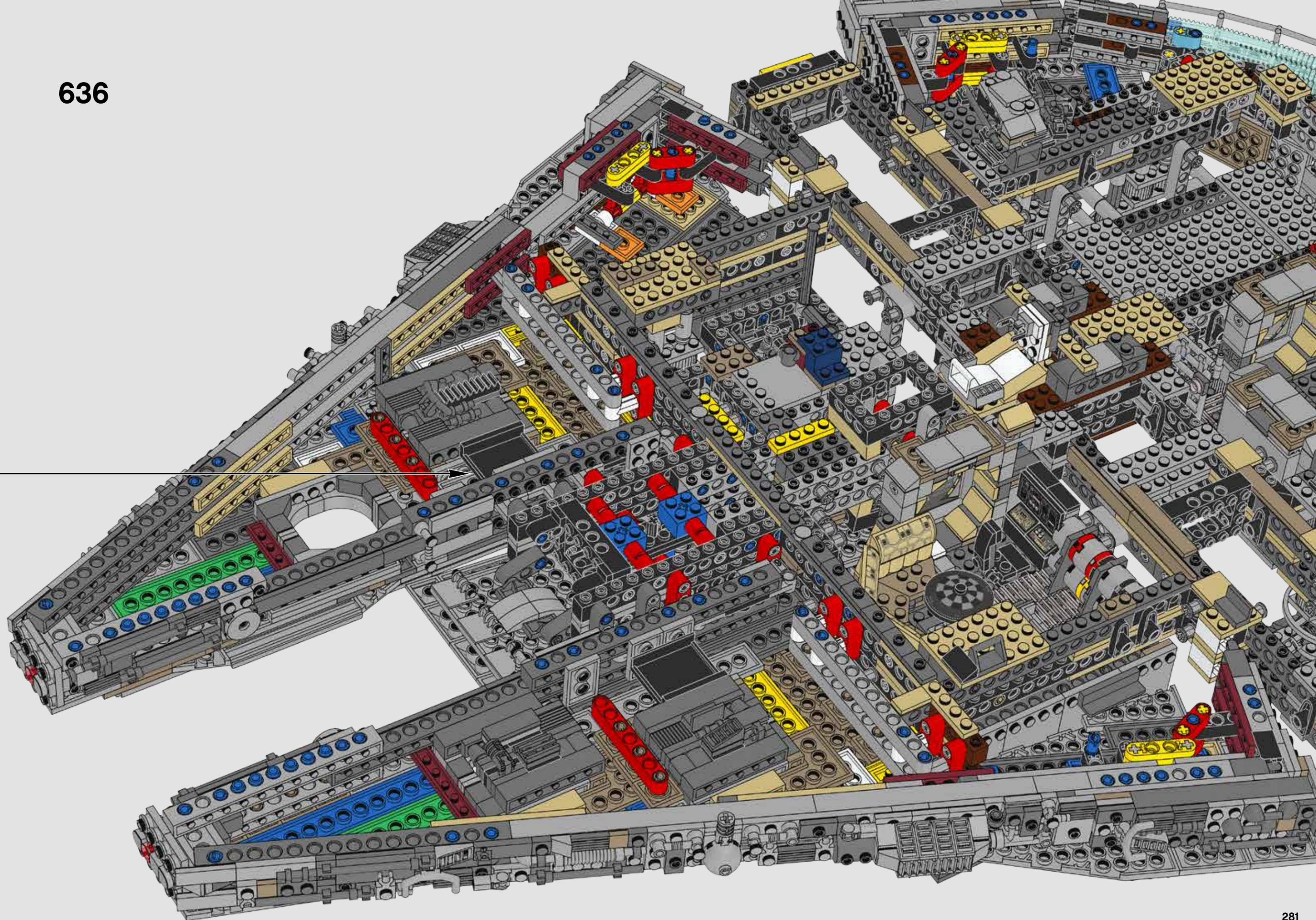

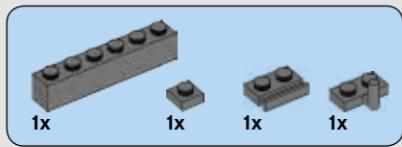

637

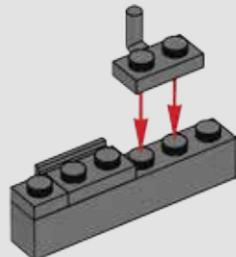

638

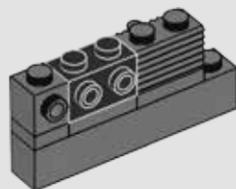

639

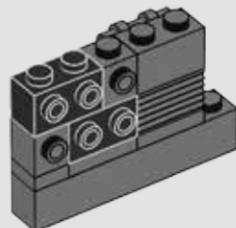

640

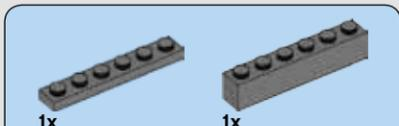
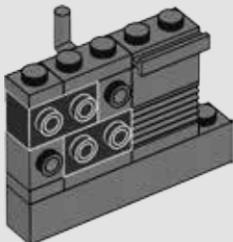

641

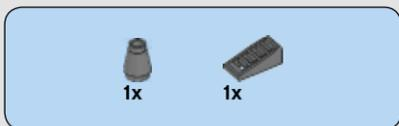
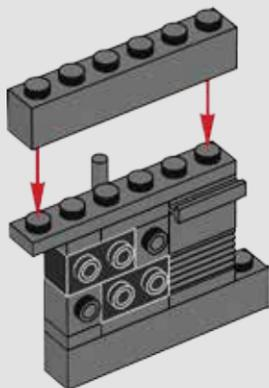

642

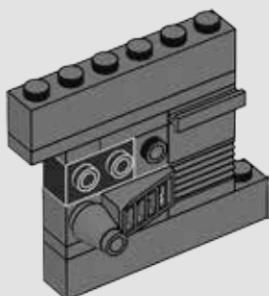

643

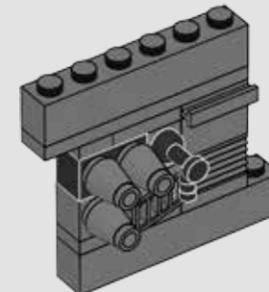

644

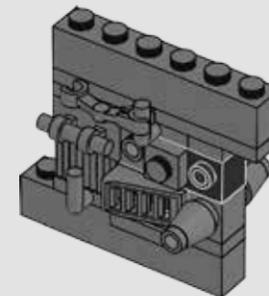

645

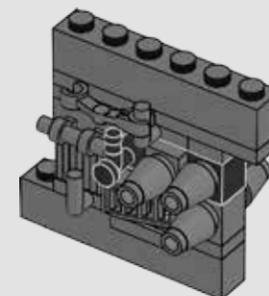

646

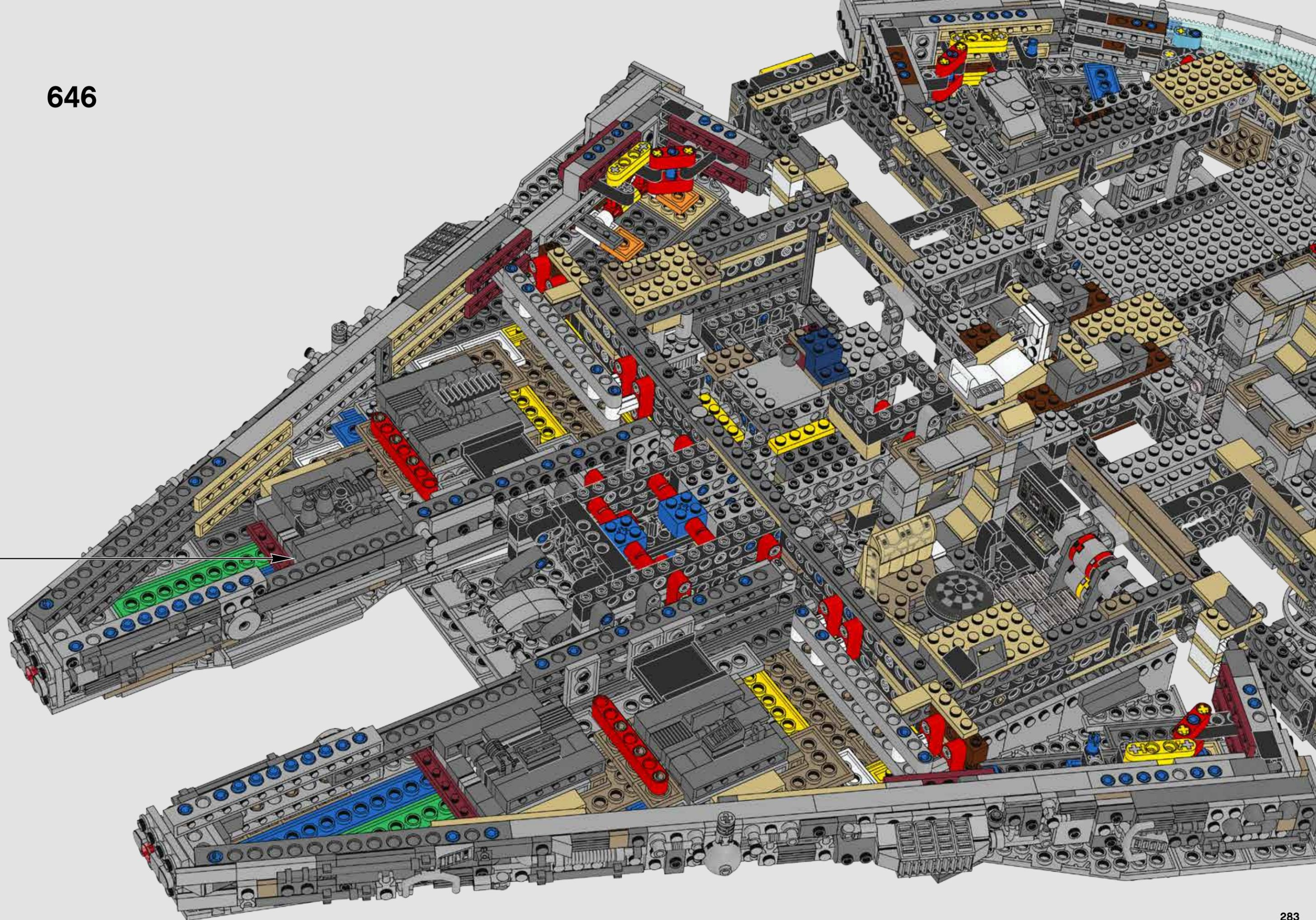

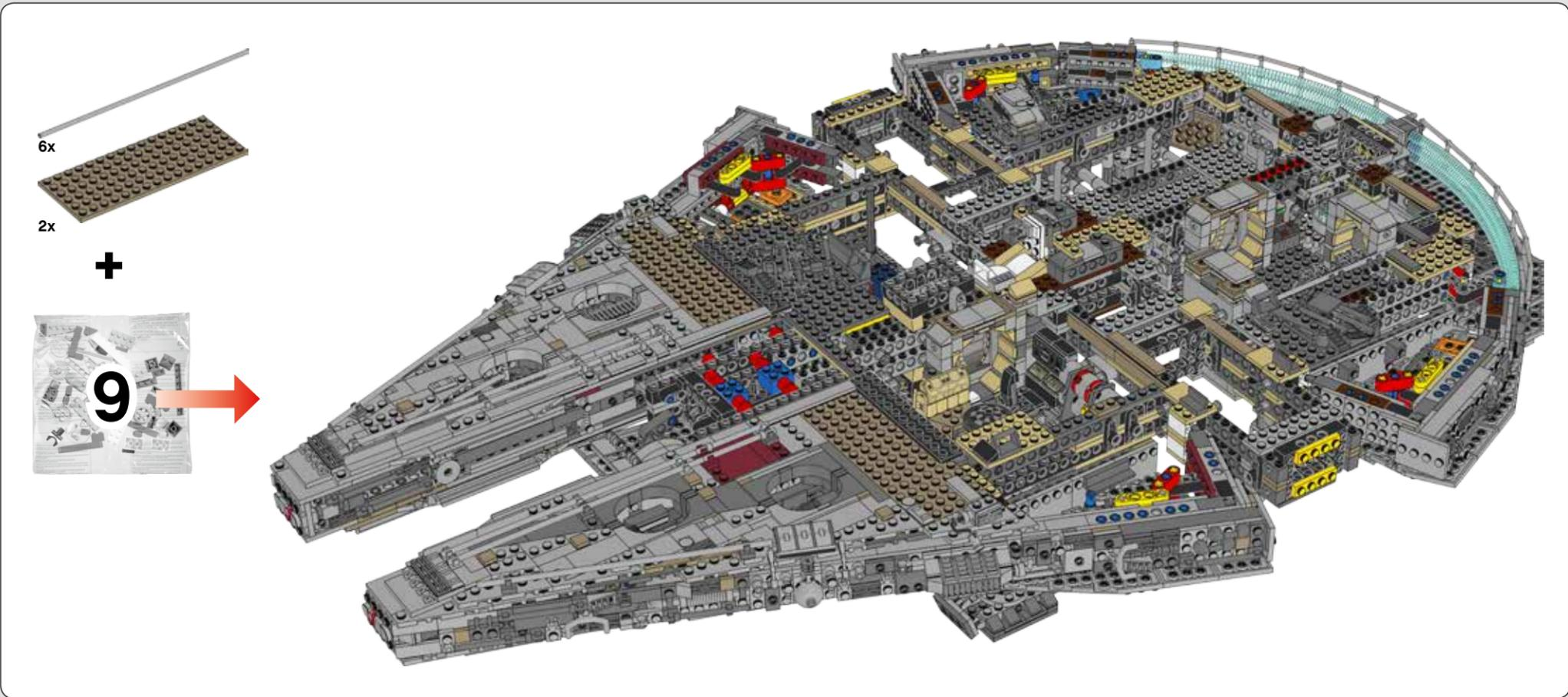

651

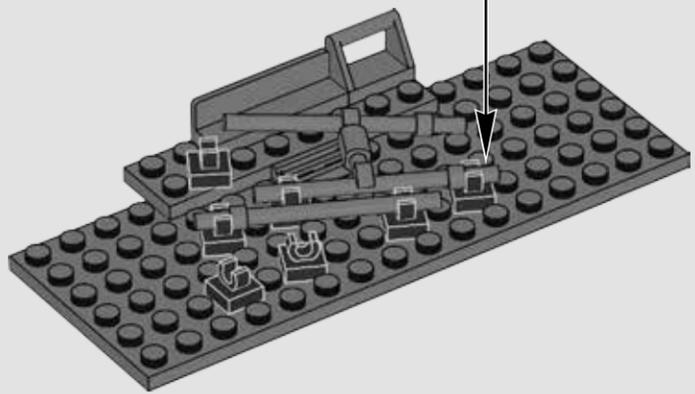
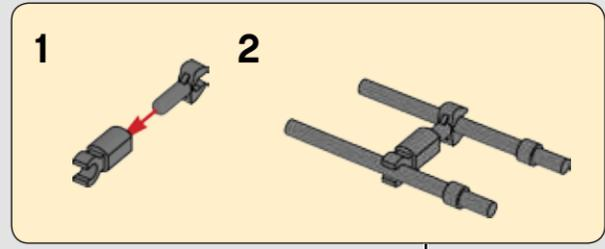

647

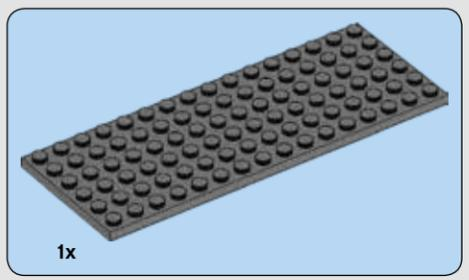
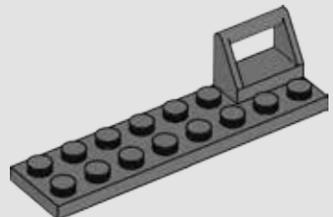

649

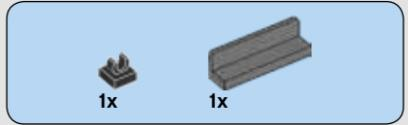
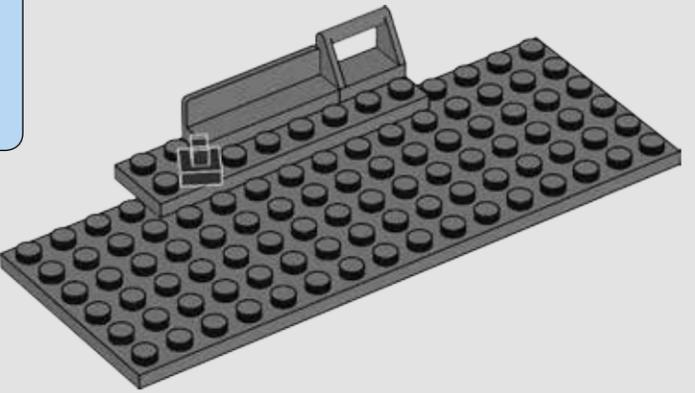

648

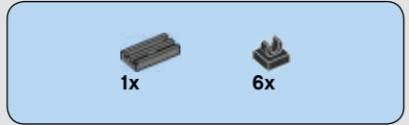
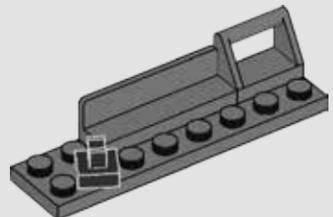

650

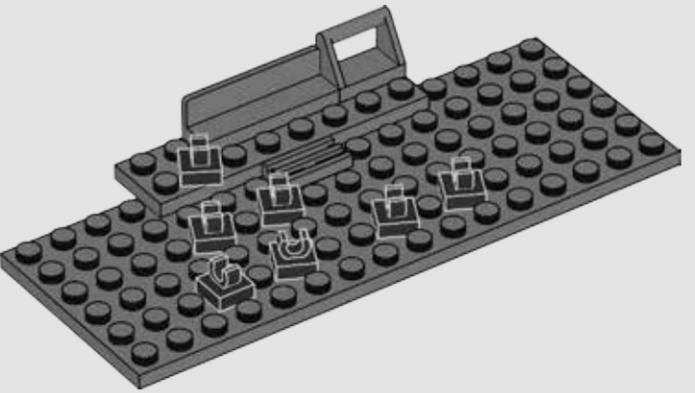

652

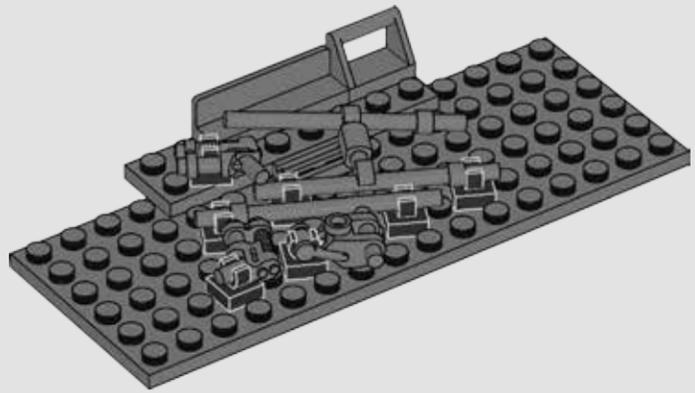

653

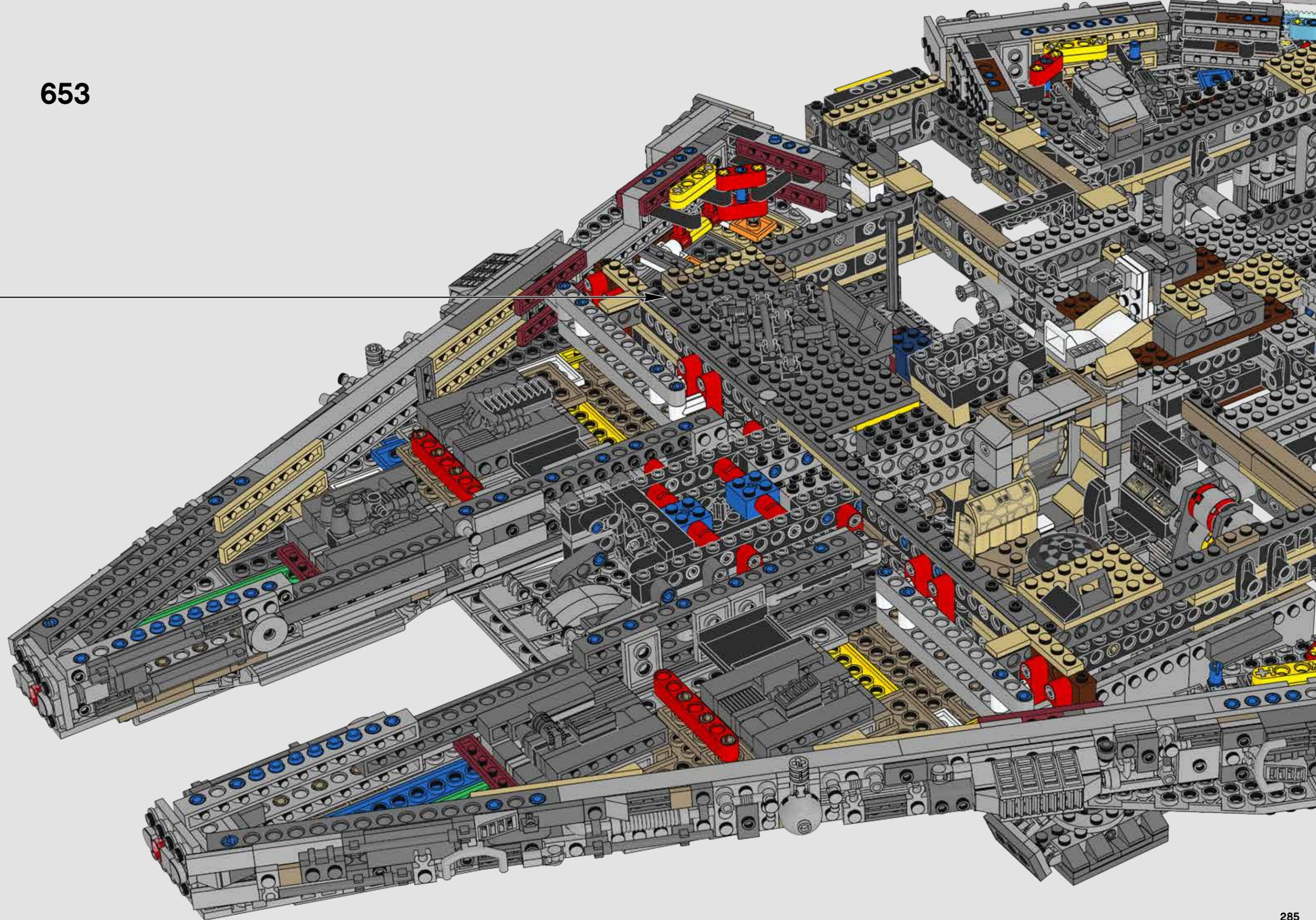

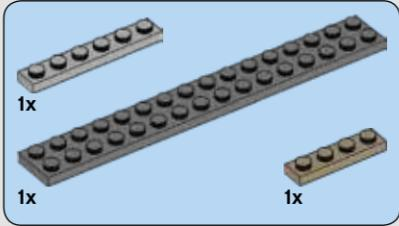
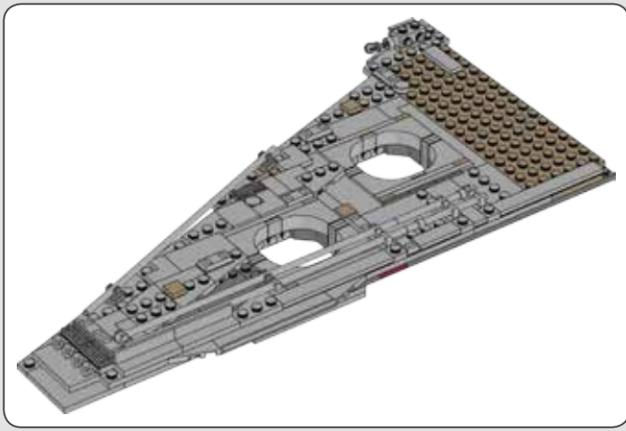

654

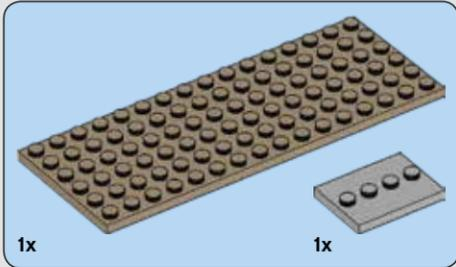
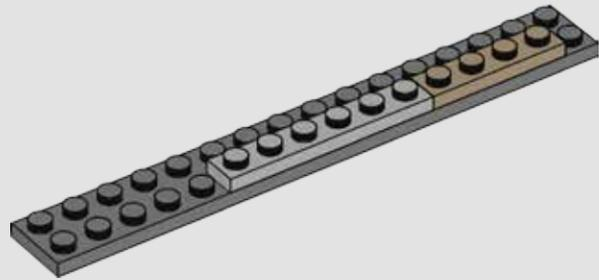

655

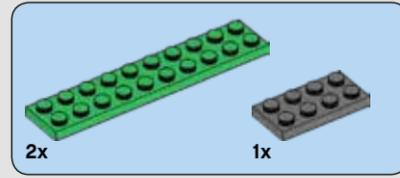
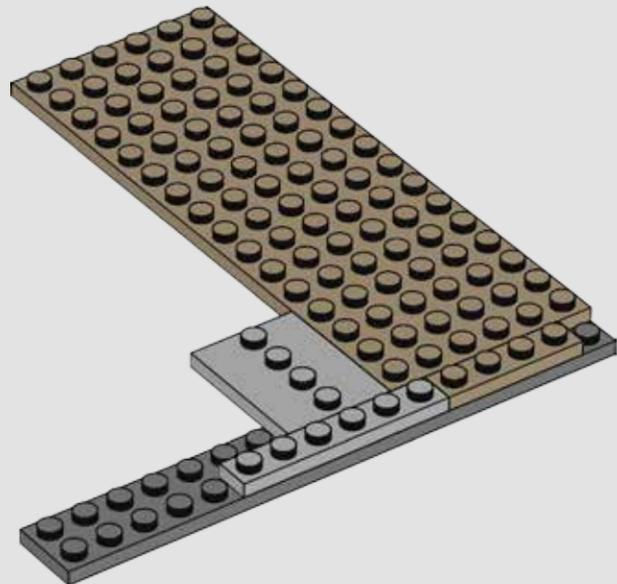

656

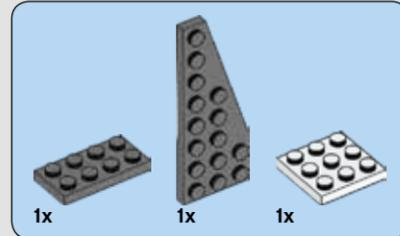

657

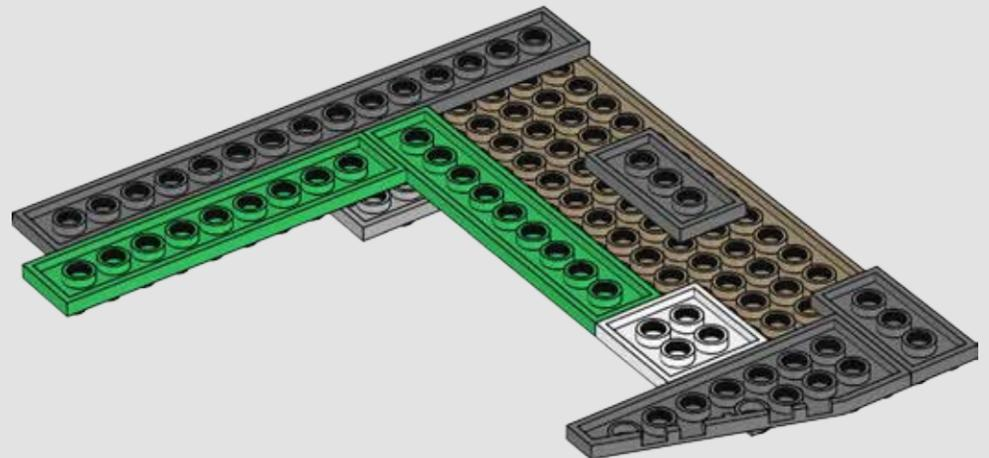

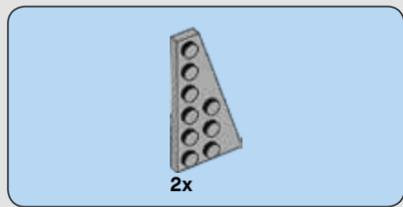

658

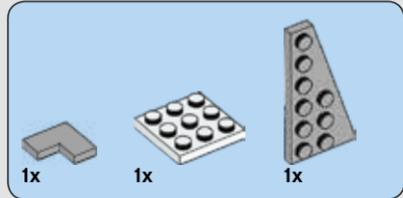
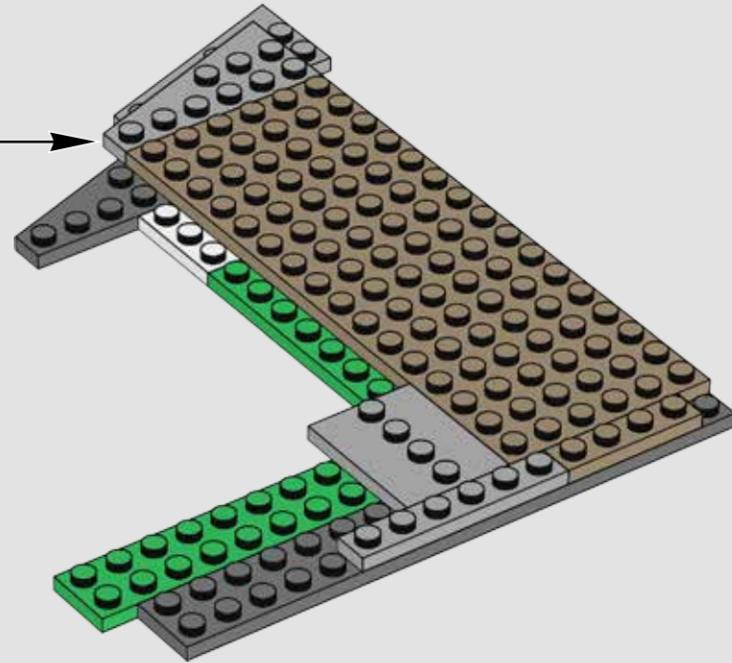
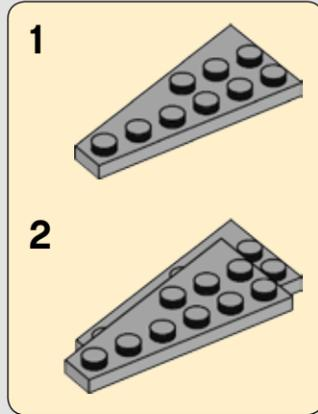

659

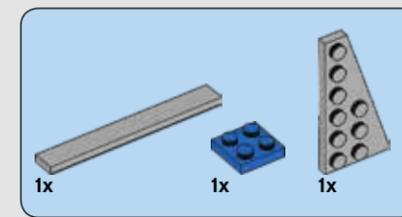
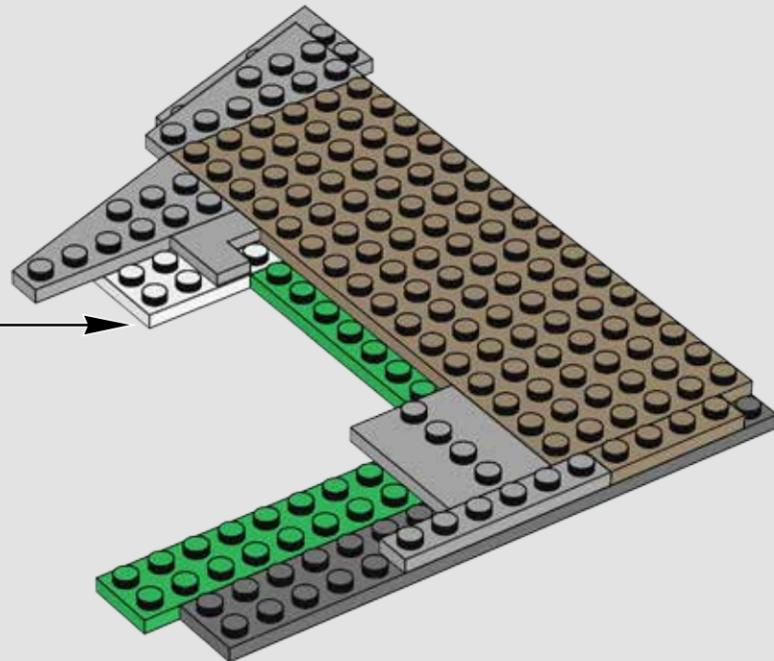
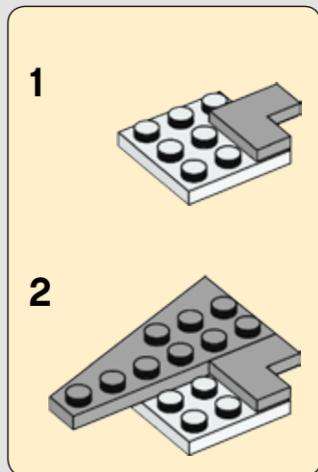

660

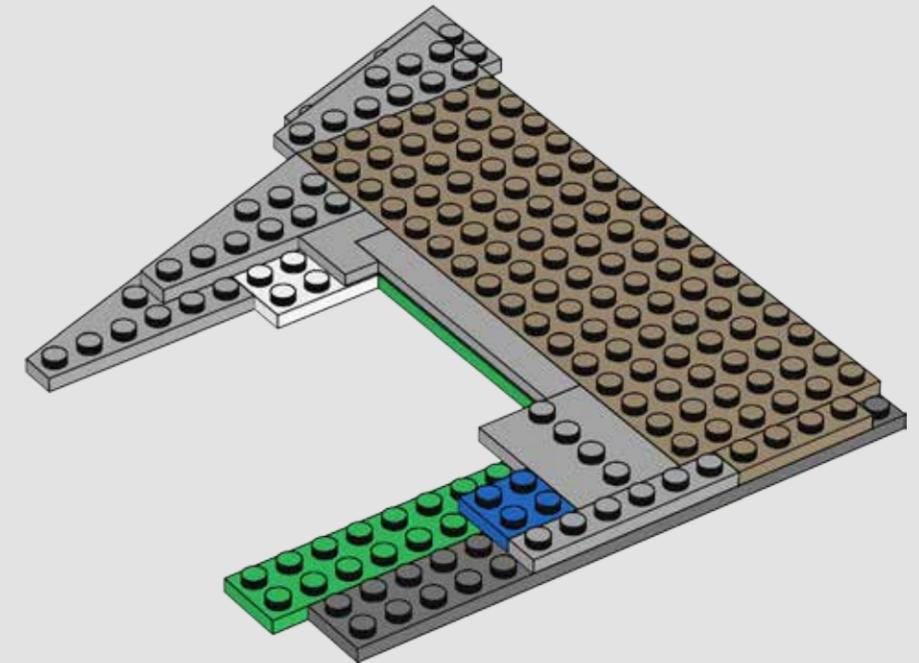

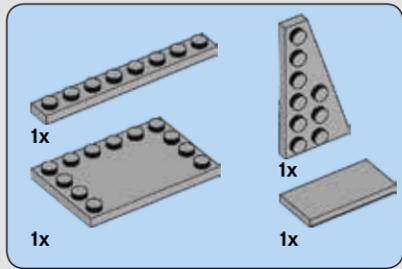

661

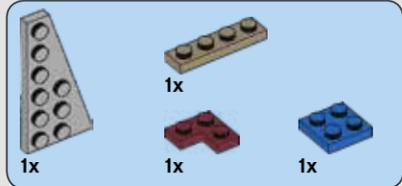
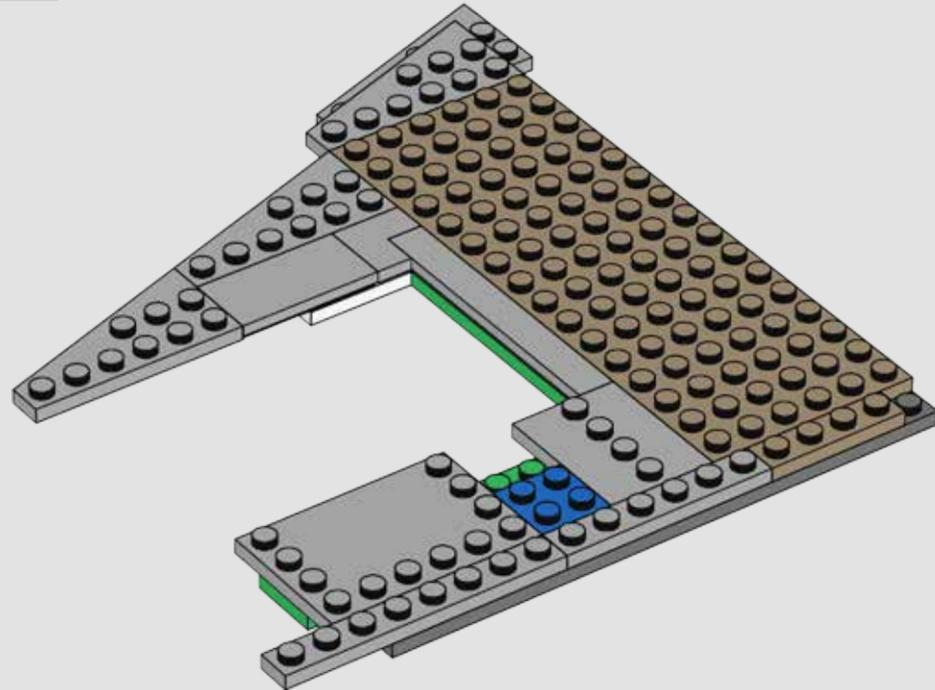

662

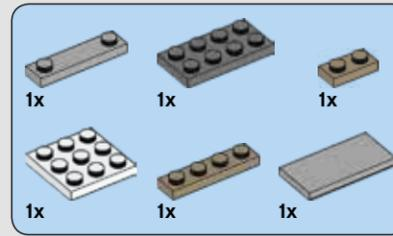

663

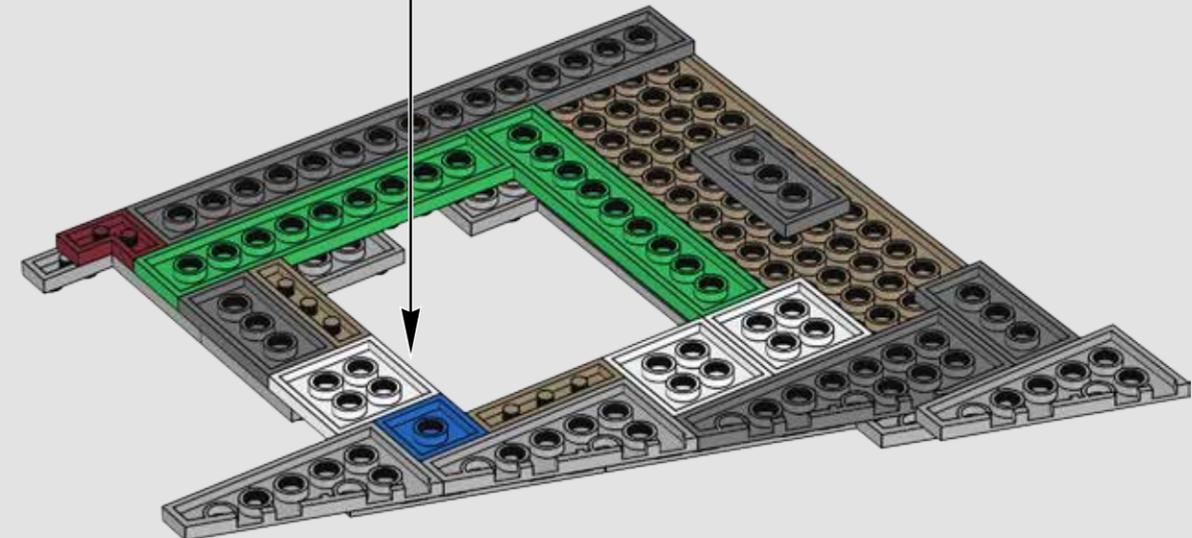
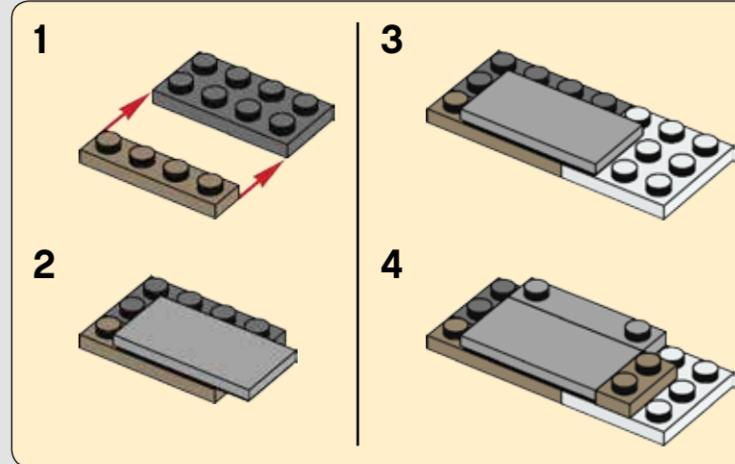



664

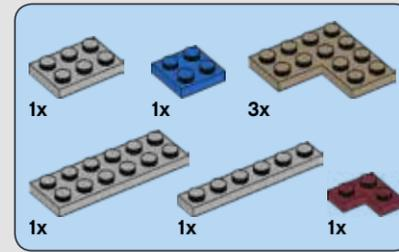
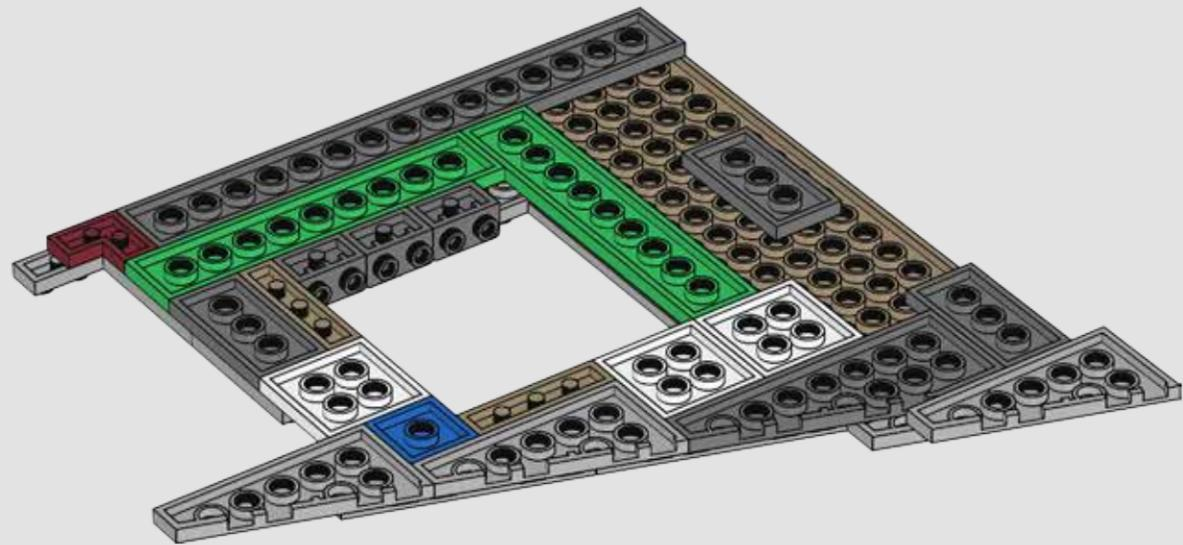

665

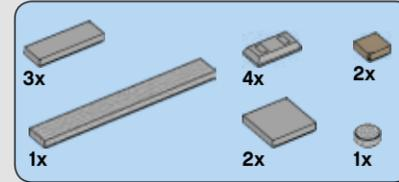
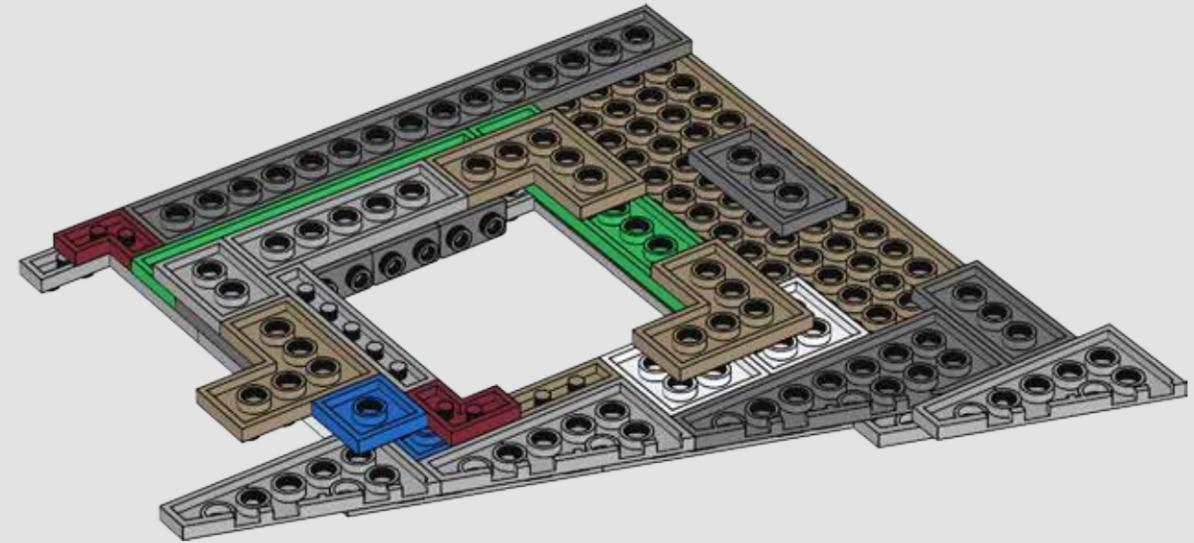

666

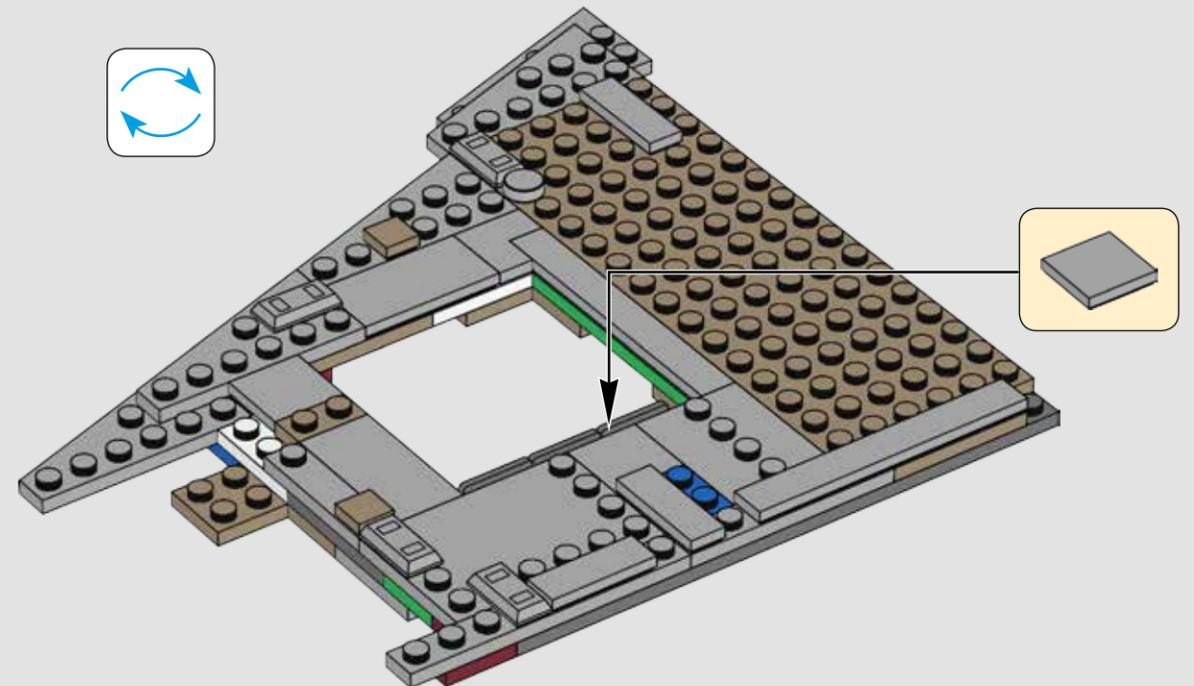

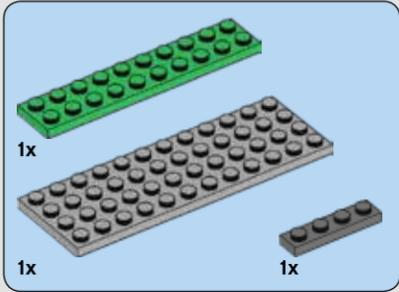
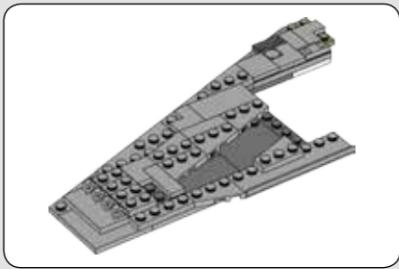

667

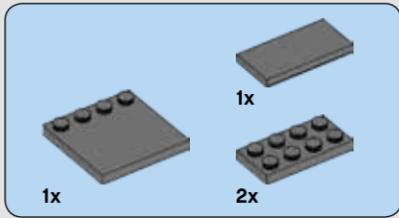
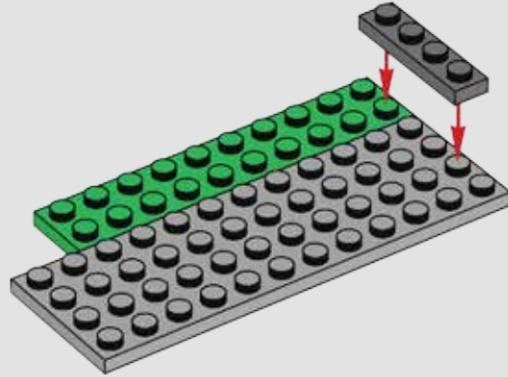

668

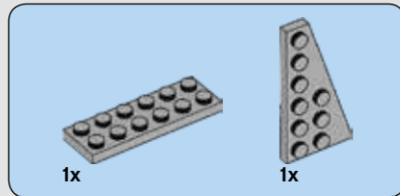
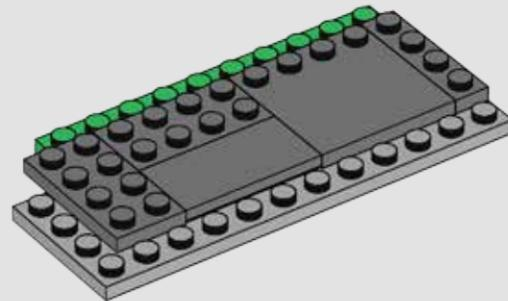

669

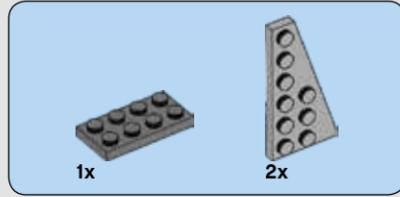
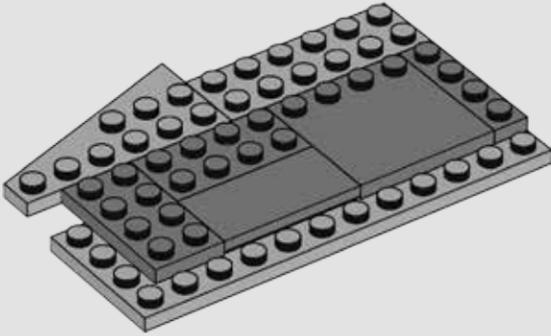

670

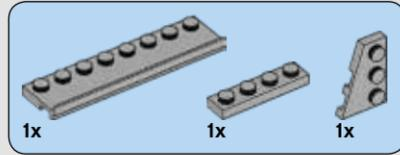
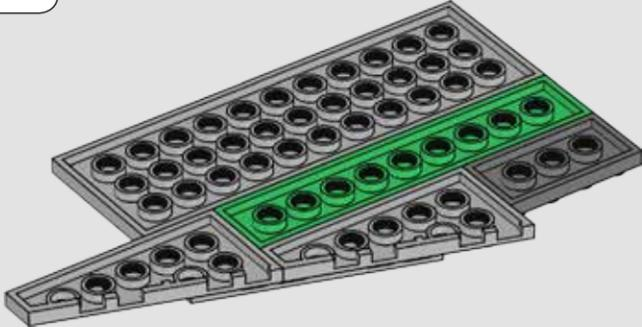

671

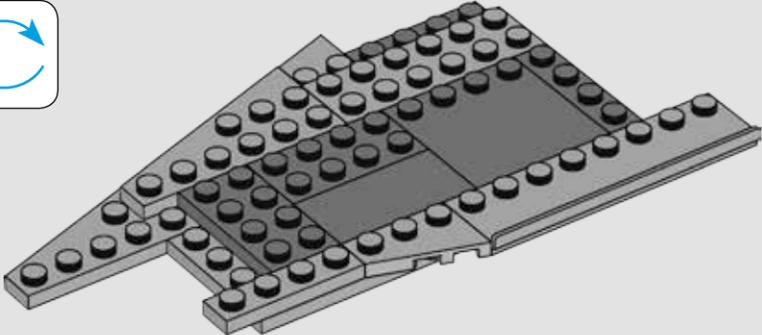

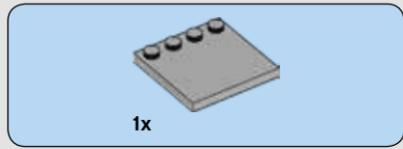

1x

672

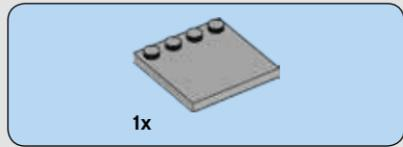
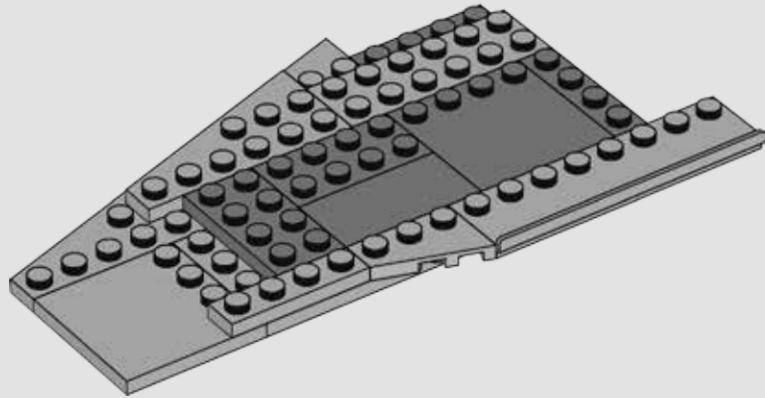

1x

673

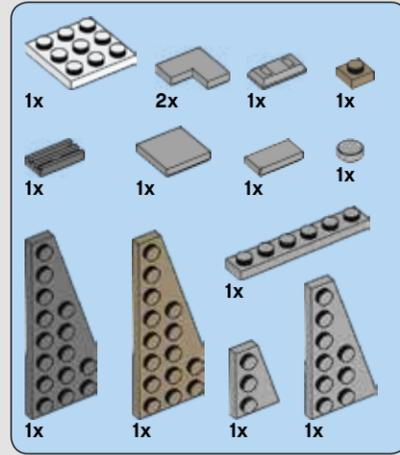
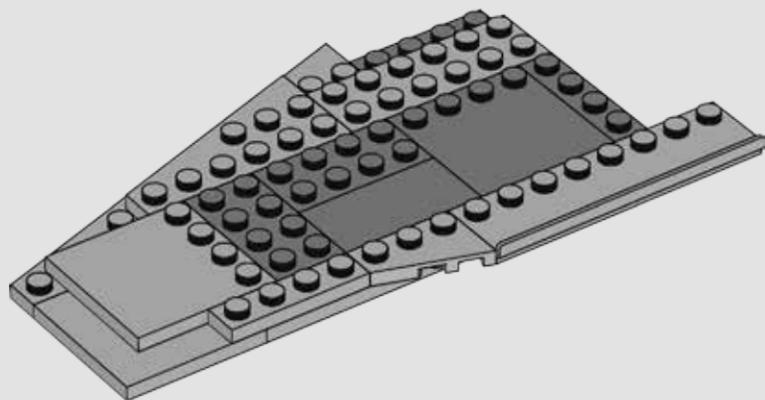

674

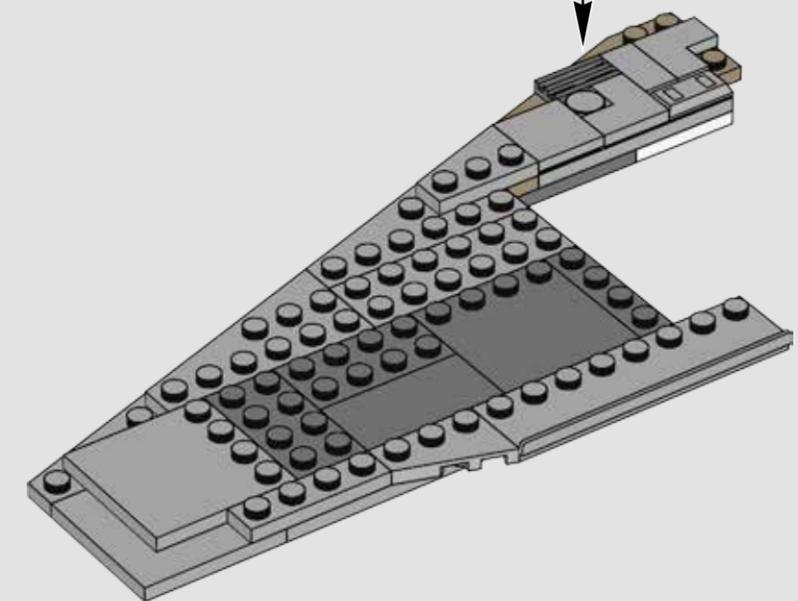
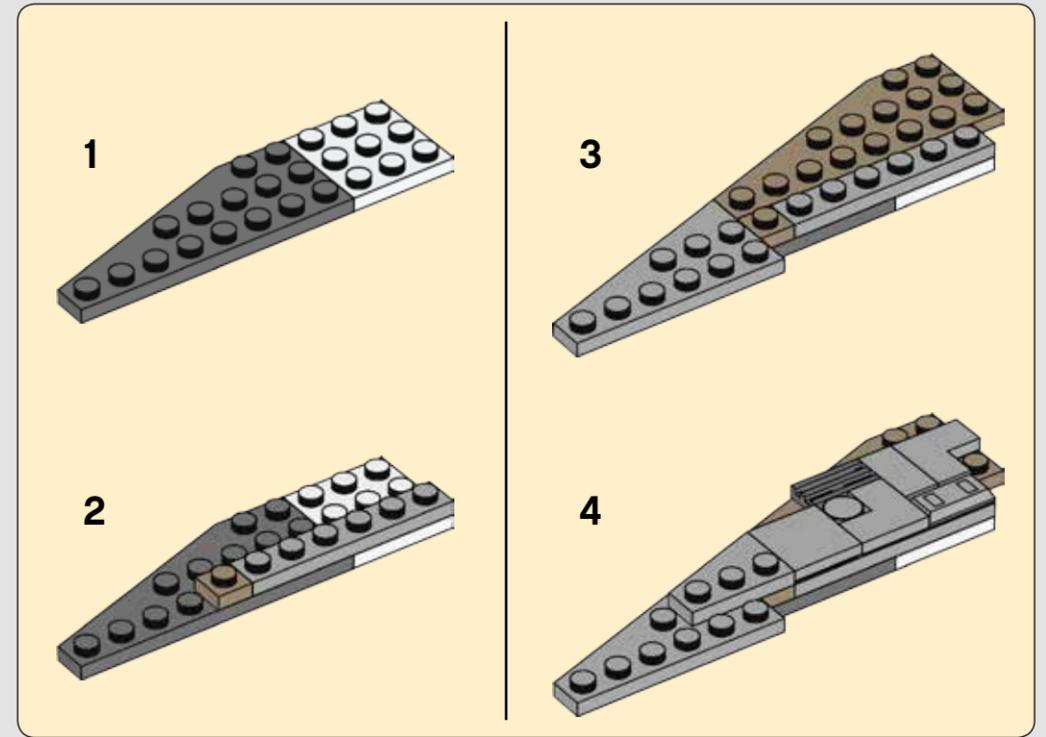

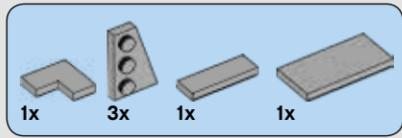

675

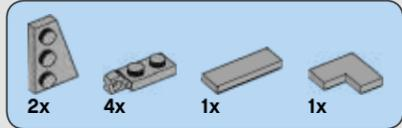
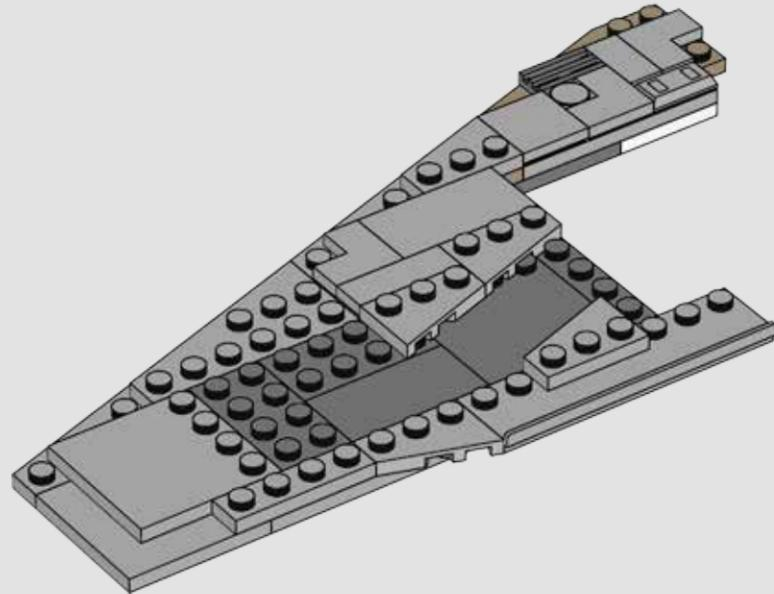

676

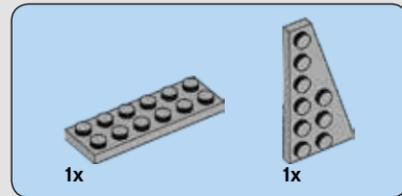
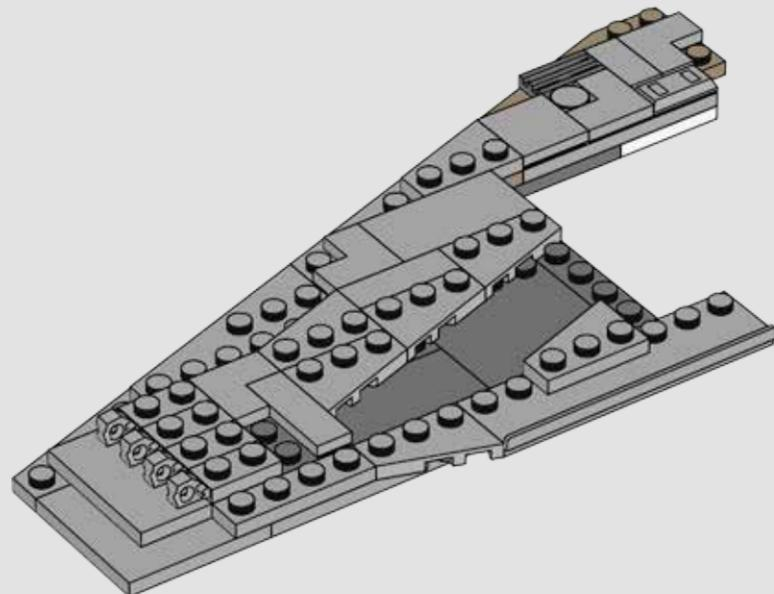

677

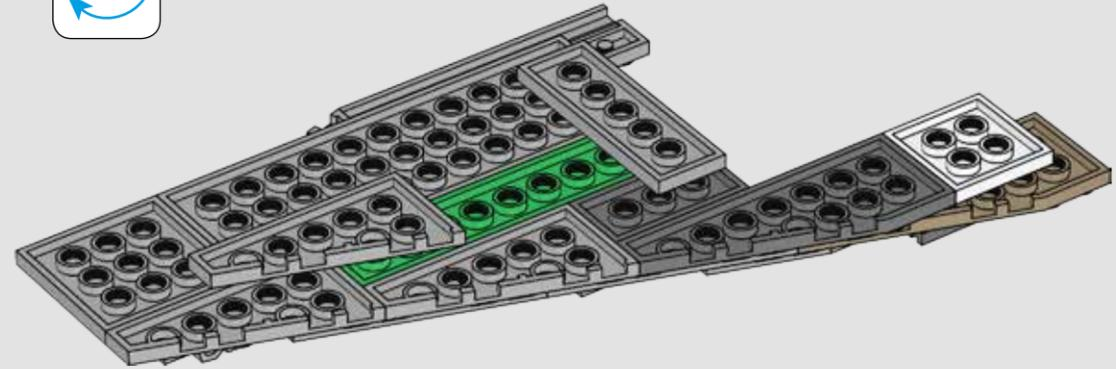

678

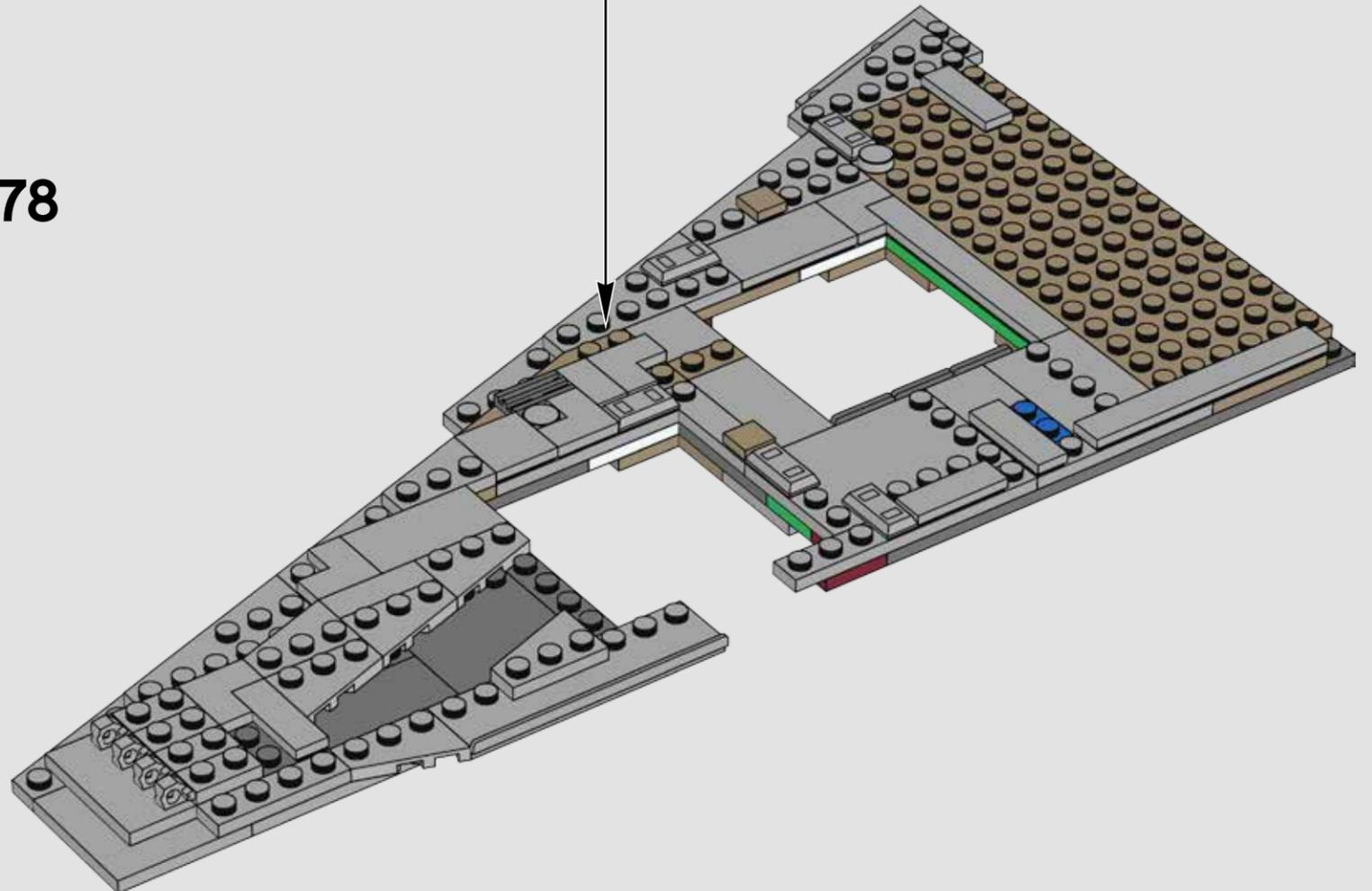

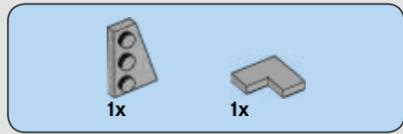

679

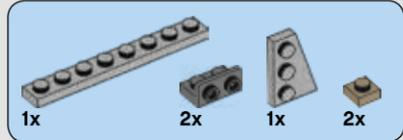
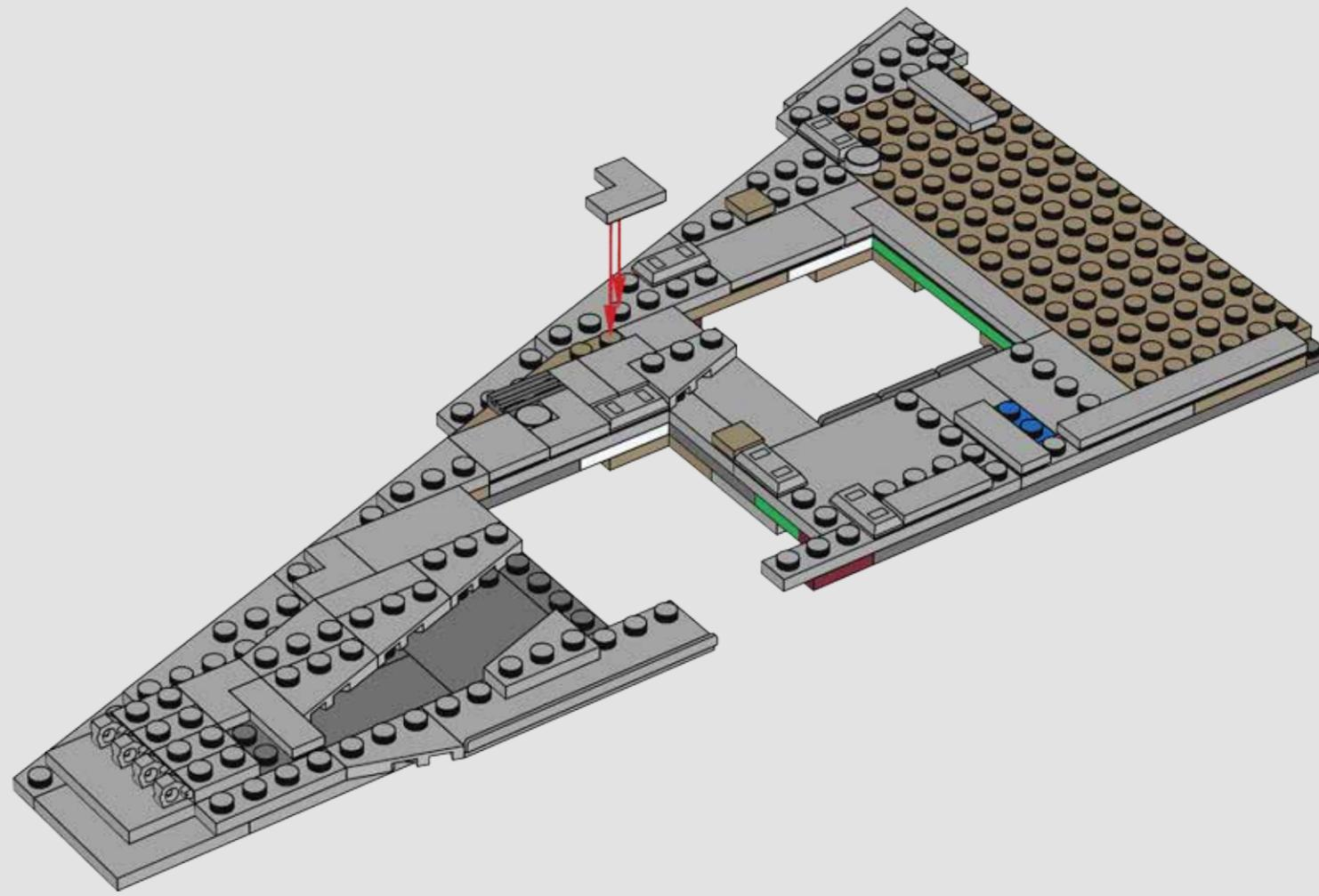

680

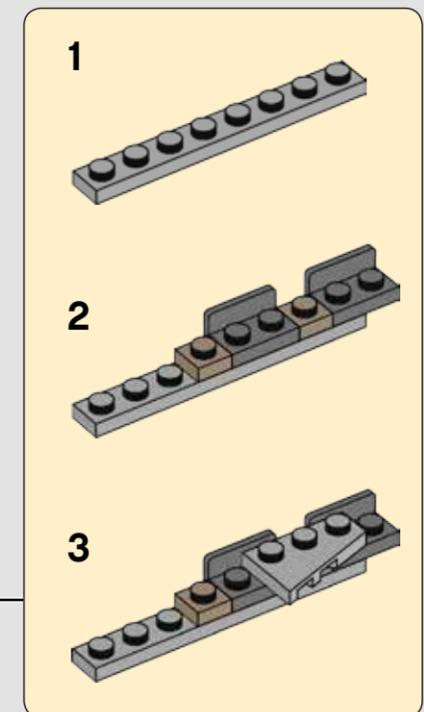
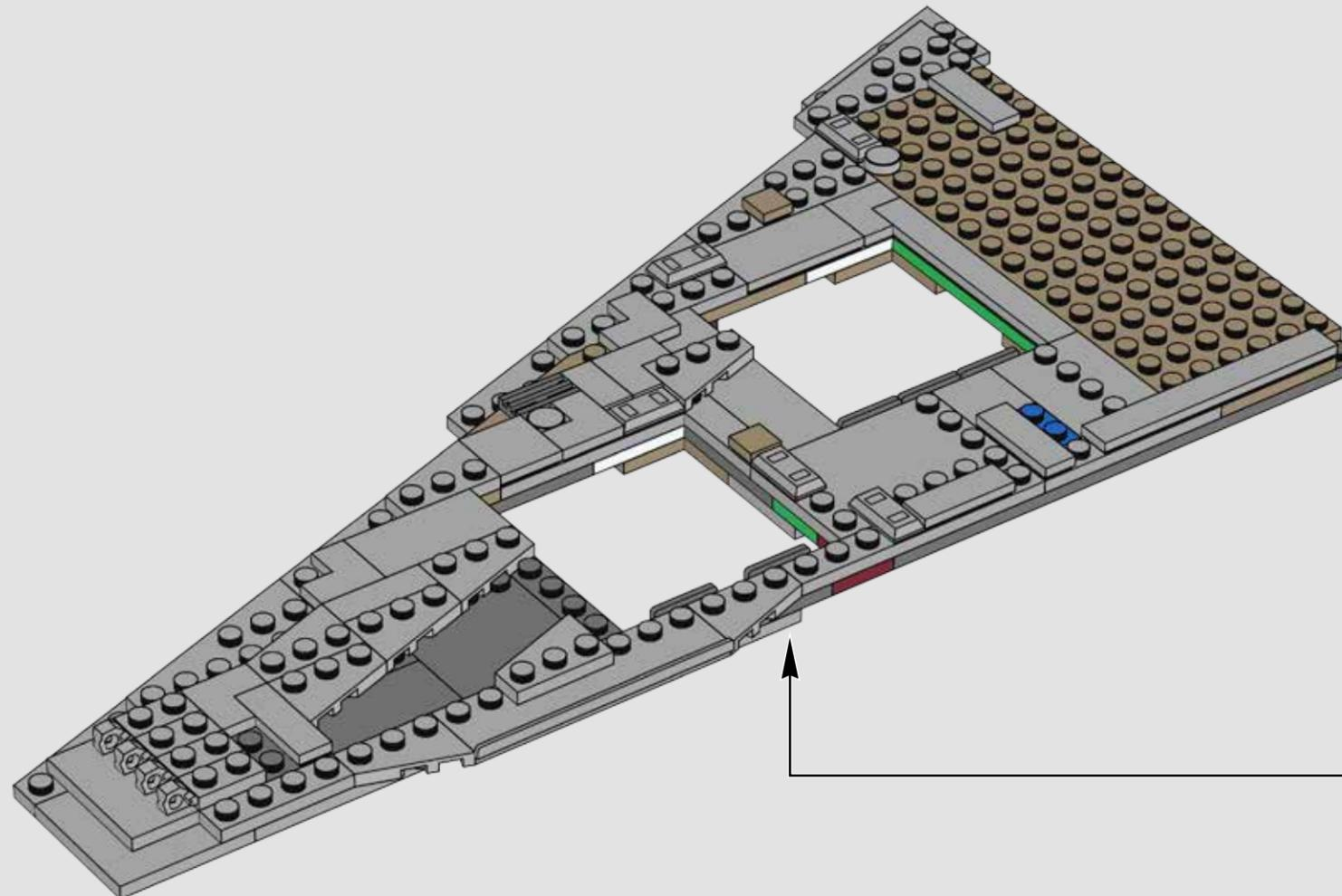

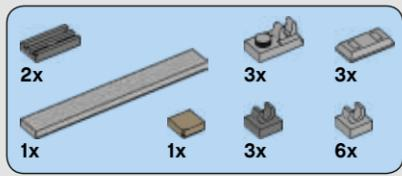

681

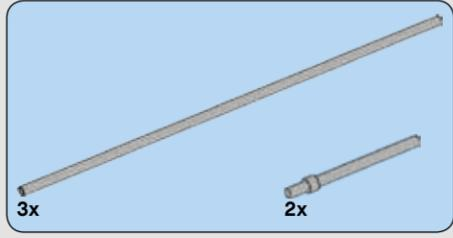
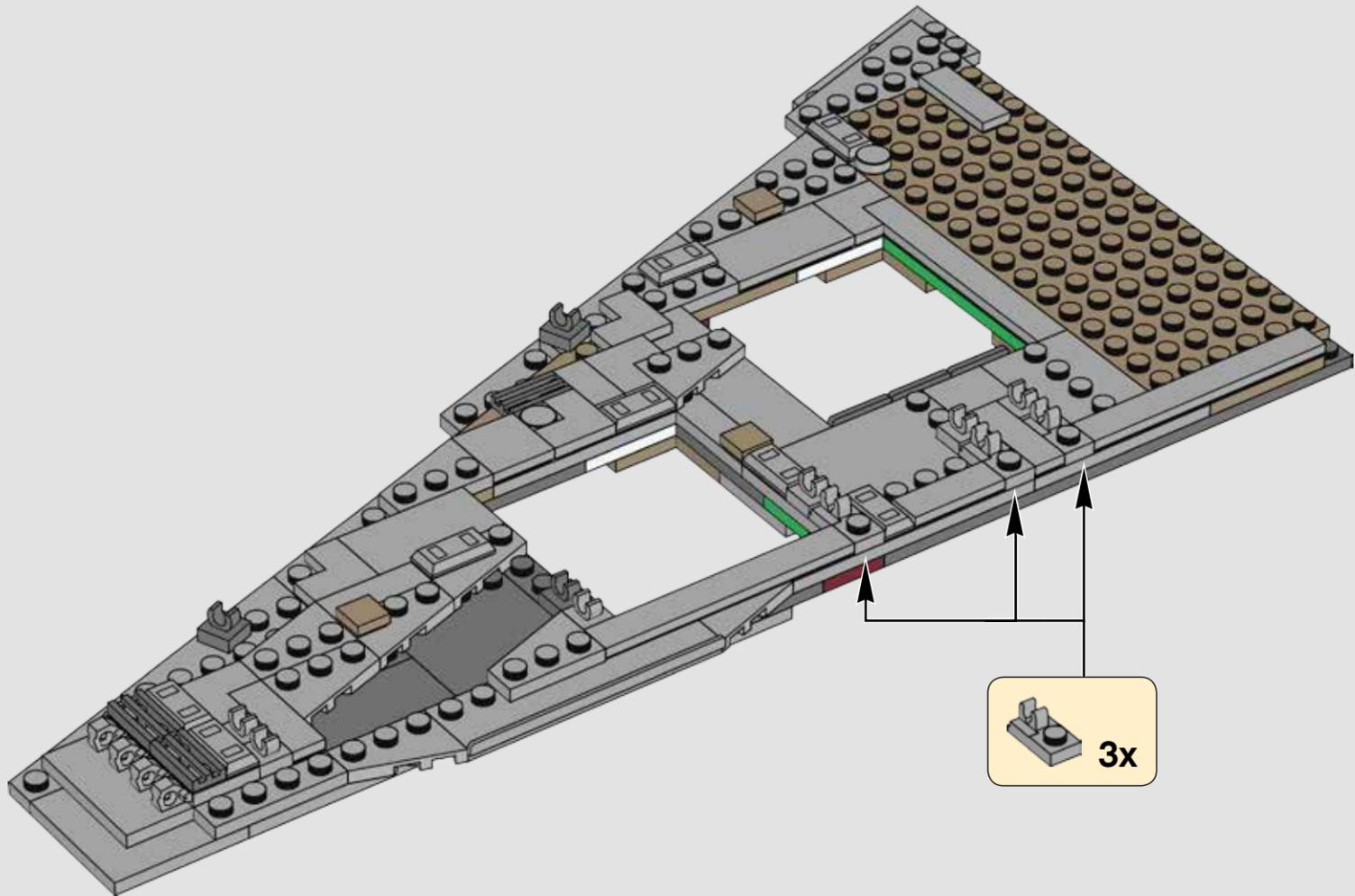

682

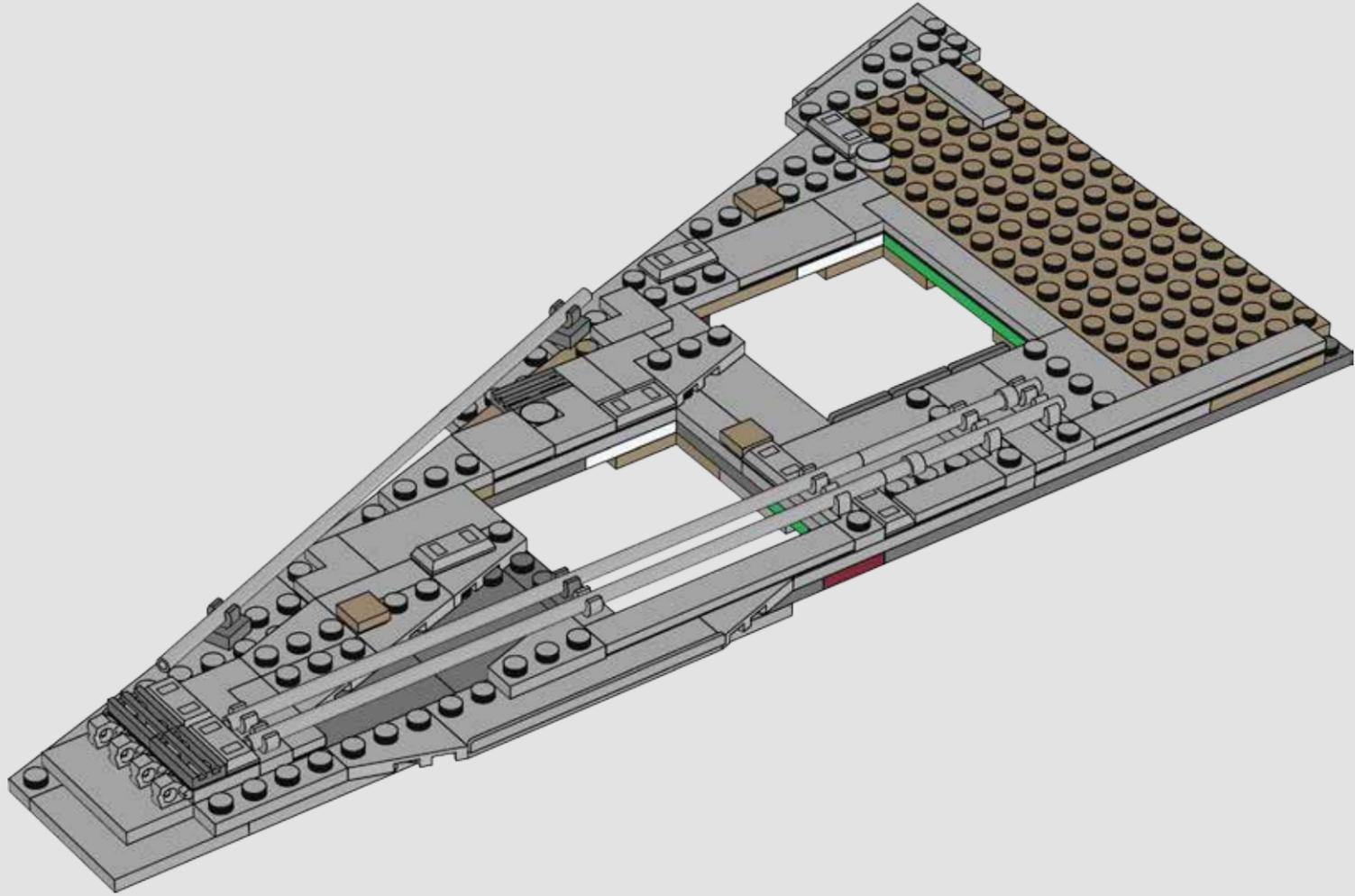

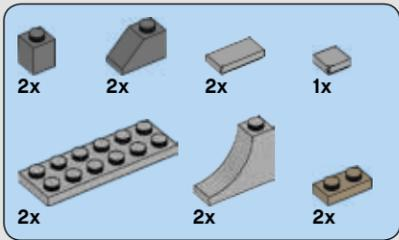

683

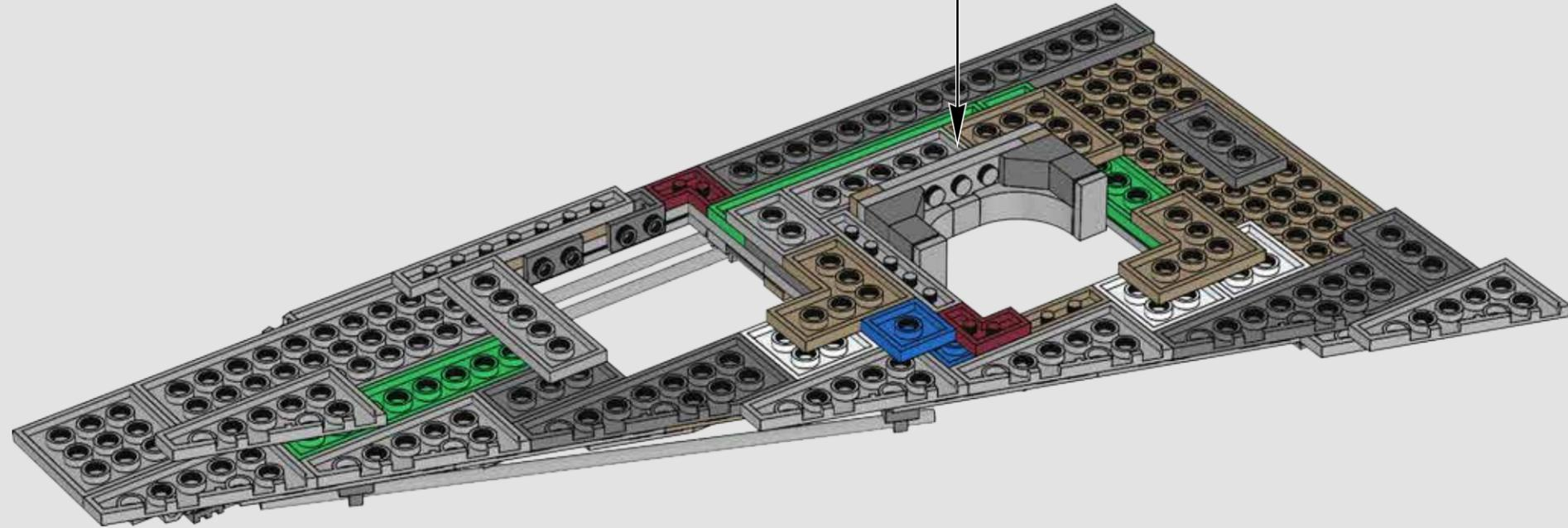
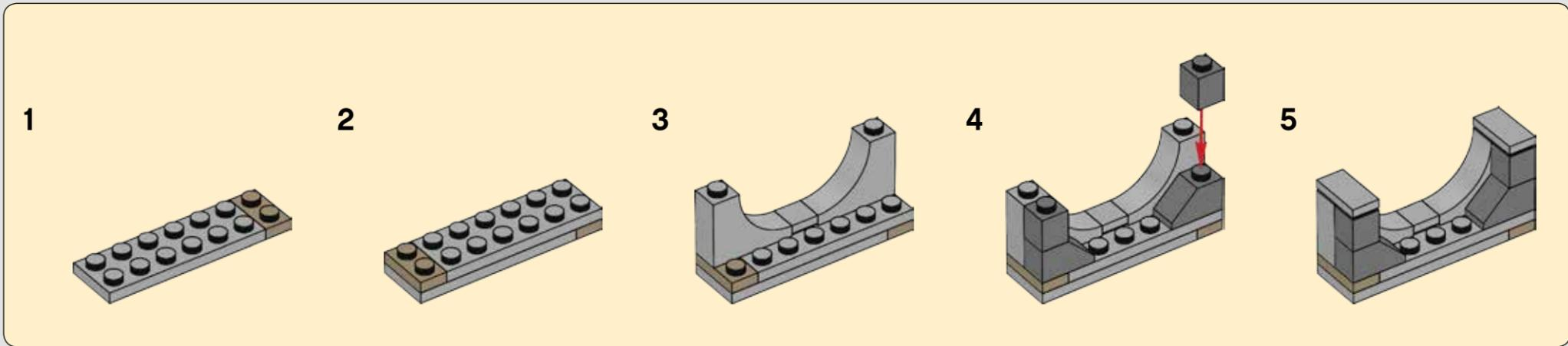

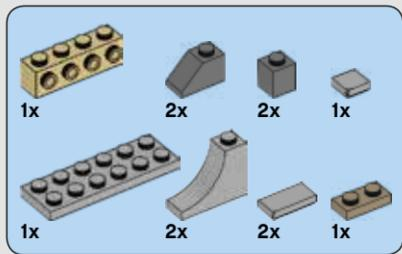

684

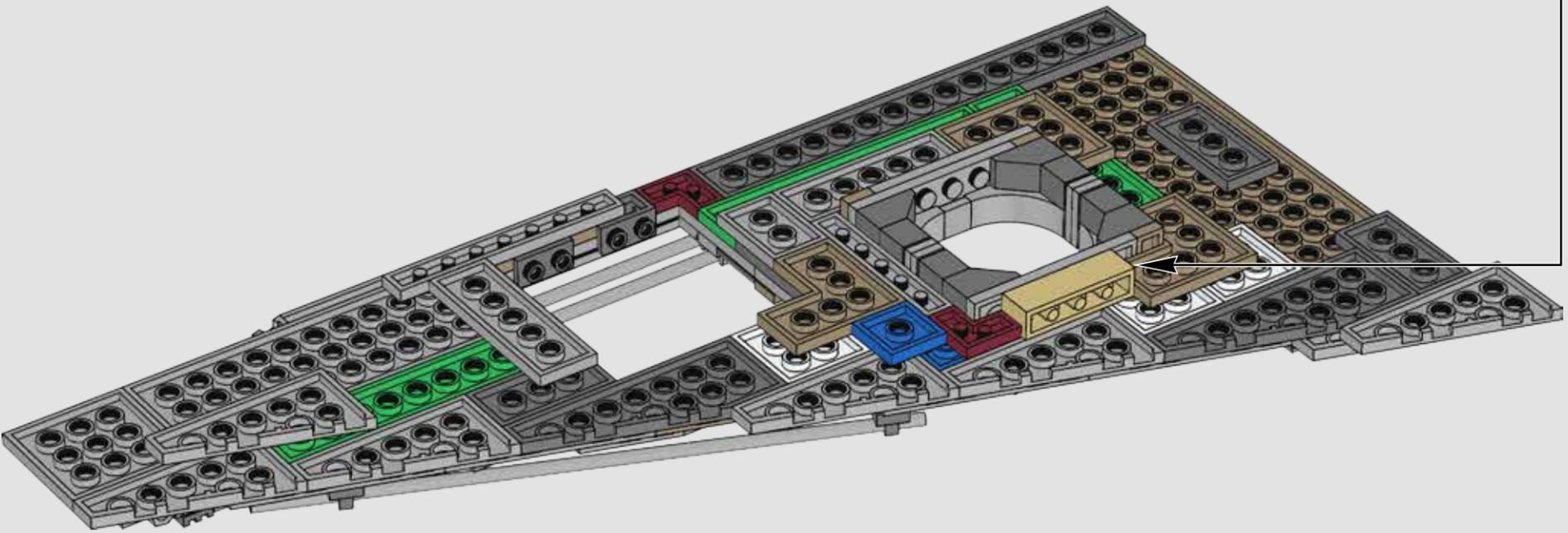
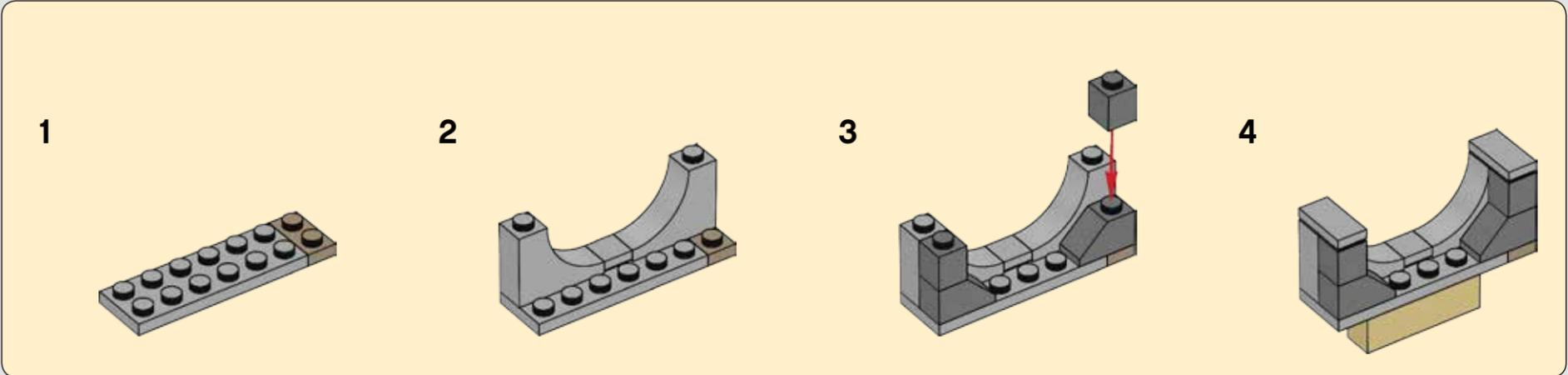

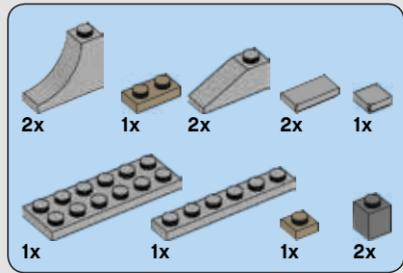

685

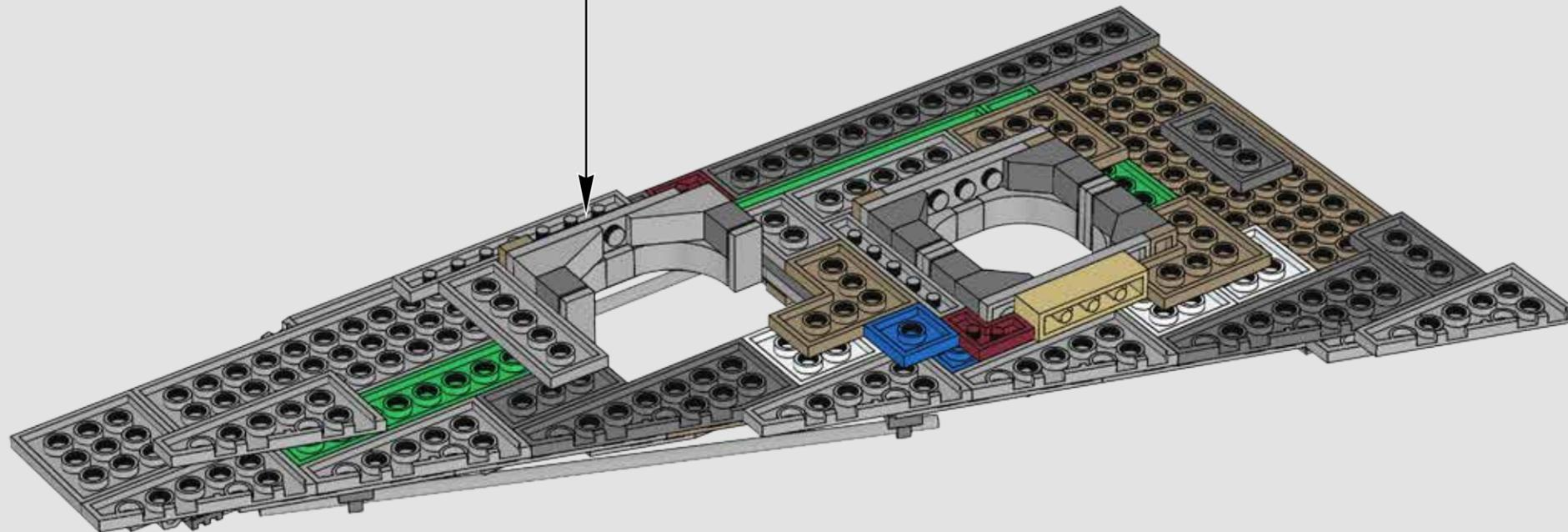
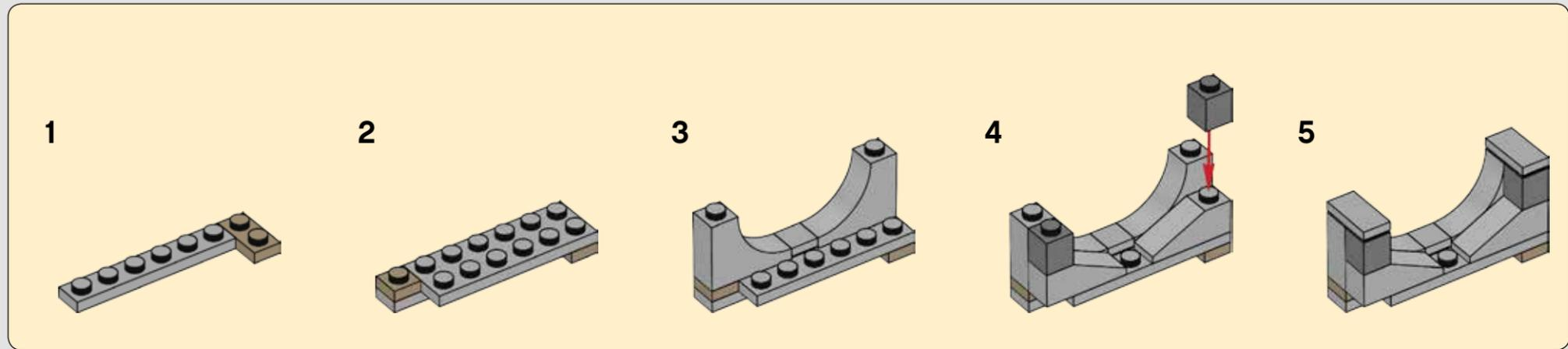

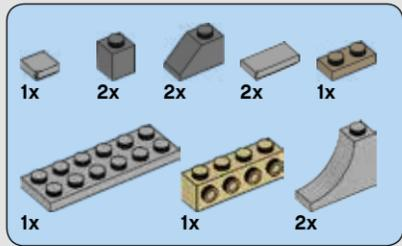

686

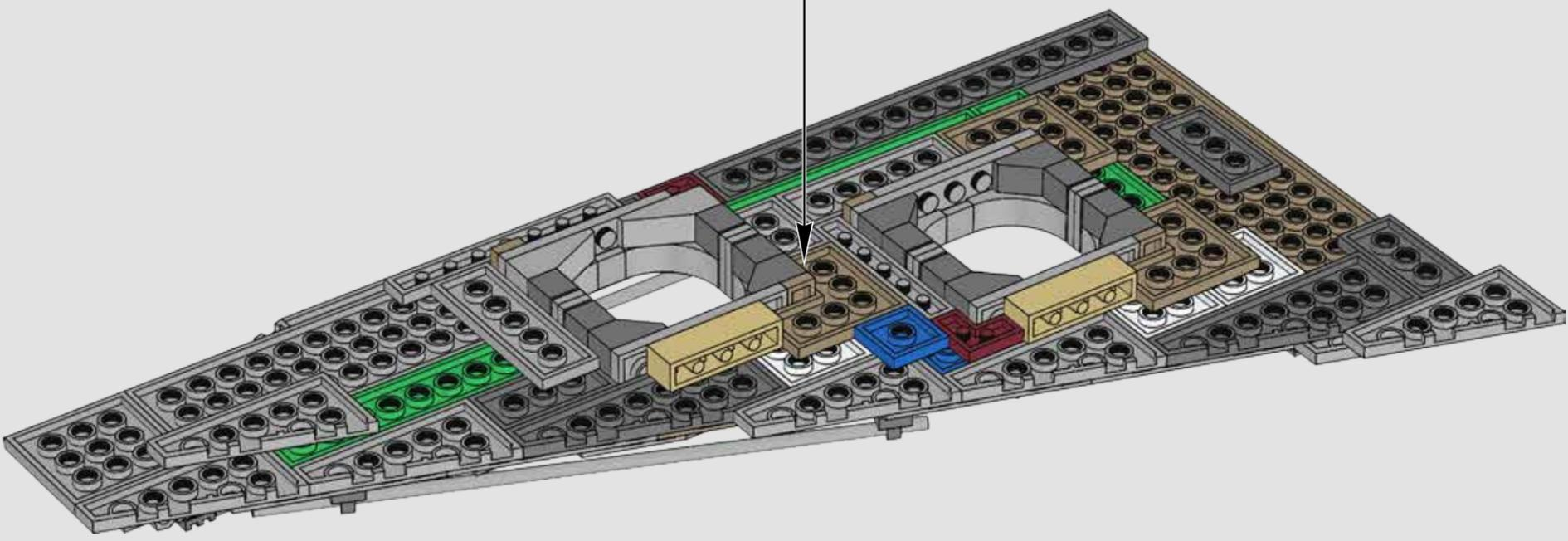
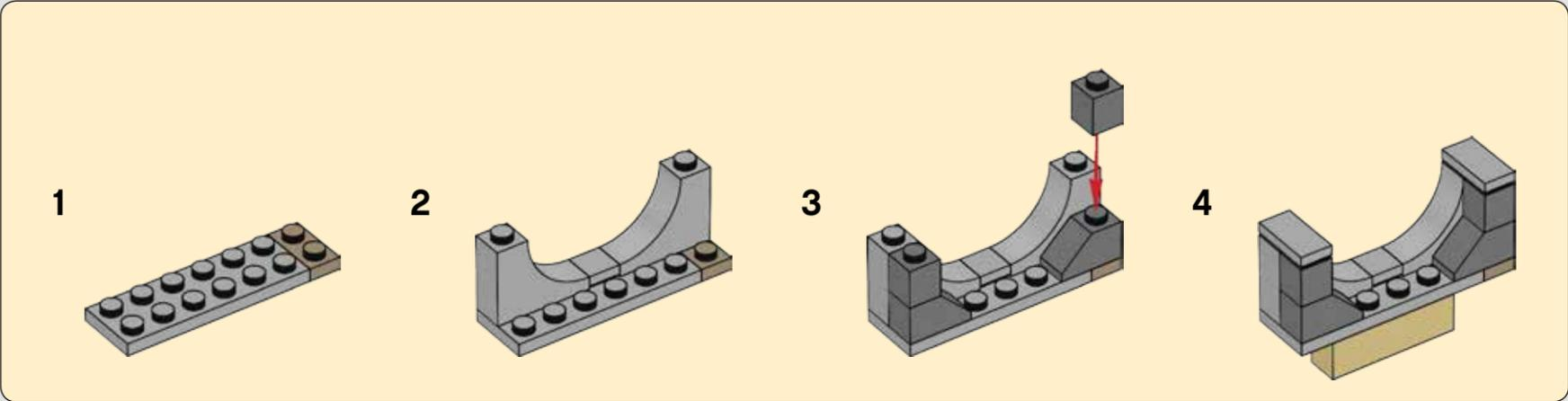

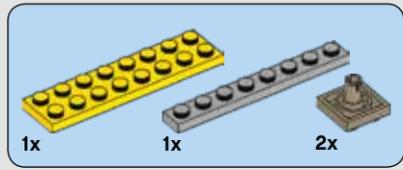

687

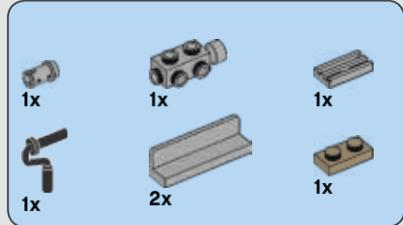
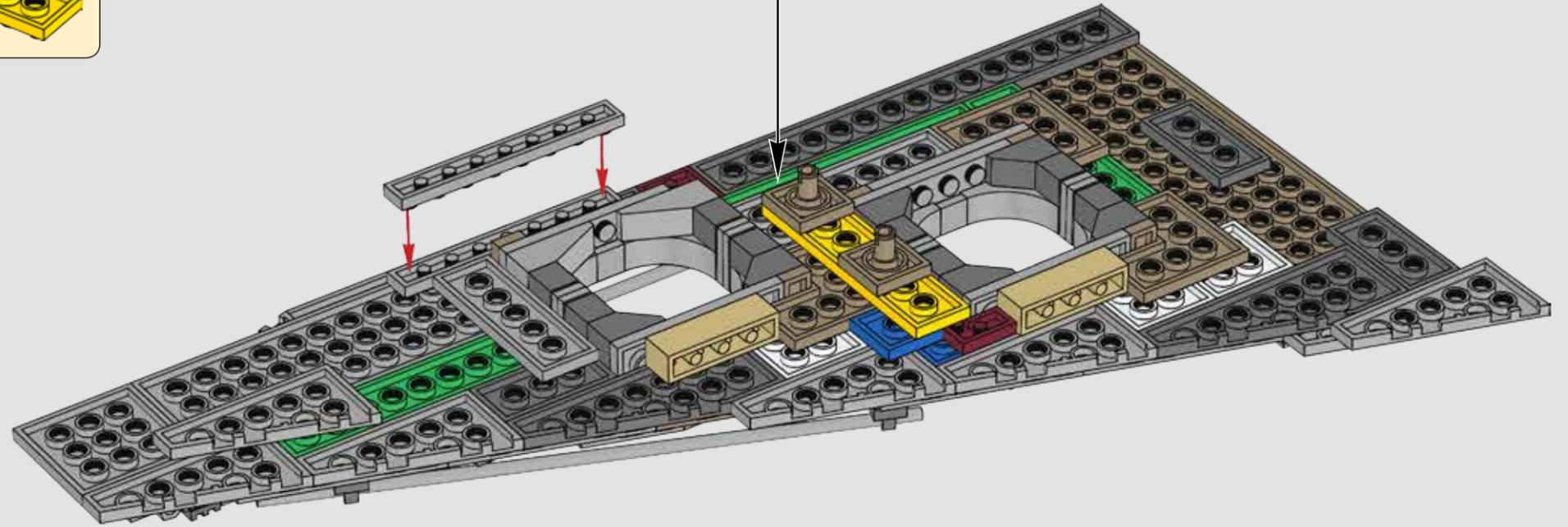
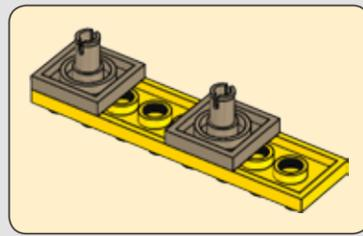

688

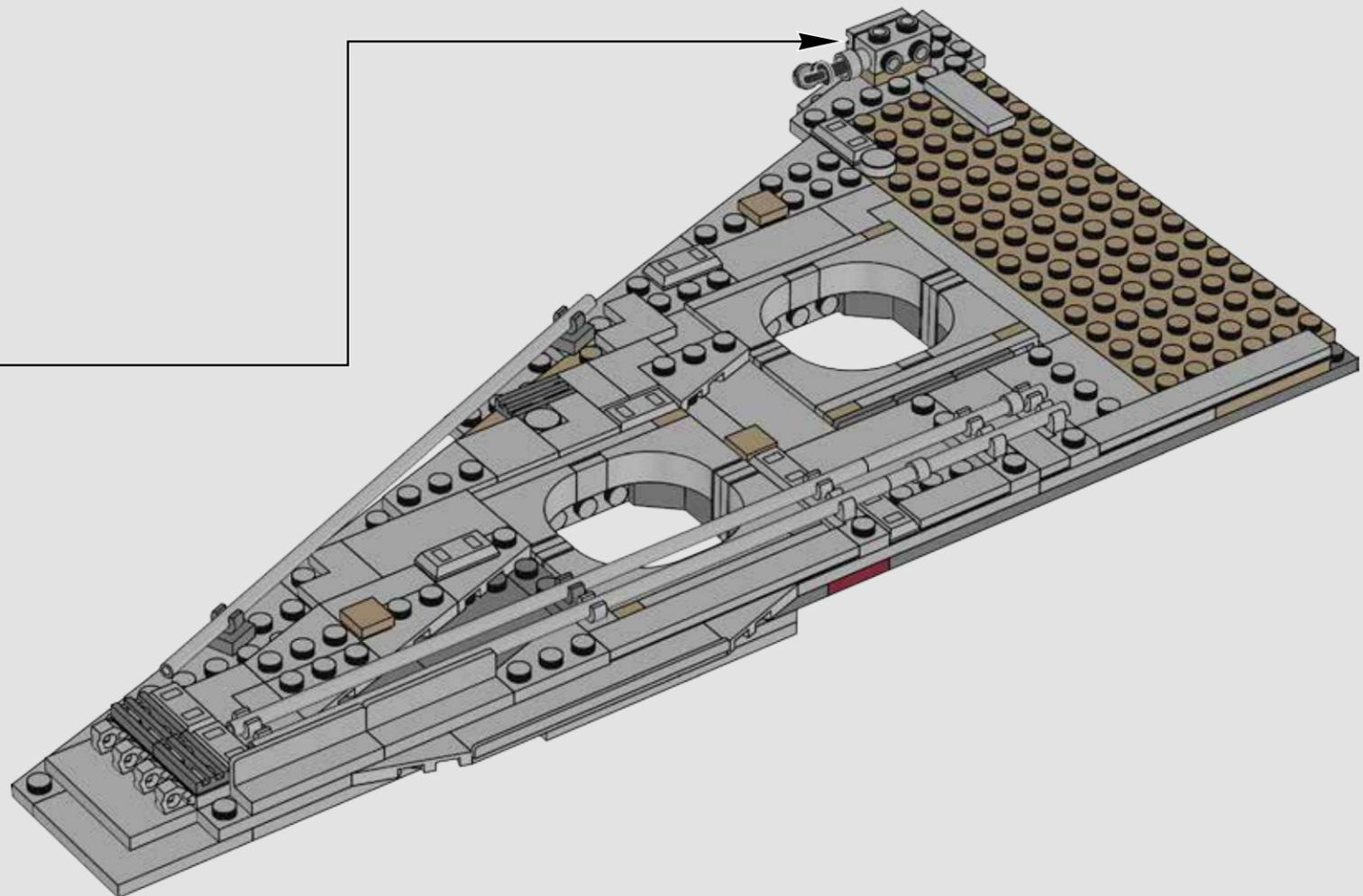
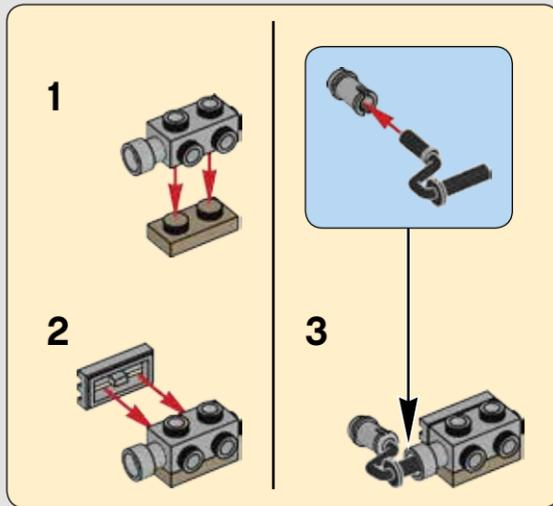

689

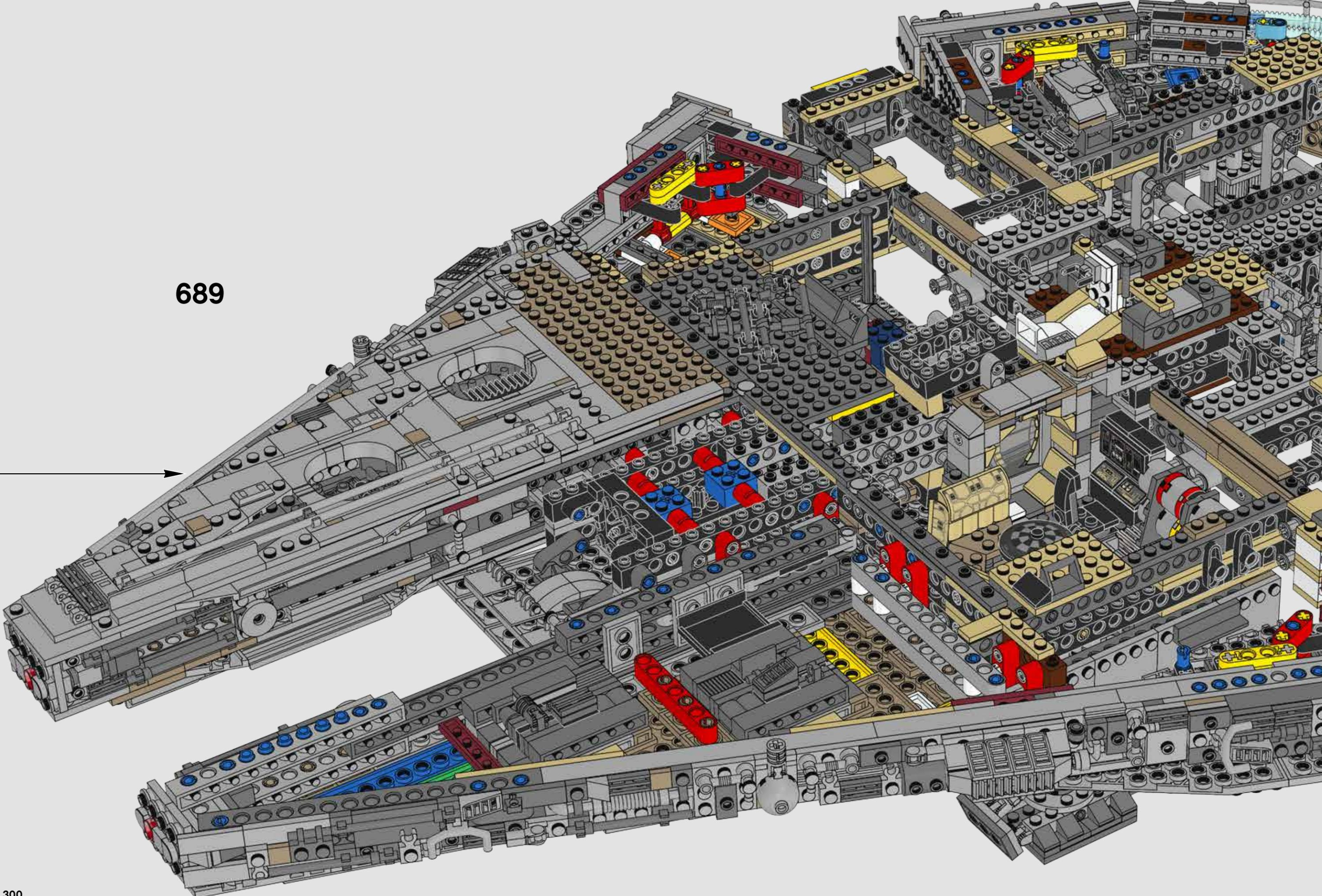

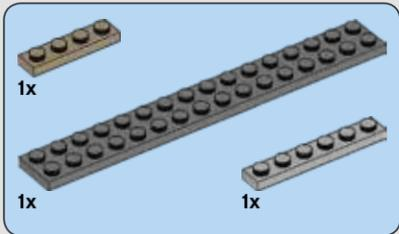
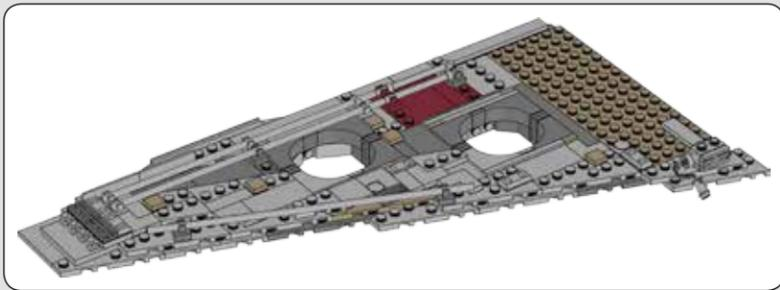

690

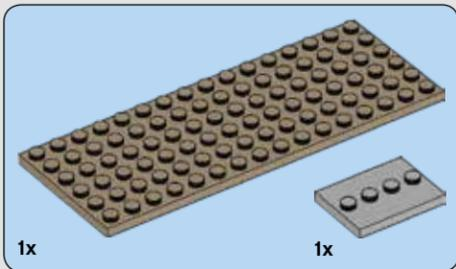
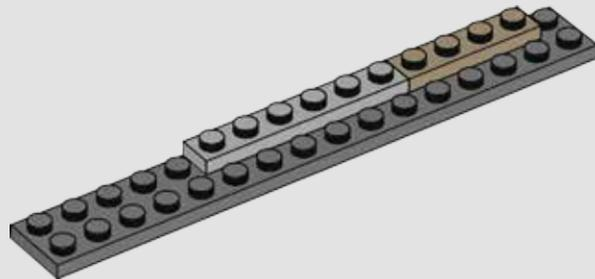

691

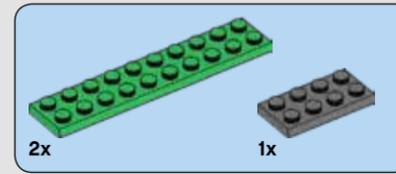
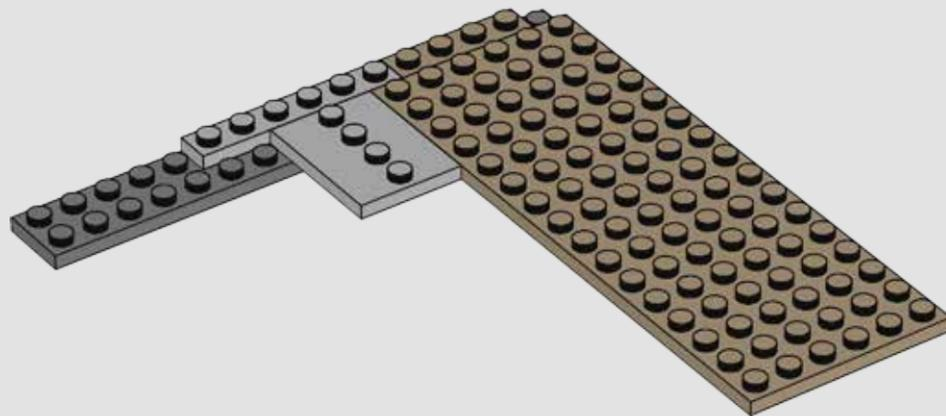

692

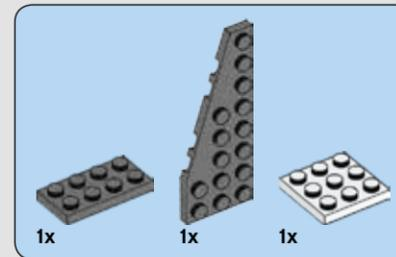
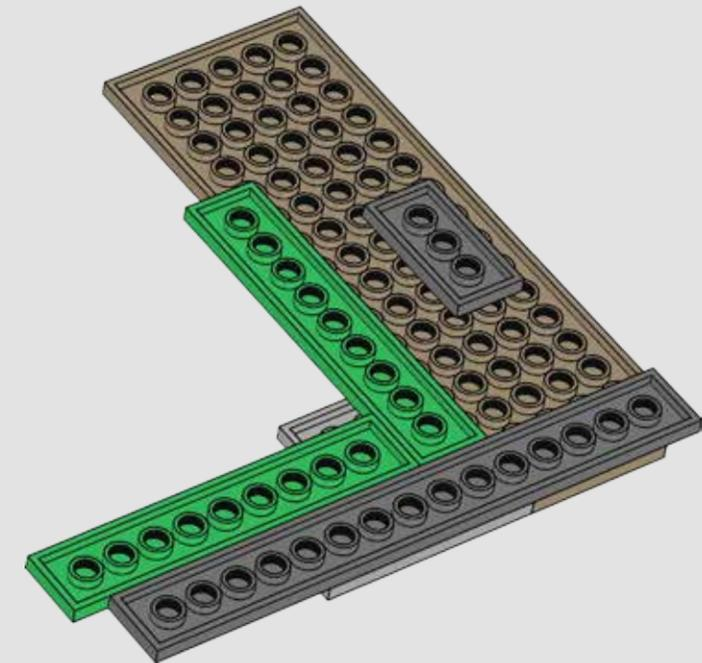

693

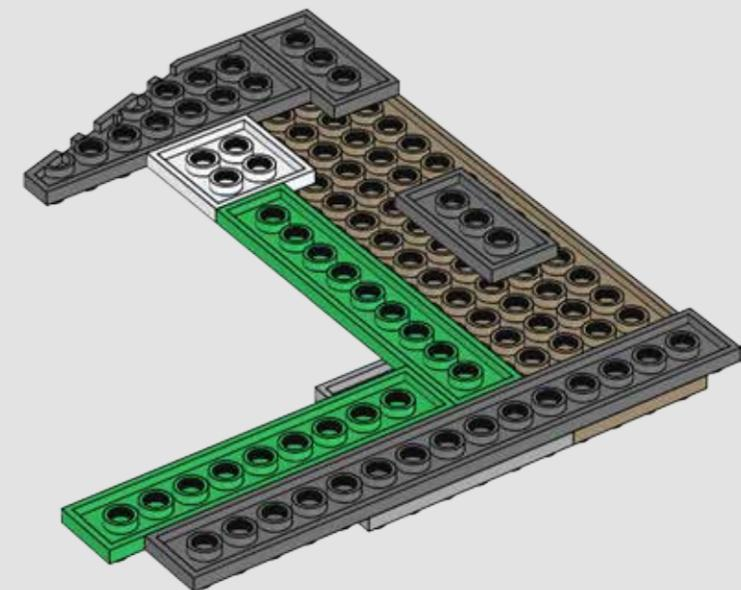

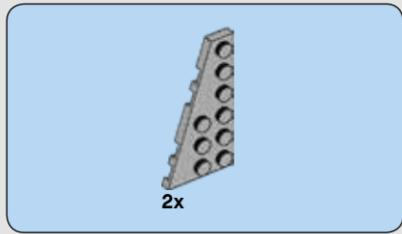

694

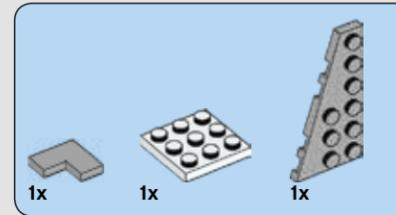
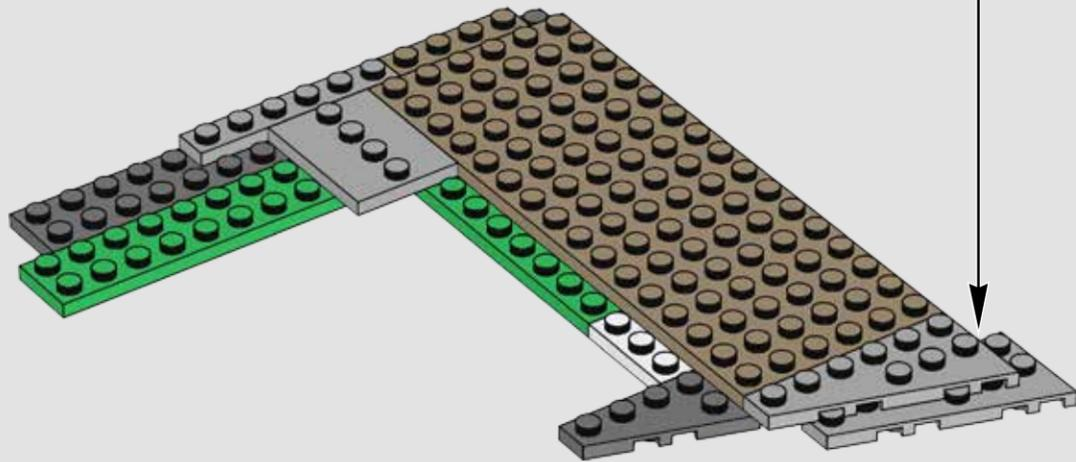
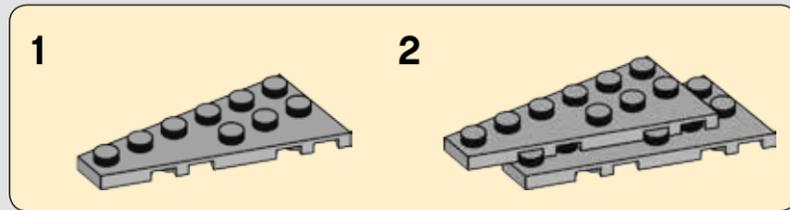

695

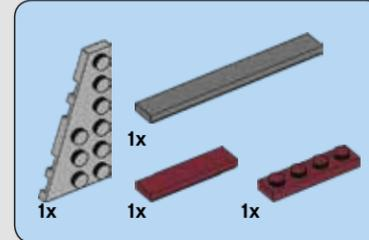
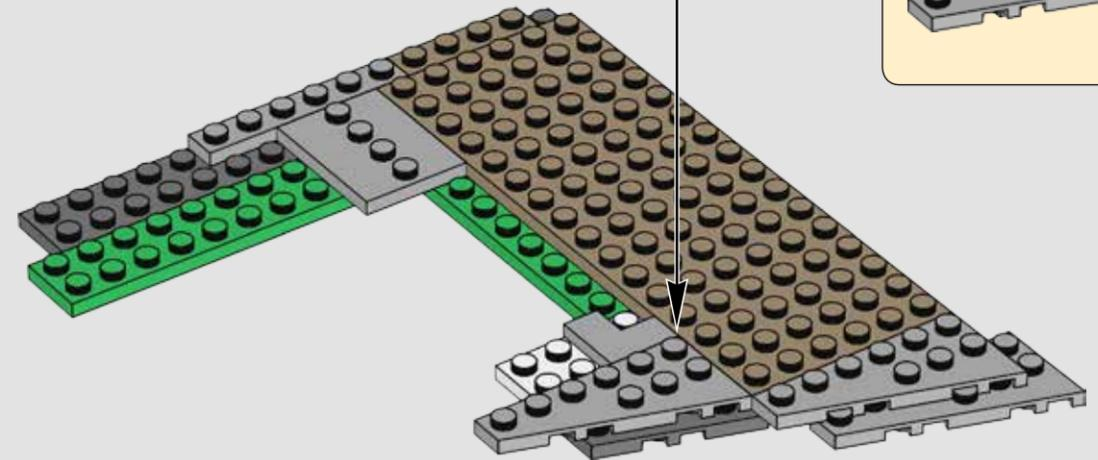
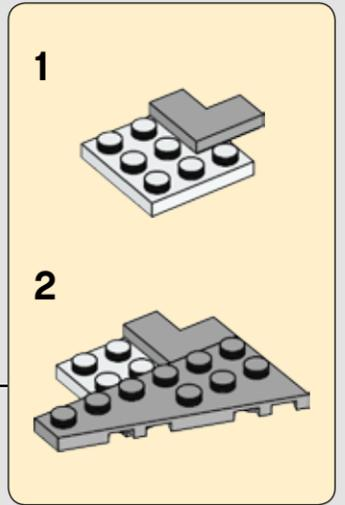

696

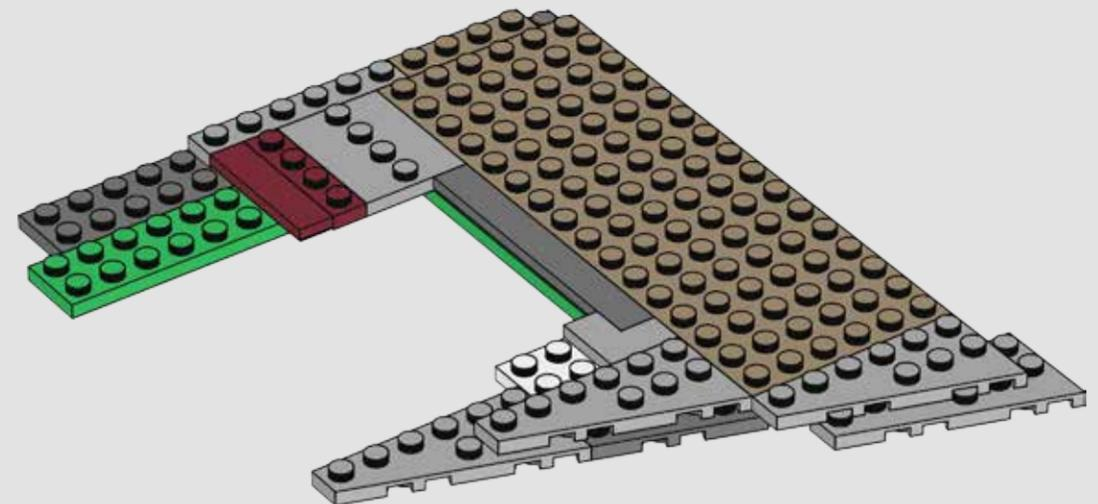

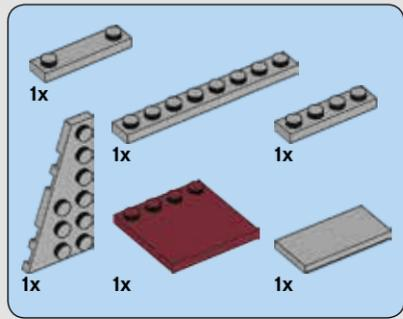

697

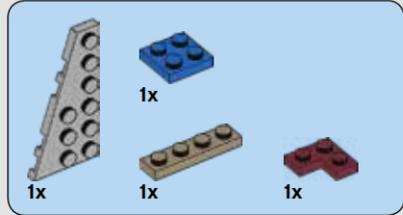
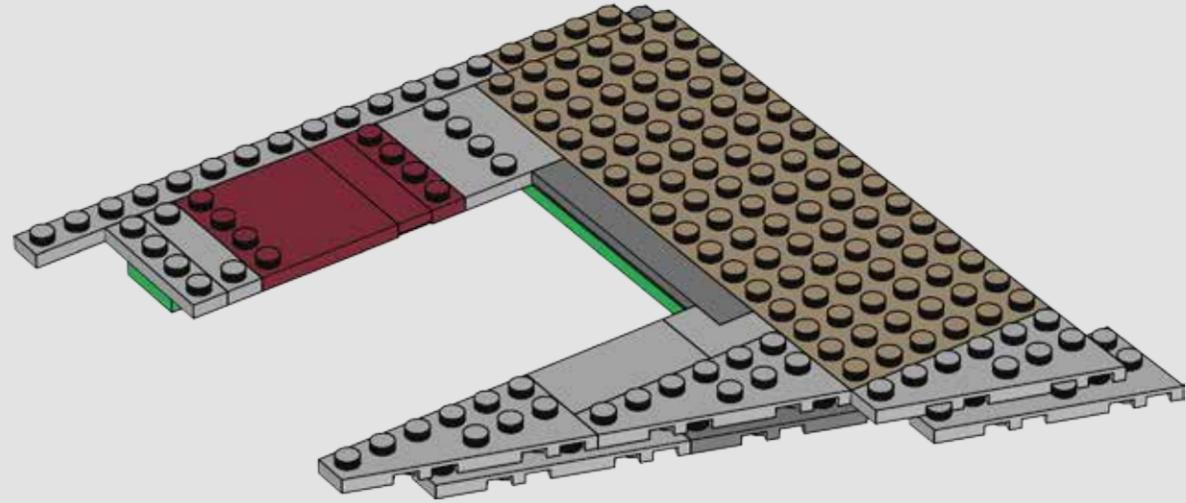

698

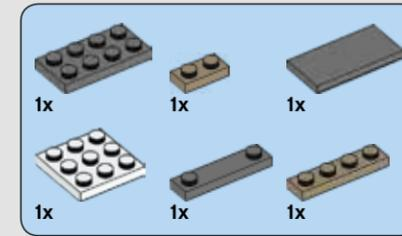
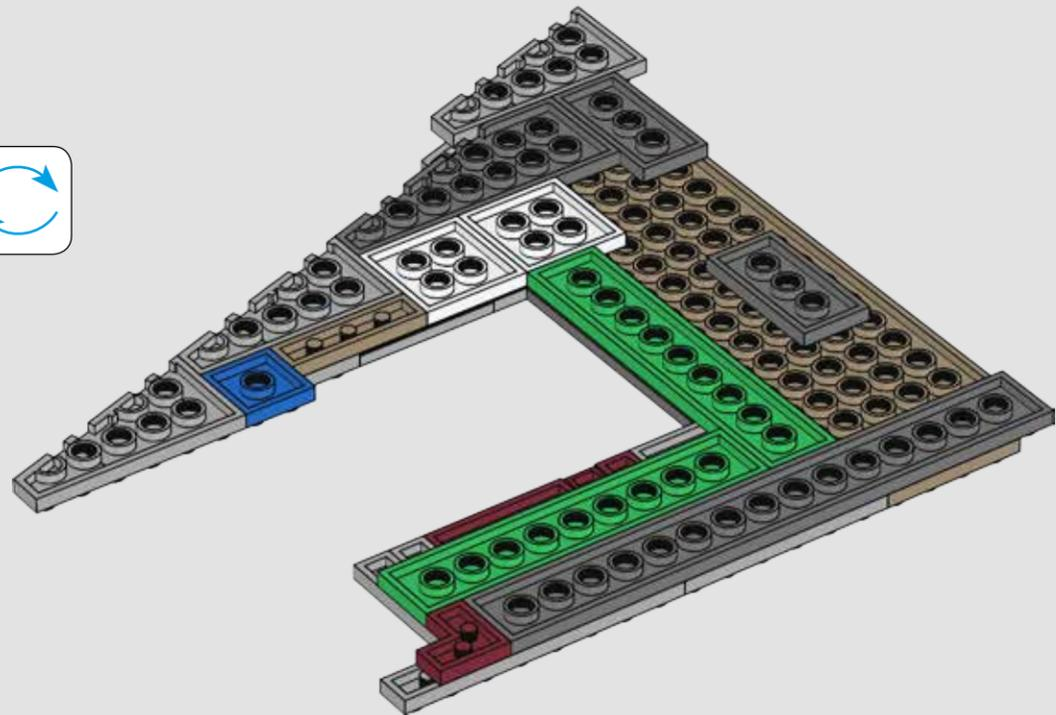

699

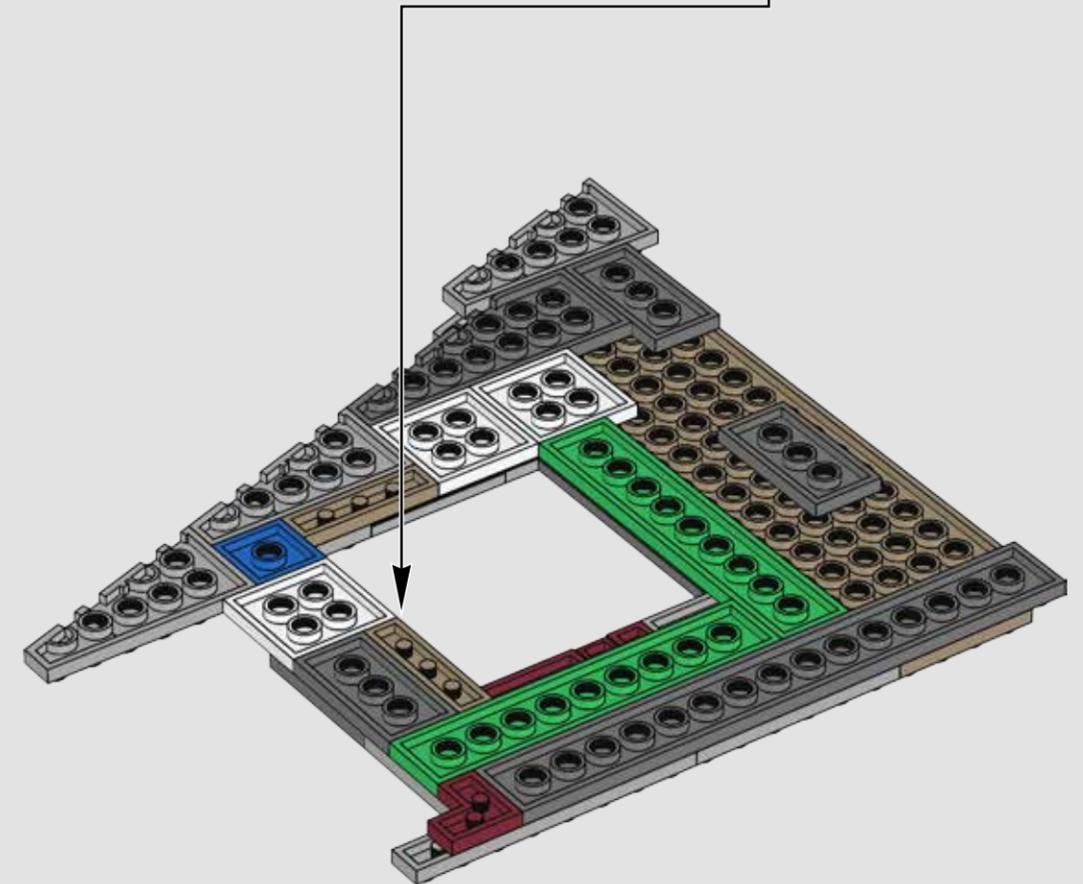
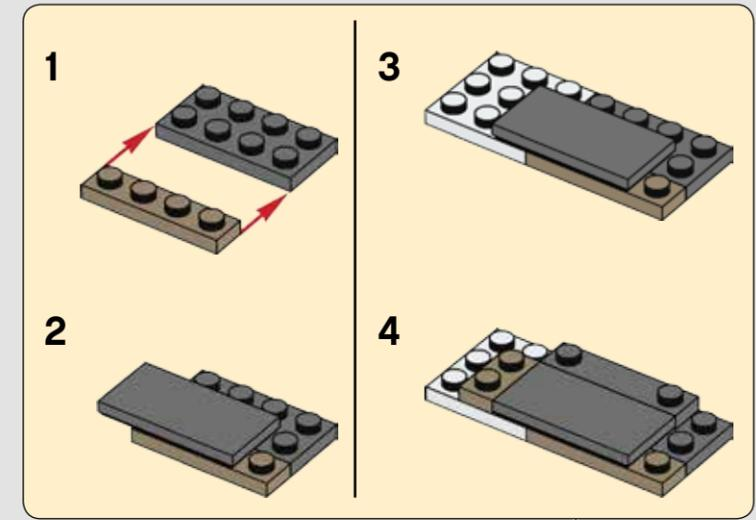



700

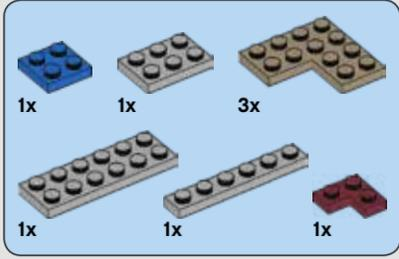
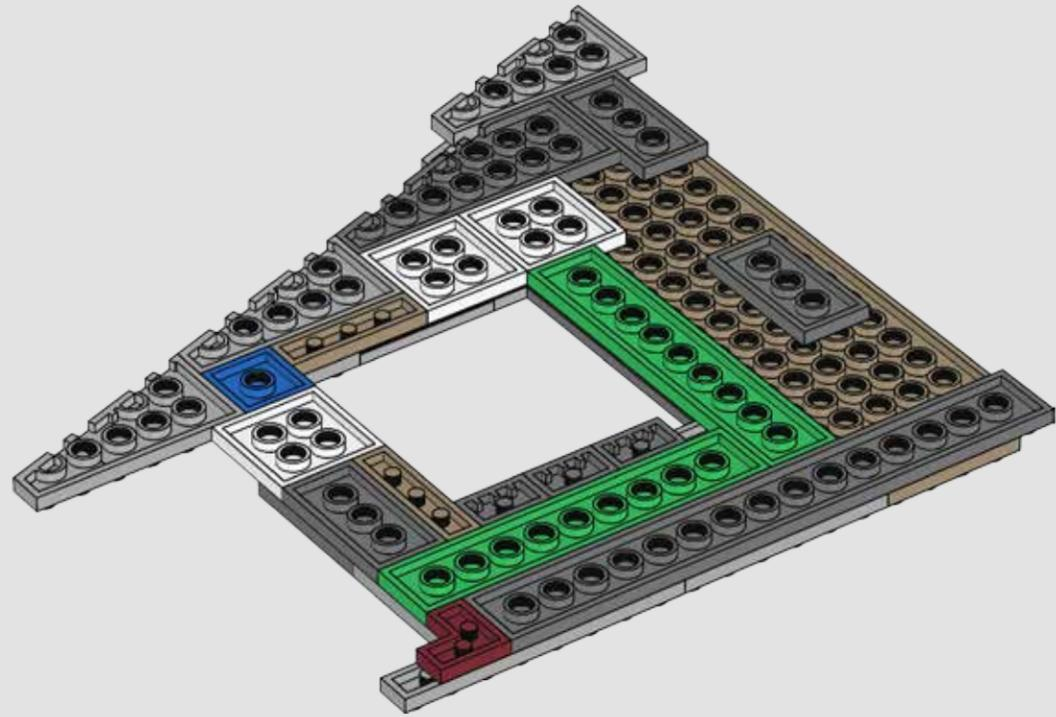

701

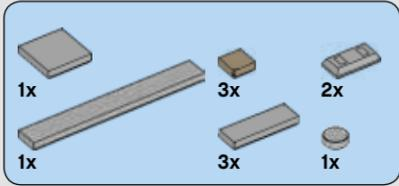
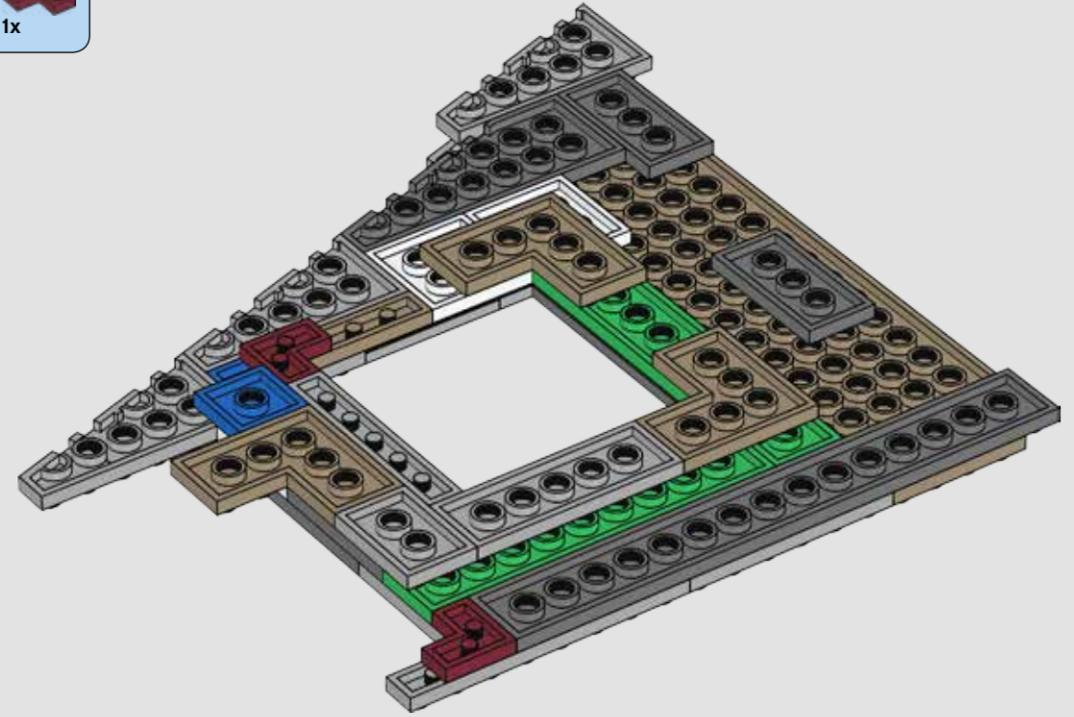

702

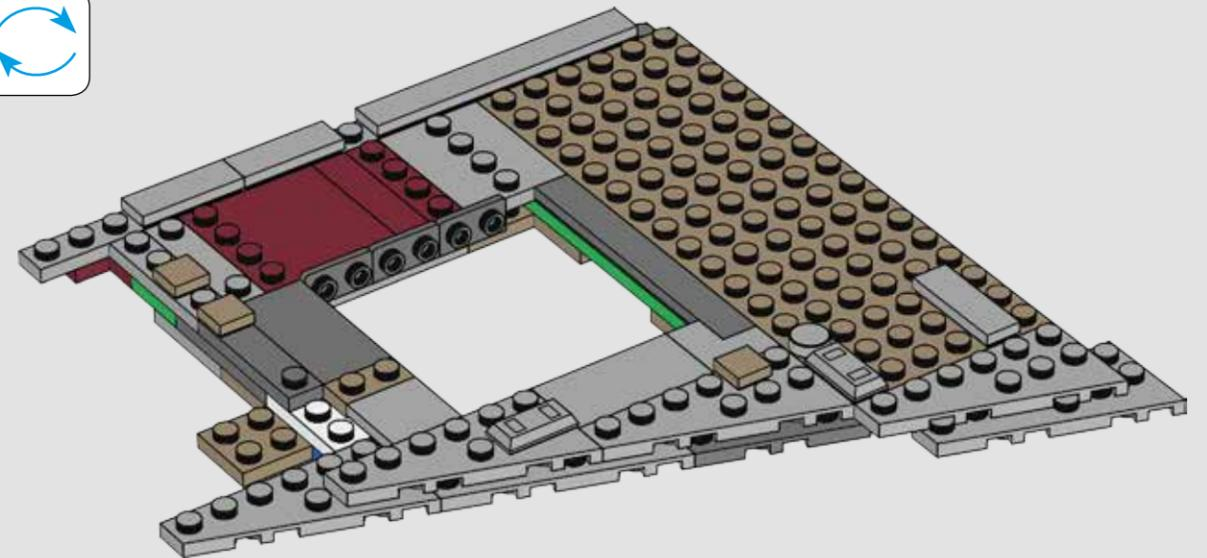

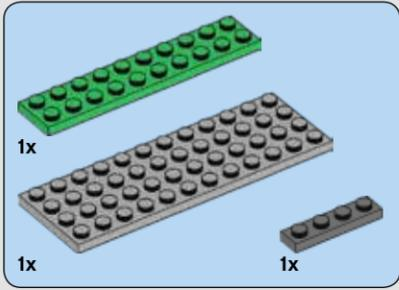
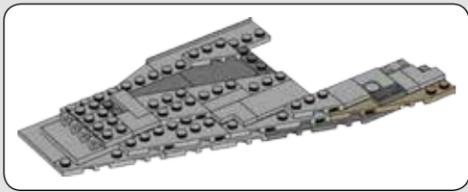

703

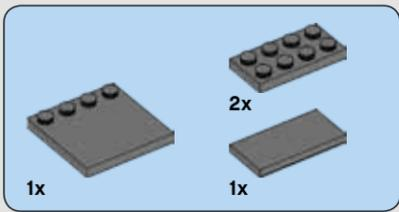
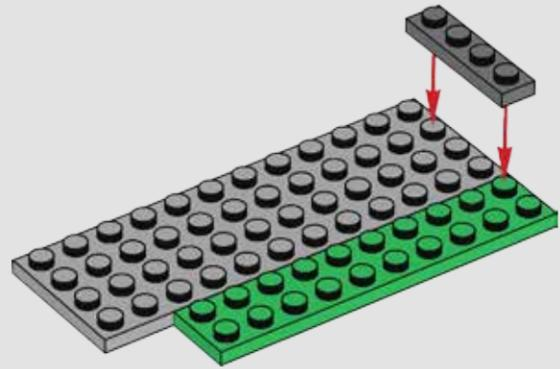

704

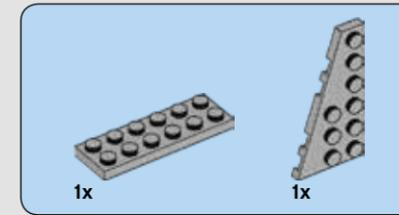
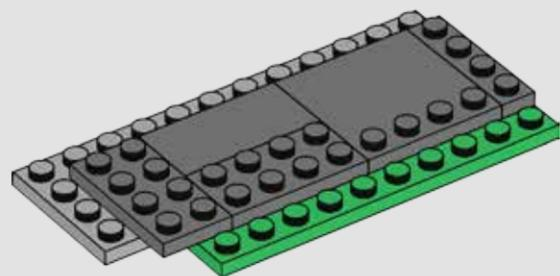

705

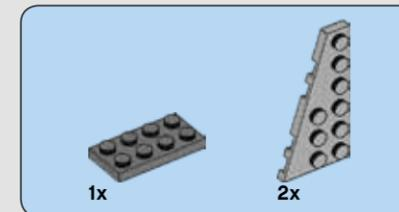
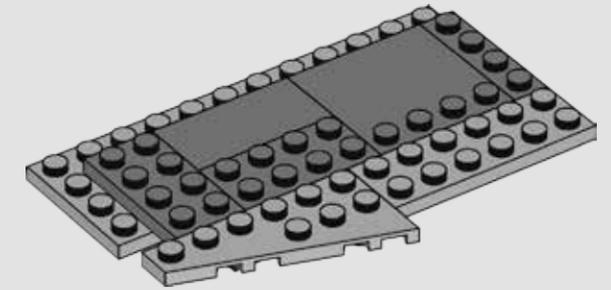

706

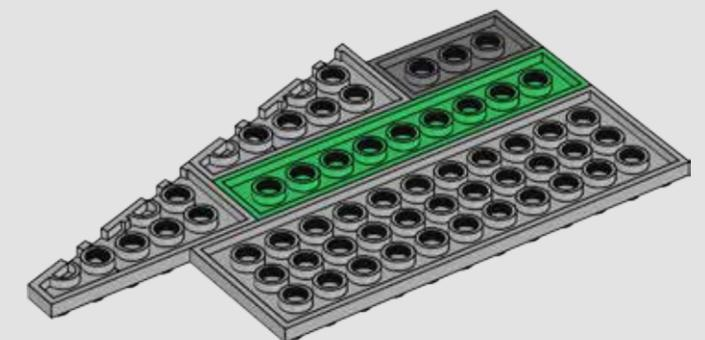

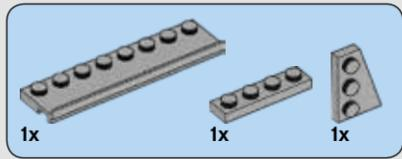

707

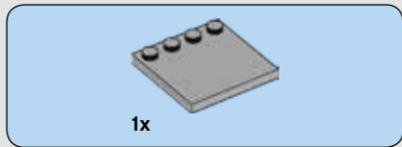
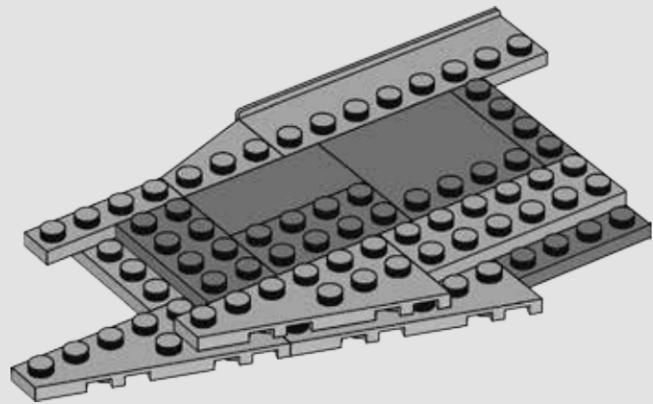

708

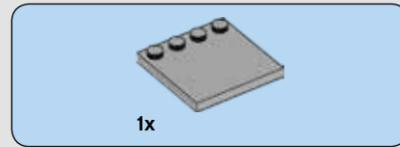
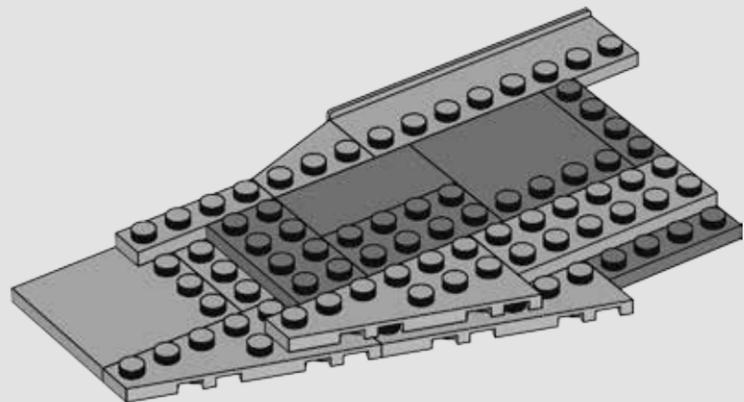

709

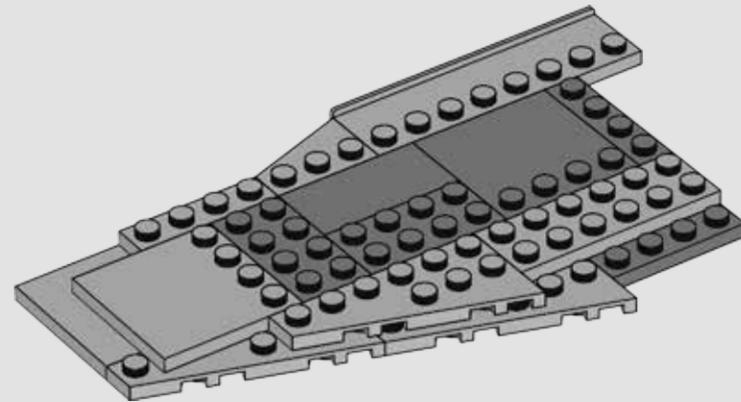

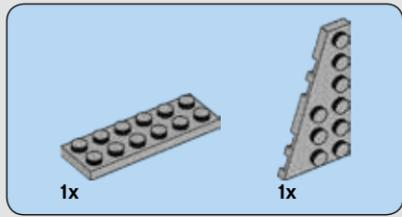

713

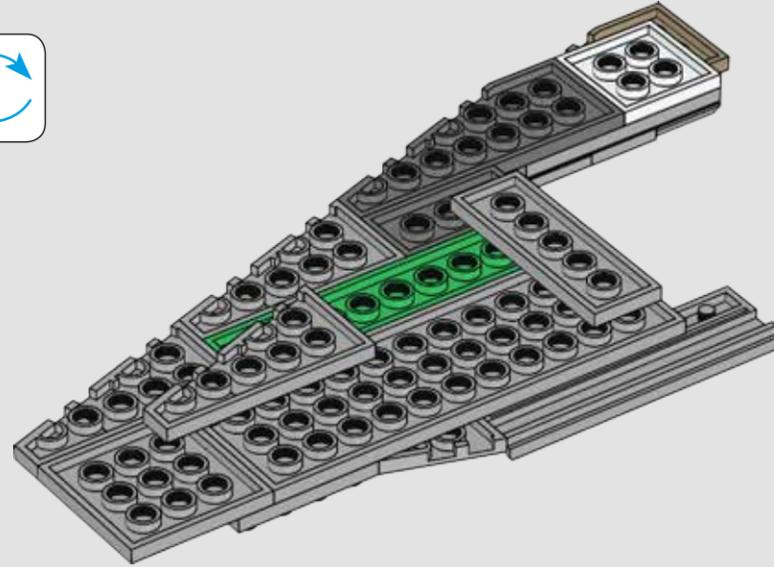

714

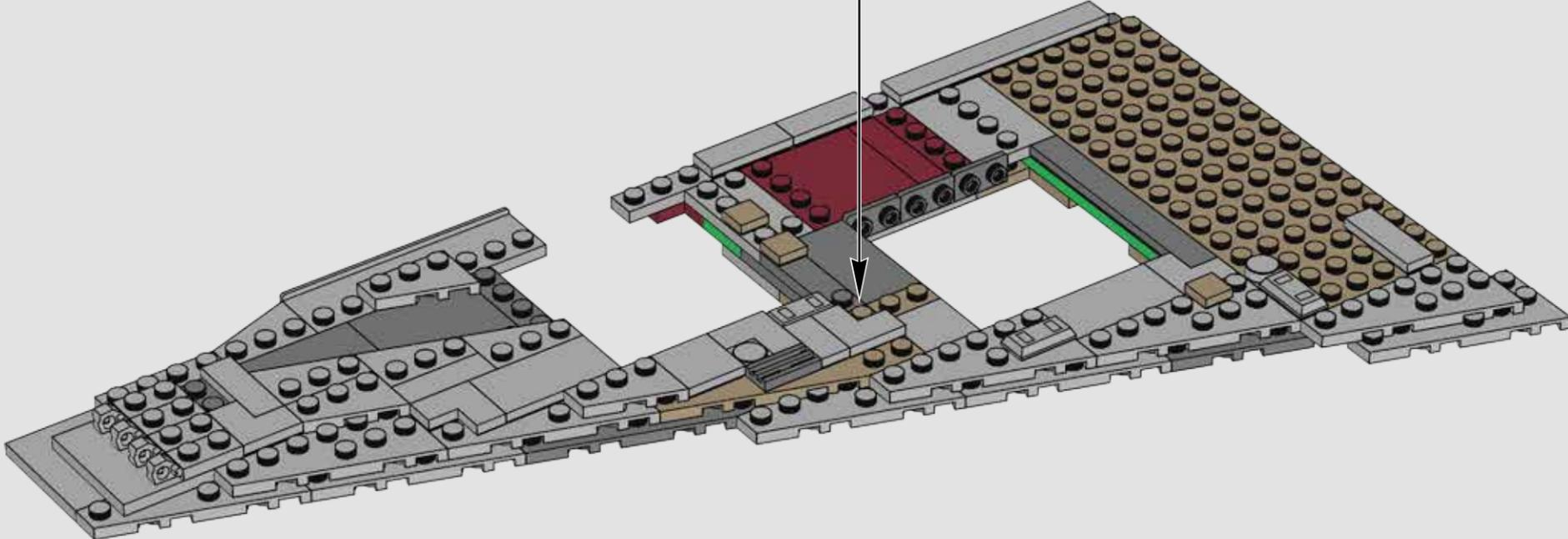

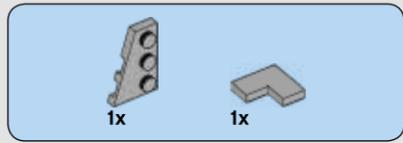

715

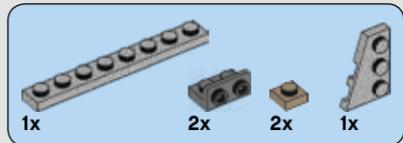
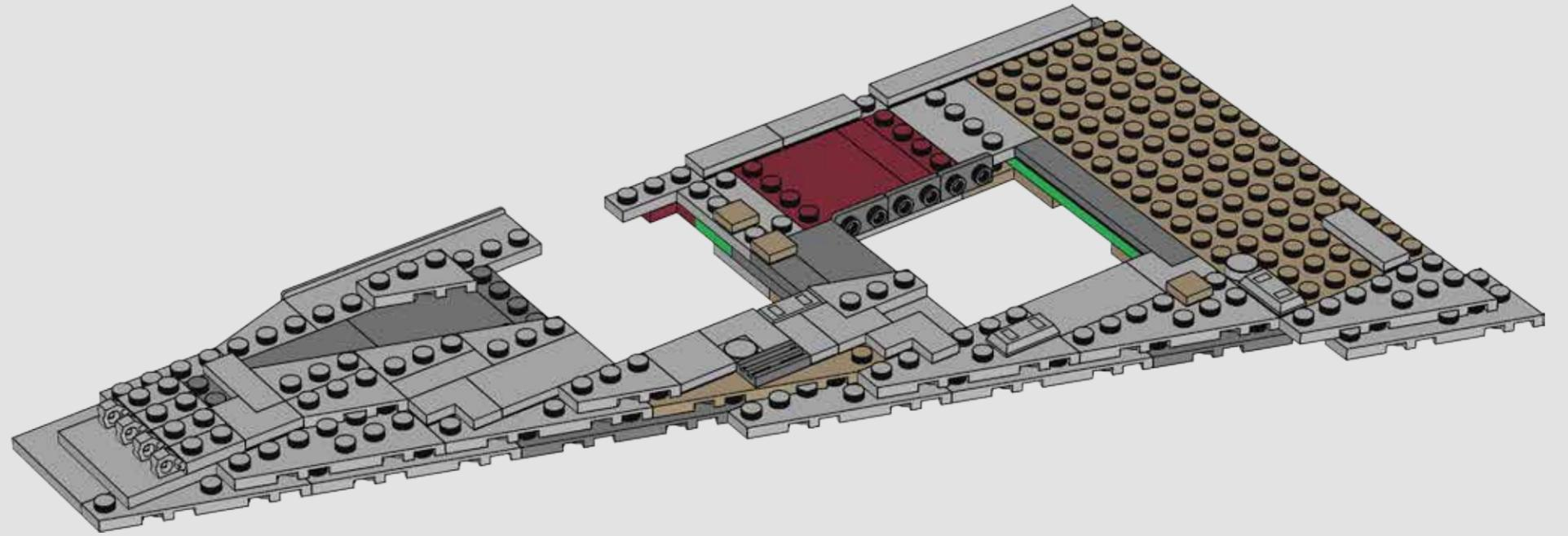

716

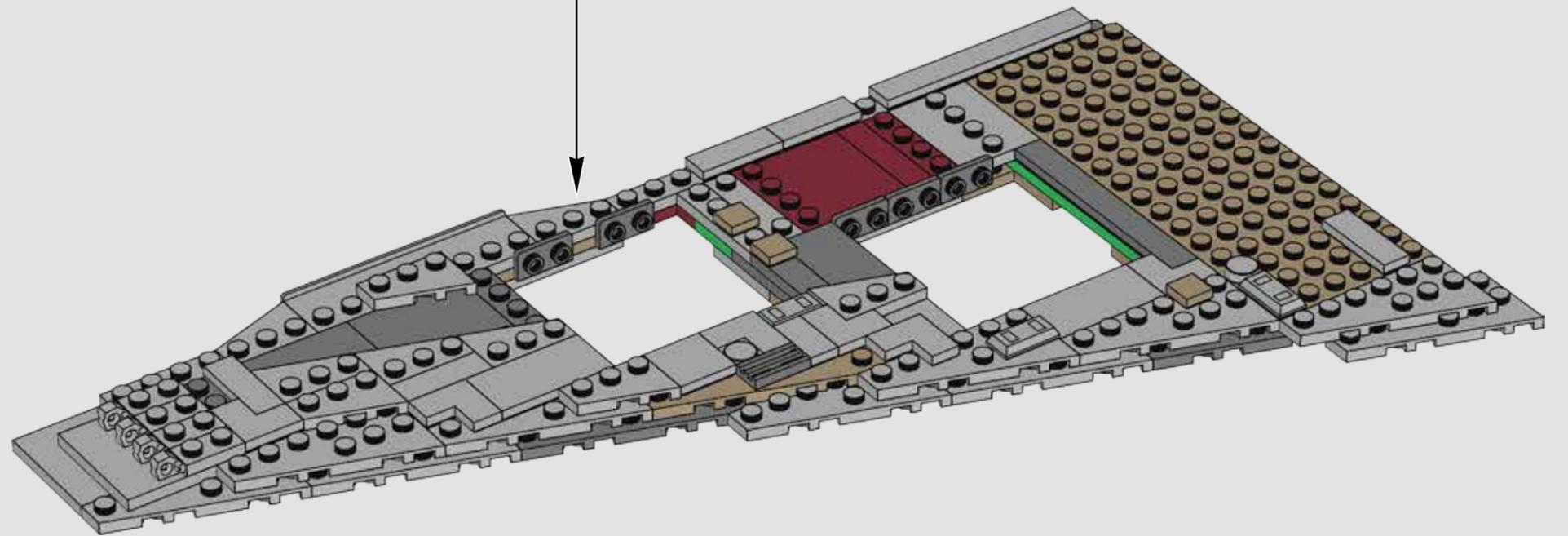
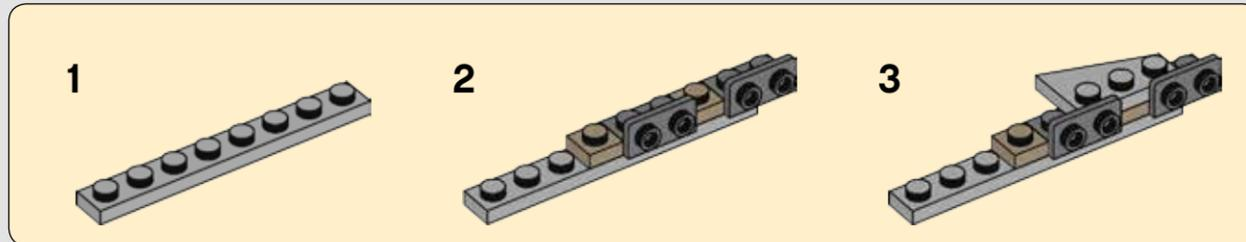

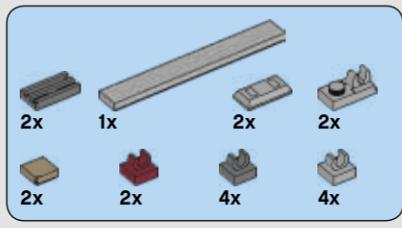

717

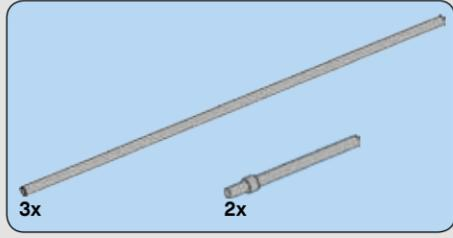
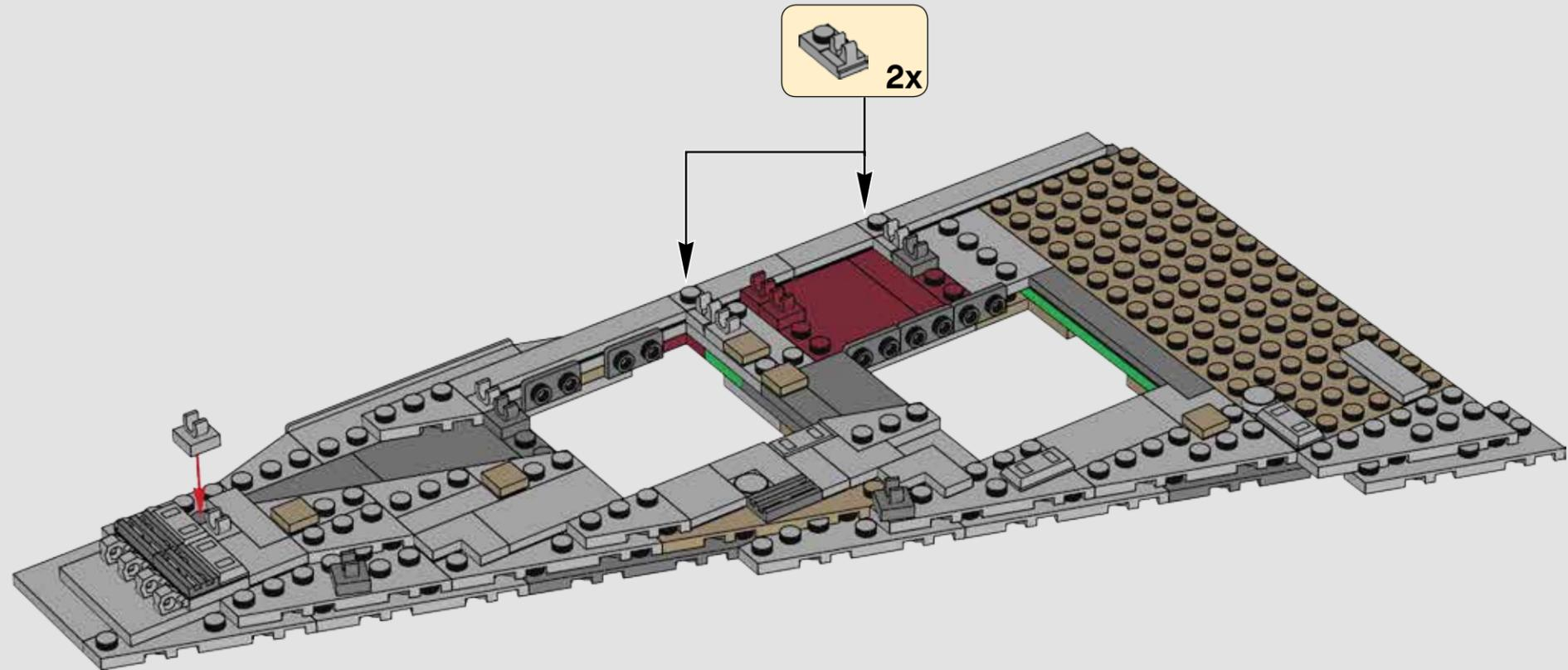

718

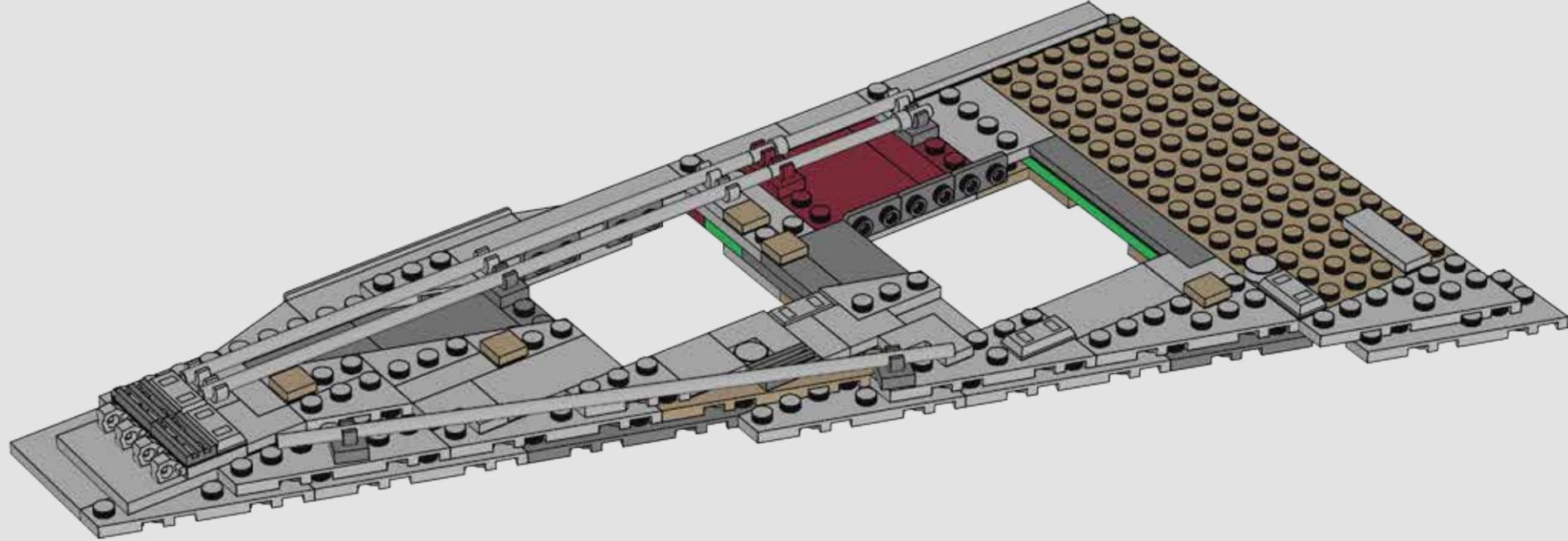

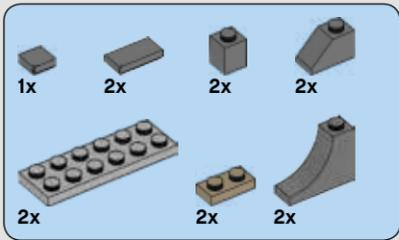

719

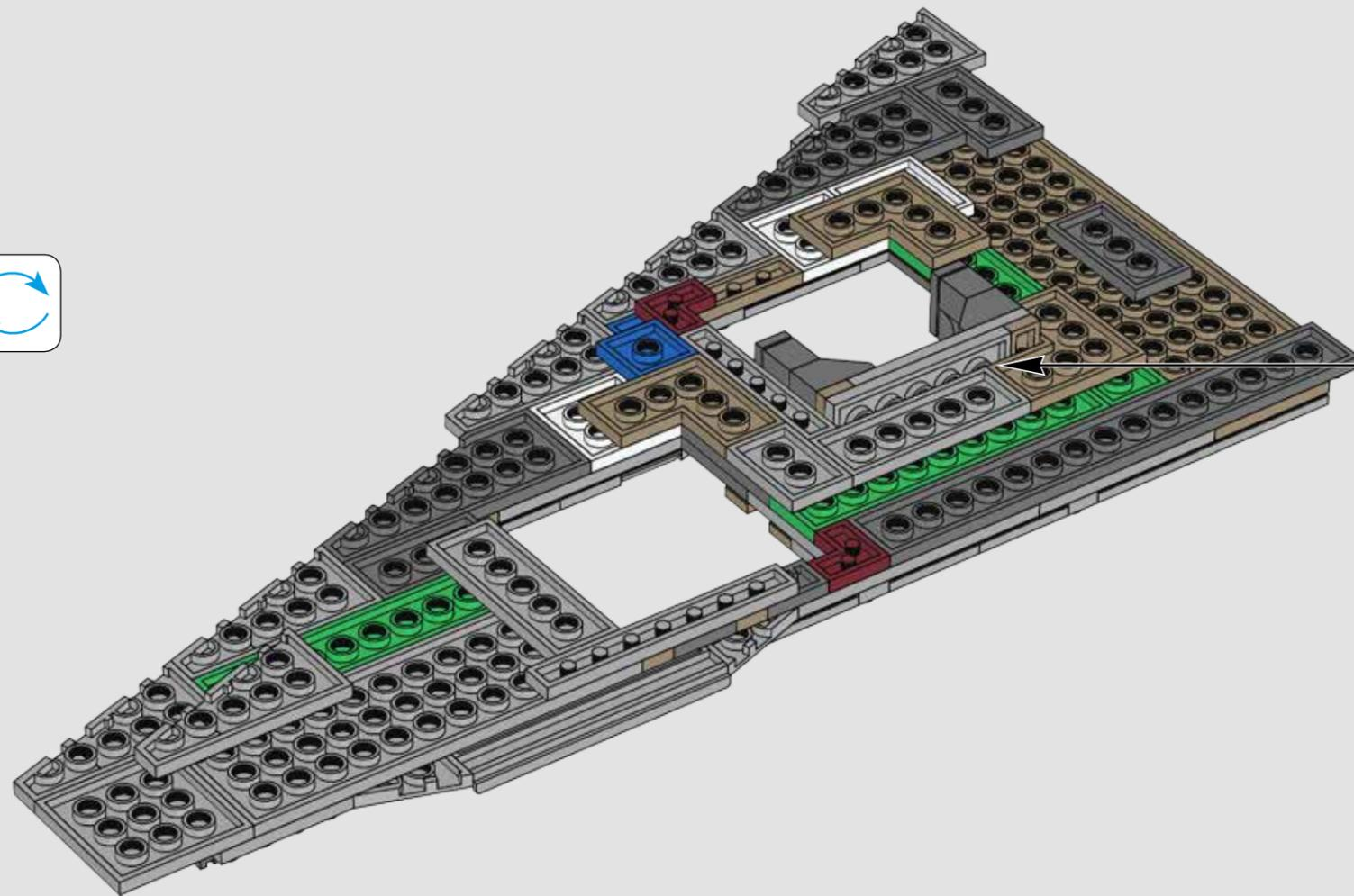
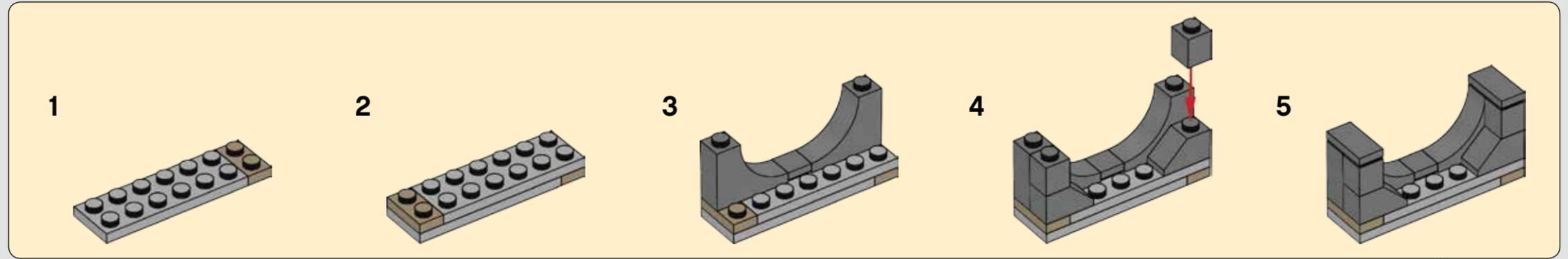

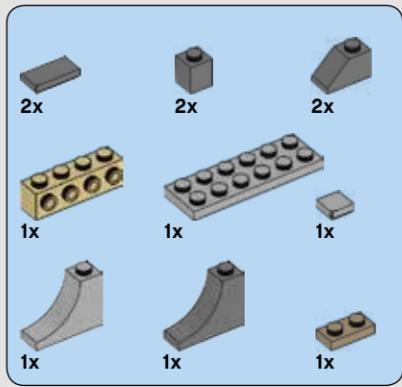

720

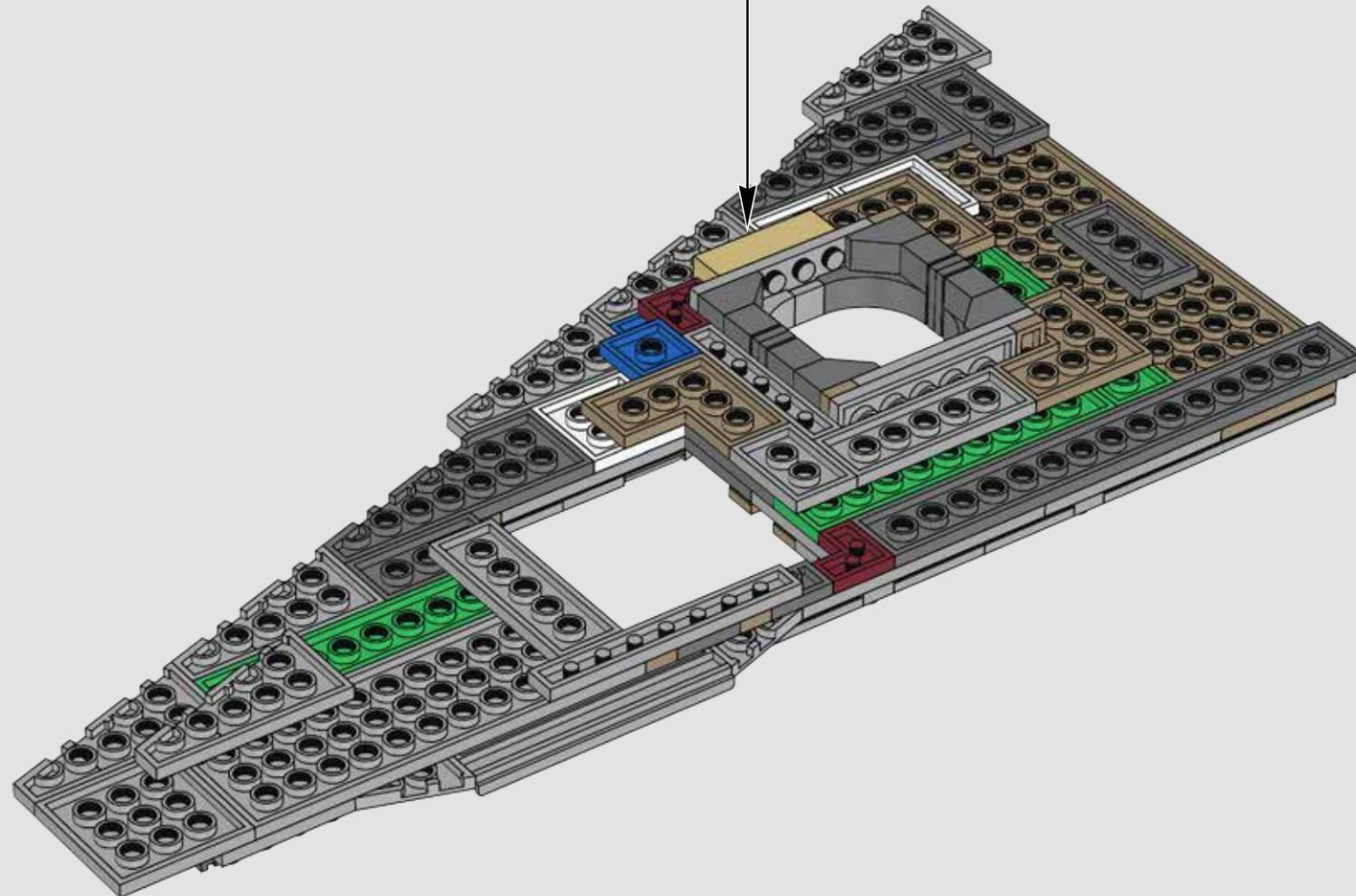
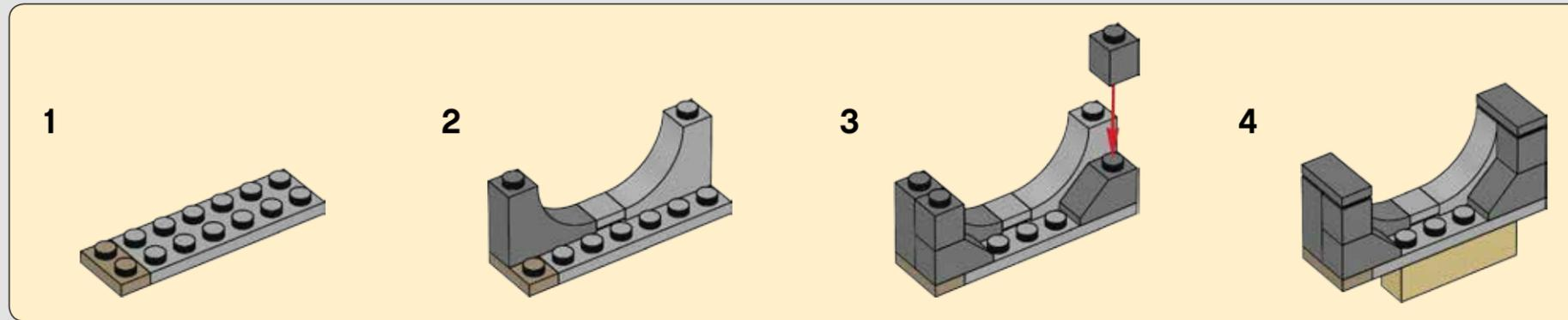

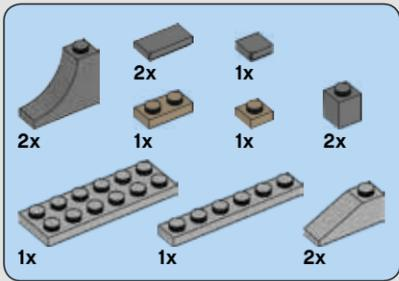

721

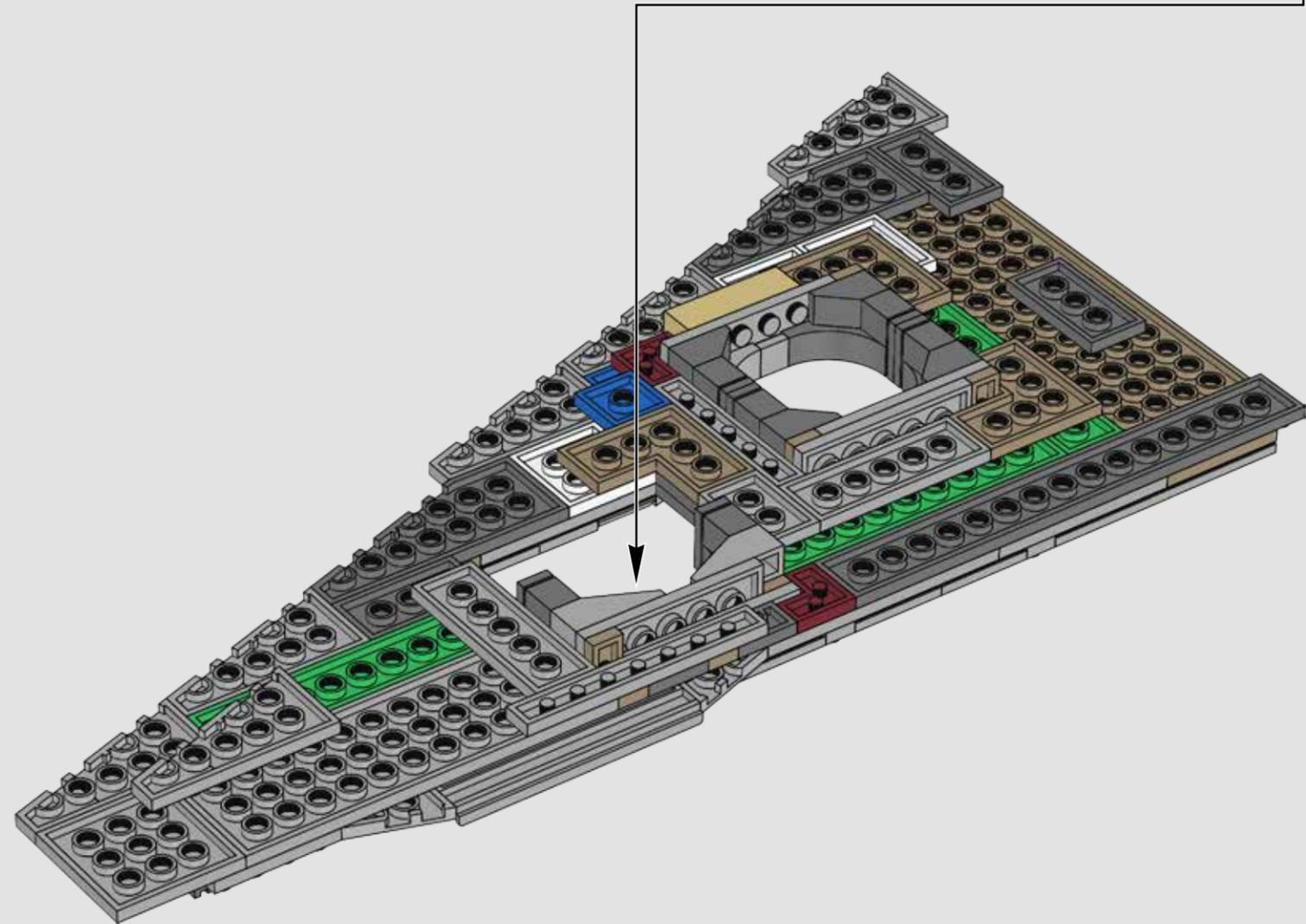
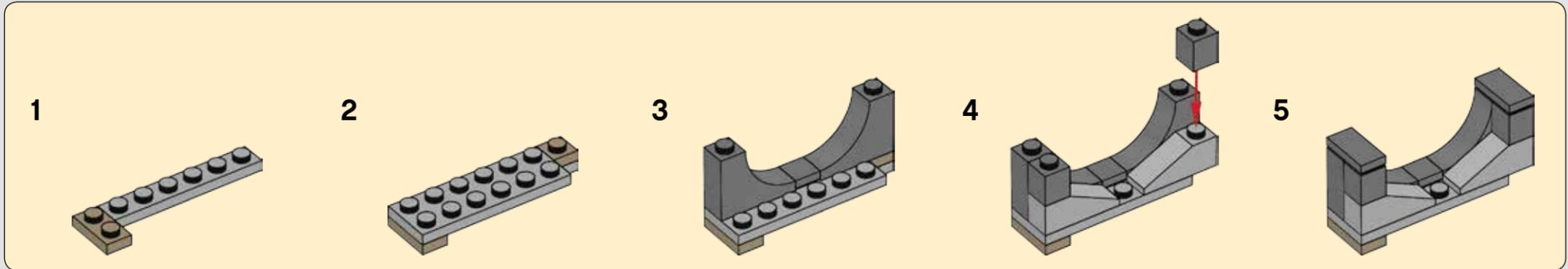

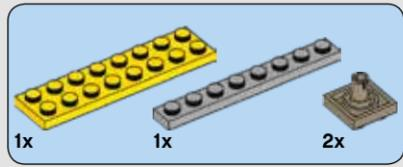

723

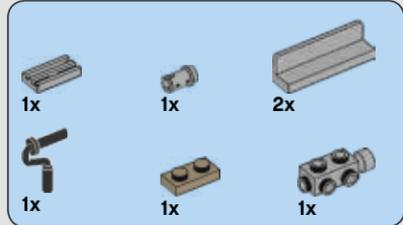
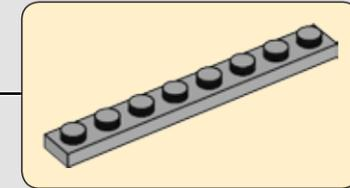
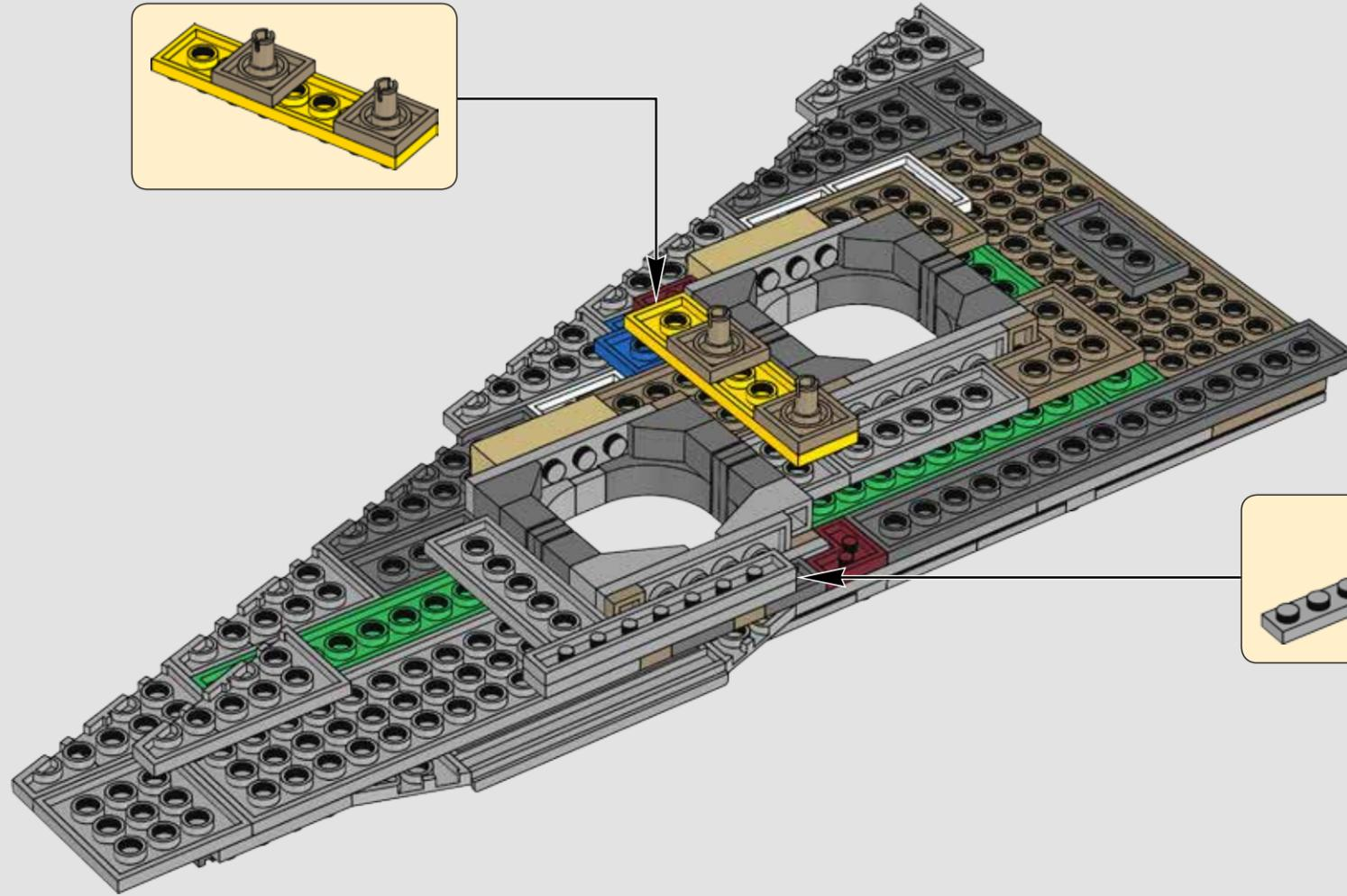
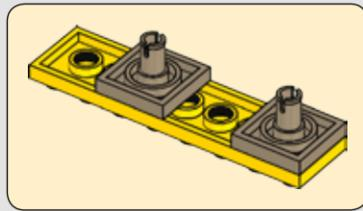

724

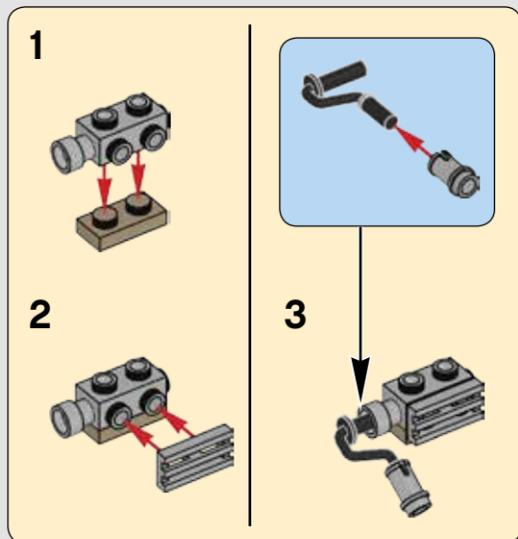
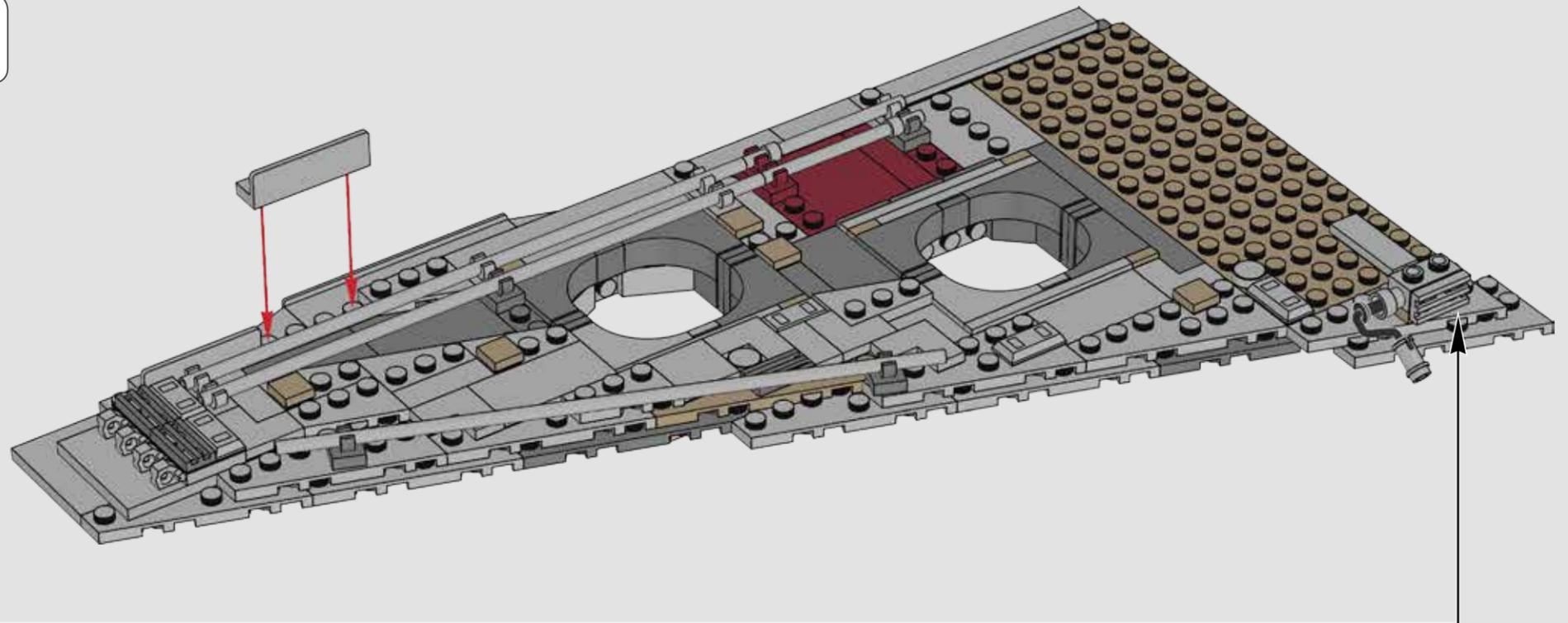

725

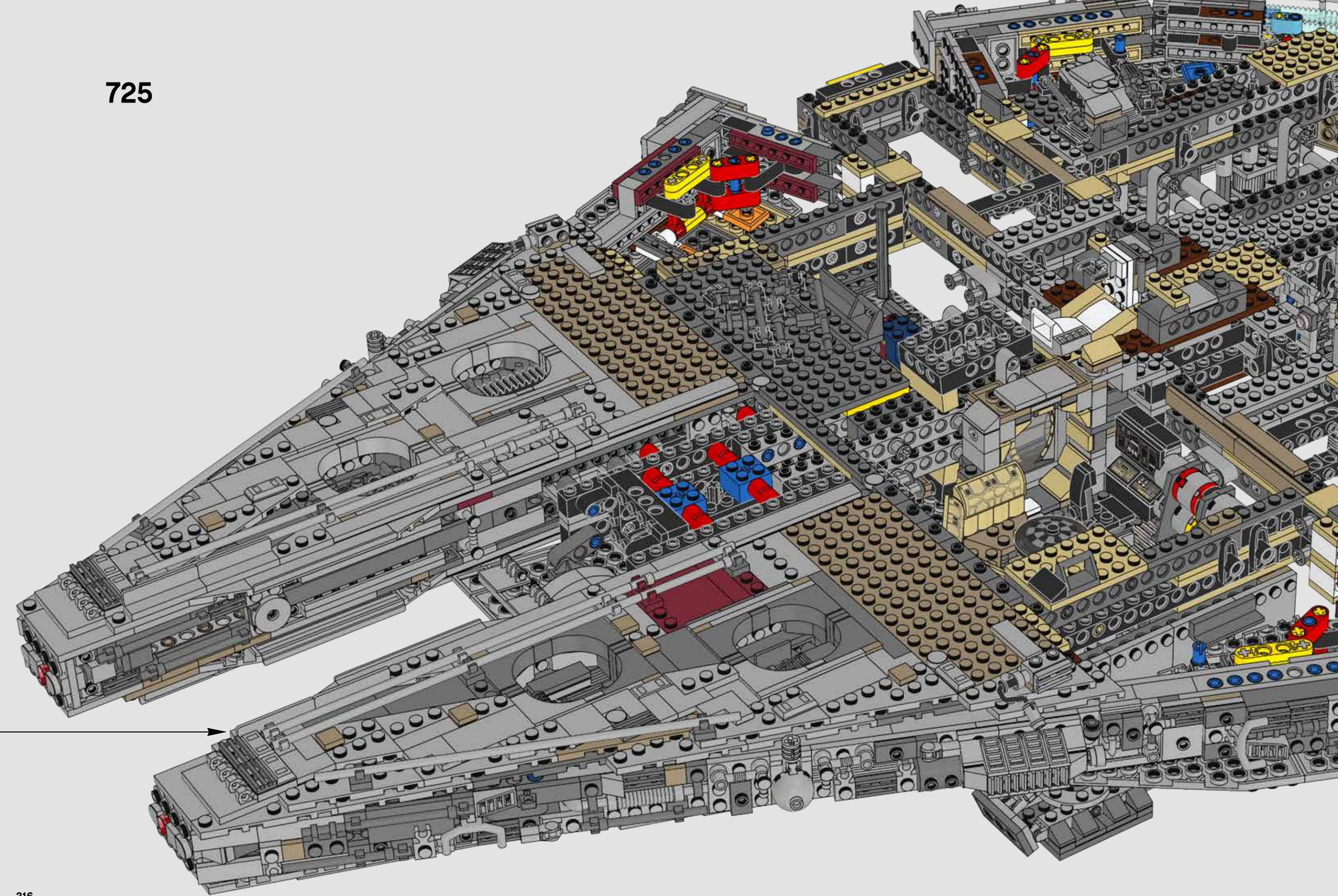

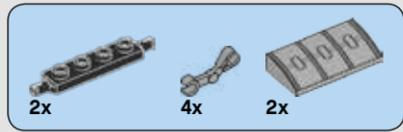

726

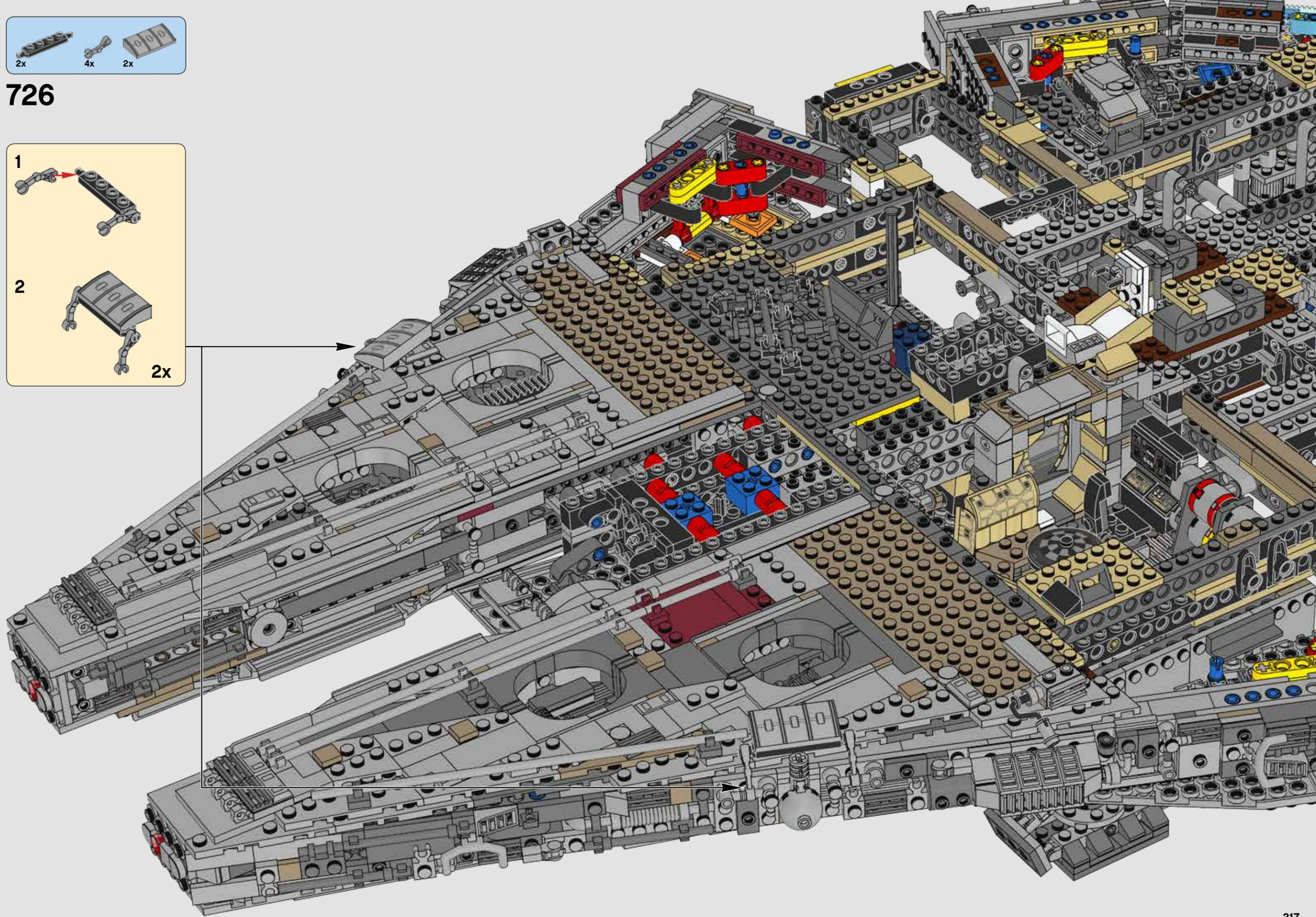
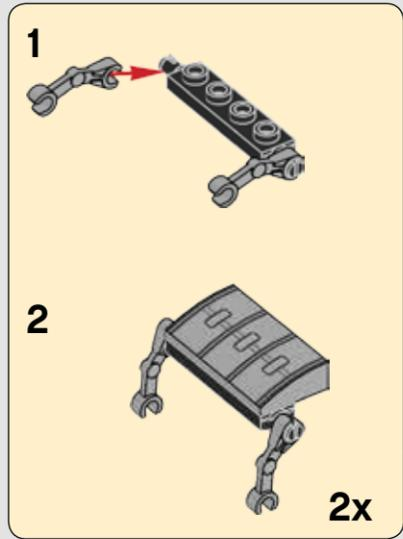

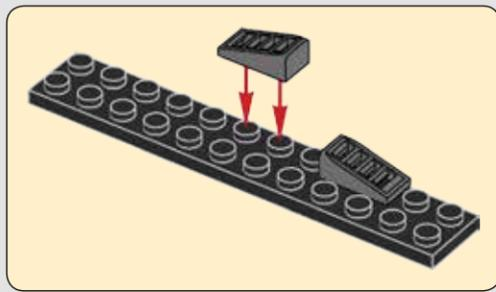
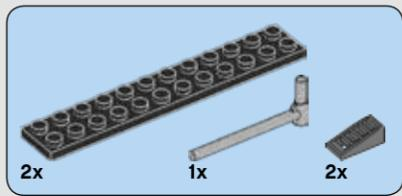

727

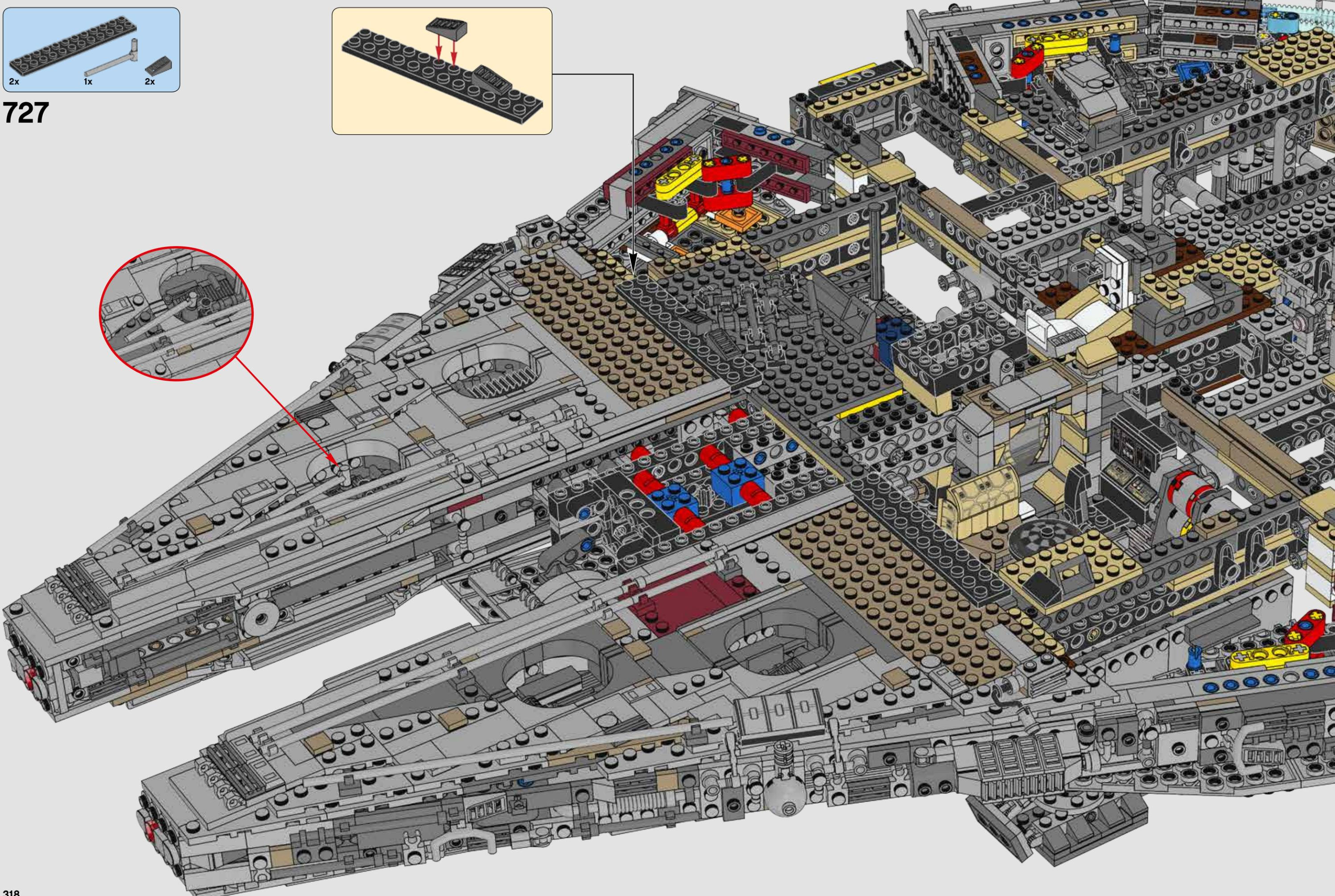
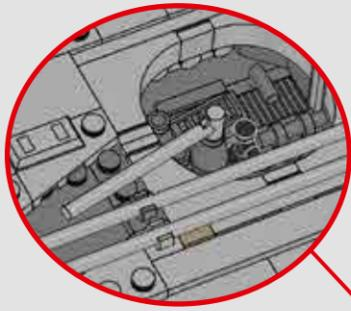

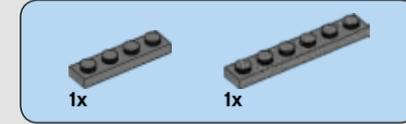
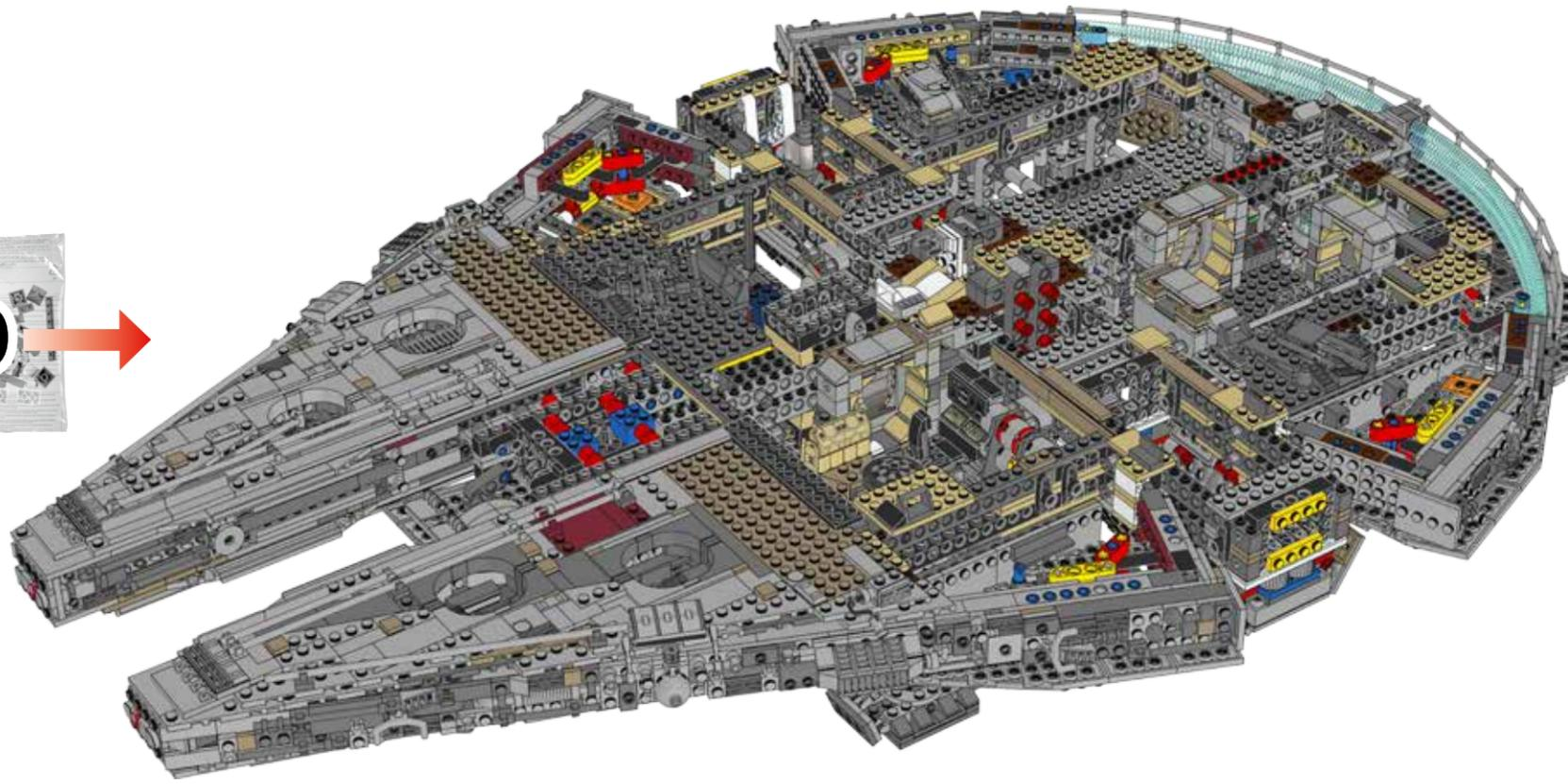

730

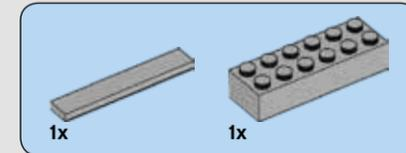
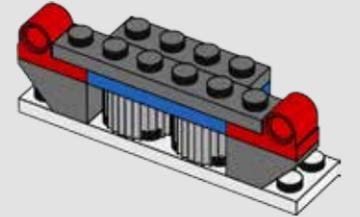

731

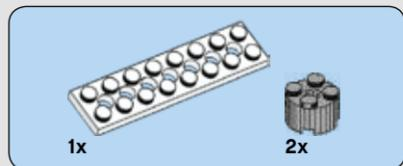
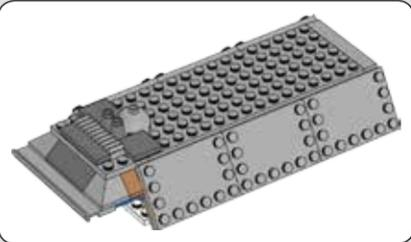
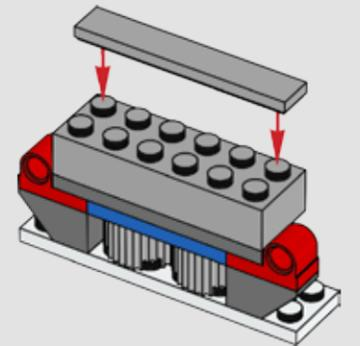

728

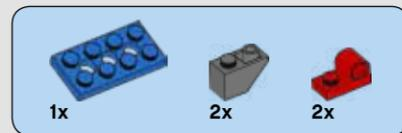
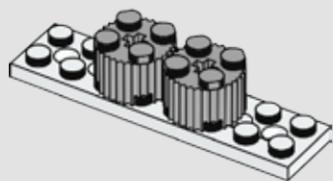

729

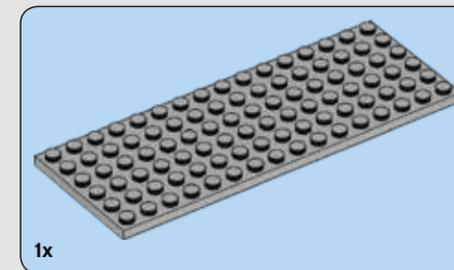
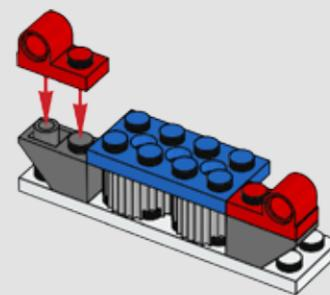

732

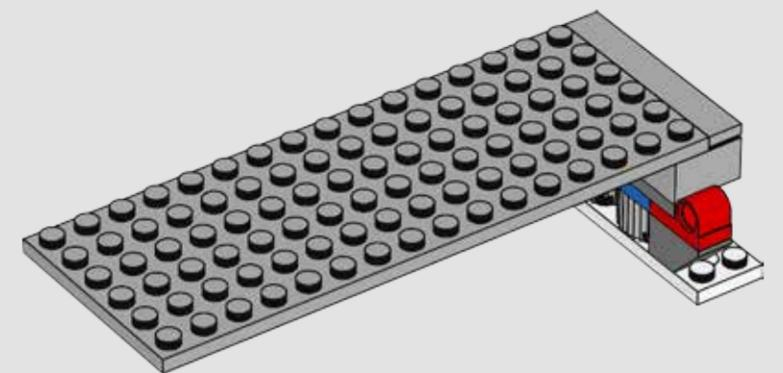

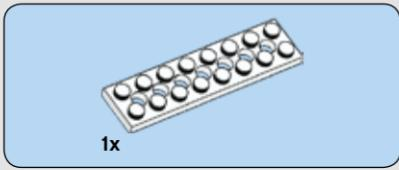

733

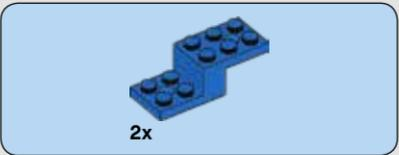
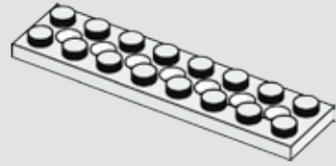

734

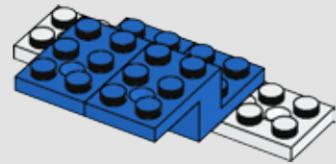

735

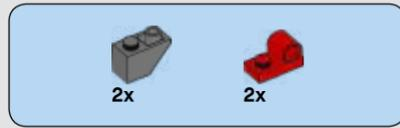
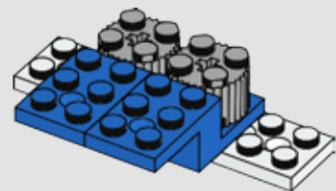

736

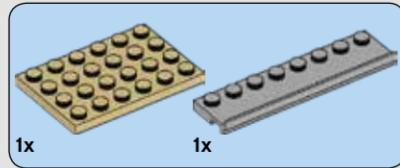
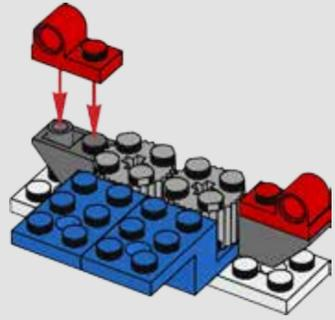

737

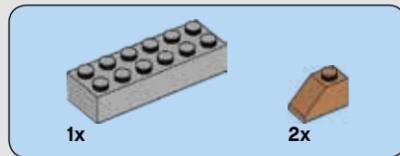
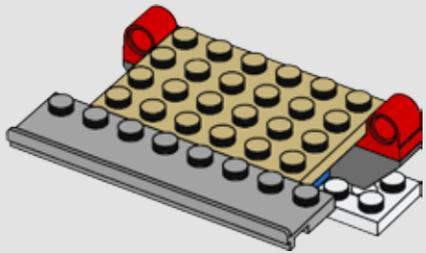

738

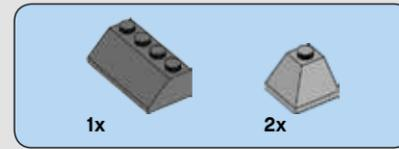
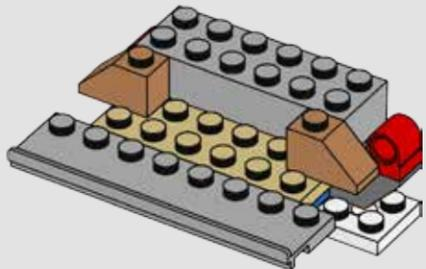

739

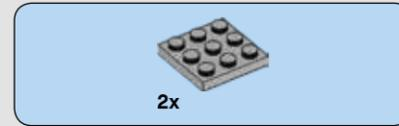
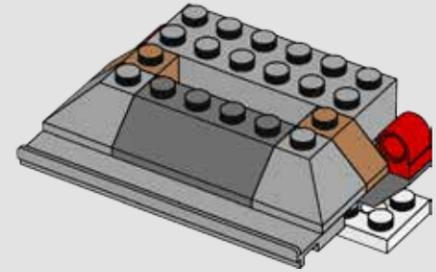

740

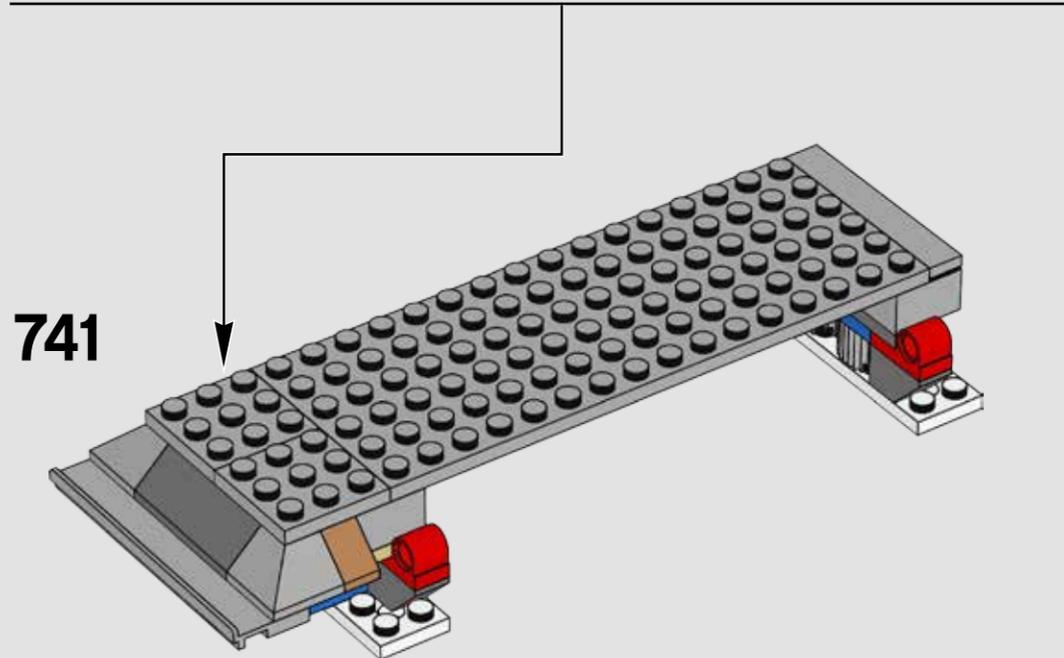
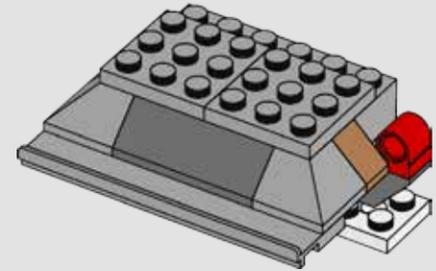

741



743

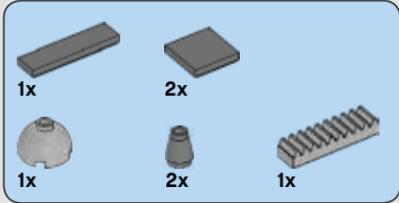
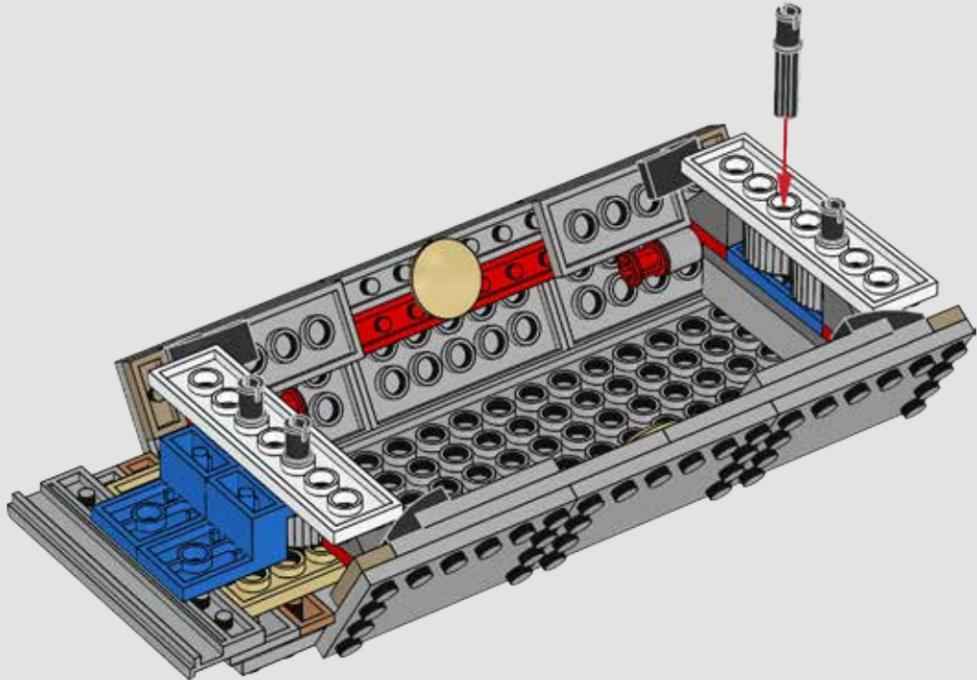

744

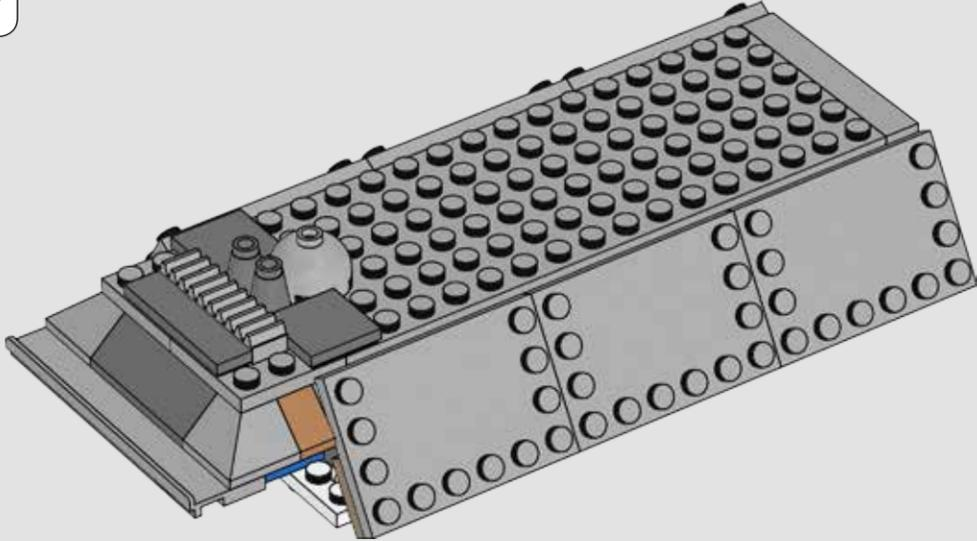

745

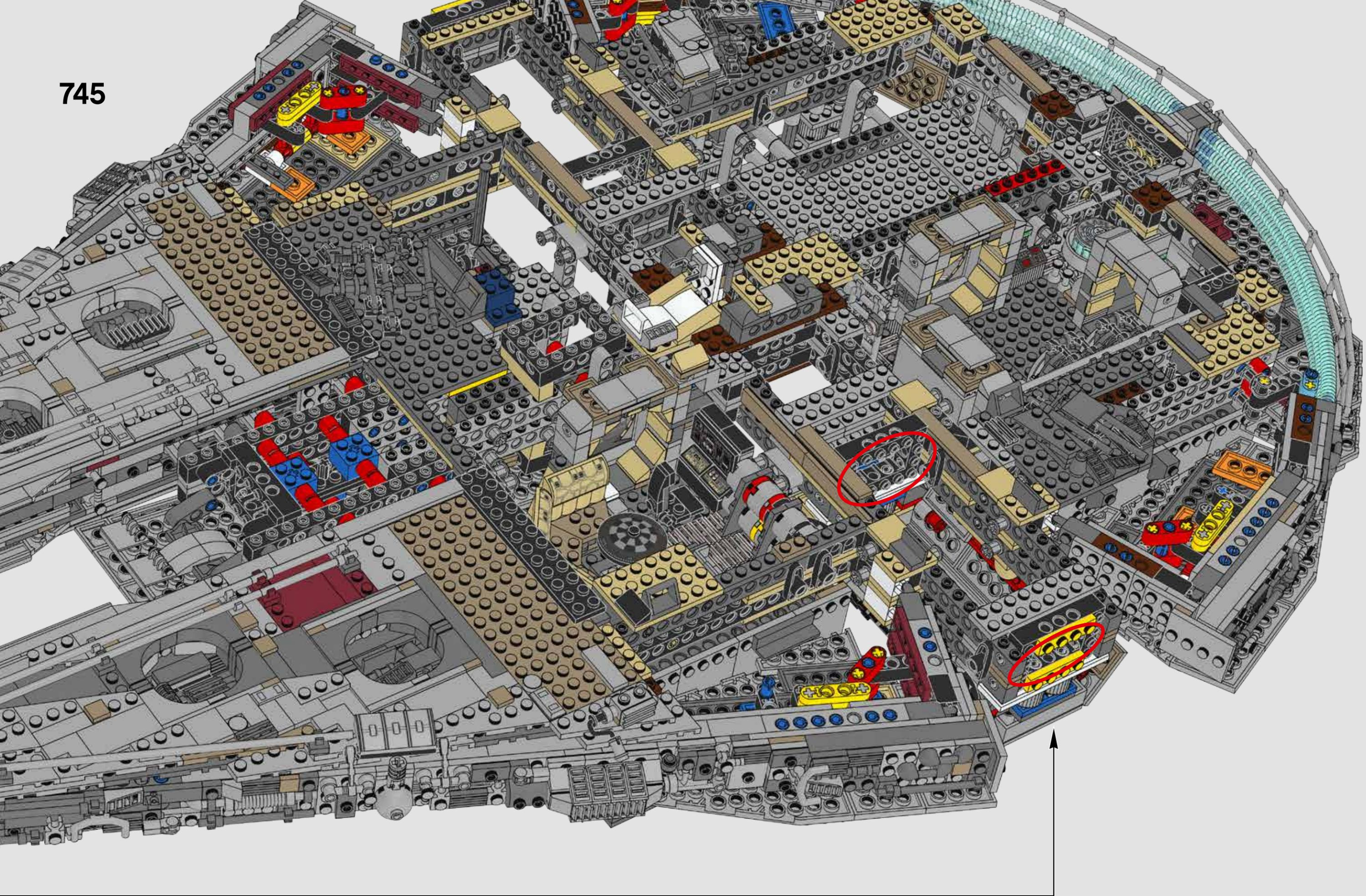

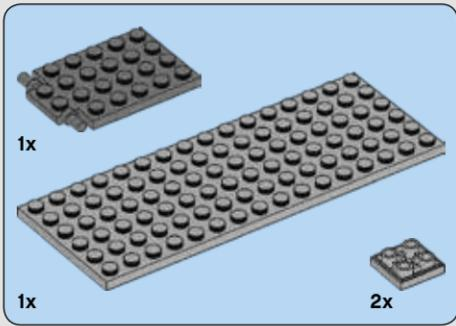
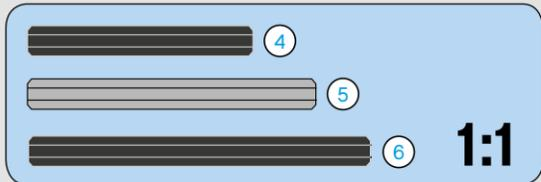
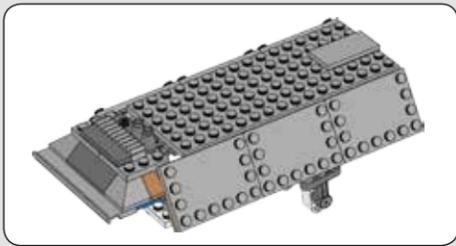

746

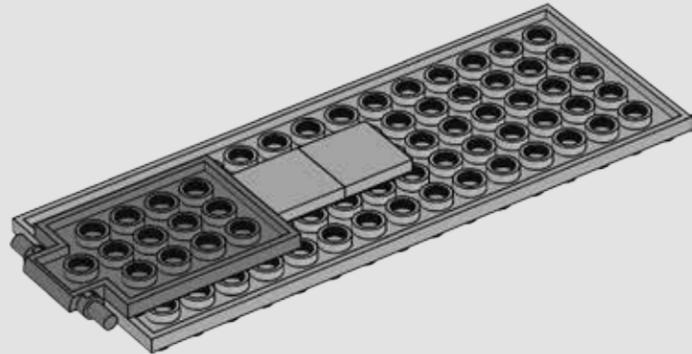

747

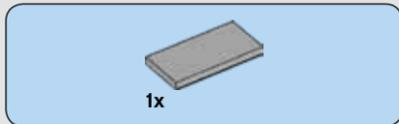
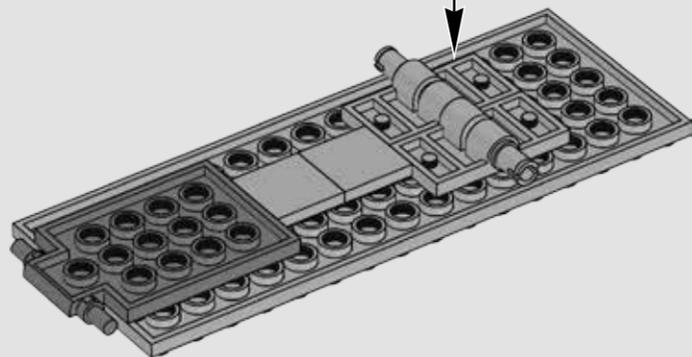
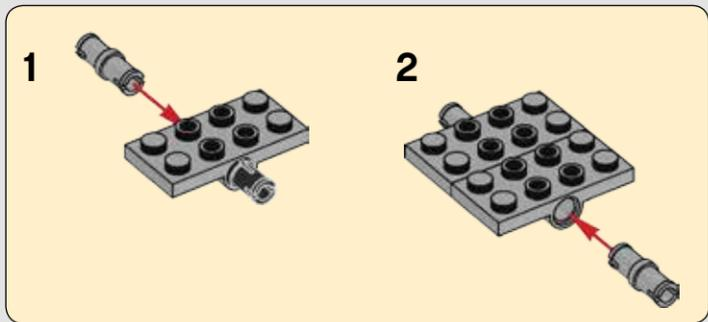

748

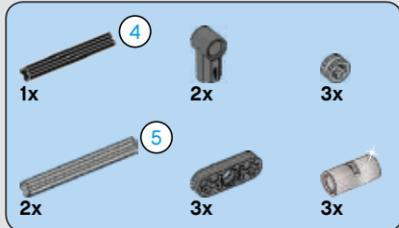
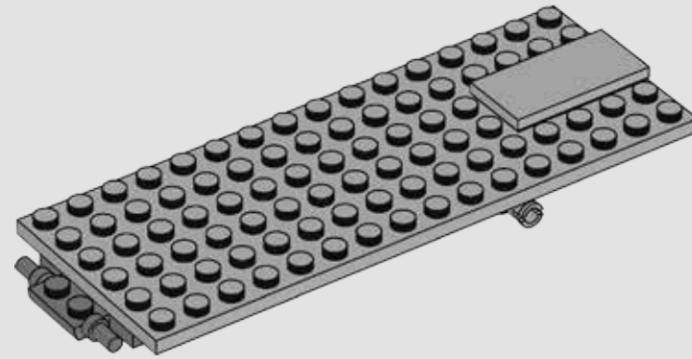

749

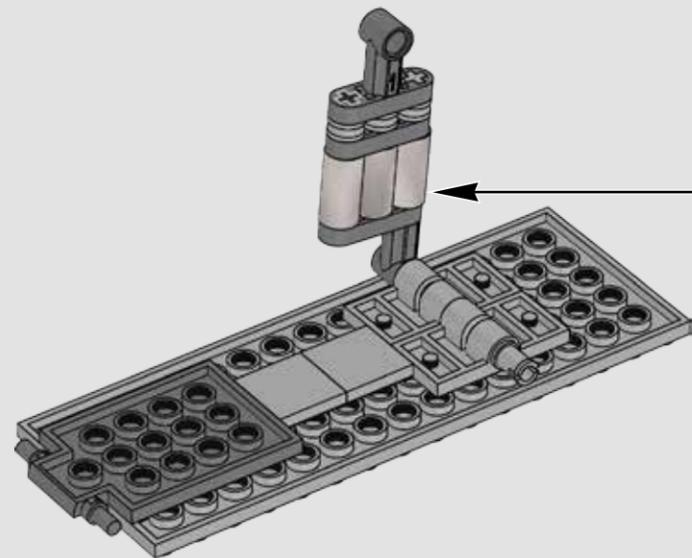
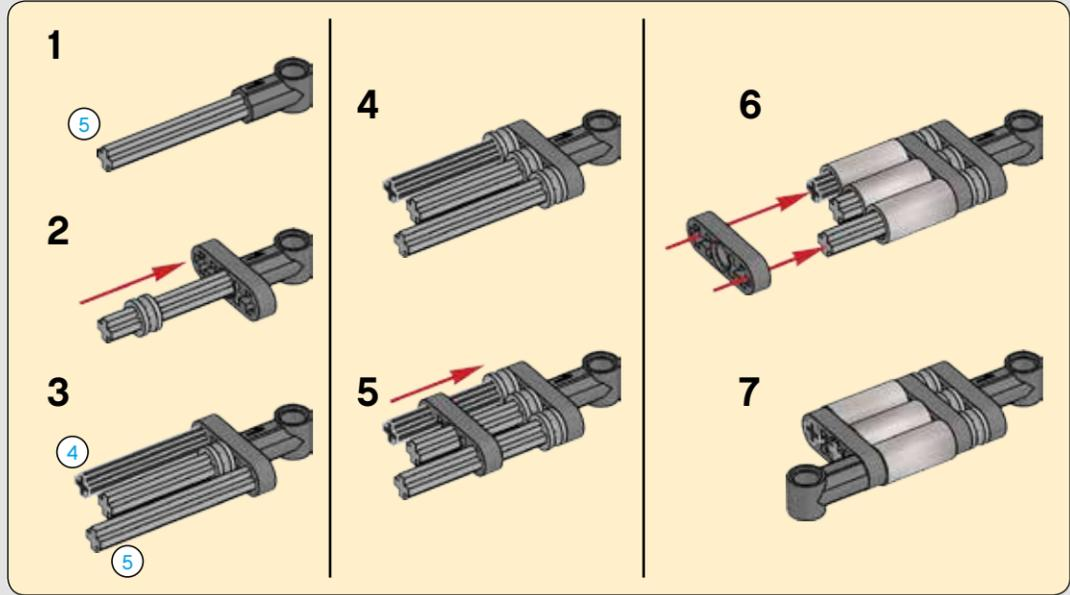

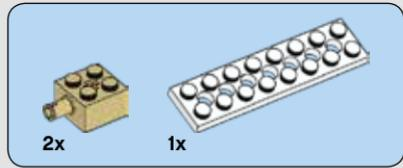

750

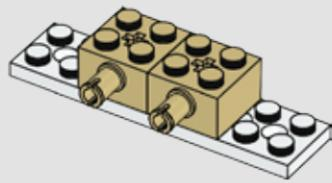

751

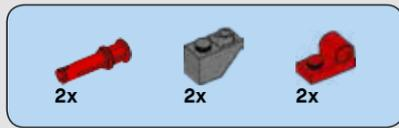
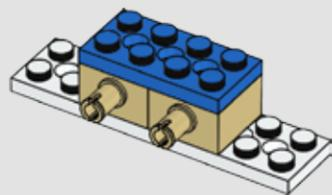

752

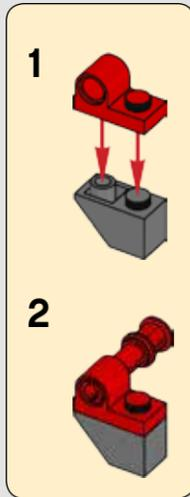

2

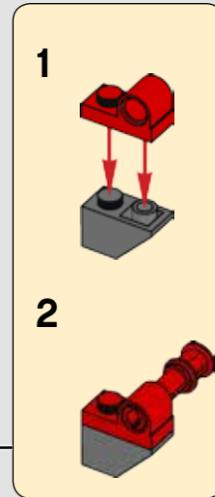
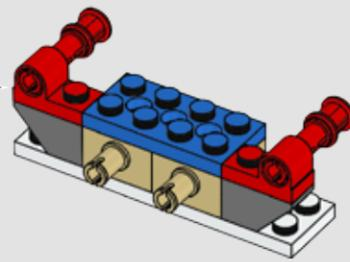

2

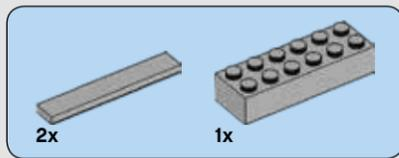

753

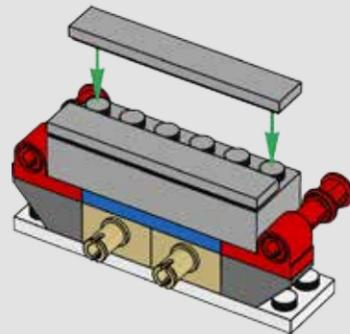

754

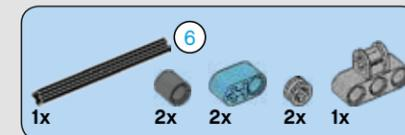
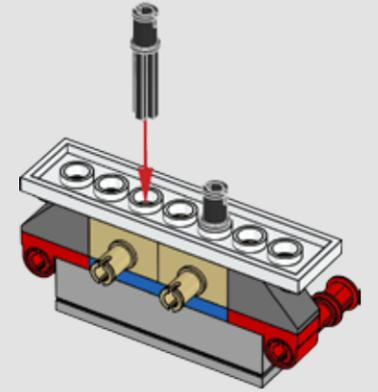

755

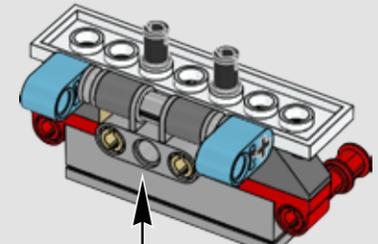
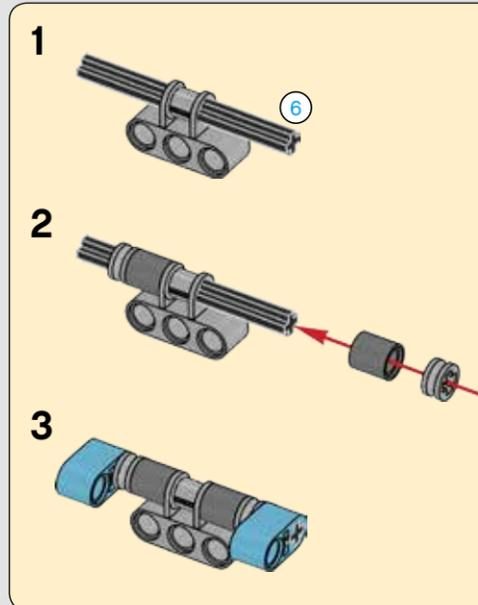

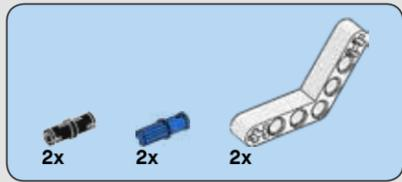

756

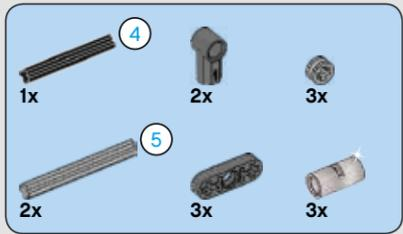
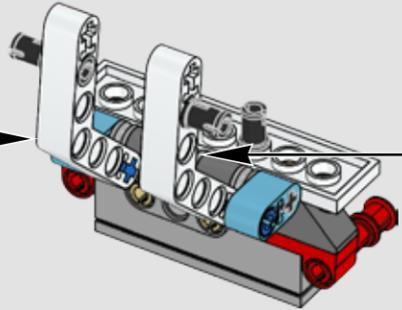
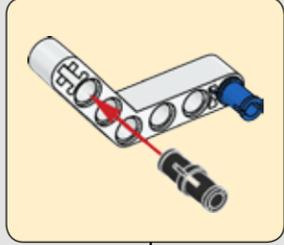
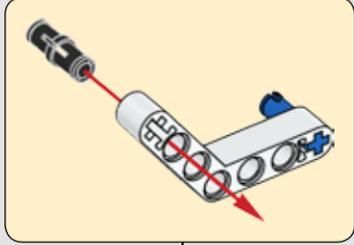

758

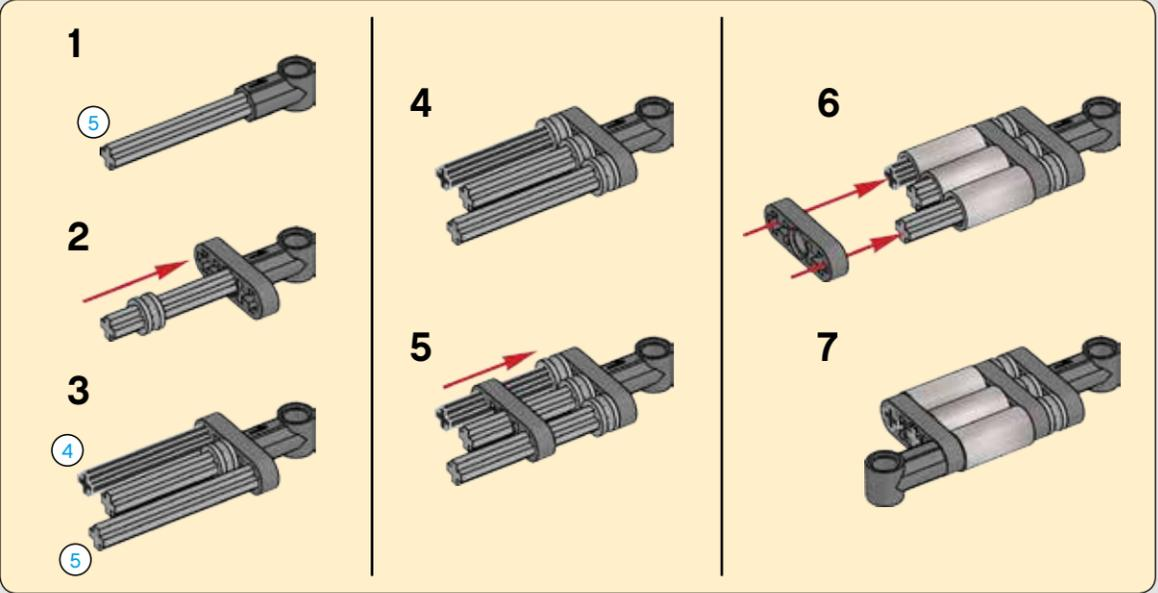

757

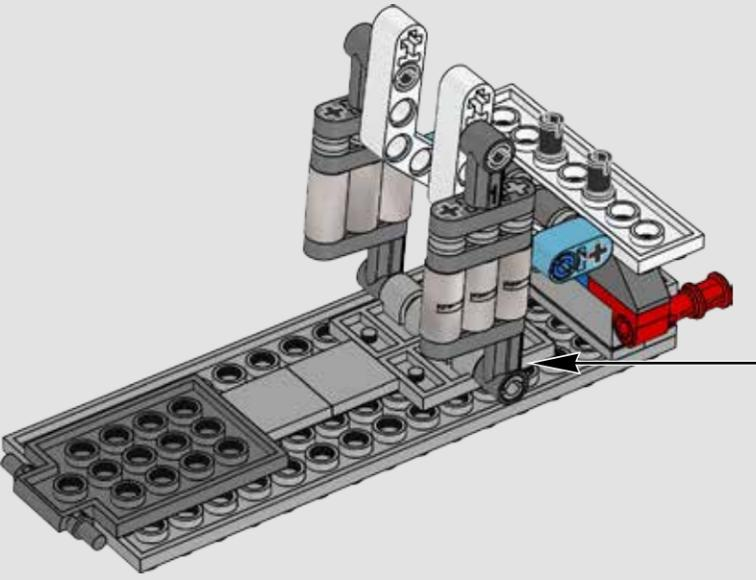
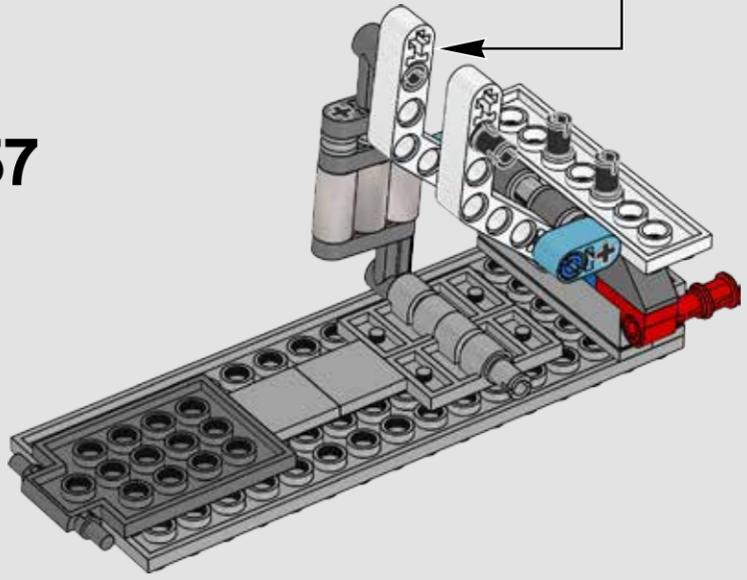

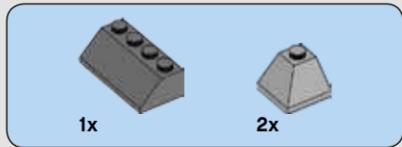

765

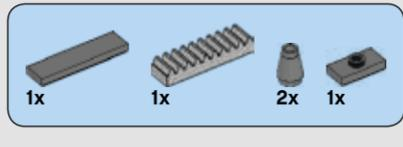
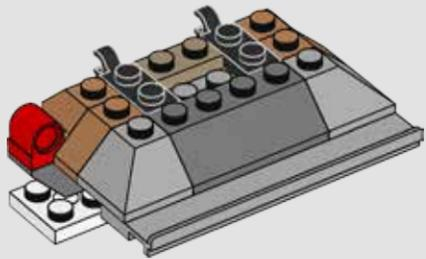

767

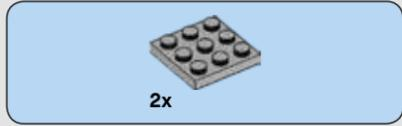
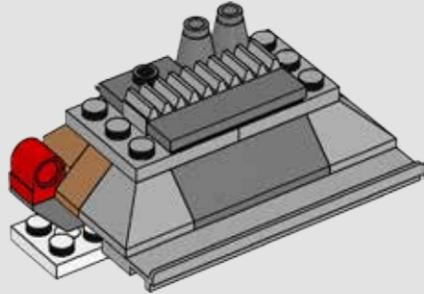

766

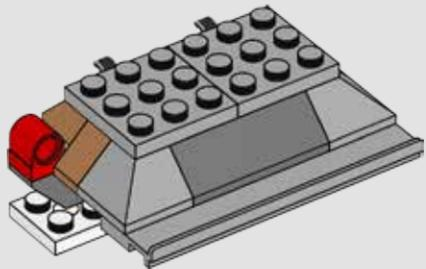

768

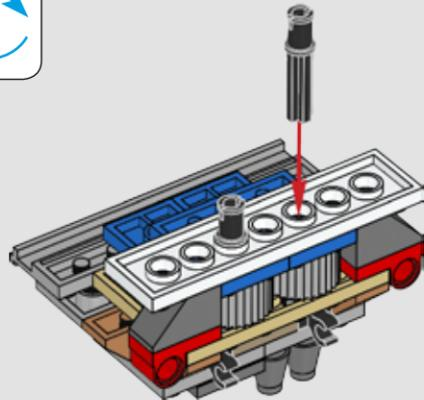

769

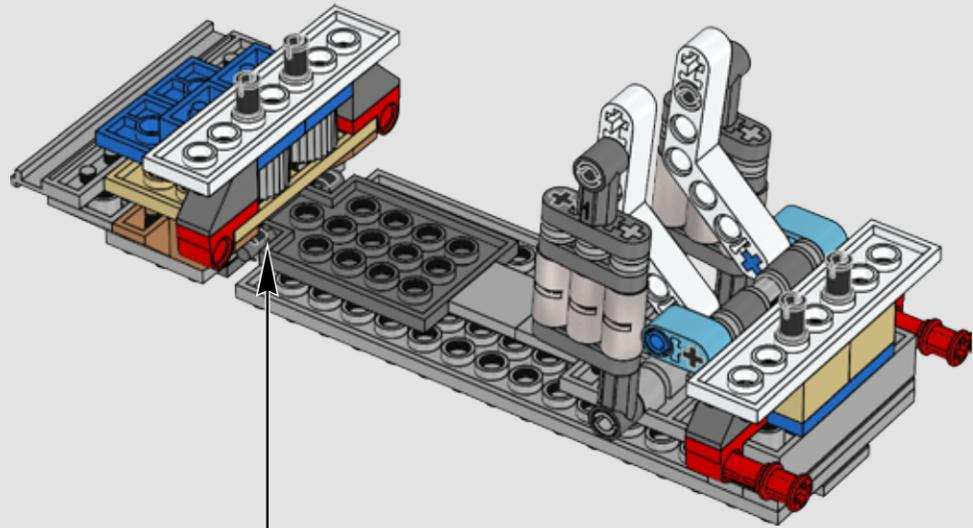

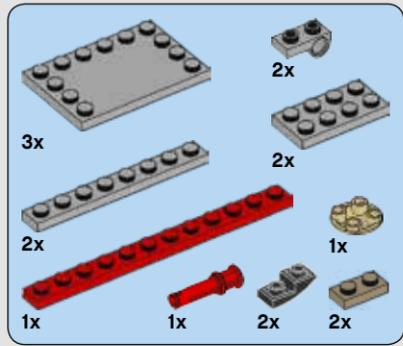

770

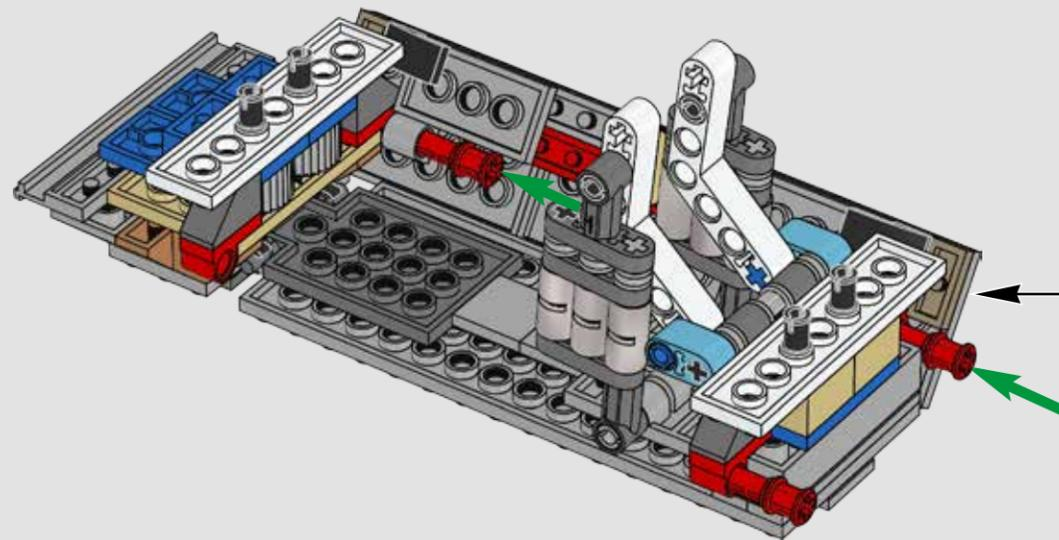
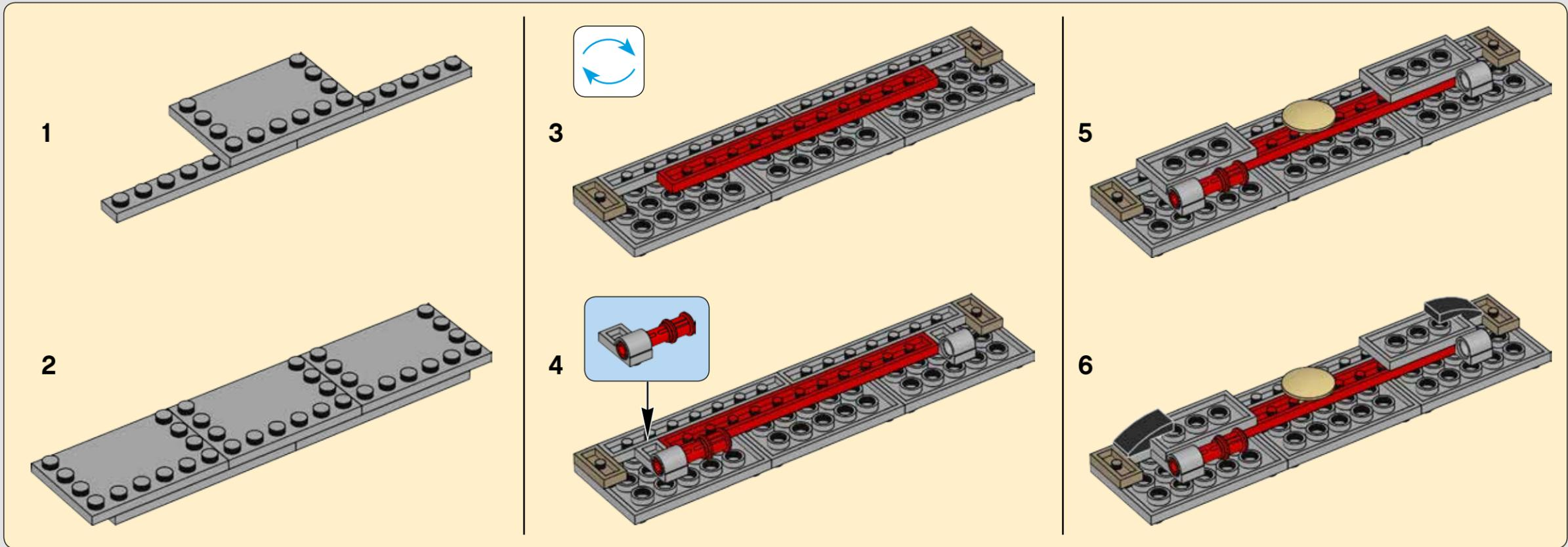

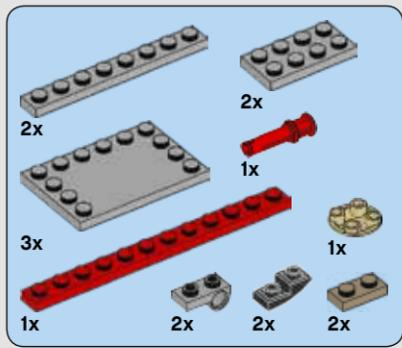

771

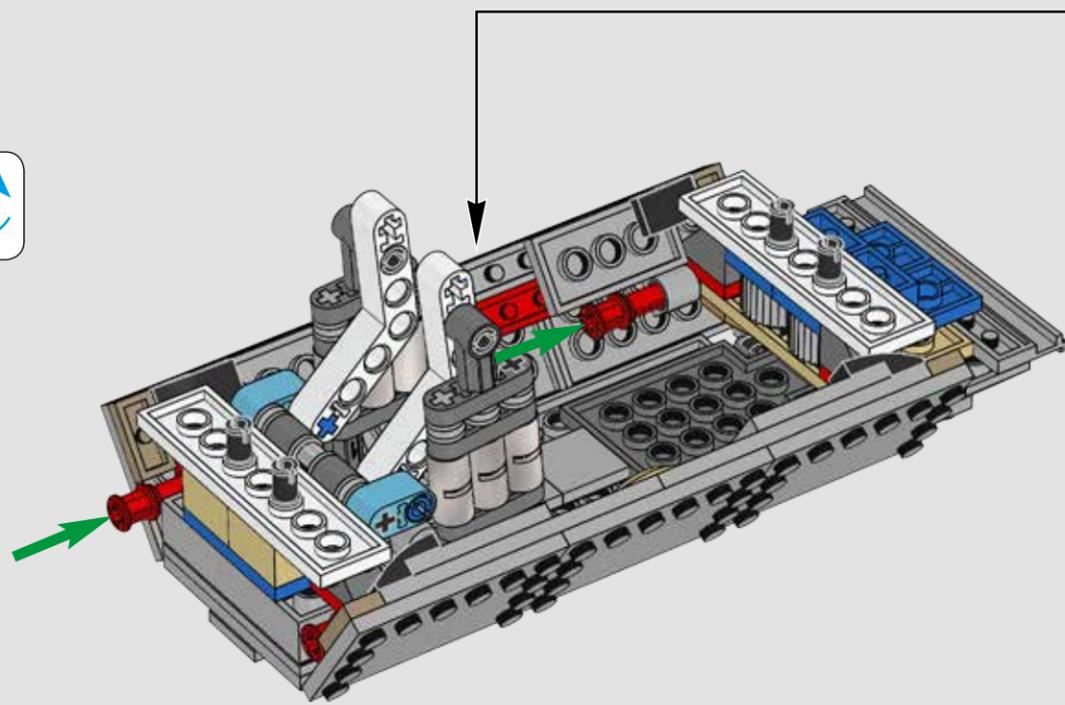
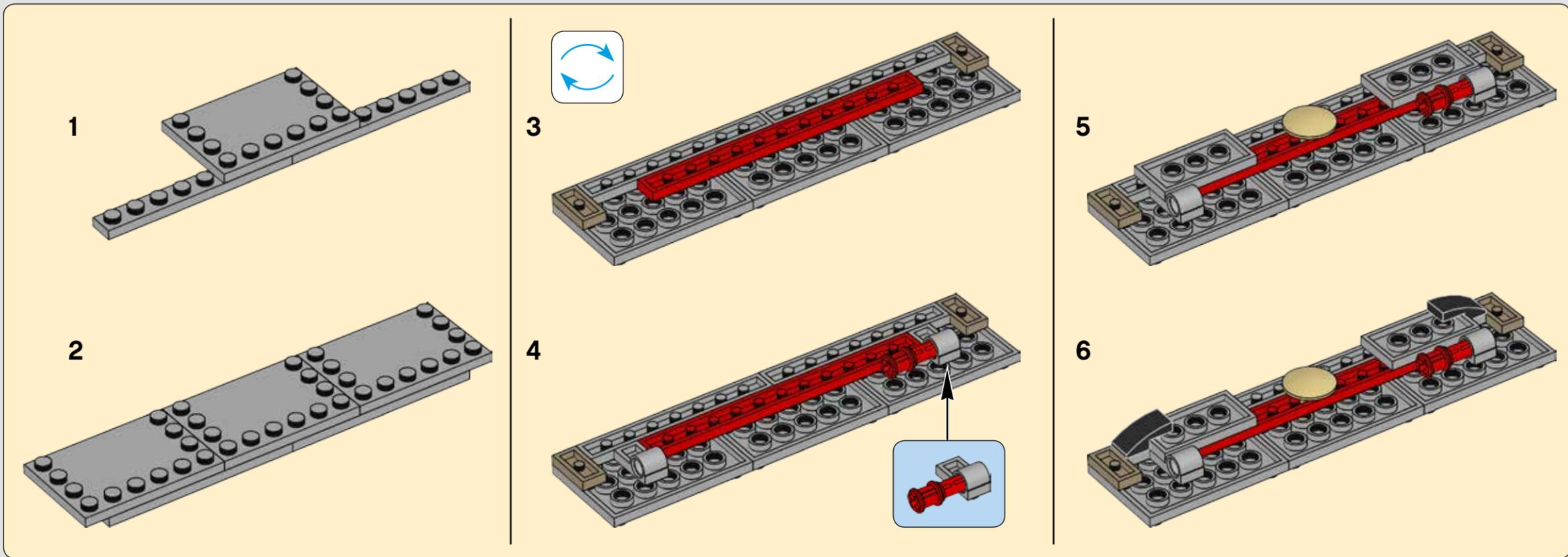

772

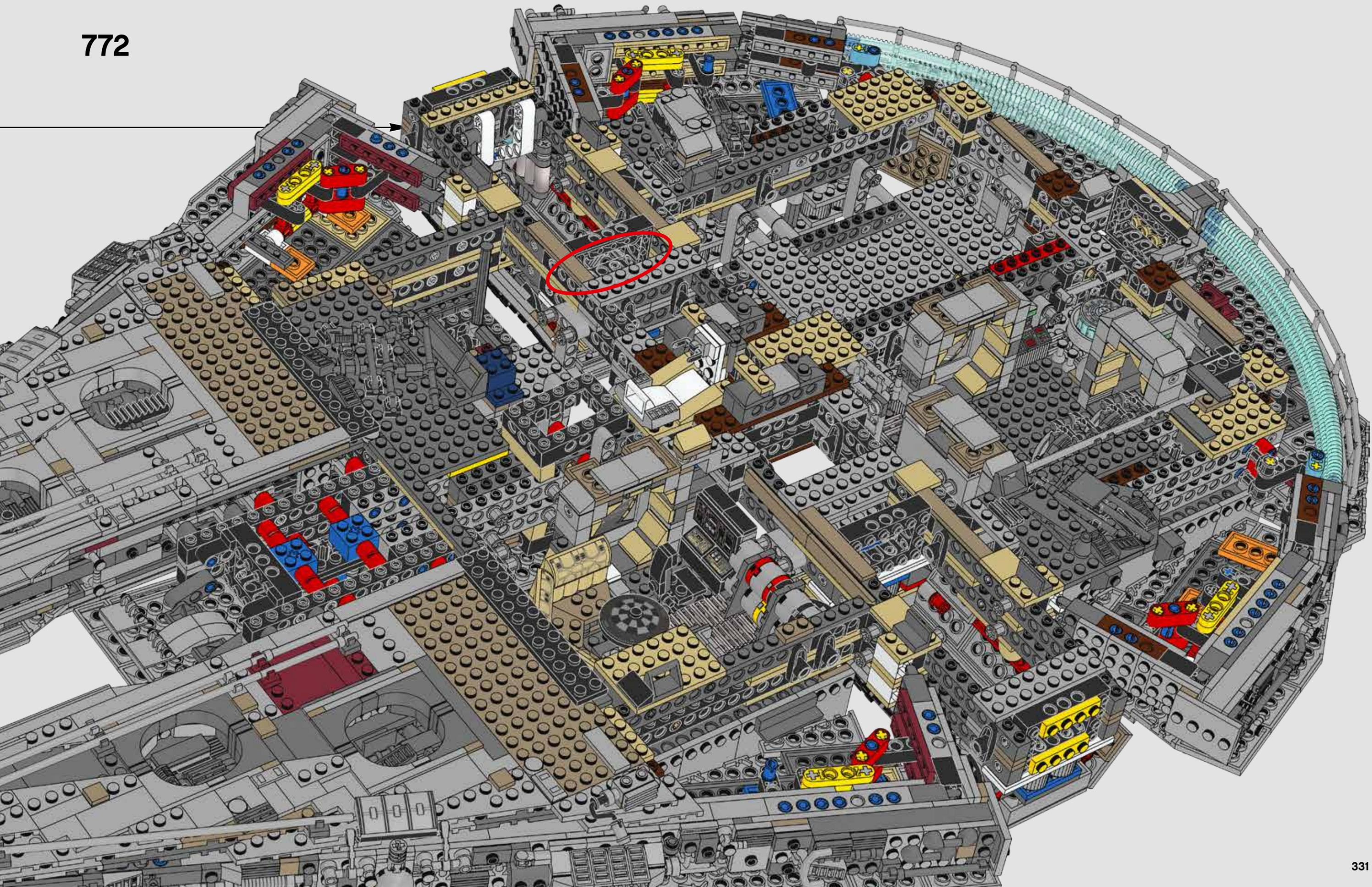

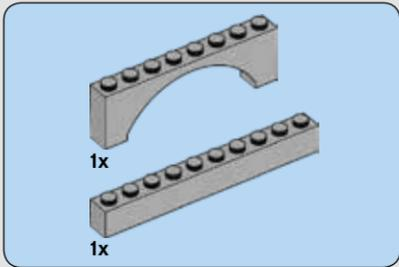
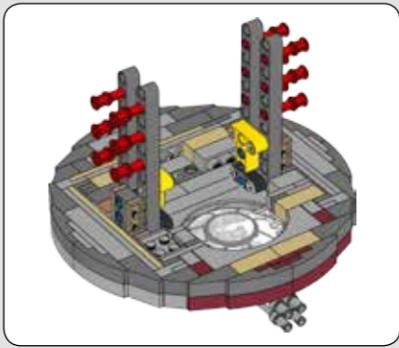

773

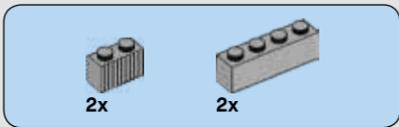
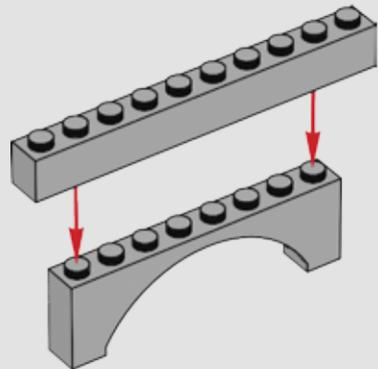

774

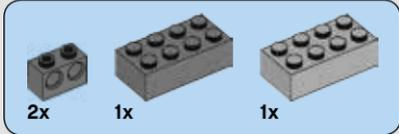
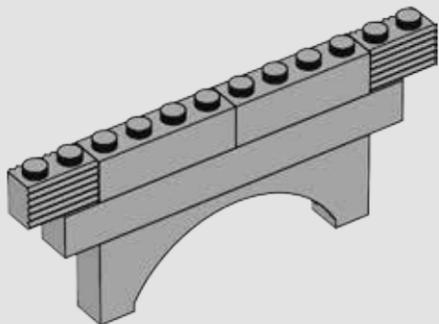

775

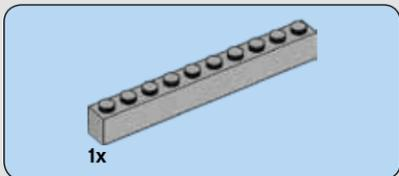
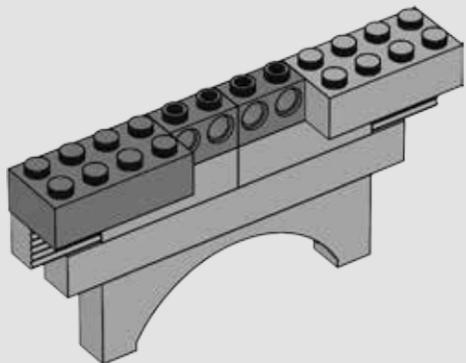

776

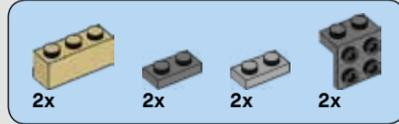
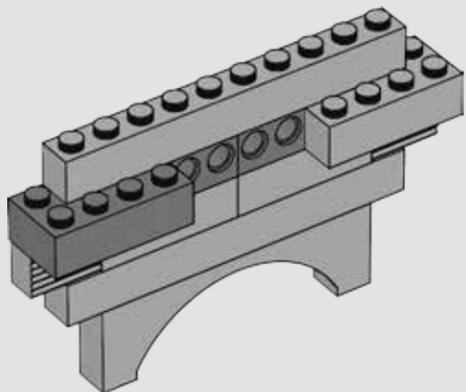

777

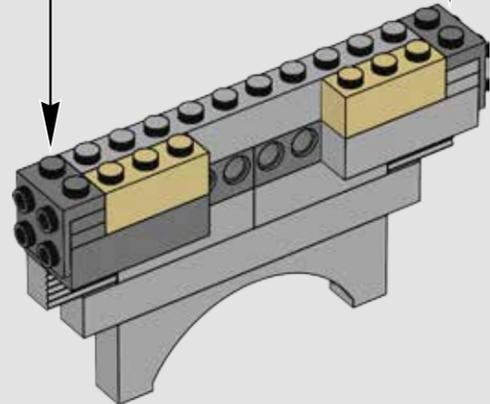
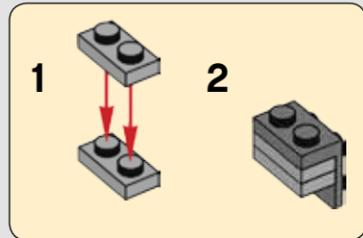
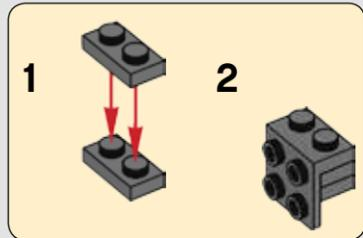



779

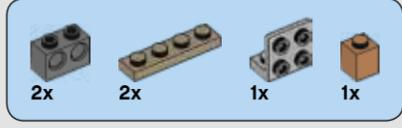
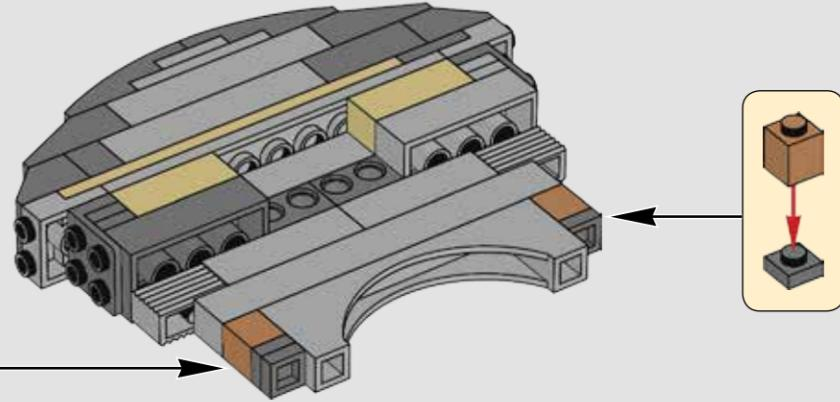
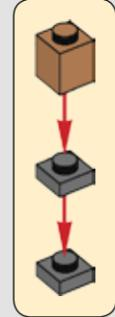

780

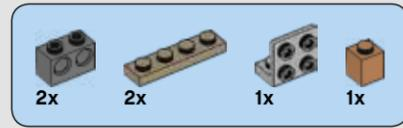
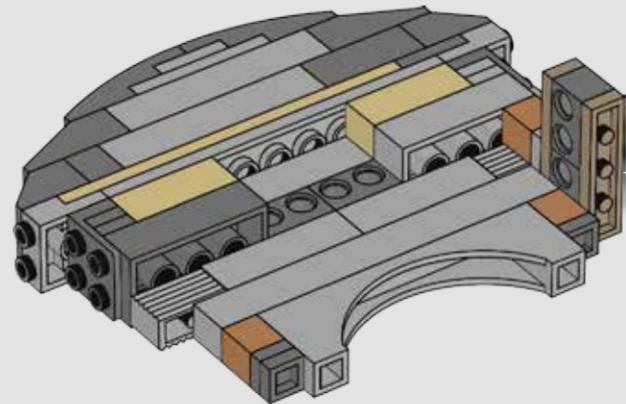
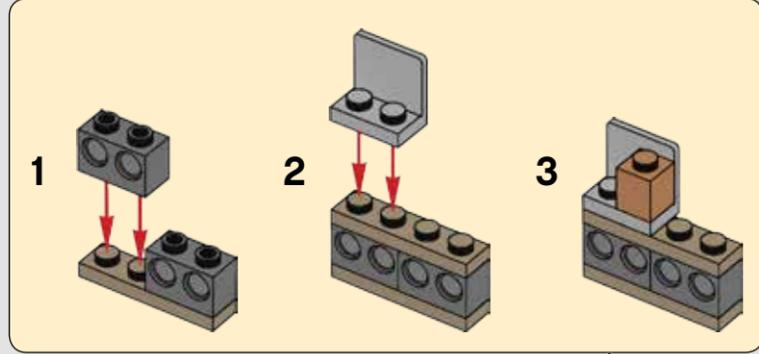

781

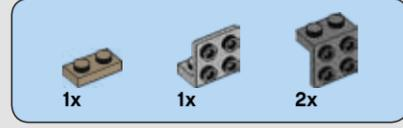
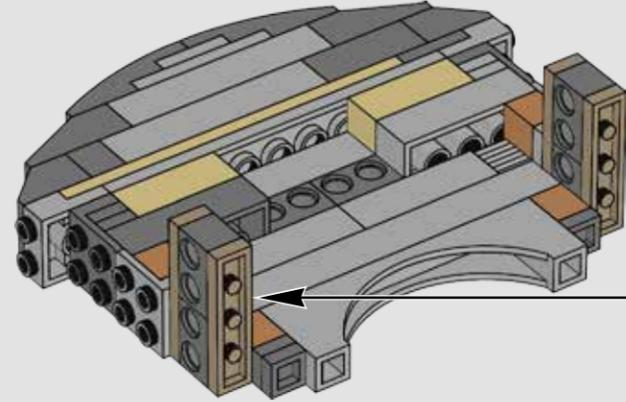
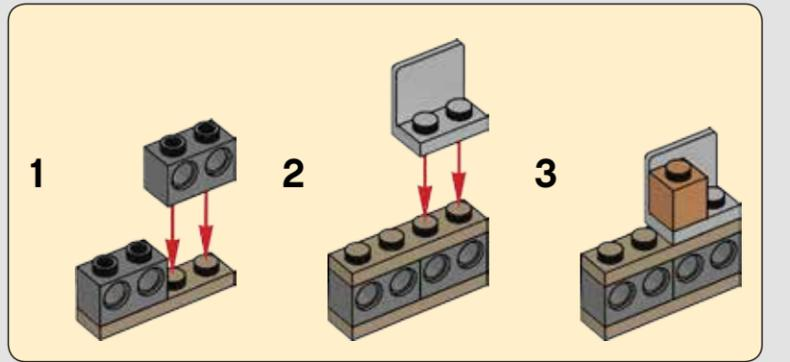

782

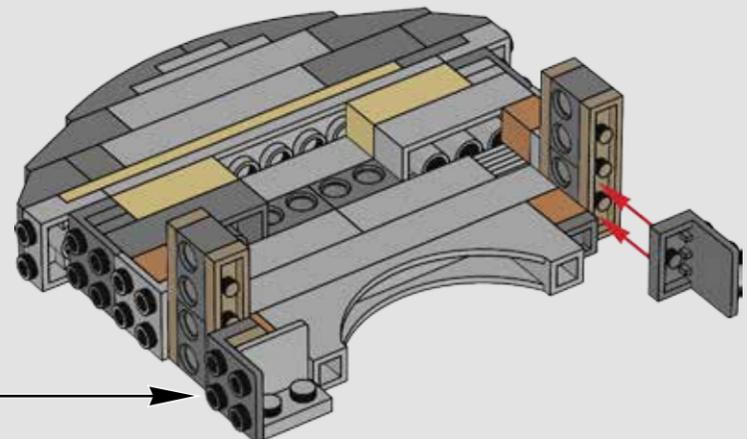
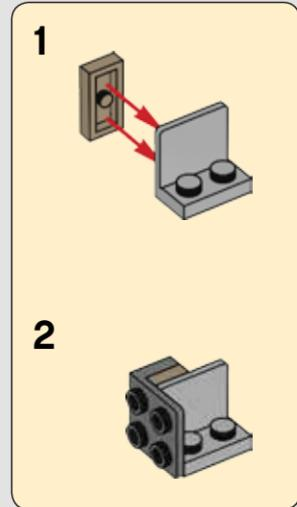

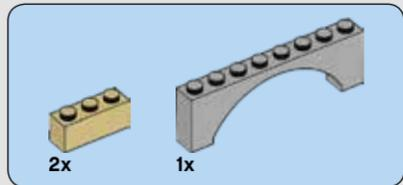
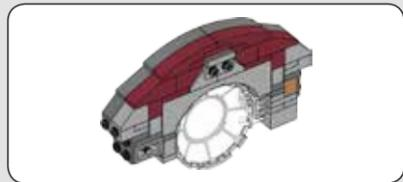

783

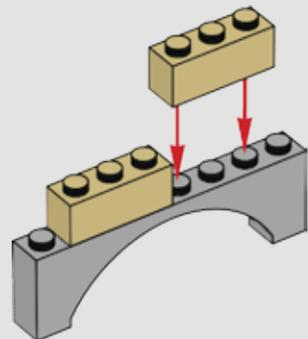

784

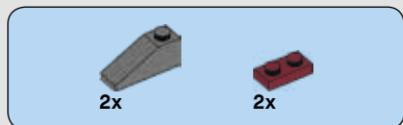
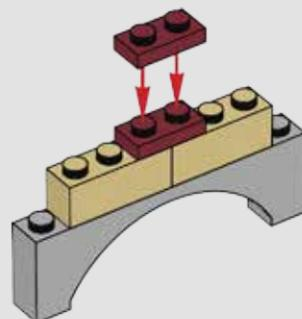

785

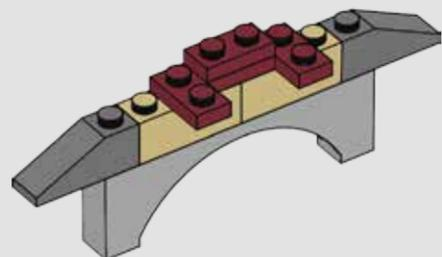

786

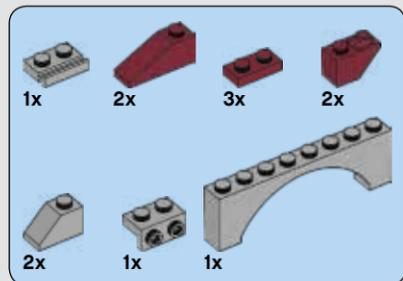
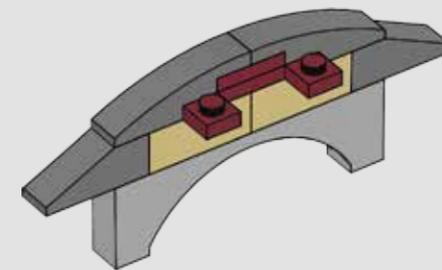

787

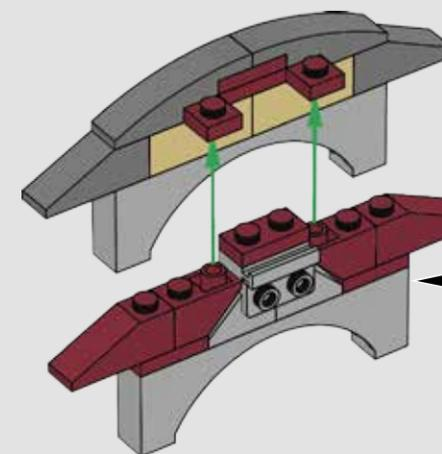
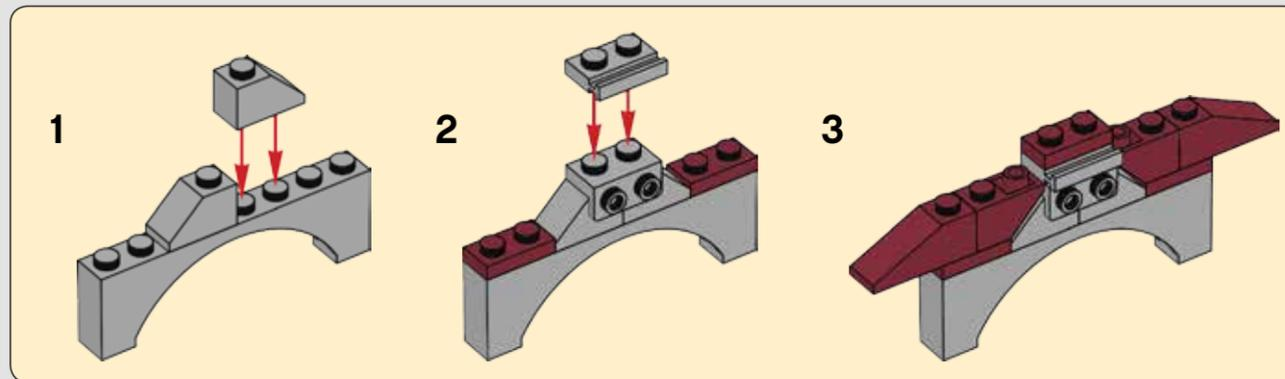

788

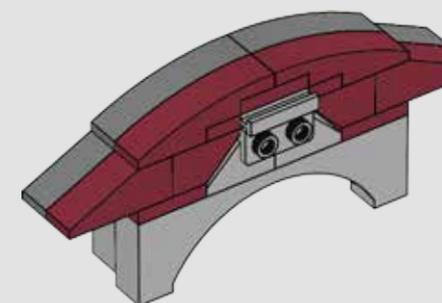

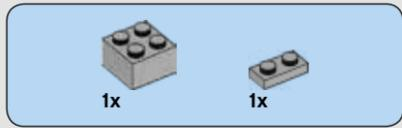

789

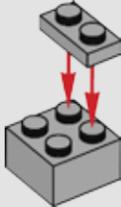

790

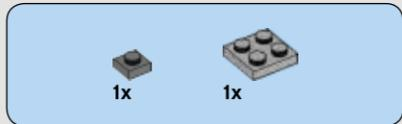
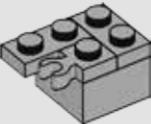

791

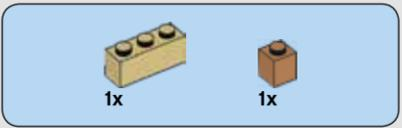
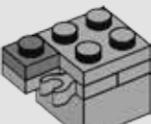

792

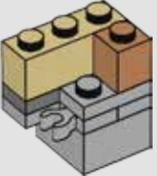

793

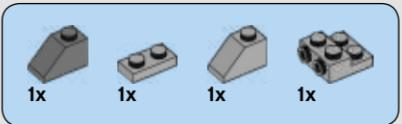
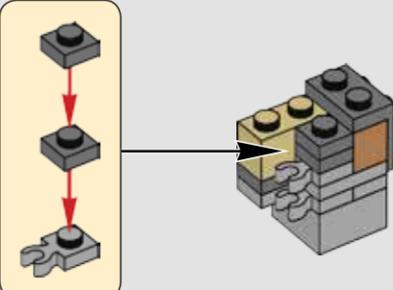

794

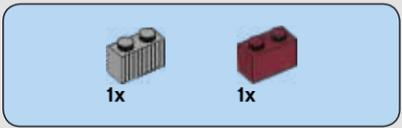
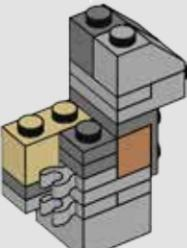
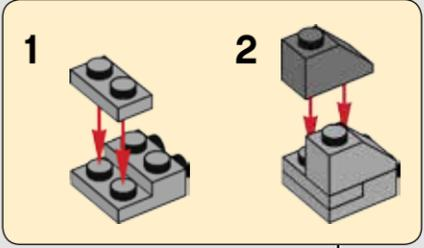

795

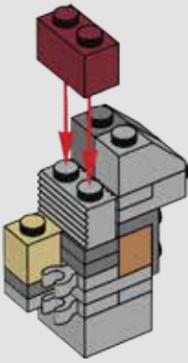

796

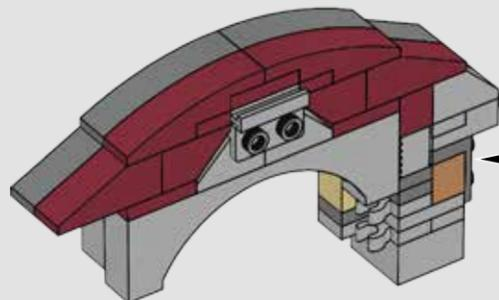

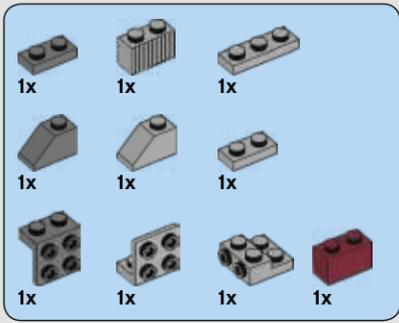

797

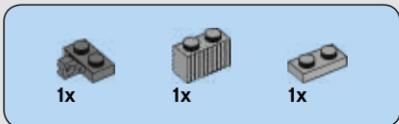
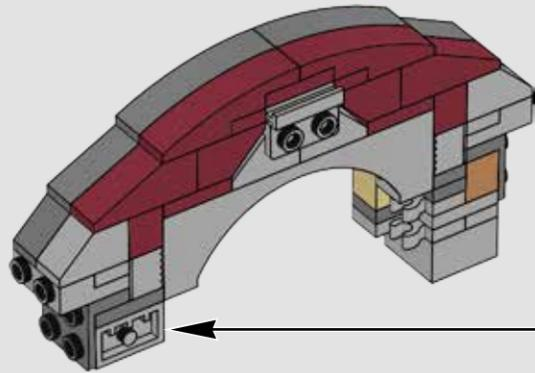
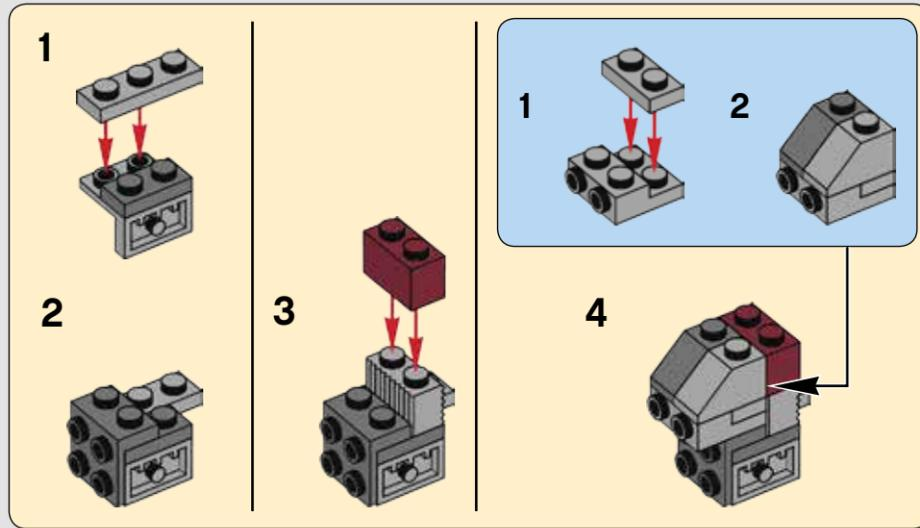

798

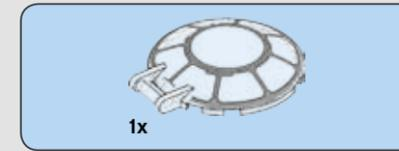
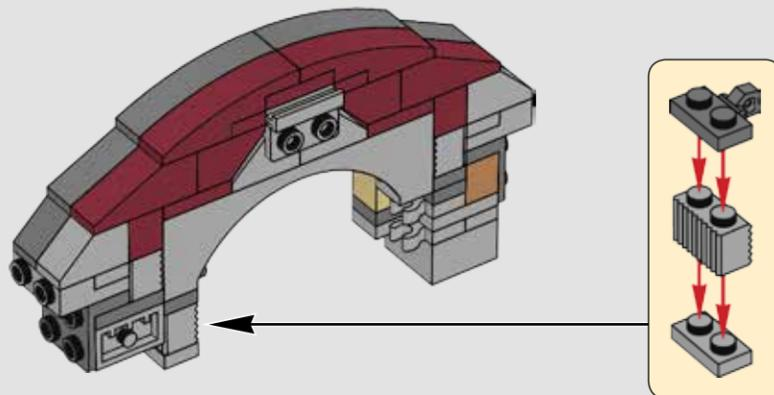

799

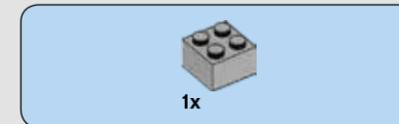
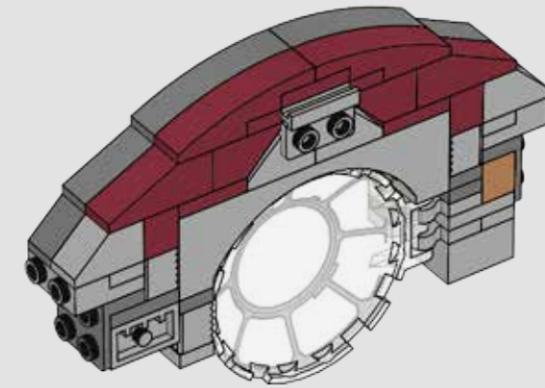

800

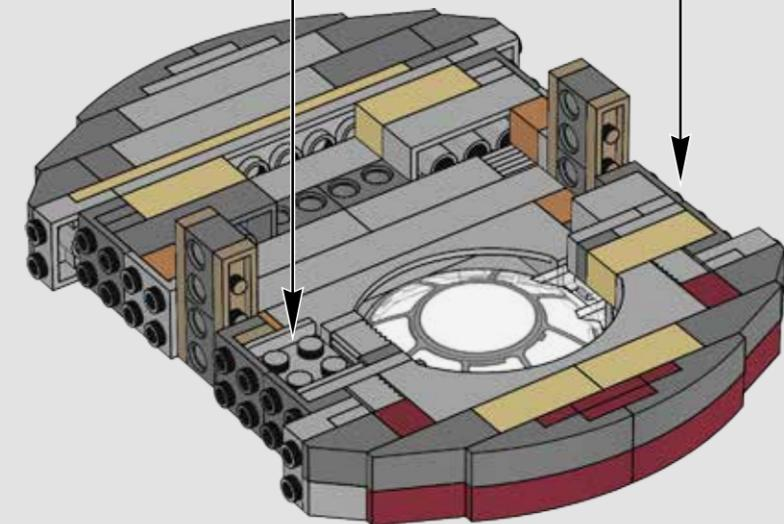
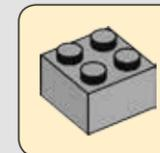

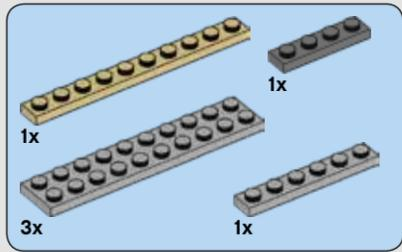

801

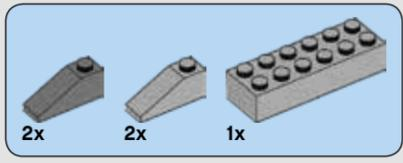
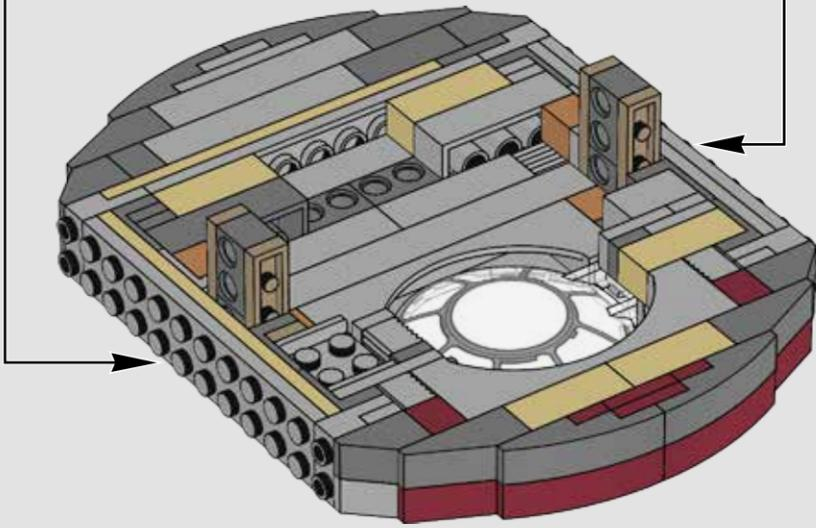
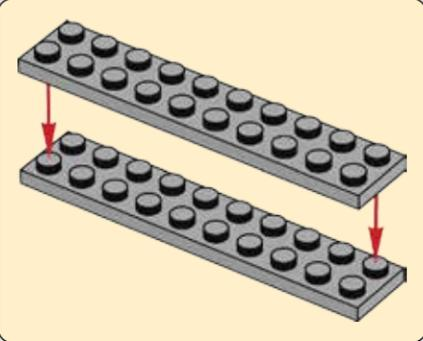
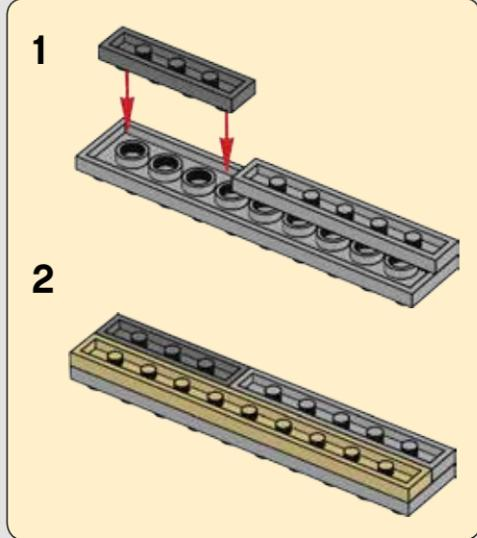

802

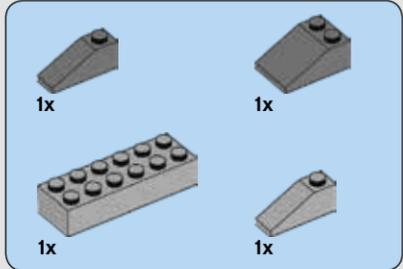
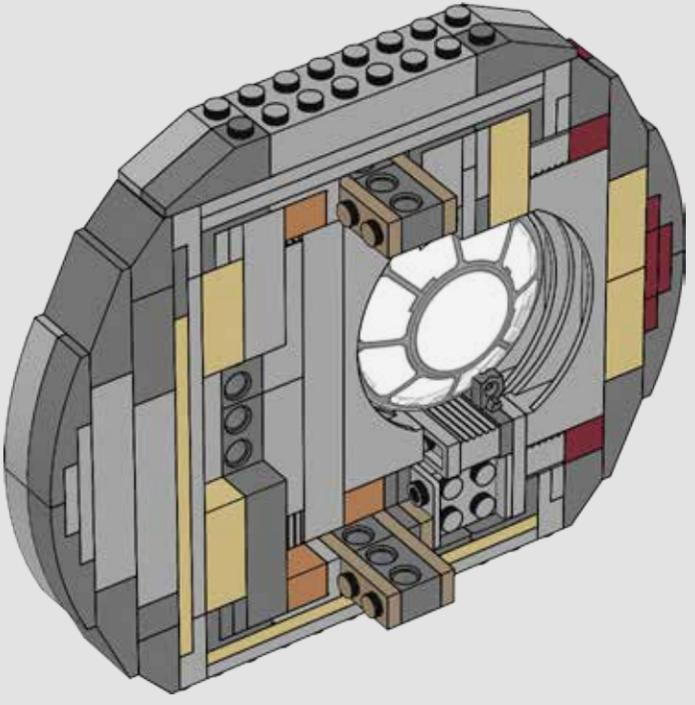

803

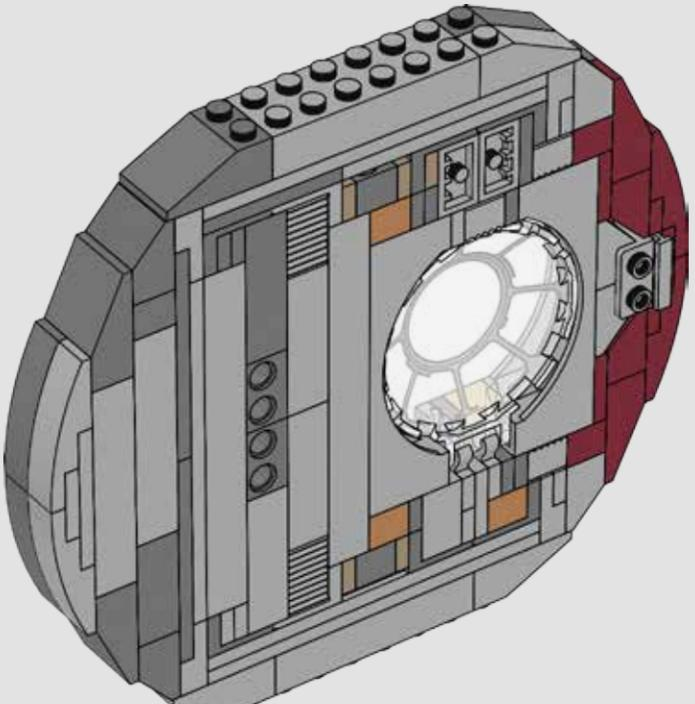

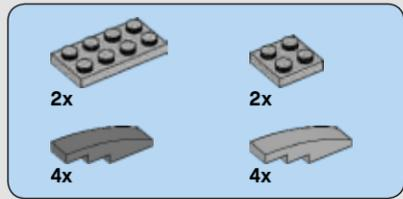

804

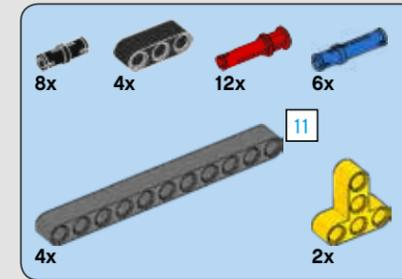
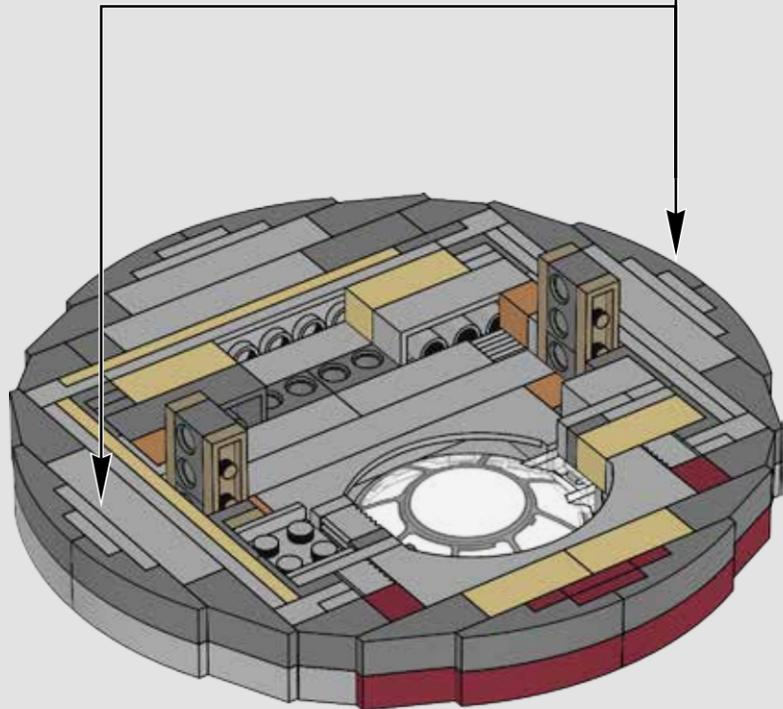
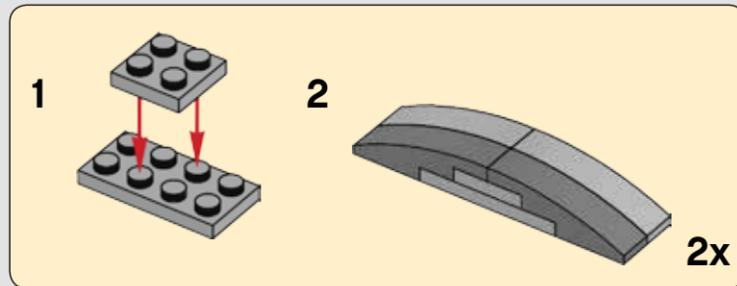

805

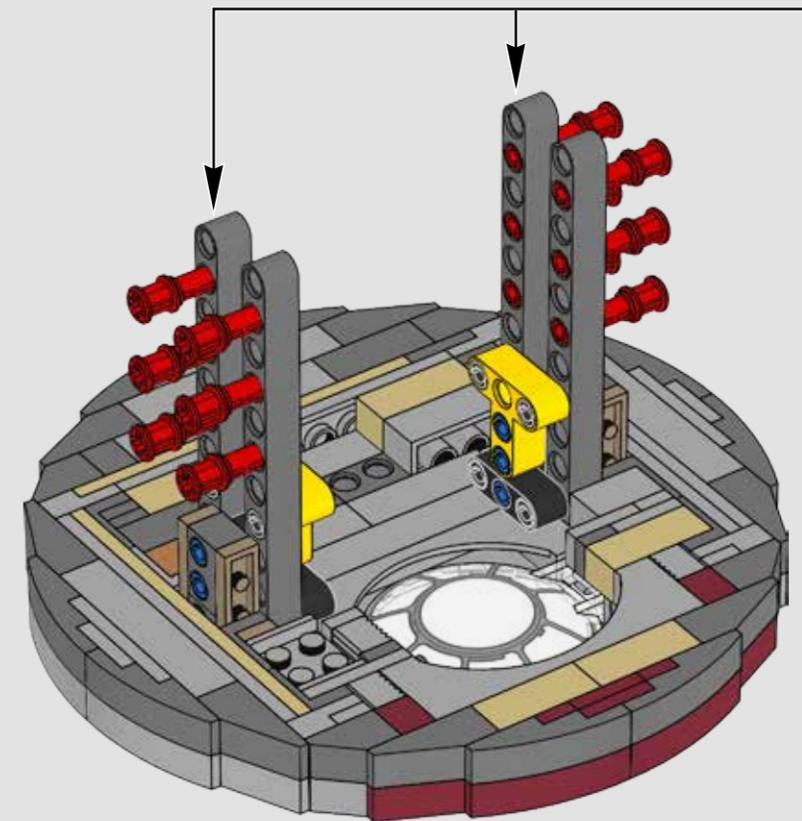
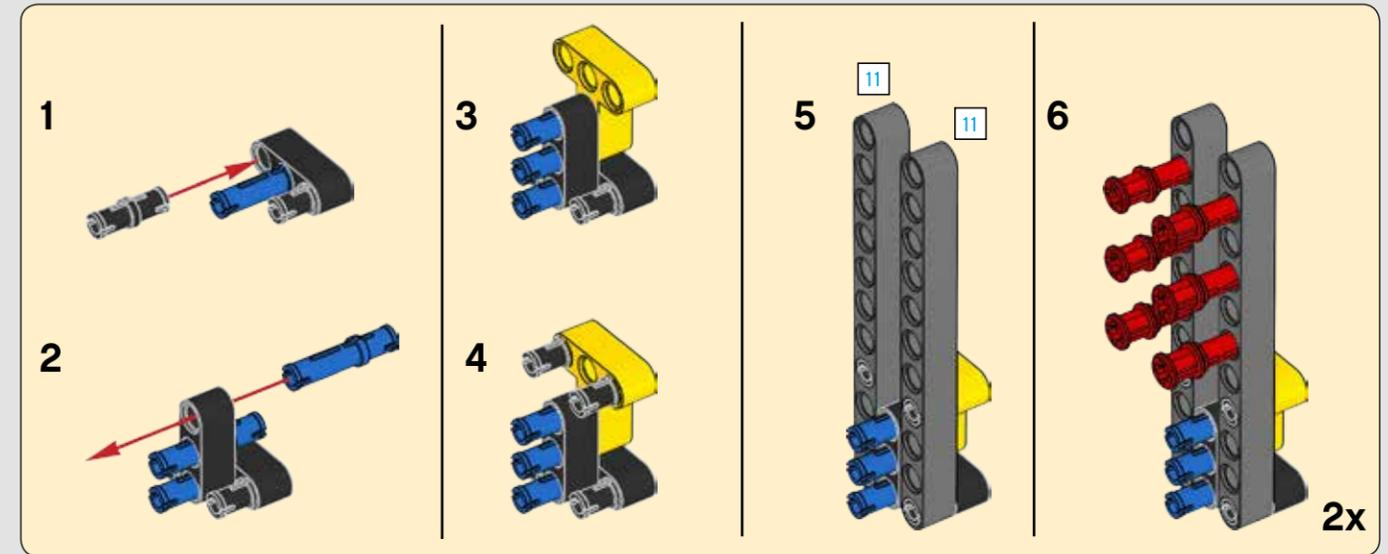
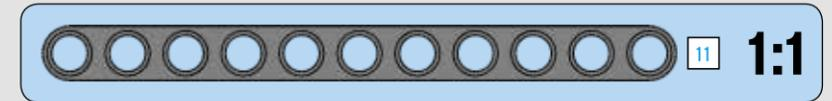

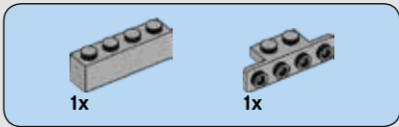
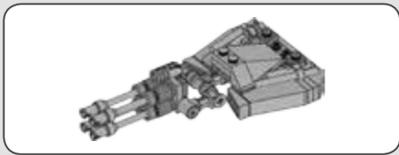

806

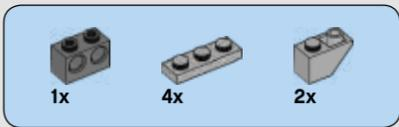
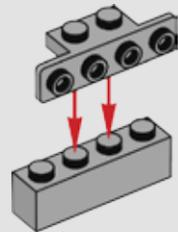

807

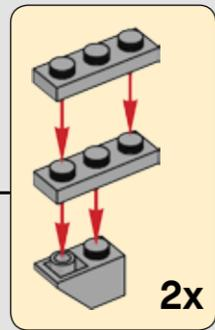
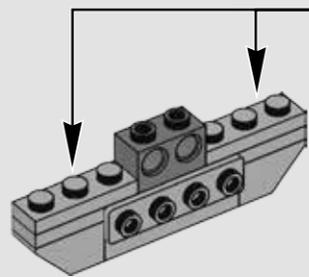

808

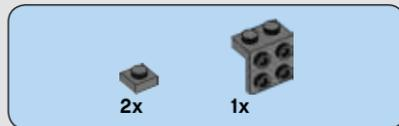
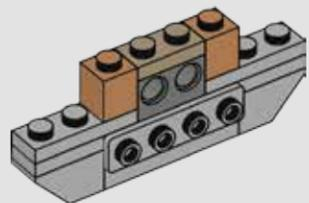

809

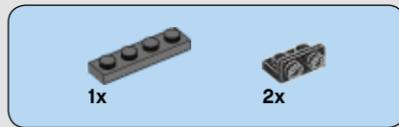
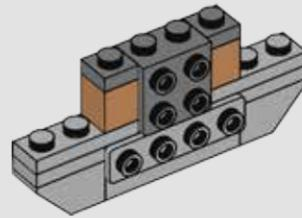

810

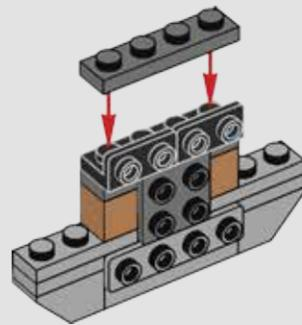

811

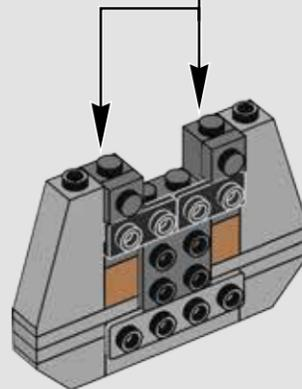
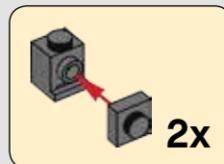

812

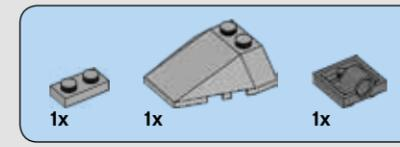
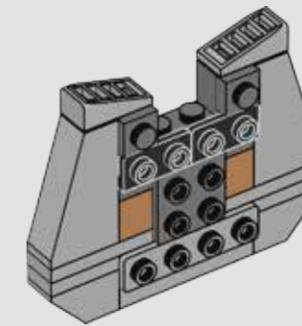

813

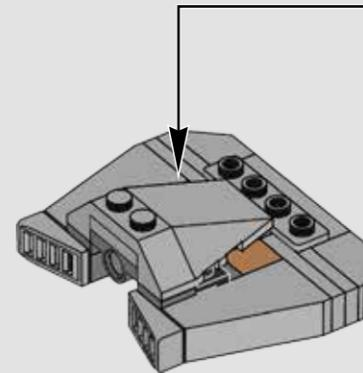
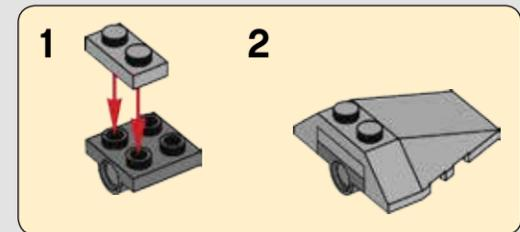

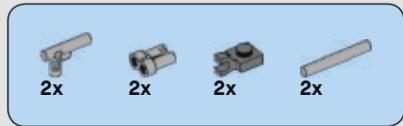

814

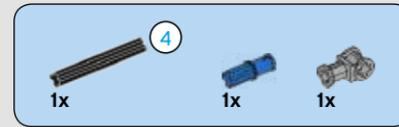
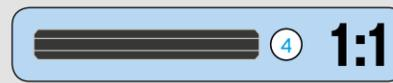
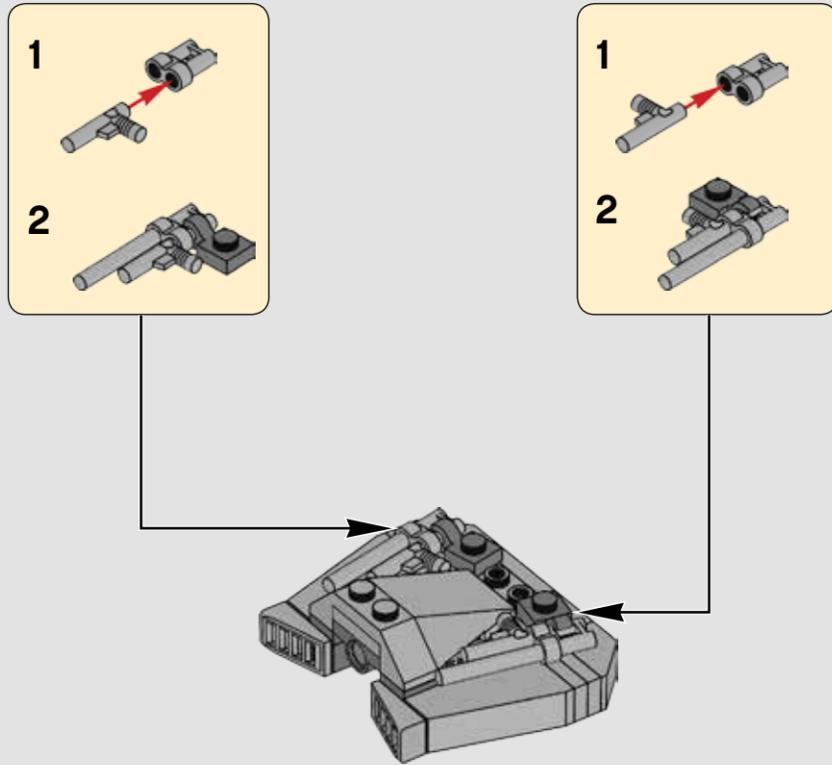

815

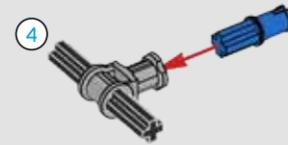

816

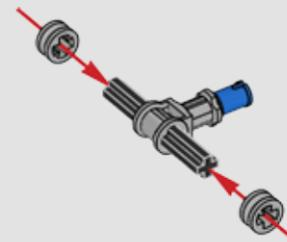

817

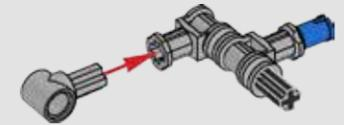

818

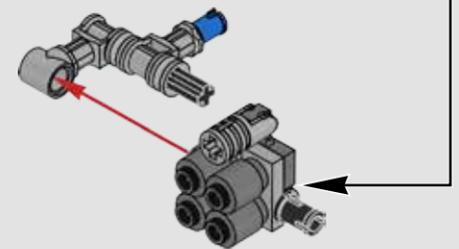
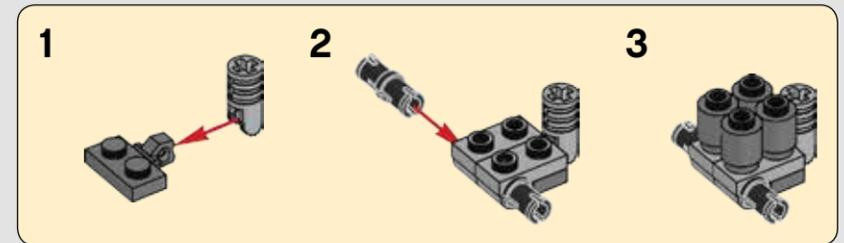



819

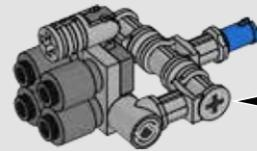
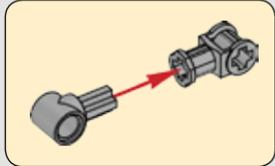

820

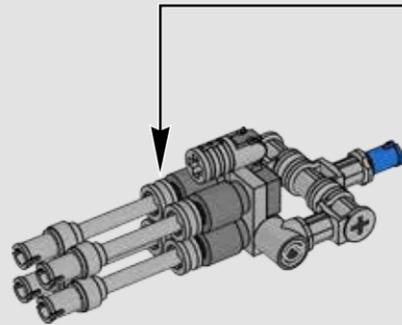
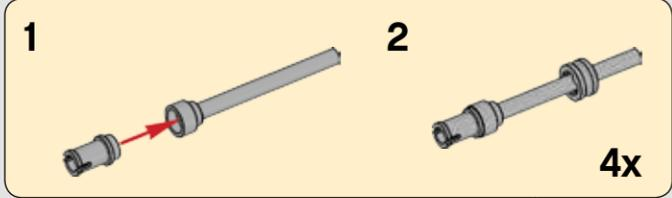

821

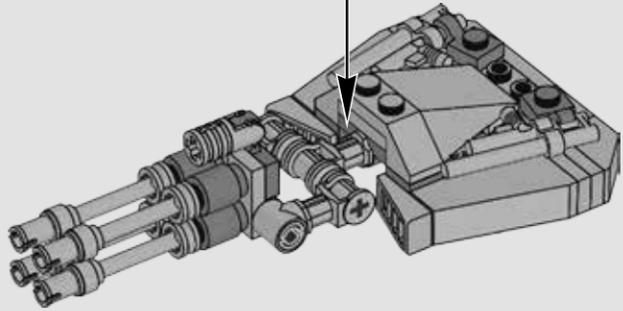

822

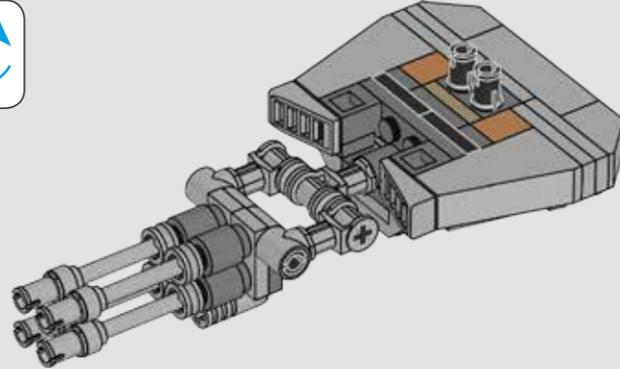

823

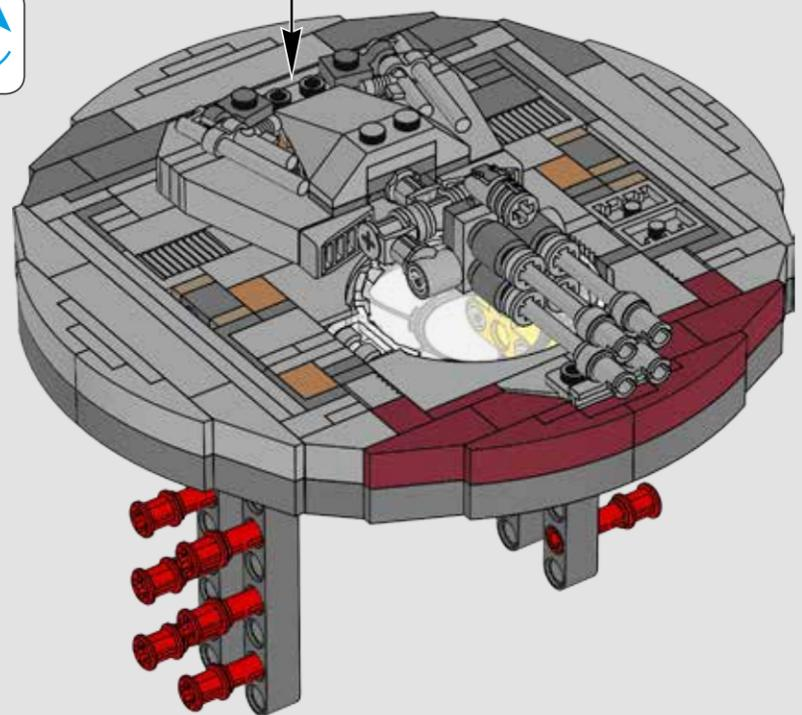

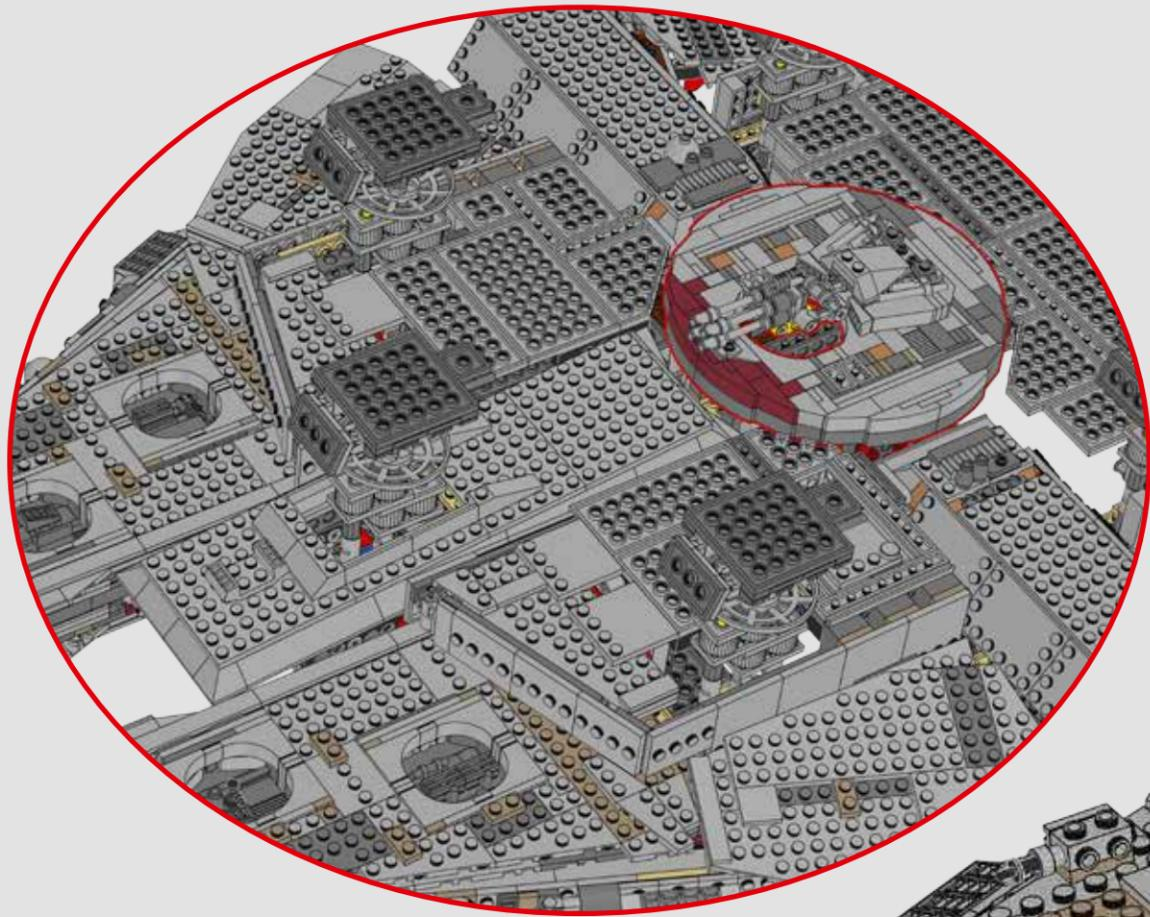

824

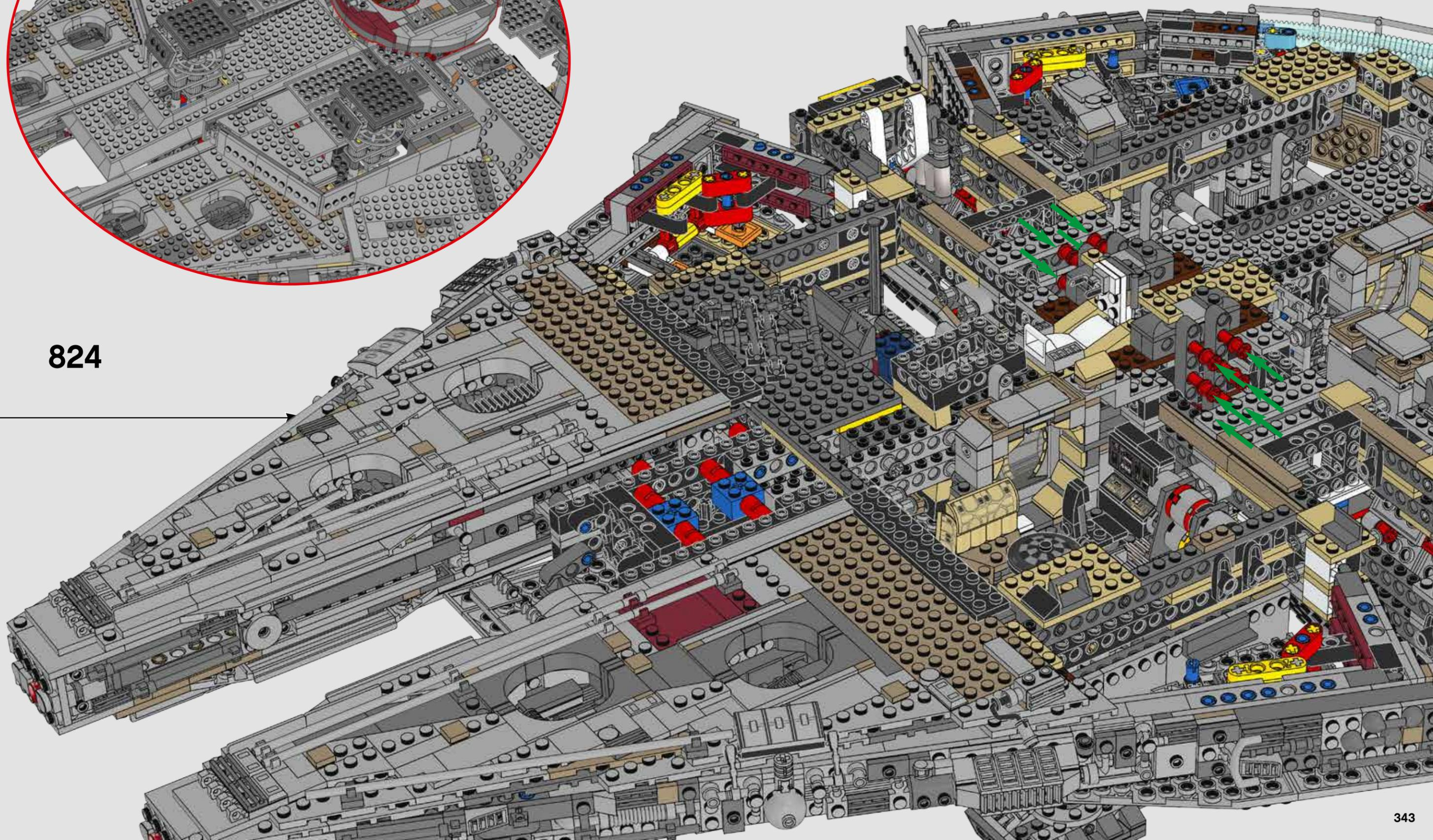

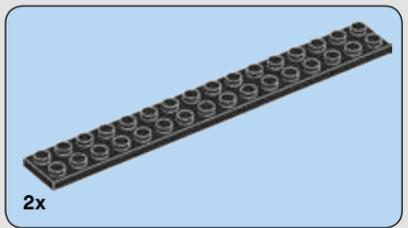
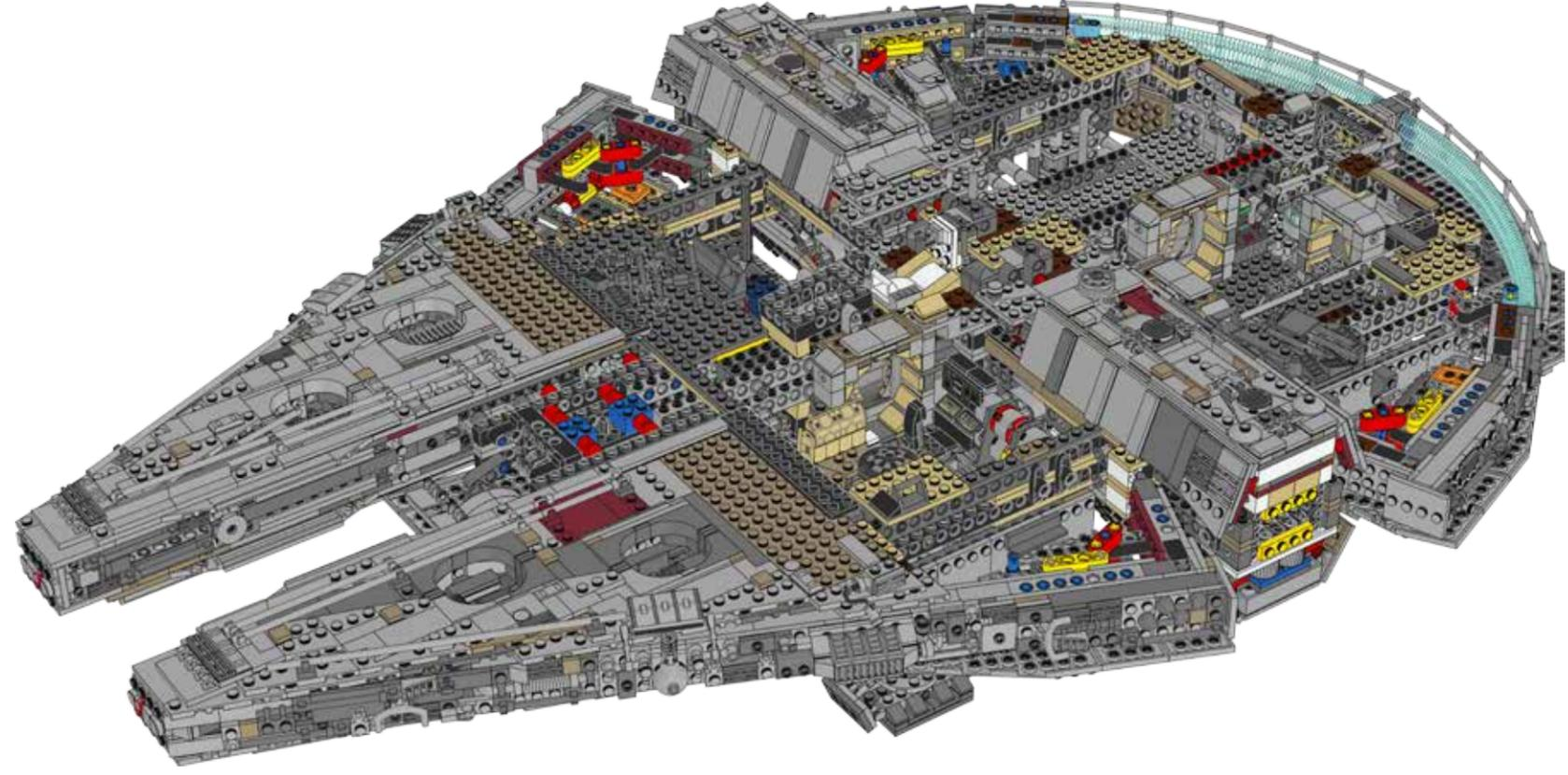

2x

826

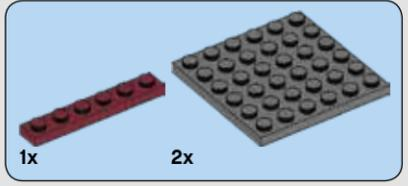
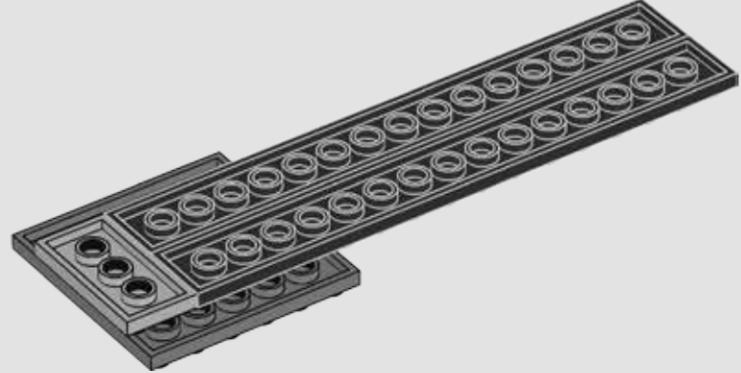

1x

2x

827

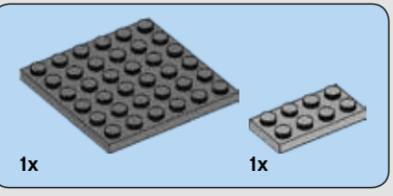
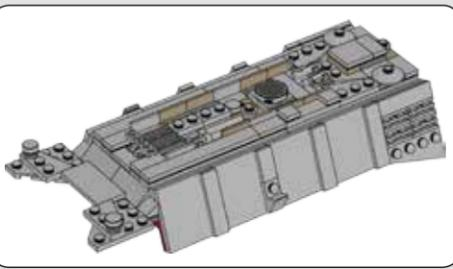
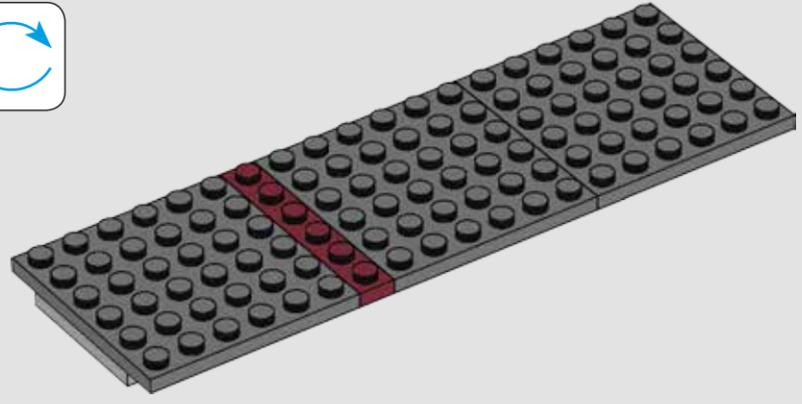

1x

1x

825

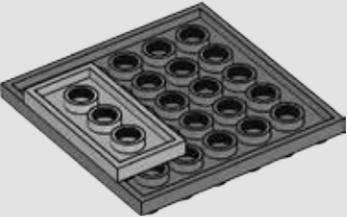

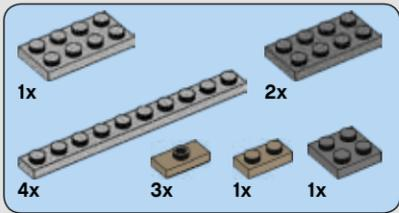

828

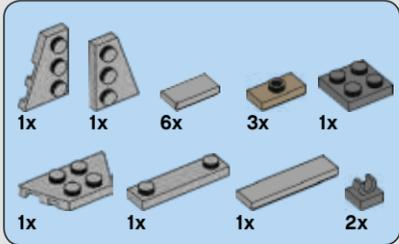

829

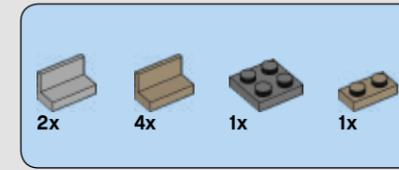
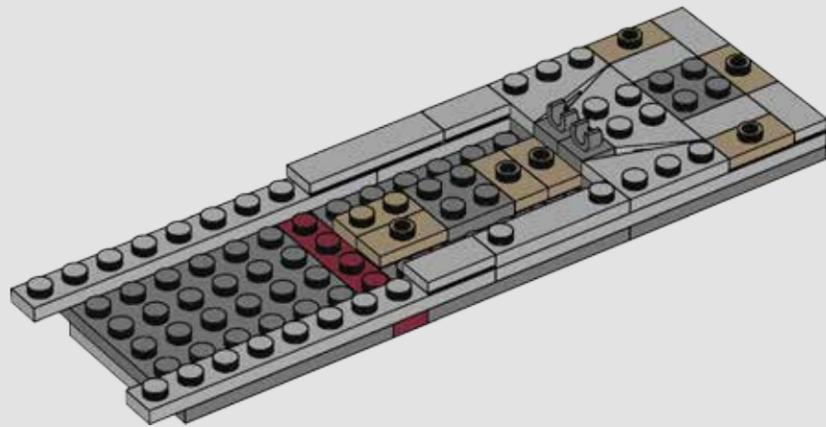

830

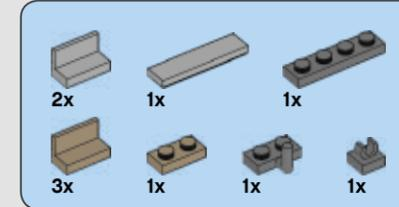
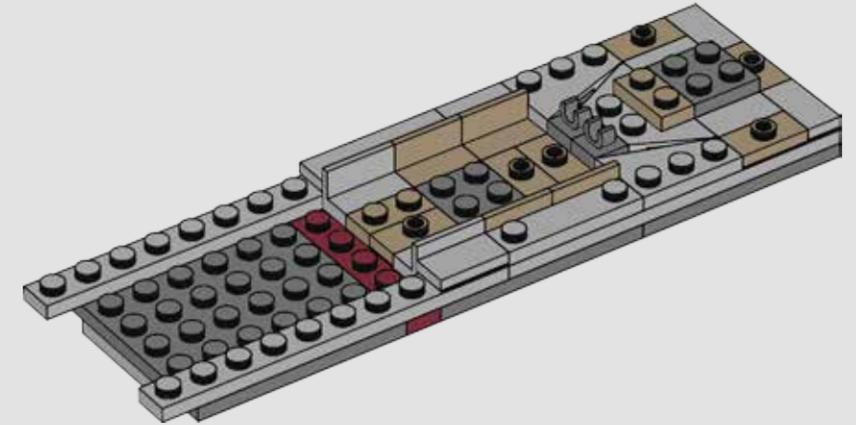

831

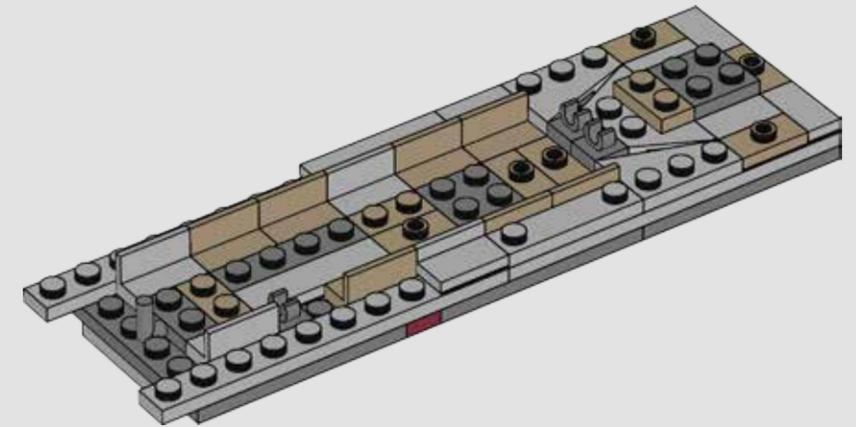

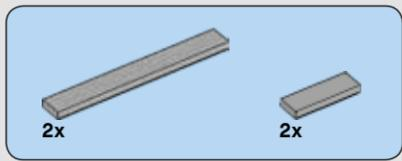

832

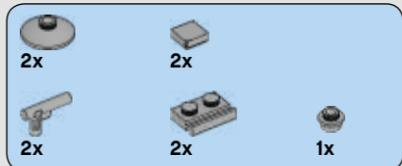
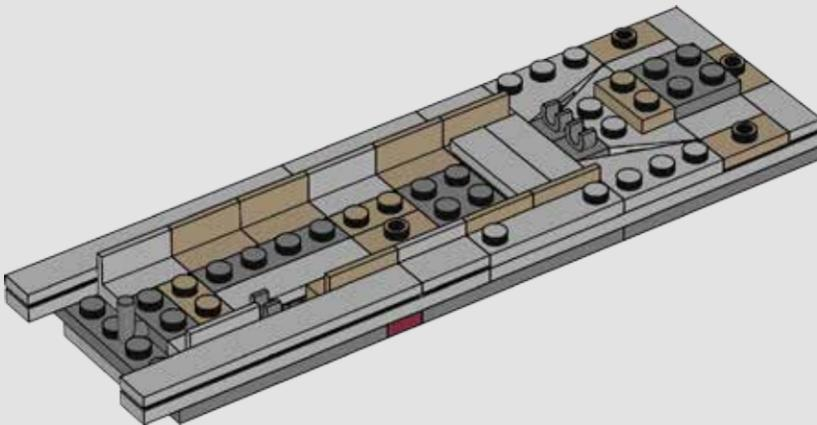

833

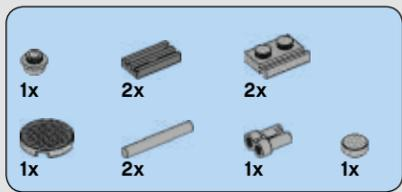
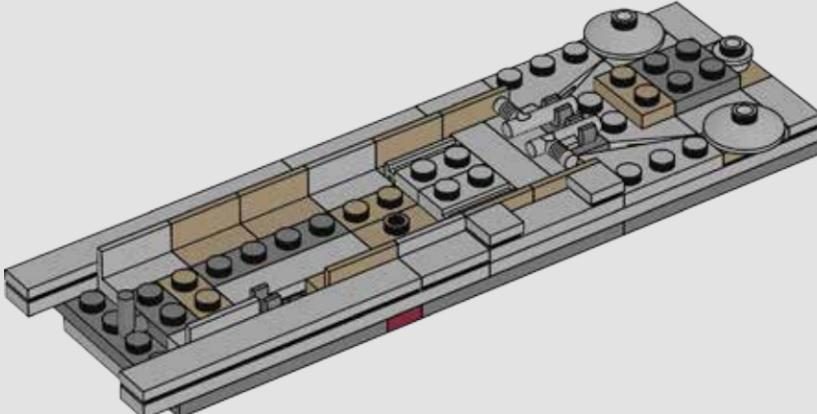

834

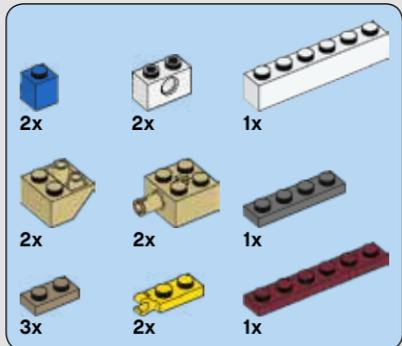
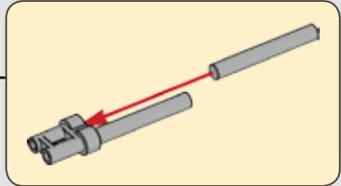
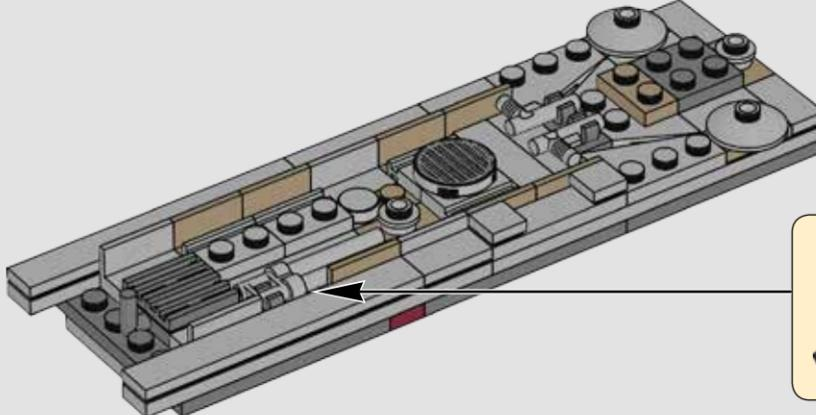

835

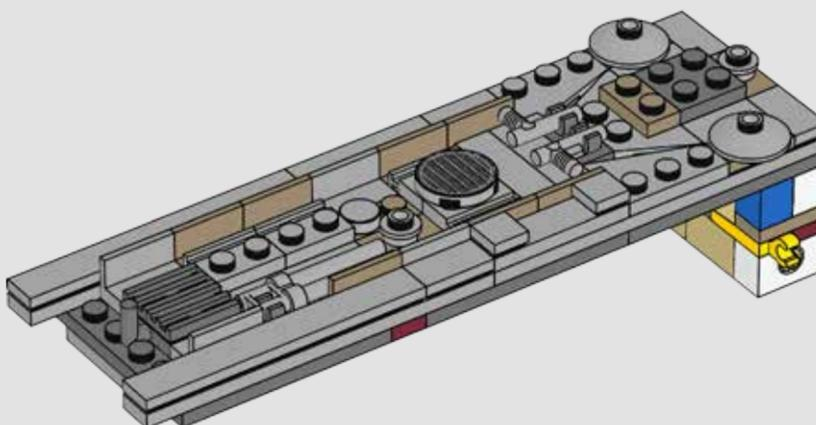
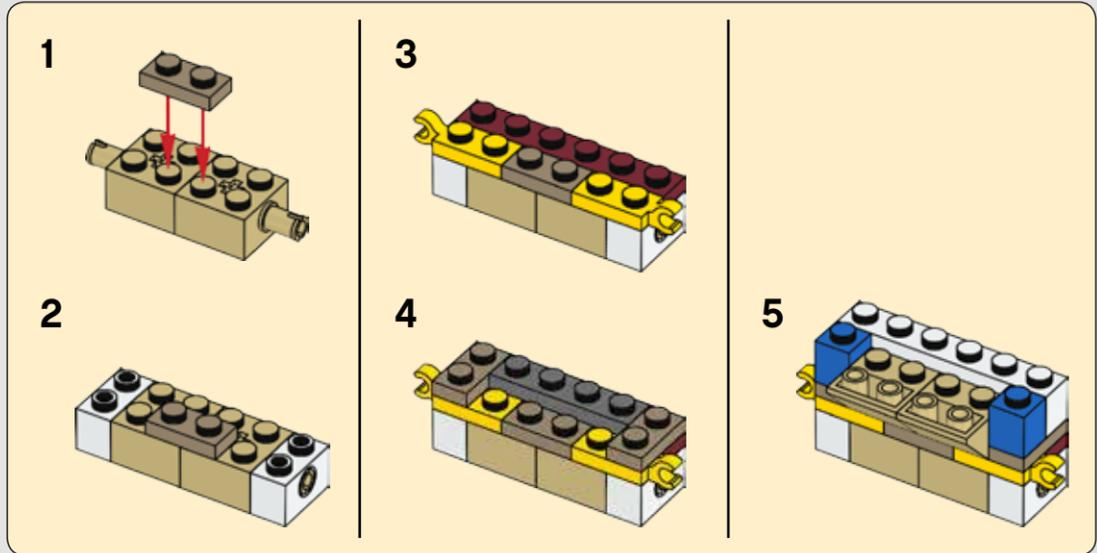

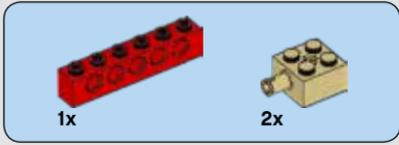
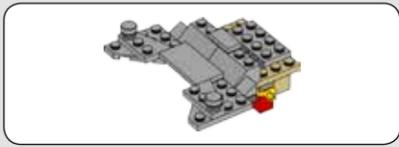

836

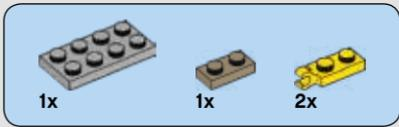
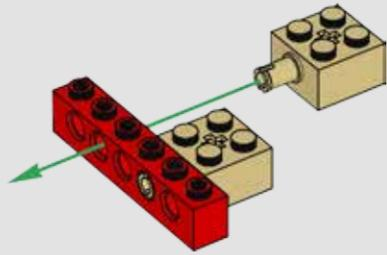

837

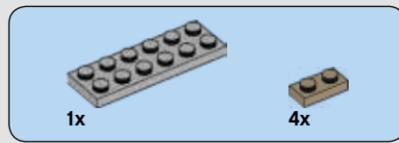
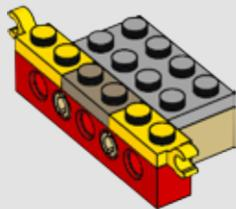

838

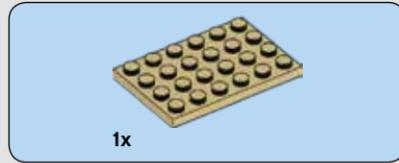
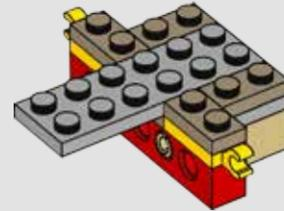

839

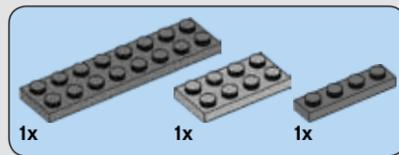
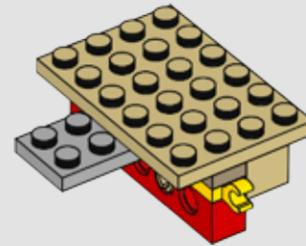

840

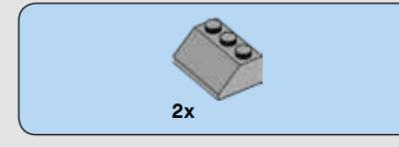
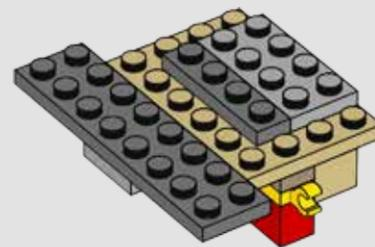

841

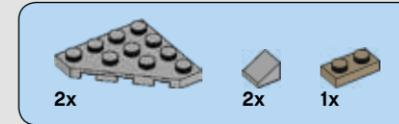
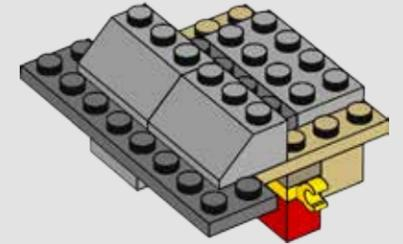

842

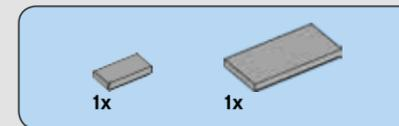
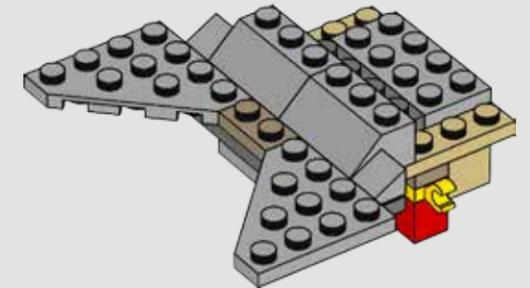

843

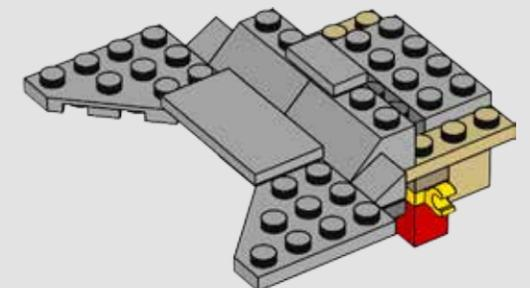

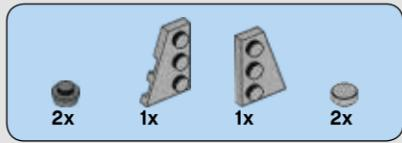

844

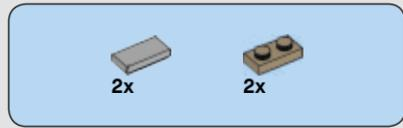
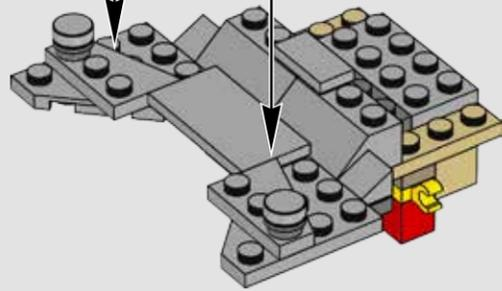
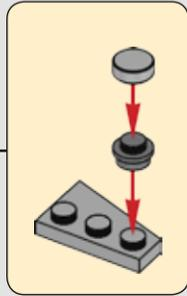
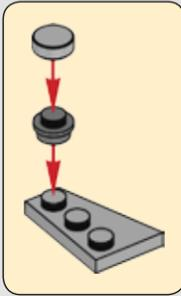

846

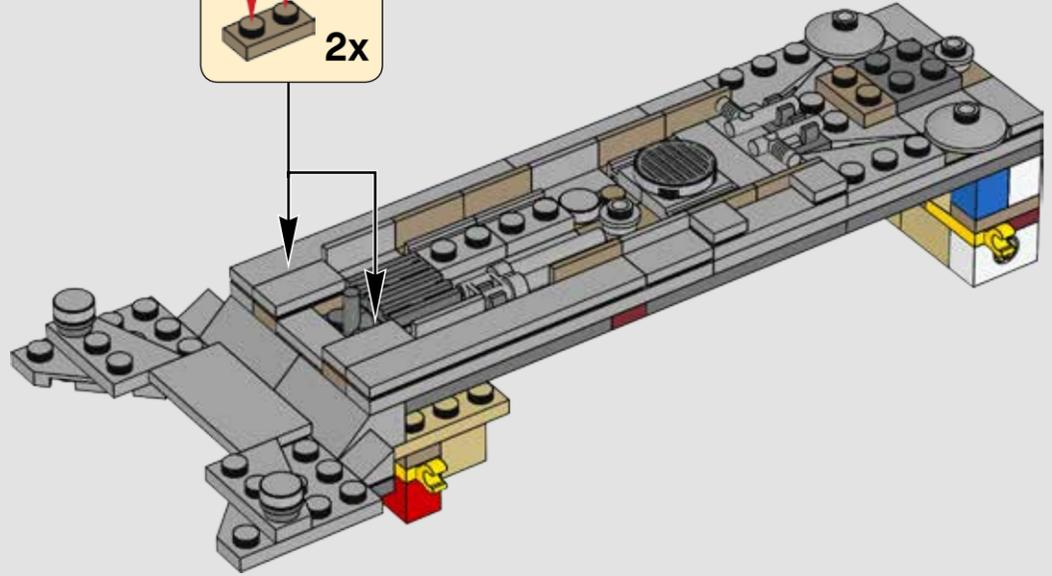
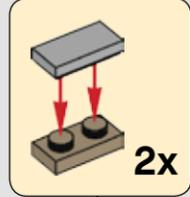

845

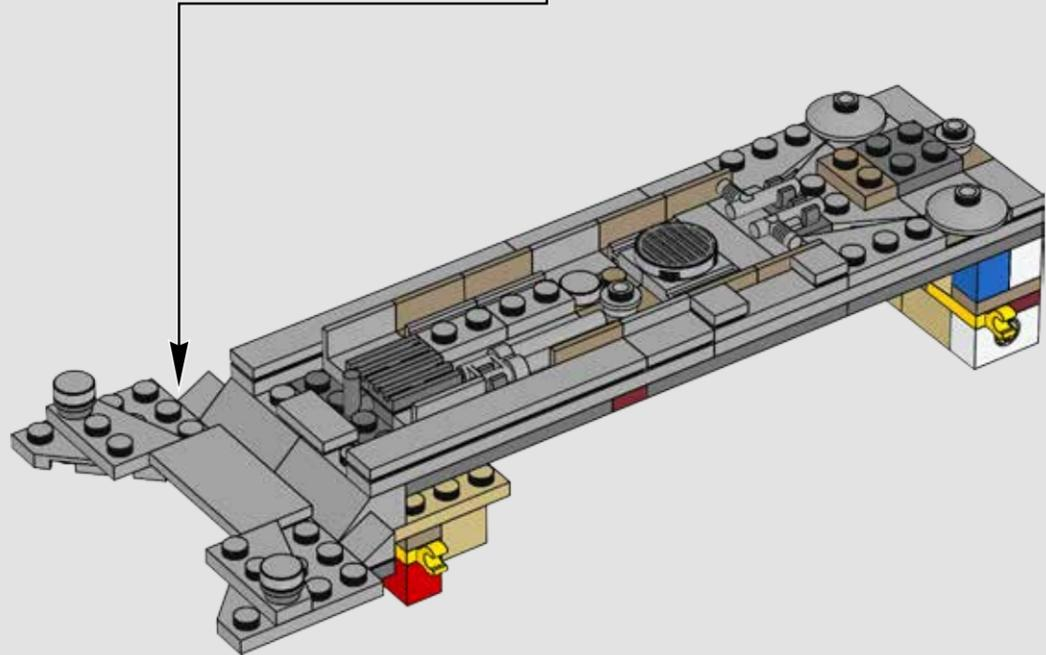

847

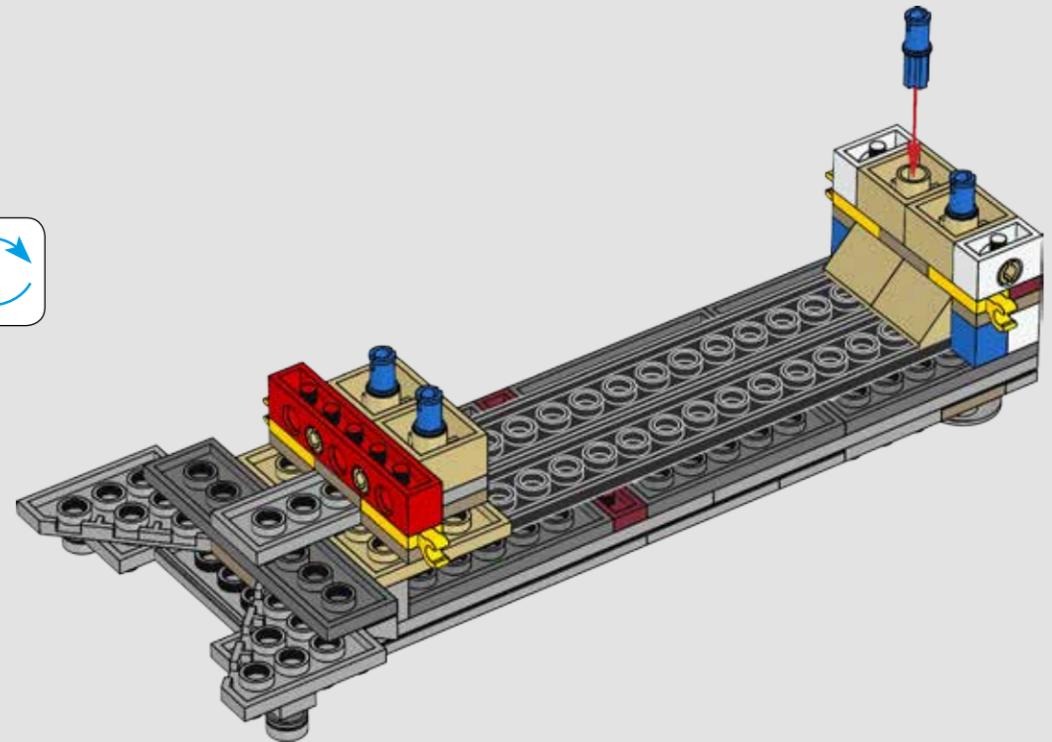

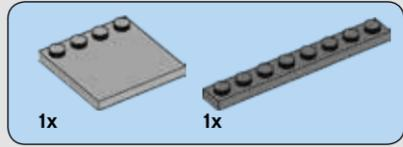
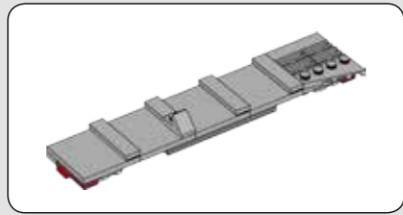

848

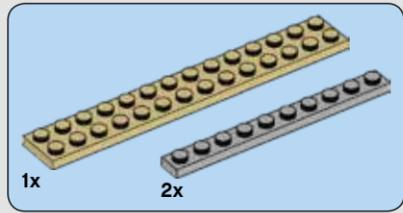
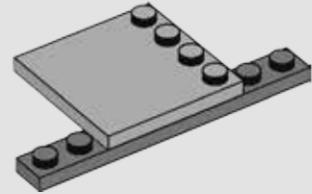

849

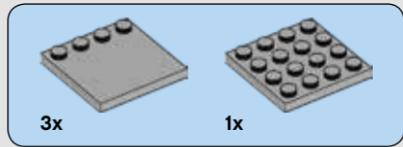
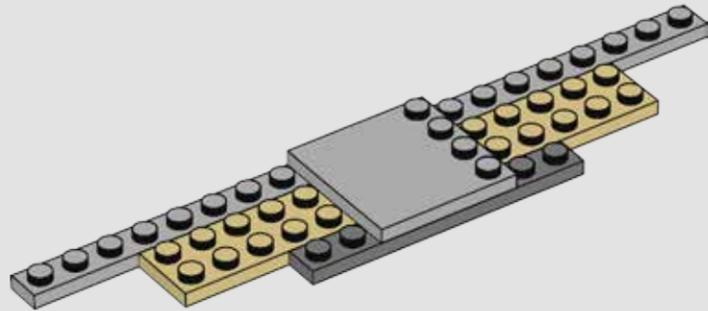

850

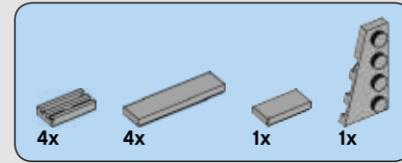
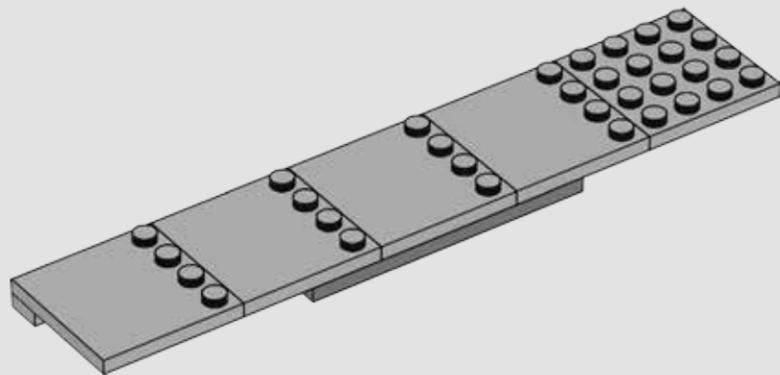

851

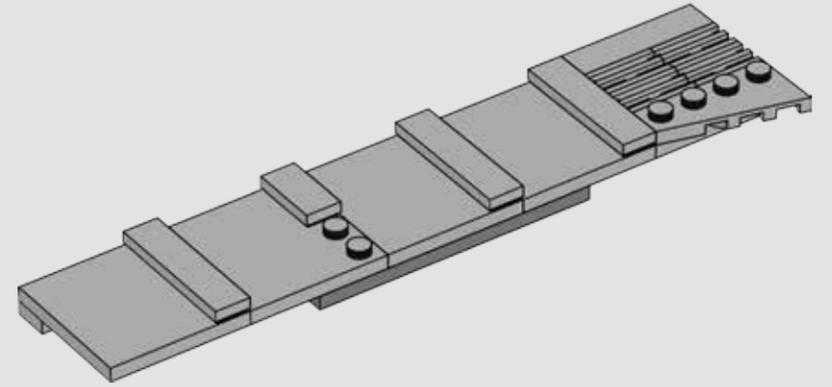

852

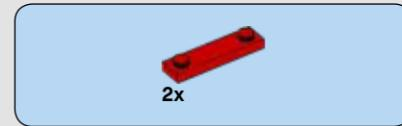
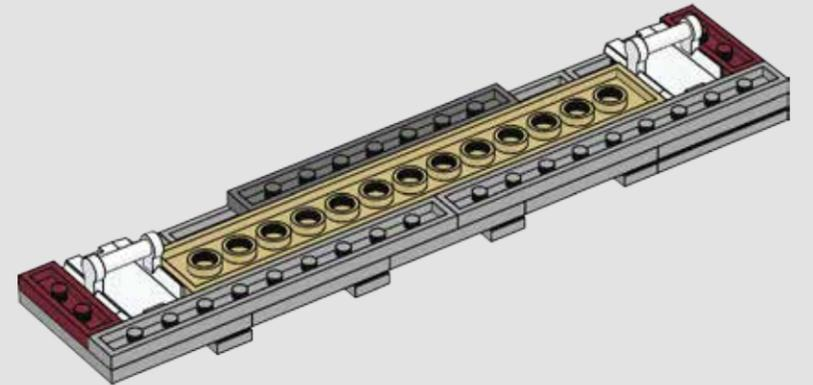

853

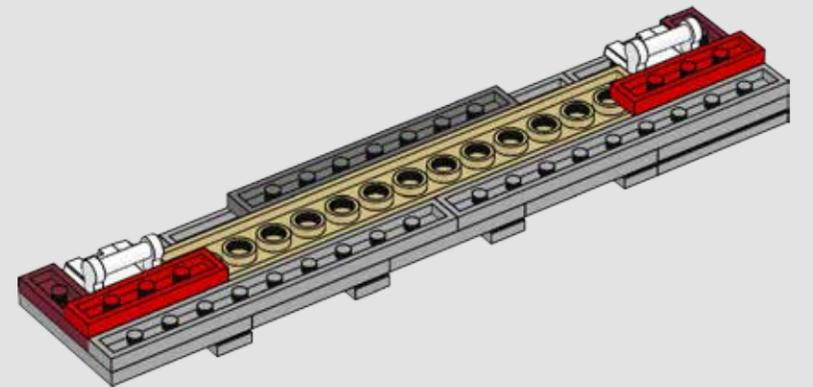



854

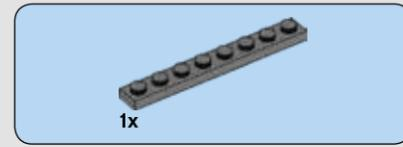
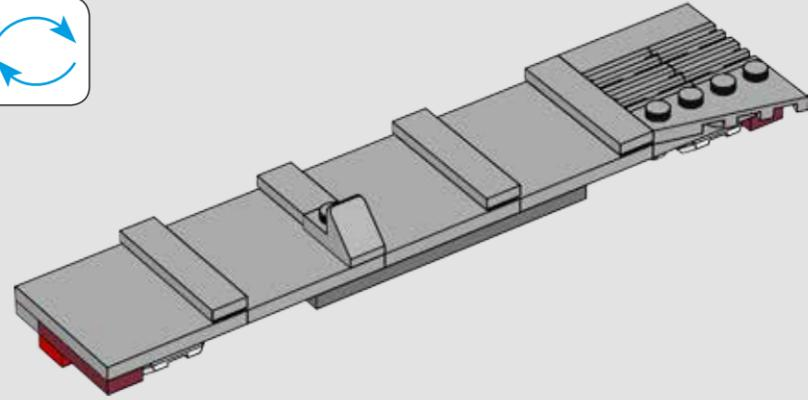

856

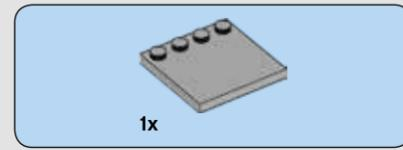

857

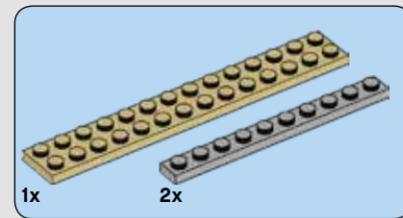
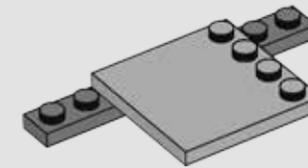

858

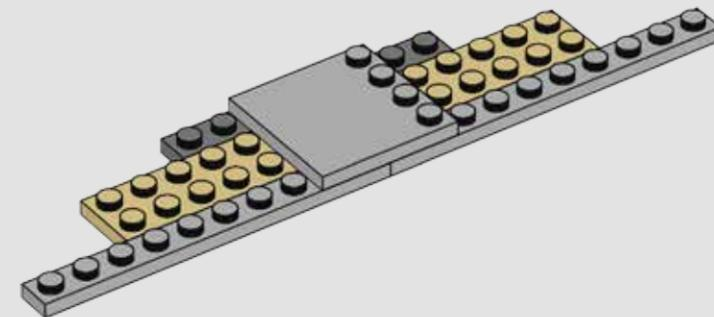

855

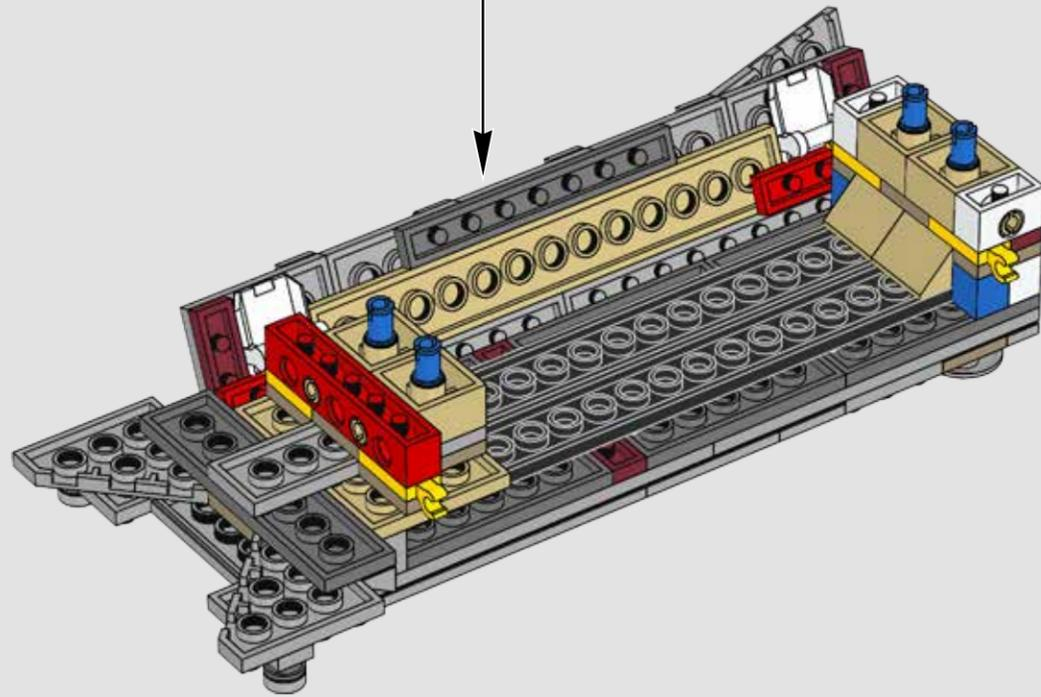

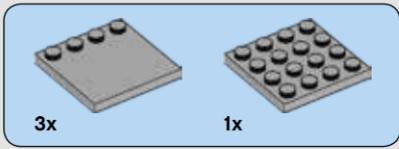

859

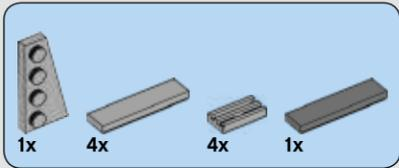
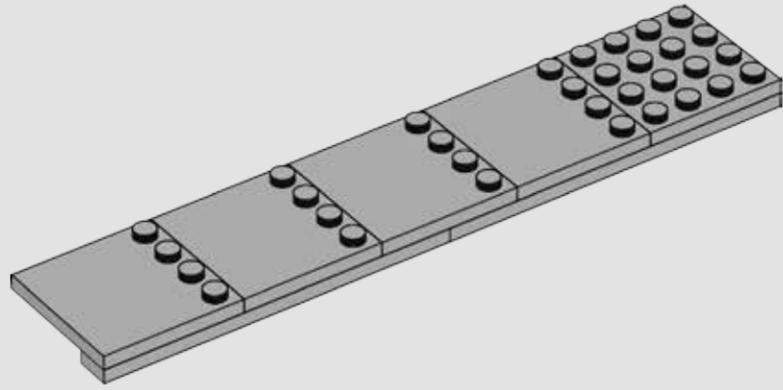

860

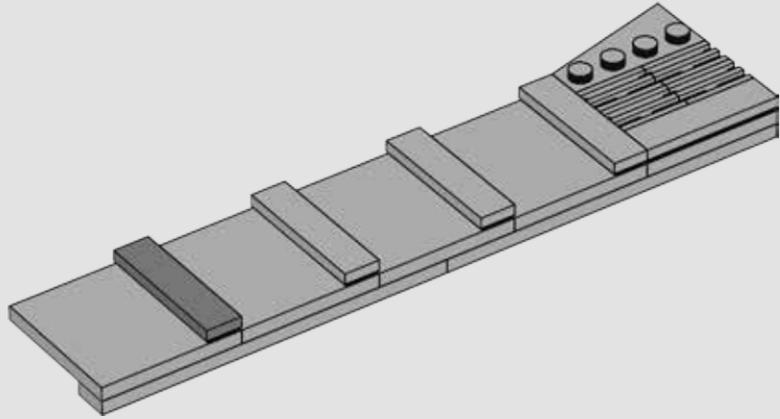

861

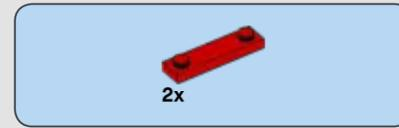

862

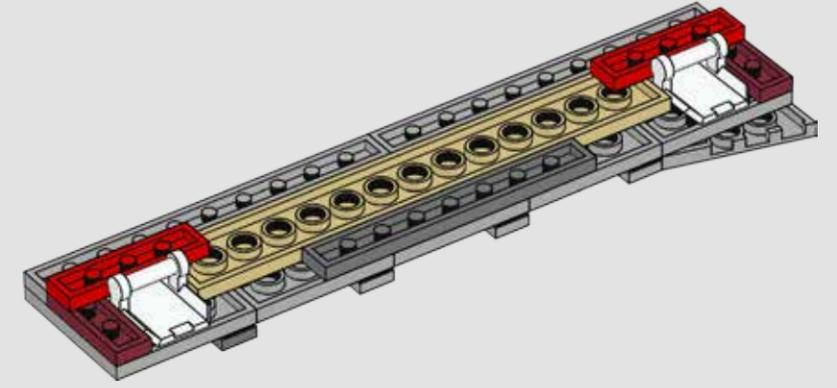

863

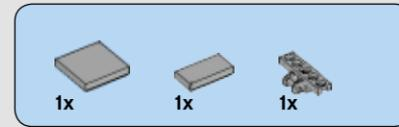
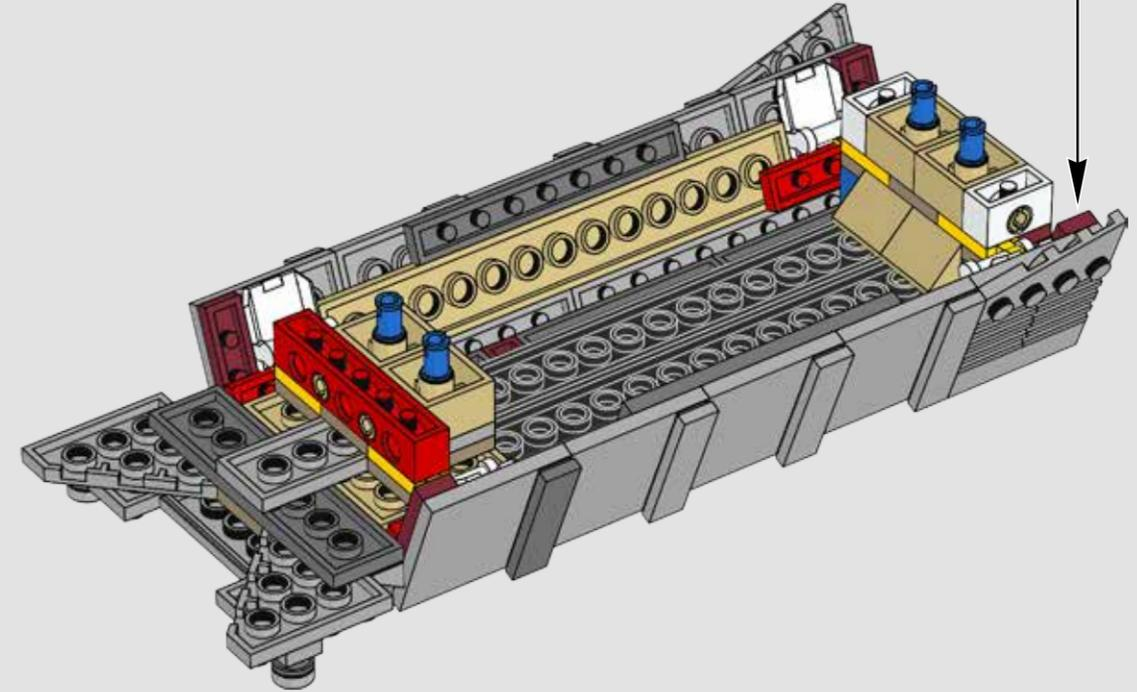

864

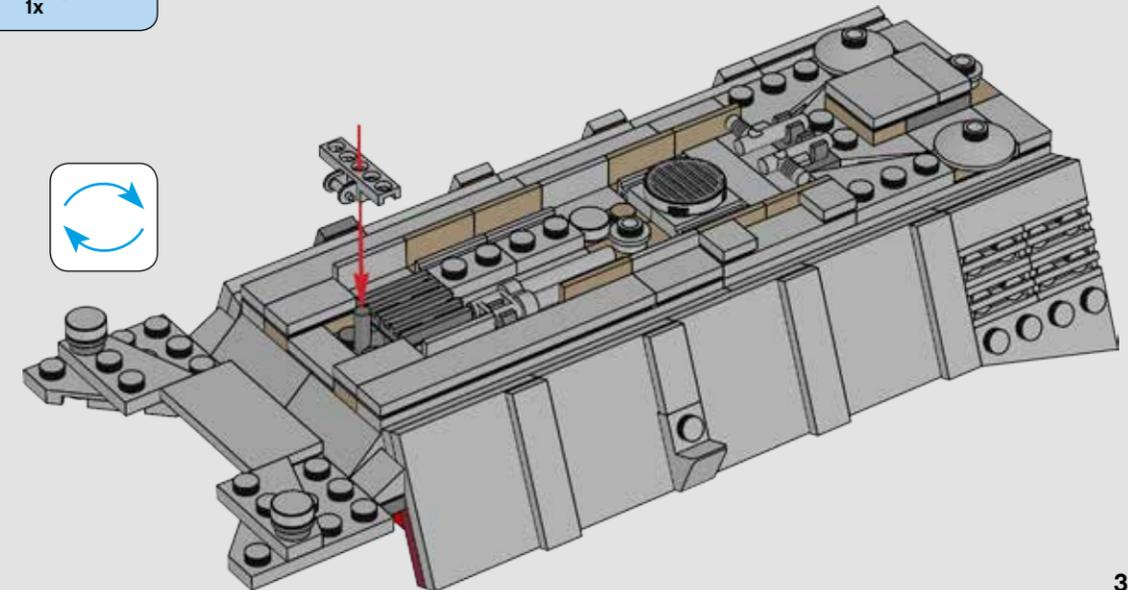

865

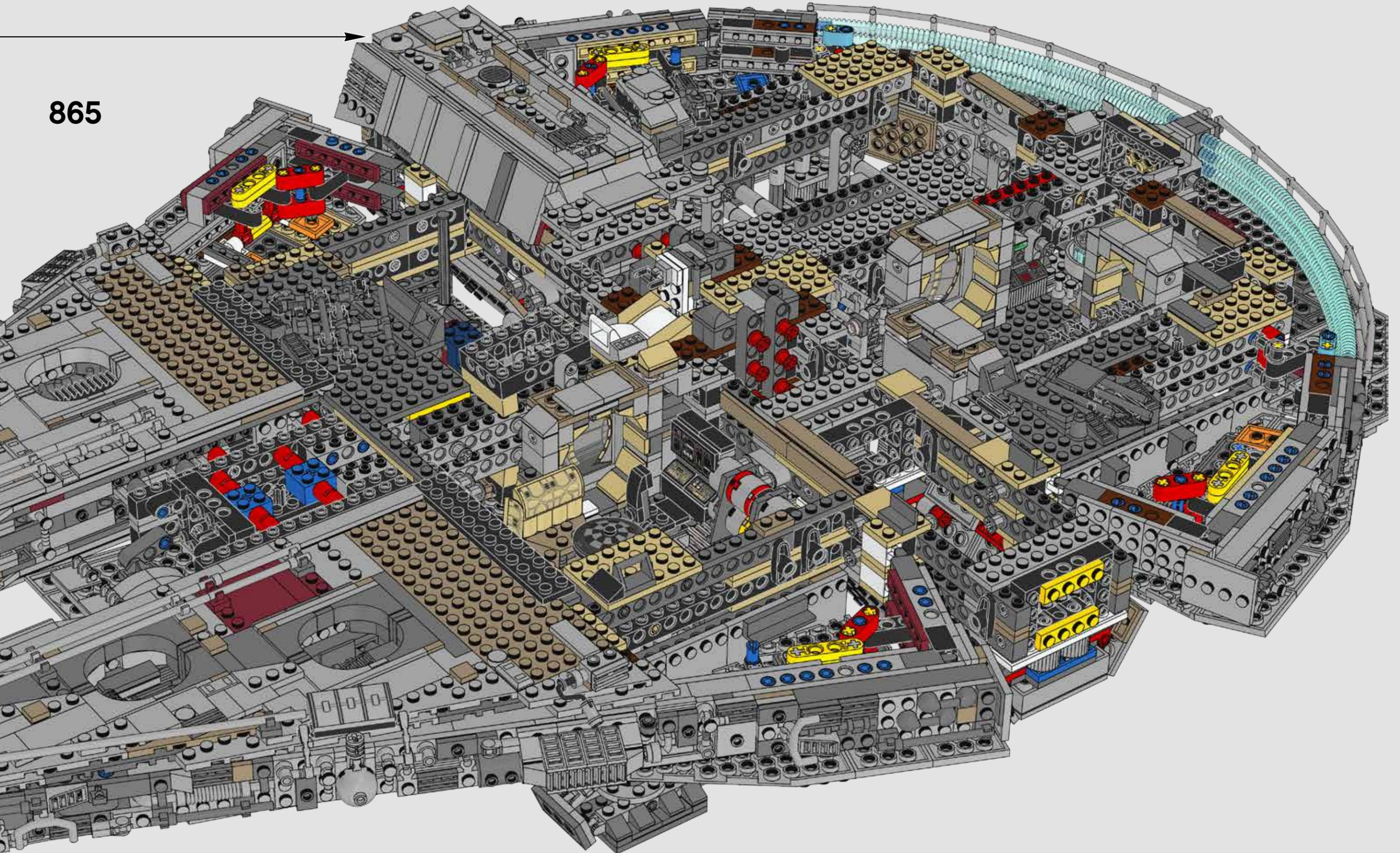

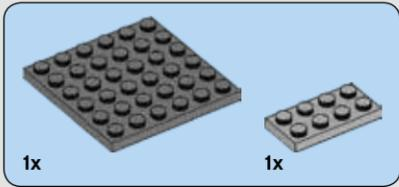
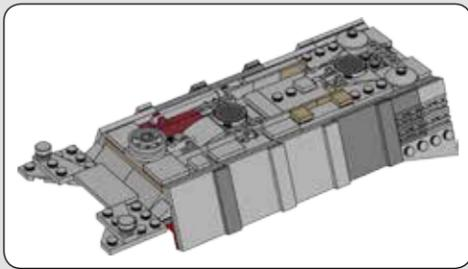

866

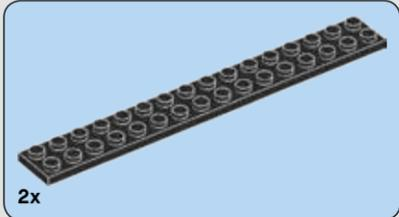

867

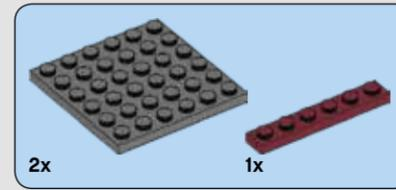
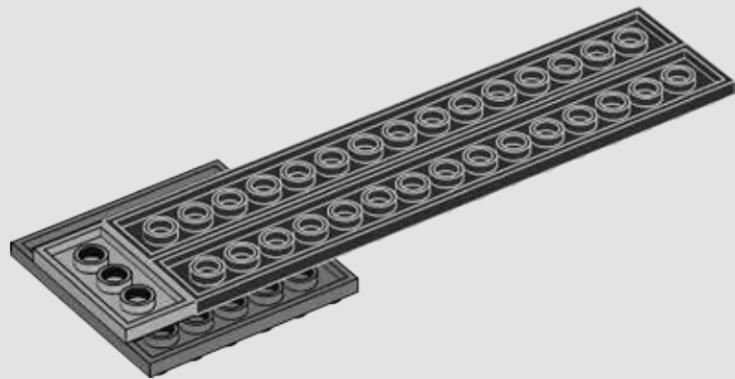

868

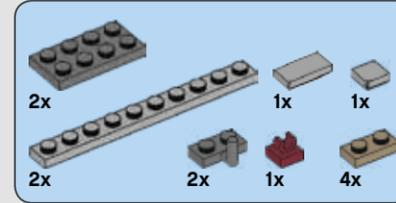
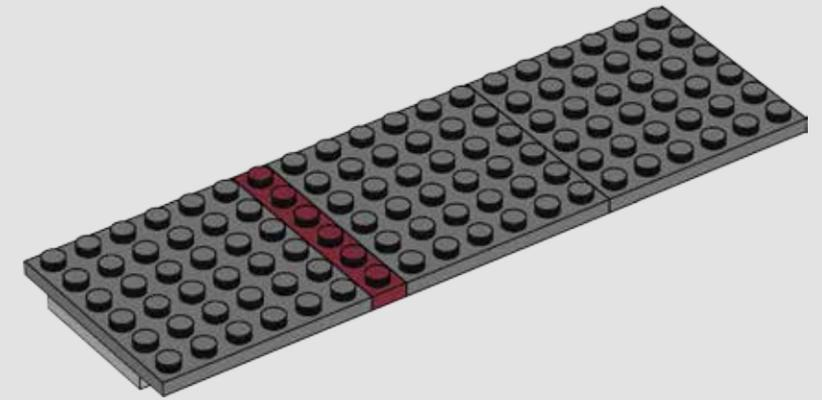

869

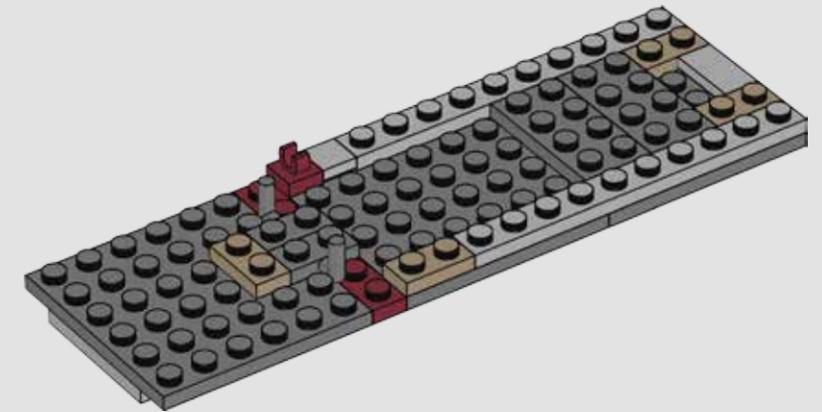

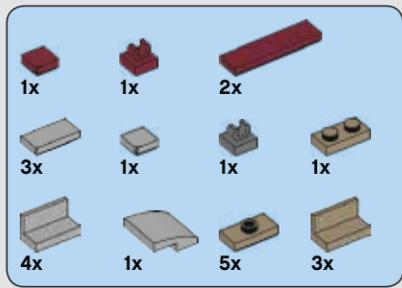

870

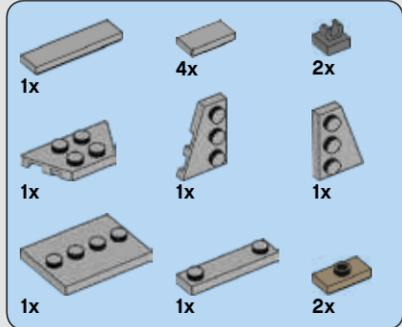
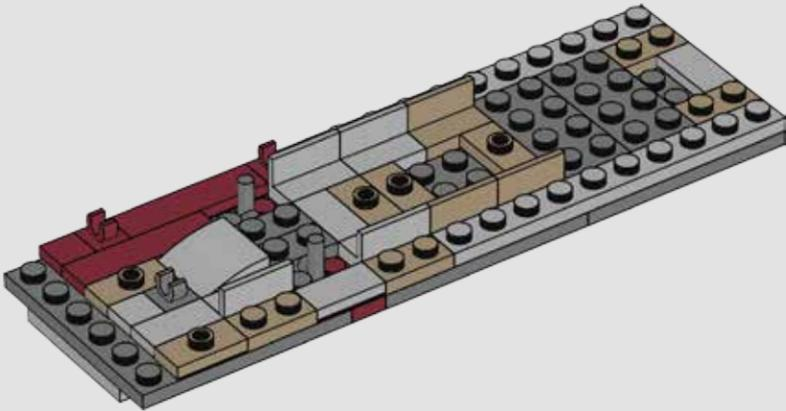

871

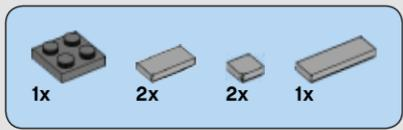
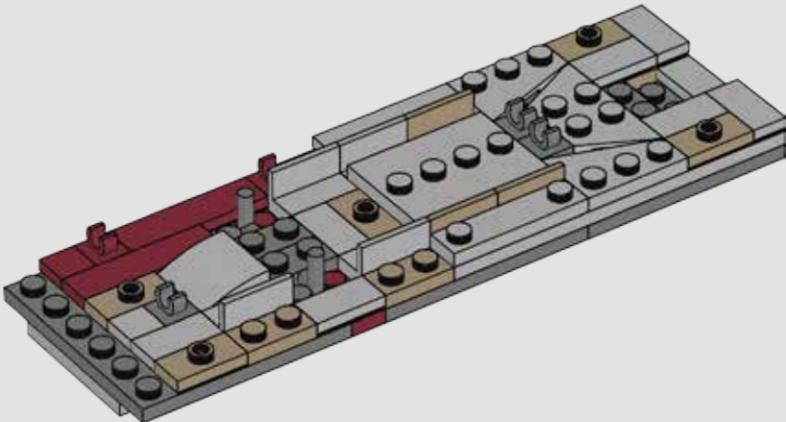

872

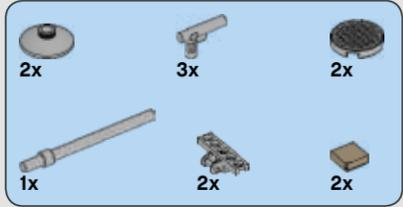
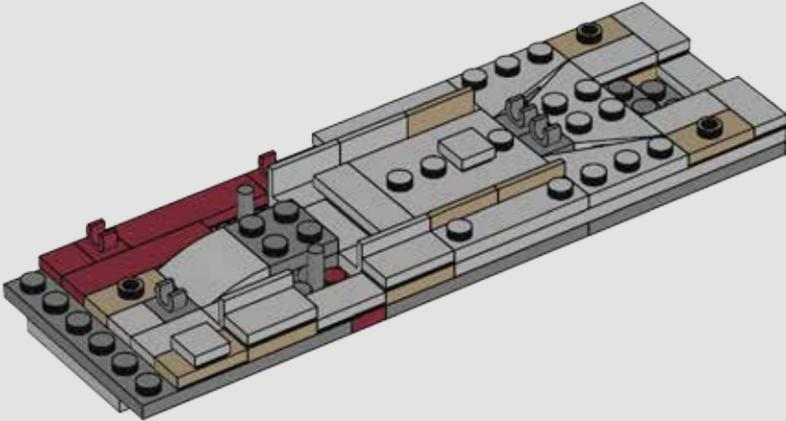

873

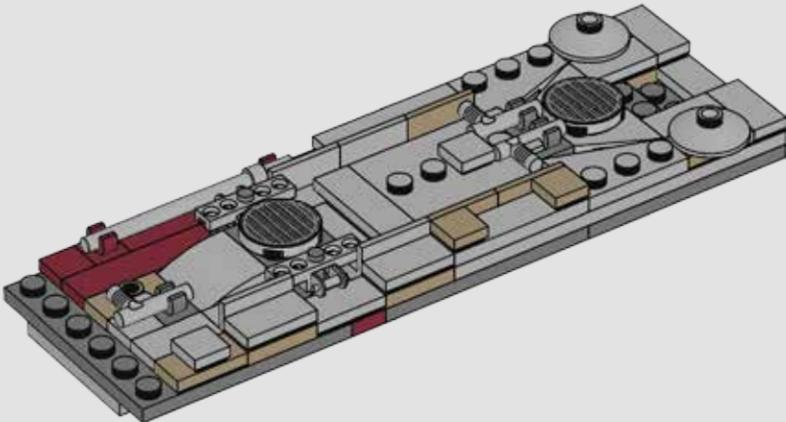

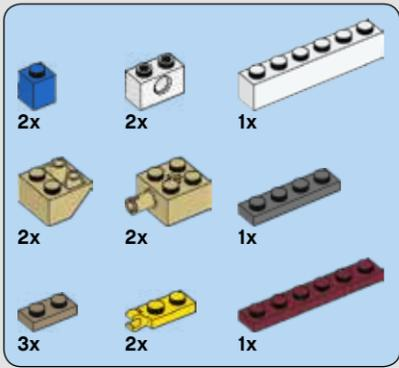

874

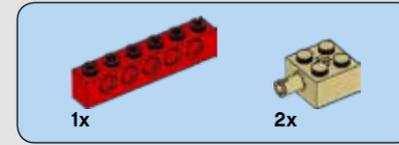
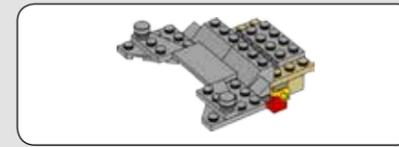
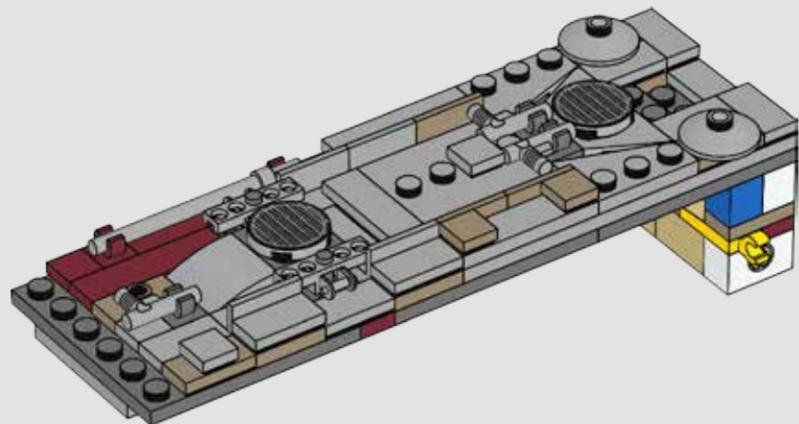
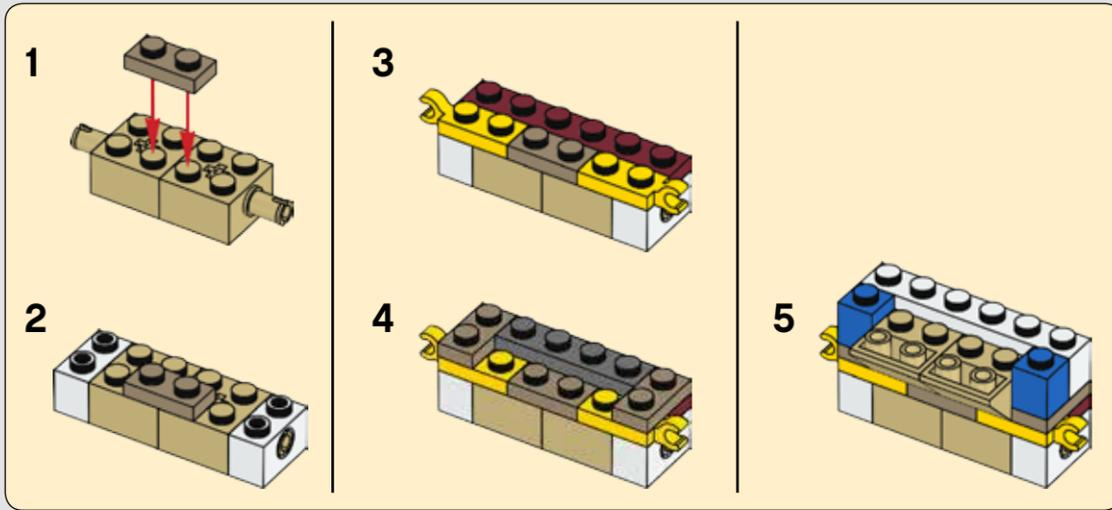

875

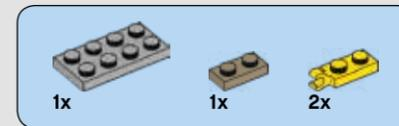
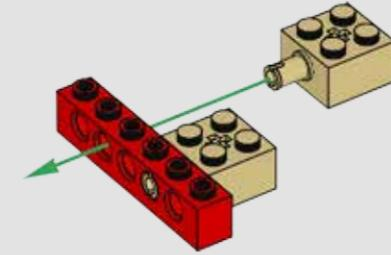

876

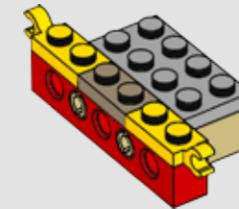

877

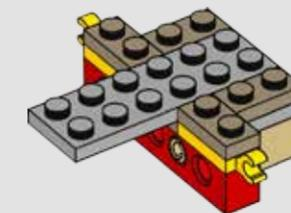

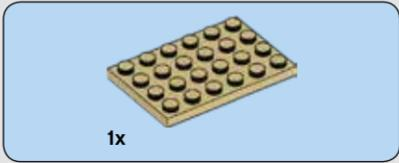

878

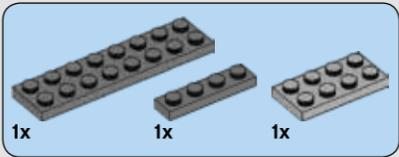
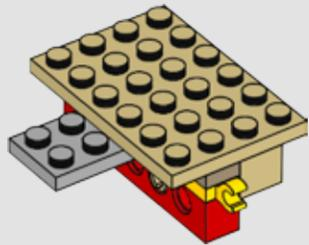

879

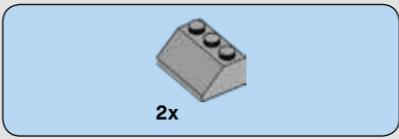
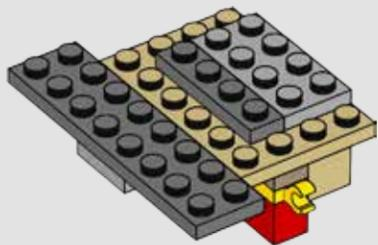

880

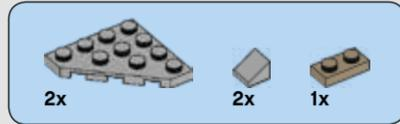
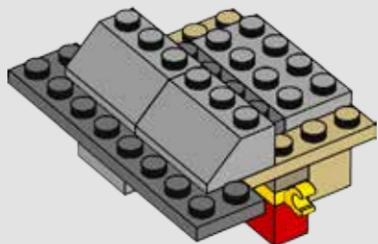

881

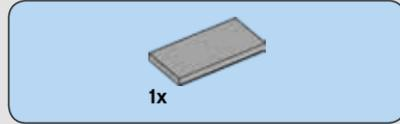
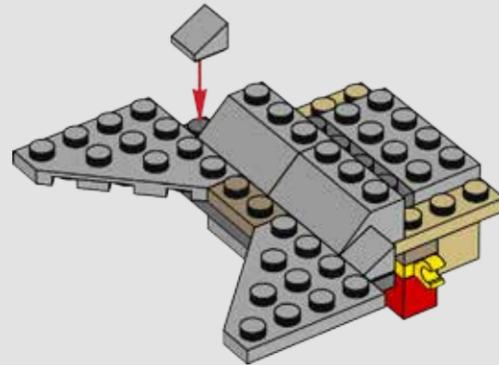

882

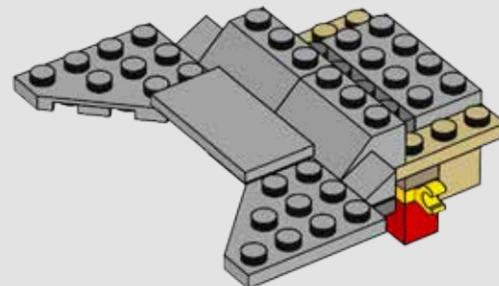

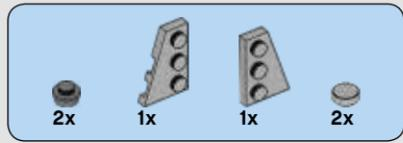

883

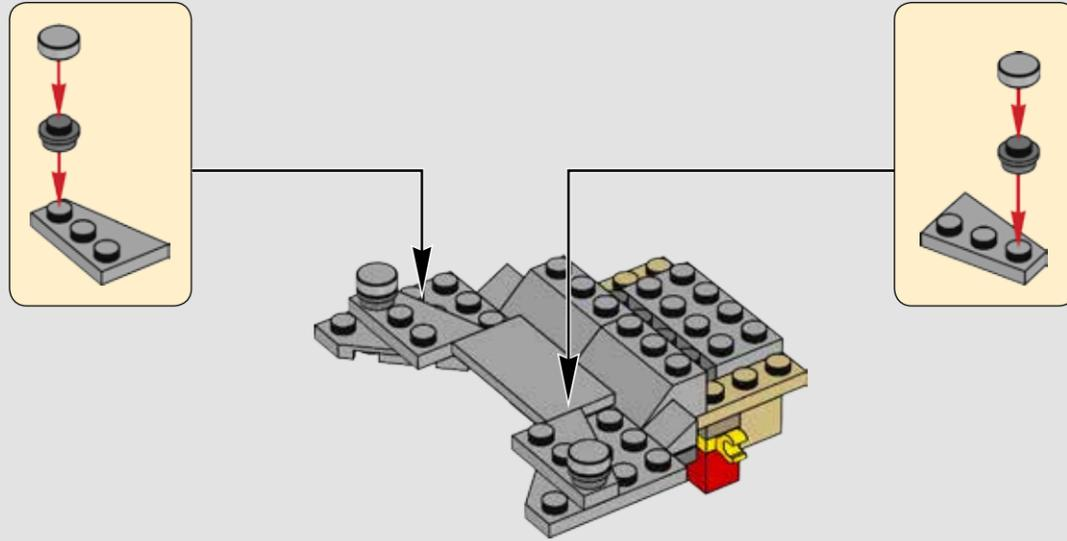

885

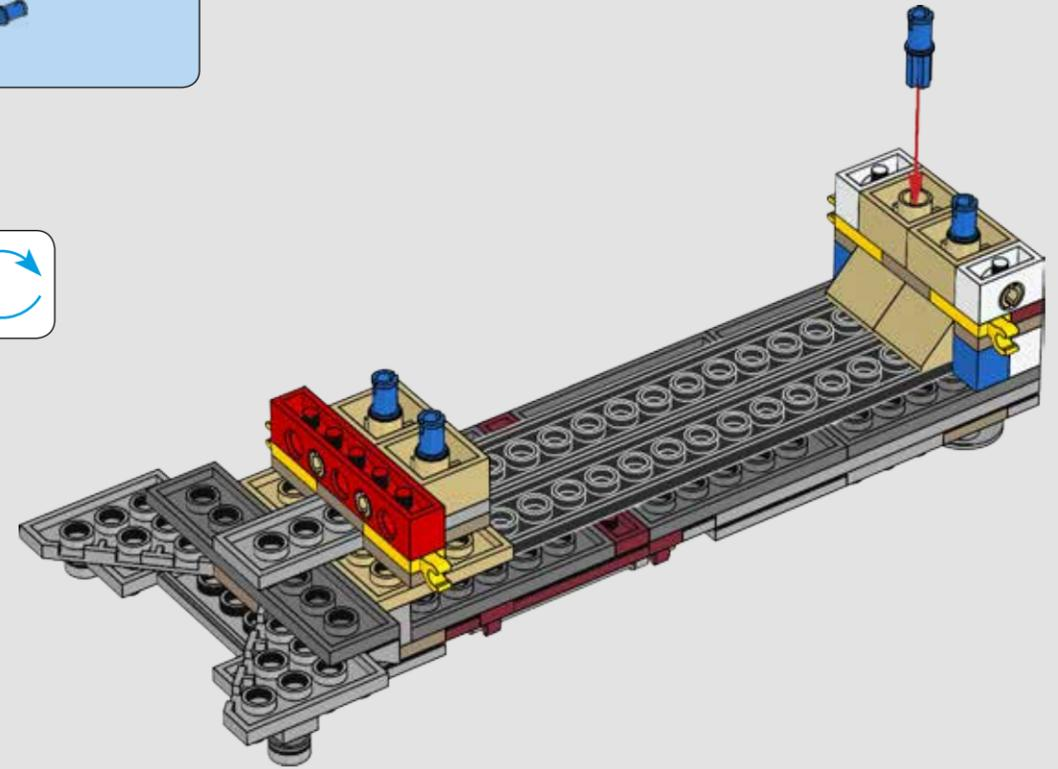

884

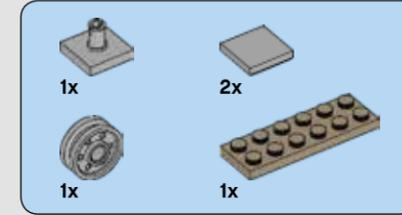
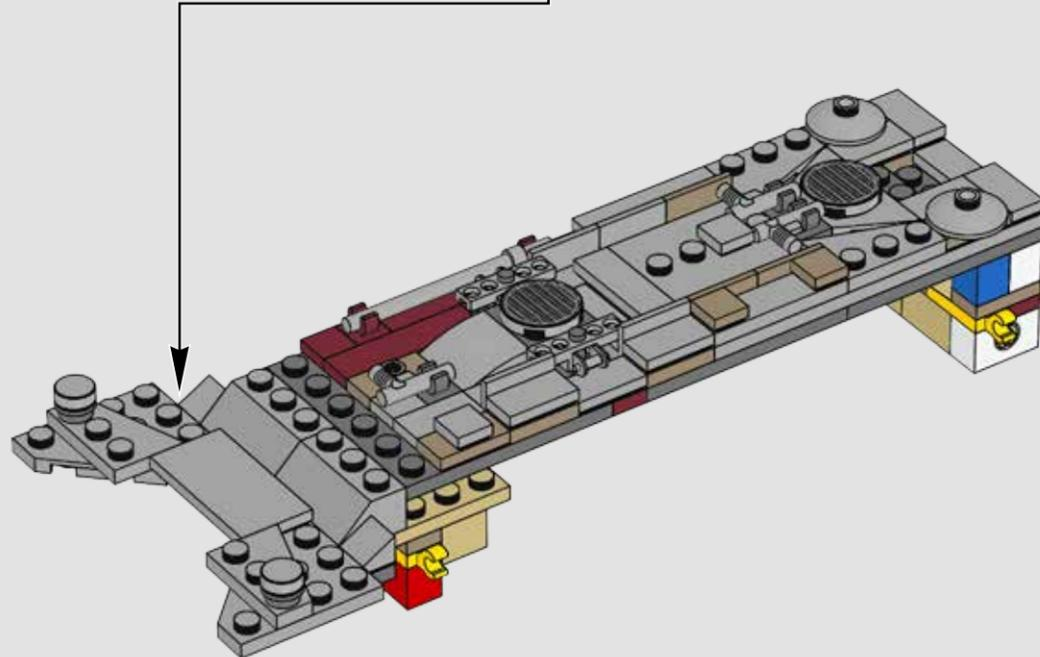

886

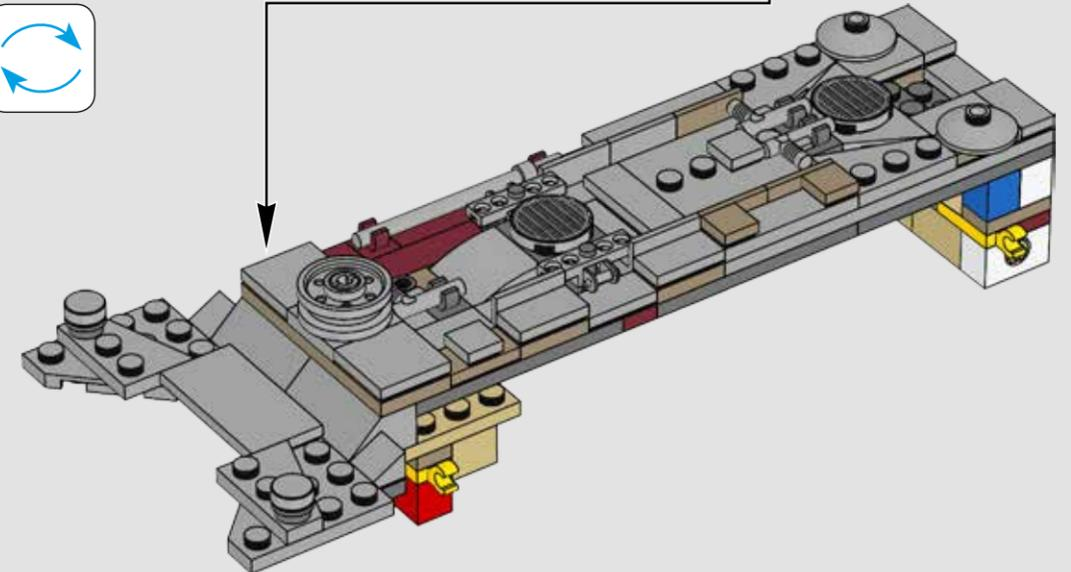
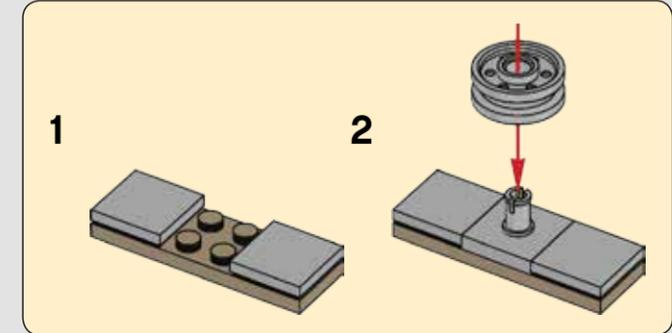

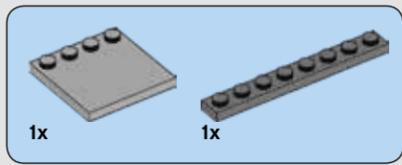

887

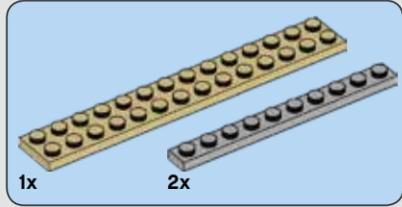
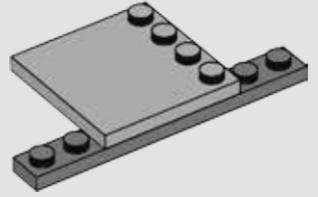

888

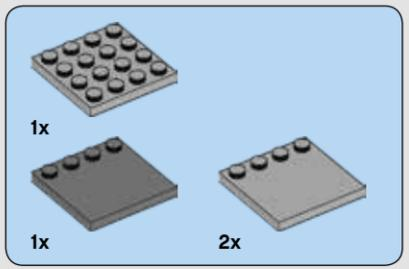
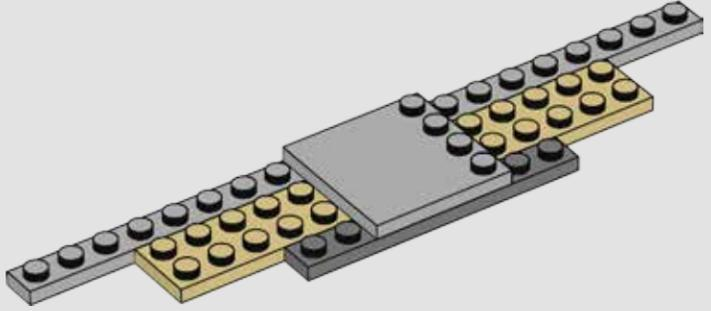

889

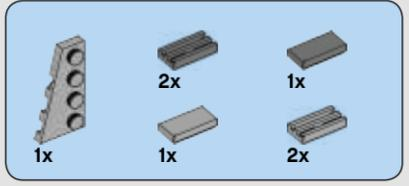
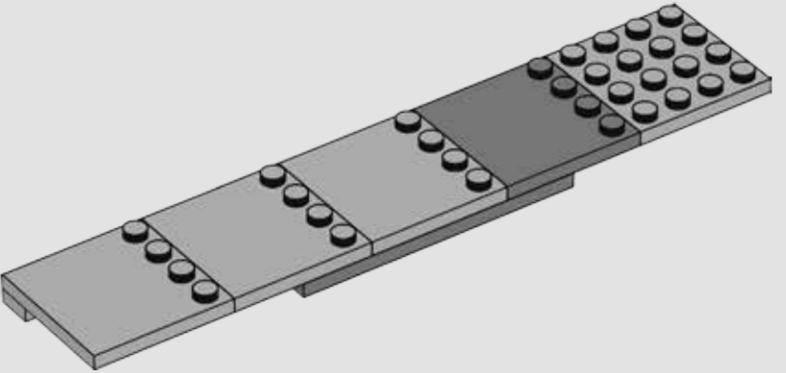

890

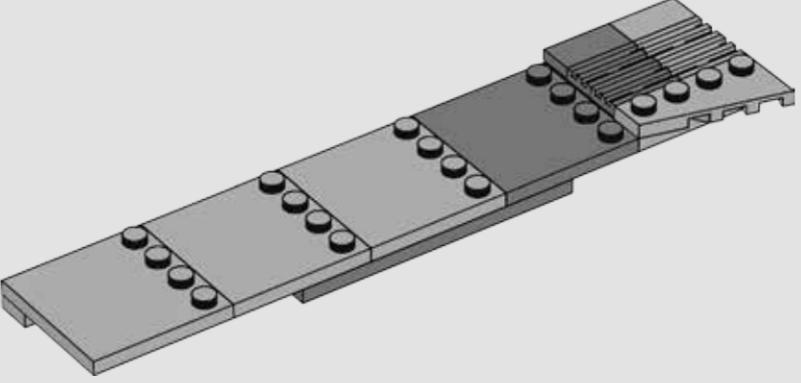

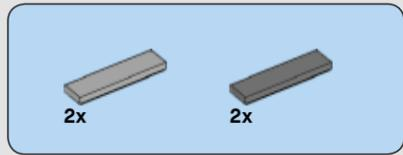

891

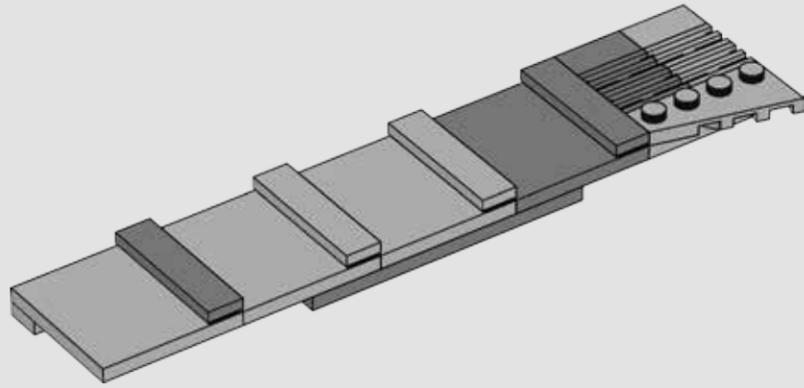

892

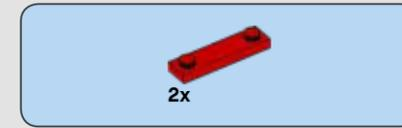
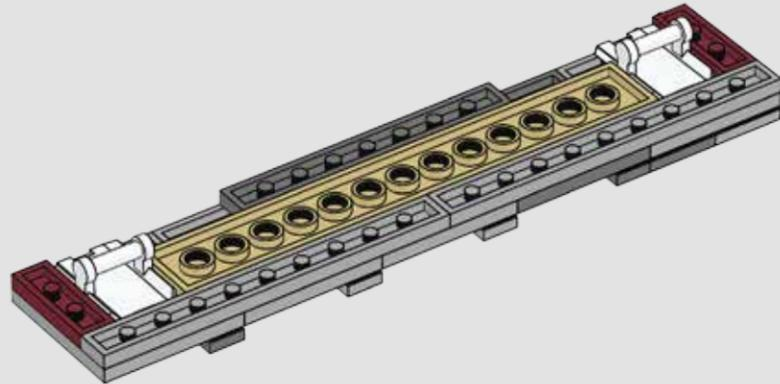

893

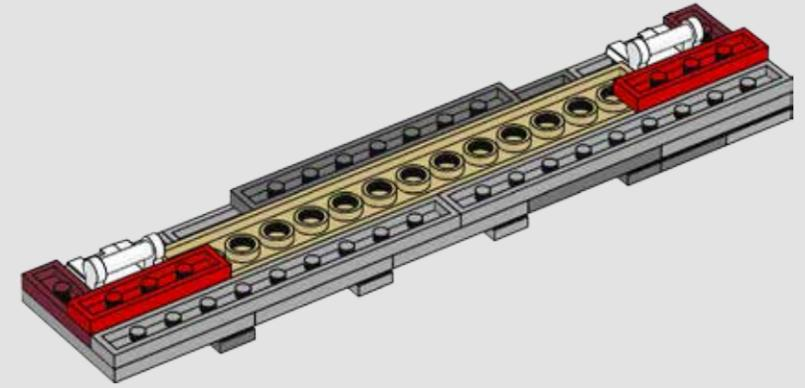

894

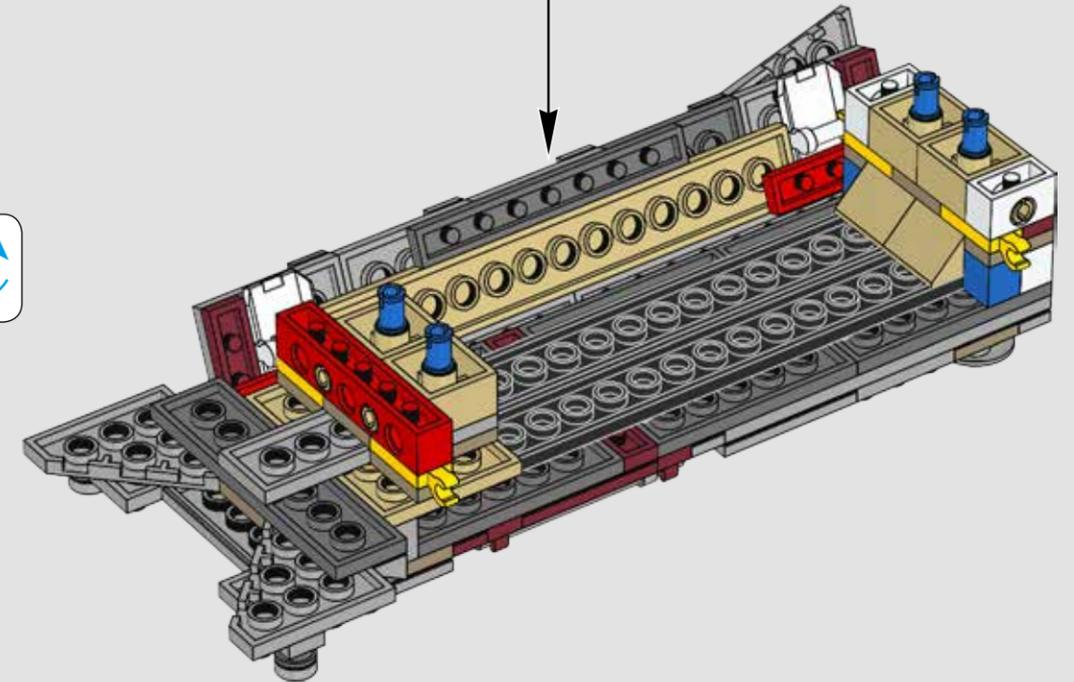

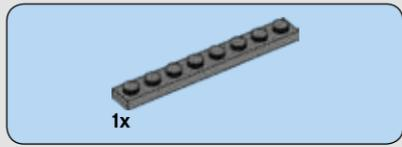

895

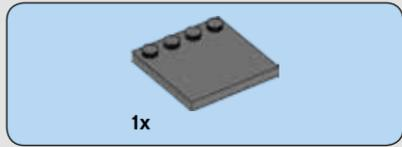

896

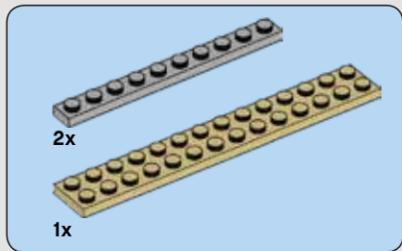
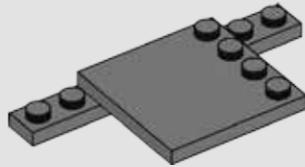

897

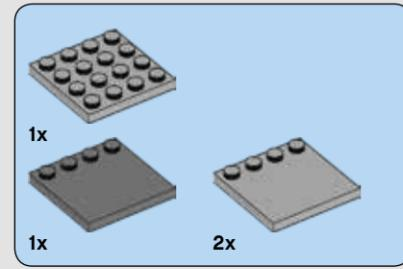
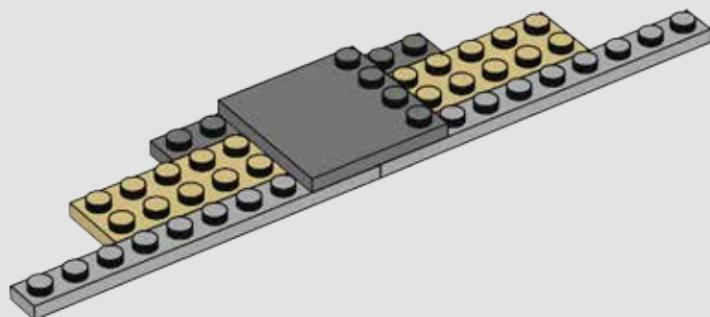

898

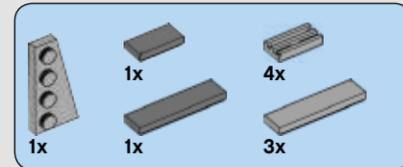
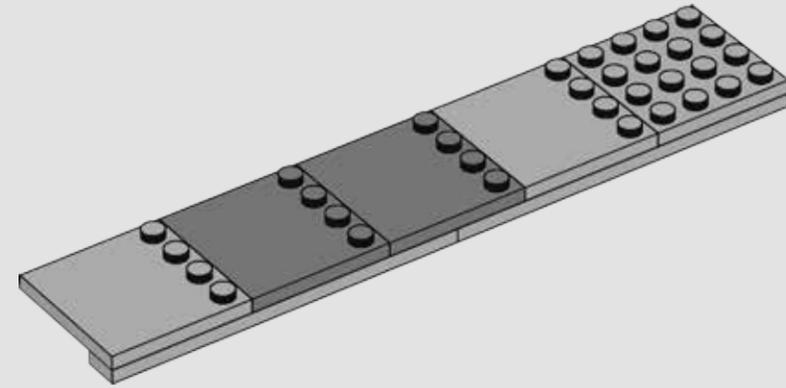

899

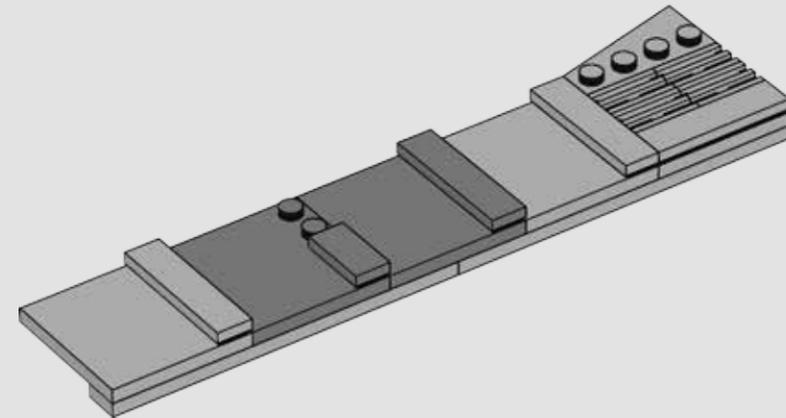



900

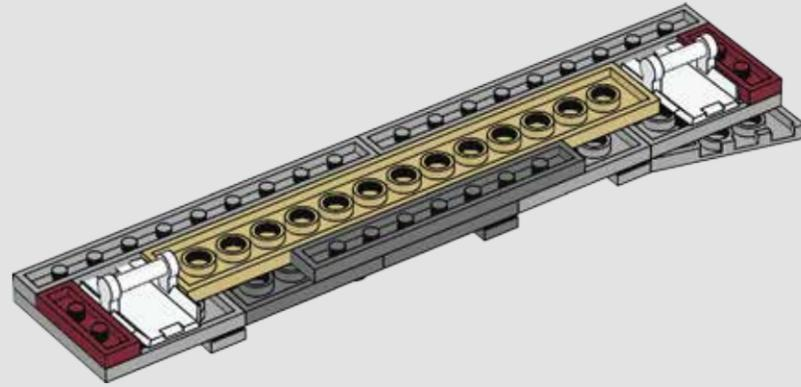

901

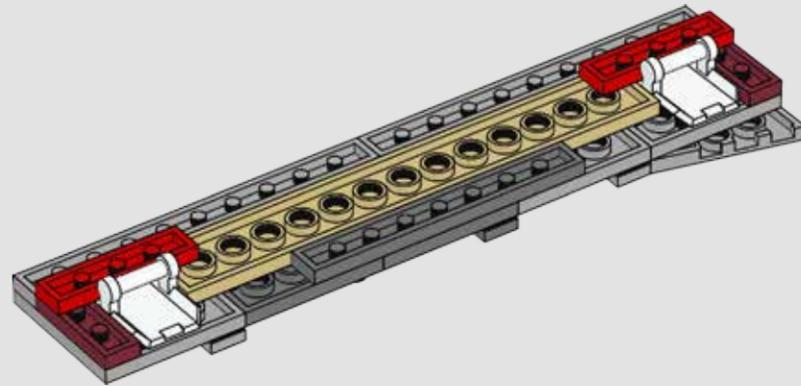

902

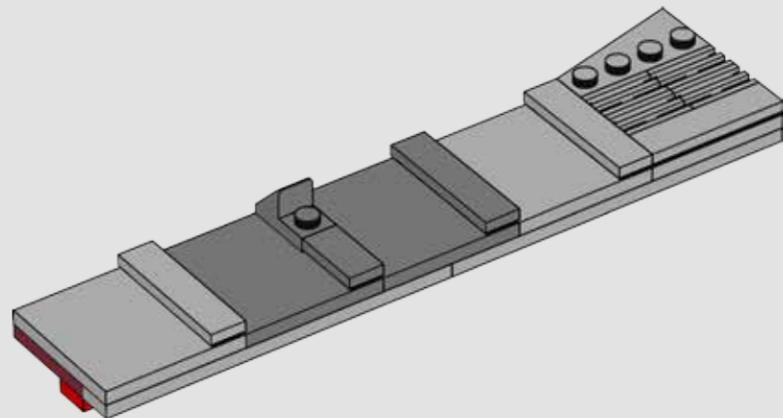

903

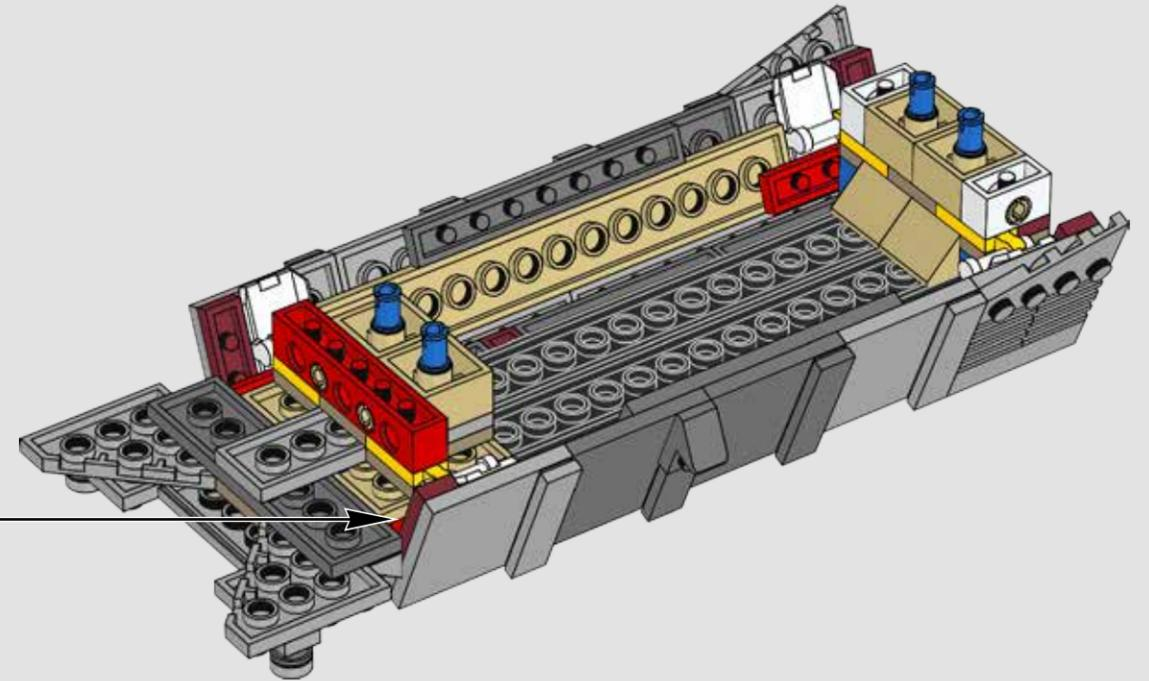

904

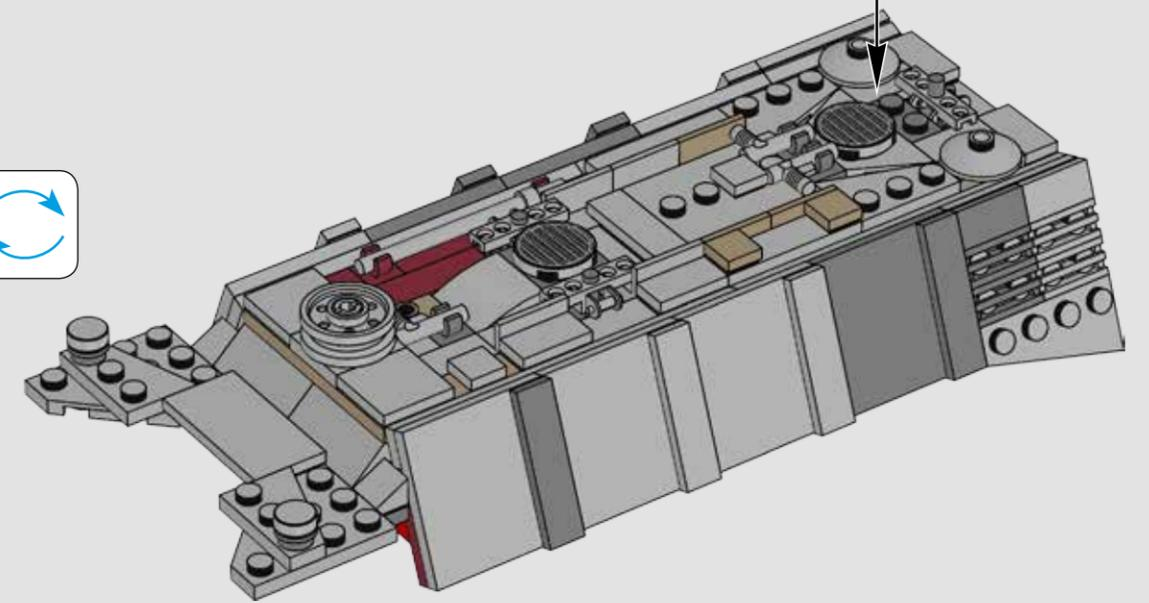
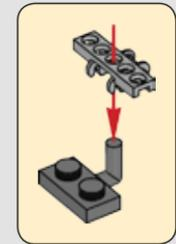

905

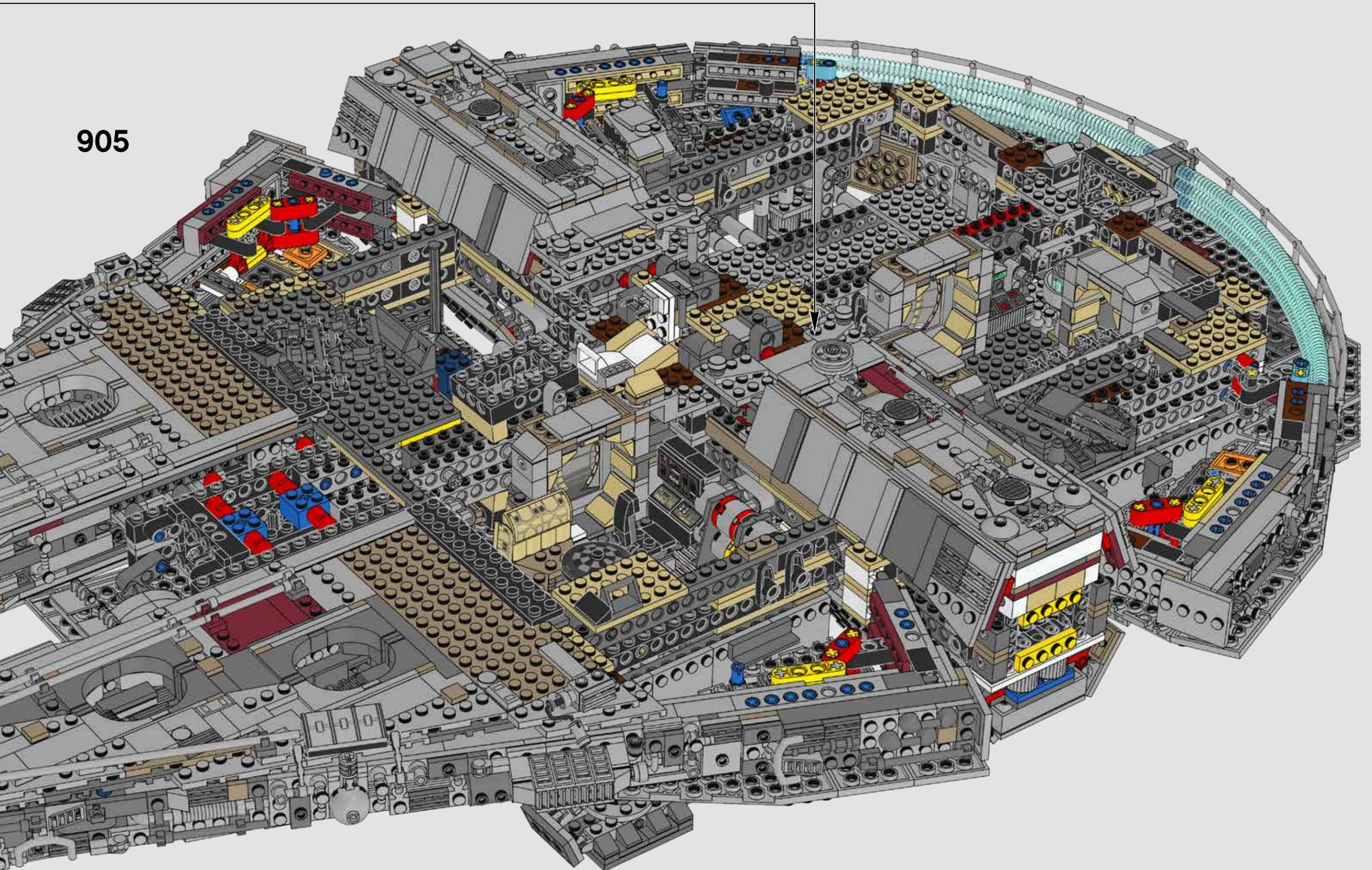

12

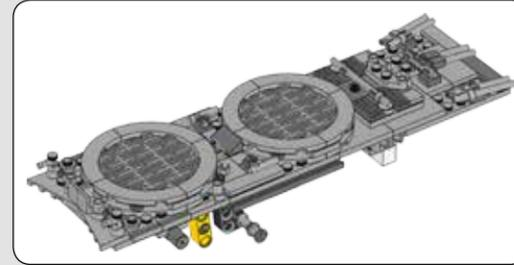
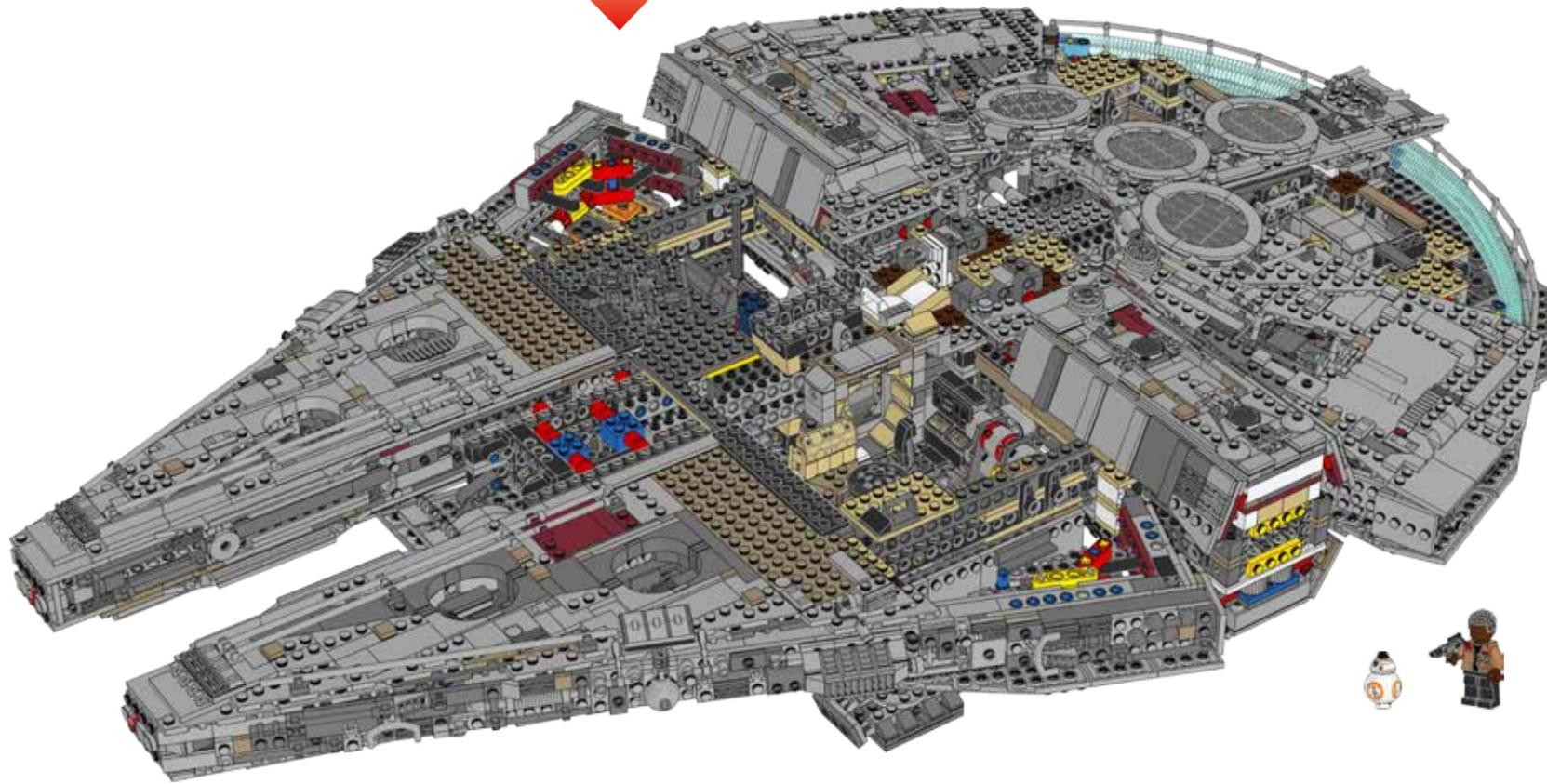

906

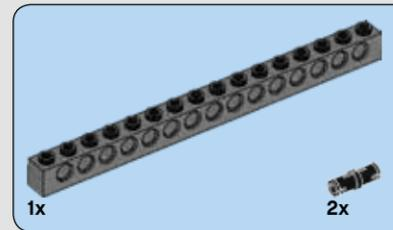

907

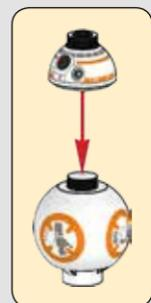
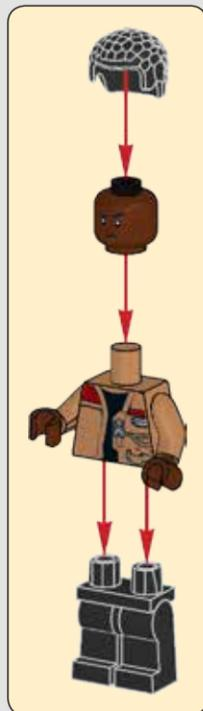
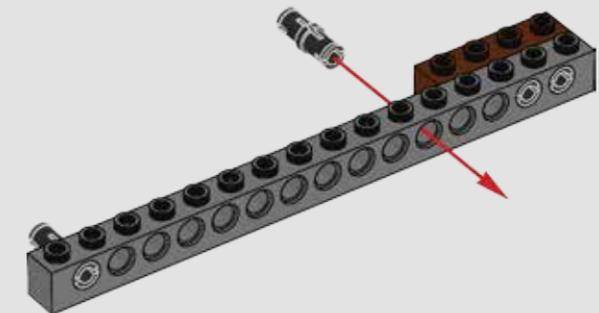

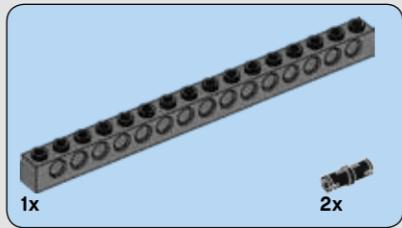

908

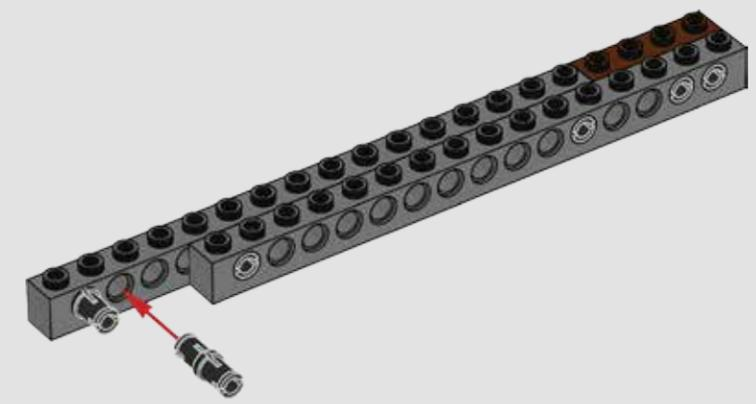

909

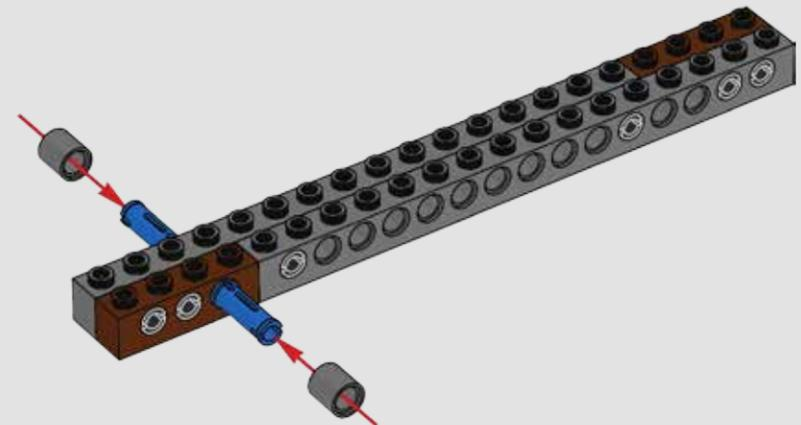

910

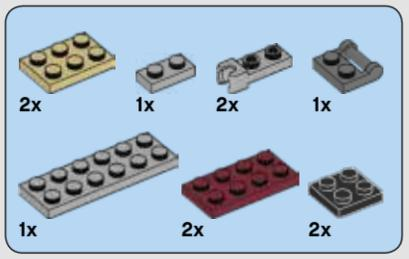
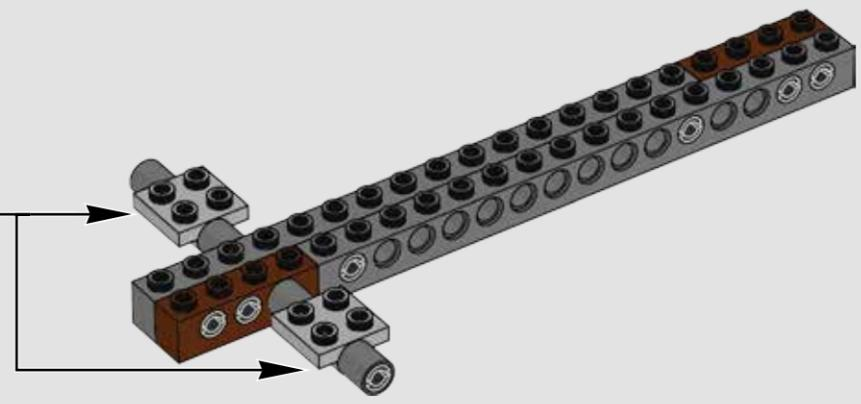
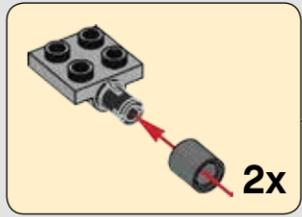

911

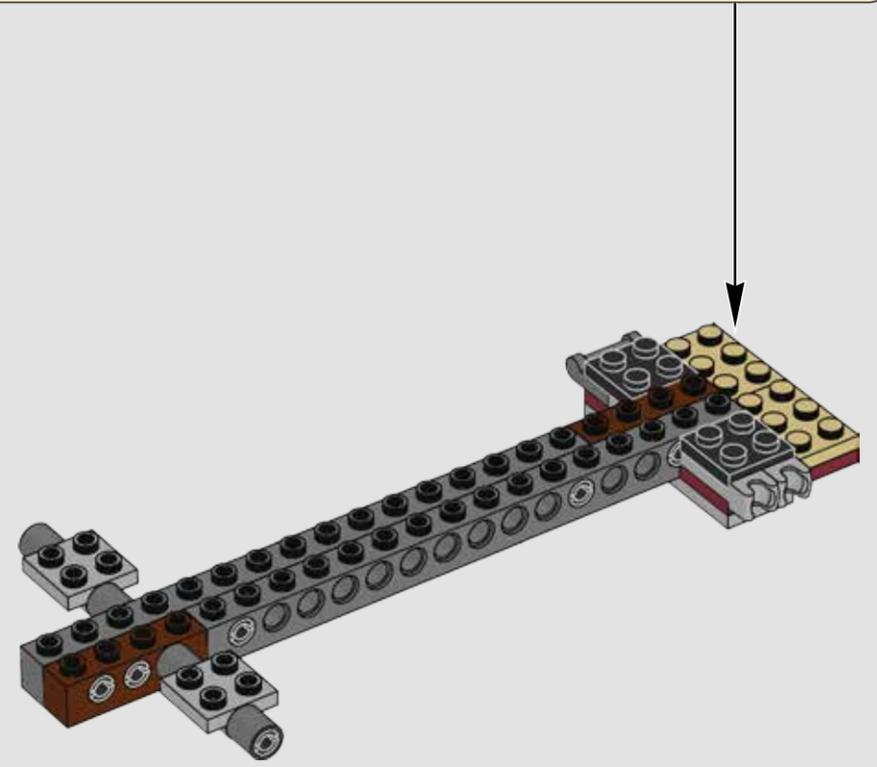
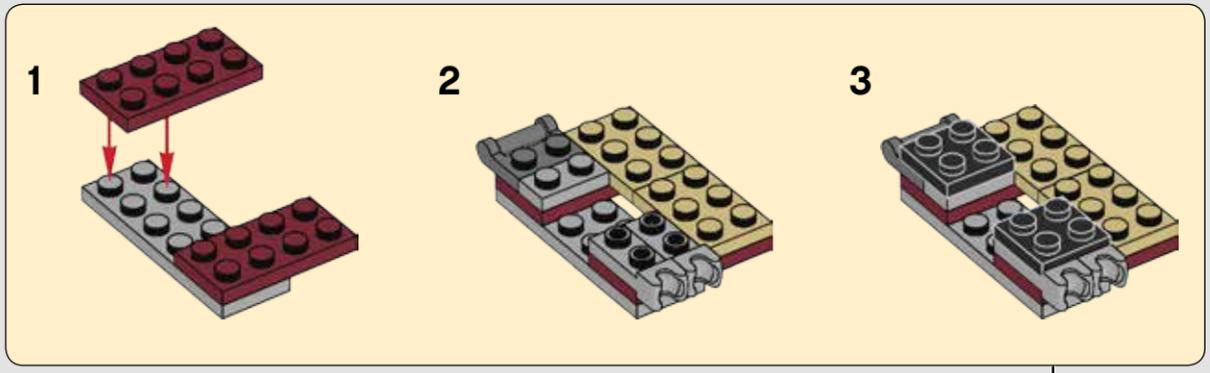

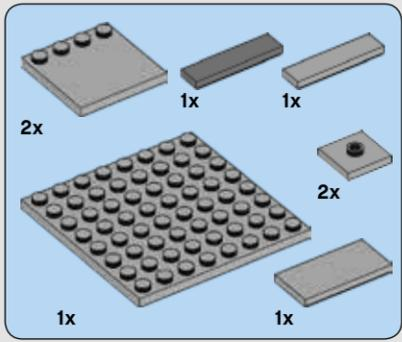

912

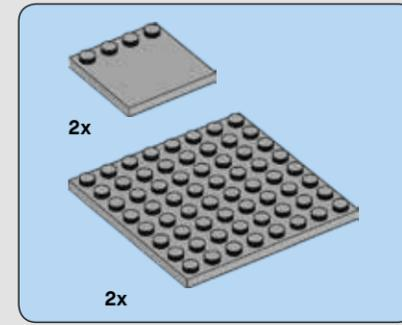
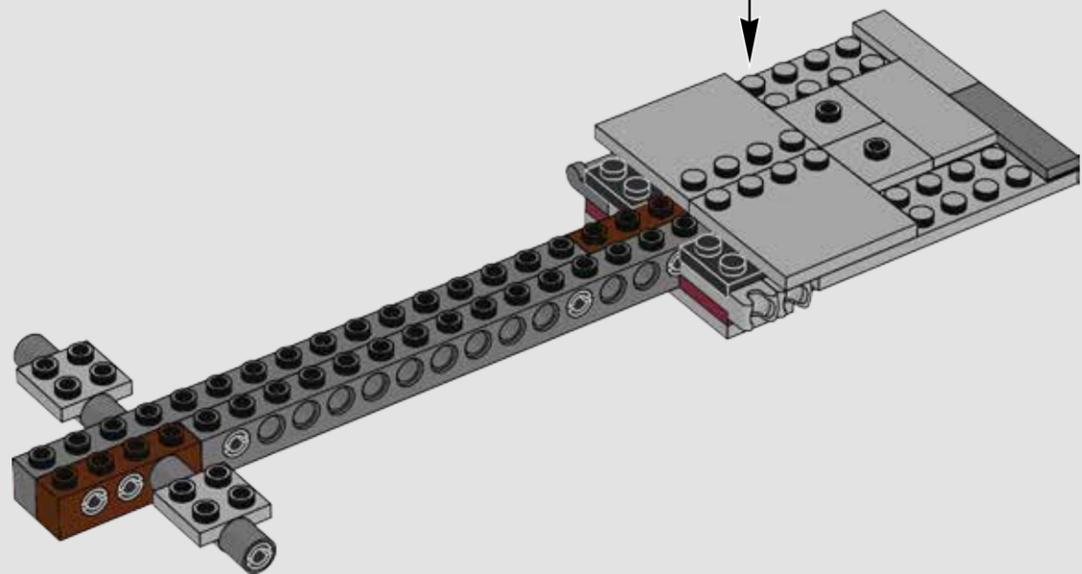
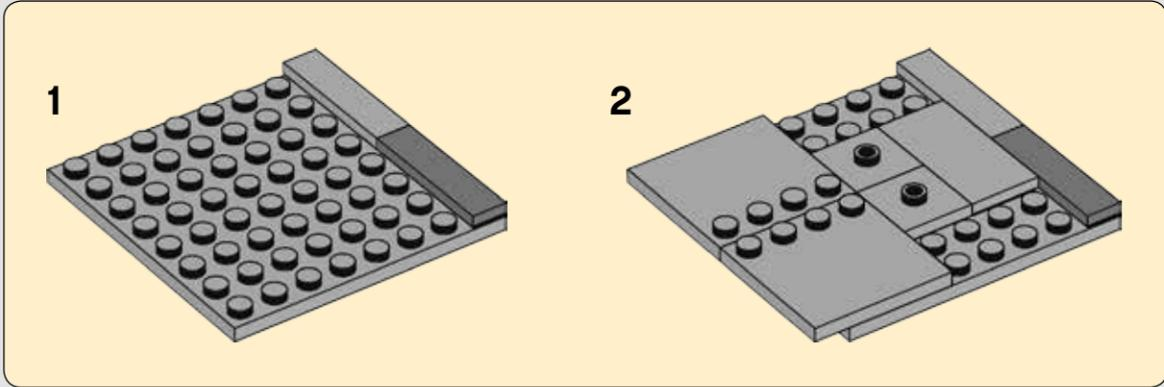

913

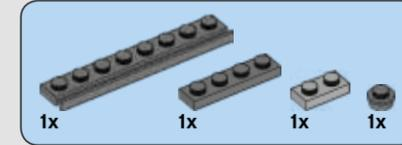
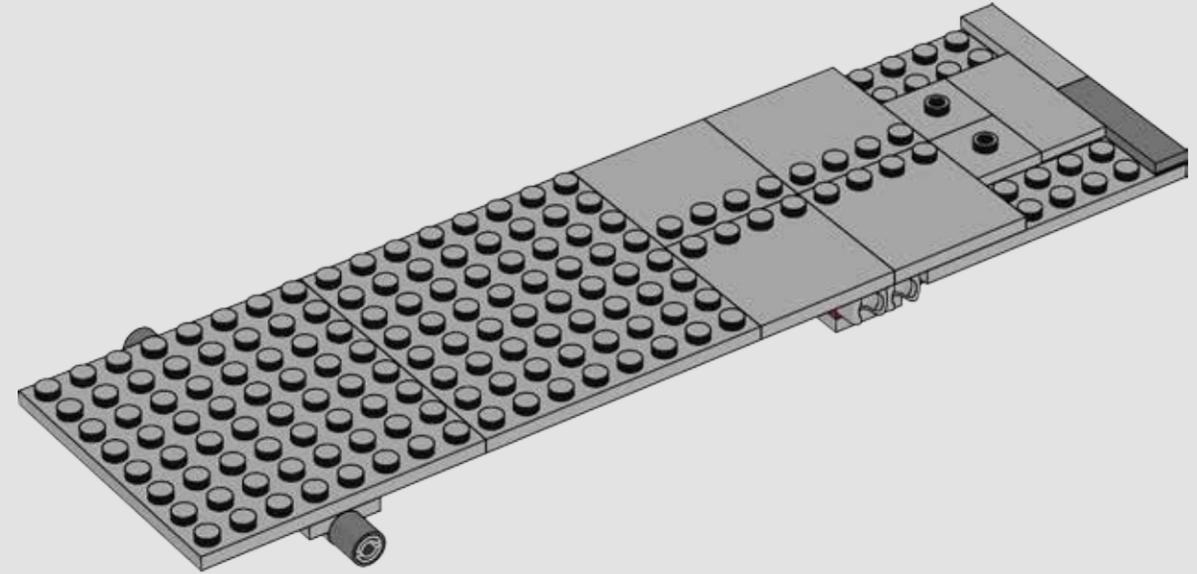

914

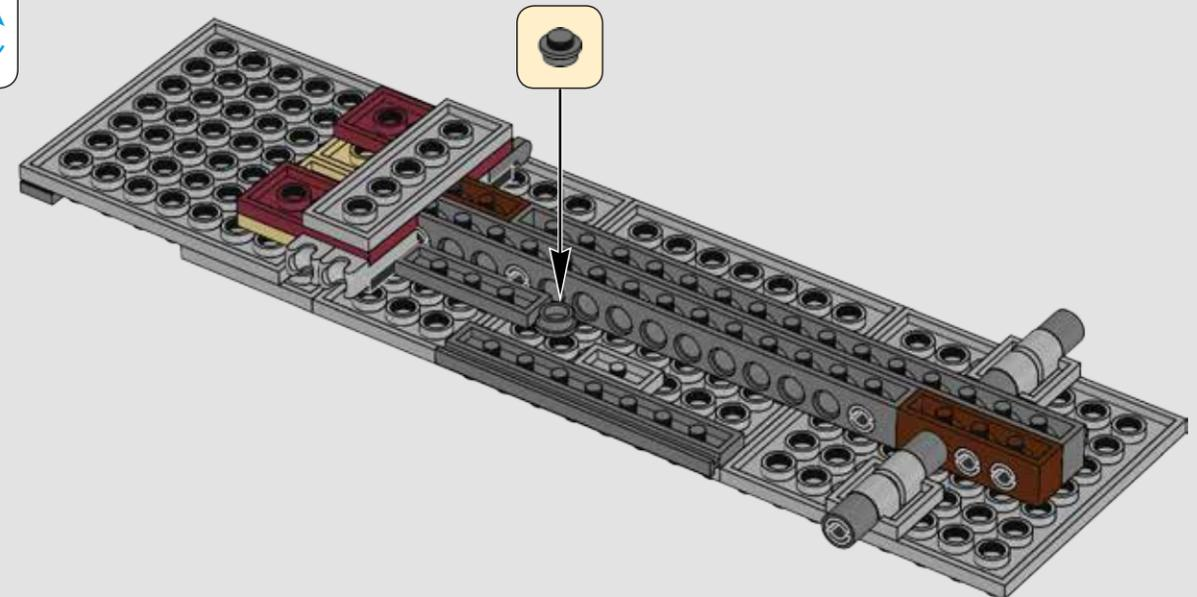



918

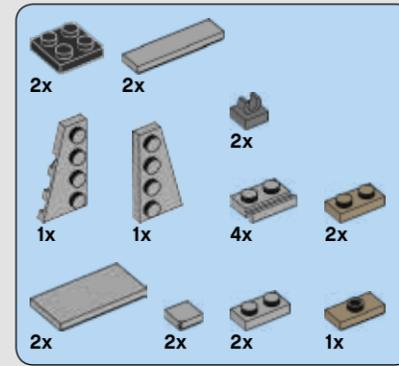
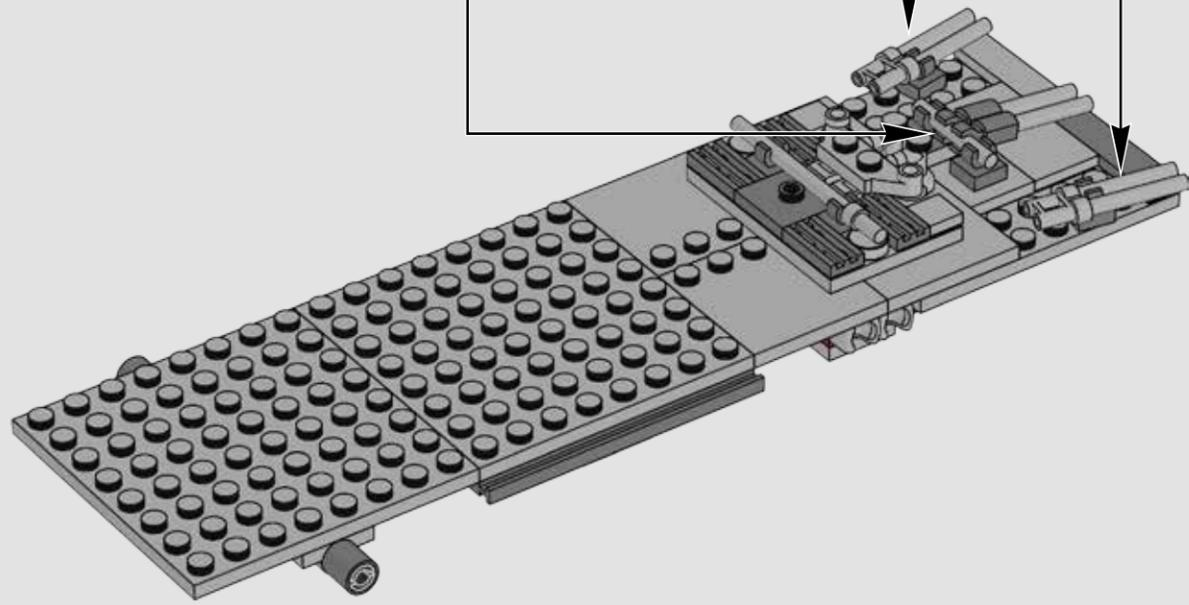
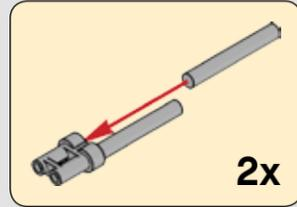
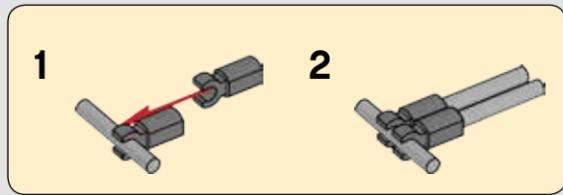

919

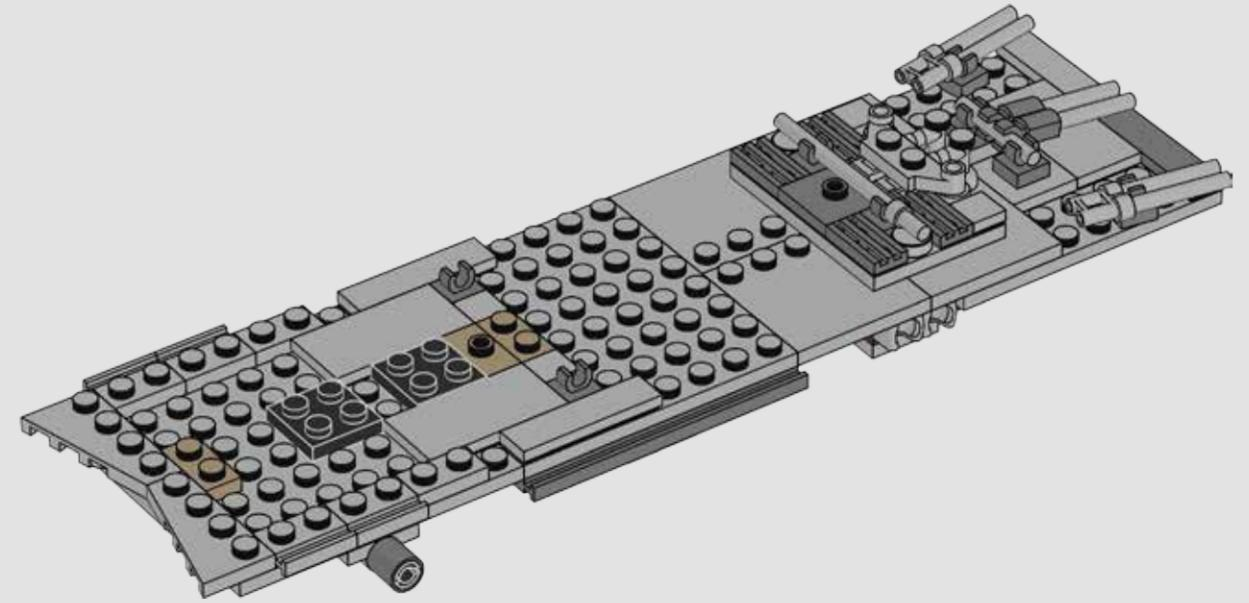

920

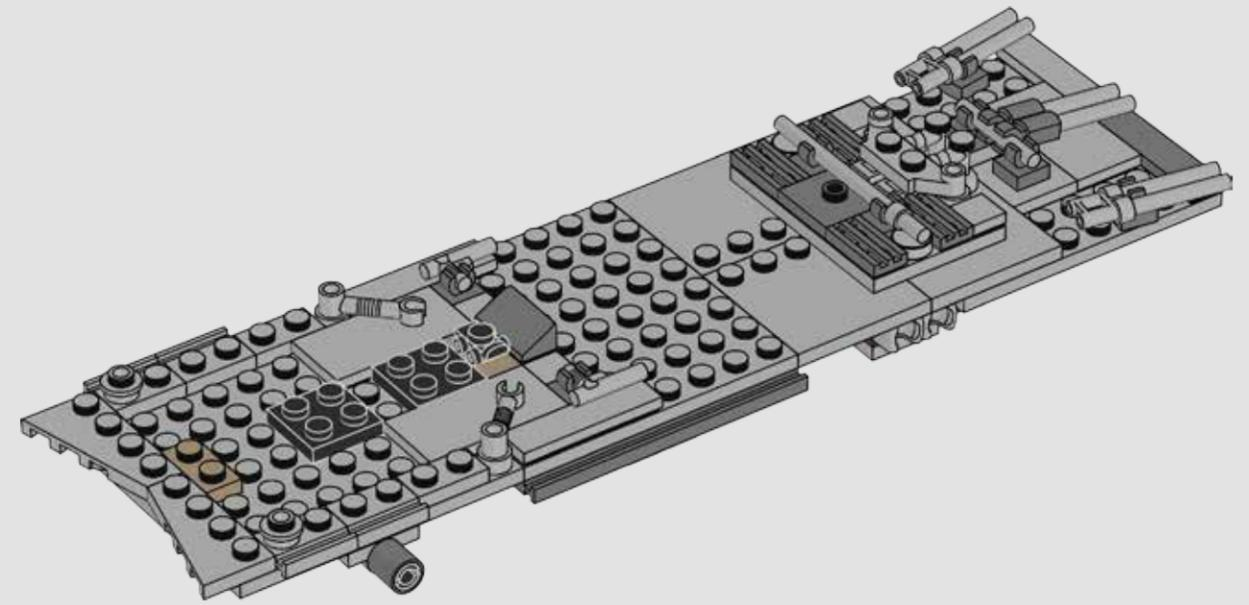

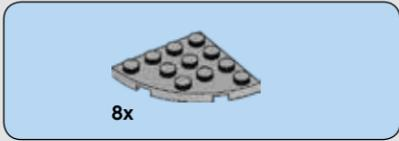

921



8x

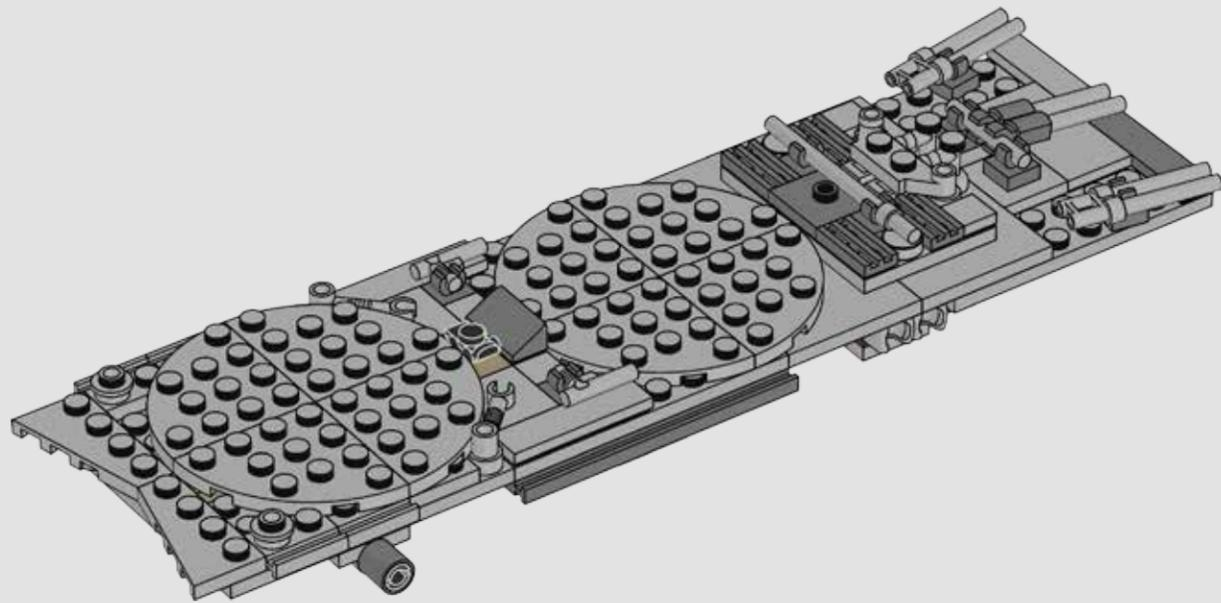

922

32x

8x

8x

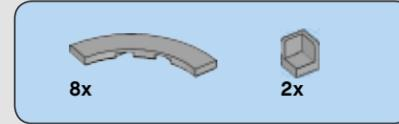
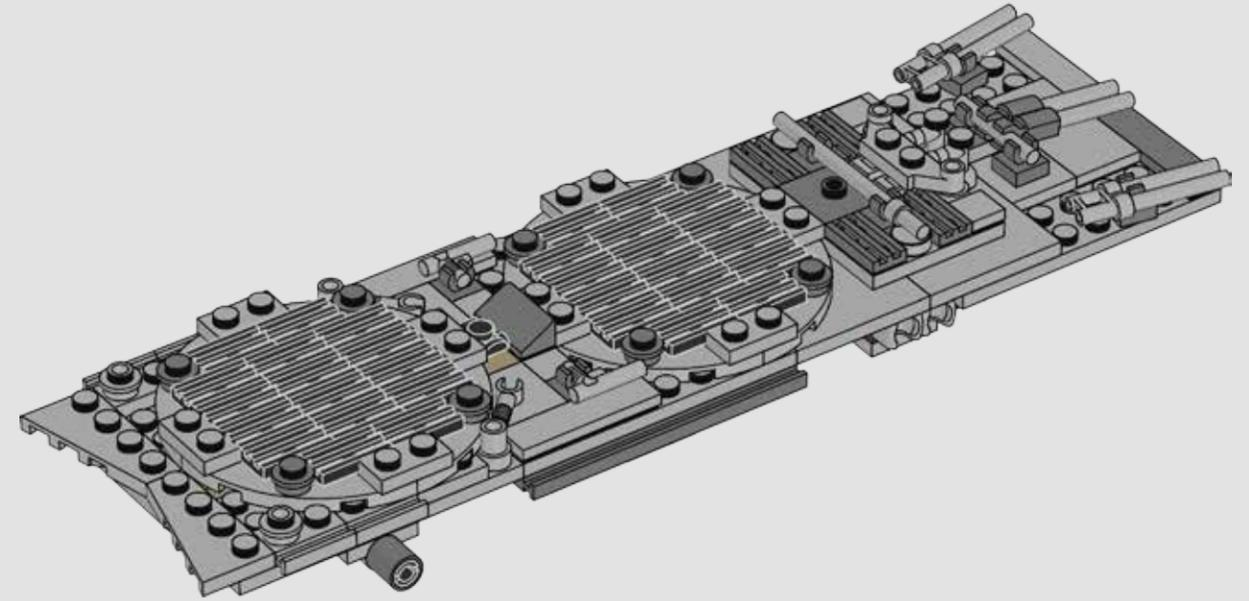

923

8x

2x

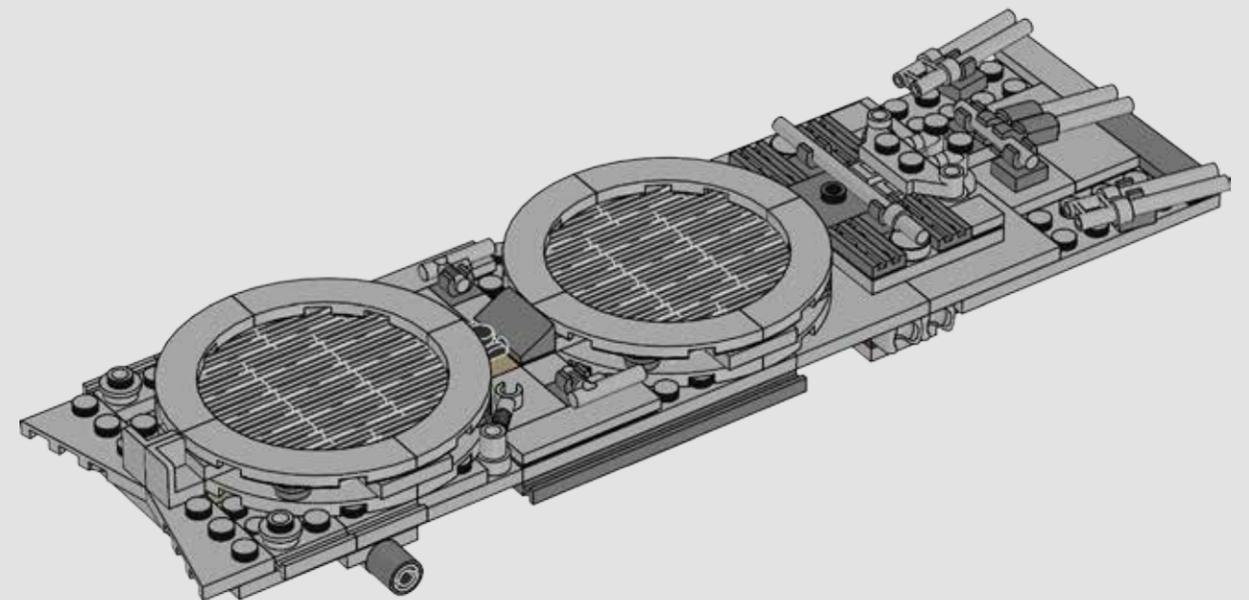



924

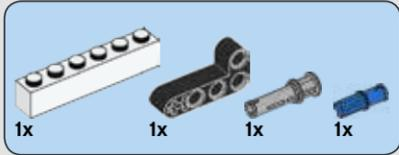
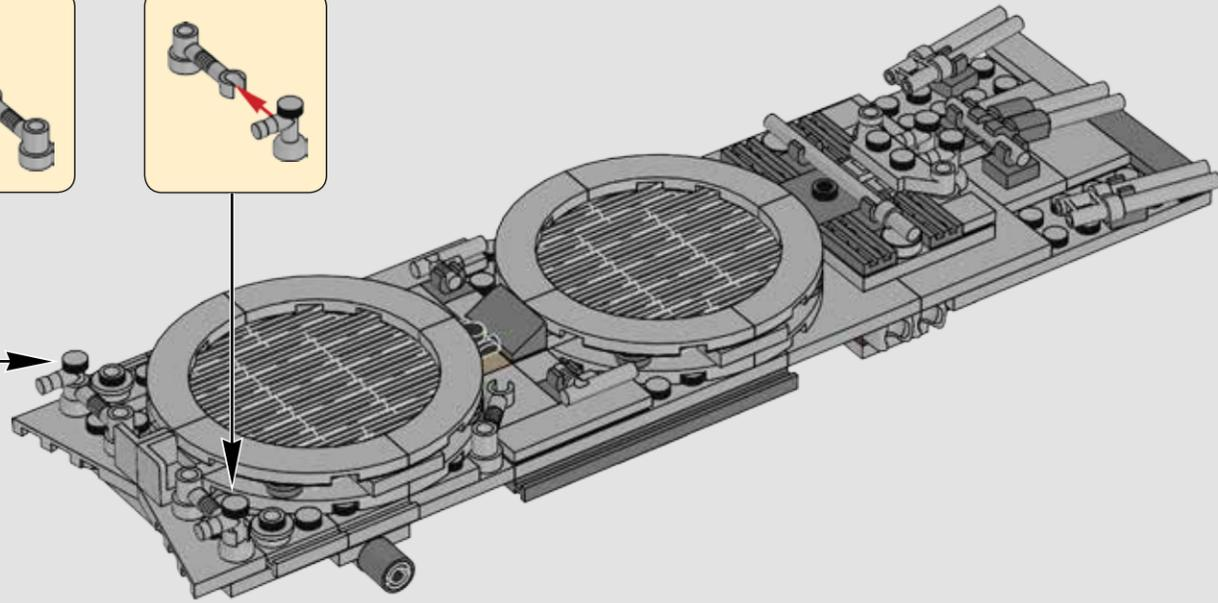
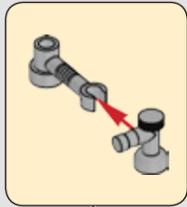
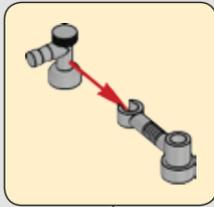

925

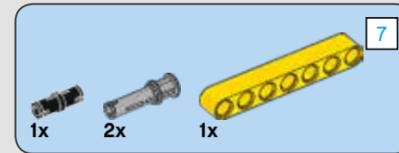
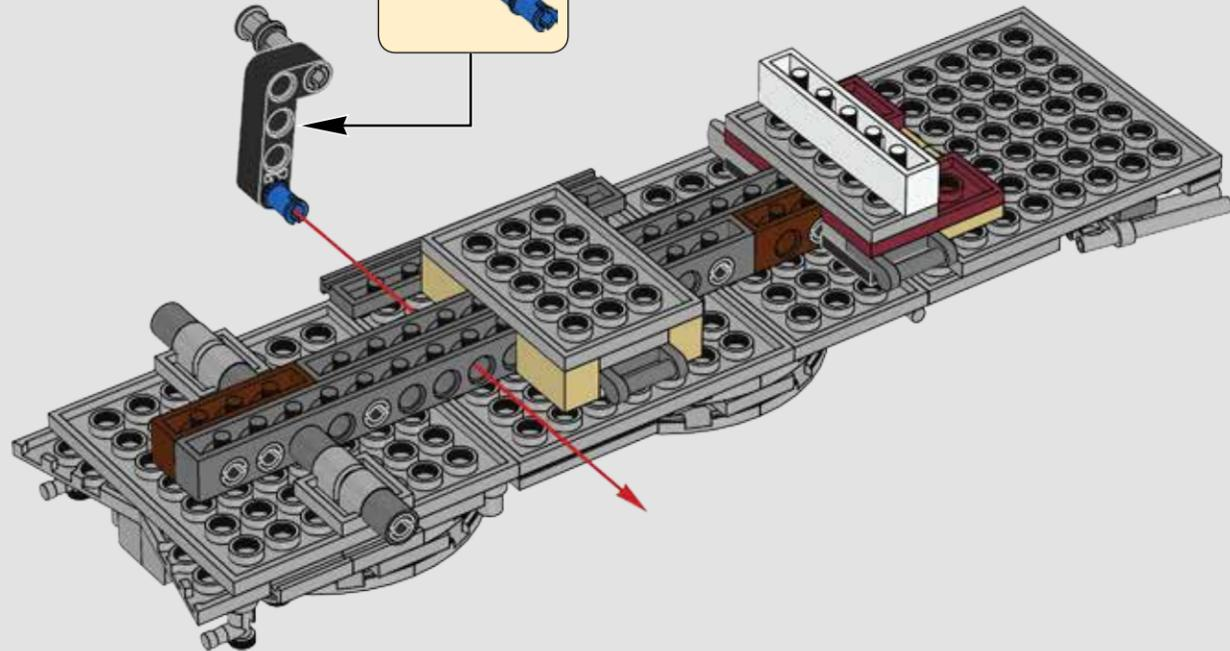
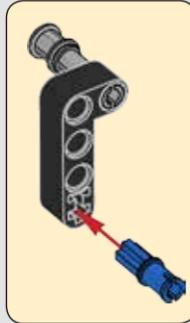

926

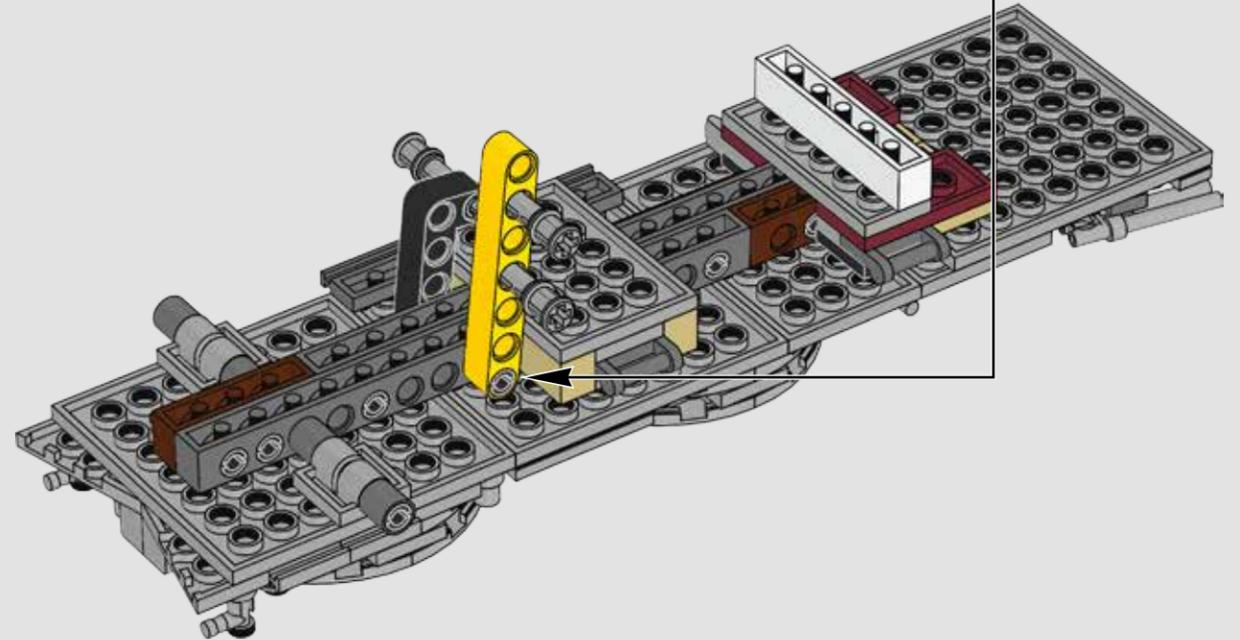
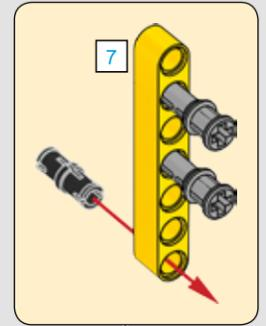
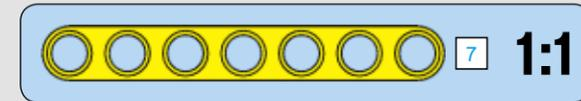

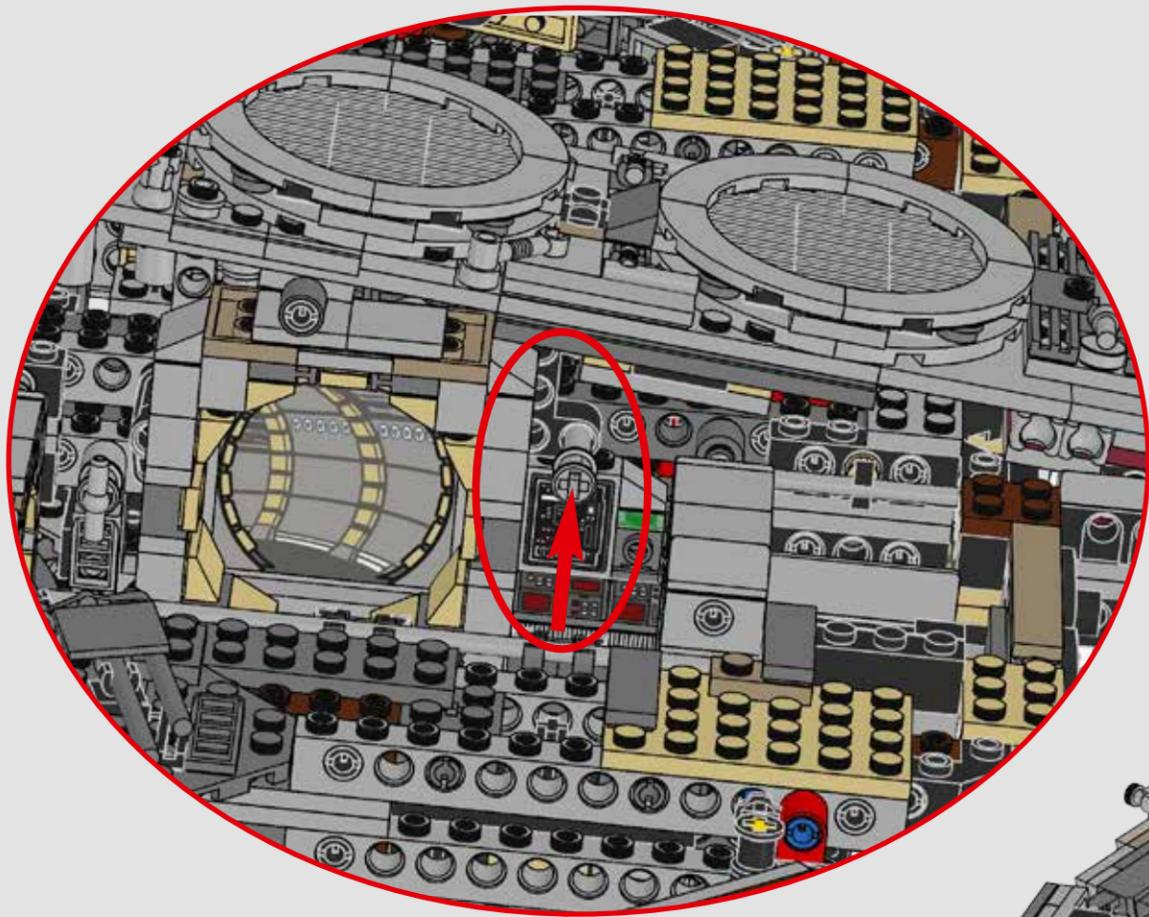

927

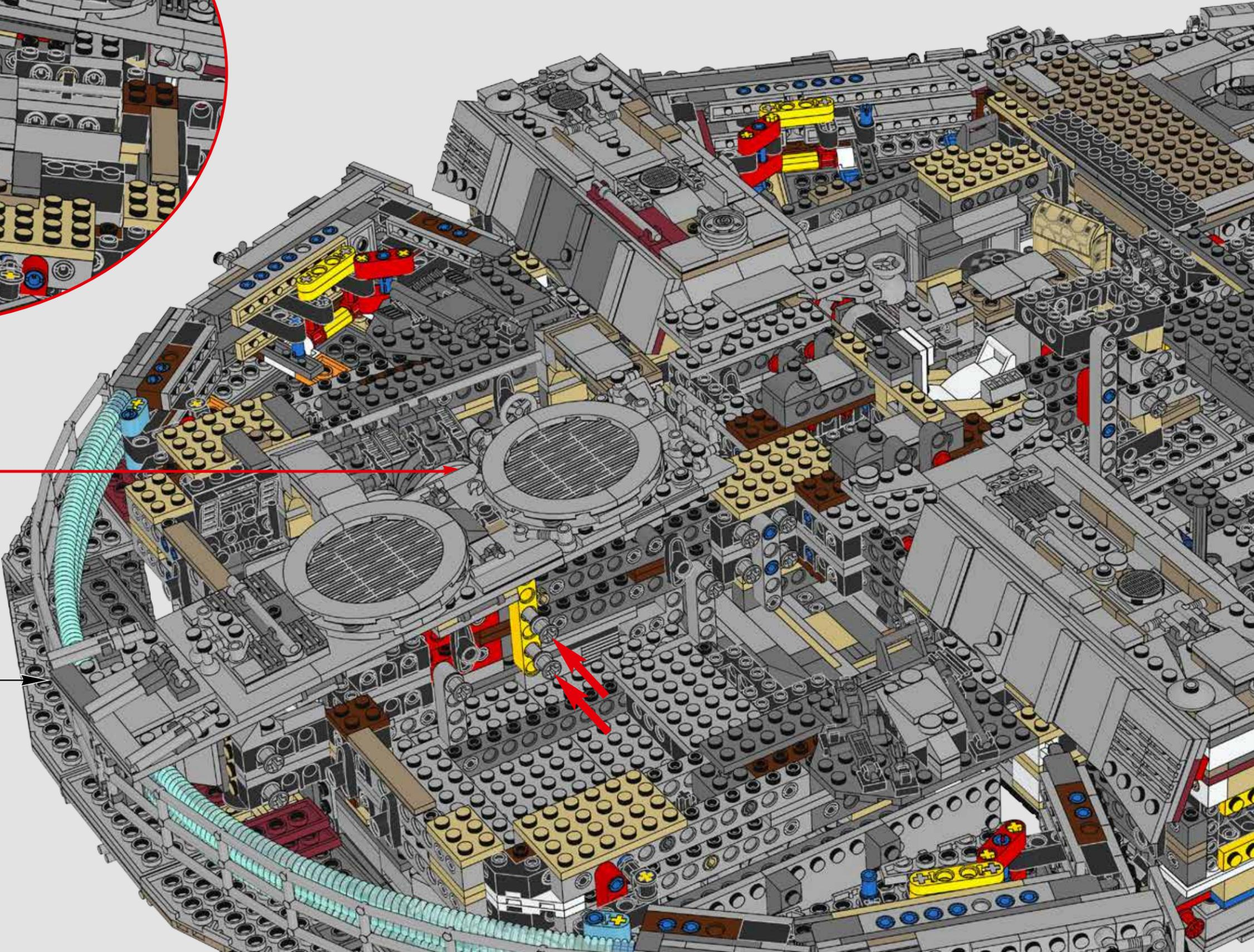

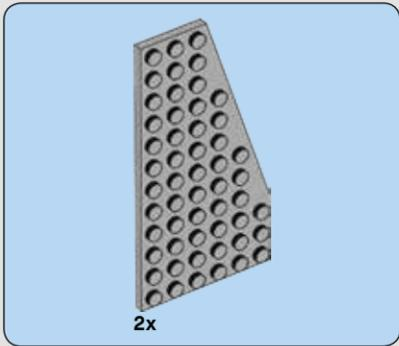
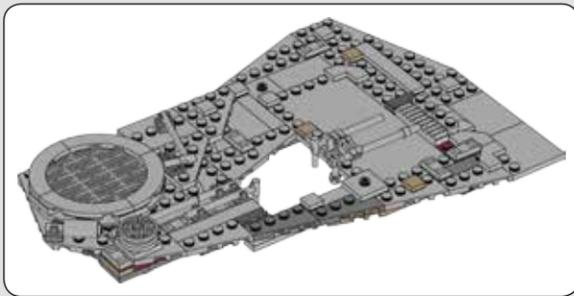

928

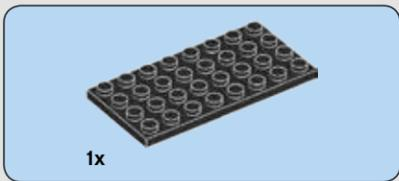
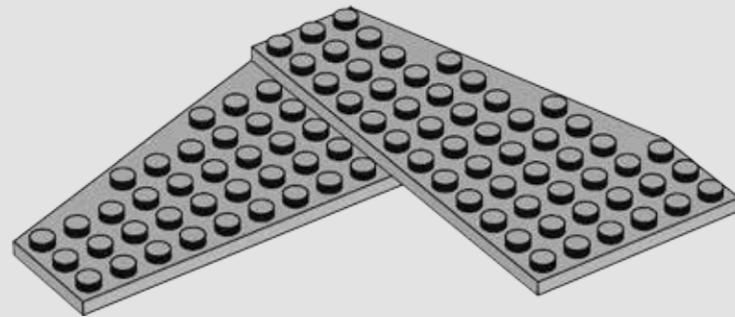

929

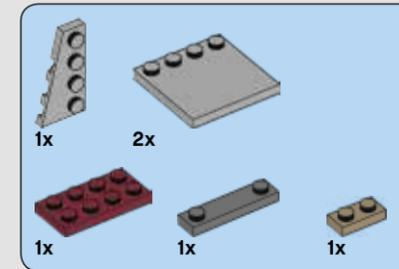
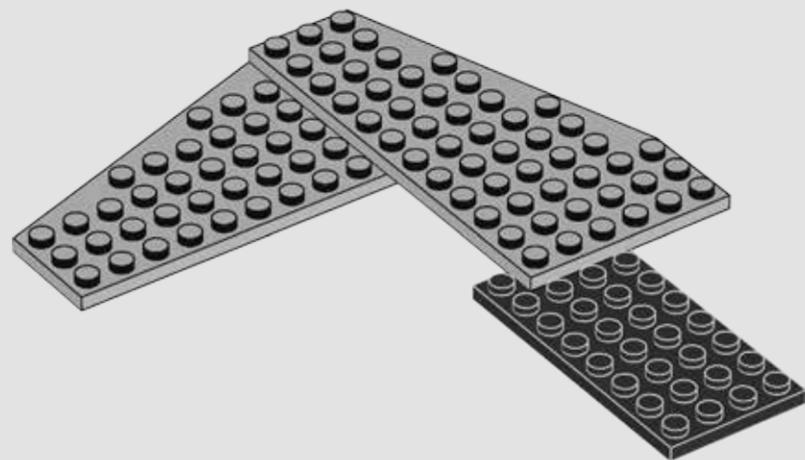

930

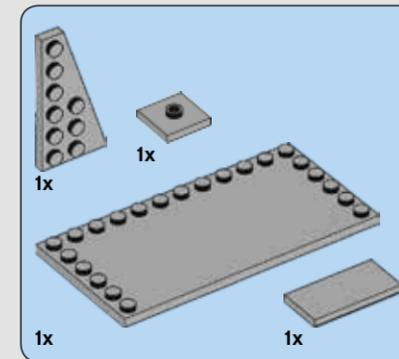
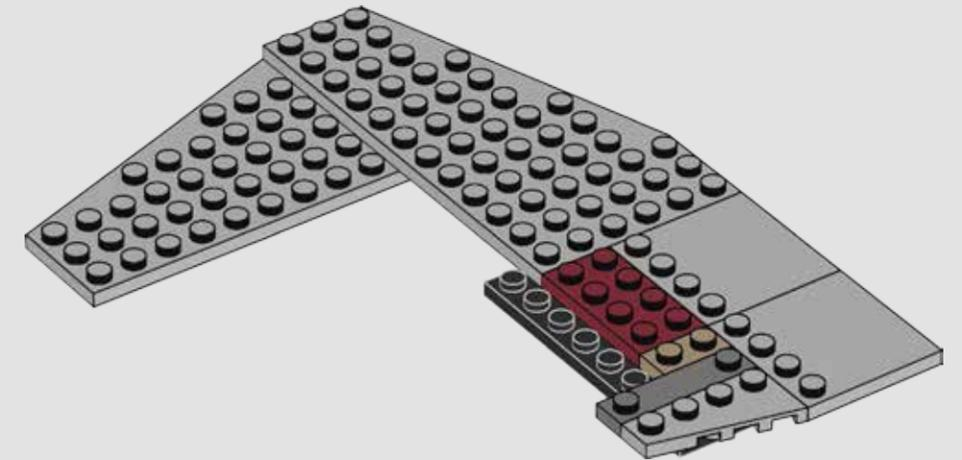

931

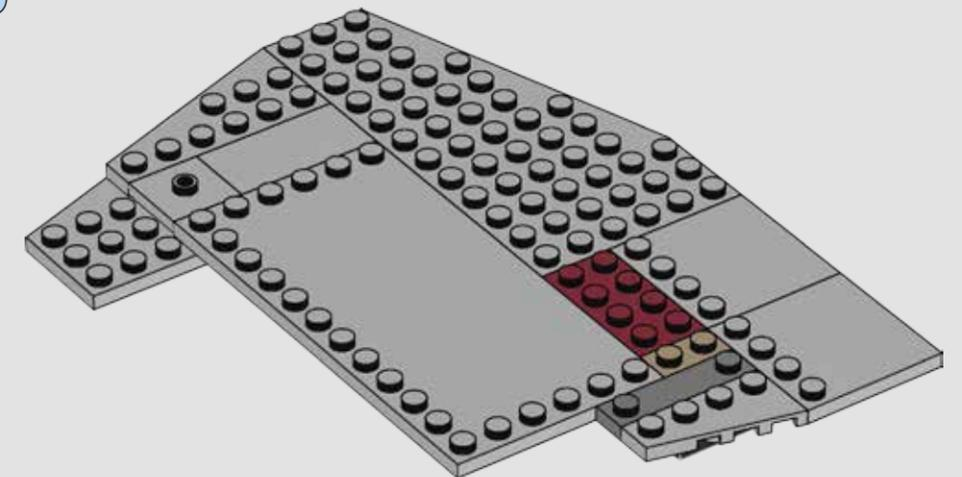

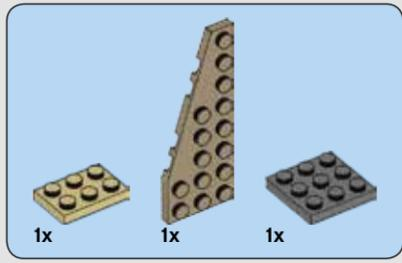

932

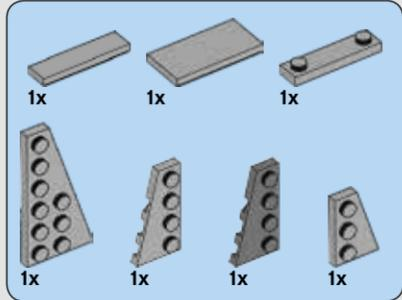

933

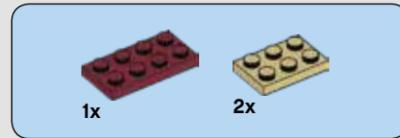
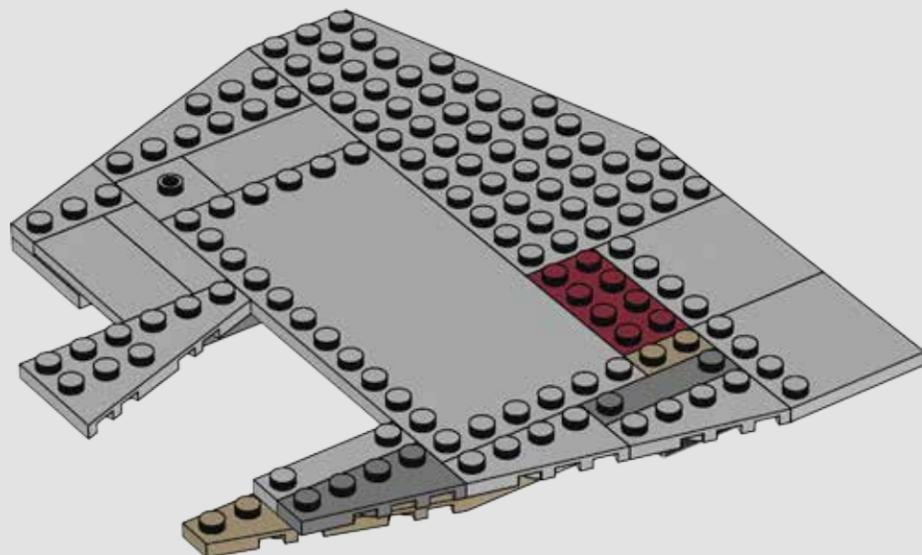

934

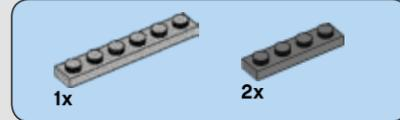
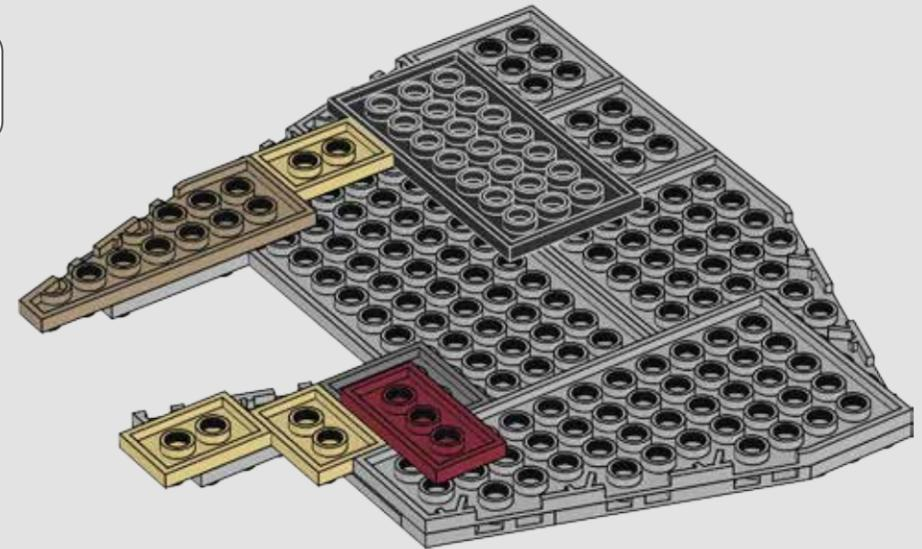

935

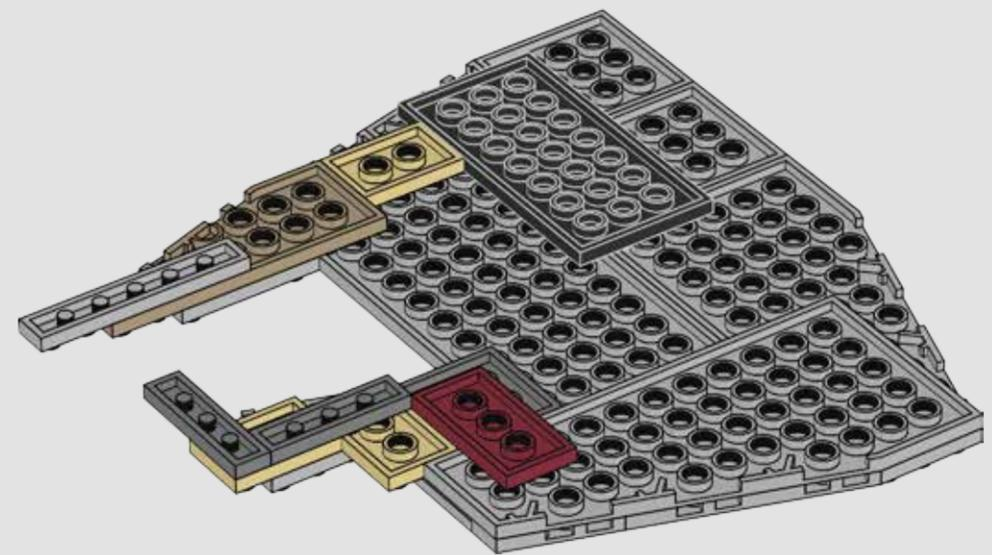

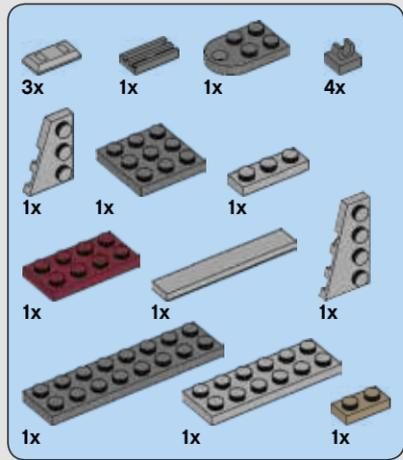

936

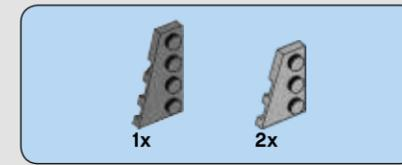
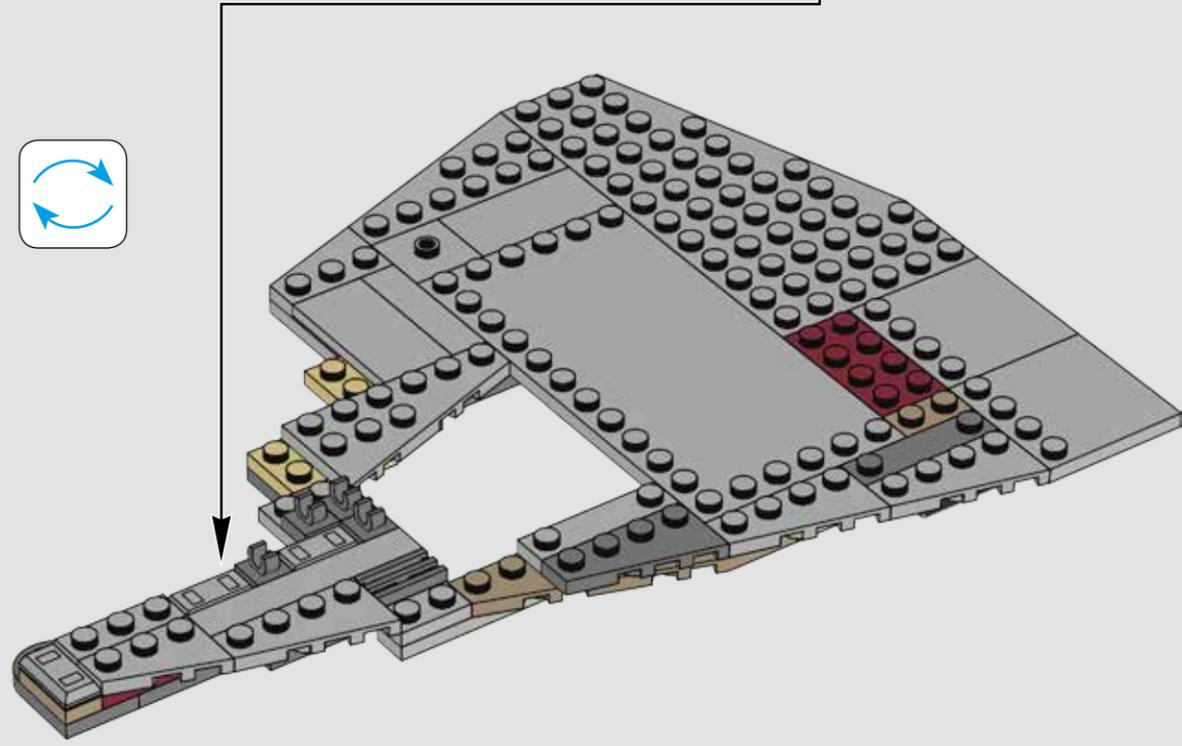
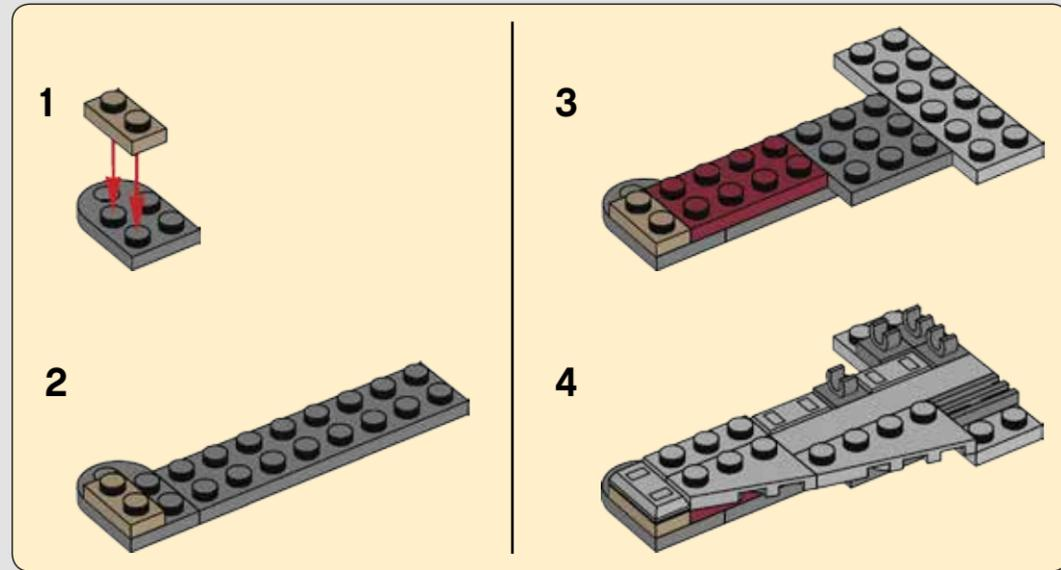

937

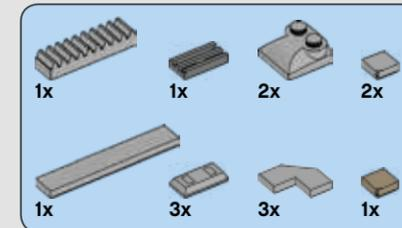
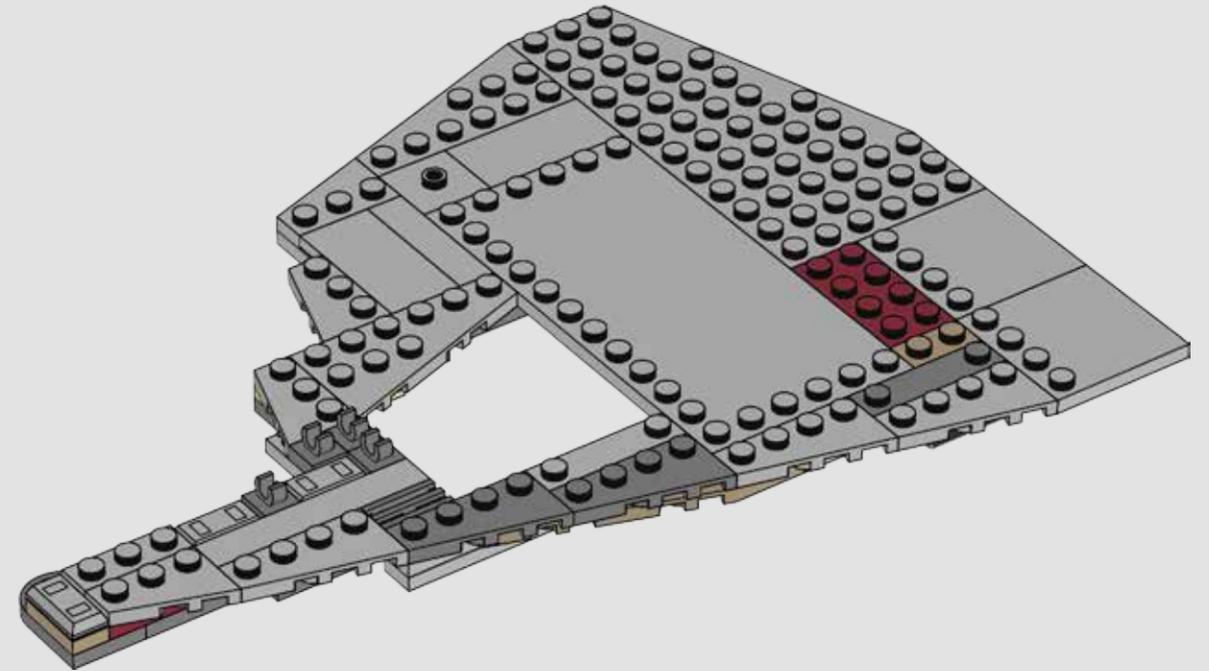

938

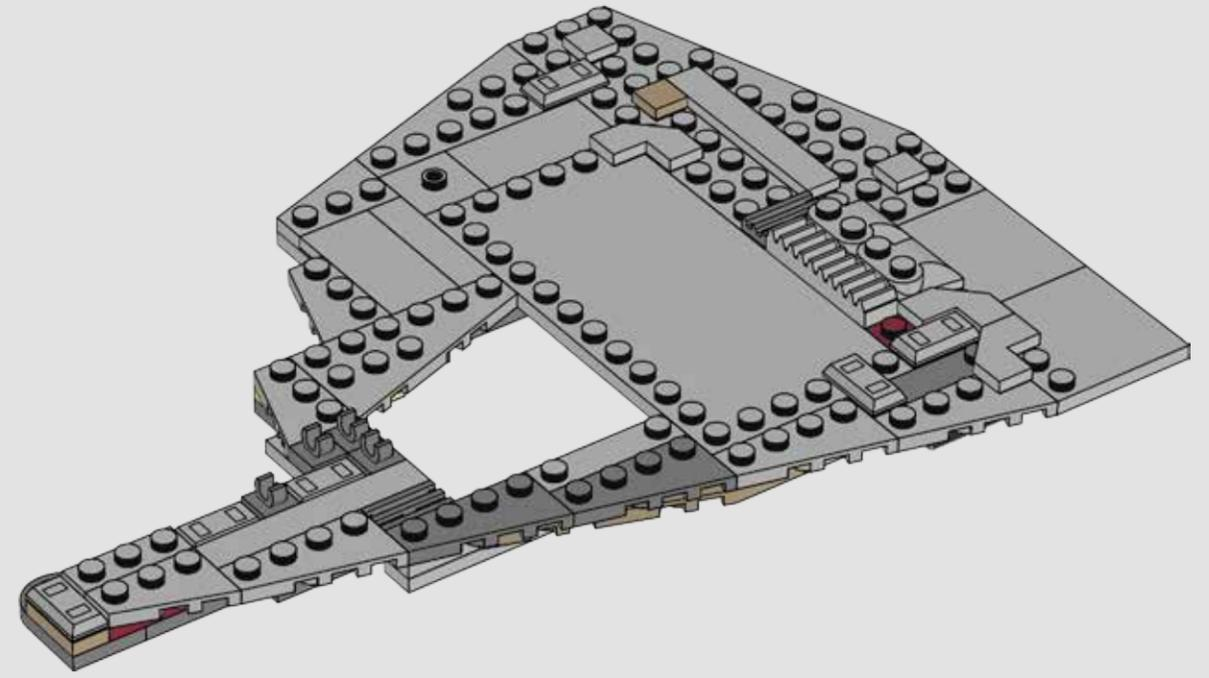

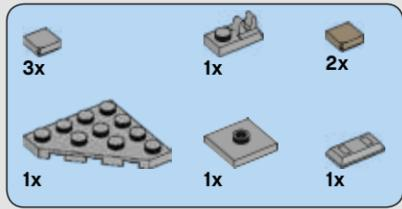

939

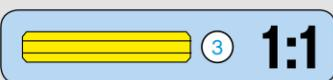
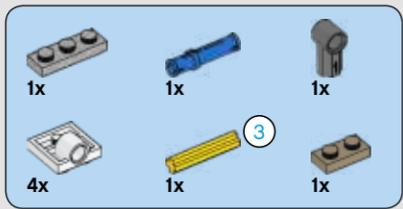
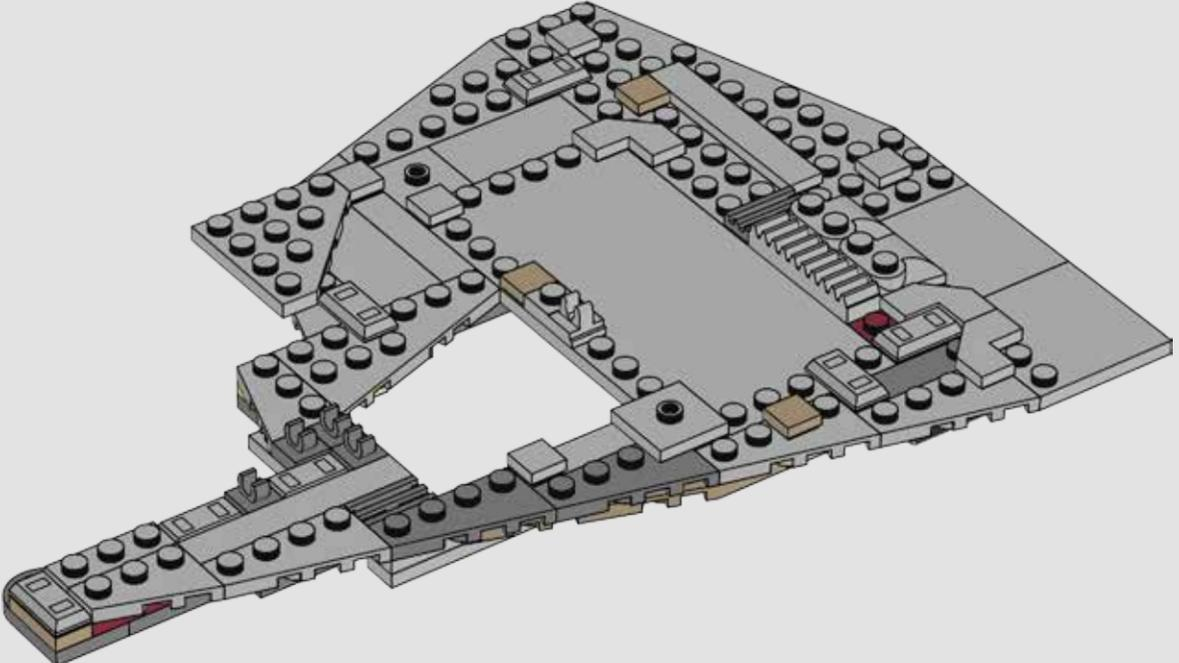

940

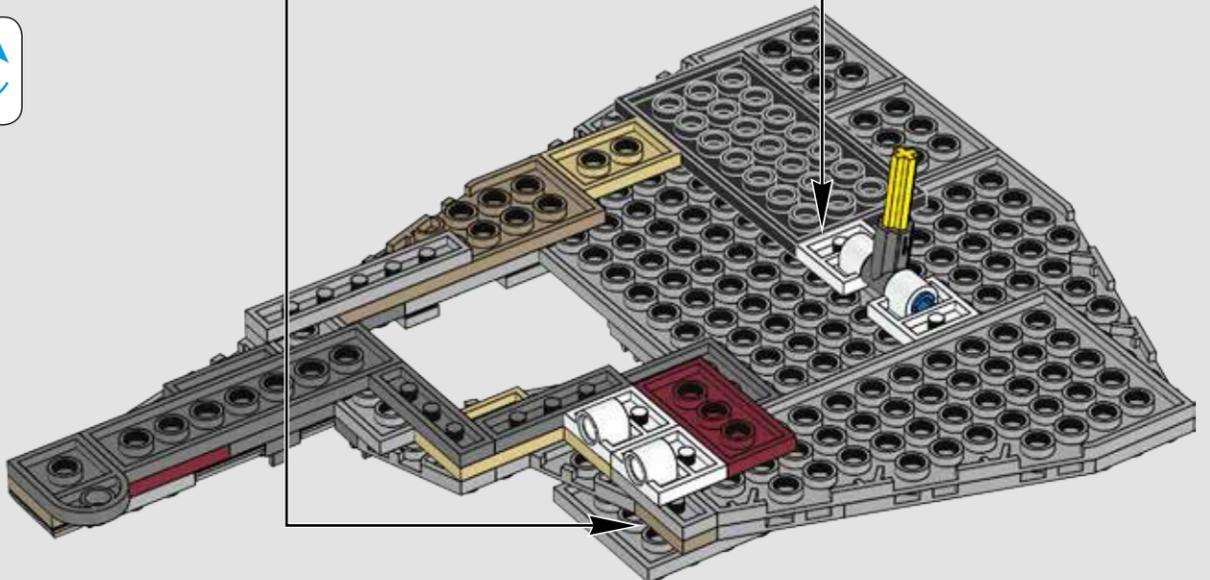
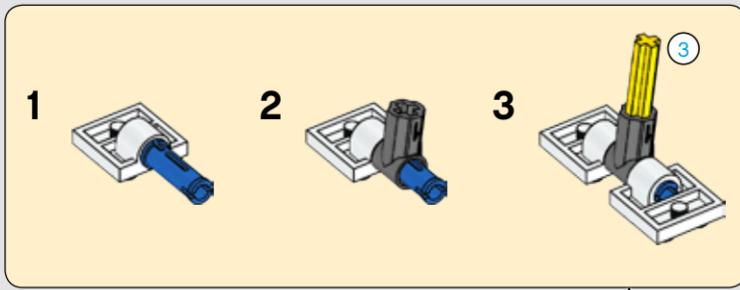
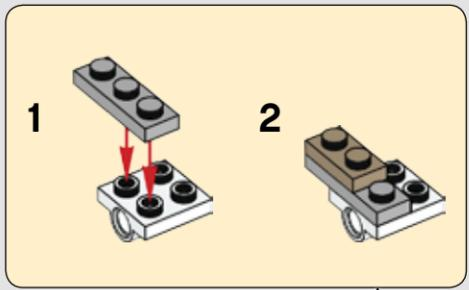

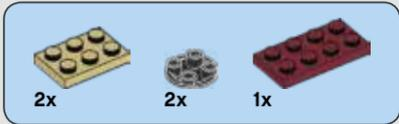

941

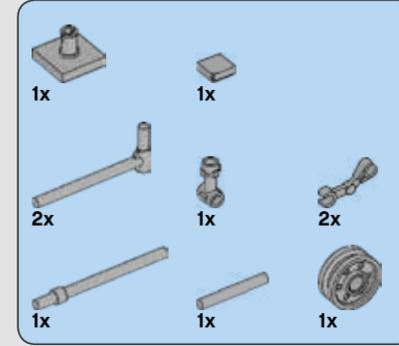
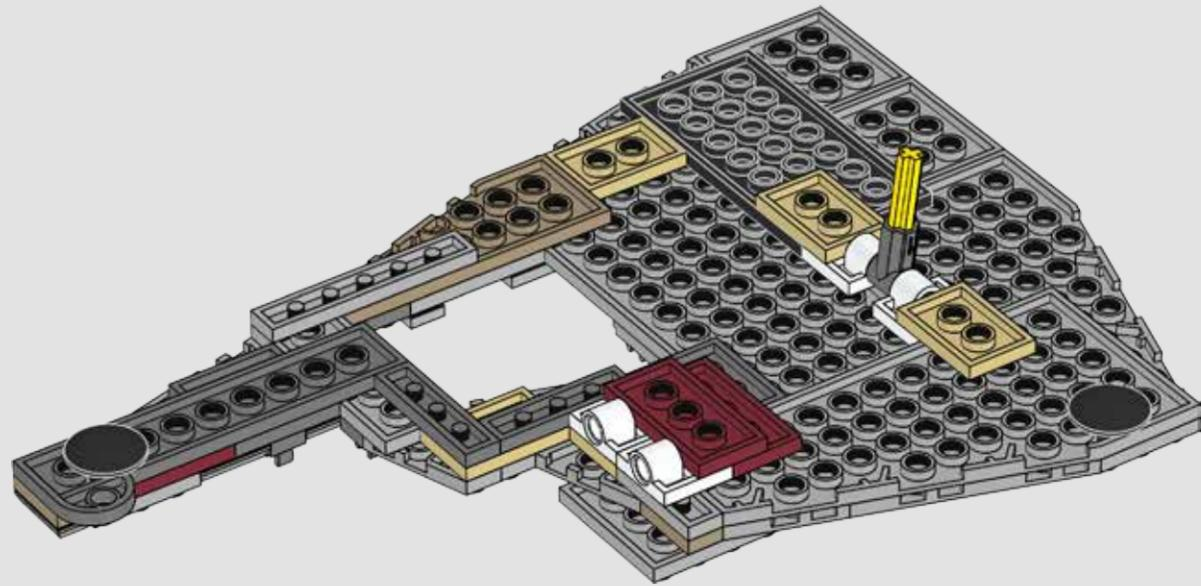

942

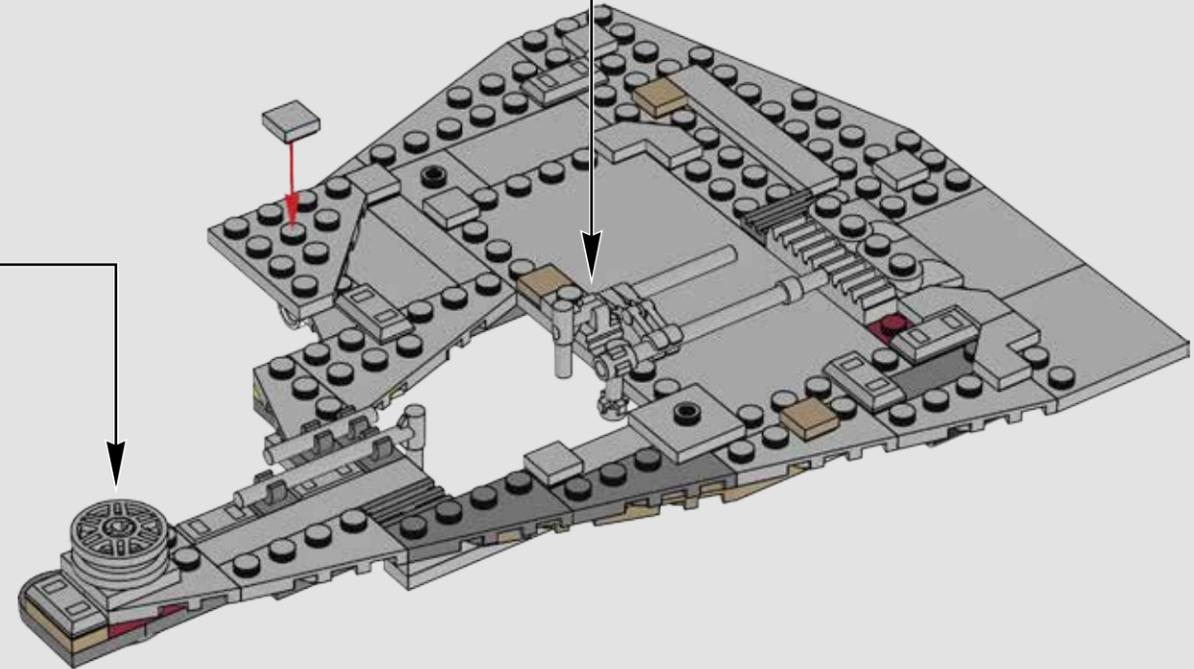
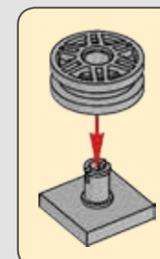
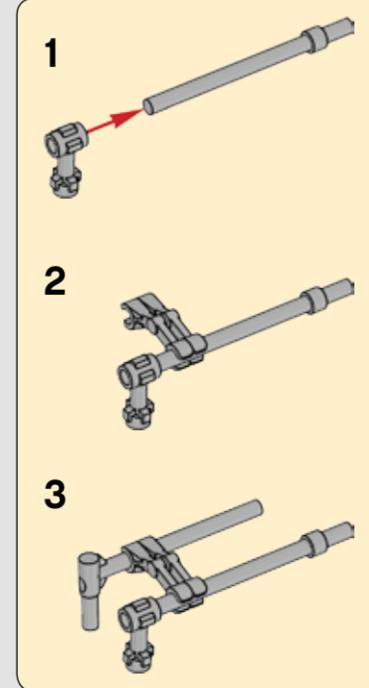

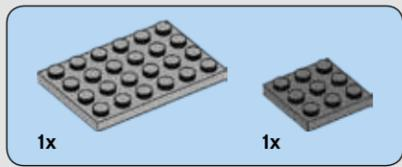

943

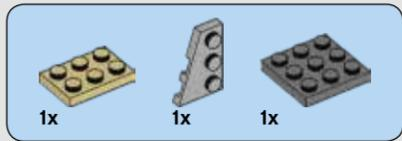

944

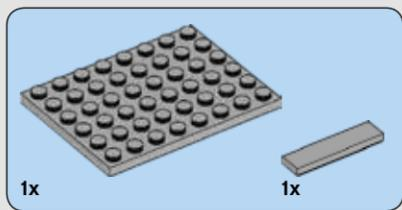
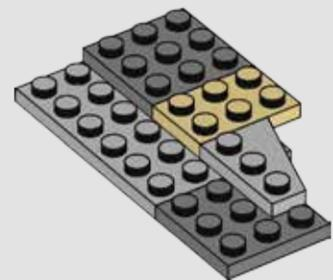

945

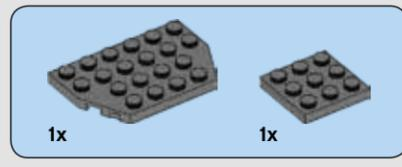
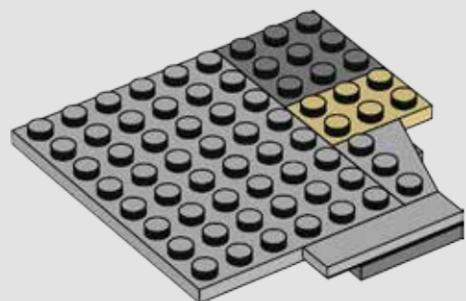

946

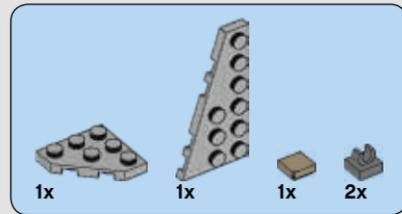

947

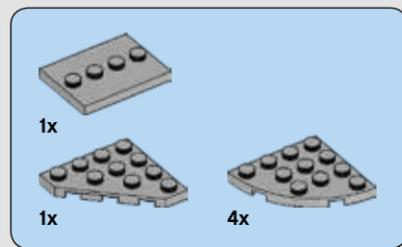
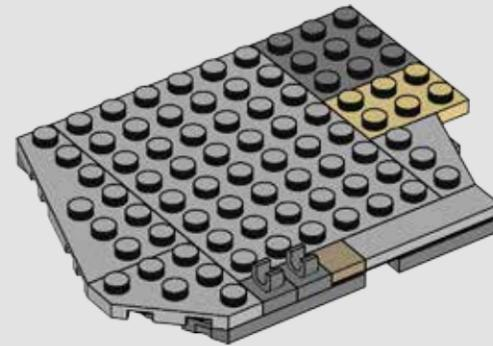

948

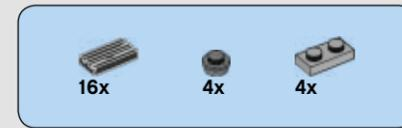
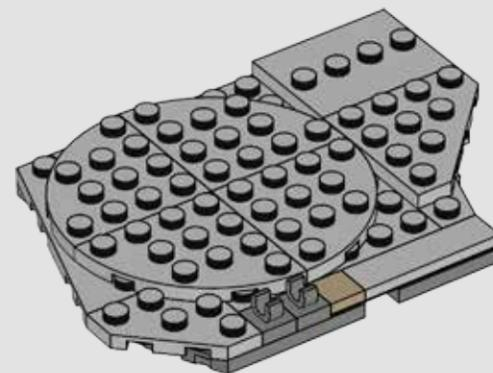

949

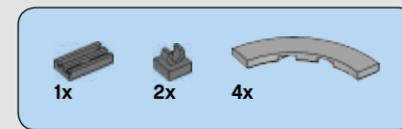
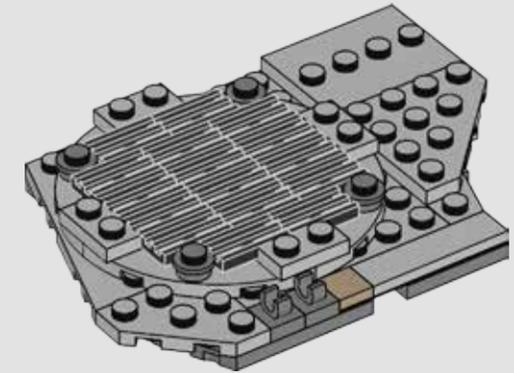

950

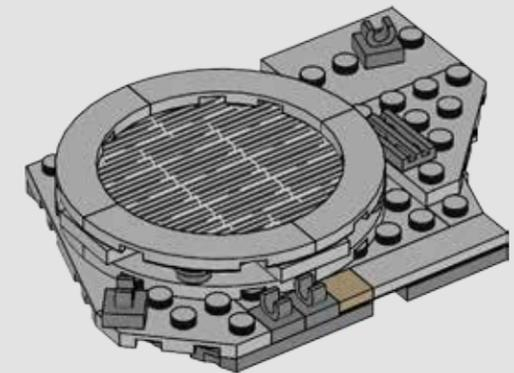

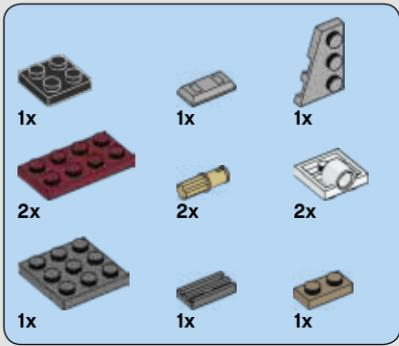

951

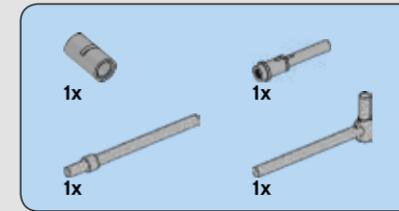
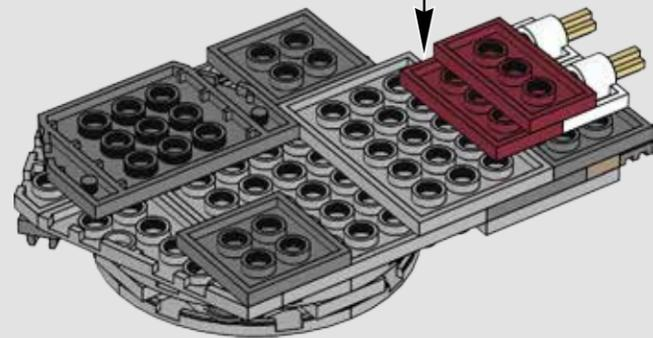
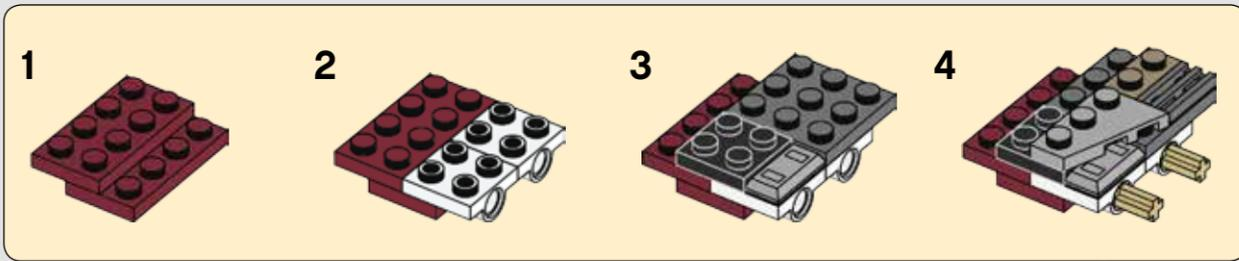

952

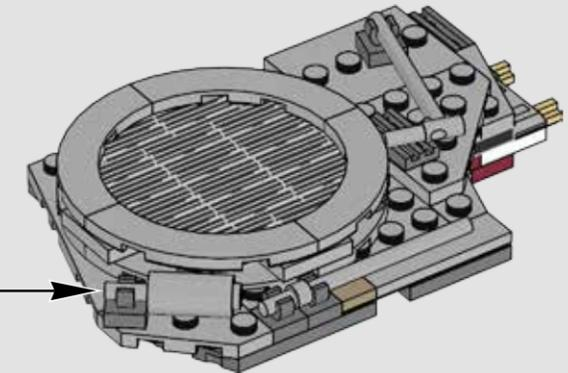
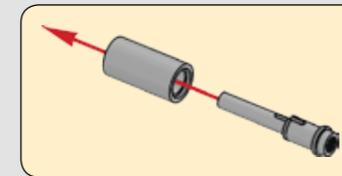

953

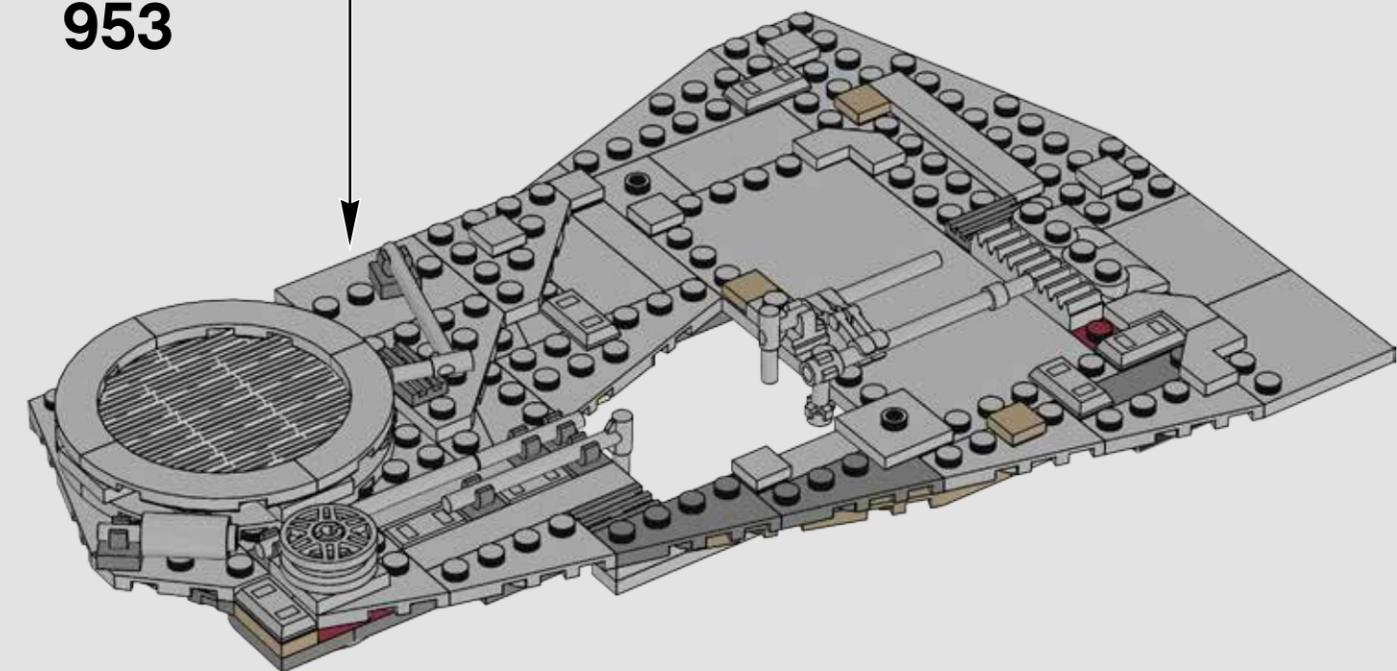



954

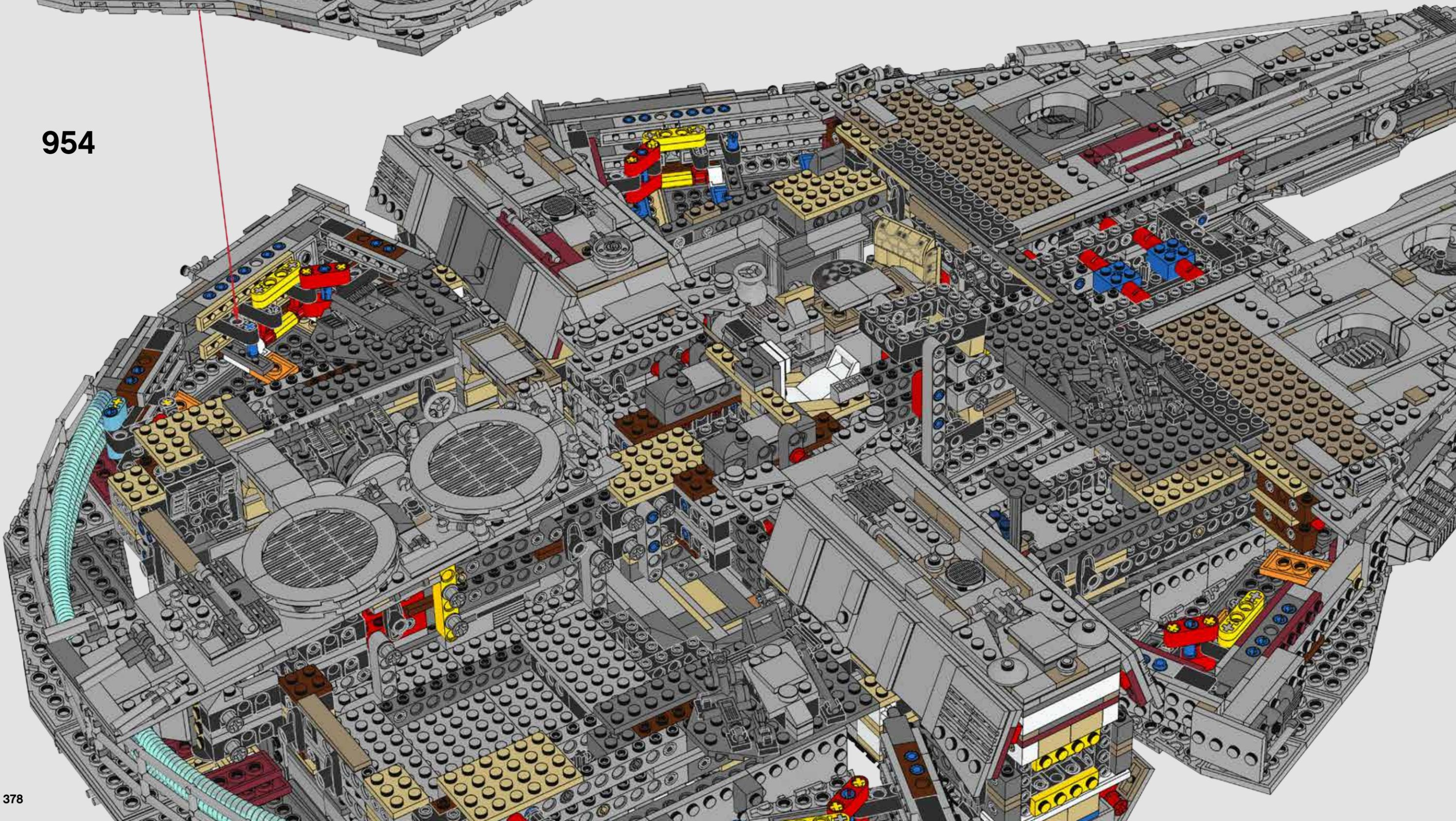

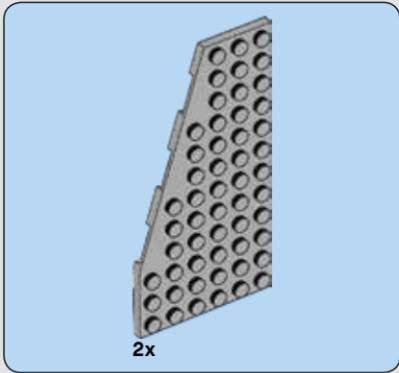
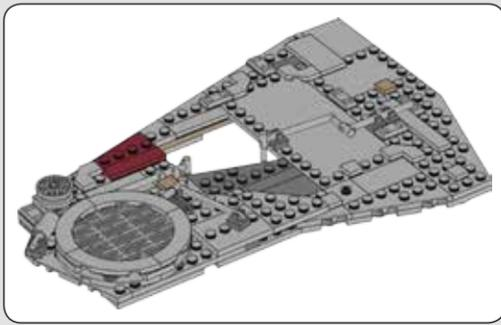

955

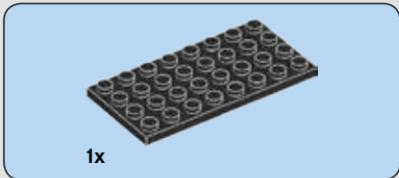
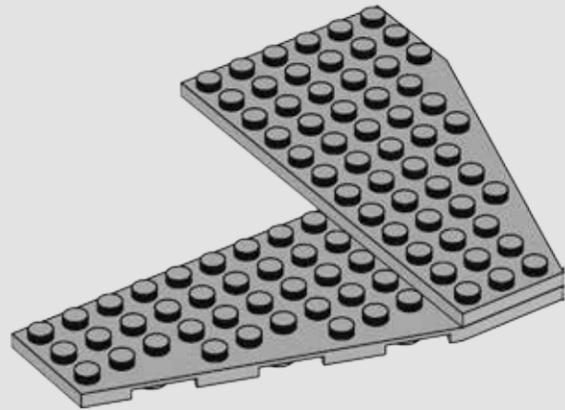

956

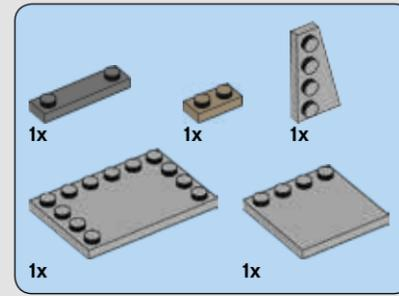
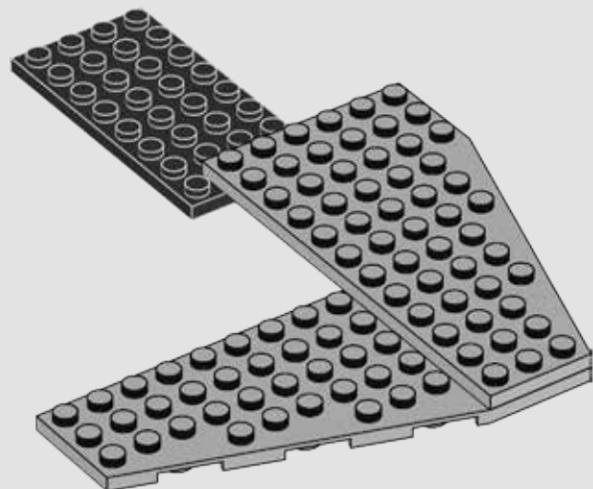

957

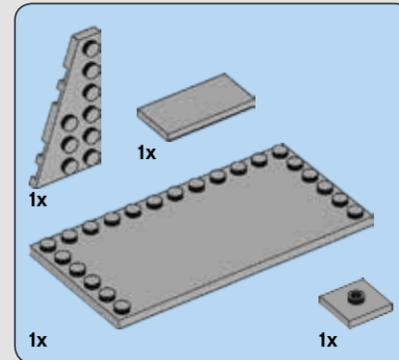
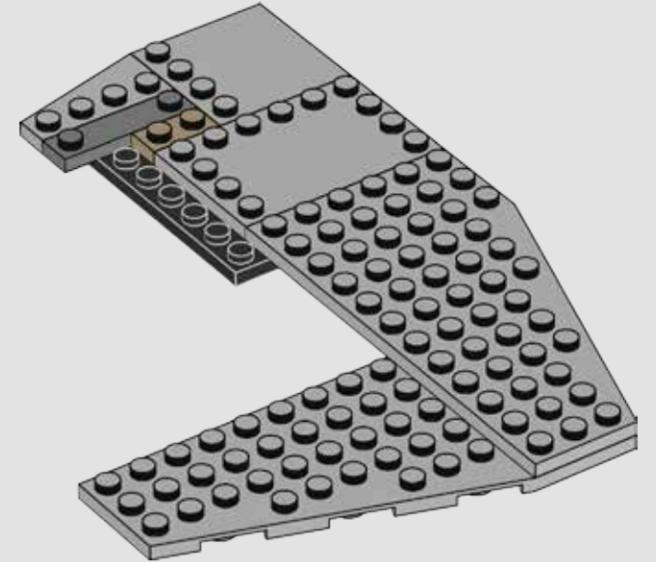

958

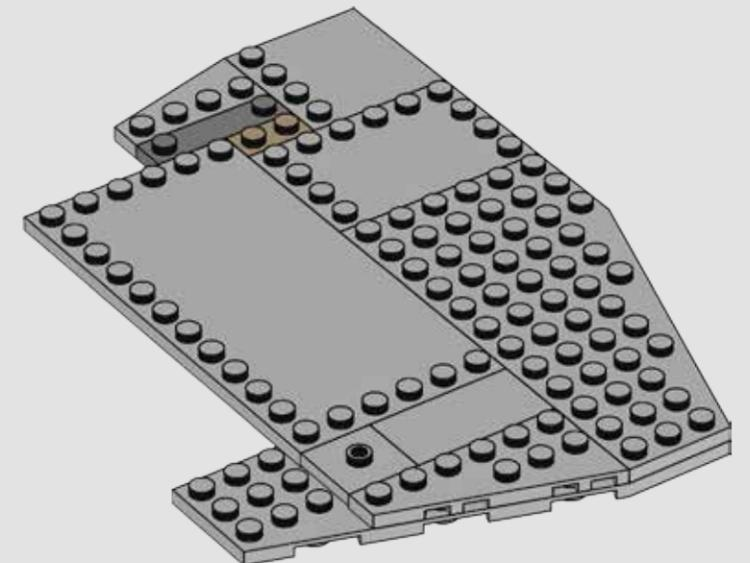

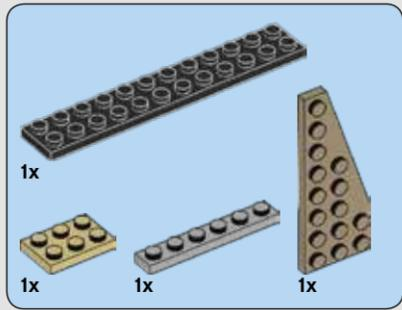

959

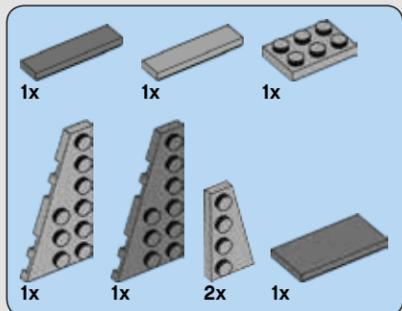
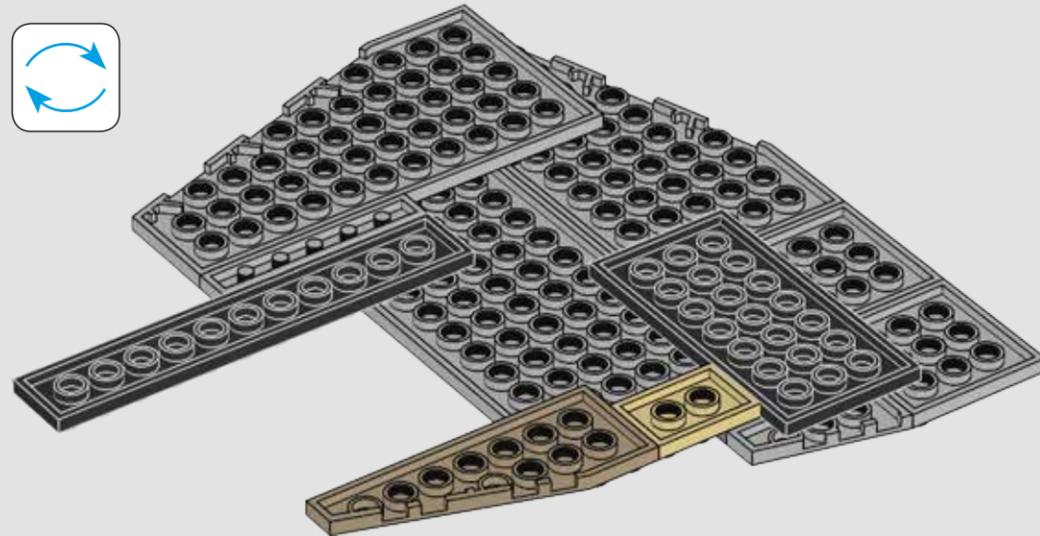

960

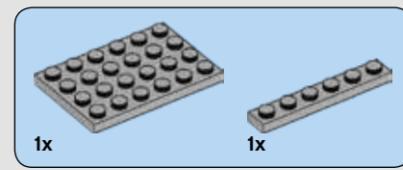
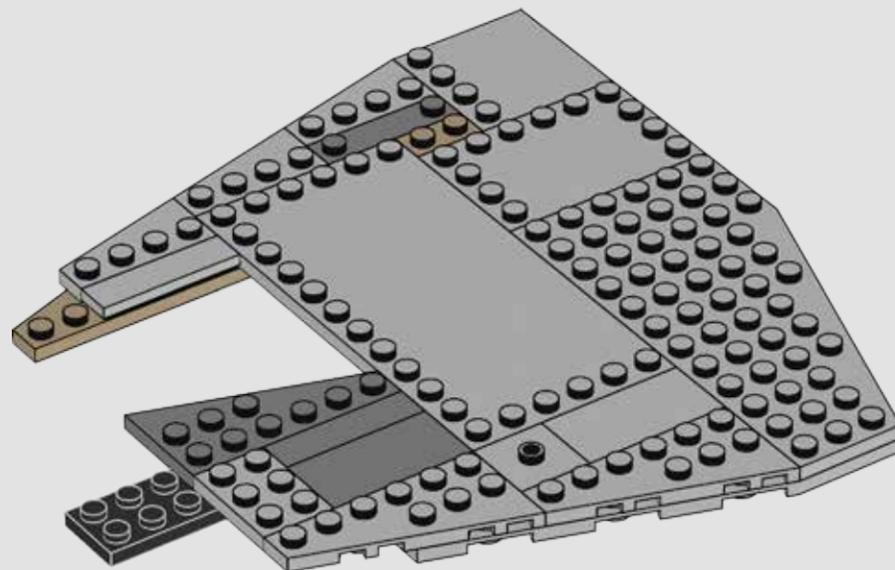

961

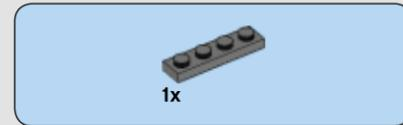
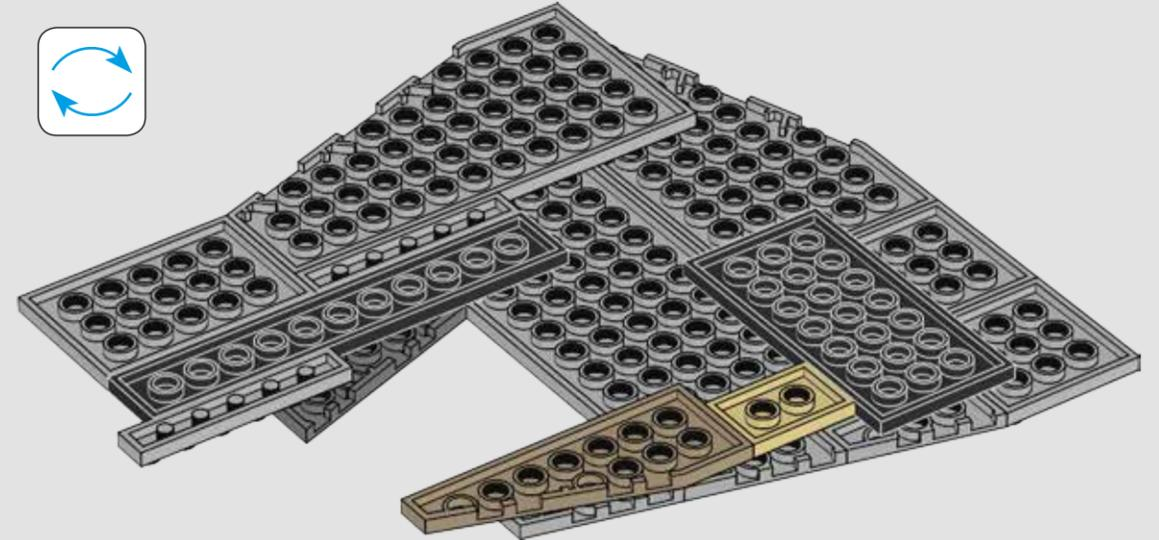

962

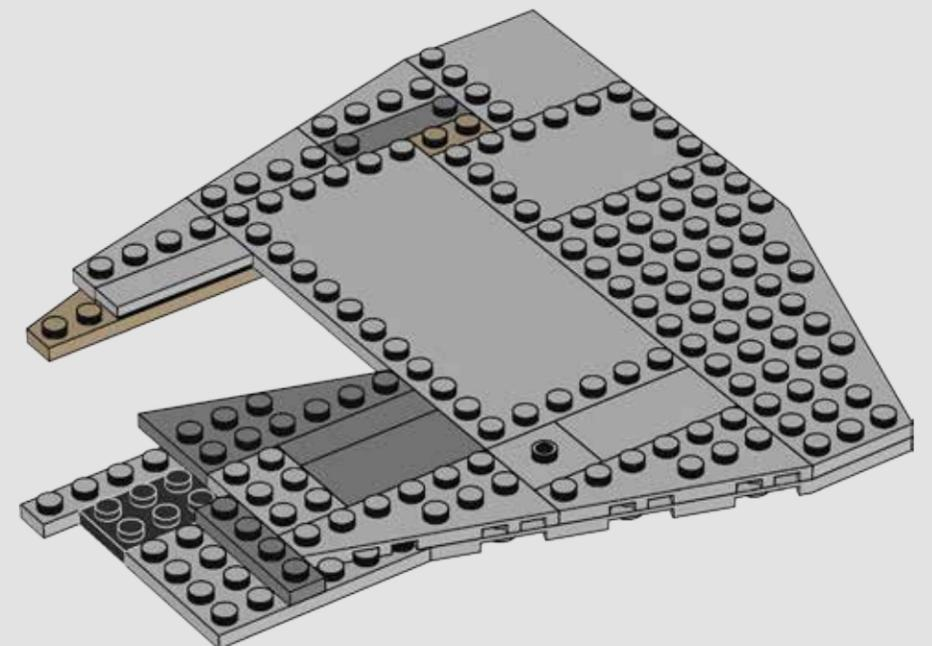

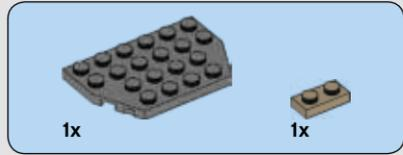
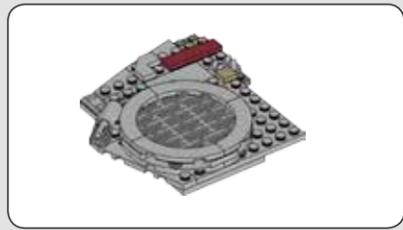

963



964

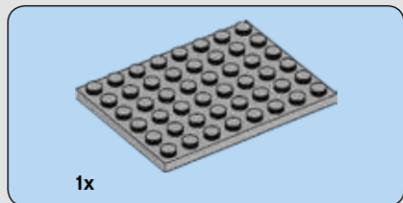
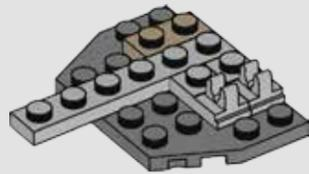

965

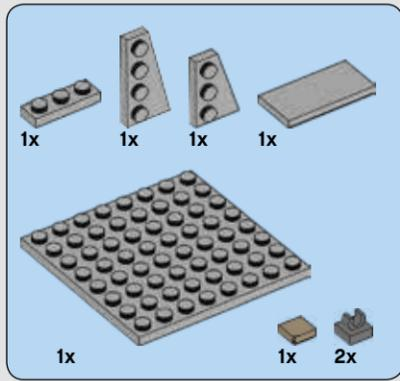
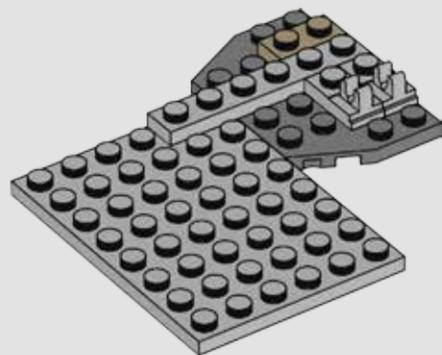

966

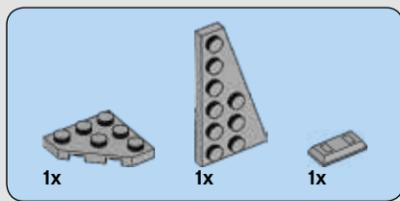
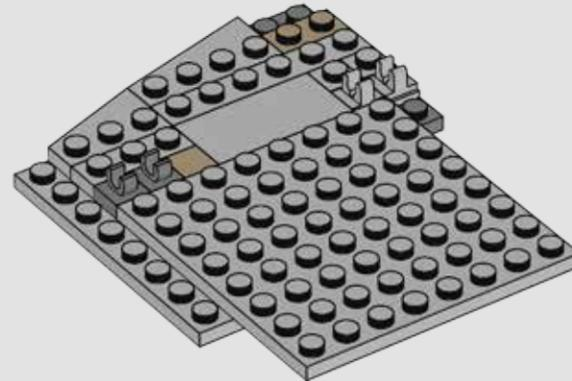

967

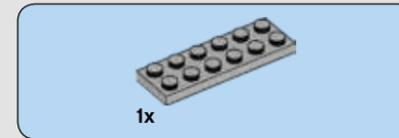
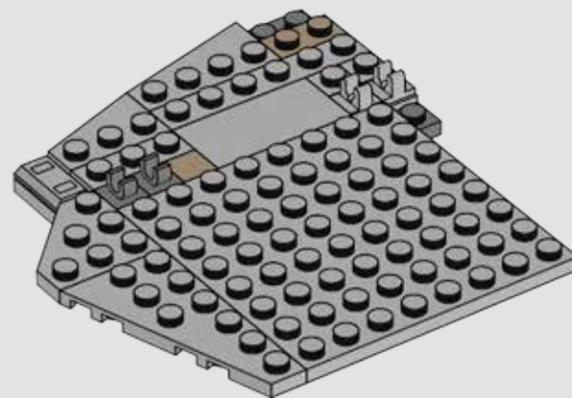

968

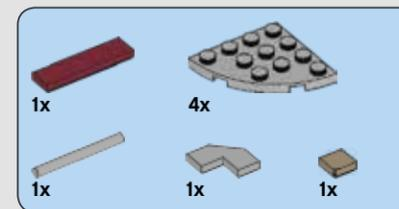
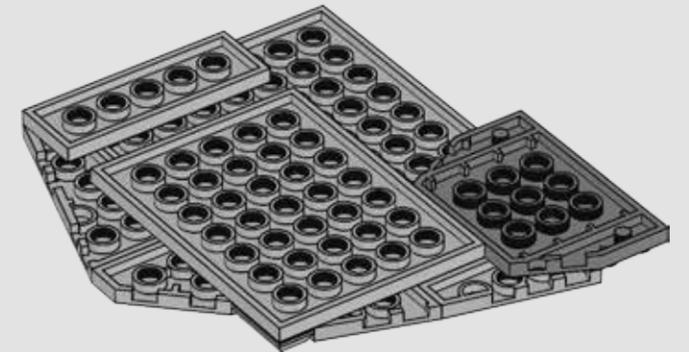

969

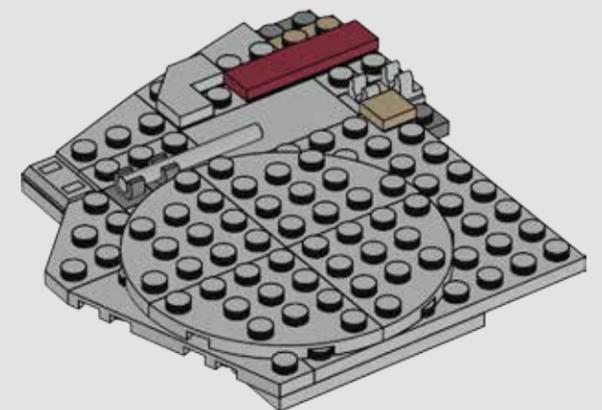

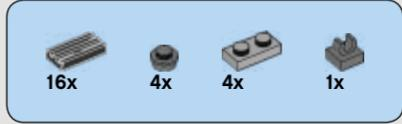

970

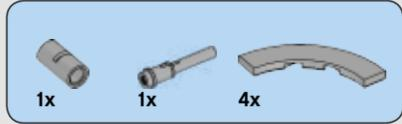
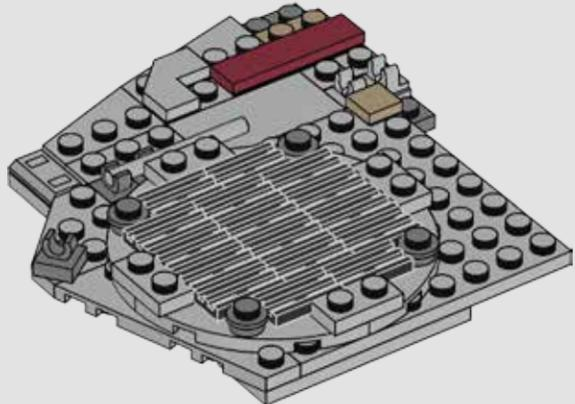

971

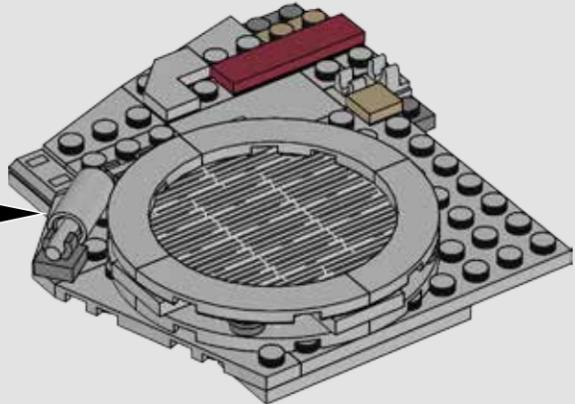
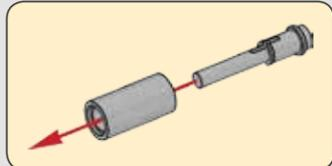

972

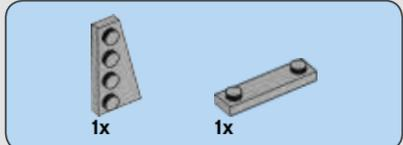
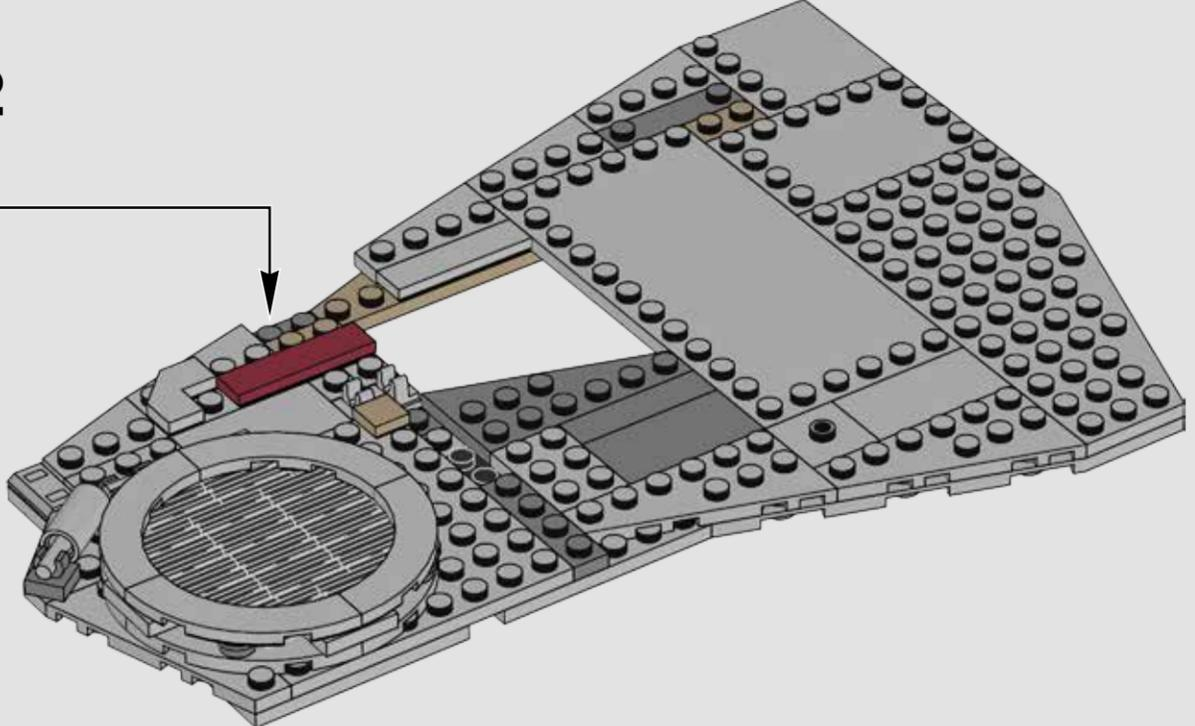

973

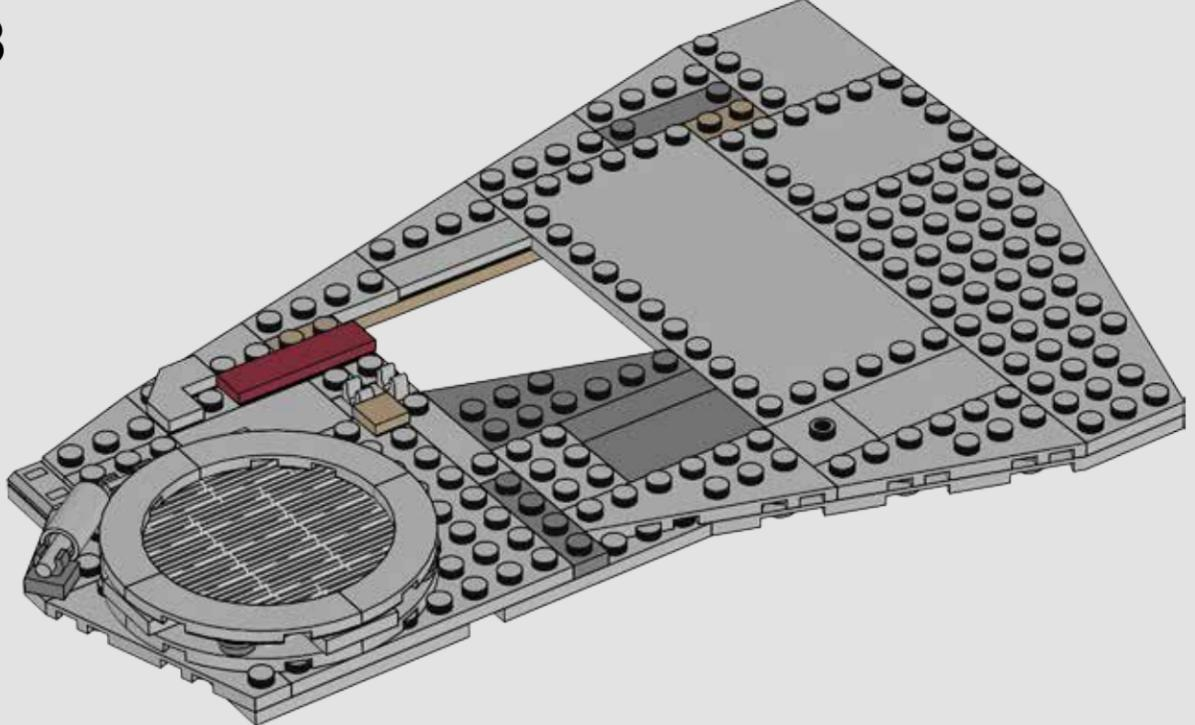

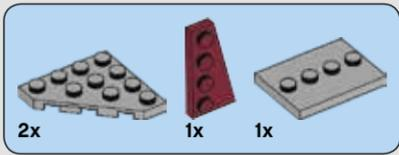

974

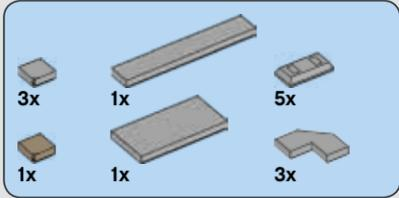

975

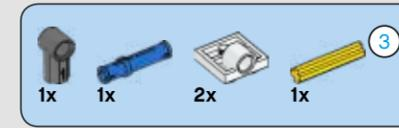

976

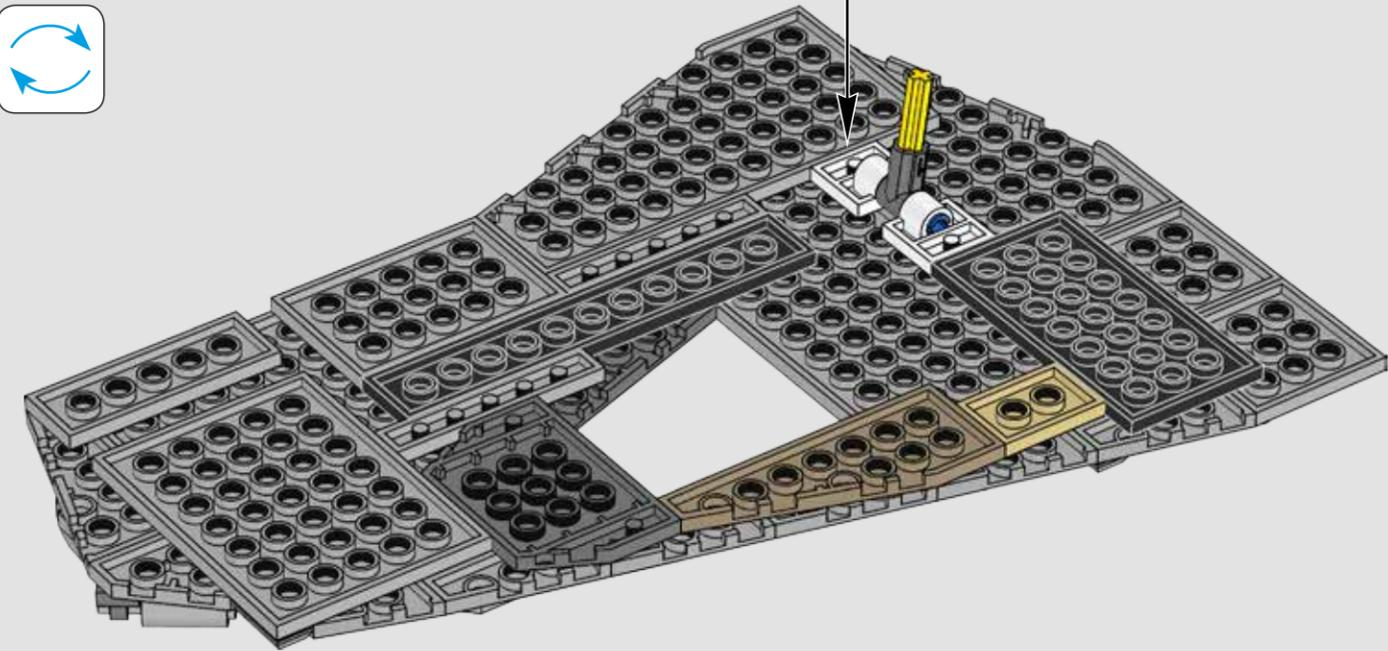
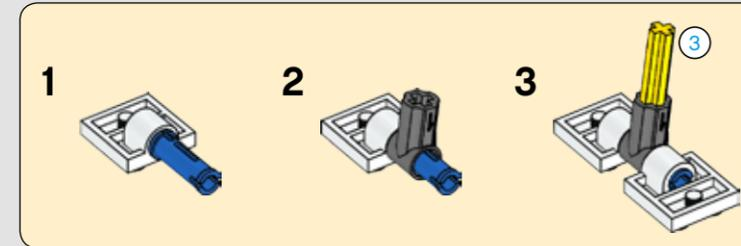

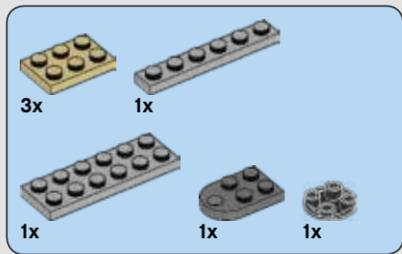

977

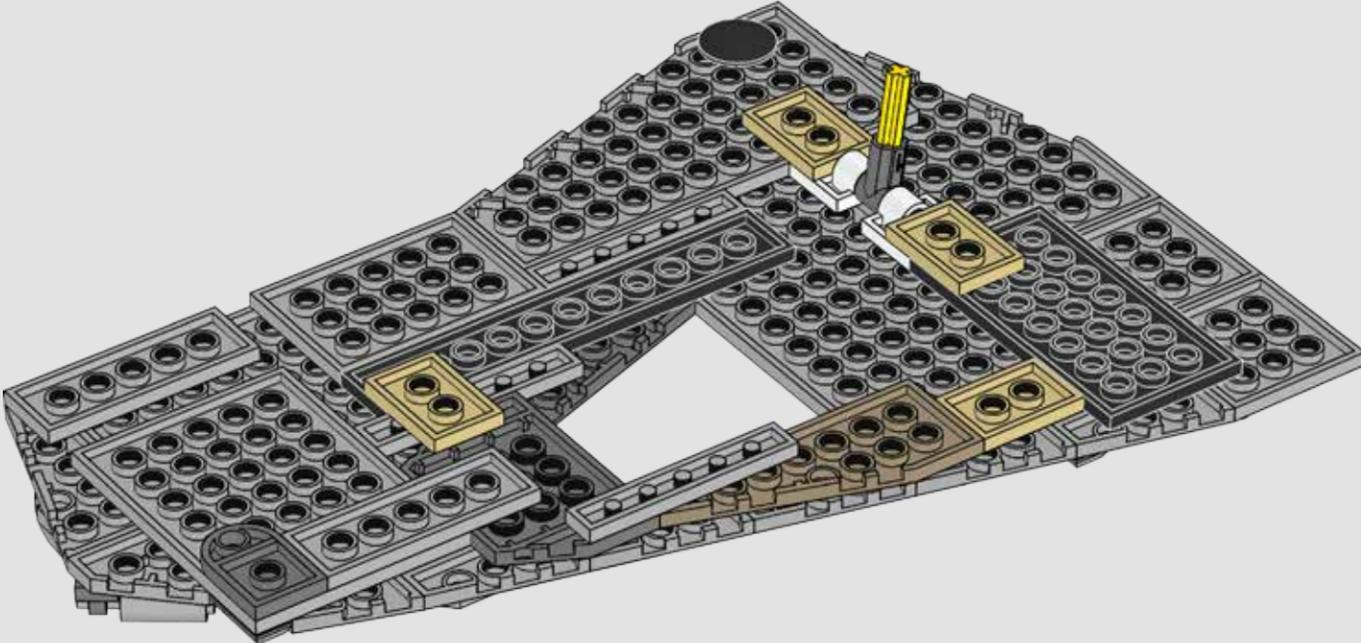

978

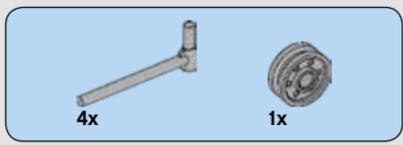
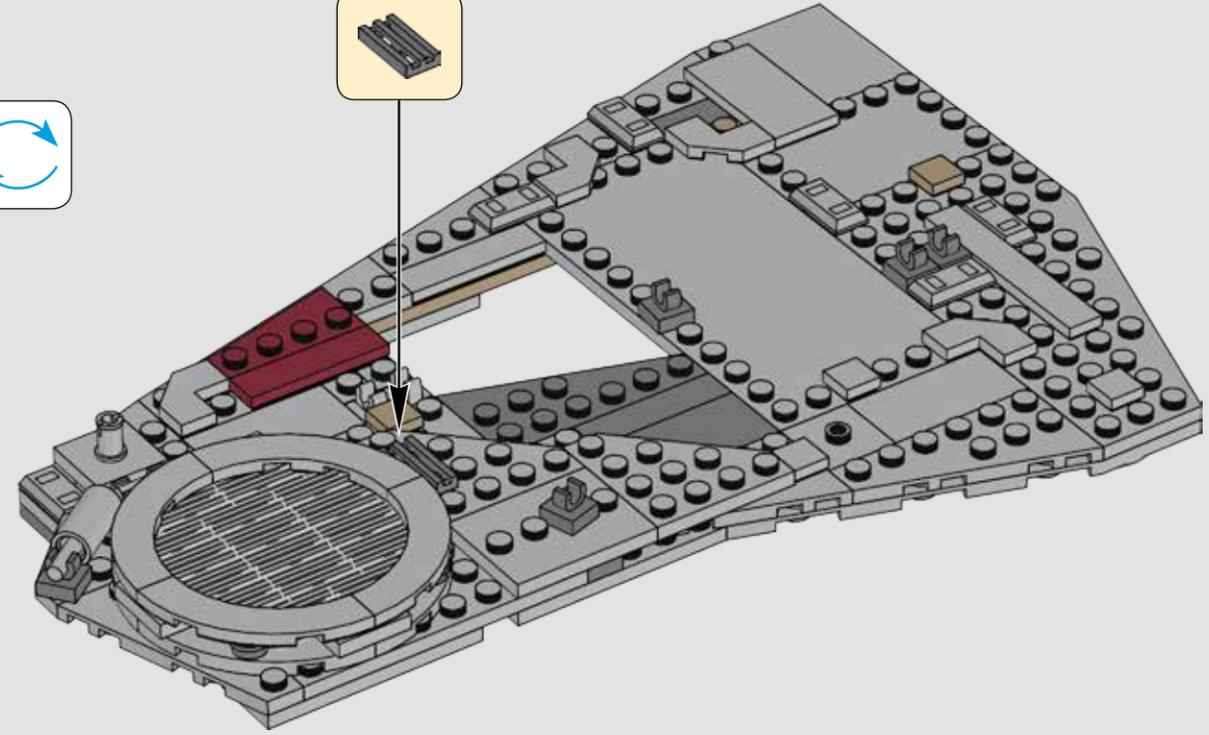

979



980

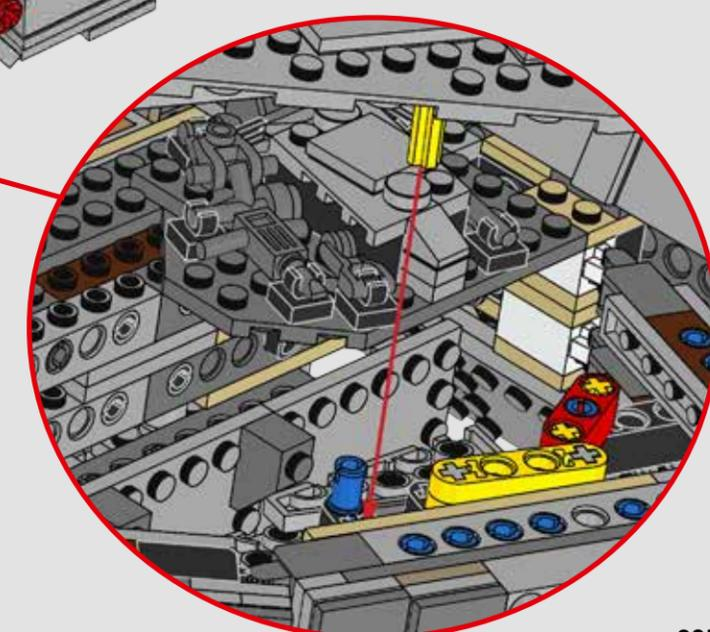
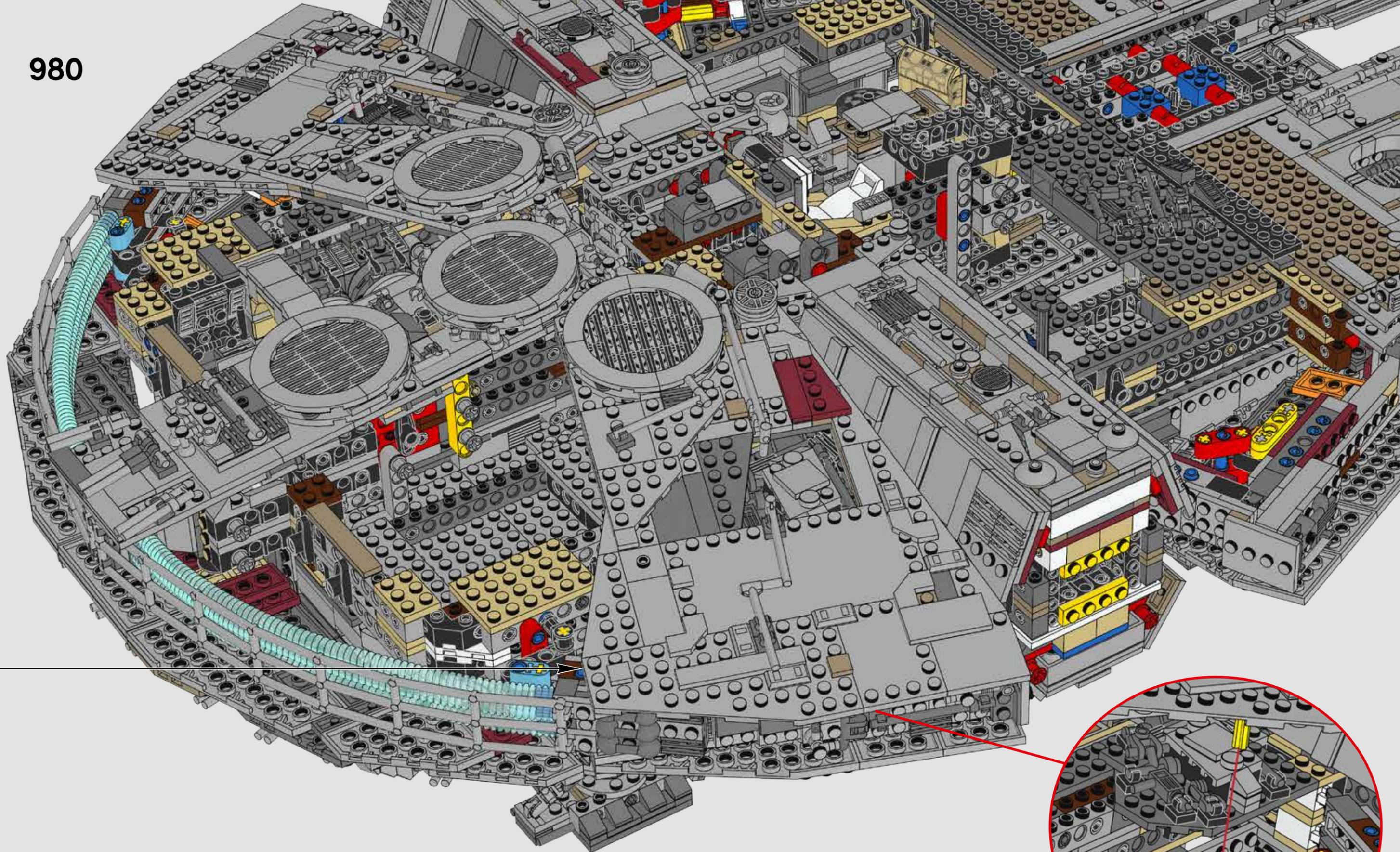

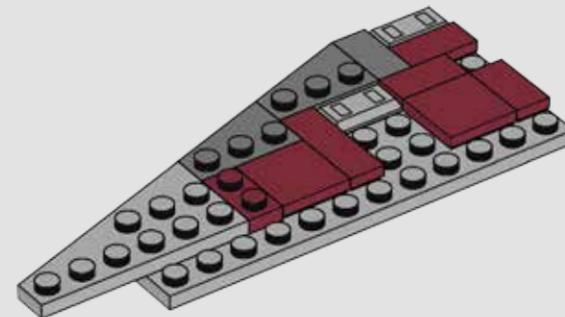
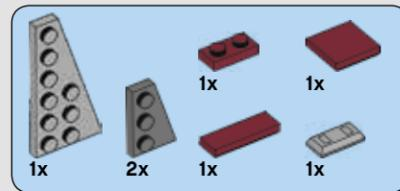
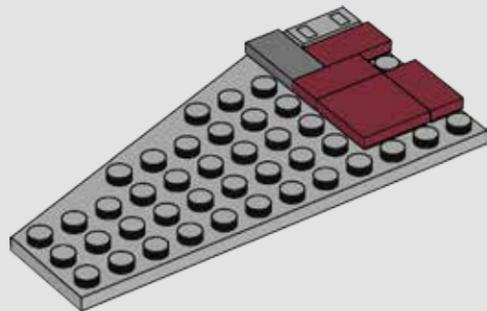
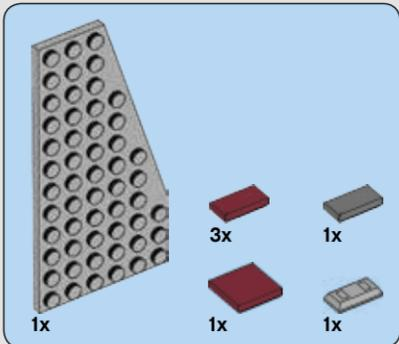
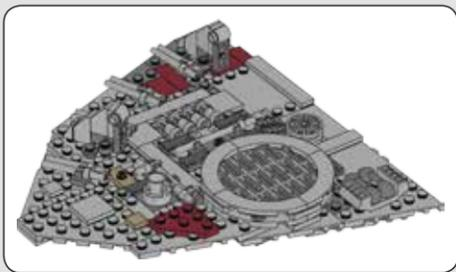
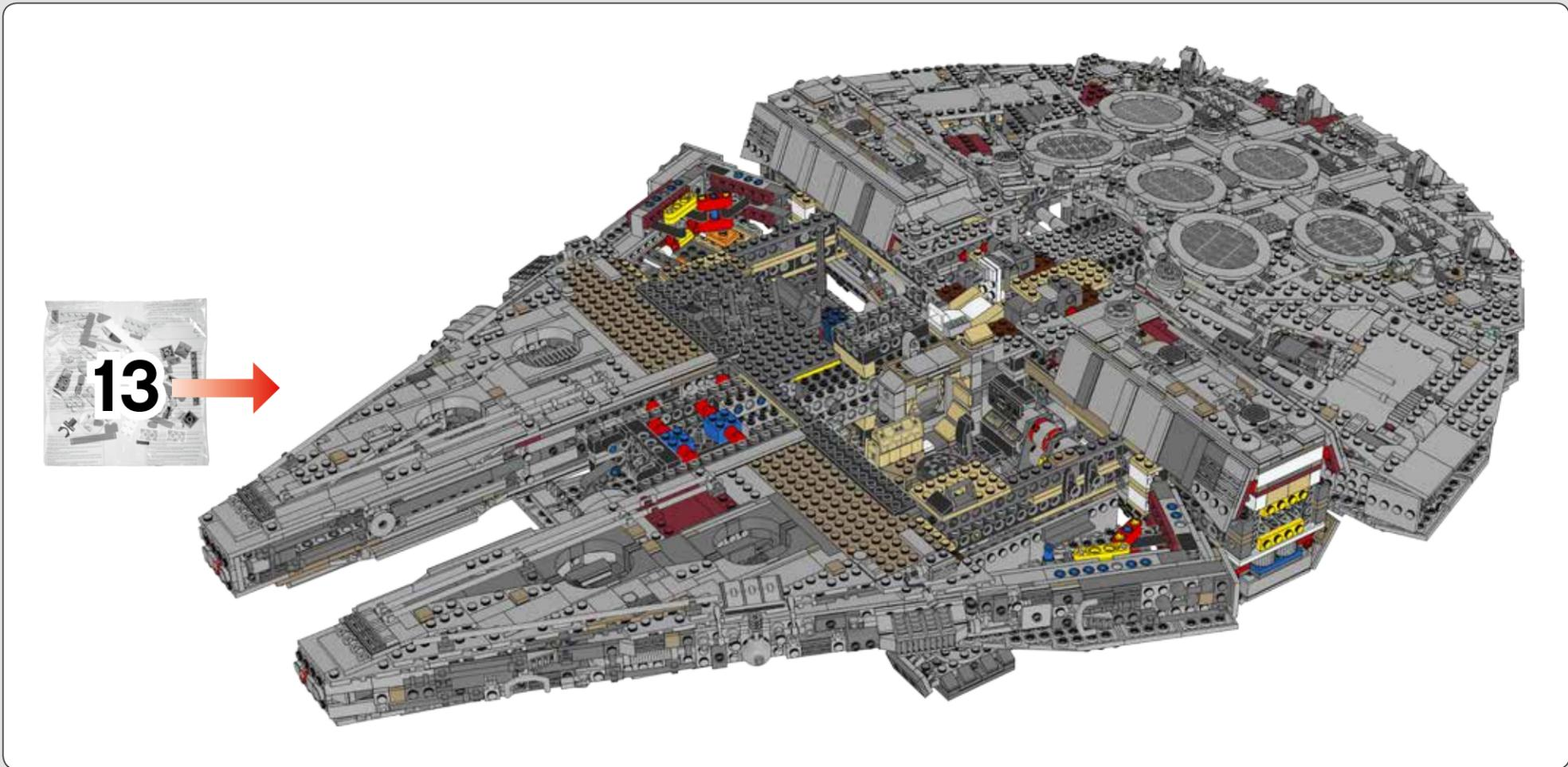

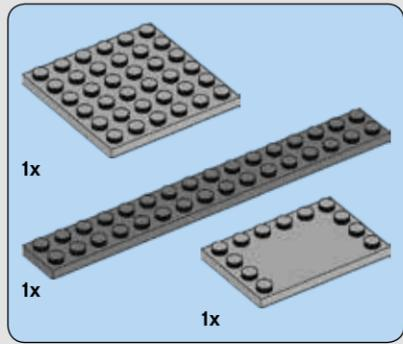

983

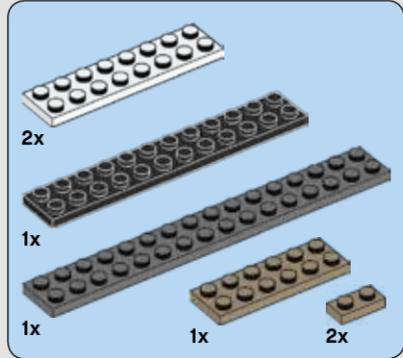
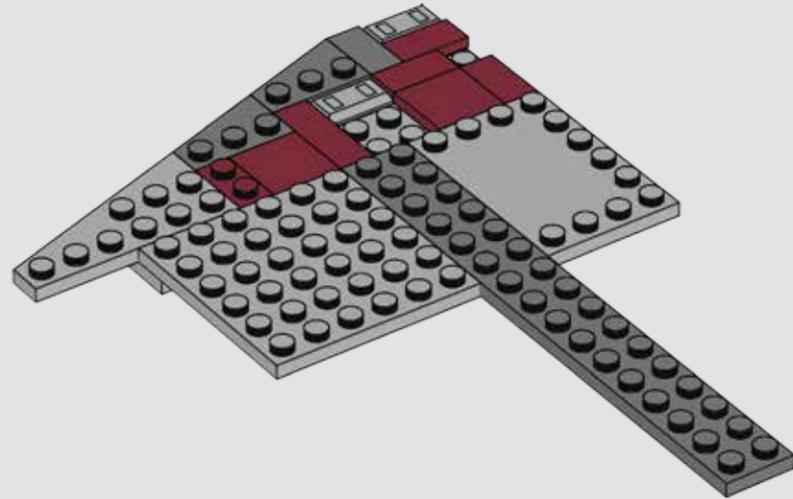

984

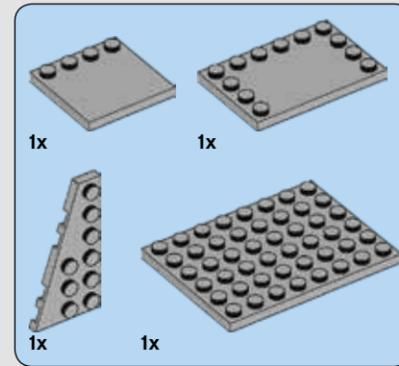
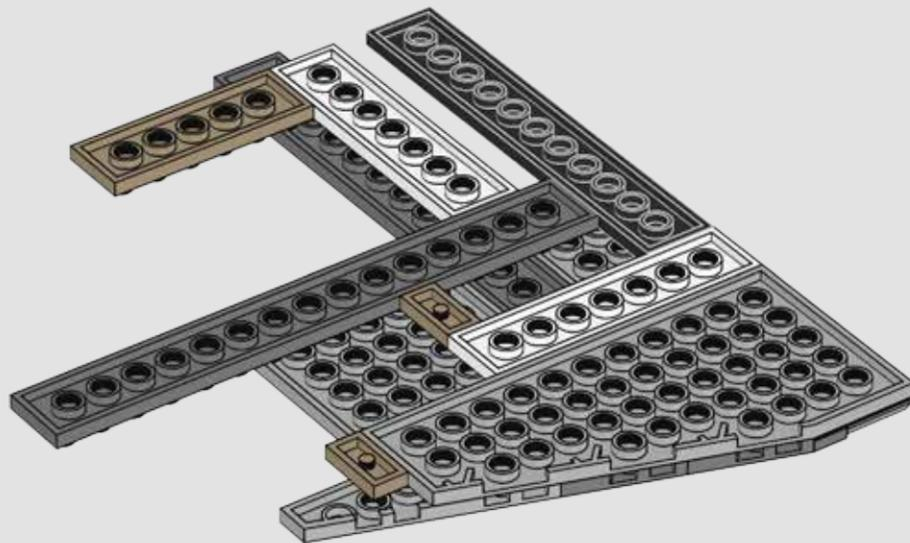

985

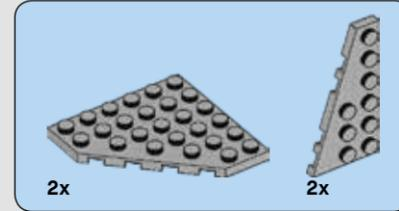
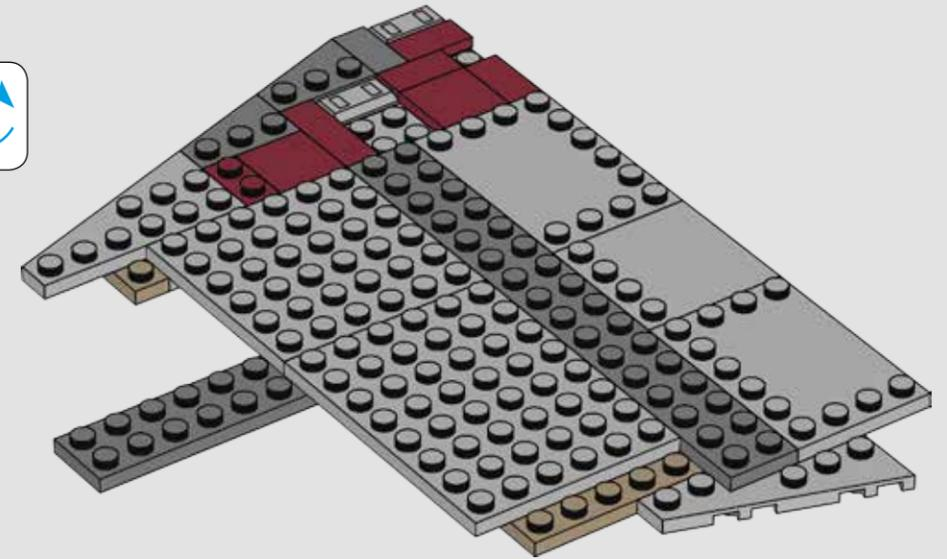

986

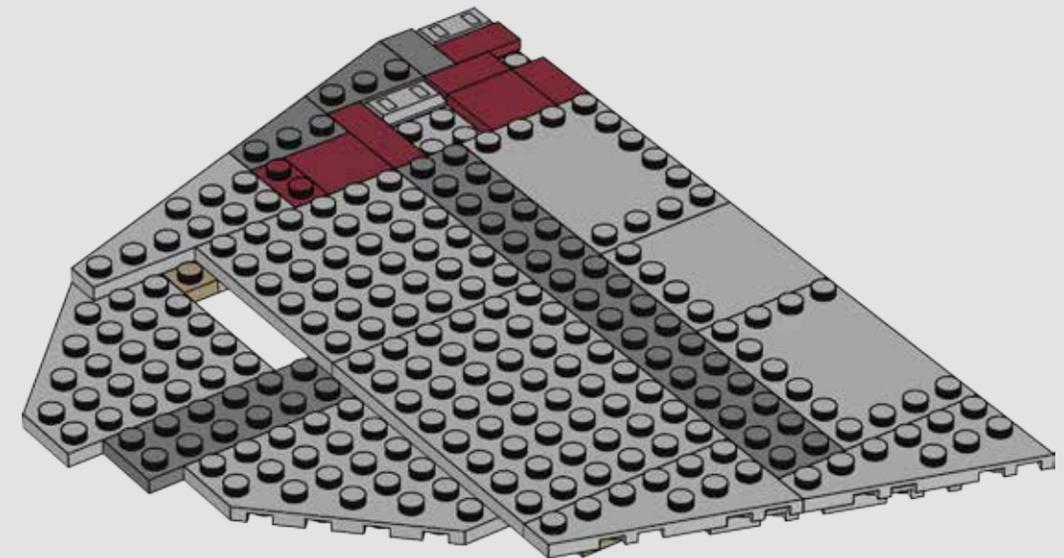

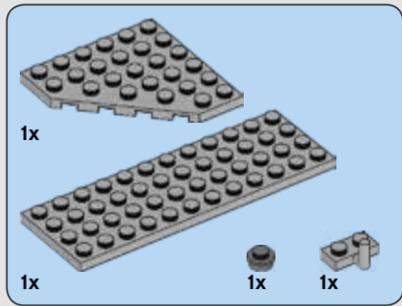

987

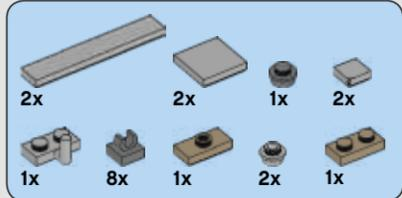
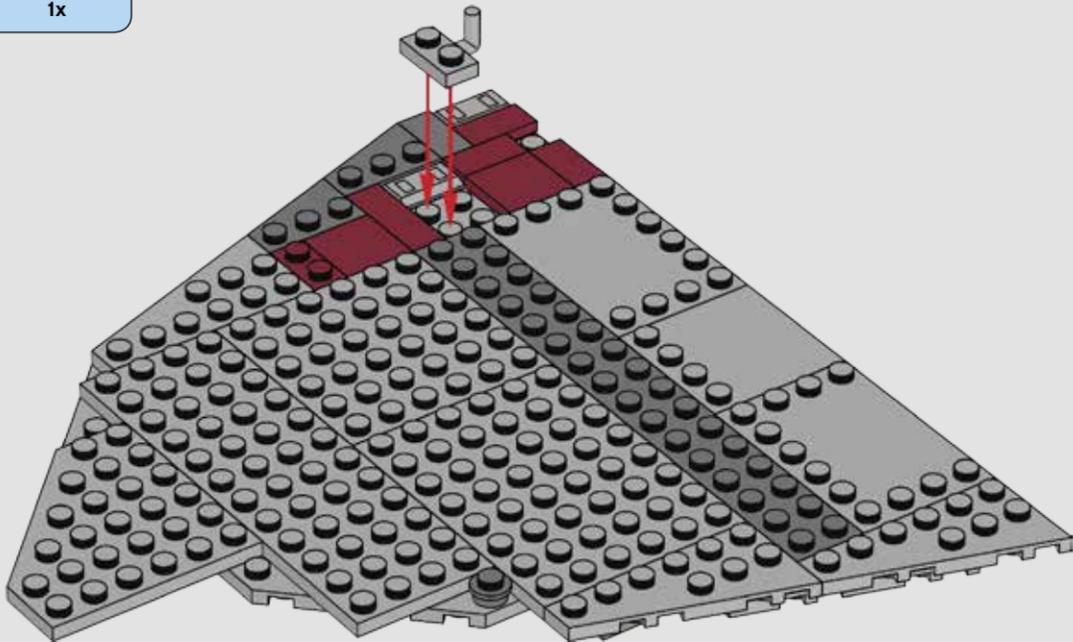

988

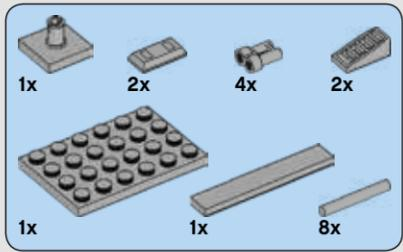
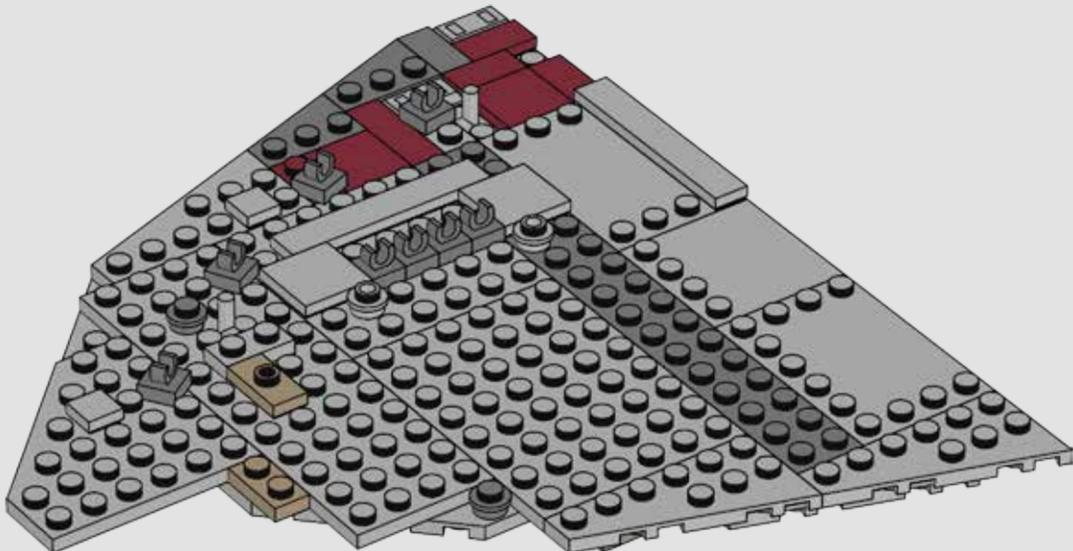

989

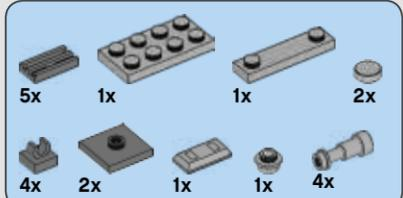
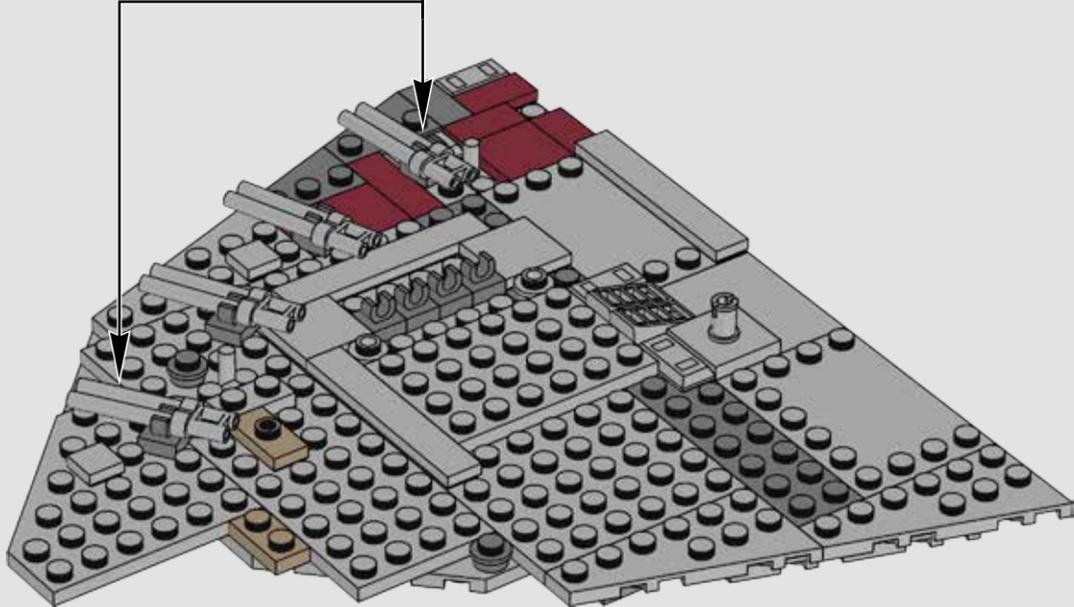
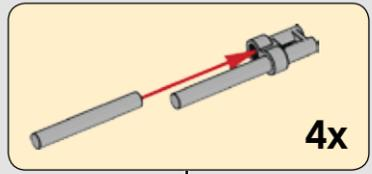

990

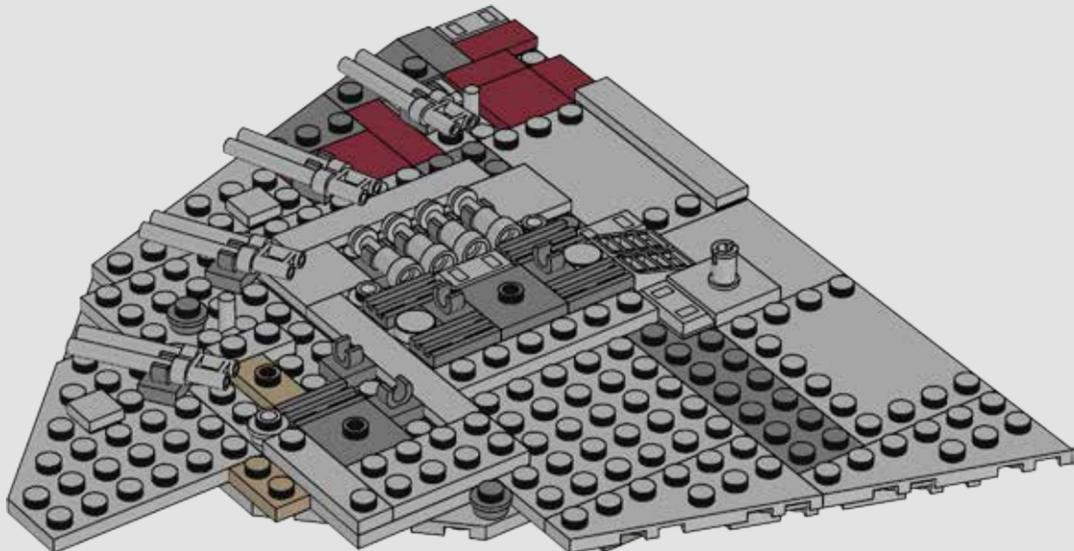

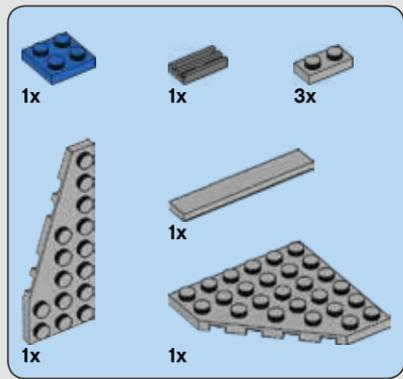

991

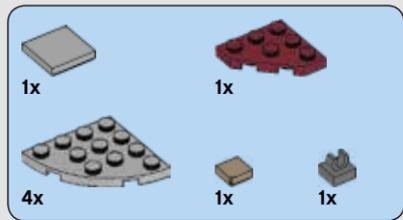
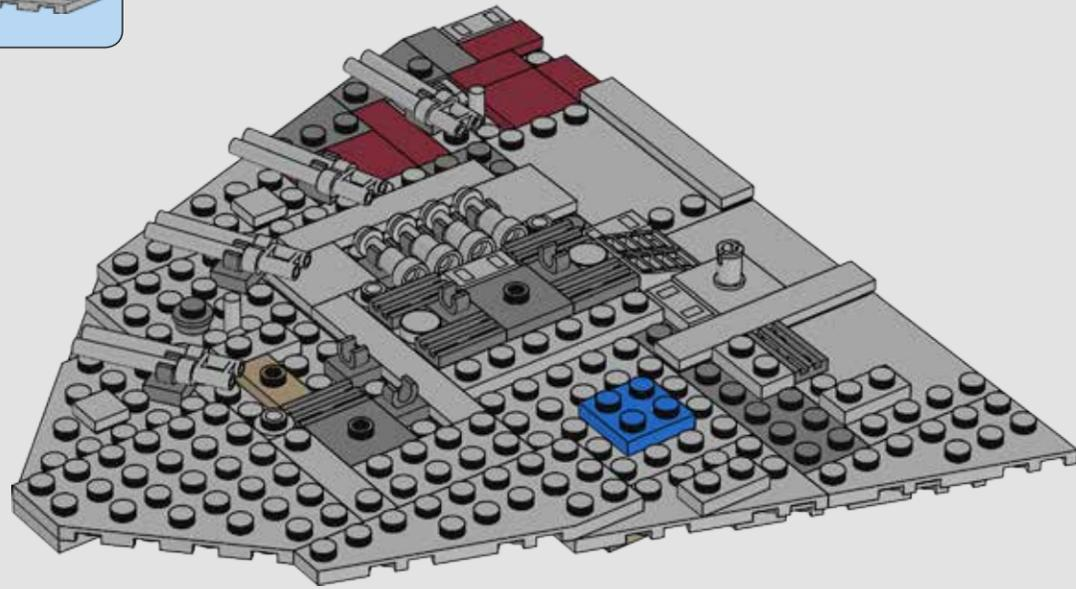

992

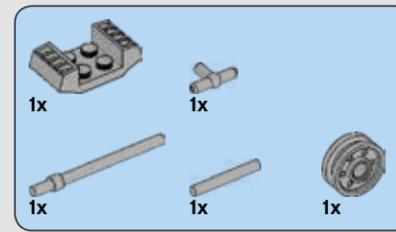
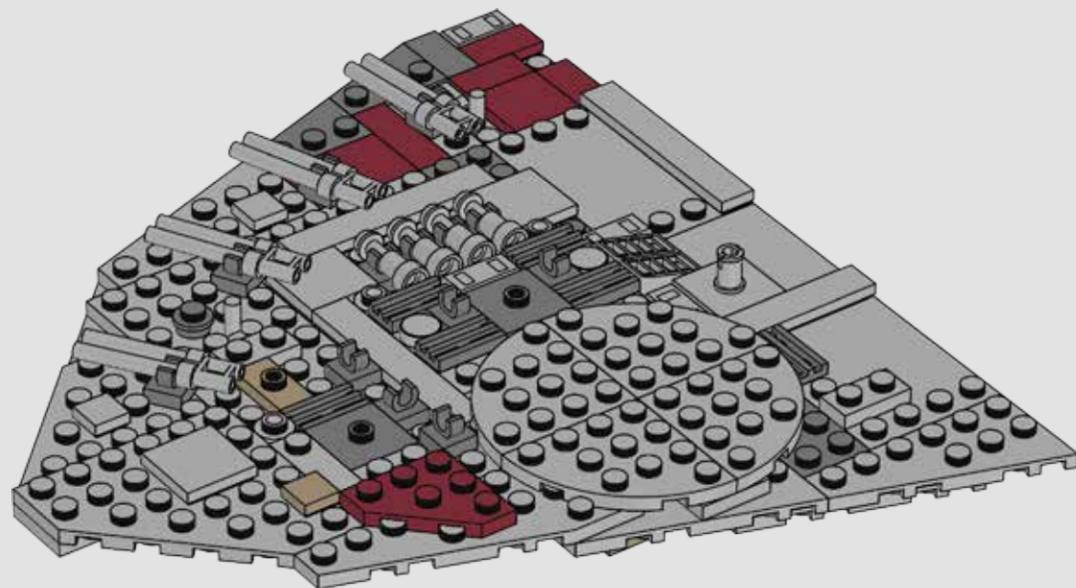

993

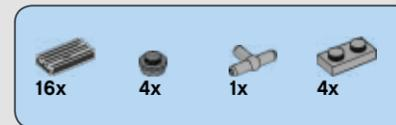
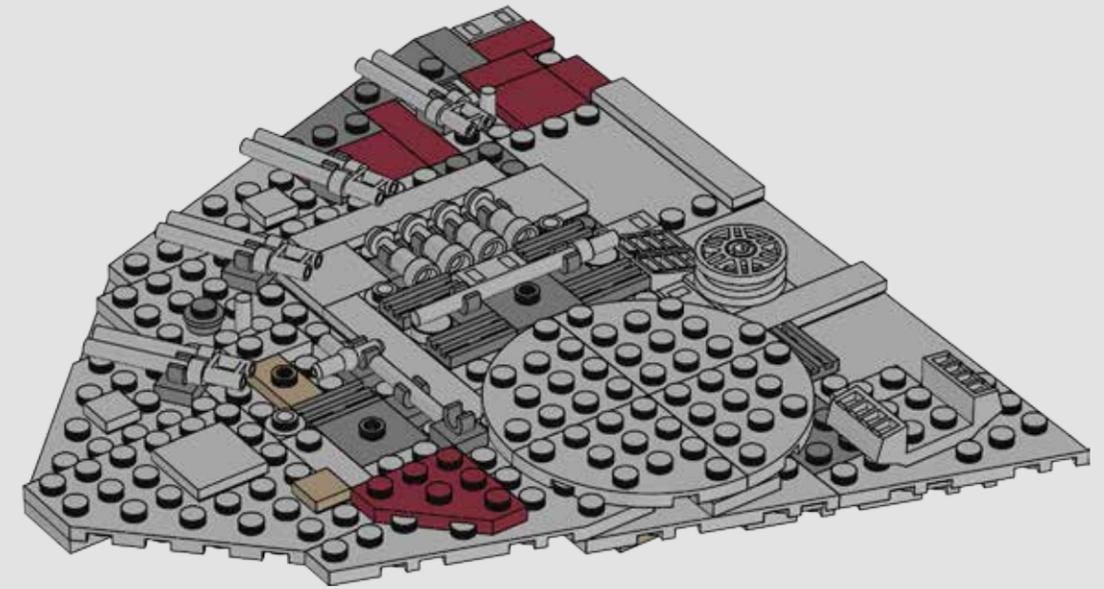

994

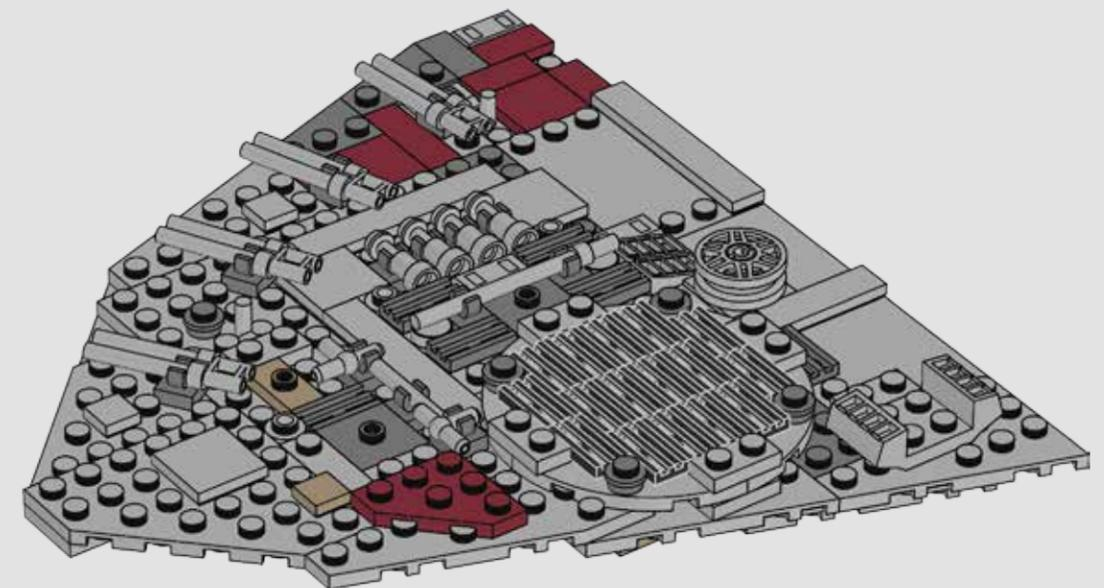

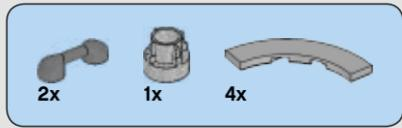

995

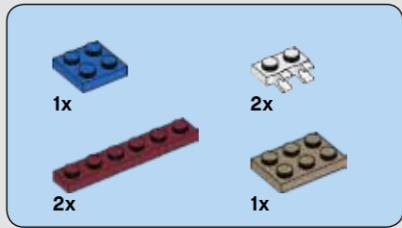
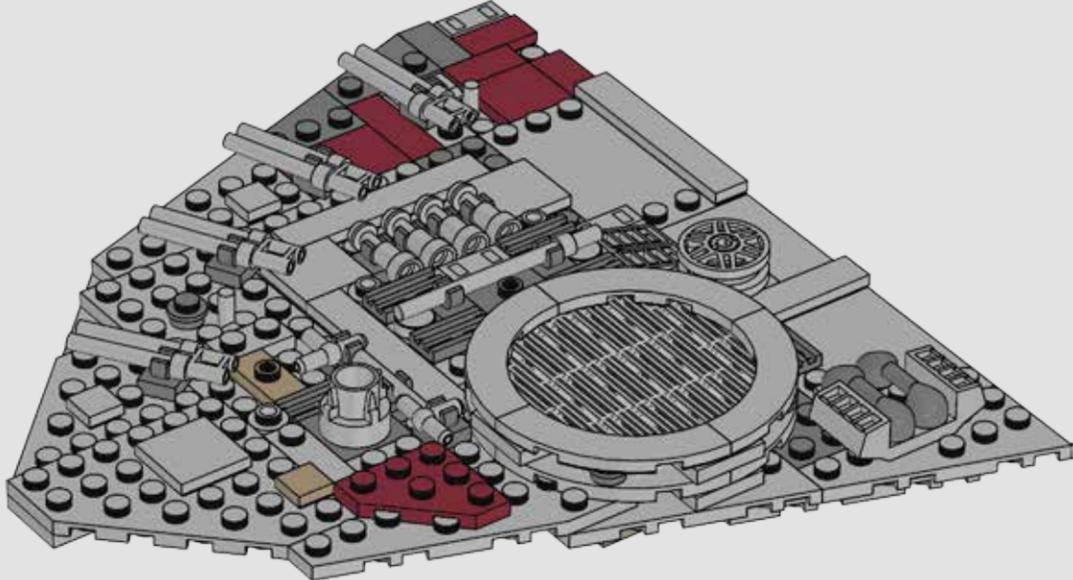

996

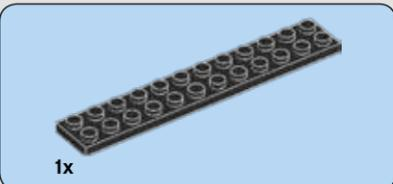
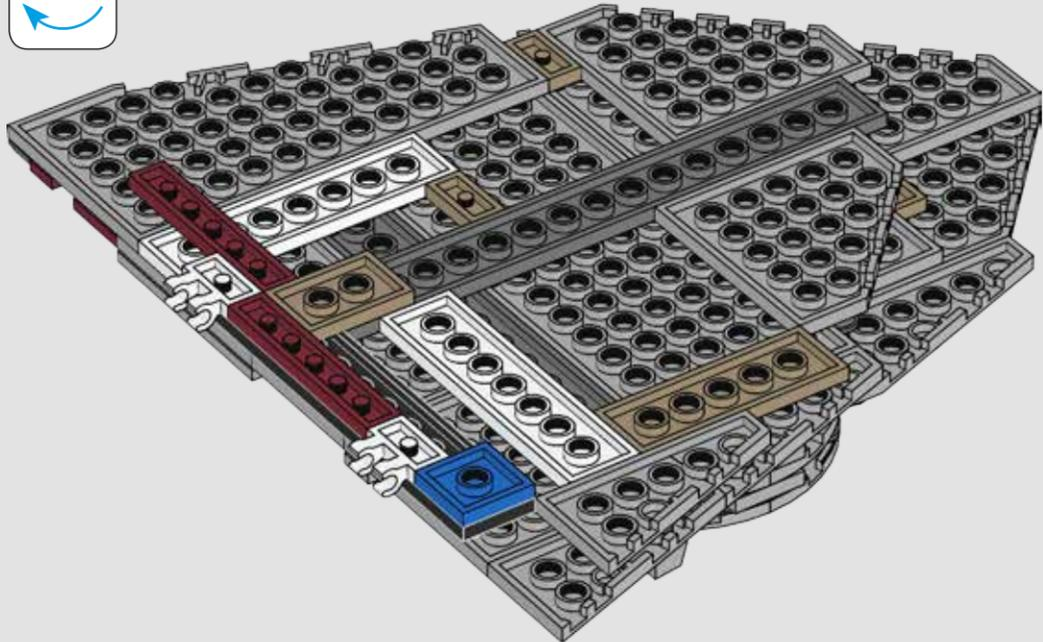

997

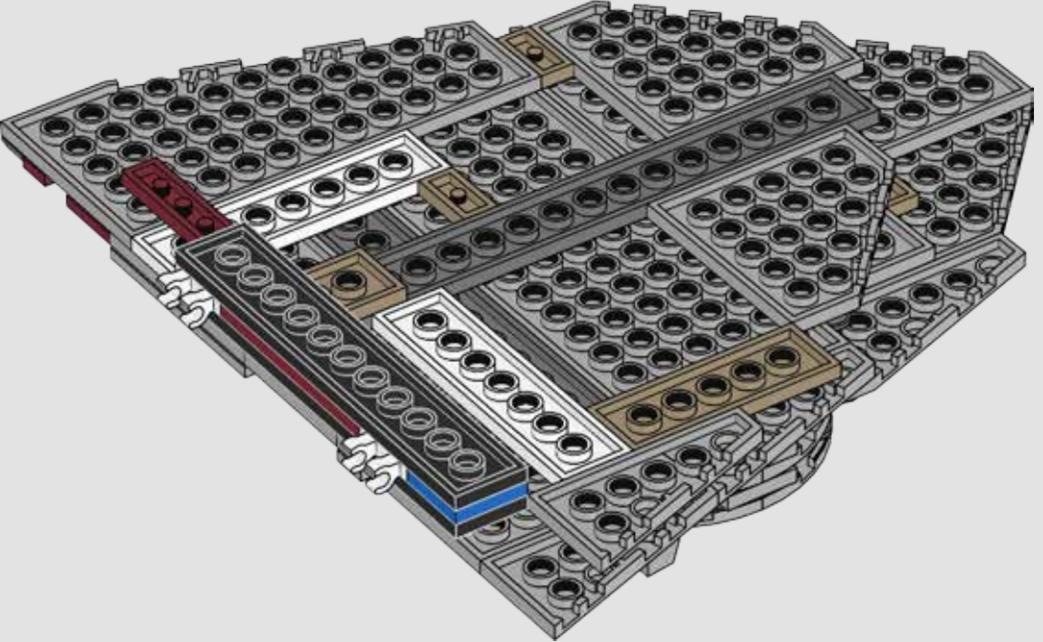

998

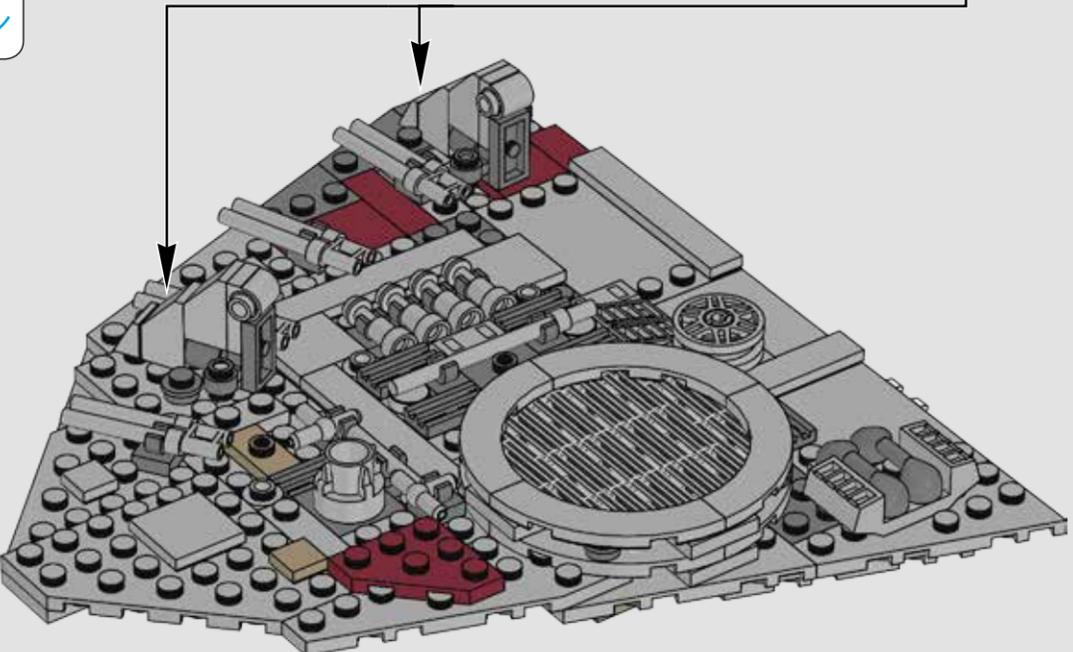
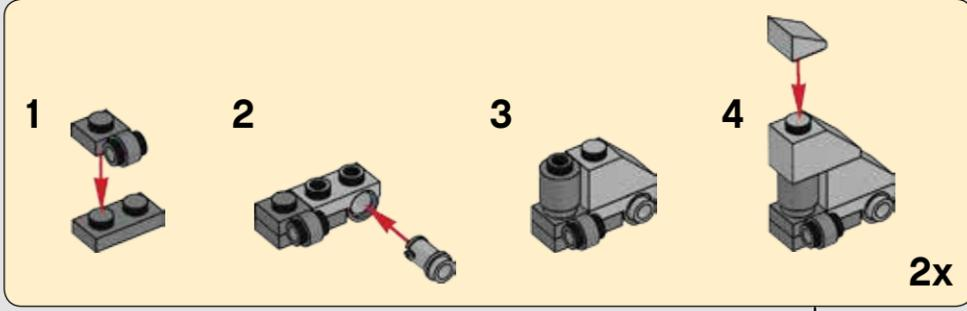

999

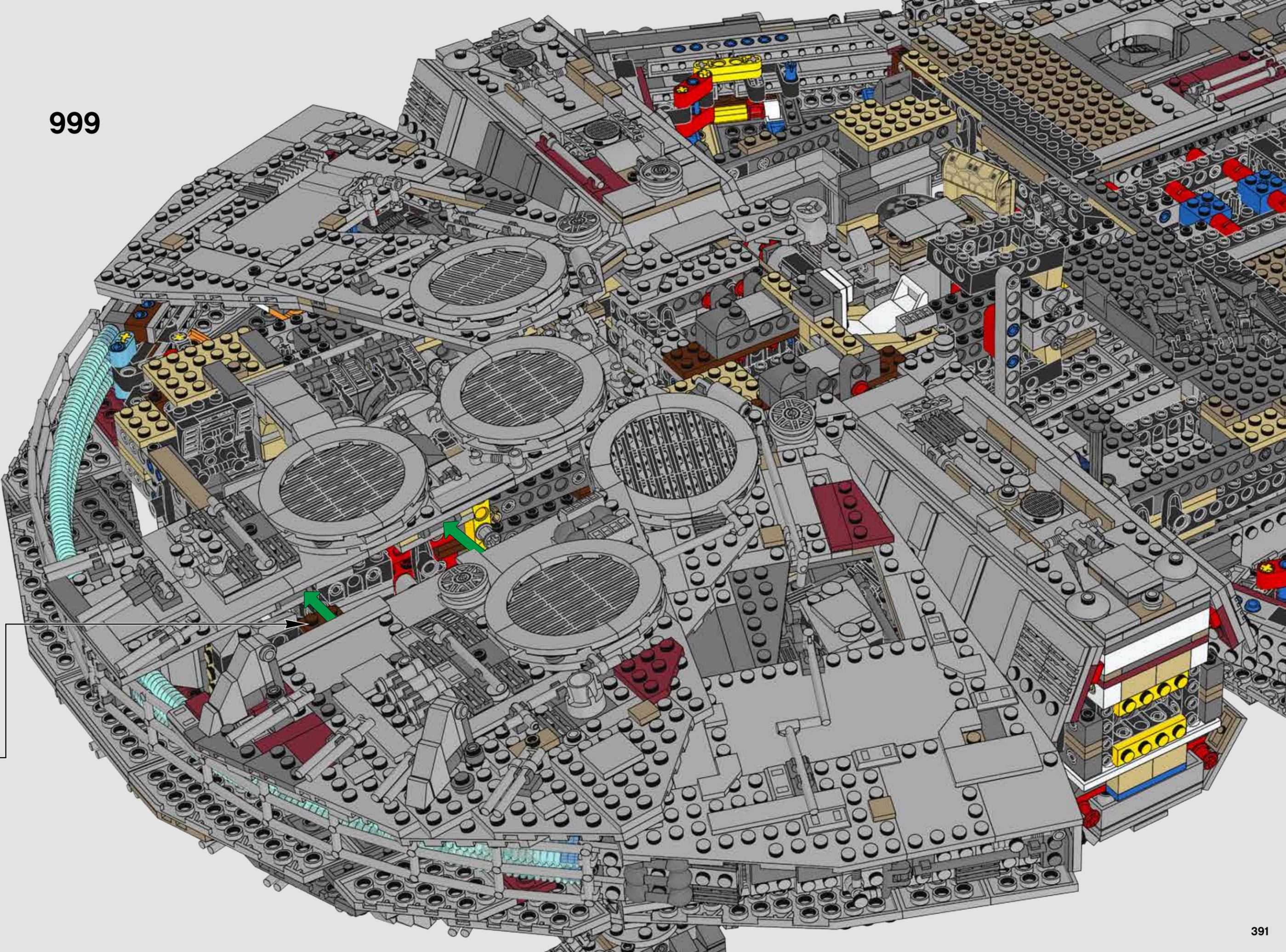

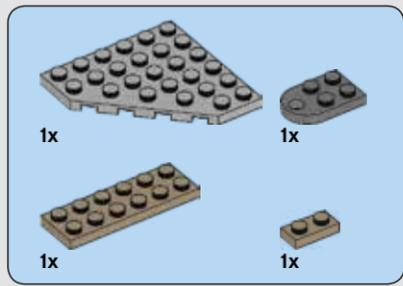

1004

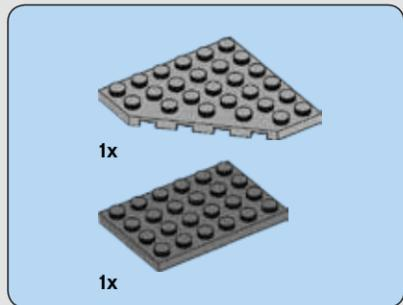

1005

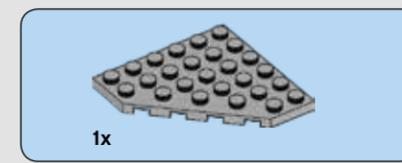

1006

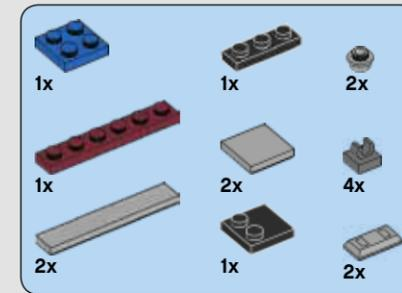
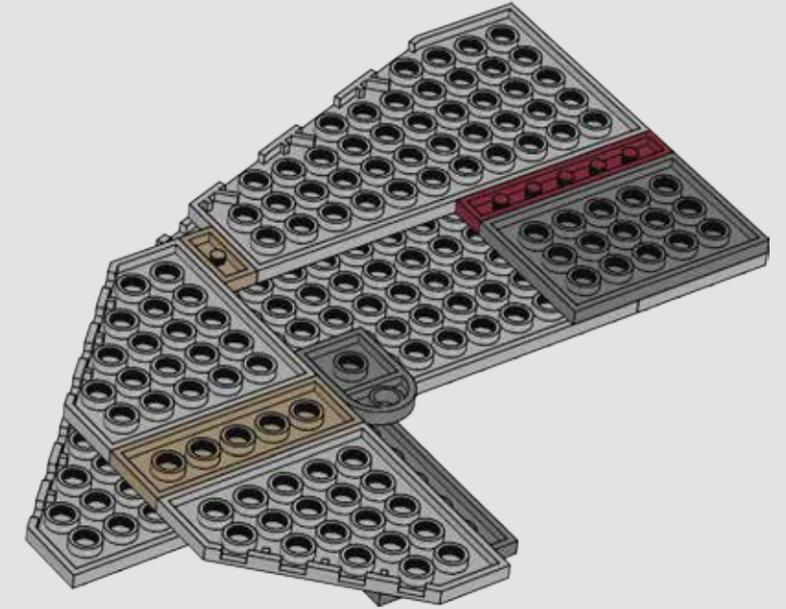

1007

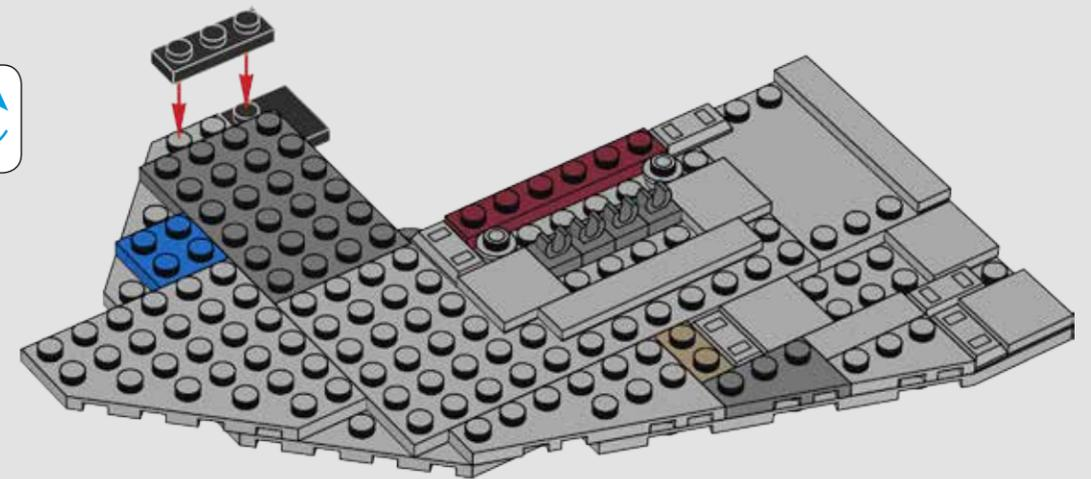



1008

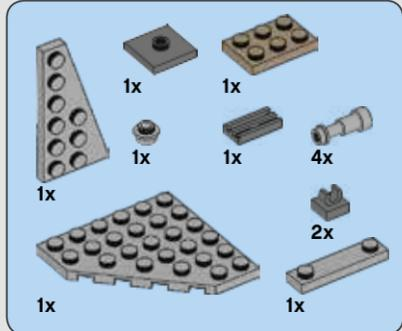
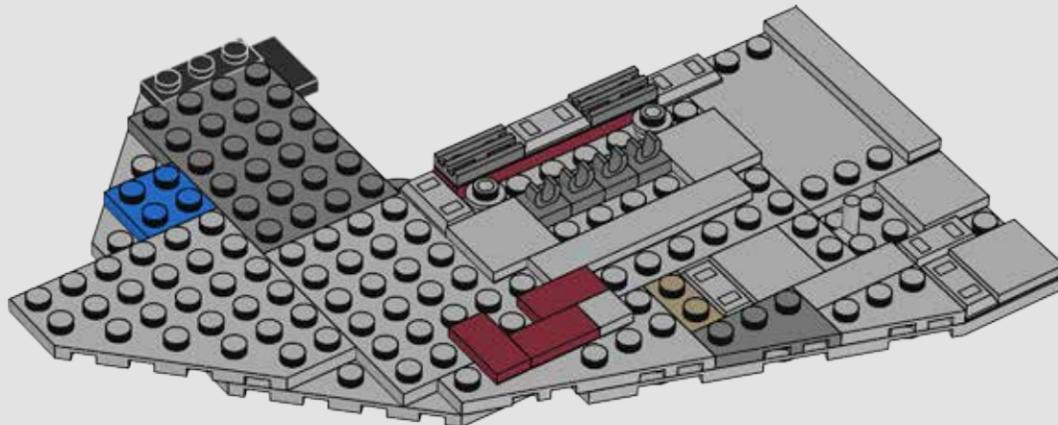

1009

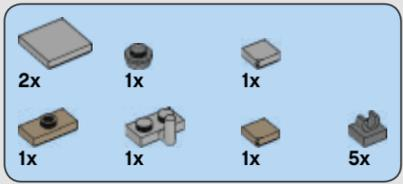
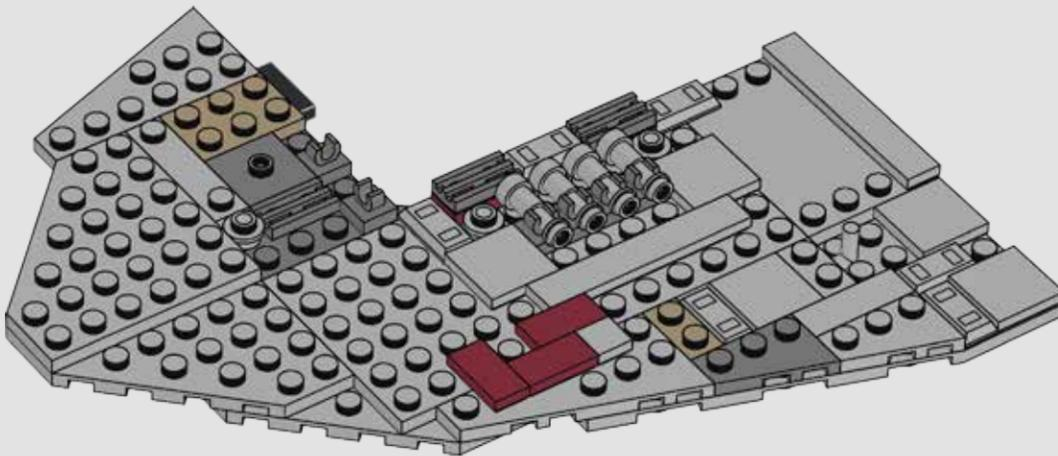

1010

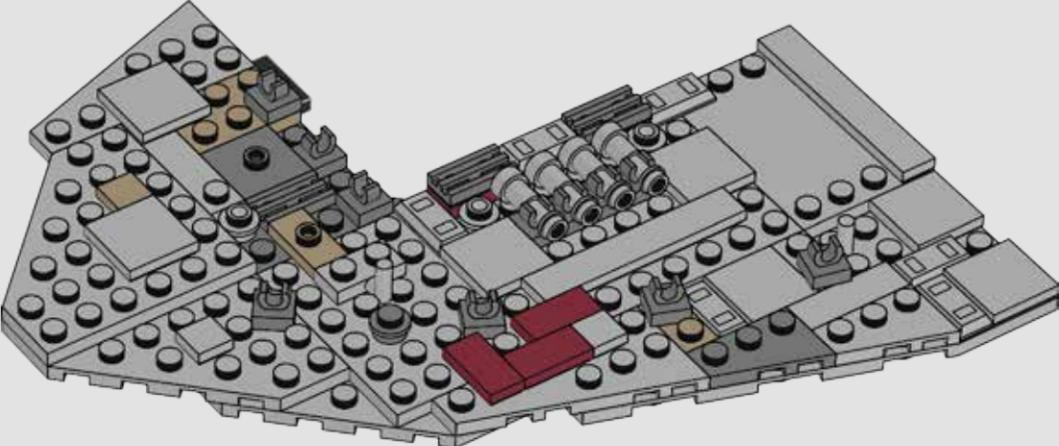

1011

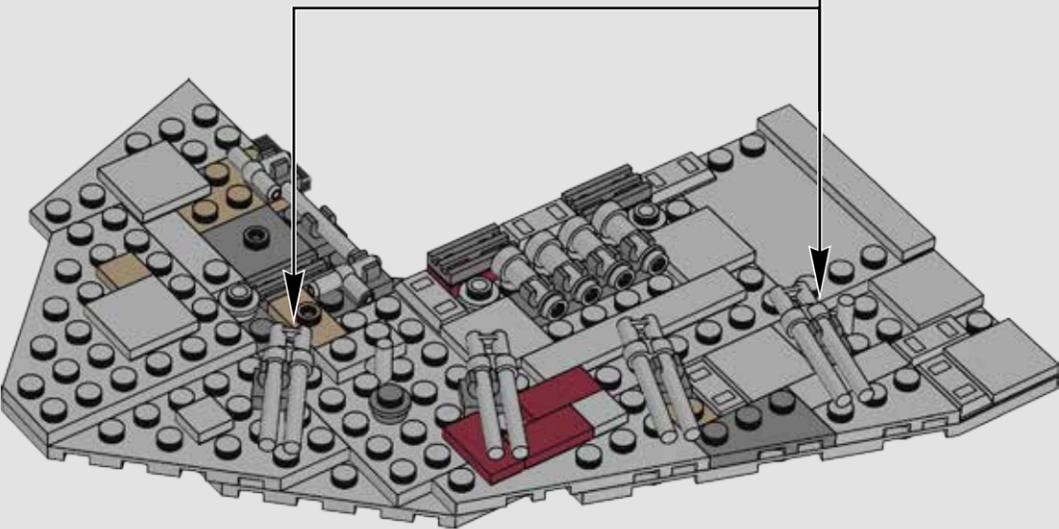
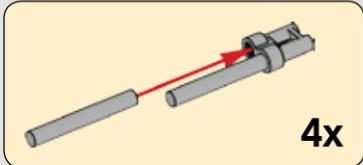

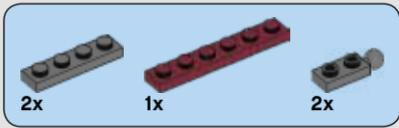

1012



1013

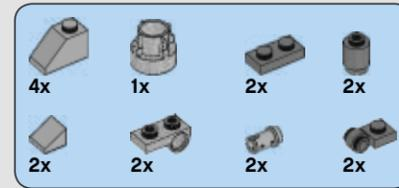
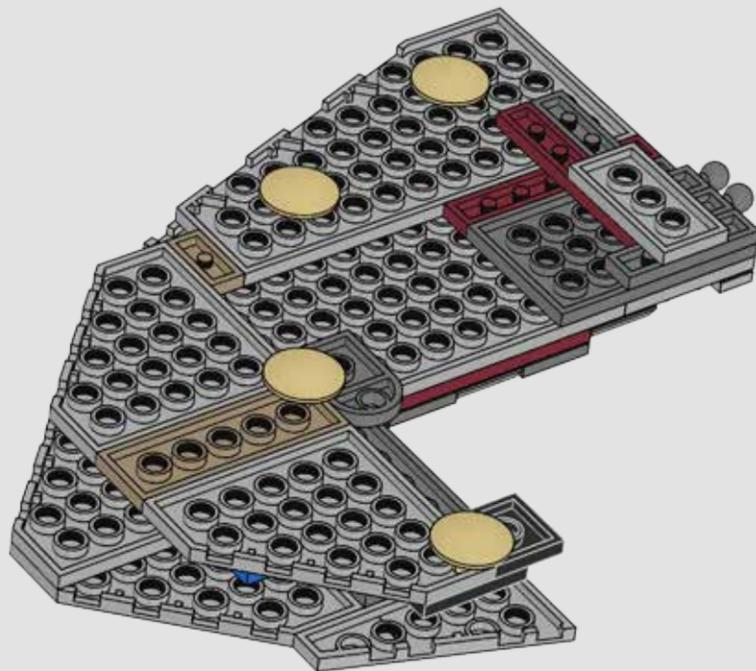

1014

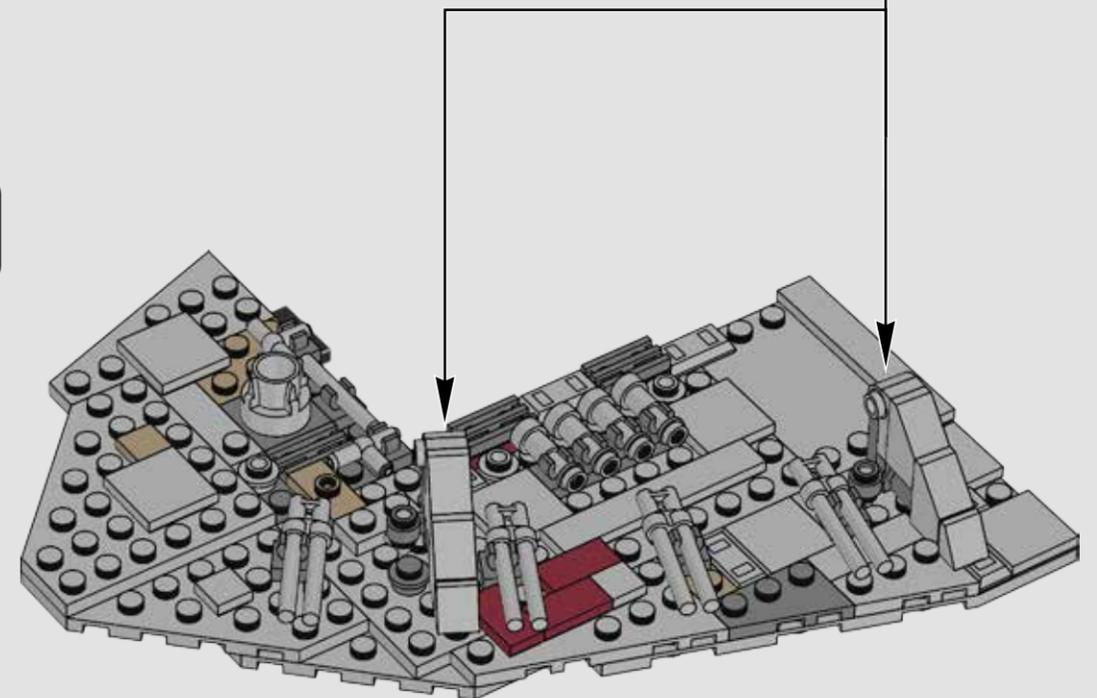
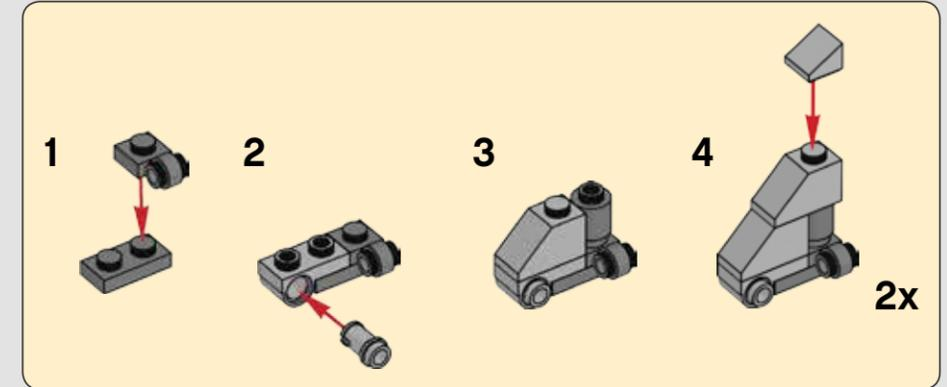

1015

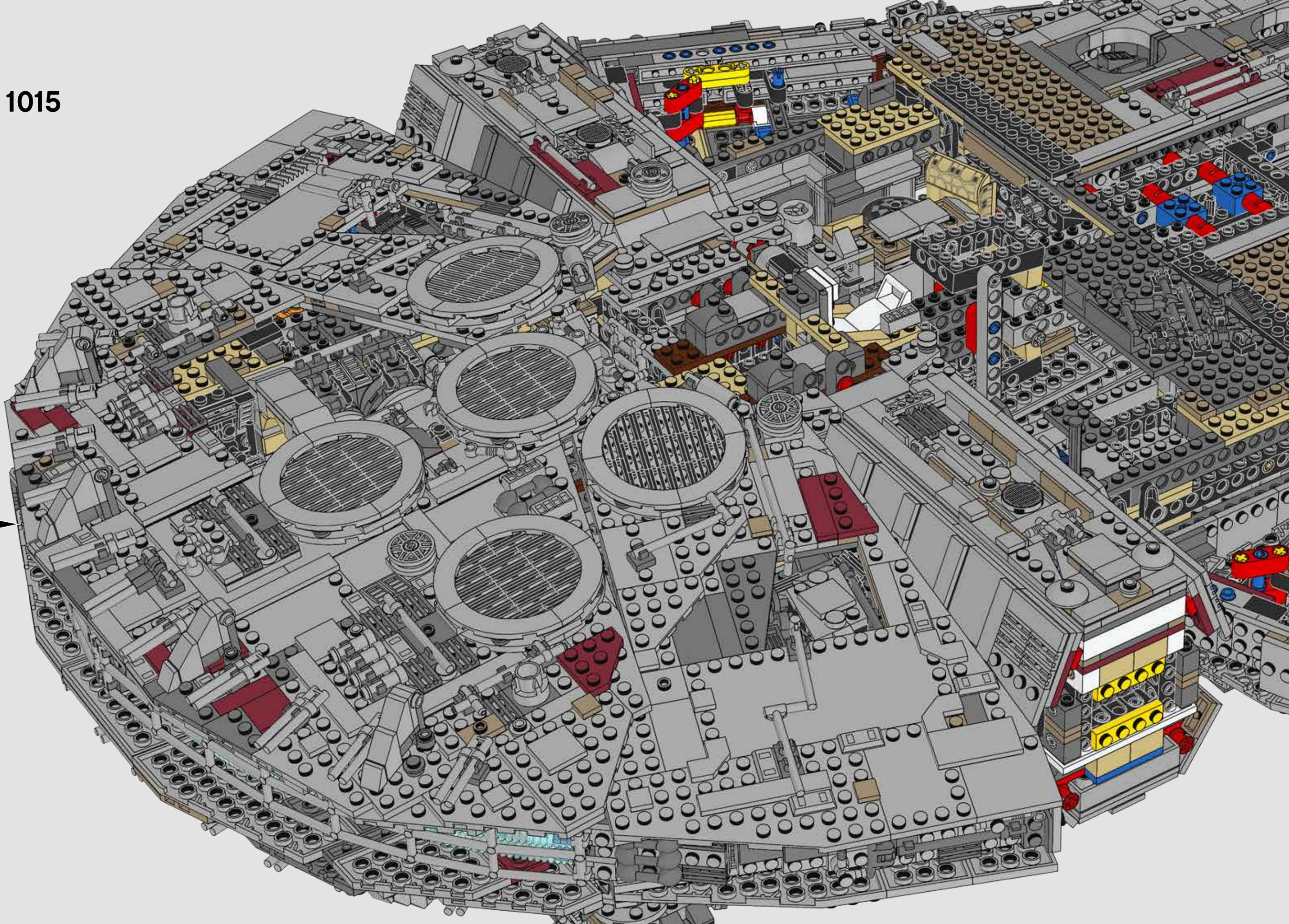

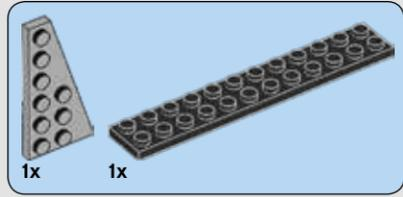
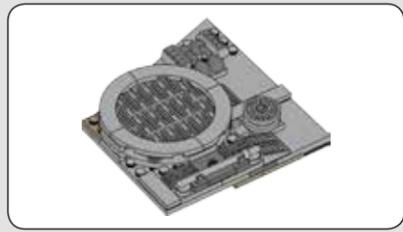

1016

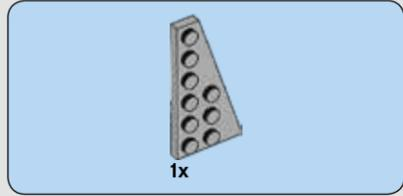
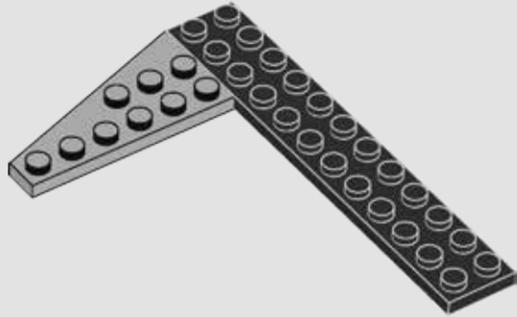

1017

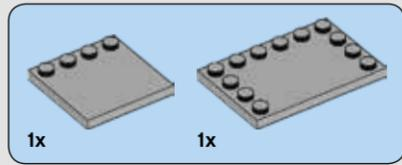
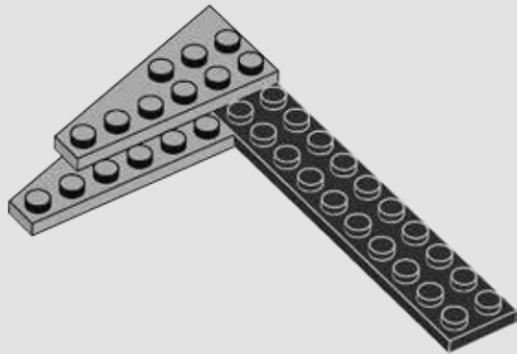

1018

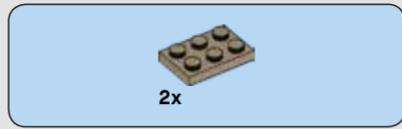
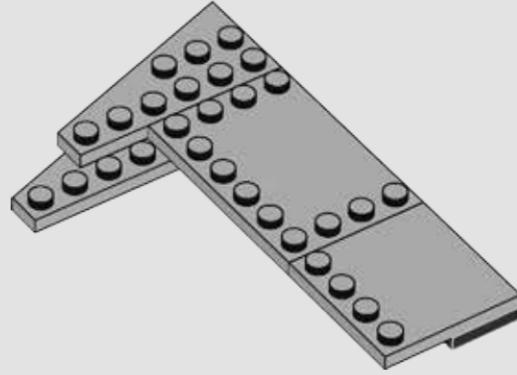

1019

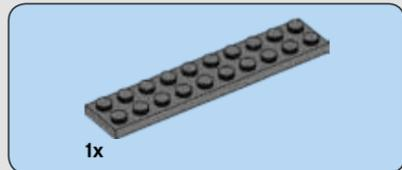
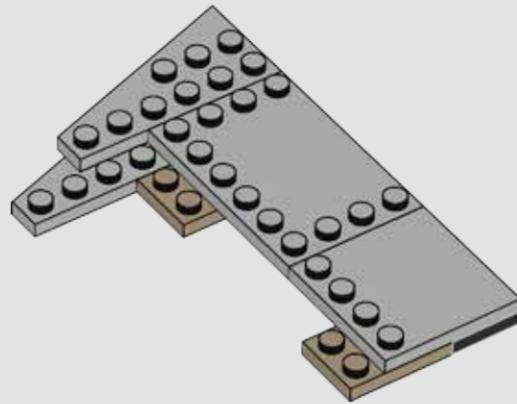

1020

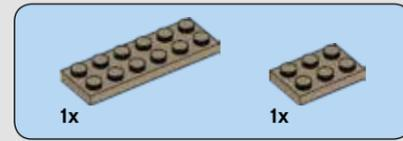
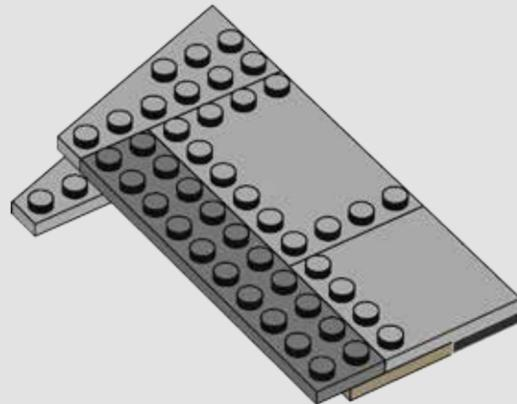

1021

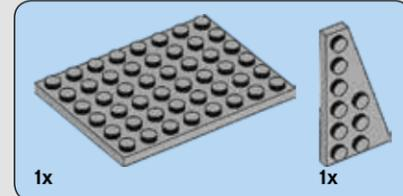
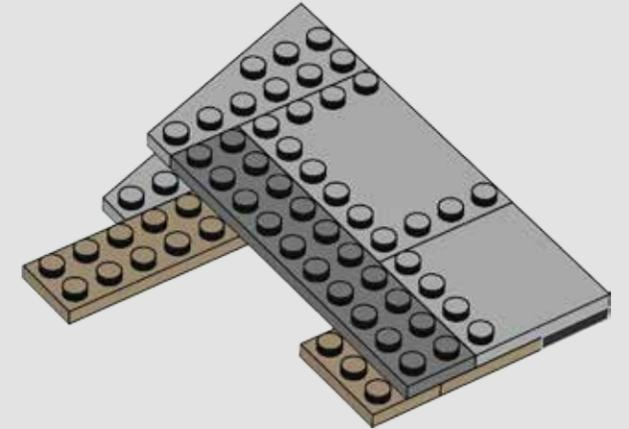

1022

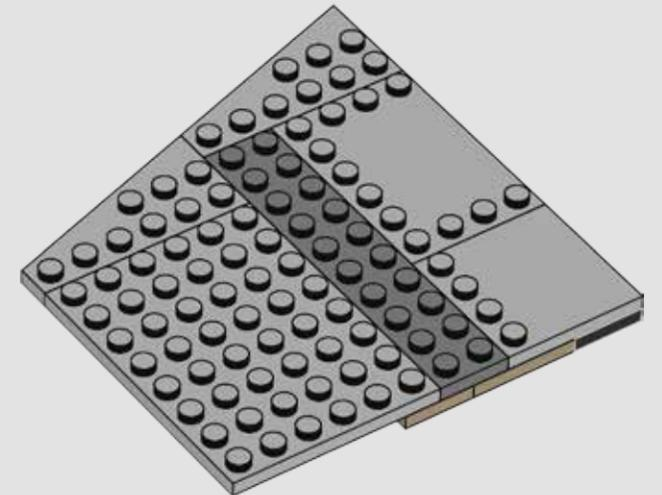

1x

1023

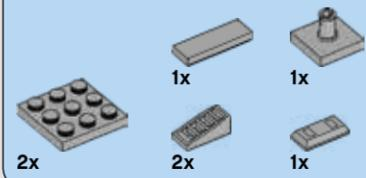
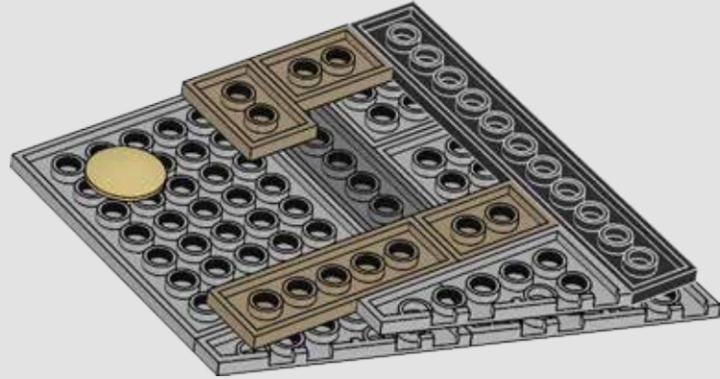

1025

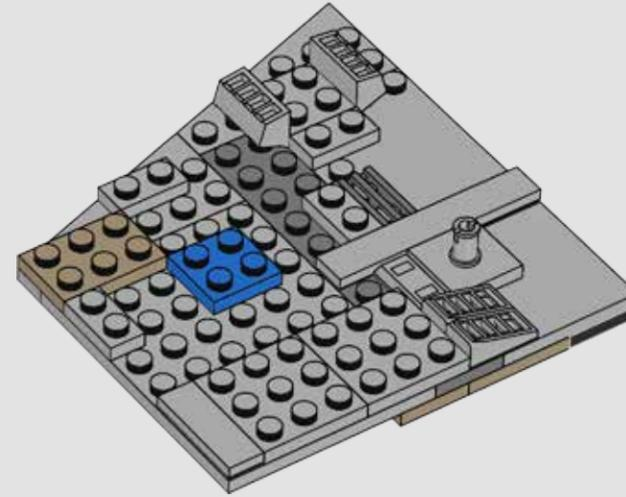

1027

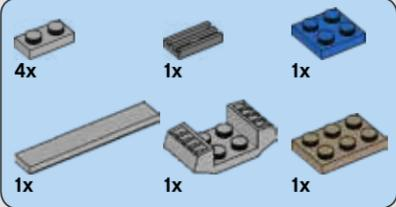
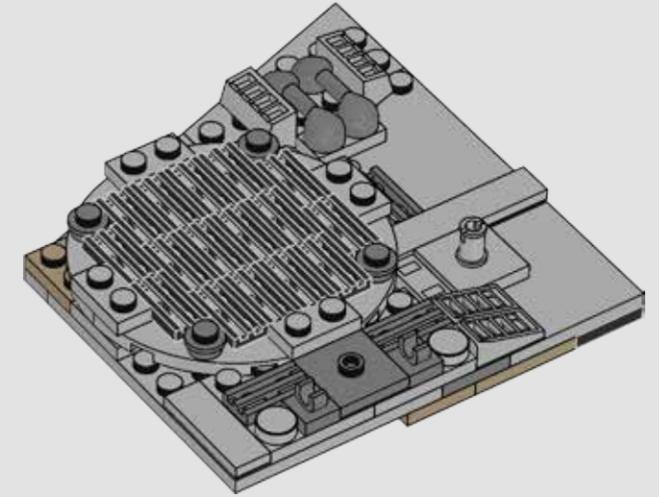

1024

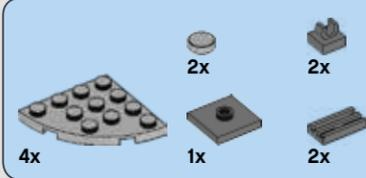
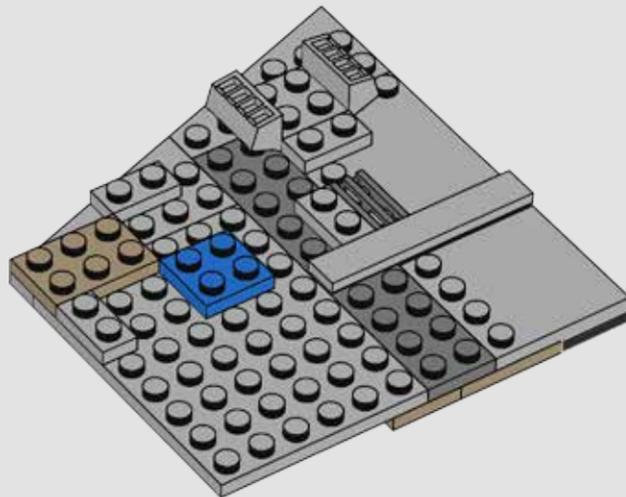

1026

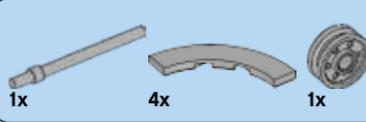
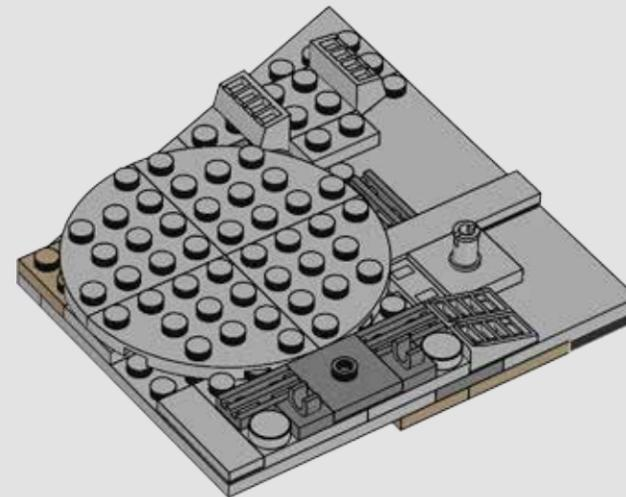

1028

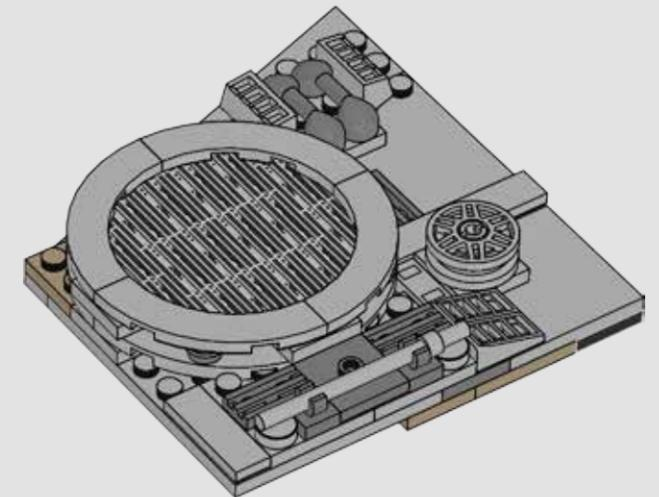

1029

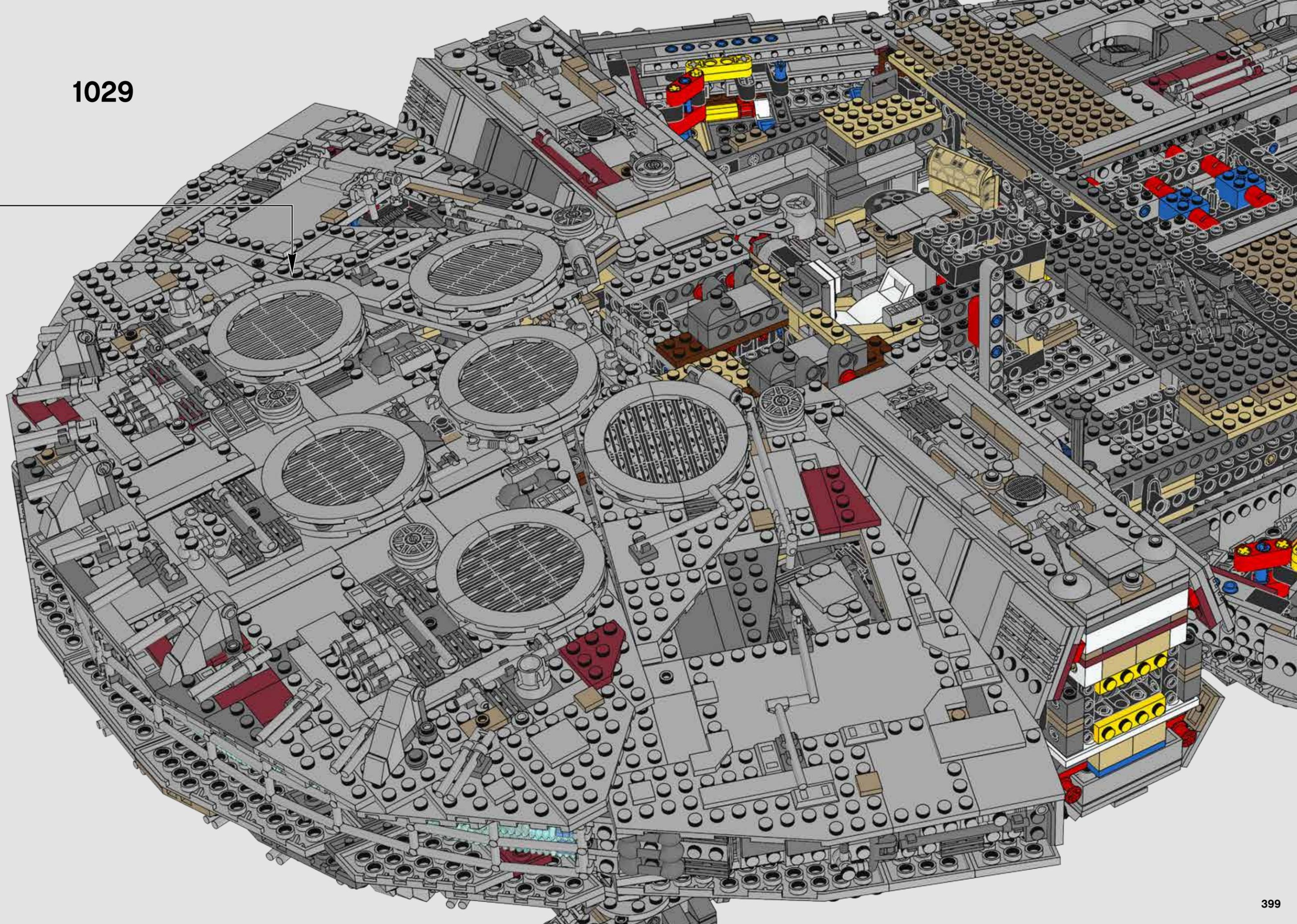

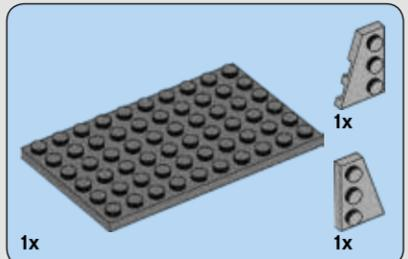
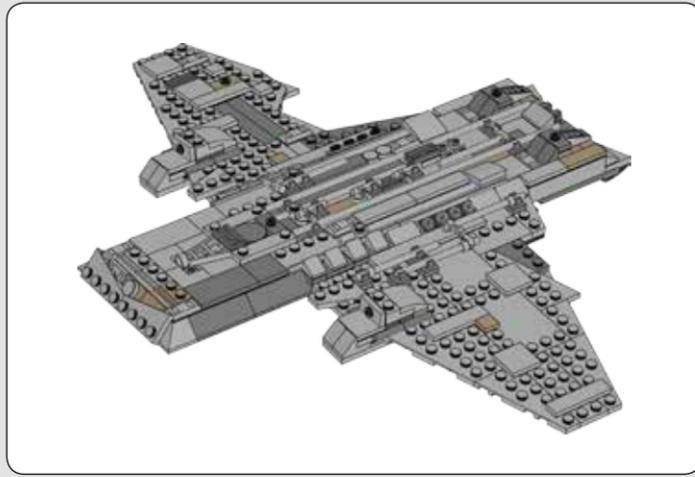
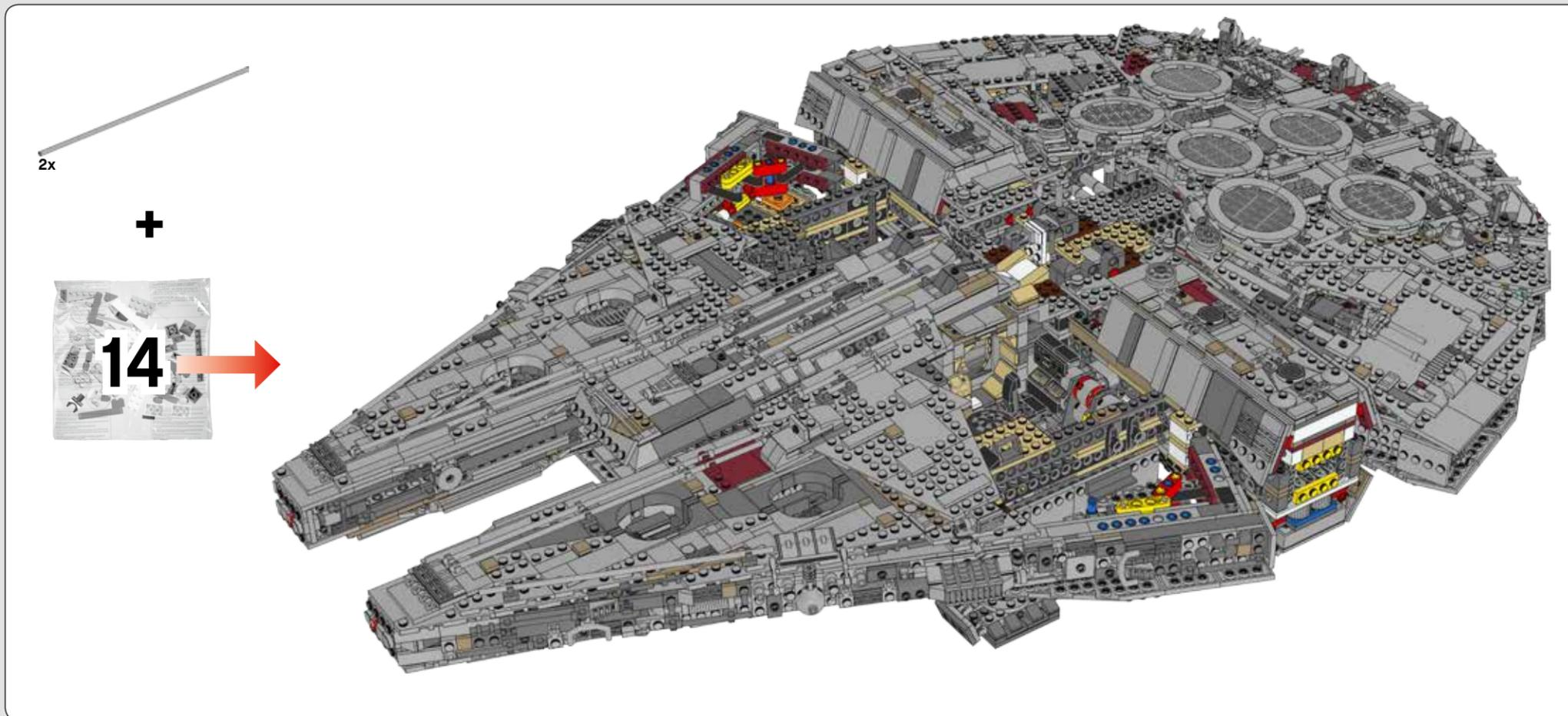

1030

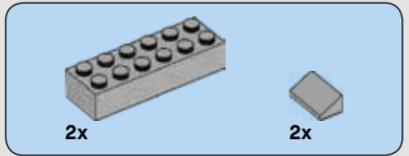
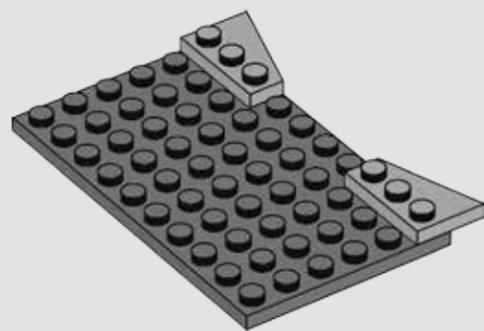

1031

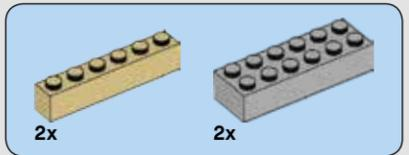
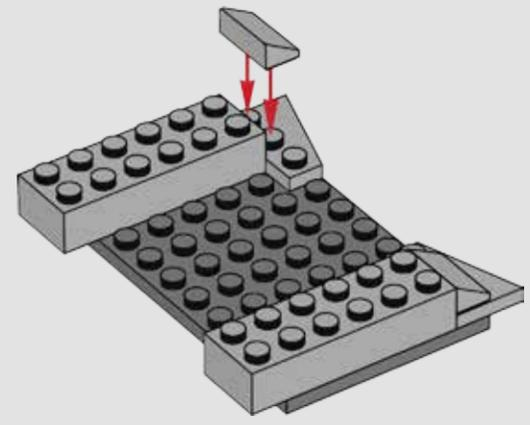

1032

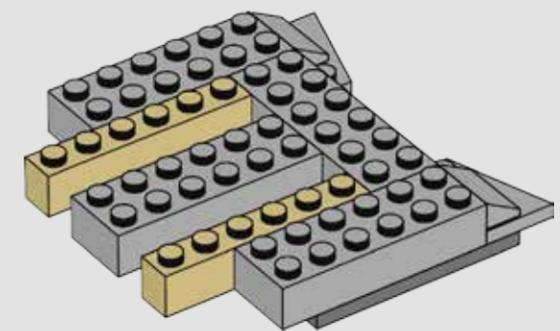

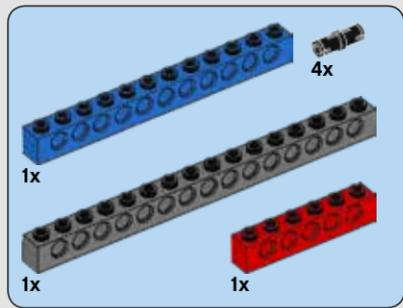

1033

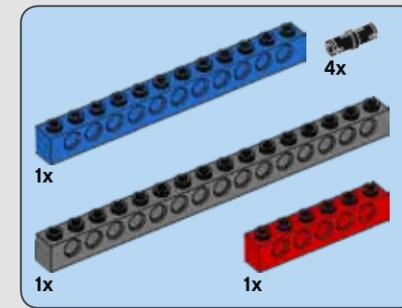
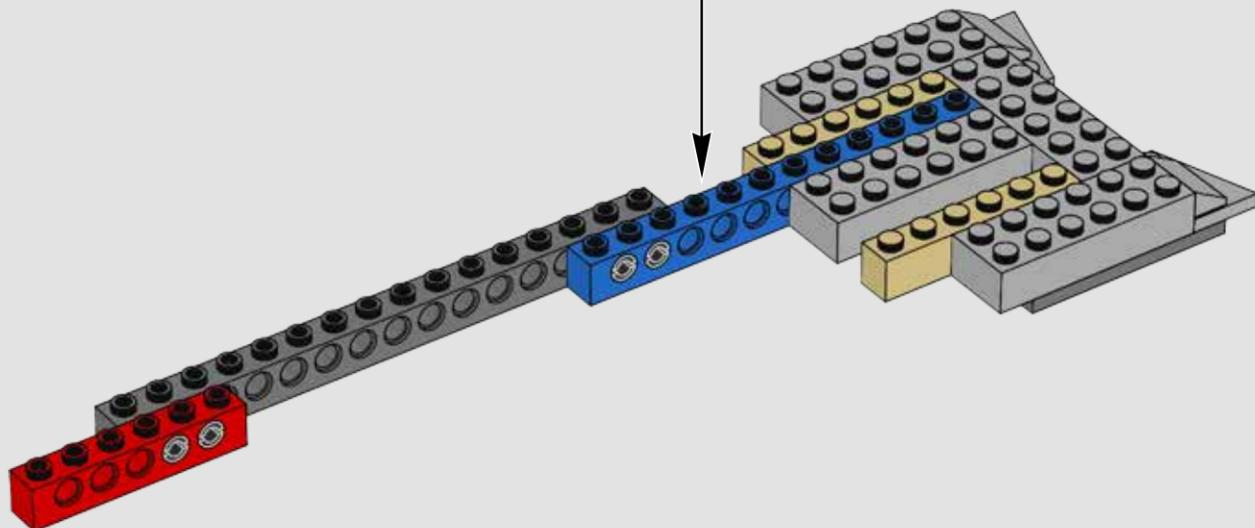
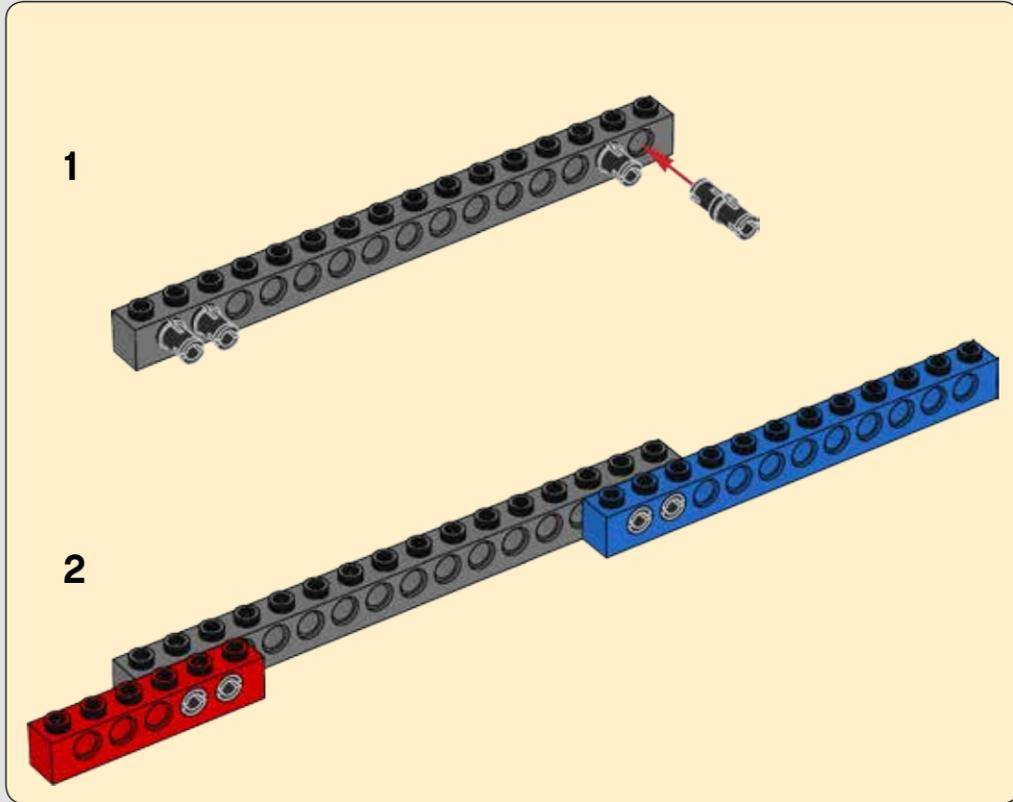

1034

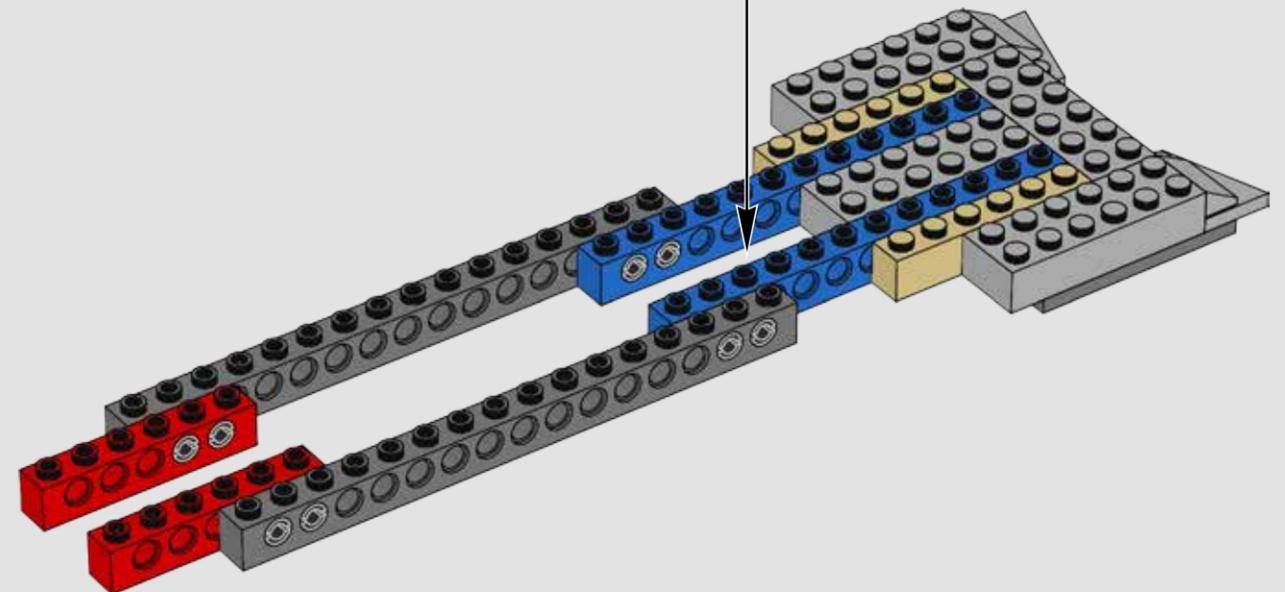
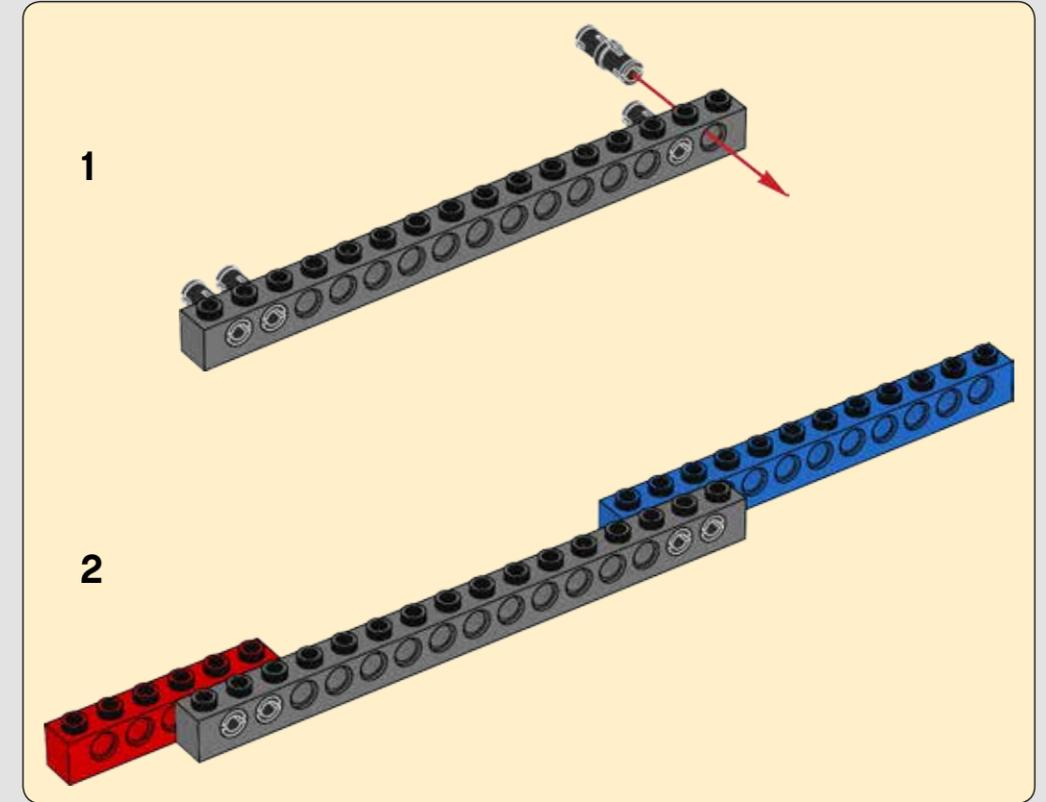

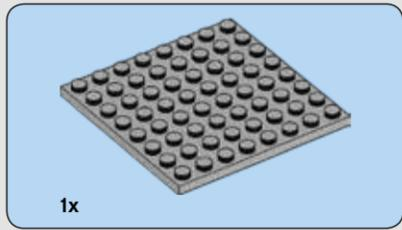

1x

1035

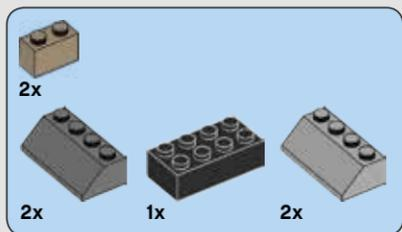
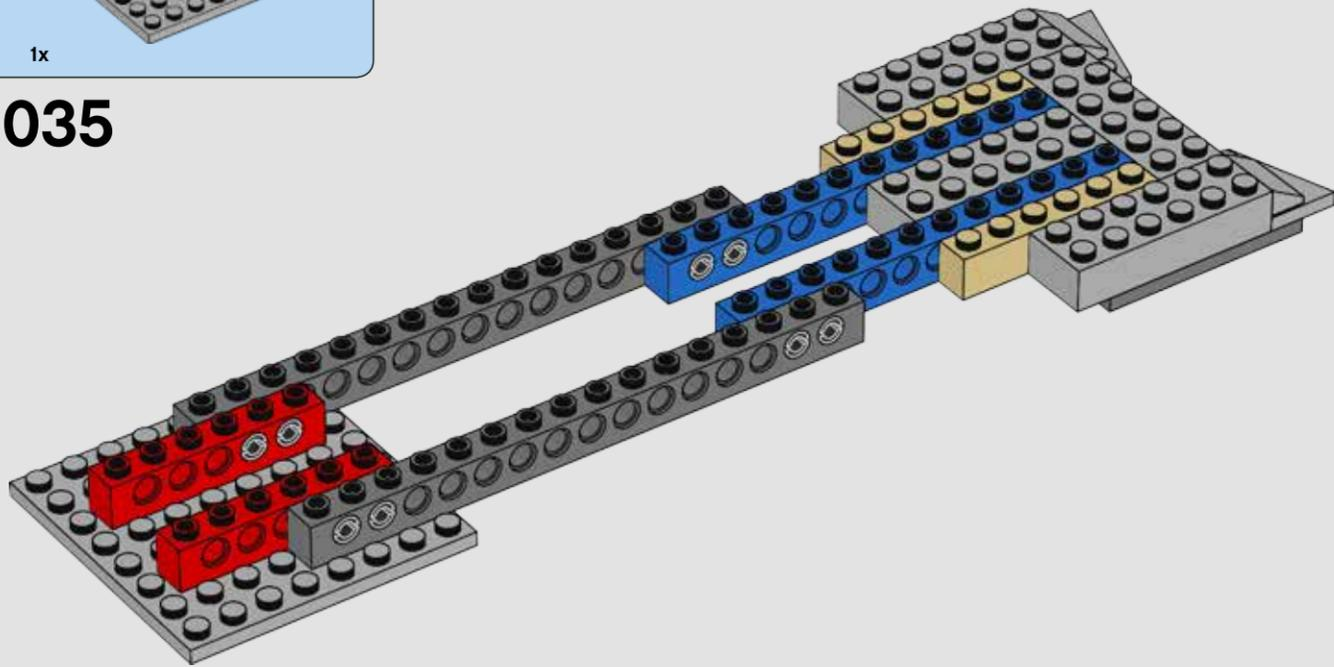

1036

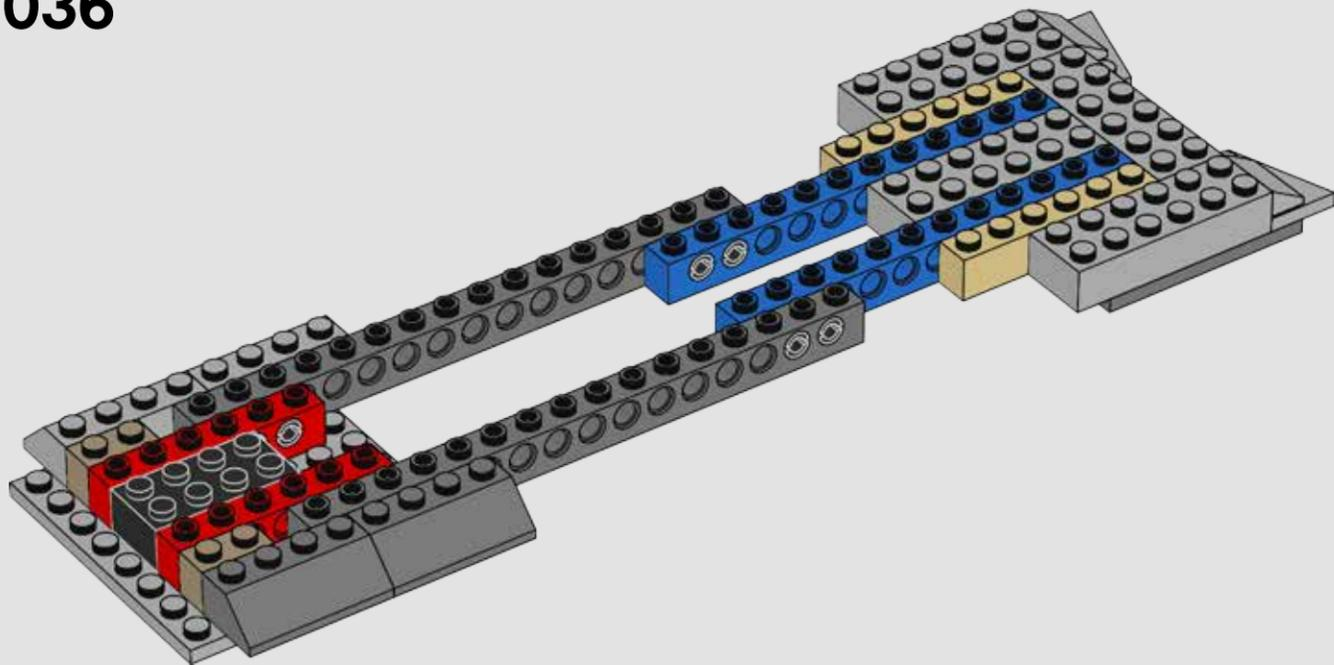

1037

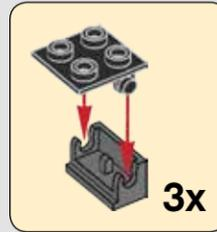

3x

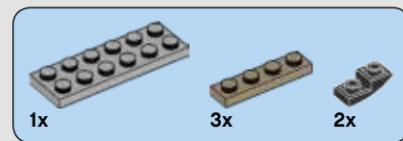
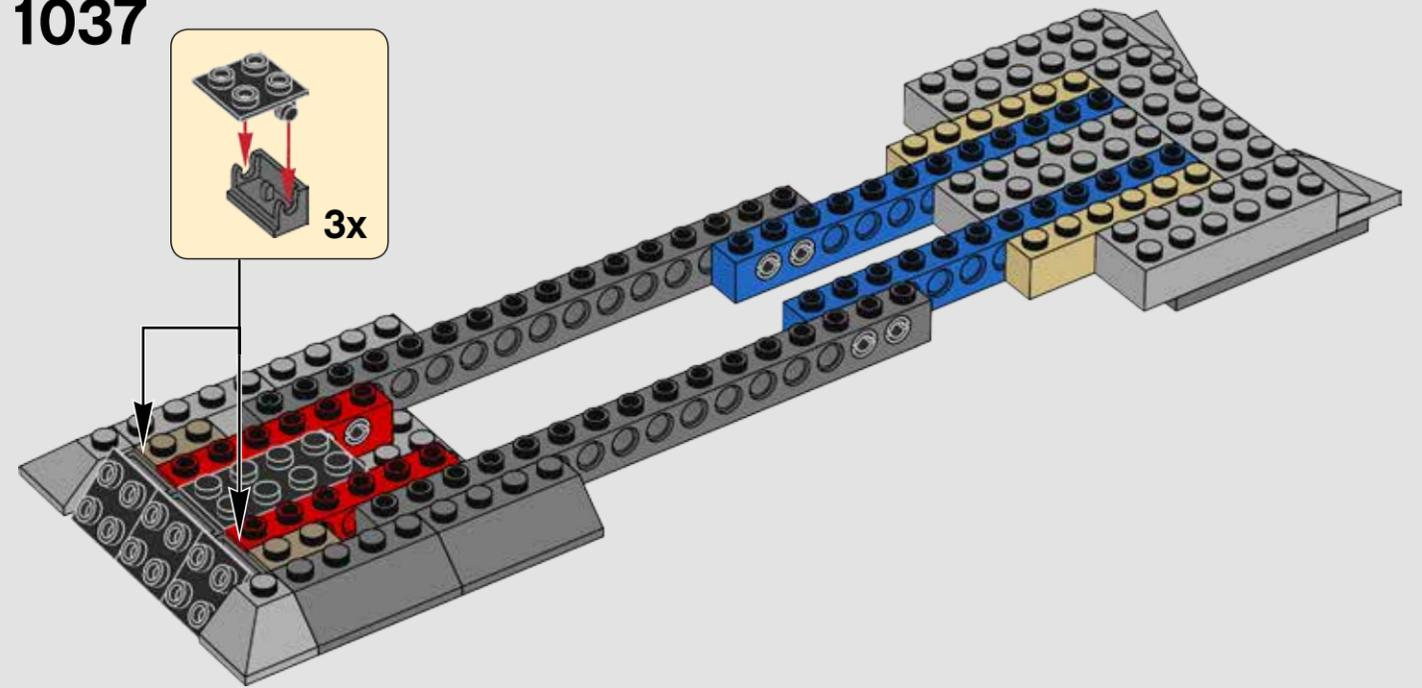

1038

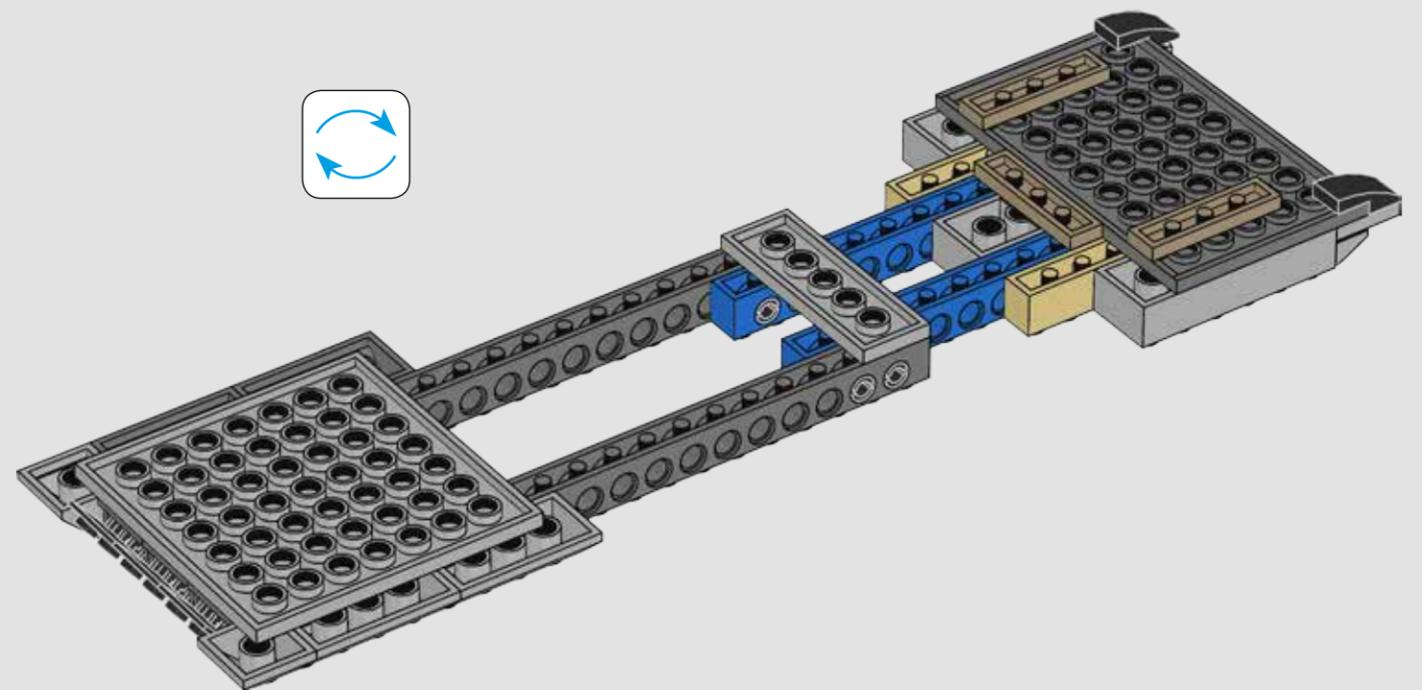

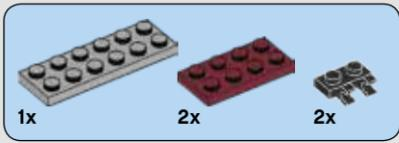

1039

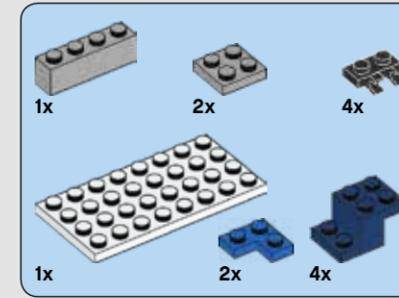
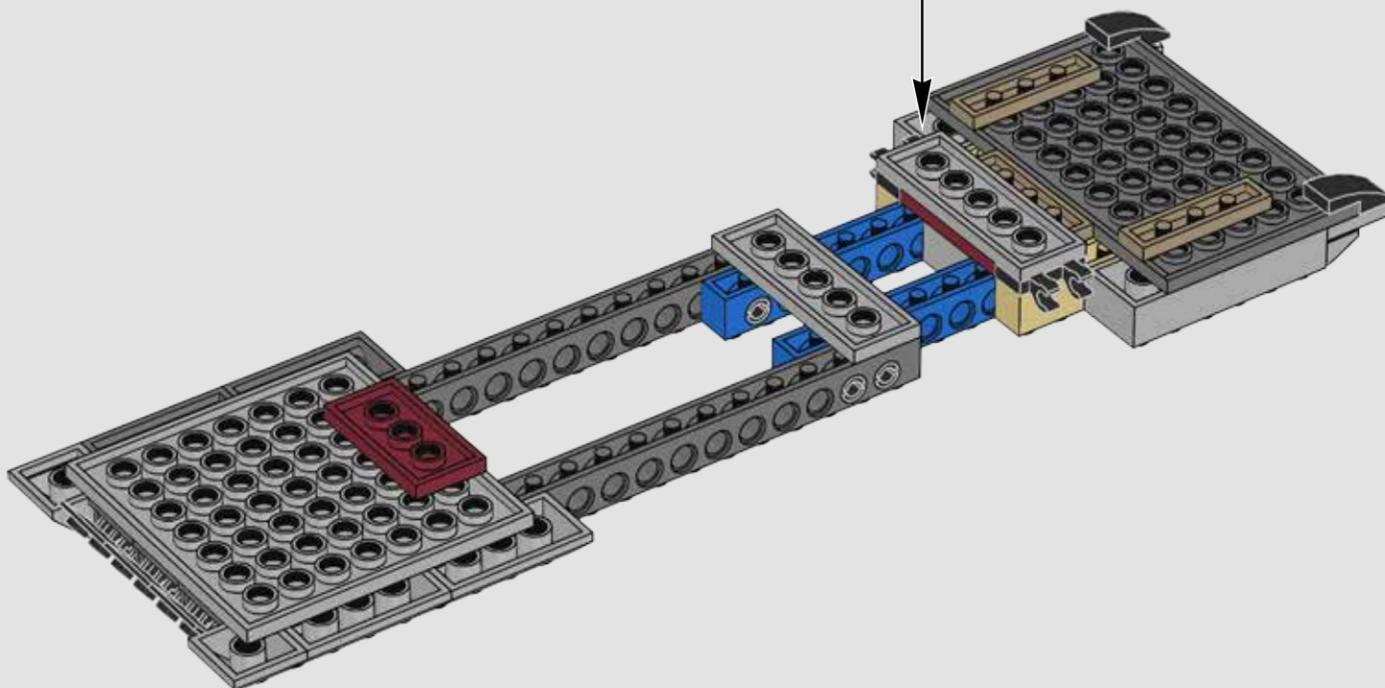
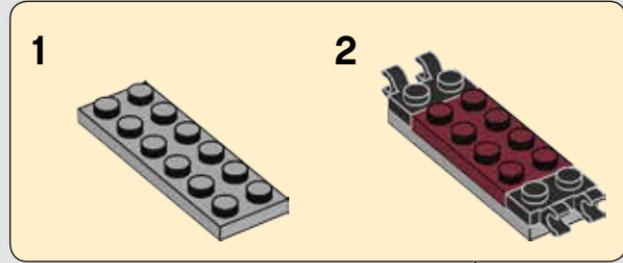

1040

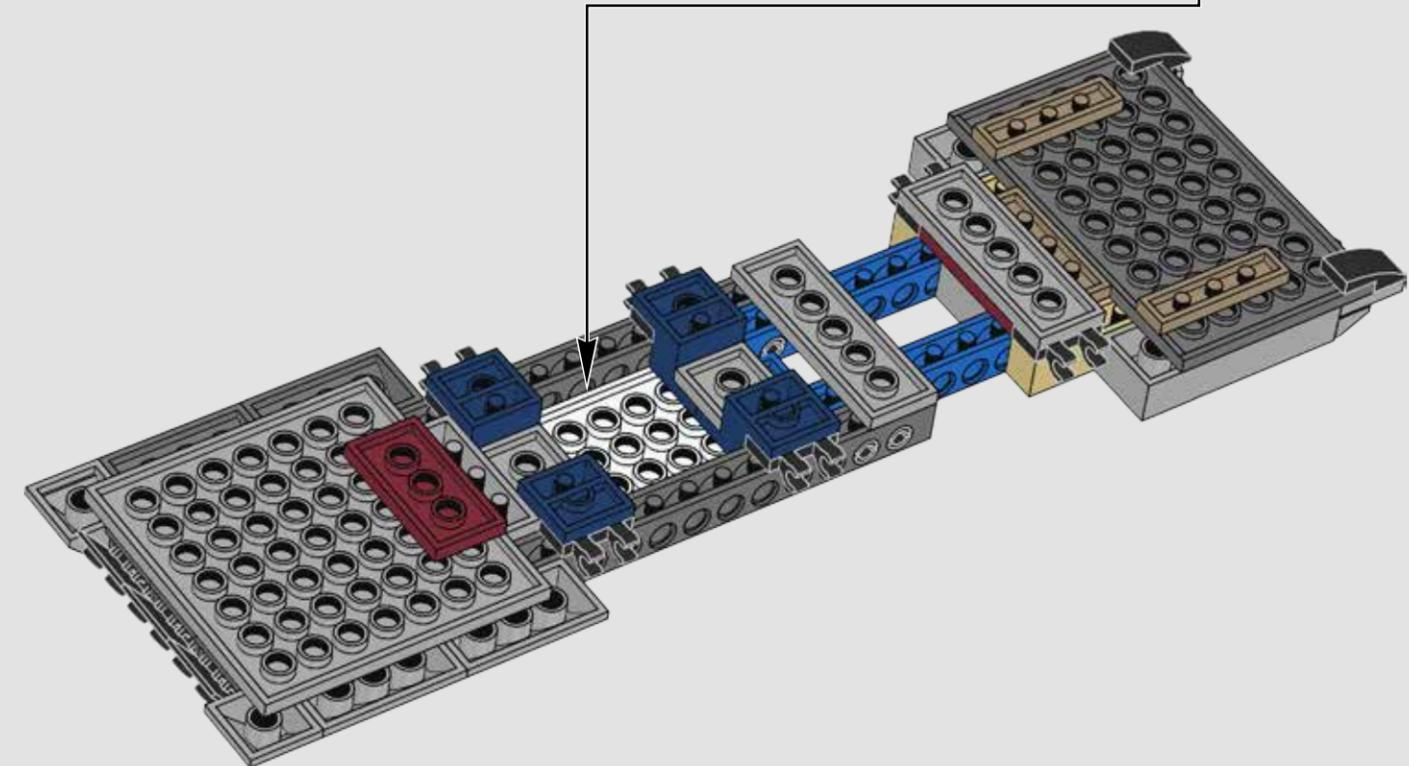
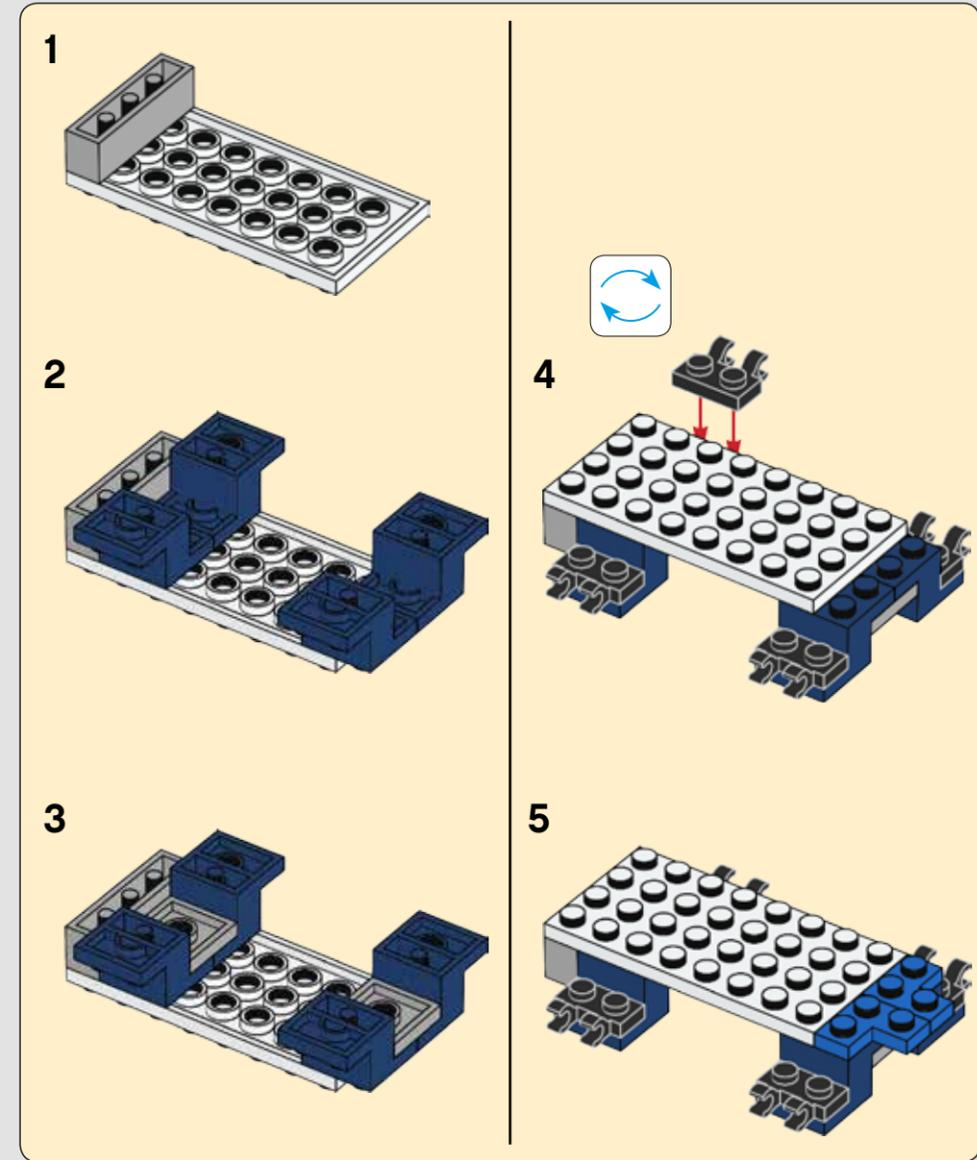

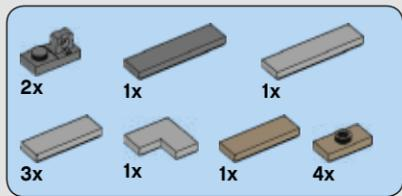

1041

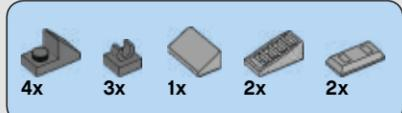
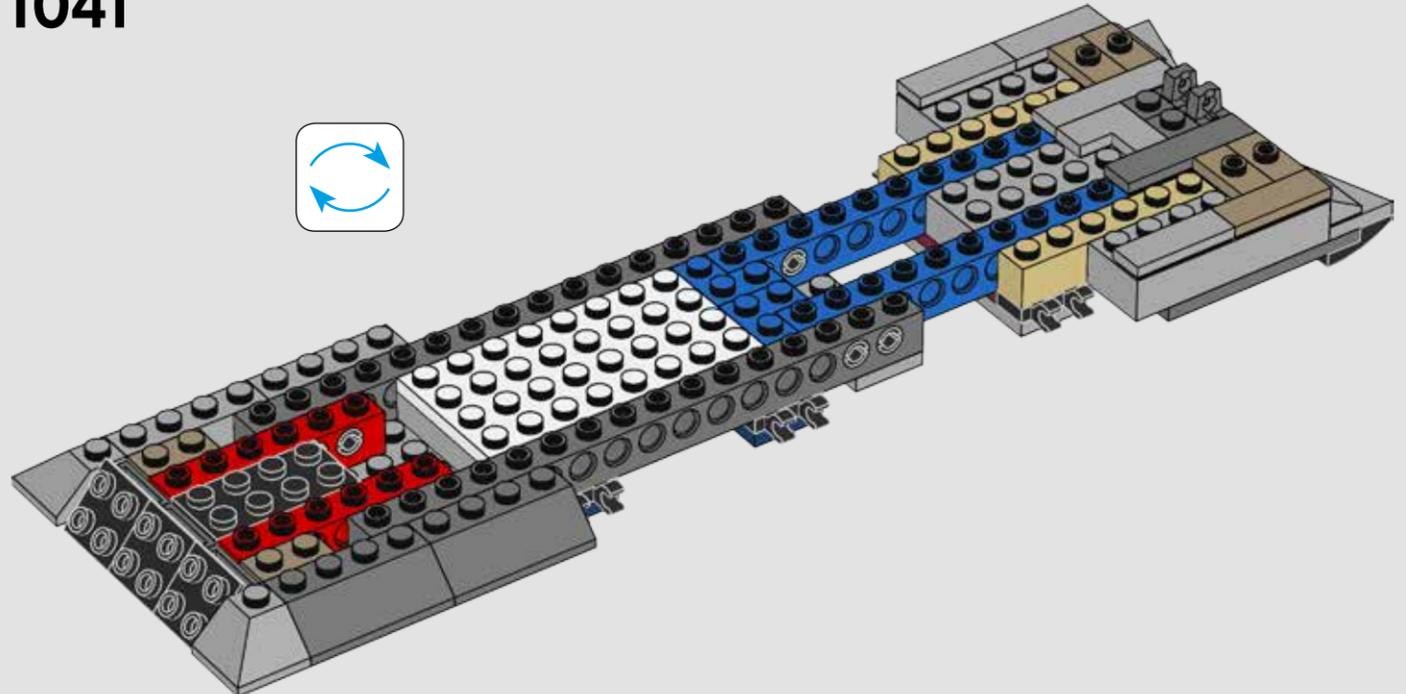

1042

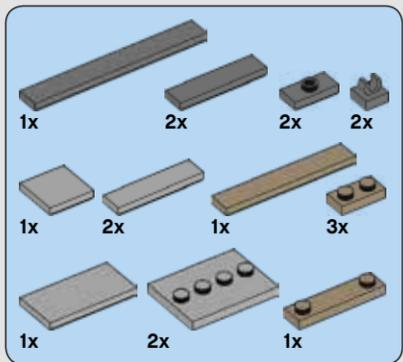
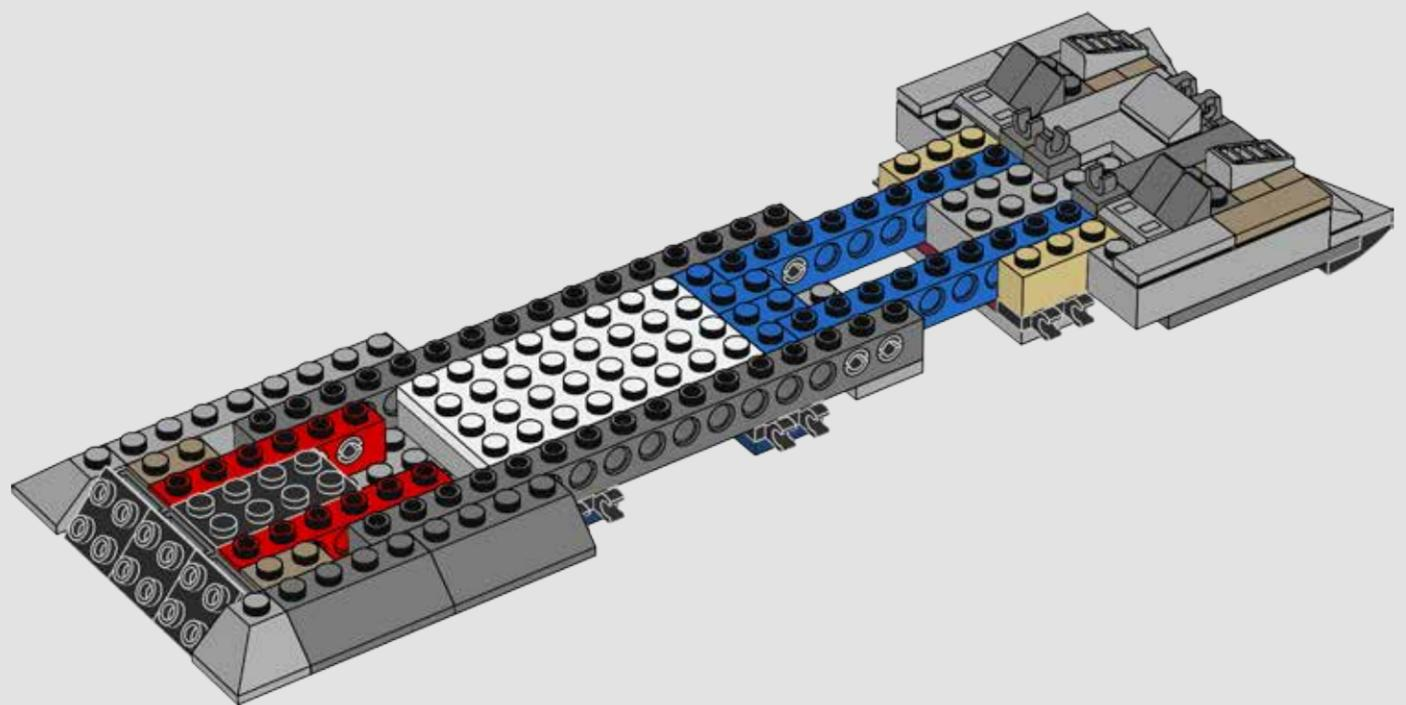

1043

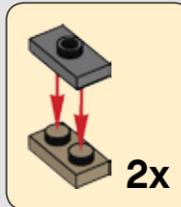
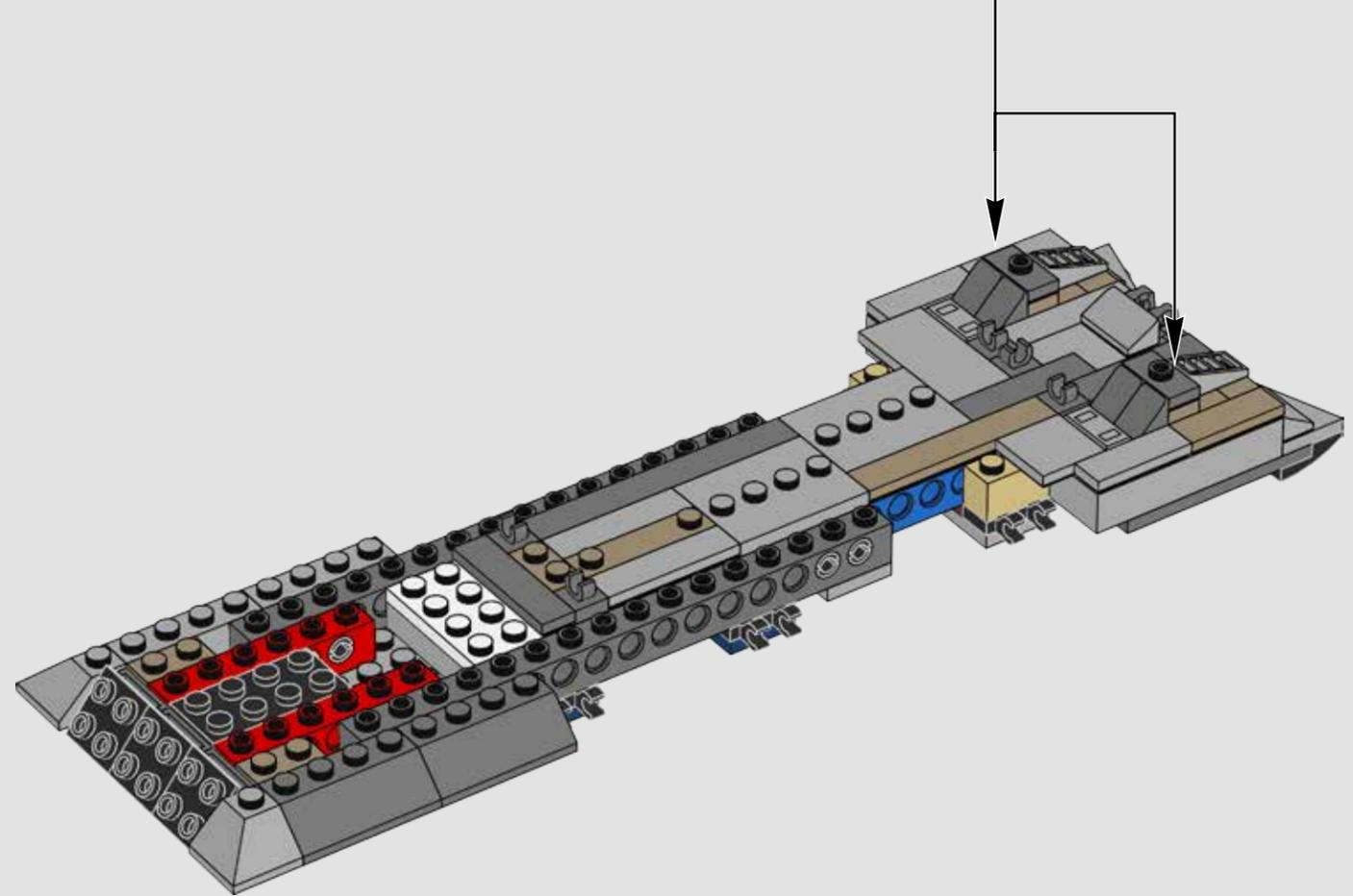

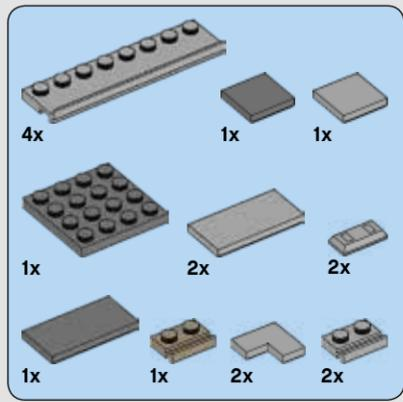

1044

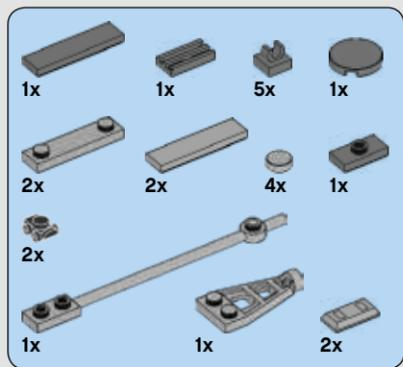
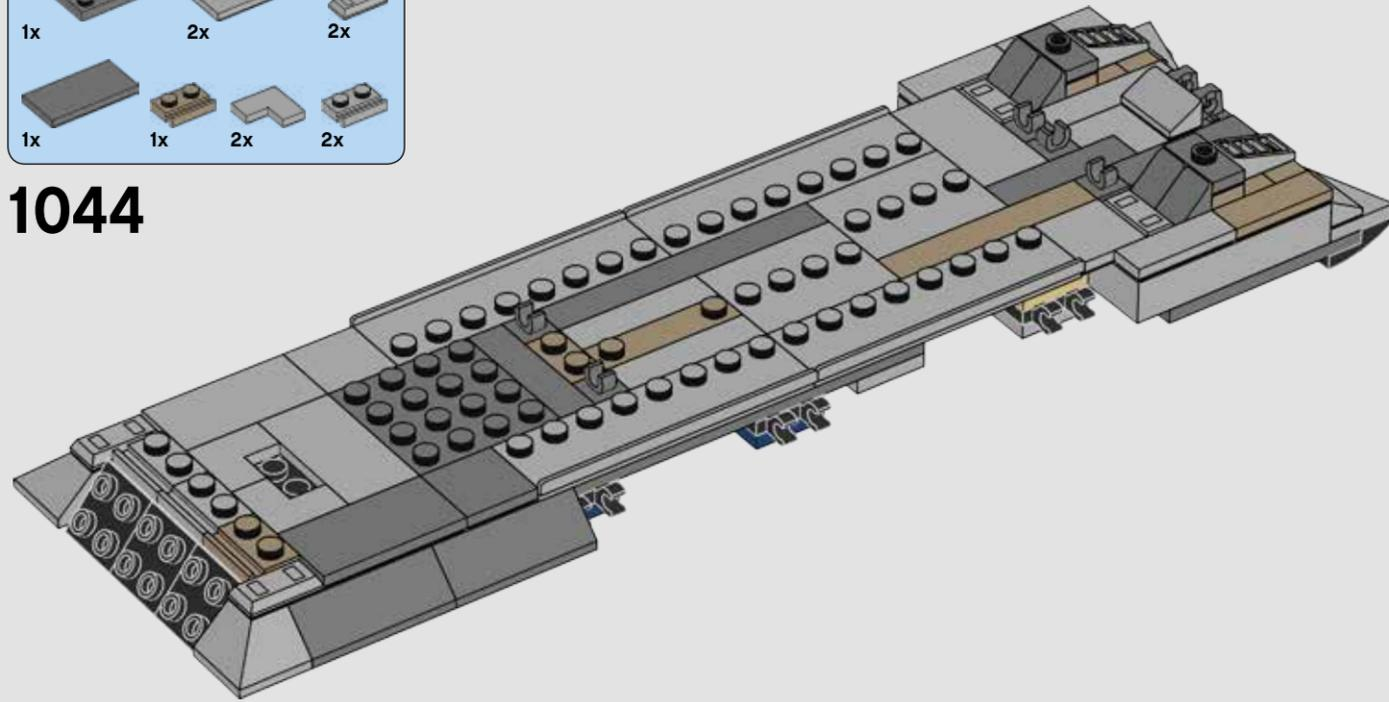

1045

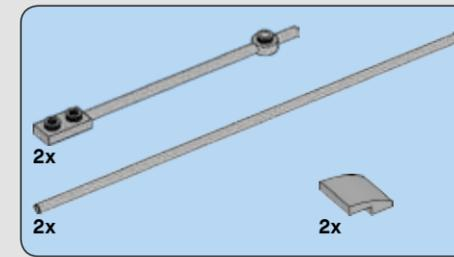
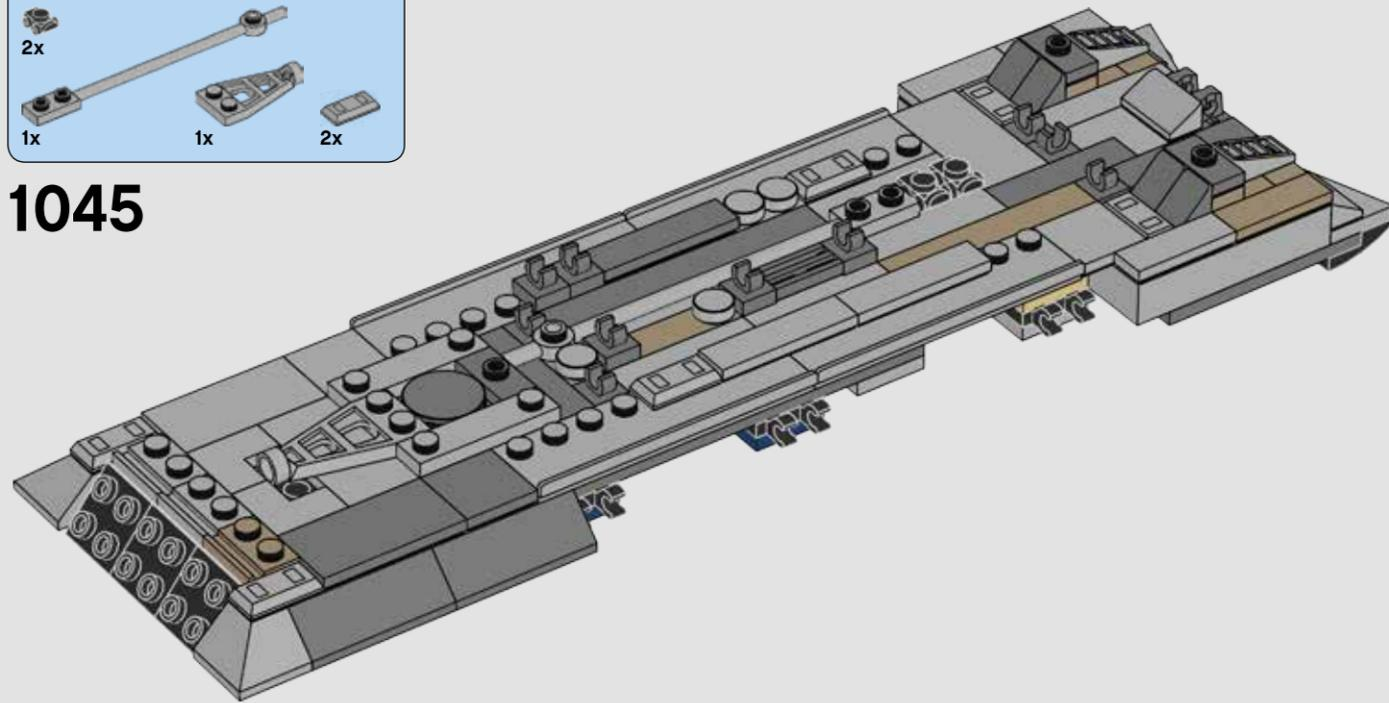

1046

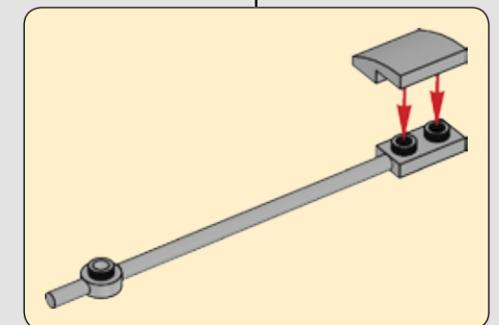
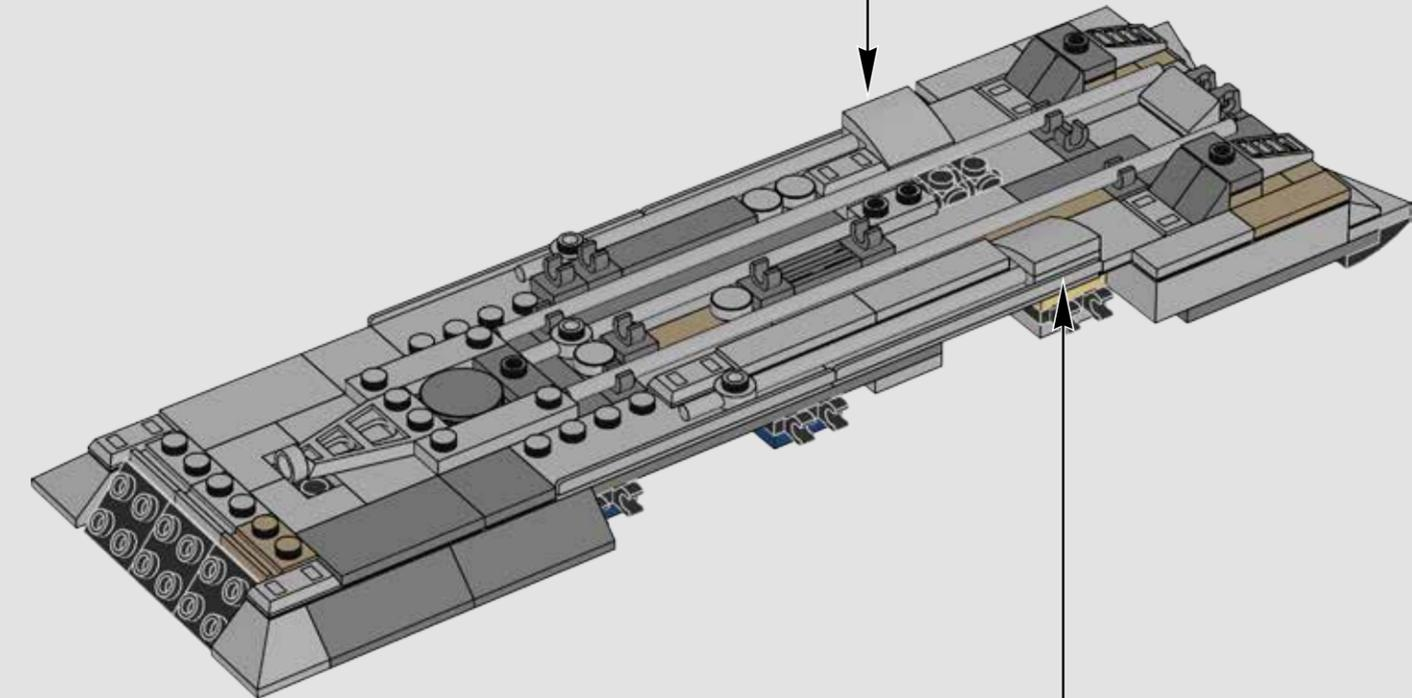
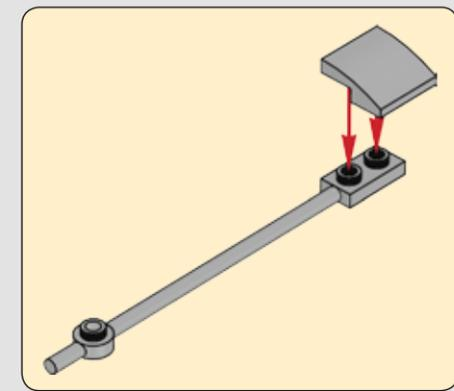



1047

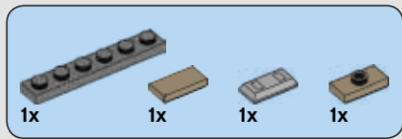
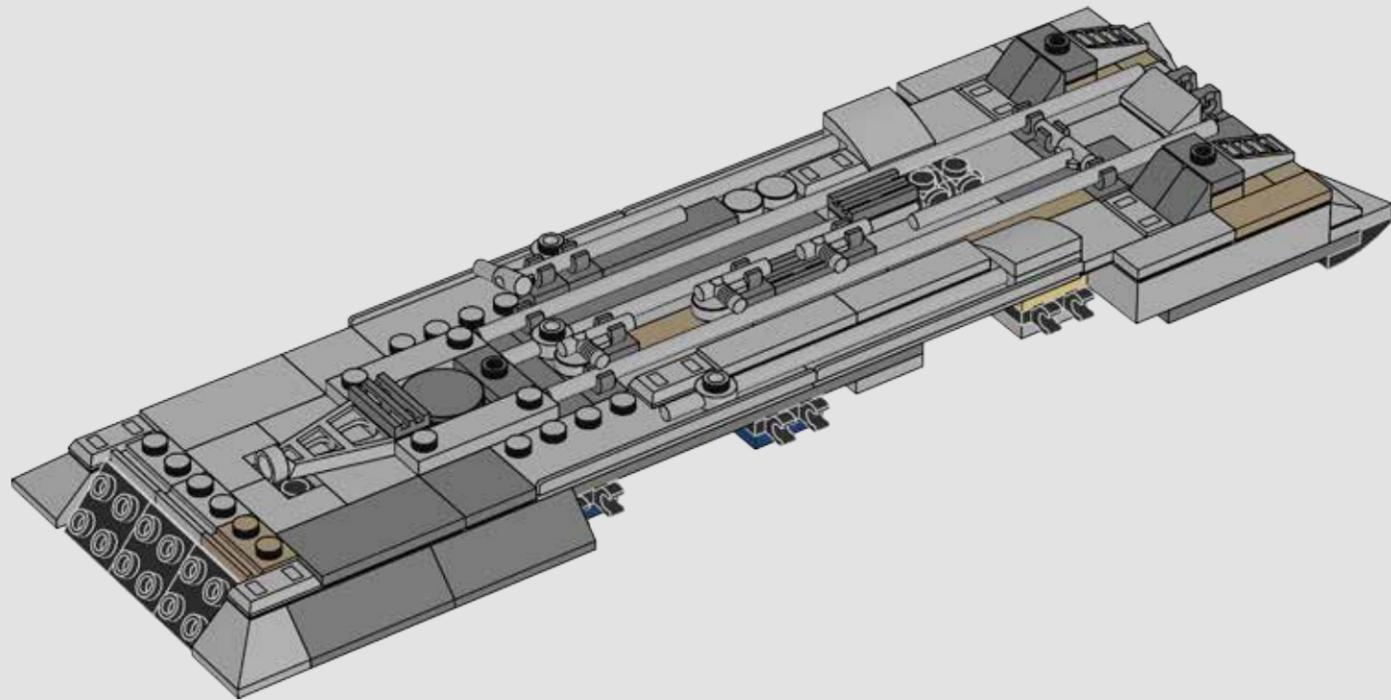

1048

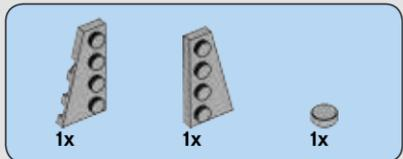
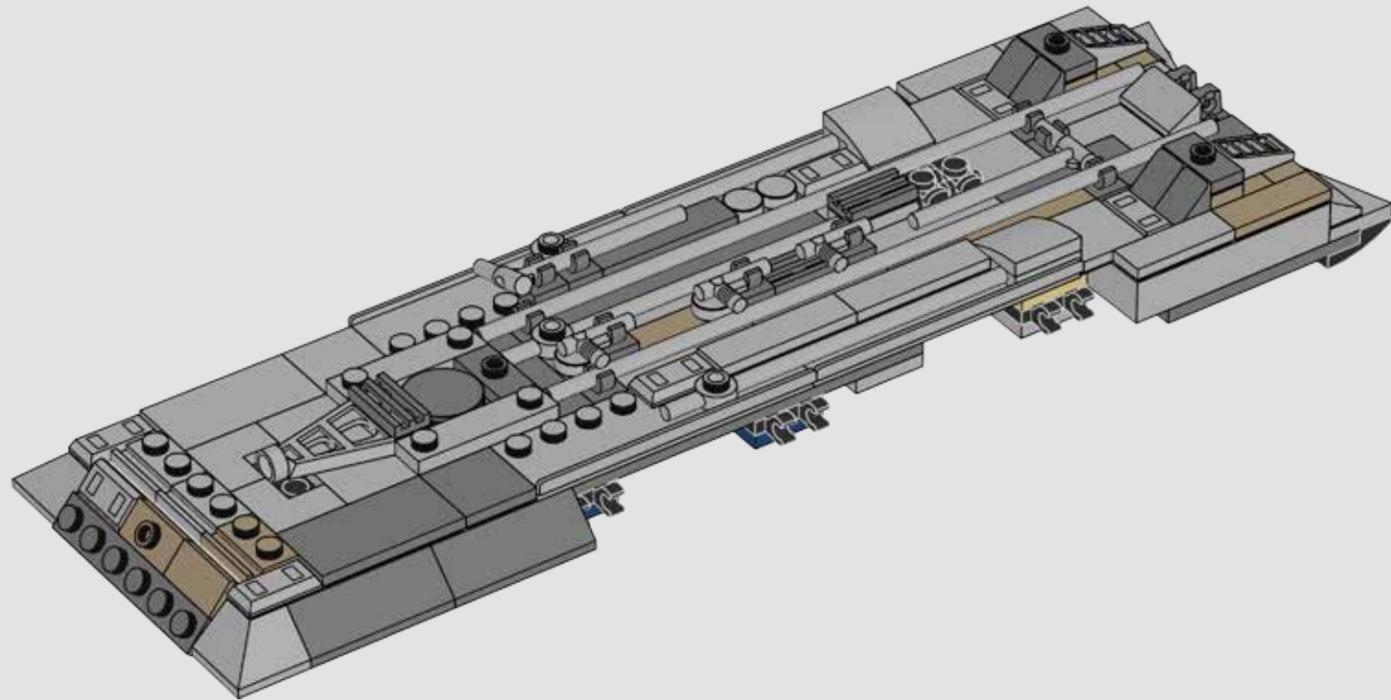

1049

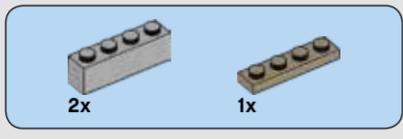
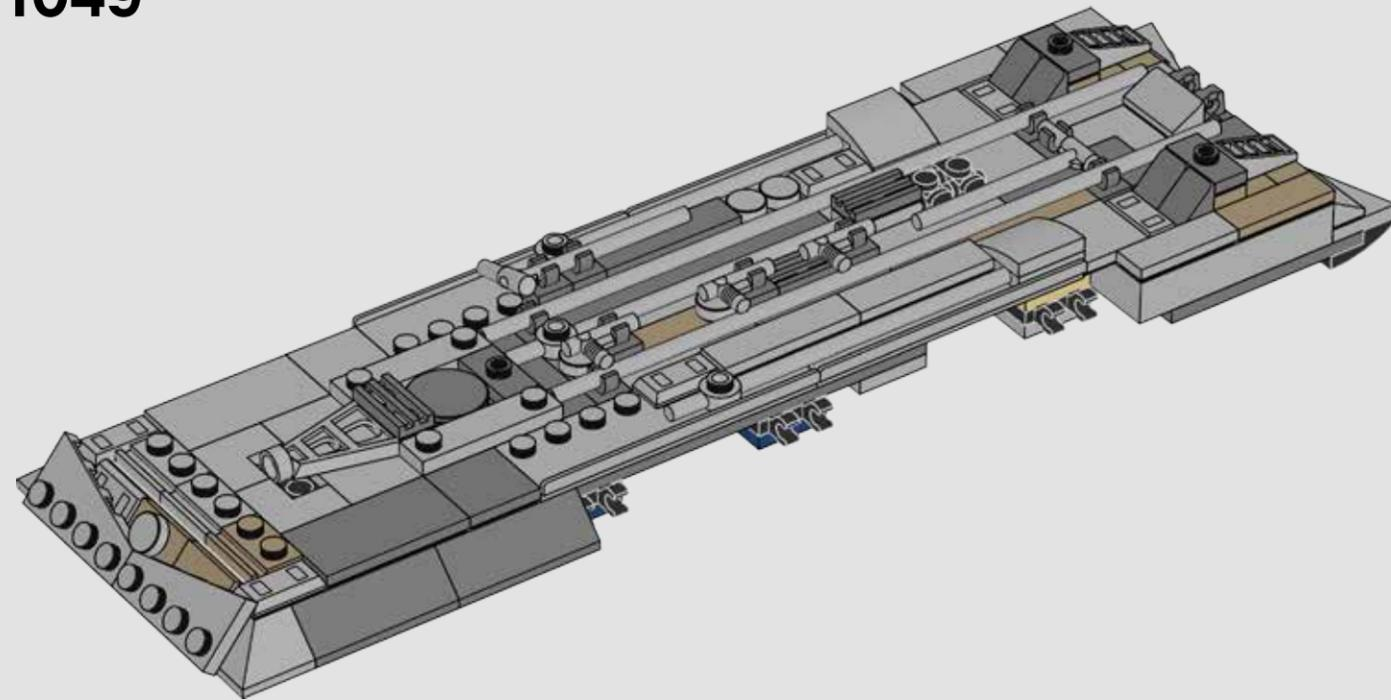

1050

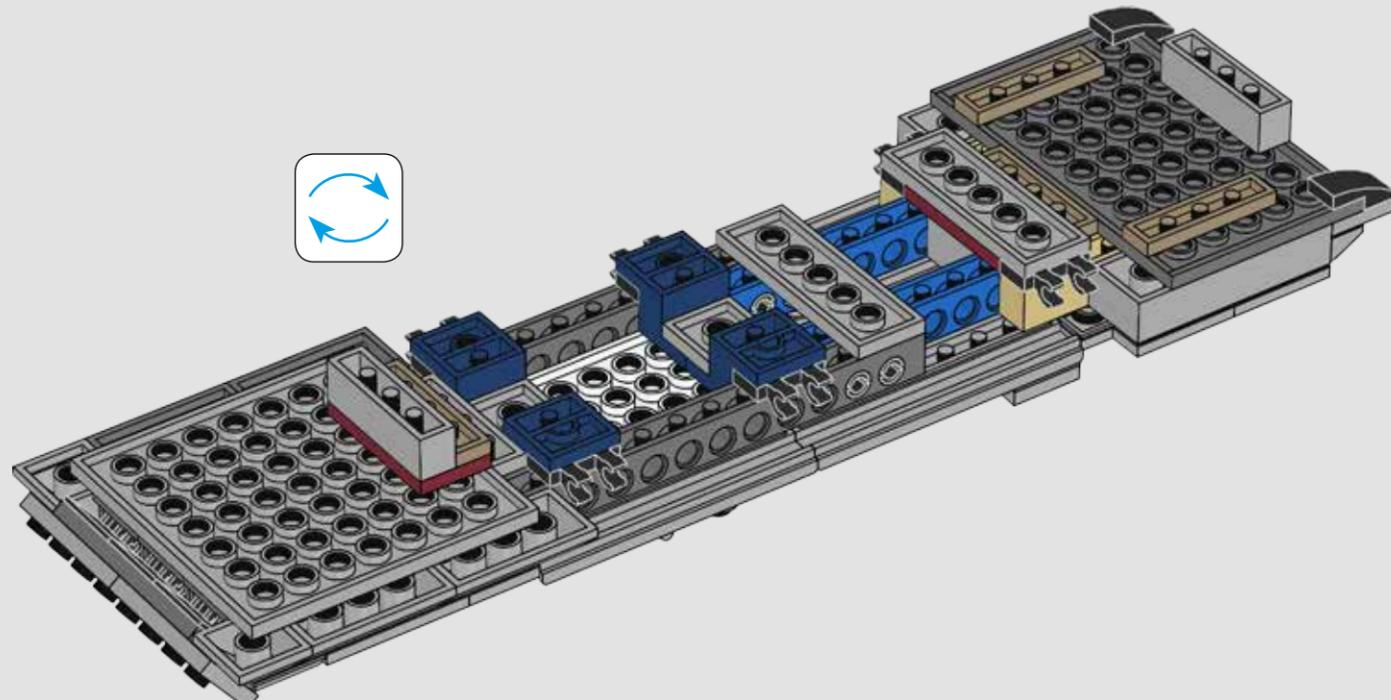

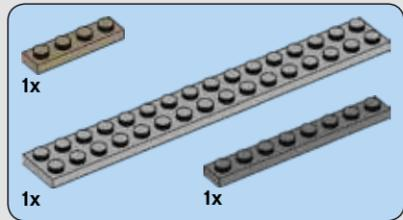
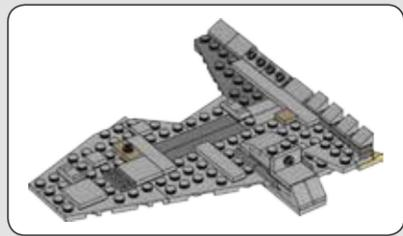

1051

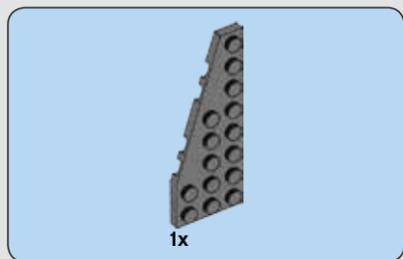
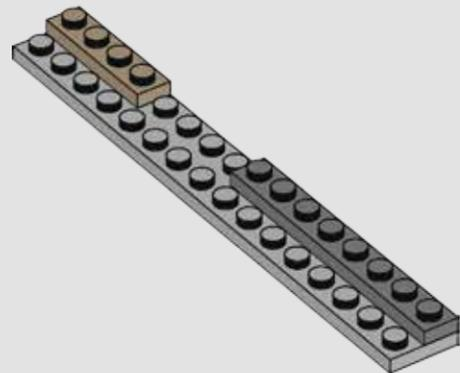

1052

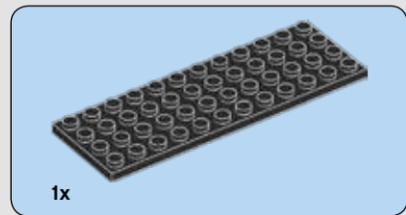
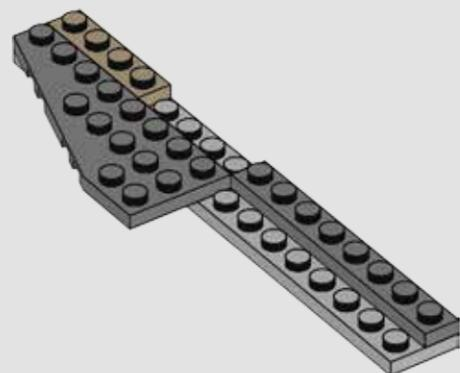

1053

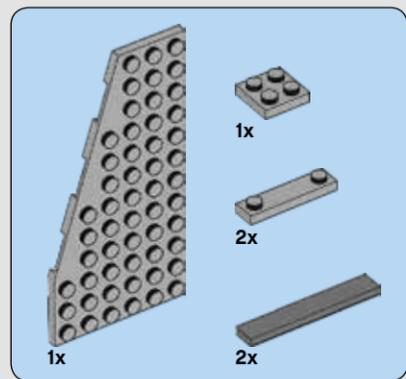
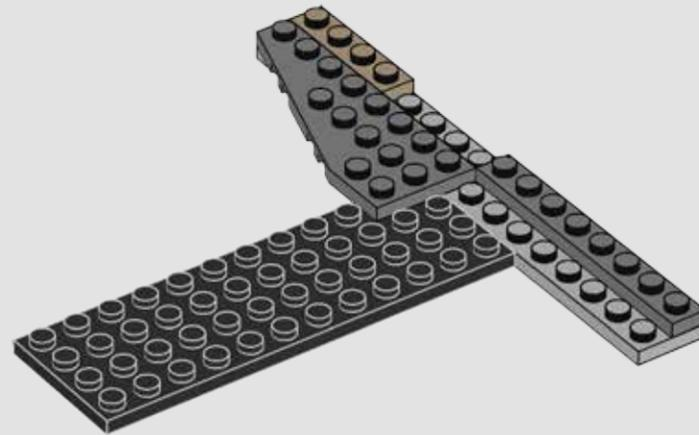

1054

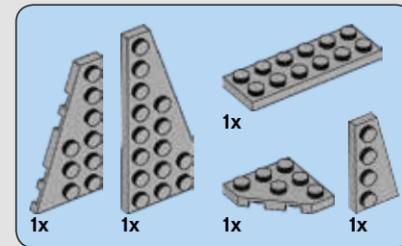
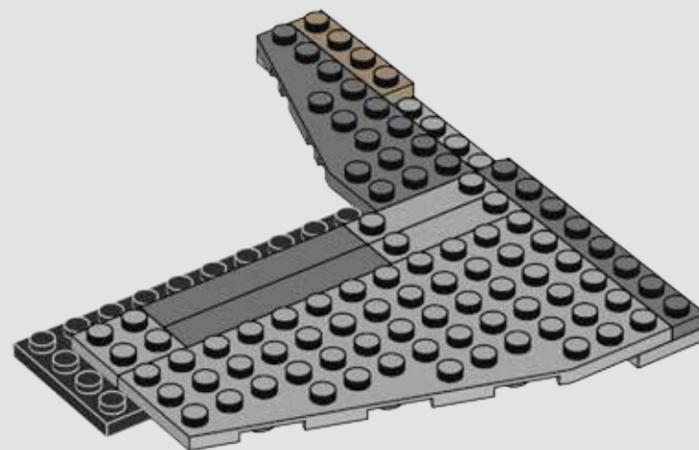

1055

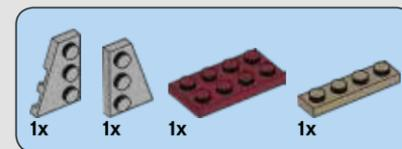
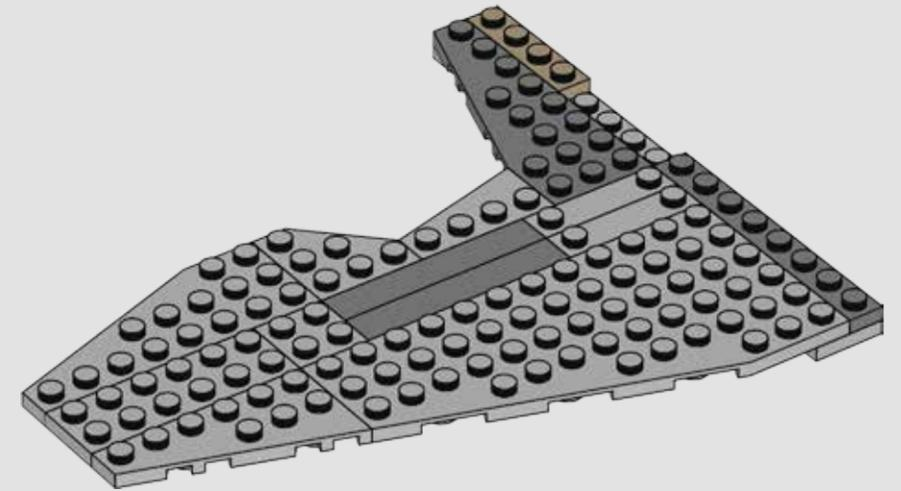

1056

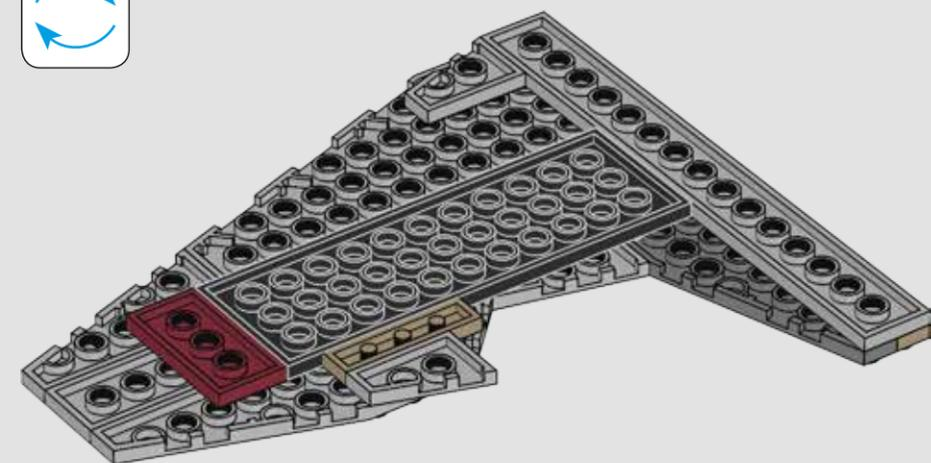

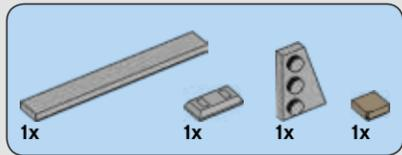

1057

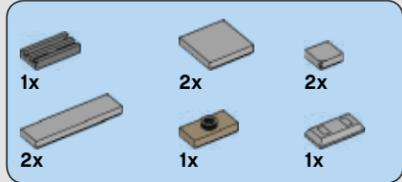
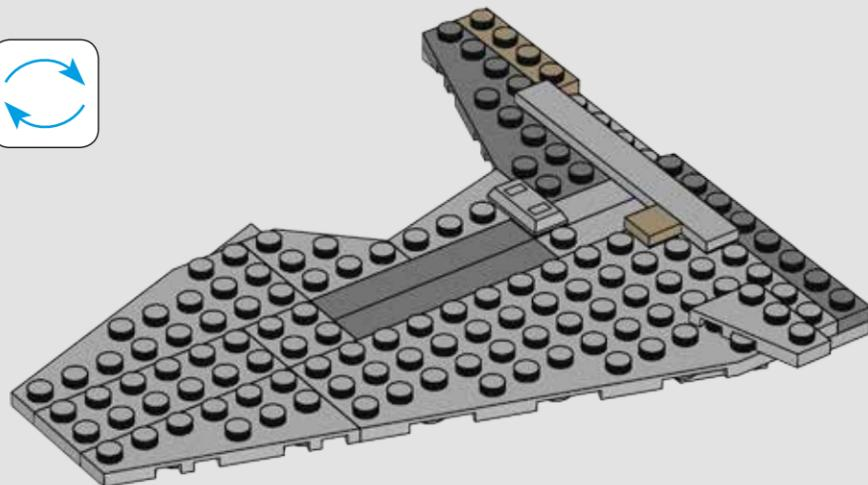

1058

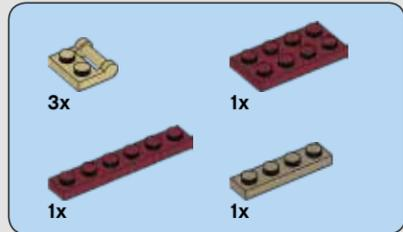
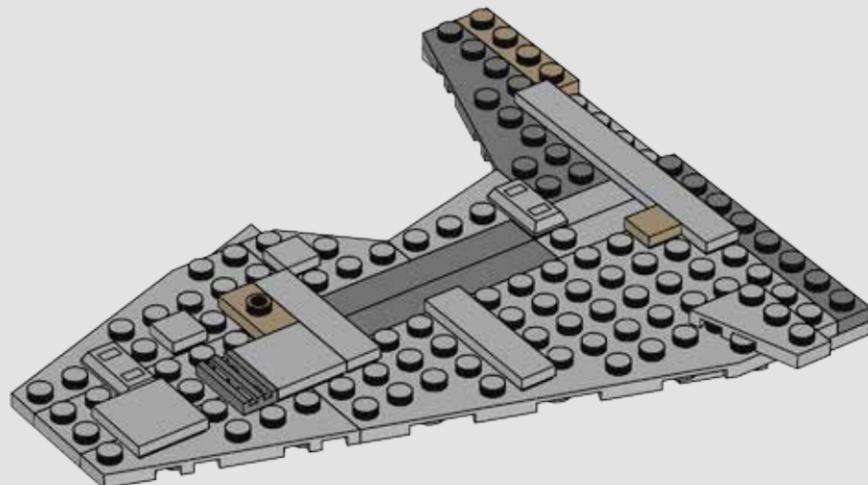

1059

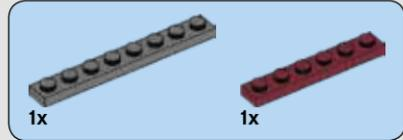
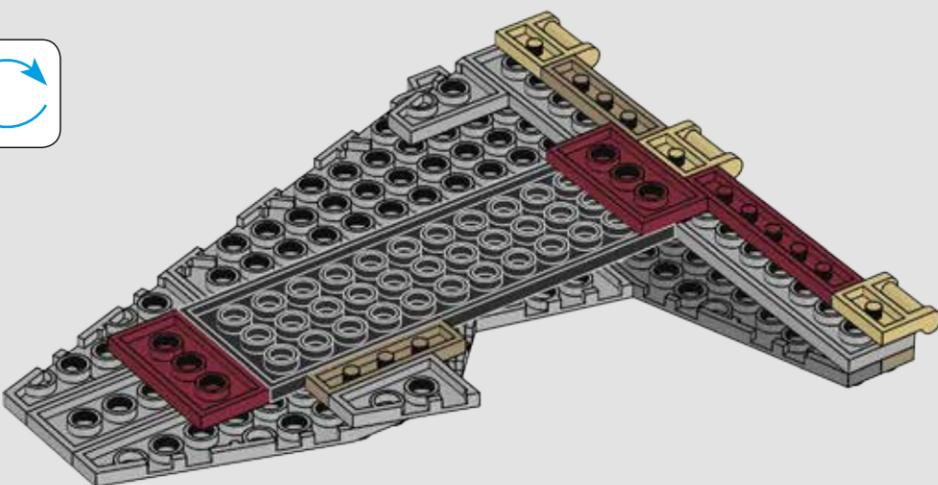

1060

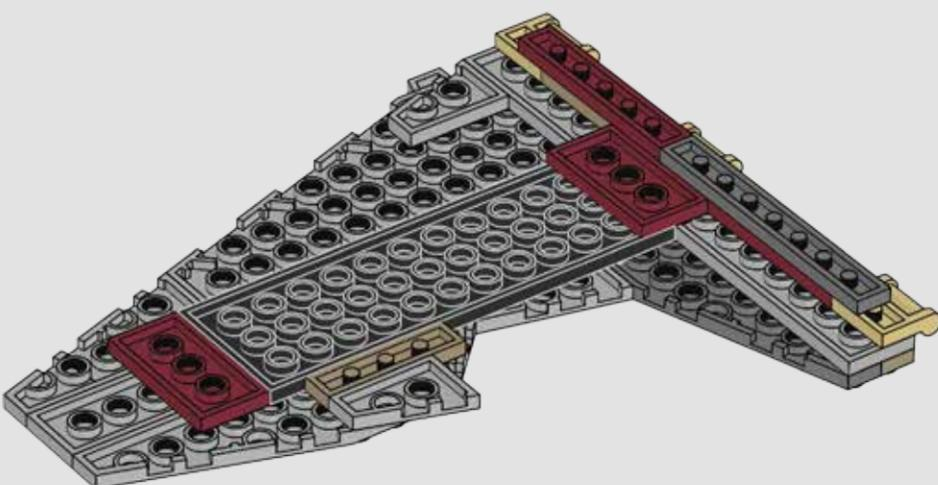

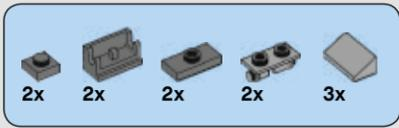

1061

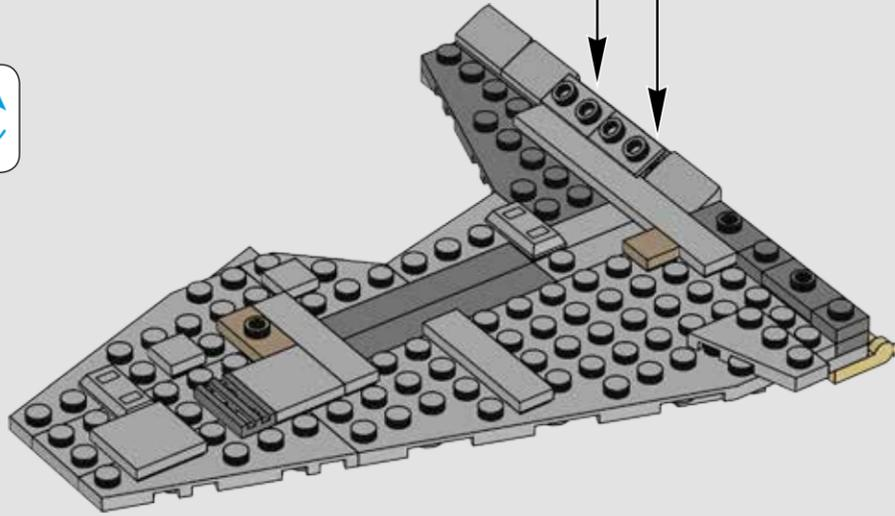
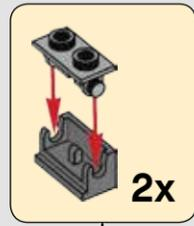

1062

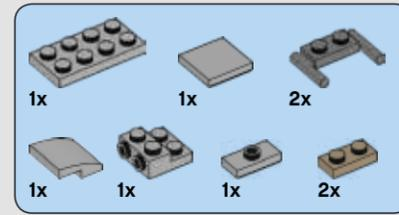
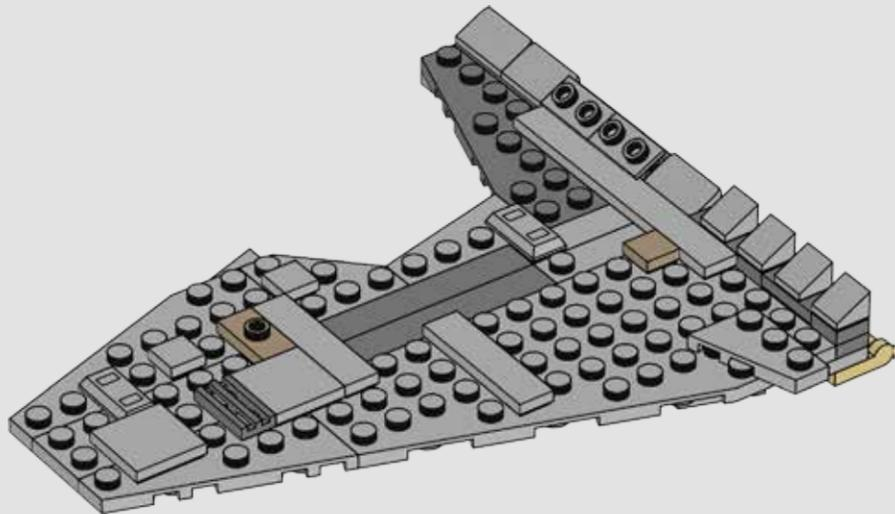

1063

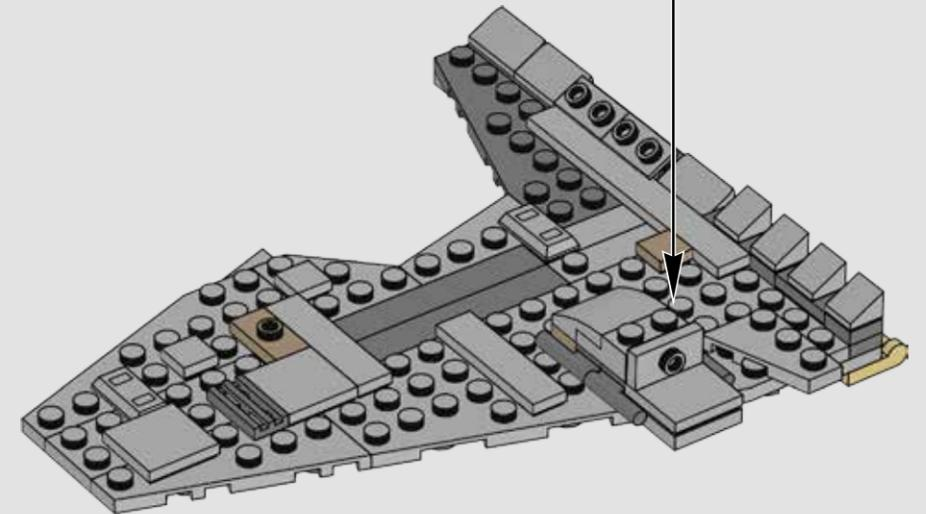
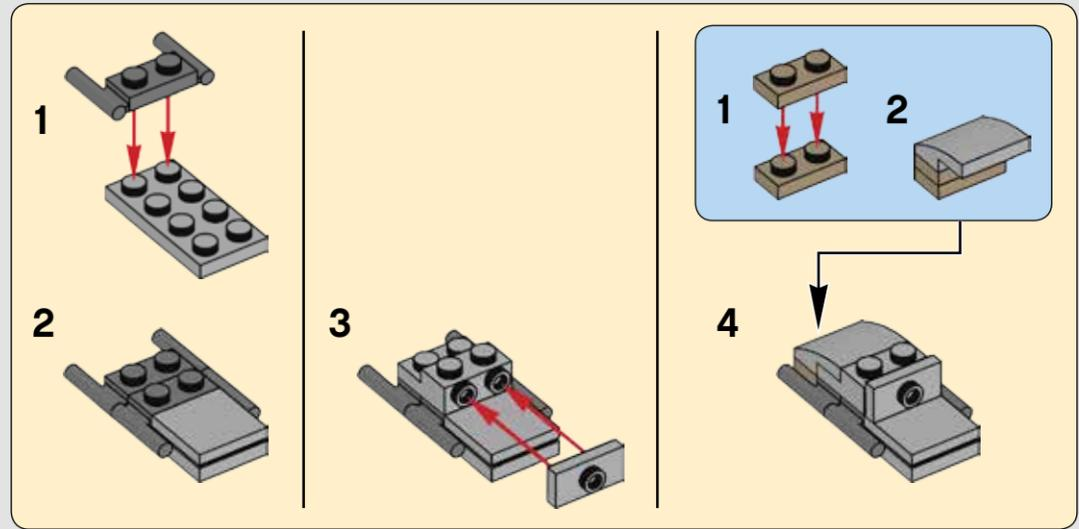



1064

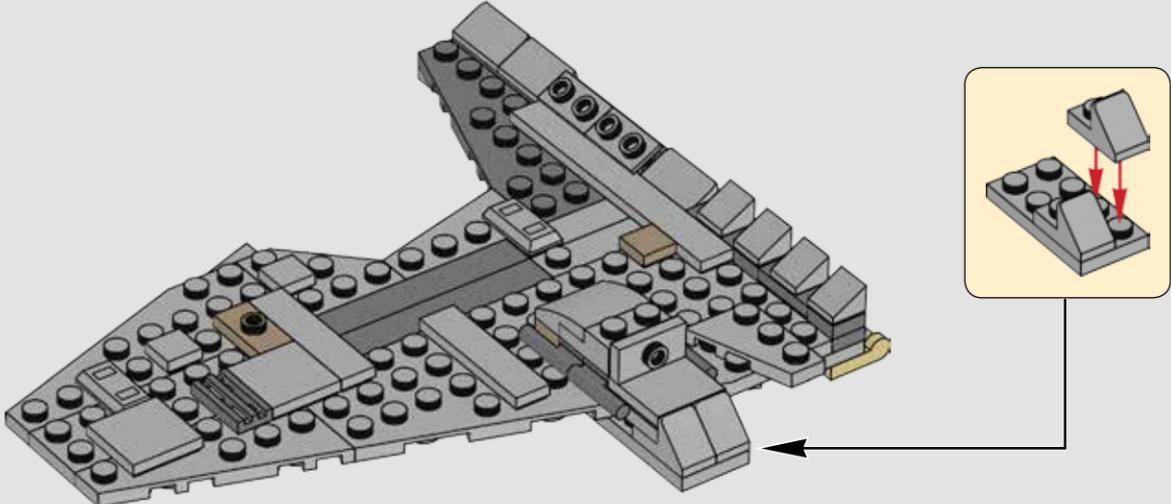

1065

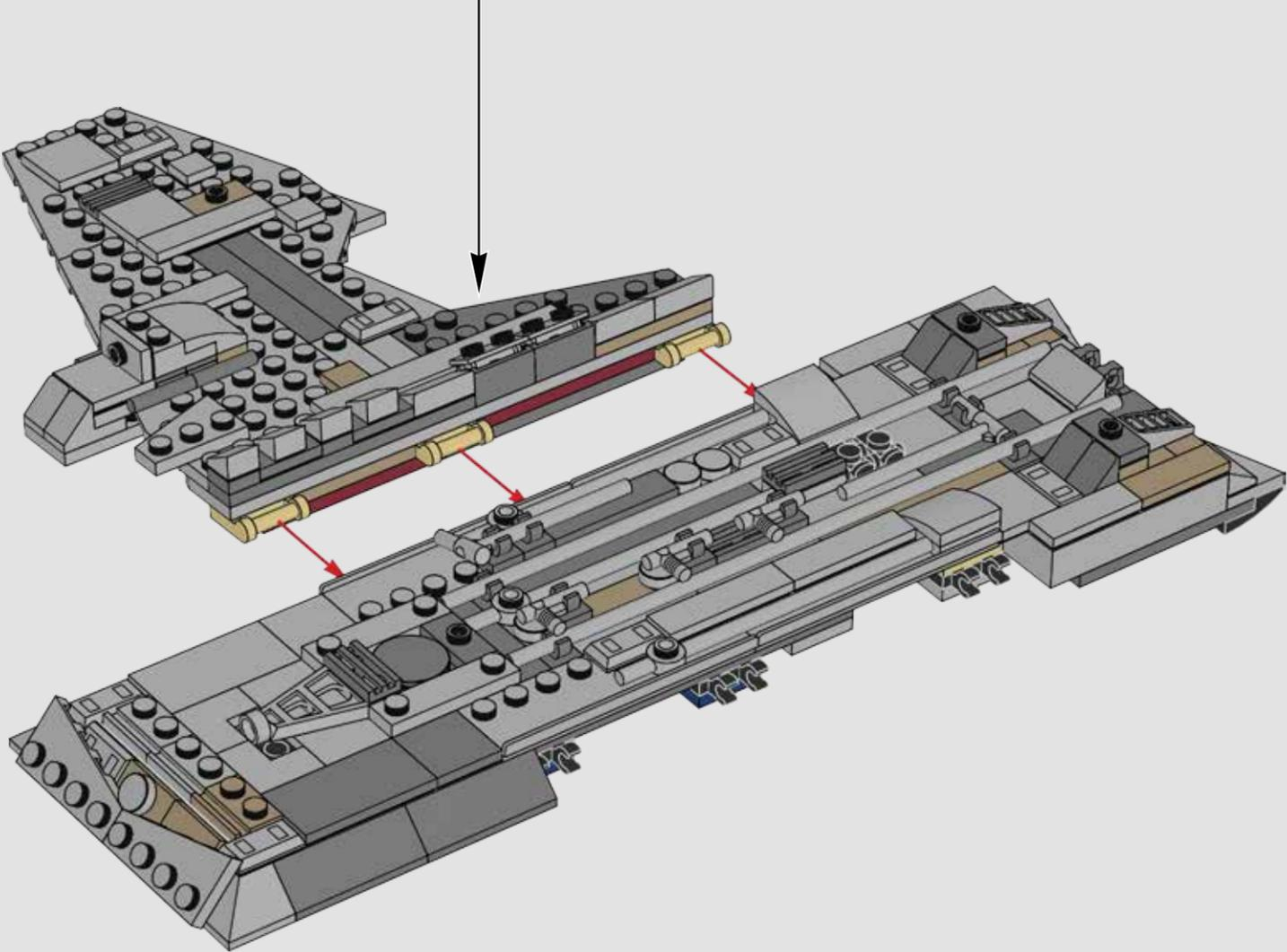

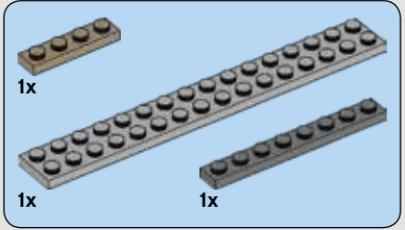
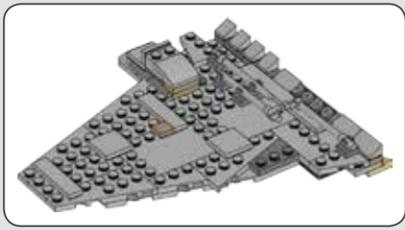

1066

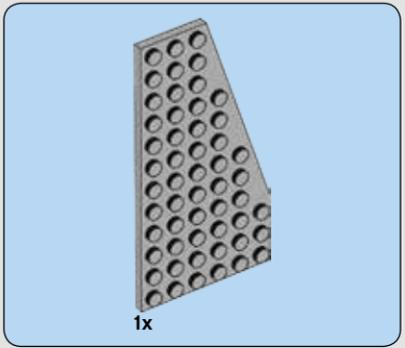
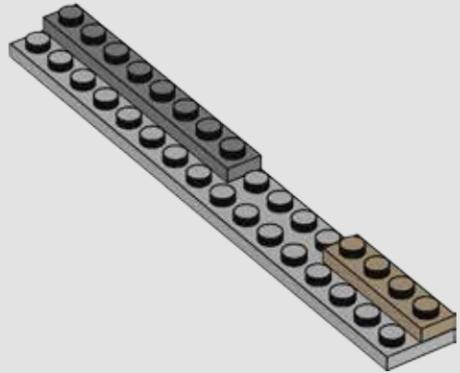

1067

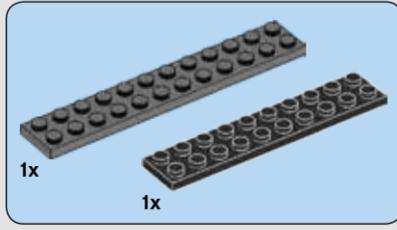
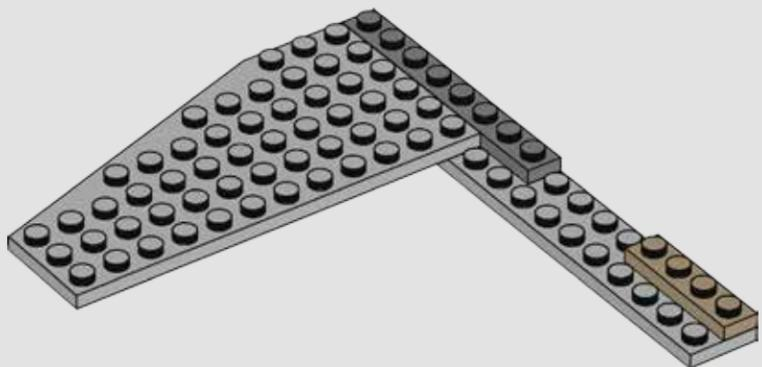

1068

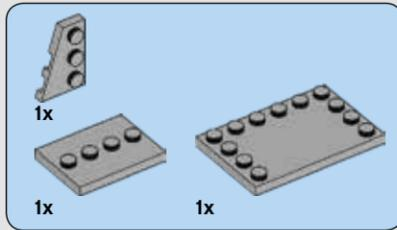
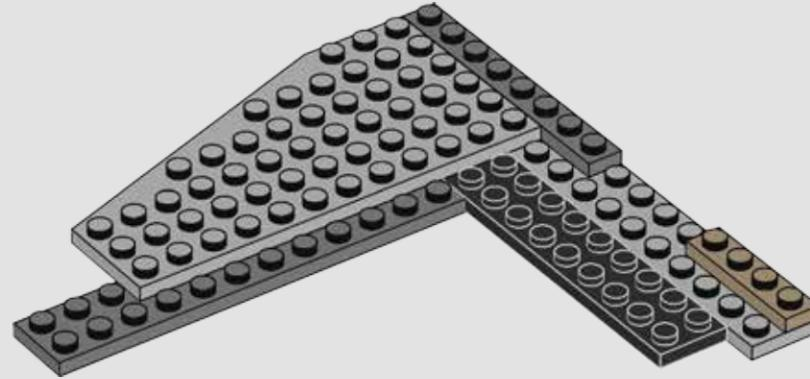

1069

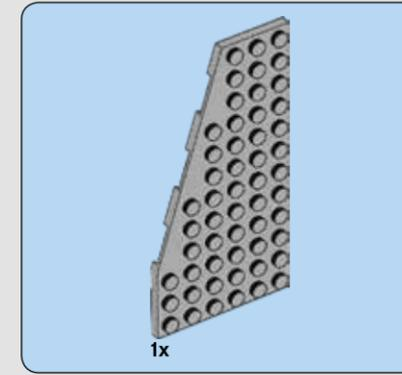
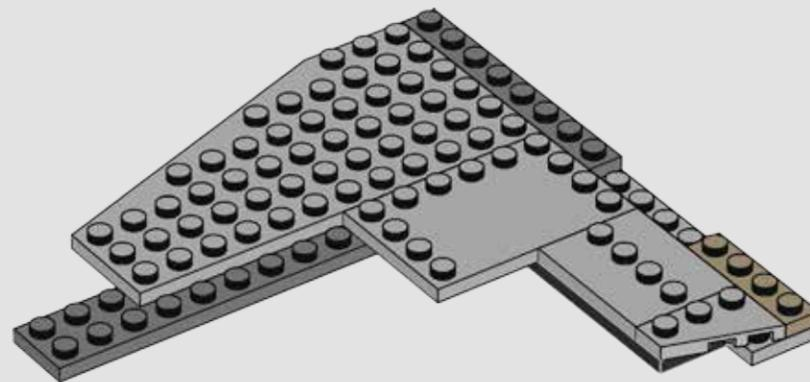

1070

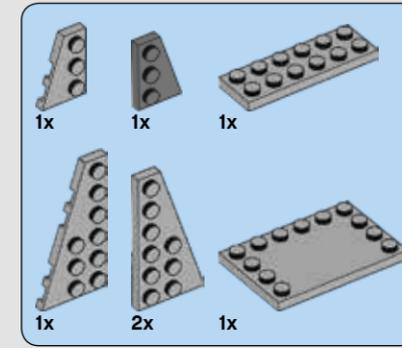
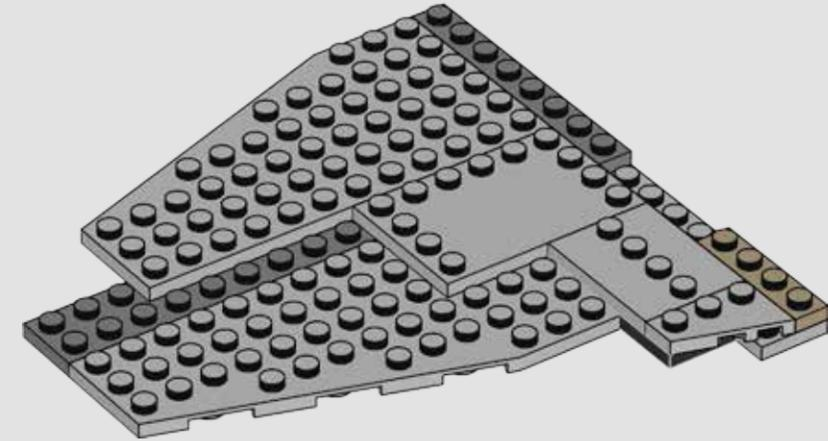

1071

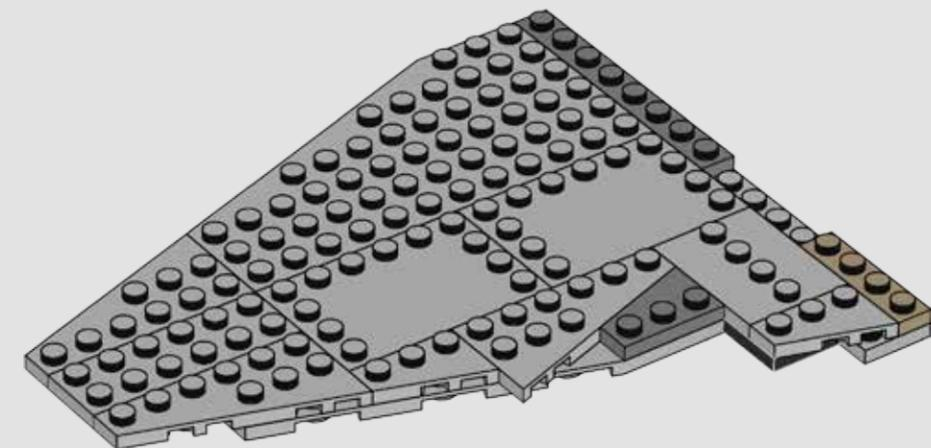

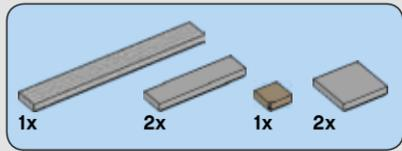

1072

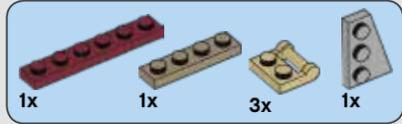
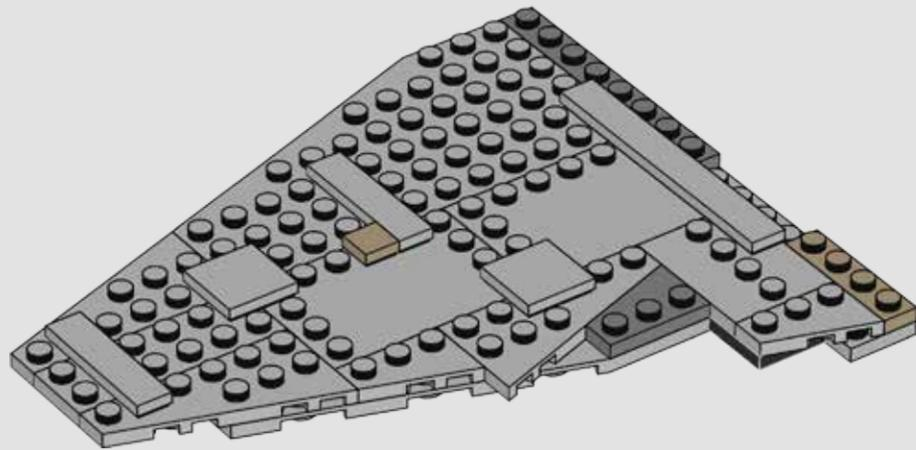

1073

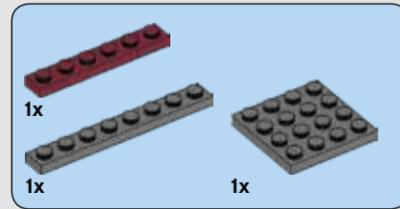
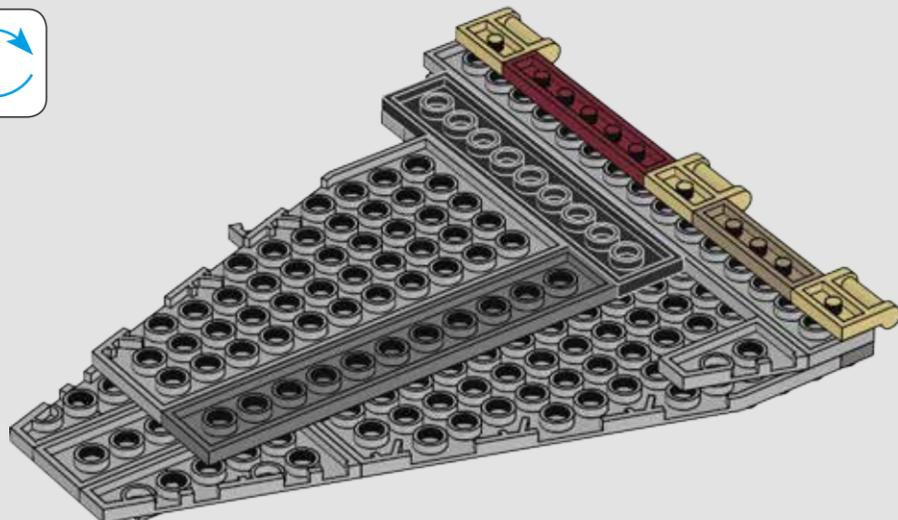

1074

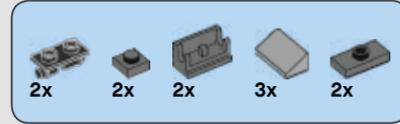
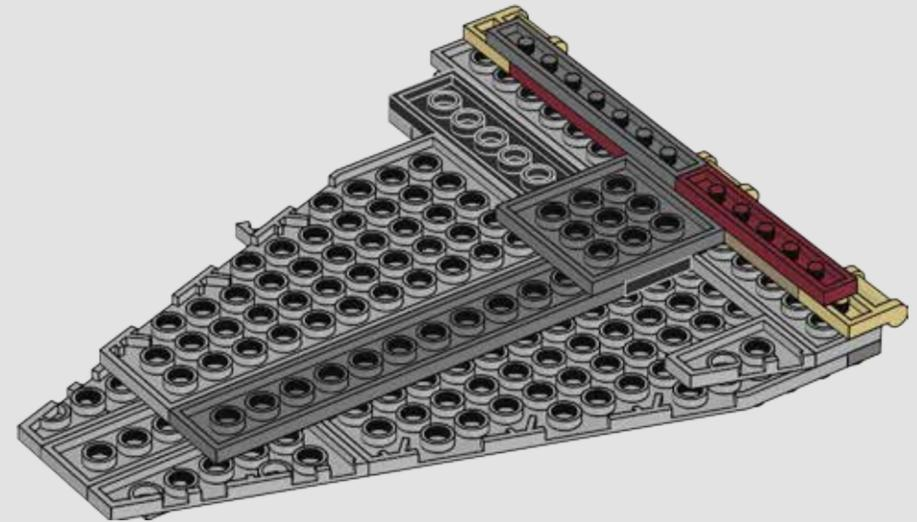

1075

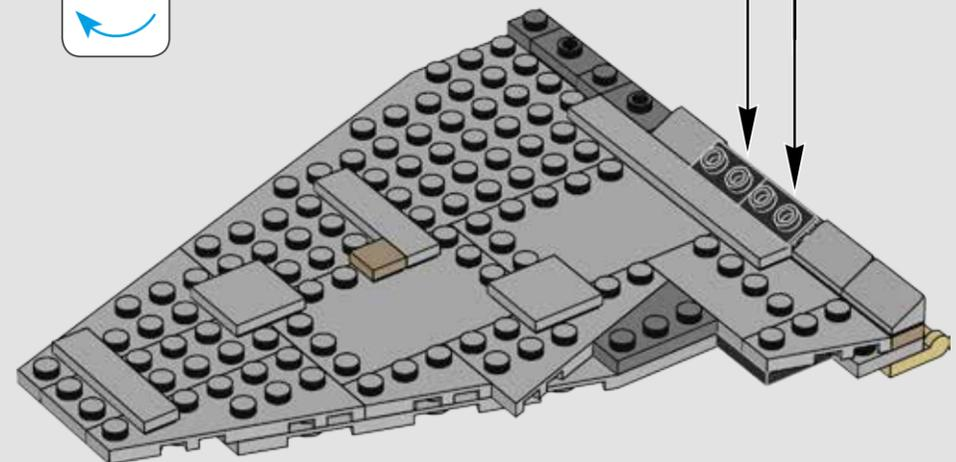
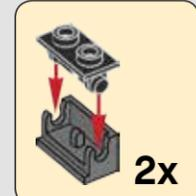



1076

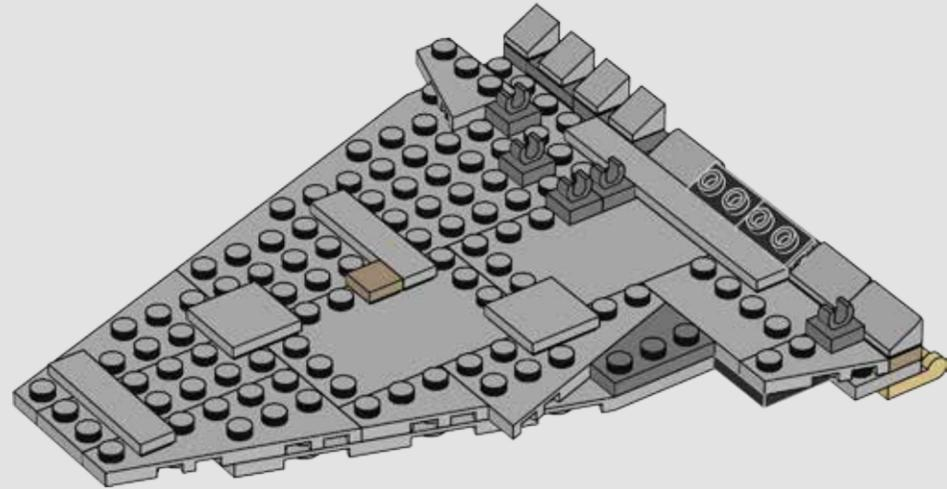

1077

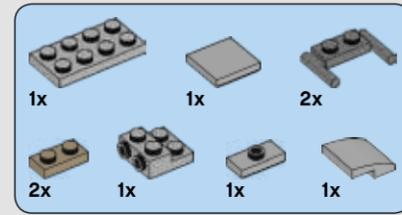
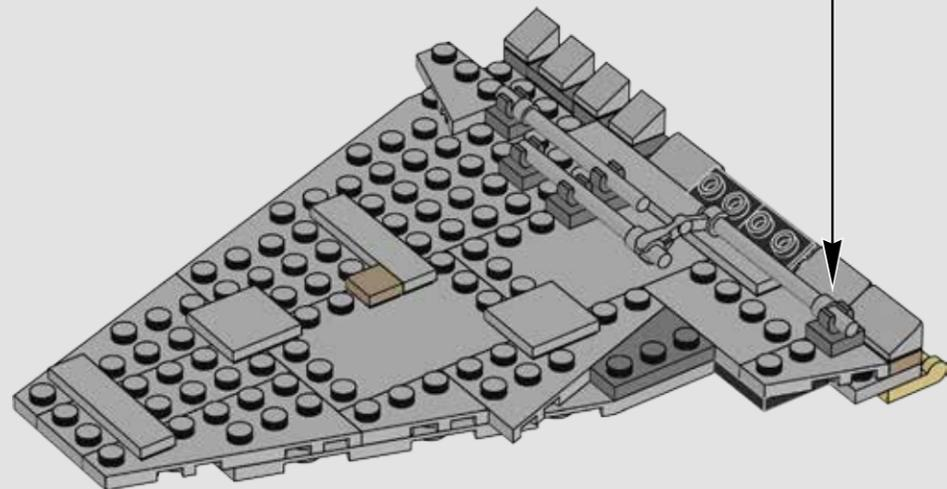
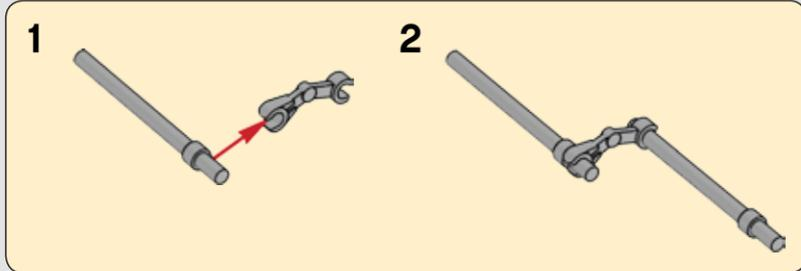

1078

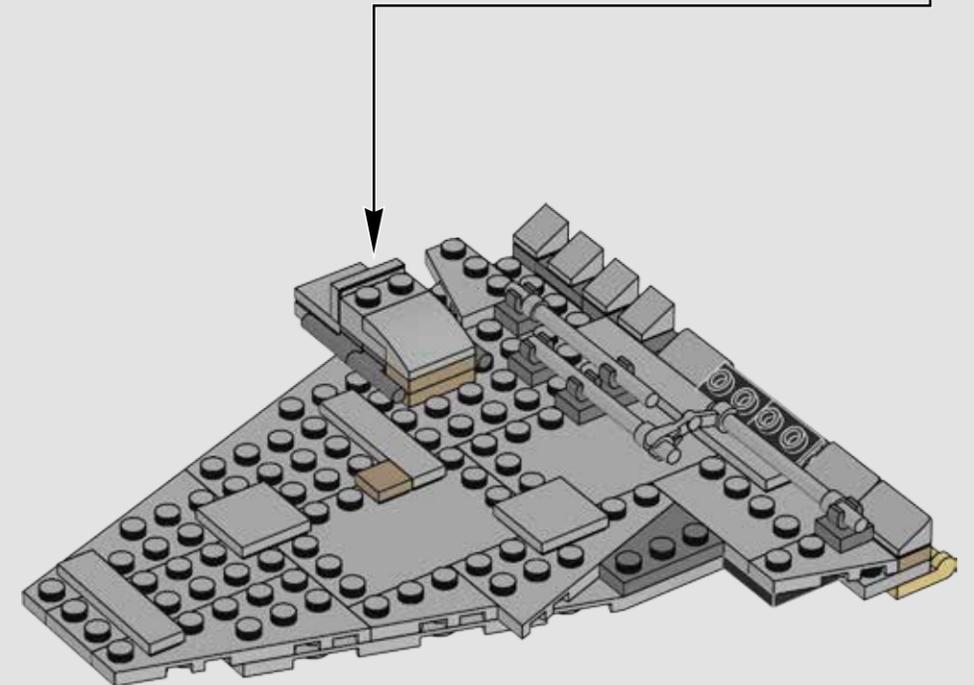
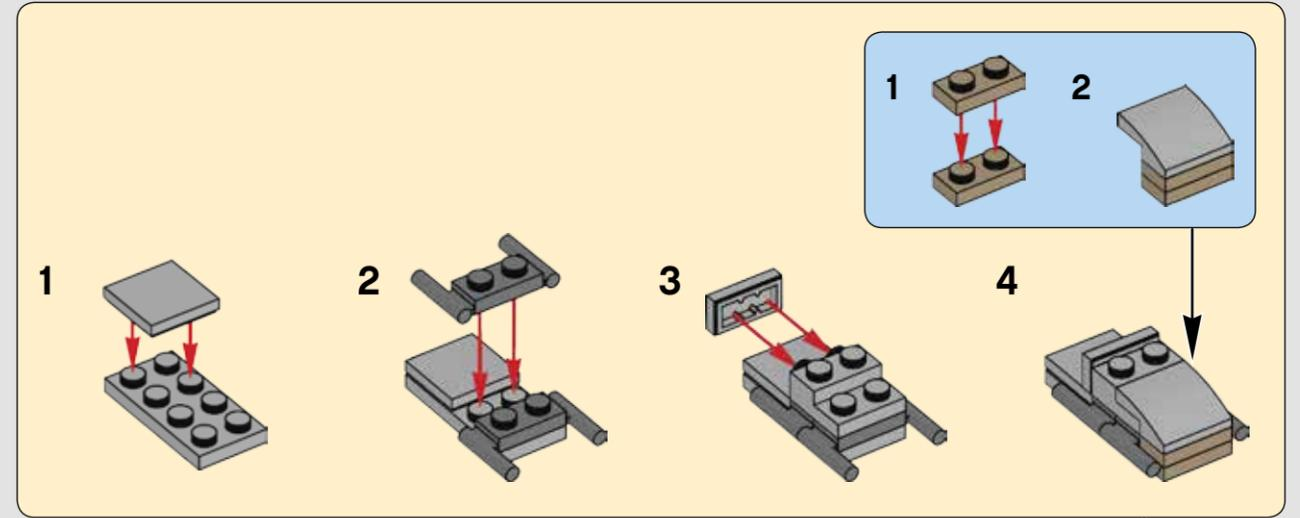

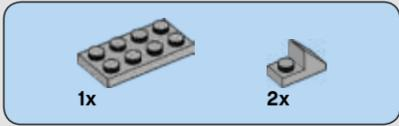

1079

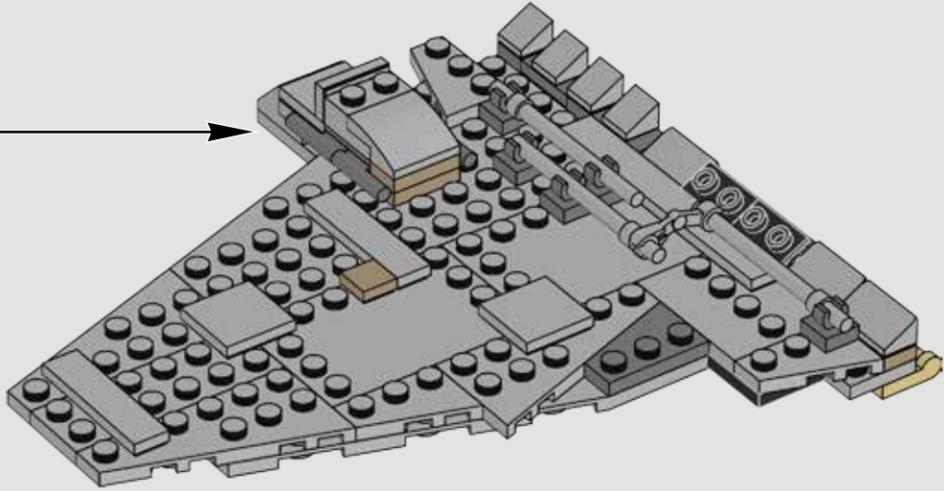
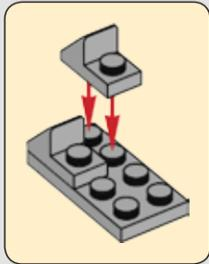

1080

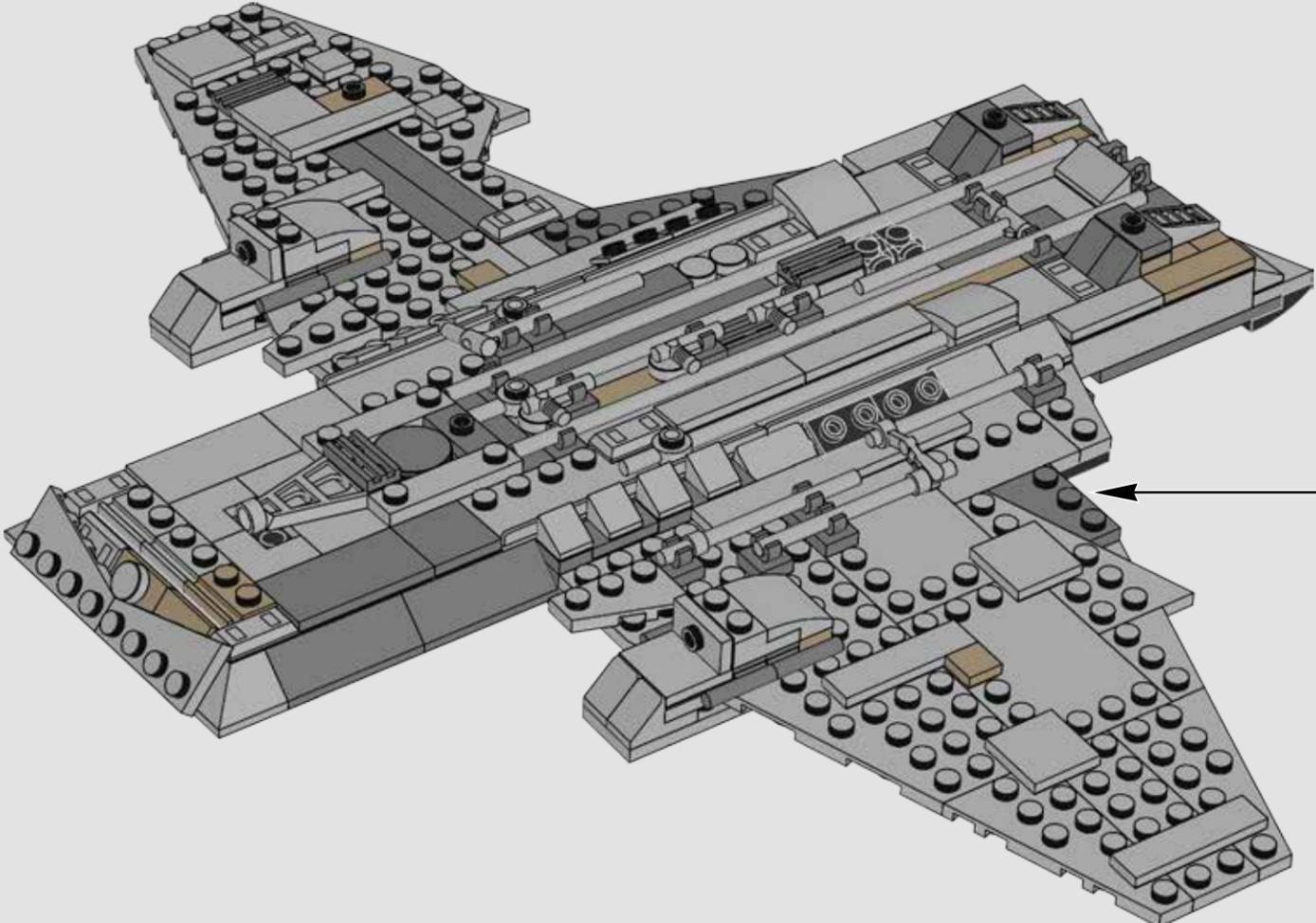

1081

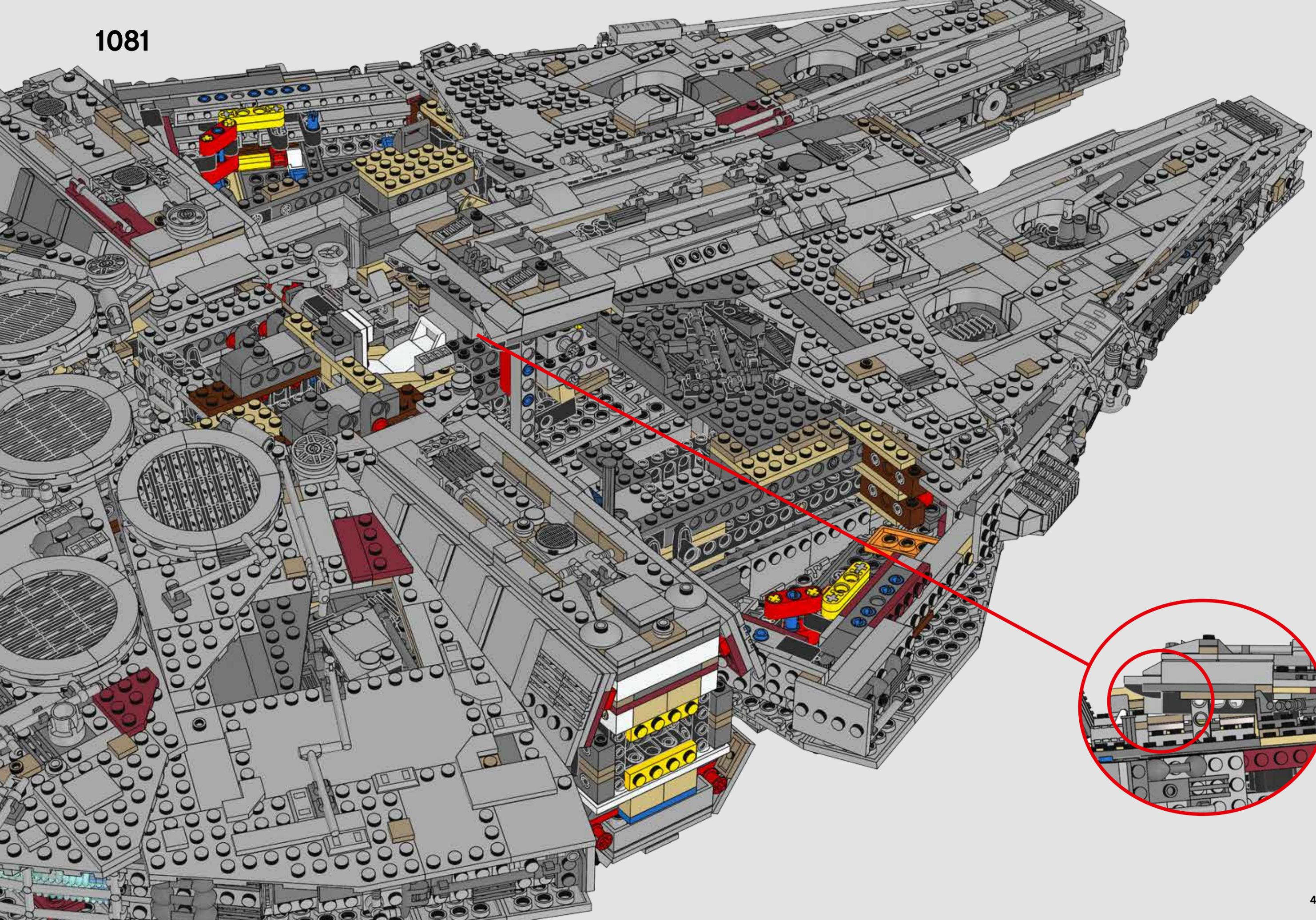

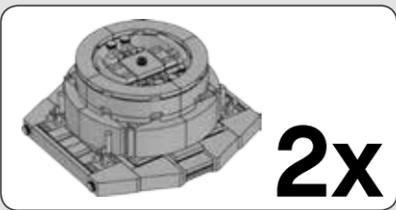
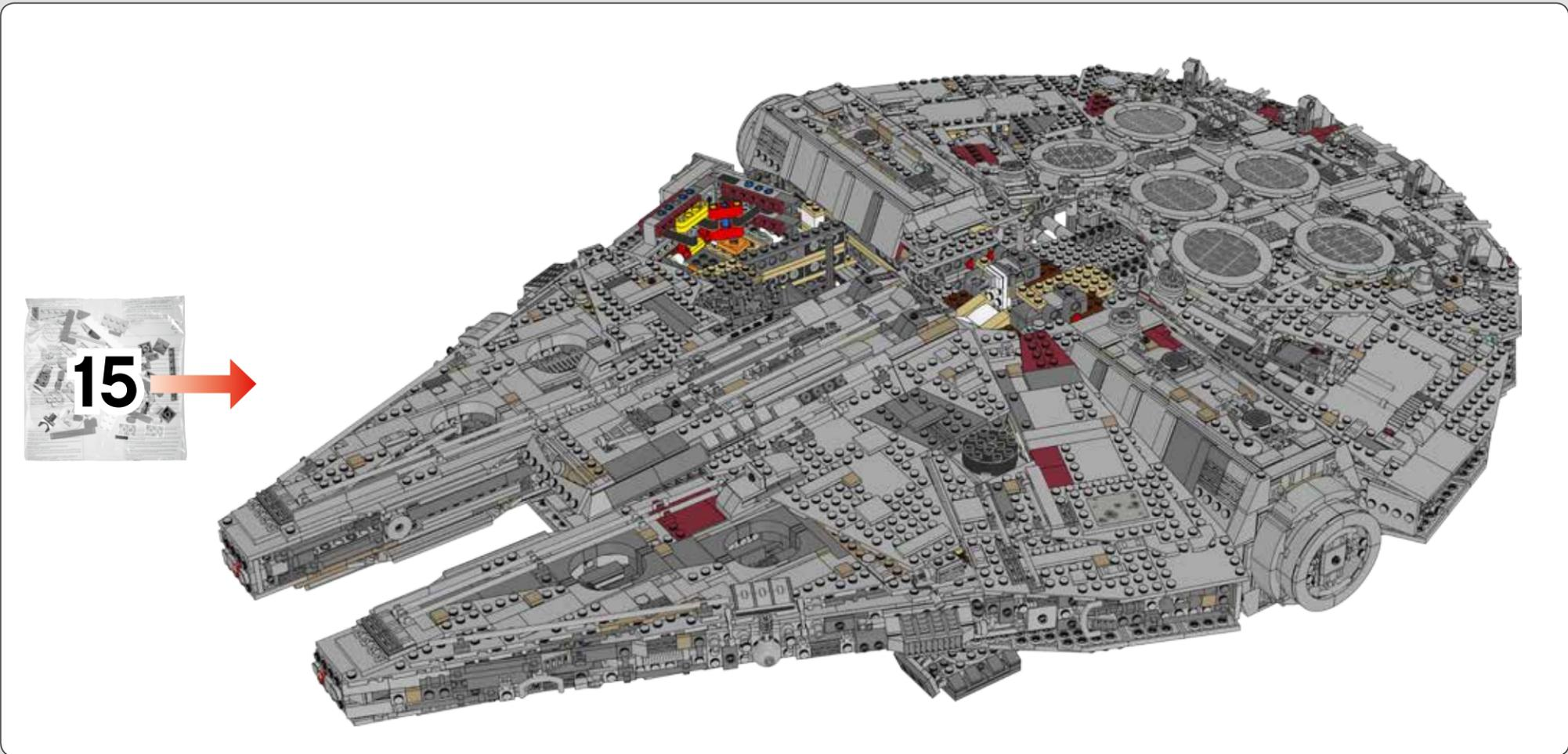

1082

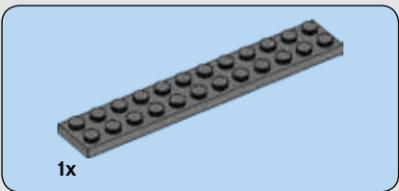
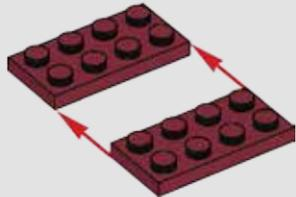

1083

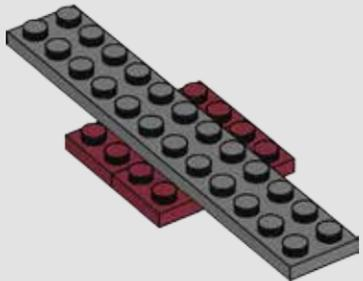

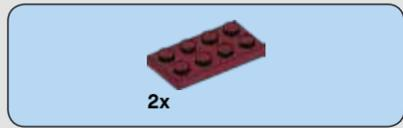

1084

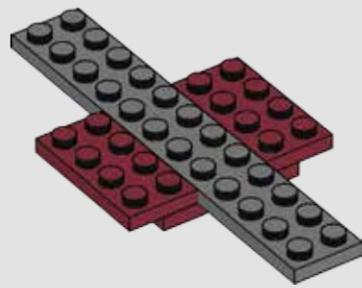

1085

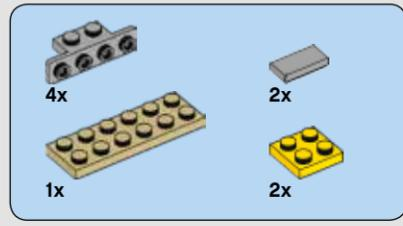
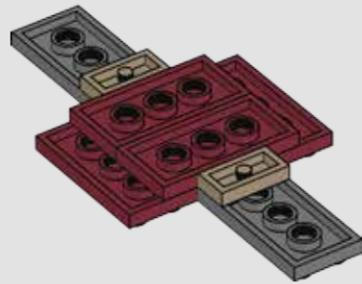

1086

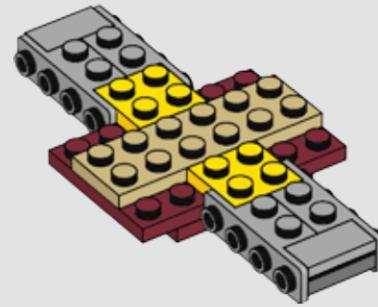

1087

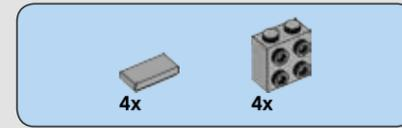
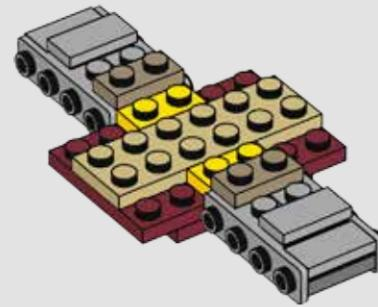

1088

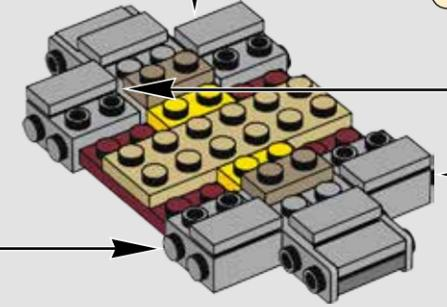
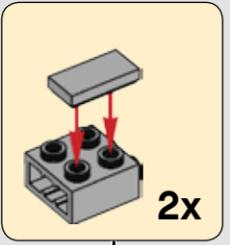
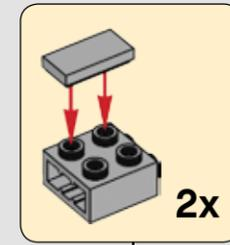

1089

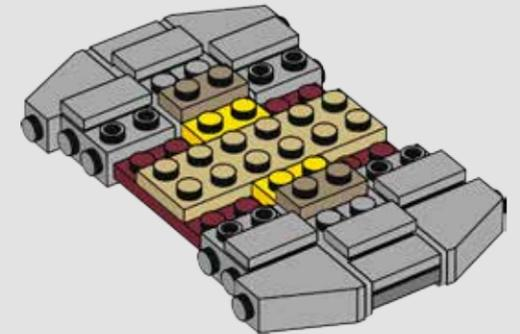

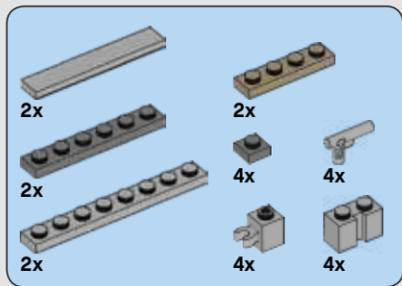

1090

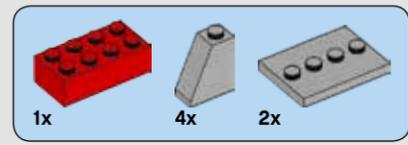
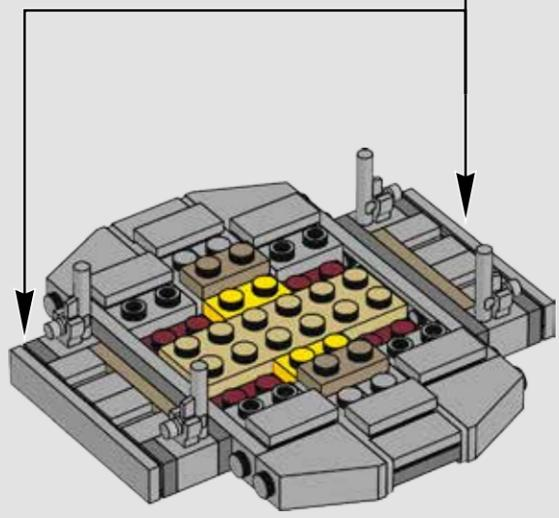
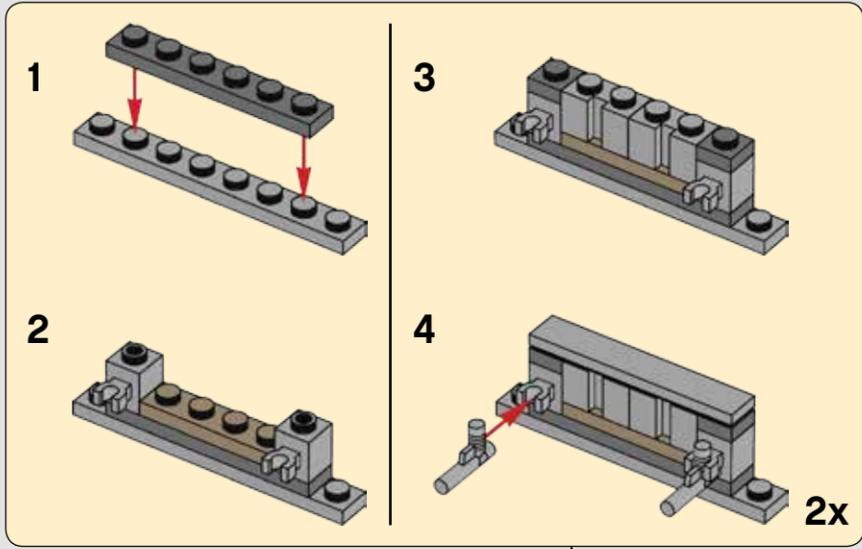

1091

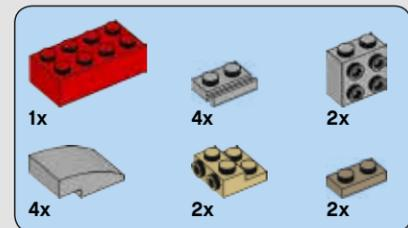
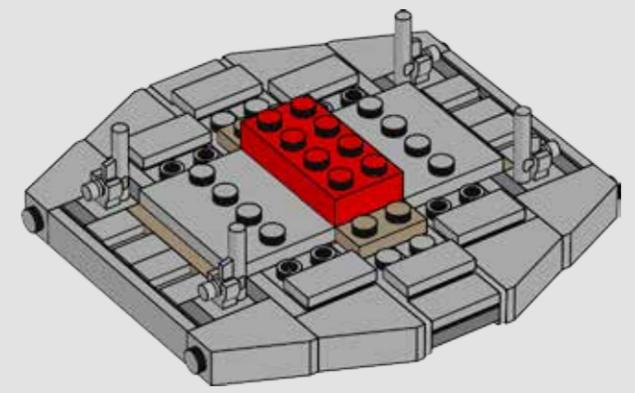

1092

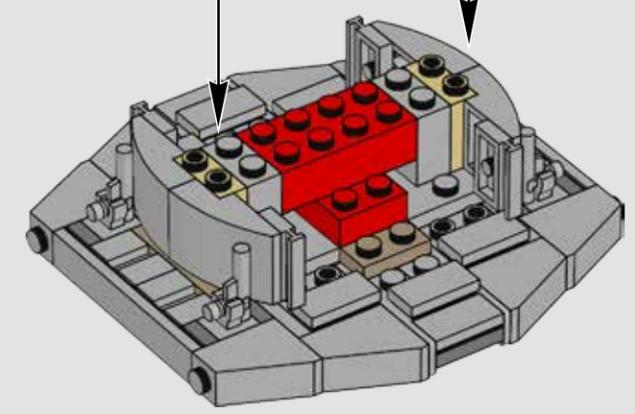
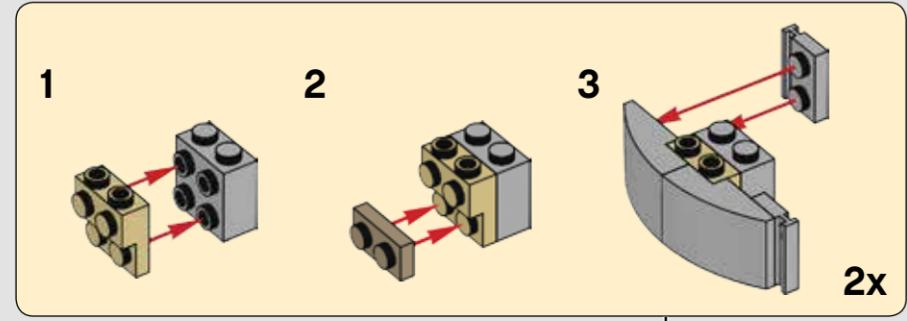

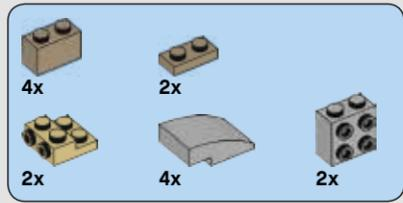

1093

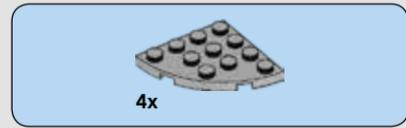
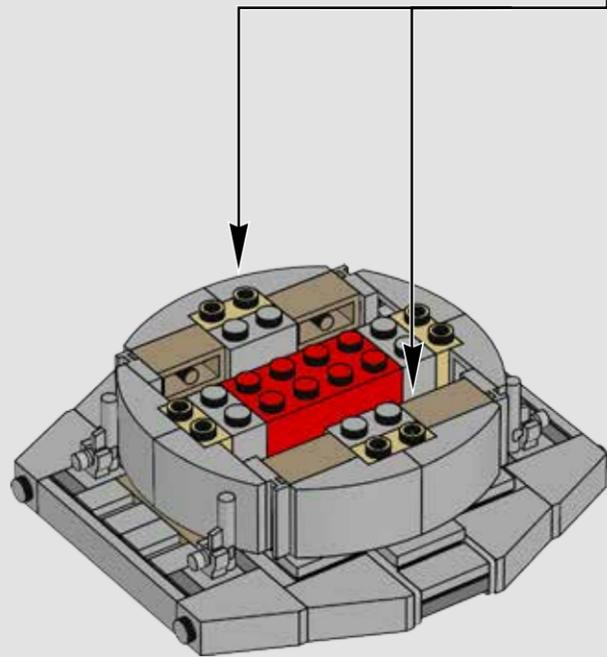
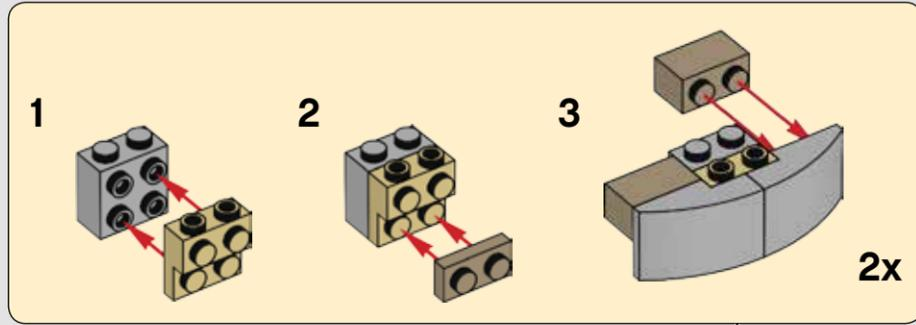

1094

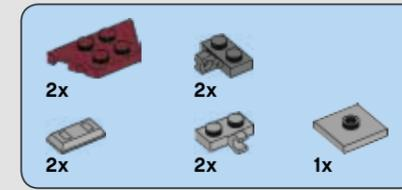
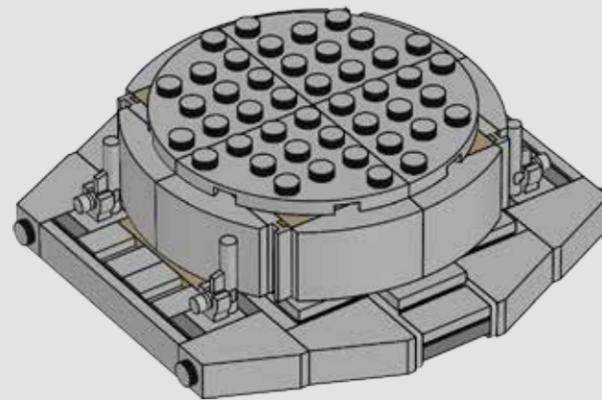

1095

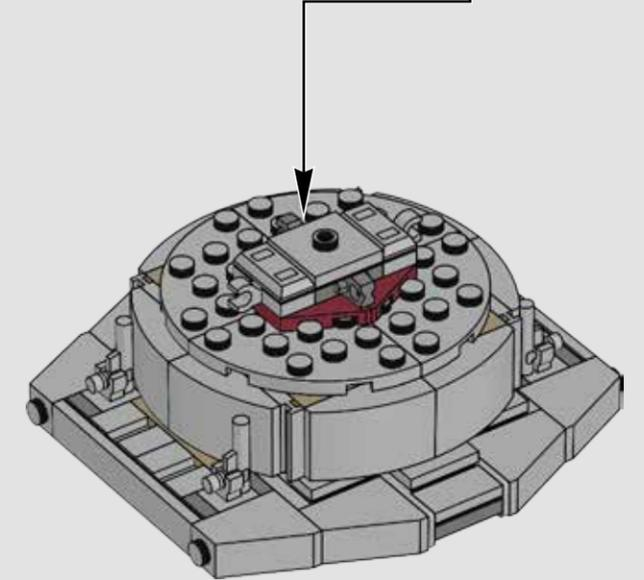
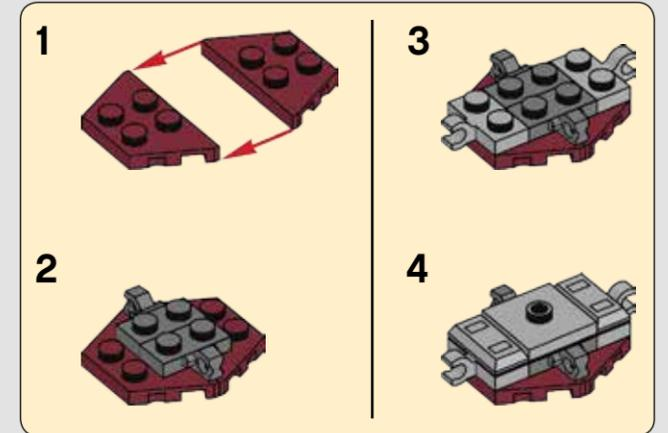

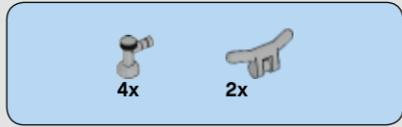

1096

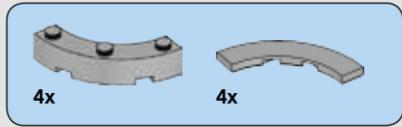
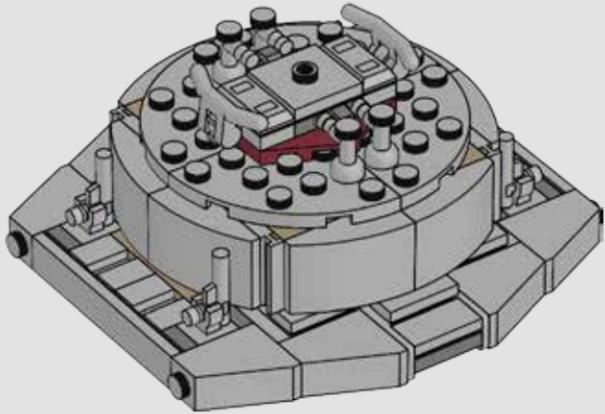

1097

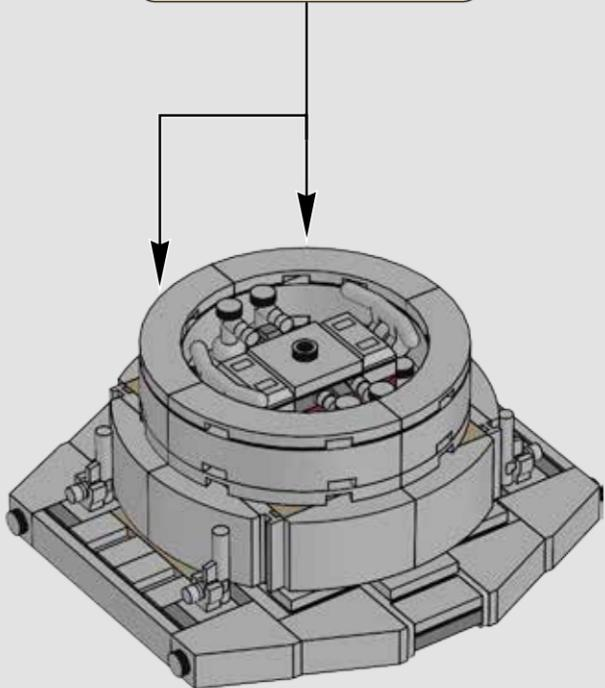
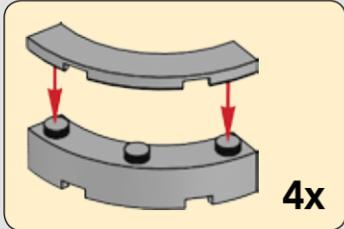

1098

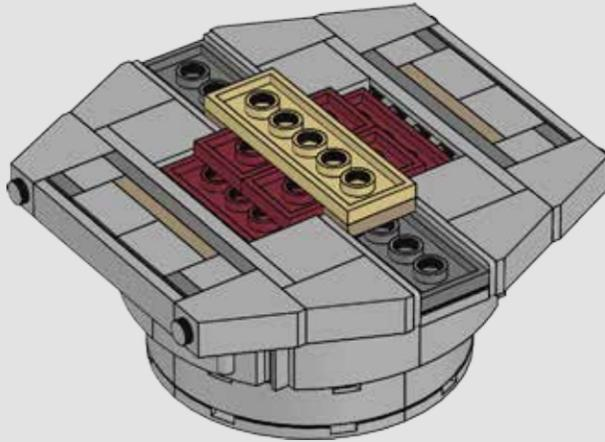

2x

1099

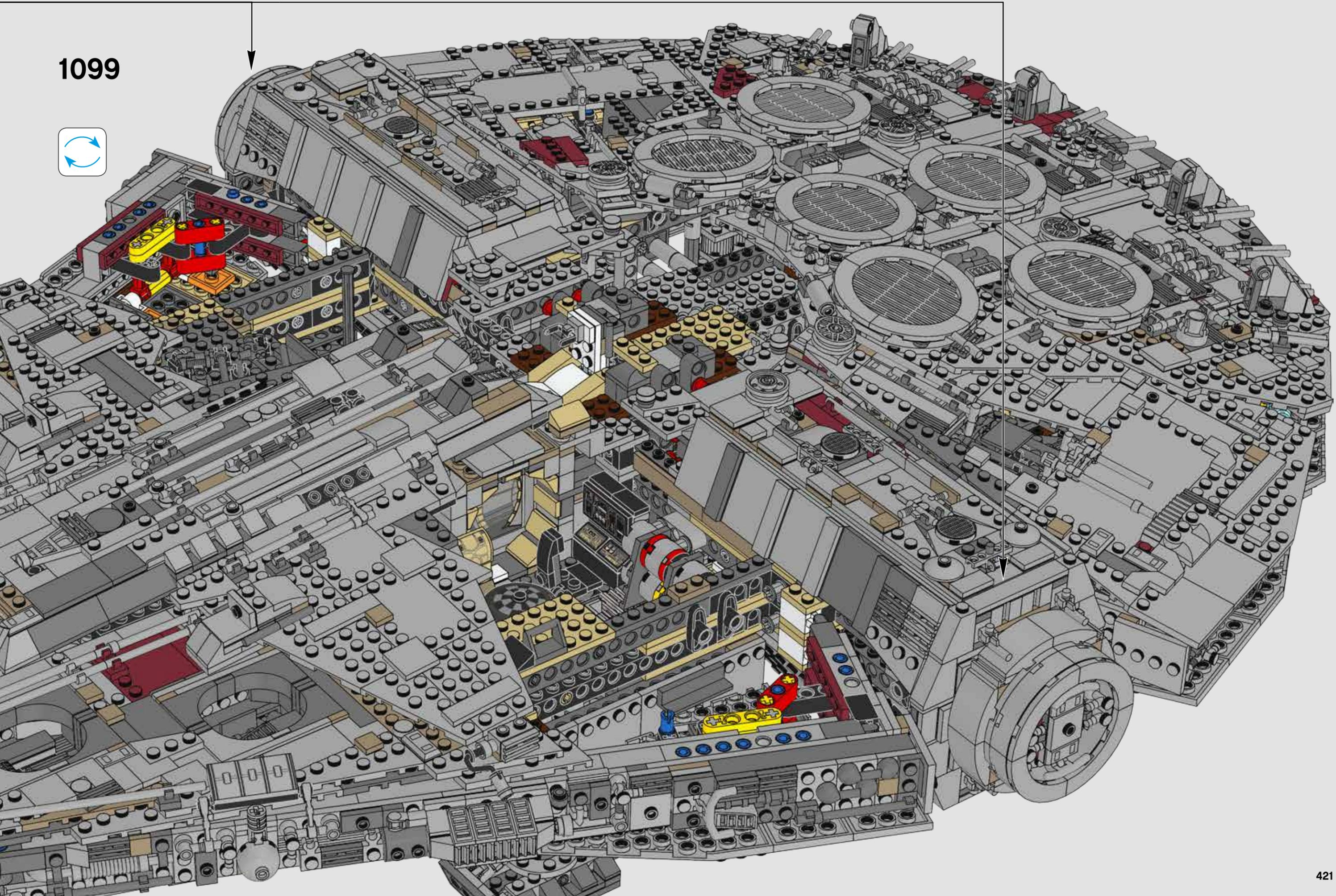

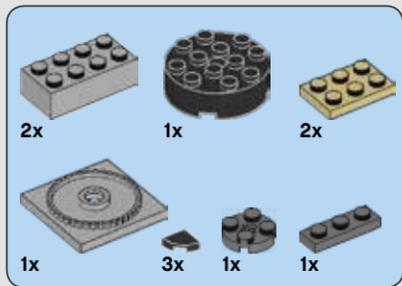

1100

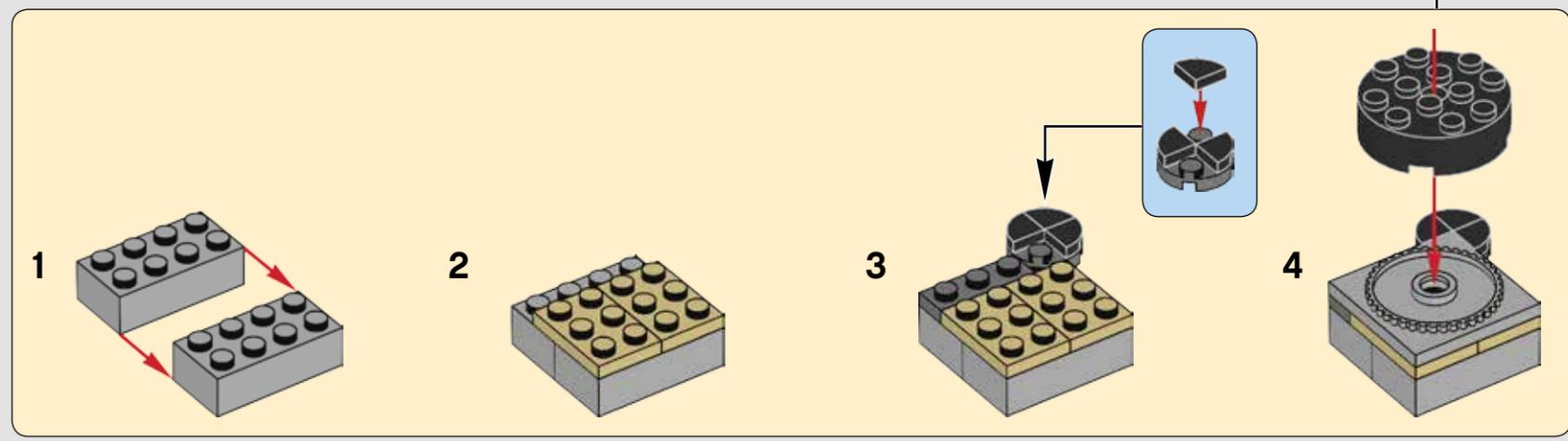
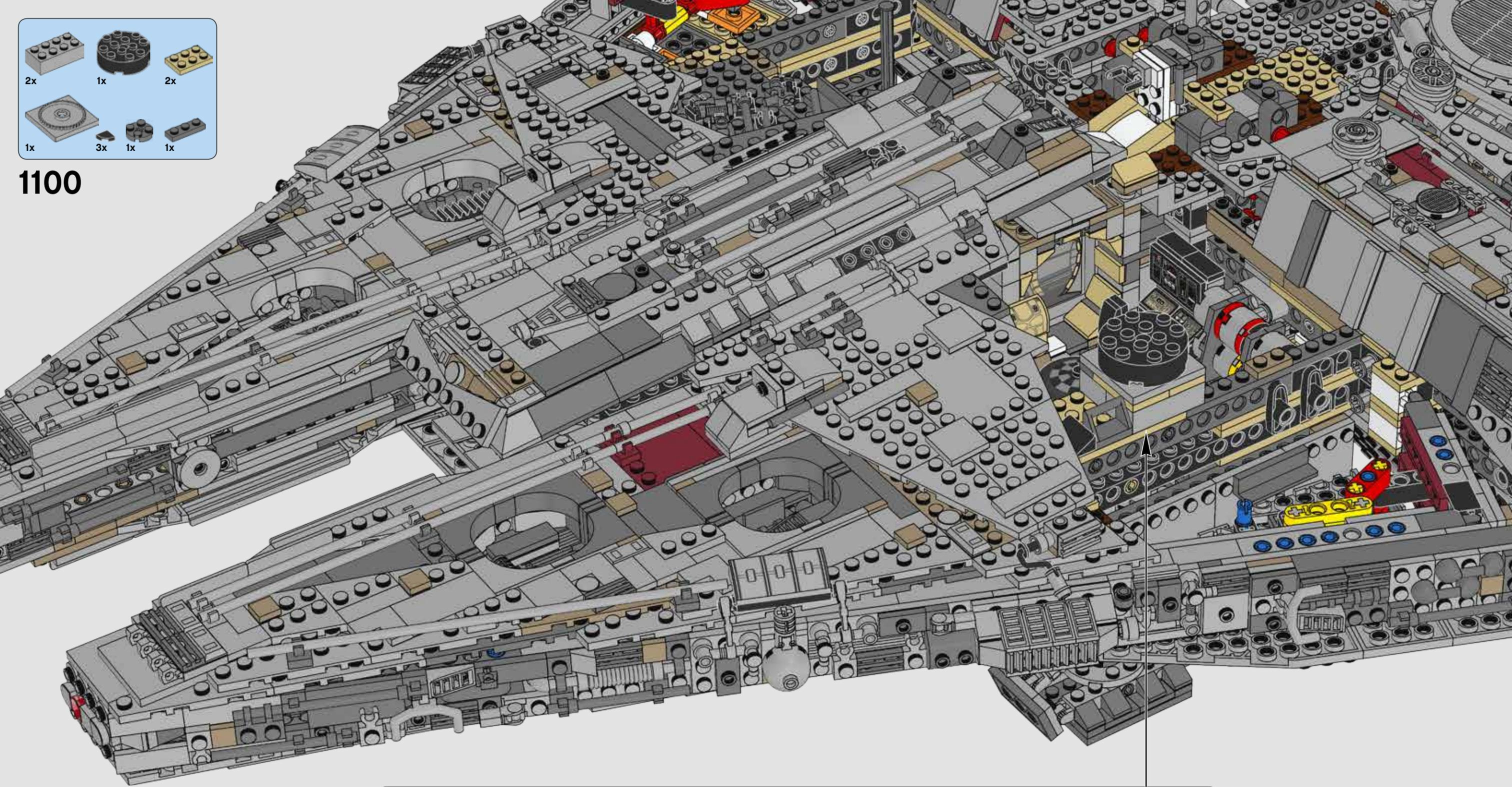

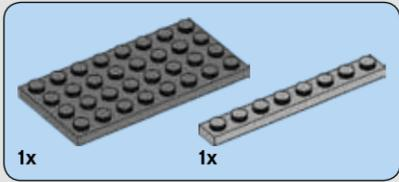
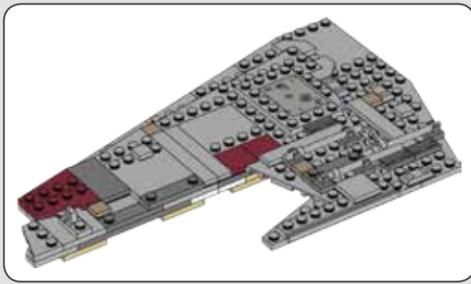

1101

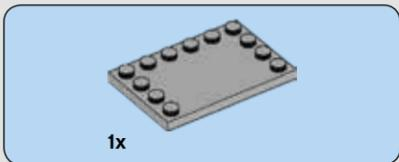
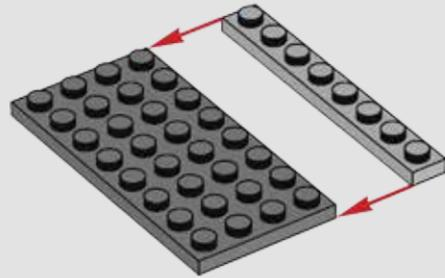

1102

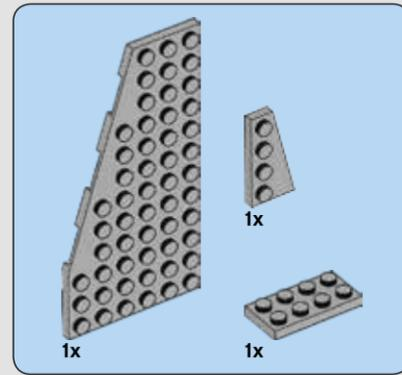
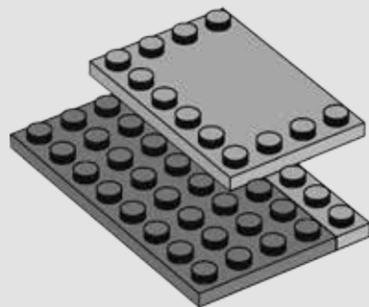

1103

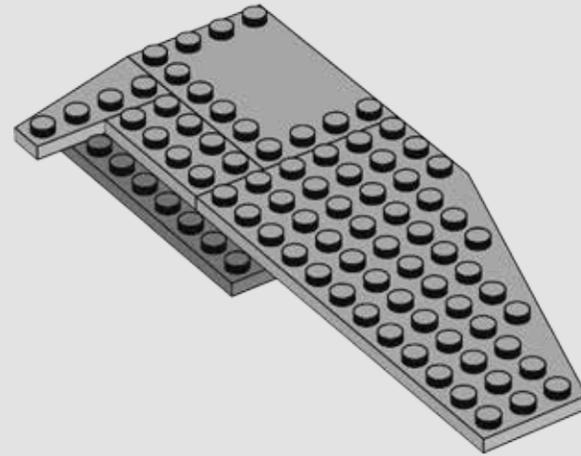

1104

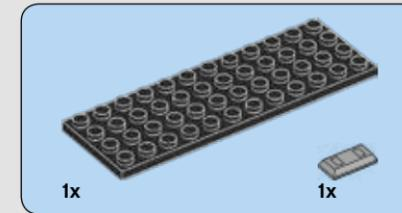
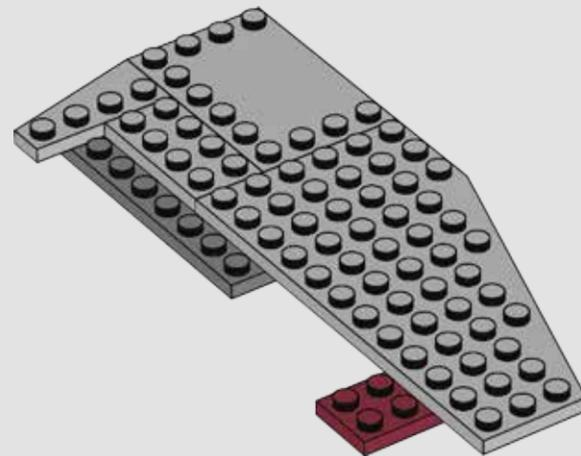

1105

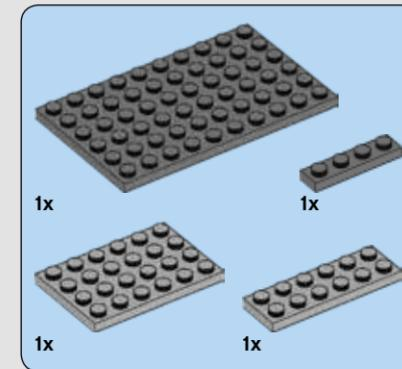
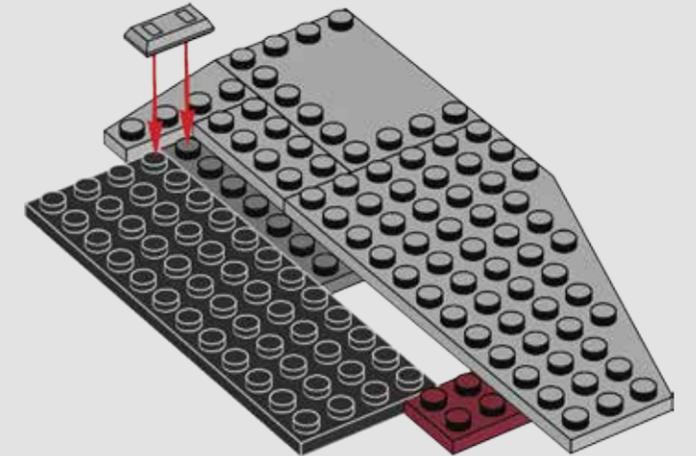

1106

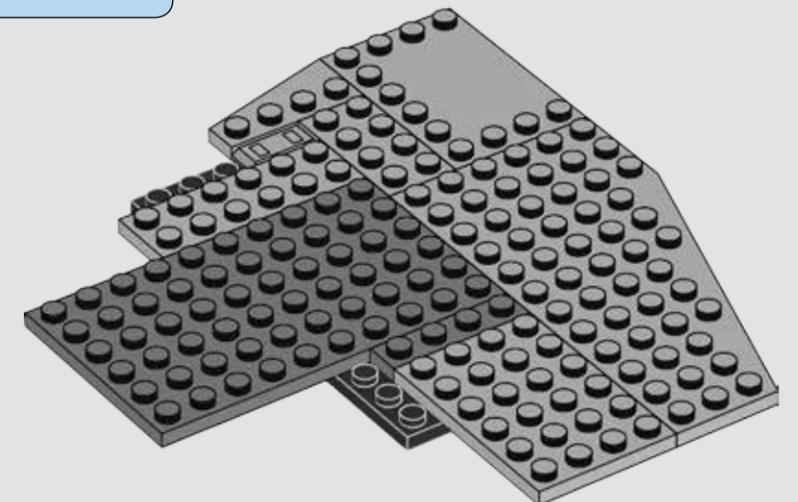

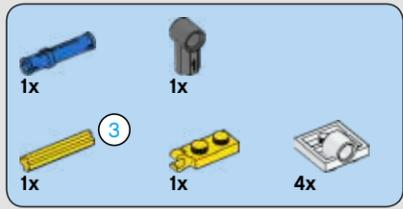

1111

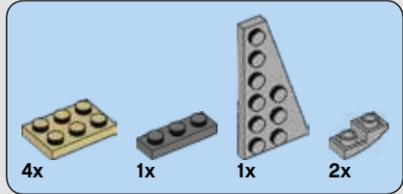
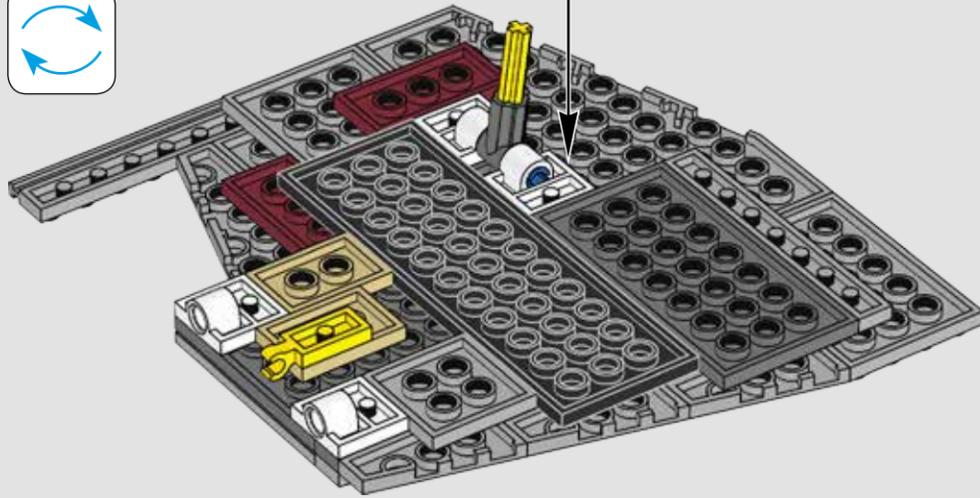
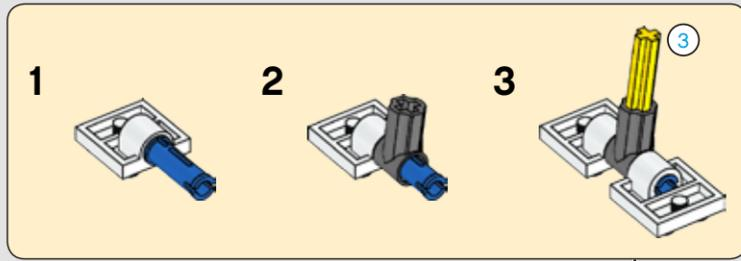

1112

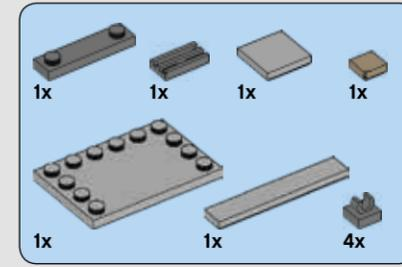
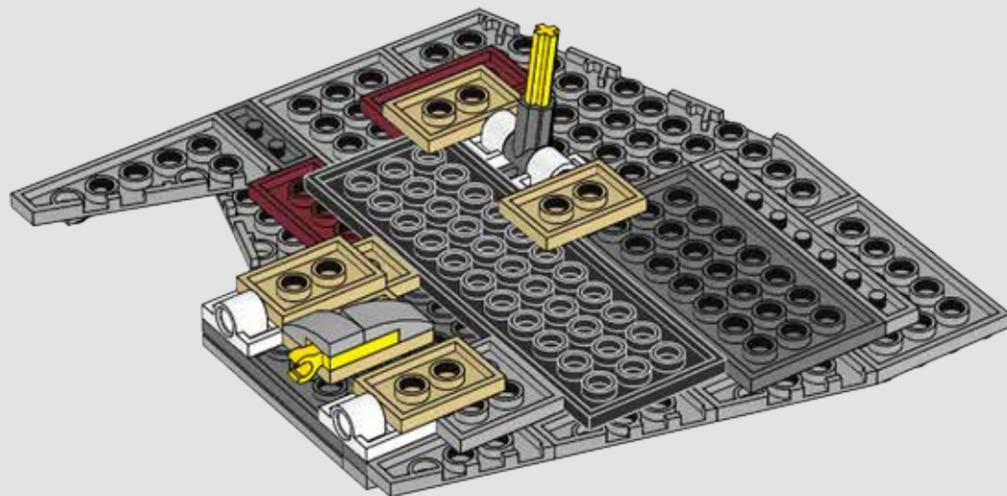

1113

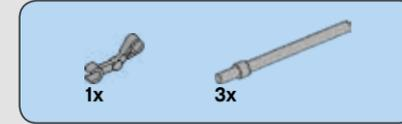
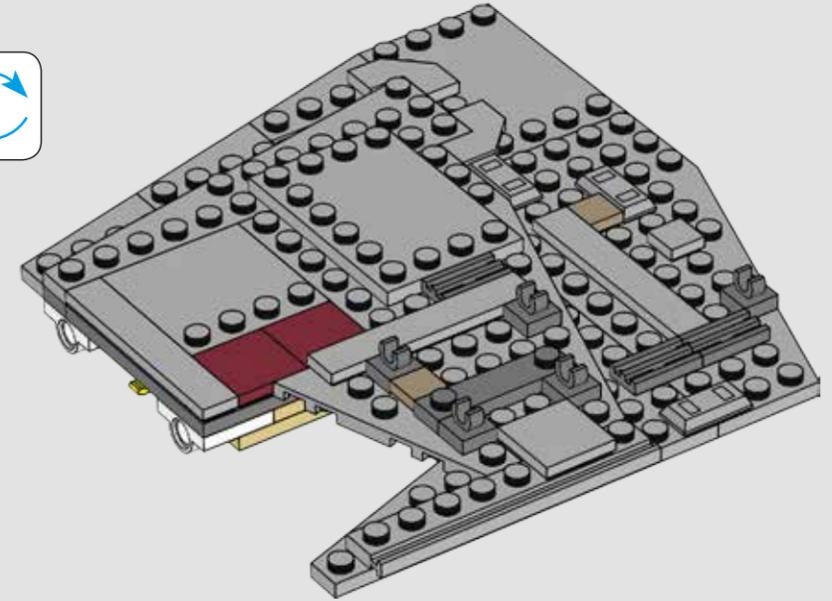

1114

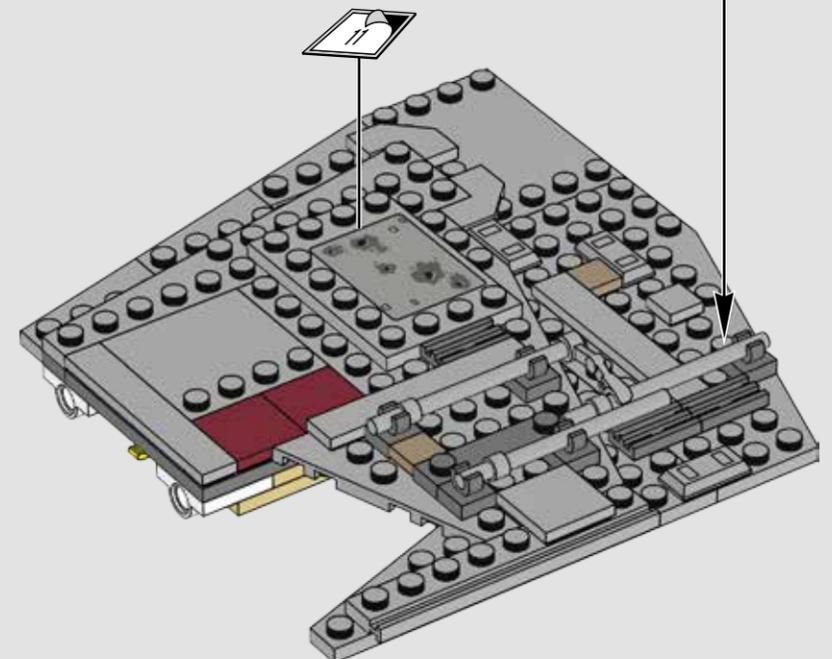
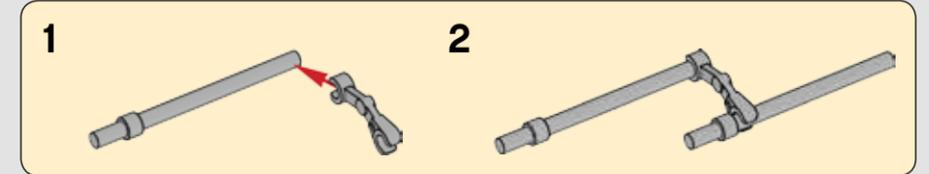



1121

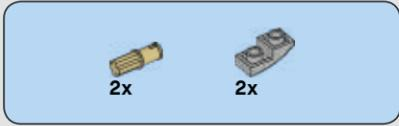
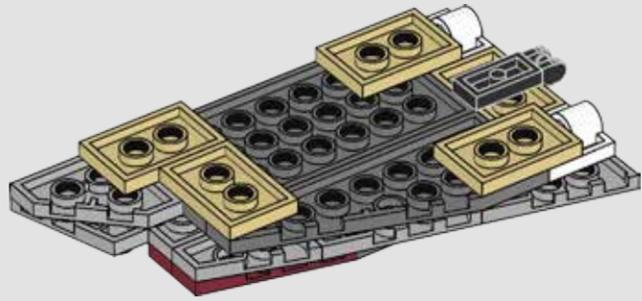

1122

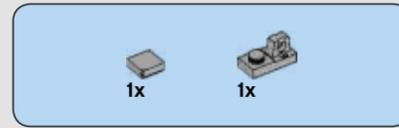
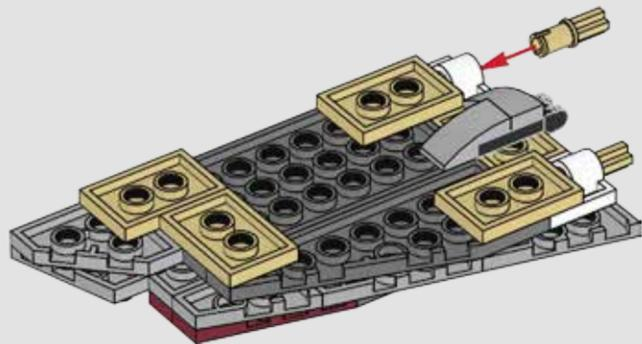

1123

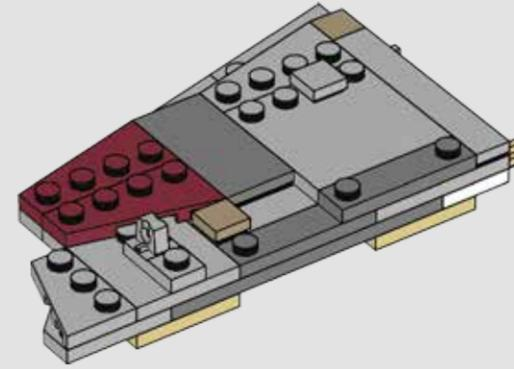

1124

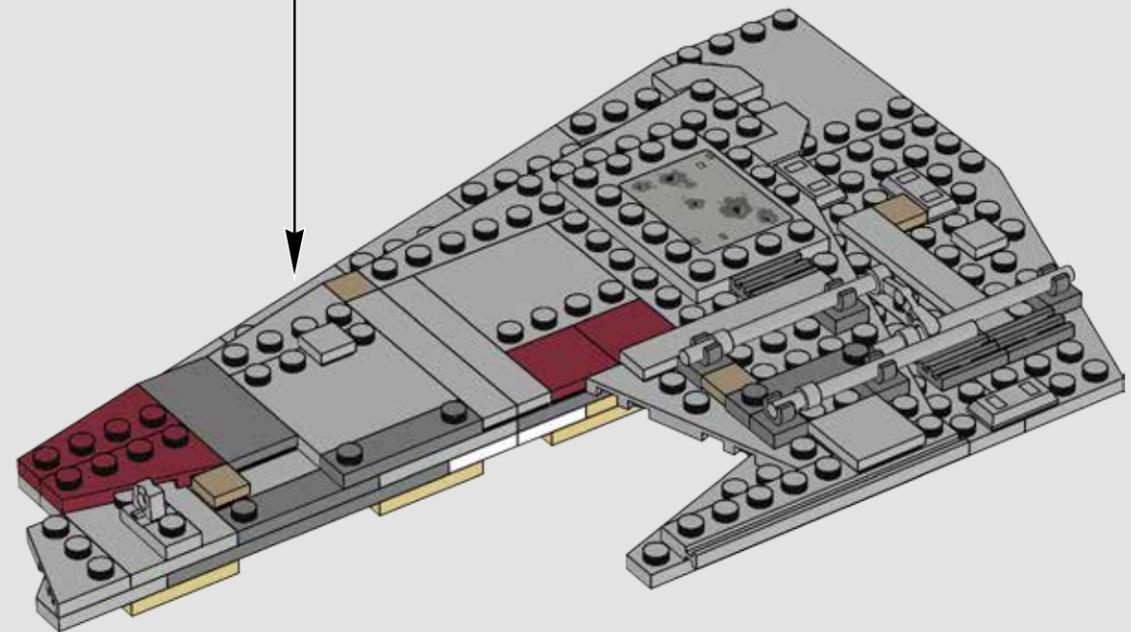

1125

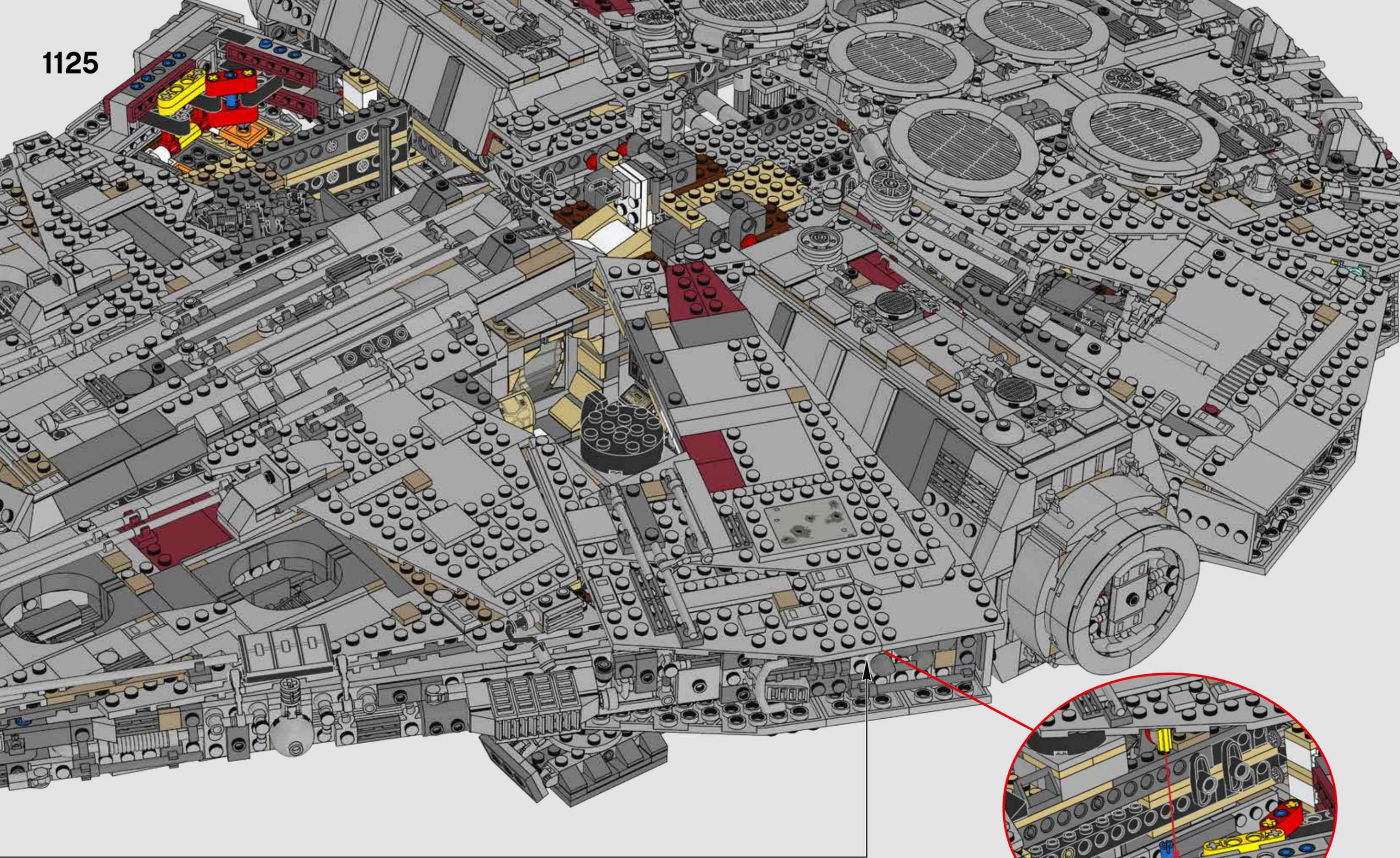

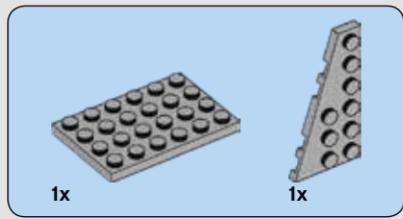

1126

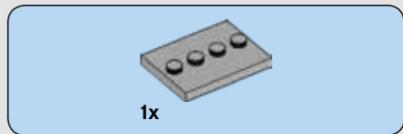
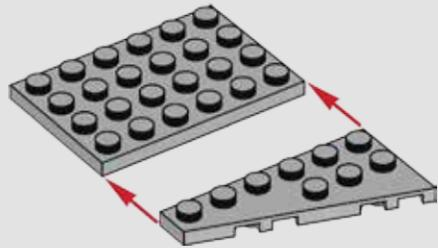

1127

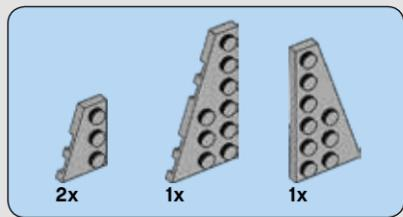
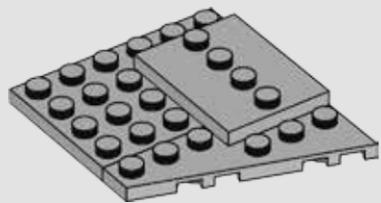

1128

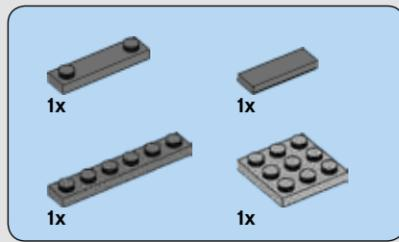
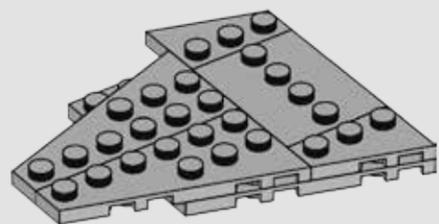

1129

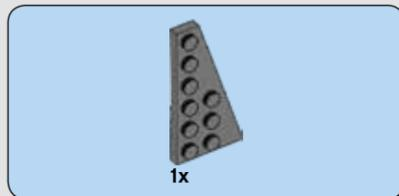
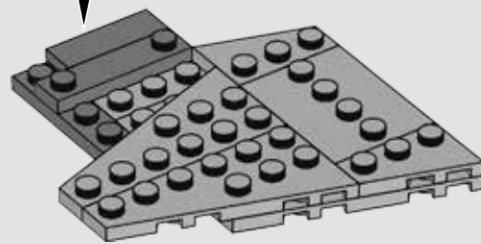

1130

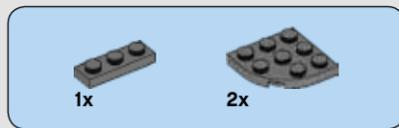
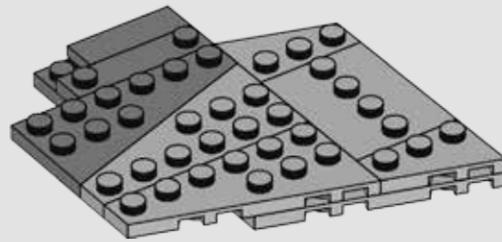

1131

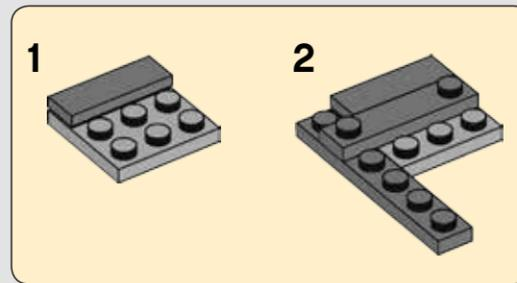
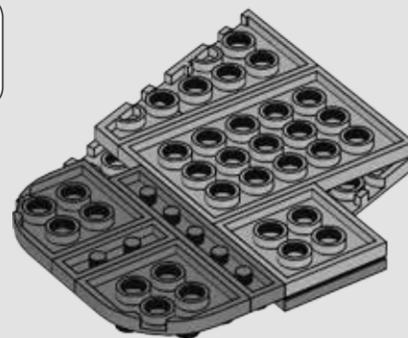

1132

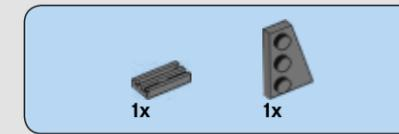
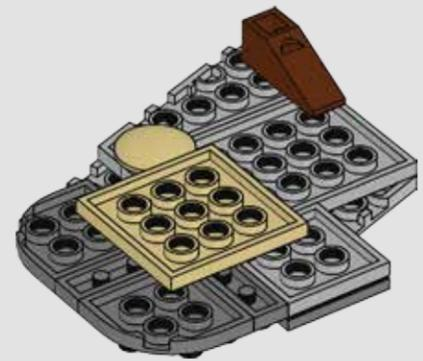

1133

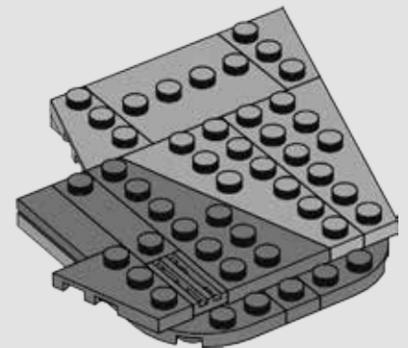

1134

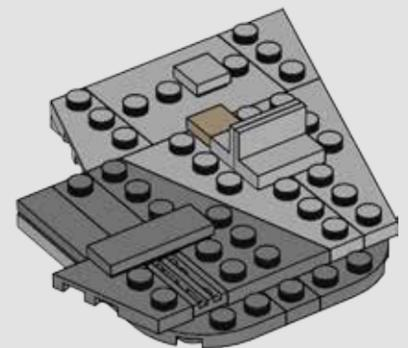

1135

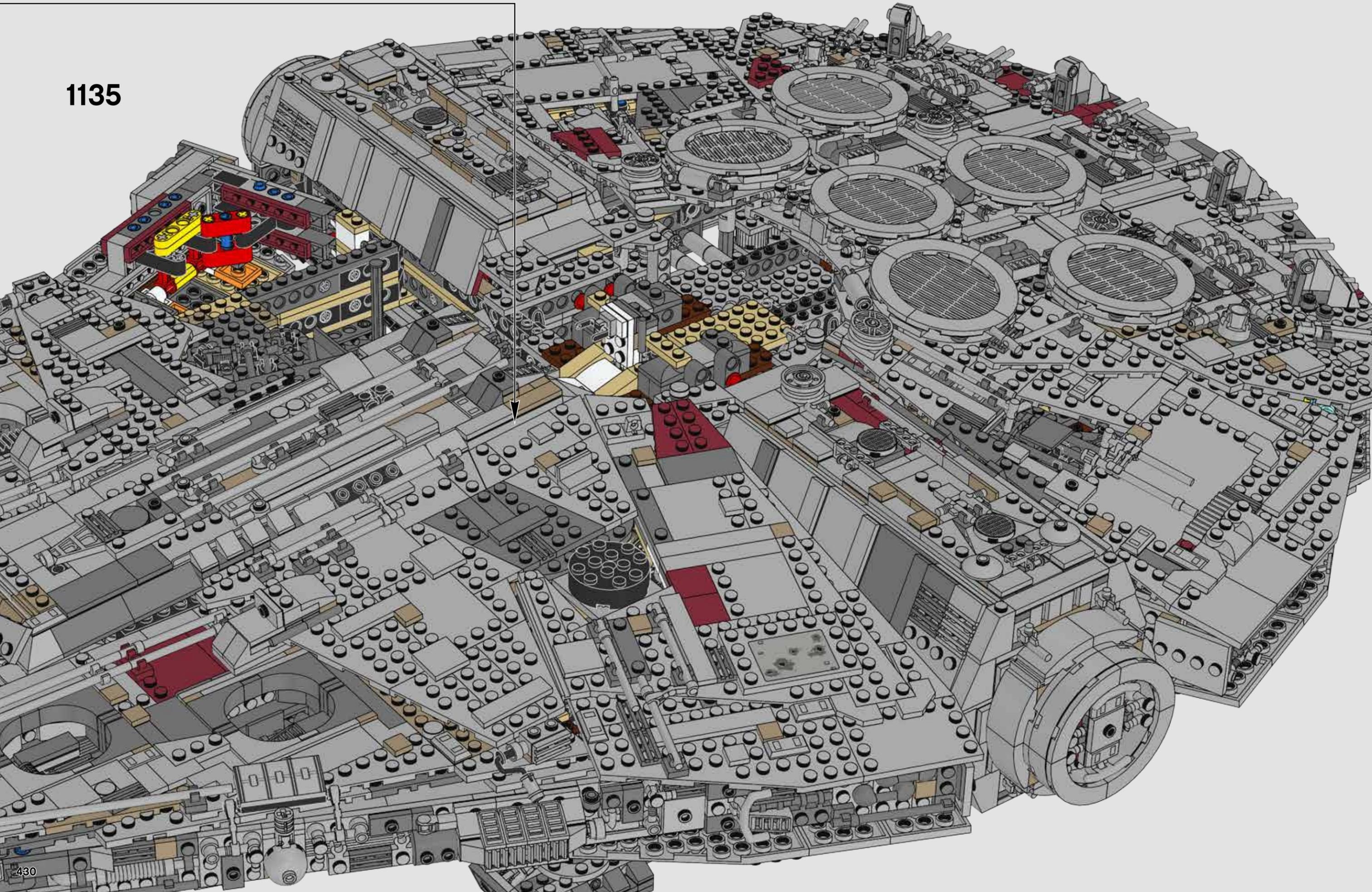

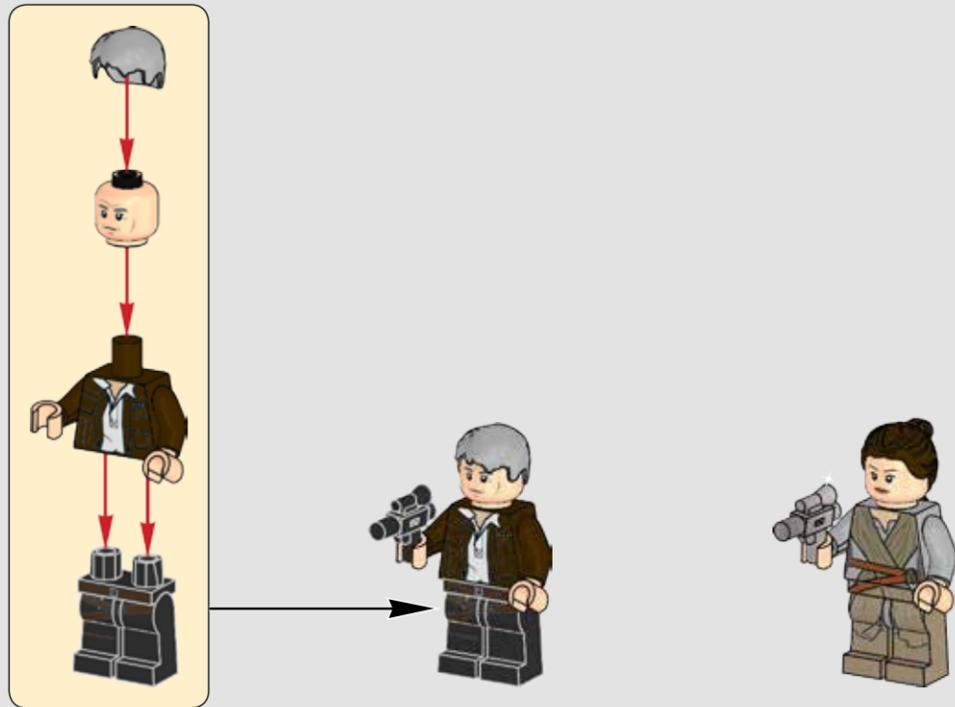
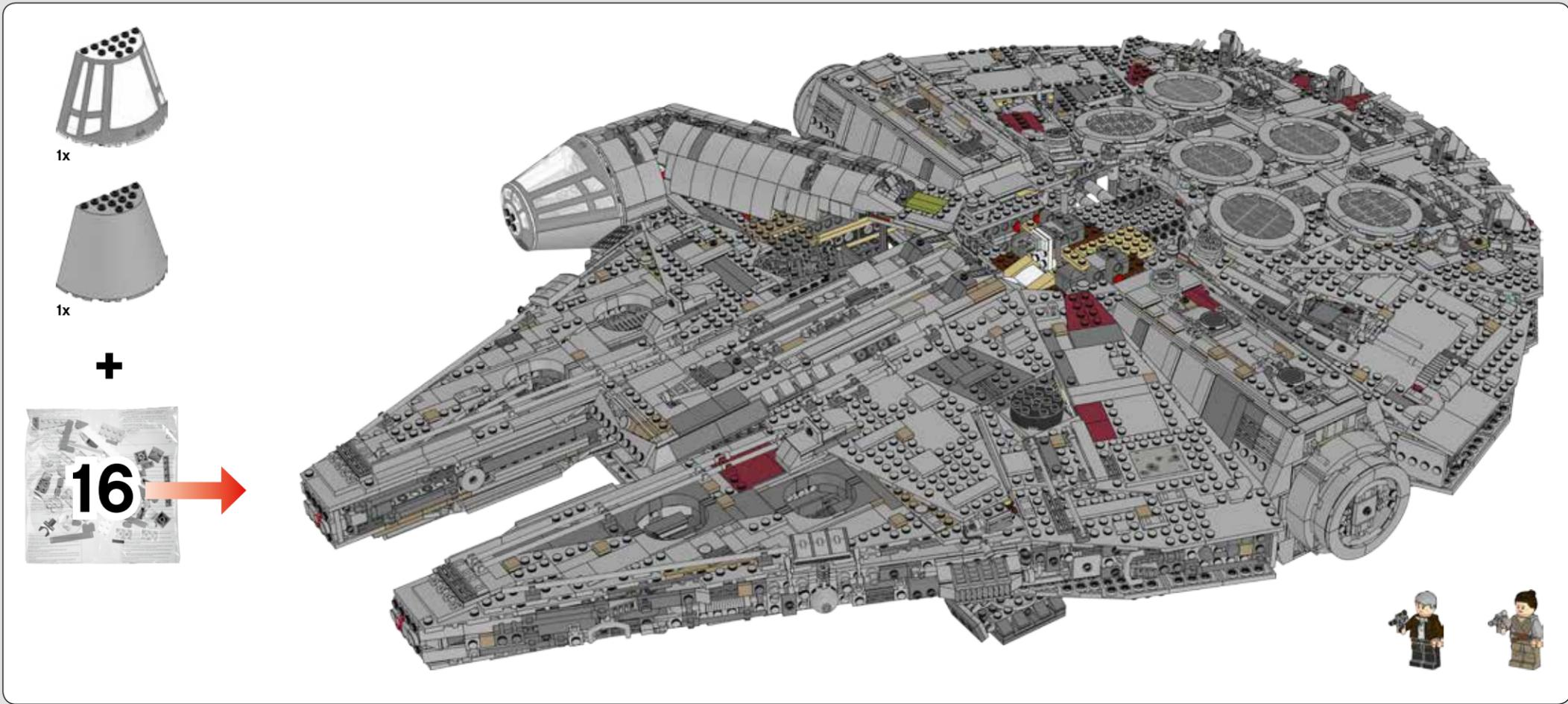

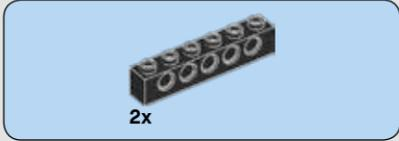
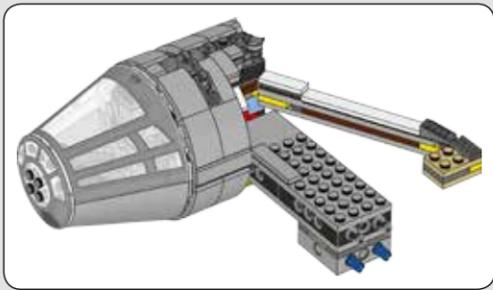

1136

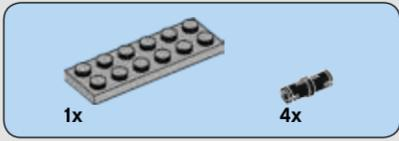
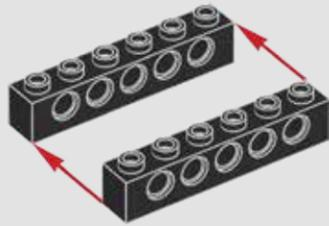

1137

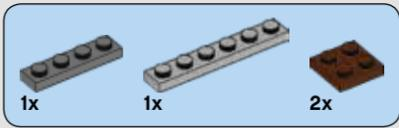
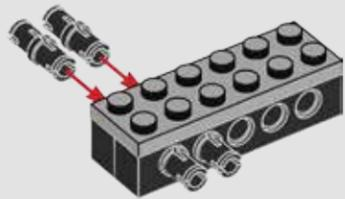

1138

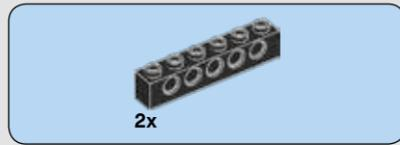
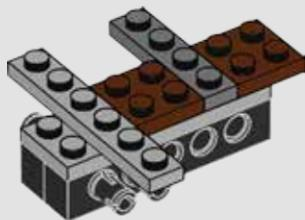

1139

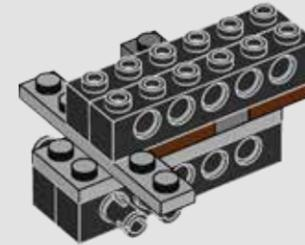

1140

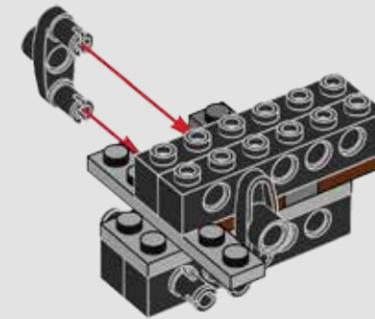

1141

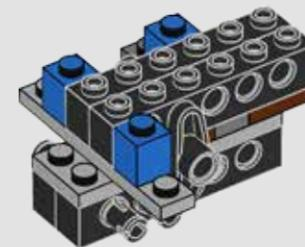

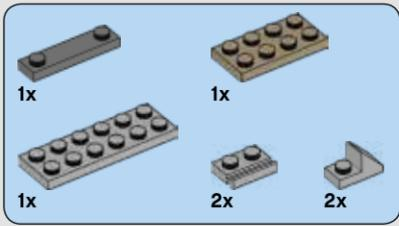

1142

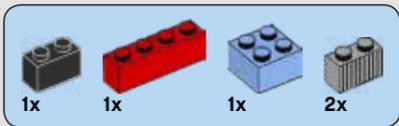
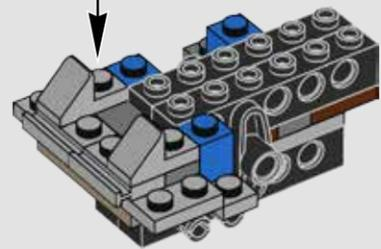
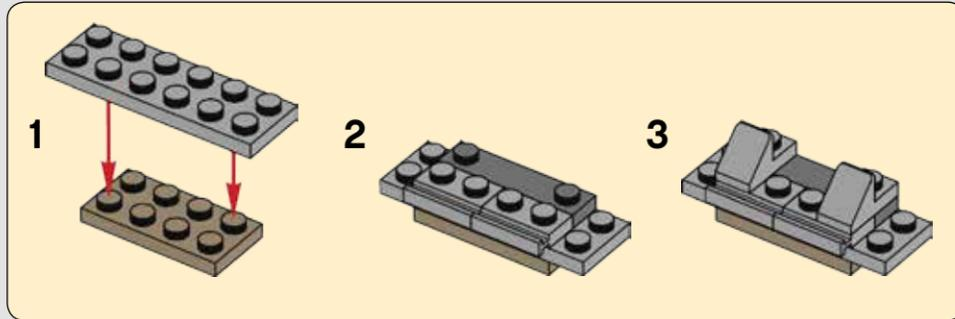

1143

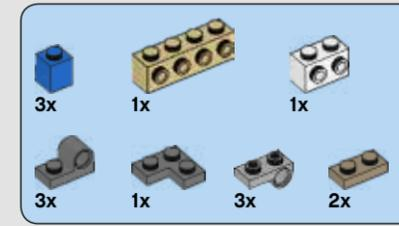
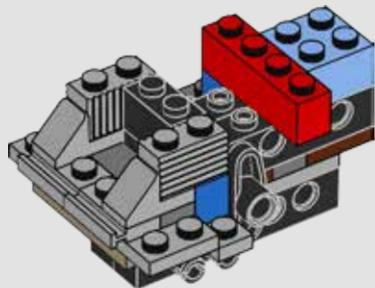

1144

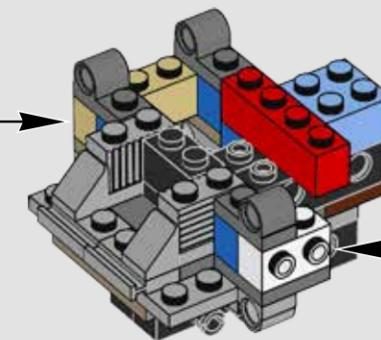
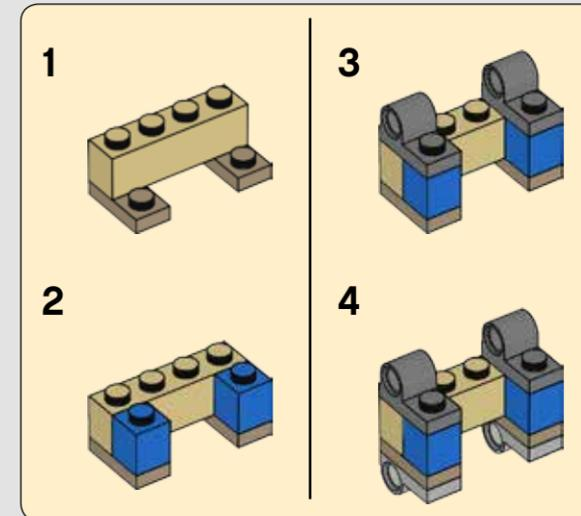



1145

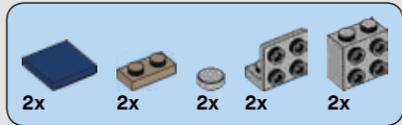
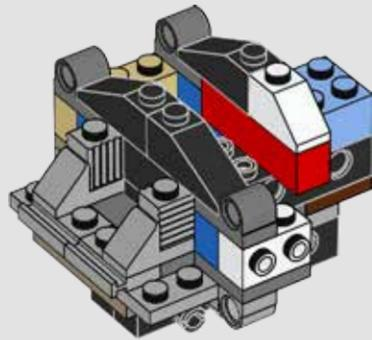

1146

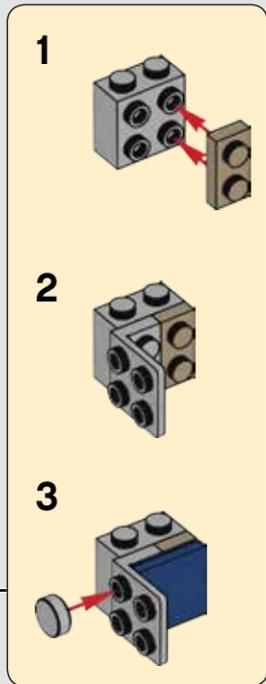
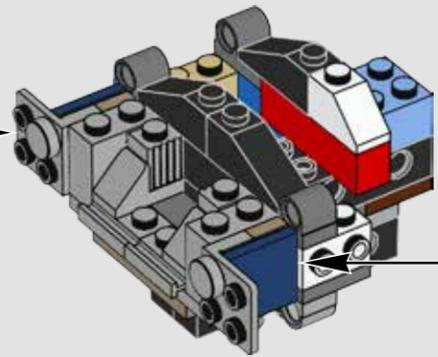
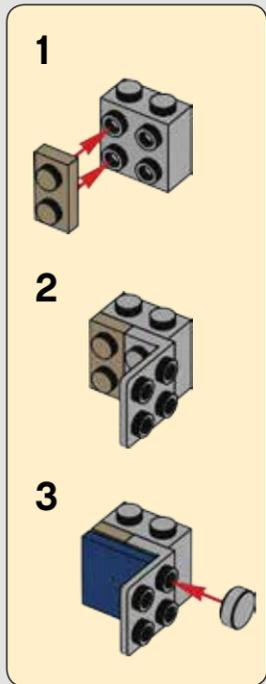

1147

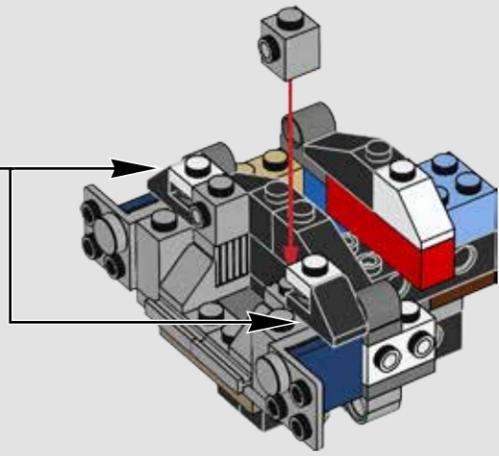
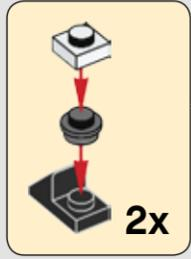

1148

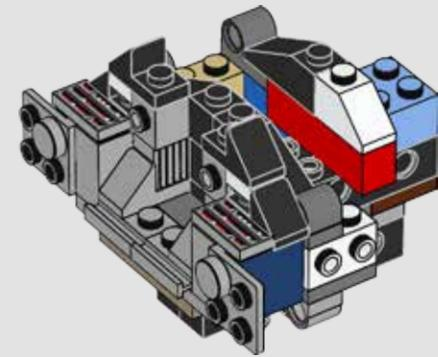

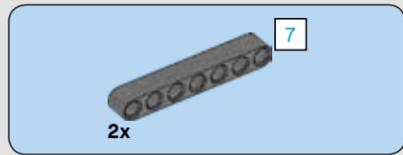

1149

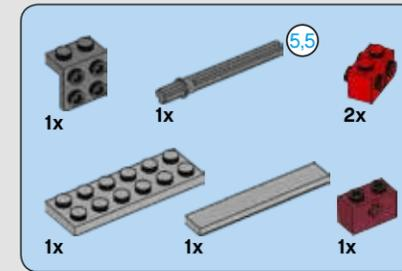
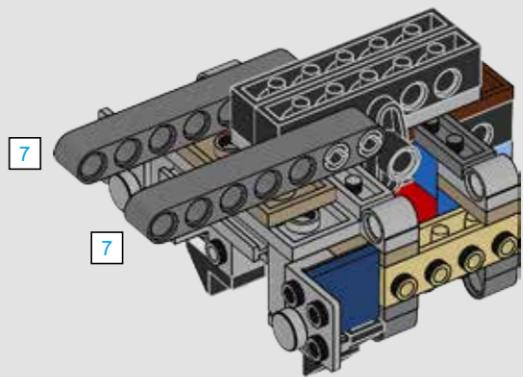
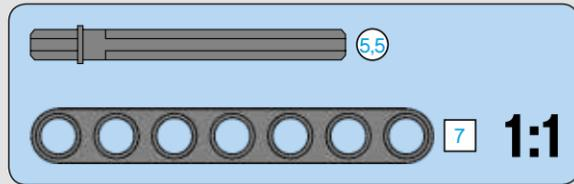

1150

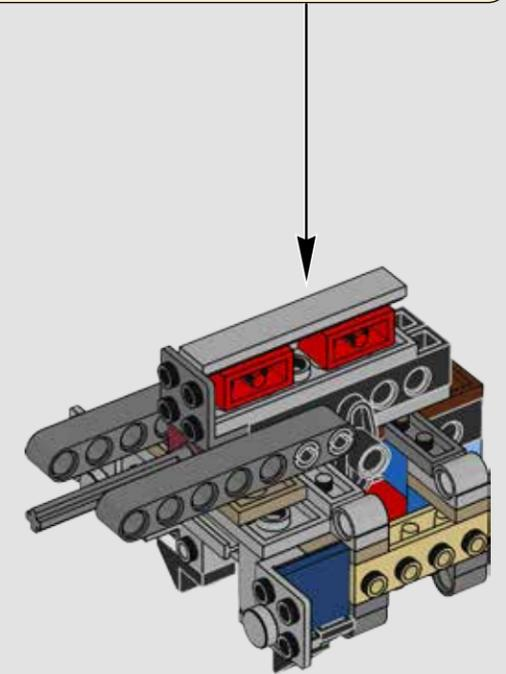
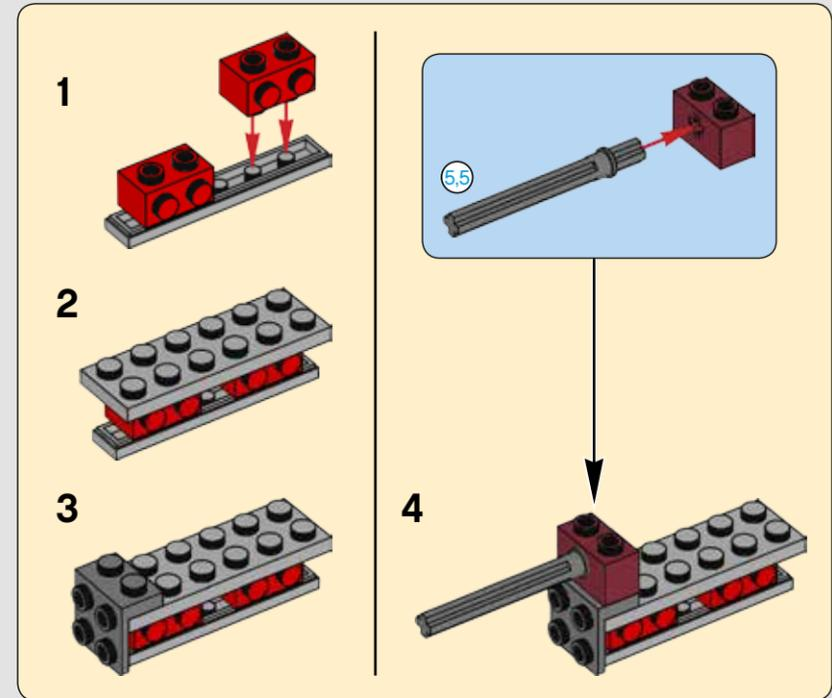

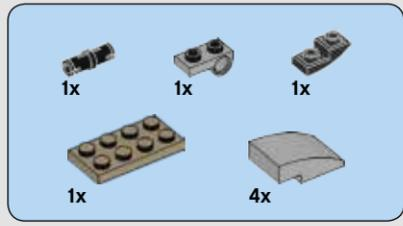

1160

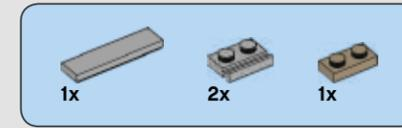
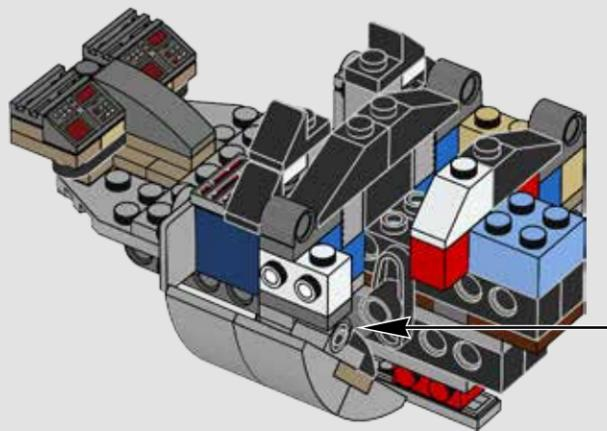
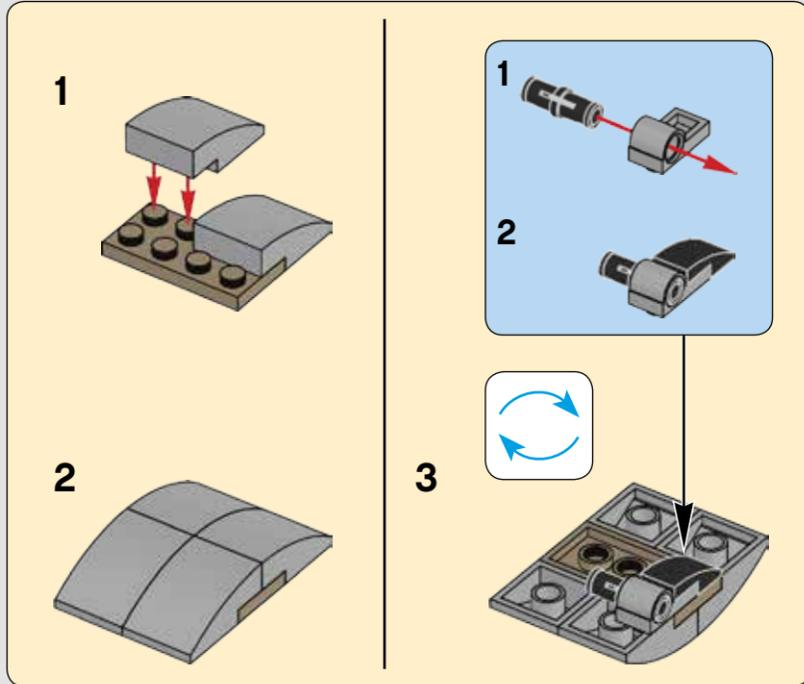

1161

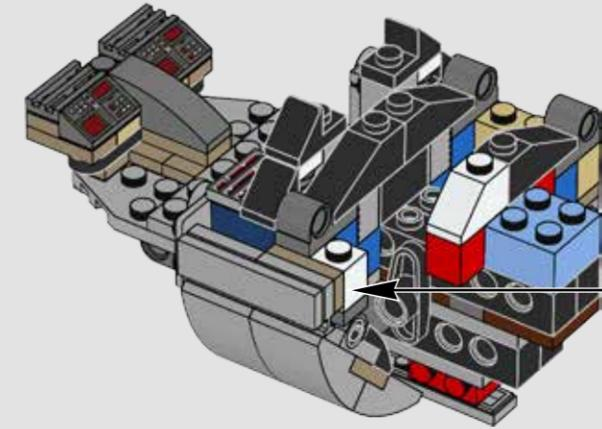
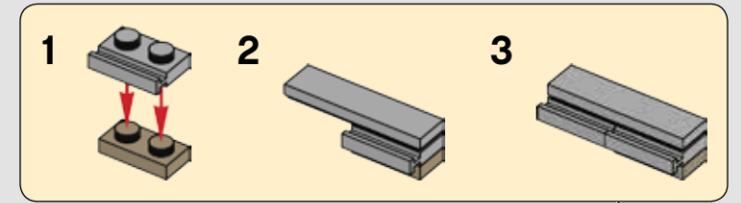

1162

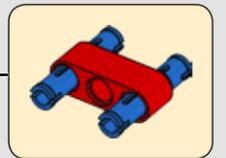
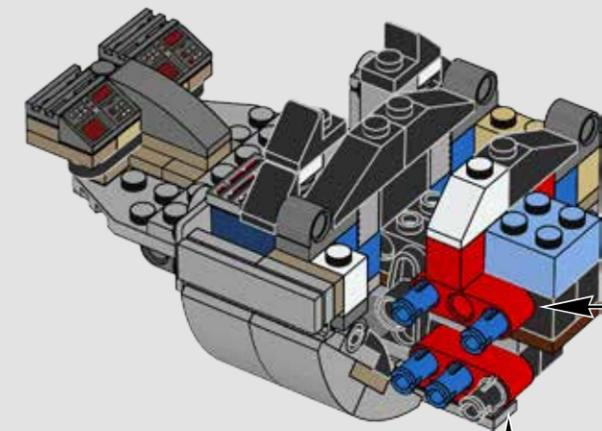

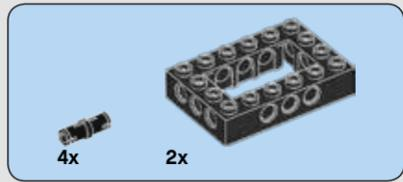

1168

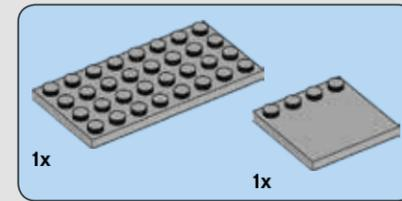
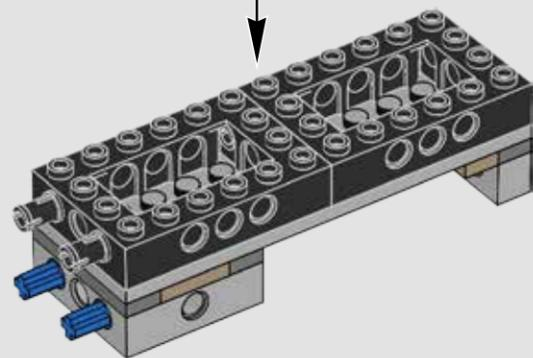
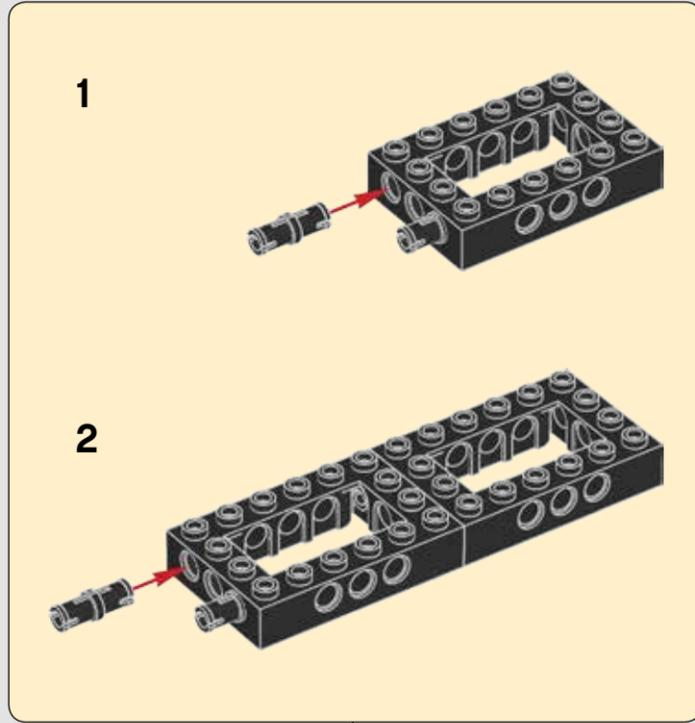

1169

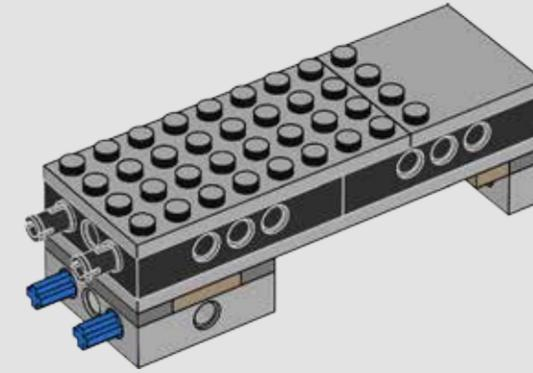

1170

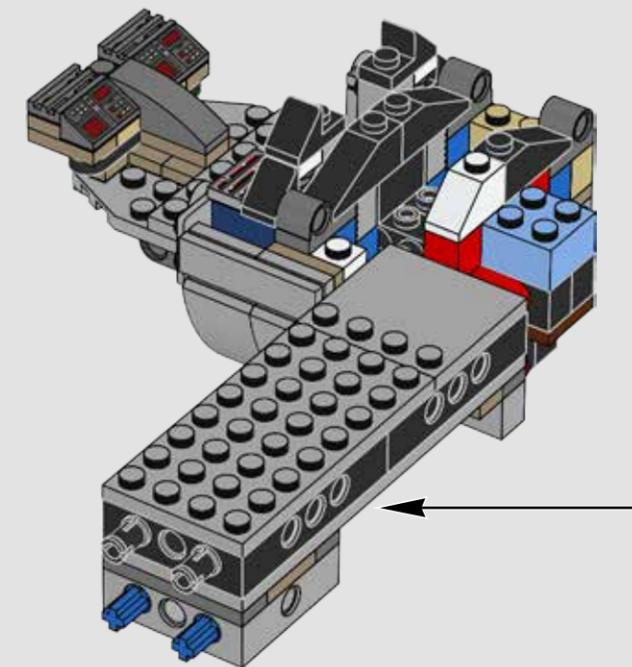

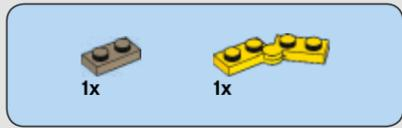

1171

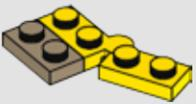

1172

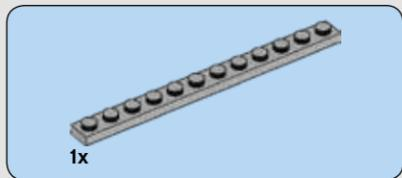
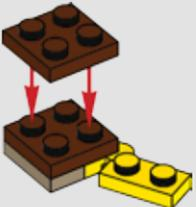

1173

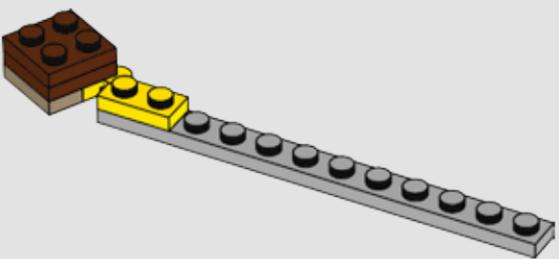

1174

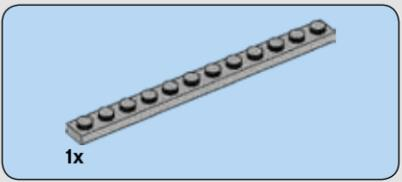
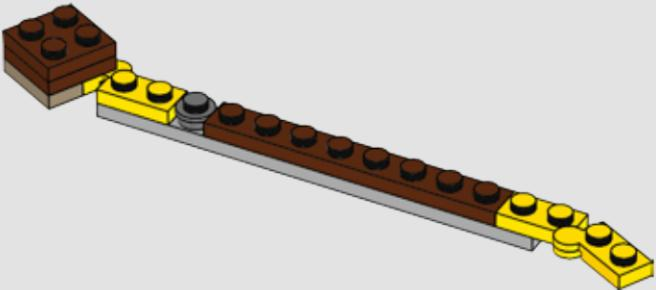

1175

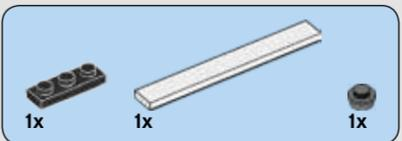
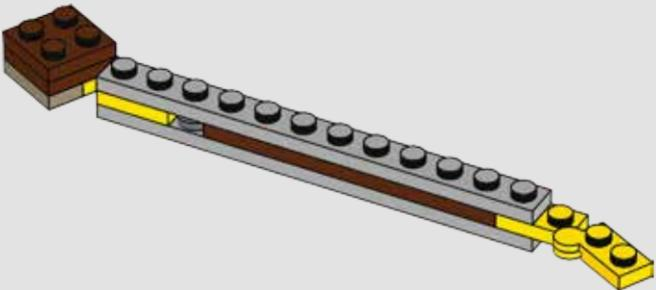

1176

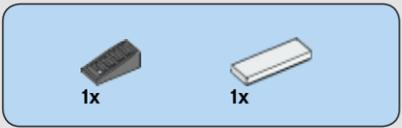
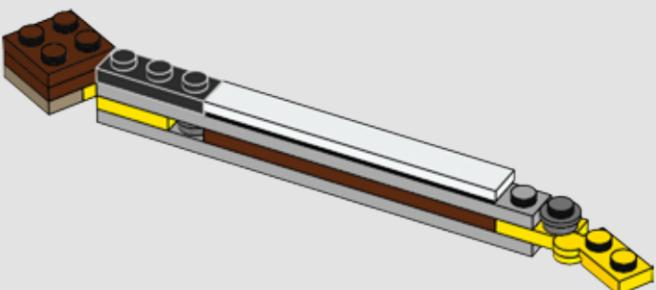

1177

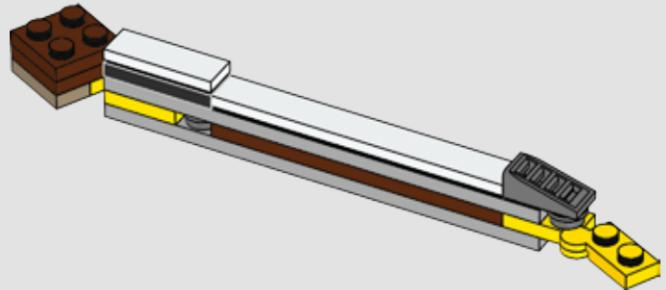

1178

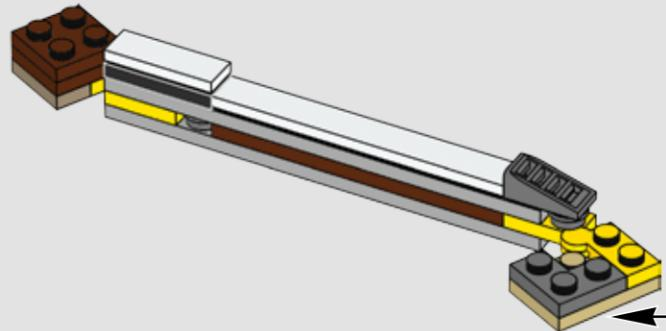

1179

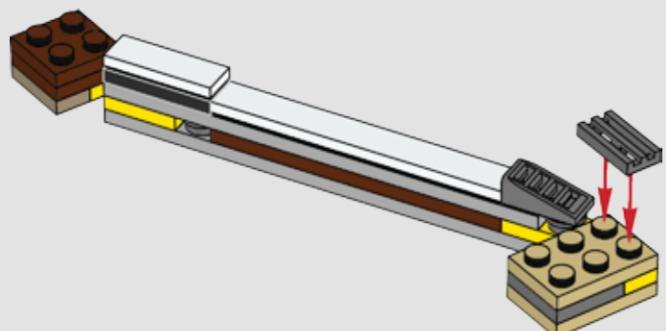

1180

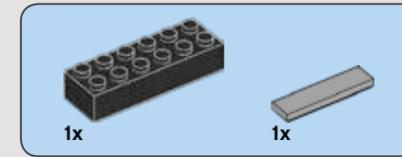
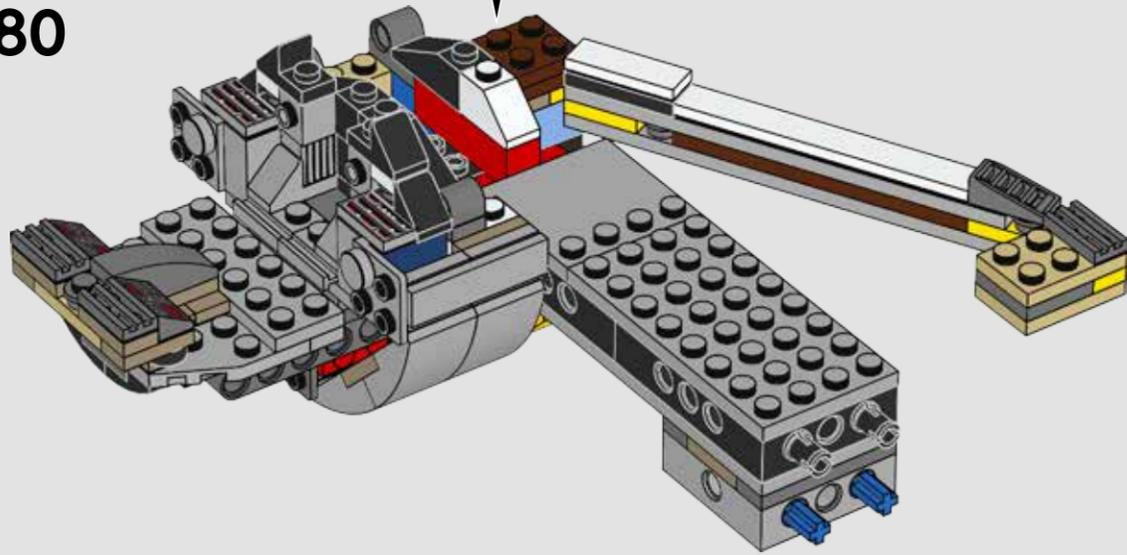

1181

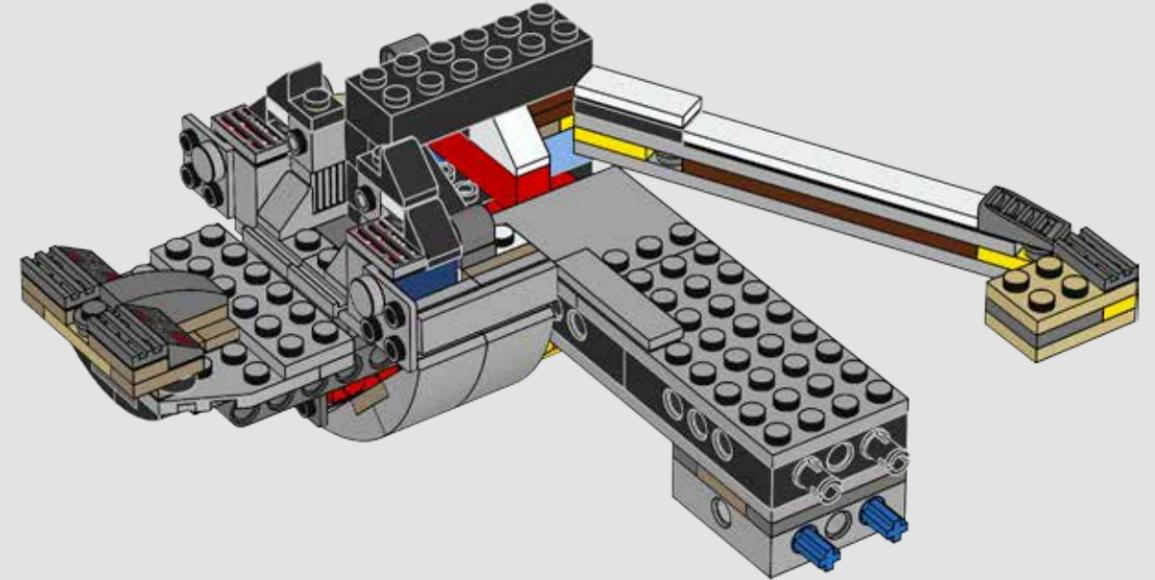

1182

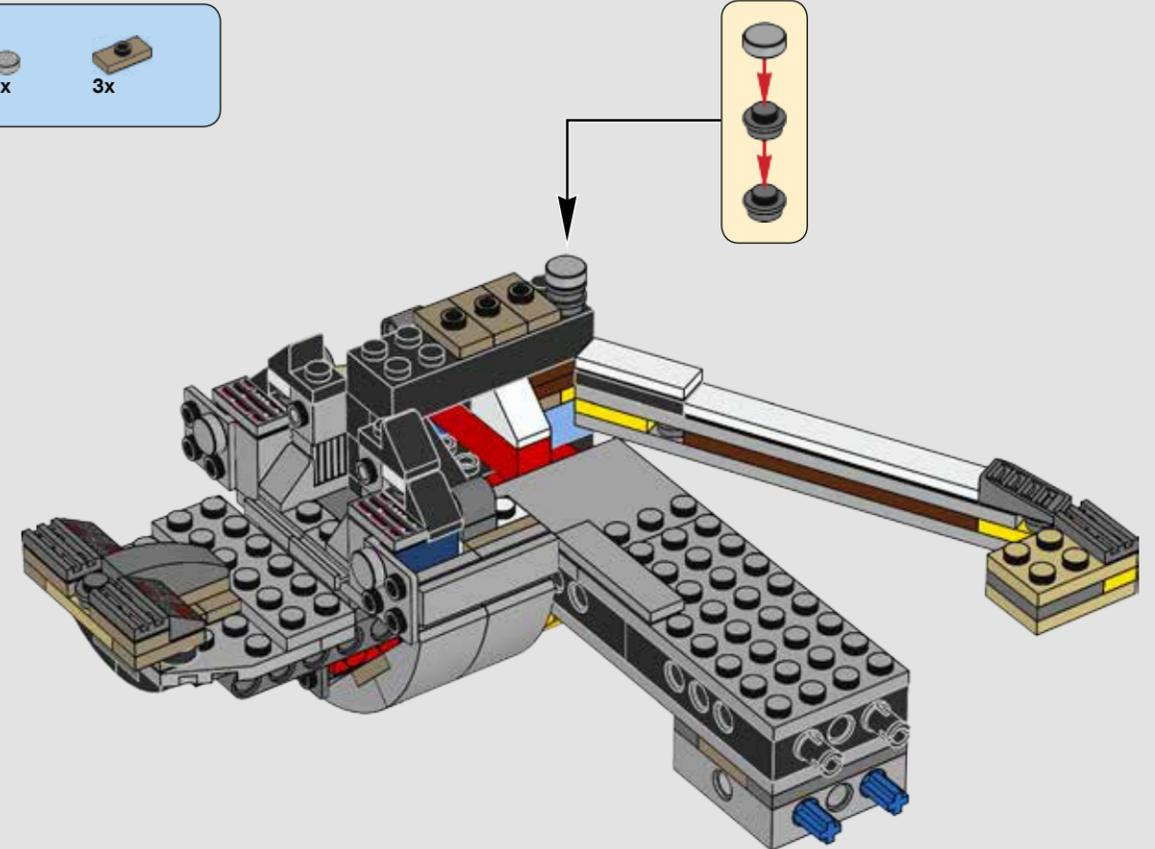

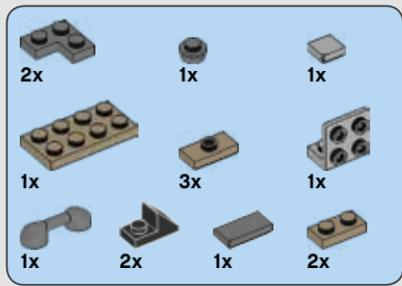

1183

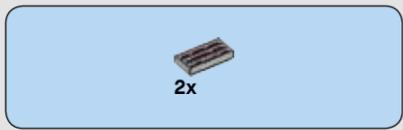
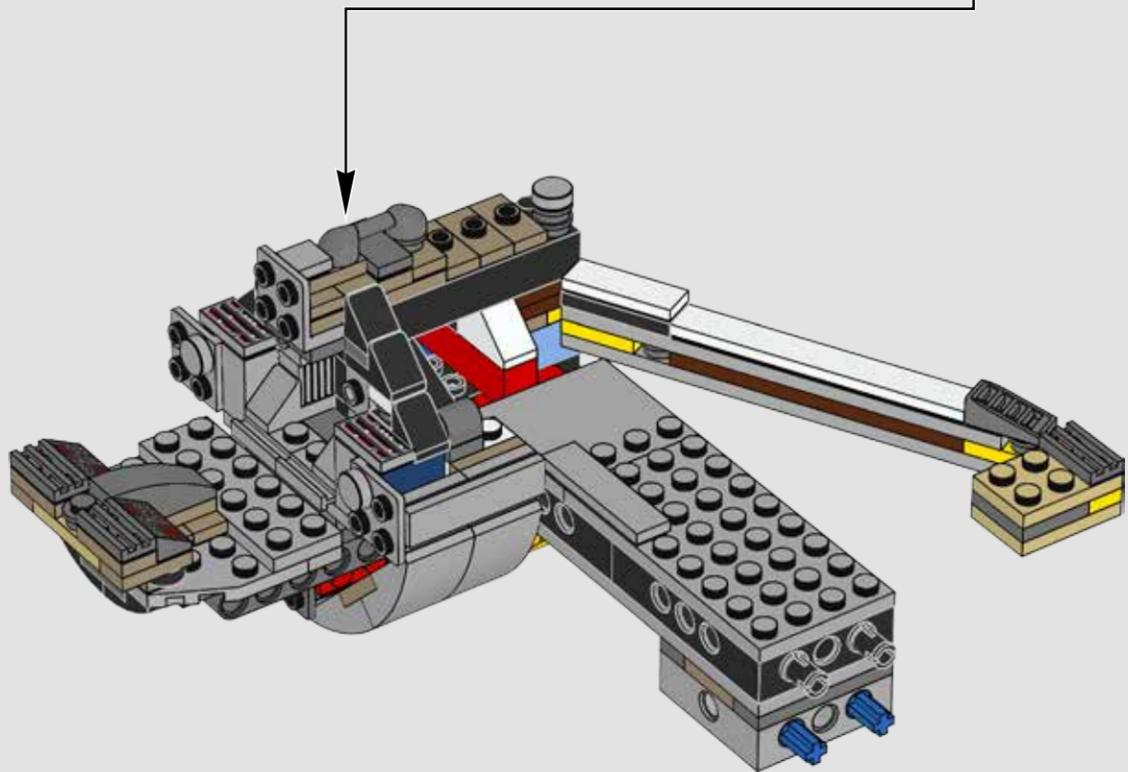
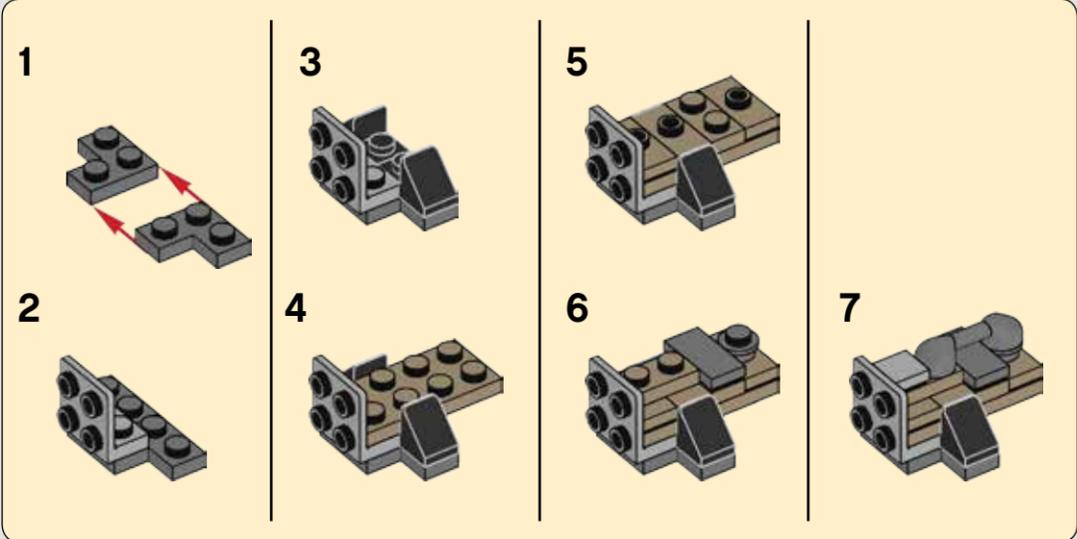

1184

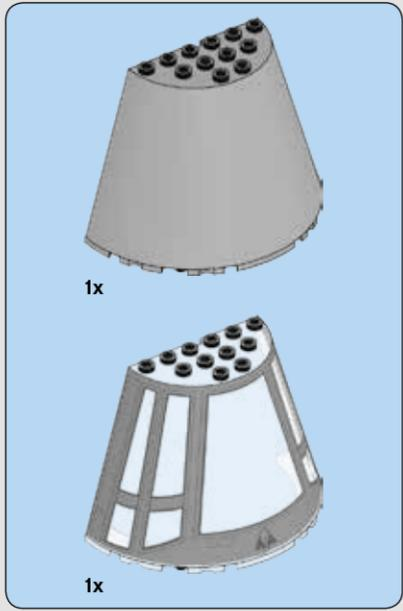
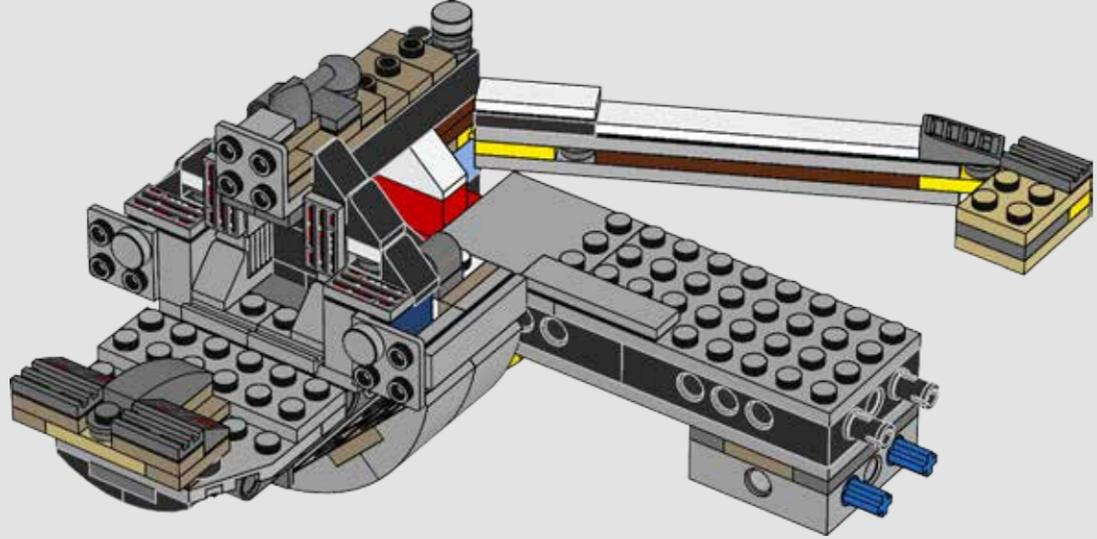

1185

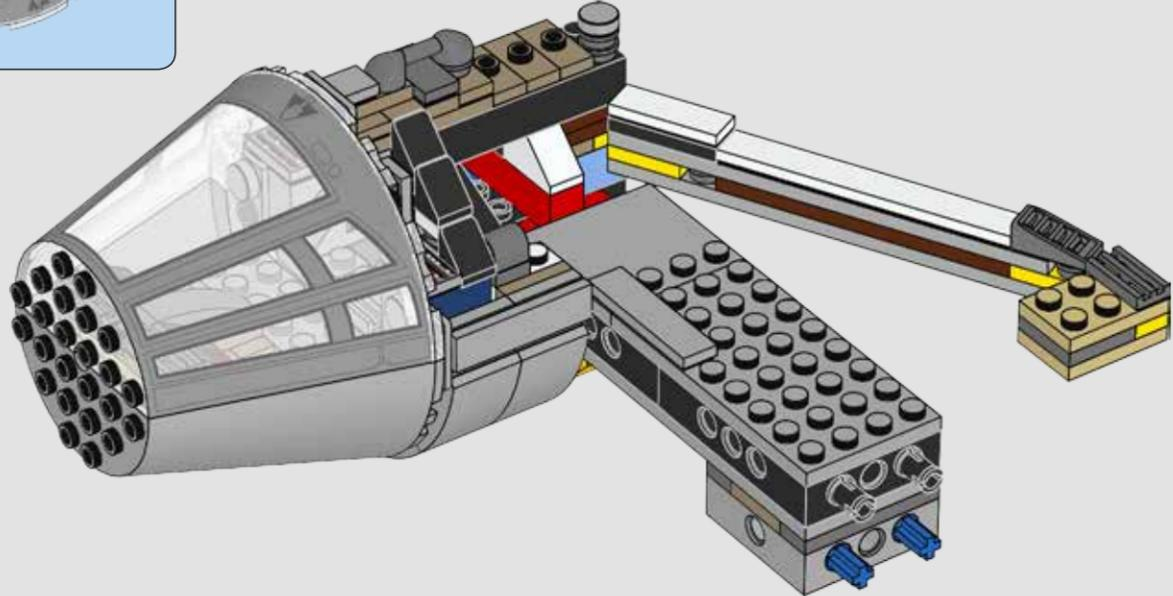



1186

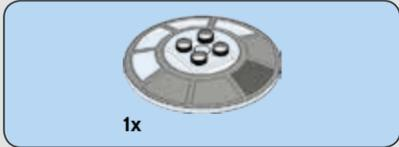
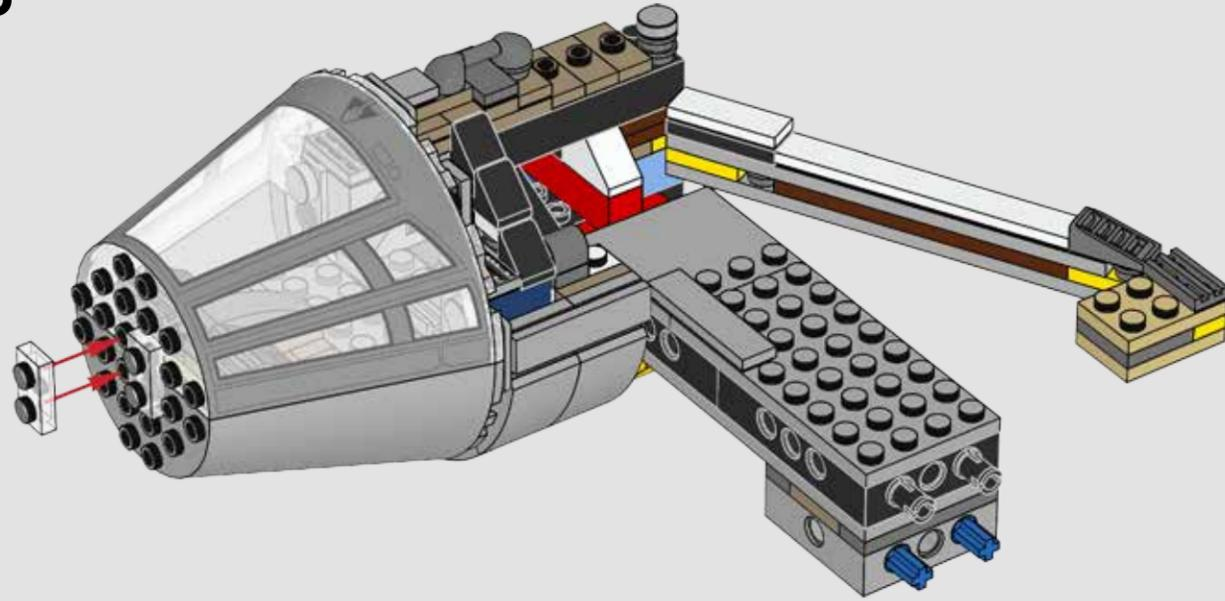

1187

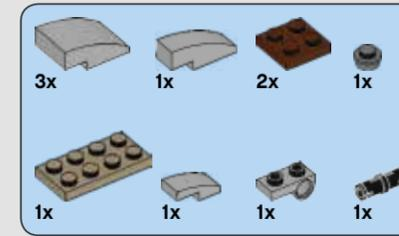
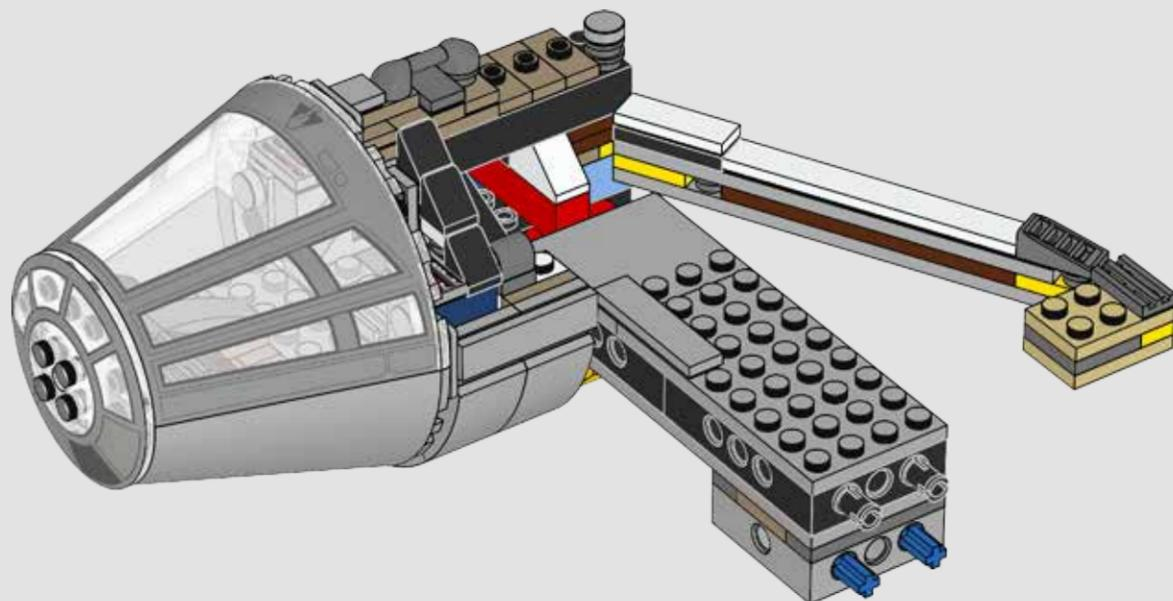

1188

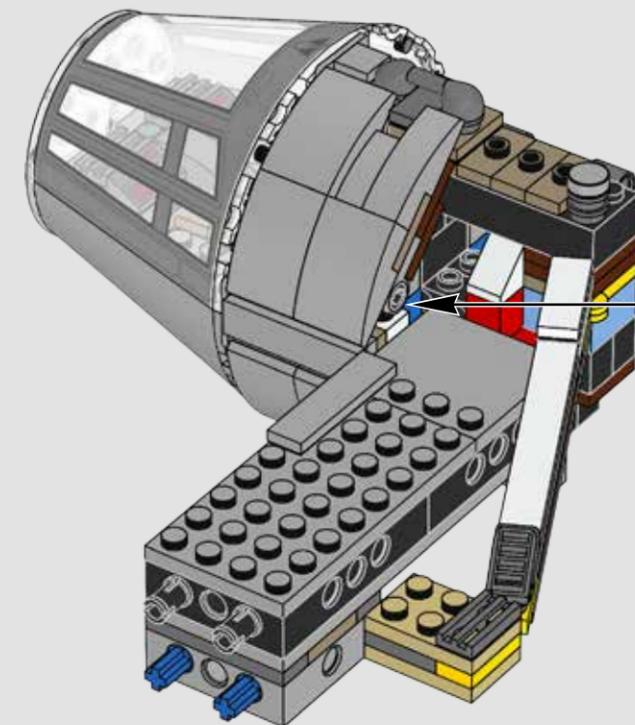
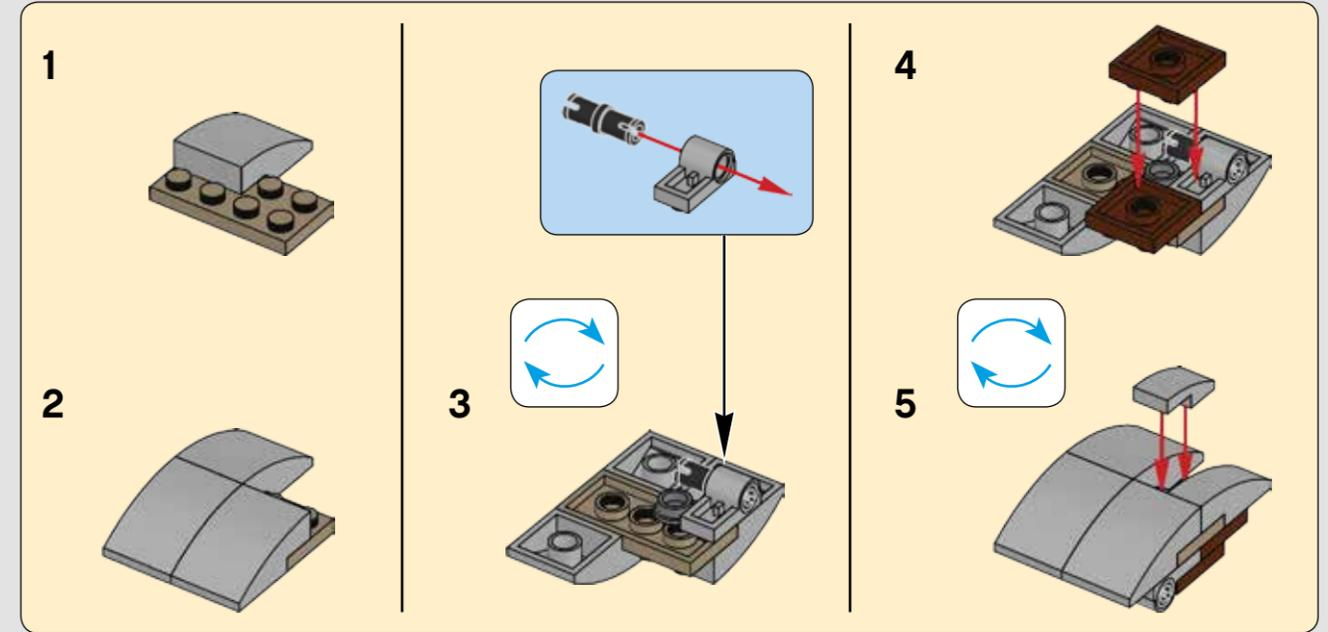



1189

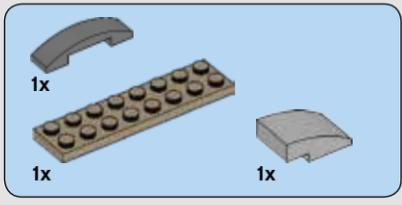
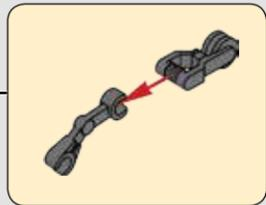
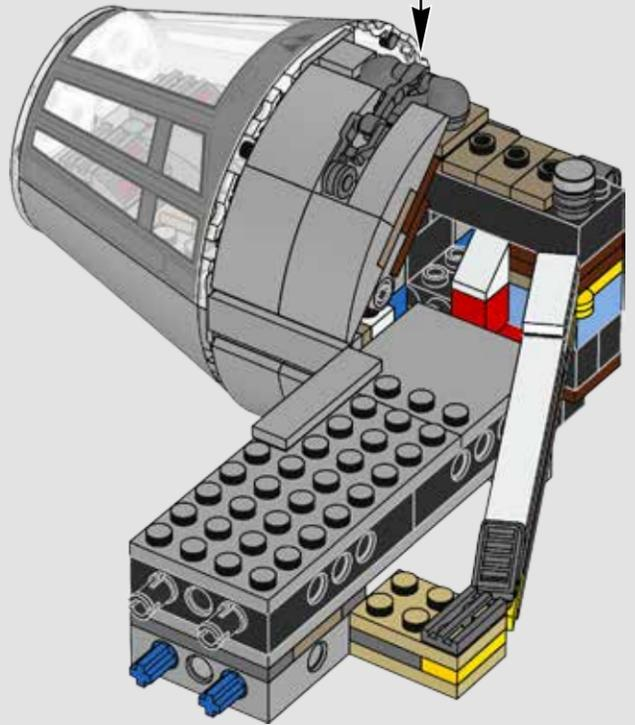

1191

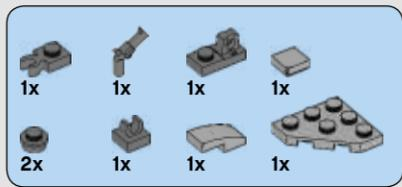
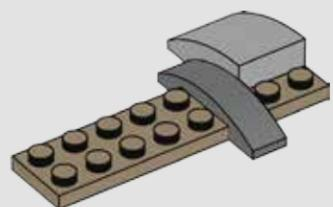

1190

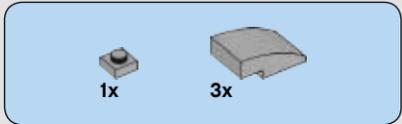
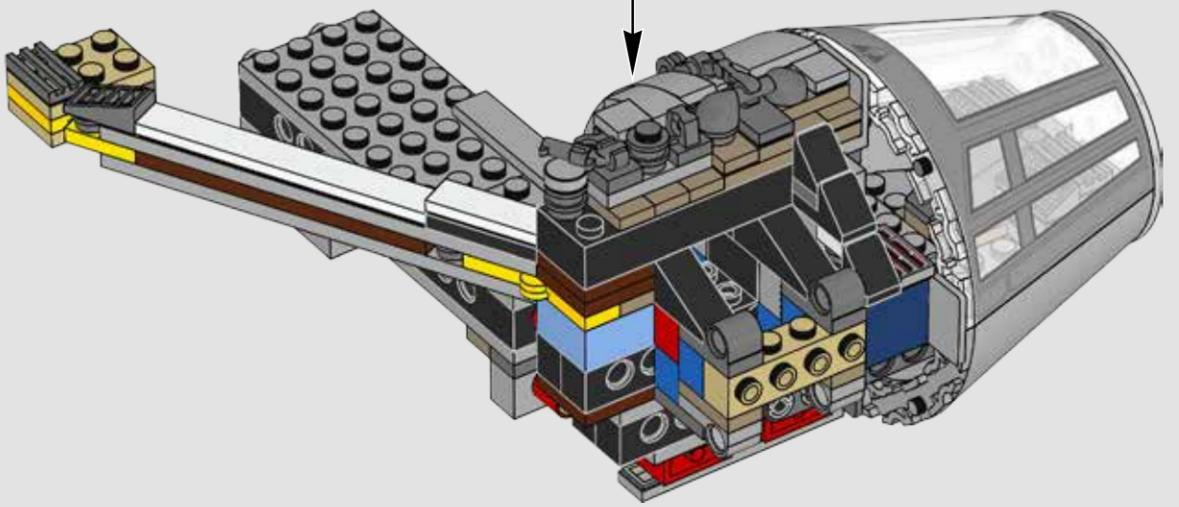
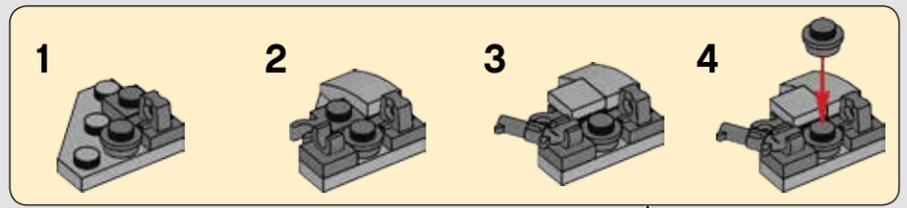

1192

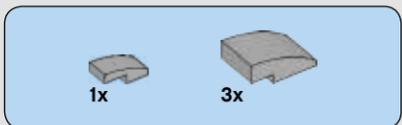
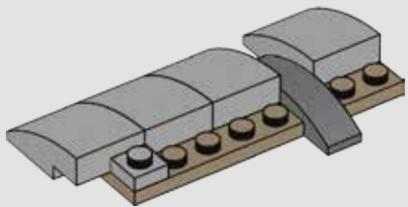

1193

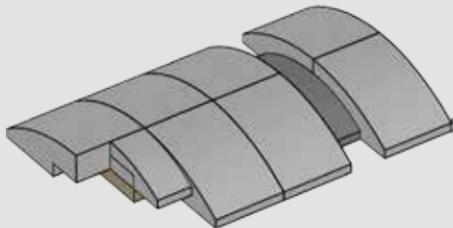

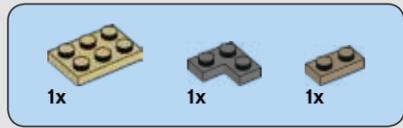

1194

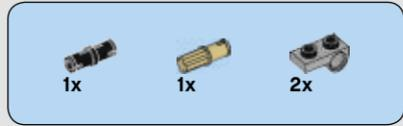
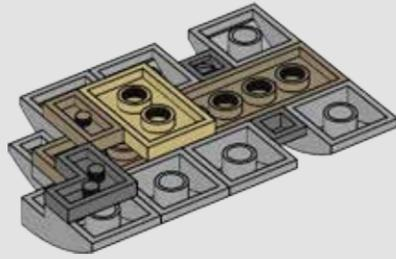

1195

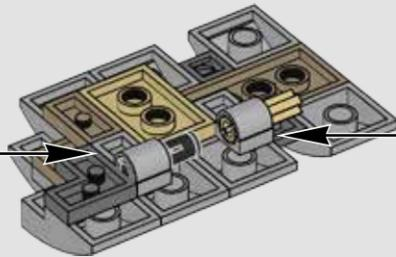
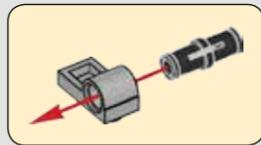
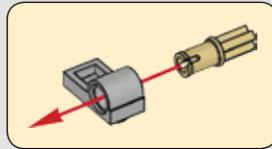

1196

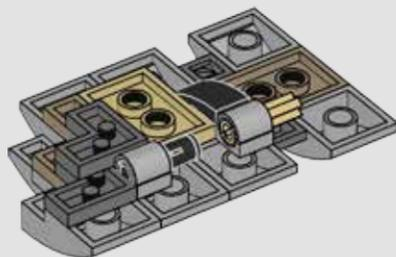

1197

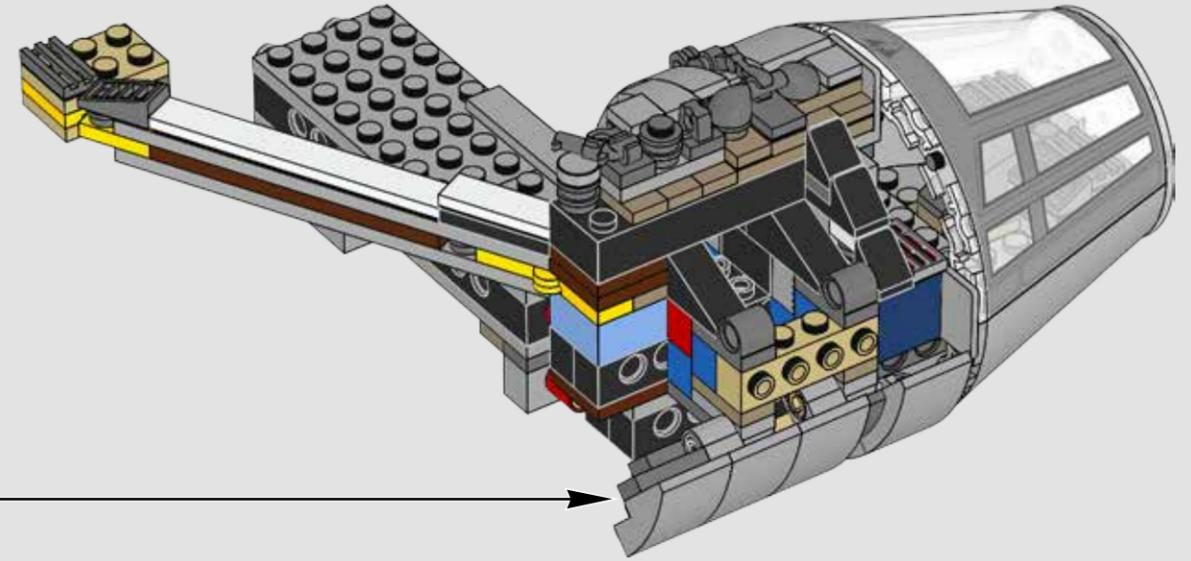

1198

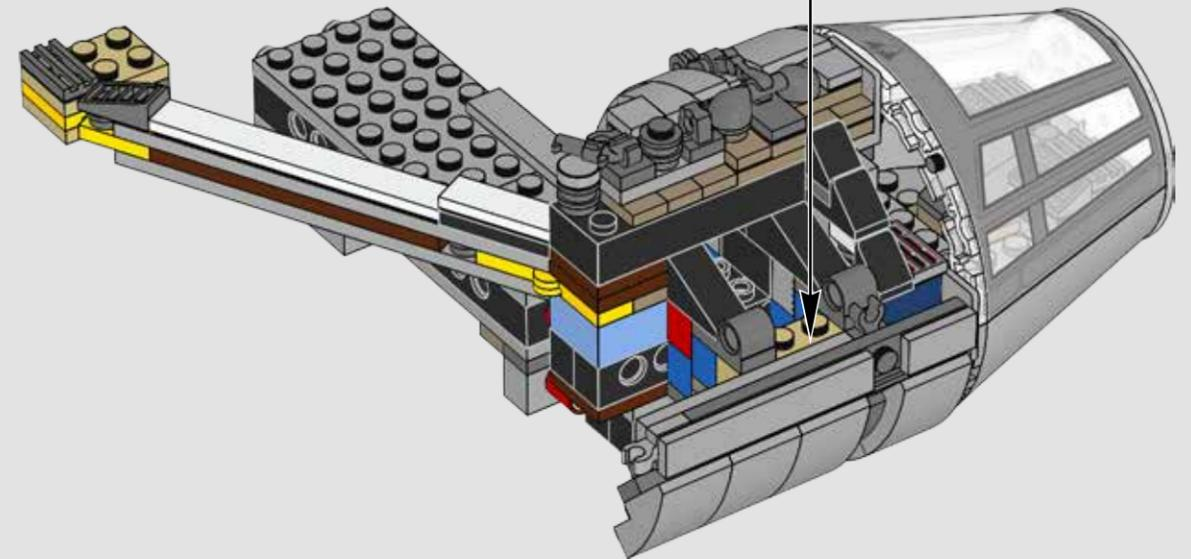
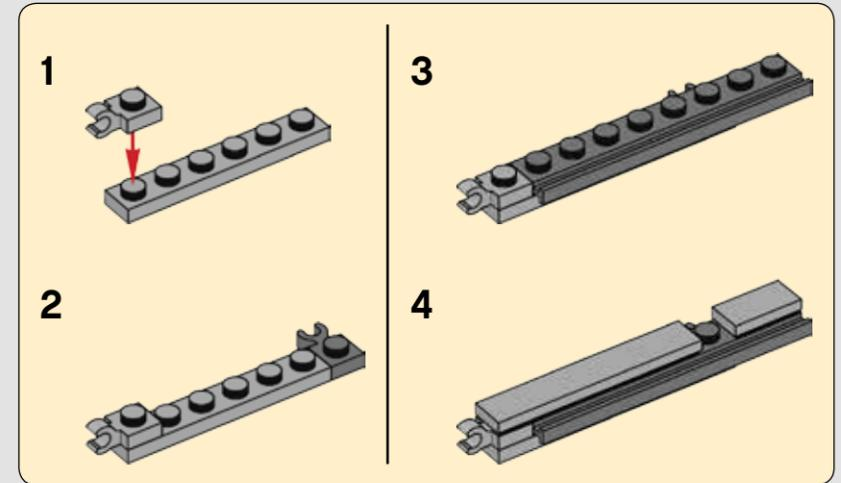
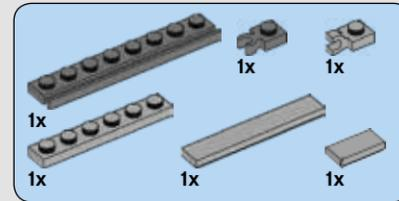

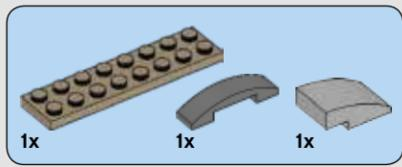

1199

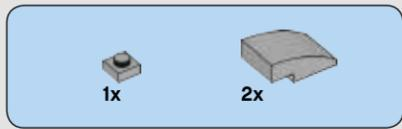
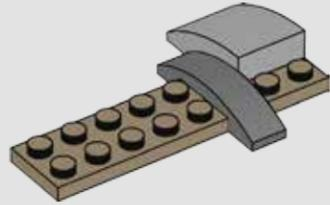

1200

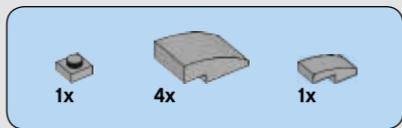
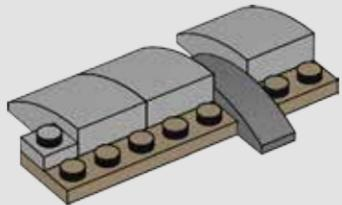

1201

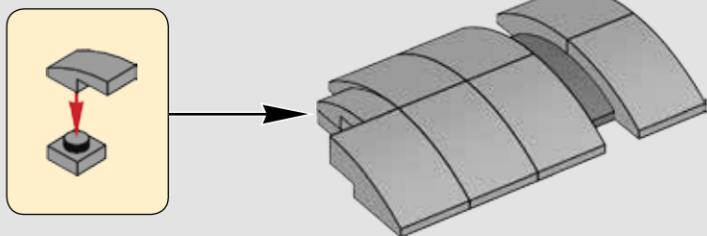

1202

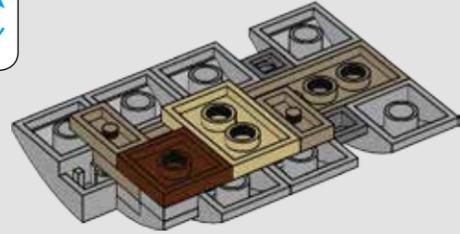

1203

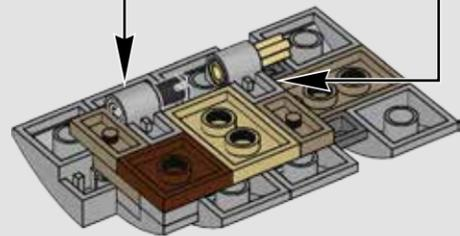
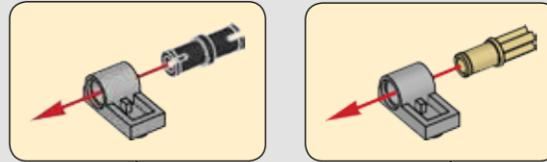

1204

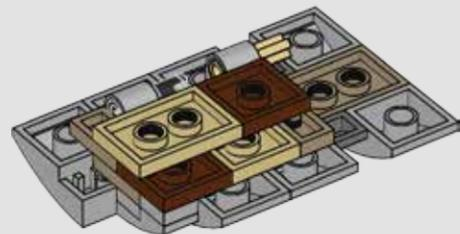

1205

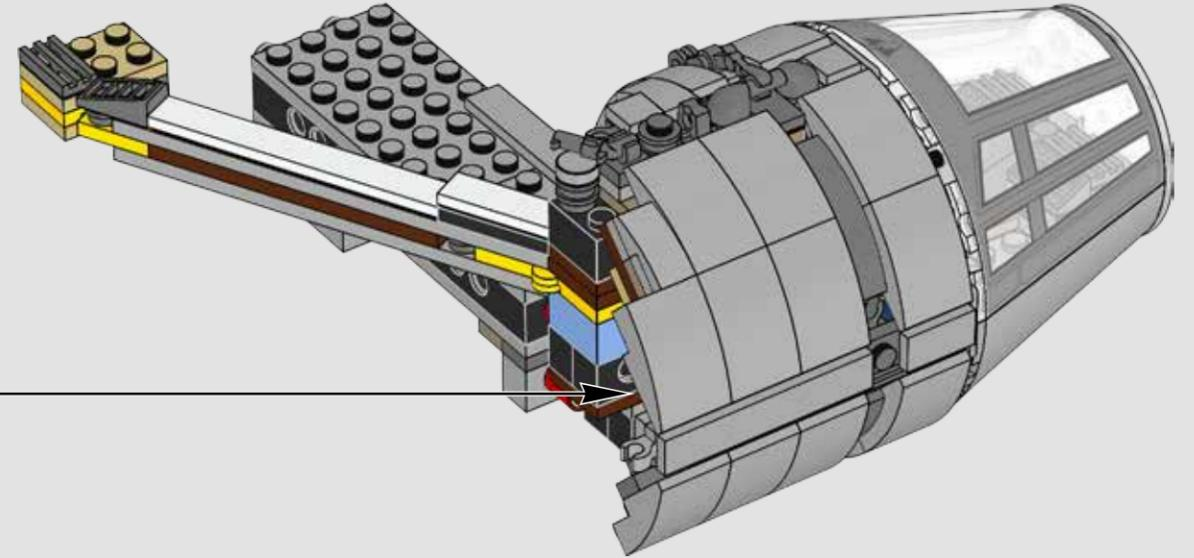

1206

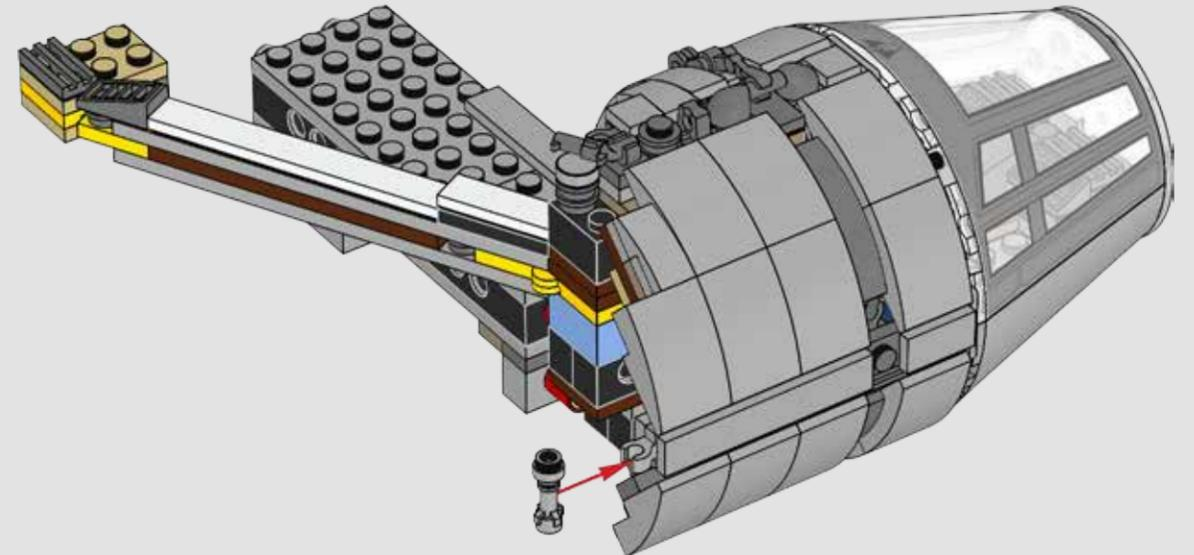

1207

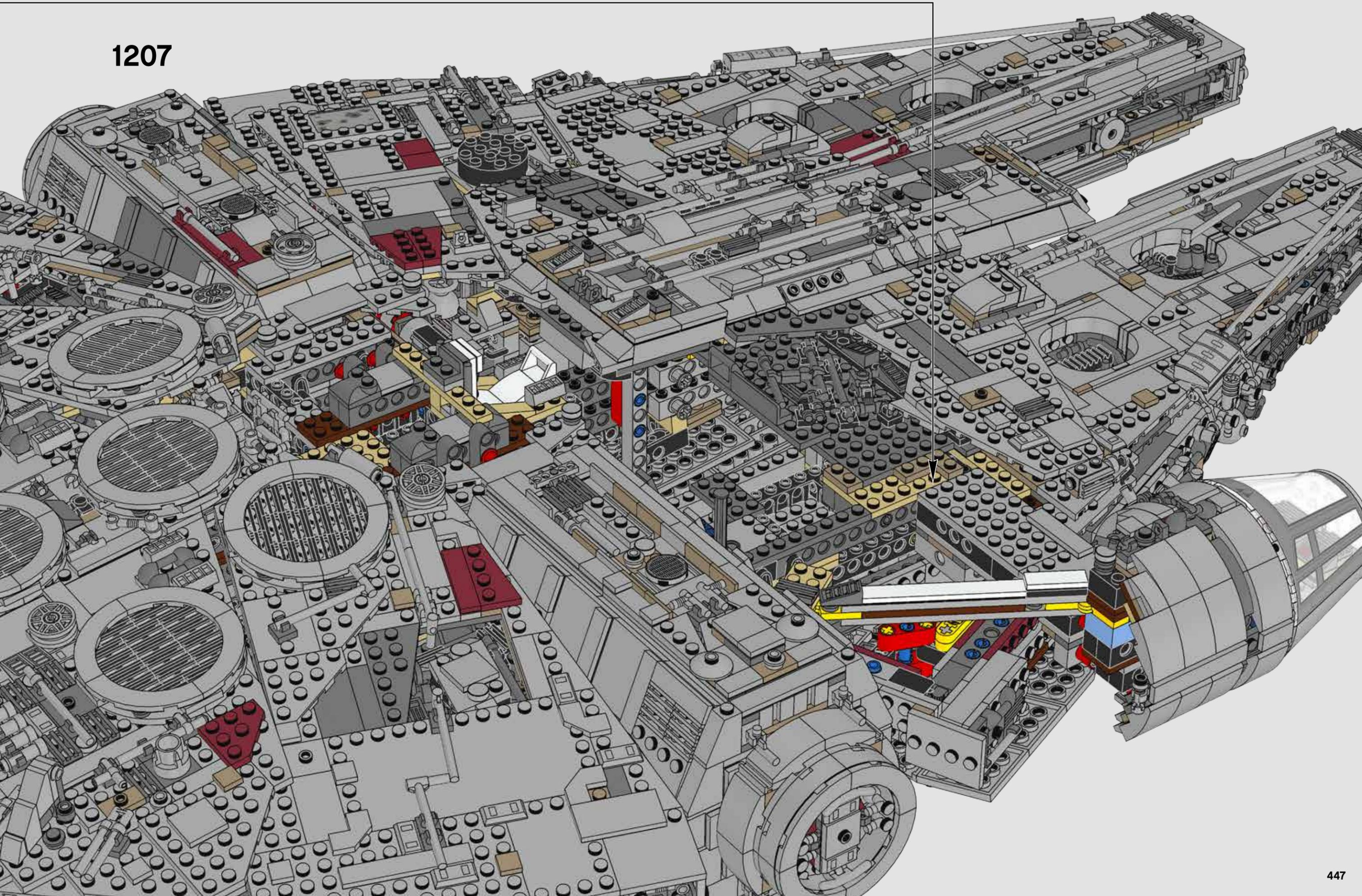

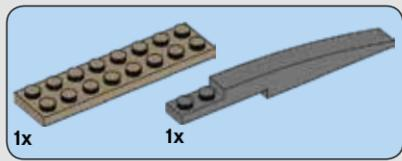

1x

1x

1208

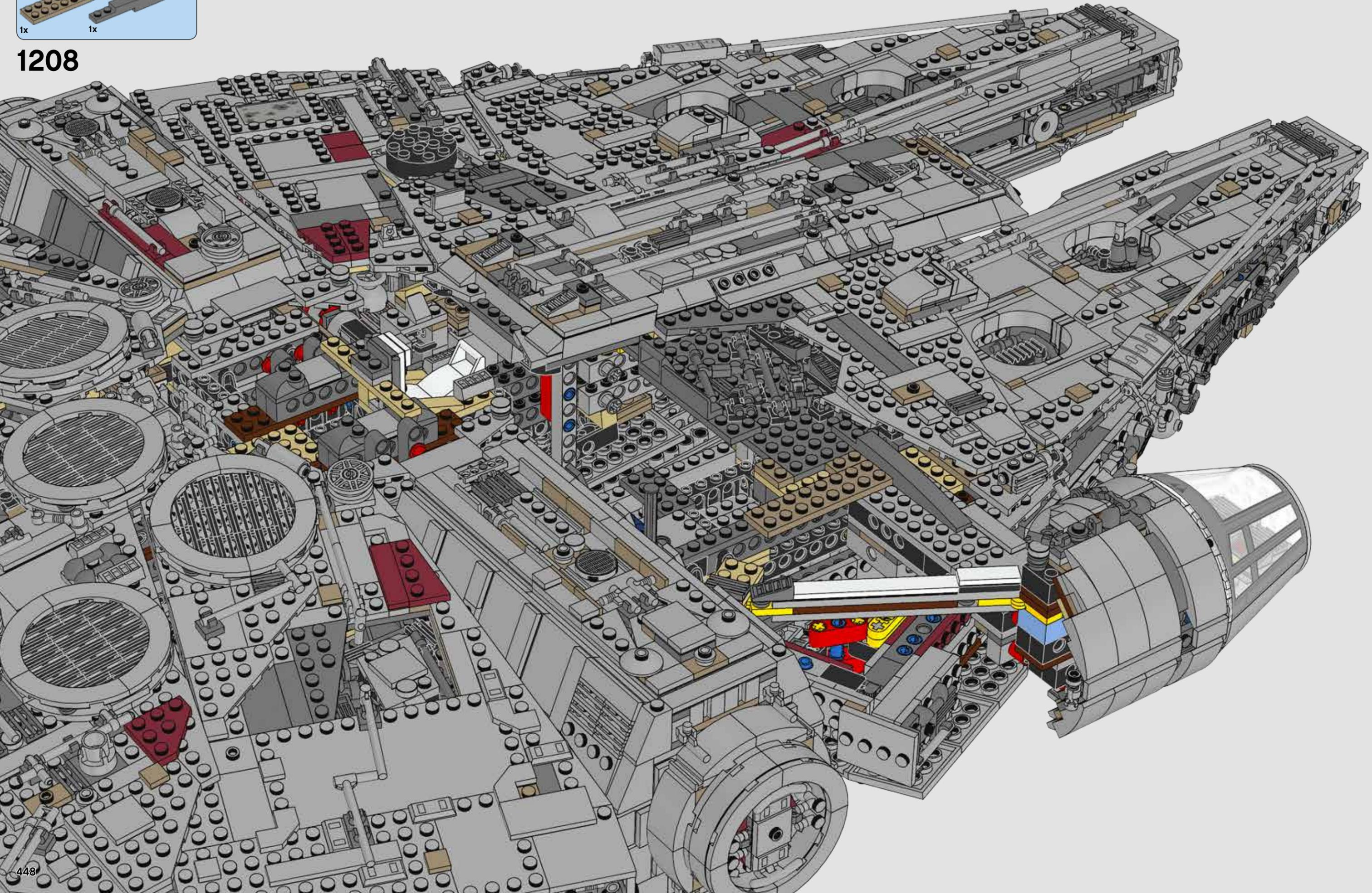

1209

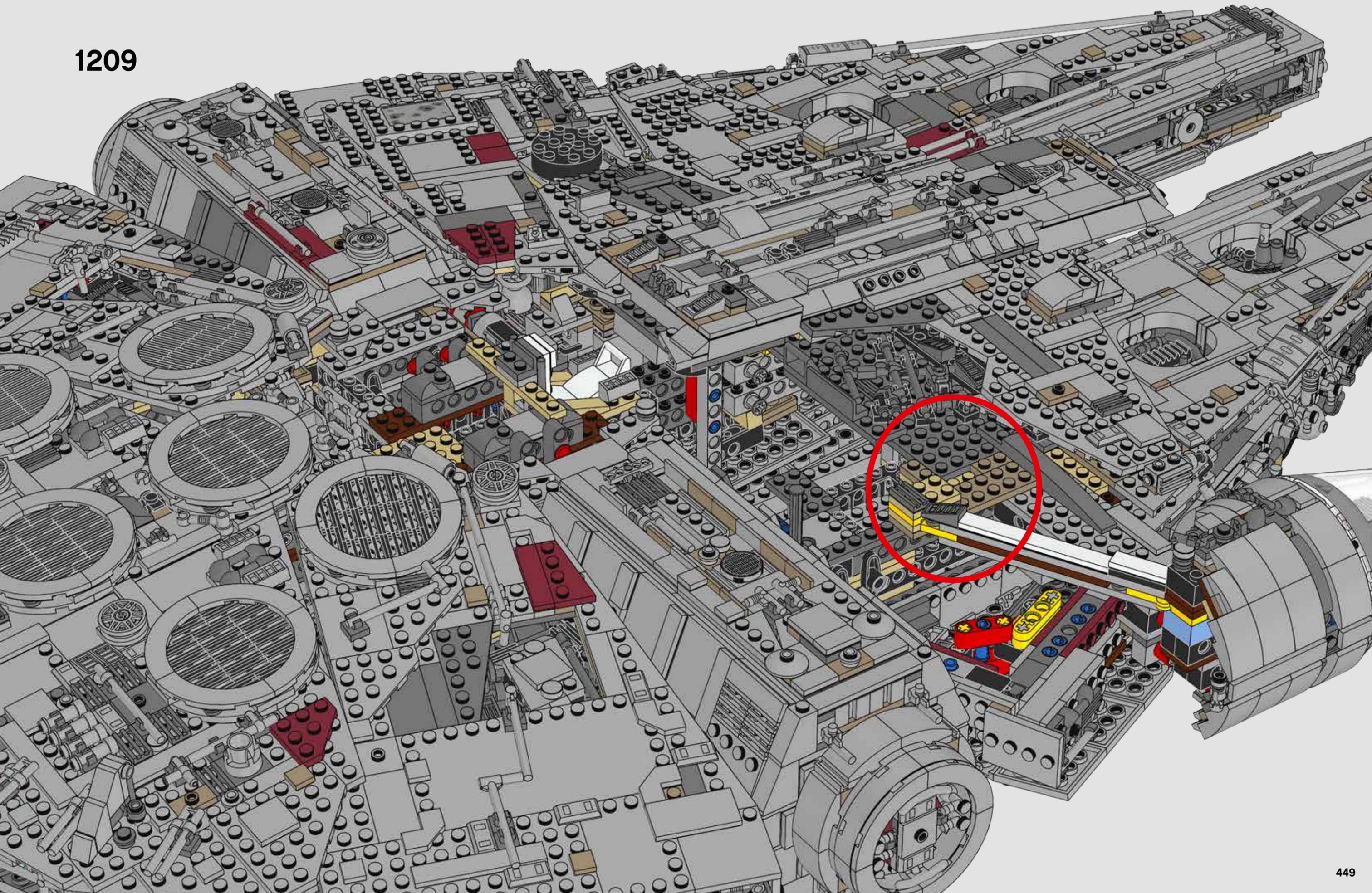

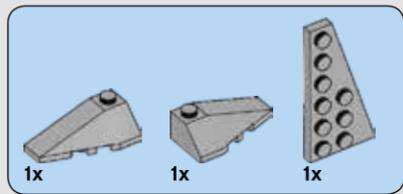

1218

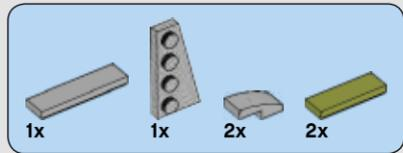
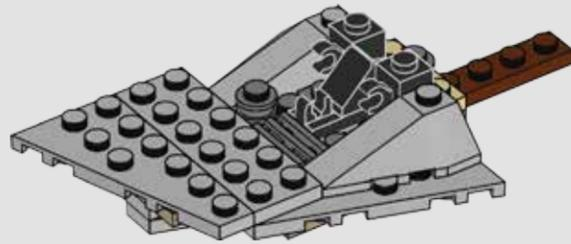

1219

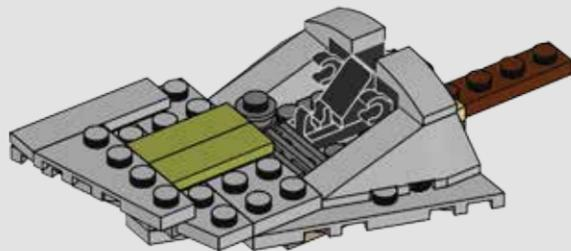

1220

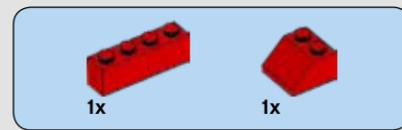
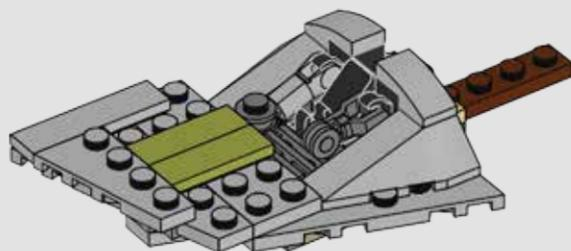

1221

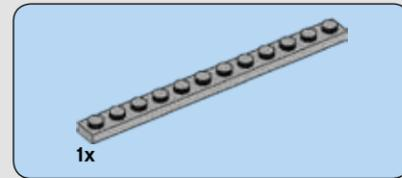
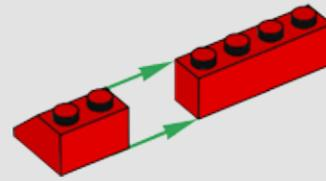

1222

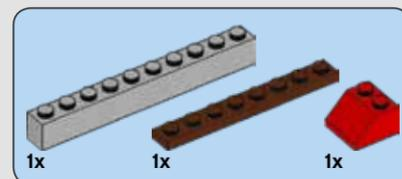
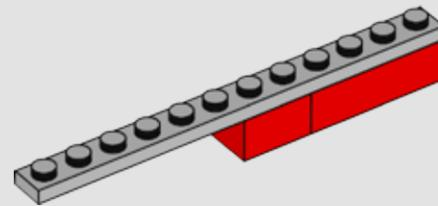

1223

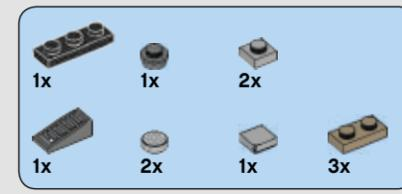
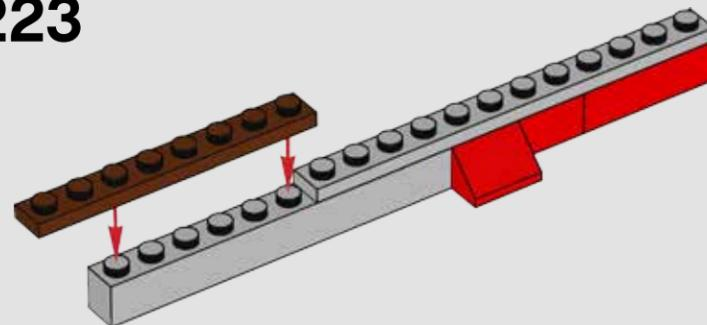

1224

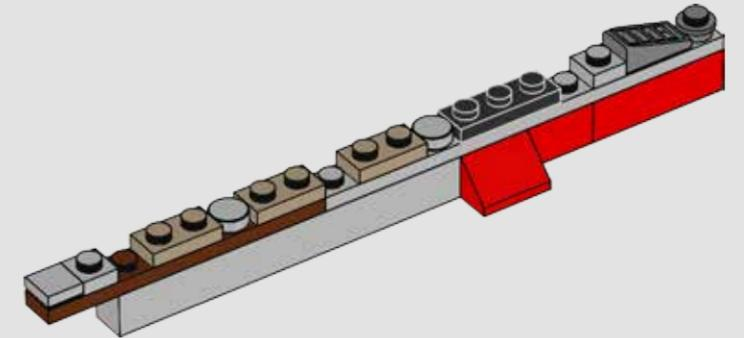

1225

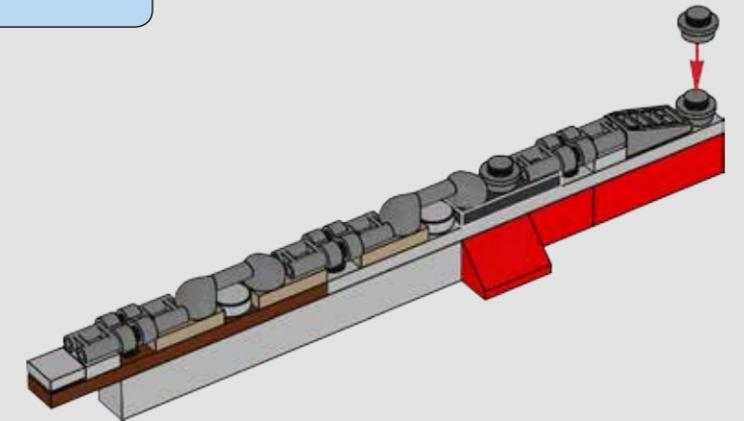

1226

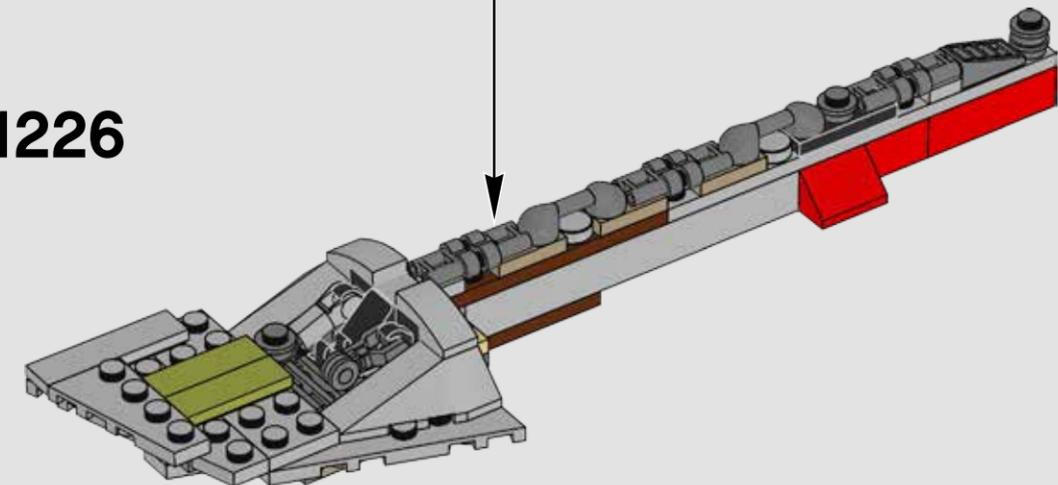

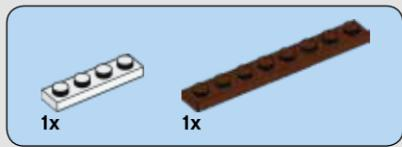

1227

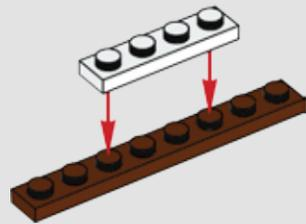

1228

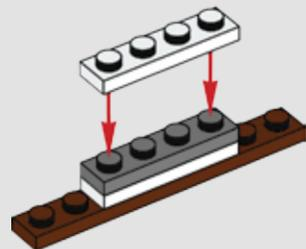

1229

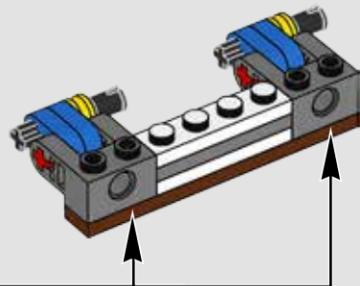
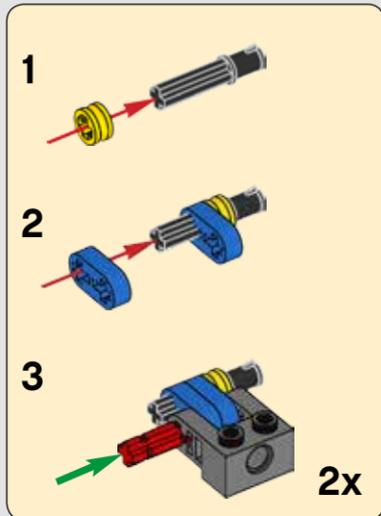

1230

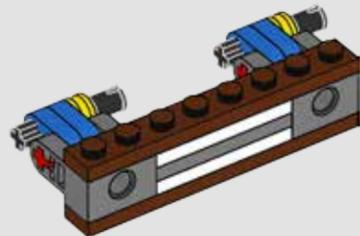

1231

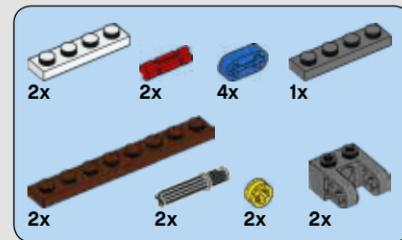
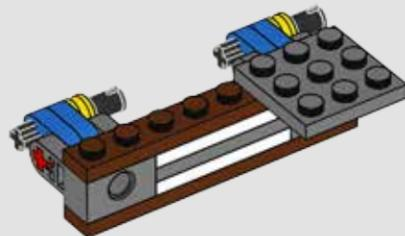

1232

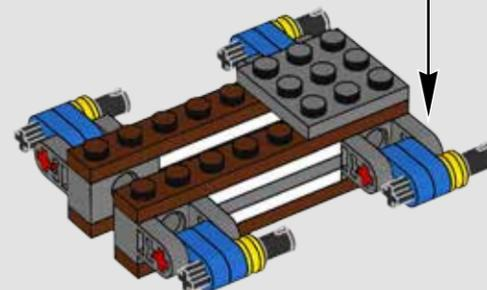
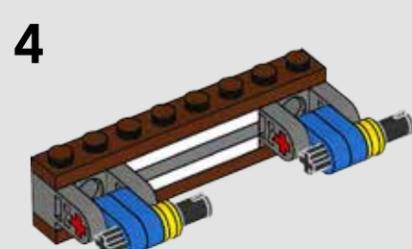
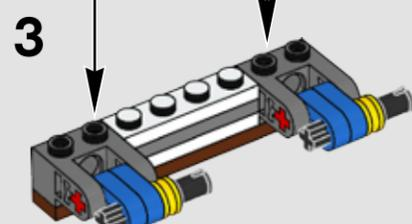
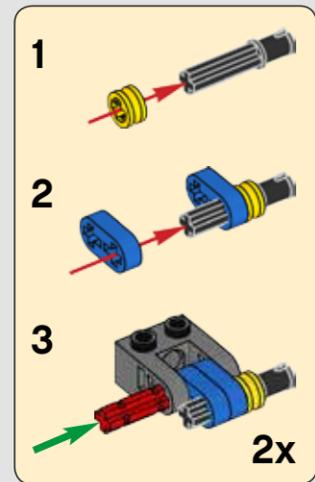
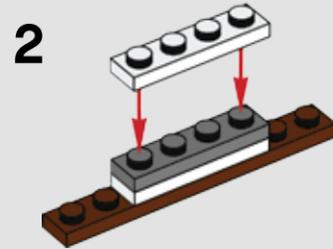
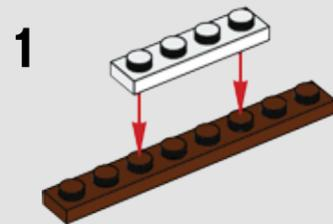

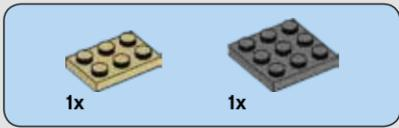

1233

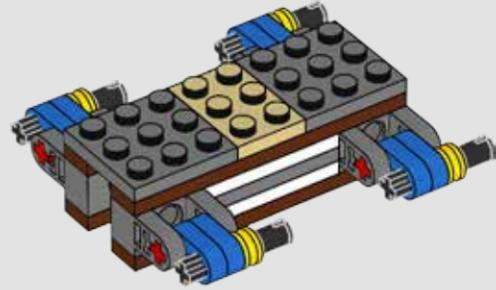

1235

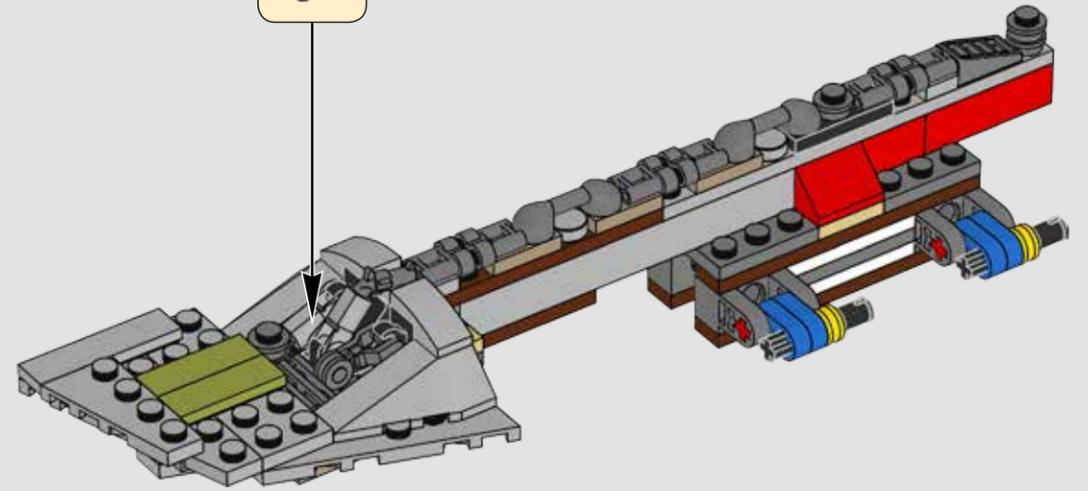
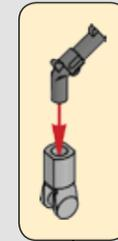

1234

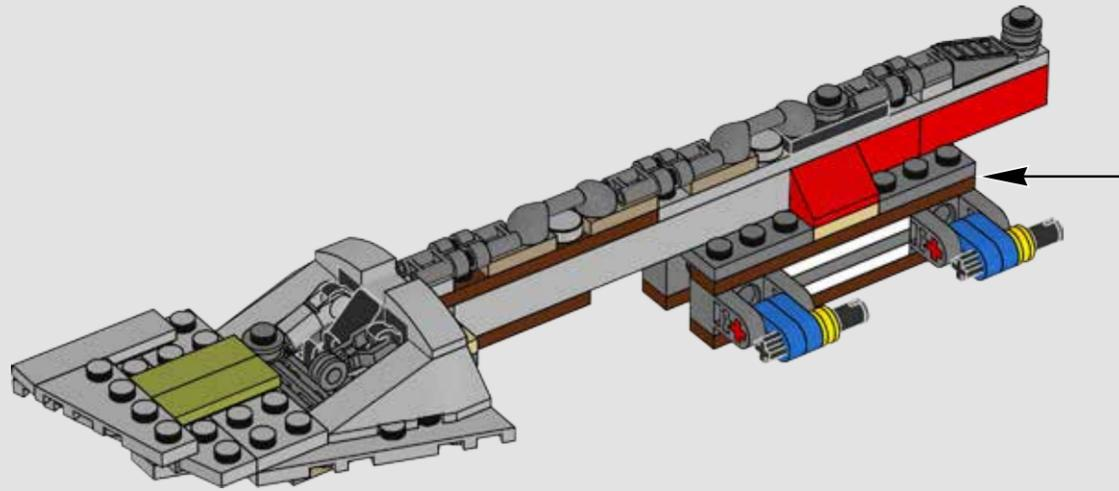

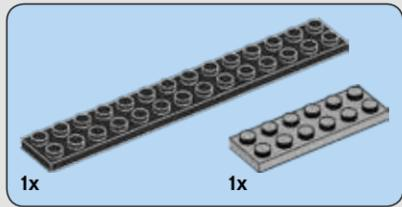

1236

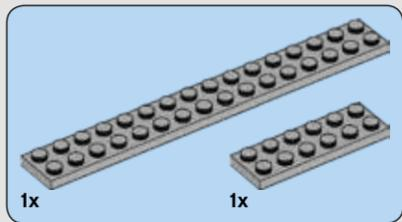
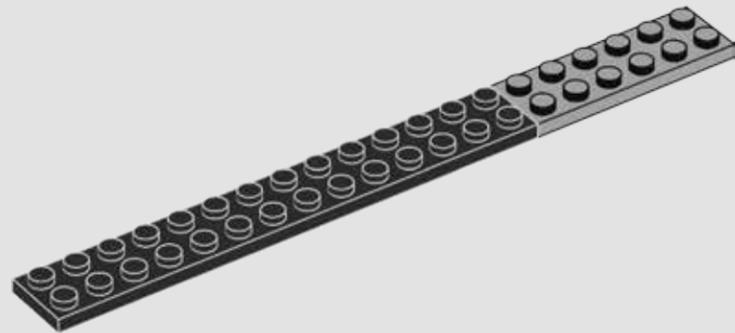

1237

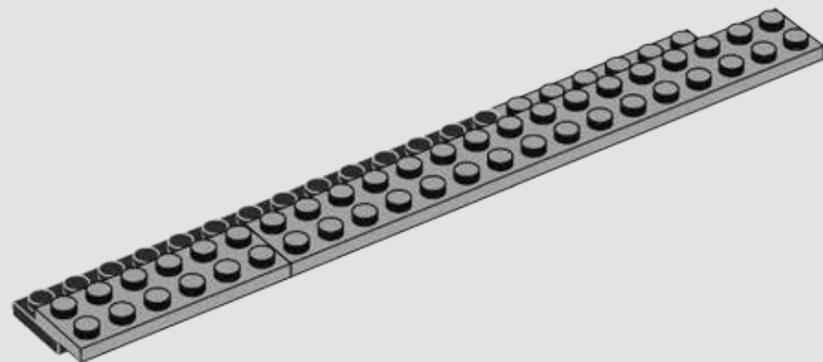

1238

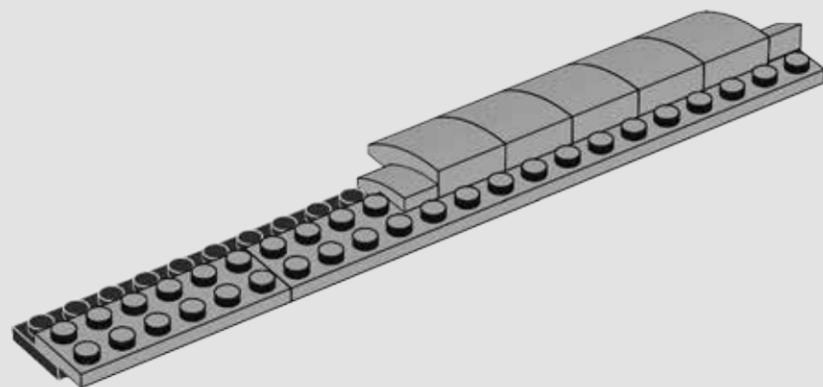

1239

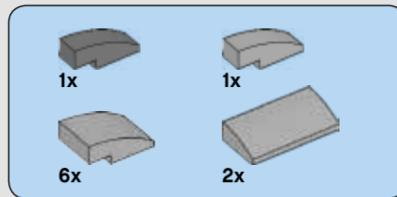
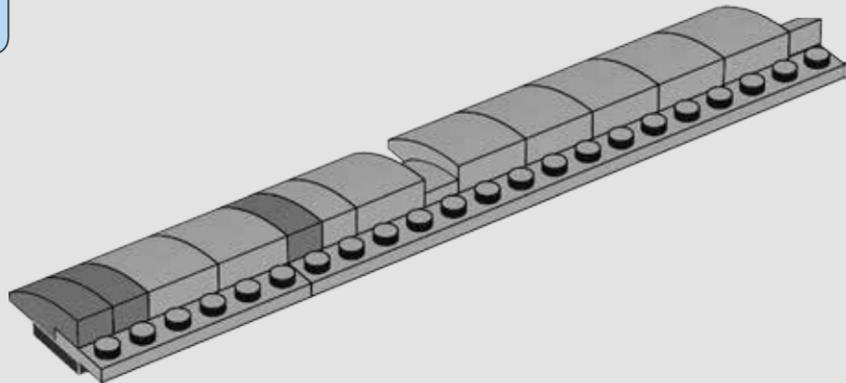

1240

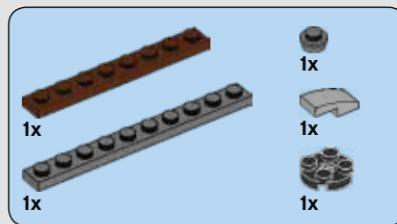
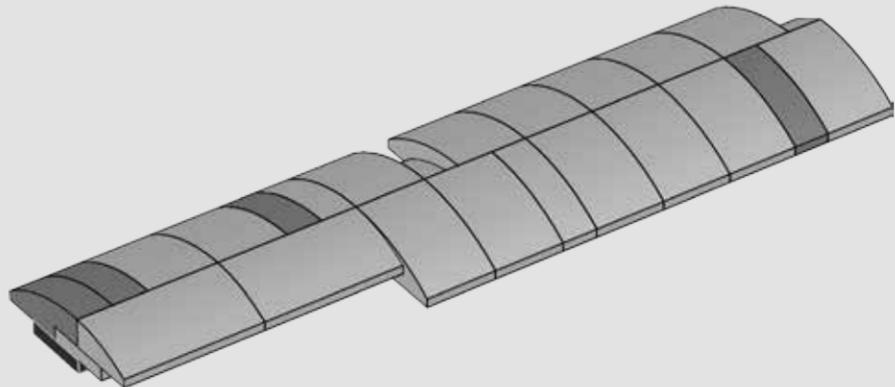

1241

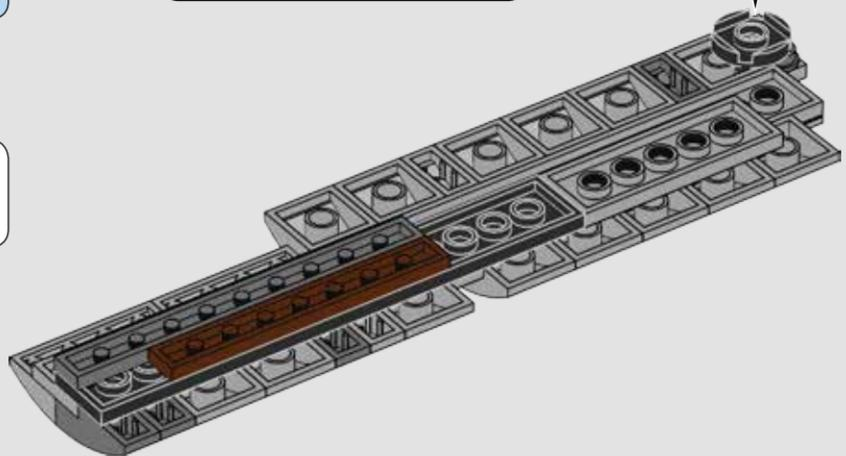
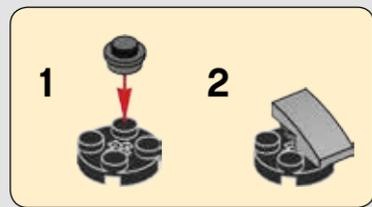

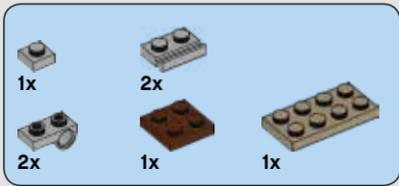

1242

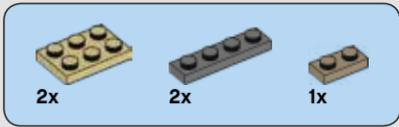
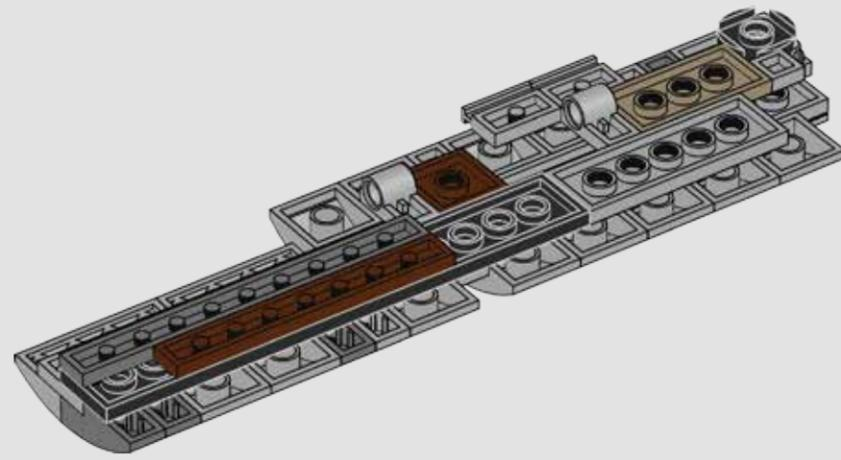

1243

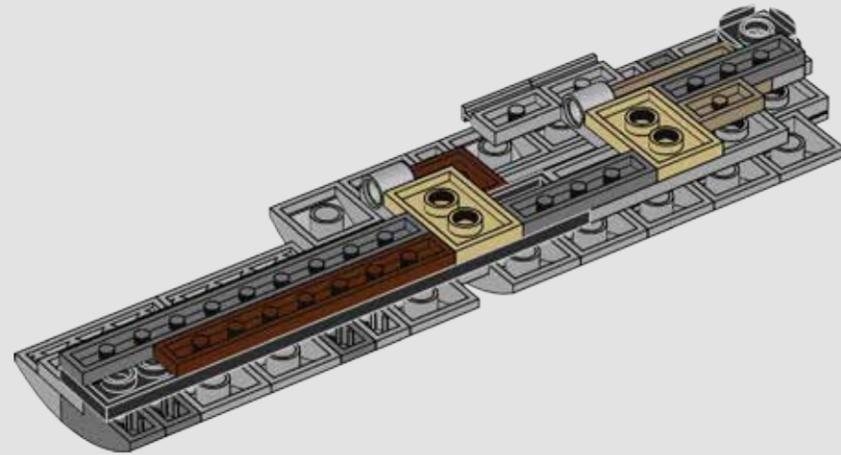

1244

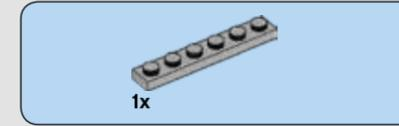
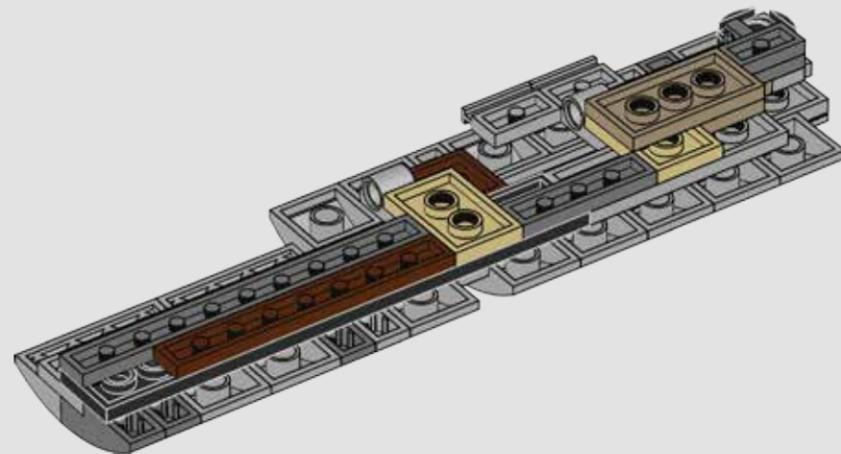

1245

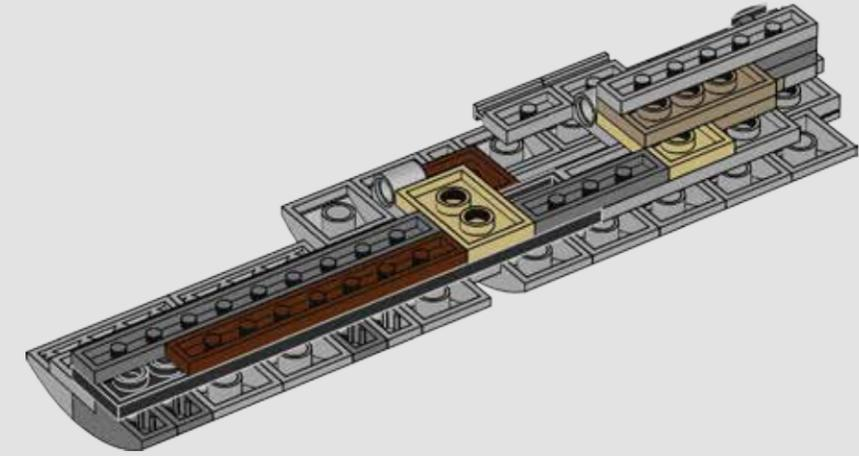

1246

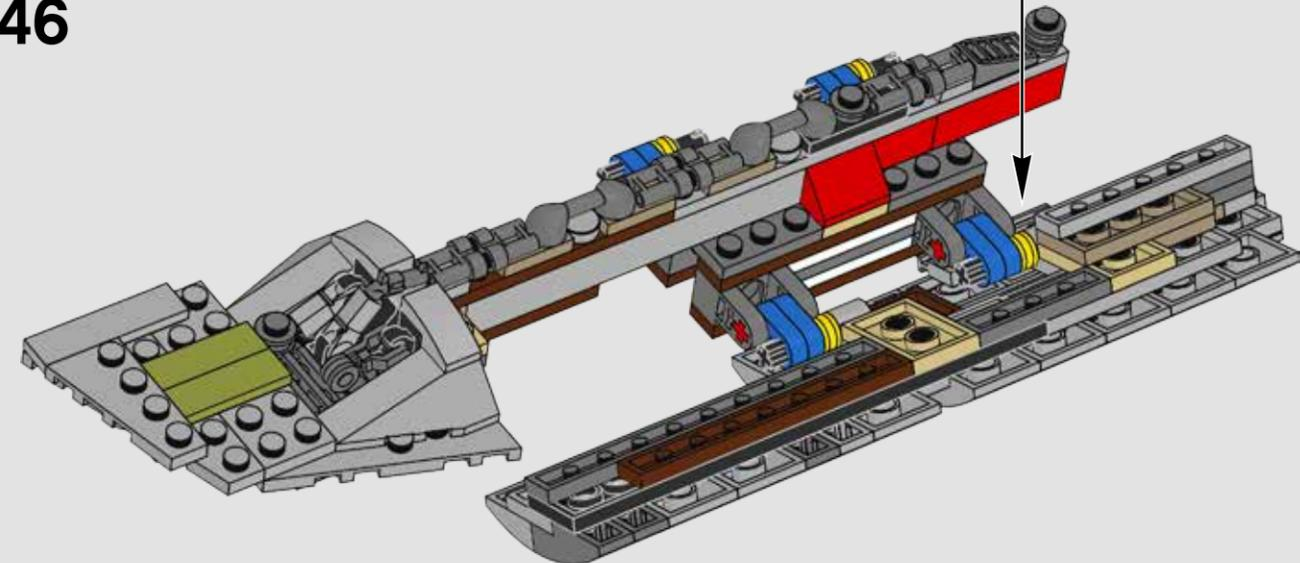

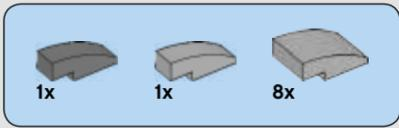

1253

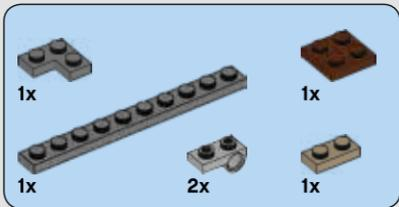
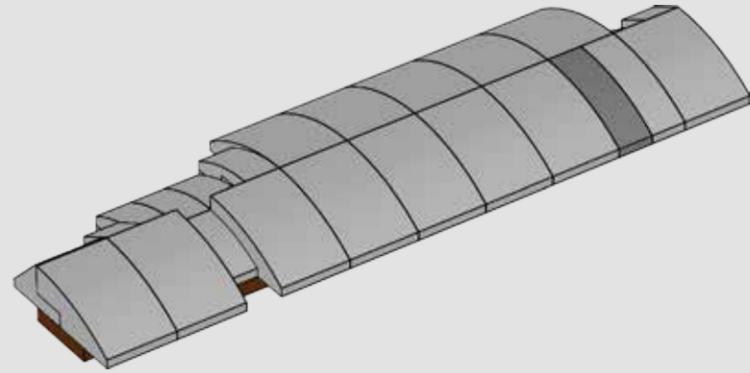

1254

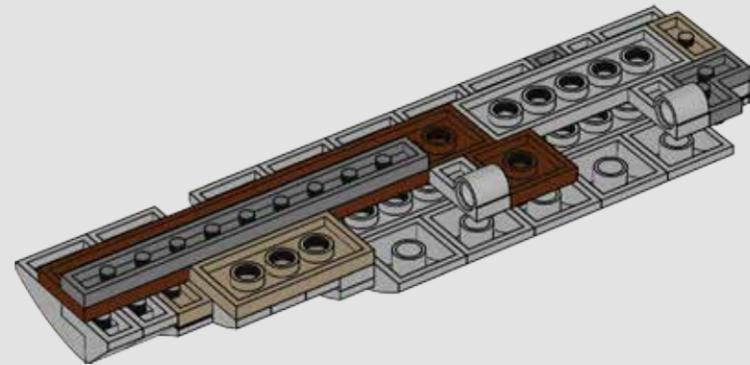

1255

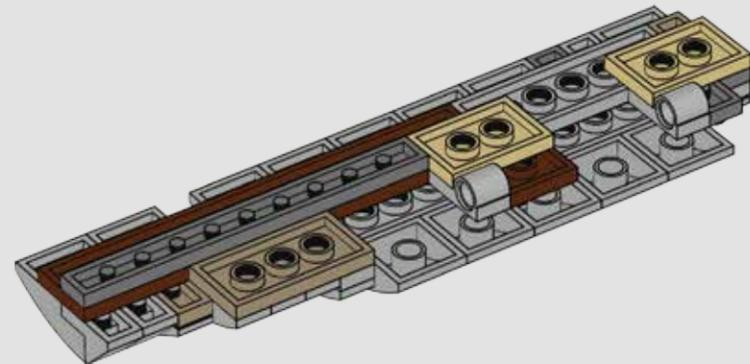

1256

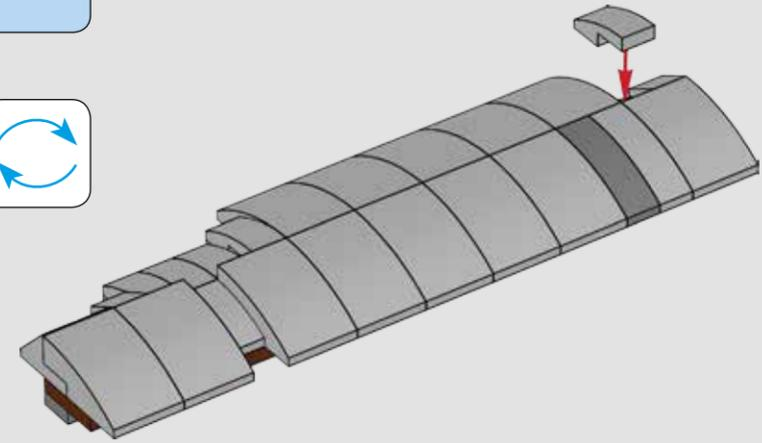

1257

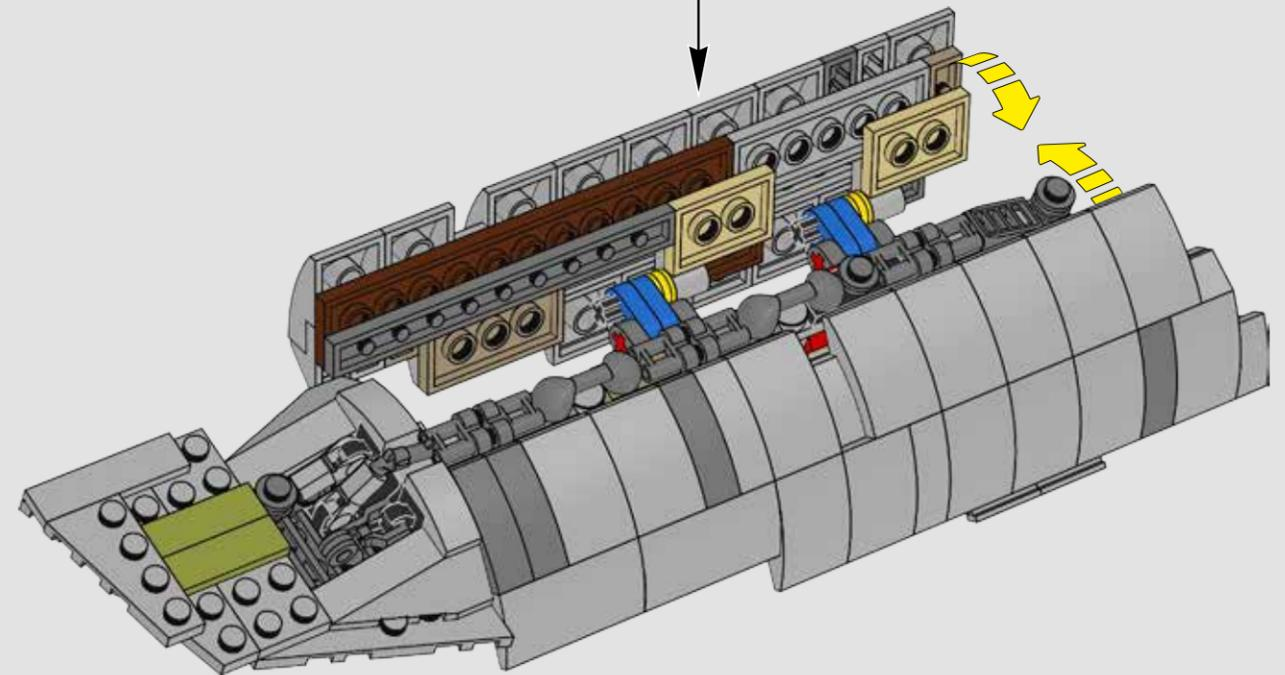

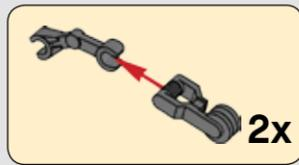

1258

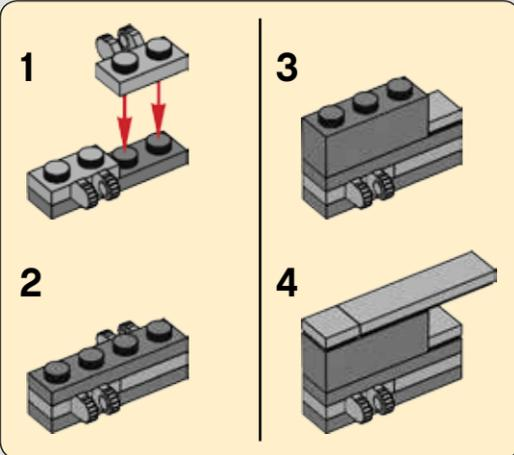
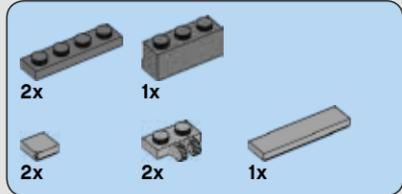
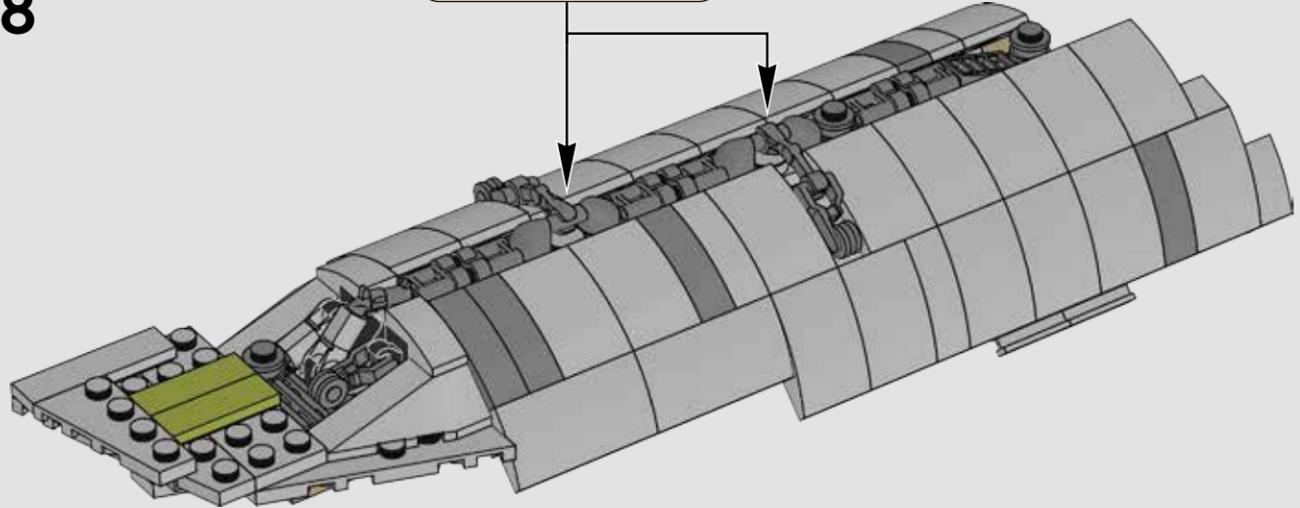

1259

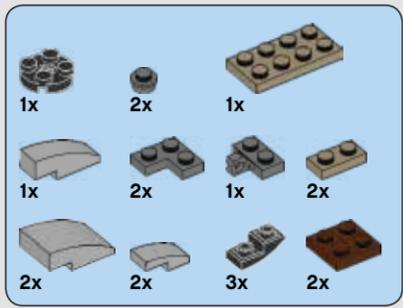
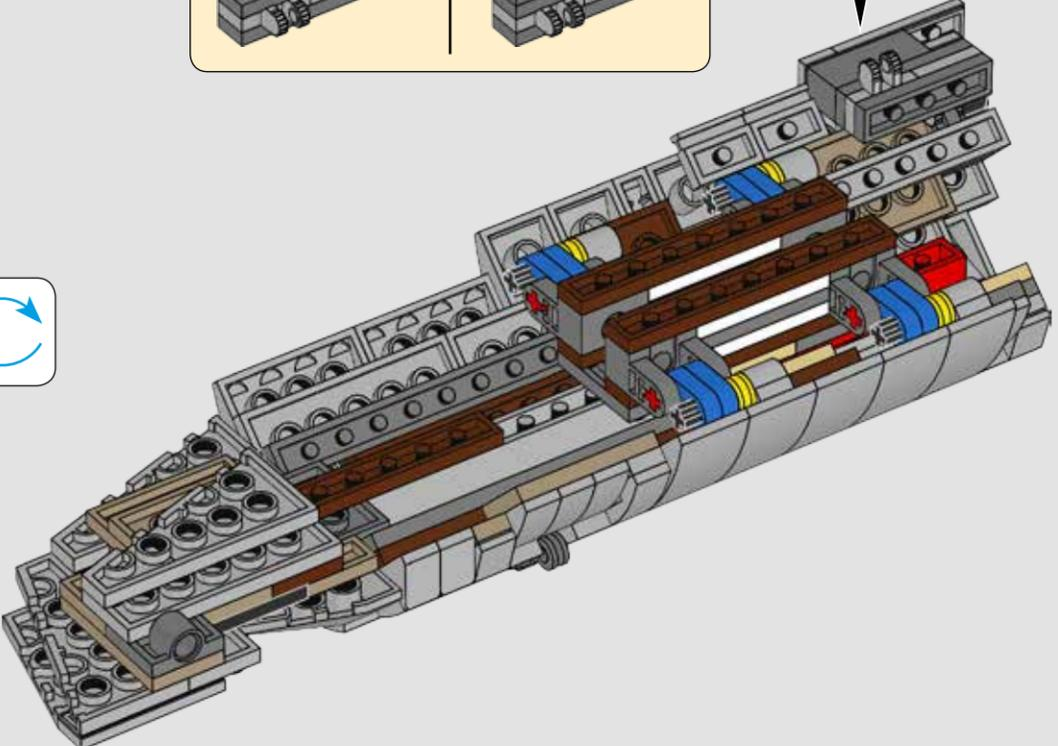

1260

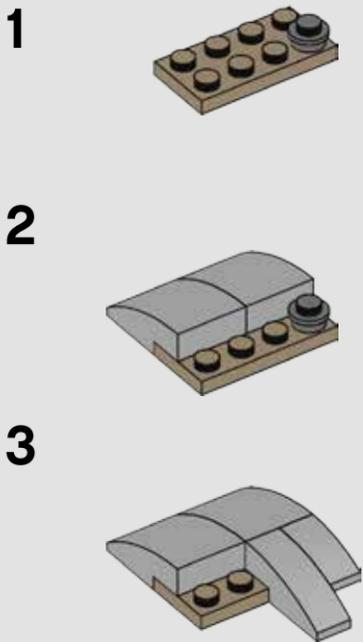

4

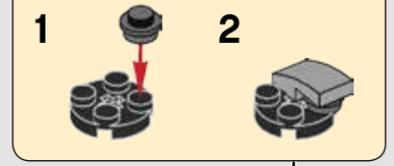
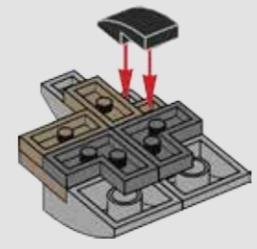

5

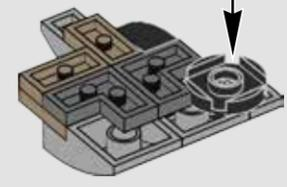

6

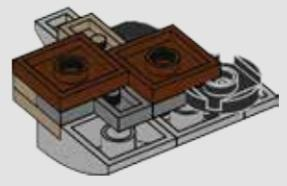

7

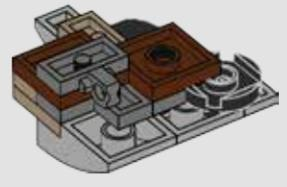

8

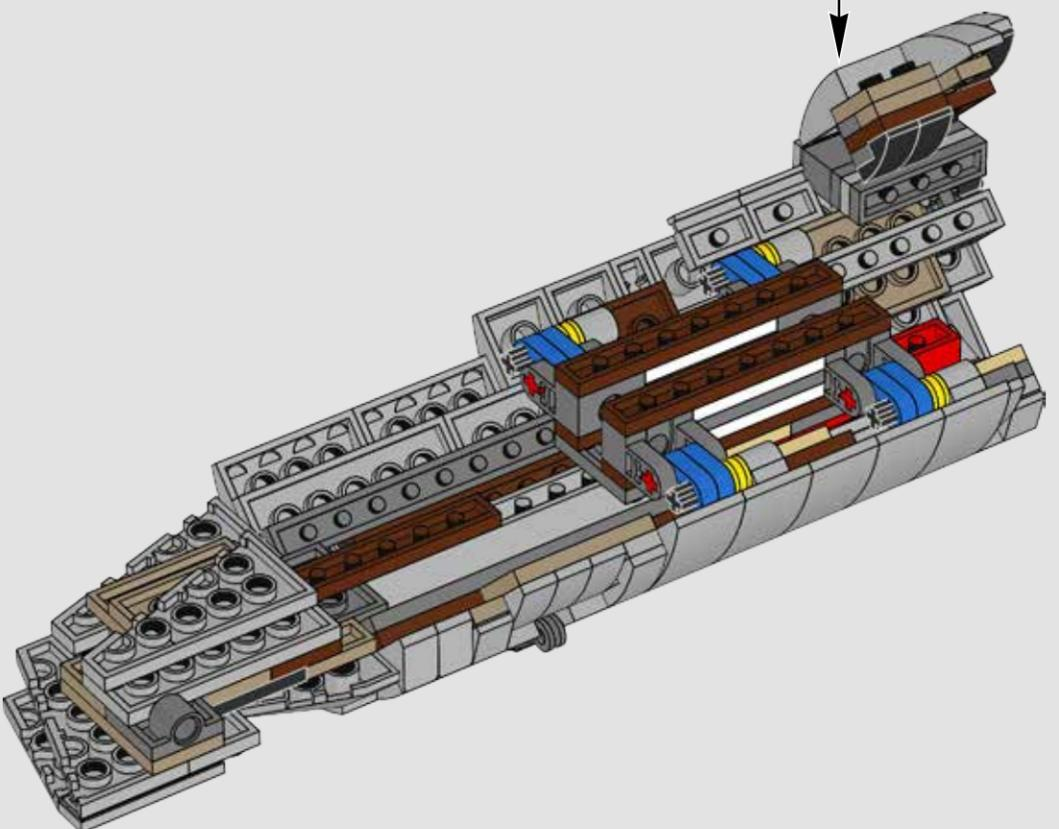
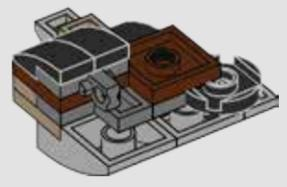

1261

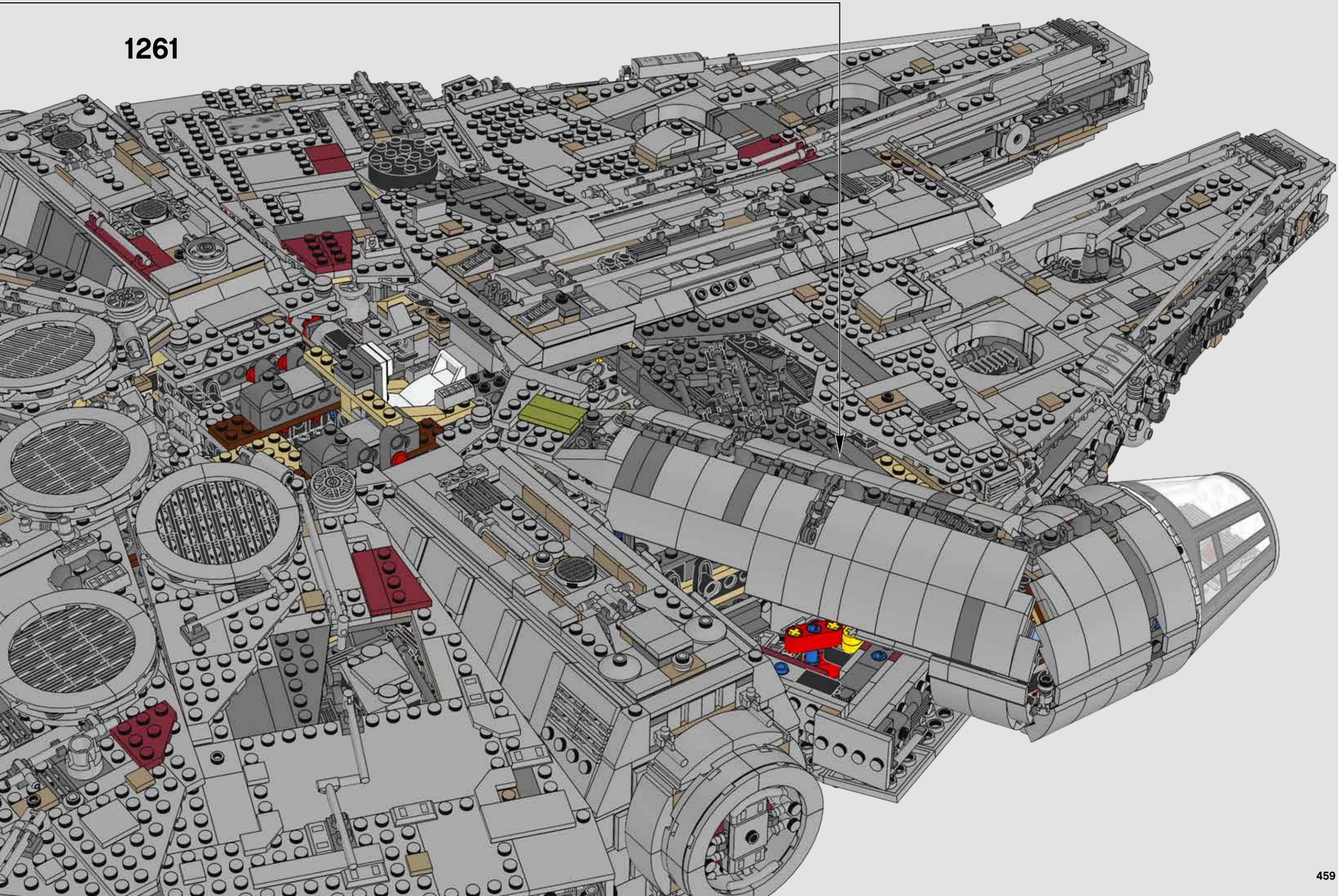



+



17

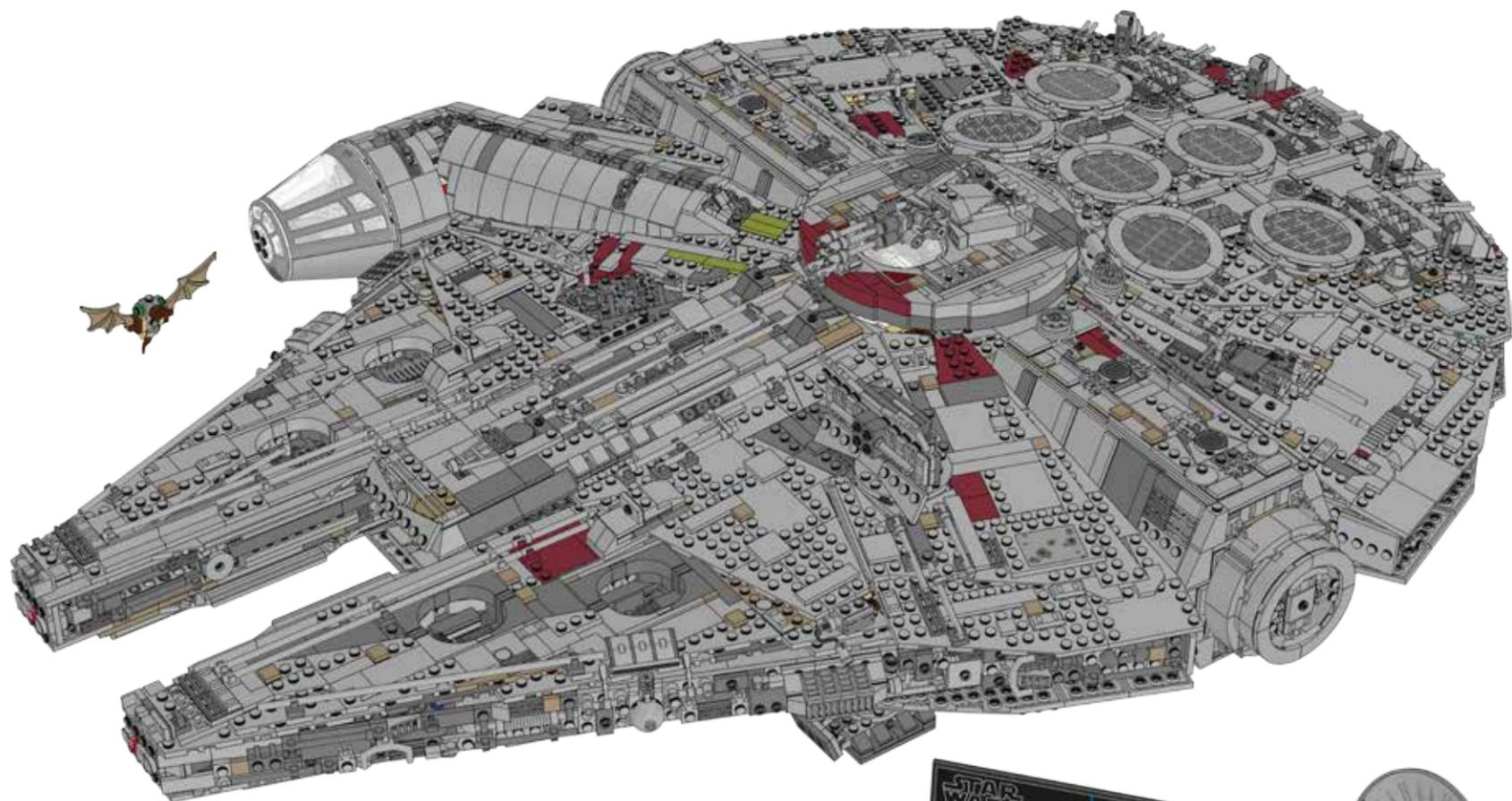

1262

1

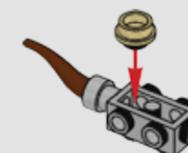

2



3



4



5

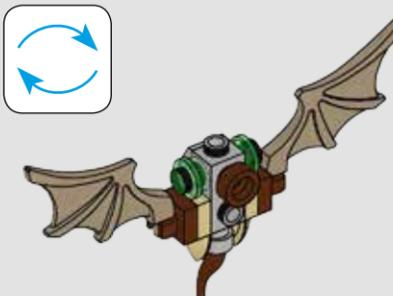

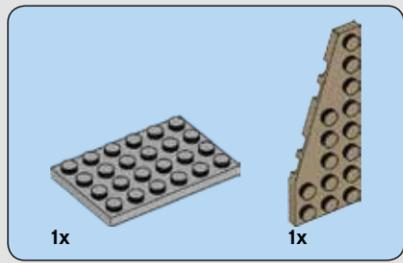

1263

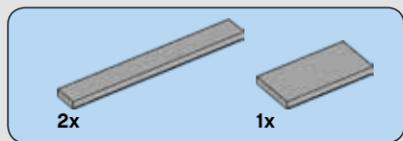
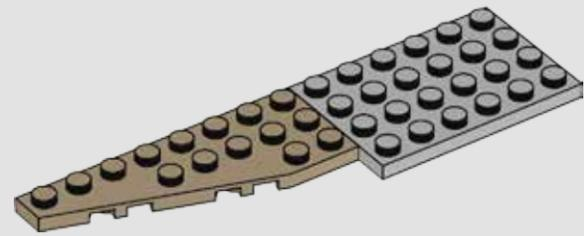

1264

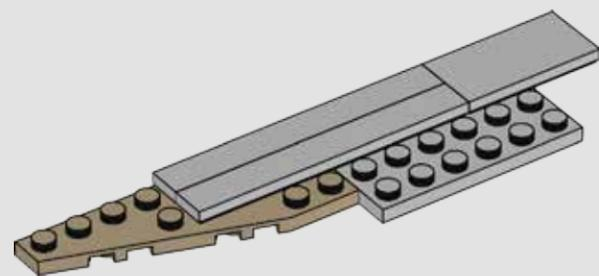

1265

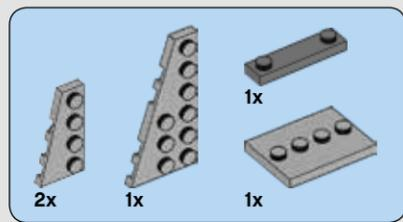
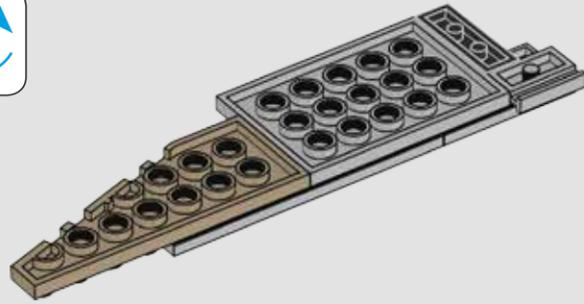

1266

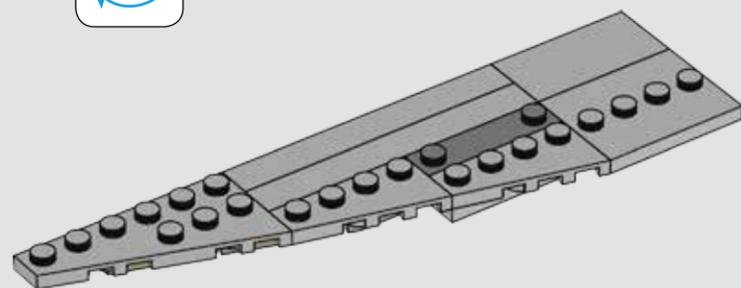

1267

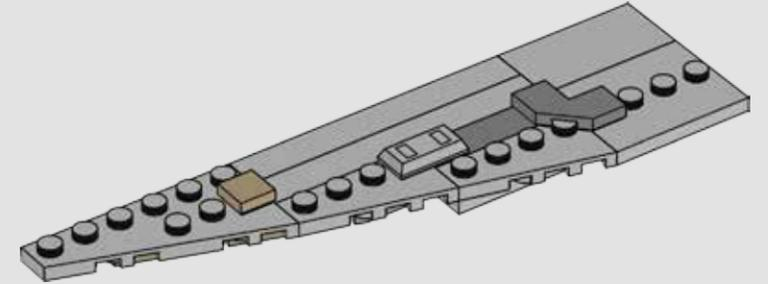

1268

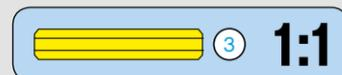
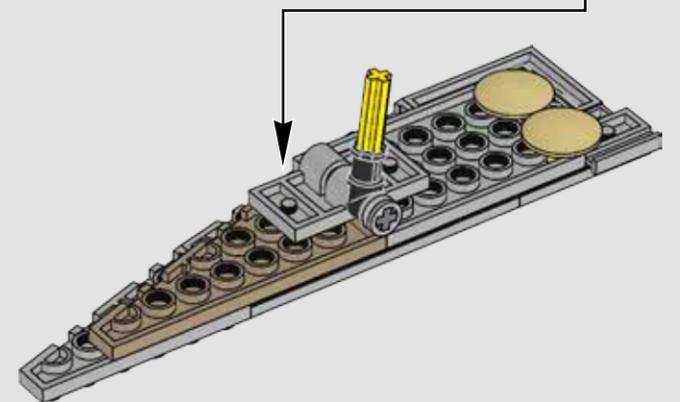
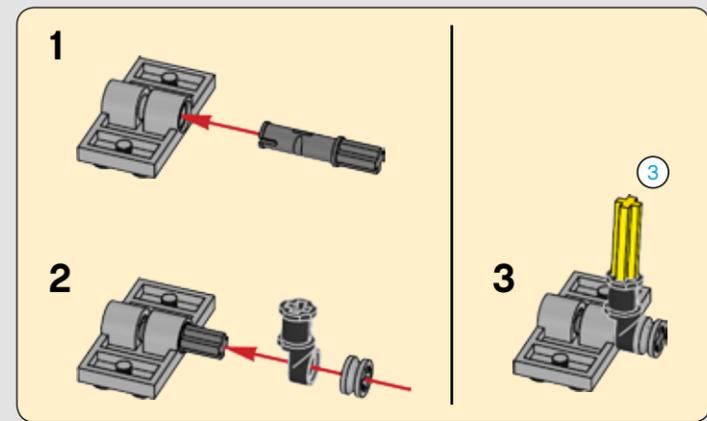

1269

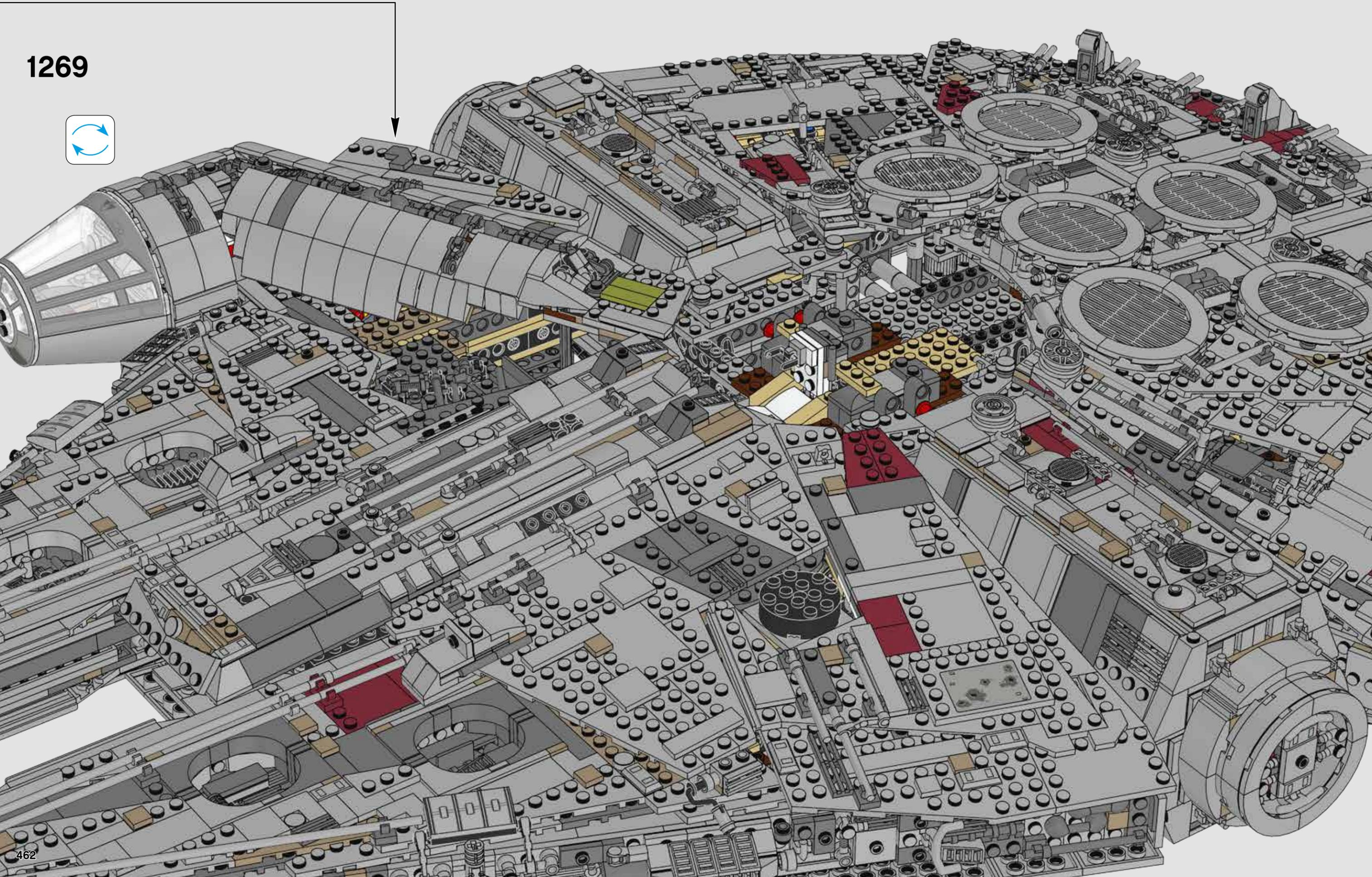

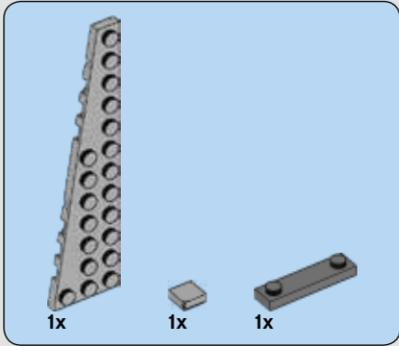
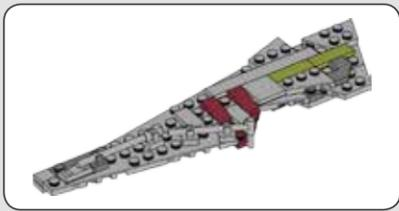

1270

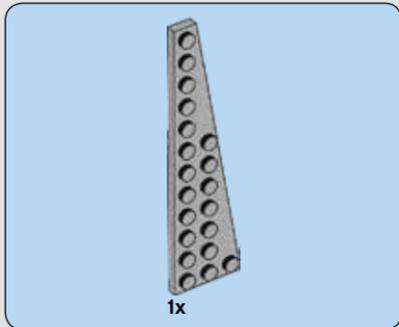
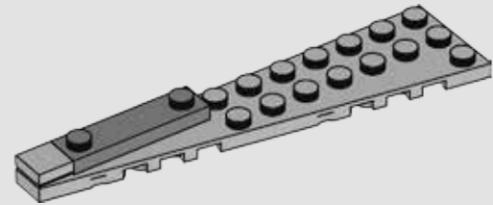

1271

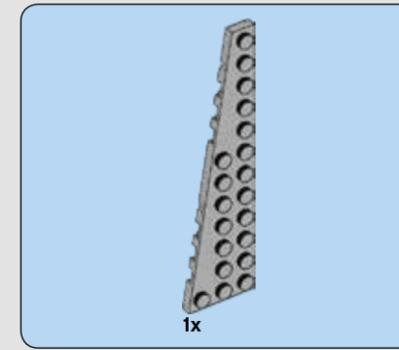
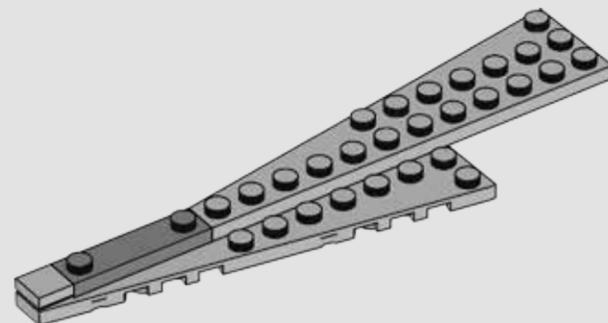

1272

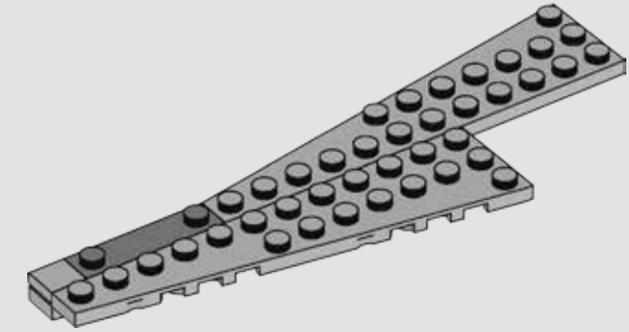

1273

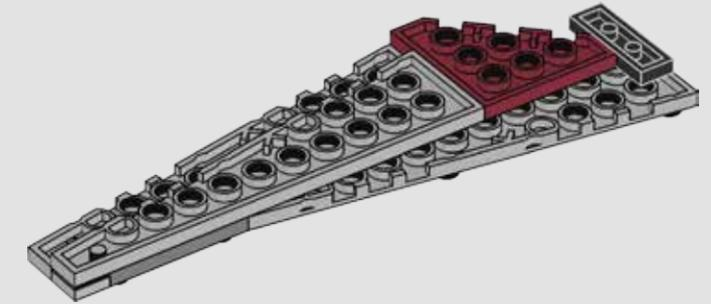

1274

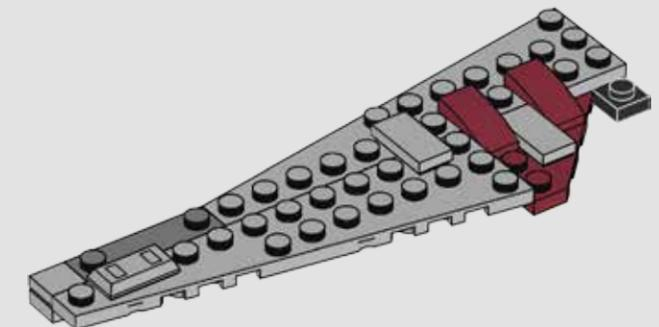

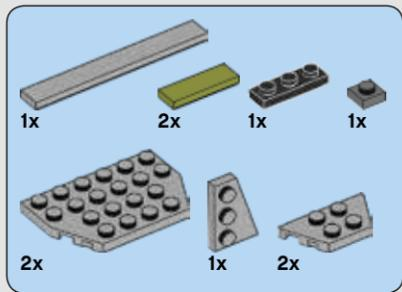

1275

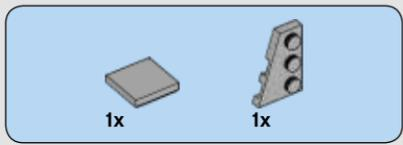
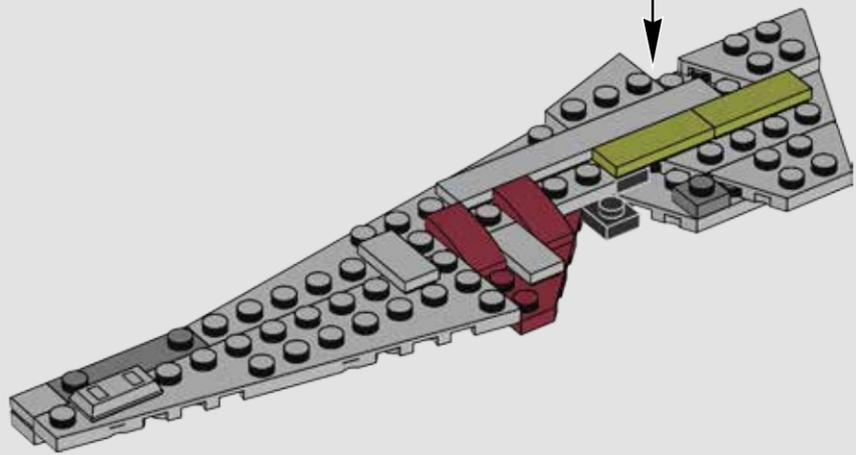
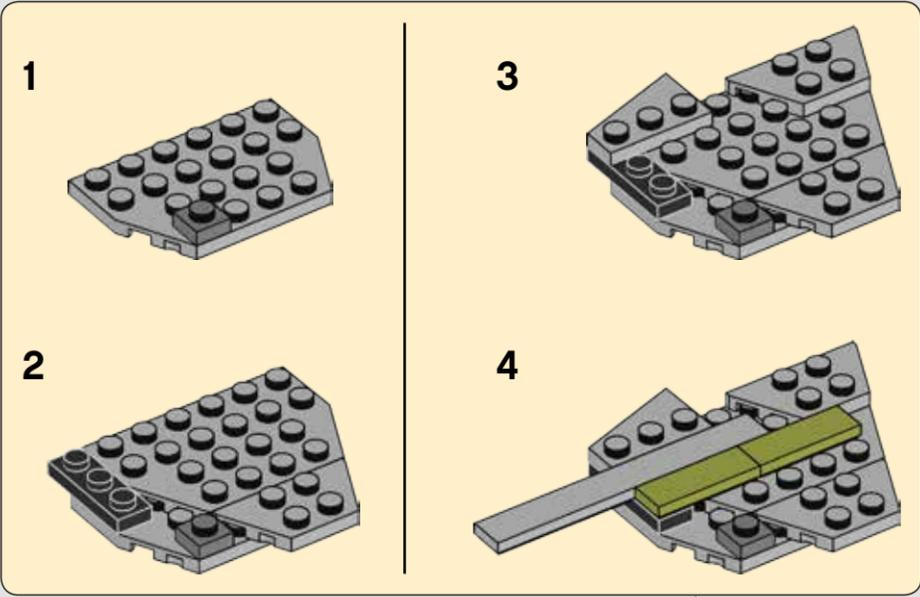

1276

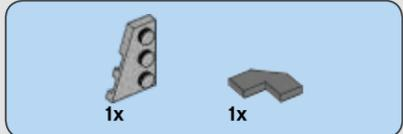
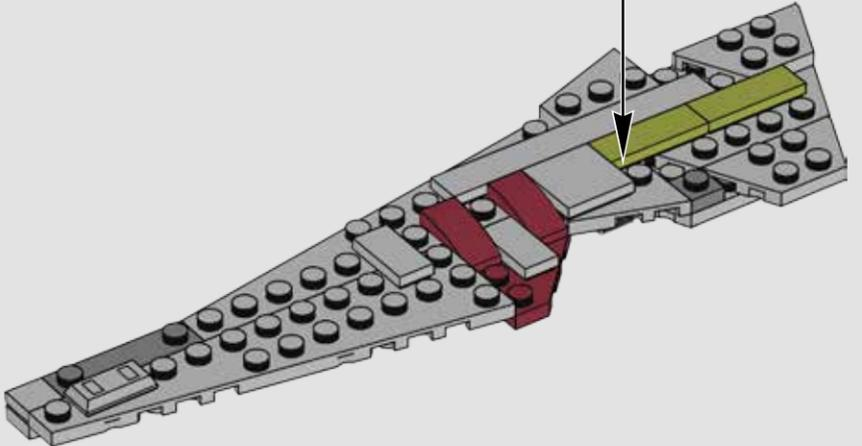
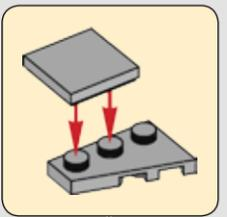

1277

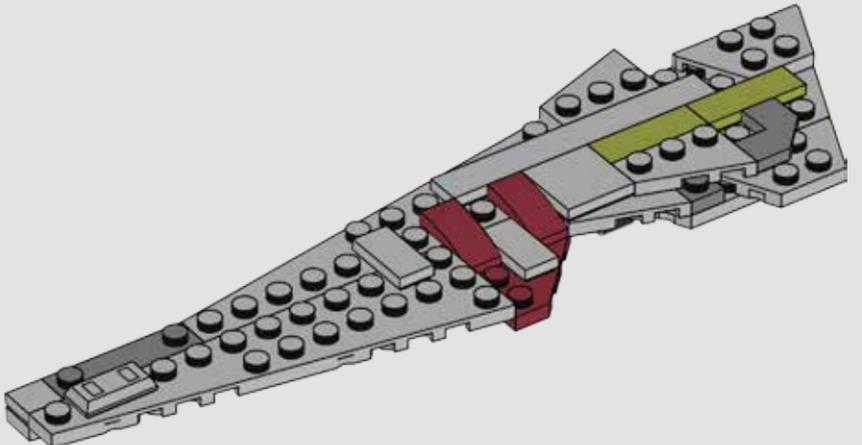

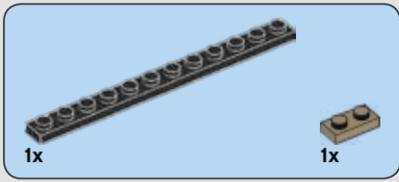

1278

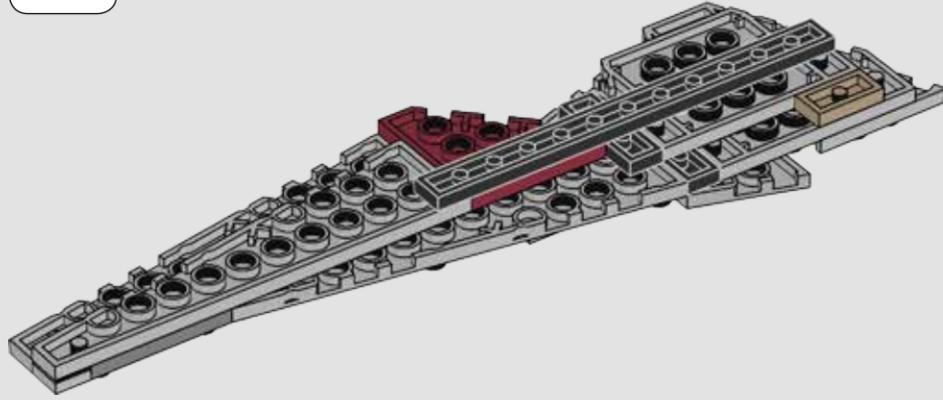

1279

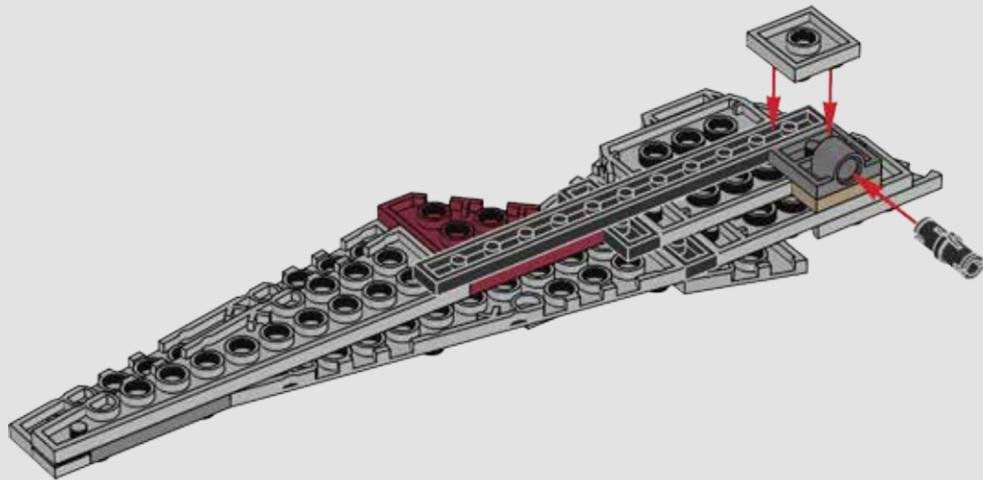

1280

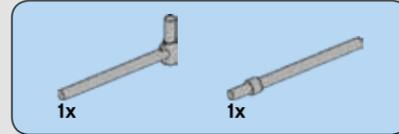
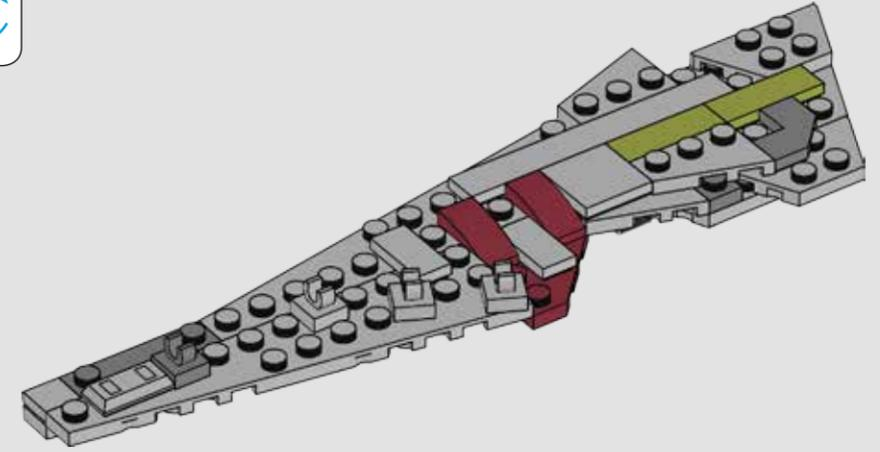

1281

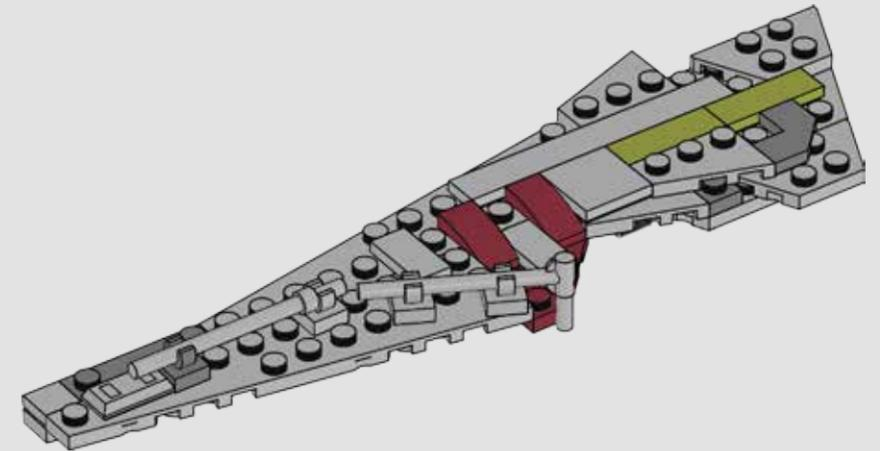

1282

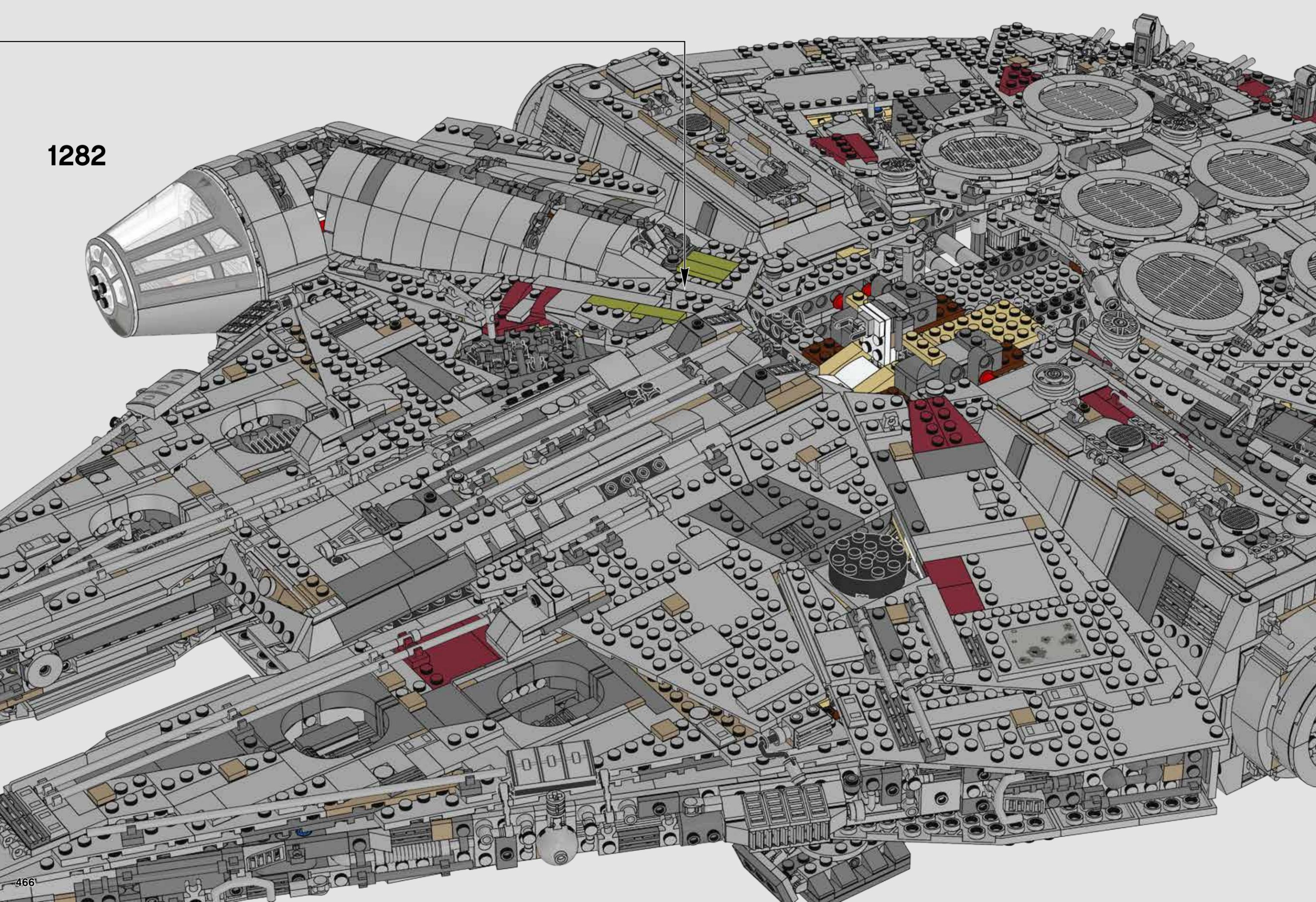

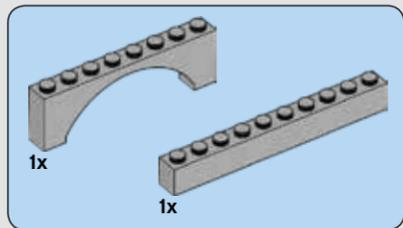
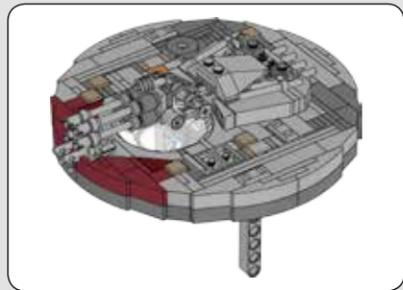

1283

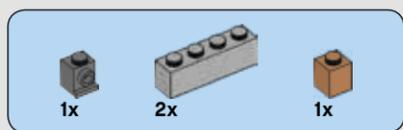
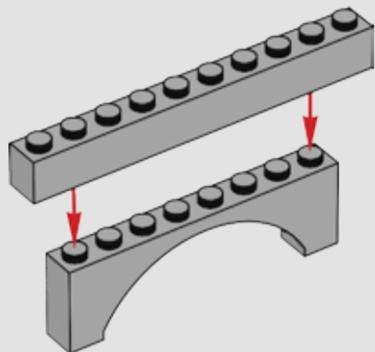

1284

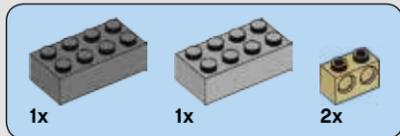
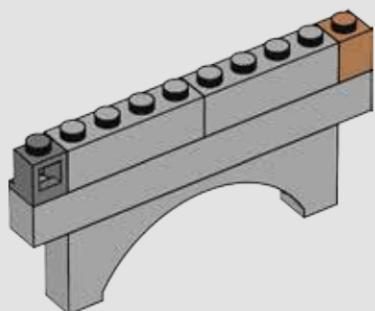

1285

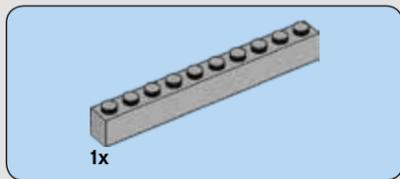
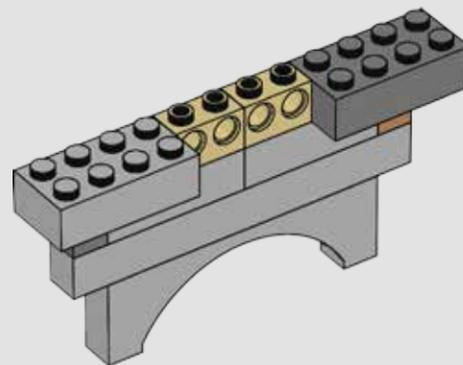

1286

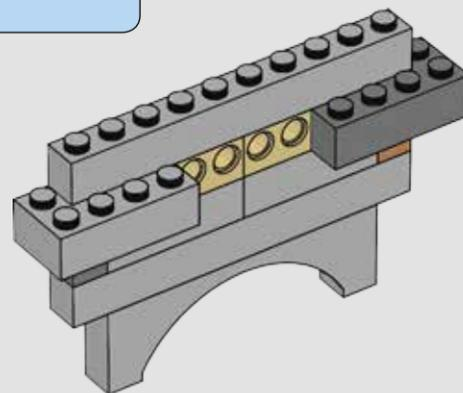

1287

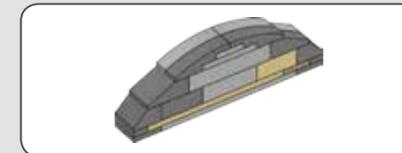
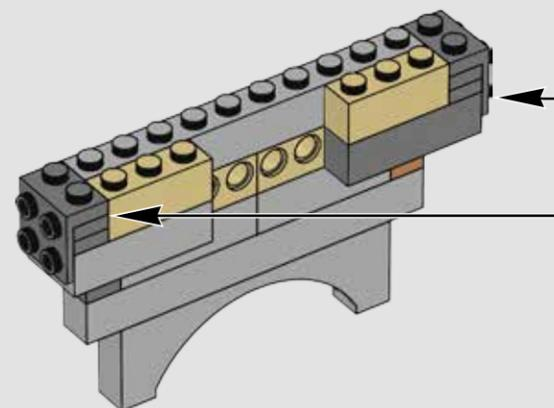
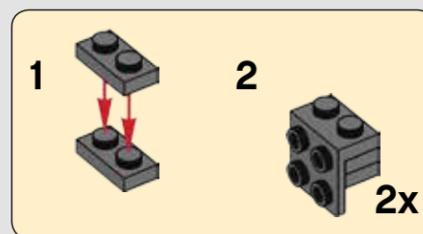

1288

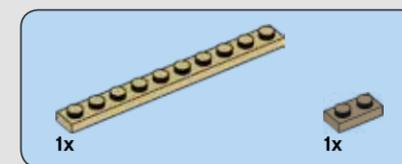
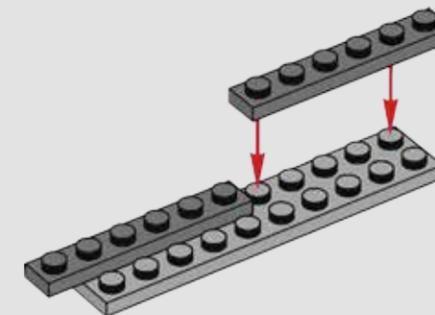

1289

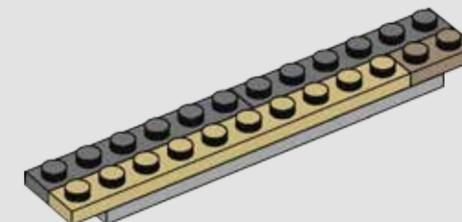



1290

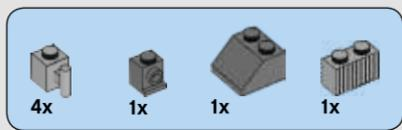
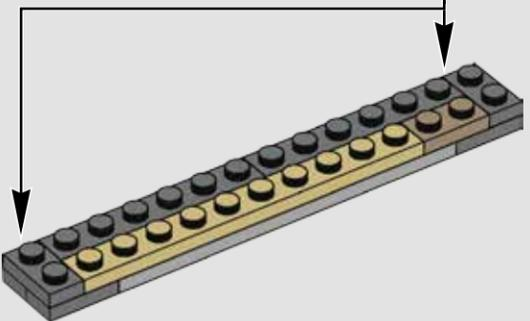
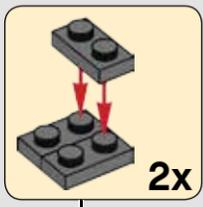

1291

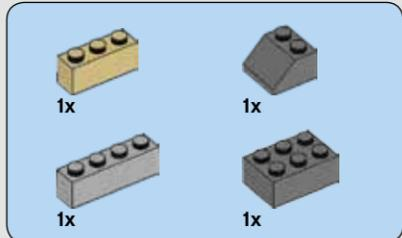
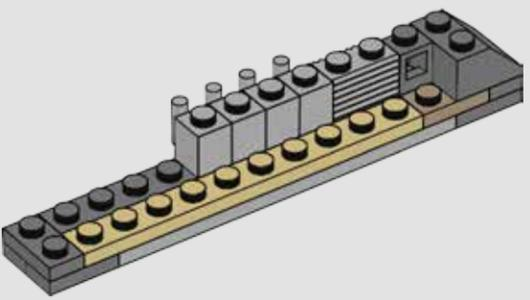

1292

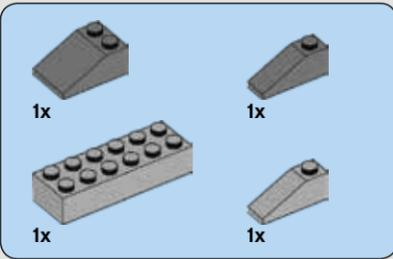
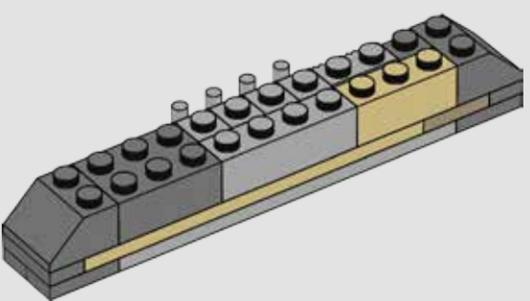

1293

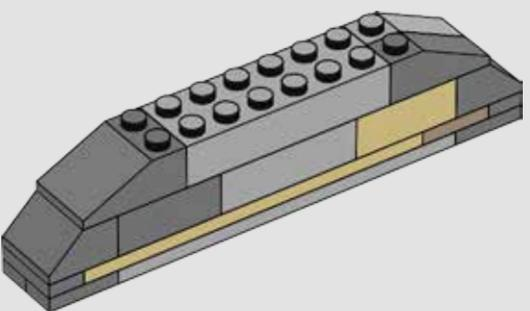

1294

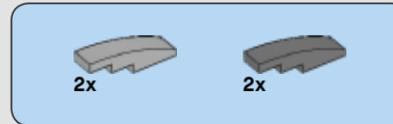
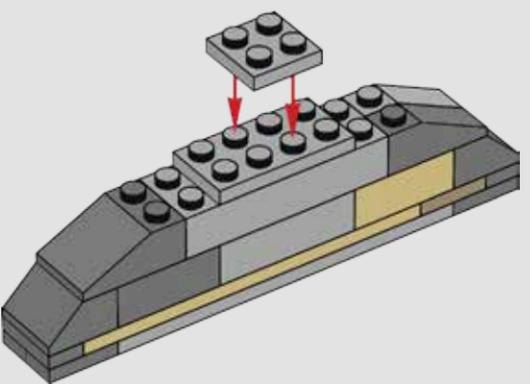

1295

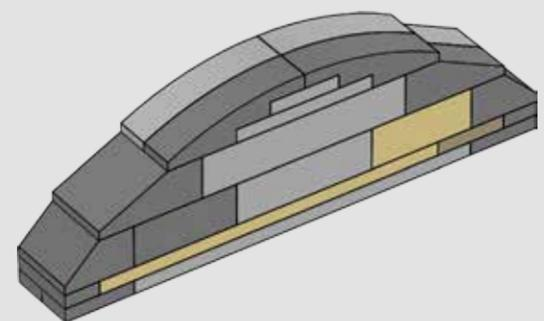

1296

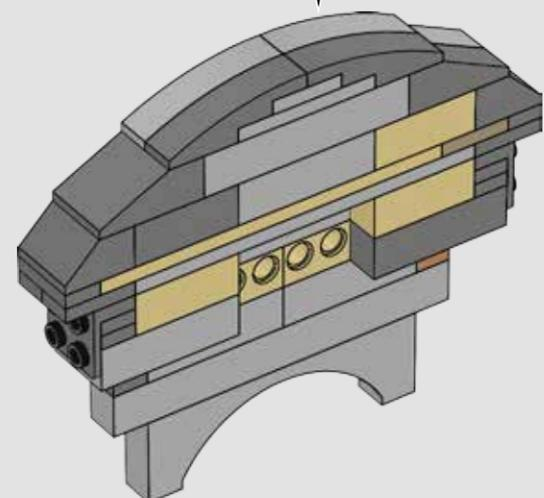

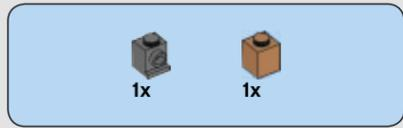

1297

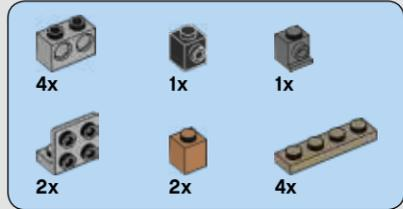
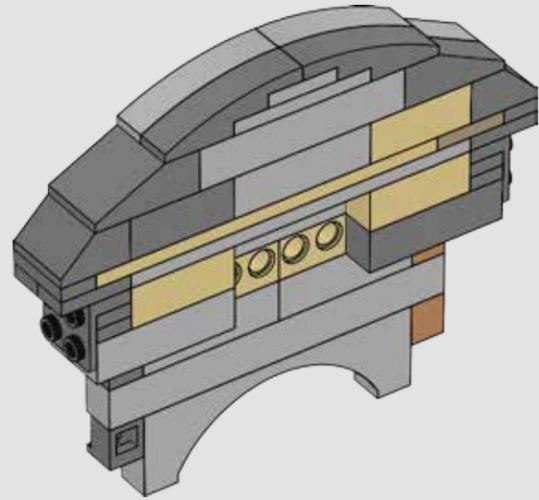

1298

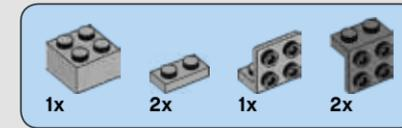
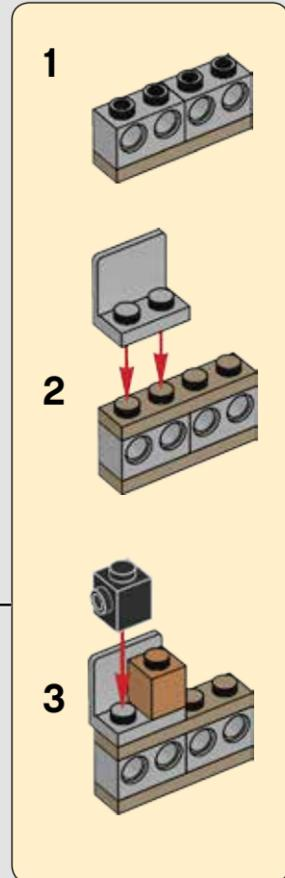
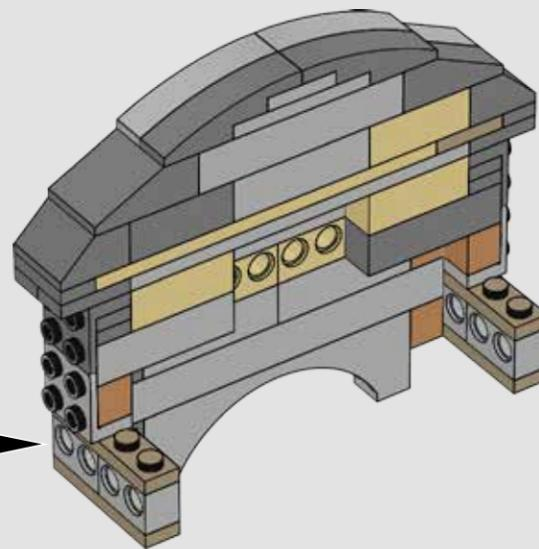
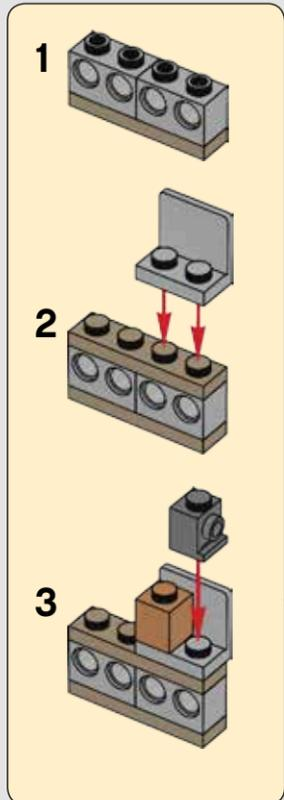

1299

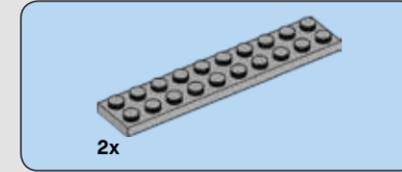
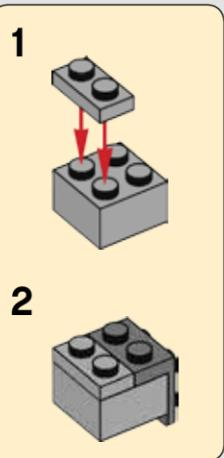
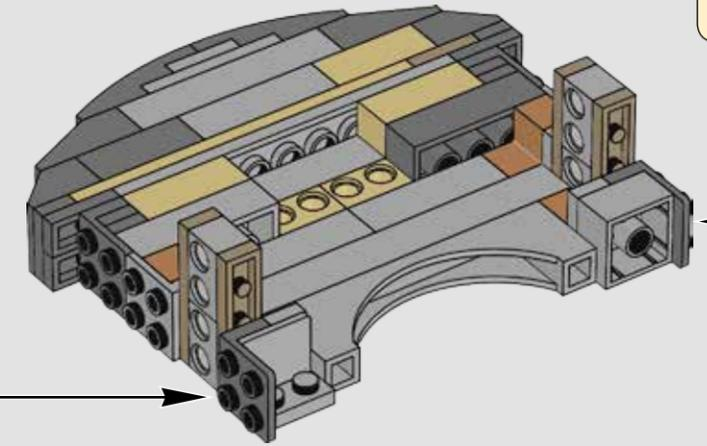
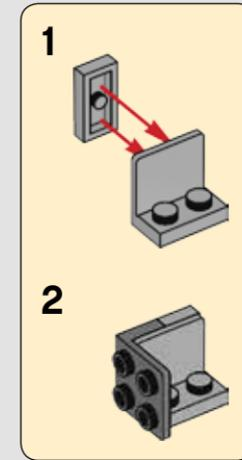

1300

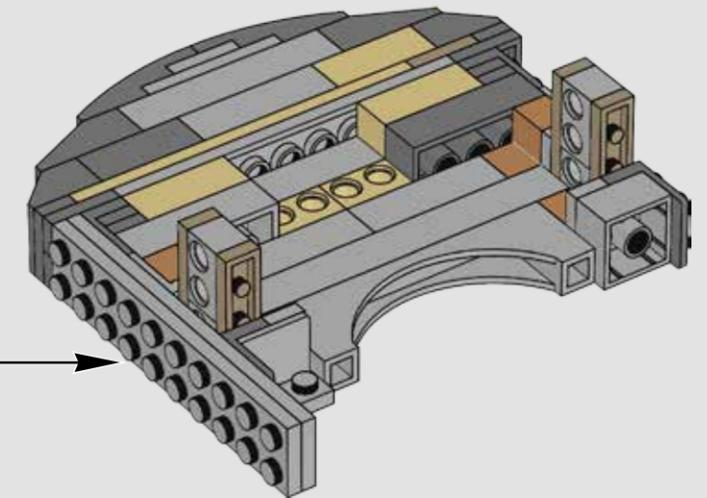
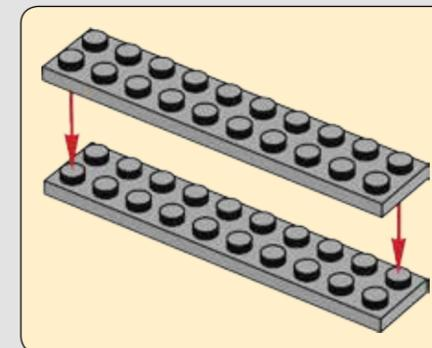

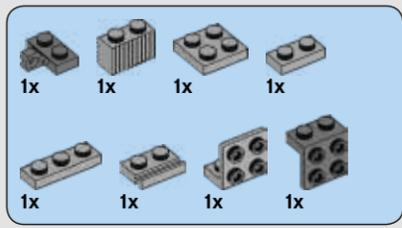

1301

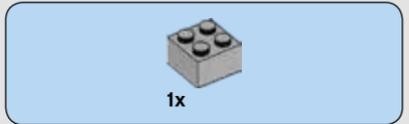
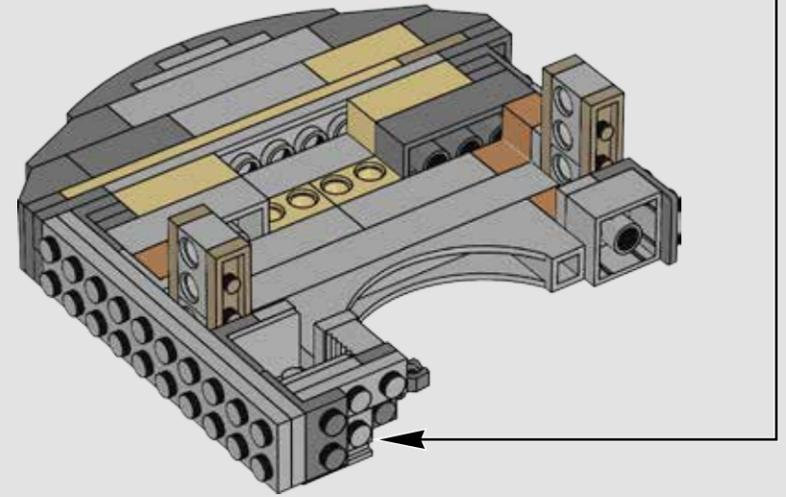

1302

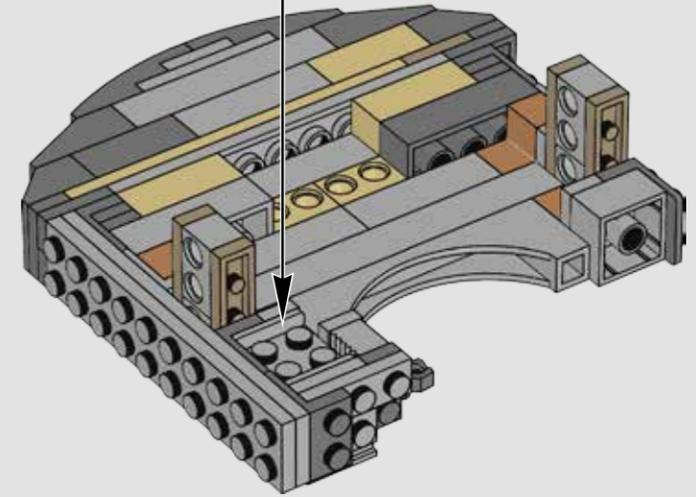
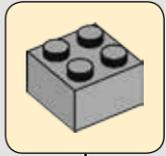



1308

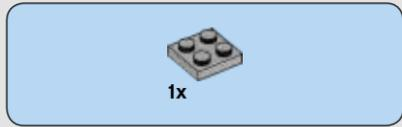

1309

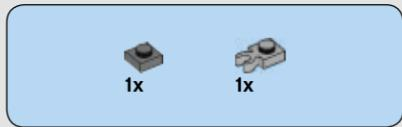
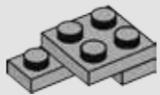

1310

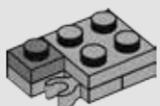

1311

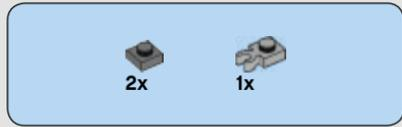
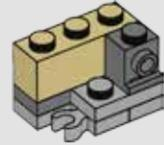

1312

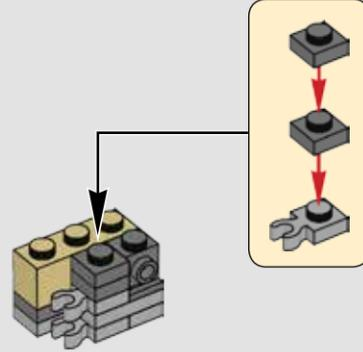

1313

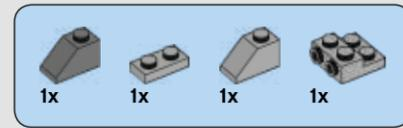
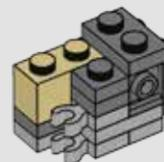

1314

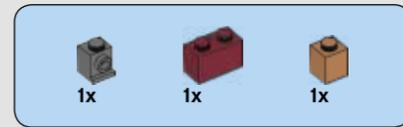
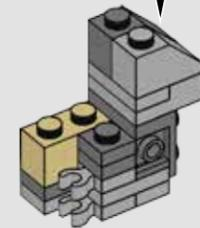
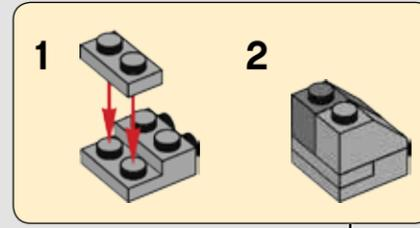

1315

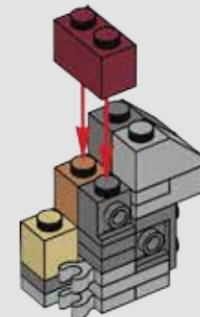

1316

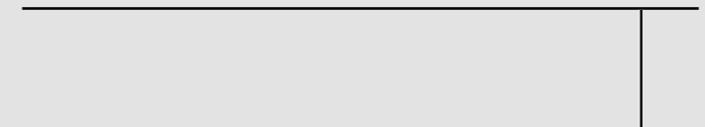
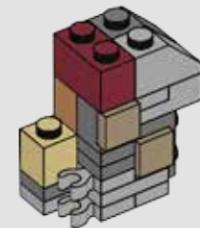

1317

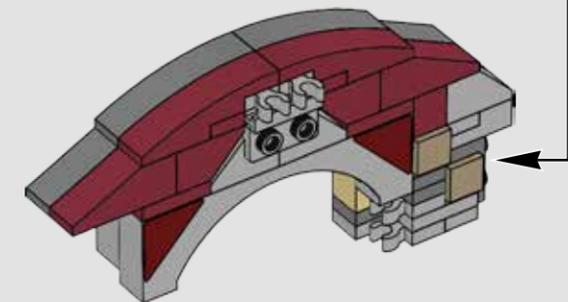

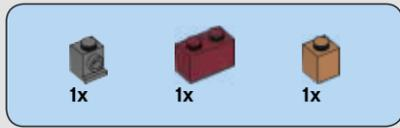

1318

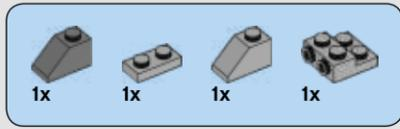
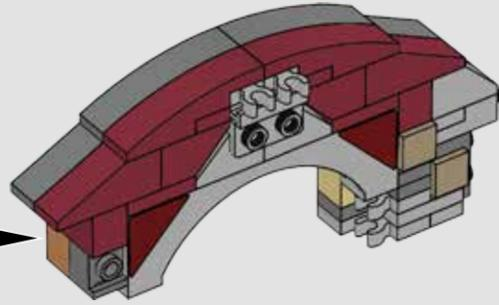
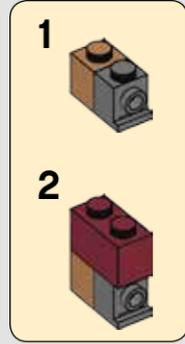

1319

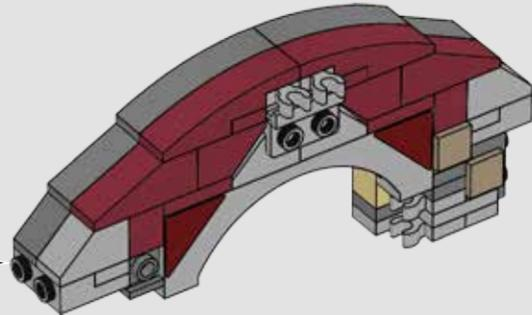
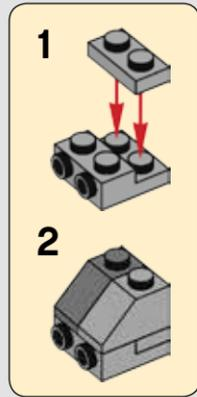

1320

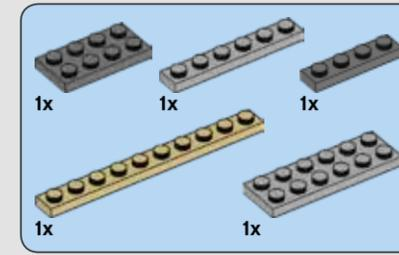
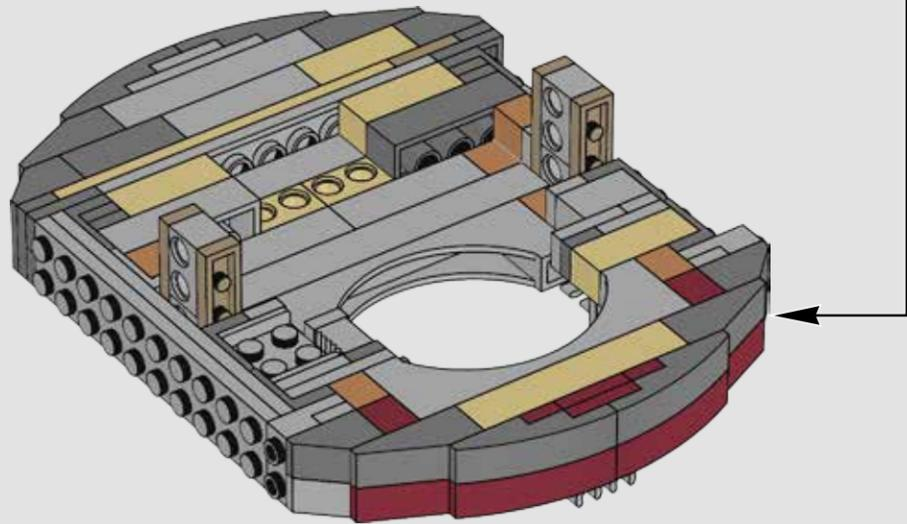

1321

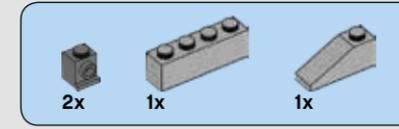
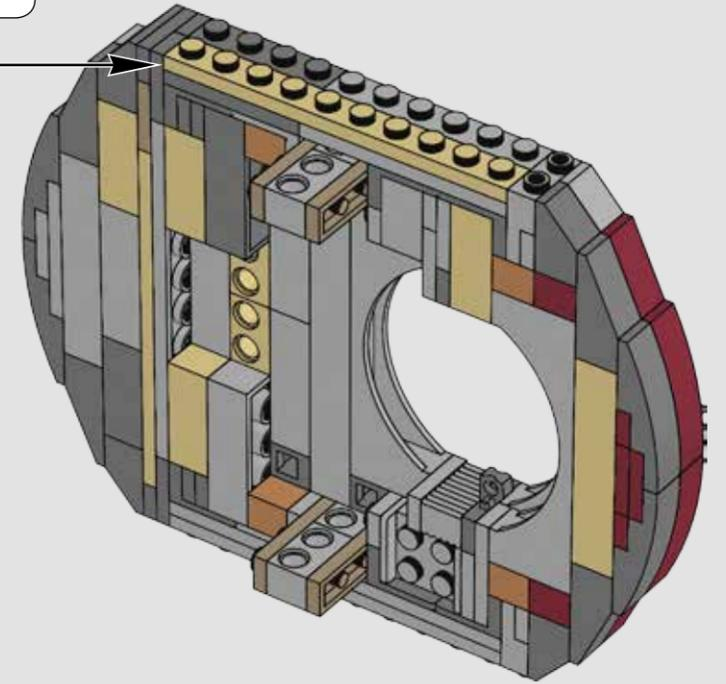
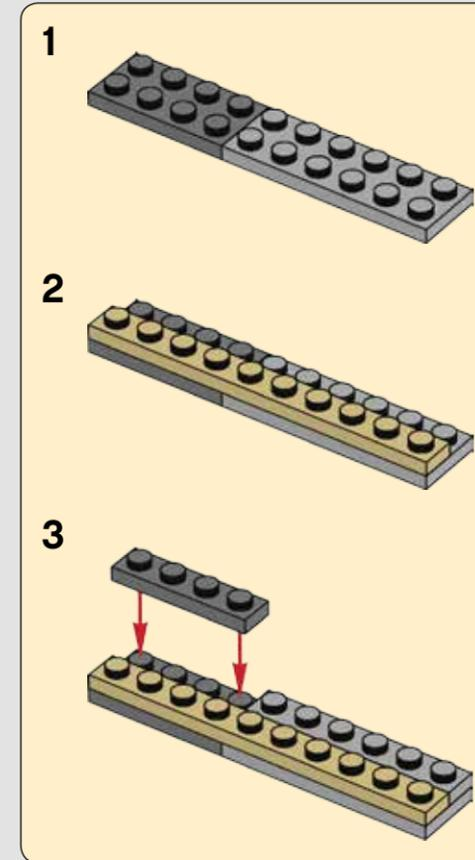

1322

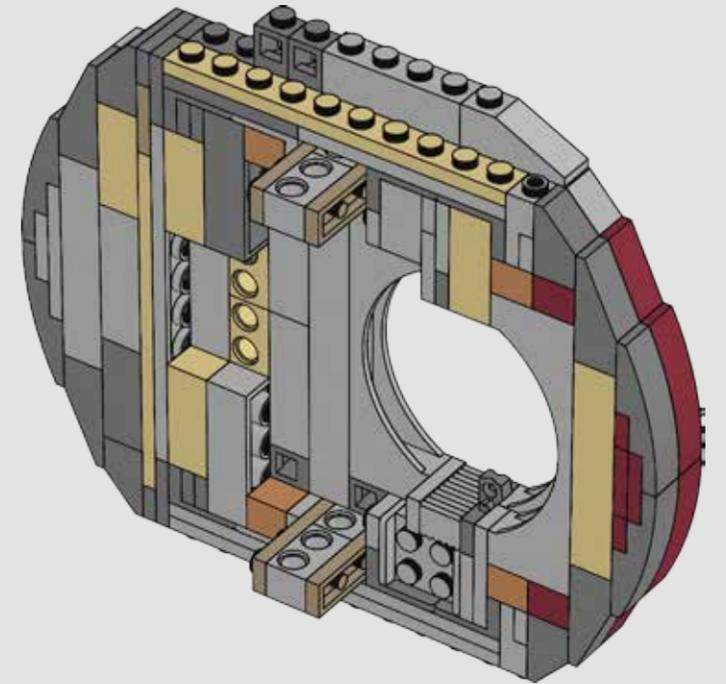

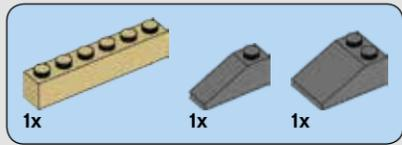

1323

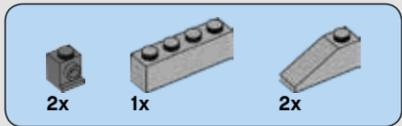
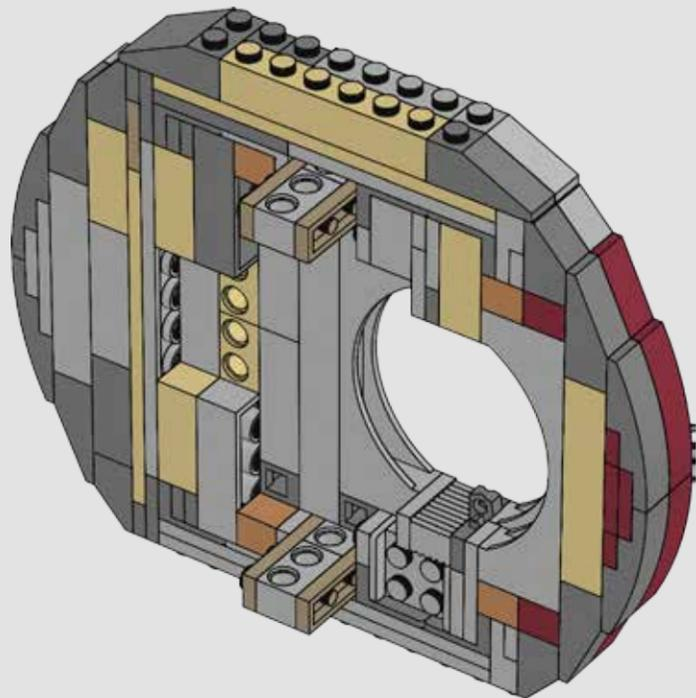

1324

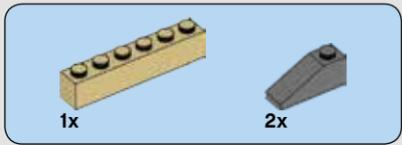
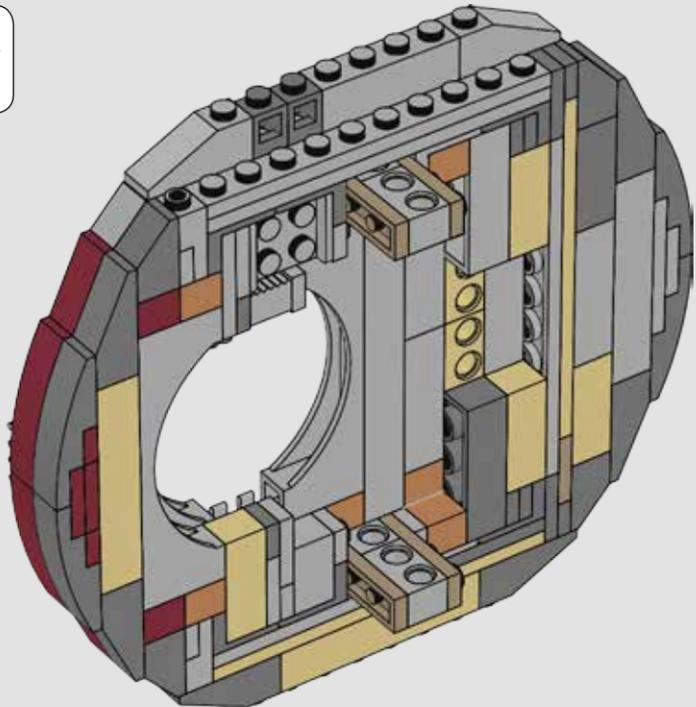

1325

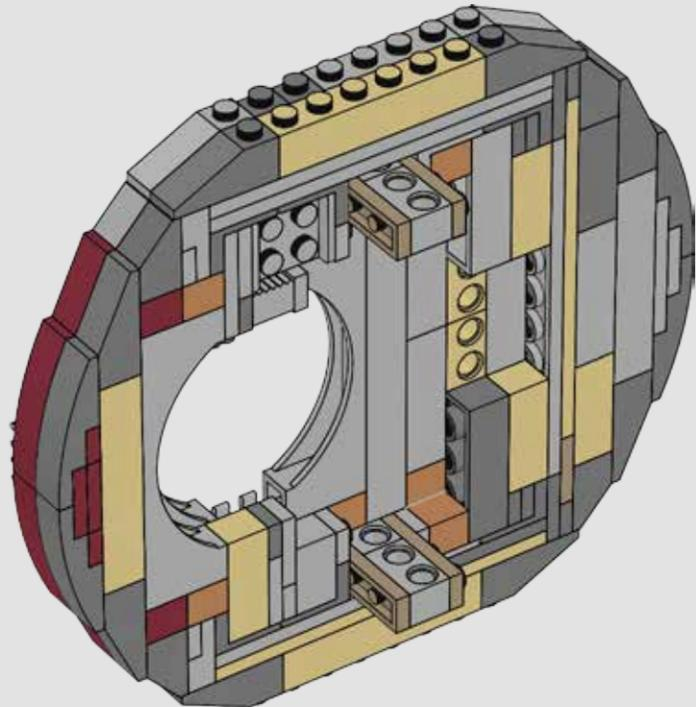

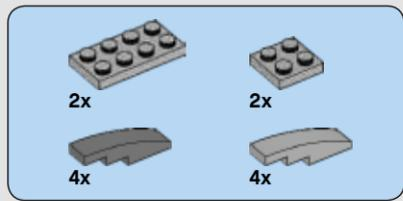

1326

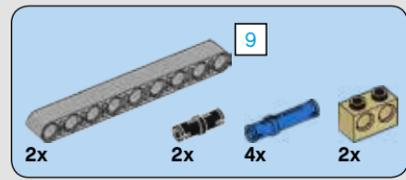
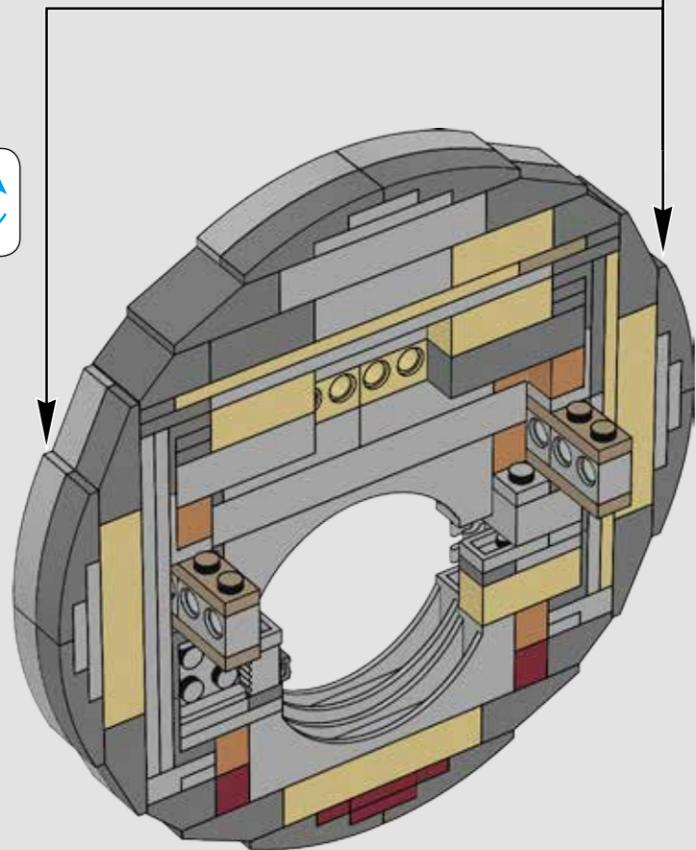
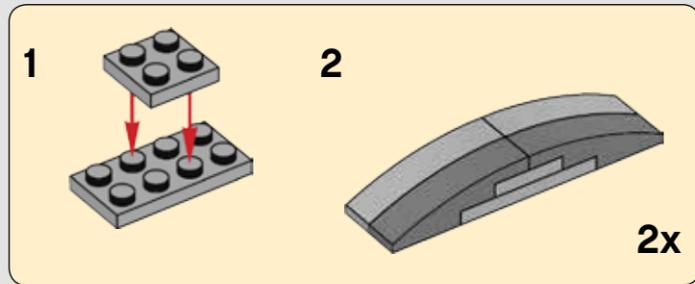

1327

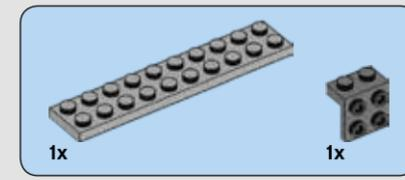
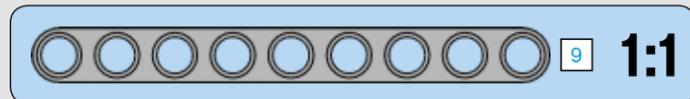
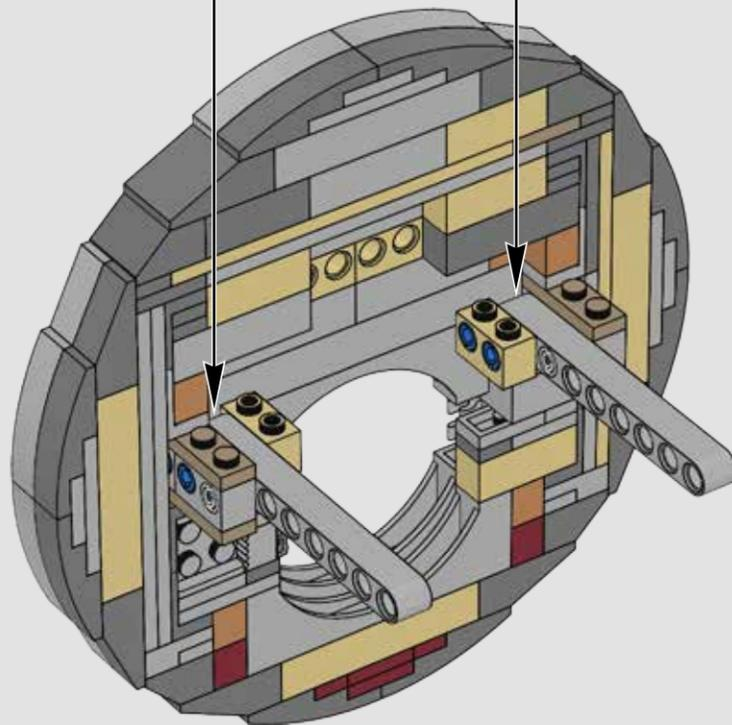
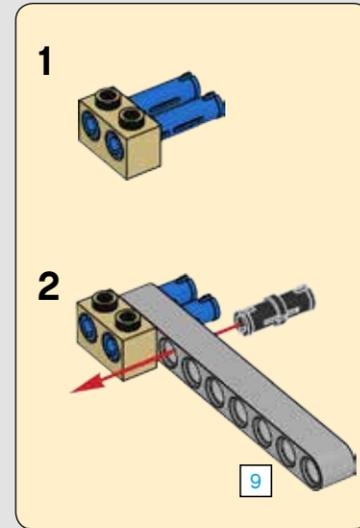
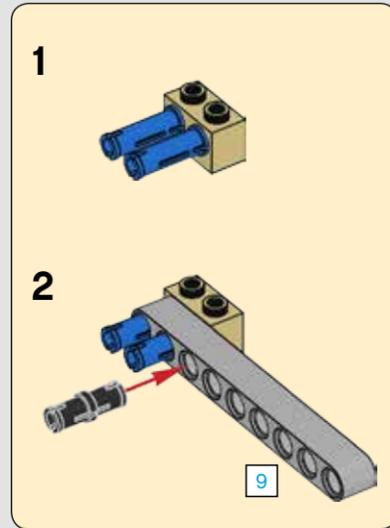

1328

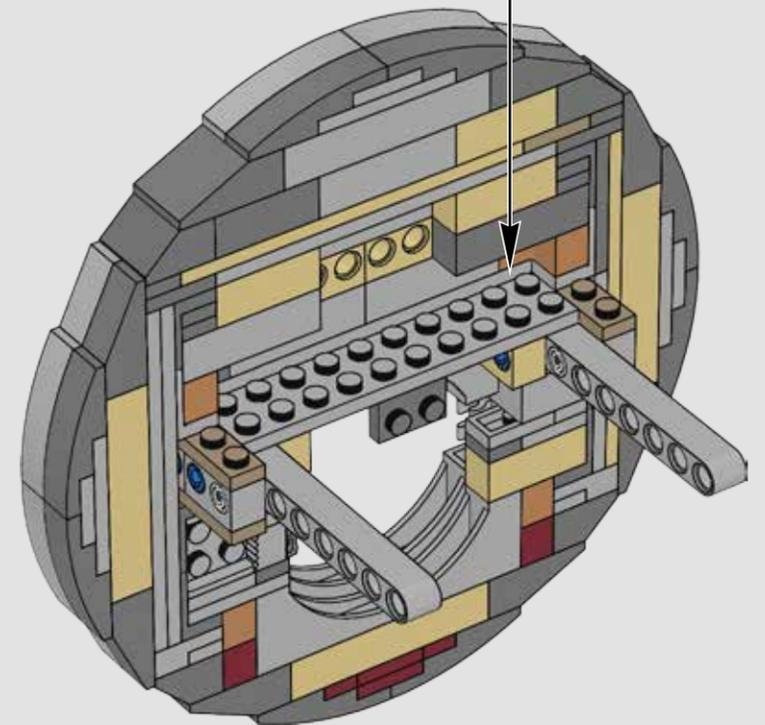
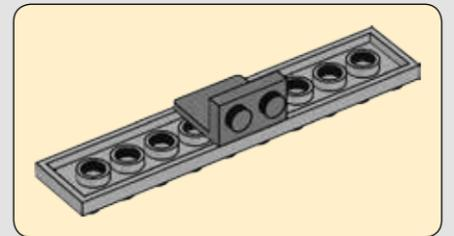

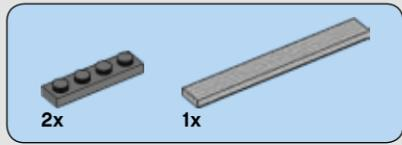

1329

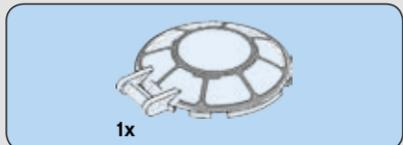
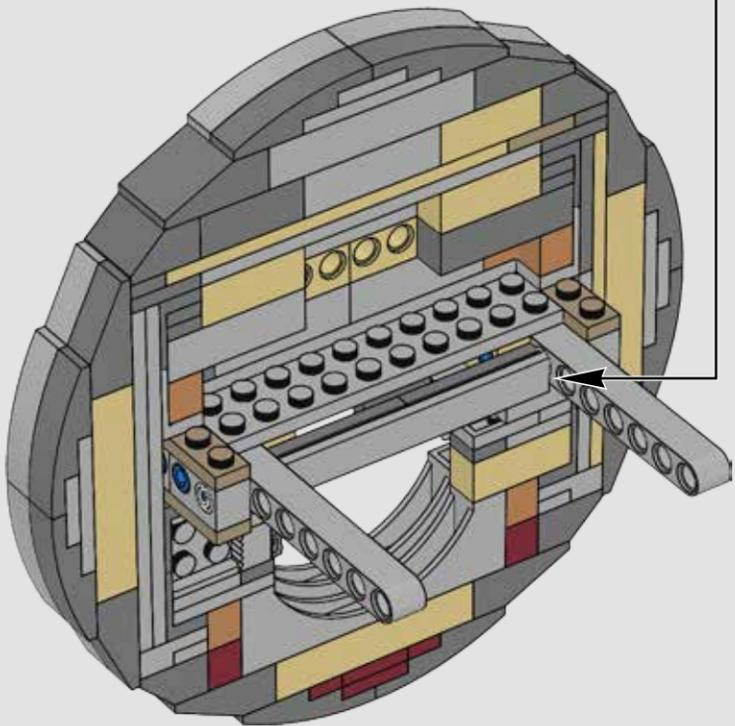
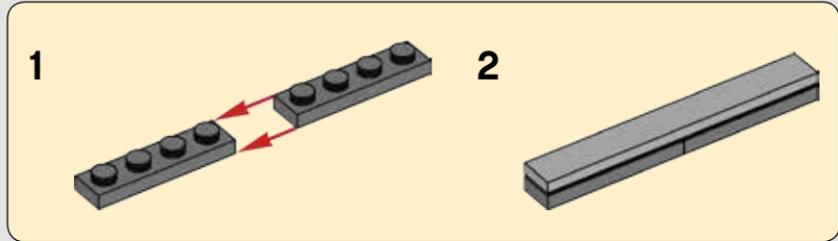

1330

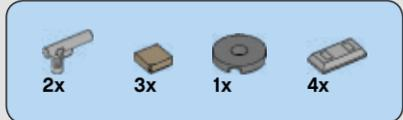
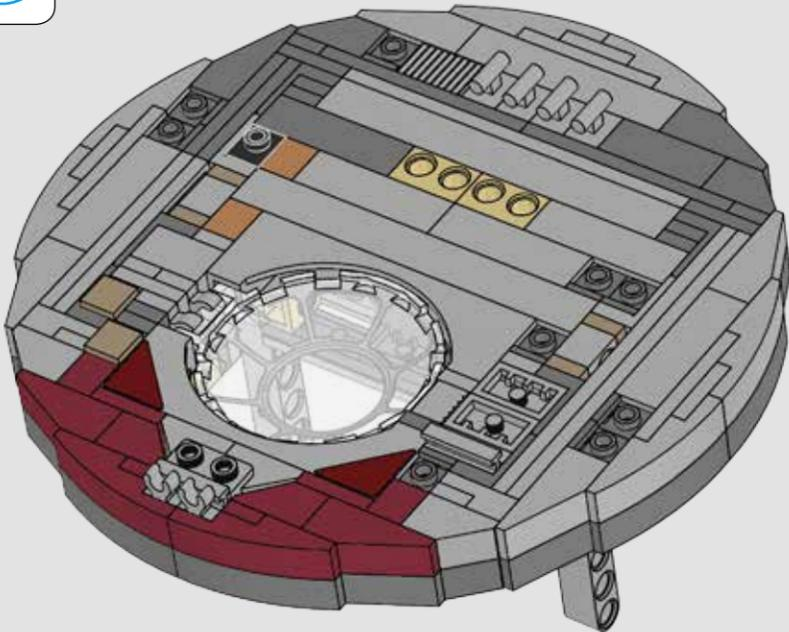

1331

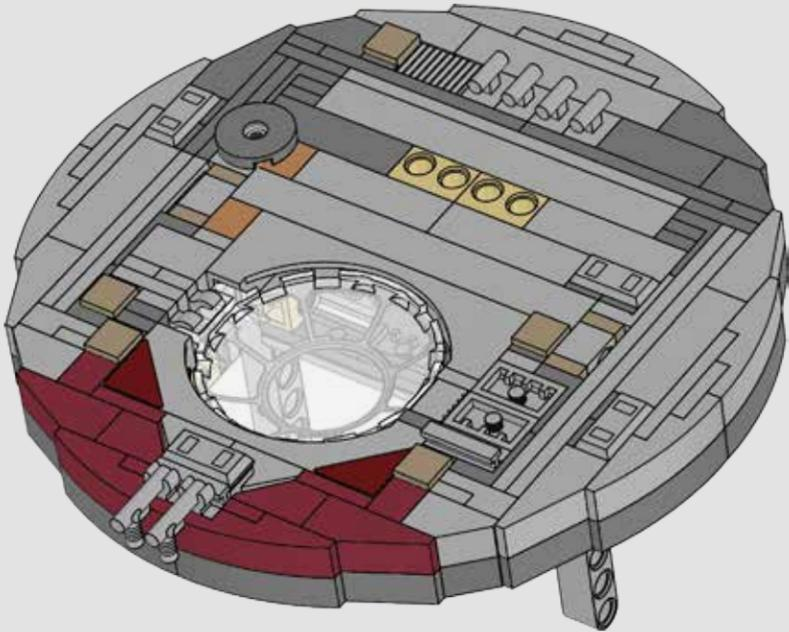

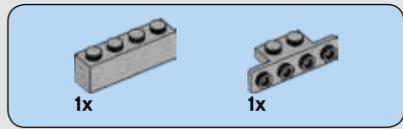
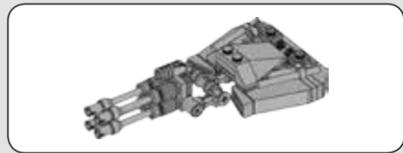

1332

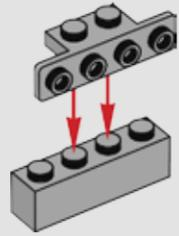

1333

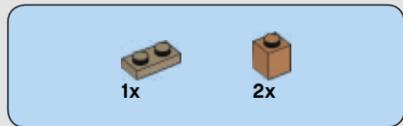
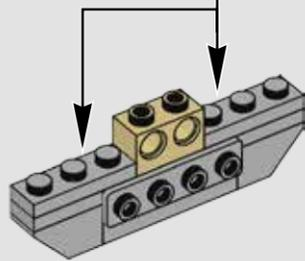
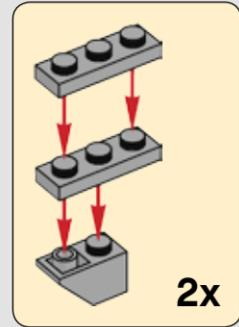

1334

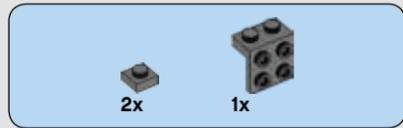
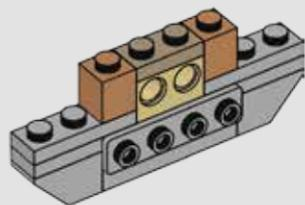

1335

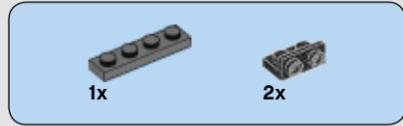
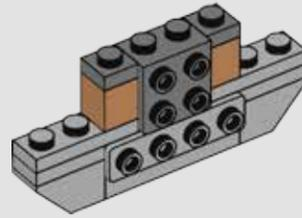

1336

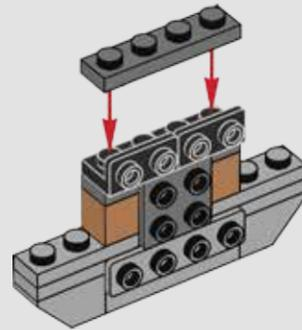

1337

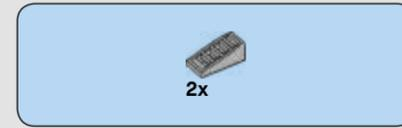
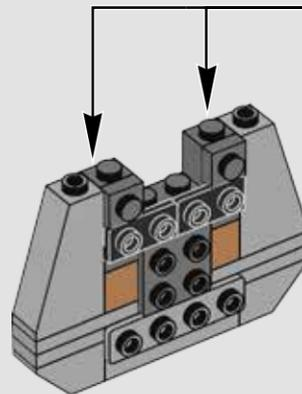

1338

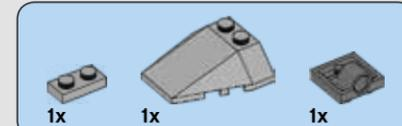
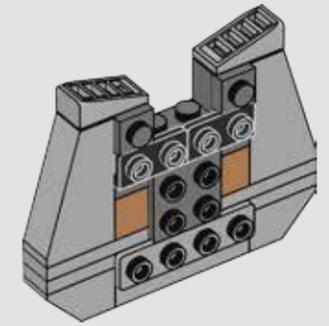

1339

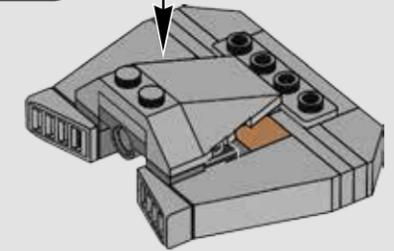
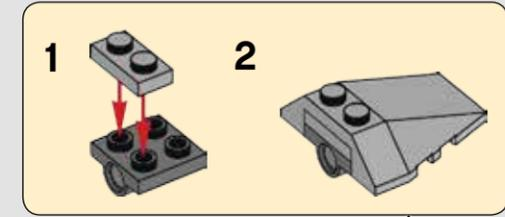

1340

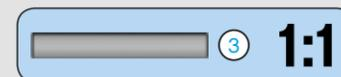
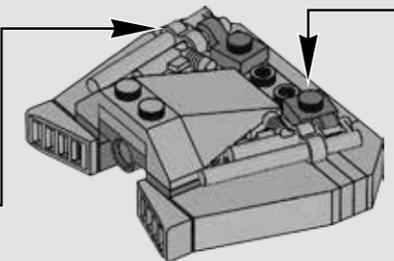
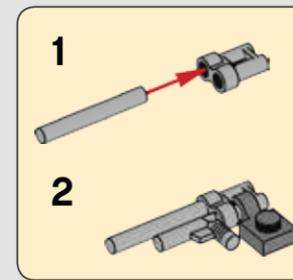
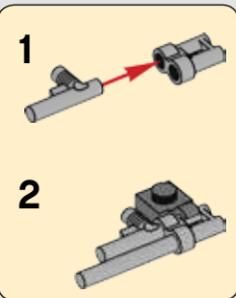

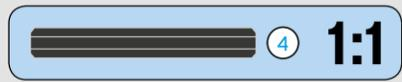
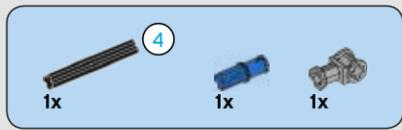

1341

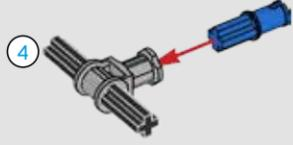

1342

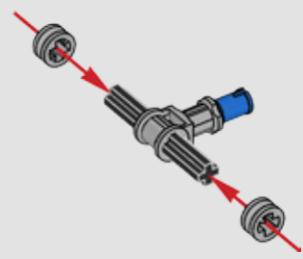

1343

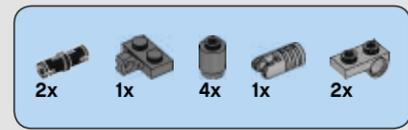
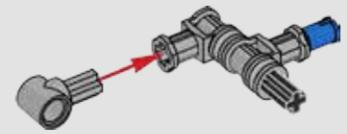

1344

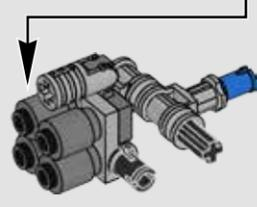
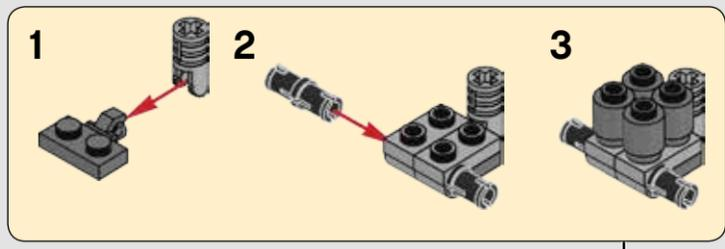

1345

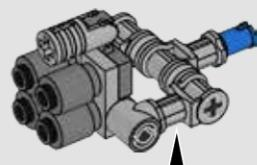
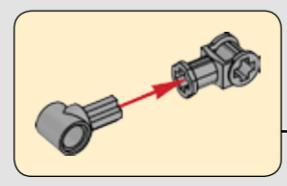

1346

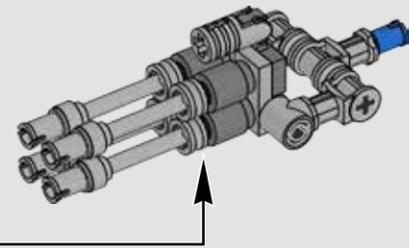
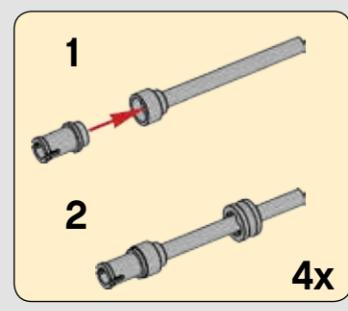

1347

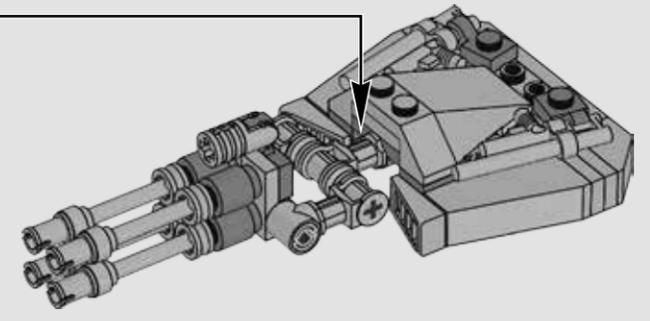

1348

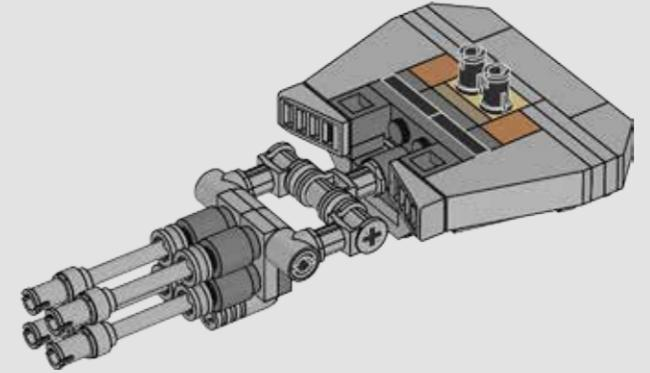

1349

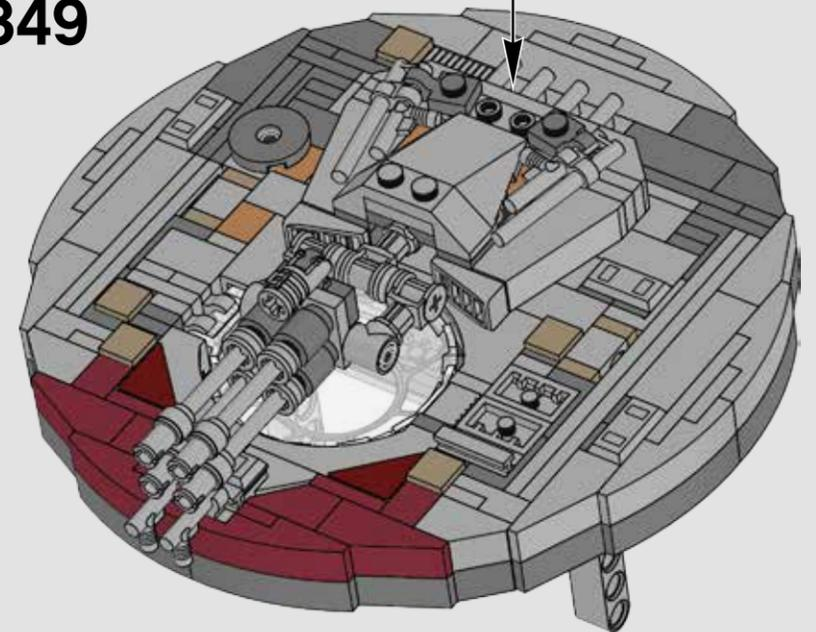

1350

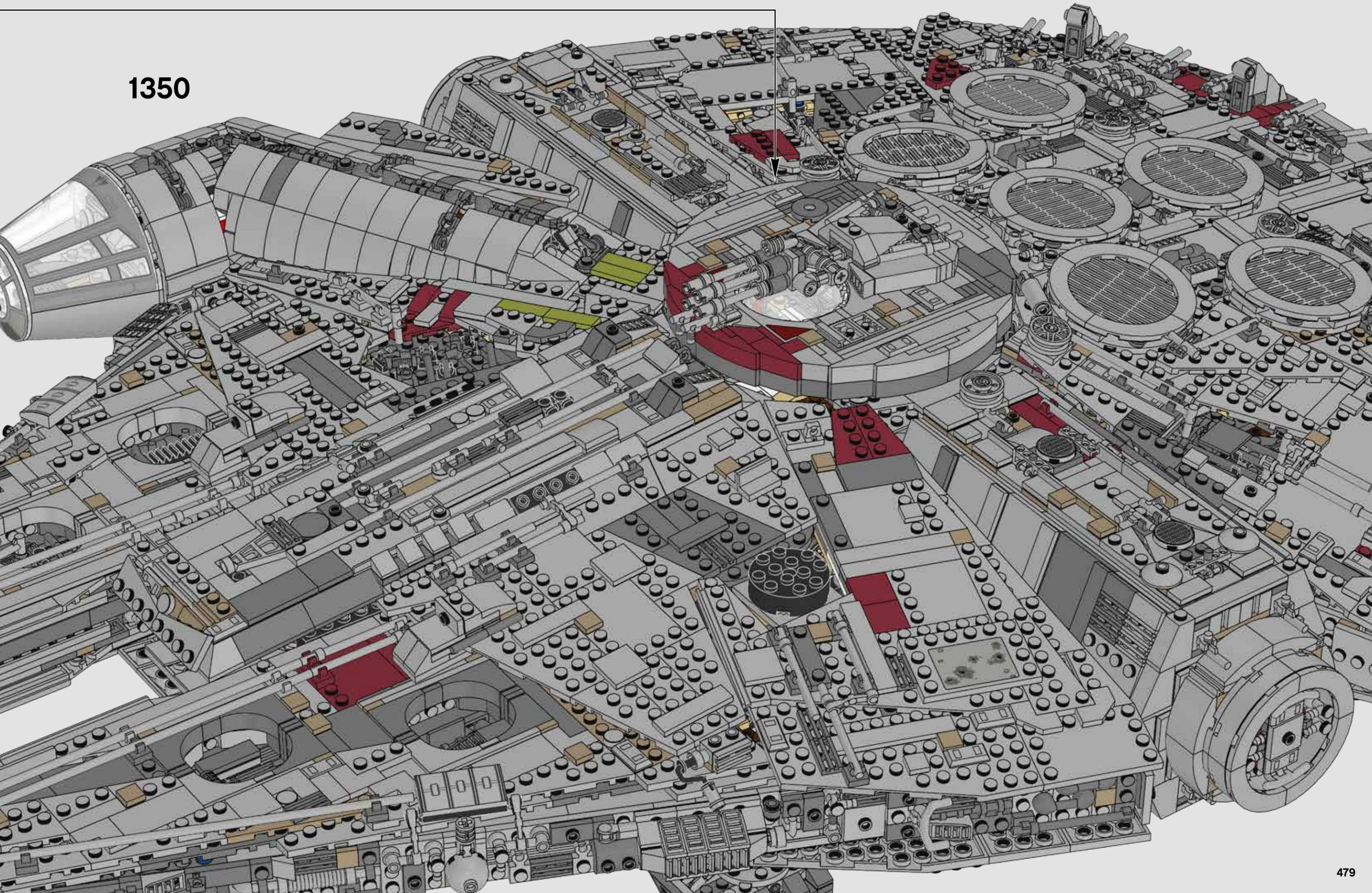

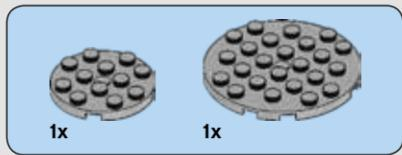

1351

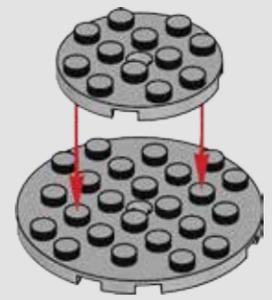

1352

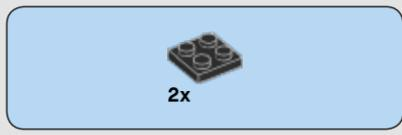
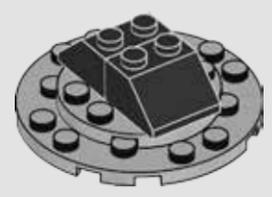

1353

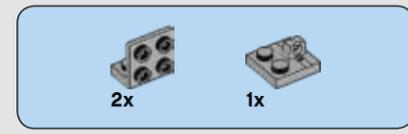
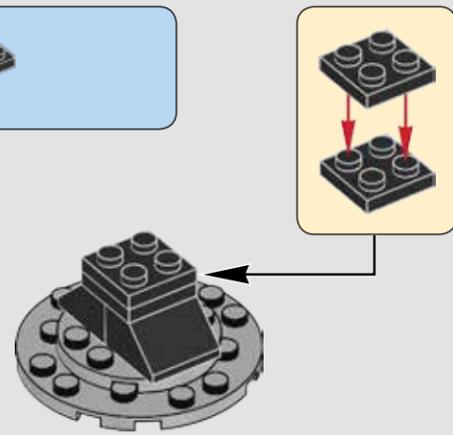

1354

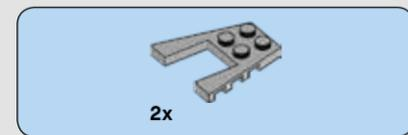
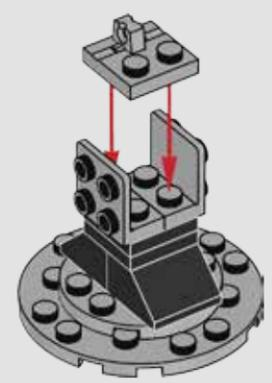

1355

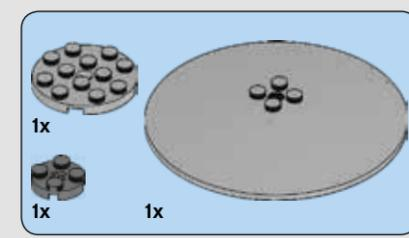
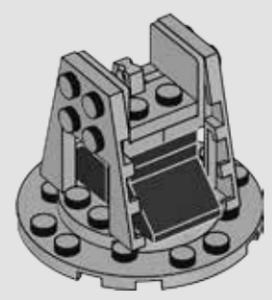

1356

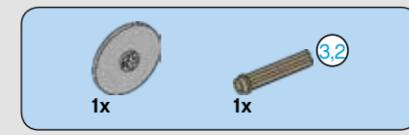
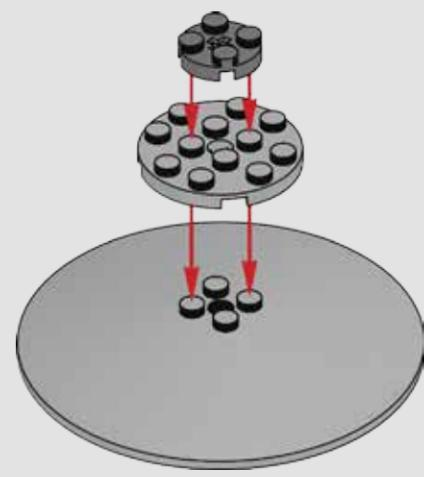

1357

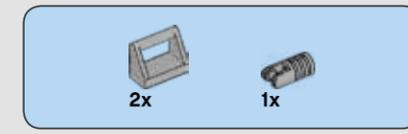
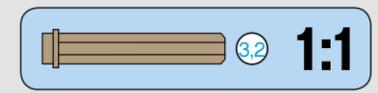
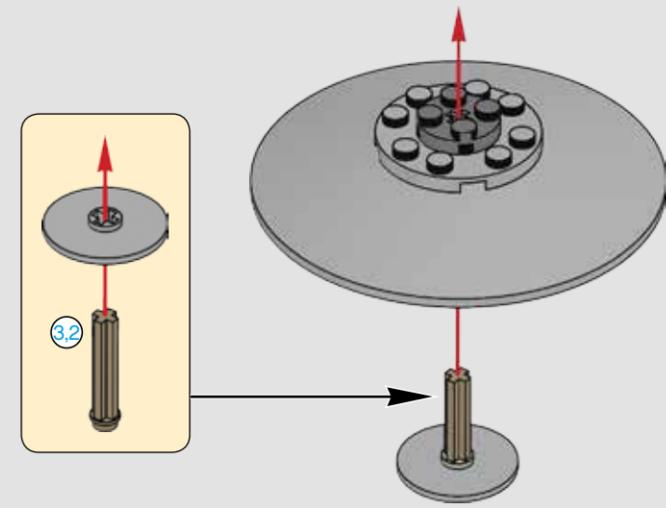

1358

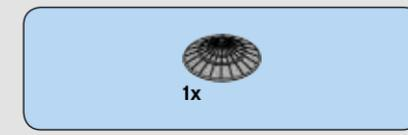
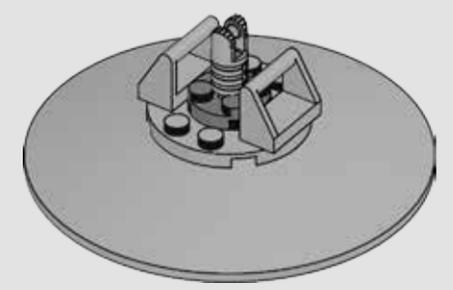

1359

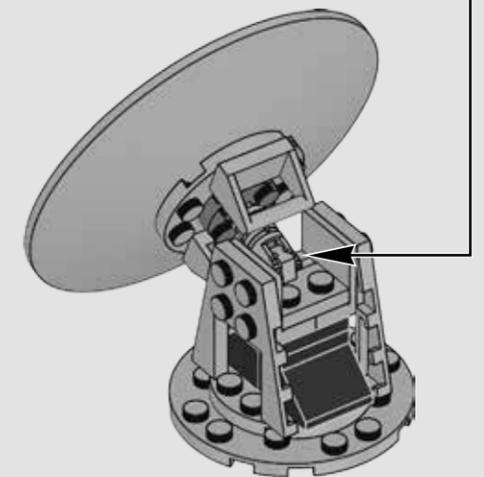
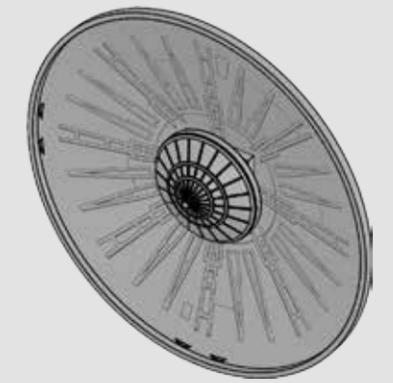

1360

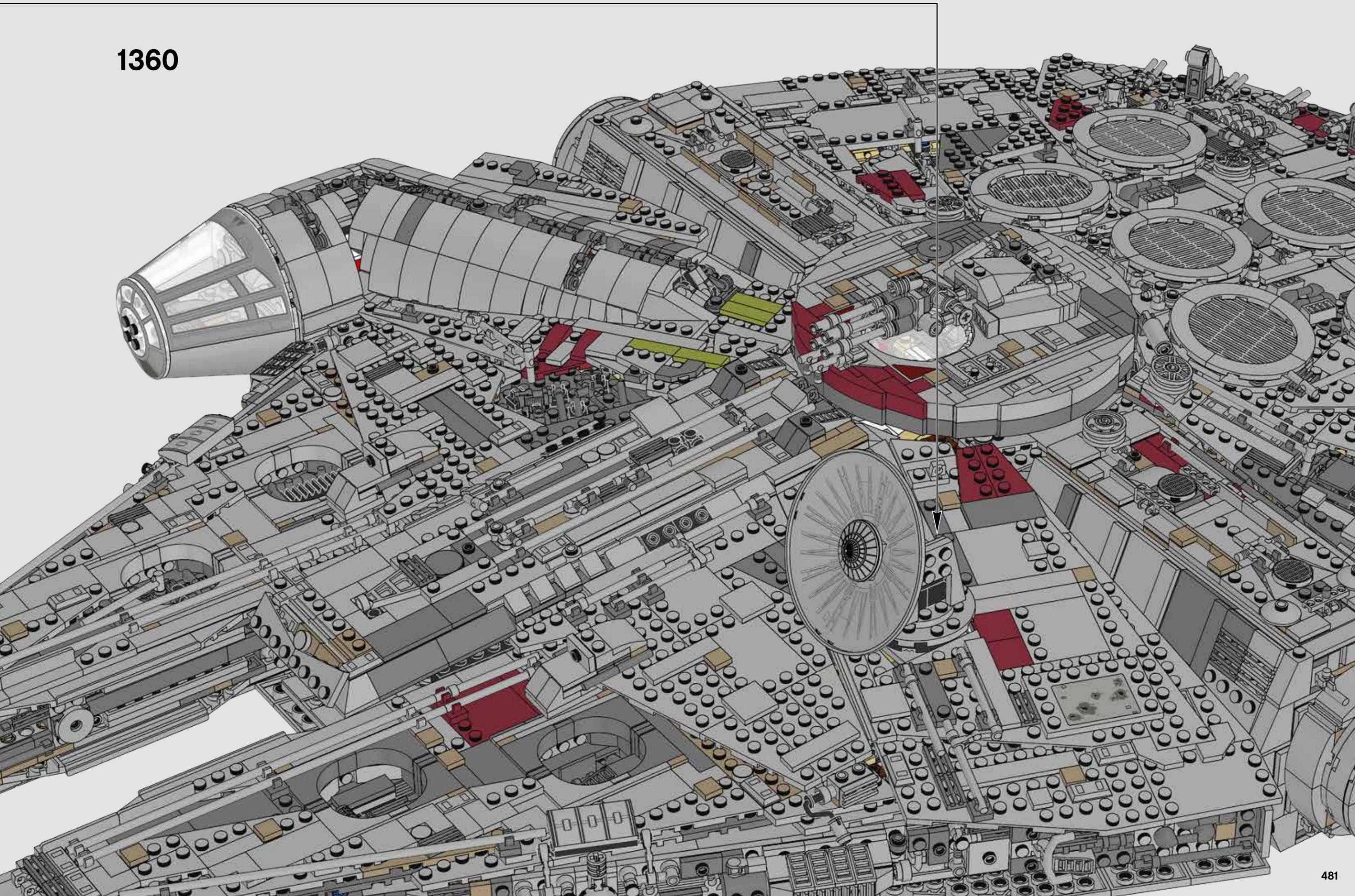

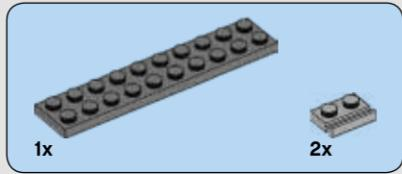

1361

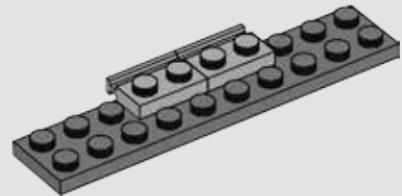

1362

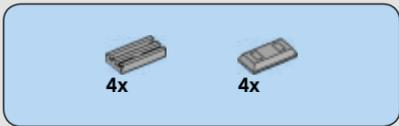
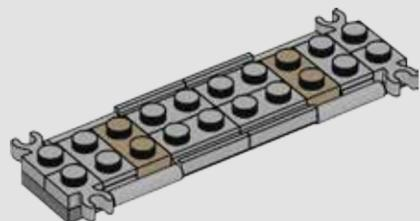

1363

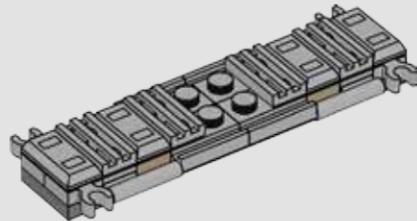

1364

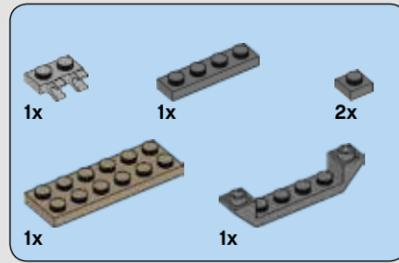
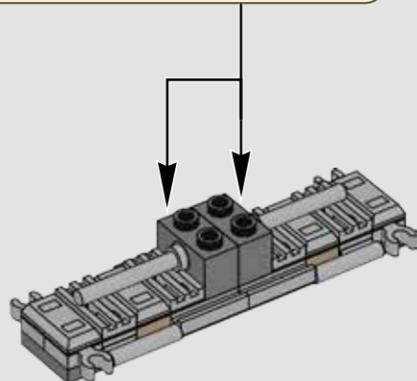
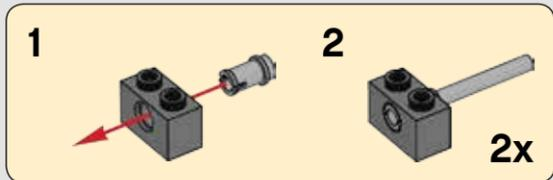

1365

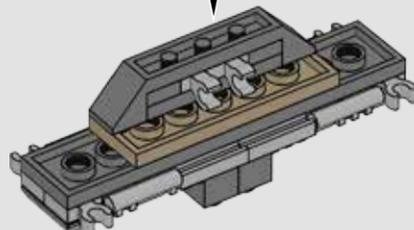
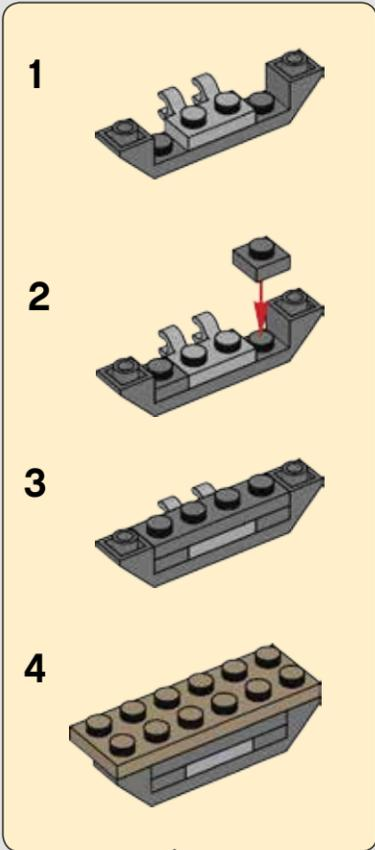

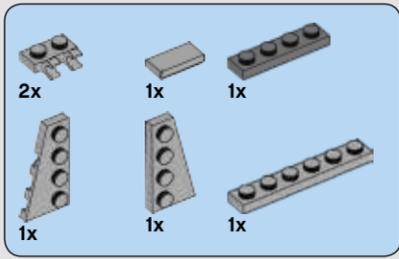

1366

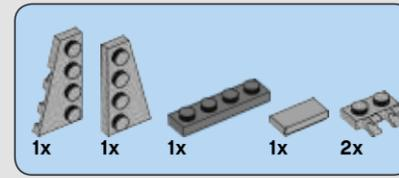
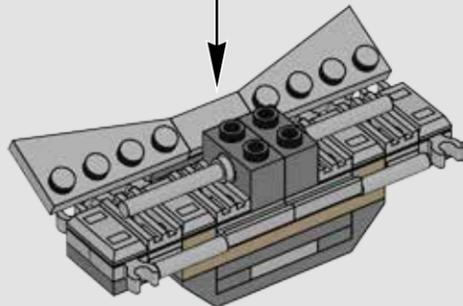
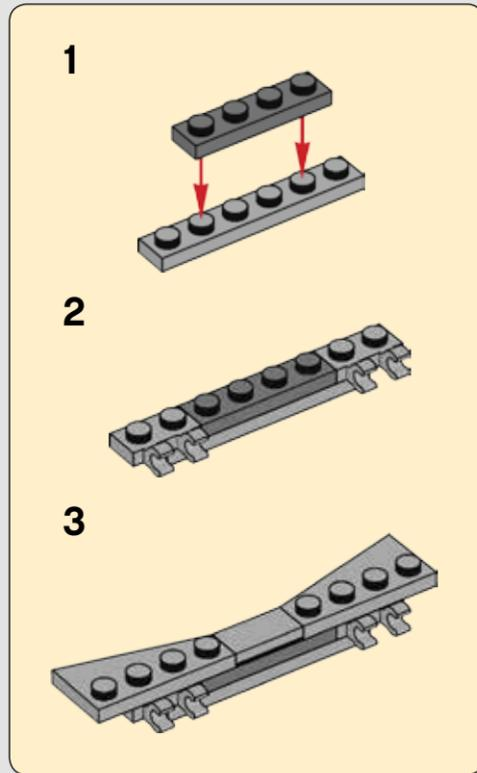

1367

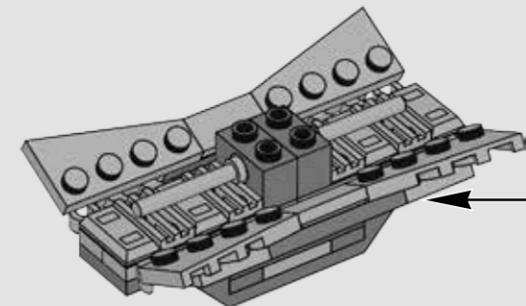
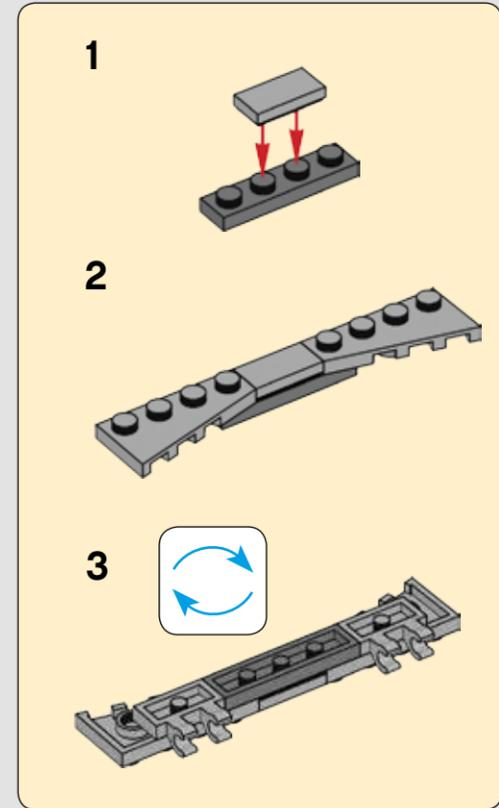

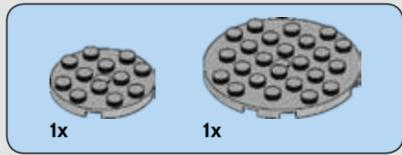

1368

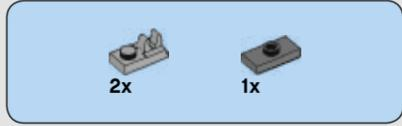
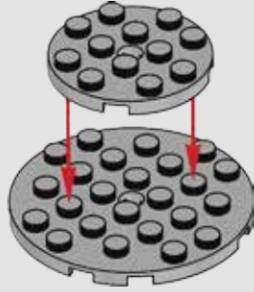

1369

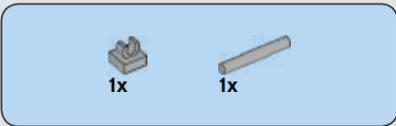

1370

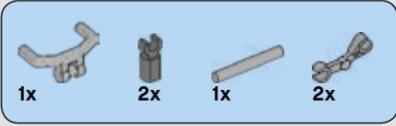
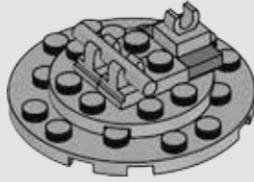

1371

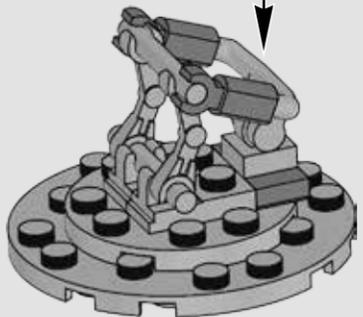
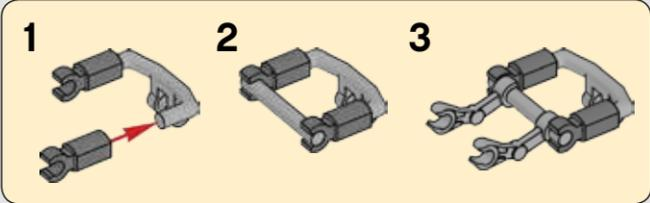

1372

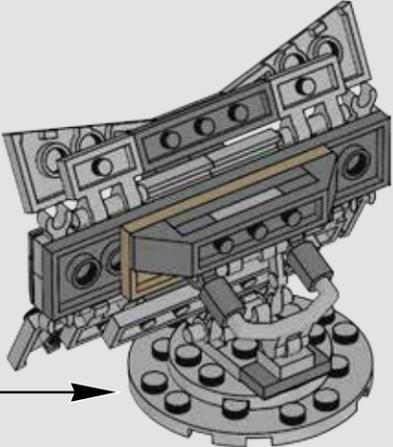

1373

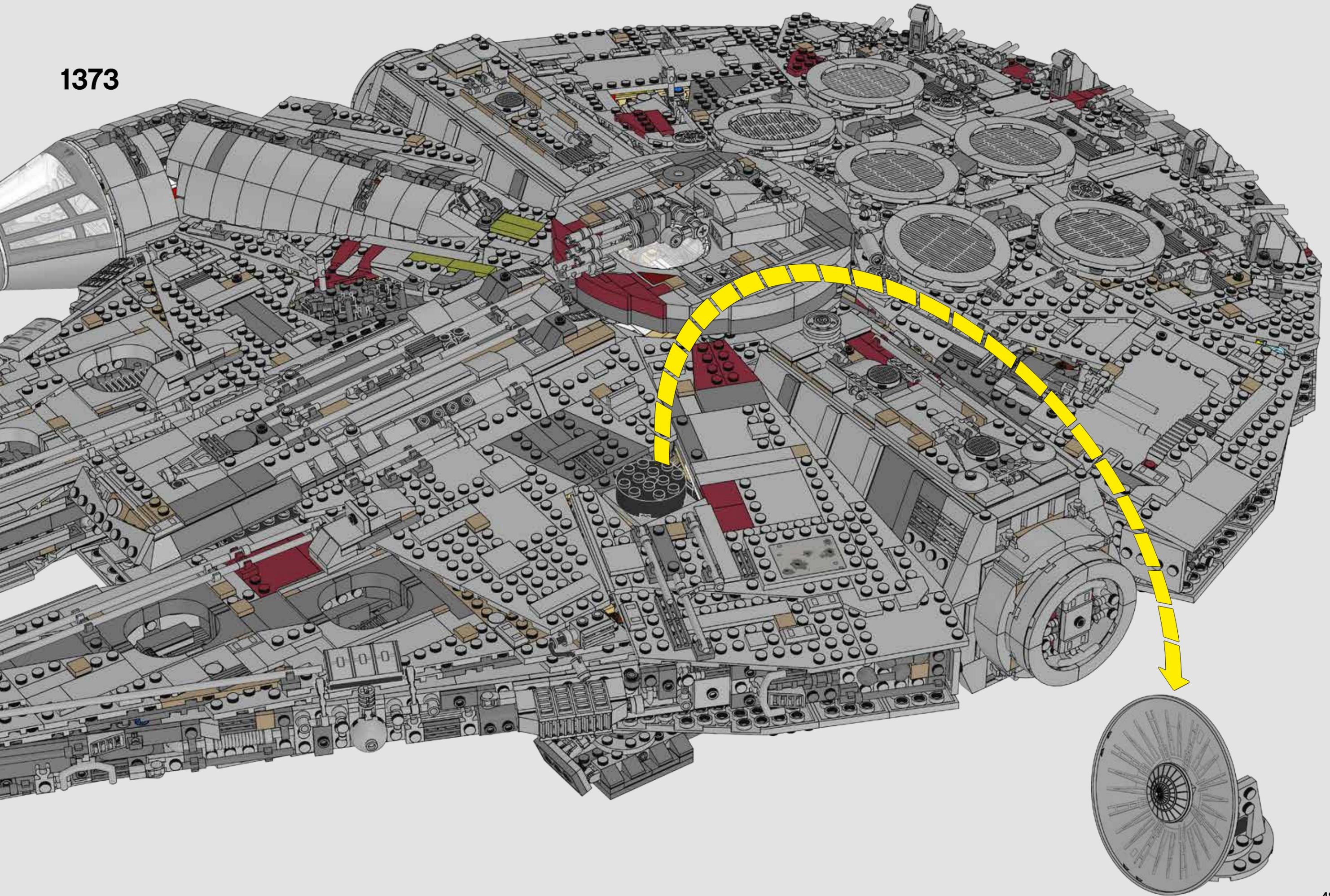

1374

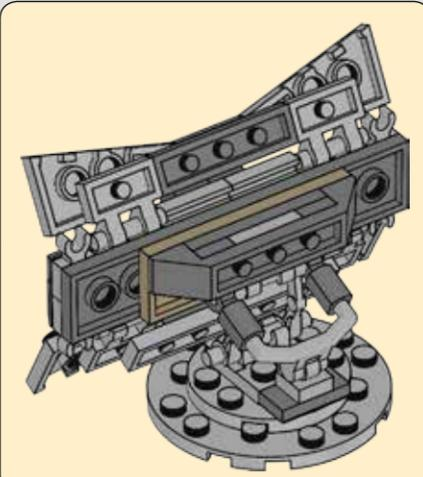
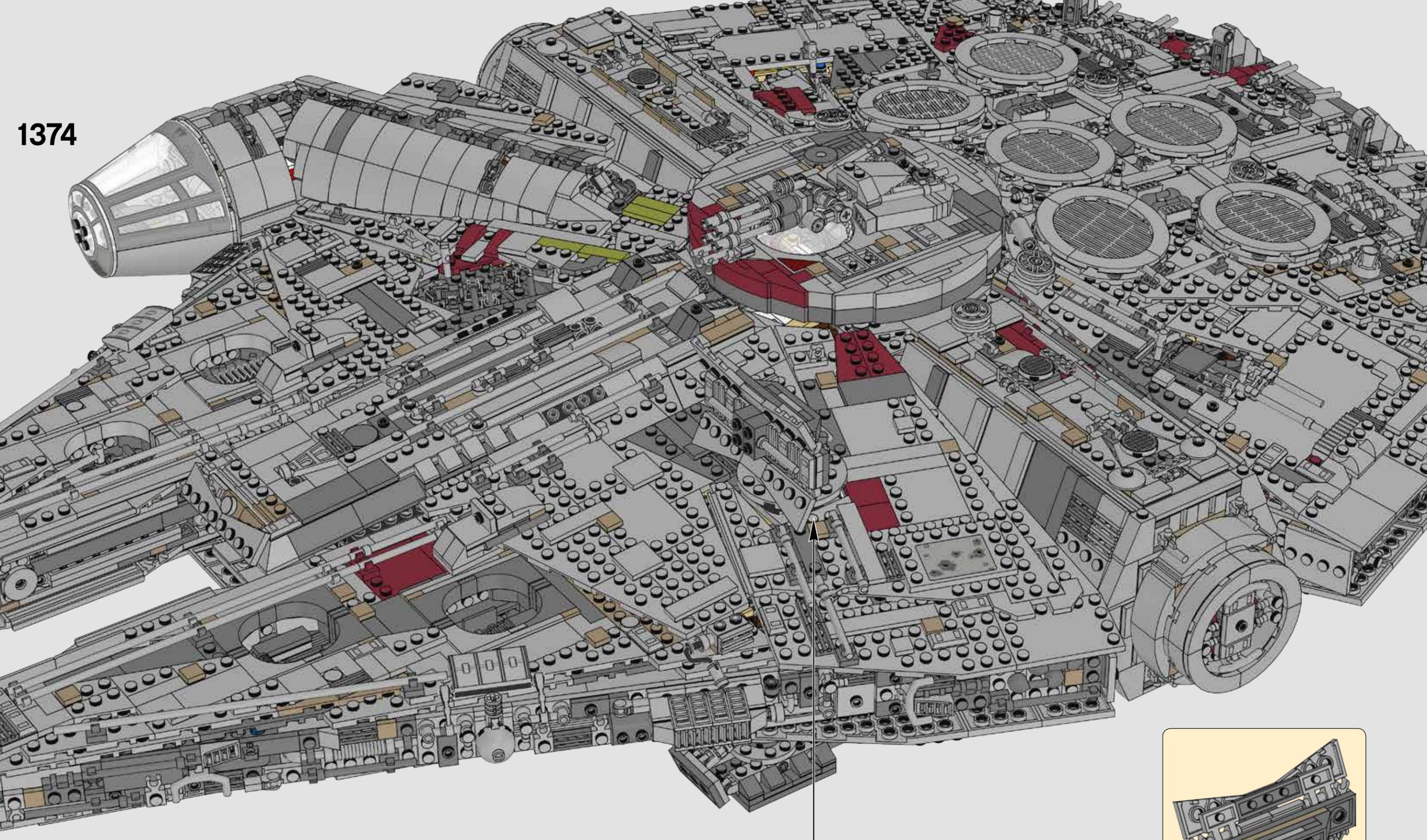

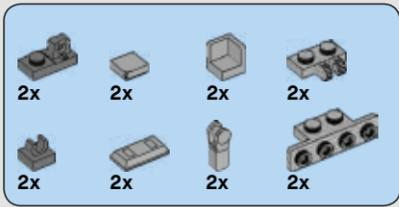

1375

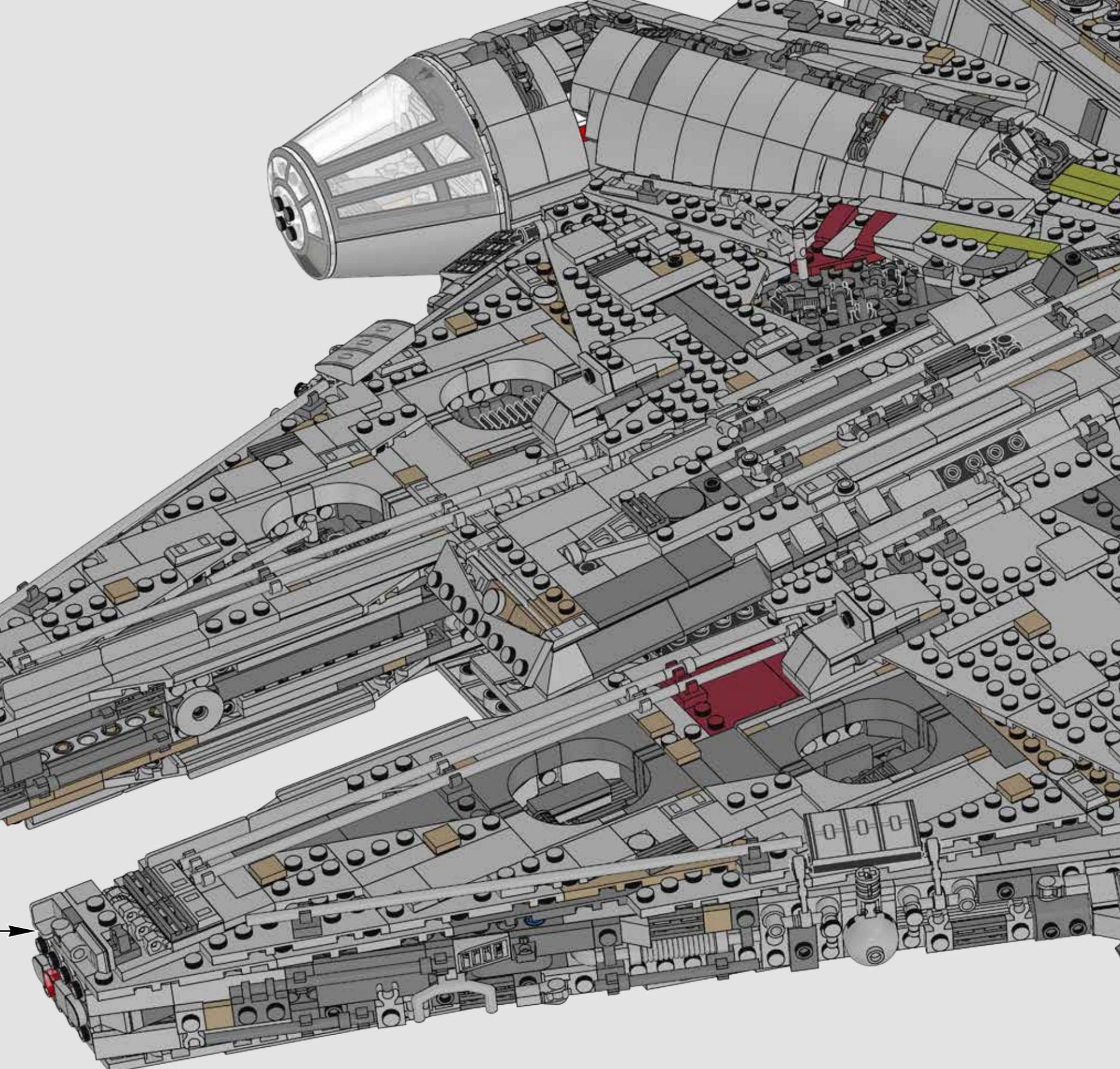
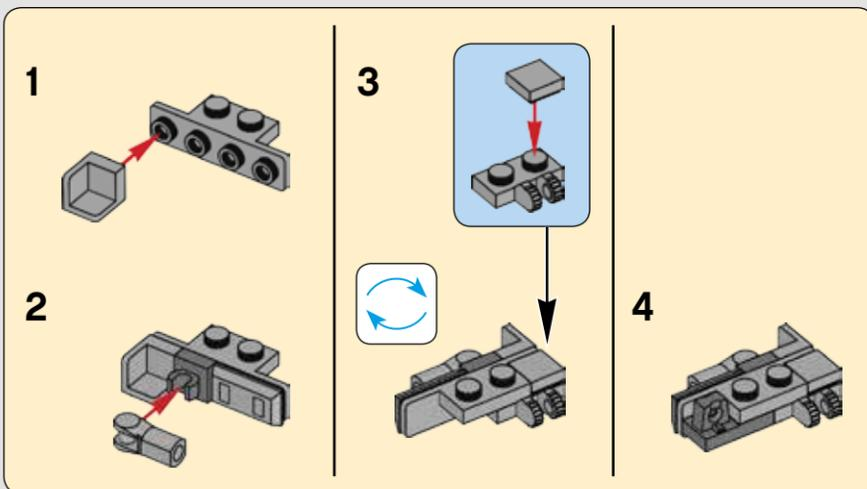
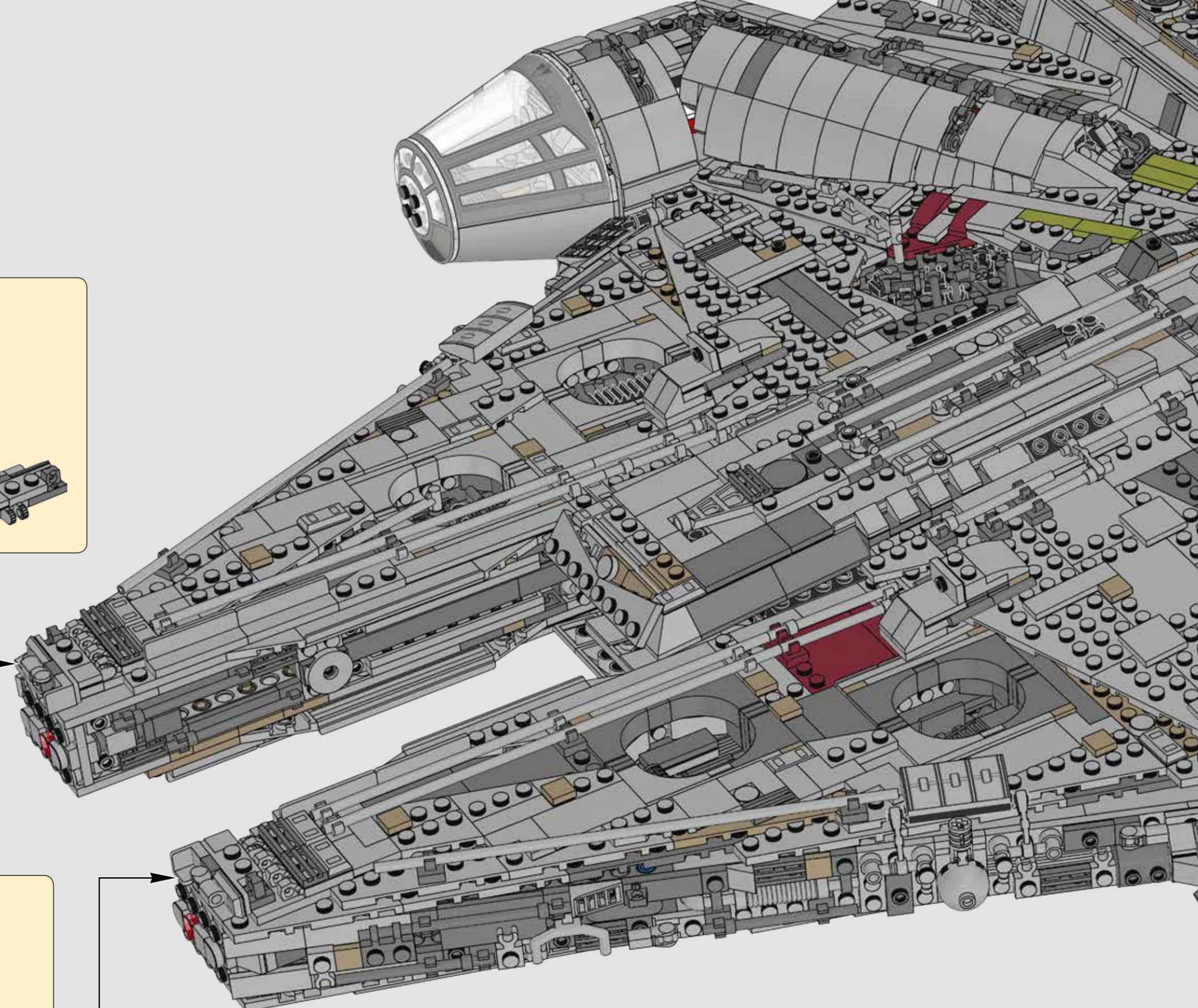
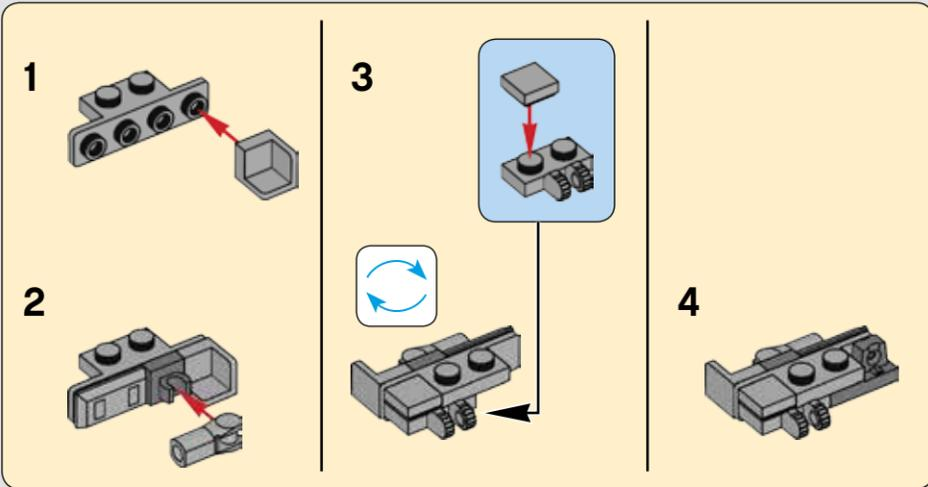

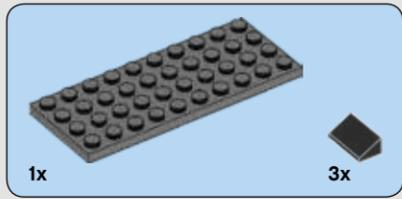

1376

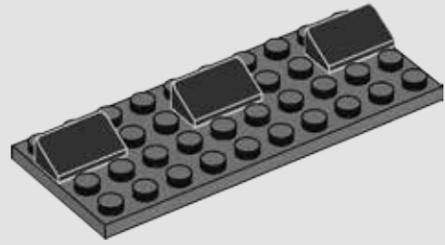

1377

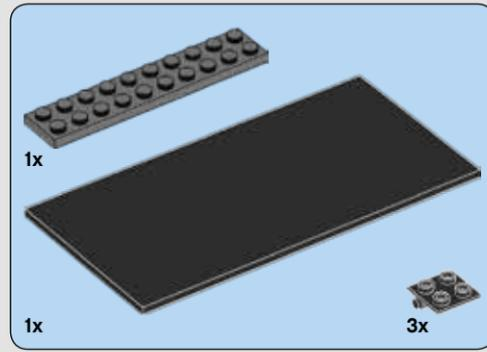
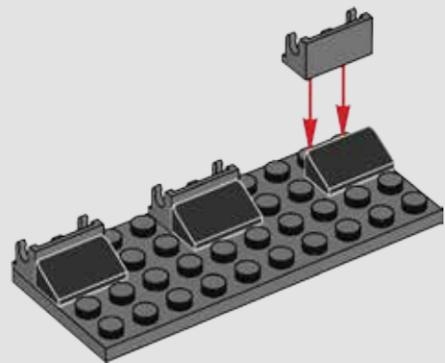

1378

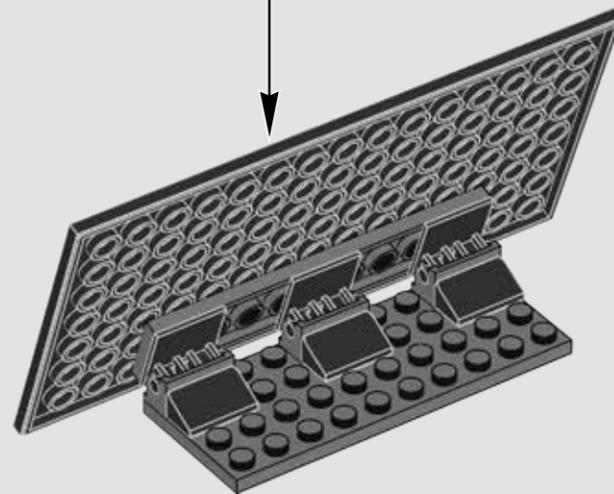
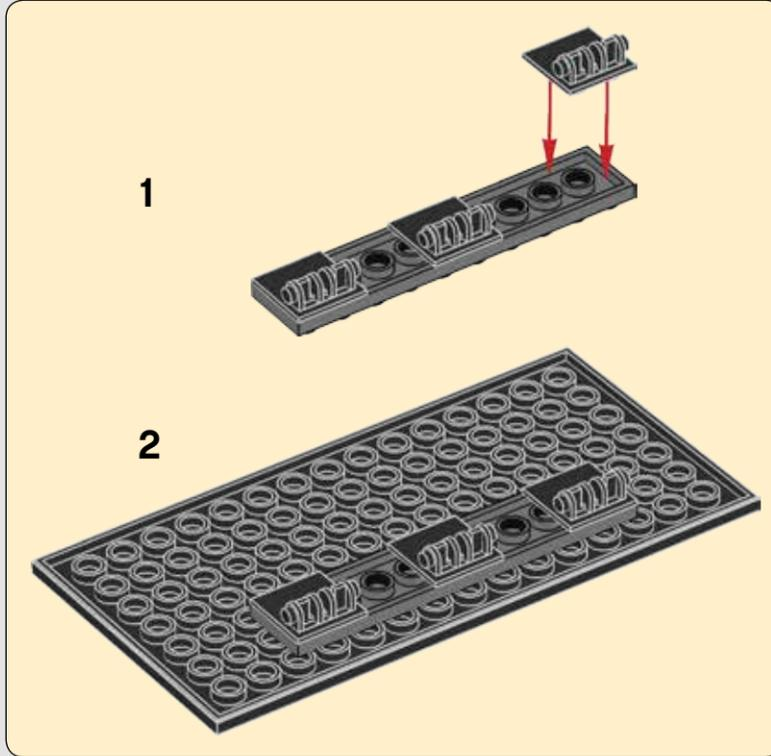

1379



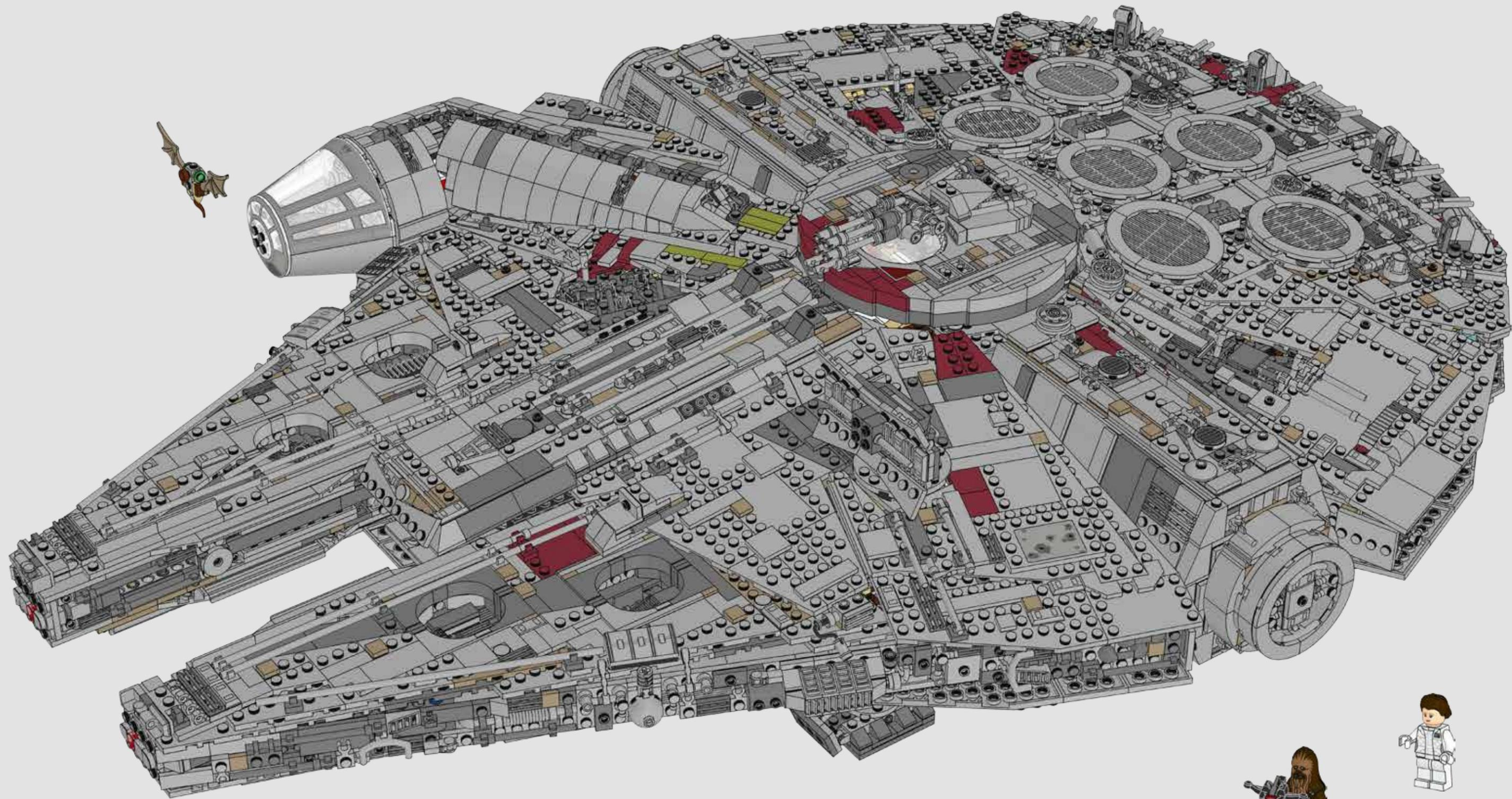

STAR WARS
Millennium Falcon
 Corellian Light Freighter YT-1300 Series (modified by Han Solo)

Manufacturer:	Corellian Engineering Corporation
Length:	34.76 meters
Engine:	Grodyne 58842 sublight drives
Maximum Speed:	100 km/h in atmosphere
Hyperdrive System:	Class 0.5 Iai-Sim 52P05 Hyperdrive
Weapons:	2 CEC AG-2G Quad Laser Cannons, 1 BlasTech AX-108 "Ground Buzzer" blaster cannon, 2 Arakyd ST2 concussion missile tubes
Capacity:	2 Pilots, 6 Passengers, and 100 metric tons of cargo

©LFL

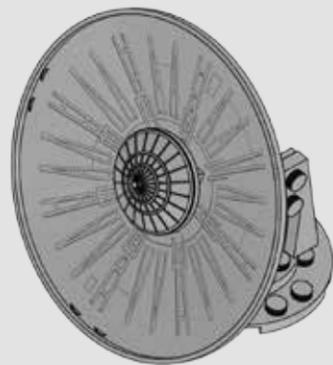

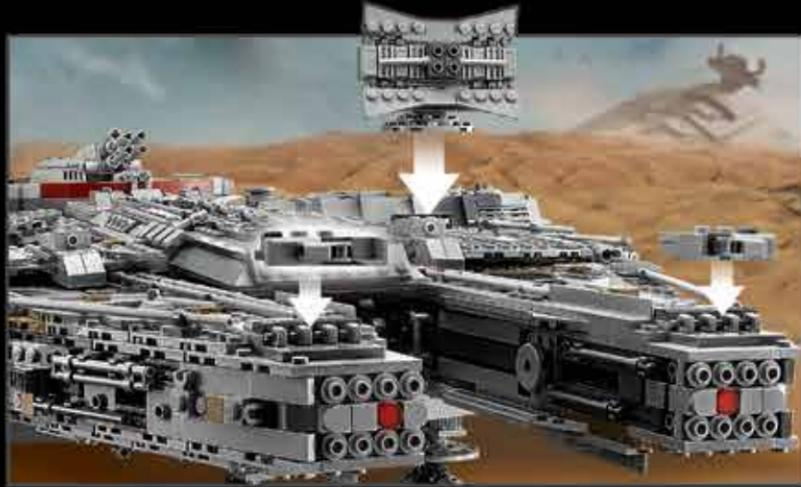
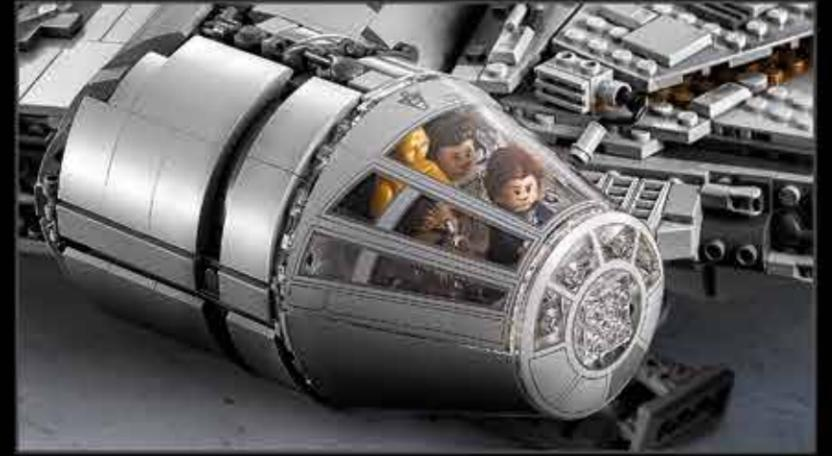

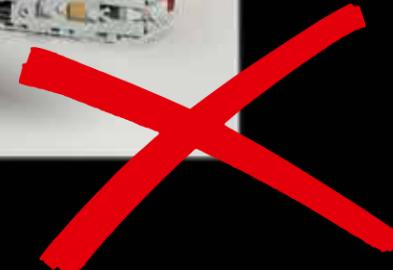
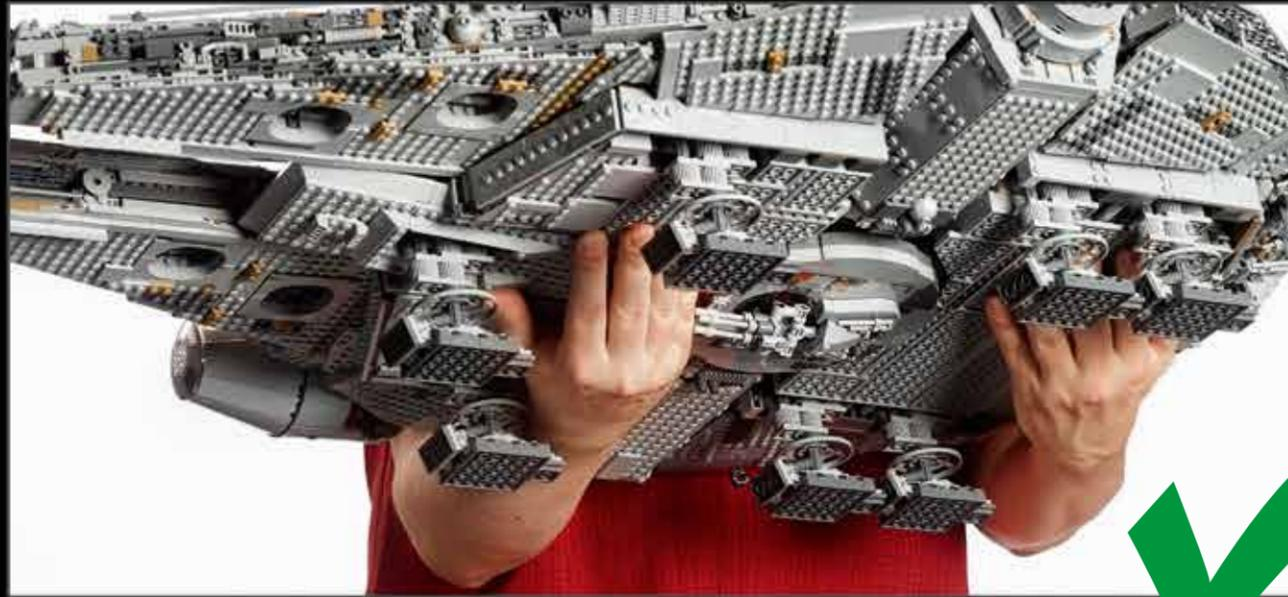

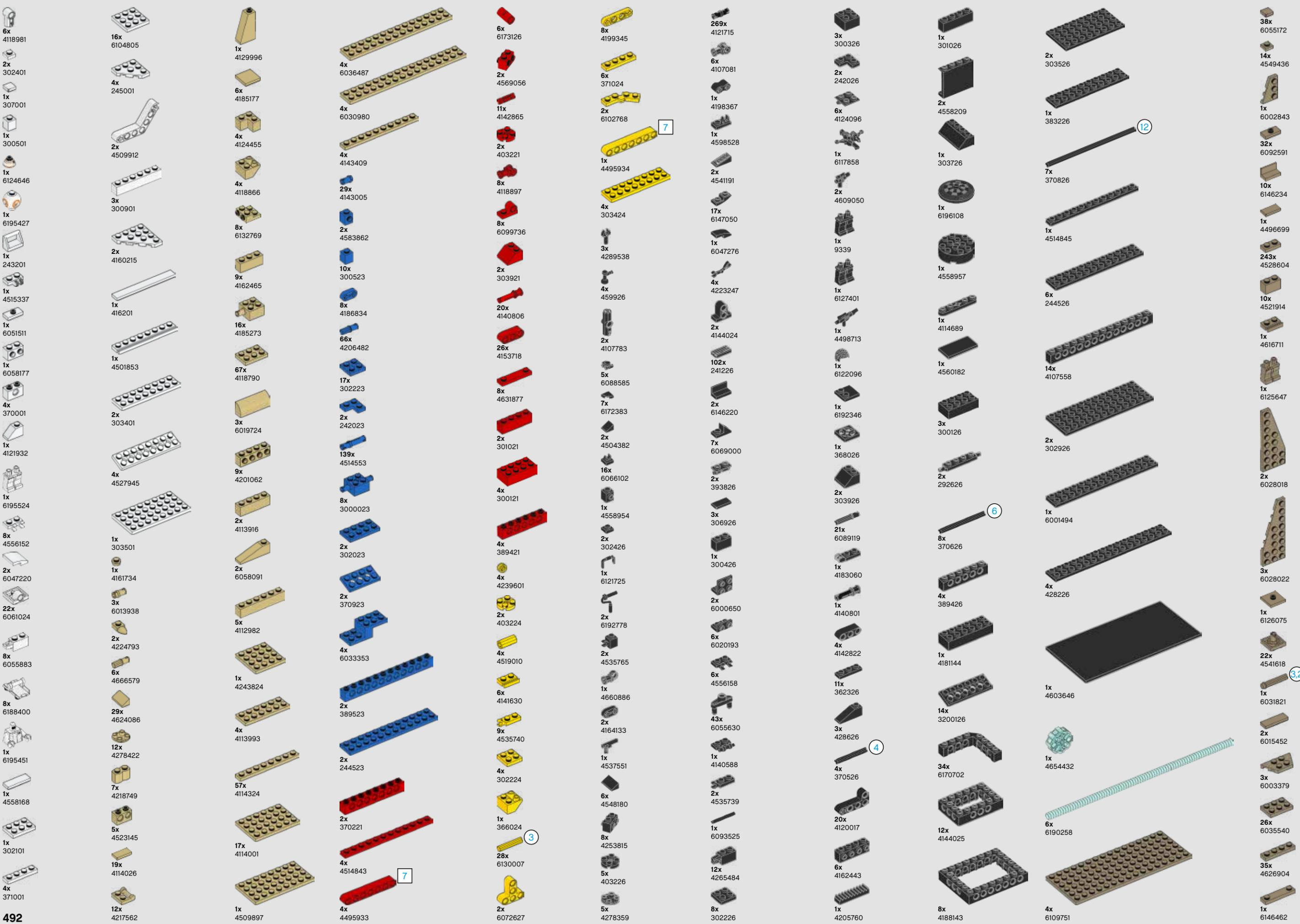

12

7

6

3.2

7

3

4



2x 6195496
14x 4267874
10x 4507047
10x 6151537
5x 4550329
2x 4595712
3x 4246957
8x 383228
6x 6173004
4x 6046903
2x 4205004
5x 6132157
1x 6195431
4x 6071222
3x 4550169
1x 6008593
2x 6008595
7x 4539090

14x 4539097
4x 4590811
4x 4539102
2x 6173168
4x 4585751
4x 4539105
10x 4539076
1x 4583299
4x 4650862
4x 6206250
4x 4541544
6x 4539060
1x 4539061
4x 6042953
1x 4539064
33x 4539071
29x 4539062
1x 6173167
1x 4539070
2x 4646864
3x 3005741
2x 3005748
2x 4217436

1x 4201235
1x 6186673
2x 6071274
1x 6127307
1x 6159776
1x 6133924
23x 4216695
1x 4211195
23x 4267994
8x 4216945
10x 4211214
1x 4225700
1x 4539481
8x 6152107
1x 4640844
26x 6168647
30x 4650260
50x 4211573
6x 6151688
29x 4211503
30x 4211483
2x 4558953
2x 6195329

15x 4211399
15x 6071229
46x 4521921
4x 4211389
5x 4215513
53x 4211415
1x 4595836
4x 6170569
2x 4278756
27x 4550170
6x 4211508
1x 4541978
1x 4630107
5x 4222047
1x 6075237
4x 4535764
16x 4594238
8x 4533772
22x 4211732
31x 4211791
38x 4211794
16x 4211735
24x 4514195

4x 6190437
35x 6173127
20x 4568637
4x 4211475
6x 4657459
2x 6052200
3x 6052204
2x 6179186
2x 6078985
34x 4650645
3x 6092956
4x 4211512
8x 4211637
5x 4211526
1x 4540203
2x 4211807
5x 6123815
6x 4211553
26x 4211383
10x 4509886
16x 4219913
4x 4515341
1x 4593679

22x 6066097
16x 4515374
4x 6028812
70x 6134378
9x 6144138
16x 6015344
10x 6146223
73x 4211398
4x 4211437
16x 4211440
18x 4598526
69x 4211414
2x 4211470
4x 4212363
12x 6093859
36x 6092111
4x 4211541
16x 6028813
20x 4211350
2x 4211357
10x 4211658
8x 4617170
33x 6168633

8x 4611702
18x 6123809
4x 4211494
24x 4211614
4x 4585429
9x 4657366
5x 6117967
13x 4654580
2x 4654582
5x 6044729
5x 4556157
13x 4211644
33x 4211568
4x 4258308
14x 4550251
2x 4667578
58x 6093527
8x 4211803
40x 4282786
40x 4282789

1x 4258273
2x 4208988
2x 4209006
1x 4258275
1x 6124903
12x 6126082
2x 4211376
10x 6132886
5x 4211365
17x 4211397
39x 4211413
8x 4211353
18x 4666449
5x 6102357
4x 4211387
2x 4494475

15x 6065824
13x 6177078
1x 6181755
10x 4216250
11x 4211815
3x 4211881
2x 6043639
14x 4211694
8x 4654577
75x 4211865
3x 4211502
2x 4520320
1x 4538007
1x 6187170
9x 4211428
23x 4211429
2x 6172809

3x 4644102
5x 4251163
26x 6129340
15x 4211488
31x 4558169
1x 6138067
12x 4211773
12x 6014615
6x 6116608
4x 4507056
105x 4211396
66x 6132207
2x 4211464
15x 6071299
15x 4211394
14x 4599498
22x 4211441
31x 4211445
5x 4211450
12x 6042950
47x 4211356

1x 4180418
2x 6013497
4x 4211409
1x 4511007
10x 4515351
2x 4211664
1x 6074888
13x 6015347
5x 4211361
8x 4211473
6x 4211748
1x 4180408
2x 6195323
2x 4597901
63x 4211395
22x 4560183
4x 6176242
4x 4211639
4x 4211385

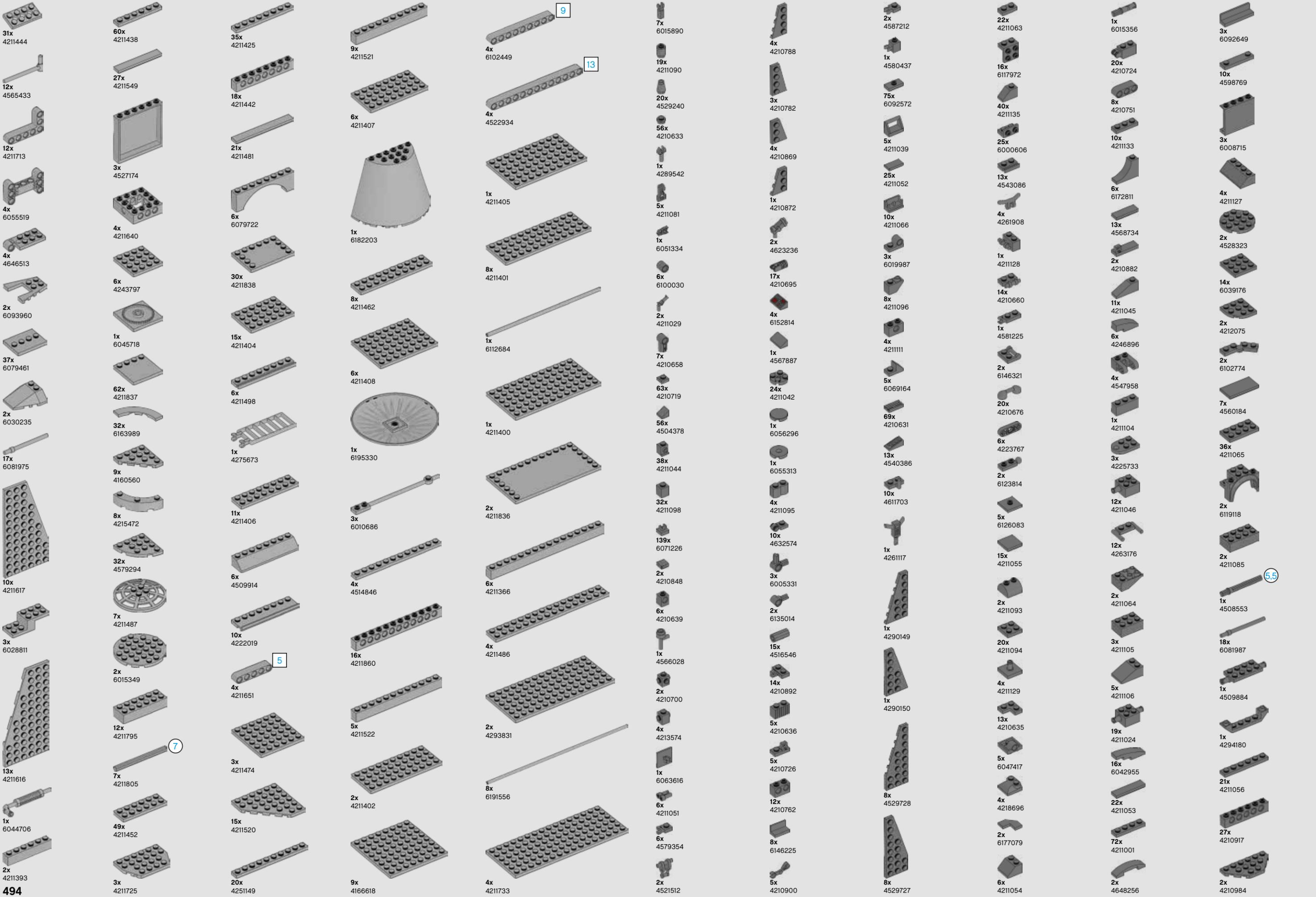

31x
4211444

12x
4565433

12x
4211713

4x
6055519

4x
4646513

2x
6093960

37x
6079461

2x
6030235

17x
6081975

10x
4211617

3x
6028811

13x
4211616

1x
6044706

2x
4211393

49x
4211452

3x
4211725

2x
4211393

494

60x
4211438

27x
4211549

3x
4527174

4x
4211640

6x
4243797

1x
6045718

62x
4211837

32x
6163989

9x
4160560

8x
4215472

32x
4579294

7x
4211487

2x
6015349

12x
4211795

7x
4211805

49x
4211452

3x
4211725

35x
4211425

18x
4211442

21x
4211481

6x
6079722

30x
4211838

15x
4211404

6x
4211498

1x
4275673

11x
4211406

6x
4509914

10x
4222019

4x
4211651

3x
4211474

15x
4211520

20x
4251149

9x
4211521

6x
4211407

1x
6182203

8x
4211462

6x
4211408

1x
6195330

3x
6010686

4x
4514846

16x
4211860

5x
4211522

2x
4211402

9x
4166618

4x
6102449

4x
4522934

1x
4211405

8x
4211401

1x
6112684

1x
4211400

2x
4211836

6x
4211366

4x
4211486

2x
4293831

8x
6191556

4x
4211733

9

13

7x
6015890

19x
4211090

20x
4529240

56x
4210633

1x
4289542

5x
4211081

1x
6051334

6x
6100030

2x
4211029

7x
4210658

63x
4210719

56x
4504378

38x
4211044

32x
4211098

139x
6071226

2x
4210848

6x
4210639

1x
4566028

2x
4521512

4x
4210788

3x
4210782

4x
4210869

1x
4210872

2x
4623236

17x
4210695

4x
6152814

1x
4567887

24x
4211042

1x
6056296

1x
6055313

4x
4211095

10x
4632574

3x
6005331

2x
6135014

15x
4516546

14x
4210892

5x
4210636

5x
4210900

2x
4587212

1x
4580437

75x
6092572

5x
4211039

25x
4211052

10x
4211066

3x
6019987

8x
4211096

4x
4211111

5x
6069164

69x
4210631

13x
4540386

10x
4611703

1x
4261117

1x
4290149

1x
4290150

8x
4529728

8x
4529727

22x
4211063

16x
6117972

40x
4211135

25x
6000606

13x
4543086

4x
6261908

1x
4211128

14x
4210660

1x
4581225

2x
6146321

20x
4210676

6x
4223767

2x
6123814

5x
6126083

15x
4211055

2x
4211093

20x
4211094

4x
4211129

6x
4211054

1x
6015356

20x
4210724

8x
4210751

10x
4211133

6x
6172811

13x
4568734

2x
4210882

11x
4211045

6x
4246896

4x
4547958

1x
4211104

3x
4225733

12x
4211046

12x
4263176

2x
4211064

3x
4211105

5x
4211106

19x
4211024

2x
4648256

3x
6092649

10x
4598769

3x
6008715

4x
4211127

2x
4528323

14x
6039176

2x
4212075

2x
6102774

7x
4560184

36x
4211065

2x
6119118

2x
4211085

1x
4508553

18x
6081987

1x
4509884

1x
4294180

21x
4211056

27x
4210917

2x
4210984

5.5

- 1x 6037666
- 20x 4257526
- 3x 4211107
- 2x 4211061
- 15x 4211134
- 3x 4210678
- 4x 4603472
- 5x 4211122
- 13x 4211067
- 3x 4211114
- 50x 4256828
- 8x 4210796
- 2x 4210720
- 1x 4226358
- 9x 4211100
- 2x 4210651
- 5x 4509911
- 2x 4243831
- 8x 4211002
- 2x 4495931
- 2x 4521572
- 1x 4499858
- 1x 4595710
- 2x 4210815
- 8x 4210998
- 4x 4211008
- 2x 4211115
- 2x 4210967
- 4x 4210997
- 15x 6057986
- 6x 6058135
- 1x 6127357
- 21x 4633691
- 6x 6054858
- 32x 4619636
- 1x 6124928
- 1x 4653753
- 1x 6138412
- 1x 6078373
- 1x 6063675
- 1x 4632767
- 1x 6063666
- 1x 6195522
- 1x 6122095
- 1x 6058788
- 1x 6127399
- 2x 4167842
- 1x 6195333
- 2x 6195331
- 1x 6205311
- 1x 6124907
- 1x 6194148
- 1x 6195440
- 1x 6195443
- 2x 4157103
- 4x 4159007
- 2x 4158355
- 1x 4654448



LEGO.com/productfeedback

GEWINNE	GAGNE	ГАНА
<p>Erzähle uns auf www.LEGO.com/productfeedback etwas über die Erfahrungen, die du mit diesem LEGO® Set gemacht hast, und sichere dir die Chance auf einen coolen LEGO Preis!</p> <p>Es gelten die Teilnahmebedingungen</p>	<p>Rends-toi sur www.LEGO.com/productfeedback et donne-nous quelques commentaires sur ce produit LEGO® pour avoir une chance de gagner un prix LEGO !</p> <p>Voir Conditions Générales</p>	<p>Visita www.LEGO.com/productfeedback y envíanos tu opinión acerca de este set LEGO®. ¡Participarás en el sorteo de un premio LEGO!</p> <p>Términos y Condiciones aplicables</p>
获取奖品	경품 당첨 기회	ЗАПОЛНИ АНКЕТУ И ПОЛУЧИ ПРИЗ
<p>登录 www.LEGO.com/productfeedback 给出关于此乐高®套装的简短反馈, 就有机会获得炫酷乐高奖品</p> <p>《条款及条件》适用</p>	<p>www.LEGO.com/productfeedback 페이지로 이동하여 이 레고® 세트에 대한 간략한 피드백을 보내 주시고 멋진 레고 경품을 탈 수 있는 기회도 잡으십시오</p> <p>약관 적용</p>	<p>Перейди по ссылке www.LEGO.com/productfeedback ответь всего на несколько вопросов об этом наборе LEGO®, и у тебя появится шанс выиграть замечательный приз от компании LEGO.</p> <p>Применяются Условия и правила участия</p>

Customer Service
Kundenservice
Service Consommateurs
Servicio Al Consumidor
LEGO.com/service or dial

: 00800 5346 5555
: 1-800-422-5346

