

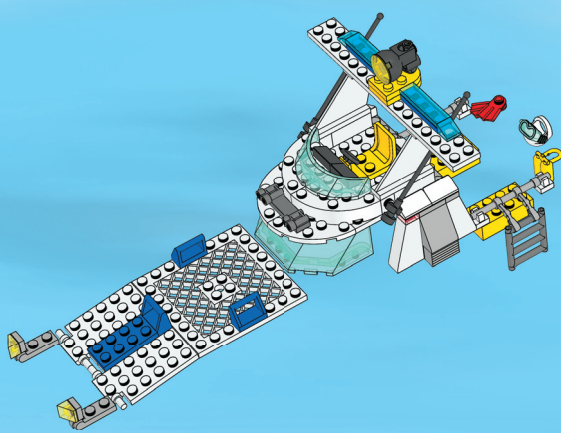

7287

# CITY

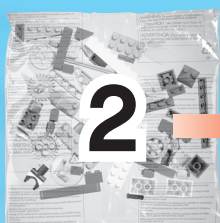

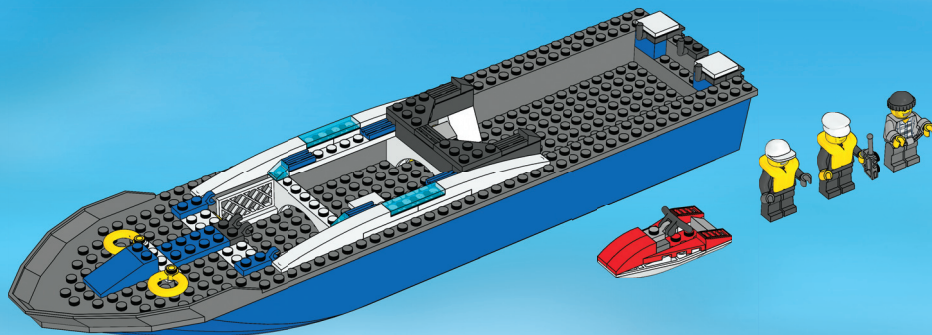
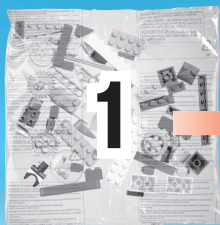

1

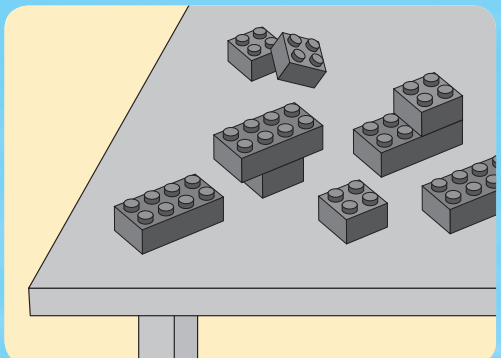
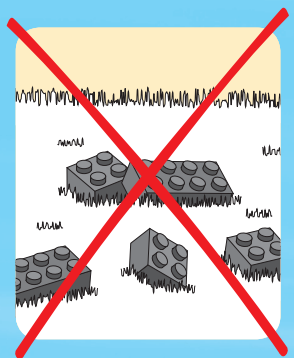

2

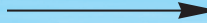

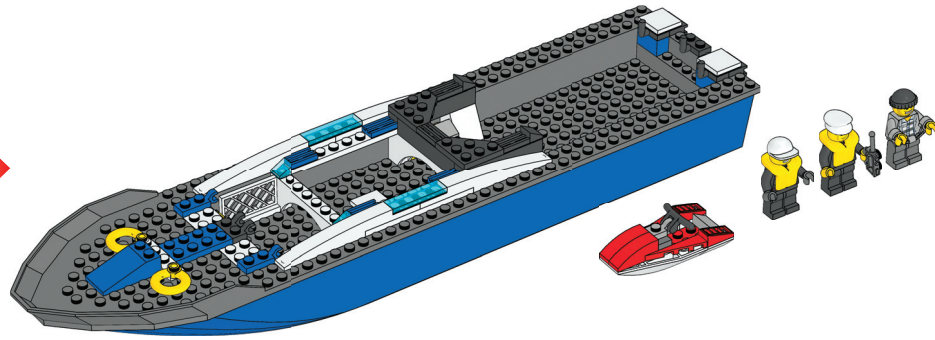

3

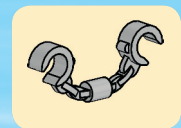
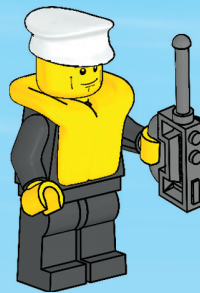
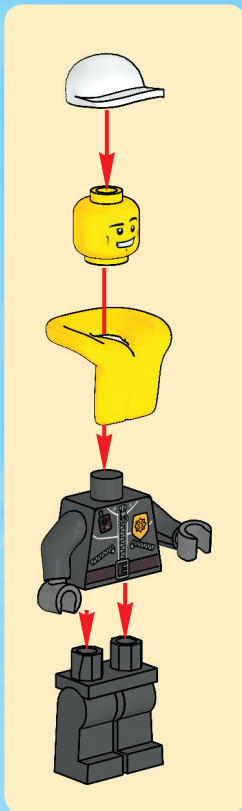

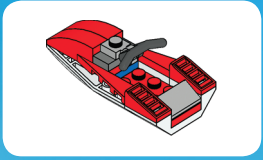

1

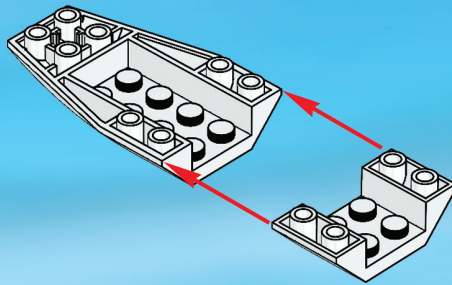

2

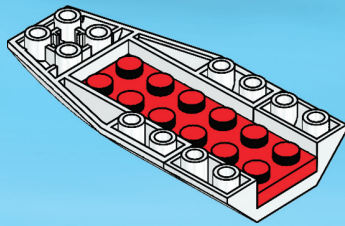

3

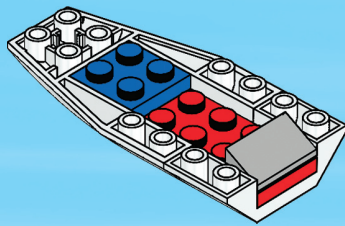

4

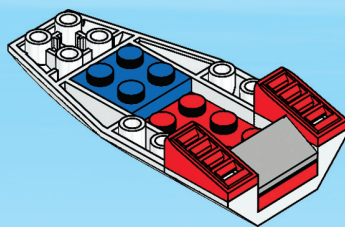



5

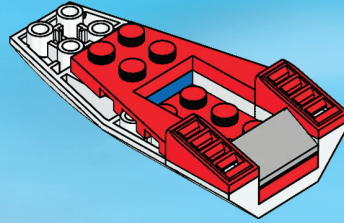

6

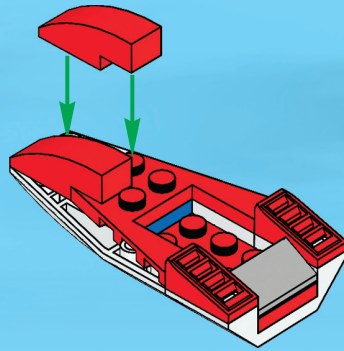

7

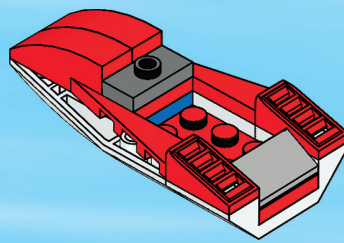

8

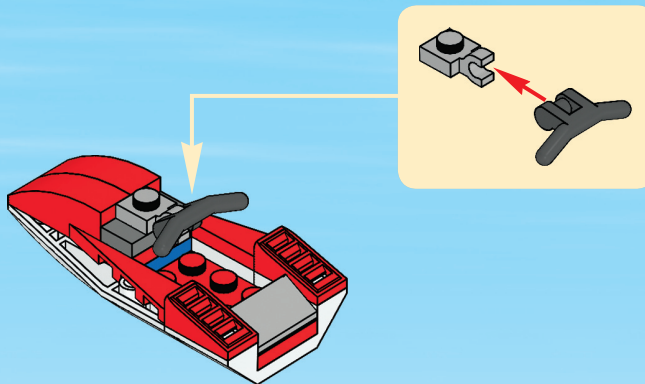

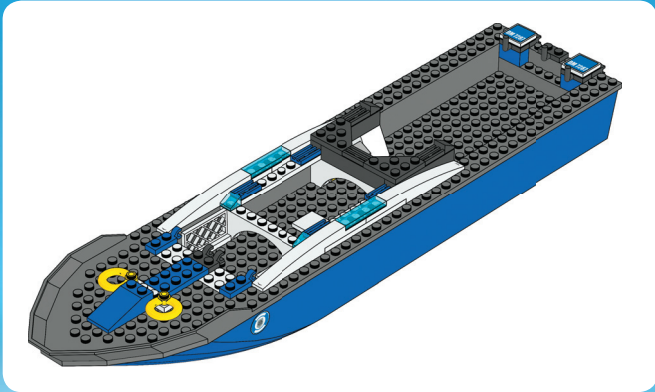

1

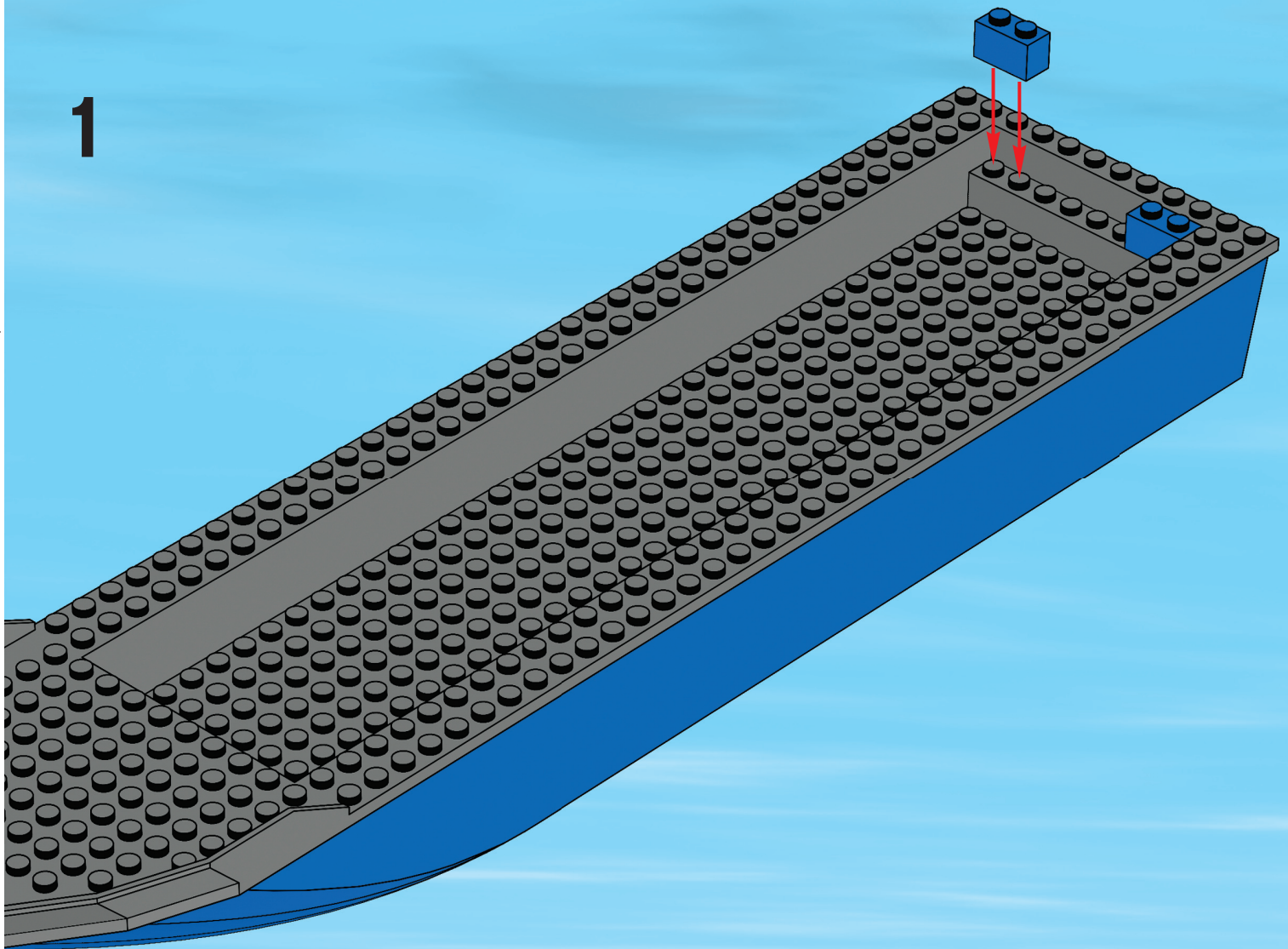

6





2

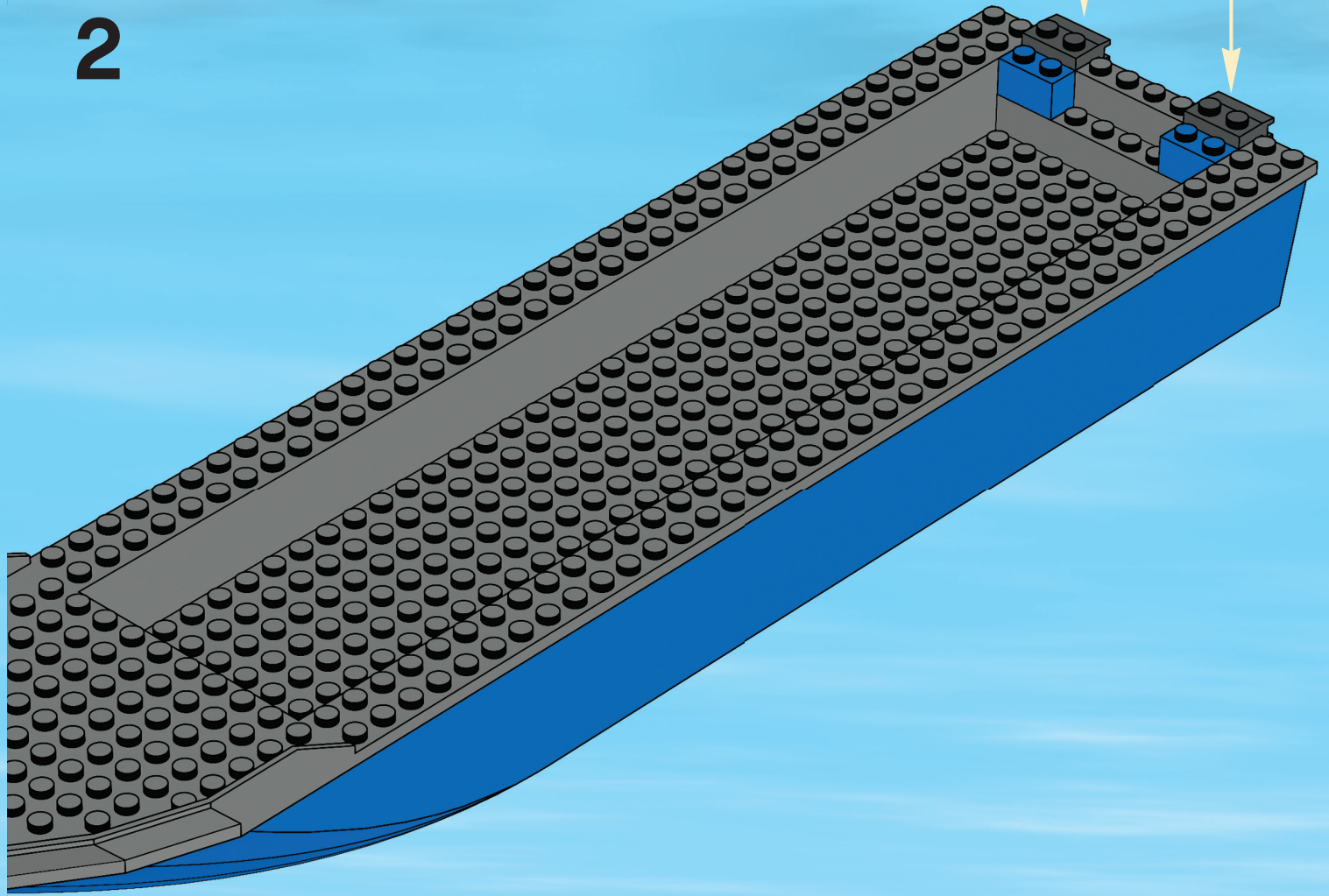
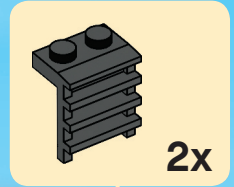



3

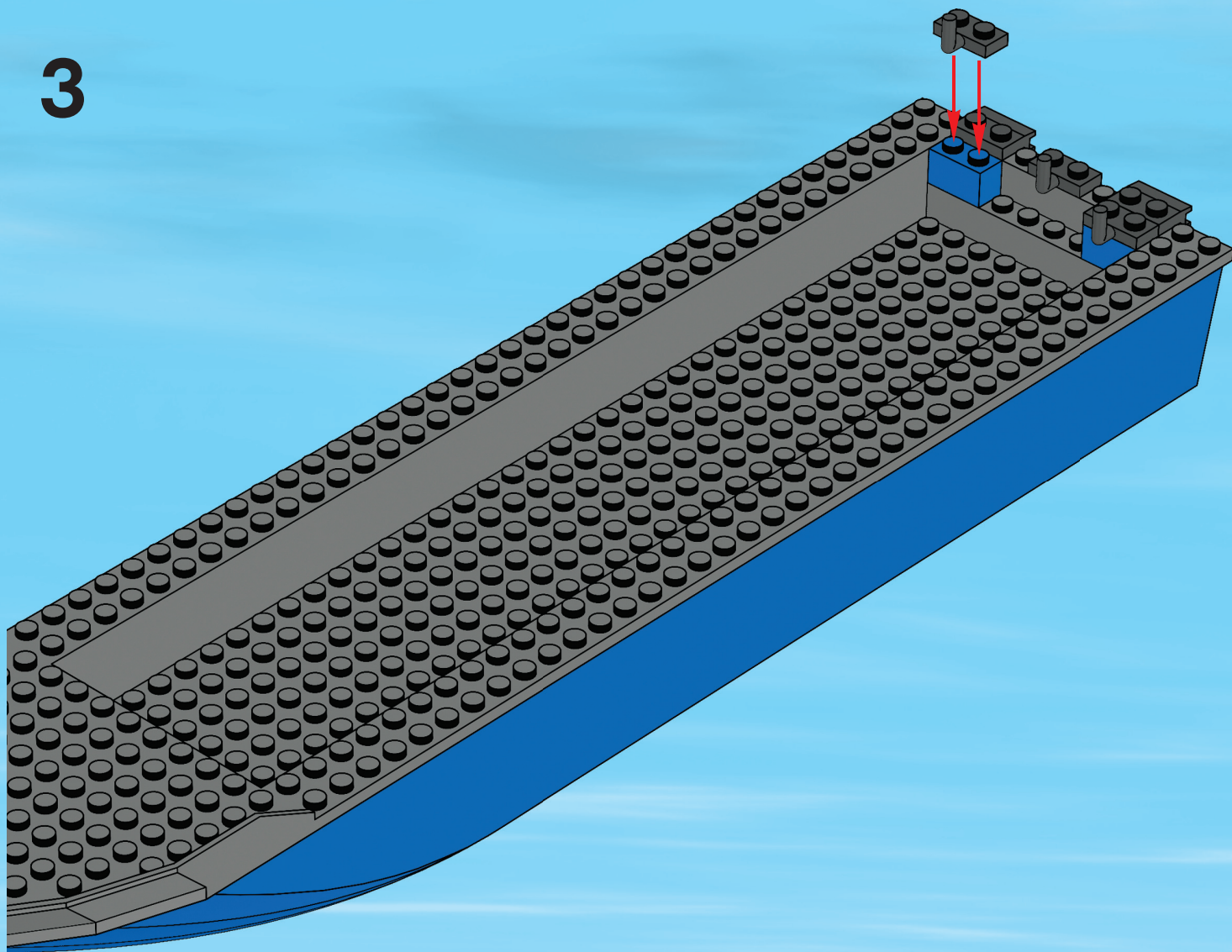

8







4

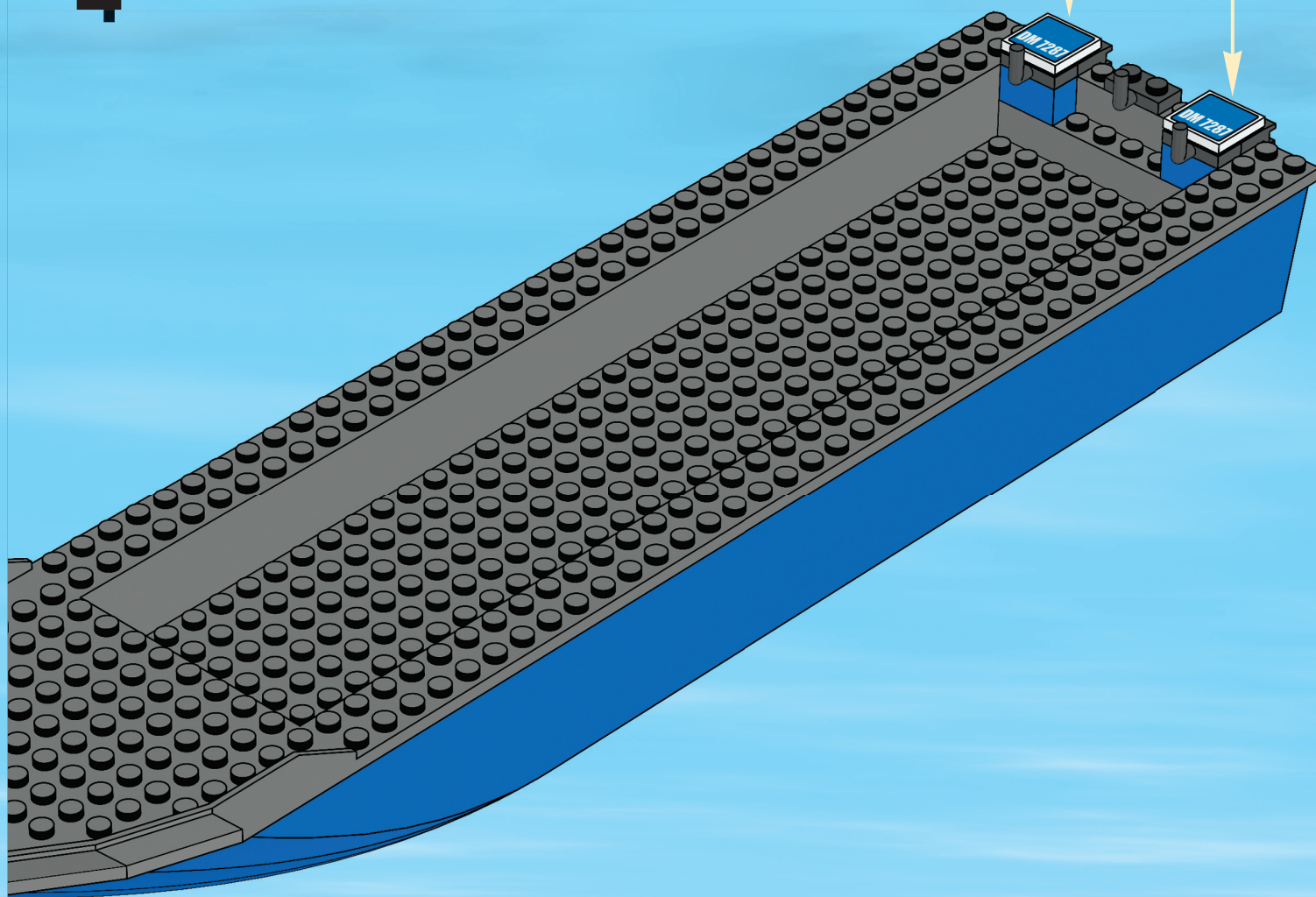
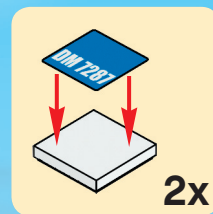



5

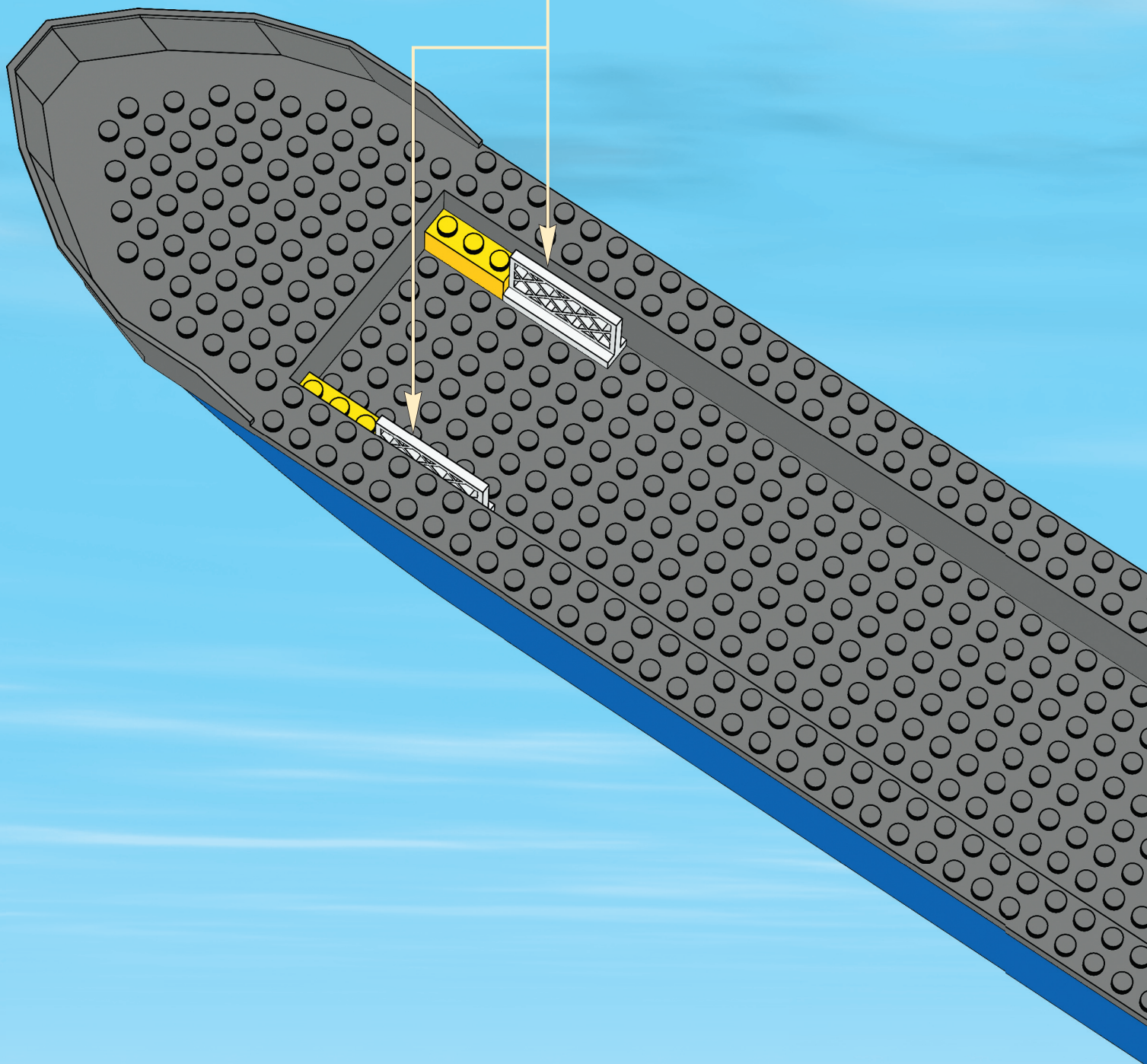
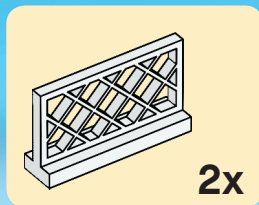

10



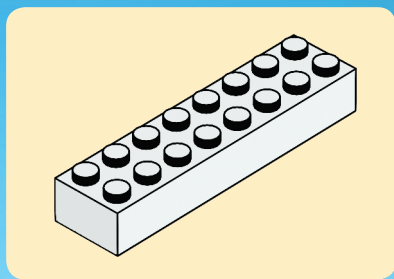

6

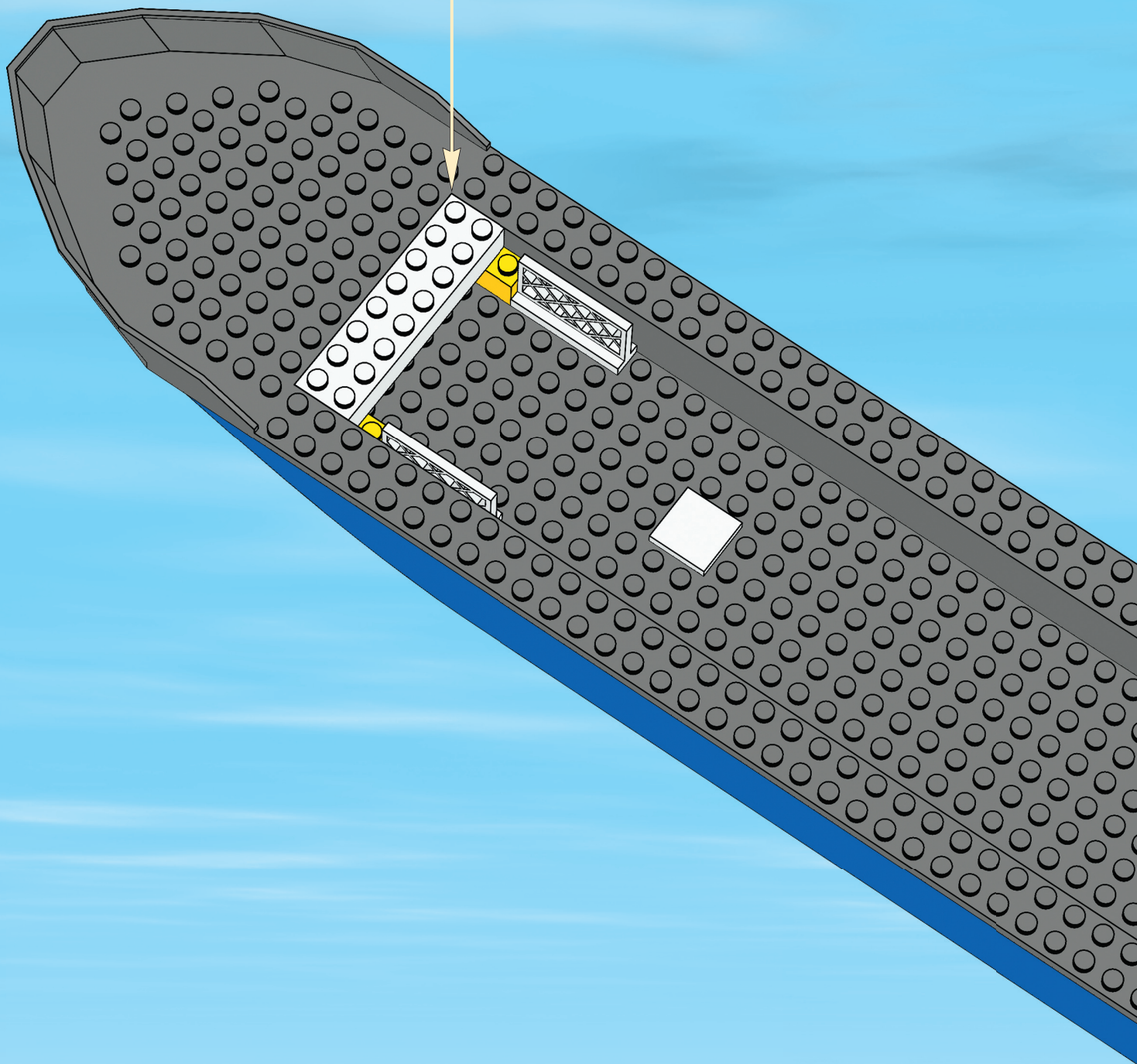



7

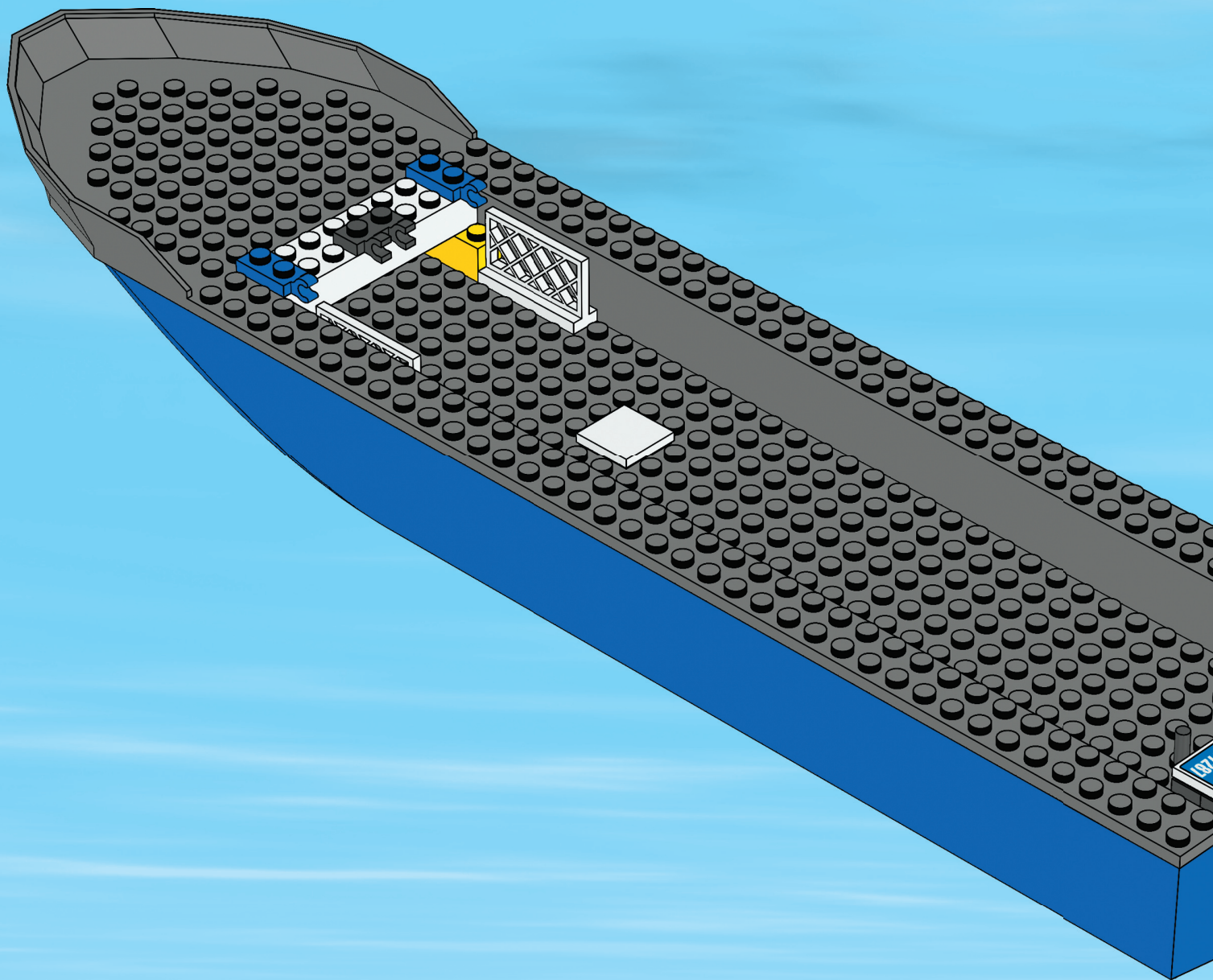



8

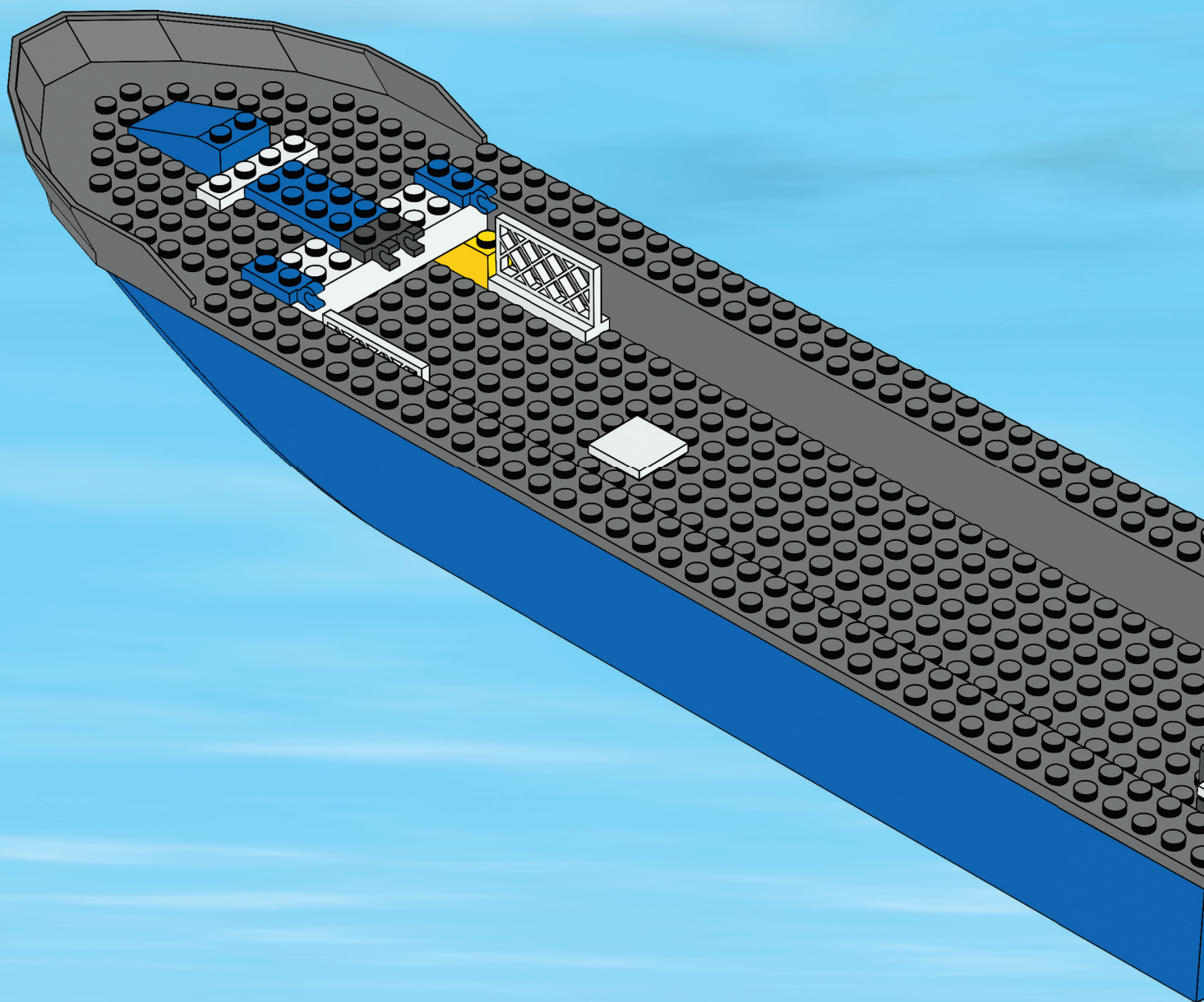



9

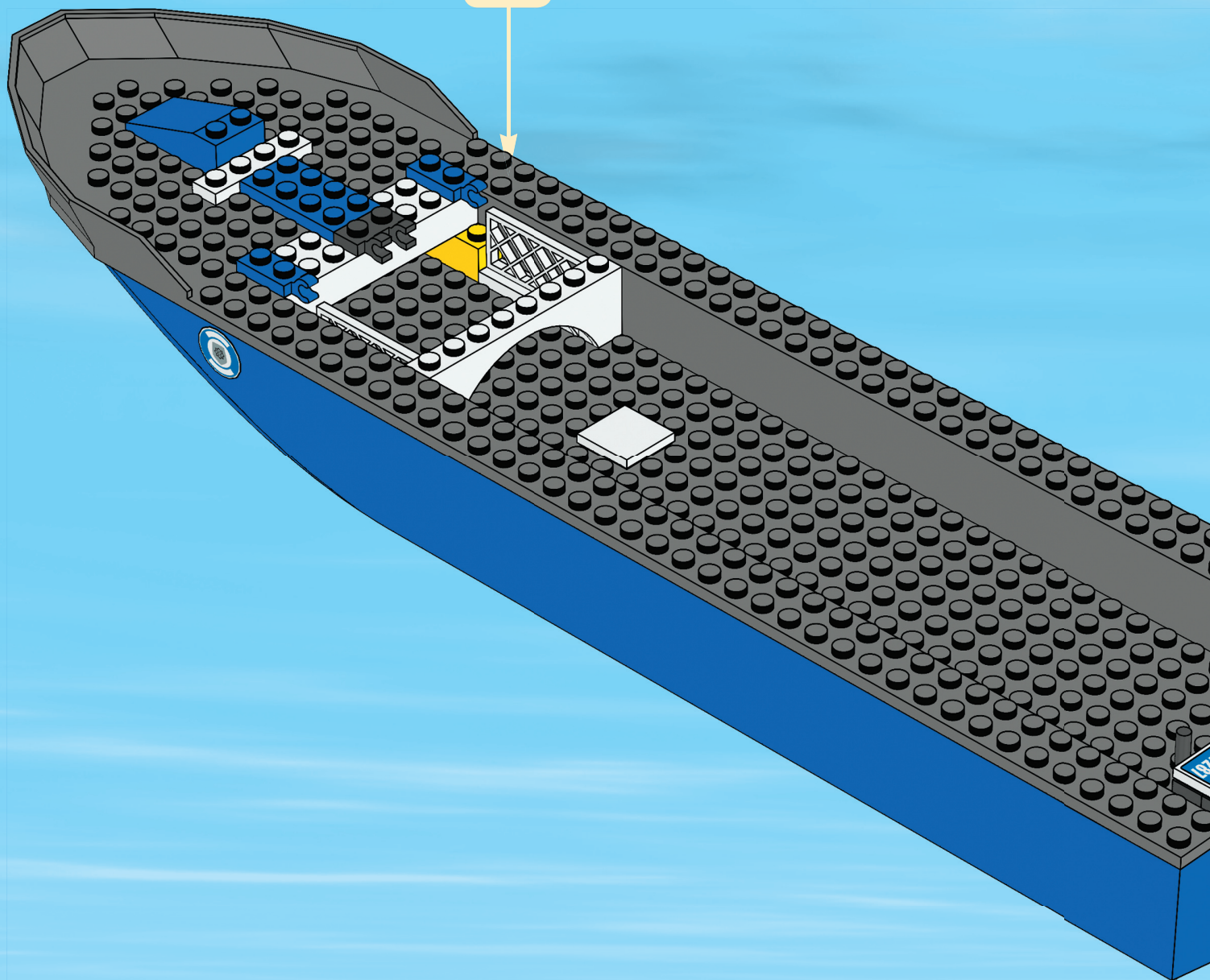



10

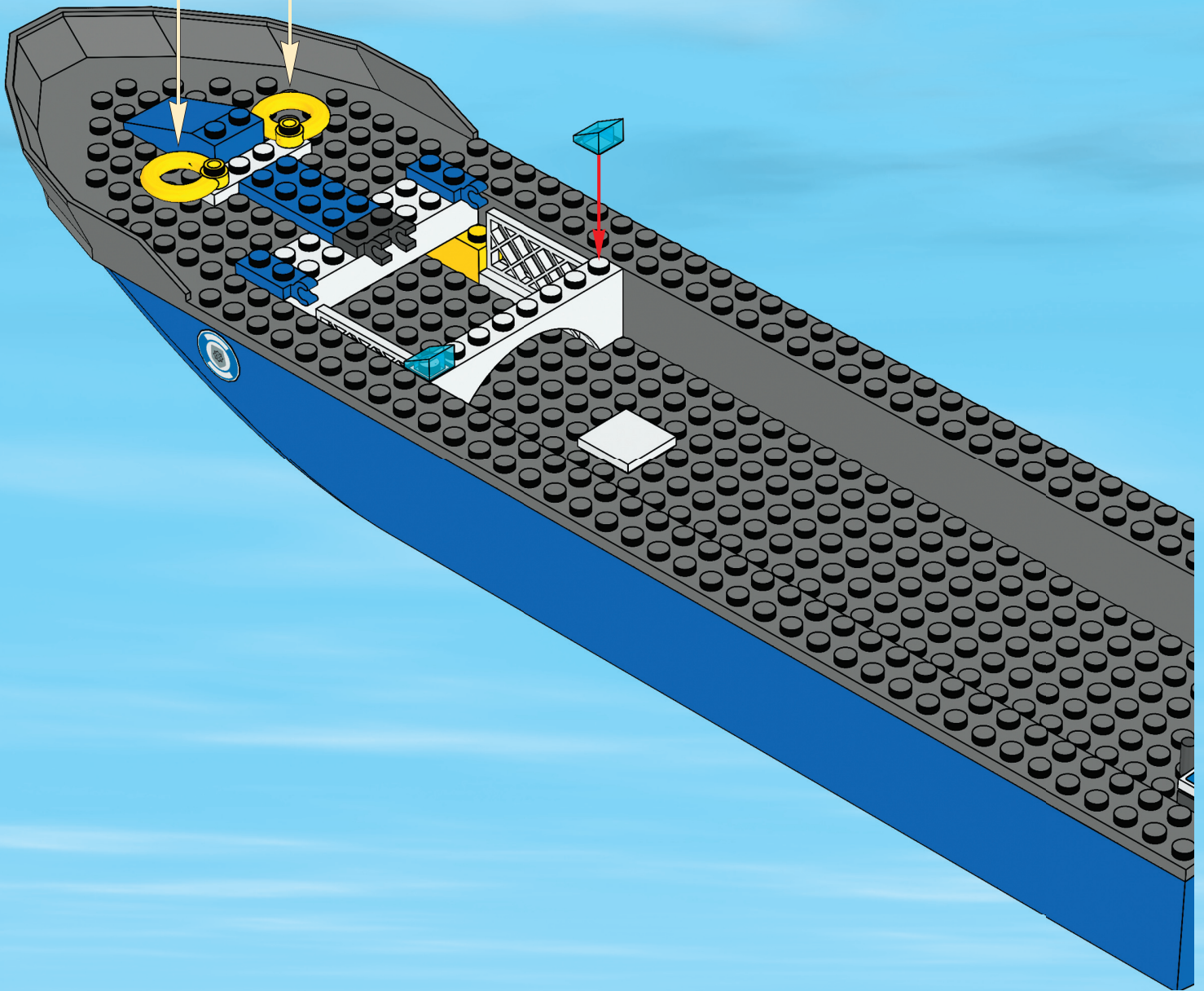

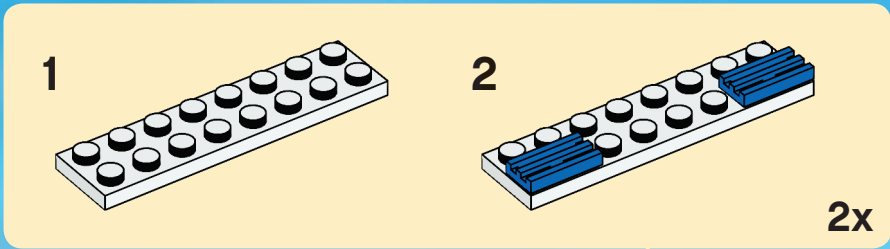

11

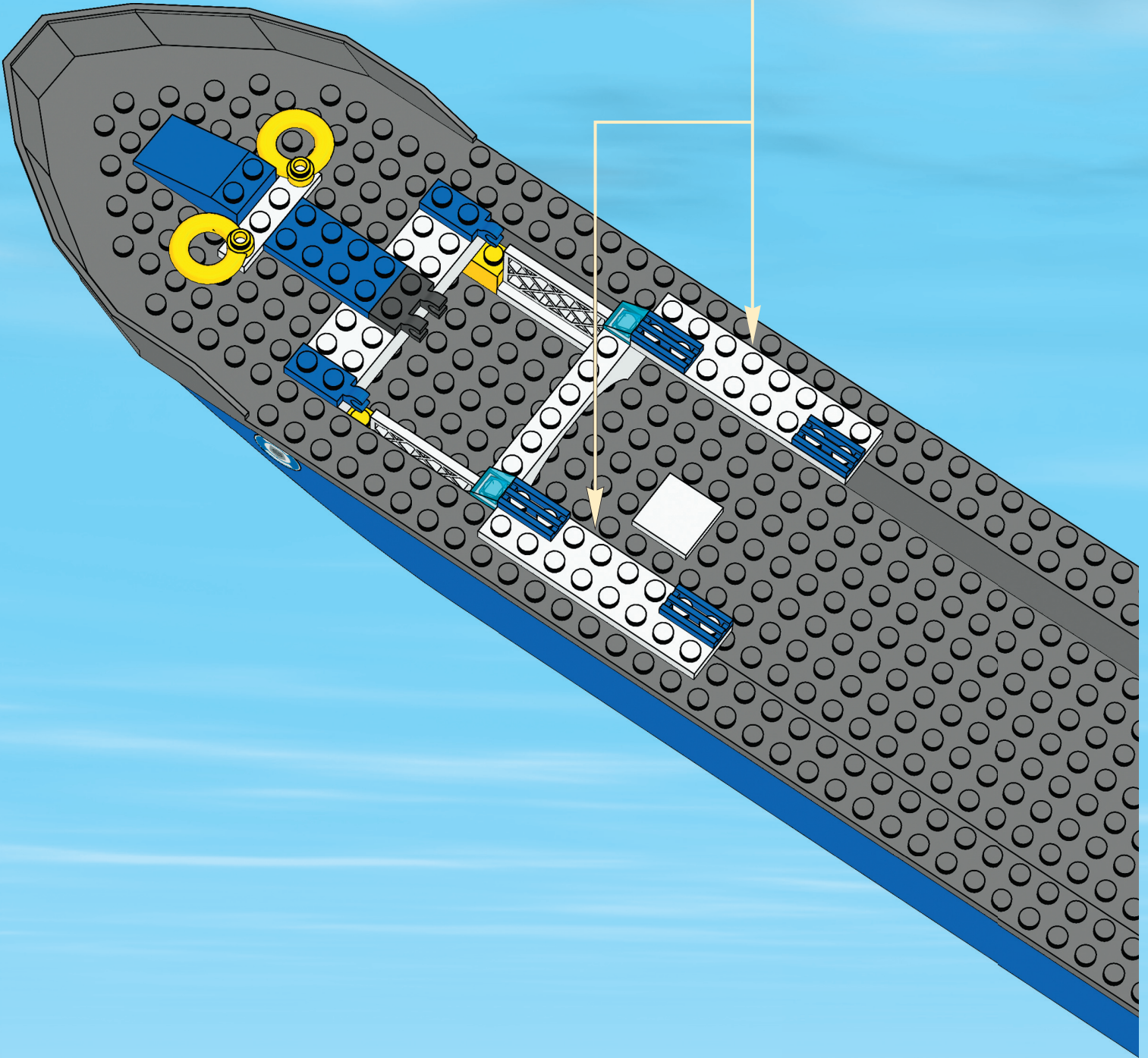



12

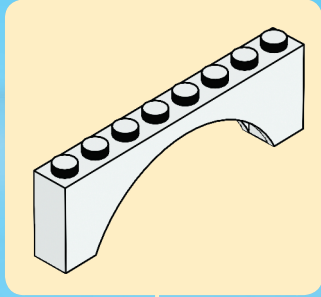
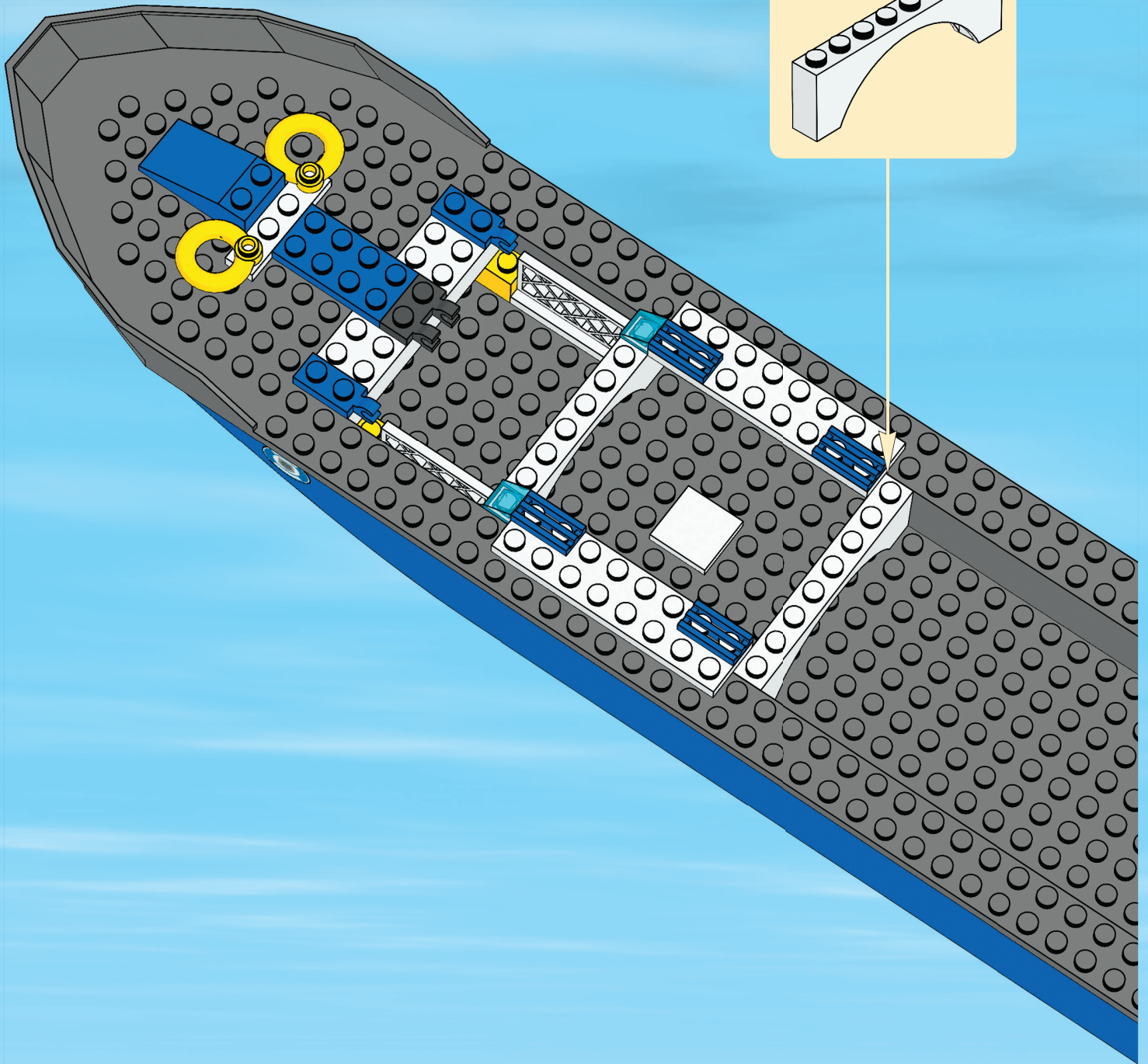



13

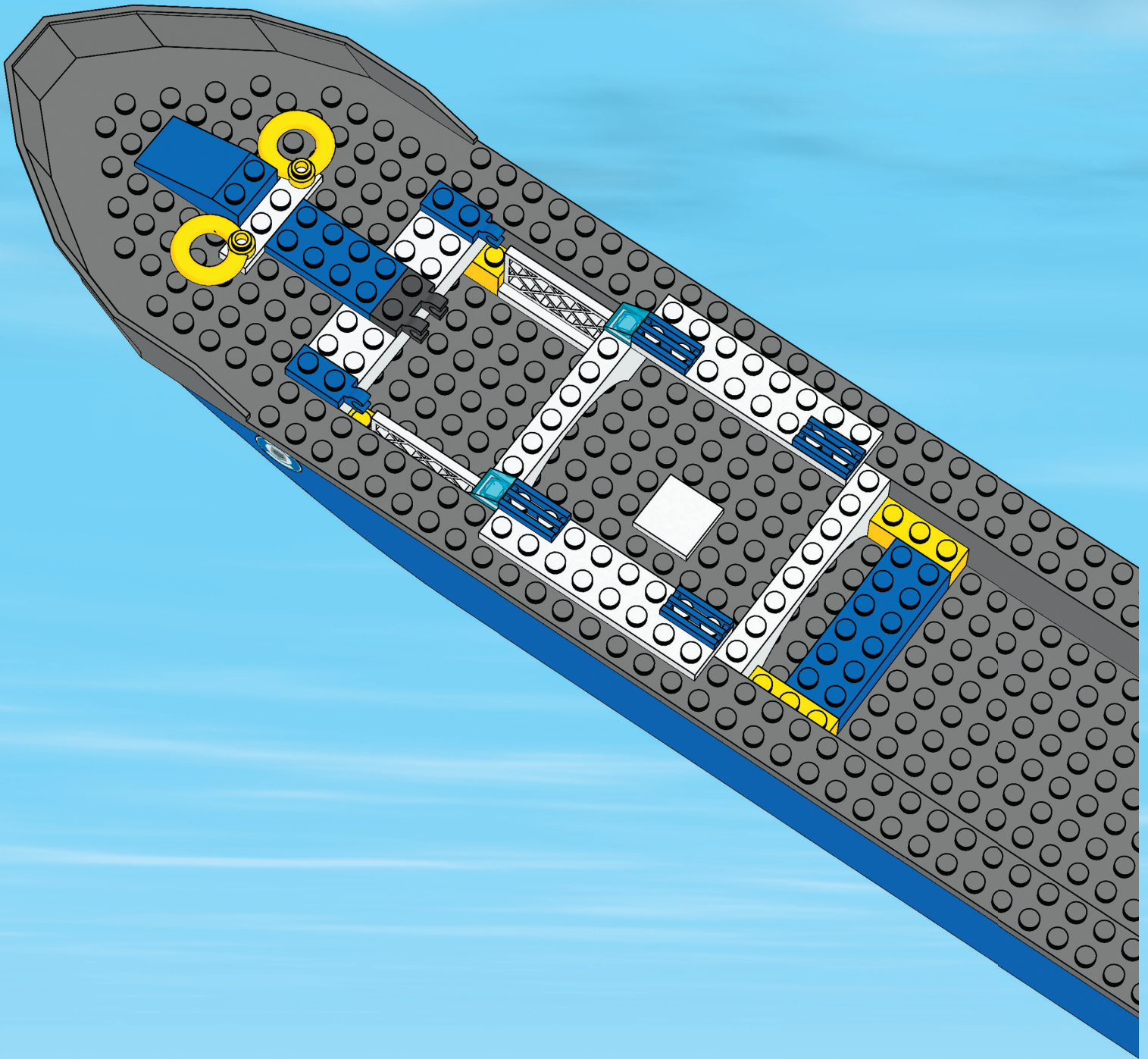

18



14

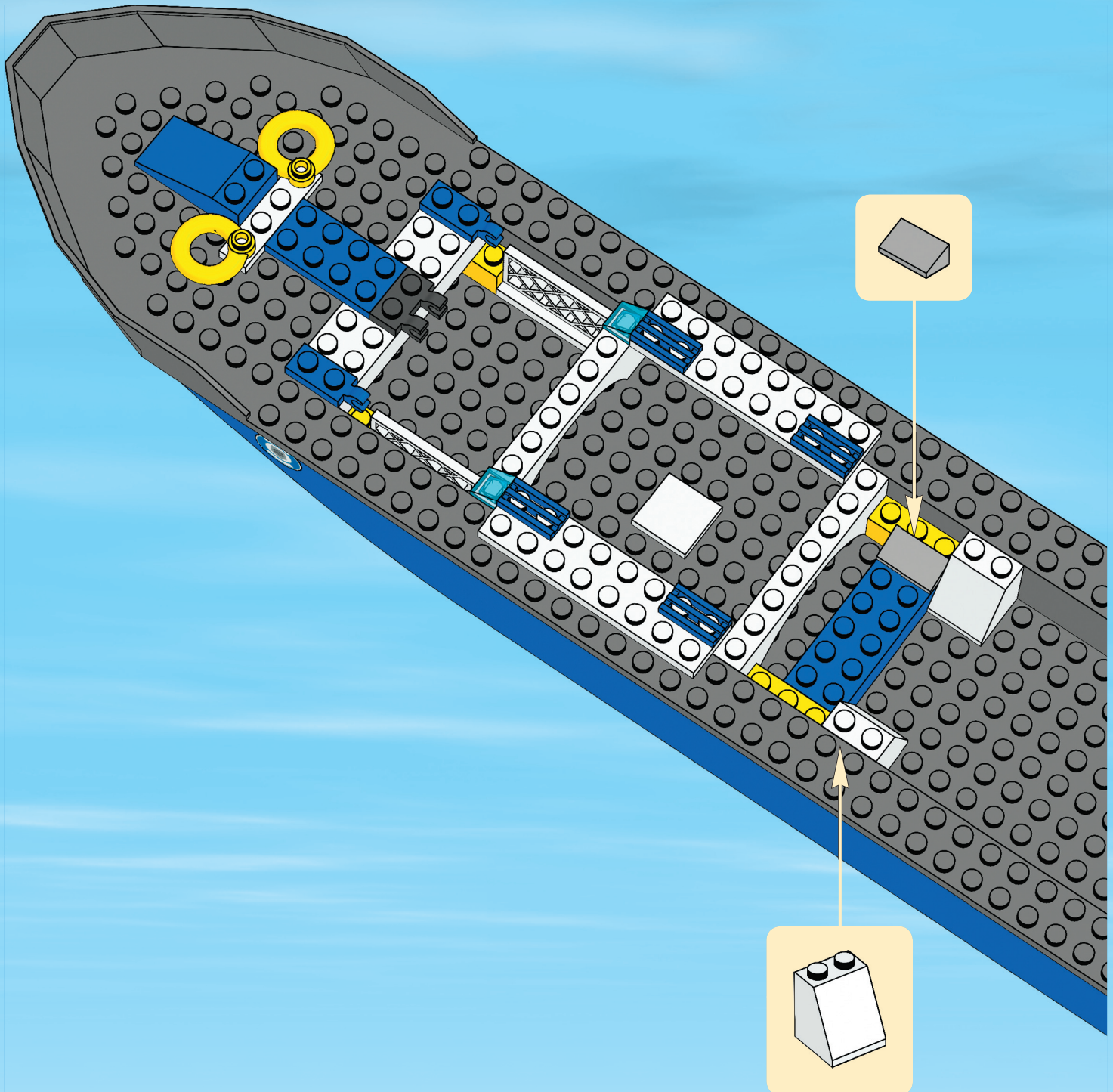



15

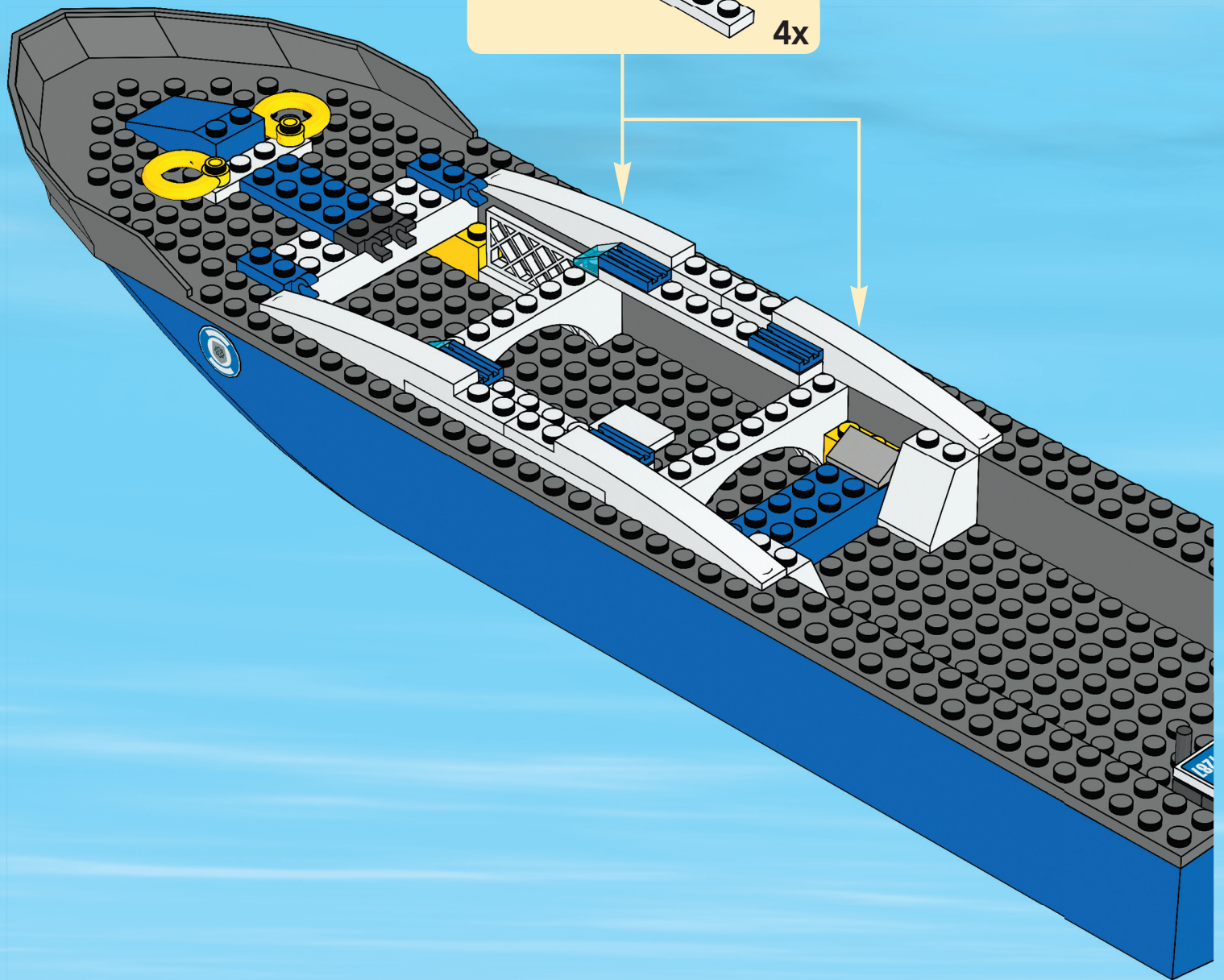
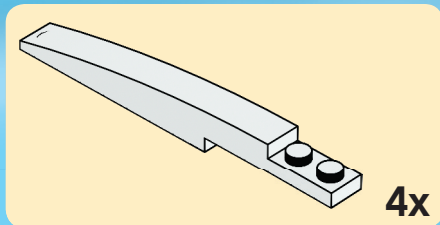

20





16

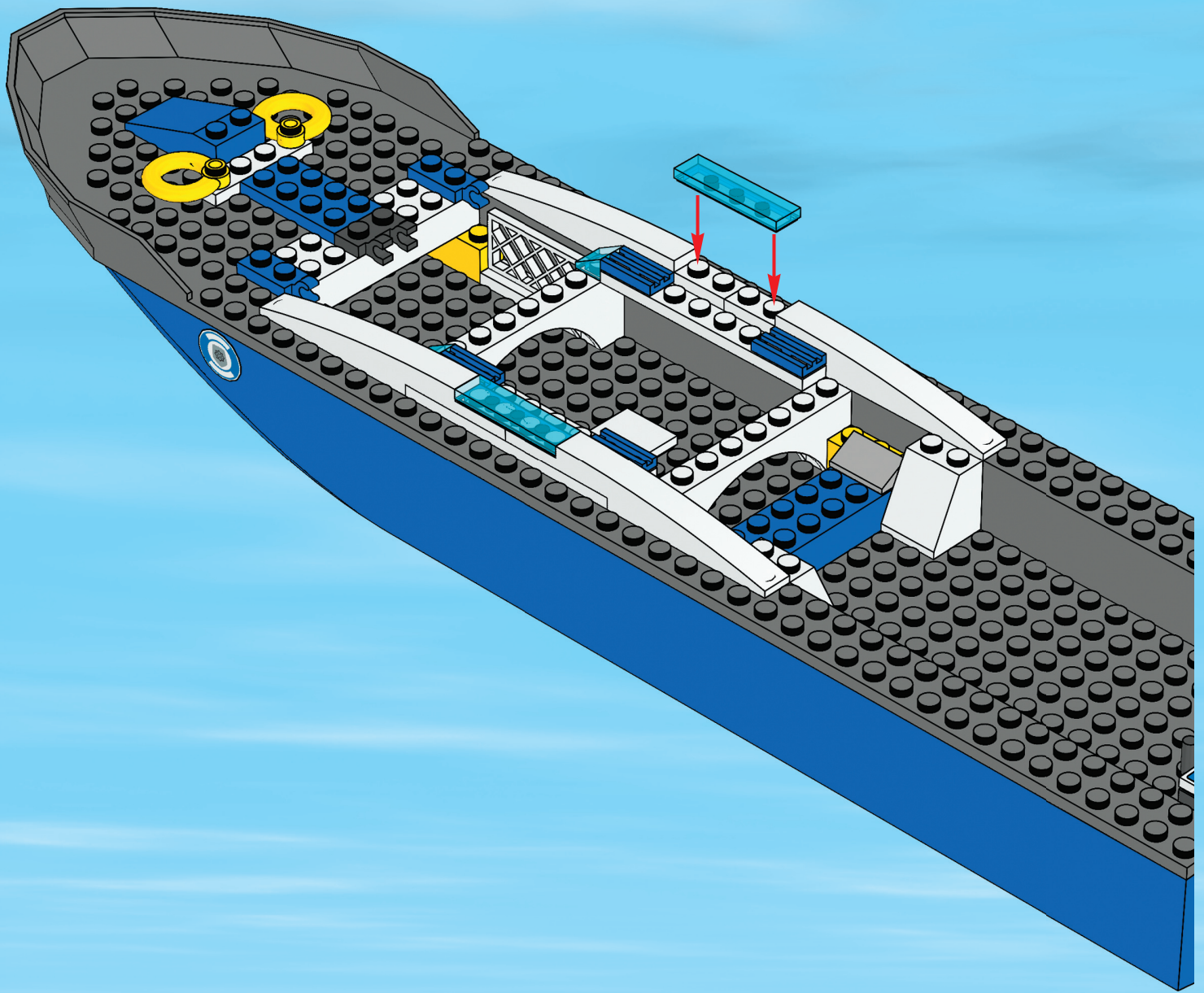



17

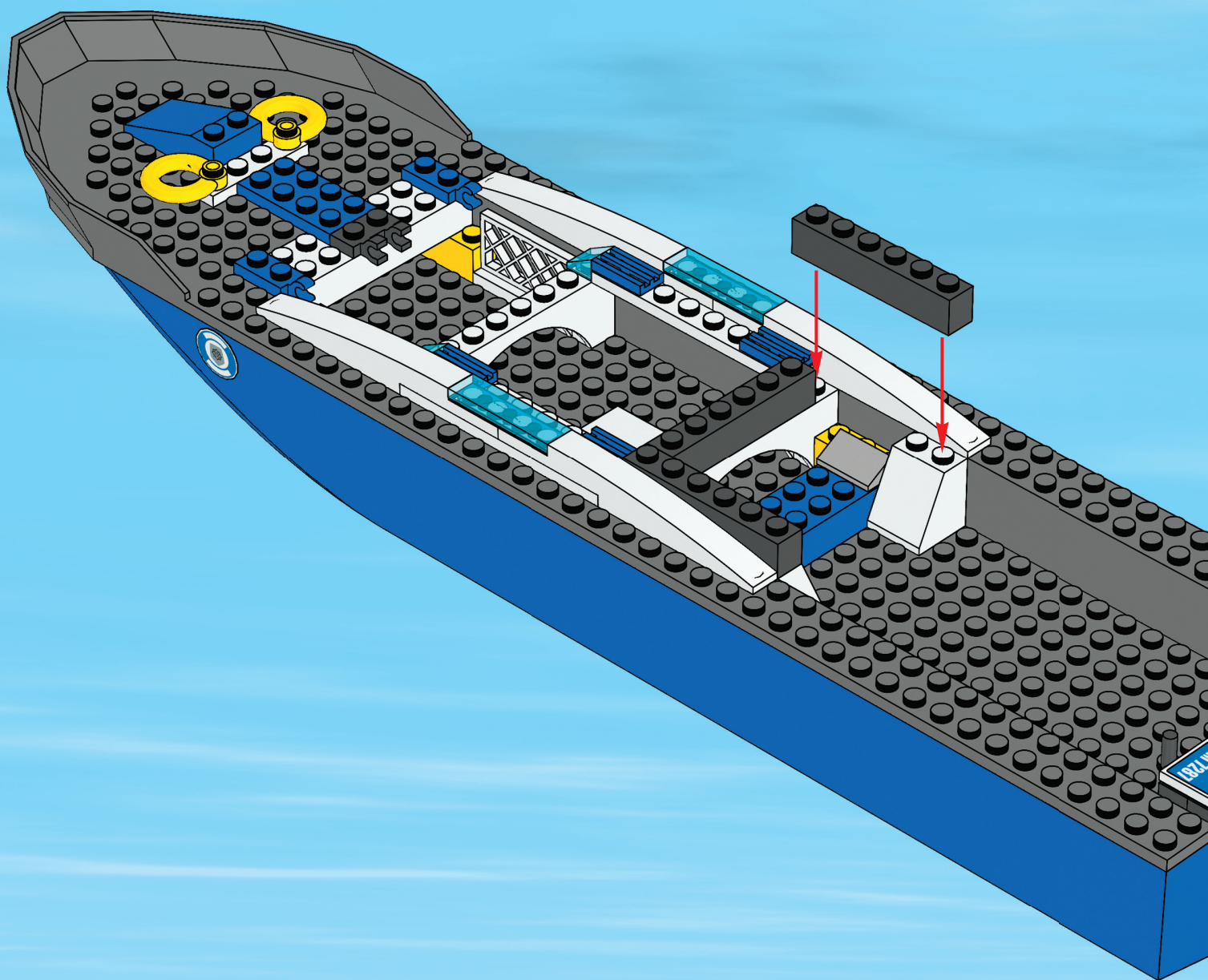

22





18

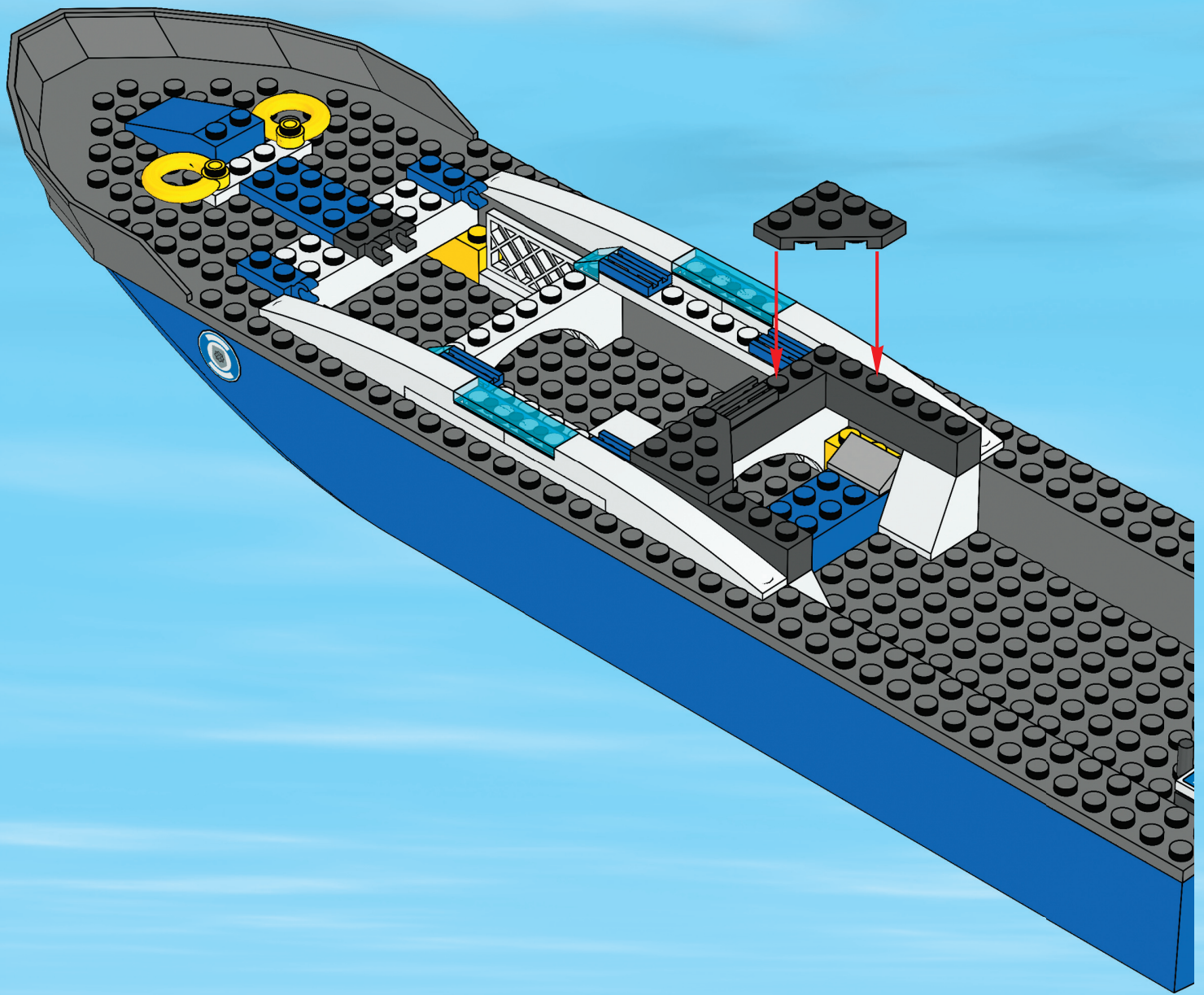



19

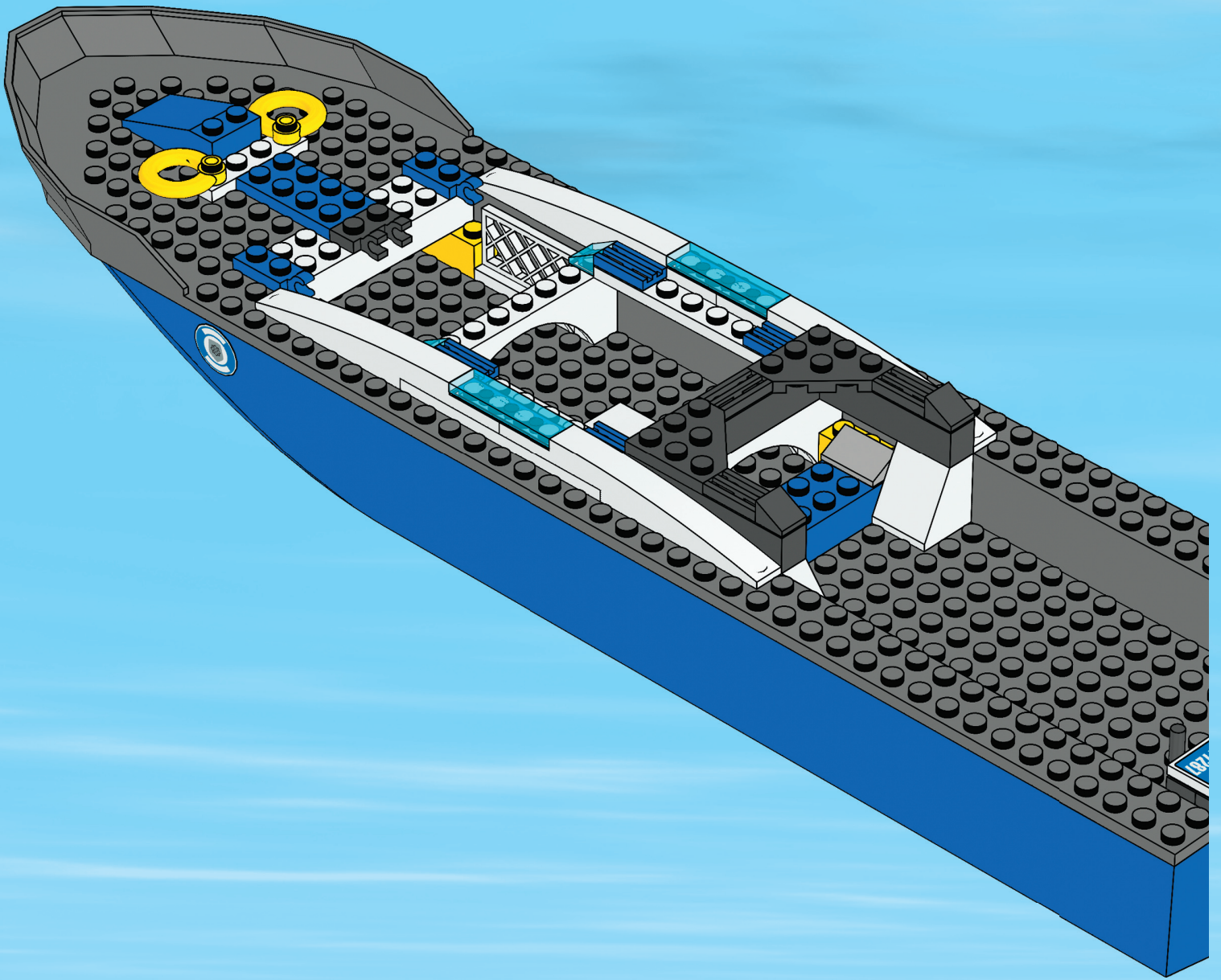

24





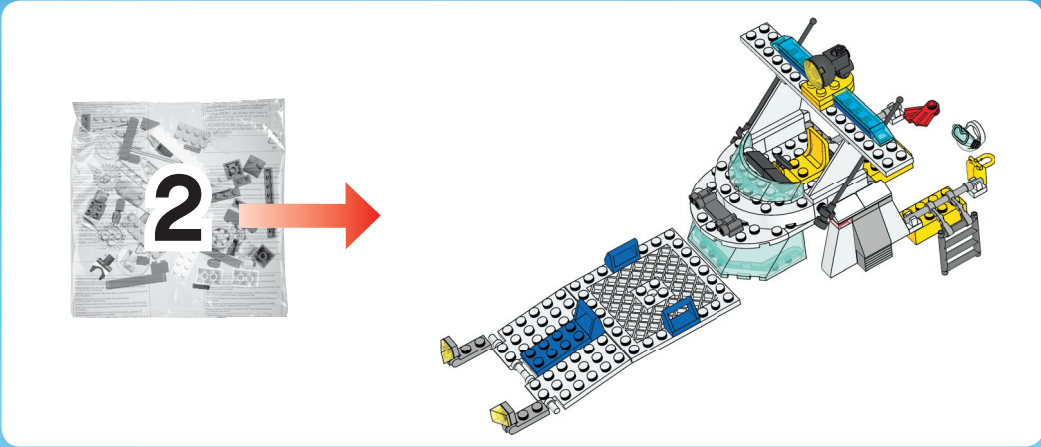

20

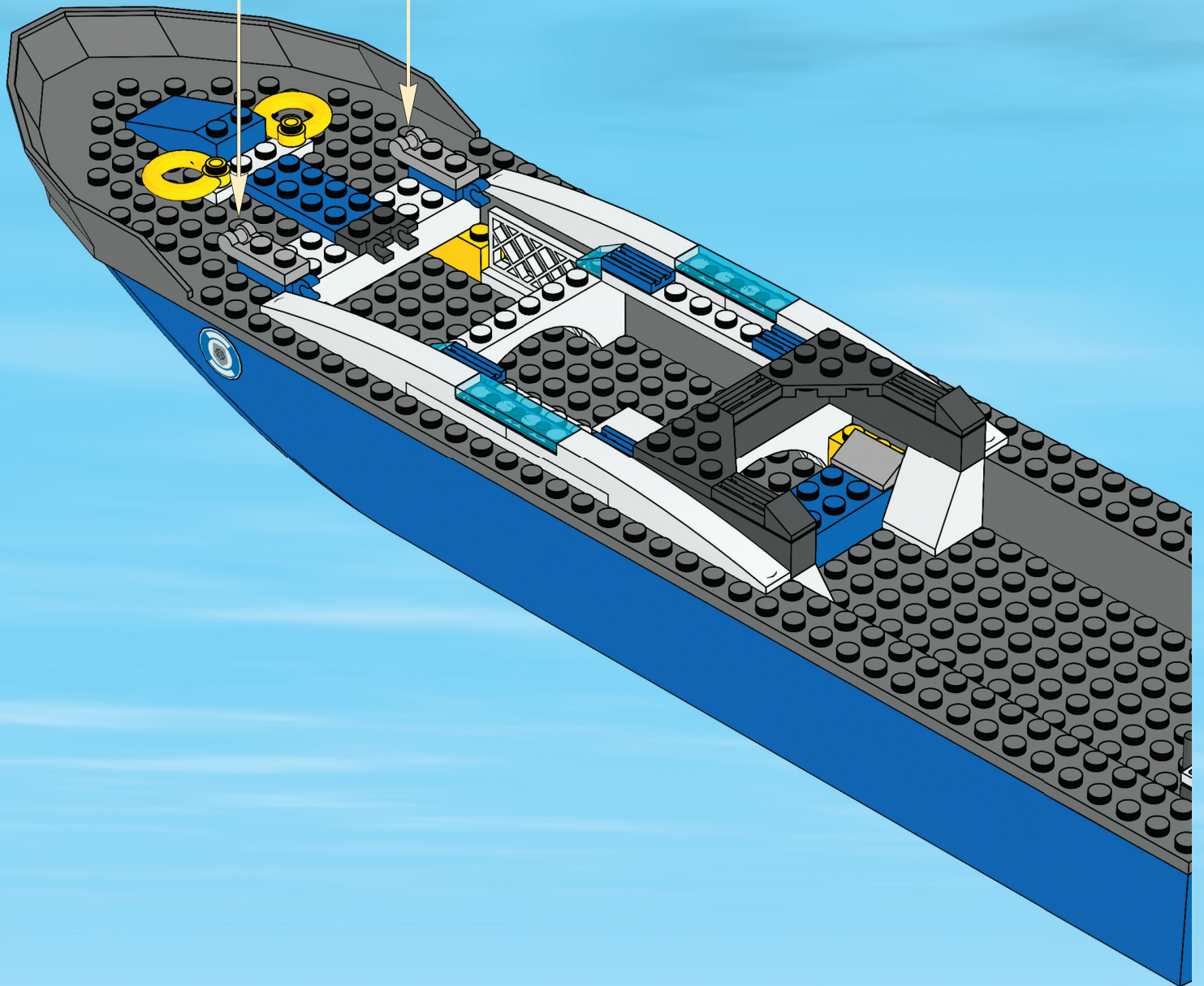
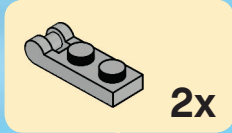



21

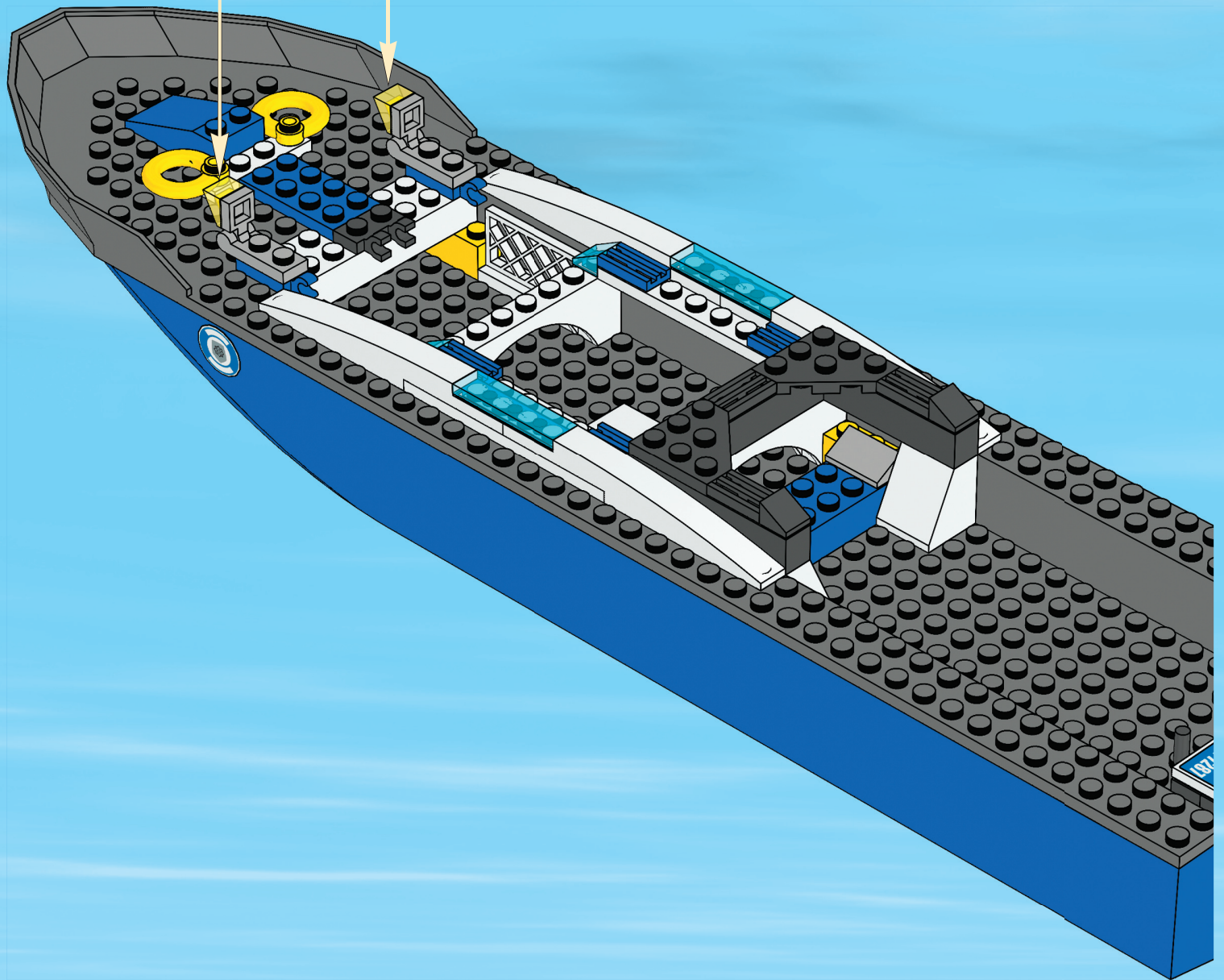
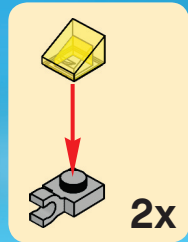

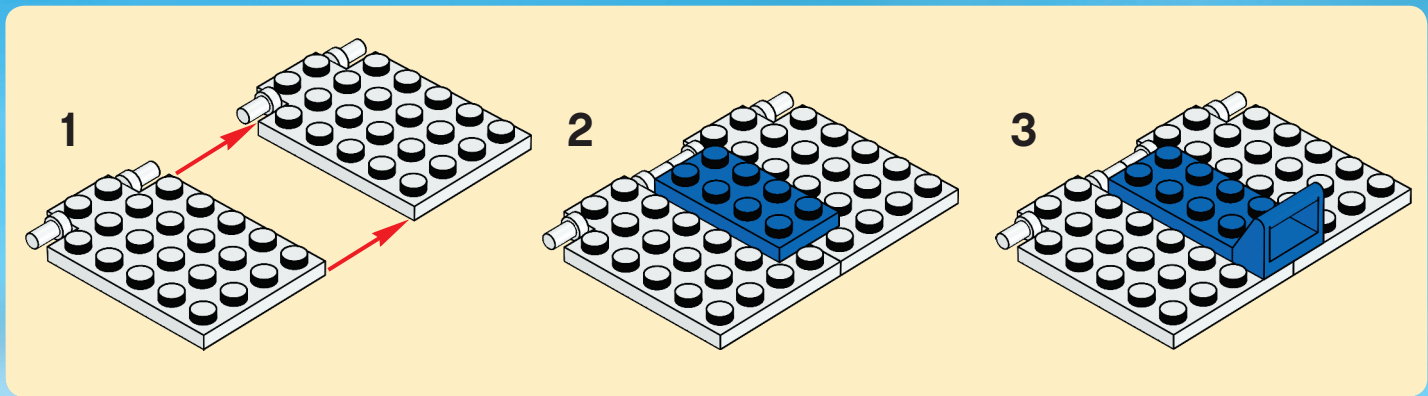

22

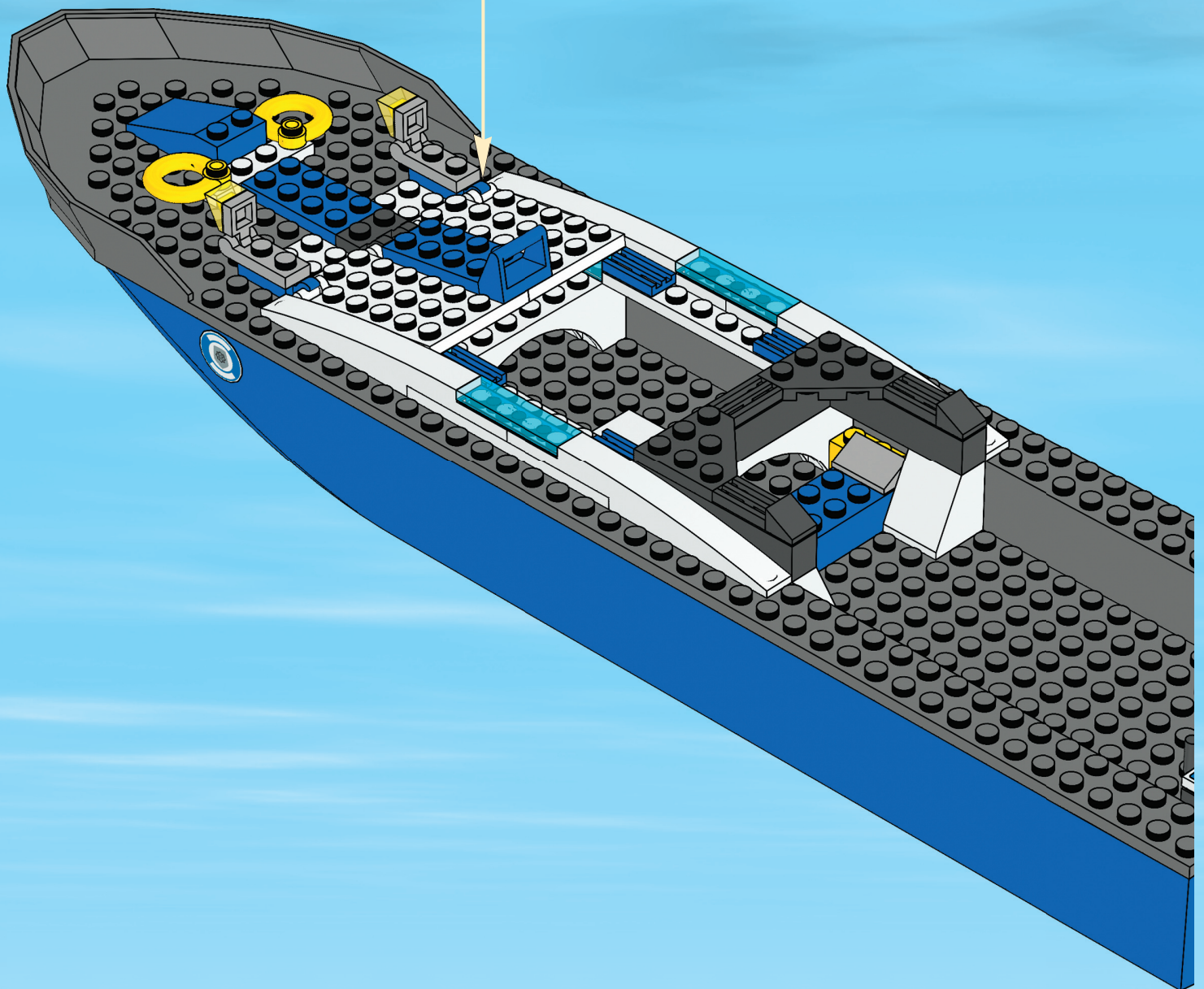



23

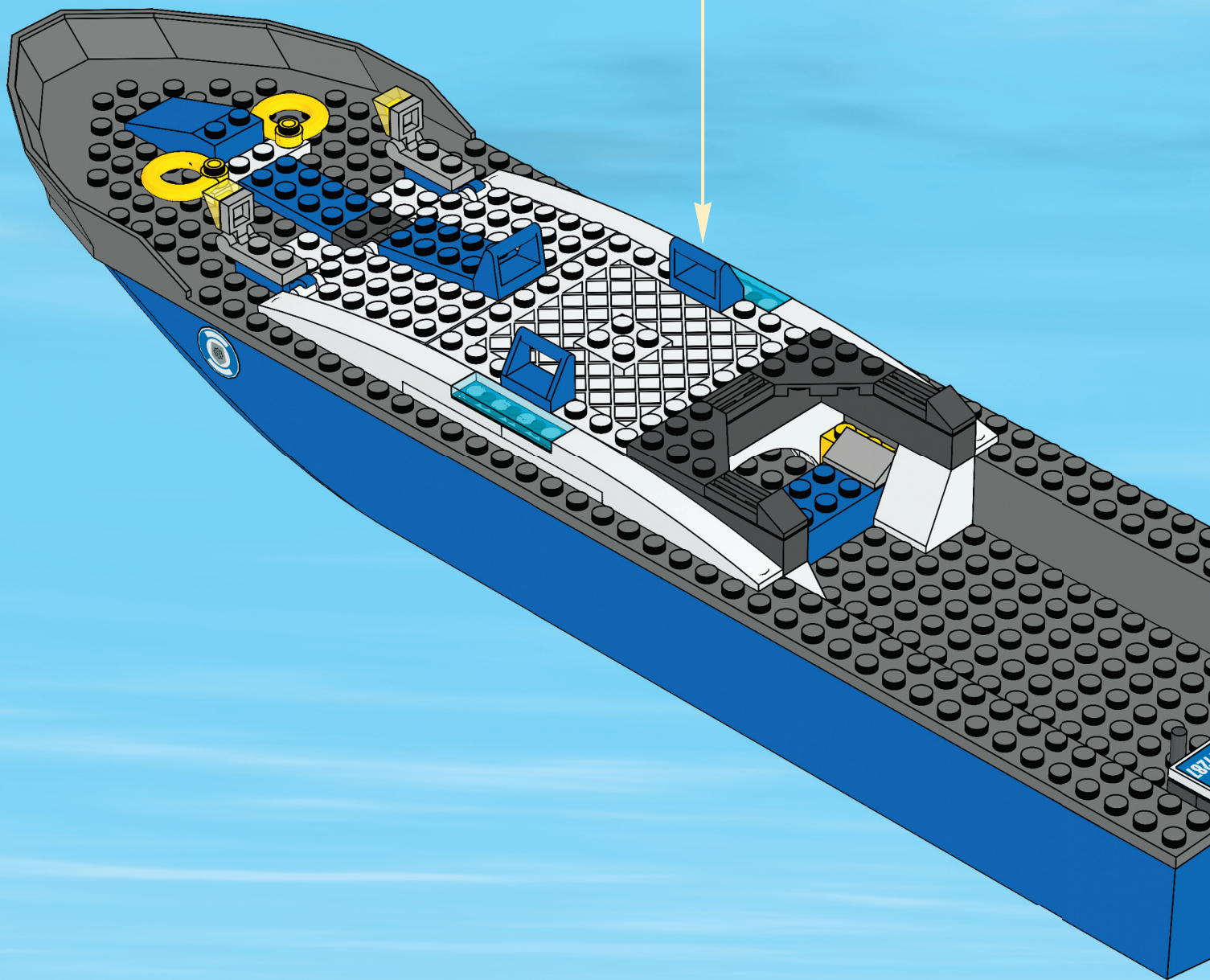
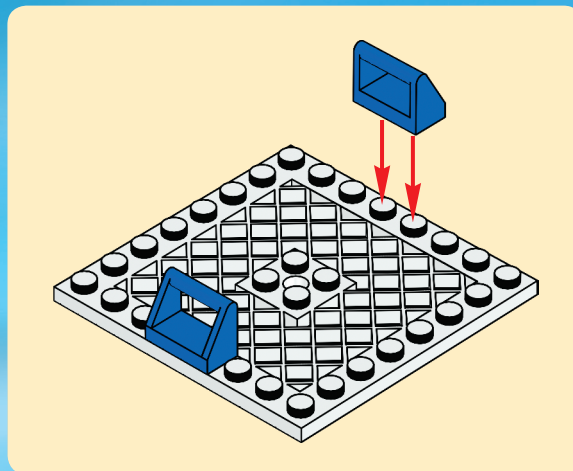



24

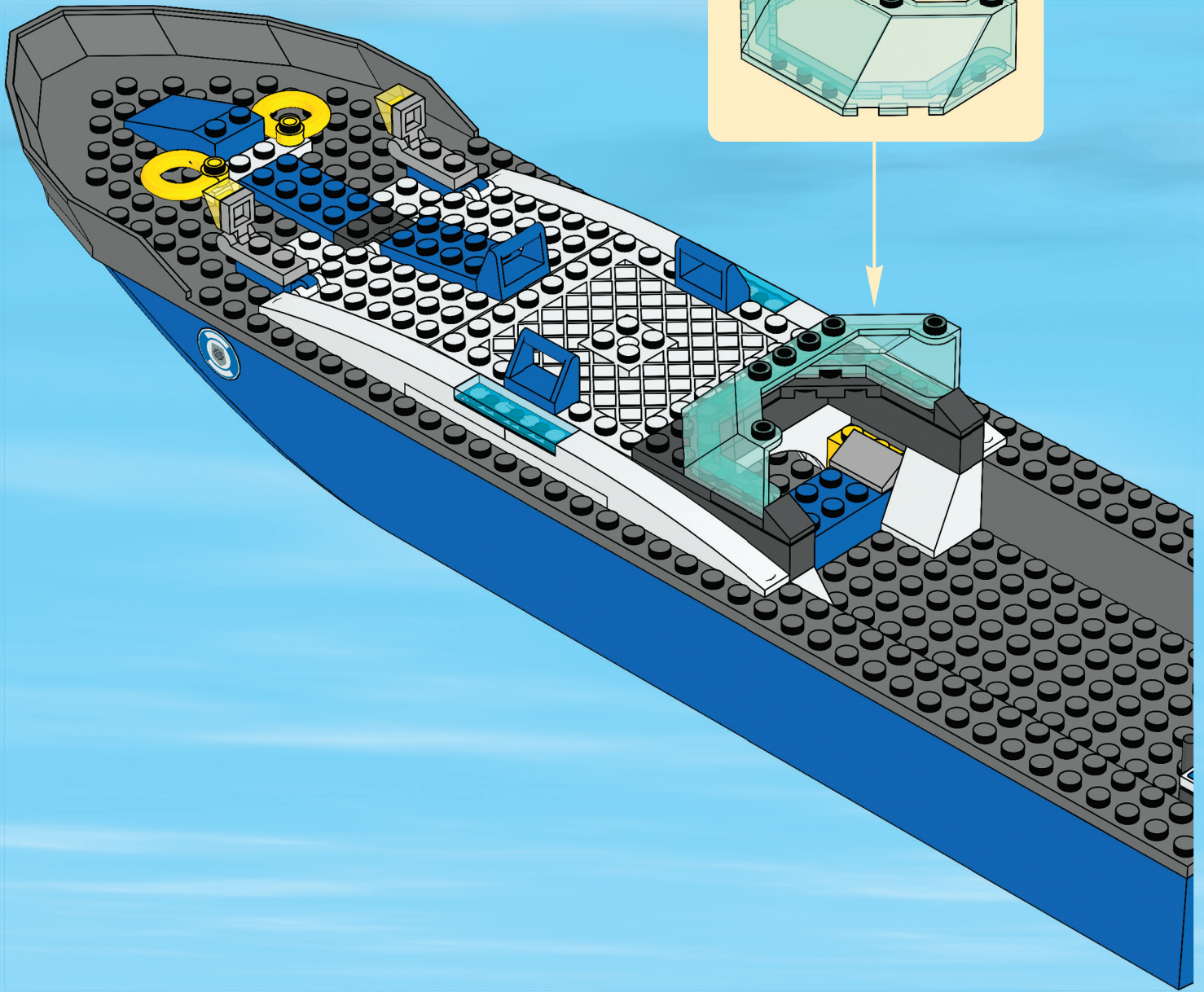
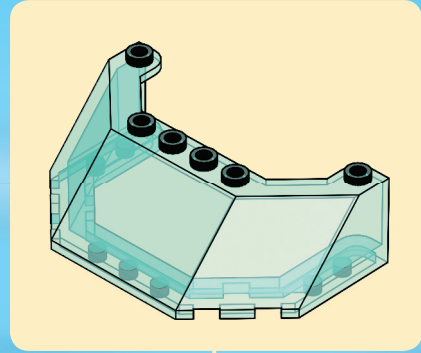

25

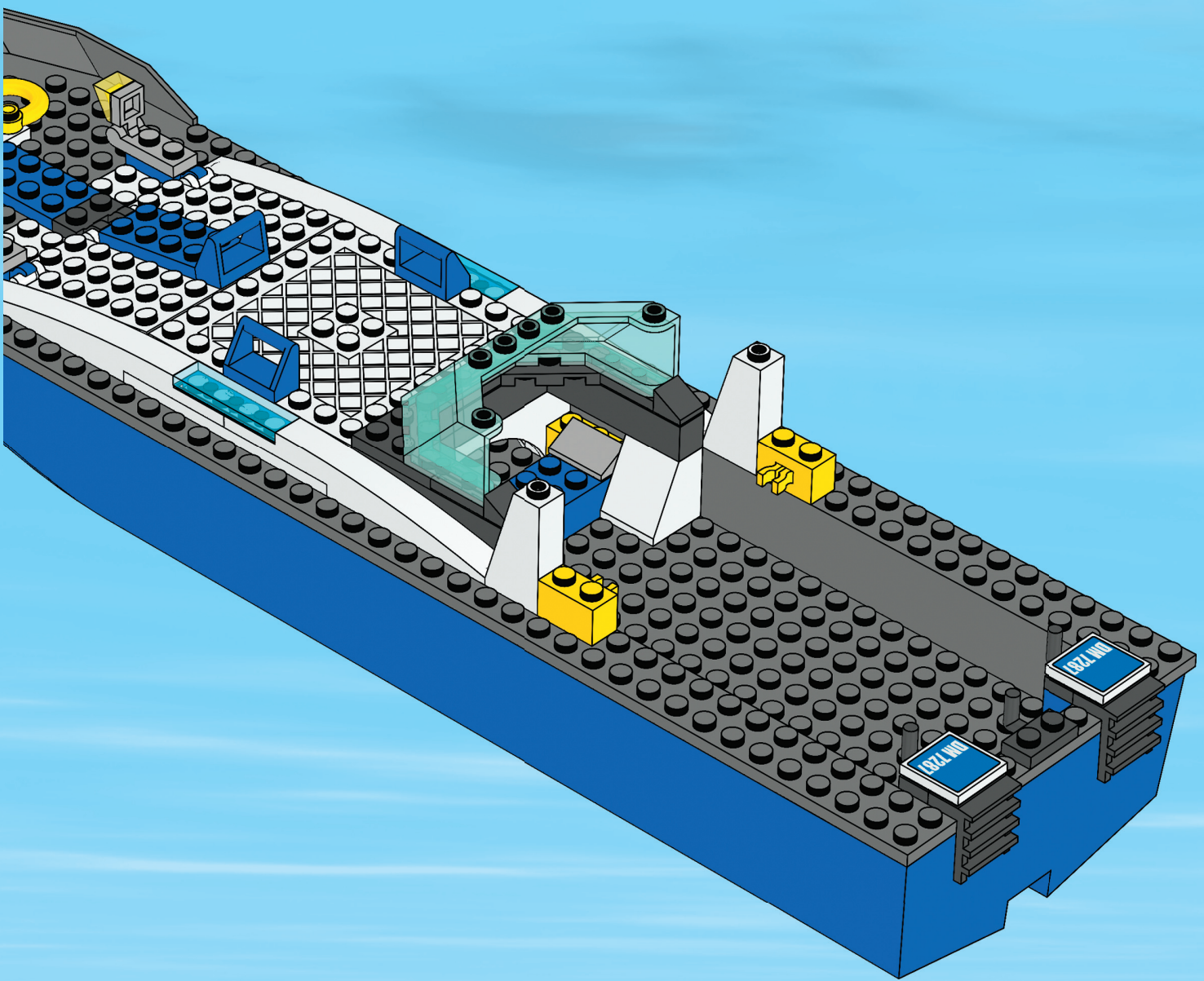

30

26

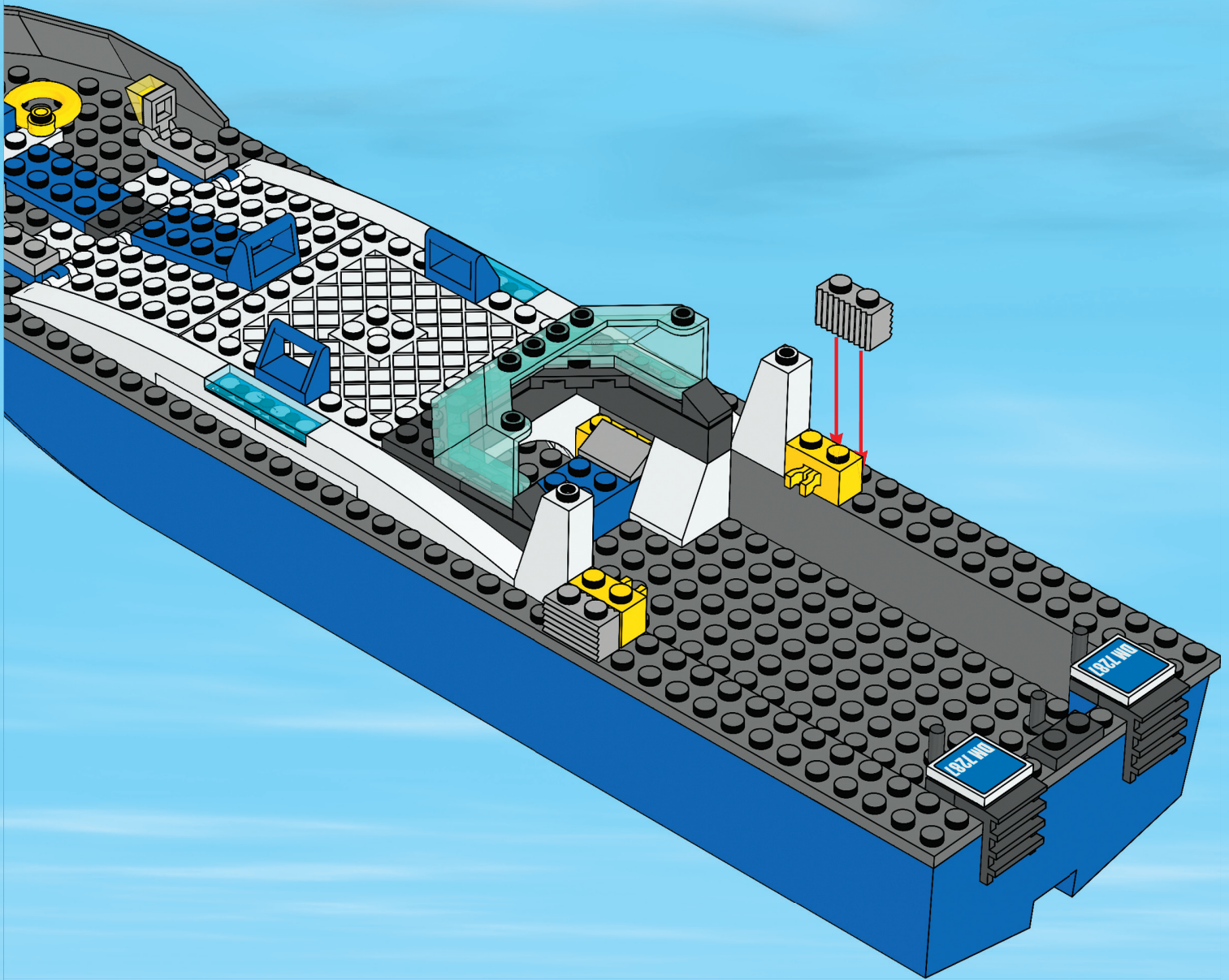

27

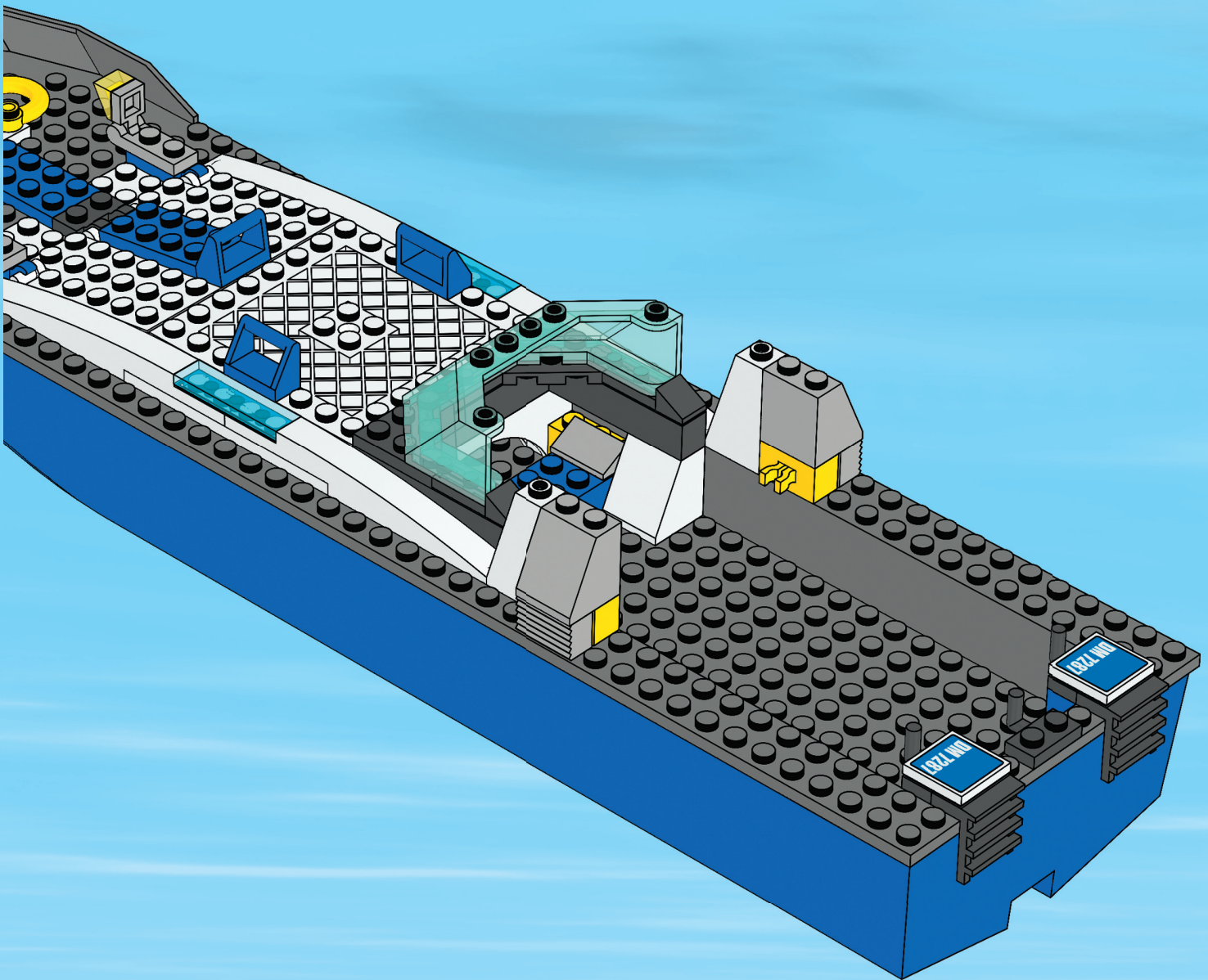





28

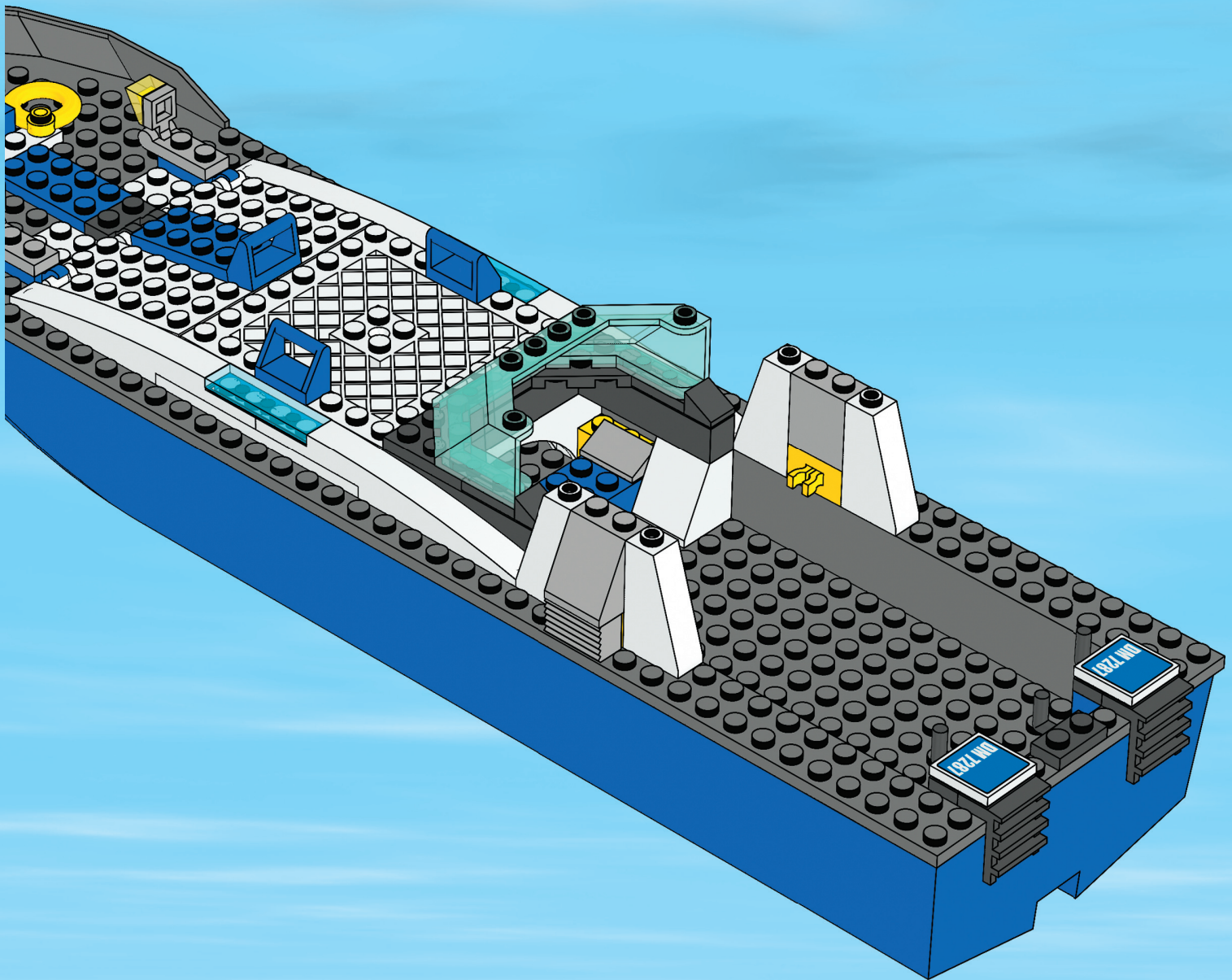

29

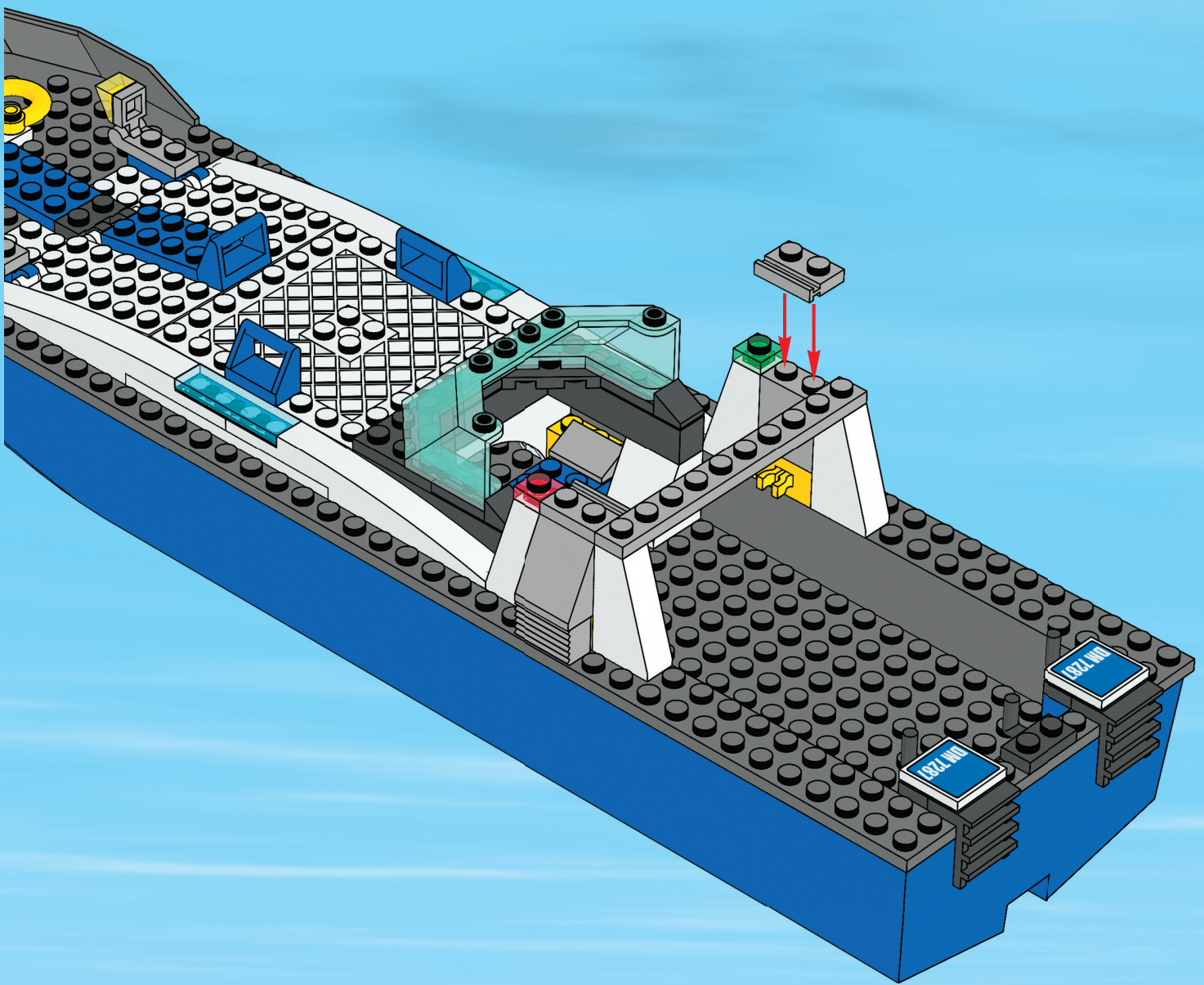

34



30

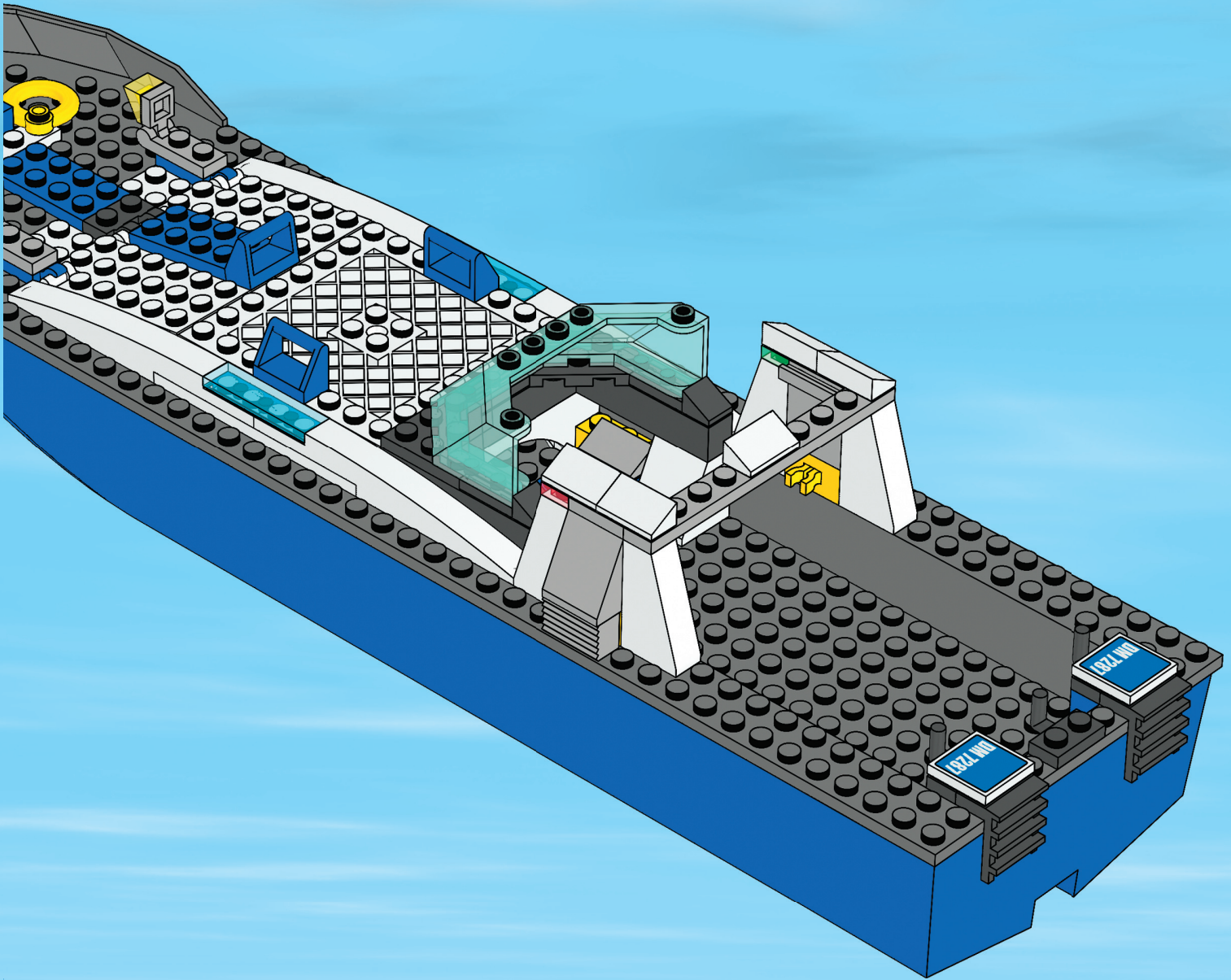

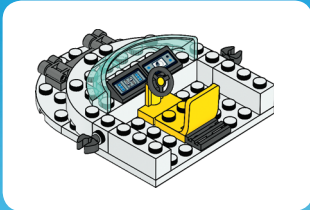

1

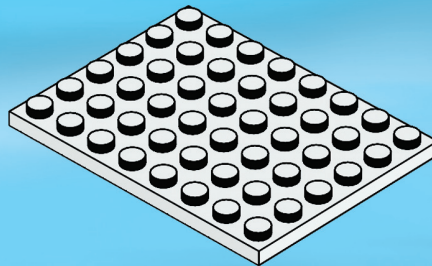

2

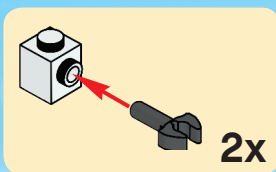
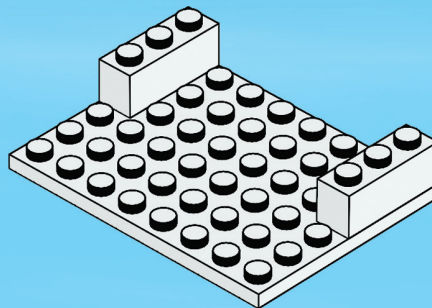

3

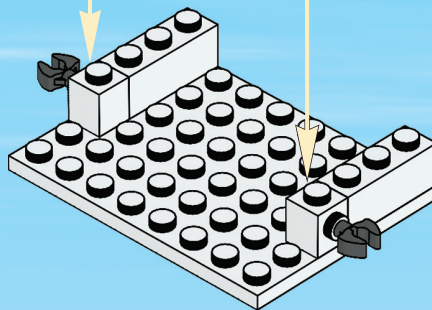



4

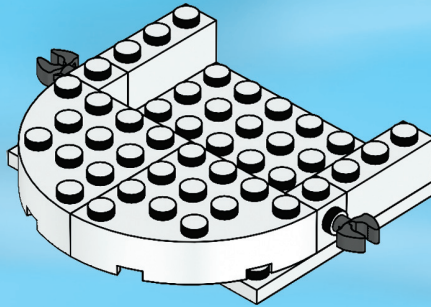

5

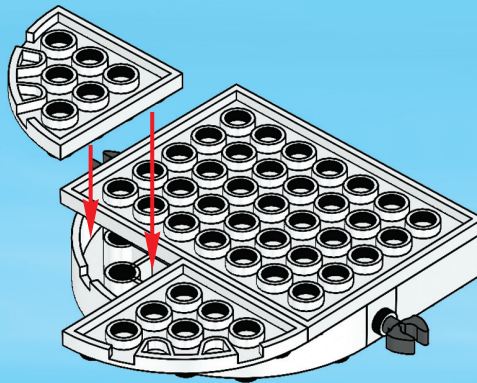

6

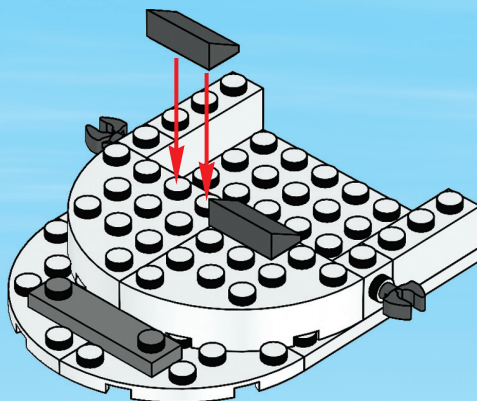



7

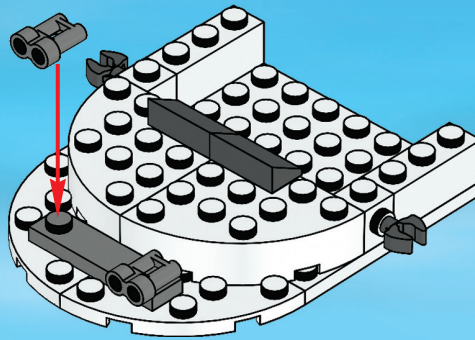

8

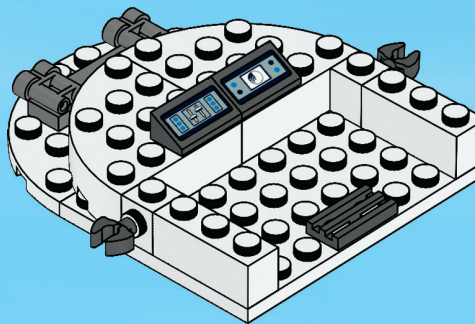

9

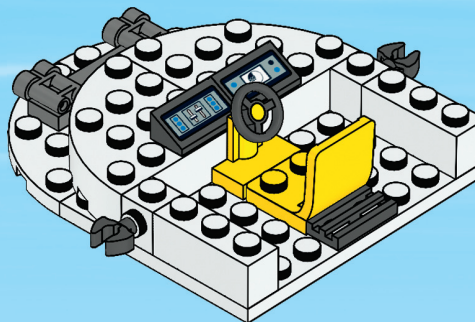



10

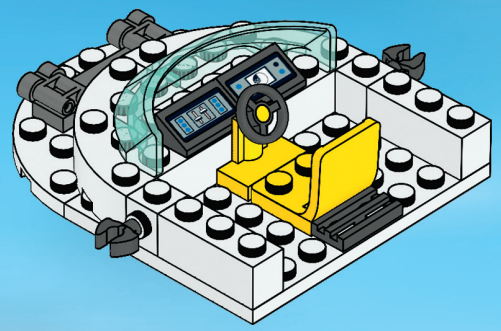

31

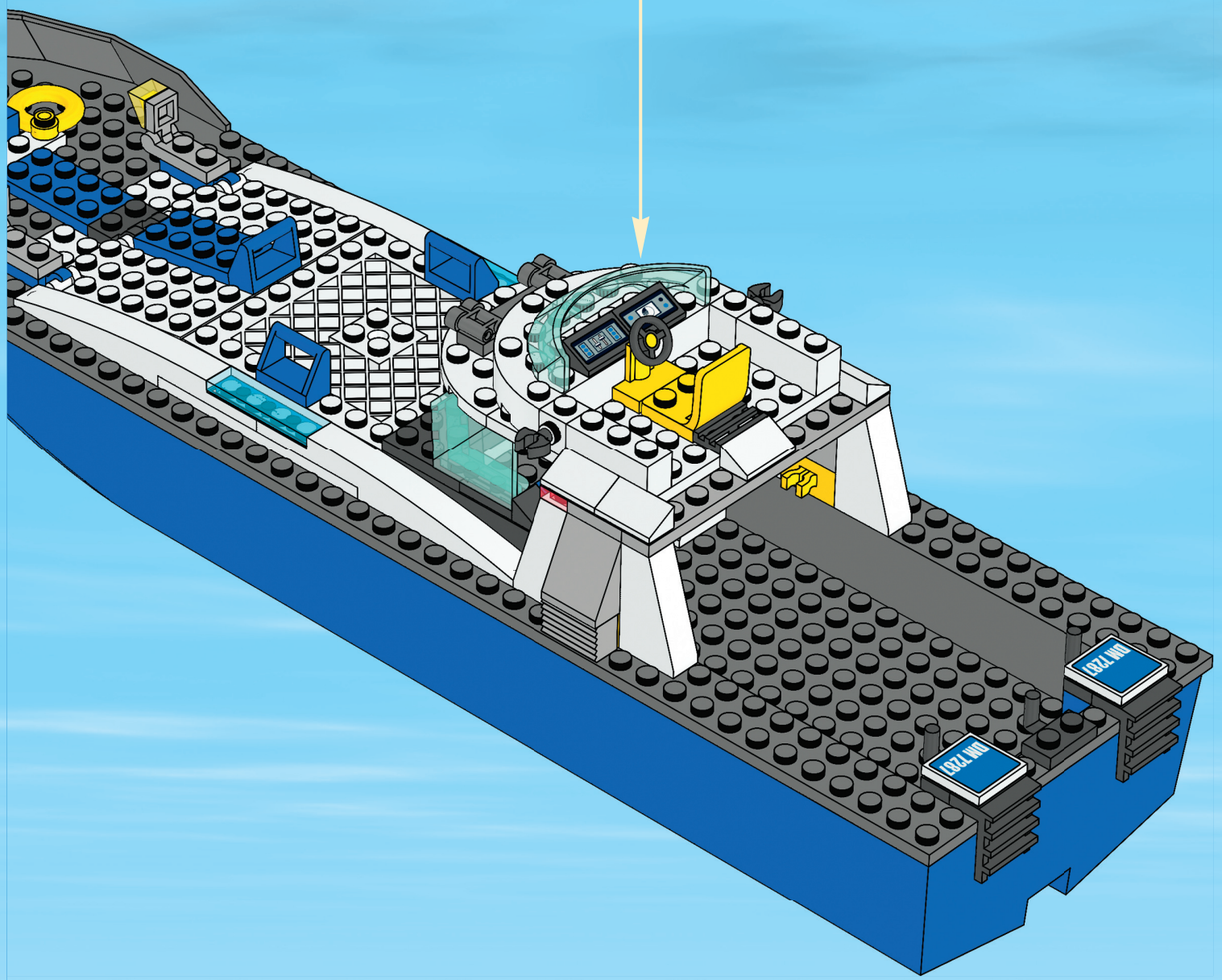

32

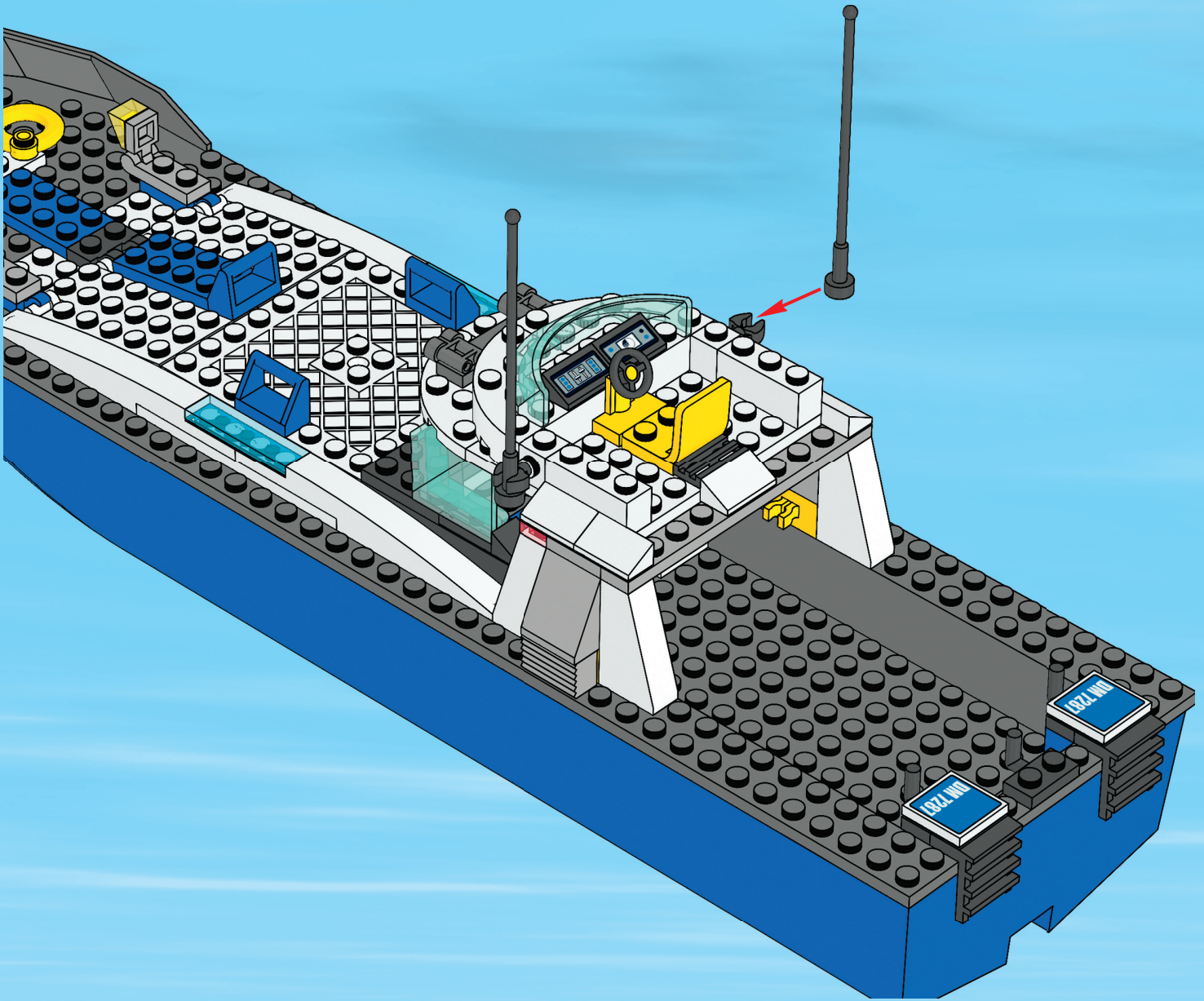





33

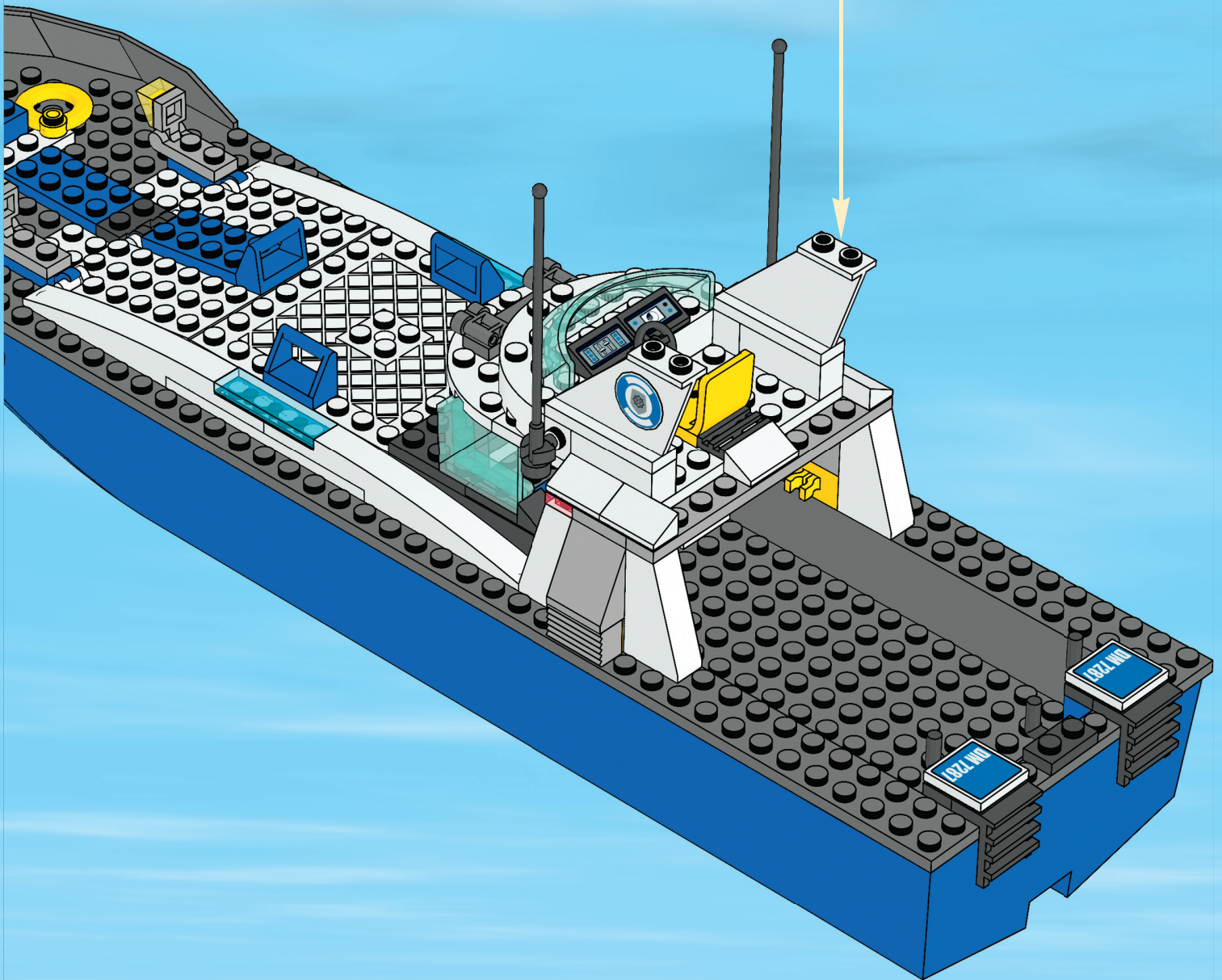
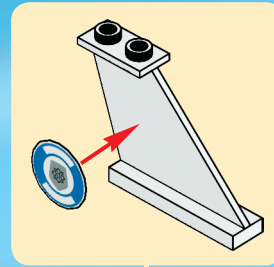

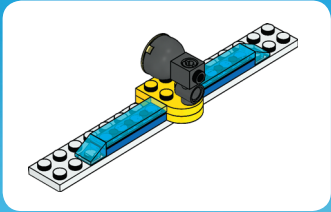

1

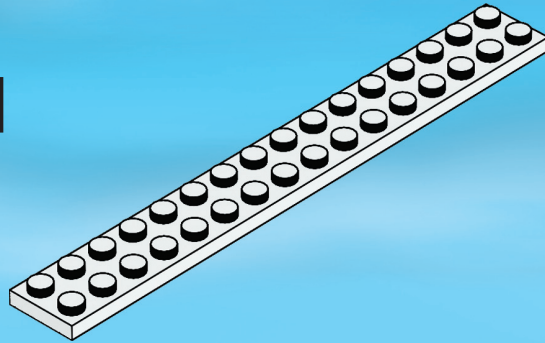

2

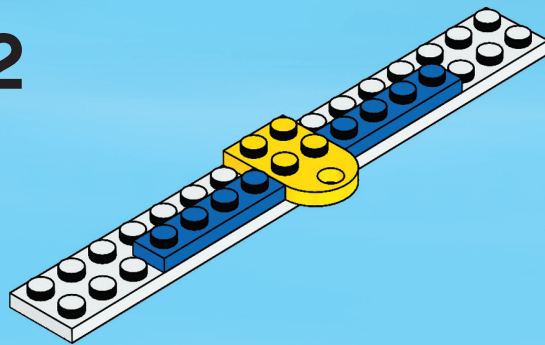

3

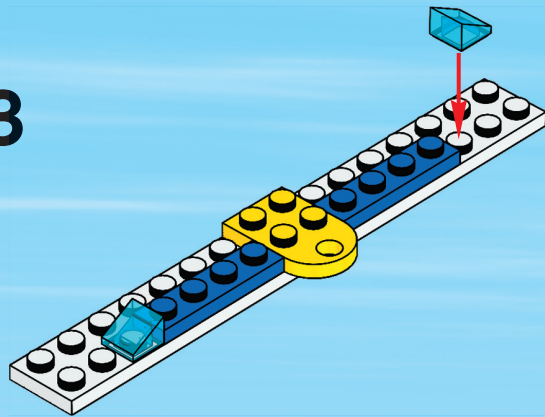

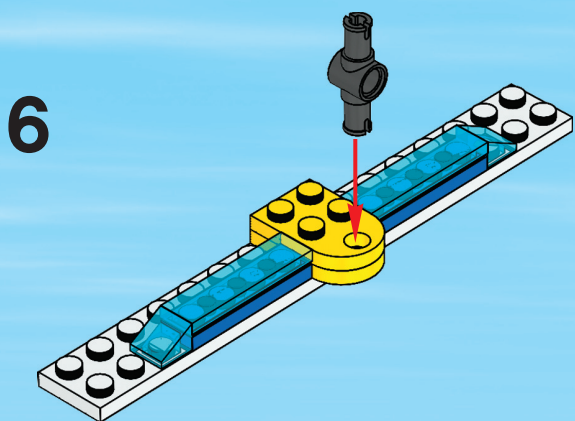
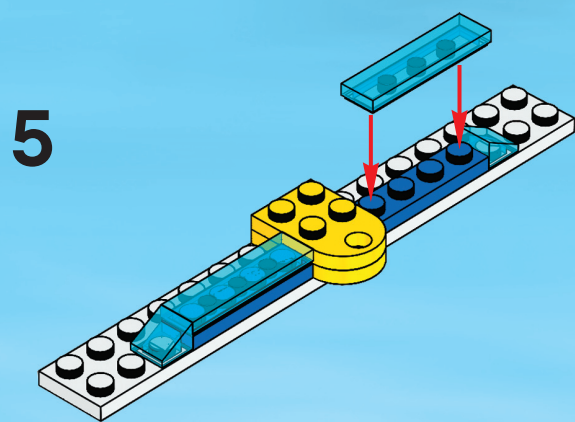
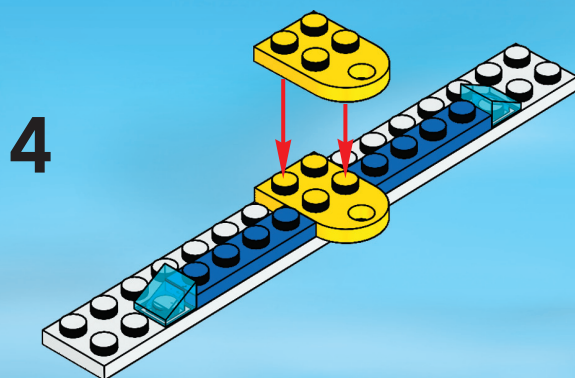



6

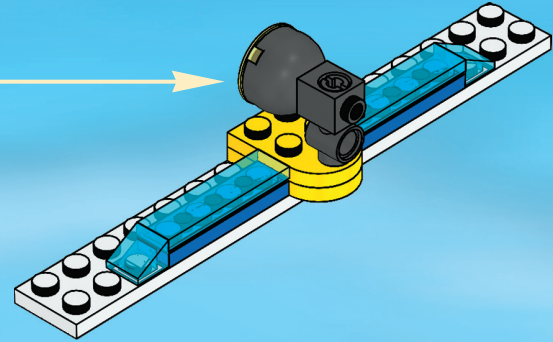
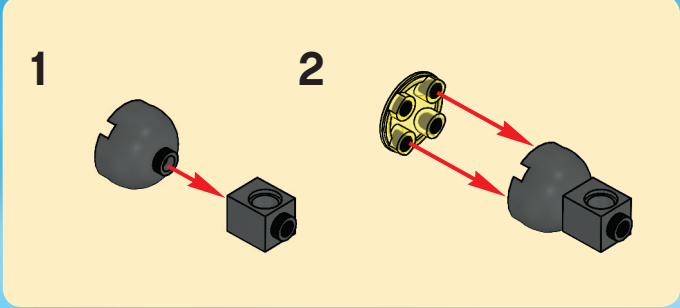

34

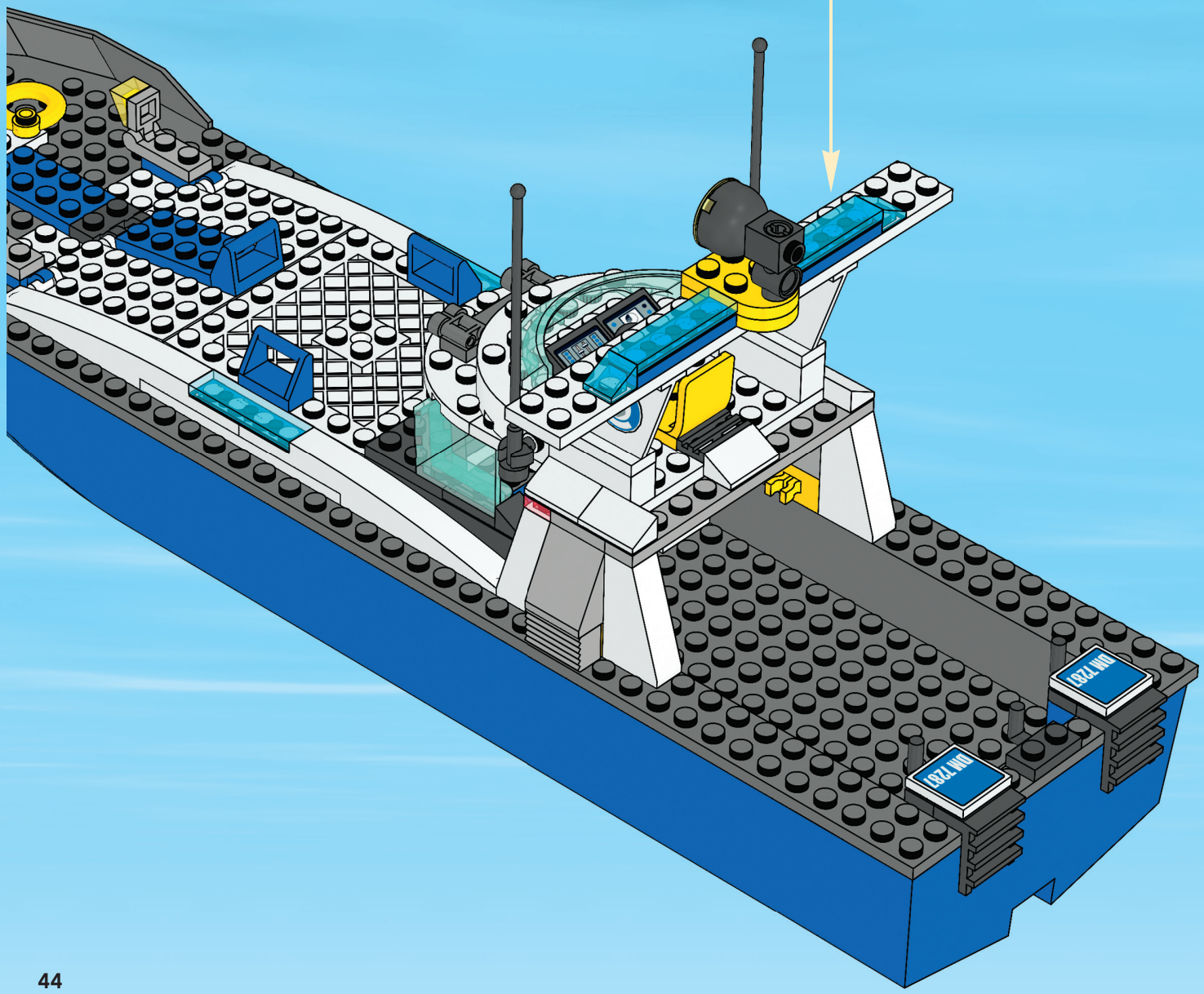

35

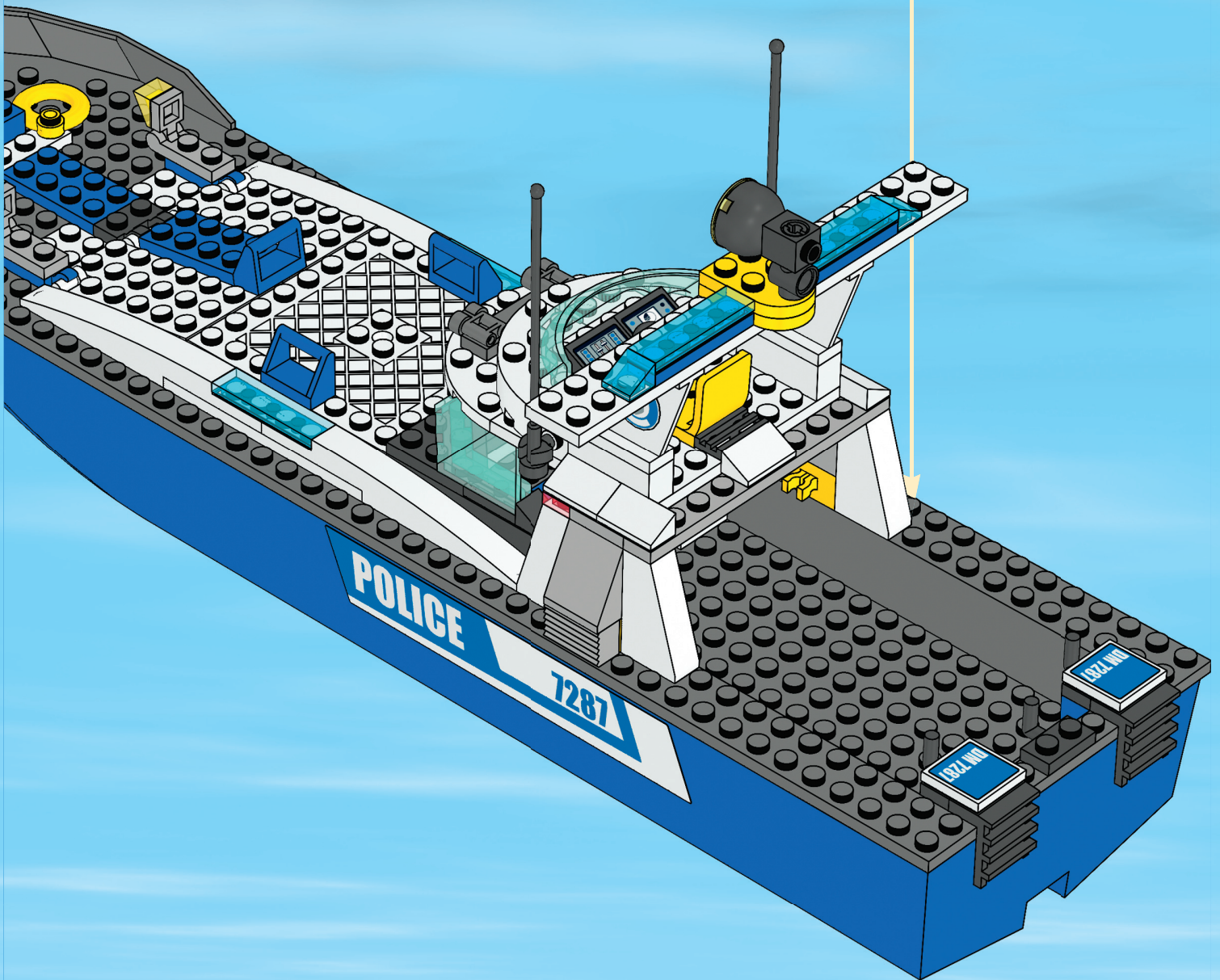
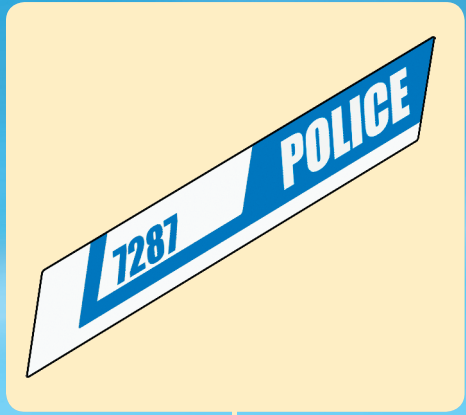

36

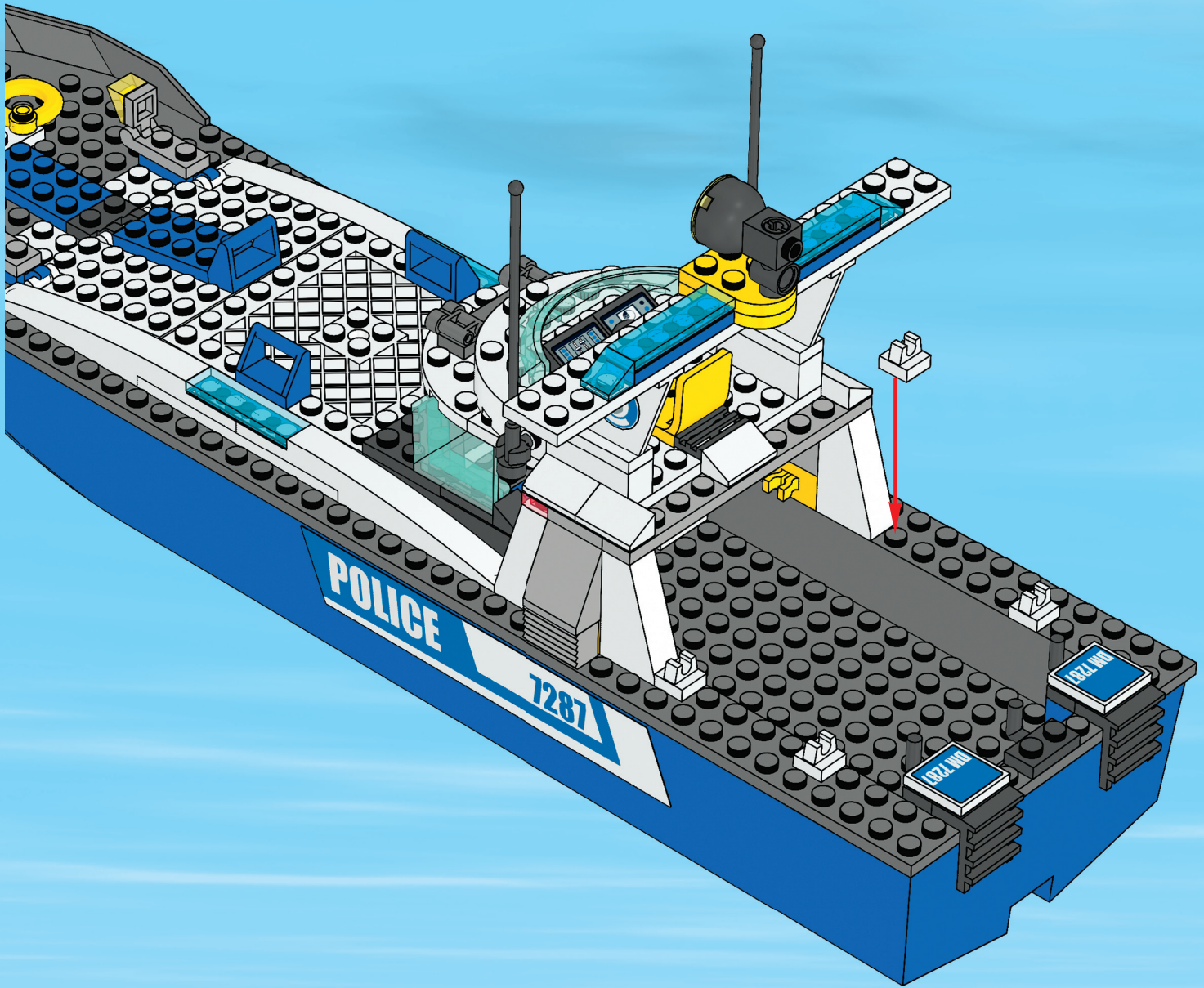

37

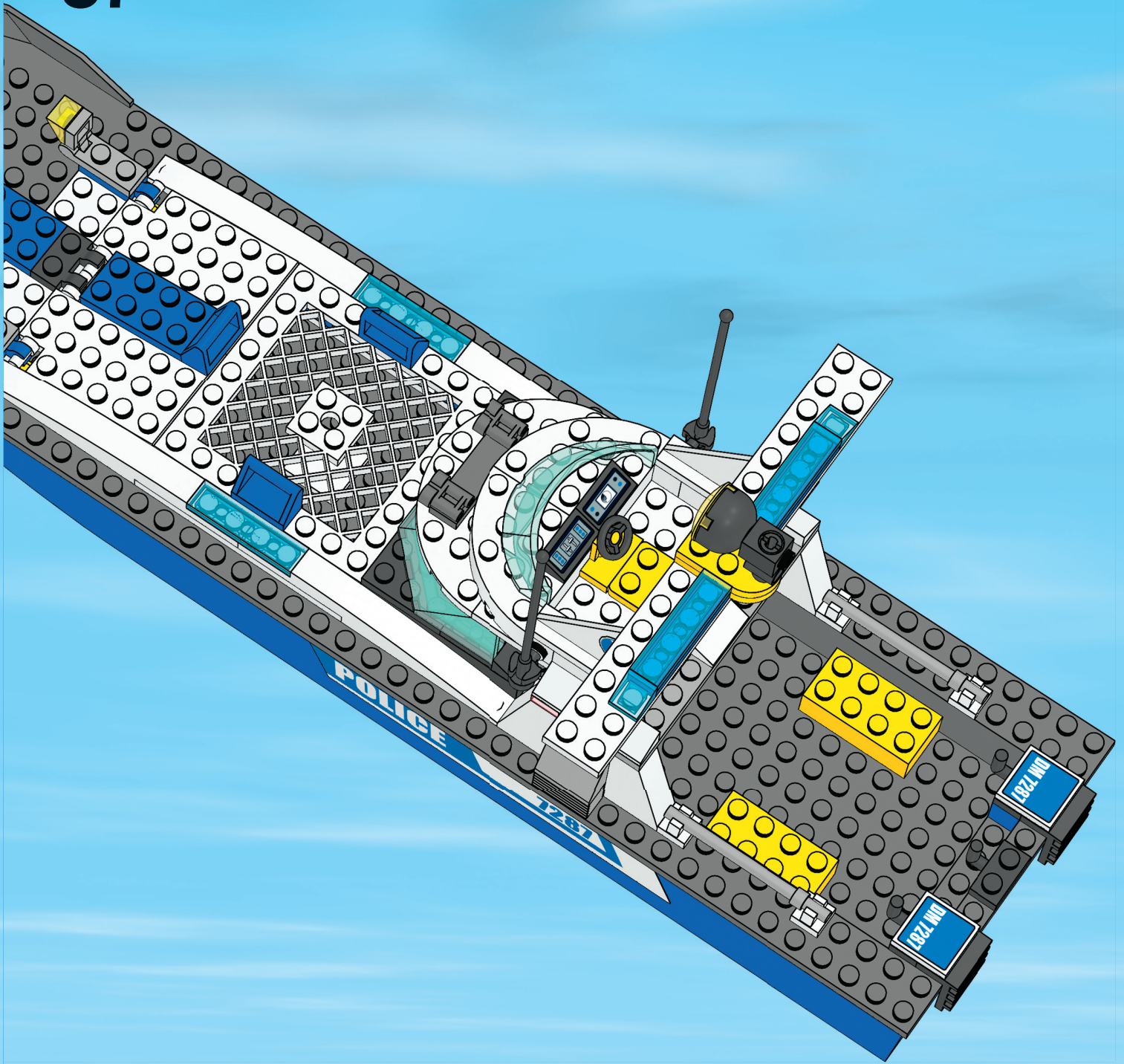

38

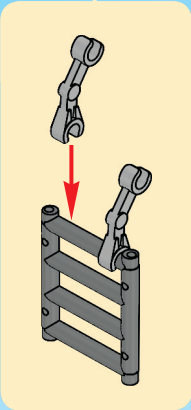
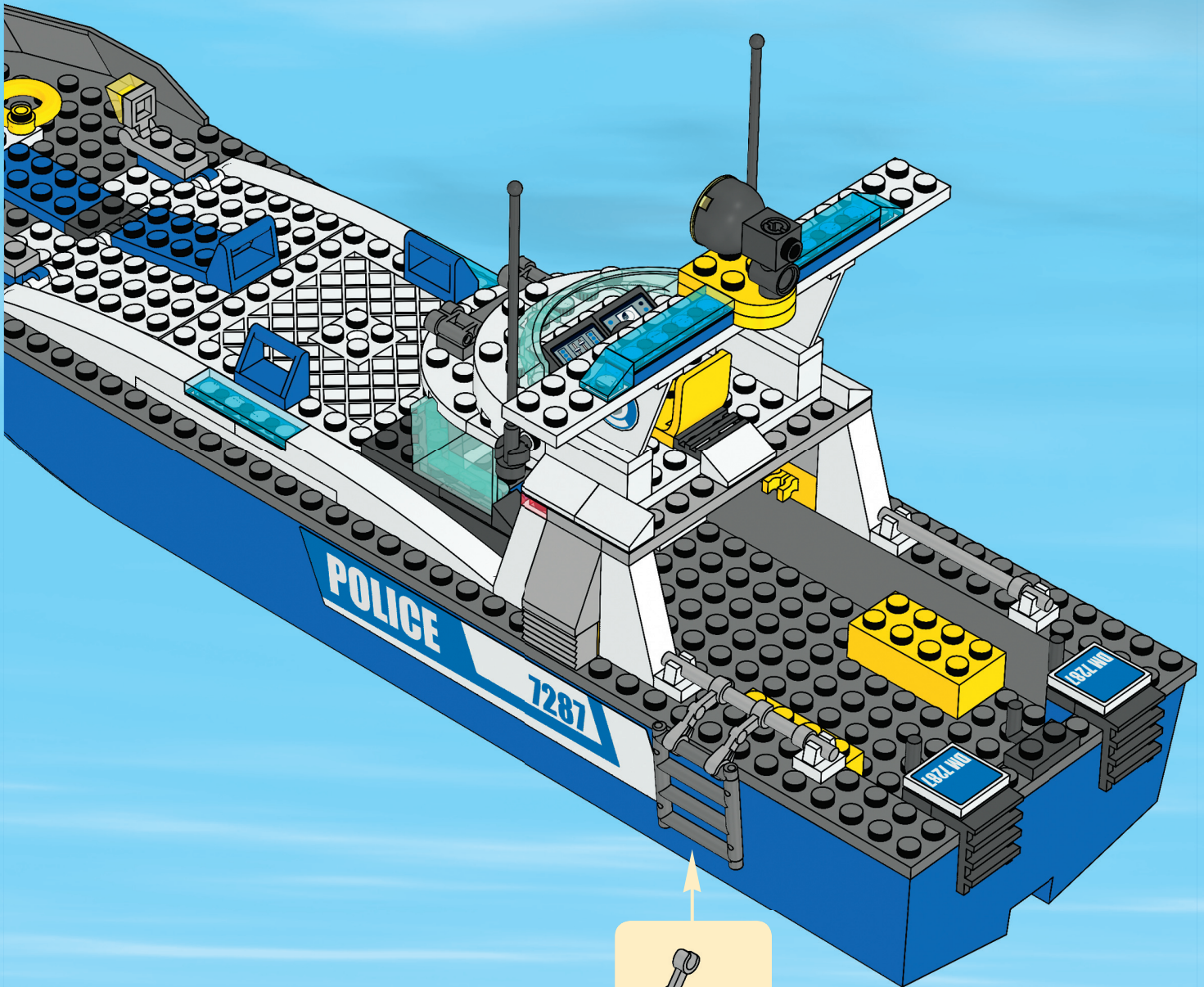

48



39

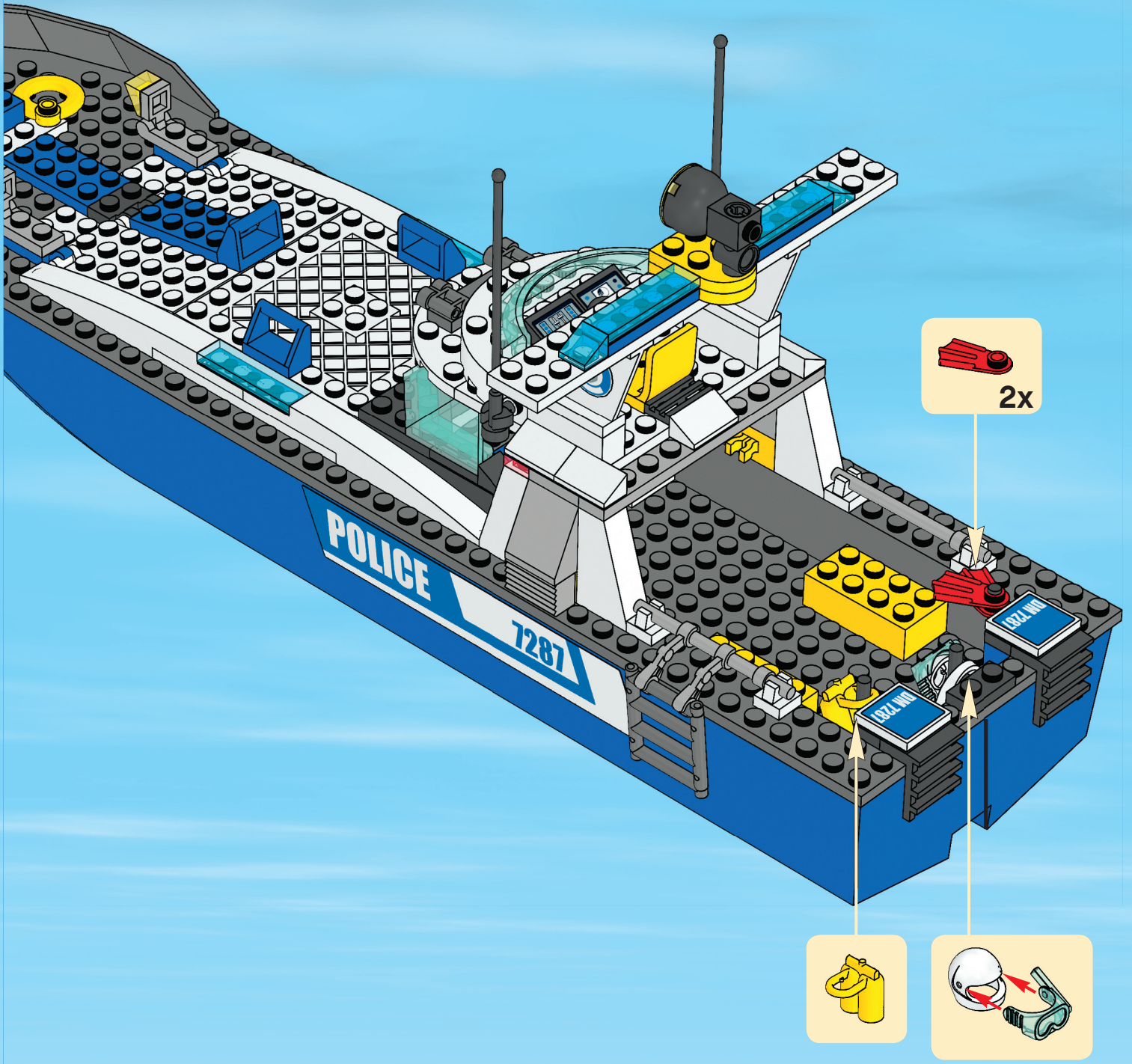

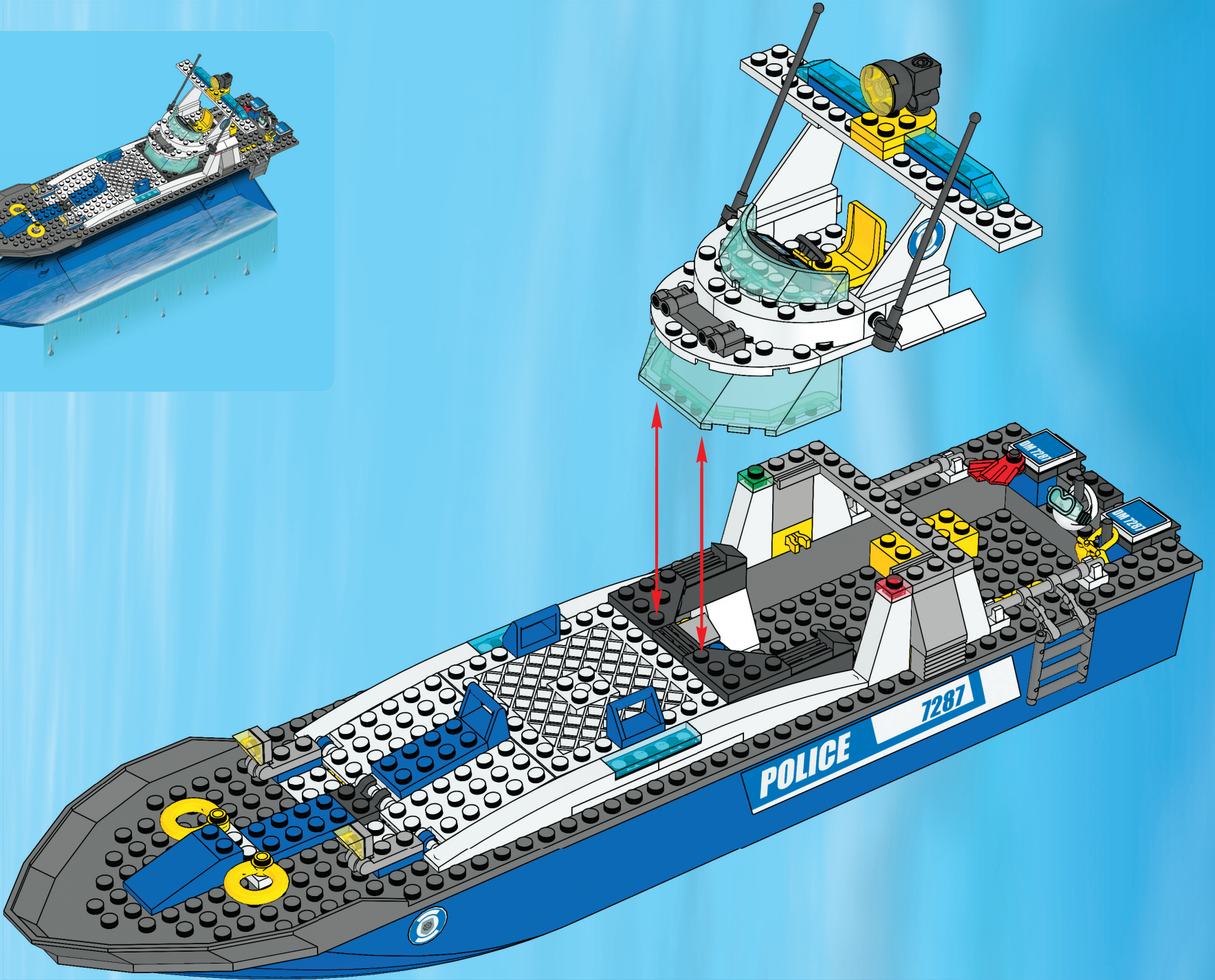
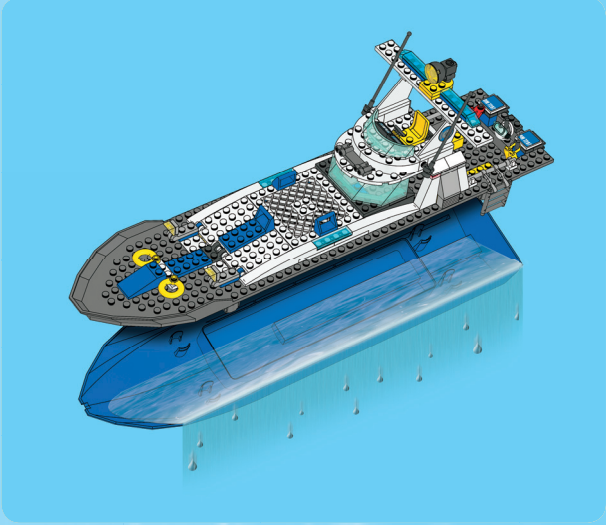

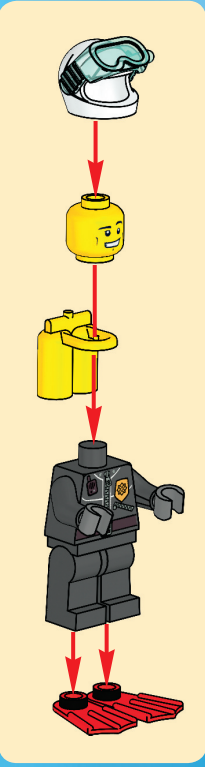
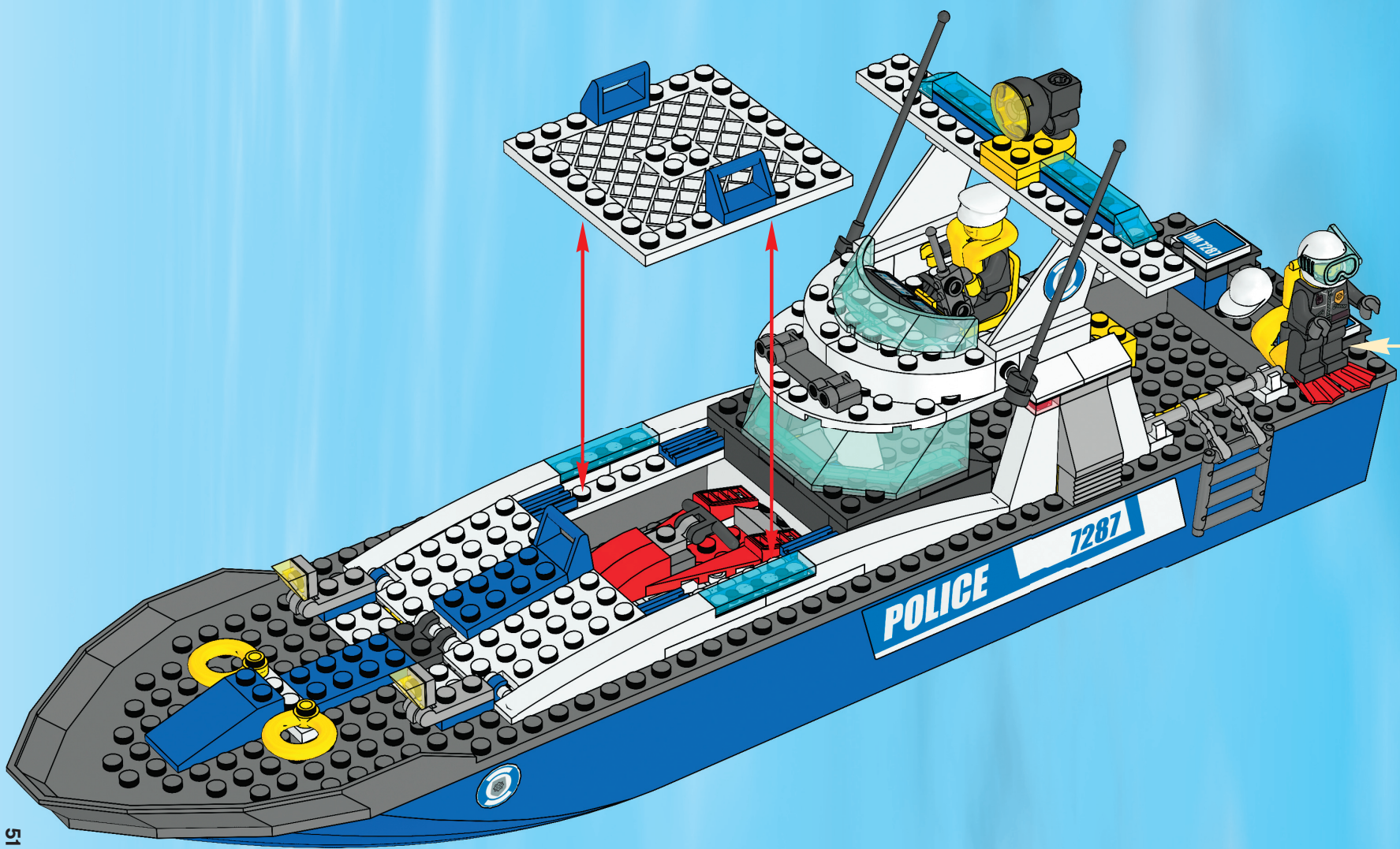

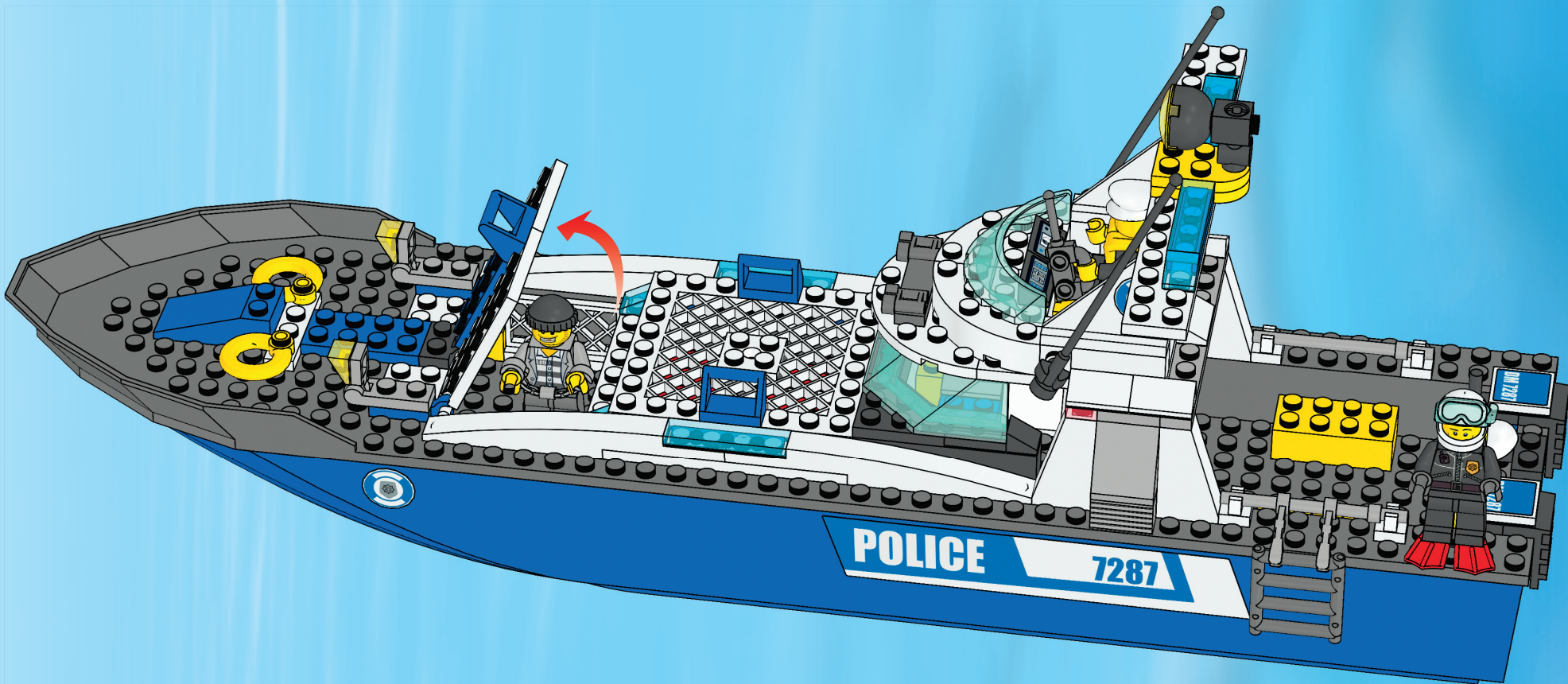

2x  
362201

1x  
300701

2x  
4603243

2x  
4178429

2x  
4599044

1x  
303601

1x  
4603245

2x  
4160736

4x  
4547368

1x  
4261693

1x  
371001

2x  
303401

1x  
4119227

4x  
255501  
2x  
4558952

5x  
4547489

4x  
446001

2x  
4234525

1x  
4173943

3x  
306801

2x  
4587272

1x  
4298609

1x  
362401

1x  
4567912

2x  
234001

2x  
4540382

2x  
4251162

1x  
379521

1x  
4561034

1x  
4278006

2x  
300423

1x  
4181139

1x  
4124107

1x  
302223

2x  
371023

2x  
302023

4x  
241223

2x  
4568990

3x  
243223

4x  
362224

2x  
300124

2x  
4113206

2x  
4188313

1x  
9553

1x  
407924

1x  
4259915

1x  
4215503

1x  
4586454

2x  
4527354

1x  
383824

2x  
4260843

3x  
300926

1x  
4216660

1x  
654126

2x  
4504382

2x  
4548180

4x  
241226

3x  
4569733

1x  
4556158

2x  
4227684

2x  
4603502

2x  
256926

2x  
9339

1x  
4275401

1x  
4598864

1x  
4157108

1x  
396226

1x  
3003126

2x  
4289538

1x  
4560174

1x  
3000841

1x  
4499885

1x  
4599045

1x  
4525032

4x  
4244366

4x  
4590989

2x  
4260942

1x  
4278415

1x  
4217436

2x  
4211051

2x  
4211383

2x  
4568637

2x  
4234535

1x  
4251149

3x  
4541978

2x  
4211568

2x  
4515369

2x  
4538098

1x  
4600359

2x  
4211658

1x  
4518282

1x  
4598769

1x  
4211119

1x  
4521886

1x  
4222693

1x  
4603000

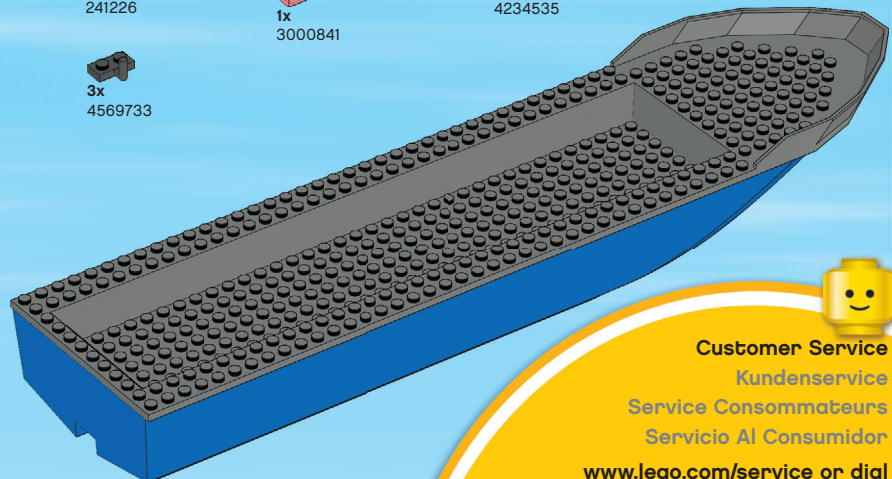

Customer Service  
Kundenservice  
Service Consommateurs  
Servicio Al Consumidor  
[www.lego.com/service](http://www.lego.com/service) or dial



: 00800 5346 5555  
: 1-800-422-5346

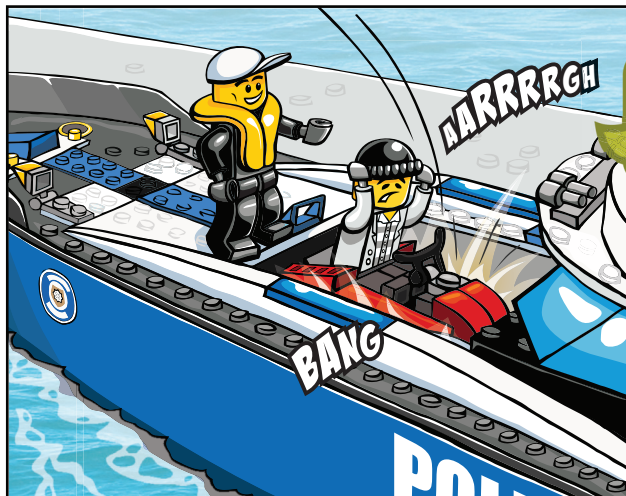
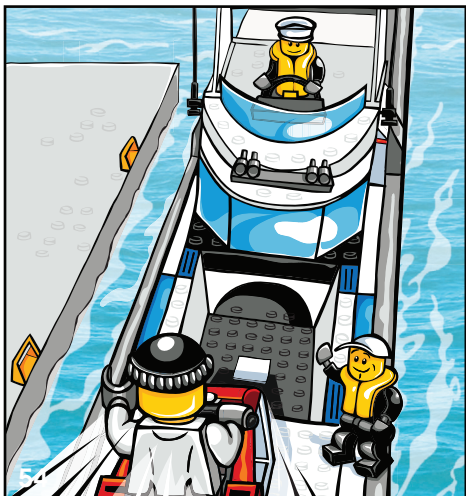
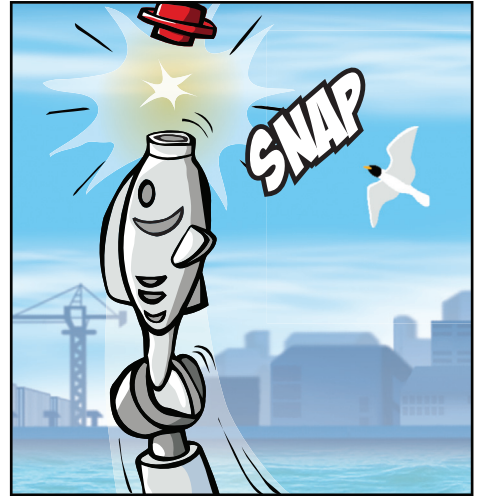

City.LEGO.com/comicbuilder



# CITY



**WWW.LEGO.COM**

**USE THIS KEY TO UNLOCK SECRET CONTENT!  
SCHALTE MIT DIESEM CODE GEHEIMEN INHALT FREI!  
UTILISE CETTE CLÉ POUR DÉBLOQUER LE CONTENU SECRET !**

**A9ZAX9**

**¡USA ESTA CLAVE PARA ACCEDER AL CONTENIDO SECRETO!  
USA ESTA CHAVE PARA ABRIR O CONTEÚDO SECRETO!  
EZZEL A KULCCSAL JUTHATSZ HOZZÁ A TITKOS TARTALOMHOZ!**



**CITY.LEGO.COM/COMICBUILDER**



# CITY



7279



7285



7286



7287



7288



7498





CITY



3365



3366



3367



3368

**LEGO**

**CITY**



7208

7207

7239

7942





[www.LEGOclub.com](http://www.LEGOclub.com)

**LEGO club**™

**FREE! GRATIS! GRATUIT!**



**LEGO® Club Magazine**



**LEGO® Club Email**

**SIGN UP ONLINE!**

[www.LEGOclub.com](http://www.LEGOclub.com)

VISIT THE WORLD'S  
BIGGEST LEGO® SHOP!  
[www.LEGOshop.com](http://www.LEGOshop.com)

GO TO  
[www.LEGOclub.com](http://www.LEGOclub.com)

00800 5346 5555\*

1-866-534-6258 • 1-877-518-5346

US & Canada only Canada seulement



\* Freephone. Mobile charges may apply. \* Numéro sans frais. Des frais peuvent s'appliquer avec les téléphones cellulaires. \* Gebührenfrei. Kosten für Anrufe aus Mobilfunknetzen können abweichen. \* Gratis telefoonnummer vanaf vaste lijn. \* Det er et gratis nummer, når du ringer fra fasttelefon. \* Det är gratis, när du ringer från en fast telefon. \* Numéro sans frais. Des frais peuvent s'appliquer avec les téléphones portables.



# WIN!

Go to [www.LEGOsurvey.com/product](http://www.LEGOsurvey.com/product) to fill out a survey for a chance to win a cool LEGO® Product. No purchase necessary. Open to all residents where not prohibited.

 [www.LEGO.com](http://www.LEGO.com)



# [www.LEGOsurvey.com/product](http://www.LEGOsurvey.com/product)

## GEWINNE!

Nimm an der Umfrage auf [www.LEGOsurvey.com/product](http://www.LEGOsurvey.com/product) teil und hab die Chance ein cooles LEGO® Produkt zu gewinnen!

Die Teilnahme am Gewinnspiel führt zu keinerlei Kaufverpflichtungen. Teilnahme in allen nicht ausgeschlossenen Ländern möglich.

4656086

## WIN!

Ga naar [www.LEGOsurvey.com/product](http://www.LEGOsurvey.com/product), vul een enquêteformulier in en maak kans op een cool LEGO® product.

Geen aankoopverplichting. Iedereen mag deelnemen, uitgezonderd ingezetenden van landen waar een enquêteverbod geldt.

## GAGNE!

Visite [www.LEGOsurvey.com/product](http://www.LEGOsurvey.com/product) pour répondre à un questionnaire et avoir une chance de gagner un produit LEGO® très cool !

Aucune obligation d'achat. Ouvert à tous les résidents des pays autorisés.

## 当てよう!

[www.LEGOsurvey.com/product](http://www.LEGOsurvey.com/product) にアクセスして、アンケートにご記入ください。当選者にはレゴ製品を差し上げます。

お買い上げの必要はありません。禁止されていない限り、すべての皆様にご利用いただけます。

LEGO and the LEGO logo are trademarks of the LEGO Group. ©2011 The LEGO Group. © 2011 Lucasfilm Ltd. & TM. All rights reserved.