



NEXO KNIGHTS



72001





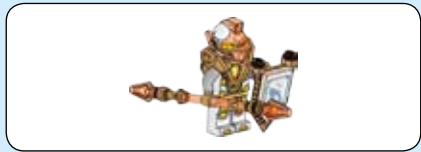

1

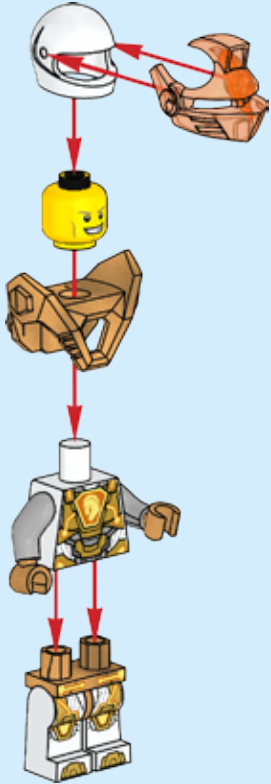



2



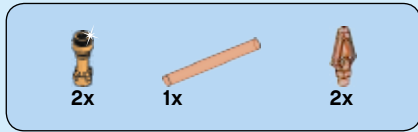

3

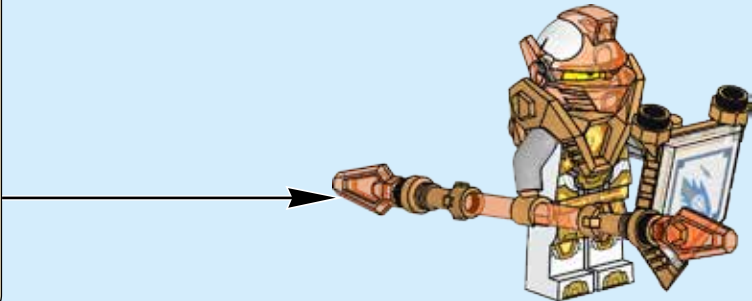
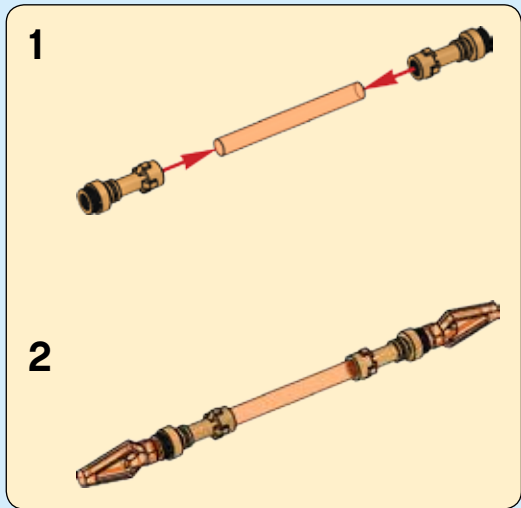



1

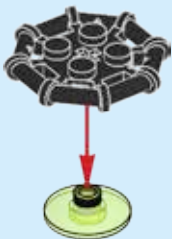

6



2

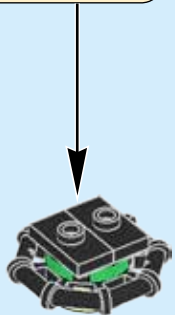



3

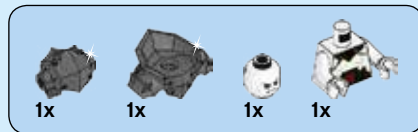
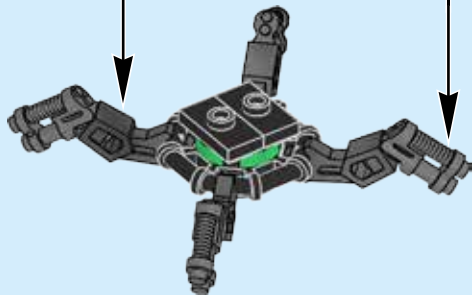
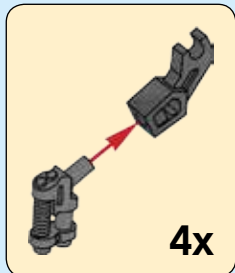

4

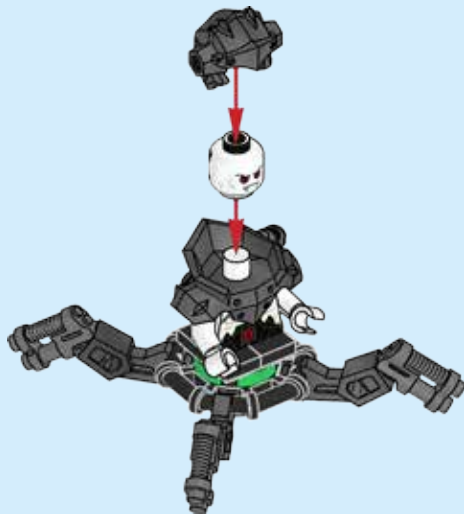



5



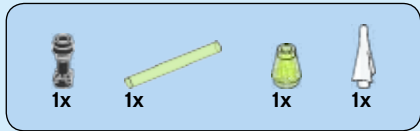

6

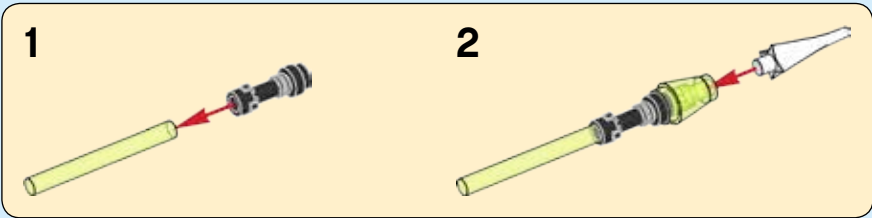



1

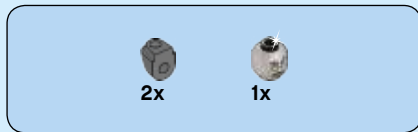

2

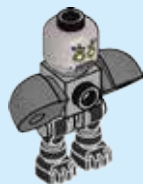

3

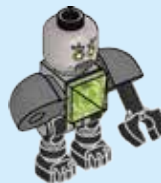



4

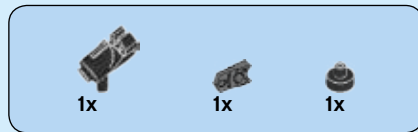

5





2x



2x

6

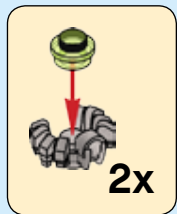

2x

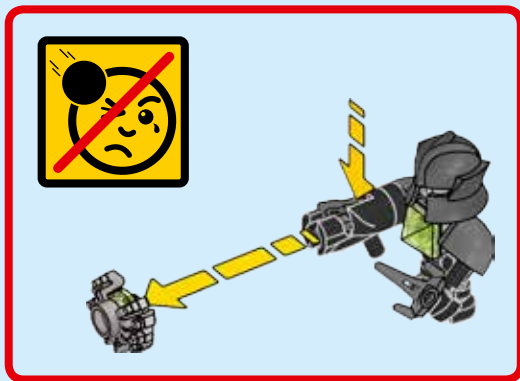
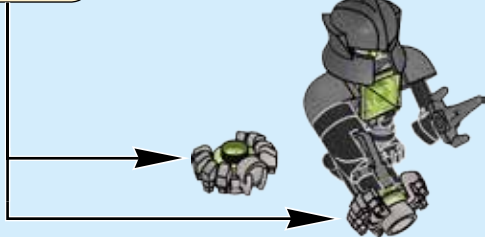

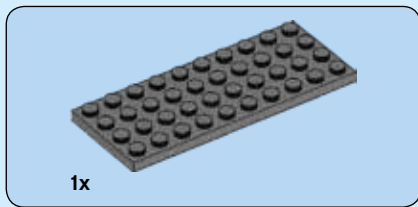

1

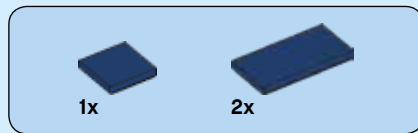
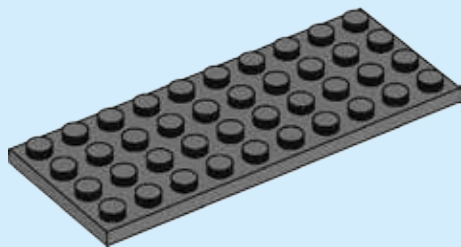

2

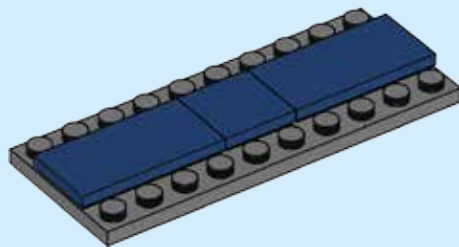

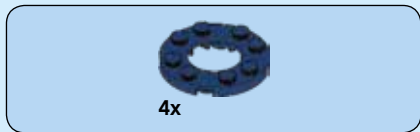

3

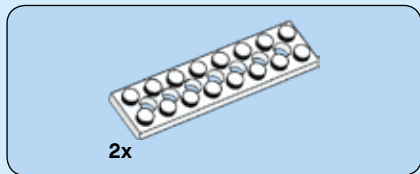
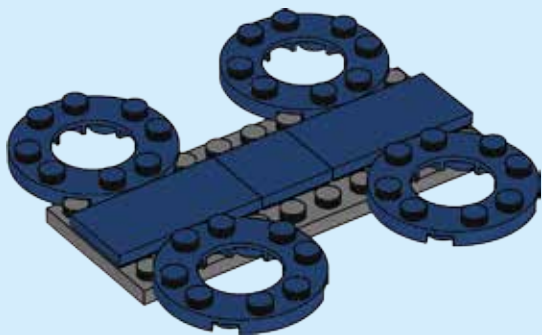

4

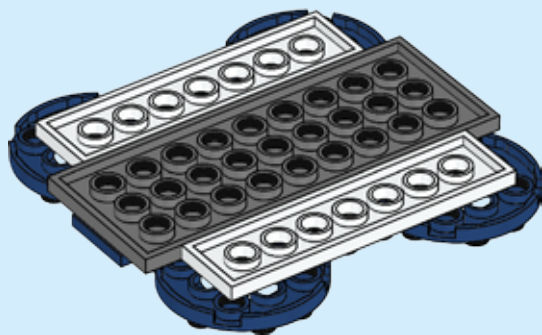
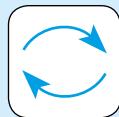

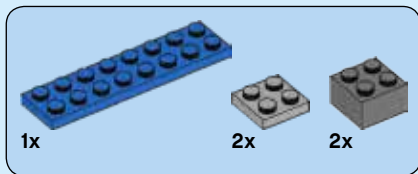

5

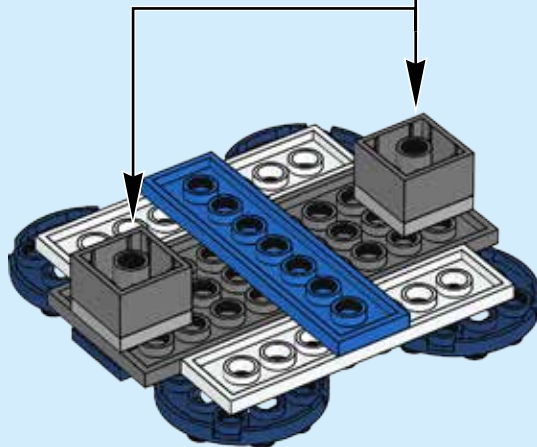
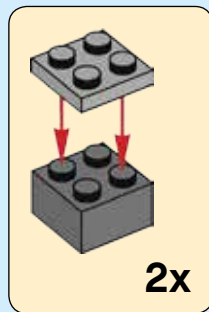



6

1



2

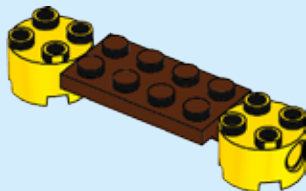

3



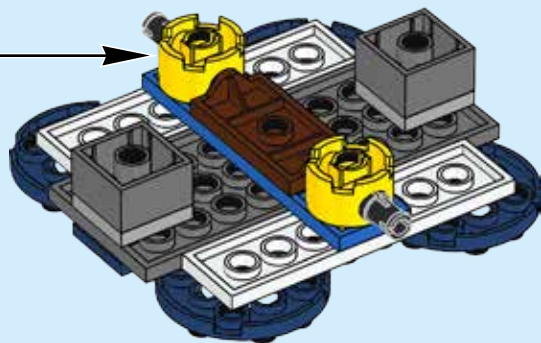

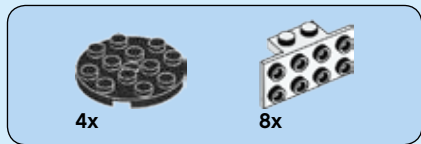

7

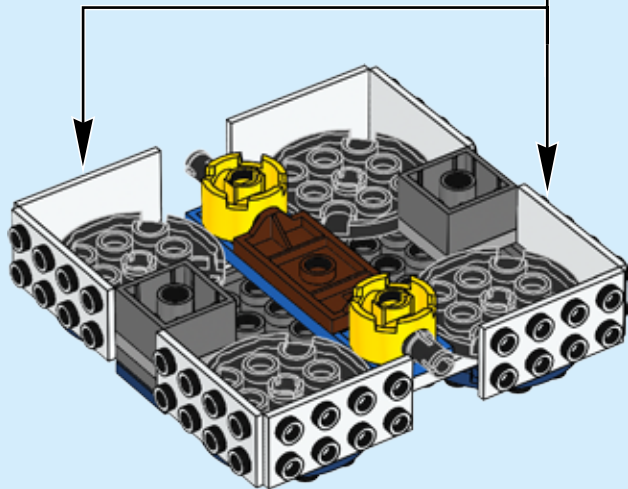
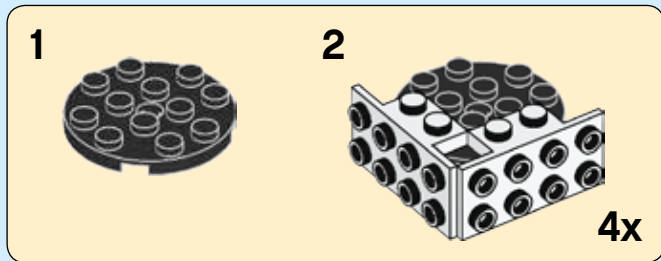

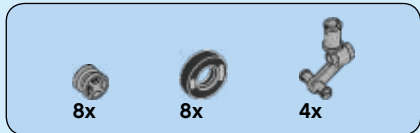

8

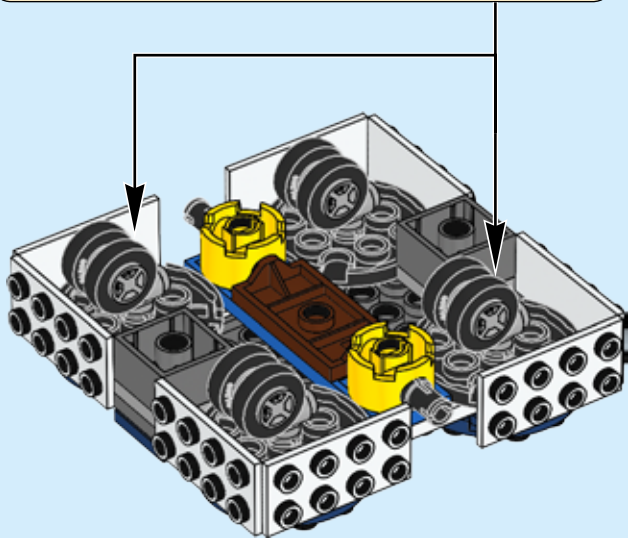
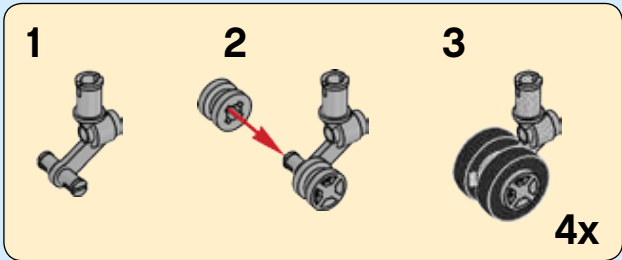



4x

9

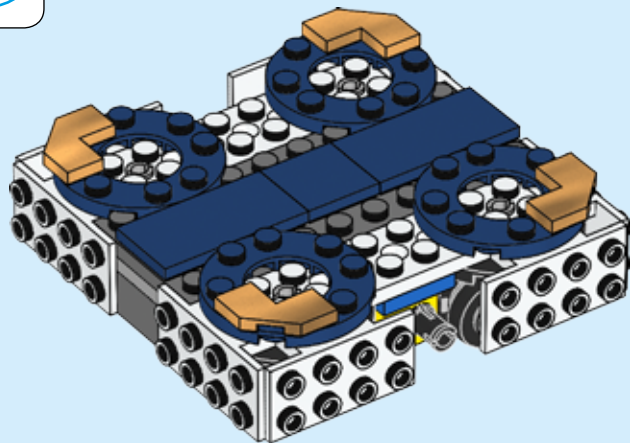
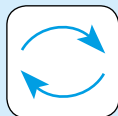

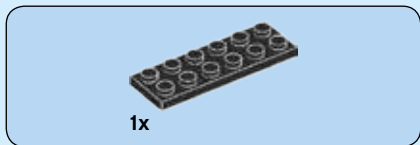
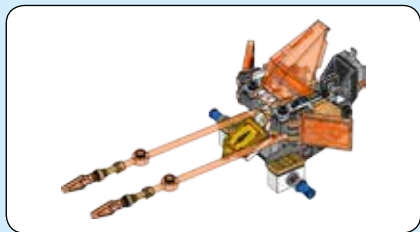

10

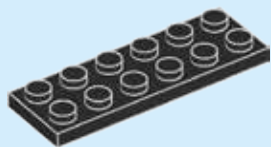

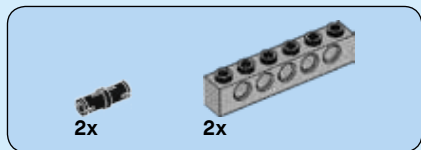

11

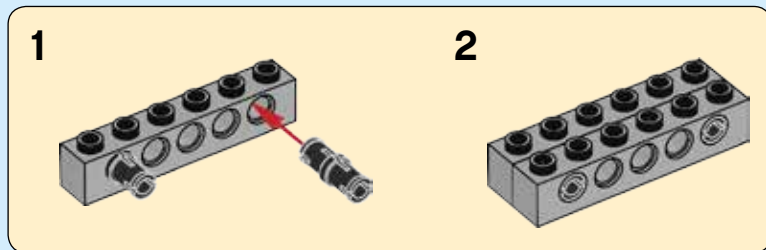

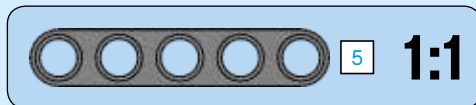
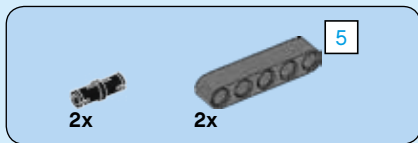

12

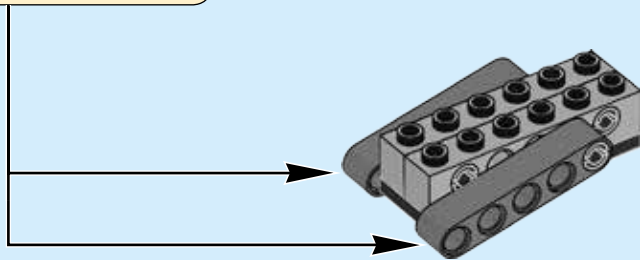
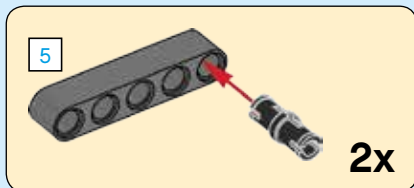



13

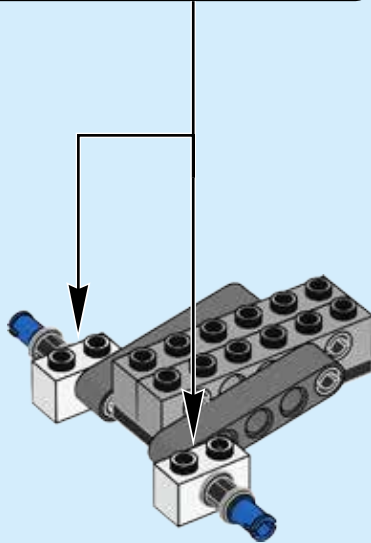
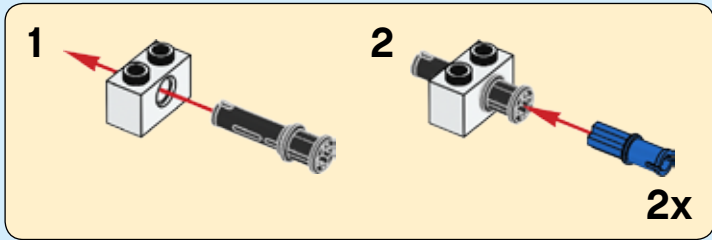



14

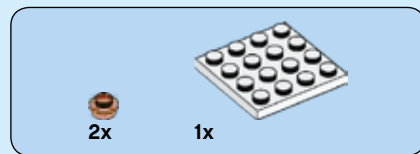
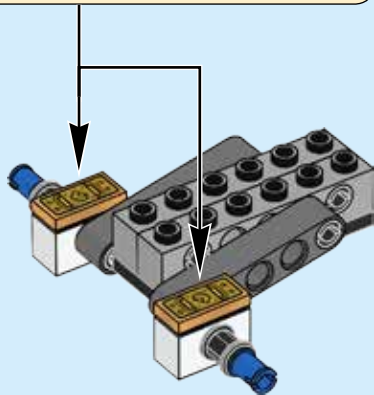
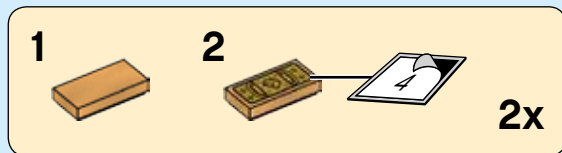

15

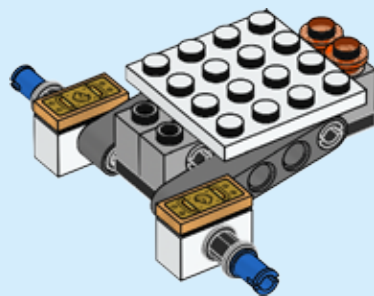

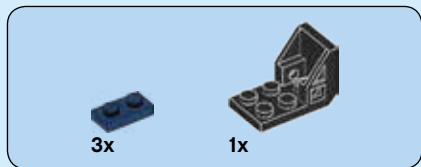

16

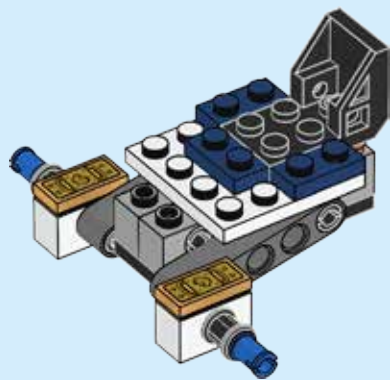

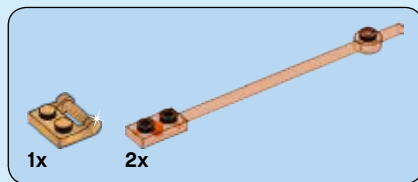

17

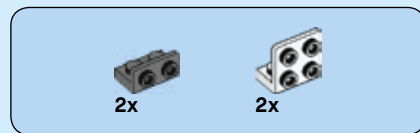
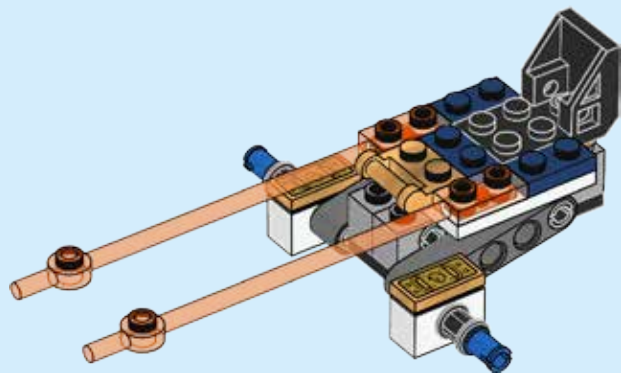

18

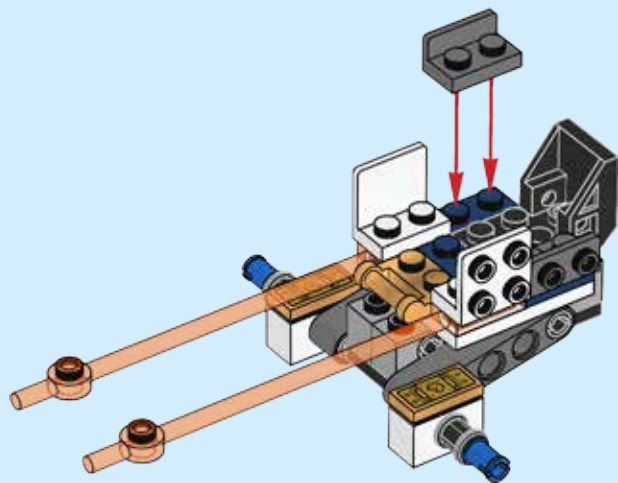



1x



2x

19

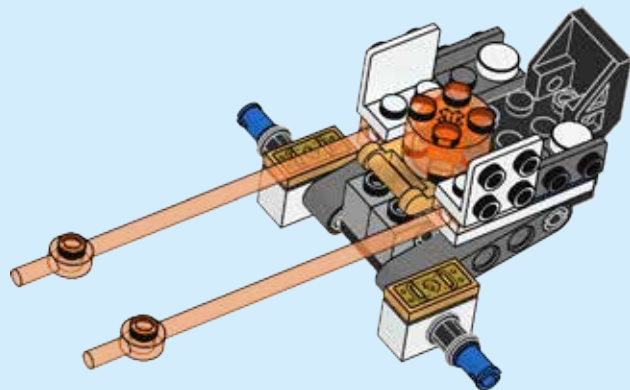



2x

20

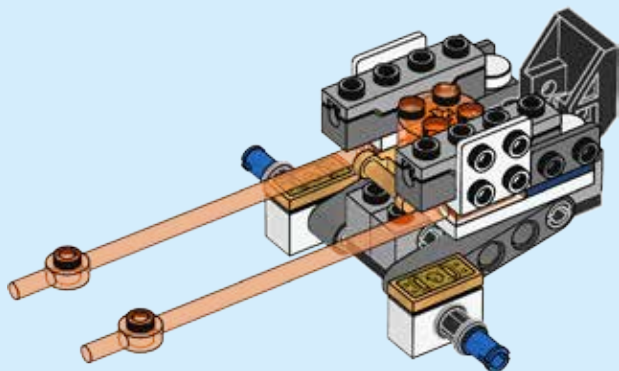

1x



2x

21

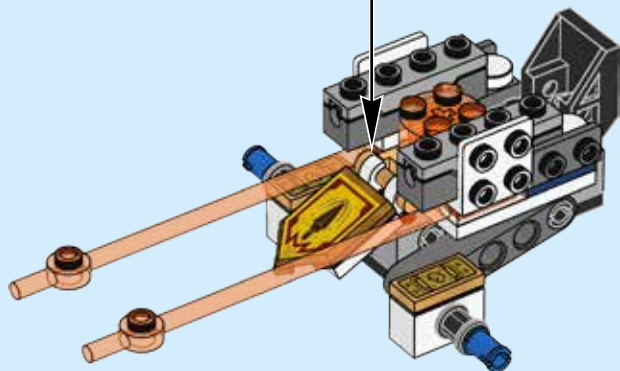
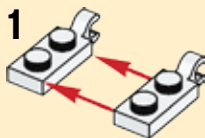



2x

22

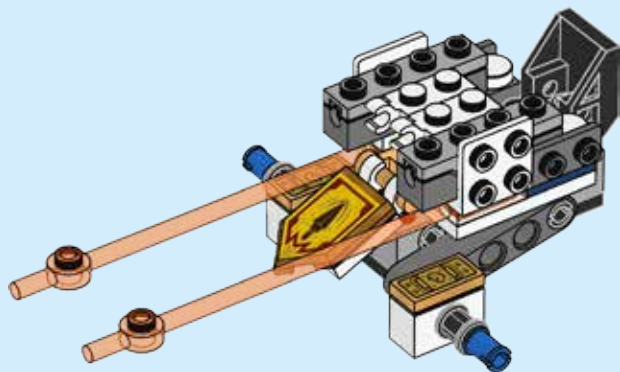

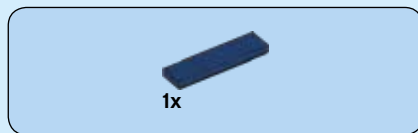

23

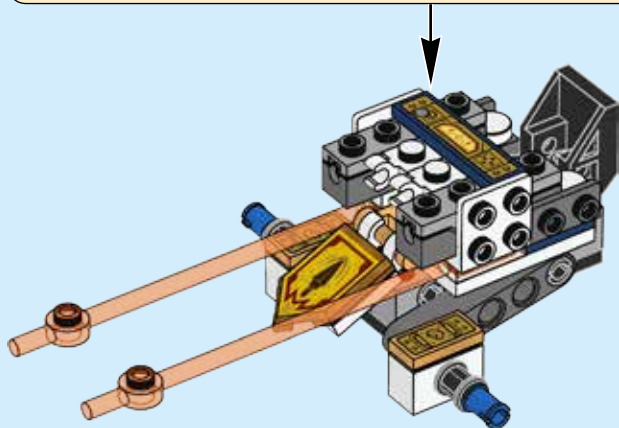

24

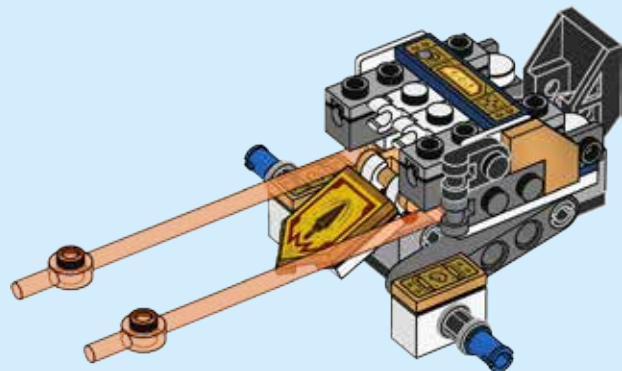



1x



1x



1x

25

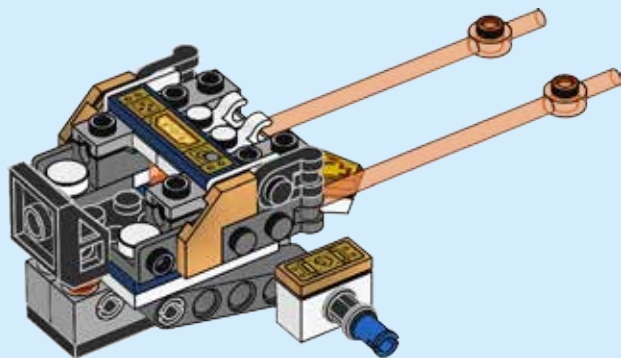
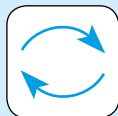



2x



1x

26

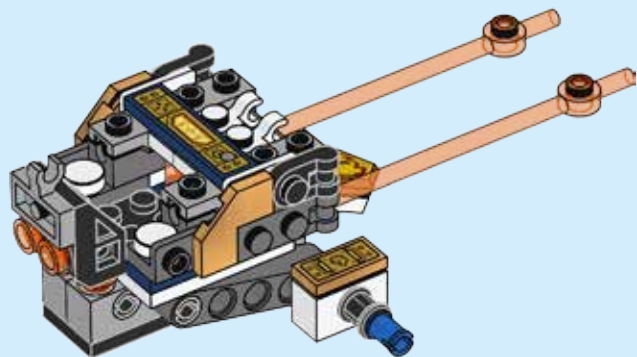

1x



1x

27

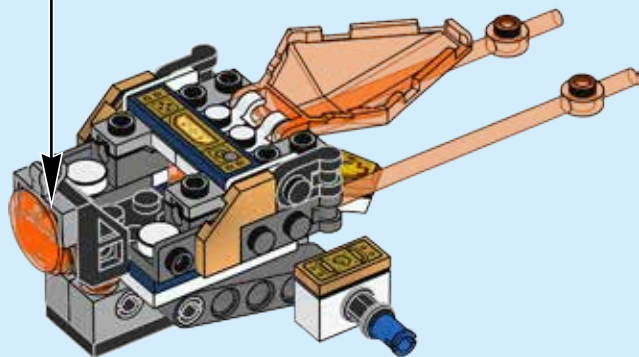



2x

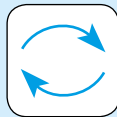

28

1



2

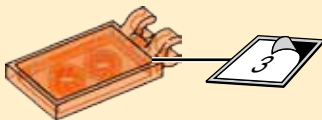

1



2

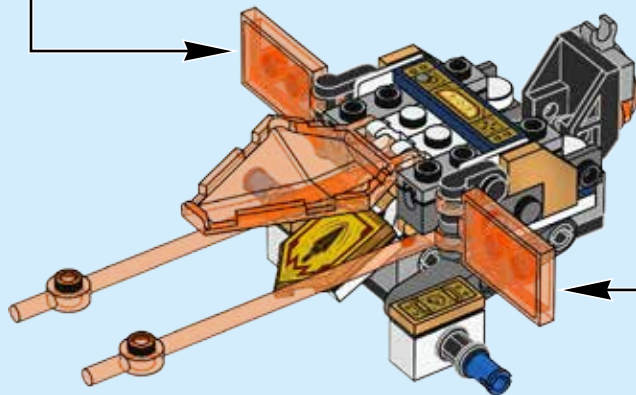
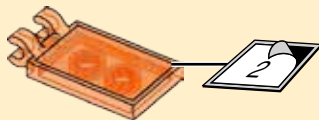



2x



2x

29



2x

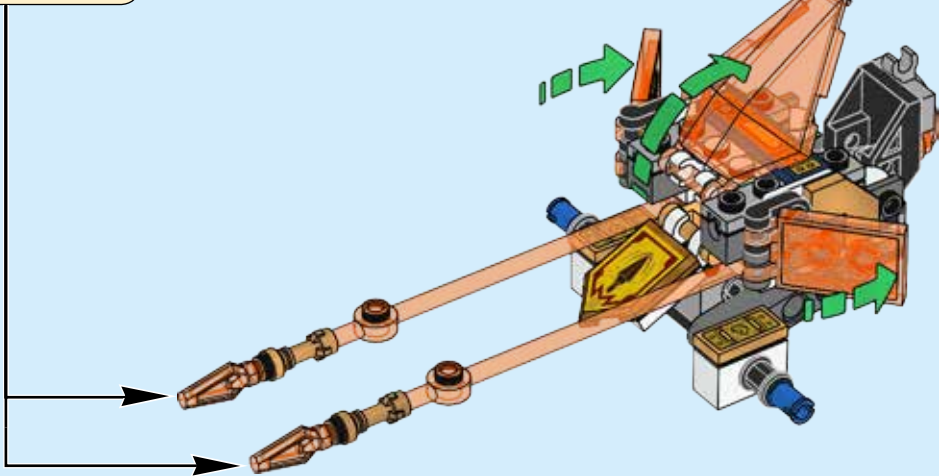

30

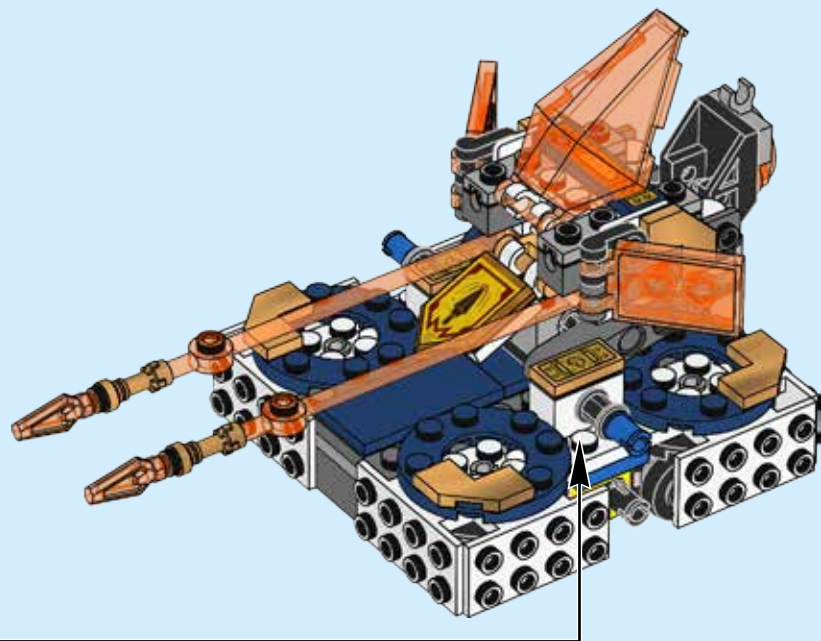

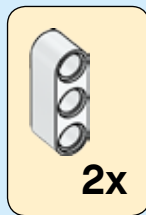
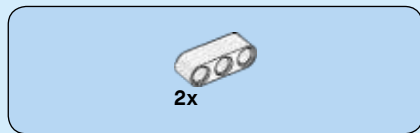

31

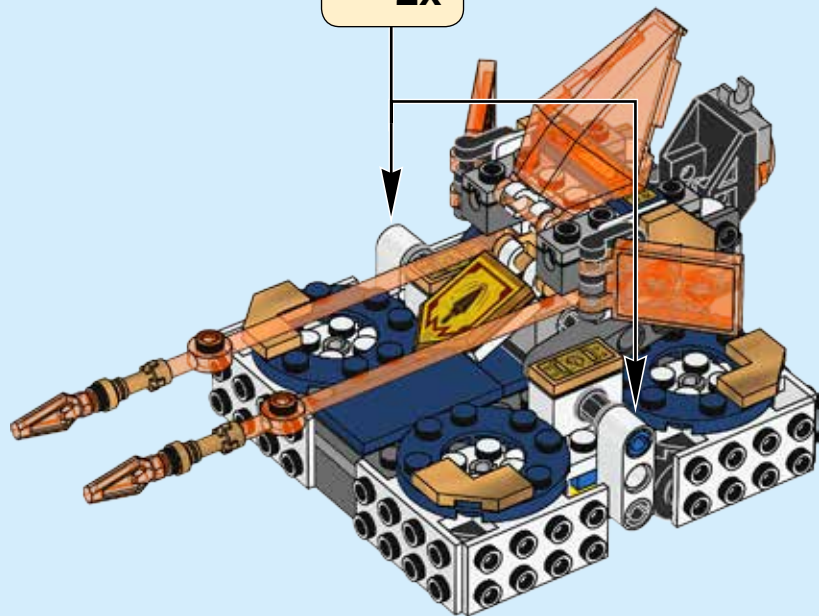



1x



1x



1x

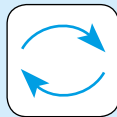

32

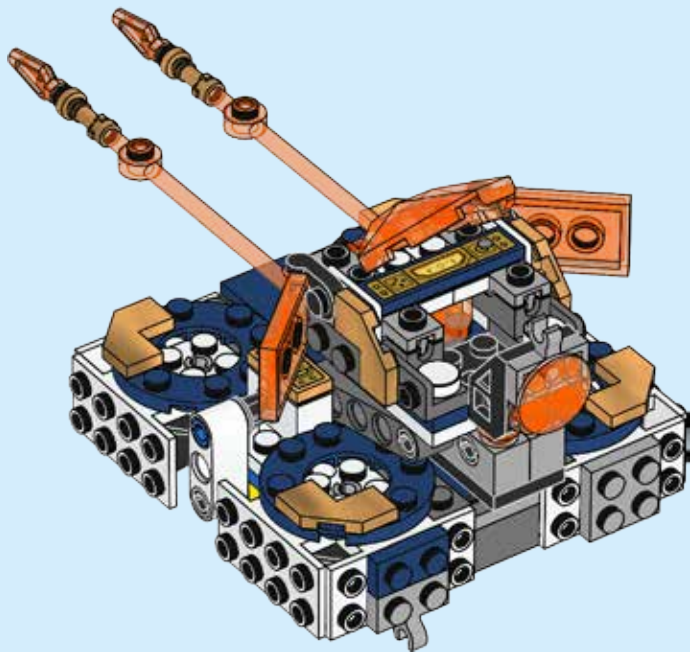



4x

33

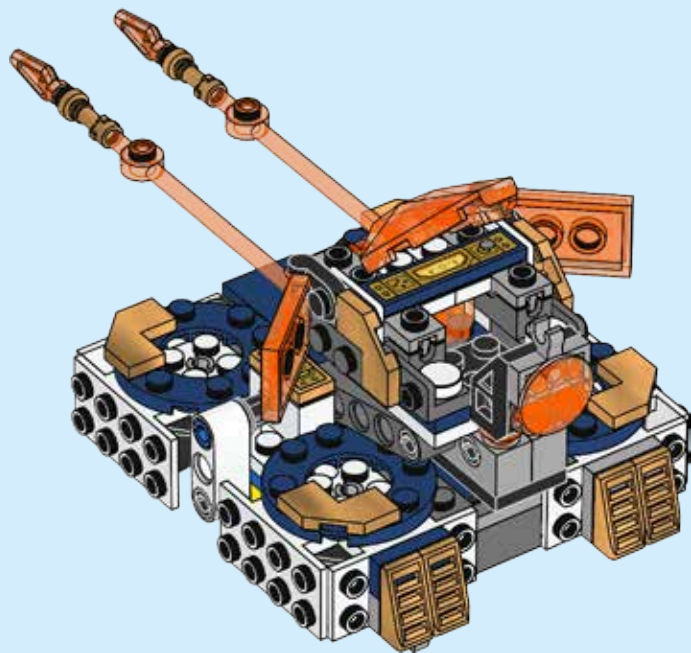

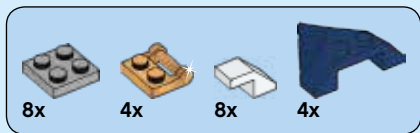

34

1

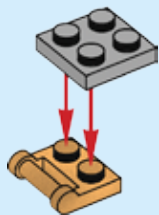

2



3

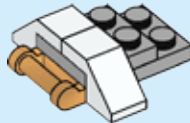

4

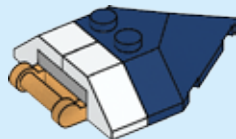

4x

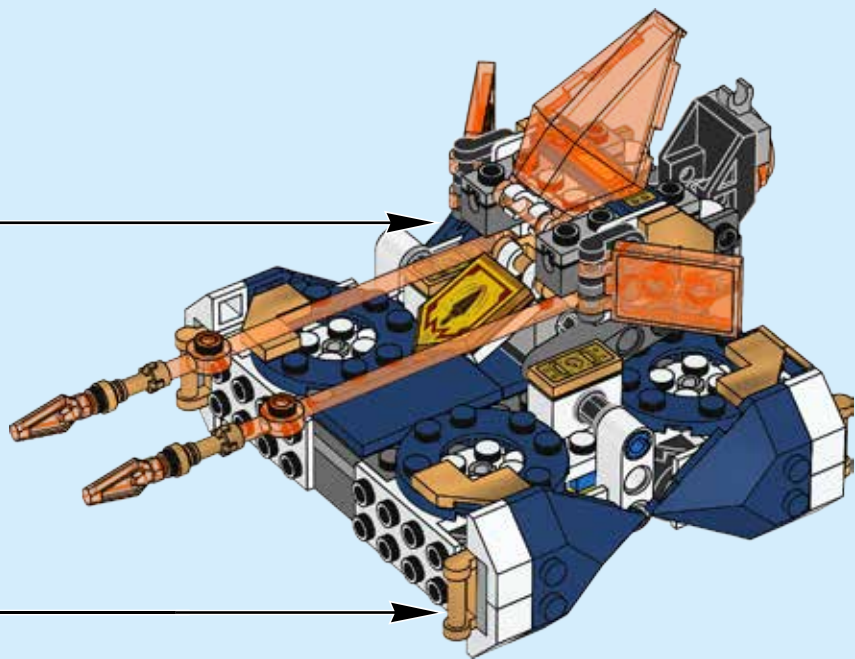
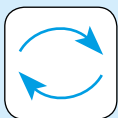



2x



4x



4x



2x



2x

35

1

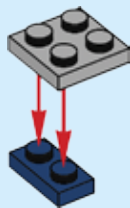

2

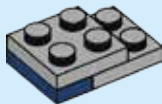

3

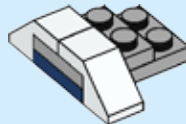

4

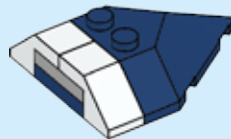

2x

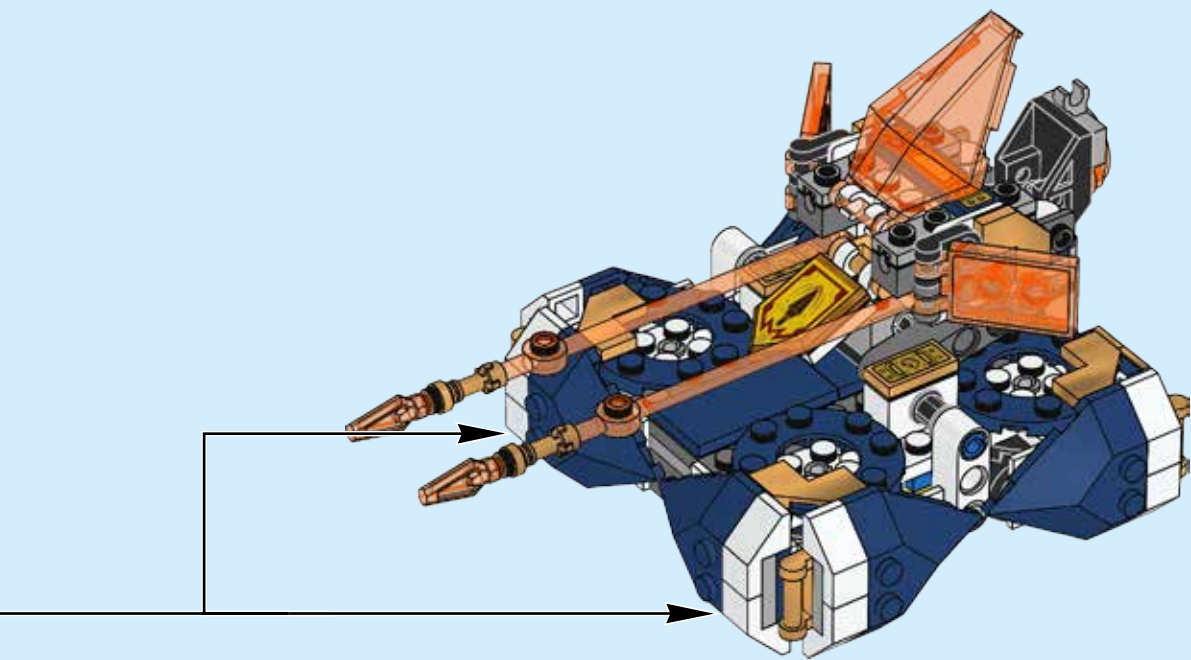

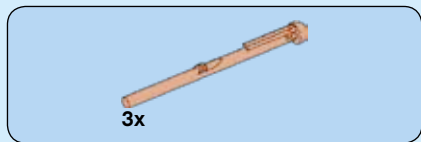



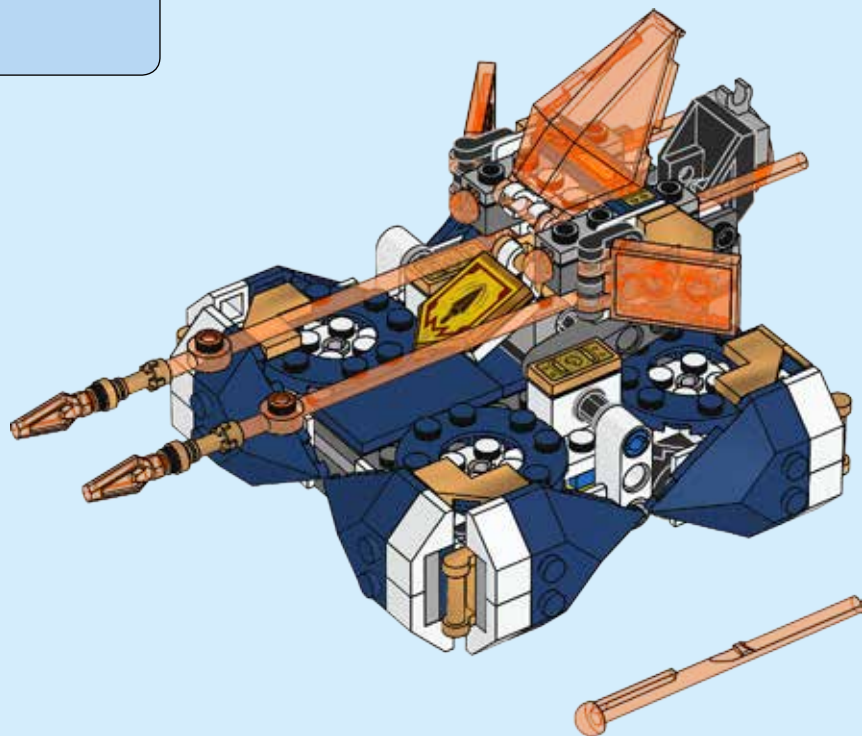

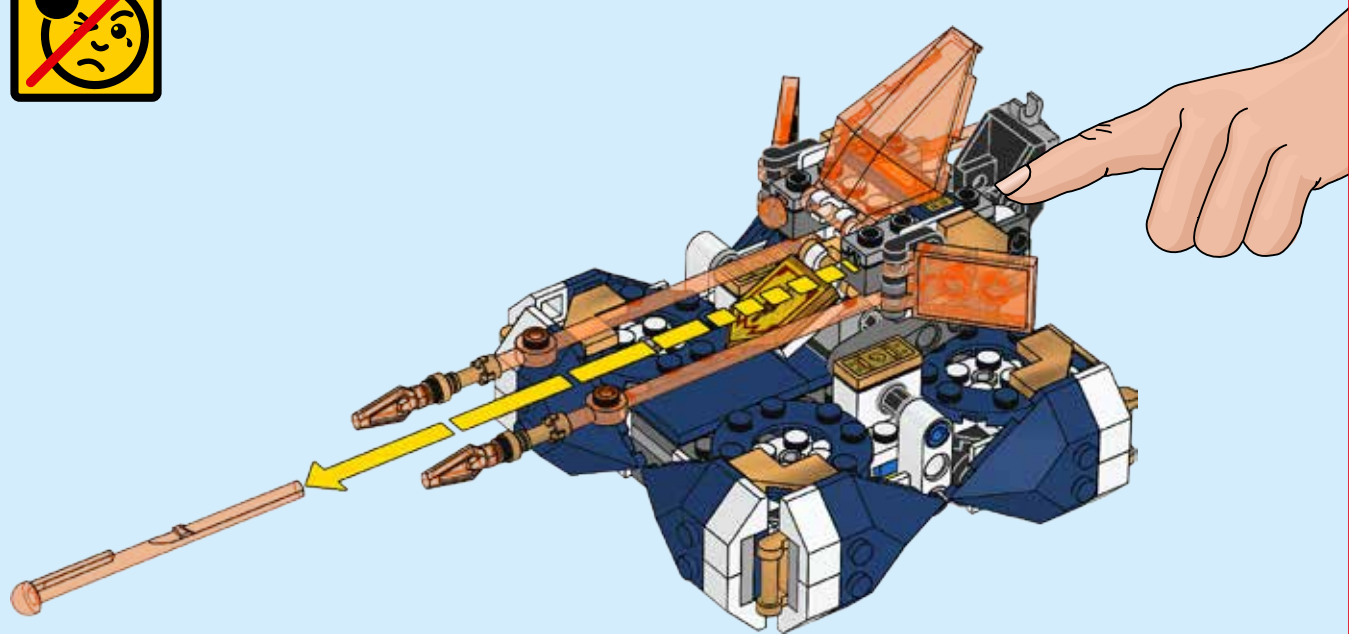

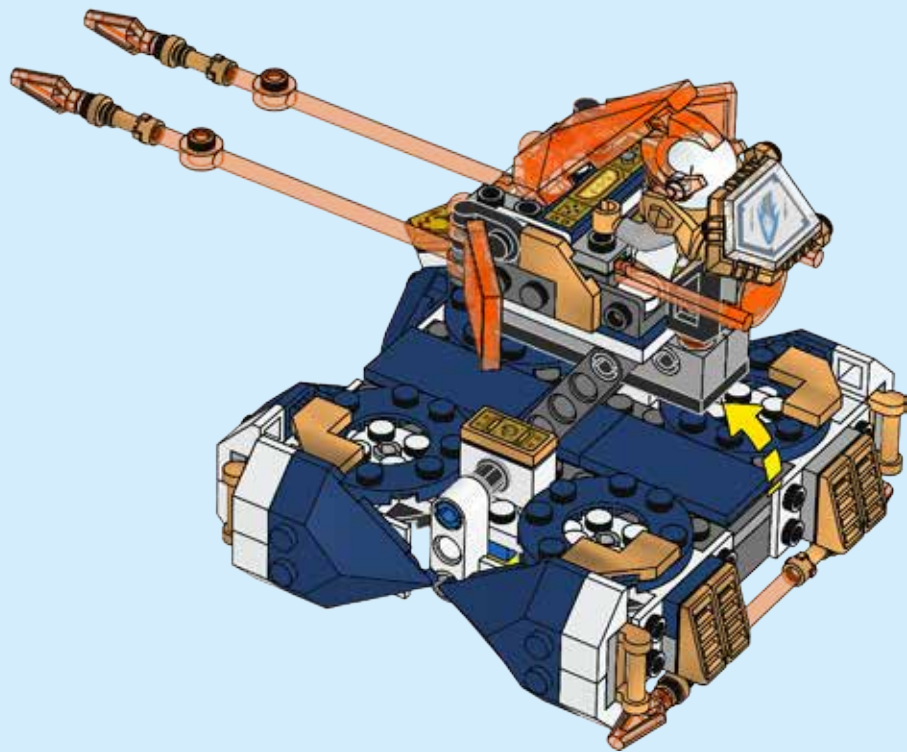



























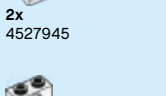















36



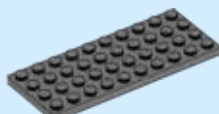



 1x 6124911	 2x 4208160	 8x 4516843	 1x 4598897	 2x 6175554	 4x 6003147
 2x 6102524	 8x 6158058	 2x 6157554	 2x 6038453	 1x 6051334	 4x 6167584
 1x 6136388	 1x 4243812	 1x 6051331	 1x 6186675	 4x 4623236	 2x 6107197
 2x 4646844	 2x 4527945	 2x 6092585	 1x 4289538	 2x 6000606	 1x 6202742
 1x 6211812	 2x 4527945	 2x 4140801	 1x 6018805	 2x 4211060	 5x 4585493
 1x 4298609	 2x 370001	 6x 4121715	 2x 4206482	 2x 4521187	 1x 6208621
 1x 6211938	 12x 6166894	 1x 6021678	 1x 303423	 2x 4210686	 6x 6207046
 1x 6210730	 2x 6097637	 4x 4515350	 1x 4270882	 1x 4211122	 1x 6210503
 1x 6210734	 4x 4535737	 1x 379526			

4x
6166891

4x
3005747

1x
6124909

1x
611647

1x
6161314

1x
6120914

2x
6133781

1x
6210498

3x
6124908

2x
6164074

1x
6172166

4x
6008484

1x
6208797

1x
6208776

1x
4646870

1x
6208778

1x
6208780

1x
6053084

2x
6057034

1x
6138727

1x
6057005

1x
6133484

1x
4626400

1x
403228

1x
6211590

2x
6208782

6x
4528981

1x
4205004

1x
6103985

6x
6129858

4x
6108550

2x
4569836

2x
6048898

2x
4211466

8x
4211506

1x
6129994

4x
4519013

2x
6028812

15x
4211397



Customer Service

Kundenservice

Service Consommateurs

Servicio Al Consumidor

LEGO.com/service or dial



00800 5346 5555 :

1-800-422-5346 :



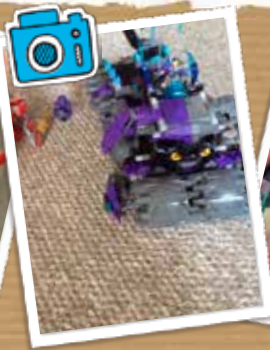

LEGO

**NEXO
KNIGHTS**



**POWER UP
YOUR BRICK PLAY**

**LIBÈRE LE POUVOIR
DE TES BRIQUES**

**MÁS DIVERSION
CON TUS BRICKS**



**BATTLE WITH
MERLOK POWERS**

**COMBATS AVEC LES
POUVOIRS MERLOK**

**LUCHA CON LOS
PODERES DE MERLOK**



**MEJORAS EN EL
JUEGO DIGITAL**



**UPGRADE YOUR
GAME PLAY**

**AMÉLIORE TON
JEU**



LEGO® NEXO KNIGHTS™ MERLOK 2.0



LEGO.COM/DEVICECHECK

WIN

GO TO WWW.LEGO.COM/PRODUCTFEEDBACK AND
GIVE US YOUR SHORT **FEEDBACK** ABOUT THIS
LEGO® SET FOR A CHANCE TO WIN
A COOL LEGO PRIZE.

Terms & Conditions apply

LEGO.com/productfeedback



GEWINNE

Erzähle uns auf
www.LEGO.com/productfeedback

etwas über die Erfahrungen, die du mit
diesem LEGO® Set gemacht hast, und
sichere dir die Chance auf einen coolen
LEGO Preis!

Es gelten die Teilnahmebedingungen

GAGNE

Rends-toi sur
www.LEGO.com/productfeedback

et donne-nous quelques commentaires sur
ce produit LEGO® pour avoir une chance
de gagner un prix LEGO!

Voir Conditions Générales

GANAN

Visita
www.LEGO.com/productfeedback

y envíanos tu opinión acerca de este set
LEGO®. ¡Participarás en el sorteo de un
premio LEGO!

Términos y Condiciones aplicables

获取奖品

登录
www.LEGO.com/productfeedback

给出关于此乐高®套装的简短反馈，
就有机会获得炫酷乐高奖品

《条款及条件》适用

LEGO, the LEGO logo, NEXO KNIGHTS and the NEXO KNIGHTS logo are trademarks of the/son des marques de commerce du/son marcas registradas de LEGO Group. ©2018 The LEGO Group.

6225090