



NEXO KNIGHTS



72001







1

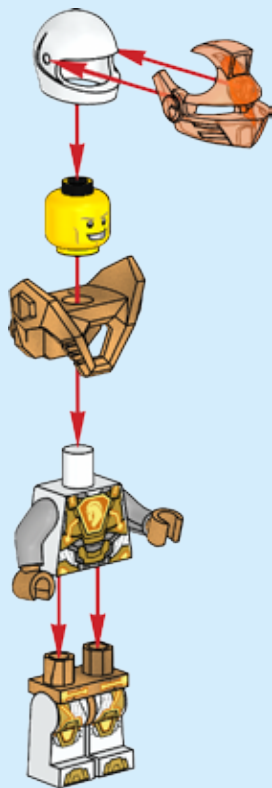



2



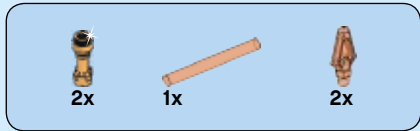

3

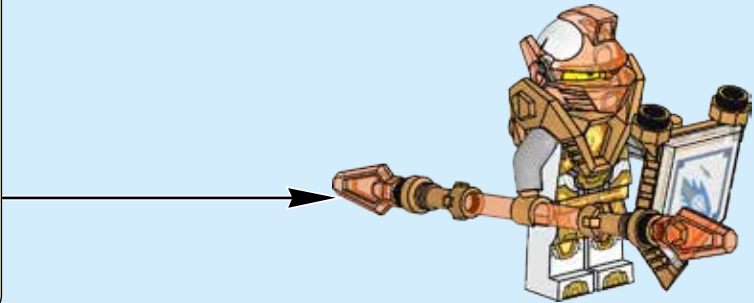
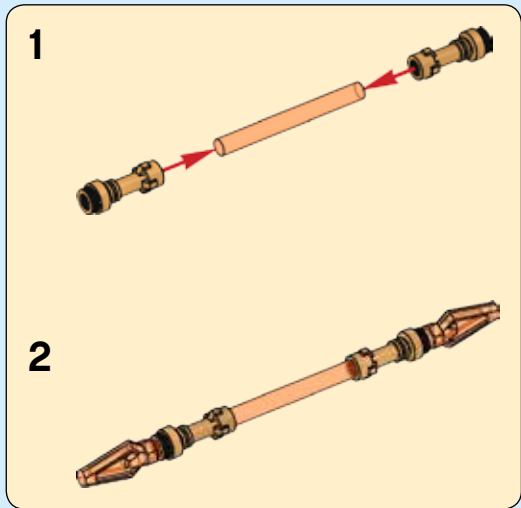



1

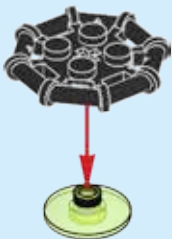

6

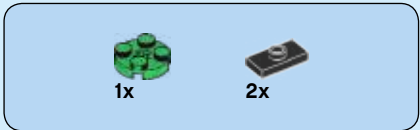

2

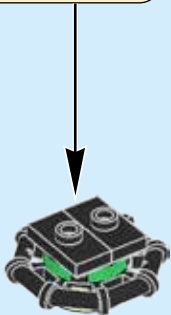



3

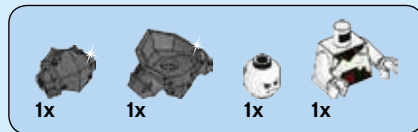
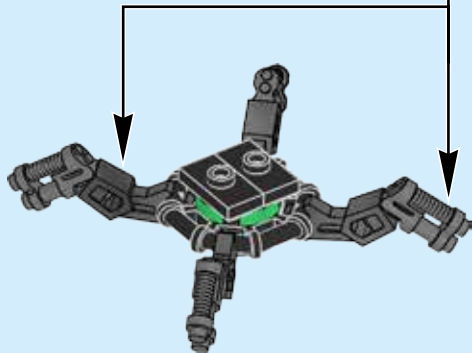
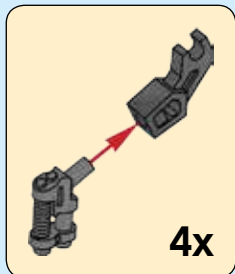

4

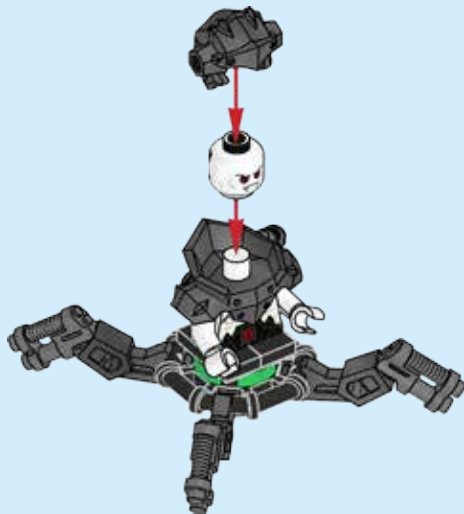



5



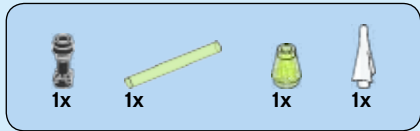

6

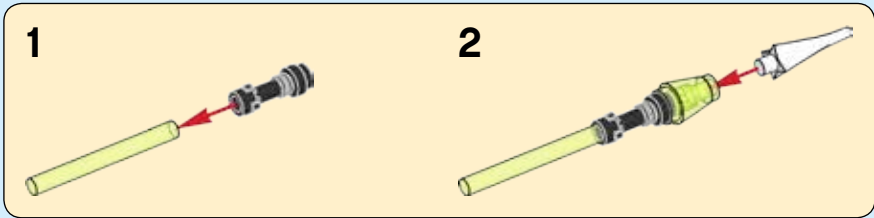

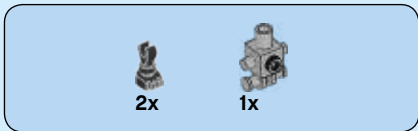

1

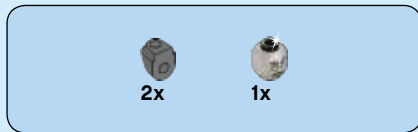

2

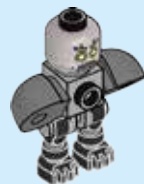

3

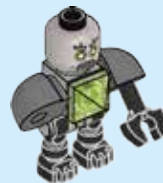

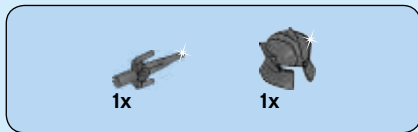

4

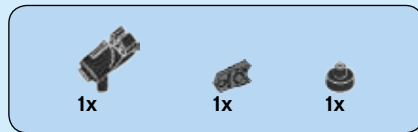

5



2x

2x

6

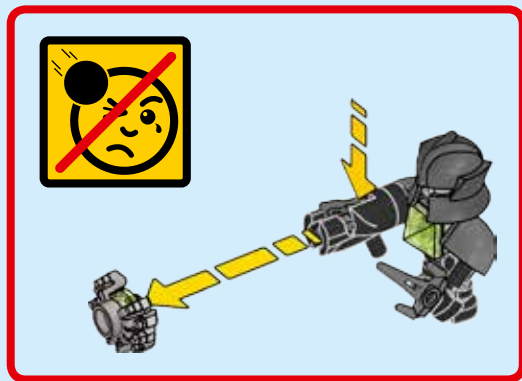
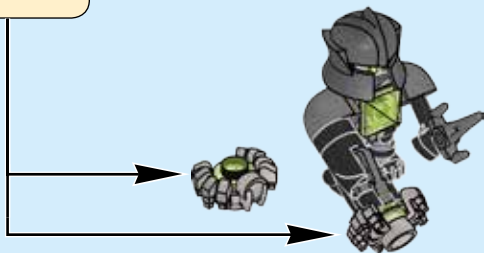
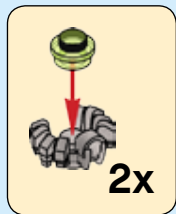

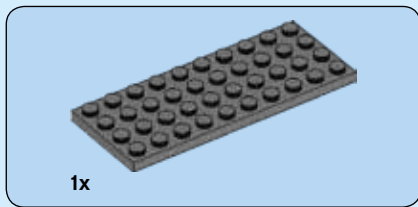

1

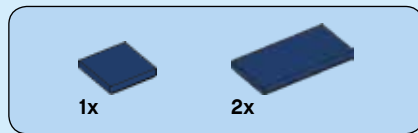
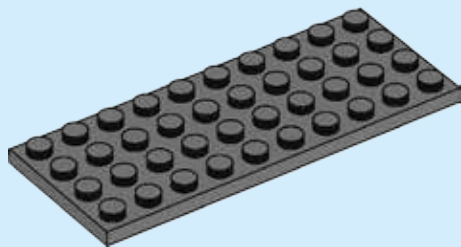

2

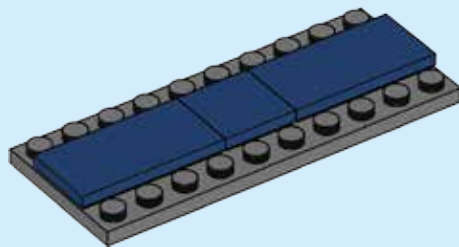

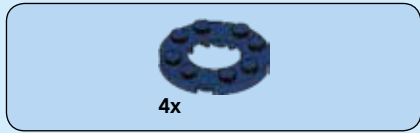

3

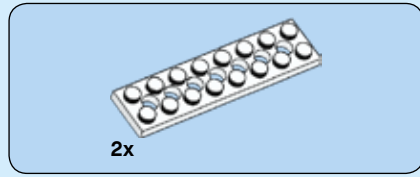
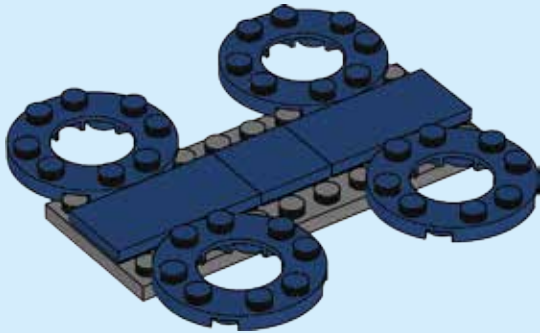

4

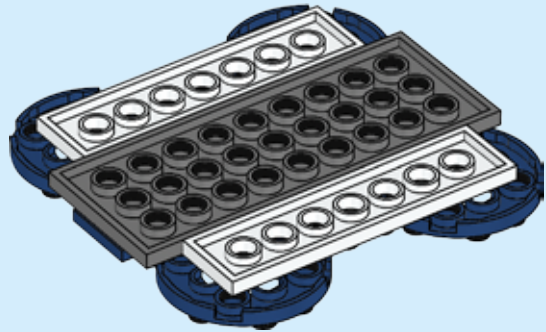
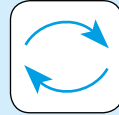

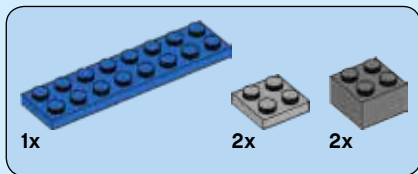

5

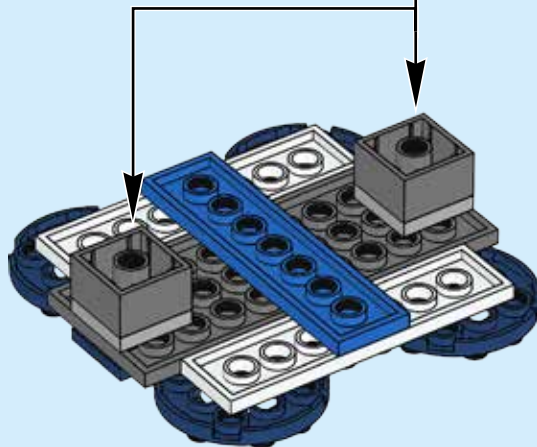
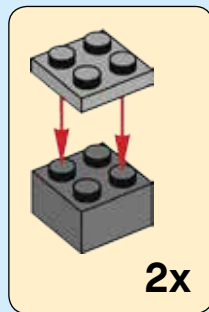



6

1



2

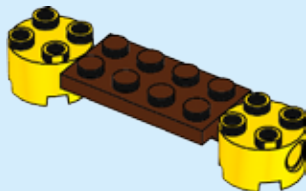

3

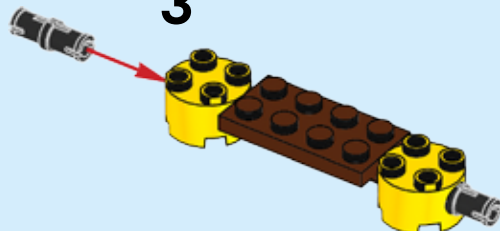

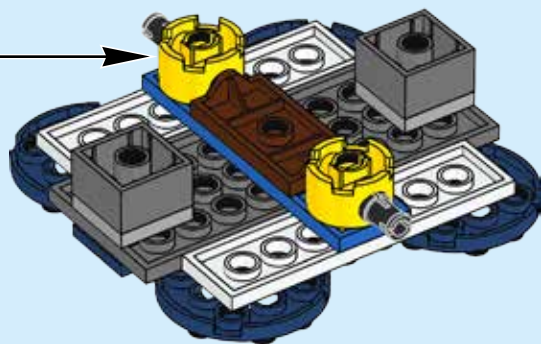



7

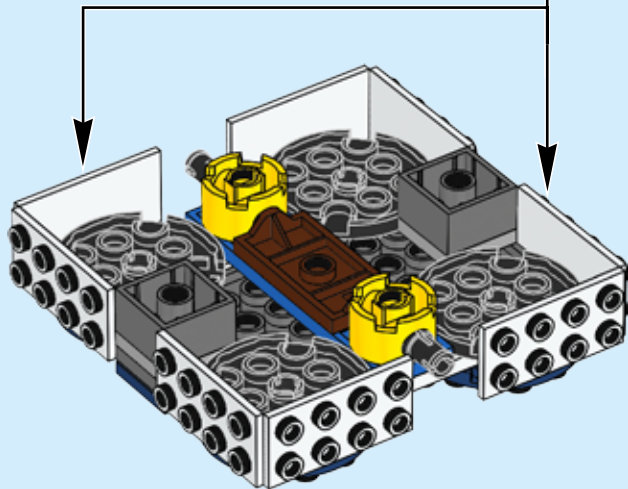
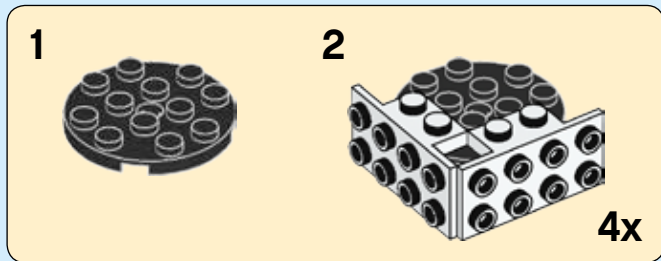

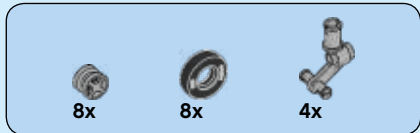

8

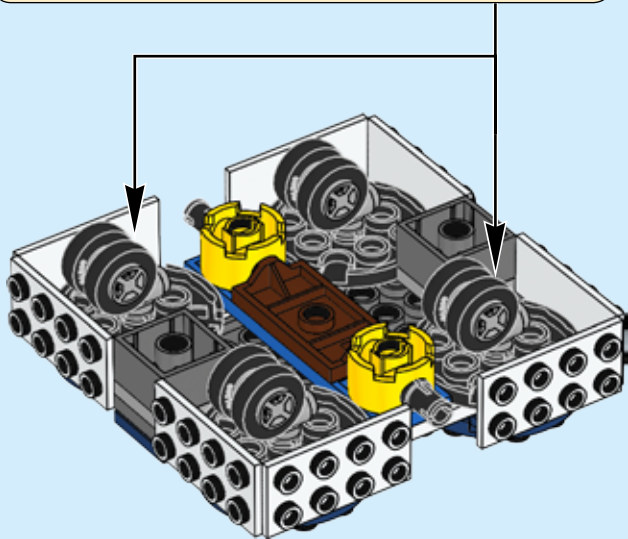
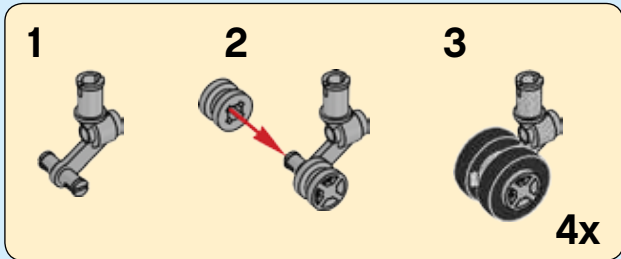



4x

9

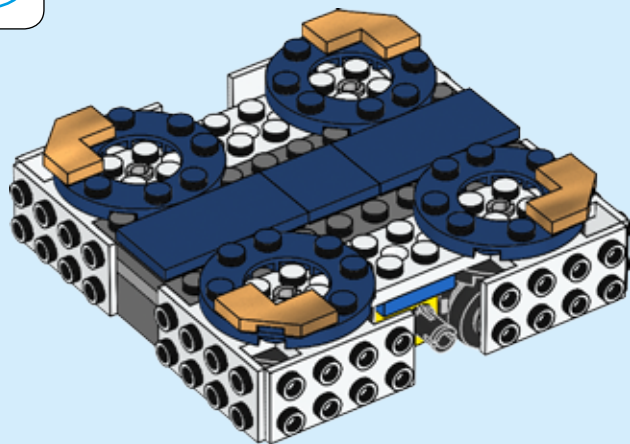
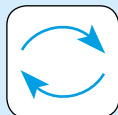

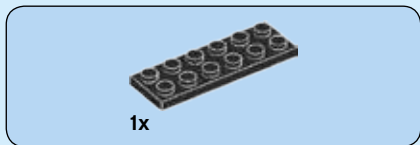
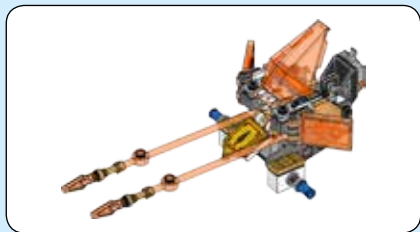

10

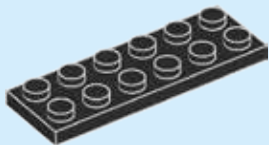

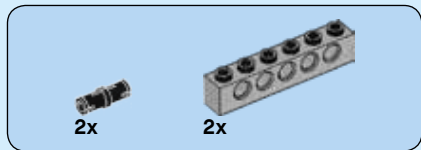

11

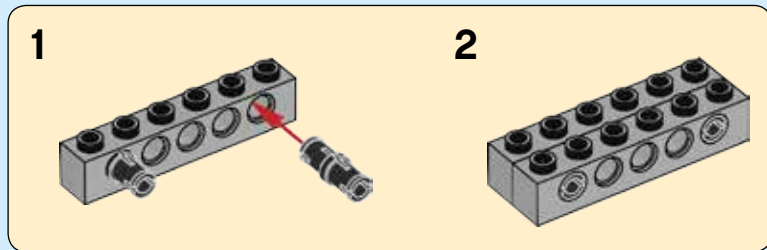

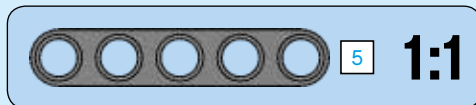
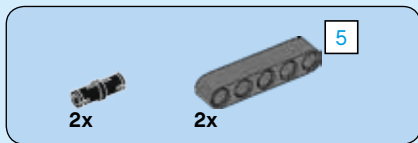

12

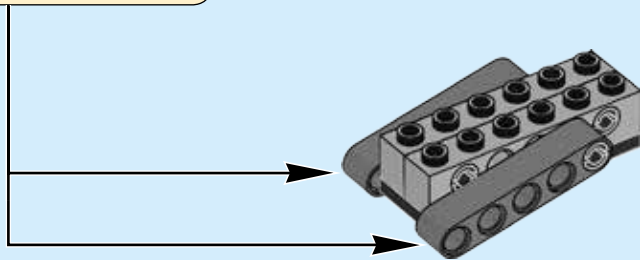
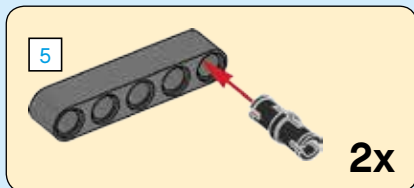



13

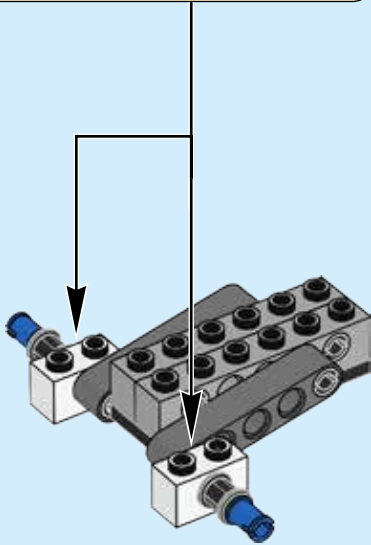
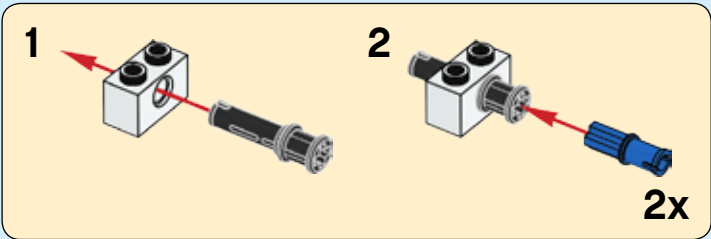



14

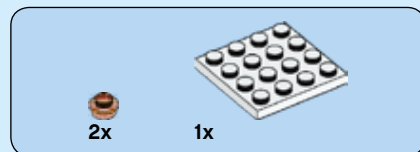
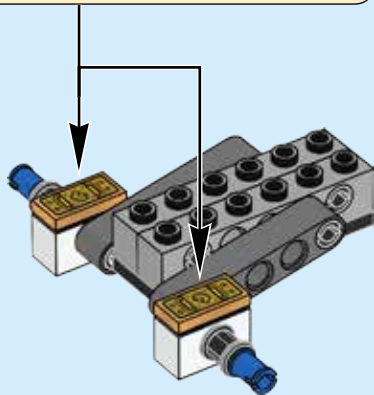
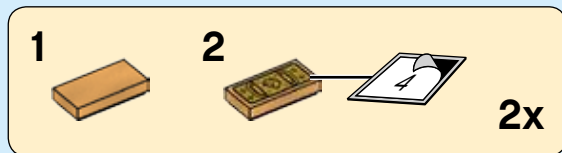

15

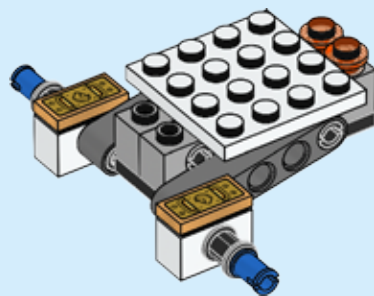

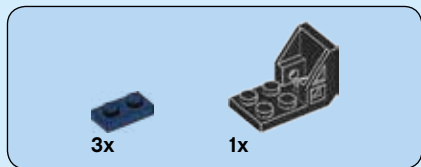

16

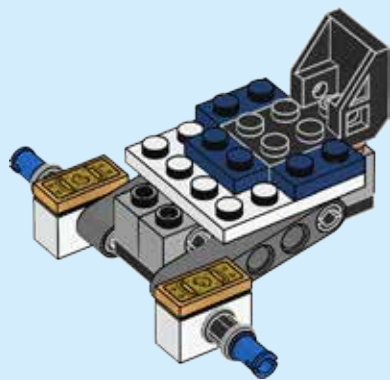

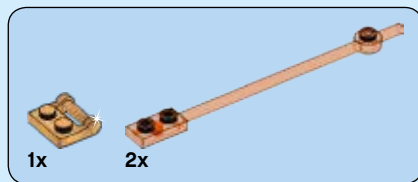

17

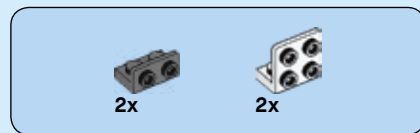
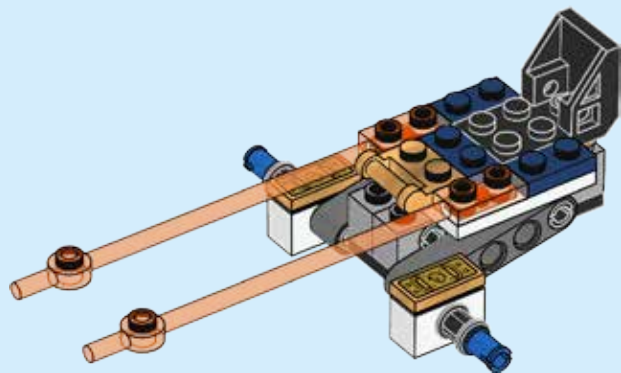

18

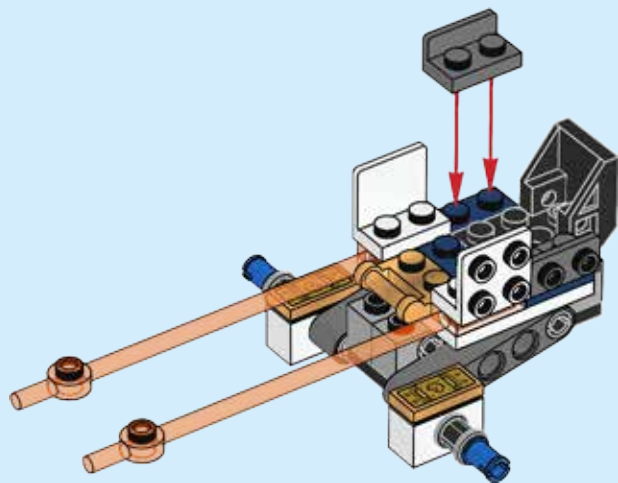



1x



2x

19

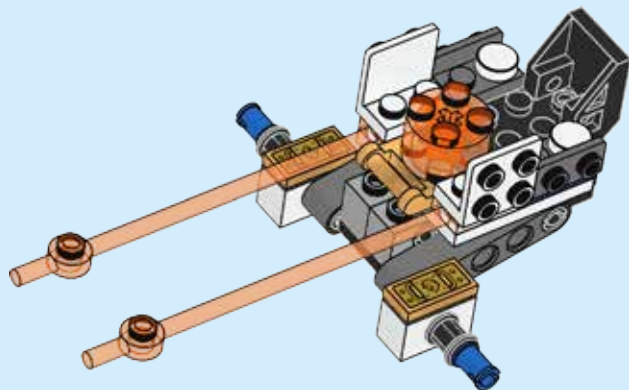



2x

20

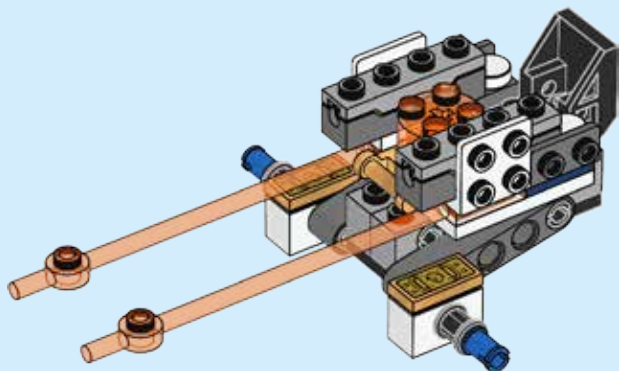

1x



2x

21

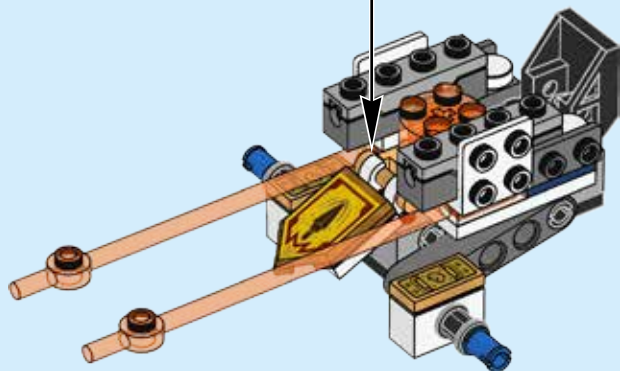
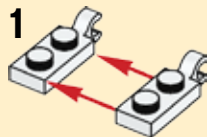



2x

22

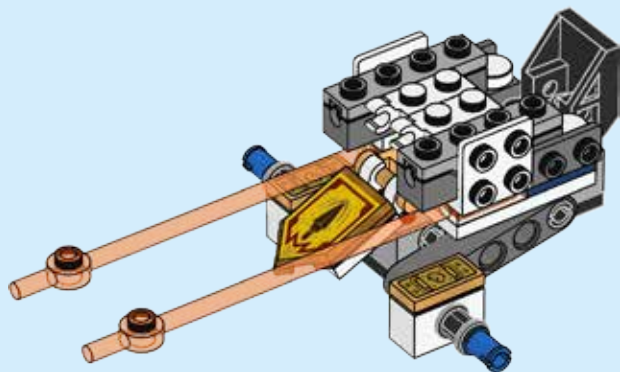



23

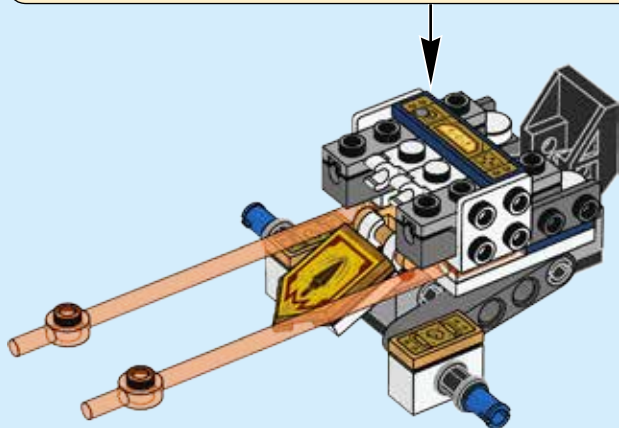

24

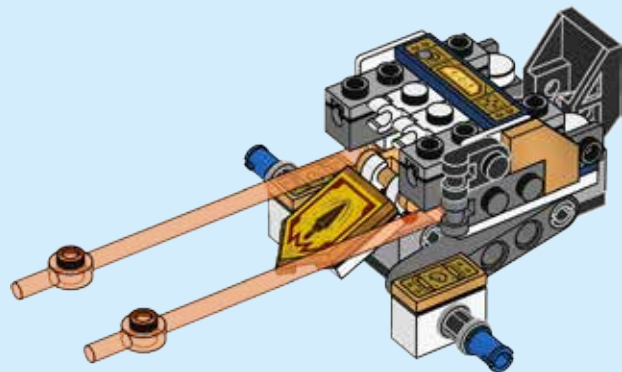



1x



1x



1x

25

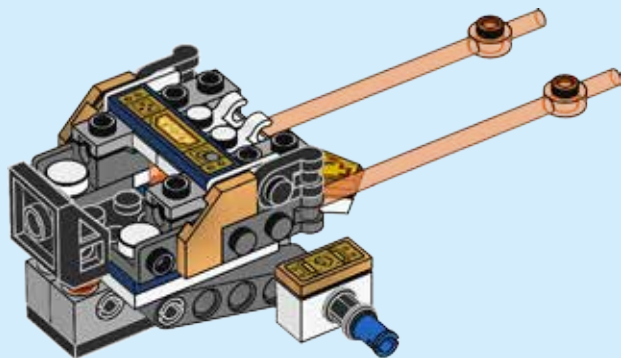
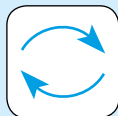



2x



1x

26

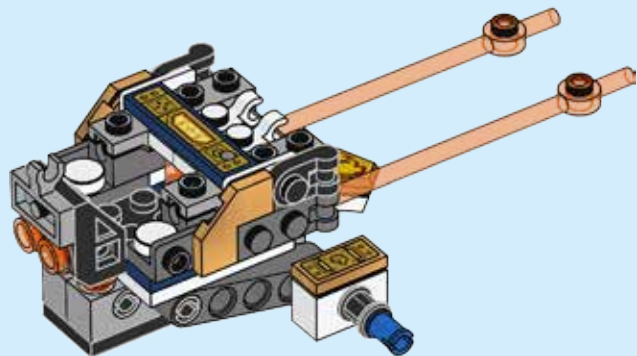

1x



1x

27

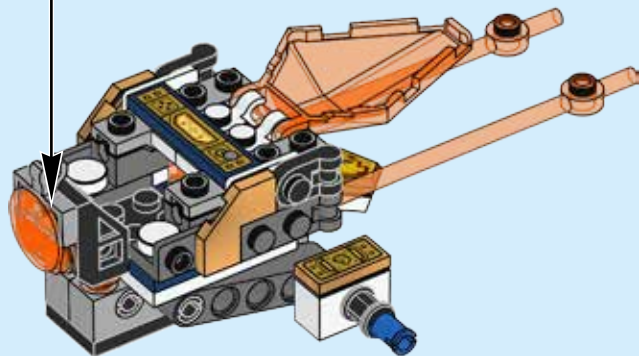



2x

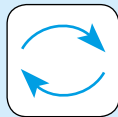

28

1



2

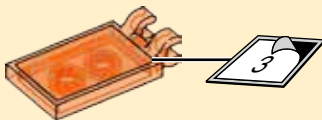

1

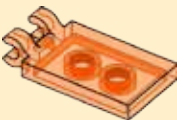

2

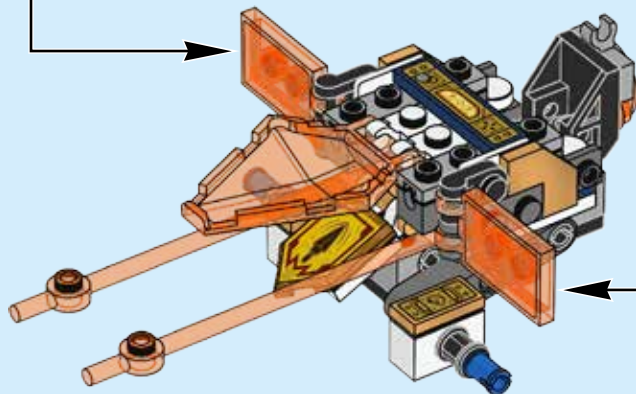



2x



2x

29



2x

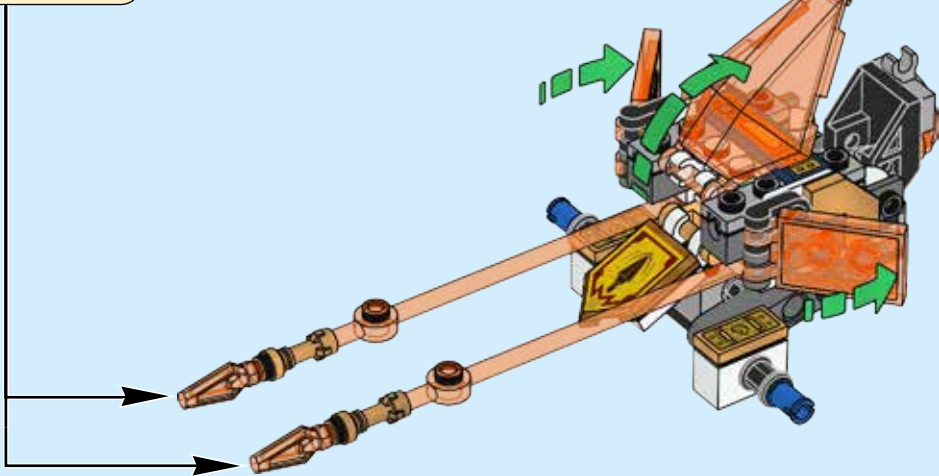

30

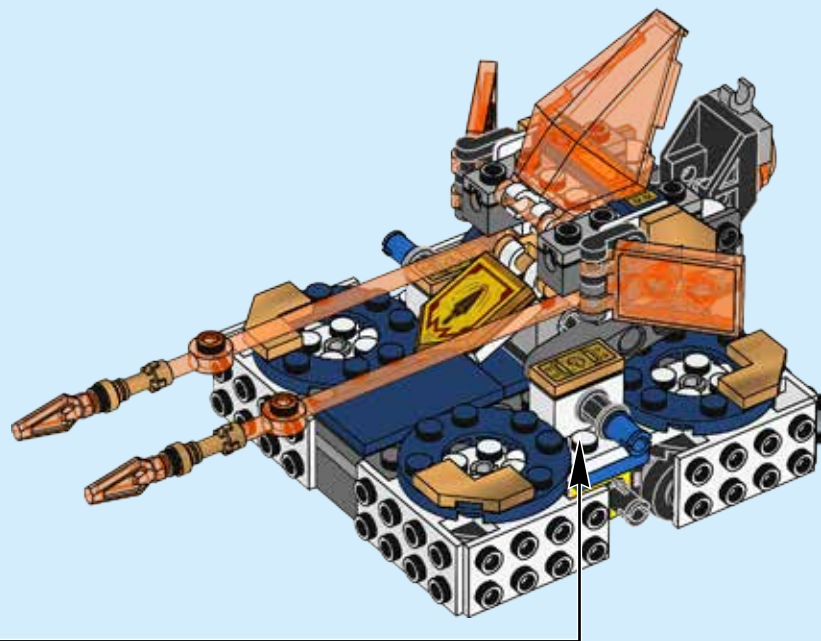

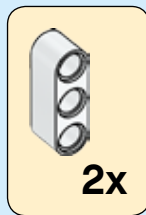
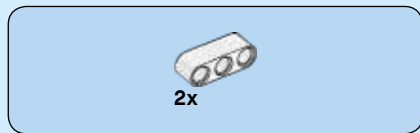

31

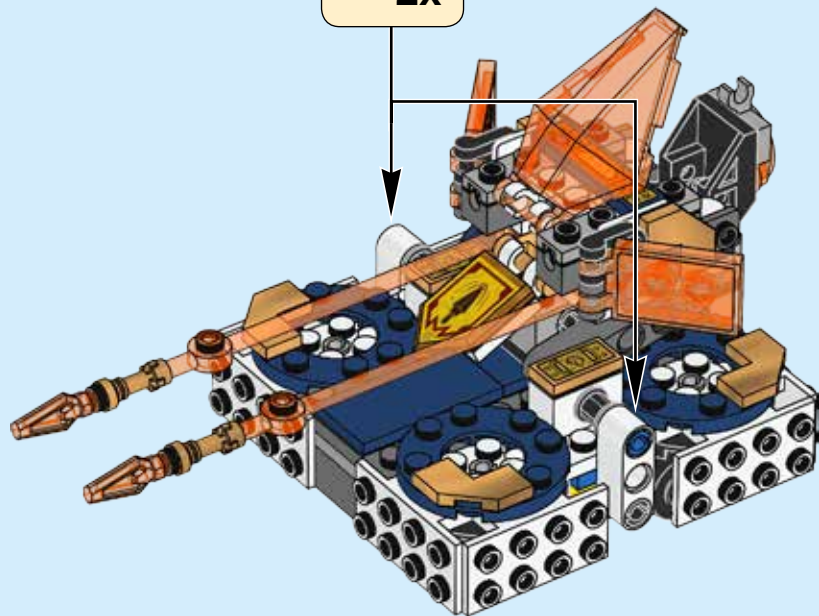



1x



1x



1x

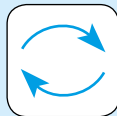

32

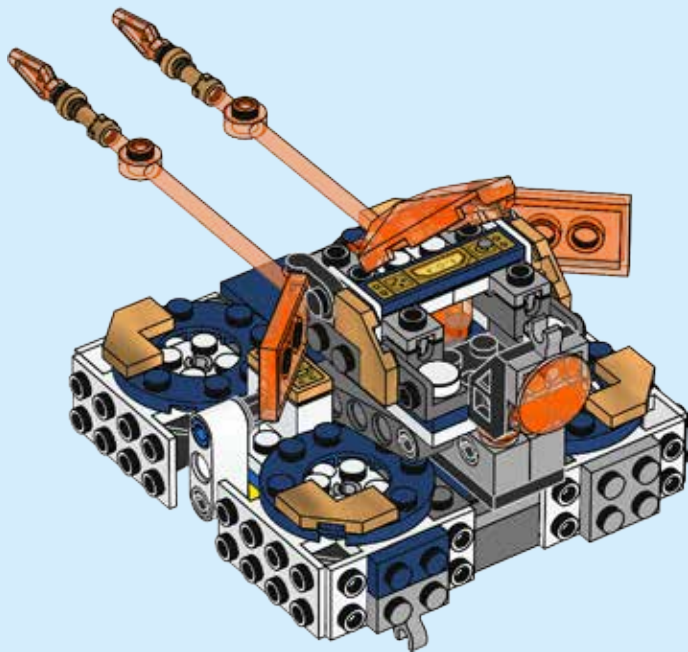



4x

33

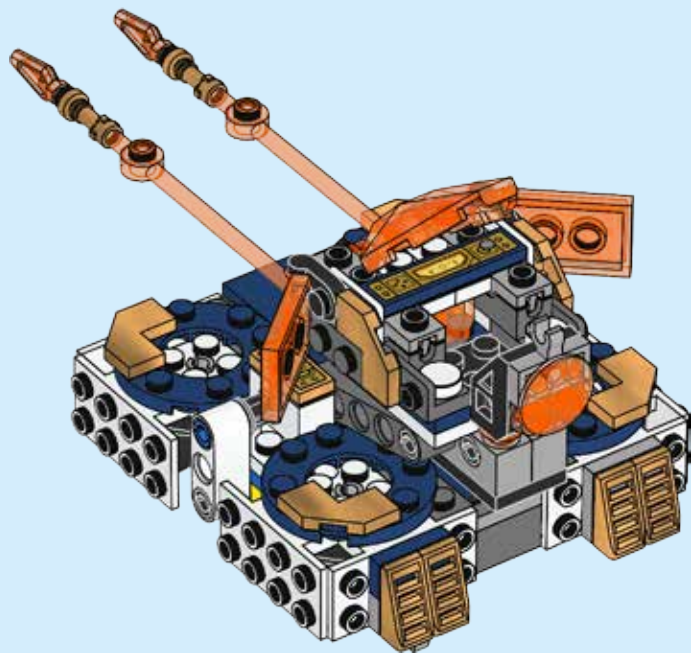

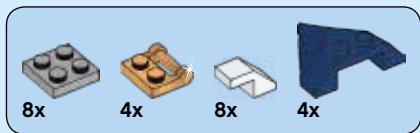

34

1

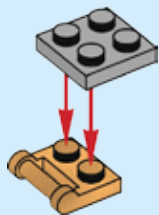

2



3

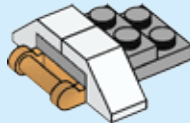

4

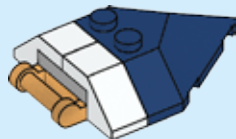

4x

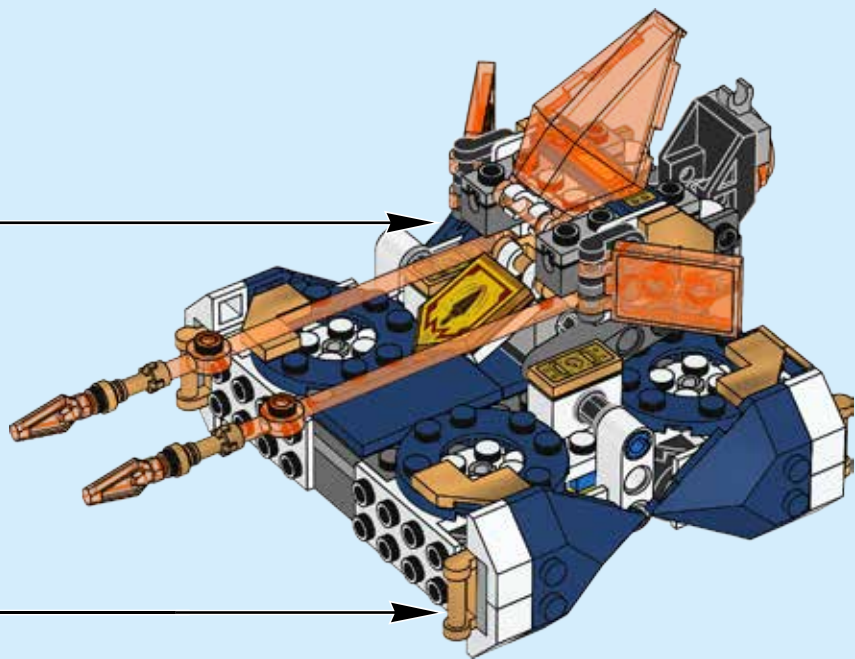
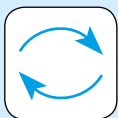



2x



4x



4x



2x



2x

35

1

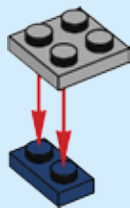

2

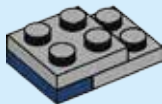

3

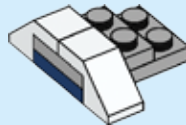

4

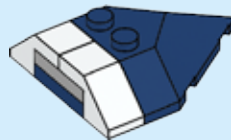

2x

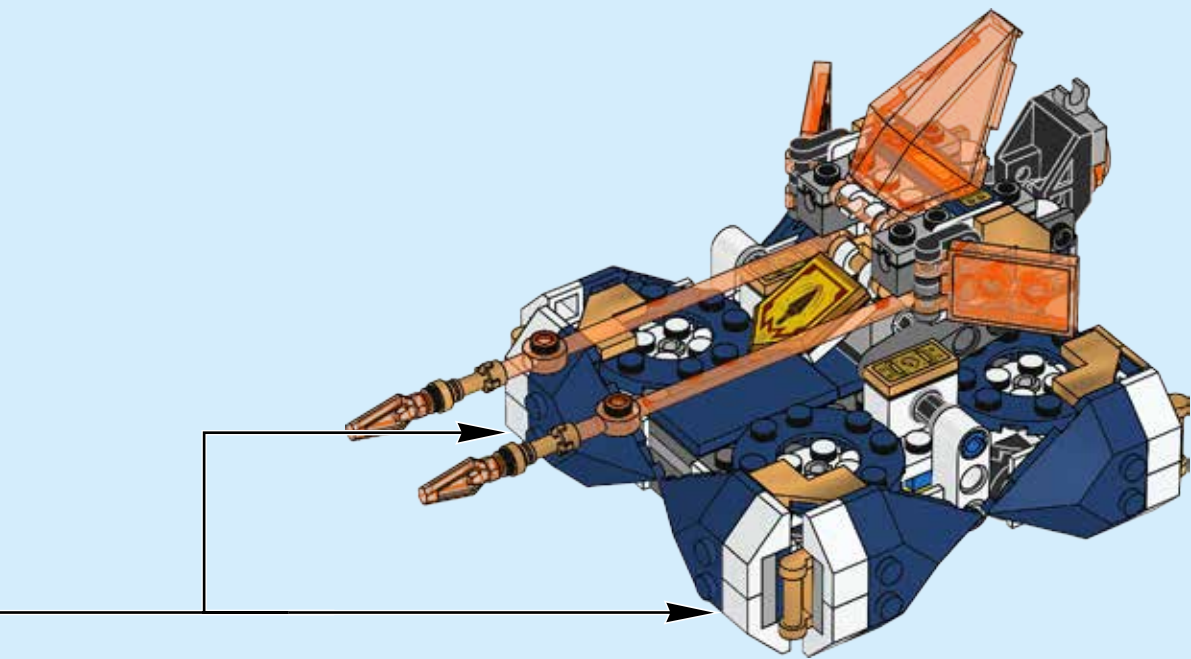

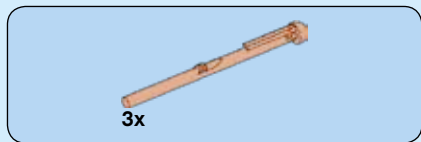



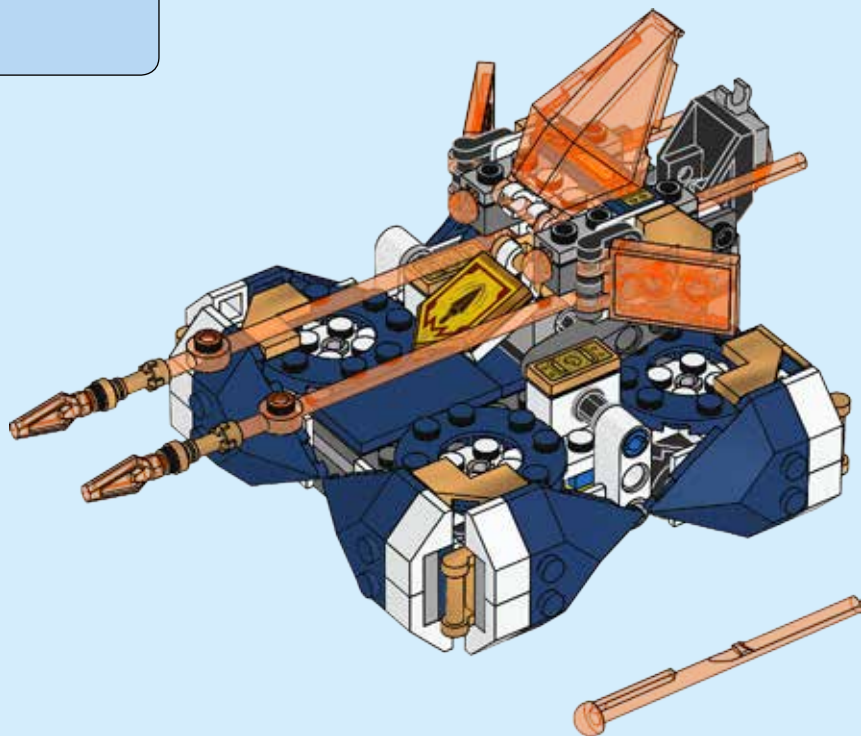

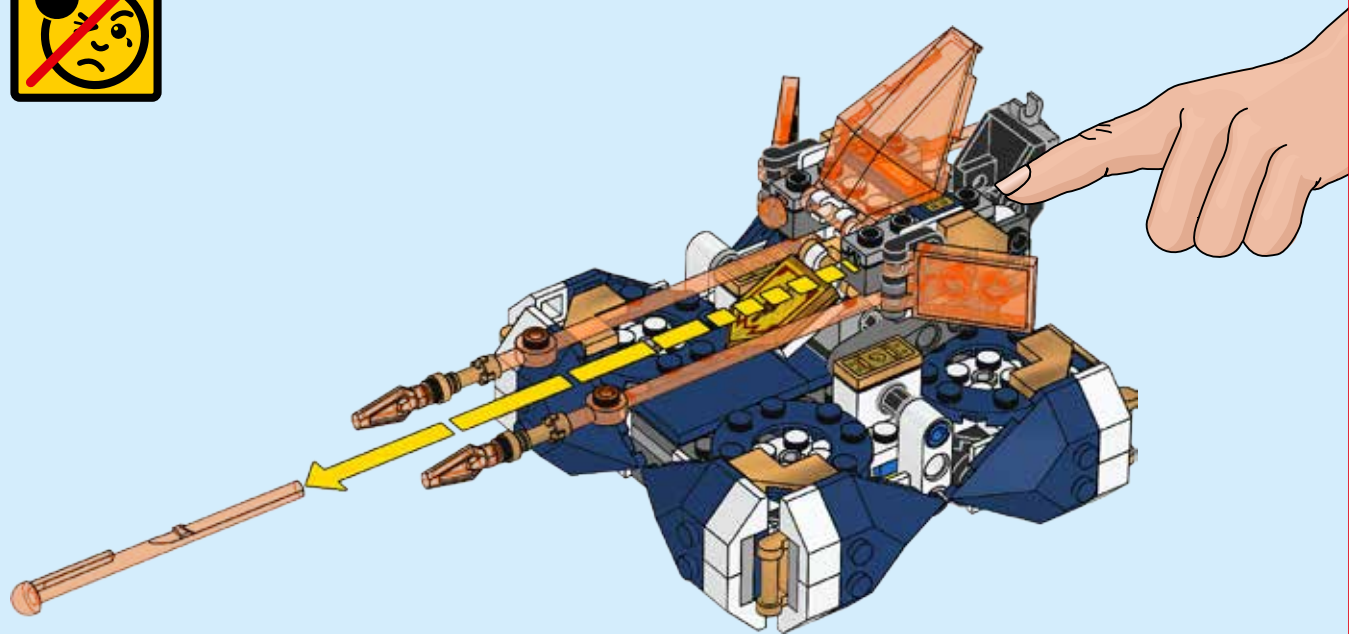

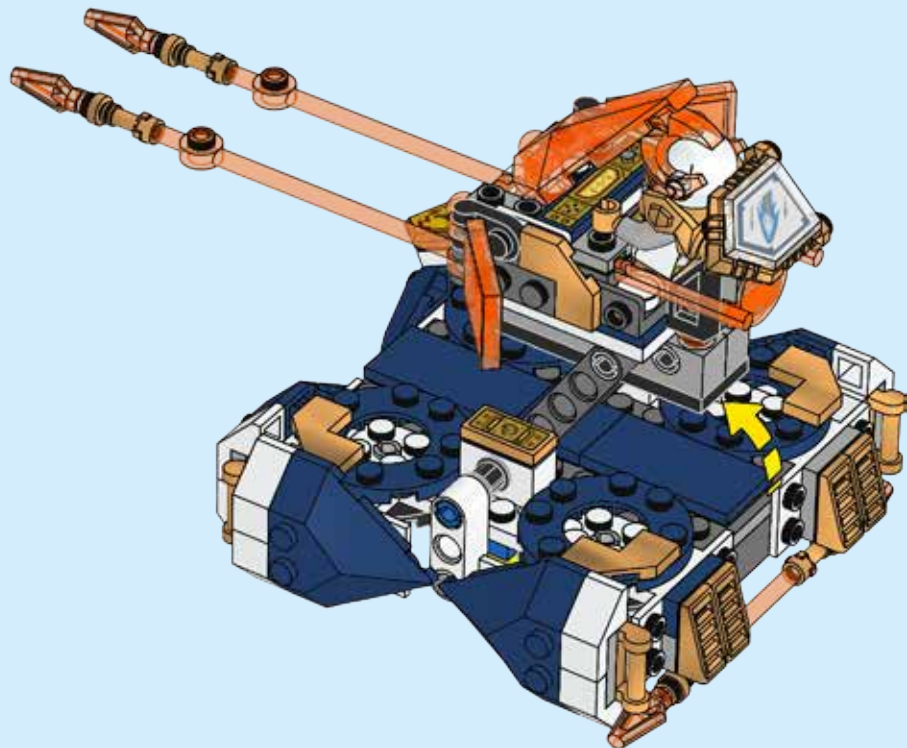



























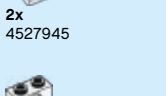













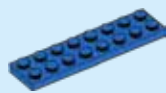



36

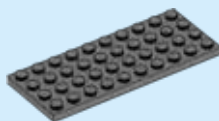





| | | | | | |
|---|---|--|--|--|--|
|  1x 6124911 |  2x 4208160 |  8x 4516843 |  1x 4598897 |  2x 6175554 |  4x 6003147 |
|  2x 6102524 |  8x 6158058 |  2x 6157554 |  2x 6038453 |  1x 6051334 |  4x 6167584 |
|  1x 6136388 |  1x 4243812 |  1x 6051331 |  1x 6186675 |  4x 4623236 |  2x 6107197 |
|  2x 4646844 |  2x 4527945 |  2x 6092585 |  1x 4289538 |  2x 6000606 |  1x 6202742 |
|  1x 6211812 |  2x 4527945 |  2x 4140801 |  1x 6018805 |  2x 4211060 |  5x 4585493 |
|  1x 4298609 |  2x 370001 |  6x 4121715 |  2x 4206482 |  2x 4521187 |  1x 6208621 |
|  1x 6211938 |  12x 6166894 |  1x 6021678 |  1x 303423 |  2x 4210686 |  1x 6207046 |
|  1x 6210730 |  2x 6097637 |  4x 4515350 |  1x 4270882 |  1x 4211122 |  6x 6207046 |
|  1x 6210734 |  4x 4535737 |  1x 379526 | | |  1x 6210503 |



4x
6166891



4x
3005747



1x
6124909



1x
611647



1x
6161314



1x
6120914



2x
6133781



1x
6210498



3x
6124908



2x
6164074



1x
6172166



4x
6008484



1x
6208797



1x
6208776



1x
4646870



1x
6208778



1x
6208780



1x
6053084



2x
6057034



1x
6138727



1x
6057005



1x
6133484



1x
4626400



1x
403228



1x
6211590



2x
6208782



6x
4528981



1x
4205004



1x
6103985



6x
6129858



4x
6108550



2x
4569836



2x
6048898



2x
4211466



8x
4211506



1x
6129994



4x
4519013



2x
6028812



15x
4211397



Customer Service

Kundenservice

Service Consommateurs

Servicio Al Consumidor

LEGO.com/service or dial



00800 5346 5555 :



1-800-422-5346 :





The LEGO logo is positioned in the top left corner, featuring the word "LEGO" in white, bold, sans-serif font inside a red square with rounded corners.

NEXO KNIGHTS

The Nexo Knights logo shield is located to the right of the title. It is a yellow shield with a black border, containing a stylized black figure of a knight with a sword.

POWER UP YOUR BRICK PLAY

HOL DIR NOCH MEHR KRÄFTE FÜR'S SPIELEN MIT DEINEN SETS
AUGMENTE LA PUISSANCE DE TON JEU
POTENZIA IL TUO GIOCO CON I MATTONCINI
MÁS DIVERSION CON TUS LADRILLOS
TORNA O TEU JOGO DE PEÇAS MAIS PODEROSO
ERŐSÍTSD MEG A KÖCKA JÁTEKODATI
为您的积木拼搭“能量升级”

BATTLE WITH MERLOK POWERS

ERLEBE SPANNENDE ACTION MIT MERLOK KRÄFTEN
BATS-TOI AVEC LES POUVOIRS DE MERLOK
COMBATTI CON I POTERI DI MERLOK
LUCHA CON LOS PODERES DE MERLOK
COMBATE COM PODERES MERLOK
HARCÓLJ MERLOK ERŐKKELI
借助梅洛克能量进行战斗



UPGRADE YOUR GAME PLAY

HOL DIR NOCH MEHR KRÄFTE FÜR'S DIGITALE SPIEL
AMÉLIORE TON EXPÉRIENCE DE JEU
POTENZIA IL TUO GAME PLAY
MEJORAS EN EL JUEGO DIGITAL
FAZ UM UPGRADE DO TEU JOGO
FEJLESZD A JÁTÉKOD!
升级您的游戏体验



LEGO® NEXO KNIGHTS™: MERLOK 2.0



LEGO.COM/DEVICECHECK

WIN

GO TO WWW.LEGO.COM/PRODUCTFEEDBACK AND
GIVE US YOUR SHORT **FEEDBACK** ABOUT THIS
LEGO® SET FOR A CHANCE TO WIN
A COOL LEGO PRIZE.

Terms & Conditions apply

LEGO.com/productfeedback



GEWINNE

Erzähle uns auf
www.LEGO.com/productfeedback

etwas über die Erfahrungen, die du mit
diesem LEGO® Set gemacht hast, und
sichere dir die Chance auf einen coolen
LEGO Preis!

Es gelten die Teilnahmebedingungen

GAGNE

Rends-toi sur
www.LEGO.com/productfeedback

et donne-nous quelques commentaires sur
ce produit LEGO® pour avoir une chance
de gagner un prix LEGO!

Voir Conditions Générales

GANAN

Visita
www.LEGO.com/productfeedback

y envíanos tu opinión acerca de este set
LEGO®. ¡Participarás en el sorteo de un
premio LEGO!

Términos y Condiciones aplicables

获取奖品

登录
www.LEGO.com/productfeedback

给出关于此乐高®套装的简短反馈，
就有机会获得炫酷乐高奖品

《条款及条件》适用

LEGO and the LEGO logo are trademarks of the LEGO Group. ©2018 The LEGO Group.

6225089