



# Kingdoms



7188



1

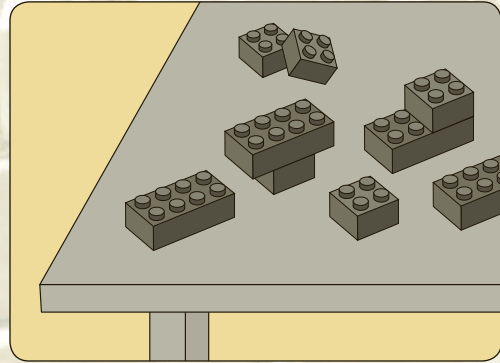
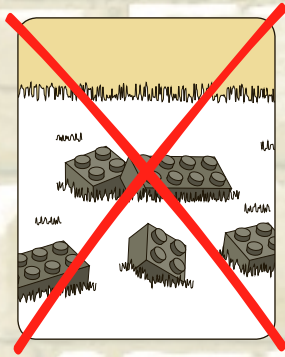

2

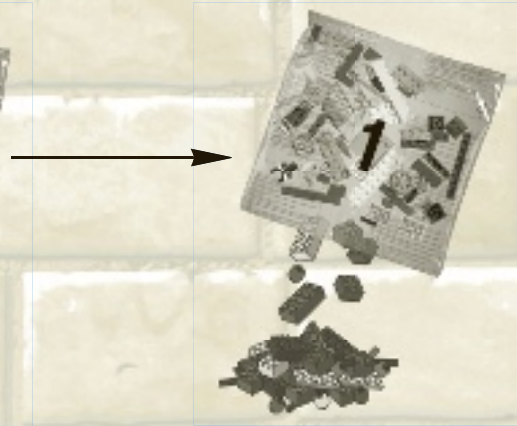



1



+



2





2x



1x



1x

1x



1

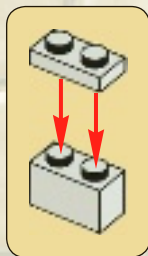





2

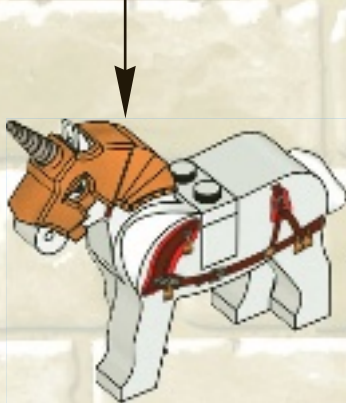
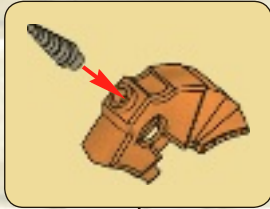

2x

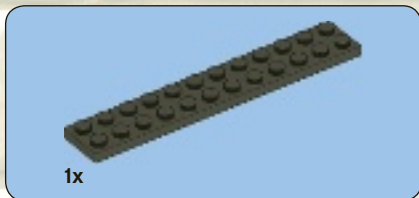

1



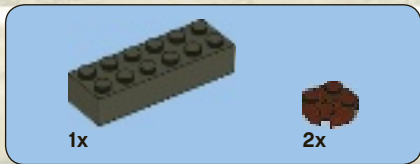

2

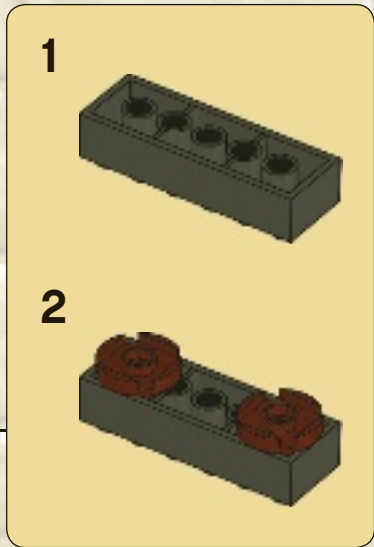
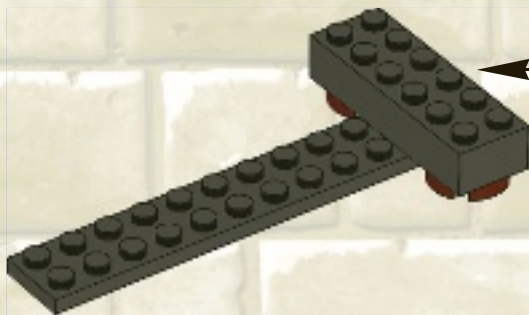



2x

3

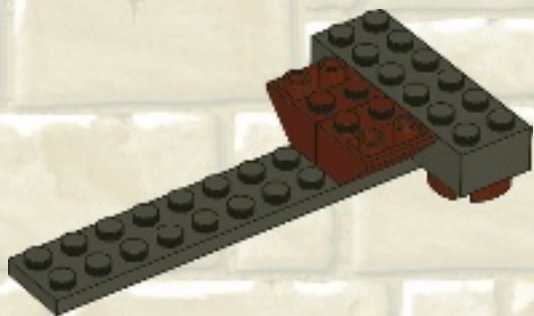

2x

4

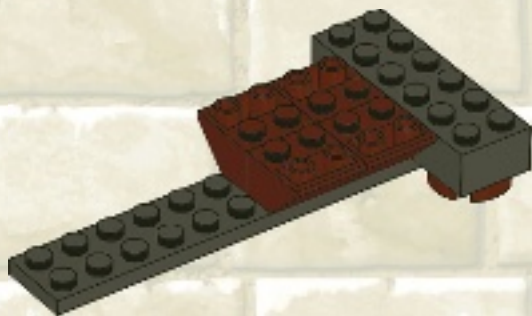





2x

5

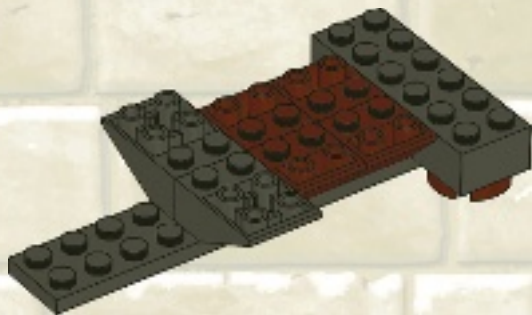

2x

6

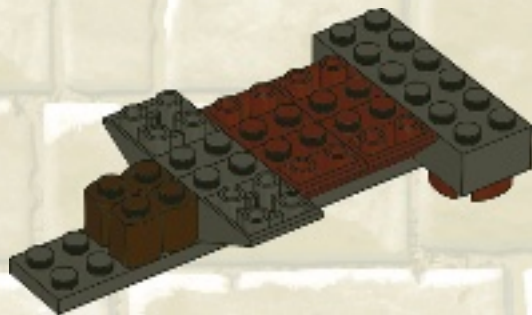



7

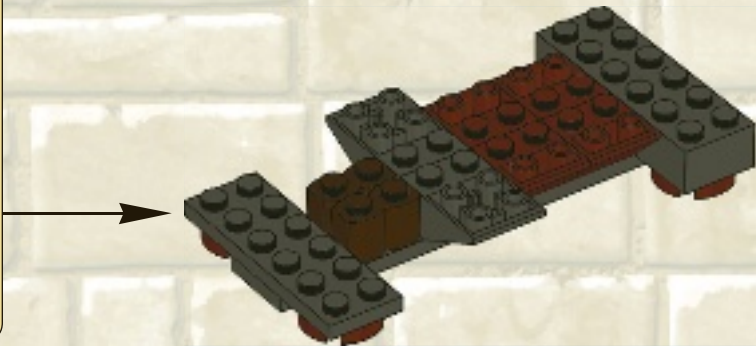
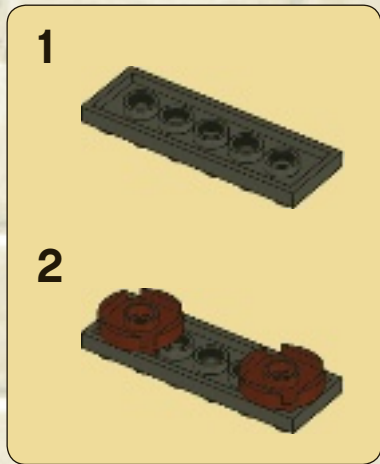



1x



1x

8

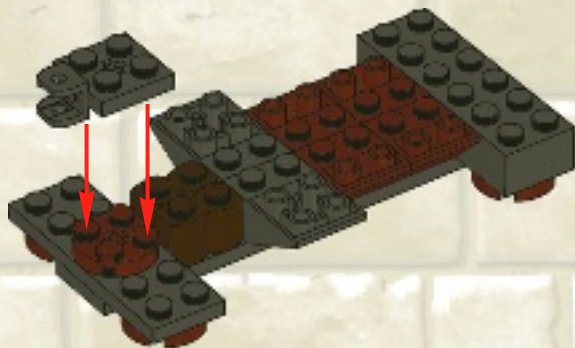

1x



2x

9

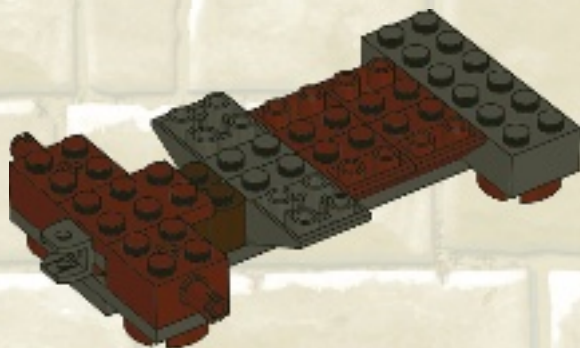

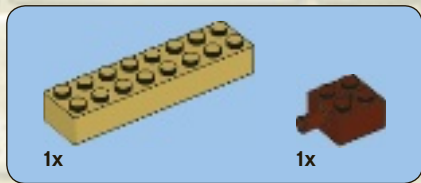

10

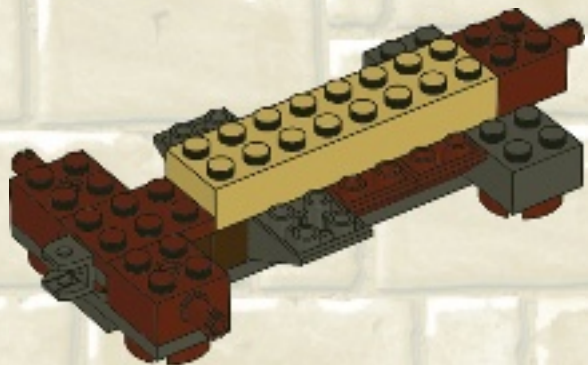

11

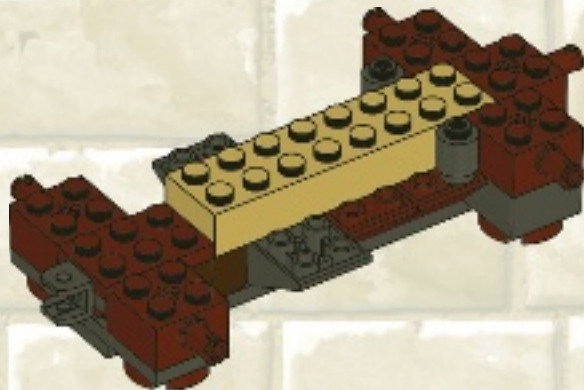





2x

12

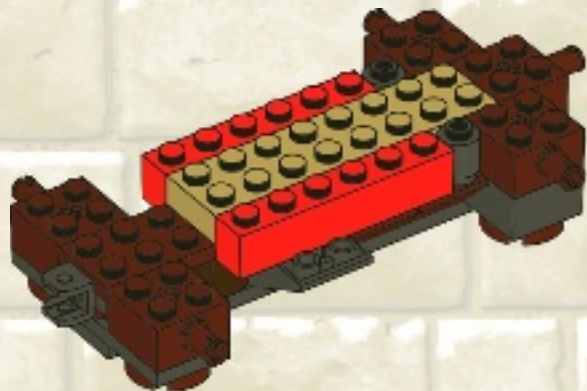

2x

13

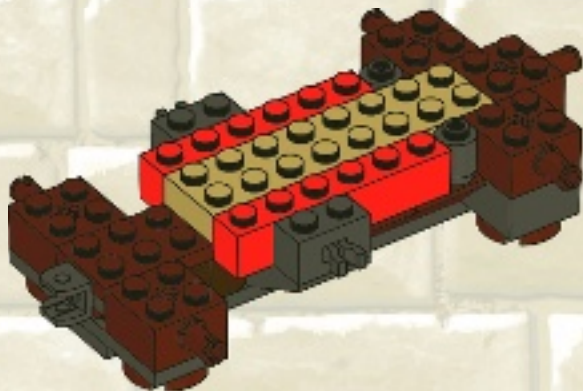



14

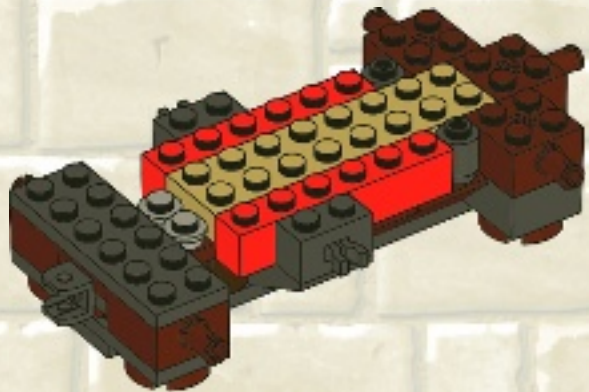

15

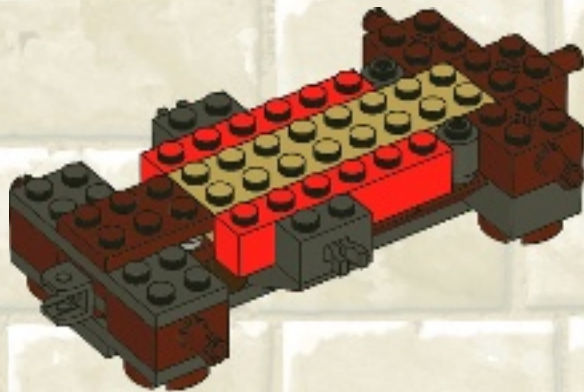



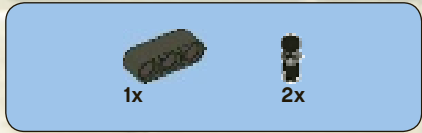

18

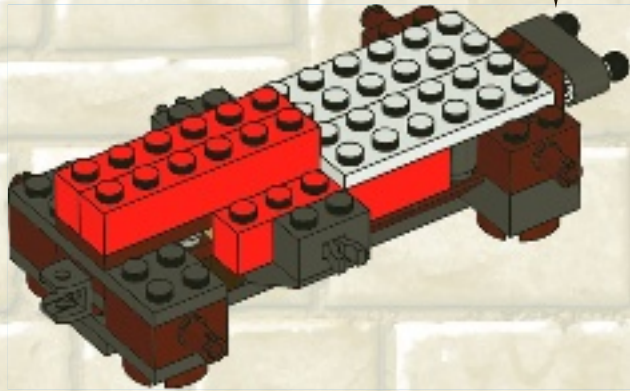
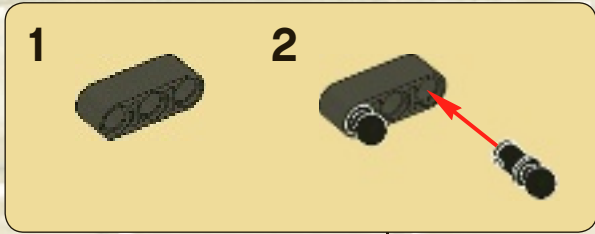





# 19

## 1

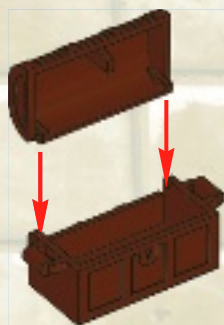

## 2



## 3



## 4



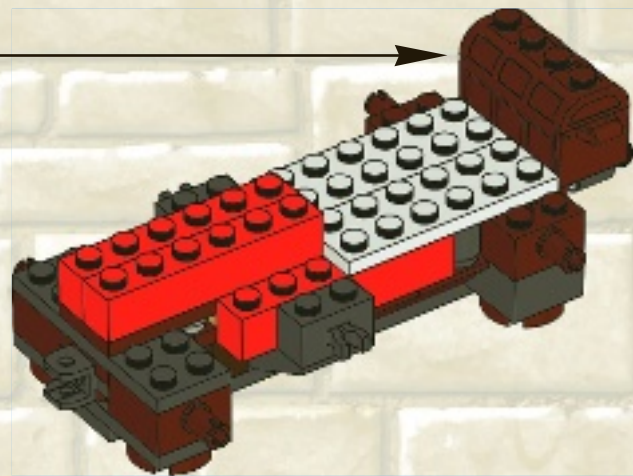

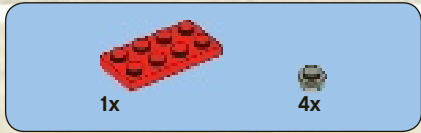

20

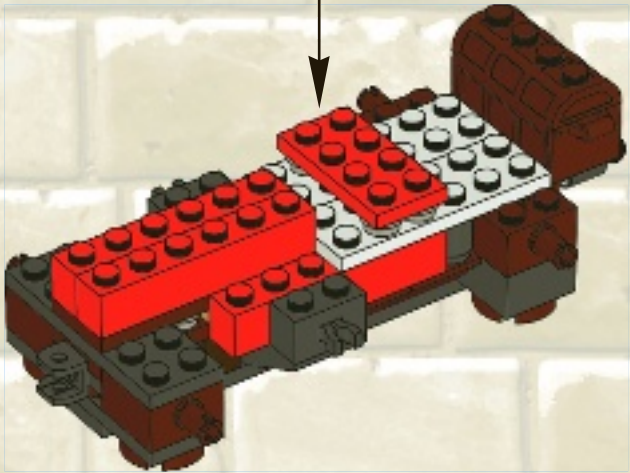
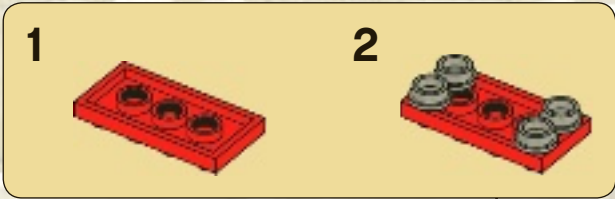



2x

21

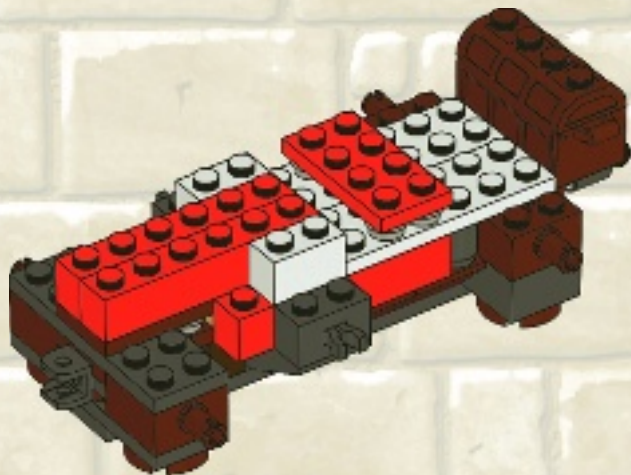

2x

22

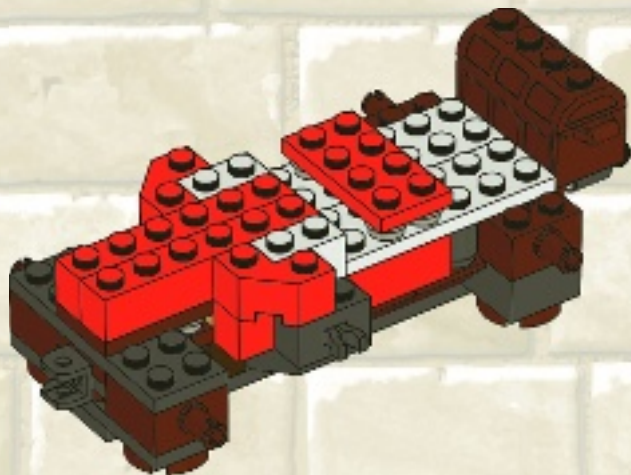



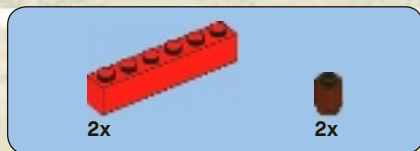

23

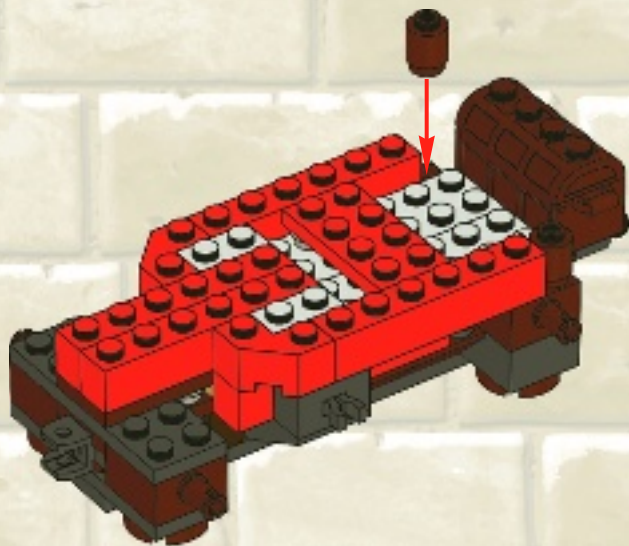



24

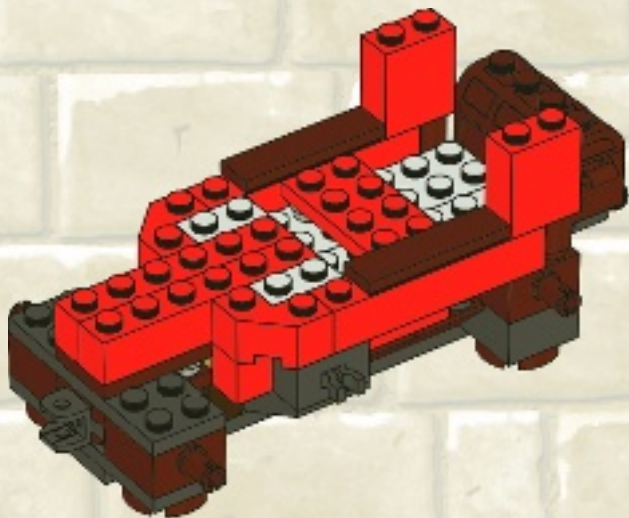

25

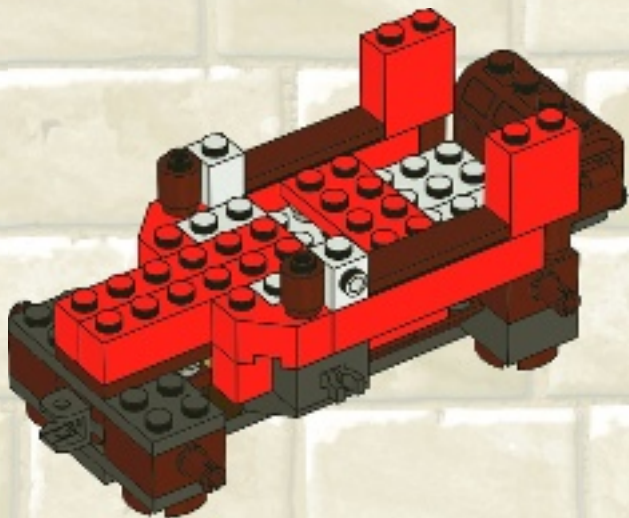



2x

26

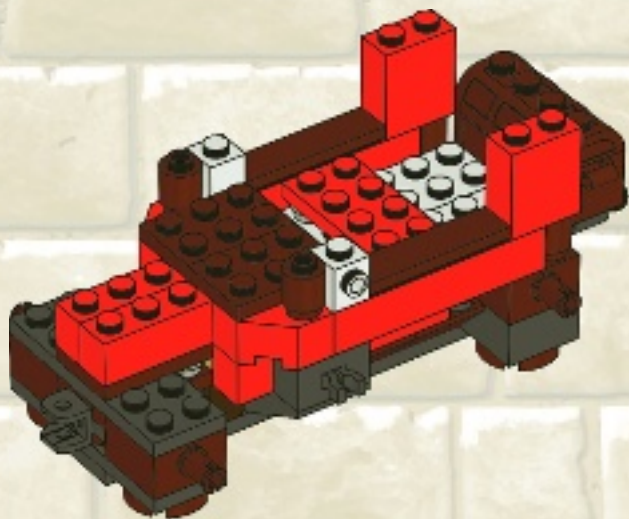

2x



2x

27

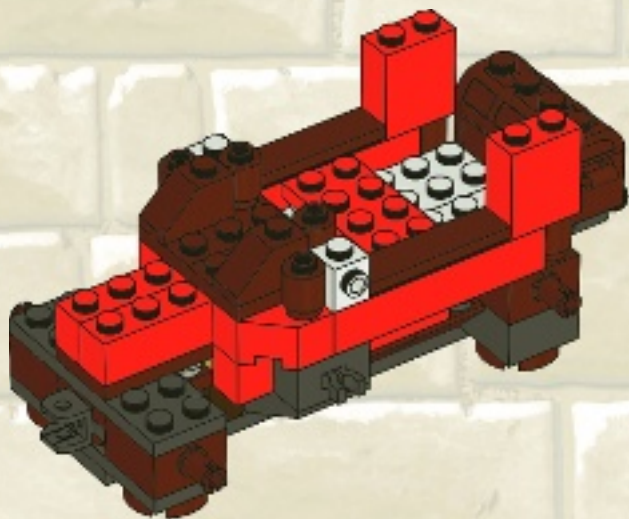



2x



2x

# 28

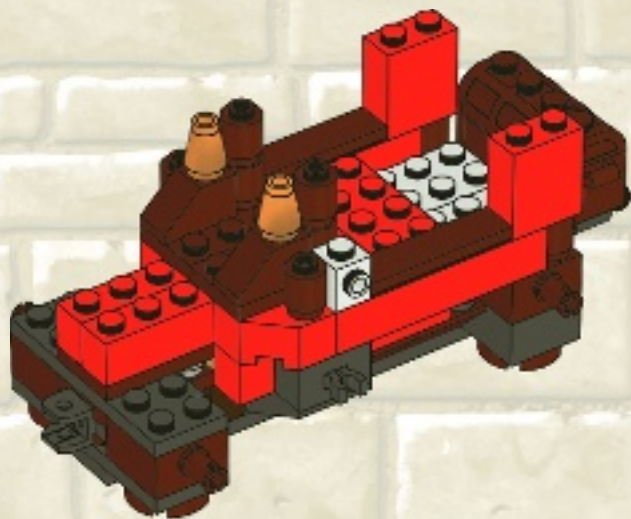





2x

29

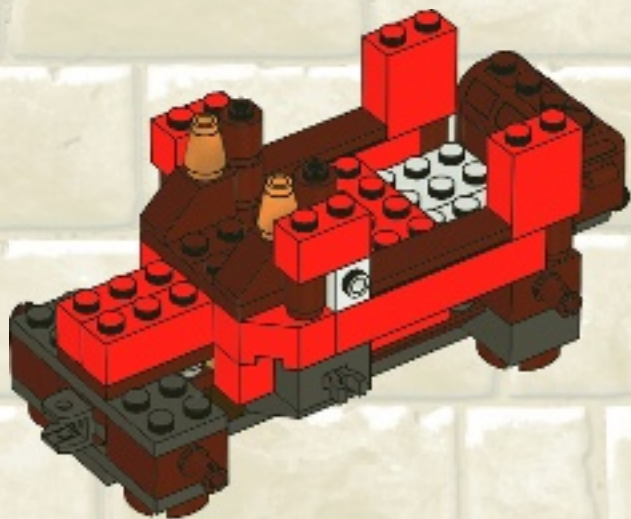

4x

30

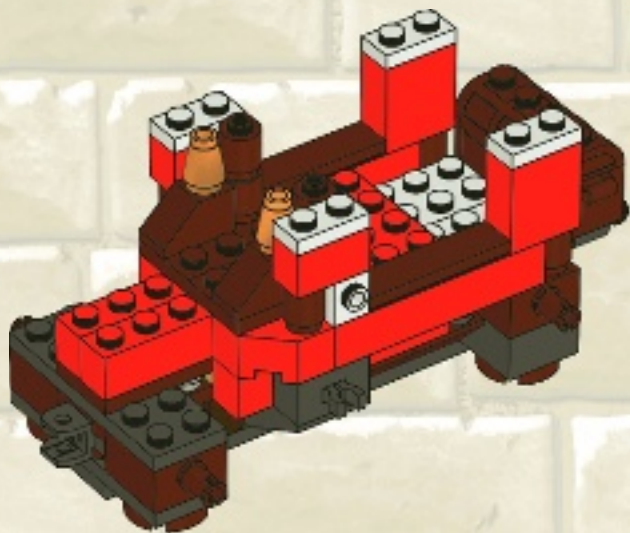



1x



1x

# 31

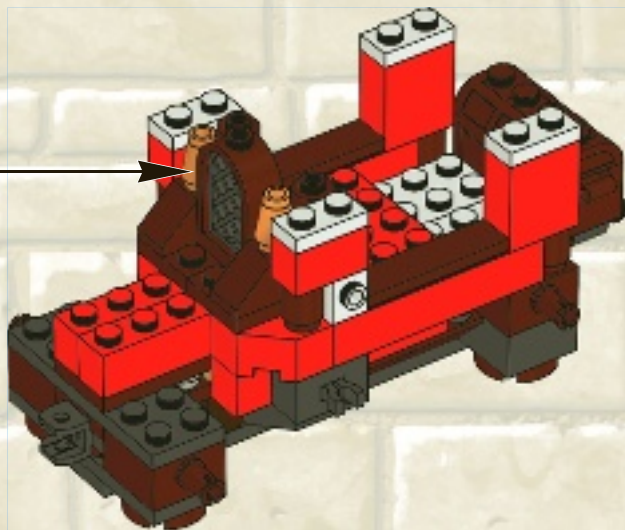
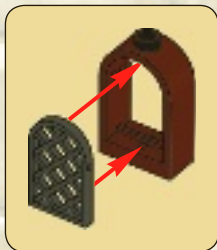



2x



1x

32

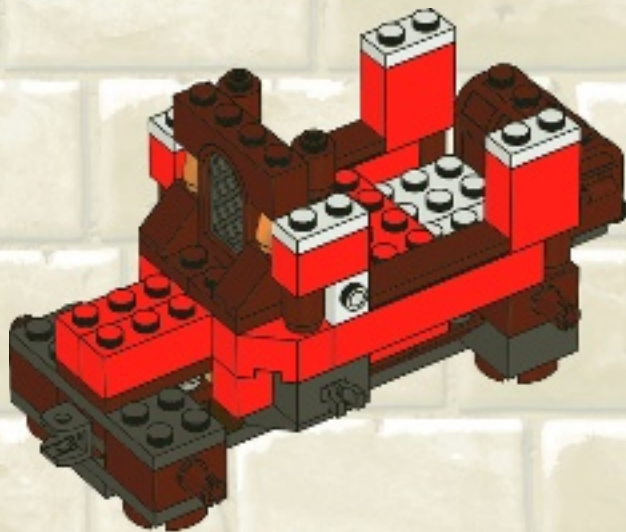



4x

33

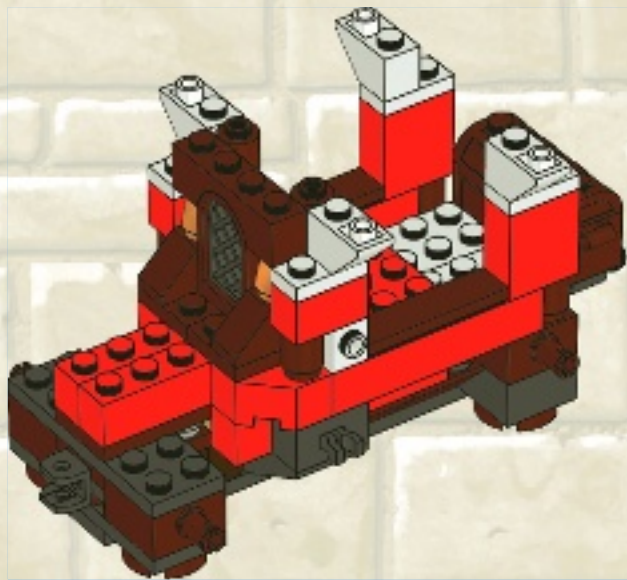





4x

34

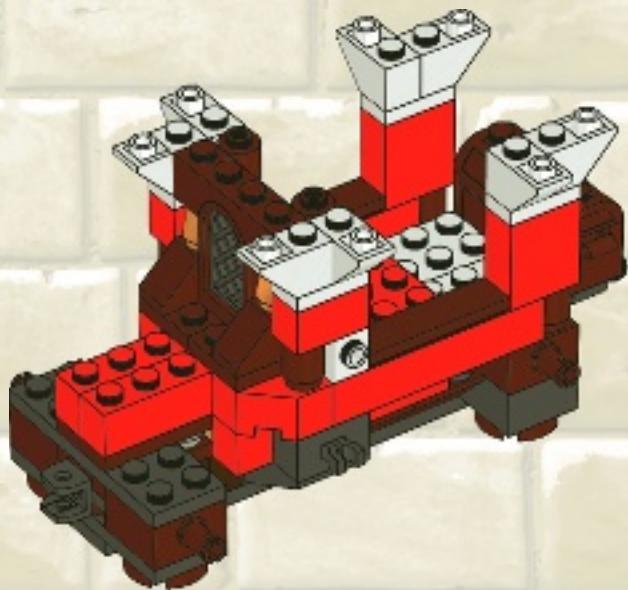



2x



2x

35

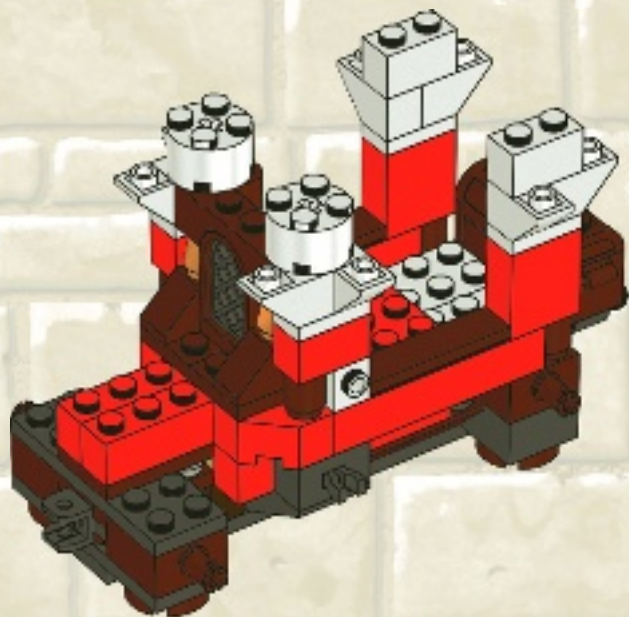

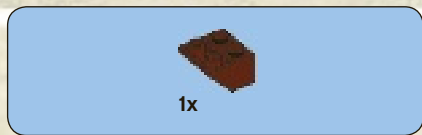

36

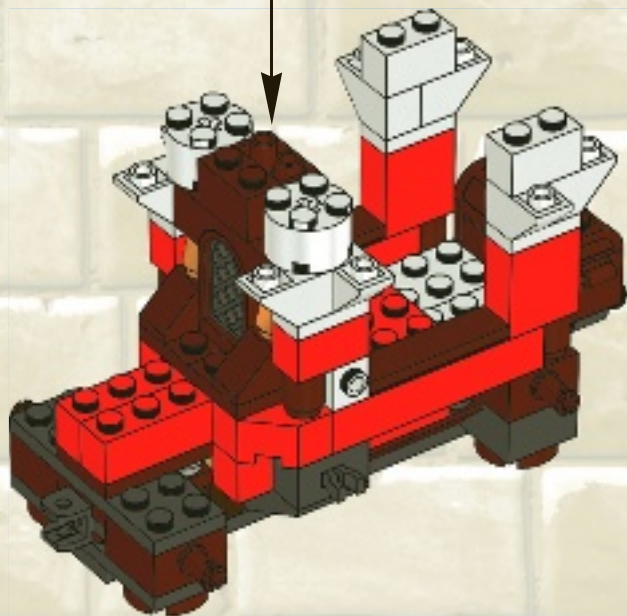



2x

37

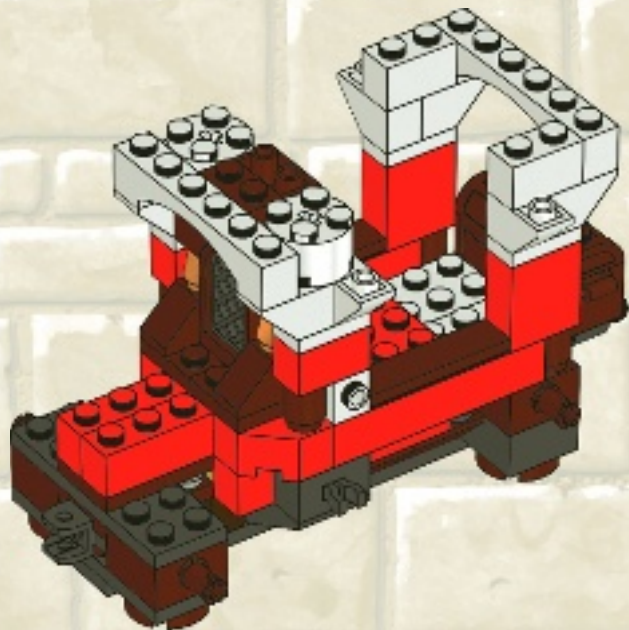



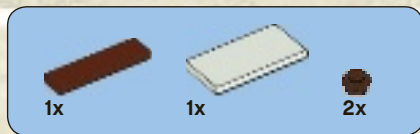

38

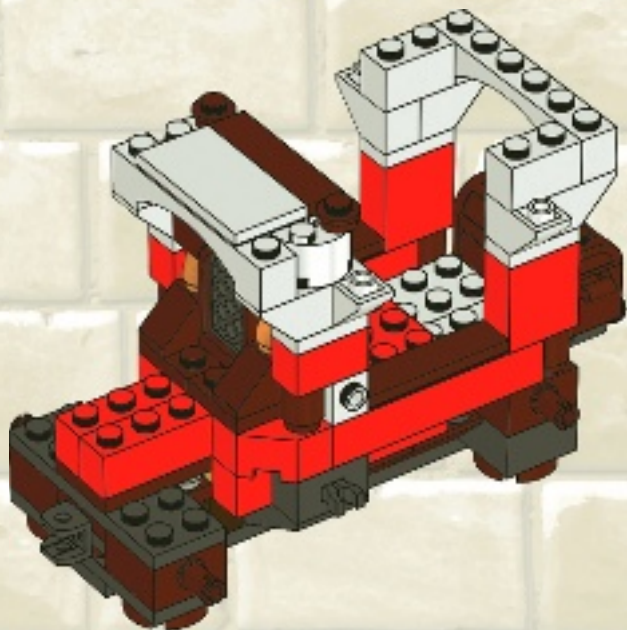



1x



2x

39

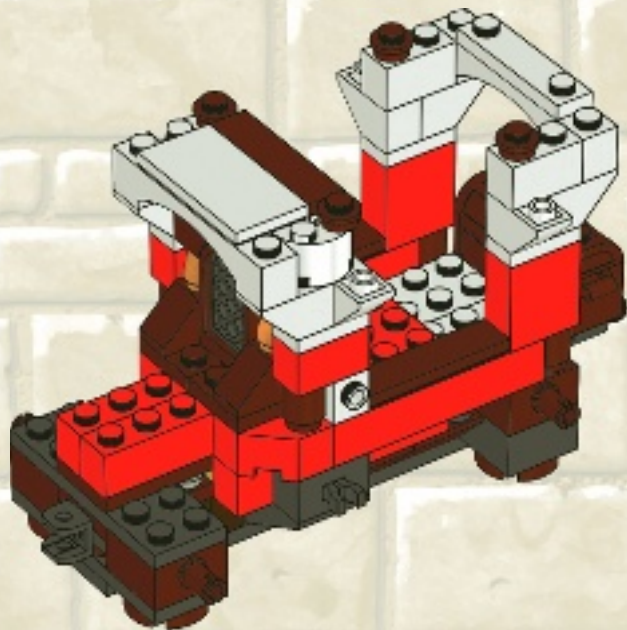



4x

40

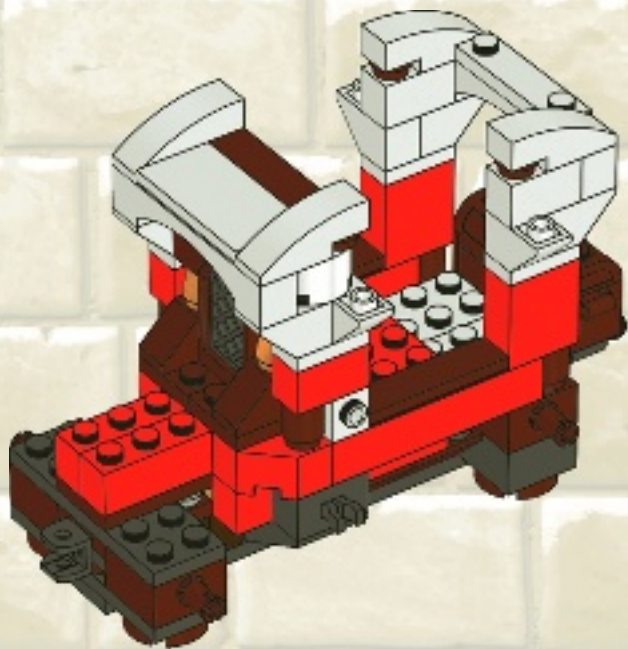



2x

41

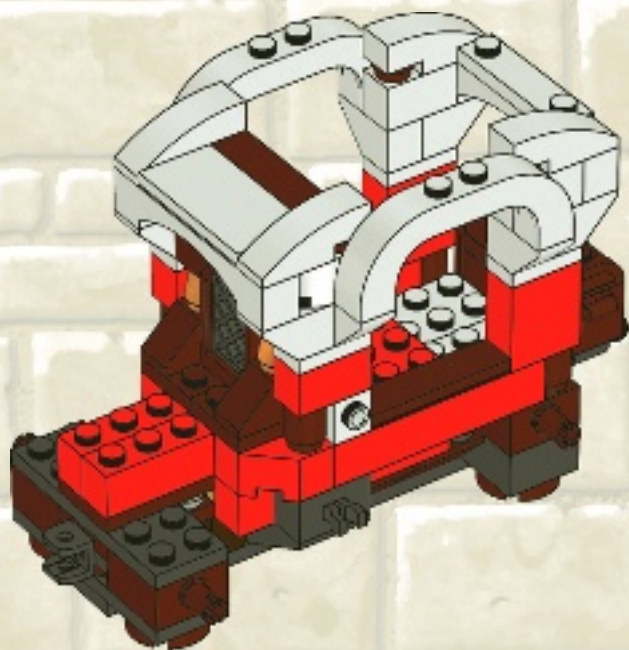



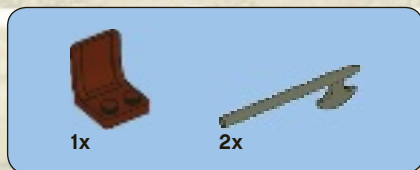

42

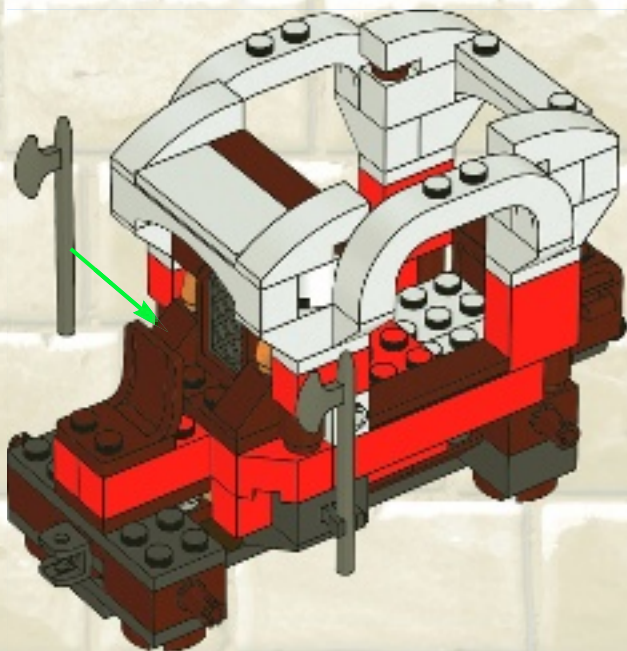



43

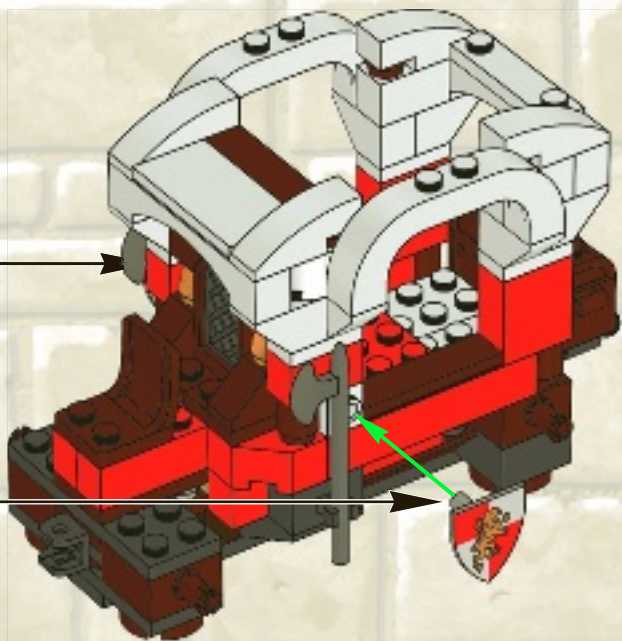
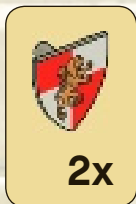

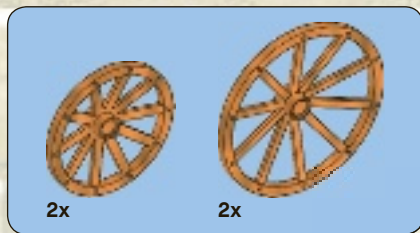

44

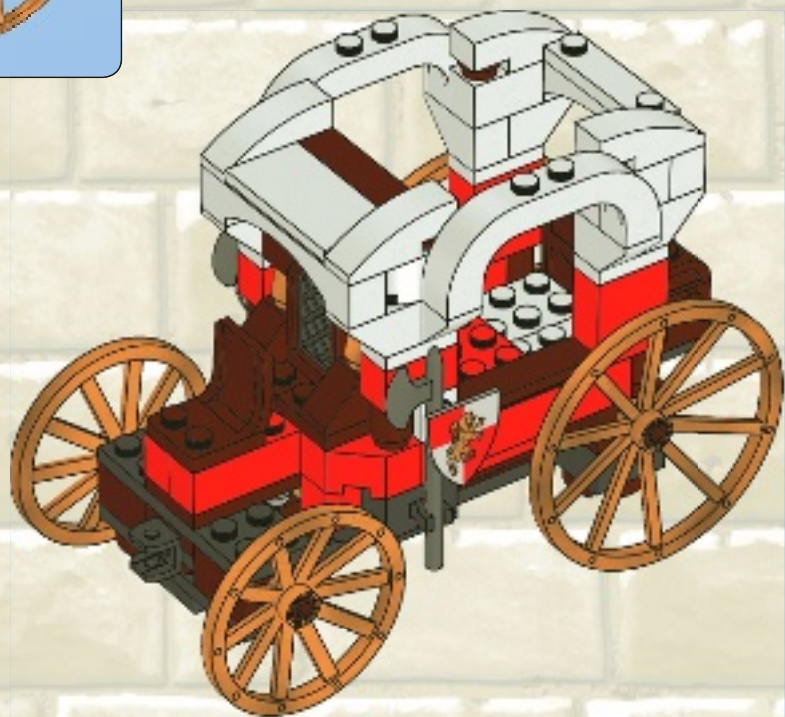

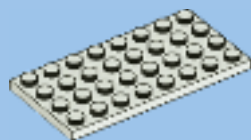

1x

1



1x



2x

2

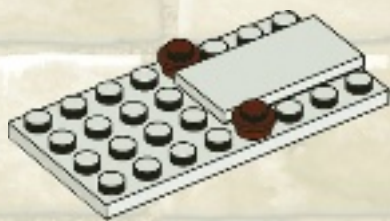





2x



2x

3

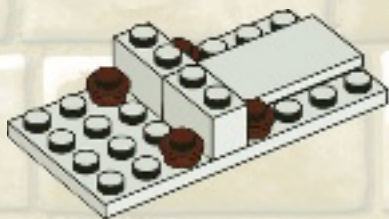

4x

4

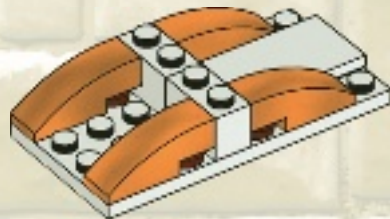

45

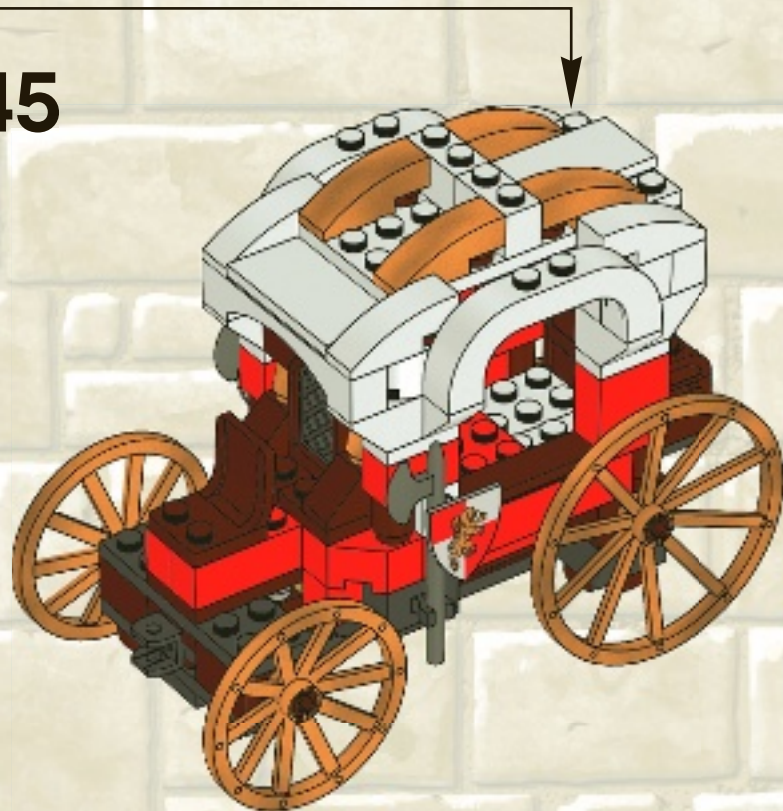

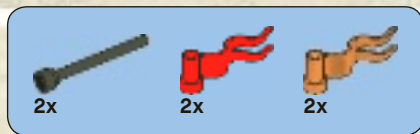

# 46

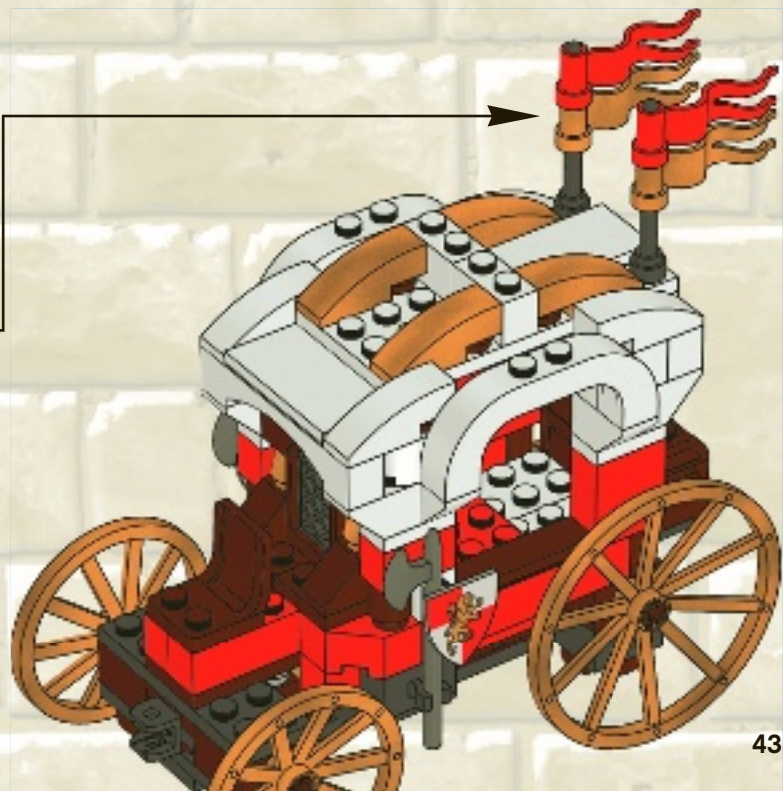
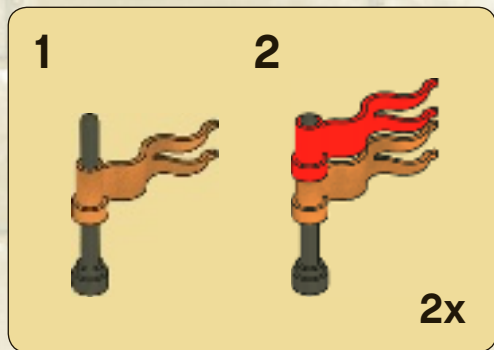



1x

1



2x



2x

2







3

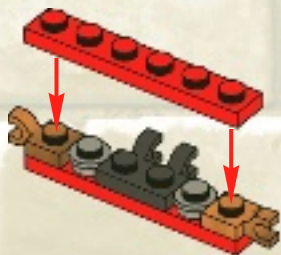

4



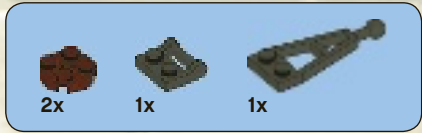

5

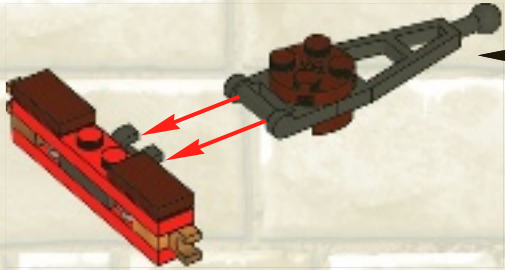

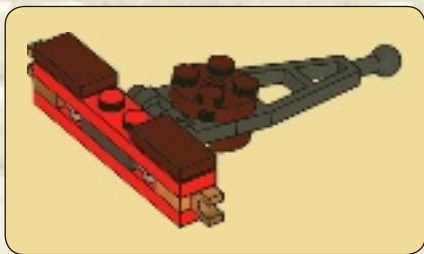

6



47

