



# Kingdoms

7187



1

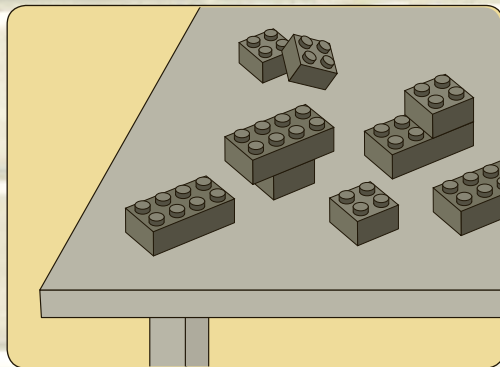
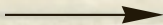
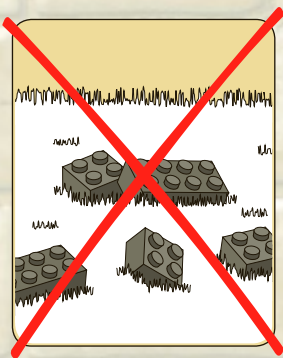

2

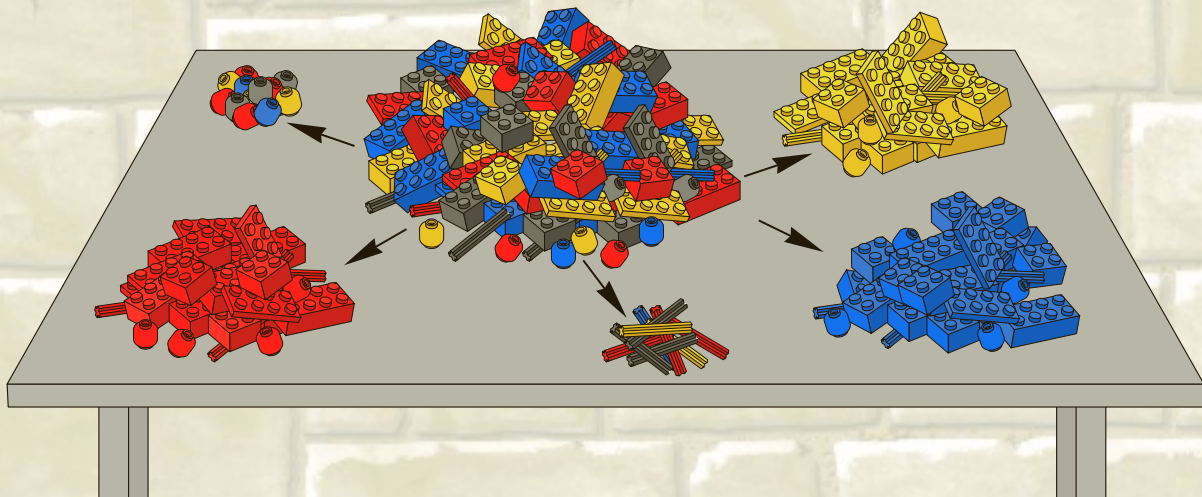

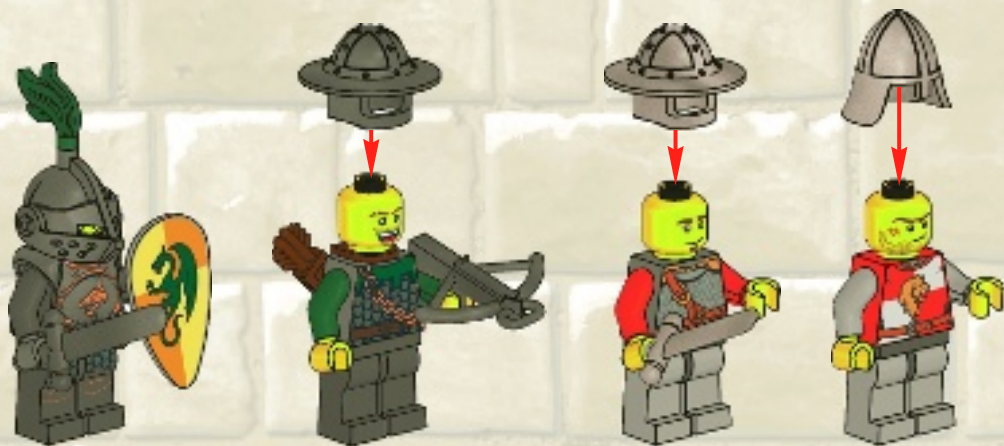
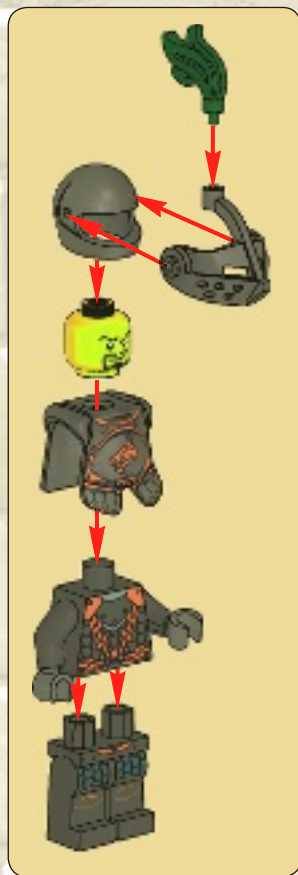

1

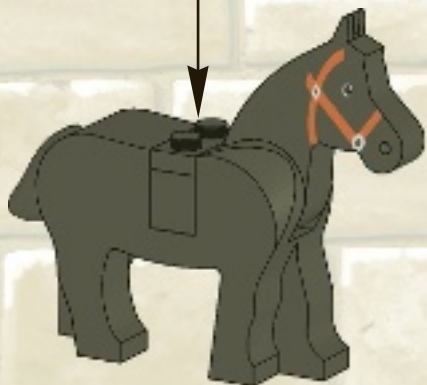
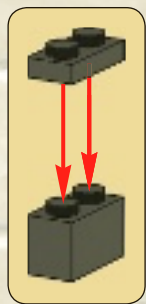

2

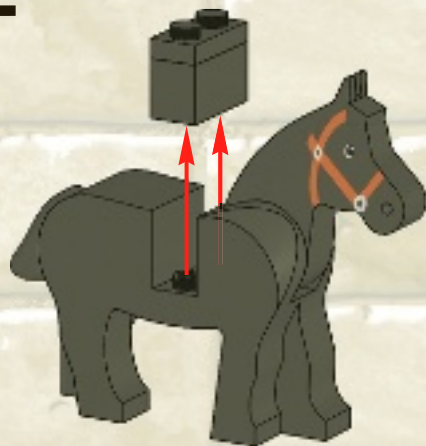



3

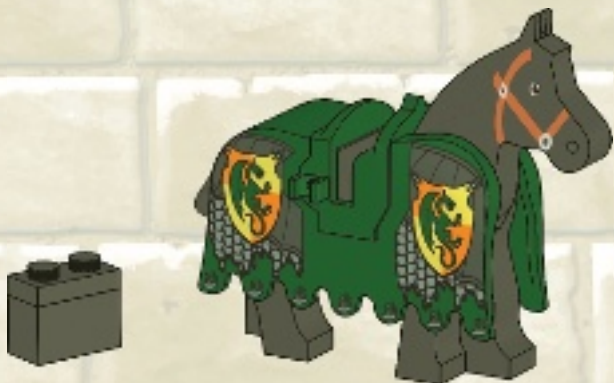

4

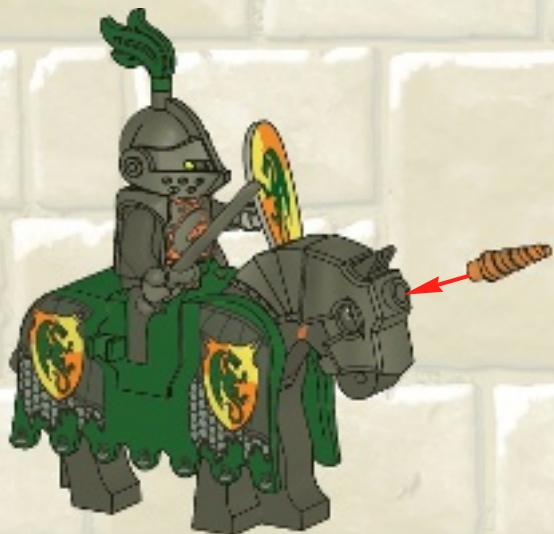



1x

1



1x

2





1x

3



1x



2x

4

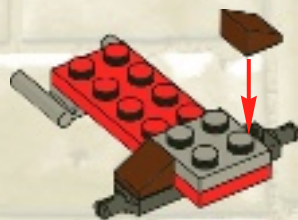



2x



2x

5



1x

6







2x

7



2x

8



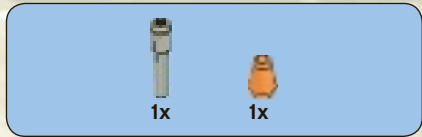

9

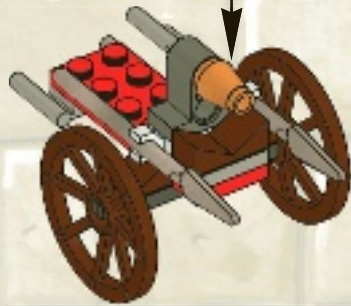
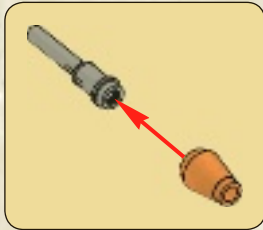
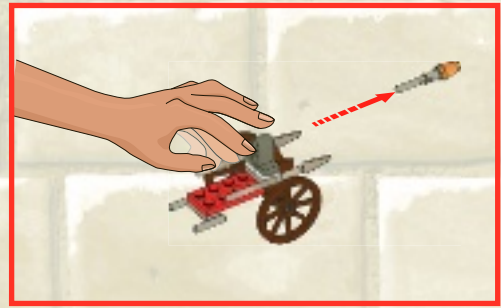

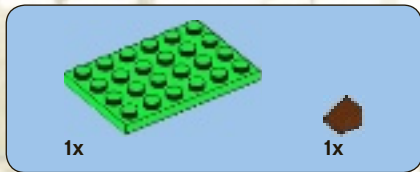

1

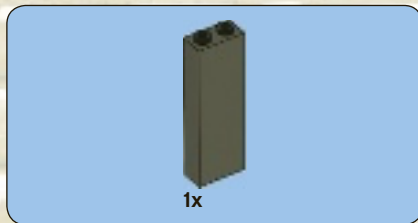

2



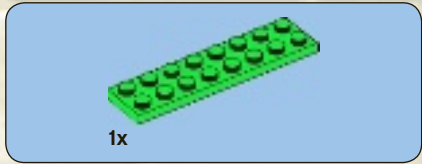

3

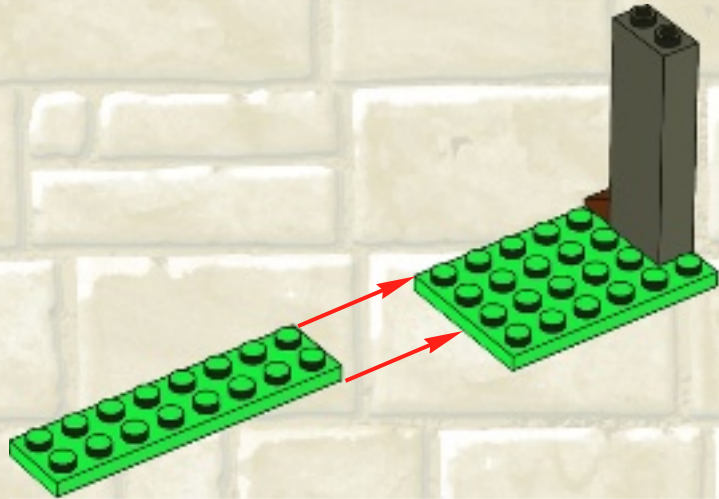





1x

4

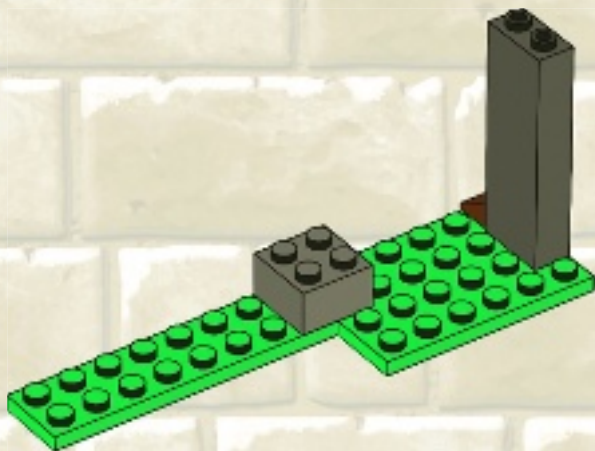

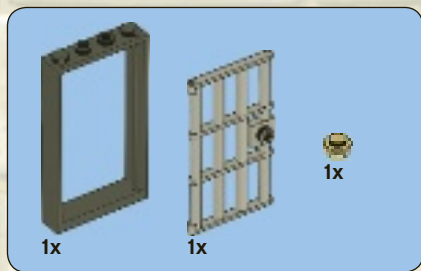

5

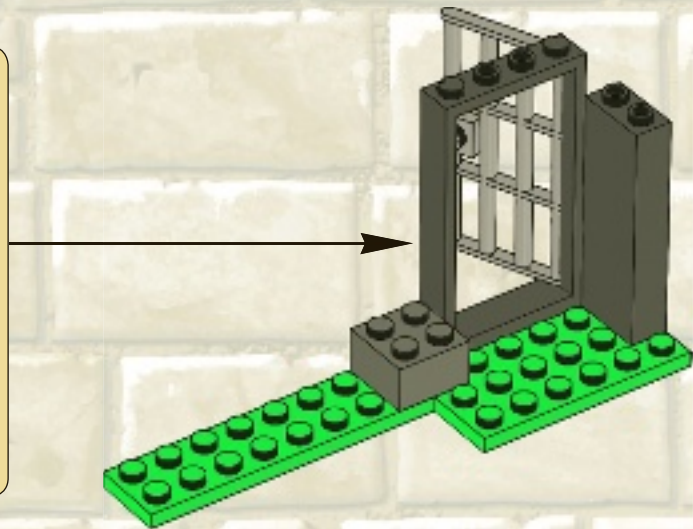
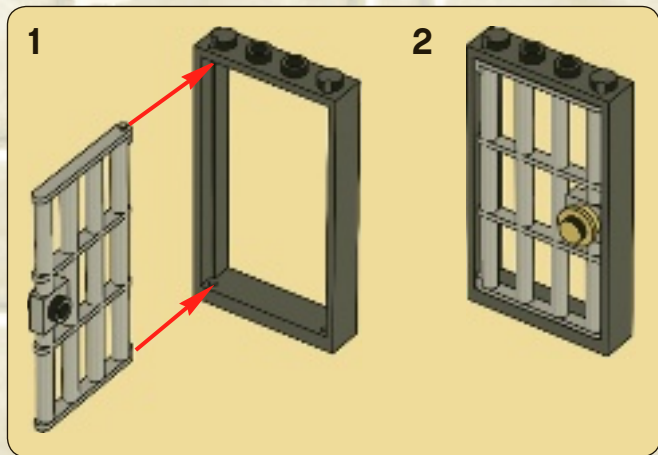

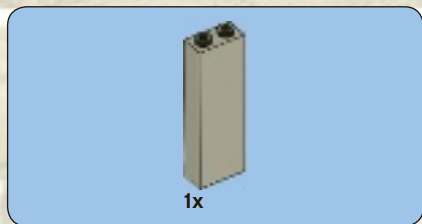

6

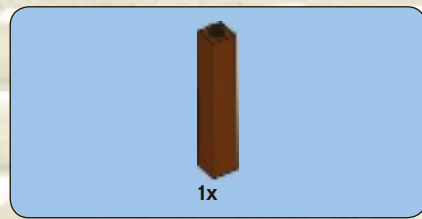
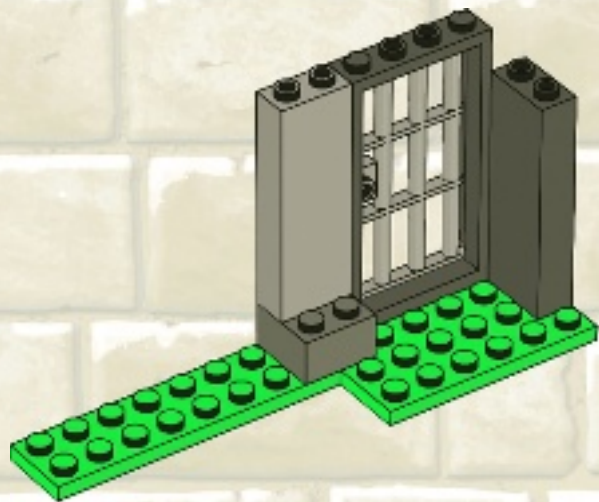

7

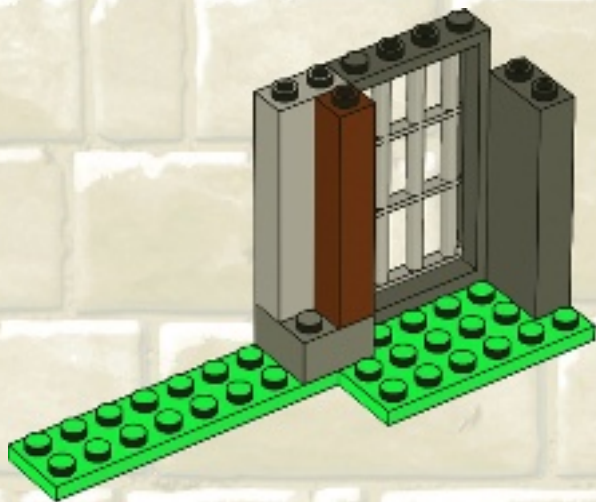

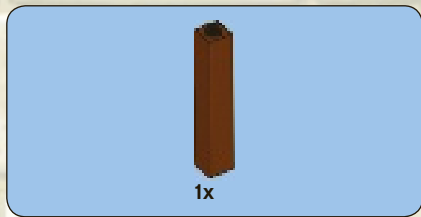

8

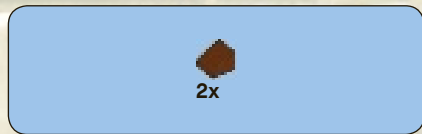
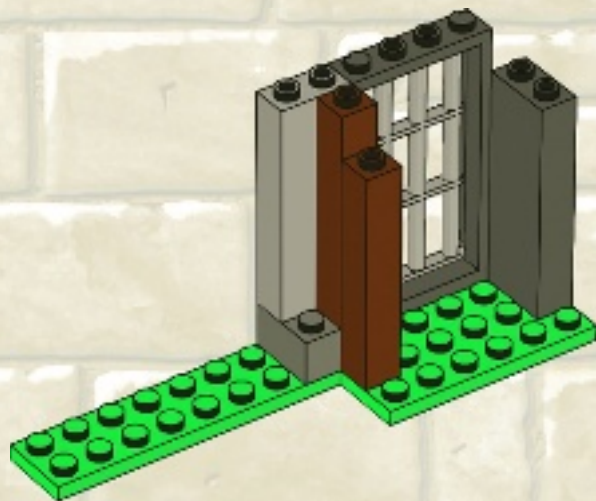

9

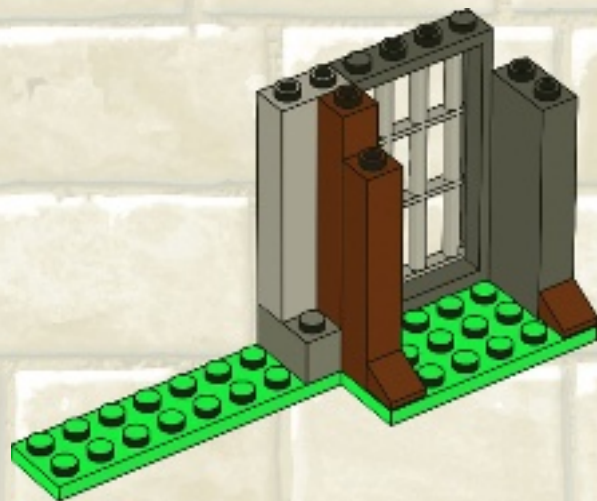





3x

10

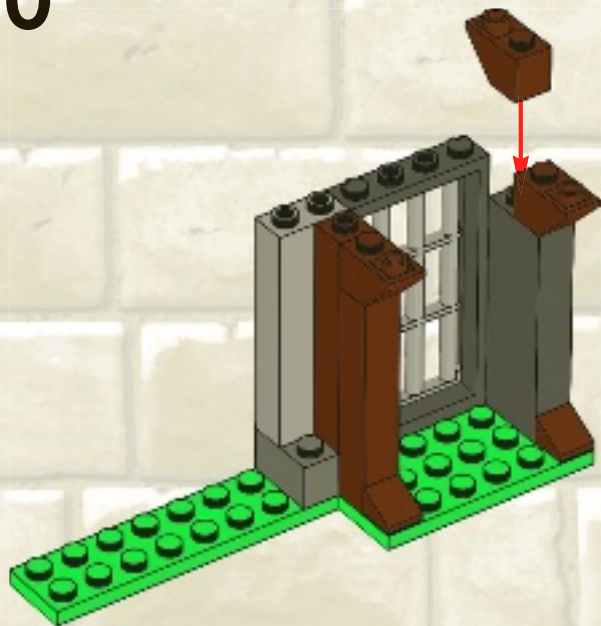

2x

11

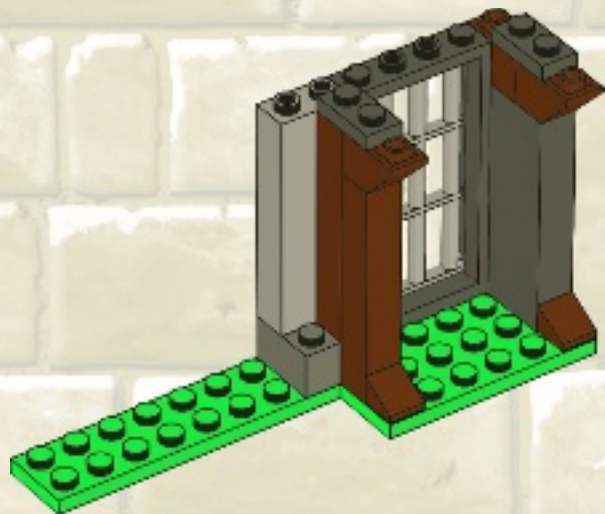

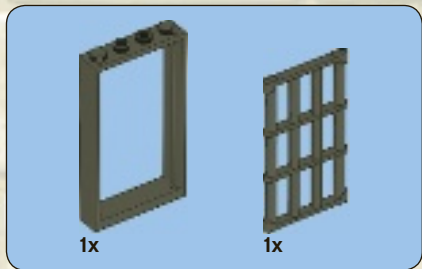

12

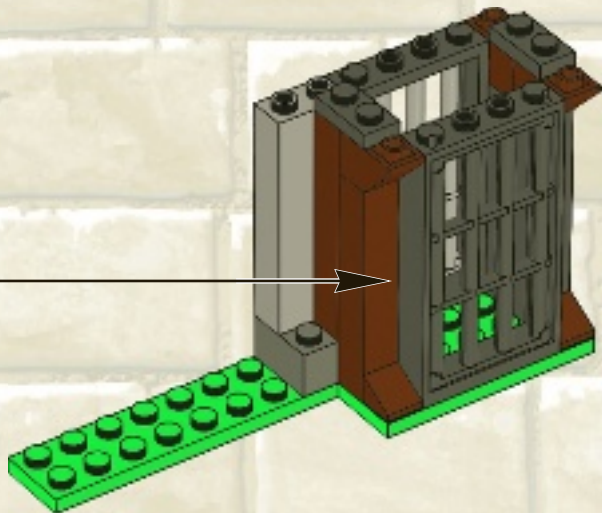
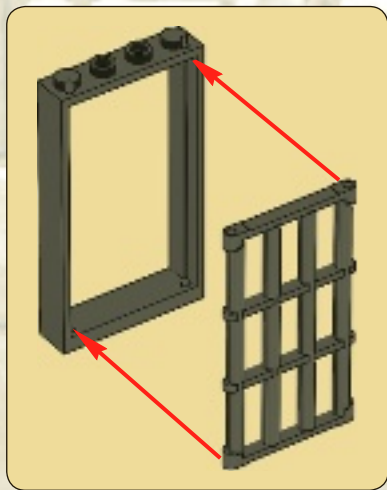



2x

13

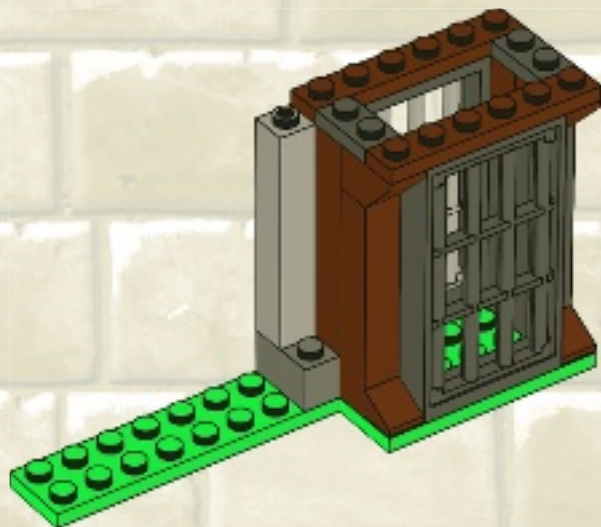

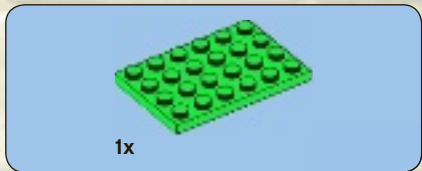

14

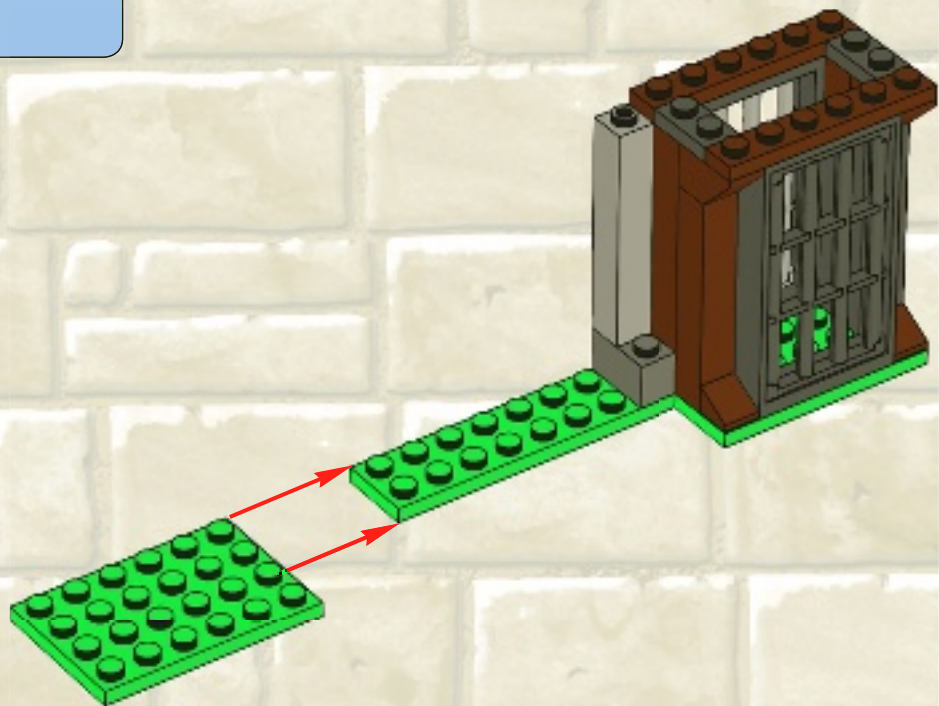



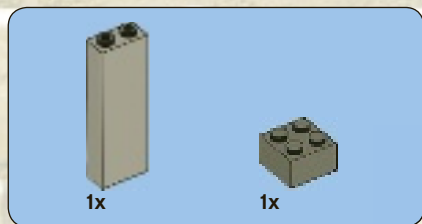

15

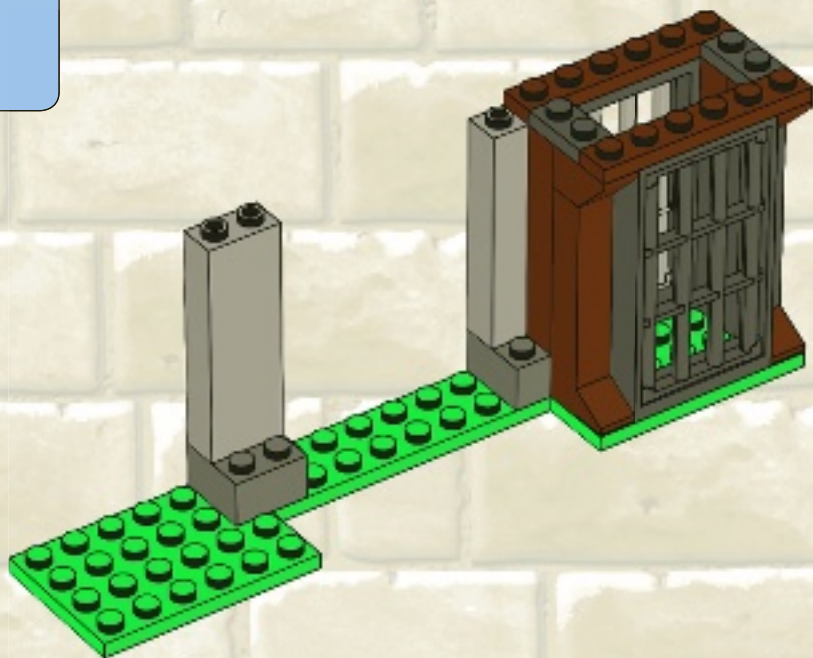



2x



4x

# 16

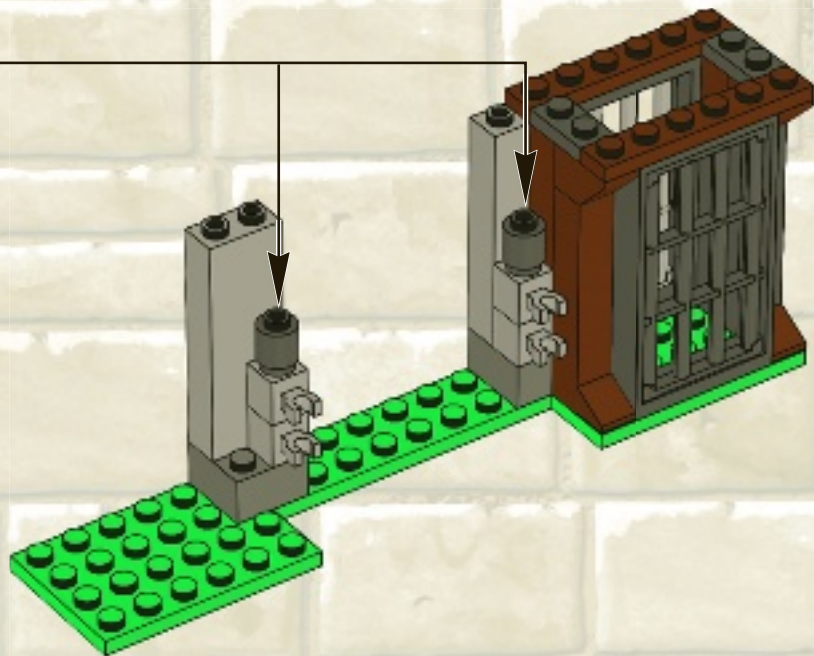
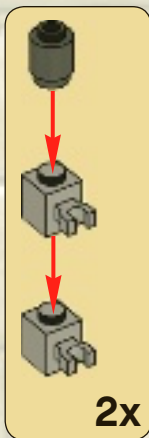

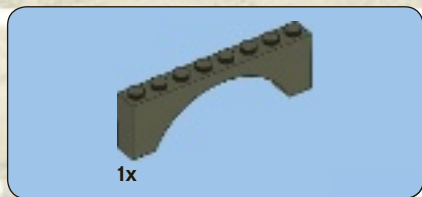

17

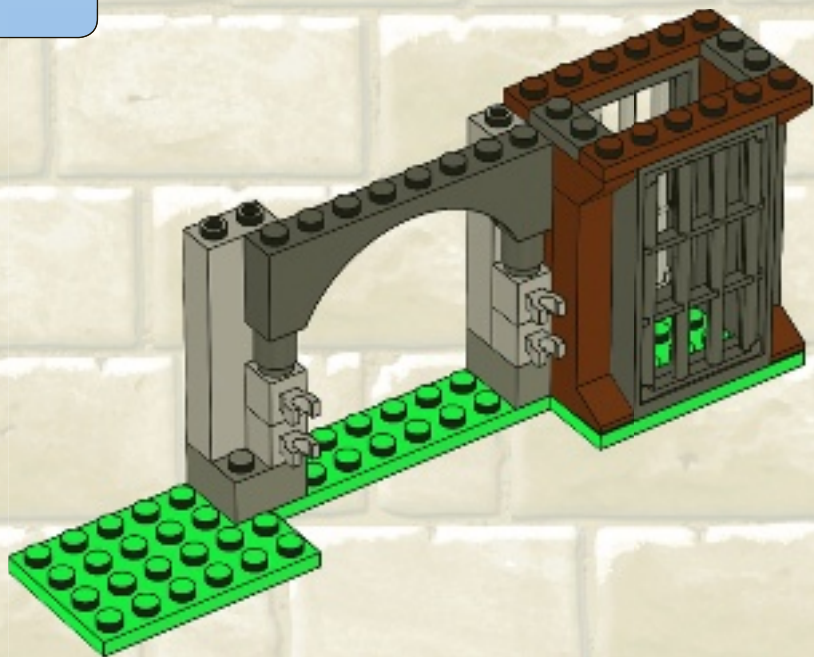

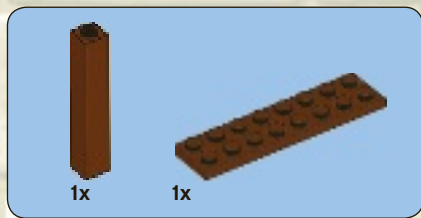

18

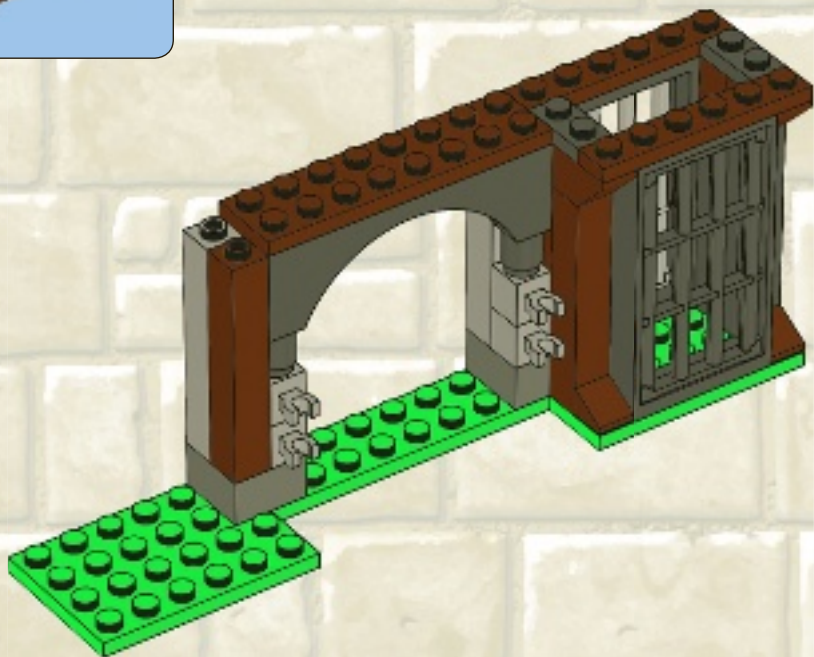



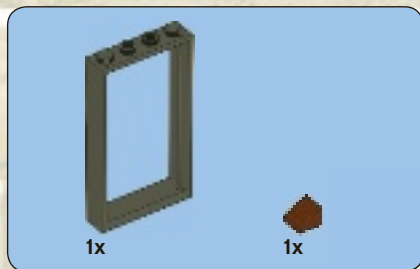

19

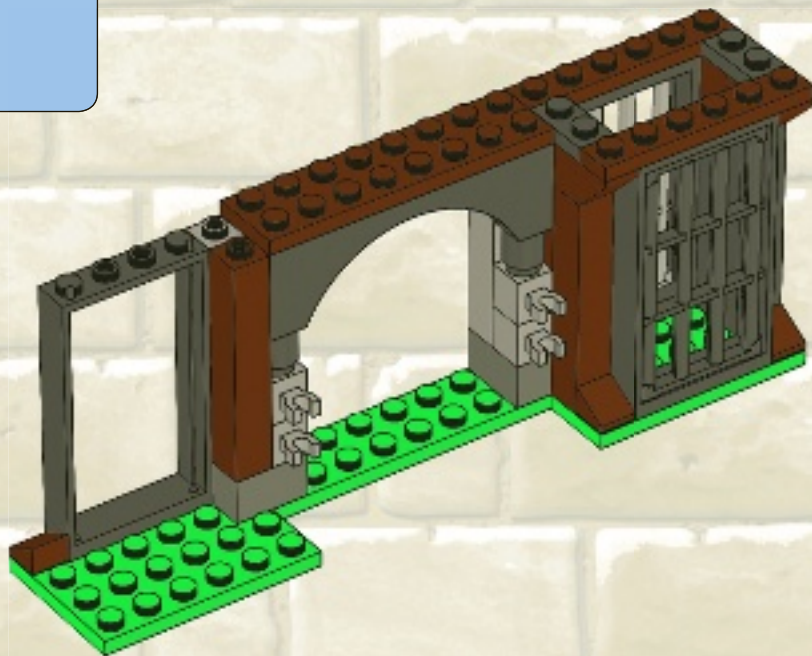

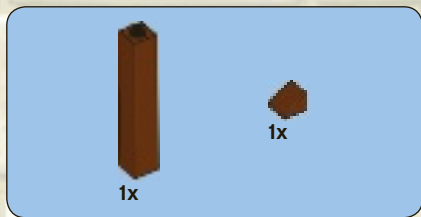

20

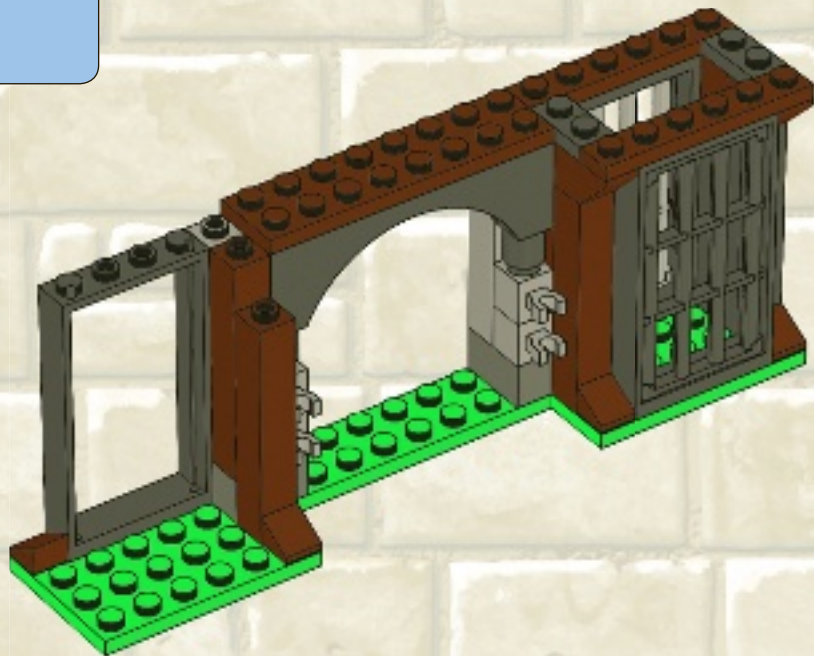



1x



1x

# 21

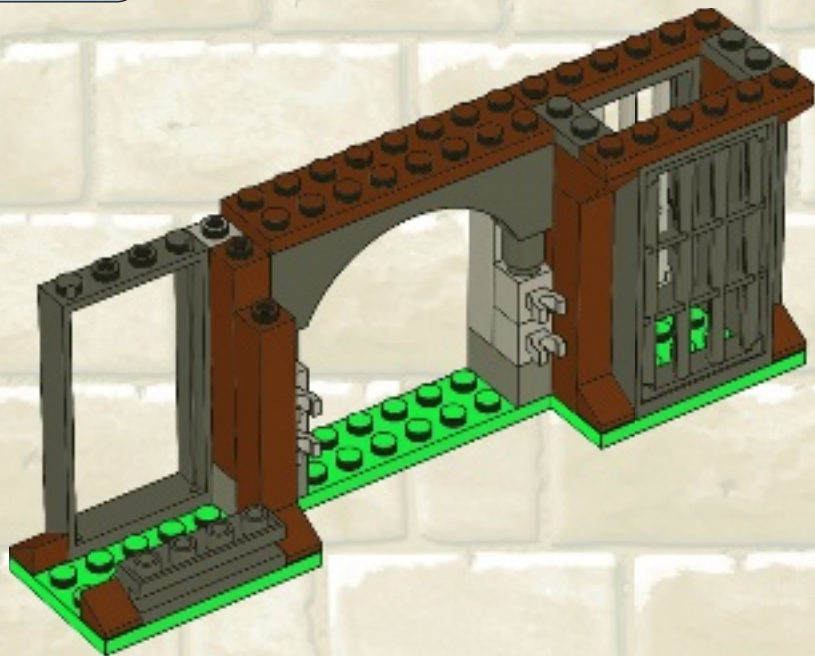



1x



1x

22

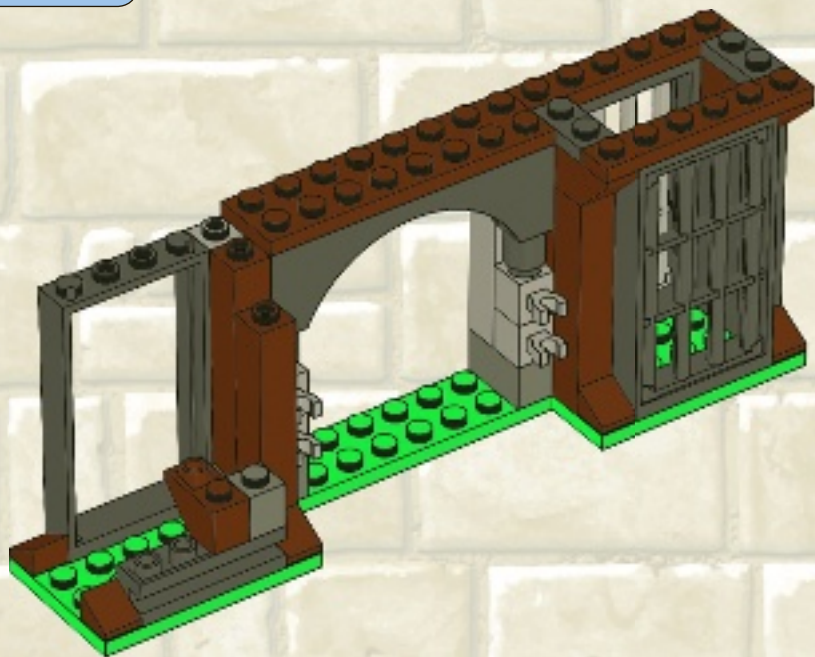





1x



1x

23

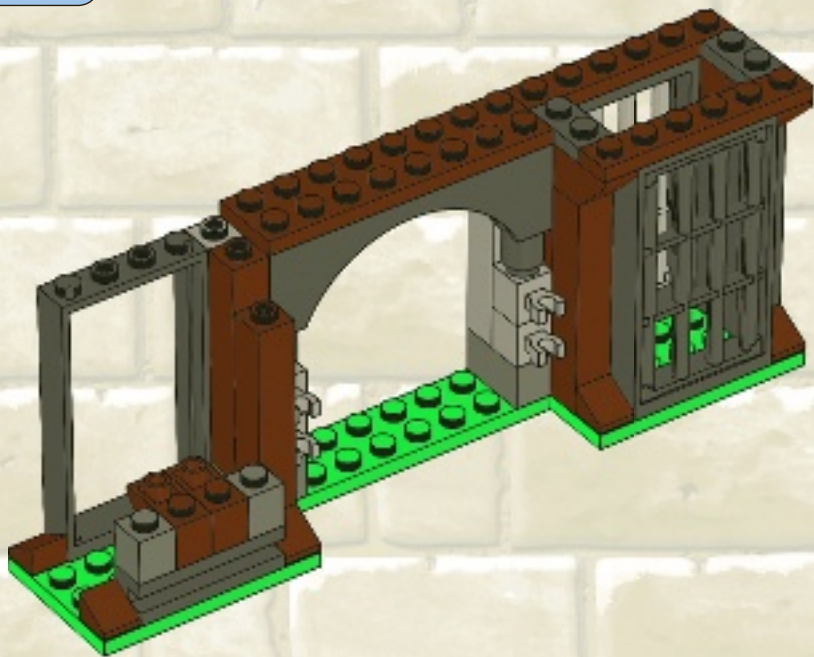



1x



1x

# 24

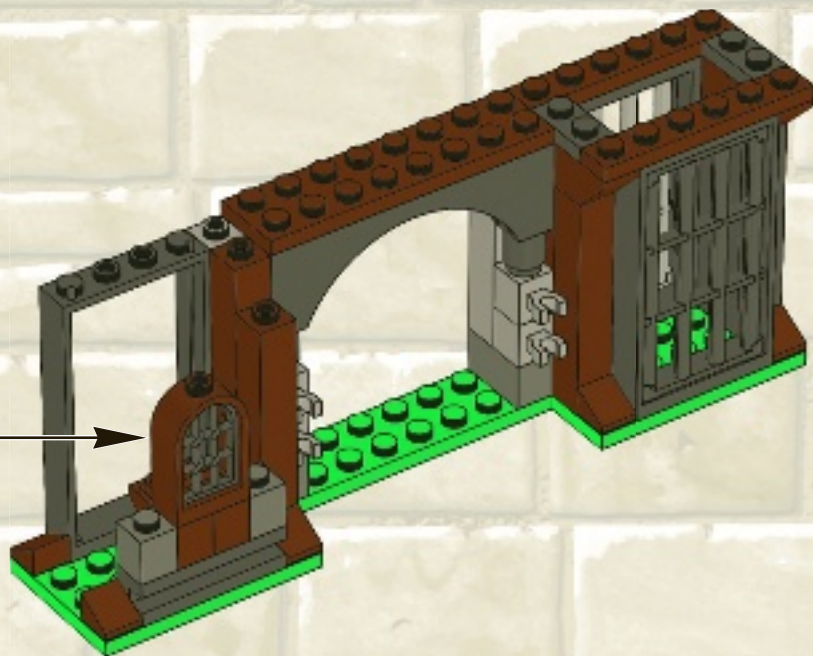
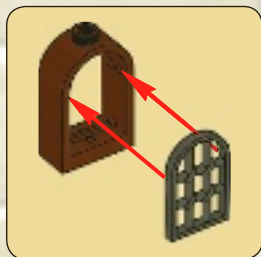



4x

# 25

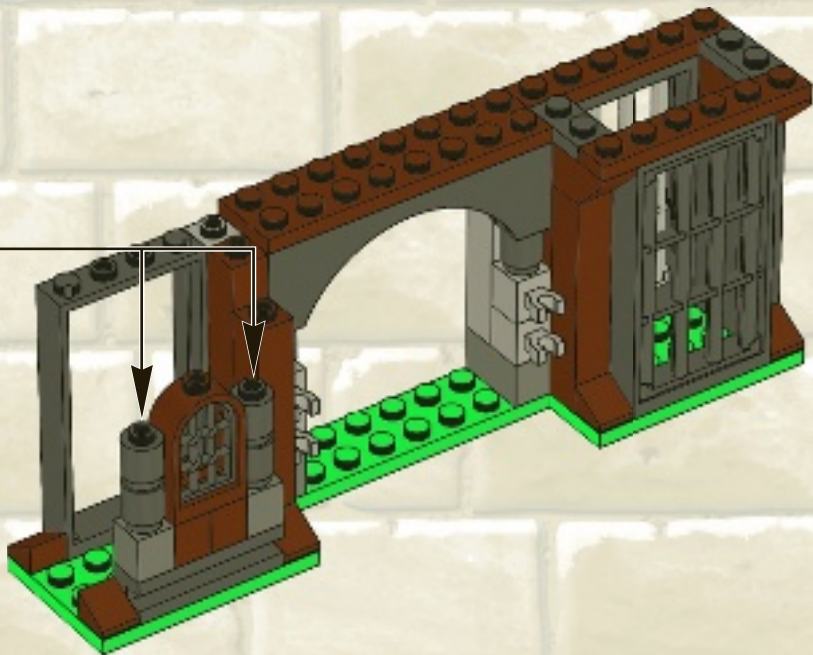
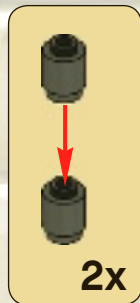

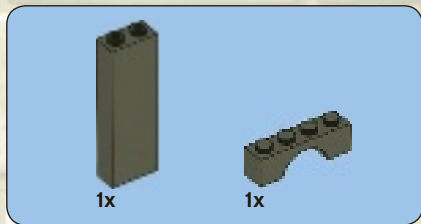

26

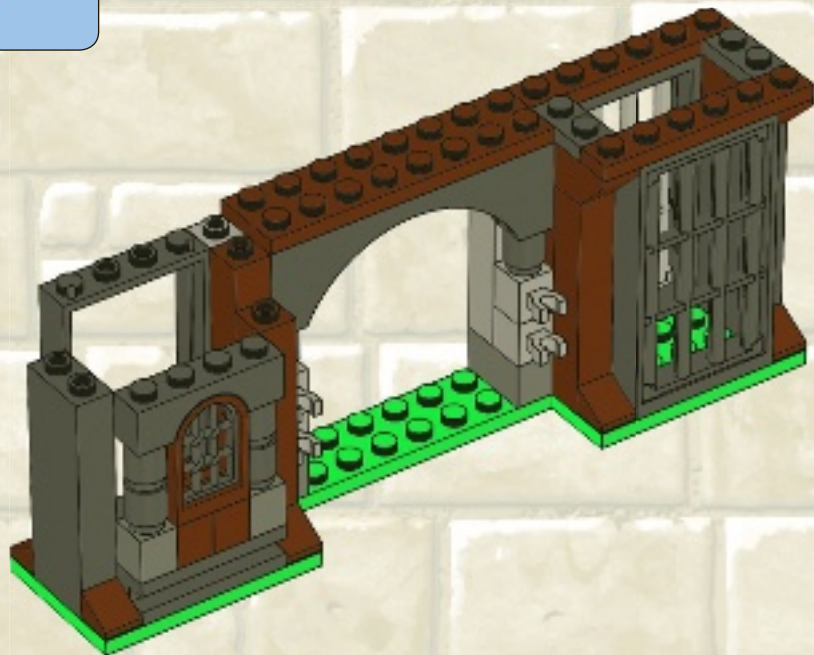





3x

27

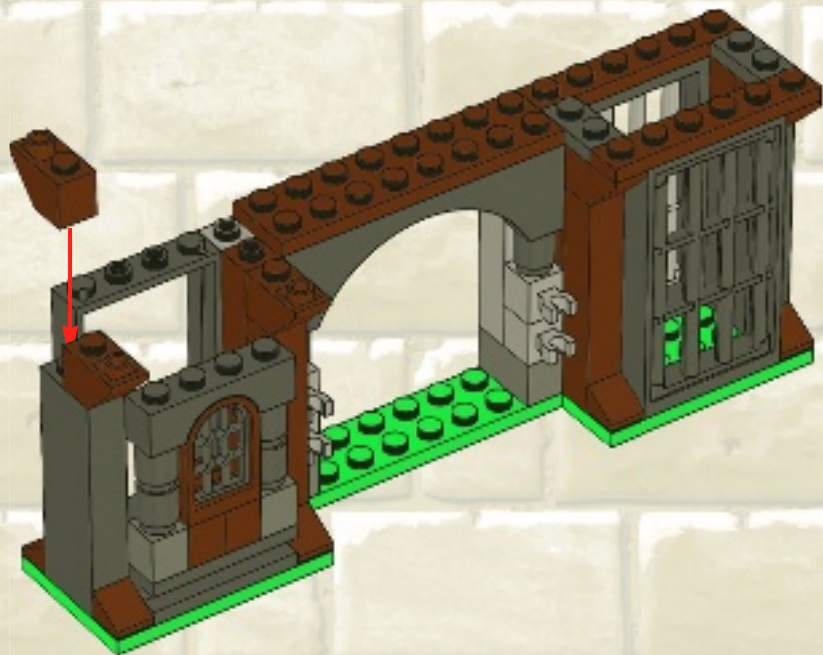



1x

28

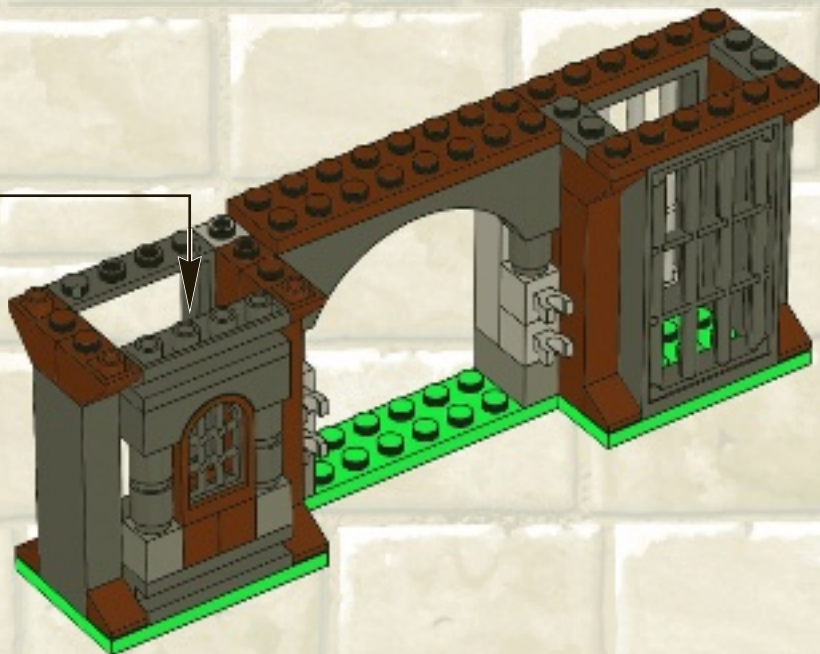
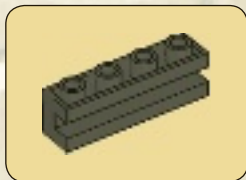



2x

29

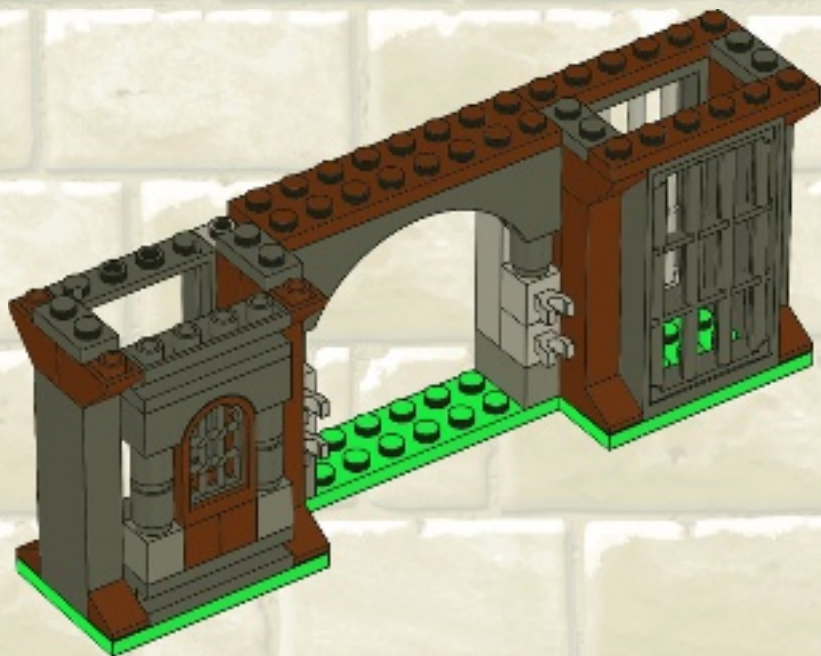



2x

30

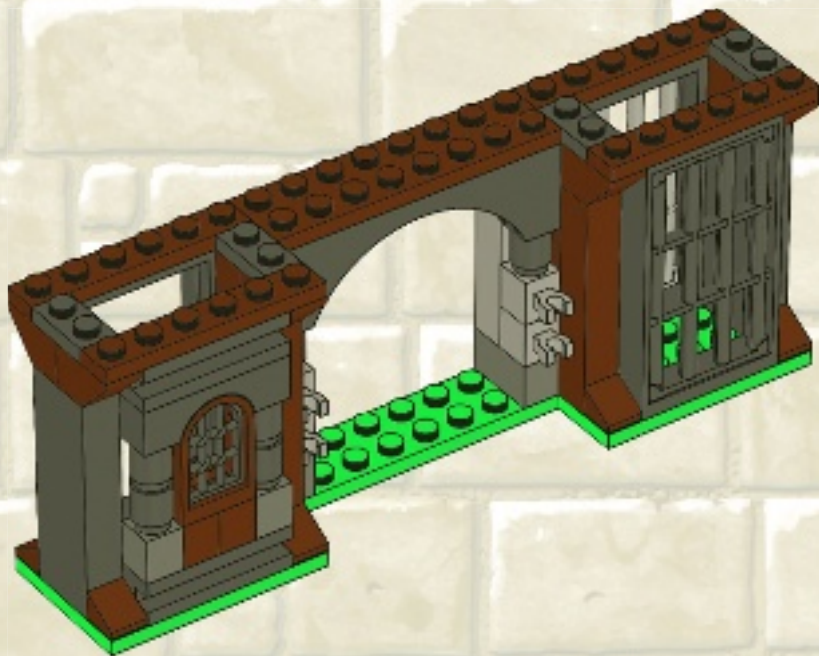





31

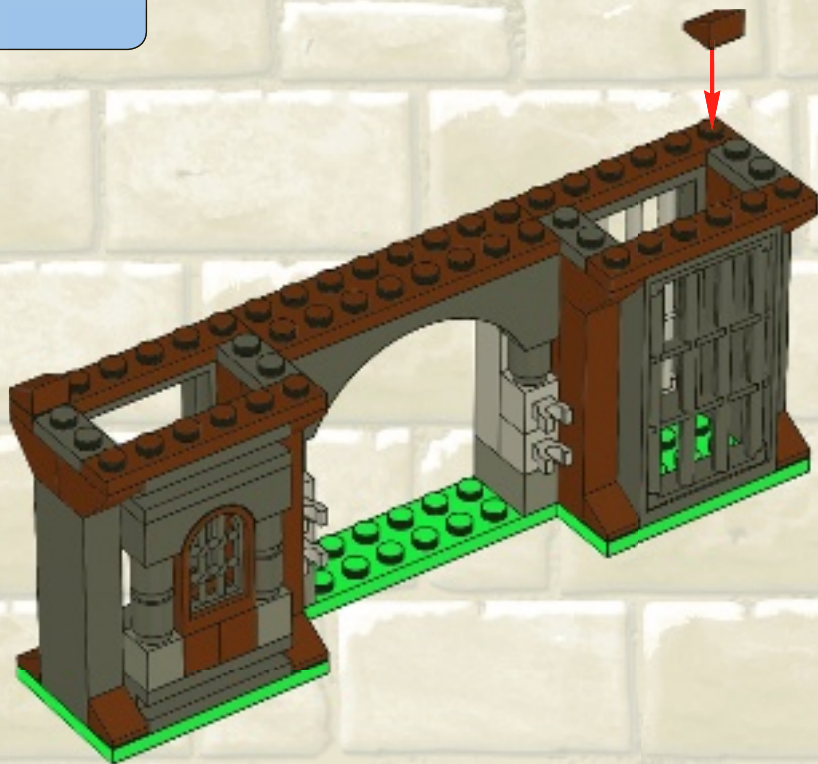



2x



1x

# 32

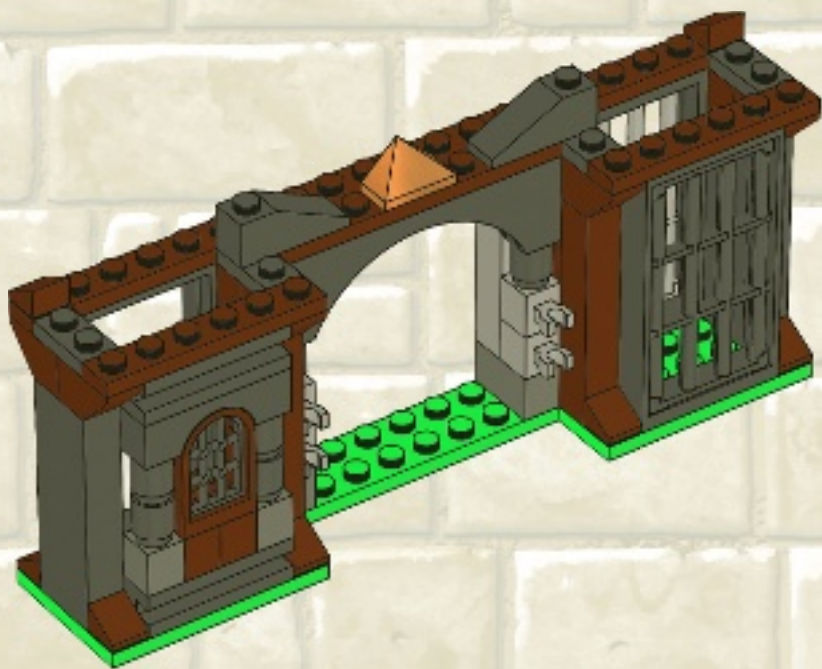



33

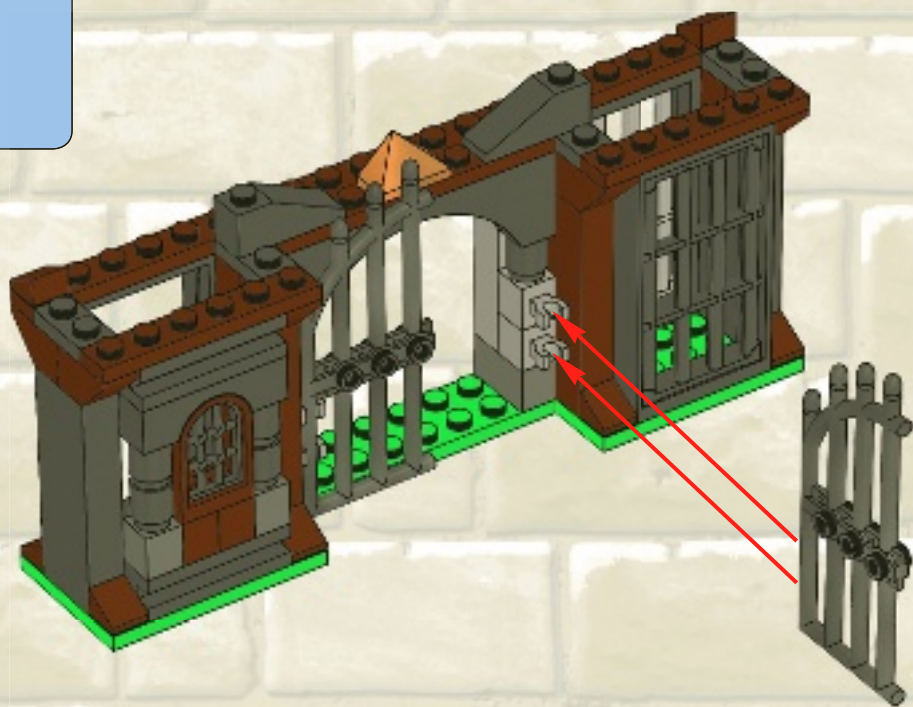



2x



2x

# 34

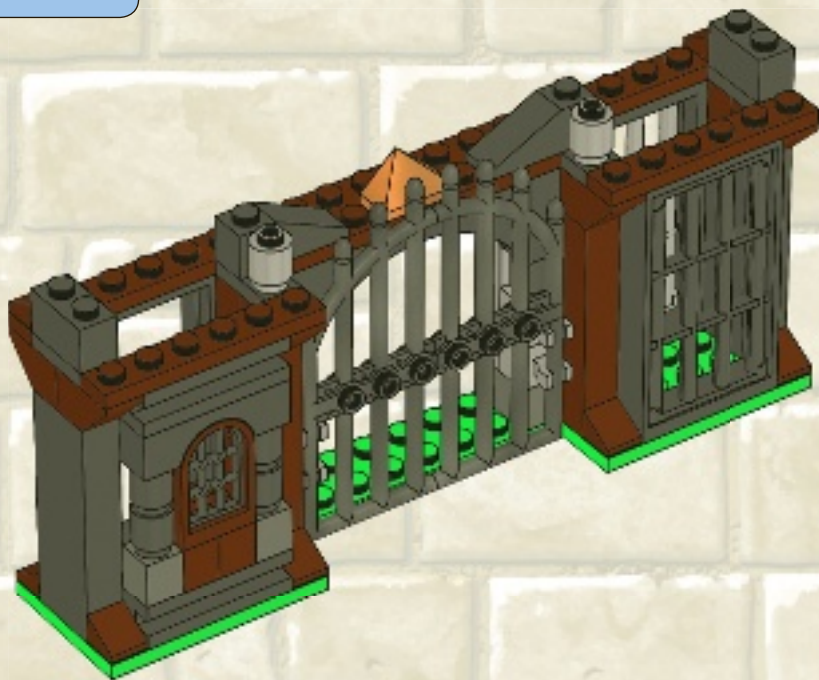





4x

35

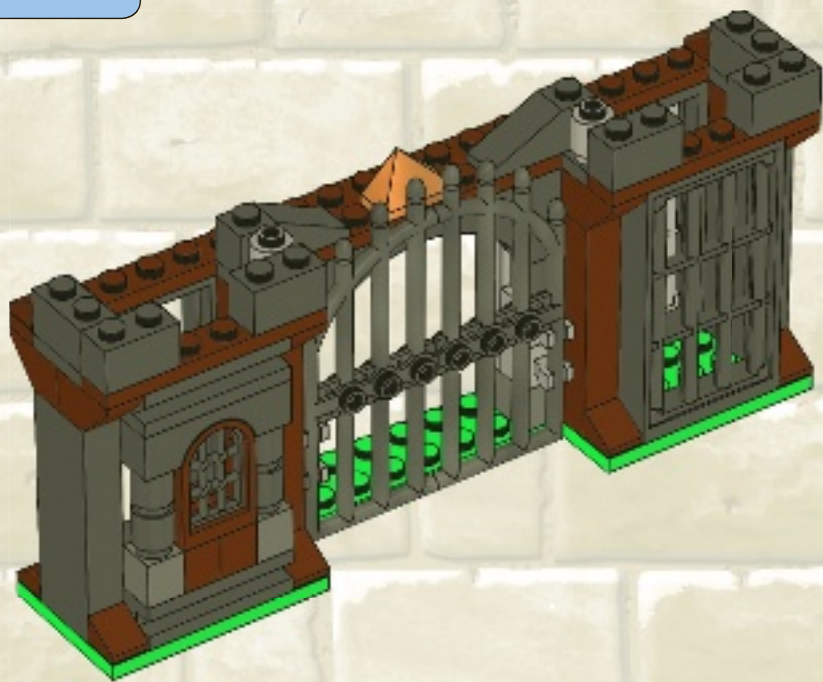



2x



2x

# 36

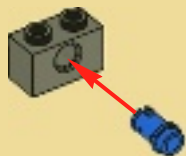

2x

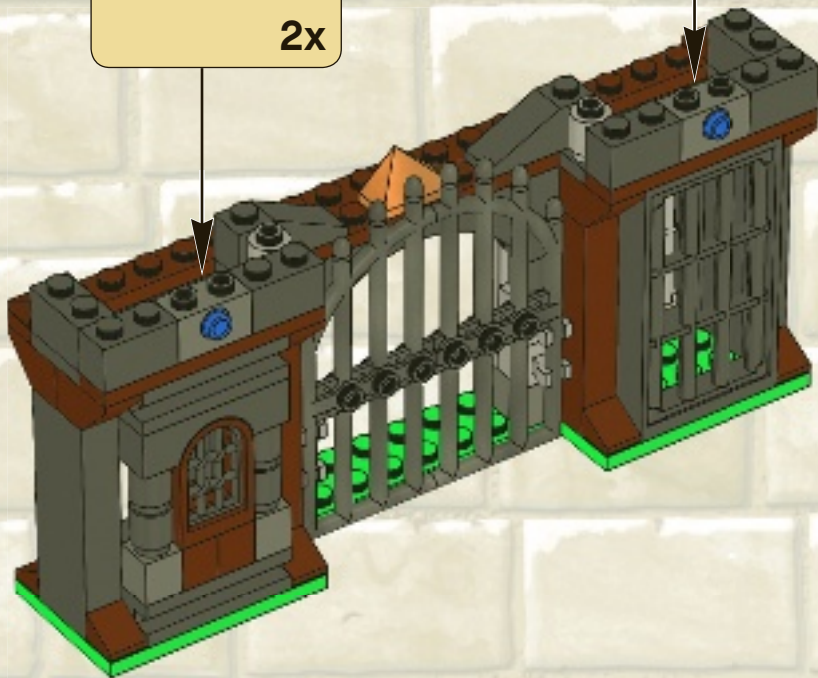



4x

37

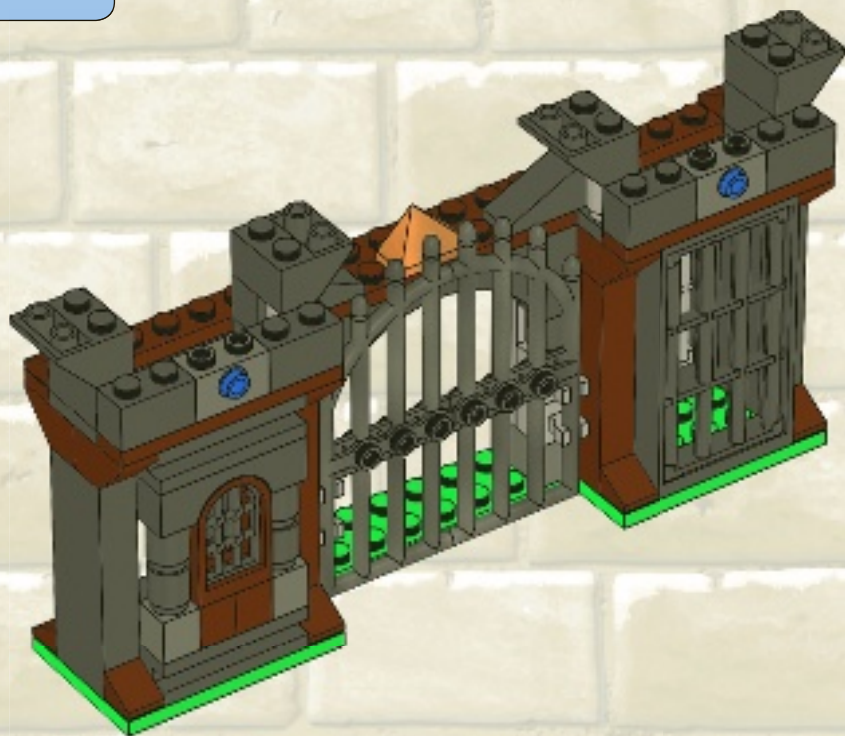



4x

38

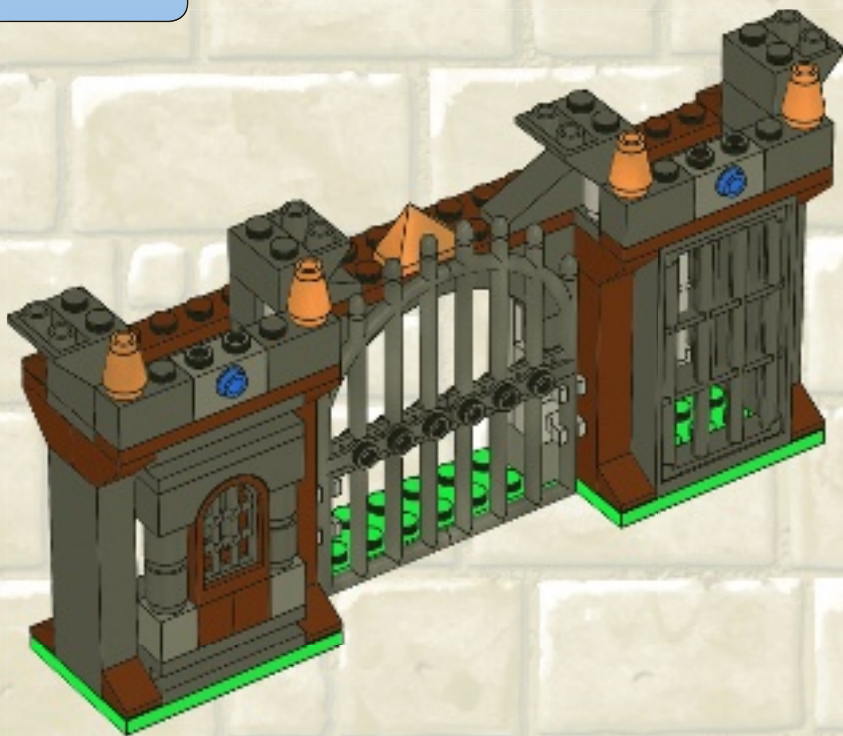





4x

39

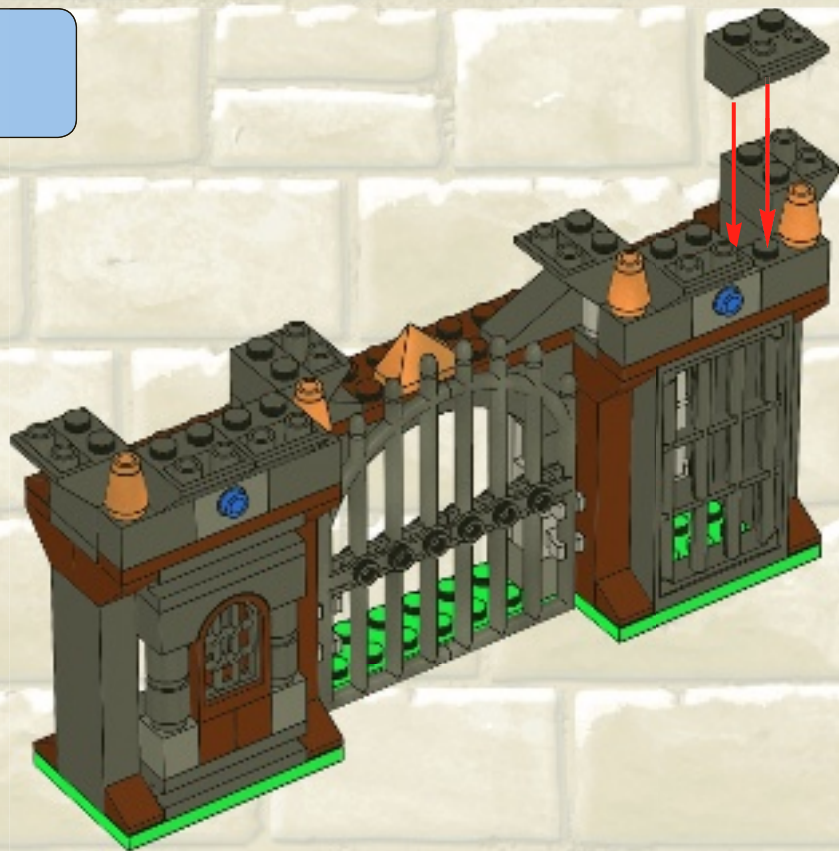



40

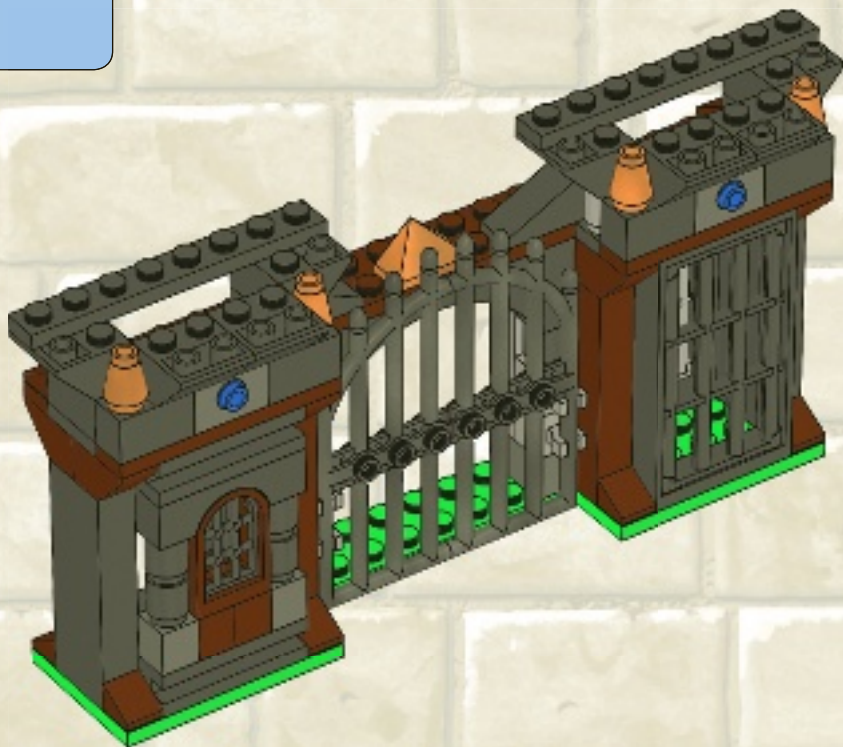



2x



4x

41

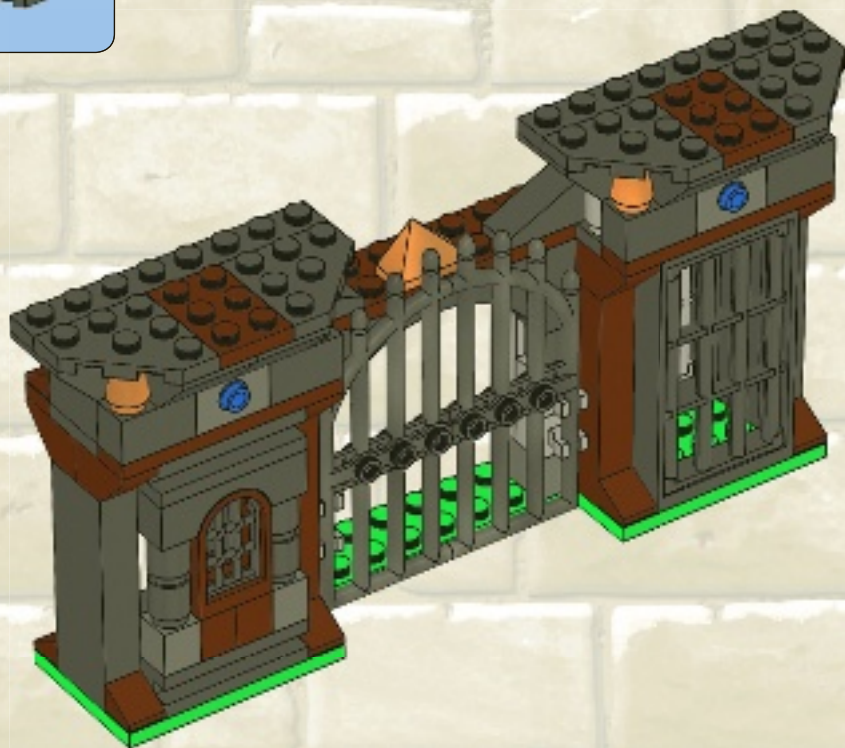



2x



1x

42

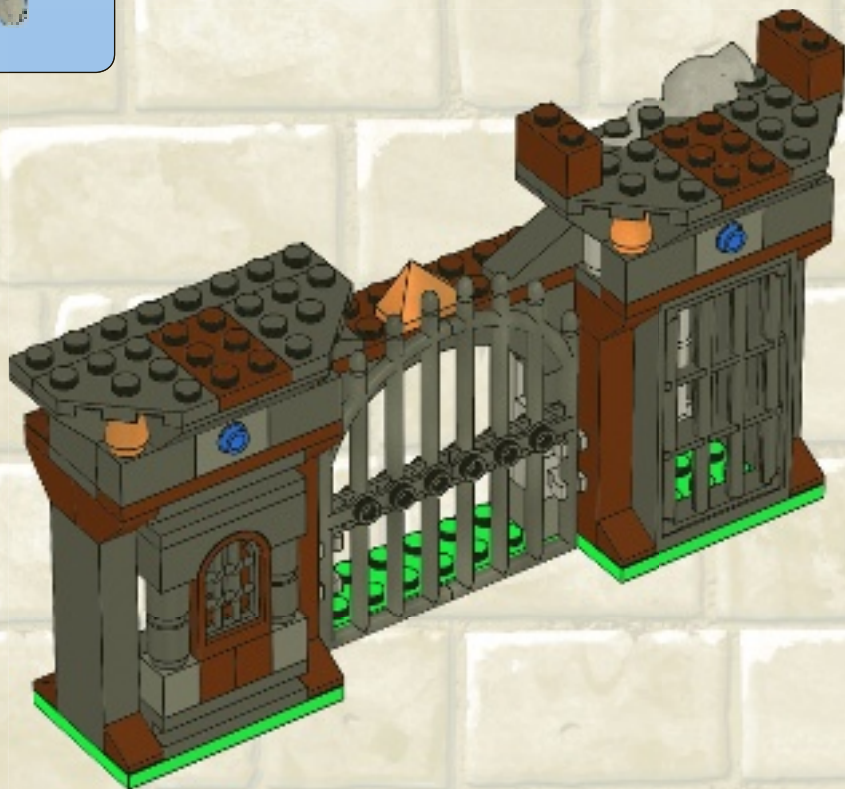





1x



1x



2x

# 43

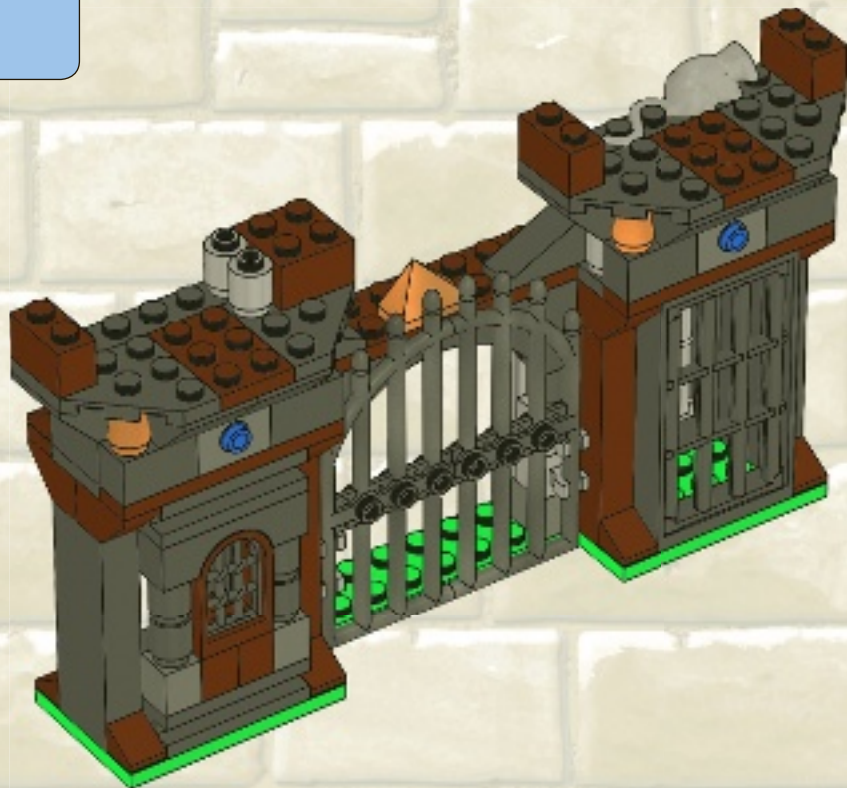



1x



1x

44

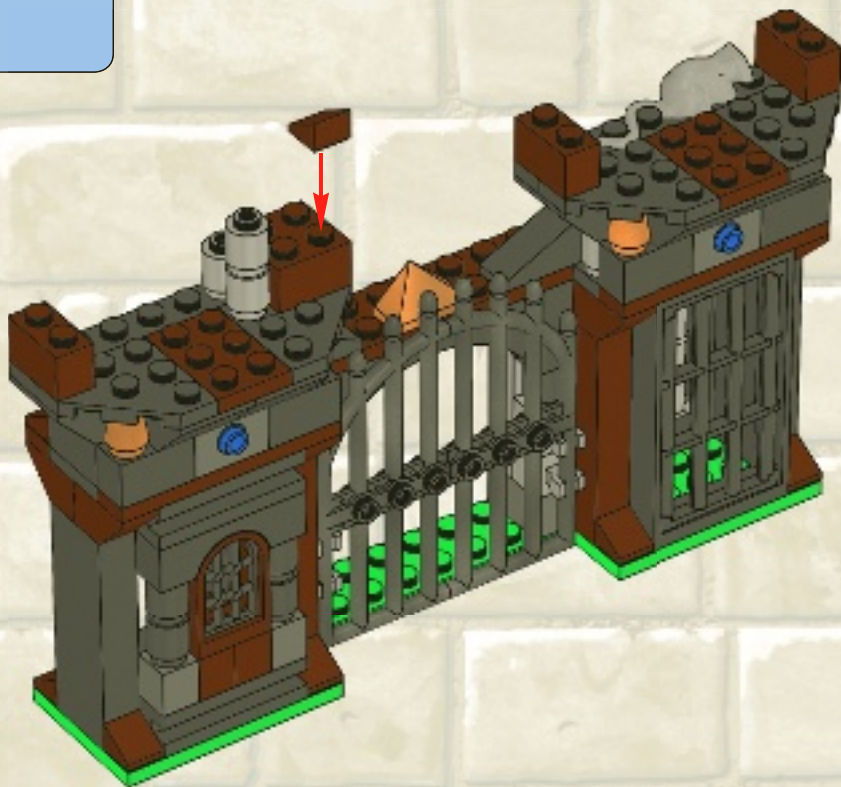



1x



1x



1x

# 45

1

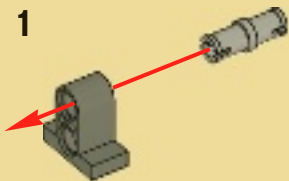

2

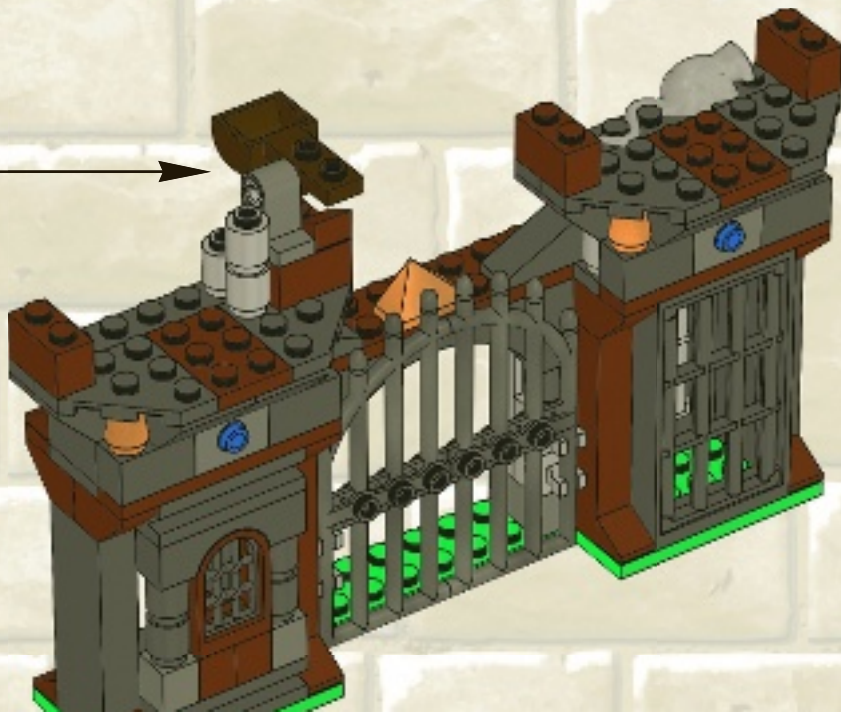
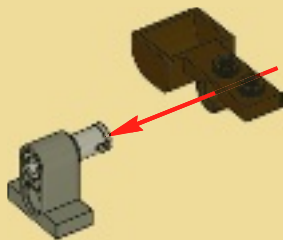

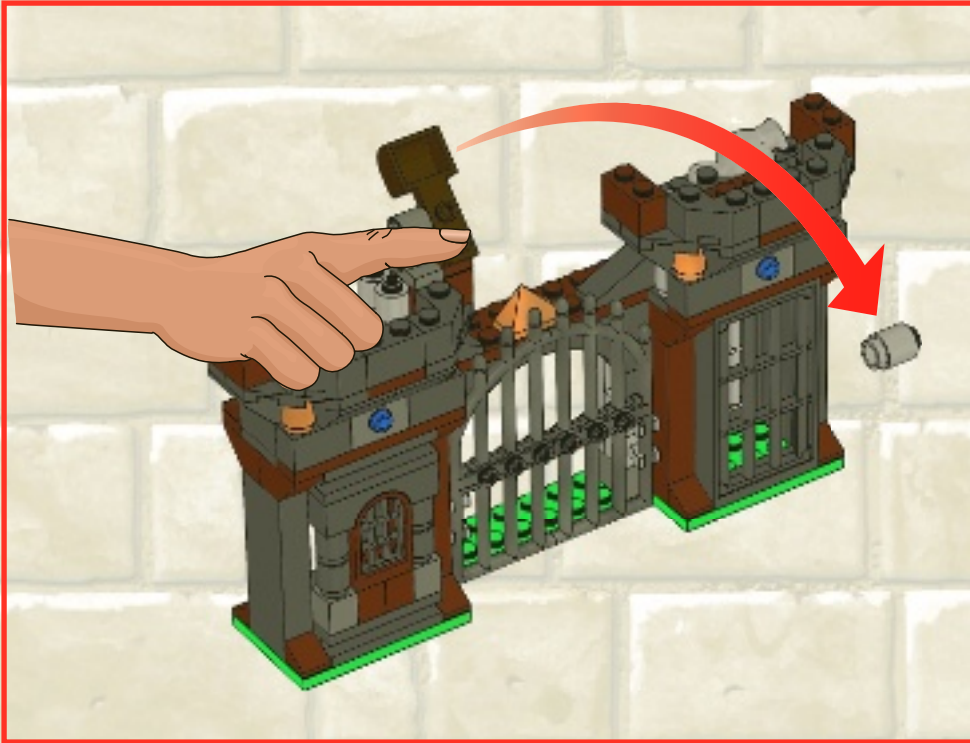





2x

46

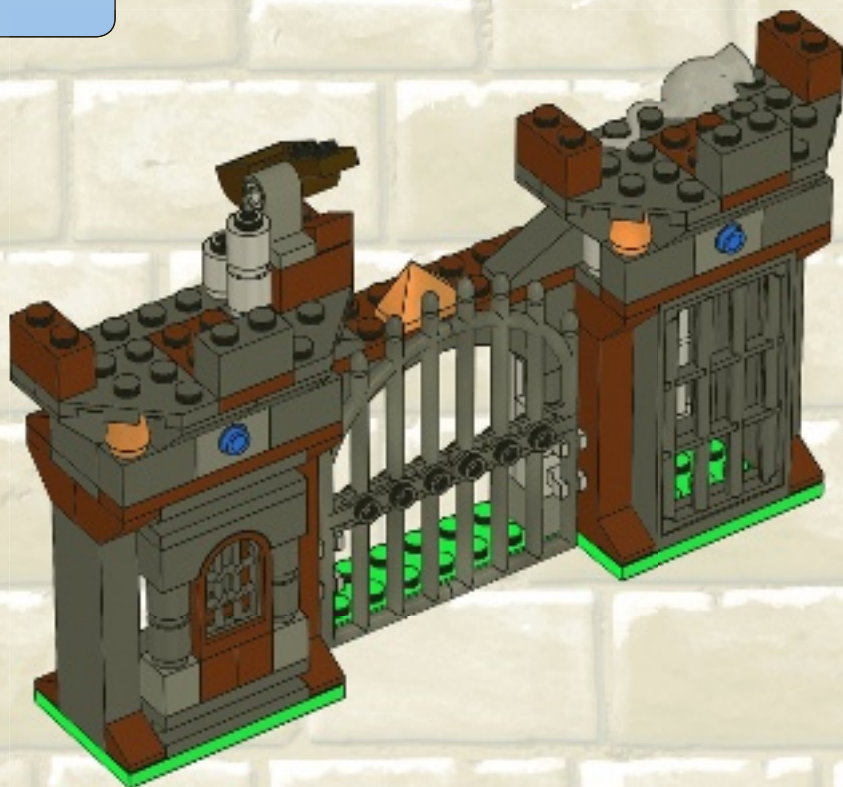



4x

47

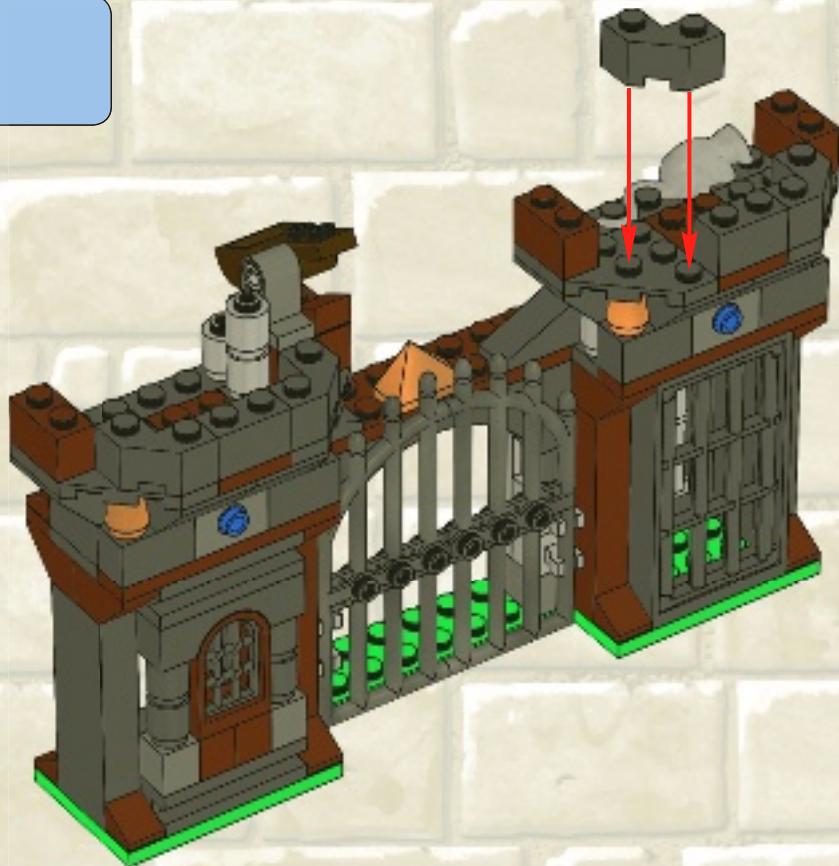



7x

48

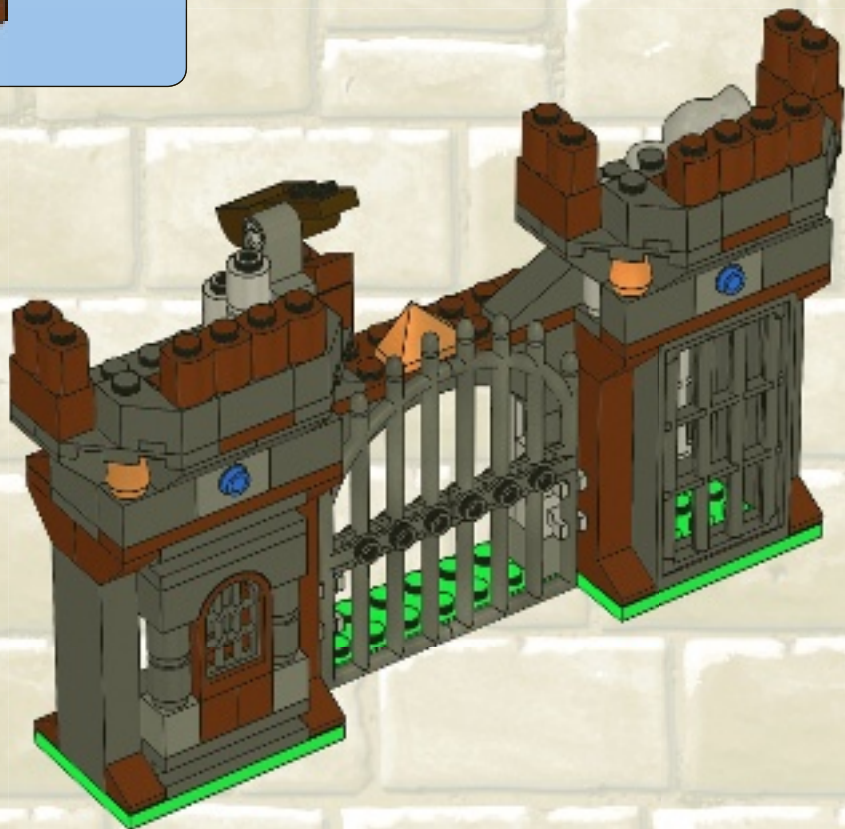



7x

49

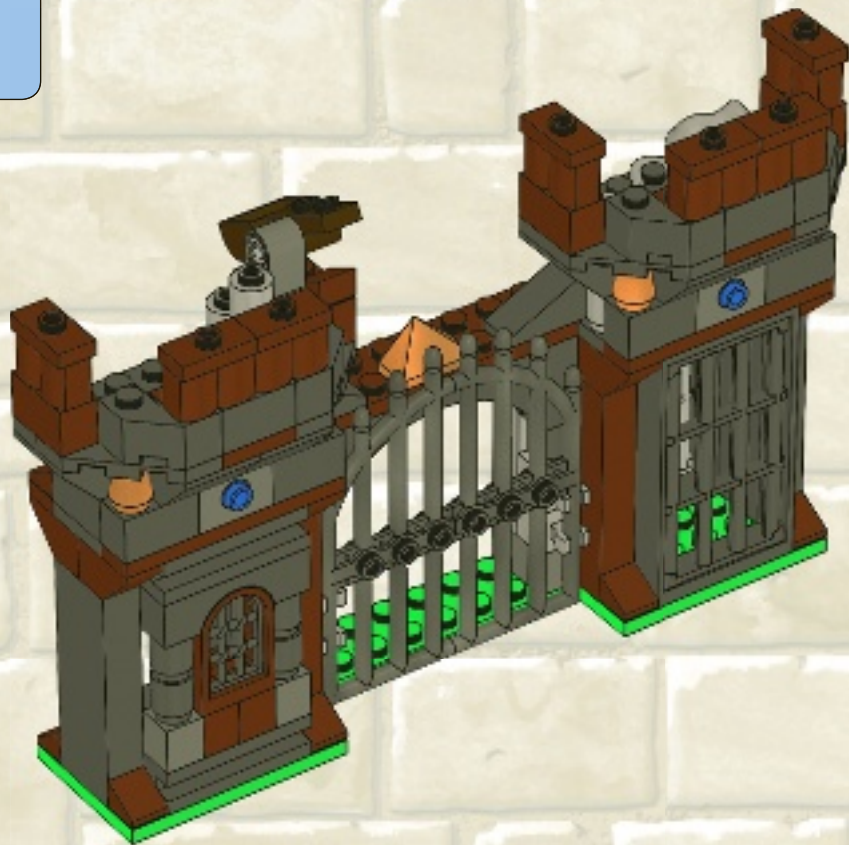





50

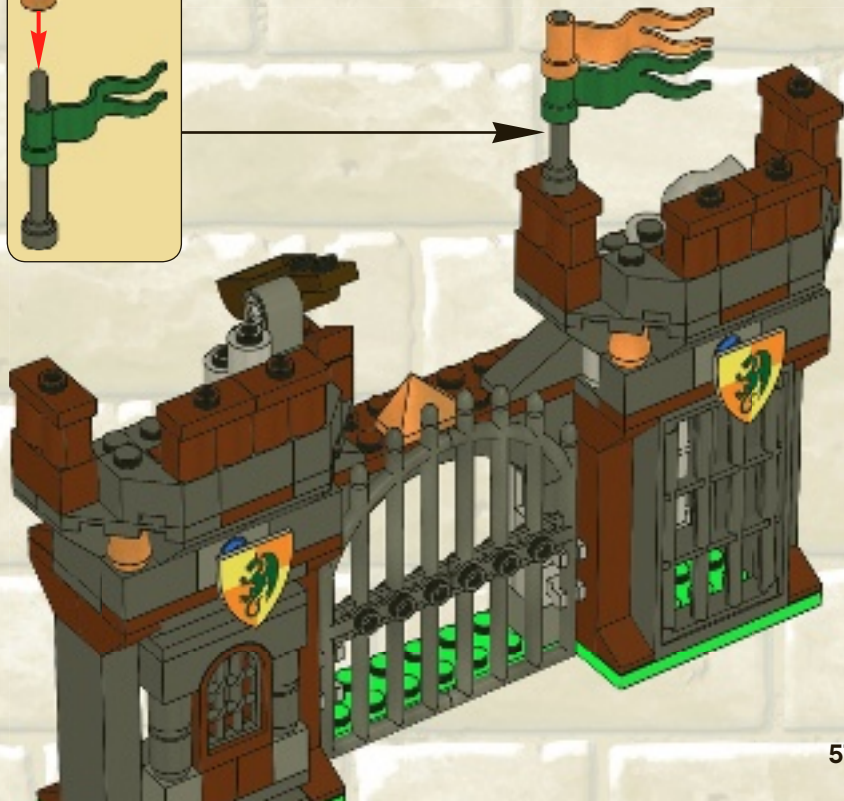
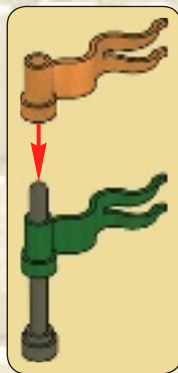

1x  1x 



51

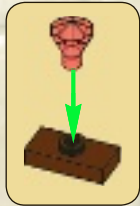
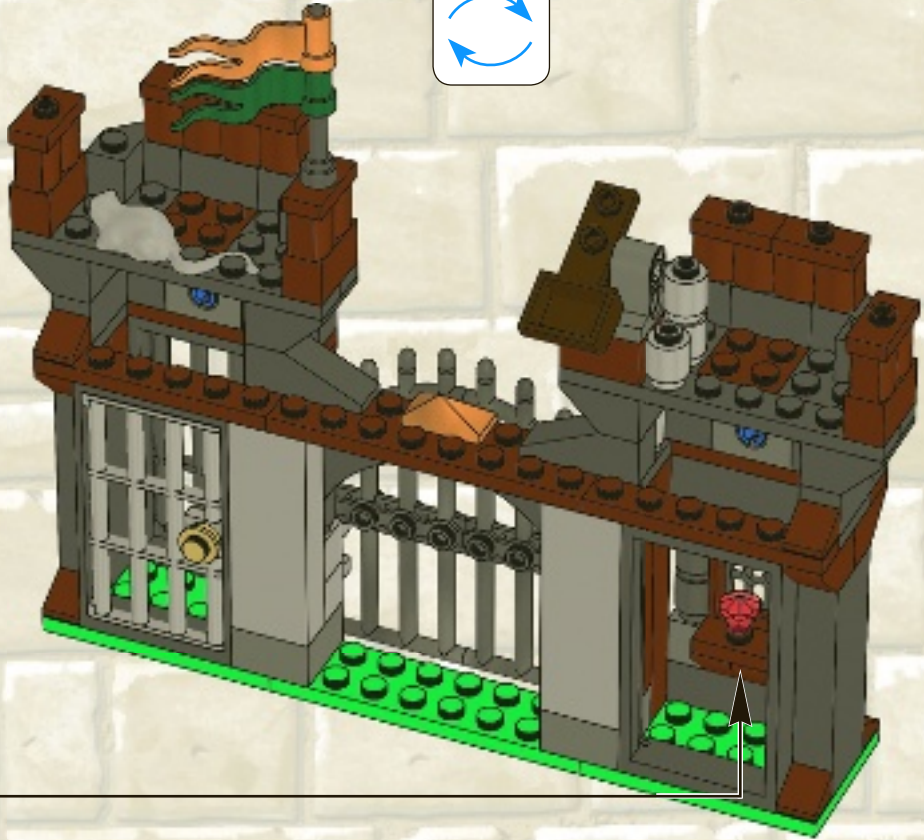







# UNIVERSE

MASSIVELY MULTIPLAYER  
ONLINE GAME



7<sup>TM</sup>

[www.pegi.info](http://www.pegi.info)

EVERYONE 10+<sup>TM</sup>



Cartoon Violence

ESRB CONTENT RATING

[www.esrb.org](http://www.esrb.org)

Online Interactions Not Rated by the ESRB

MEHRSPIELER ONLINE SPIEL • VIDEOJUENGO MULTIJUGADOR MASIVO EN LINEA  
JEU EN LIGNE MASSIVEMENT MULTIOJUEUR • JOGO MULTIJOGADOR ONLINE EM MASSA  
NAGYON SOK SZEREPLŐS ONLINE JÁTEK

[www.LEGOuniverse.com](http://www.LEGOuniverse.com)

WIN  
MAC  
DVD-ROM  
SOFTWARE







# Kingdoms





# Kingdoms



7187

6918

7188





7946



7189





[www.LEGOclub.com](http://www.LEGOclub.com)



LEGO® Club Email



LEGO® Club Magazine

SIGN UP ONLINE!

[www.LEGOclub.com](http://www.LEGOclub.com)



00800 5346 5555\*



1-866-534-6258 • 1-877-518-5346

US & Canada only

Outside continental

**LEGO club**  
**FREE! GRATIS! GRATUIT!**

- \* Freephone. Mobile charges may apply.
- \* Numéro sans frais. Des frais peuvent s'appliquer avec les téléphones cellulaires.
- \* Gebührenfrei, Kosten für Anrufe aus Mobilfunknetzen können abweichen.
- \* Gratis telefoonnummer vanaf vaste lijn.
- \* Det er et gratis nummer, når du ringer fra fasttelefon.
- \* Det är gratis, när du ringer från en fast telefon.
- \* Numéro sans frais. Des frais peuvent s'appliquer avec les téléphones portables.





**YES!** I want to join the LEGO® Club FREE! **OUI!** Je veux m'abonner au LEGO® Club GRATUITEMENT ! **Ja!** Ich möchte Mitglied im kostenlosen LEGO® Club werden.

**Ja!** Ik wil graag GRATIS lid worden van de LEGO® Club. **Ja!** Jeg ønsker å melde meg inn i LEGO® Club gratis! **Ja!** Jag vill gå med i LEGO® Club GRATIS!

First name · Prénom Vorname · Voornaam Fornavn · Förnamn	<input type="text"/>		
Last name · Nom de famille Name · Achternaam · Etternavn · Eftermann	<input type="text"/>		
Date of Birth · Date de naissance Geburtsdag · Geboortedatum Fødselsdato · Fødselsdato	<input type="text"/>	Boy · Garçon · Junge · Jongen · Gutt · Pojk	<input type="checkbox"/>
		Girl · Fille · Mädchen · Meisje Jente · Flicka	<input type="checkbox"/>
Street · Adresse Straße, Hausnr. Straat, huisnr. · Address	<input type="text"/>		
City · Ville Ort · Woonplaats Poststed · Postort	<input type="text"/>	State Prov. County	<input type="text"/>
Zip/Postcode Code Postal · PLZ Postcode Postnummer	<input type="text"/>	Country Pays Land	<input type="text"/>
Email · Courriel E-Mail · E-post	<input type="text"/>		

Mail to: / Poster à:	LEGO® Club P.O. Box 1157 Enfield, CT USA 06083-1157	Send til: 	LEGO® Club Norge Postboks 58 1314 Vøyenenga
Mail to:	LEGO® Club 33 Bath Road Slough SL1 3UF United Kingdom	Skickas till: 	LEGO® Club Sverige Ubox 841 202 29 Malmö
Per Post an:	LEGO® Club Postfach 14 15 D-36243 Niederaula	Poster à:	LEGO® Club 21 rue de la banque 75 002 PARIS FRANCE
Stuur op naar:	LEGO® Club Postbus 40250 3504 AB Utrecht		

Fill in your email address and we will send you a membership confirmation and monthly email newsletters. If you do not wish to receive the newsletters please tick here. Remplis ton adresse e-mail et nous t'enversons une confirmation d'adhésion ainsi que le bulletin e-mail mensuel. Si tu ne désires pas recevoir le bulletin, coche cette case. Vul je e-mailadres in en we sturen je een bevestiging van je lidmaatschap en maandelijks e-mail nieuwsbrieven. Als je geen e-mail wilt ontvangen, kruis dan dit vakje aan.

Ich möchte per E-Mail den monatlichen LEGO Club Newsletter erhalten. Ønsker du at vi skal sende en liten hilsen til barnet ditt for å bekrefte medlemskapet, ber vi deg kryssje av i feltet, samt oppgi e-postadressen som hilsenen skal sendes til. Om du vill att vi ska skicka en bekräftelse på ditt barns medlemskap, ber vi dig sätta ett kryss i rutan och skriva den e-post adress som bekräftelsen ska skickas till.

If you do not wish to receive additional mailings from the LEGO Club please tick here. Si tu ne désires pas recevoir de courrier supplémentaire du Club LEGO, coche cette case. Als je geen verdere post van de LEGO Club wilt ontvangen, kruis dan dit vakje aan.

Om du vill få annan informasjon från LEGO Gruppen, sätt ett kryss här. Dersom du ønsker å motta annen informasjon fra LEGO Gruppen, setter du et kryss her.

The English language version of the magazine can only be mailed to addresses in the US, Canada, the UK, and Republic of Ireland. Club membership is valid for two years and includes free copies of the LEGO Club Magazine and e-mail newsletters. In the US and Canada please allow up to 6 weeks for delivery of your first magazine. In the UK and Republic of Ireland please allow six to 14 weeks for delivery of your first magazine. By signing this form you consent the LEGO Club to use your child's data for LEGO mailings. The data will only be used for LEGO mailings and will not be sold, rented or otherwise disclosed to any company outside the LEGO Company except for disclosure to companies acting as our agents to help us provide services requested by the child. This coupon is valid for one free membership per person, group or organization. Photocopied coupons are accepted. La version française du magazine peut être postée uniquement au Canada. L'abonnement est valide pour 2 ans et inclut des exemplaires gratuits du Magazine LEGO. Aux E.-U. et au Canada, allouer 6 semaines pour la livraison de votre premier magazine. Le remplissage de ce formulaire, vous consentez à ce que LEGO utilise les informations de votre enfant pour des envois postaux de LEGO. L'information sera utilisée uniquement pour des envois postaux par LEGO et ne sera en aucun cas, vendue, louée, échangée ou divulguée à d'autres compagnies autres que la compagnie LEGO, à l'exception des compagnies affiliées qui nous procurent des services auxquels tenant en fait la demande. Formulaires photocopiés acceptés. Mit der folgenden Unterschrift erkläre ich, für mein Kind den Beitritt als Mitglied zum kostenlosen LEGO Club, der von der LEGO GmbH, D-85627 Grasbrunn, betrieben wird. Die Mitgliedschaft beinhaltet die Zusendung des LEGO Club Magazins und kann beiderseits jederzeit beendet werden. Mit der Mitgliedschaft im LEGO Club sind keinerlei Verpflichtungen verbunden. Das deutschsprachige LEGO Club Magazin wird nur an Adressen in Deutschland, Österreich und der Schweiz versendet. Eine Anmeldebestätigung kann nur per E-Mail geschickt werden. Das Magazin erscheint fünfmal jährlich. Daher kann die Zustellung des ersten Heftes bis zu drei Monate dauern. Die Mitgliedschaft ist beidseitig jederzeit kündbar ohne dass Ihnen Kosten entstehen. Sie können der werblichen Nutzung Ihrer Daten jederzeit widersprechen. Kündigung und Widerspruch können Sie anrufen (00900 / 5346 5555, Anruf gebührenfrei, Kosten für Anrufe aus dem Mobilfunknetz können abweichen) oder an die LEGO GmbH senden. Het Nederlandse LEGO Club Magazine kan alleen worden gestuurd naar adressen in Nederland. Het lidmaatschap is 2 jaar geldig en geeft recht op toezending van het gratis LEGO Club Magazine en LEGO Club e-mails. Het eerste magazine zal binnen 12 tot 14 weken toegestuurd worden. Het lidmaatschap kan op ieder moment opgezegd worden en kan na 2 jaar gratis worden verlengd, tenzij LEGO met deze activiteit stopt. Uw gegevens worden uitsluitend gebruikt voor mailings van LEGO en zullen niet worden verkocht, verhuurd of op welke wijze dan ook verstrekt aan derden buiten de LEGO Groep, uitgezonderd de organisaties die namens ons optreden om de informatie te sturen waarvoor toestemming is verleend. Den norske utgaven av magasinet sendes kun til adresser i Norge. Medlemskap i klubben gjelder i 2 år og inkluderer gratisutgaver av LEGO Club Magazine. Pårenge minimum opp til seks ukers leveringstid for første magasin. Ved å undertegne dette skjemaet, gir du ditt samtykke til at LEGO Club kan bruke opplysningene om barnet ditt i LEGO ferdenseliser. Dataene vil utelukkende bli brukt i LEGO ferdenseliser og vil ikke bli solgt, utleiet eller på annen måte geres tilgjengelig for selskaper utenfor LEGO gruppen, unntatt selskaper som er våre agenter og som hjelper oss å tilby tjenestene barnet etterter. Dette skjemaet gjelder for ett gratis medlemskap per person, gruppe eller organisasjon. Den svenska versionen av tidningen kan endast skickas till adresser i Sverige. LEGO-medlemskapet är giltigt i 2 år och innefattar gratis exemplar av LEGO Club Magazine. Vånligen räknat med minimum 6 veckor för leverans av din första tidning. Genom att skicka in det här formuläret godkänner du att LEGO Club använder barnets uppgifter för LEGO utskick. Uppgifterna kommer bara att användas för LEGO utskick och kommer inte att säljas, hyras ut eller vidarebefordras till något företag som inte tillhör LEGO Gruppen, med undantag av företag som agerar som våra ombud för att tillhandahålla tjänster som barnet har begärt. Den här kupongen gäller för ett gratis medlemskap per person, grupp eller organisation. En complétant ce bulletin d'adhésion, vous acceptez que LEGO Club utilise les données relatives à votre enfant pour l'envoi de courriers concernant LEGO. Ces données seront uniquement utilisées pour l'envoi d'information concernant LEGO et ne seront ni vendues, ni louées, ni utilisées par d'autres sociétés que le groupe LEGO, à l'exception des sociétés agissant pour le compte de LEGO en tant que sous-traitant de services divers. L'abonnement au LEGO Club est valable pour une période de 2 ans. Il inclut l'envoi par courrier du magazine LEGO Club et par email des newsletters. Un délai de 6 à 14 semaines est à prévoir pour la réception de votre premier magazine. Ce bulletin d'adhésion gratuit est valable pour l'inscription d'une seule personne. Les photocopies sont acceptées. ATTENTION! Le bulletin d'adhésion doit être rempli et signé par un parent ou un tuteur.

Parent's signature · Signature d'un parent ou d'un tuteur ·  
Unterschrift Erziehungsberechtigter · Handtekening ouders ·  
Foreldres/foresattes underskrift · Förälders /förmyndares underskrift

Date  
Datum  
Date  
Dato



2x  
4211060



1x  
4504649



1x  
4506011



1x  
4623965



1x  
4113954



2x  
4211363



2x  
4211111



1x  
4584762



1x  
4506014



1x  
4623961



2x  
4586334



2x  
4210763



1x  
4161734



1x  
4568951



1x  
4617237



1x  
4623382



5x  
4211412



1x  
4586498



1x  
4586499



1x  
4611879



1x  
4617242



1x  
4520320



1x  
4610149



2x  
4211098



1x  
4622506



2x  
4611883



1x  
4617248



1x  
4211397



2x  
4492335



5x  
4529247



1x  
4583752



2x  
4623336



1x  
4622502



1x  
4211464



1x  
4211807



1x  
4295174



1x  
4587127



1x  
4629841



4x  
4533772



1x  
4512743



**Customer Service**  
**Kundenservice**  
**Service Consommateurs**  
**Servicio Al Consumidor**

[www.lego.com/service](http://www.lego.com/service) or dial





# WIN!

Go to [www.LEGOsurvey.com/product](http://www.LEGOsurvey.com/product) to fill out a survey for a chance to win a cool LEGO® Product.

No purchase necessary.

Open to all residents where not prohibited.



## [www.LEGOsurvey.com/product](http://www.LEGOsurvey.com/product)

### GEWINNE!

Nimm an der Umfrage auf [www.LEGOsurvey.com/product](http://www.LEGOsurvey.com/product) teil und hab die Chance ein cooles LEGO® Produkt zu gewinnen!

Die Teilnahme am Gewinnspiel führt zu keinerlei Kaufverpflichtungen. Teilnahme in allen nicht ausgeschlossenen Ländern möglich.

### WIN!

Ga naar [www.LEGOsurvey.com/product](http://www.LEGOsurvey.com/product), vul een enquêteformulier in en maak kans op een cool LEGO® product.

Geen aankoopverplichting. Iedereen mag deelnemen, uitgezonderd ingezetenden van landen waar een enquêteverbod geldt.

### GAGNE!

Visite [www.LEGOsurvey.com/product](http://www.LEGOsurvey.com/product) pour répondre à un questionnaire et avoir une chance de gagner un produit LEGO® très cool!

Aucune obligation d'achat. Ouvert à tous les résidents des pays autorisés.

### 当てよう!

[www.LEGOsurvey.com/product](http://www.LEGOsurvey.com/product) にアクセスして、アンケートにご記入ください。当選者にはレゴ®製品を差し上げます。

お買い上げの必要はありません。禁止されていない限り、すべての皆様にご利用いただけます。