



THE LEGO MOVIE



70828

- 1
- 2
- 3
- 4
- 5
- 6
- 7
- 8



EN Save this leaflet because it contains important information.

Important information about batteries

Never use different types of batteries together, or a combination of old and new batteries. Always remove the batteries if the product is not to be used for a long time or if the batteries have run down. Never use damaged batteries. Only use batteries of the type recommended, or a corresponding type. Insert the batteries so that the poles are correctly positioned. Rechargeable batteries must be recharged using the correct battery charger under the supervision of an adult. You cannot recharge batteries while they are still in the product, and you must never try to do so. Never attempt to recharge non-rechargeable batteries. Never short-circuit the battery holder.

DE **Wichtige Informationen zu Batterien**

Benutzen Sie niemals unterschiedlich Arten von Batterien oder alte und neue gleichzeitig. Nehmen Sie stets die Batterien heraus, wenn mit dem Modell längere Zeit nicht gespielt wird oder wenn die Batterien leer sind. Verwenden Sie niemals beschädigte Batterien. Verwenden Sie ausschließlich empfohlene bzw. geeignete Batterien. Achten Sie beim Einsetzen der Batterien auf die richtige Polung. Wiederaufladbare Batterien sollten mit einem geeigneten Ladegerät aufgeladen werden - unter der Aufsicht eines Erwachsenen. Wiederaufladbare Batterien können und sollten niemals aufgeladen werden, während sie sich im Modell befinden. Versuchen Sie unter keinen Umständen, „normale“ Batterien wieder aufzuladen. Schließen Sie das Batteriefach niemals kurz.

FR **Informations importantes concernant les piles**

Ne jamais utiliser un mélange de différents types de piles, ou de piles neuves et de piles anciennes ou déjà utilisées. Toujours retirer les piles si le produit n'est pas utilisé durant une période prolongée ou si les piles sont vides. Ne jamais utiliser de piles endommagées. Utiliser uniquement des piles du type recommandé ou d'un type équivalent. En insérant les piles, respecter scrupuleusement le sens d'orientation des pôles (+/-). Les piles rechargeables doivent être rechargées en utilisant un chargeur de piles adéquat et sous la surveillance d'un adulte. Il est impossible de recharger les piles quand elles sont installées dans le produit. Ne jamais tenter de le faire. Ne jamais essayer de recharger des piles non-rechar- geables. Ne jamais court-circuiter le compartiment des piles.

IT **Salvare questo foglio perché contiene importanti informazioni.**

Importanti informazioni sulle batterie

Non usare mai contemporanea- mente batterie di tipo diverso o batterie nuove e usate insieme. Rimuovere sempre le batterie qualora il prodotto non venga utilizzato per periodi prolungati, oppure se le batterie sono esauste. Non utilizzare mai batterie danneggiate. Usare esclusivamente batterie del tipo raccomandato o un equivalente. Inserire le batterie avendo cura che la loro polarità sia corretta. Le batterie ricaricabili vanno ricaricate in un caricabatterie di tipo idoneo e con la supervisione di un adulto. Non è possibile e non bisogna mai tentare di ricaricare le batterie mentre queste sono inserite nel prodotto. Non tentare mai di ricaricare batterie non ricaricabili. Non cortocircuitare mai il portabatterie.

NL **Belangrijke informatie over batterijen**

Gebruik nooit verschillende soorten of een combinatie van oude en nieuwe batterijen tegelijkertijd. Verwijder de batterijen altijd als je het product lange tijd niet wilt gebruiken of als batterijen leeg zijn. Gebruik nooit beschadigde batterijen. Gebruik uitsluitend batterijen van het aanbevolen type of een overeenkomstig type. Plaats de batterijen met de polen in de juiste richting. Opladbare batterijen moeten in een voor dit doel bestemde oplader en onder toezicht van een volwassene opnieuw worden opgeladen. Opladbare batterijen kunnen niet worden opgeladen terwijl ze zich nog in het product bevinden en dit mag ook niet worden geprobeerd. Probeer nooit niet-oplaadbare batterijen opnieuw op te laden. Laat de batterijhouder nooit kortsluiten.

ES **Información importante acerca de las pilas**

No use pilas de diferentes tipos ni pilas nuevas y antiguas para alimentar el producto. Extraiga las pilas del producto si este va a permanecer sin uso durante un período prolongado de tiempo o aquellas se han agotado. No use pilas dañadas. Use sólo pilas del tipo recomendado u otro equivalente. Inserte las pilas de modo que los polos queden situados en las posiciones correctas. La carga de pilas recargables debe tener lugar empleando un cargador apropiado y bajo la supervisión de un adulto. Las pilas recargables no se pueden cargar mientras permanecen insertadas en el producto; no intente hacerlo. No trate de cargar pilas no recargables. No cortocircuite el compartimento de las pilas.

DA **Vigtige oplysninger om batterier**

Brug aldrig forskellige batterityper sammen eller en kombination af gamle og nye batterier. Fjern altid batterierne, hvis produktet ikke skal bruges i lang tid, eller hvis batterierne er flade. Brug aldrig beskadigede batterier. Brug kun den anbefalede type batterier eller en tilsvarende type. Sæt batterierne i, så polerne vender den rigtige vej. Genopladelige batterier skal oplades i den rigtige batterioplader. Batterierne skal sættes i opladeren under opsyn af en voksen. Batterierne kan ikke oplades, mens de stadig sidder i produktet, og man må aldrig forsøge at gøre det. Forsøg aldrig at oplade ikke-genopladelige batterier. Kortslut aldrig batteriholderen.

IS **Mikilvægar upplýsingar um rafhlöður**

Aldrei skal nota mismunandi gerðir rafhláðna samtímis, né nýjar og eldri rafhlöður samtímis. Ef ekki á að nota tækið í lengri tíma eða ef rafhlöðurnar eru orðnar tómar skal fjárlægja rafhlöðurnar. Aldrei skal nota rafhlöður sem hafa skemmst. Aðeins skal nota rafhlöður af þeirri gerð sem mælt er með, eða samsvarandi gerð. Setja skal rafhlöðurnar í þannig að +- og -skaut þeirra snúi rétt. Endurhláðanlegar rafhlöður skal endurhláða með réttu hléslutæki undir eftirliti fullorðinna. Rafhlöður er ekki hægt að endurhláða á meðan þær eru enn í vörunni og það má aldrei reyna að gera það. Aldrei skal reyna að endurhláða rafhlöður sem ekki eru endurhláðan -legar. Aldrei ætti að valda skammhlaupi í rafhlöðuhólfinu.

FI **Tärkeää tietoa paristoista**

Älä koskaan käytä erityyppisiä paristoja yhdessä. Älä myöskään käytä samassa laitteessa sekä vanhoja että uusia paristoja. Poista paristot tuotteesta aina, kun se on pitemmän aikaa käyttämättä, tai kun paristot ovat tyhjentyneet. Älä koskaan käytä viallisia paristoja. Käytä vain tuotteessa suositeltuja tai vastaavantyyppisiä paristoja. Aseta paristot siten, että navat osoittavat oikeaan suuntaan. Ladattavat paristot on ladattava oikeanlaisella laiturilla aikuisen valvonnassa. Ne on poistettava tuotteesta lataamisen ajaksi. Älä koskaan yritä ladata paristoja, joita ei ole tarkoitettu ladattaviksi. Älä koskaan aiheuta oikosulkuja pariston kosketinten välillä.

SV **Viktig information om batterier**

Använd aldrig olika sorters batterier samtidigt, och inte heller en kombination av gamla och nya batterier. Ta alltid ur batterierna om produkten inte ska användas under en längre tid eller om batterierna är slut. Använd aldrig skadade batterier. Använd bara batterier av den typ som rekommenderas, eller av en motsvarande typ. Sätt i batterierna så att polerna hamnar i rätt läge. Laddningsbara batterier måste laddas med rätt slags batteriladdare och under en vuxens överinseende. Du kan inte ladda batterierna medan de fortfarande sitter i produkten, och du får heller aldrig försöka göra det. Försök aldrig ladda icke laddningsbara batterier. Kortslut aldrig batteriutrymmets kontaktytor.

NO **Viktig informasjon om batterier**

Bruk aldri ulike typer batterier sammen og heller aldri gamle og nye batterier sammen. Ta alltid ut batteriene hvis produktet ikke skal brukes på lang tid, eller hvis batteriene er brukt opp. Bruk aldri skadde batterier. Bruk kun anbefalt type batterier eller tilsvarende type. Sett inn batteriene med polene vendt riktig vei. Opppladbare batterier skal lades opp med riktig batterilader, under overoppsyn av en voksen. Det er ikke mulig å lade opp batteriene mens de fremdeles er i produktet, og du må aldri forsøke å gjøre det. Forsøk aldri å lade opp ikke-oppladbare batterier. Kortslett aldri batteriholderen.

PT **Guardar este folheto por conter informações importantes.**

Informação importante sobre as pilhas

Nunca use diferentes tipos de pilhas em simultâneo, ou uma combinação de pilhas usadas e novas. Retire sempre as pilhas se o produto não for usado durante muito tempo ou se as pilhas já não tiverem carga. Nunca use pilhas danificadas. Use apenas pilhas do tipo recomendado ou de um tipo correspondente. Insira as pilhas de forma a que os pólos fiquem corretamente posicionados. As pilhas recarregáveis devem ser recarregadas com o carregador de pilhas correto e sob a supervisão de um adulto. Não pode recarregar as pilhas enquanto as mesmas se encontram colocadas no produto e nunca deve tentar fazê-lo. Nunca tente recarregar pilhas não recarregáveis. Nunca deixe o compartimento das pilhas entrar em curto-círcuito.

EL **Σημαντικές πληροφορίες για τις μπαταρίες**

Μην χρησιμοποιείτε ποτέ διαφορετικούς τύπους μπαταριών μαζί και μην συνδυάζετε παλιές και καινούργιες μπαταρίες. Αφαιρείτε πάντα τις μπαταρίες αν δεν σκοπεύετε να χρησιμοποιήσετε το προϊόν για αρκετό καιρό ή αν οι μπαταρίες έχουν αδειάσει. Ποτέ μην χρησιμοποιείτε μπαταρίες που έχουν φθορές. Χρησιμοποιείτε μόνο μπαταρίες του ουσιασμένου τύπου ή κάποιου αντίστοιχου τύπου. Τοποθετήστε τις μπαταρίες με τους πόλους στη σωστή θέση. Οι επαναφορτιζόμενες μπαταρίες πρέπει να επαναφορτίζονται χρησιμοποιώντας το σωστό φορτιστή μπαταριών υπό την επίβλεψη ενηλίκου. Δεν μπορείτε να επαναφορτίσετε τις μπαταρίες όταν αυτές βρίσκονται μέσα στο προϊόν και δεν πρέπει ποτέ να δοκιμάσετε κάτι τέτοιο. Μην επιχειρήσετε ποτέ να επαναφορτίσετε μη επαναφορτιζόμενες μπαταρίες. Ποτέ μην βραχυκυκλώνετε τη θήκη των μπαταριών.

JA **電池取扱いに関する重要事項**

異なるタイプの電池や古い電池を混ぜて使用しないでください。商品を長時間使用しないときや電池が切れたときは、電池を必ず取り外してください。不具合のある電池は 絶対に使用しないでください。推奨されているタイプまたは対応しているタイプの電池を必ず使用してください。電極を確認して電池を正しい向きに入れてください。充電式電池は、保護者に見てもらった上で適切な充電器を使って充電してください。電池を商品の中に入れてまま充電することは絶対に避けてください。充電式ではない電池は絶対に充電しないでください。電池ホルダをショートさせないでください。

ZH **该包装含重要信息应保留。**

关于电池的重要信息

请勿同时使用不同类型的电池，或把新旧程度不同的电池混合使用。如果产品将有很长时间不会使用，或者电池已经没电，请注意取出电池。切勿使用已破损的电池。务必仅使用推荐类型或兼容类型的电池。装入电池时请注意正负极。如果使用充电电池，请务必在成人监护下使用正确的电池充电器进行充电。电池仍在产品中时不可进行充电，请勿强行尝试充电。请勿尝试给非充电电池充电。切勿对电池仓进行短路连接。

KO **배터리 사용 시 주의사항**

다른 종류의 배터리를 함께 사용하거나, 새 전지와 오래된 전지를 혼용하지 마세요. 배터리가 방전되었거나 장기간 제품을 작동하지 않을 때에는 반드시 배터리를 분리하세요. 파손된 배터리는 사용하지 마세요. 레고에서 권장하는 유형의 배터리만 사용하세요. 양극과 음극의 위치를 잘 맞춰서 넣으세요. 어른의 감독에 따라 지정된 충전기에 충전지를 충전해야 합니다. 충전지를 제품에 넣은 상태로 충전하면 안 됩니다. 일반 배터리는 충전해서 사용하지 수 없습니다. 배터리 홀더의 접촉부에 배터리를 정확히 끼워서 사용하세요.

RU **Необходимая информация об элементах питания**

Ни в коем случае не используйте одновременно элементы питания различных типов, а также элементы питания с разным сроком годности. В обязательном порядке вынимайте элементы питания из терминалов в случае, если вы не пользуетесь прибором в течение долгого времени, либо в случае, если в элементах питания закончился заряд. Ни в коем случае не используйте поврежденные элементы питания. Используйте только рекомендуемые элементы питания либо элементы питания соответствующего типа. Установите элементы питания, соблюдая указанную полярность. Аккумуляторные элементы питания должны подзаряжаться в соответствующем зарядном устройстве под наблюдением взрослого. Ни в коем случае не пытайтесь подзаряжать элементы питания, находящиеся в приборе. Ни в коем случае не пытайтесь подзаряжать неперезаряжаемые элементы питания. Ни в коем случае не пытайтесь замкнуть полюса в устройстве для элементов питания.

PL

Ważne informacje dotyczące baterii

Nigdy nie należy stosować razem różnych rodzajów baterii ani stosować równocześnie starych i nowych baterii. Jeżeli produkt nie jest używany przez dłuższy czas lub jeżeli baterie się wyczerpały, należy wyjąć baterie. Nigdy nie należy stosować uszkodzonych baterii. Należy stosować wyłącznie zalecany rodzaj baterii lub rodzaj mu odpowiadający. Przy wkładaniu baterii należy zwrócić uwagę na właściwe położenie biegunów. Baterie akumulatorowe należy ładować w odpowiedniej ładowarce pod nadzorem osoby dorosłej. Nie można naładować baterii bez wyjścia ich z produktu i nigdy nie należy tego próbować. Nigdy nie należy próbować ładowania baterii jednorazowych. Nigdy nie należy doprowadzać do zwarcia w gnieździe baterii.

CZ

Důležité informace o bateriích

Nikdy nepoužívejte najednou různé typy baterií nebo kombinaci starých a nových baterií. Nebude-li se výrobek delší dobu používat nebo jsou-li baterie vybité, vždy je vyjměte z výrobku. Nikdy nepoužívejte poškozené baterie. Používejte pouze doporučené nebo odpovídající typy baterií. Baterie instalujte se správnou orientací pólu. Nabíjitelné baterie musí být nabity ve vhodné nabíječce pod dohledem dospělé osoby. Nabíjitelné baterie nelze nabíjet, jsou-li umístěny ve výrobku, a nesmíte se o to ani pokoušet. Nikdy se nesnažte nabíjet baterie, které nejsou nabíjitelné. Nikdy neskratujte kontakty v prostoru pro baterie.

SK

Dôležitá informácia o batériách

Nikdy nepoužívajte naraz odlišné typy batérií ani nekombinujte staré batérie s novými. Batérie vždy vyberte, ak sa výrobok nebude dlhšie používať, alebo ak sa batérie vybili. Nikdy nepoužívajte poškodené batérie. Používajte jen odporúčané alebo zodpovedajúce typy batérií. Batérie vkladajte so správnou orientáciou pólov. Nabíjateľné batérie sa musia nabíjať vo vhodnej nabíjačke pod dozorom dospelej osoby. Nabíjateľné batérie sa nesmú nabíjať, ak sú umiestnené vo výrobku, a nesmiete sa o to ani pokúšať. Nikdy sa nesnažte nabíjať batérie, ktoré nie sú nabíjateľné. Nikdy neskratuje kontakty v priestore pre batérie.

HU

Fontos tudnivalók az elemekről

Soha ne használjon különbözô típusú elemeket, illetve ne használjon vegyesen új és használt elemeket. Mindig távolítsa el az elemeket, ha a készülékelt előre láthatóan hosszabb ideig nem fogják használni, vagy ha az elemek lemerültek. Soha ne használjon megrongálódott elemeket. Csak az ajánlott típusú, vagy annak megfelelő elemet használjon. Az elemeket helyesen helyezze be, a polaritásuknak megfelelően. Az akkumulátorokat csak a megfelelő akkumulátor- töltővel szabad feltölteni, feltölt felügyelete mellett. Az akkumulá- torokat nem lehet feltölteni, ha azok a készülékben vannak. Ezt meg sem szabad próbálni. Soha ne próbálja meg feltölteni a nem tölthető elemeket. Soha ne hozzon létre rövidzárlatot az elemtartó kivezetéséin.

UA

Необхідна інформація про батарейки

Ніколи не використовуйте одночасно батарейки різних типів або батарейки з різним терміном придатності. Обов'язково вилучайте батарейки з приладу, якщо довго не користуєтесь ним, або якщо в батарейках вже скінчився заряд. Ніколи не використовуйте пошкоджені батарейки. Використовуйте батарейки лише рекомендованого або відповідного типу. Вставляйте батарейки, враховуючи задану полярність. Акумуляторні батарейки повинні заряджатись у відповідному зарядному приладі під наглядом дорослого. В будь-якому випадку не намагайтеся підзарядити батарейки, що знаходяться в приладі. В будь-якому випадку не намагайтеся підзарядити батарейки, що не підлягають підзарядці. В будь-якому випадку не намагайтеся зробити коротке замикання в приладі для батарей.

HR

Važne obavijesti o bateriji

Nikada nemoj koristiti različite vrste baterija zajedno, isto tako ni kombinaciju starih i novih baterija. Uvijek izvadite baterije ako dugo nečes koristiti proizvod ili ako su one potrošene. Nikada nemoj koristiti oštećene baterije. Koristi samo preporučenu vrstu ili odgovarajuću vrstu baterija. Umetni baterije pazeci da dobro okreneš polove. Akumulatorske se baterije moraju puniti uz pomoć propisanog punjača i uz nadzor odrasle osobe. Baterije se ne smiju puniti dok su još u proizvodu i to nikada nemoj pokušavati. Nikada ne pokušavaj puniti baterije koje nisu predviđene za punjenje. Nikada ne izazivaj kratki spoj u držaču baterija.

SR

Важне информације о батеријама

Никада не користите различите типове батерија заједно нити комбинацију старих и нових батерија. Увек извадите батерије уколико производ нећете дуже време користити или уколико су батерије празне. Никада не користите оштећене батерије. Употребљавајте само препоручени тип батерија или одговарајућу замену. Ставите батерије тако да су у полови правилно позиционисани. Батерије на пуњење се морају пунити одговарајућим пуњачем под надзором одраслог лица. Није могуће пунити батерије док су у производу и никад не покушавајте да радите то. Никада не покушавајте да пуните батерије које не могу да се пуне. Никада не изазивајте кратак спој у куишту за батерије.

MK

Важни информации за батериите

Никогаш не користете различити типови батерии заедно или комбинација од стари и нови батерии. Секогаш отстранувајте ги батериите доколку не го користите производот подолго време или доколку се потрошиле. Никогаш не користете оштетени батерии. Користете ги само препорачаните батерии или батерии од соодветен тип. Вметнете ги батериите така што точно ќе ги наместите половите. Батериите на полнење мора да се полнат со соодветниот полнач под надзор на возрастно лице. Не може да ги полните батериите додека сè уште се наоѓаат во производот и никогаш не смеете да го правите тоа. Никогаш не обидувајте се да ги полните батериите за еднократна употреба. Никогаш не предизвикувајте краток spoj на држачот за батерии.

SL

Pomembne informacije o baterijah

Nikoli ne uporabljajte skupaj različnih baterij ali kombinacije starih in novih baterij. Vedno odstranite baterije, če izdelka dlje časa ne boste uporabljali ali če so iztrošene. Nikoli ne uporabljajte poškodovanih baterij. Uporabljajte le baterije priporočenega ali ustreznega tipa. Baterije vstavite tako, da so njihovi poli pravilno obrnjeni. Akumulatorske baterije je treba polniti s pravim polnilnikom pod nadzorom odrasle osebe. Akumulatorskih baterij ni mogoče polniti, dokler so še v izdelku. Tega tudi ne smete poskušati. Nikoli ne poskušajte polniti baterij, ki niso akumulatorske. Pazite, da ležišč za baterije ne boste spravili v kratek stik.

RO

Informații importante despre baterii

Nu folosiți niciodată împreună tipuri diferite de baterii, sau o combinație de baterii vechi și noi. Îndepărtați întotdeauna bateriile dacă produsul nu este folosit timp îndelungat sau dacă bateriile s-au epuizat. Nu folosiți niciodată baterii deteriorate. Folosiți numai baterii de tipul recomandat, sau un tip corespunzător. Introduceți bateriile astfel ca poli să fie poziționați corect. Bateriile reincărcabile trebuie reincărcate utilizând încărcătorul corect sub supravegherea unui adult. Nu puteți reincărca bateriile în timp ce acestea sunt încă în produs, și niciodată nu trebuie să încercați să faceți acest lucru. Nu încercați niciodată să reincărcați baterii nereîncărcabile. Nu scurtcircuitați niciodată suportul bateriei.

BG

Важна информация за батериите

Никога не използвайте едновременно различни типове батерии или комбинация от стари и нови батерии. Винаги изваждайте батериите, ако izdelieto няма да се използва продължително време или ако батериите са се изтозили. Никога не използвайте повредени батерии. Използвайте само батерии от препоръчвания тип или съответстващ на него тип. Поставете батериите така, че полюсите да са разположени правилно. Акумуляторните батерии трябва да се зареждат с подходящо зареждащо устройство под надзора на възрастни. Батериите не могат да се зареждат, докато са поставени в izdelieto, затова никога не опитвайте да правите това. Никога не опитвайте да зареждате батерии, които не са акумулаторни. Никога не свързвайте на късо контактите на отделението за батериите.

LV

Saglabājiet šo brošūru, jo tajā ir sniegta svarīga informācija.

Svarīga informācija par baterijām

Nekad vienlaikus nelietojiet dažādu tipu, kā arī vecas un jaunās baterijas. Vienmēr iznemiet baterijas, ja tās ir izlādējušas vai ja produkts ilgāku laiku netiek lietots. Nekad nelietojiet bojātas baterijas. Lietojiet tikai ieteicamā tipa vai atbilstoša tipa baterijas. Ievietojot baterijas, ievērojiet pareizu polaritāti. Uzlādējumu bateriju lādēšanai izmantojiet atbilstošu bateriju lādētāju; uzlāde jāveic pieaugušo uzraudzībā. Baterijas nevar uzlādēt un nekad nedrīkst mēģināt uzlādēt, kamēr tās ievietotas produktā. Nekad nemēģiniet uzlādēt baterijas, kas nav uzlādējamas. Nepieļaujiet issavienojumu bateriju nodalījumā.

ET

Oluline teave patareide kohta

Ära kunagi kasuta koos erinevat tüüpi patareisid, samuti vanu ja uusi patareisid. Kui mänguasja ei kasutata pika aja jooksul, võta patarei sellest välja. Ära kunagi kasuta kahjustatud patareisid. Kasuta ainult ettenähtud tüüpi või nendega samaväärseid patareisid. Pane patareid mänguasja sisse nii, et pluss- ja miinusleemmi asend oleks õige. Akusid tuleb laadida ainult neile ettenähtud akulaadija abil täiskasvanu järelvalve all. Akusid ei saa laadida sel ajal, kui need on mänguasja sees. Ära kunagi püüa nii teha. Ära kunagi proovi akulaadijaga laadida tavalisi patareisid. Patareipesa klemmide vahel ei tohi tekkida lühist.

LT

Svarbi informacija apie elementus

Vienu metu nenaudokite skirtingų elementų, taip pat su naujais elementais nenaudokite senų. Jei nenaudosite gaminio ilgesnį laiką arba jei elementai išseko, visumomet išimkite juos iš gaminio. Niekada nenaudokite pažeistų elementų. Naudokite tik rekomenduojamo arba atitinkamo tipo elementus. Elementus dėkite atsižvelgdami į jų poliškumą. Elementus galima įkrauti tik tinkamu krovikliu ir prižiūrint suaugusiesiems. Jokiū būdu negalima, ir niekuomet nebandykite, įkrauti elementų neišėjus jų iš gaminio. Niekada nebandykite įkrauti vienkartinių elementų. Saugokitės, kad elementų įdėkle nesukeltumėte trumpojo jungimo.

TR

Piller hakkında önemli bilgiler

Hiçbir zaman farklı tipte pilleri ya da eski pillerle yeni pilleri bir arada kullanmayın. Ürün uzun süre kullanılmayacaksa ya da piller bitmişse, pilleri ürünün içinden çıkarın. Hiçbir zaman zedelenmiş piller kullanmayın. Sadece önerilen tipte piller ya da bunların dengi olan piller kullanın. Pilleri kutularını doğru konumda olacak şekilde yerleştirin. Şarj edilebilen pilleri doğru pil şarj aletini kullanarak, bir yetiştikinin denetiminde şarj edin. Şarj edilebilen pilleri, pil ürünün içindeyken şarj edemezsiniz bunu hiçbir zaman yapmaya çalışmayın. Hiçbir zaman, şarj edilebilir olmayan pilleri şarj etmeye çalışmayın. Hiçbir zaman pil kutusuna kısa devre yaptırmayın.

AR

معلومات مهمة عن البطاريات
يُحظر استخدام أنواع مختلفة من البطاريات معًا أو مزيج من البطاريات القديمة والجديدة.
احرص دائمًا على نزع البطاريات في حال عدم استخدام المنتج لفترة طويلة أو إذا نفذت طاقة البطاريات.
جنب استخدام البطاريات التالفة.
لا تستخدم إلا نوع البطاريات الموصى به أو نوع متماثل.
قم بتريكيب البطاريات بحيث تكون الأقطاب في موضعها الصحيح.
يجب إعادة شحن البطاريات القابلة لإعادة الشحن باستخدام شاحن البطاريات المناسب وذلك تحت إشراف شخص بالغ.
لا يمكن إعادة شحن البطاريات وهي لا تزال داخل المنتج.
ويجب ألا تجرب فعل ذلك.
يُحظر إعادة شحن البطاريات غير القابلة لإعادة الشحن.
جنب إحداث دائرة قصر في حامل البطارية.

ID

Informasi penting tentang baterai

Jangan gunakan baterai yang jenisnya berlainan, atau mencampur baterai lama dan baterai baru. Lepas baterai jika produk tidak akan digunakan untuk waktu lama atau jika baterai sudah lemah. Jangan gunakan baterai yang rusak. Gunakan jenis baterai yang dianjurkan atau yang sejenis. Masukkan baterai dengan posisi kutub yang tepat. Baterai isi ulang harus diisi ulang dengan charger baterai yang sesuai dan di bawah pengawasan orang dewasa. Anda tidak dapat mengisi ulang baterai saat masih terpasang di dalam produk, dan jangan pernah coba melakukannya. Jangan pernah coba mengisi ulang baterai biasa. Jangan pernah membuat arus pendek pada dudukan baterai.

MS

Maklumat penting tentang bateri

Jangan guna jenis bateri yang berbeza bersama-sama, atau gabungan bateri baharu dan lama. Tanggalkan bateri jika produk tidak akan digunakan untuk tempoh masa yang lama atau jika bateri telah kehabisan kuasa. Jangan guna bateri yang rosak. Hanya guna jenis bateri yang disyorkan, atau jenis yang berkaitan. Selitkan bateri supaya supaya paksi berada pada kedudukan yang betul. Bateri yang boleh dicaskan semula perlu dicas semula menggunakan pengecas bateri yang betul bawah pengawasan orang dewasa. Anda tidak boleh mengecap bateri semasa bateri masih berada pada produk, dan anda jangan cuba berbuat demikian. Jangan cuba untuk mengecap semula bateri yang tidak boleh dicaskan semula. Jangan pintas litar pemegang bateri.



EN Protect the environment by not disposing of this product with your household waste. Check with your local authority for recycling advice and facilities.

DE Schützen Sie die Umwelt und entsorgen Sie dieses Produkt nicht mit Ihrem Hausmüll. Informationen zu Recycling-Möglichkeiten erhalten Sie bei den örtlichen Behörden.

FR Protégez l'environnement : ne jetez pas ce produit avec vos autres déchets ménagers. Contactez les autorités locales pour obtenir des informations sur le recyclage et connaître les points de collecte.

IT Proteggi l'ambiente! Non smaltire questo prodotto con i rifiuti domestici. Per consulenza sul riciclaggio dei rifiuti e le strutture di riciclaggio, rivolgersi alle proprie autorità locali.

NL Bescherm het milieu: gooi dit product niet samen met het andere huishuiswieg. Raadpleeg de plaatselijke instanties voor locaties van milieustations en advies over hergebruik.

ES Proteja el medio ambiente no deshaciéndose de este producto junto con sus residuos domésticos. Solicite asesoramiento e información sobre instalaciones de reciclaje a las autoridades locales.

DA Beskyt miljøet! Smid ikke dette produkt ud sammen med husholdningsaffaldet. Få vejledning om genbrug og genbrugsstationer hos din kommune.

IS Stuðlið að umhverfisvernd með því að farga þessari vöru ekki með heimilissorpi. Leiðið upplýsinga um endurvinnslu- og förgunarstaði hjá yfirvöldum á hverjum stað.

FI Tämä tuote on hävittettävä ympäristöstävällisesti ja erillään muusta talousjätteestä. Tietoja kierrätyskesästä ja keräyspisteiden sijainnista saat paikallakuntasi teknisestä virastosta.

SV Skydda miljön genom att inte kasta denna produkt bland ditt hushållsavfall. Kontakta din kommun för frågor om återvinning och miljöstationer.

NO Beskytt miljøet. Ikke kast dette produktet i husholdningsavfallet. Kontakt kommunen for veiledning om gjenbruk og miljøstasjoner.

PT Proteja o ambiente não eliminando este produto com o seu lixo doméstico. Consulte as autoridades locais para informação sobre reciclagem e sistemas de recolha.

EL Προστατέψτε το περιβάλλον. Μην πετάτε αυτό το προϊόν μαζί με τα συνηθισμένα οικιακά απορρίμματα. Επικοινωνήστε με τις τοπικές αρχές σχετικά με συμβουλές και εγκαταστάσεις ανακύκλωσης.

JA 環境保護のため、本製品は家庭ごみとは別に処分してください。リサイクルに関する指示や施設については、お住まいの地方自治体にお問い合わせください。

ZH 注意保护环境，请勿将本产品与生活垃圾一起丢弃处理。请咨询当地相关部门，了解与回收相关的设施与建议。

KO 환경 보호를 위해 이 제품을 생활폐기물과 함께 버리지 마십시오. 재활용 방법 및 시설에 관한 사항은 현지 관계 당국에 문의하십시오.

RU Позаботьтесь об окружающей среде: не утилизируйте этот продукт вместе с бытовым мусором. Узнайте в органах местного самоуправления правила вторичной переработки и утилизации таких отходов.

PL Aby chronić środowisko naturalne, nie należy wyrzucać tego produktu wraz z odpadkami z gospodarstwa domowego. W celu uzyskania wskazówek dotyczących recyklingu oraz adresów zakładów należy skontaktować się z lokalnym urzędem.

CZ Nevyhazujte tento produkt do domácího odpadu, chráňte životní prostředí. Zjistěte si prosím u místních úřadů možnosti recyklace a dostupná zařízení.

SK Nevyhazujte tento produkt do domáceho odpadu, chráňte životné prostredie. Zistite si na miestnych úradoch možnosti recyklácie a dostupné zariadenia.

HU Környezetét óvja, ha ettől a terméktől nem a háztartási hulladékkal együtt válik meg. Érdeklődjék a lakóhelyéhez közel eső hatóságnál az újrahasznosítás módjáról és lehetőségeiről.

UA Допоможіть захистити довкілля: не утилізуйте цей виріб разом із побутовим сміттям. Вказівки з утилізації та відомості про пункти прийому з'ясуєте в місцевих компетентних органах.

HR Zaštitite okoliš tako da ovaj proizvod ne odložite u otpad zajedno s kućanskim otpadom. Od lokalnih vlasti zatražite savjet ili informacije o rogonima za recikliranje.

SR Zaštitite životnu sredinu tako što nećete da odlažete ovaj proizvod sa kućnim otpadom. Raspitajte se kod lokalnog nadležnog organa o načinu reciklaže i o sabirnom centru.

MK Zaštitete ja okolinata taka što nema da se oslobodite od proizvodot so domašniot otpad. Konsultirajte se so lokalnite vlasti za da doznaete za sovetite i objektive za recikliranje.

SL Zaščitite okolje! Okolje varujte tako, da tega izdelka ne zavržete skupaj z gospodinjiskimi odpadki. Pri krajevni upravi preverite, kakšne možnosti in kateri obrati za recikliranje obstajajo v vaši okolici.

RO Protejați mediul inconjurător și nu vă debarașiți de acest produs împreună cu deșeurile menajere. Consultați autoritățile locale pentru îndrumări și facilități de reciclare.

BG Защитете околната среда и не изхвърляйте този продукт заедно с битовите си отпадъци. Свържете се с местните власти относно съвети и съоръжения за рециклиране.

LV Lai saudzētu vidi, neizmetiet šo izstrādājumu kopā ar sadzīves atkritumiem. Vērsieties vietējās varas iestādēm, lai noskaidrotu, kur un kā tas nododams pārstrādei.

ET Keskkonda saate kaitsta nii, et ei kõrvalda seda toodet koos olmejäätmetega. Nõuandeid toote taaskasutusse võtmise ja ümbertöötlemispunktide kohta saate asjaomaset kohalikult asutuselt.

LT Saugokite aplinką: nemeskite šio produkto kartu su buitinių atliekomis. Atsižvelkite į savo vietos valdžios rekomendacijas dėl pakartotinio panaudojimo ir sąlygas.

TR Bu ürünü, evsel atıklarla birlikte atmayarak çevreyi koruyun. Geri dönüşüm tavsiyeleri ve tesisler hakkında bilgi için yerel yönetimle iletişim kurun.

AR احوم البيئة بعدم التخلص من هذا المنتج مع الخلفات المنزلية. استفسر السلطة المحلية لديك للحصول على نصح بخصوص إعادة تدوير الخلفات ومراقفه.

ID Jagalah lingkungan dengan tidak membuang produk ini bersama sampah rumah tangga Anda. Periksa peraturan pemerintah setempat tentang saran dan fasilitas daur ulang.

MS Lindungi alam sekitar dengan tidak melupuskan produk ini bersama sisa isi rumah anda. Rujuk pihak berkuasa tempatan anda tentang nasihat dan kemudahan kitar semula.

EN  WARNING: This product contains a Button Cell Battery.

 Dispose of used batteries immediately. Keep new and used batteries away from children.

If you think batteries might have been swallowed or placed inside any part of the body, seek immediate medical attention.

ES ADVERTENCIA: Este producto contiene una pila de botón.

Las pilas usadas deben desecharse inmediatamente. Mantenga las pilas nuevas y usadas fuera del alcance de los niños.

Si sospecha de la ingestión o la introducción de pilas en cualquier parte del cuerpo, busque atención médica inmediatamente.

NO ADVARSEL: Dette produktet inneholder et knappcellebatteri.

Brukte batterier skal avhendes øyeblikkelig. Nye og brukte batterier skal oppbevares utilgjengelig for barn.

Hvis du tror at batterier har blitt svelget eller puttet inn andre steder i kroppen, må du kontakte lege øyeblikkelig.

DA ADVARSEL: Dette produkt indeholder et knapcellebatteri.

Bortskaf brugte batterier omgående. Hold både nye og brugte batterier uden for børns rækkevidde.

Hvis du har mistanke om, at batterierne kan være blevet slugt eller kommet ind i nogen del af kroppen, skal du omgående søge lægehjælp.

PT AVISO: Este produto contém uma pilha tipo botão.

Elimine as pilhas usadas imediatamente. Mantenha as pilhas novas e usadas fora do alcance das crianças.

Se pensa que as pilhas podem ter sido engolidas ou colocadas no interior de alguma parte do corpo, procure de imediato assistência médica.

IS VIDVÖRUN: Þessi vara inniheldur hnapparafhlöðu.

Fargið notuðum rafhlöðum tafarlaust. Geymið nýjar og notaðar rafhlöður þar sem börn ná ekki til.

Ef þú telur að rafhlöður hafi verið gleyptar eða á annan hátt komist inn í einhvern hluta líkamans skaltu tafarlaust leita læknaástoðar.

EL ΠΡΟΕΙΔΟΠΟΙΗΣΗ: Αυτό το προϊόν περιέχει μία στρογγυλή μπαταρία μεγέθους κουμπιού.

Πετάξτε αμέσως τις χρησιμοποιημένες μπαταρίες. Κρατήστε τις καινούριες και τις χρησιμοποιημένες μπαταρίες μακριά από τα παιδιά.

Εάν νομίζετε ότι κάποια μπαταρία έχει καταποθεί ή τοποθετηθεί εντός οποιοδήποτε μέρους του σώματος, ζητήστε αμέσως ιατρική βοήθεια.

FI VAROITUS: Tämä tuote sisältää nappipariston.

Käytetyt paristot on toimitettava heti keräyspisteeseen. Pidä uudet ja käytetyt paristot poissa lasten ulottuvilta.

Jos epäilet jonkun neliäisseen pariston tai laittaneensa pariston kehoonsa, vie hänet välittömästi lääkäriin.

JA 警告: 本製品には、ボタン型電池が使用されています。

使用済みの電池は直ちに廃棄してください。新しい電池および使用済み電池はどちらもお子様の手の届かないところに保管してください。

電池を誤飲した恐れがある、または電池が身体のどこかに混入した恐れがある場合は、直ちに医師の診察を受けてください。

SV VARNING: Denna produkt innehåller ett knappcells batteri.

Kassera förbrukade batterier omedelbart. Förvara nya och använda batterier utom räckhåll för barn.

Om du tror att batterierna kan ha svalts eller placerats inuti någon del av kroppen, sök omedelbart läkervård.

ZH 警告: 本产品内含一颗纽扣电池。

请立即妥善处理旧电池。请将新、旧电池放置于儿童接触不到的地方。

如果电池被不慎吞下，或被置入身体的任何一个部位，请立即就医！

경고: 이 제품에에는 버튼 셀 배터리가 포함되어 있습니다. 다 쓴 배터리는 즉시 폐기하십시오. 배터리를 어린이의 손에 닿지 않는 곳에 보관하십시오. 배터리를 삼켰거나 신체 어느 부위에든 들어간 것으로 판단될 경우, 즉각 의사의 도움을 구하십시오.

RU
ПРЕДУСТЕРЕЖЕНИЕ. Эта игрушка работает от батарейки таблеточного типа. Своевременно утилизируйте использованные батарейки. Храните новые и использованные батарейки в местах, недоступных для детей. Если у вас есть основания полагать, что ребенок проглотил батарейку или она попала внутрь какой-либо части его тела, немедленно обратитесь за медицинской помощью.

PL
OSTRZEŻENIE: w tym produkcie znajduje się mała okrągła bateria. Gdy bateria się zużyje, należy się jej natychmiast pozbyć. Nowe i używane baterie należy przechowywać z dala od dzieci. W przypadku stwierdzenia, że bateria mogła zostać połknięta lub inaczej trafić do organizmu, należy natychmiast poszukać pomocy lekarskiej.

CZ
VAROVÁNÍ: Tento výrobek obsahuje knoflíkovou baterii. Použité baterie ihned vyjměte a zlikvidujte. Nové i použité baterie uchovávejte mimo dosah dětí. V případě spolknutí či vniknutí baterie v některé části těla okamžitě vyhledejte lékařskou pomoc.

SK
UPOZORNENIE: Tento produkt obsahuje gombíkovú batériu. Použité batérie ihneď vyberte a zlikvidujte. Nové aj použité batérie uchovávajte mimo dosahu detí. Ak si myslíte, že mohlo dôjsť k prehltnutiu batérie alebo sa batéria mohla dostať do vnútra ktorejkoľvek časti tela, okamžite vyhľadajte lekársku pomoc.

HU
FIGYELMEZTETÉS: Ez a termék gomelemet tartalmaz! Az elhasznált elemeket azonnal dobja ki! Az új és a használt elemeket ne adja gyermekek kezébe! Ha úgy gondolja, hogy valaki lenyelt egy elemet, vagy bekerült valakinek valamely testrészébe, akkor azonnal kérjen orvosi segítséget!

UA
ОБЕРЕЖНО: Продукт містить батарейку типу «таблетка». Негайно утилізуйте використані батарейки. Зберігайте нові і використані батарейки недосяжними для дітей. Якщо вам здається, що дитина проковтнула батарейку, чи вона опинилася в будь-якій частині тіла дитини, негайно зверніться до лікаря.

HR
UPOZORENJE: Ovaj proizvod sadrži gumbastu bateriju. Iskorištene baterije odmah odložite u otpad. Nove i stare baterije čuvajte dalje od djece. Ako mislite da je baterija progutana ili je dospjela unutar bilo kojeg dijela tijela, odmah zatražite liječničku pomoć.

SR
УПОЗОРЕЊЕ: Овај производ садржи дугмасту батерију. Одмах одложите искоришћене батерије у отпад. Чувајте нове и искоришћене батерије ван дохвата деце. Ако мислите да је дошло до гутања батерија или стављања у било који део тела, одмах потражите помоћ лекара.

MK
ПРЕДУПРЕДУВАЊЕ: Овој производ садржи копче-батерија. Искрплете ги веднаш искористените батерији. Држете ги новите и користените батерији подалеку од деца. Ако мислите дека е можно батериите да се проголтани или поставени во кој било дел на телото, веднаш побарајте медицинска помош.

SL
OPOZORILO: Ta izdelek vsebuje gumbasto baterijo. Iztrošene baterije takoj zavržite. Pazite, da nove ali iztrošene baterije ne bodo v dosegu otrok. Če menite, da je oseba zaužila baterijo ali si jo vstavila v kateri koli del telesa, takoj poiščite zdravniško pomoč.

RO
AVERTIZARE: Acest produs conține o baterie de tip pastilă. Debarasați-vă imediat de bateriile uzate. Nu lăsați bateriile noi și uzate la îndemână copiilor. Dacă credeți că bateriile ar fi putut fi înghițite, sau ar fi putut ajunge în interiorul oricărei părți a corpului, solicitați imediat asistență medicală.

BG
ПРЕДУПРЕЖДЕНИЕ: Този продукт съдържа батерия тип "копче". Незабавно изхвърляйте използваните батерии. Дръжте новите и стари батерии далеч от деца. Ако смятате, че е възможно батериите да са били погълнати или да са попаднали където и да е вътре в тялото, потърсете незабавно медицинска помощ.

LV
BRĪDINĀJUMS. Šis produkts satur pogas tipa akumulatoru. Nekavējoties izlietotos akumulatorus. Jaunus un lietotus akumulatorus glabāiet bērniem nepieejamā vietā. Ja uzskatāt, ka akumulators varētu būt norīts vai ievietots kādā ķermeņa daļā, nekavējoties vērsieties pēc medicīniskās palīdzības.

ET
HOIATUS! See toode sisaldab nööppatareid. Kõrvaldage kasutatud patareid viivitamatult. Hoidke uusi ja kasutatud patareisid lastele kättesaamatus kohas. Kui arvate, et keegi on patareid alla neelanud või need on sattunud mõnda kehaosasse, pöörduge kohe arsti poole.

LT
ĮSPĖJIMAS: šiame gaminyje yra sagos formos baterija. Panaudotas baterijas nedelsdami utilizuokite. Naujas ir panaudotas baterijas laikykite atokiau nuo vaikų. Jei manote, kad vaikas galėjo praryti arba įsprausti bateriją sau į kūną, nedelsdami kreipkitės medicininės pagalbos.

TR
UYARI: Bu ürün bir düğme pil içerir. Kullanılmış pilleri derhal atın. Yeni ve kullanılmıř pilleri çocuklardan uzak tutun. Pillerin yutulmuř ya da vücudun bařka bir yerine sokulmuř olabileceđini dűřünüyorsanz derhal doktora bařvurun.

AR
 خذیر یحتوی هذا المنتج على بطارية خلايا قرفصية. يرجى التخلص من البطاريات المستعملة على الفور، مع الاحتفاظ بالبطاريات الجديدة والمستعملة بعيداً عن متناول الأطفال. إذا كنت تعتقد أن البطاريات تم ابتلاعها أو إدخالها إلى أي جزء من أجزاء الجسم، فاطلب المساعدة الطبية على الفور.

ID
PERINGATAN: Produk ini berisi Baterai Sel Kancing. Segera buang baterai yang sudah tidak digunakan. Jauhkan baterai baru maupun bekas dari jangkauan anak-anak. Jika Anda curiga baterai telah tertelan atau berada dalam bagian tubuh, segeralah minta bantuan dokter.

MS
AMARAN: Produk ini mengandungi Bateri Sel Butang. Buang bateri terpakai dengan serta-merta. Jauhkan bateri baharu dan terpakai daripada kanak-kanak. Jika anda mendapati bateri mungkin telah ditelan atau termasuk ke dalam mana-mana bahagian badan, dapatkan rawatan perubatan dengan segera.

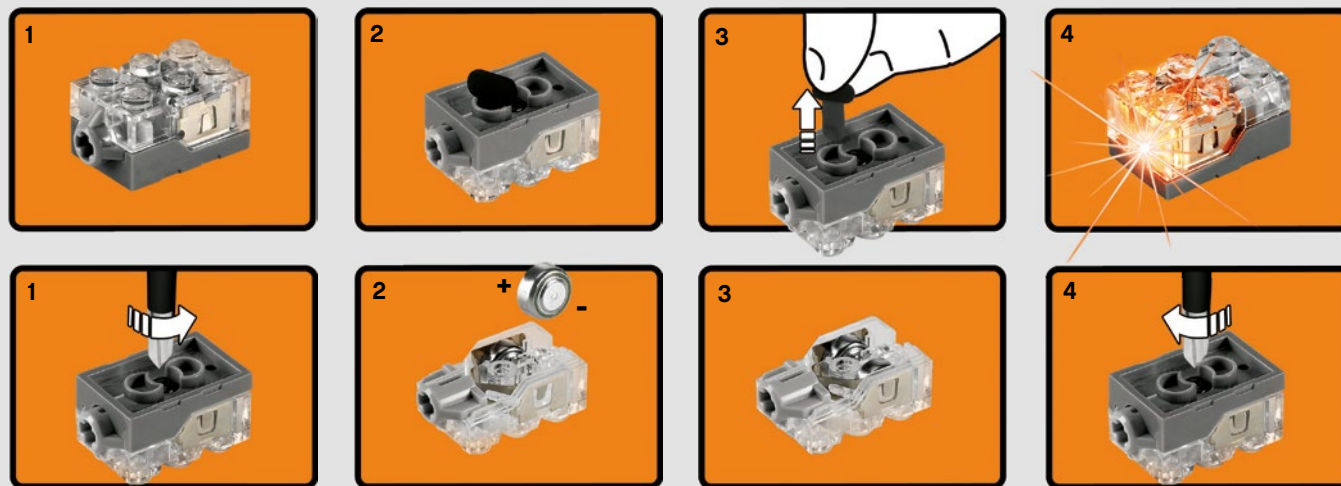

1:1
 2x LR 41 1.5V

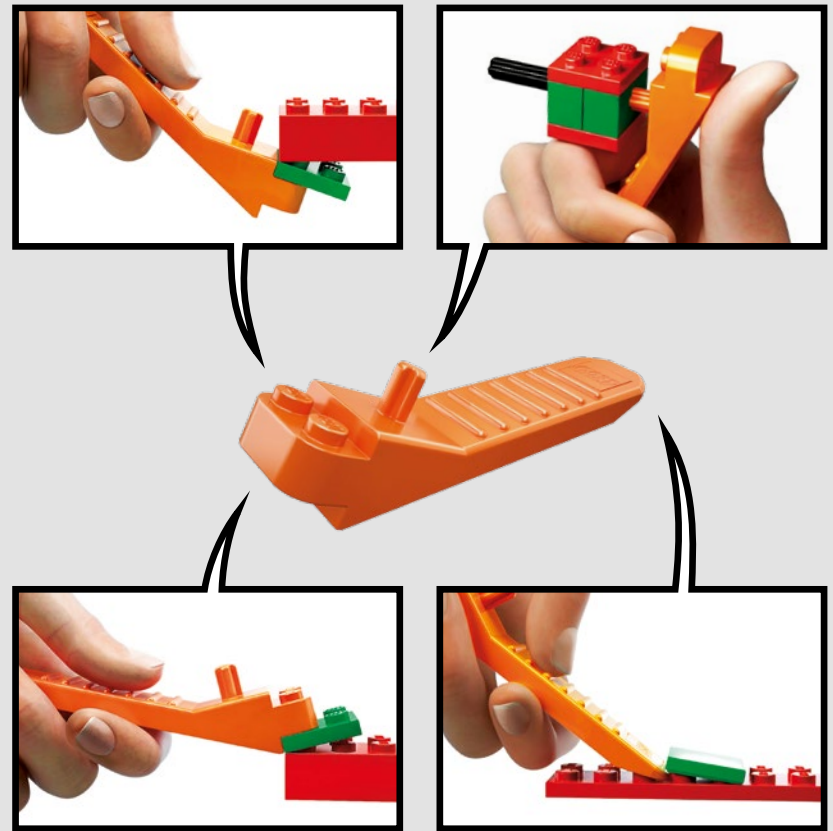
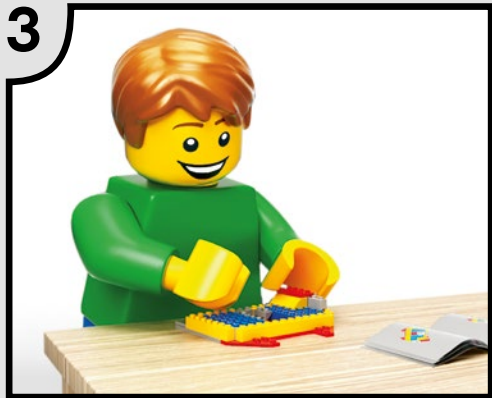
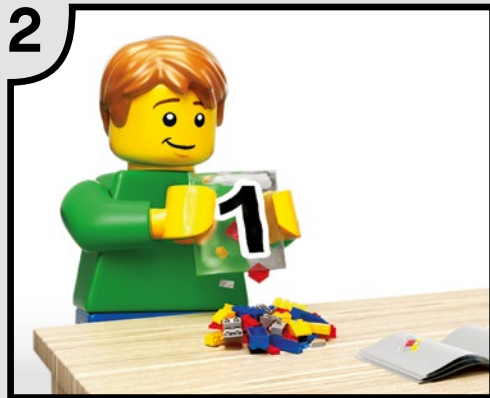

LEGO.com/brickseparator

1



2

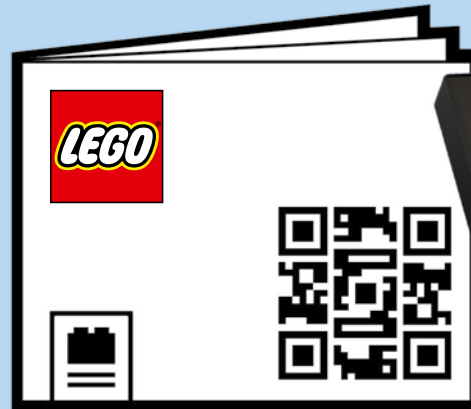

3

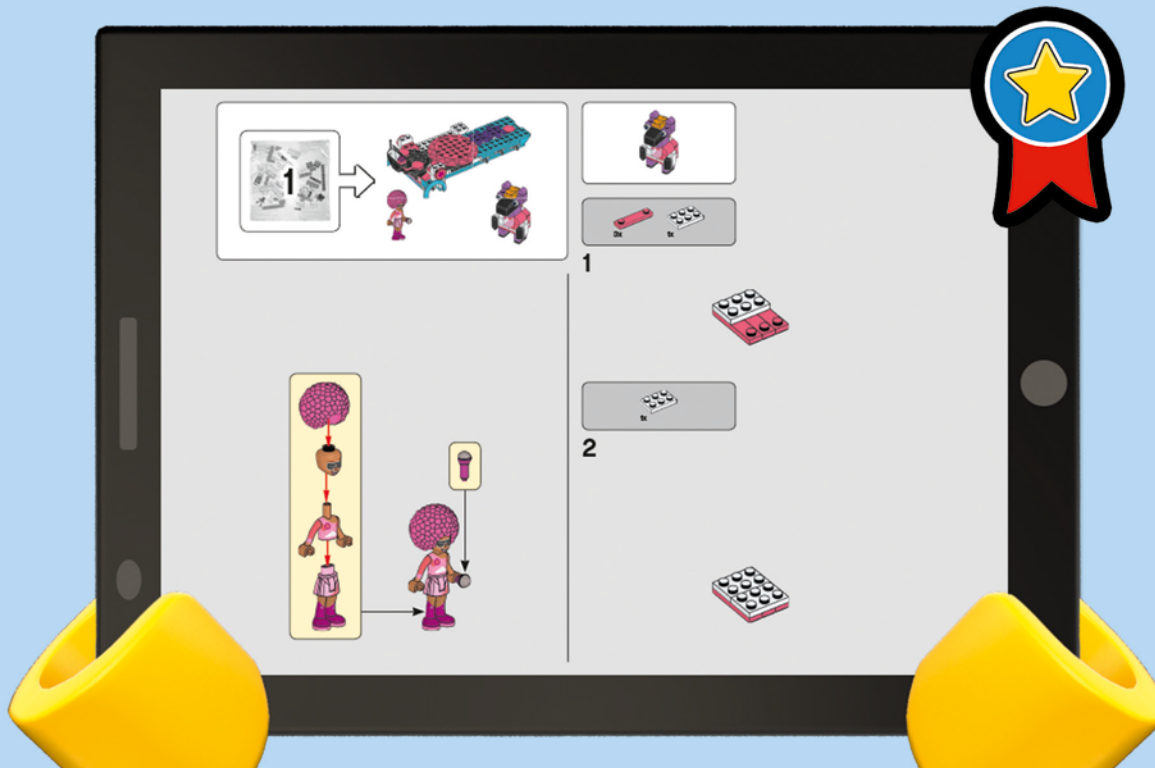

LEGO.com/apps

Check for compatibility
 Kompatibilität prüfen
 Vérifier la compatibilité
 Controlla la compatibilità
 Comprueba tu compatibilidad
 Verificar a compatibilidade
 Ellenőrizd a kompatibilitást
 Pārbaudīt saderību
 检查兼容性

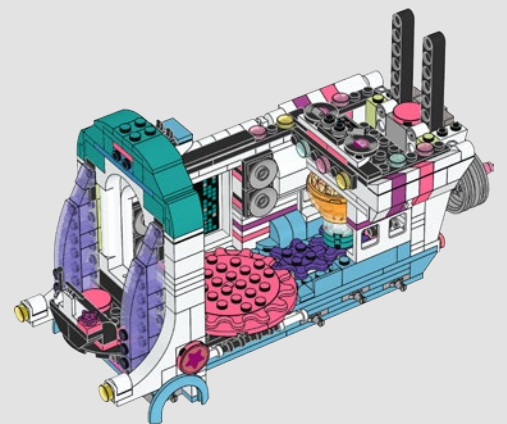
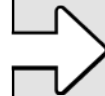
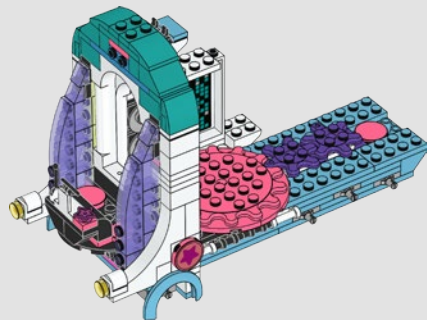
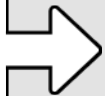
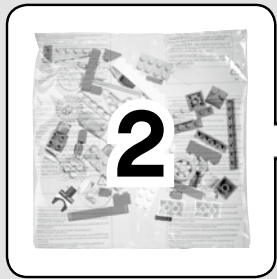
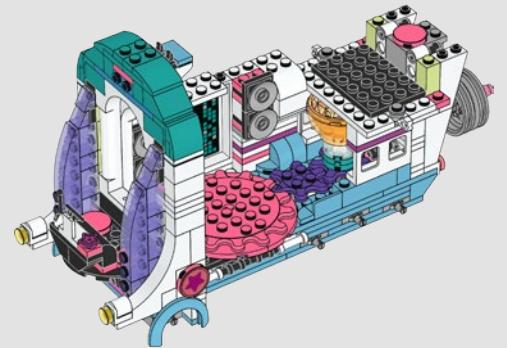
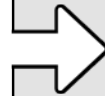
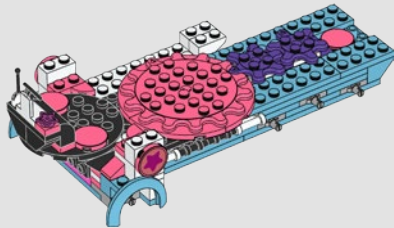
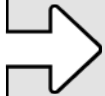

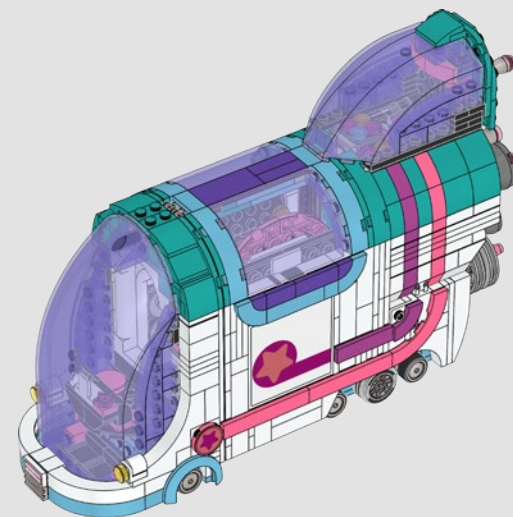
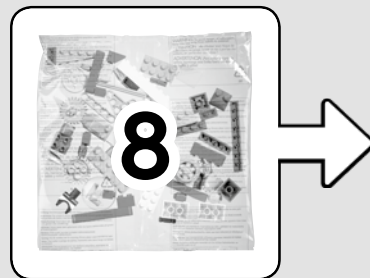
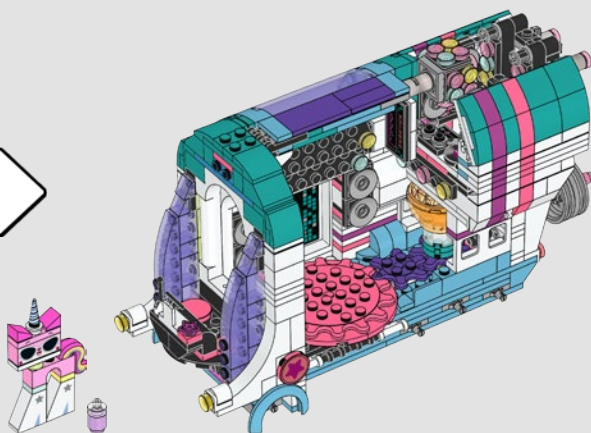
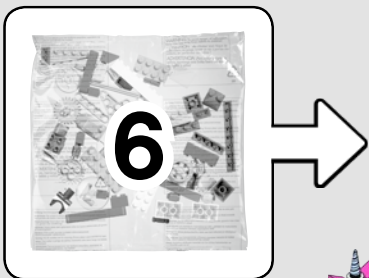
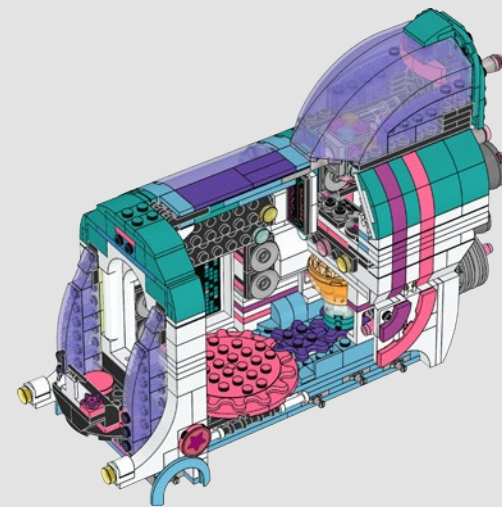
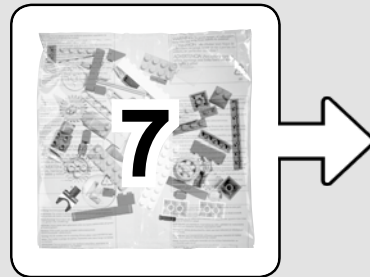
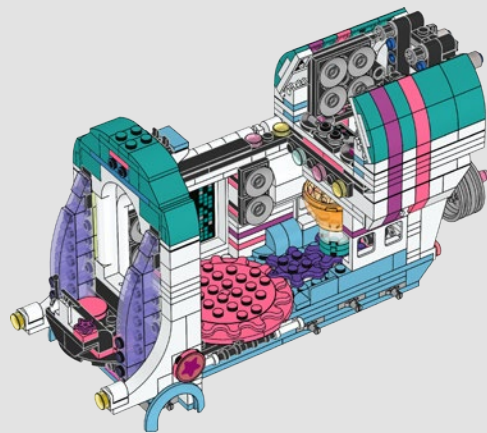
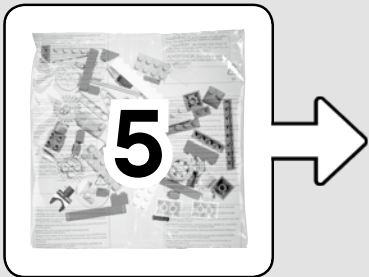

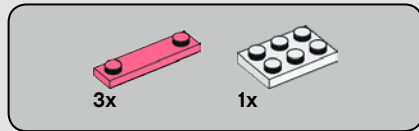
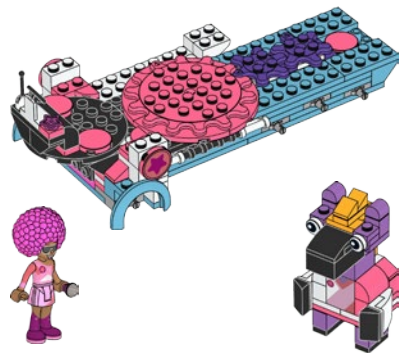
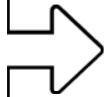

1

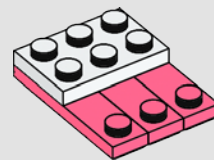

2

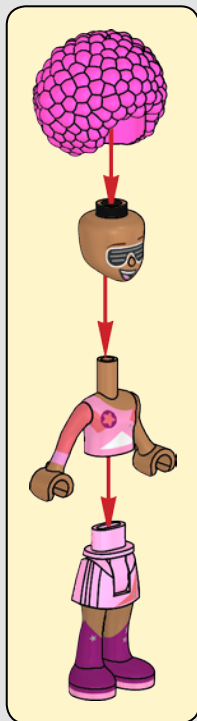



3

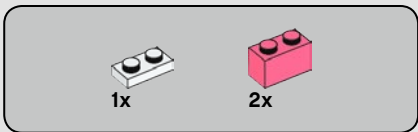
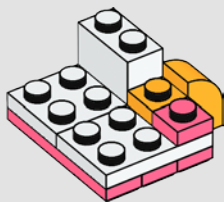

4

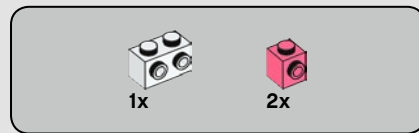
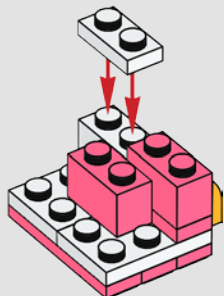

5

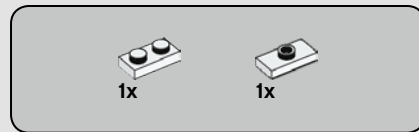
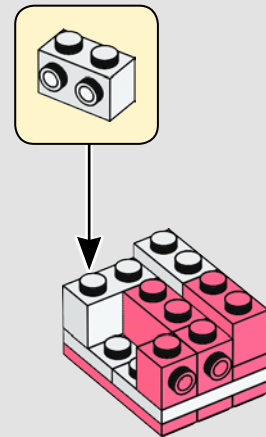

6

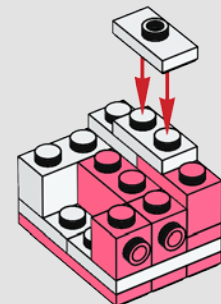

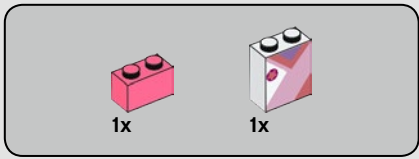

7

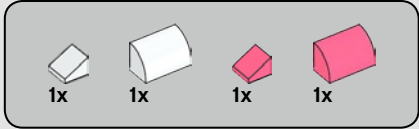
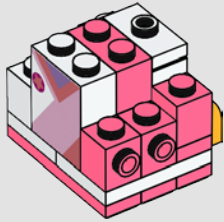

8

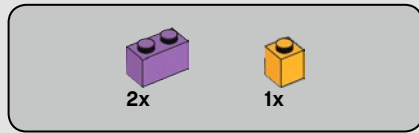
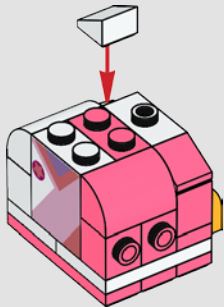

9

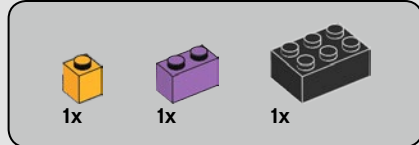
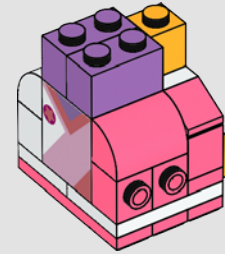

10

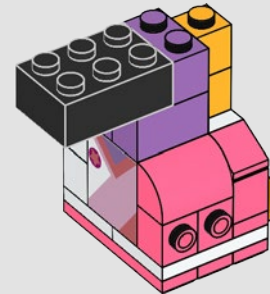

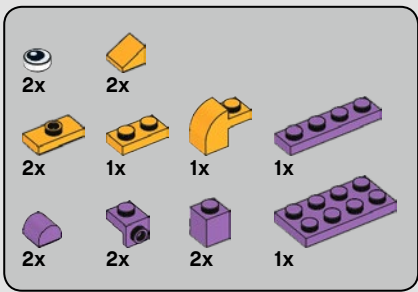

11

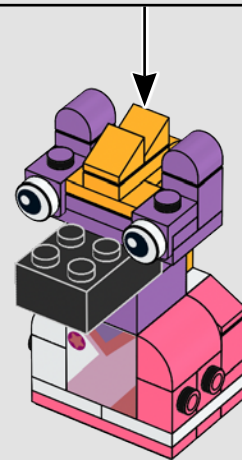
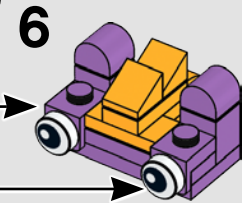
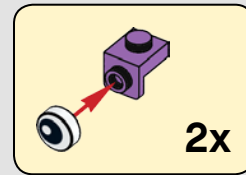
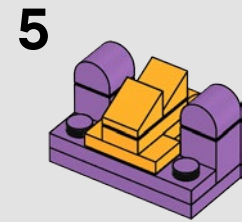
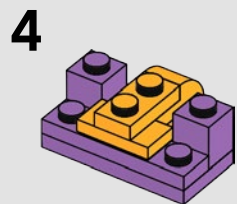
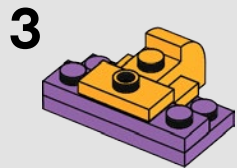
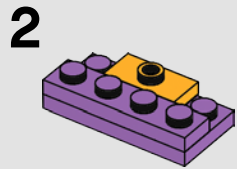
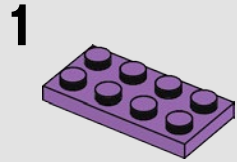

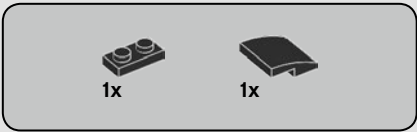

12

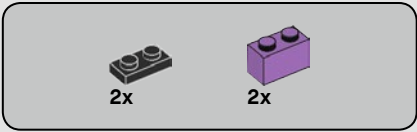
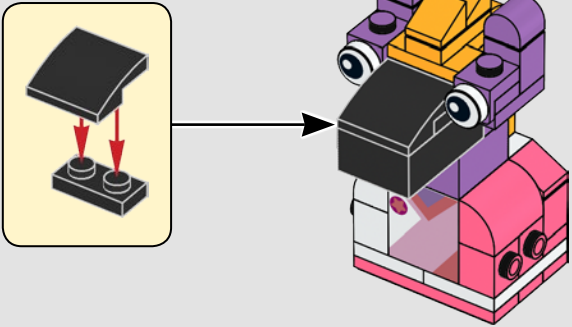

13

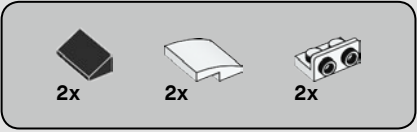
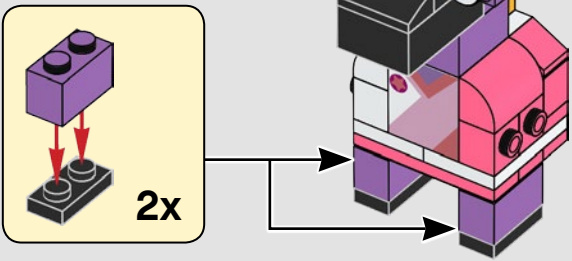

14

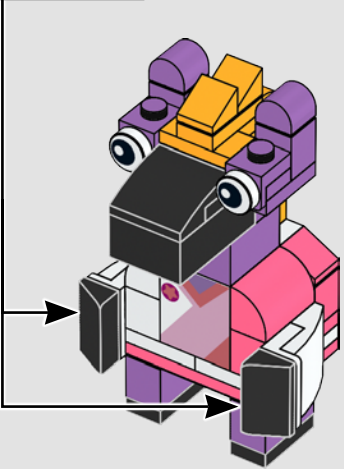
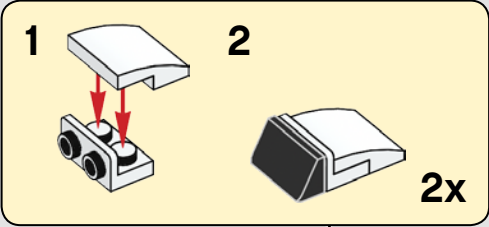

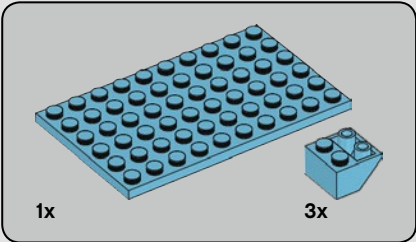
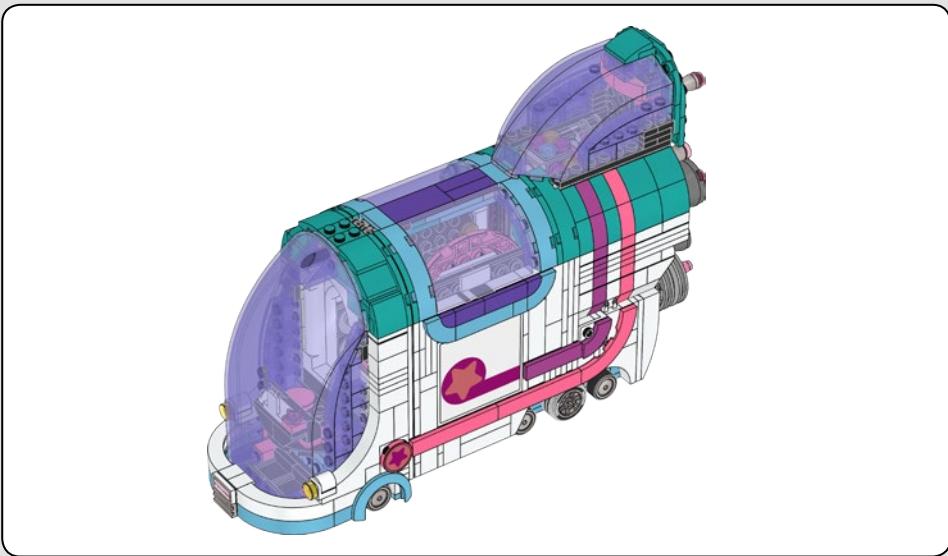

1

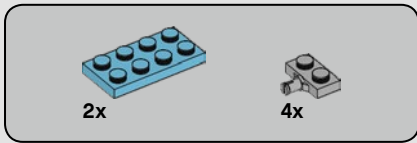
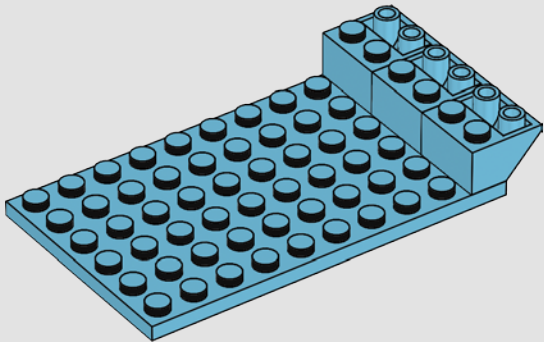

2

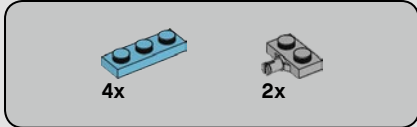
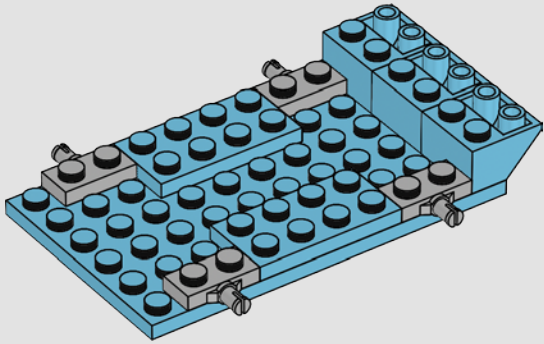

3

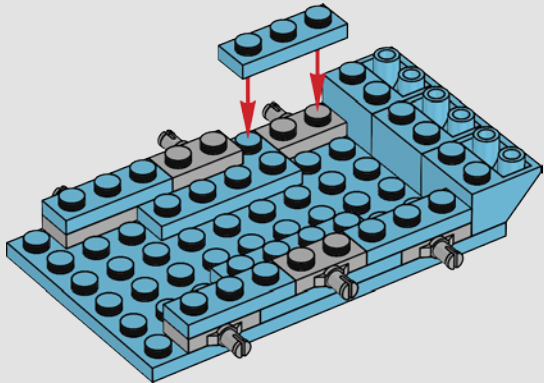

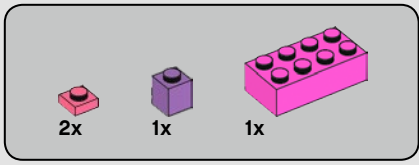

4

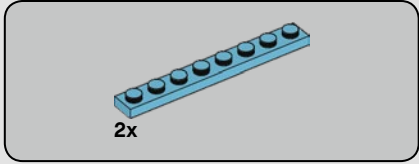
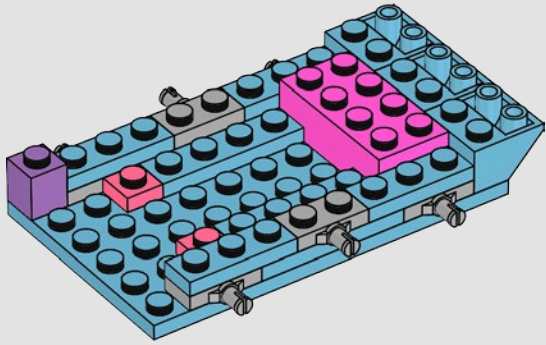

5

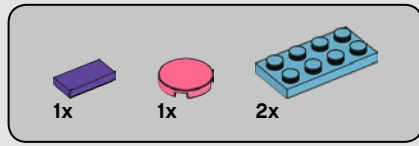
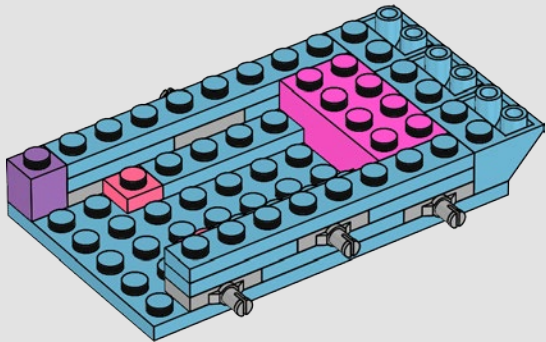

6

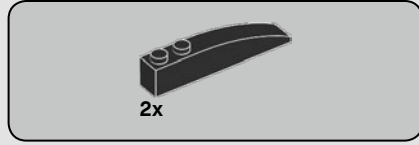
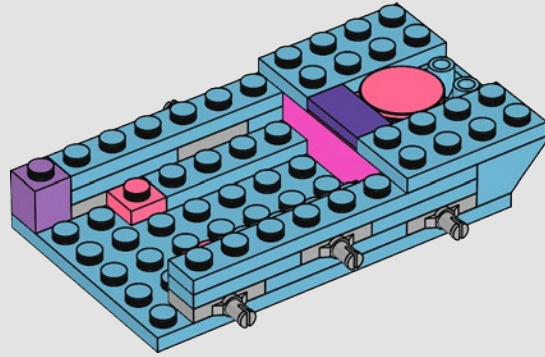

7

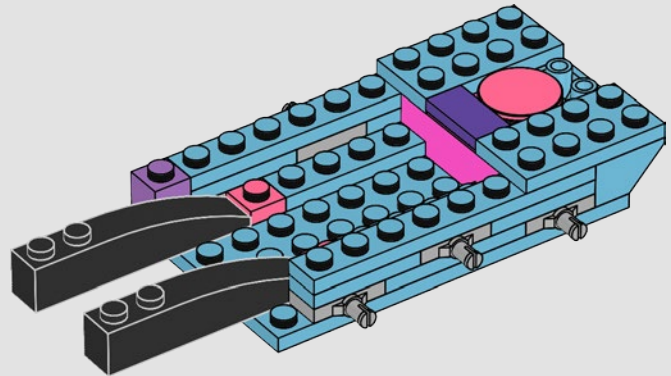

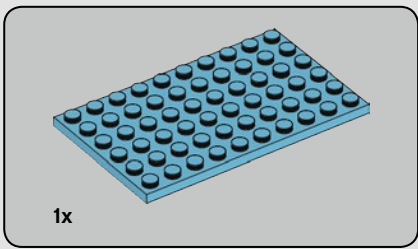

8

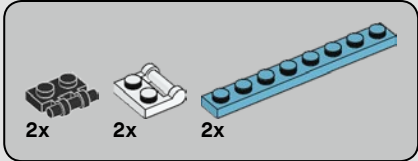
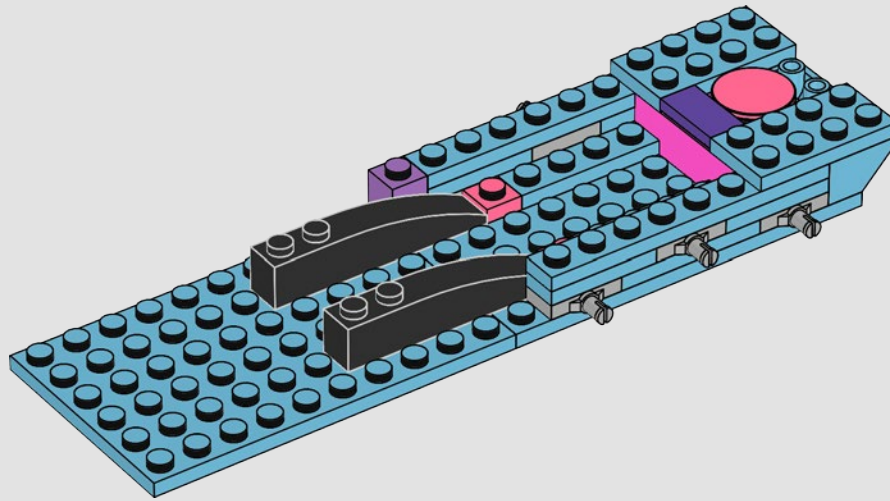

9

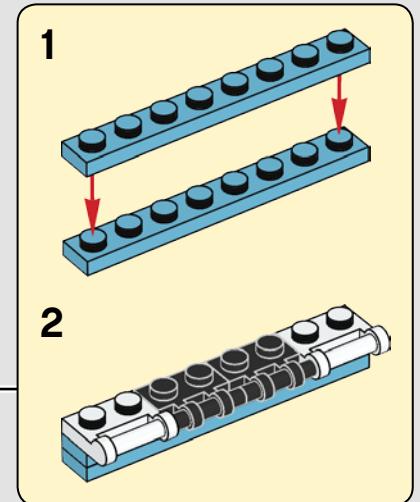
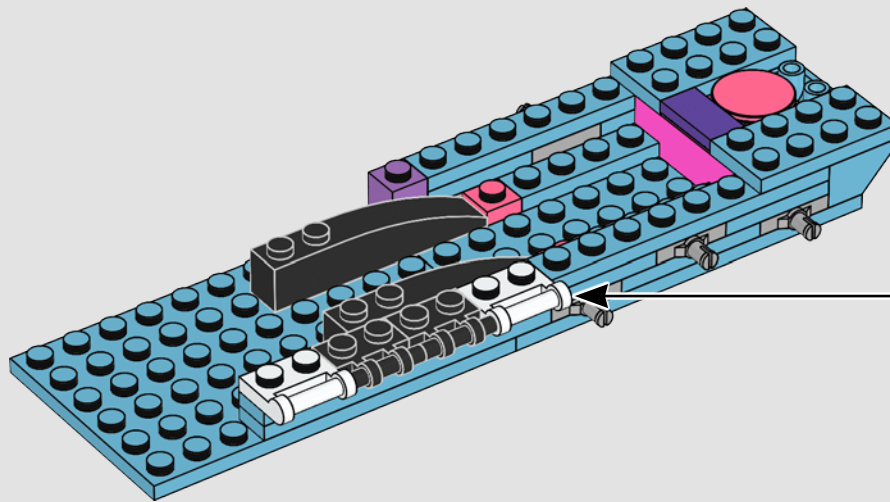

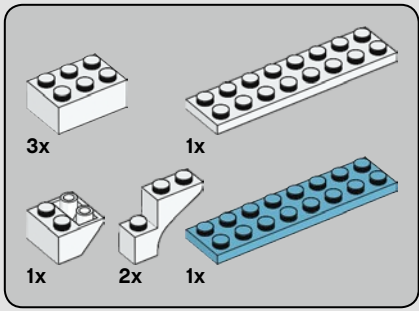

10

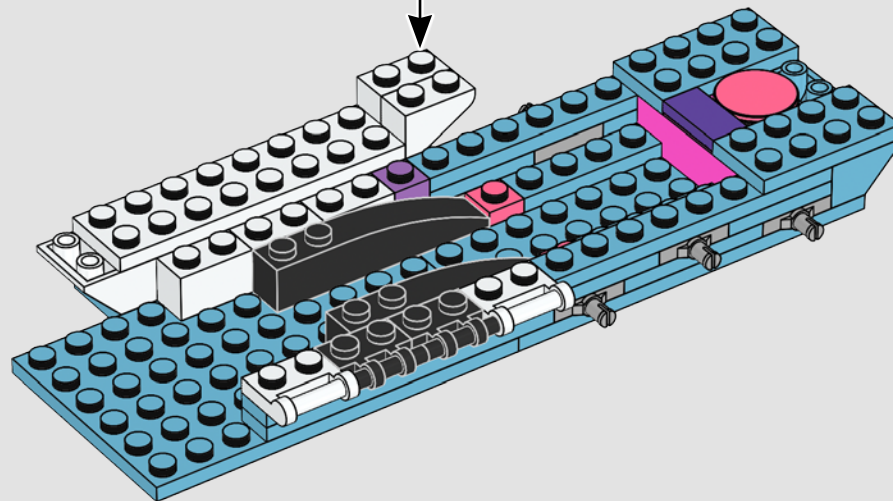
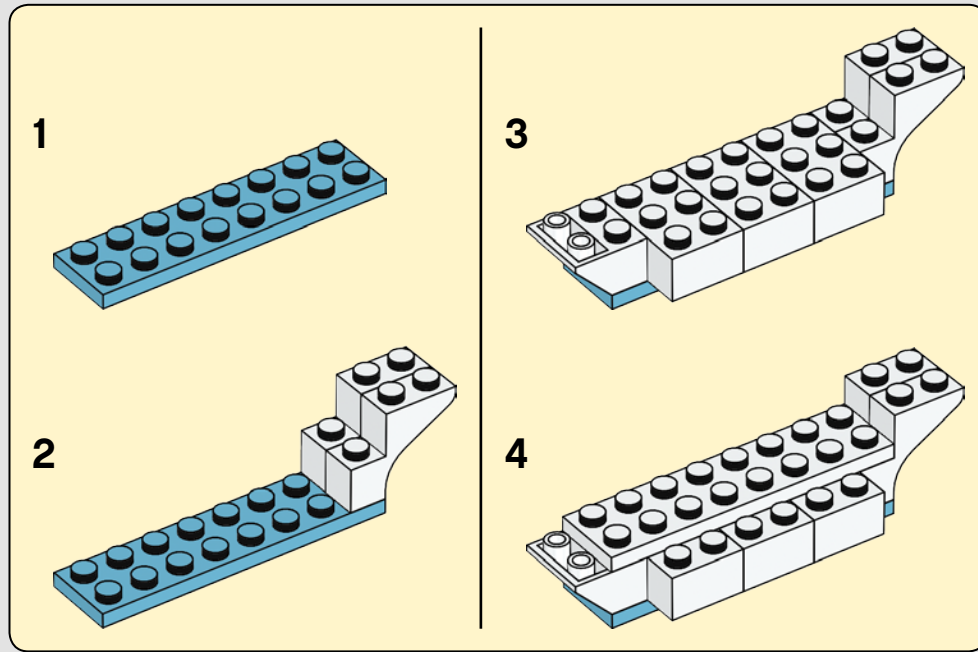

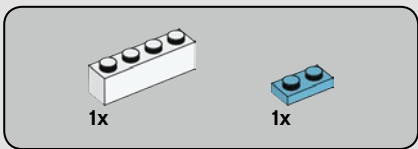

11

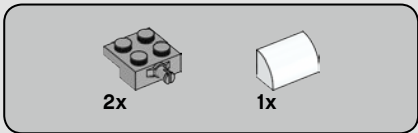
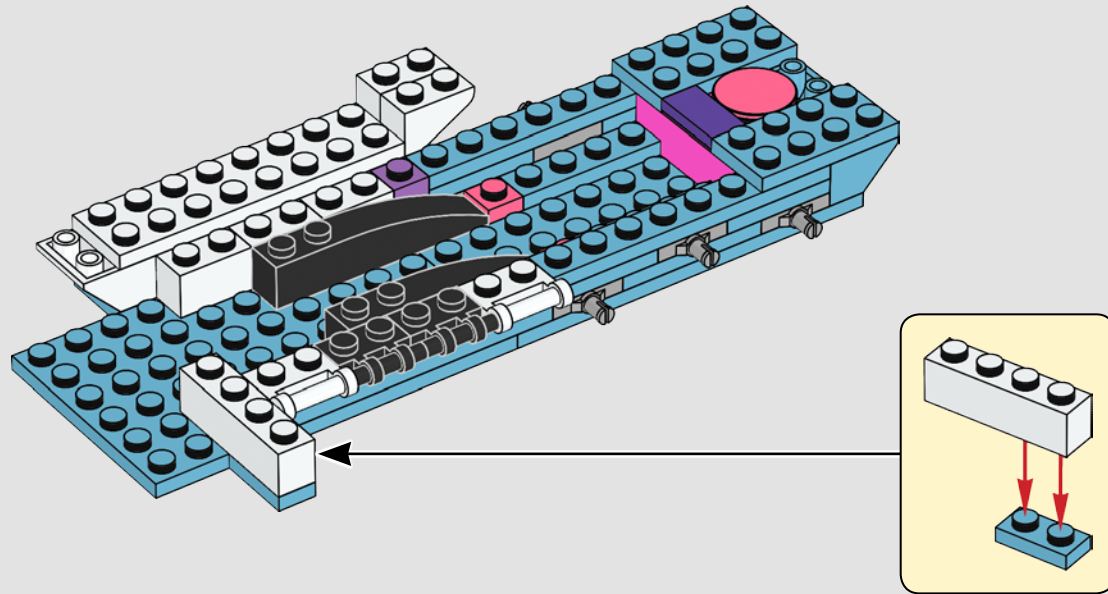

12

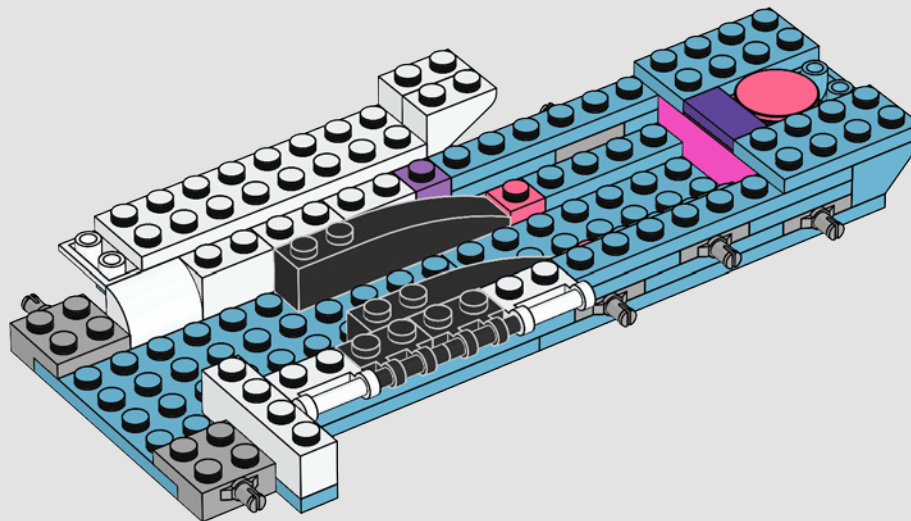

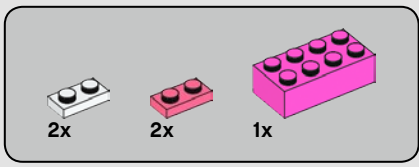

13

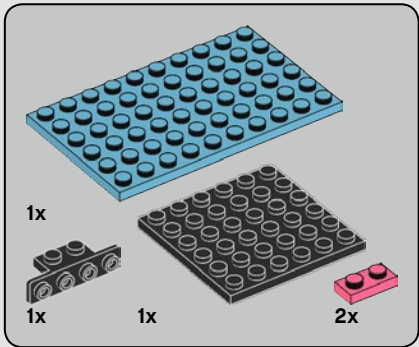
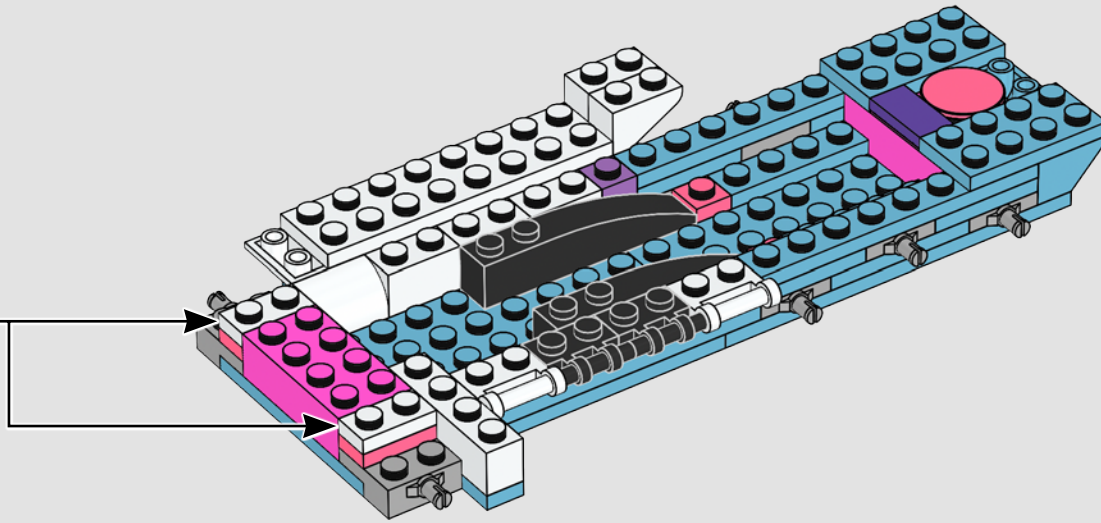
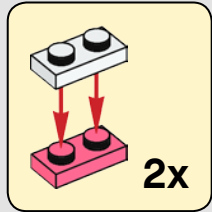

14

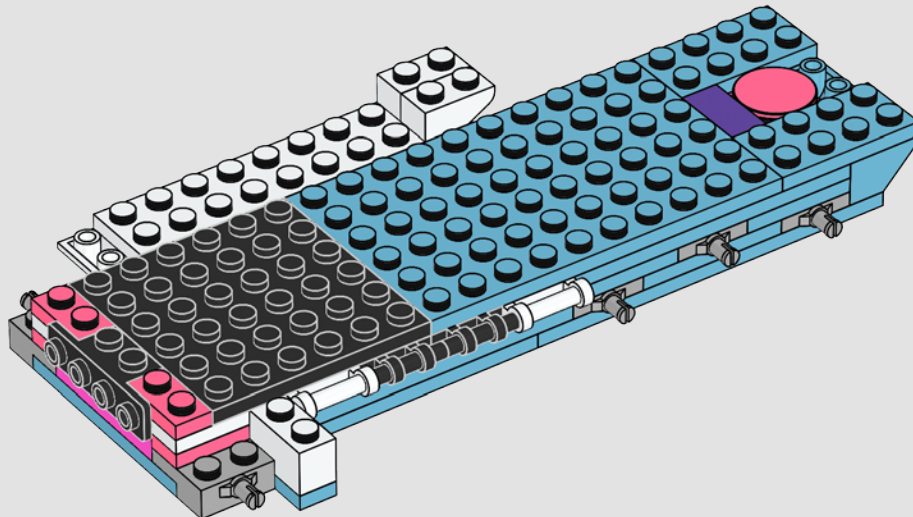

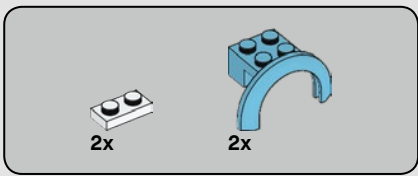

15

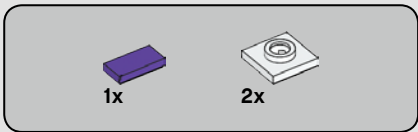
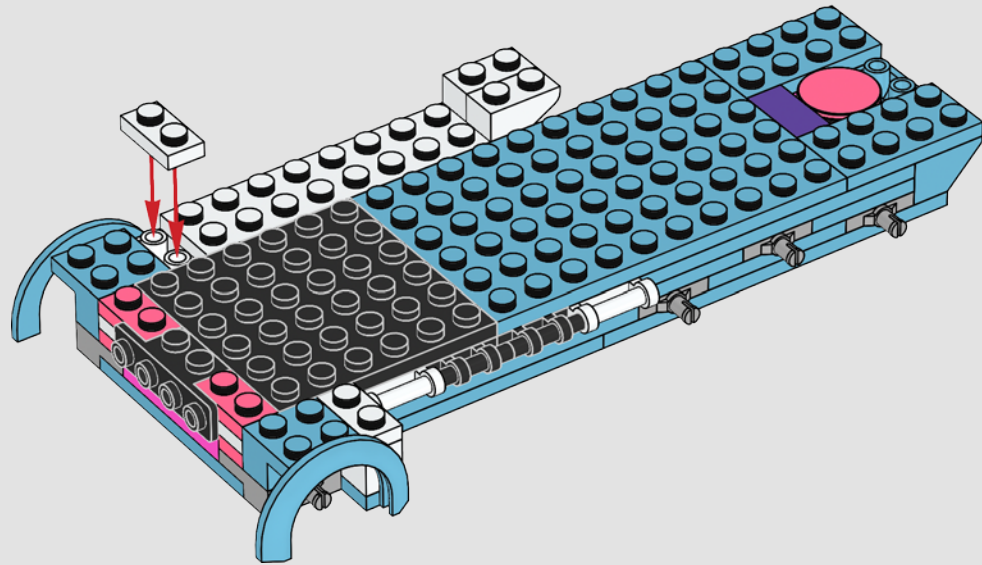

16

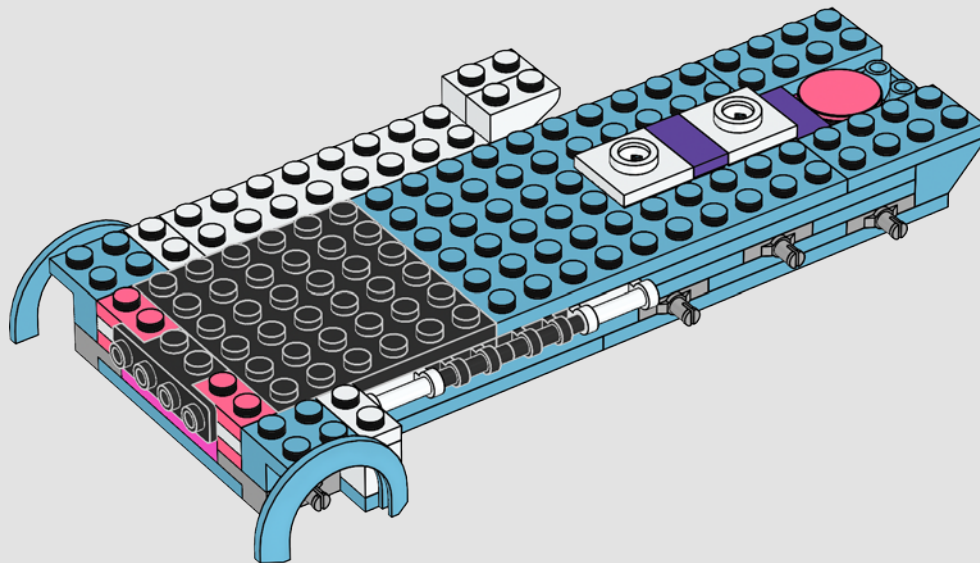

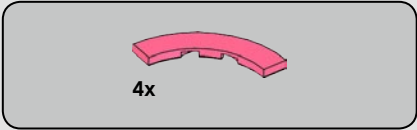

17

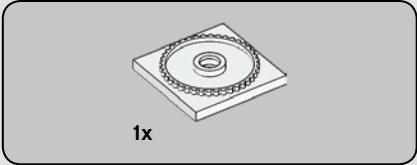
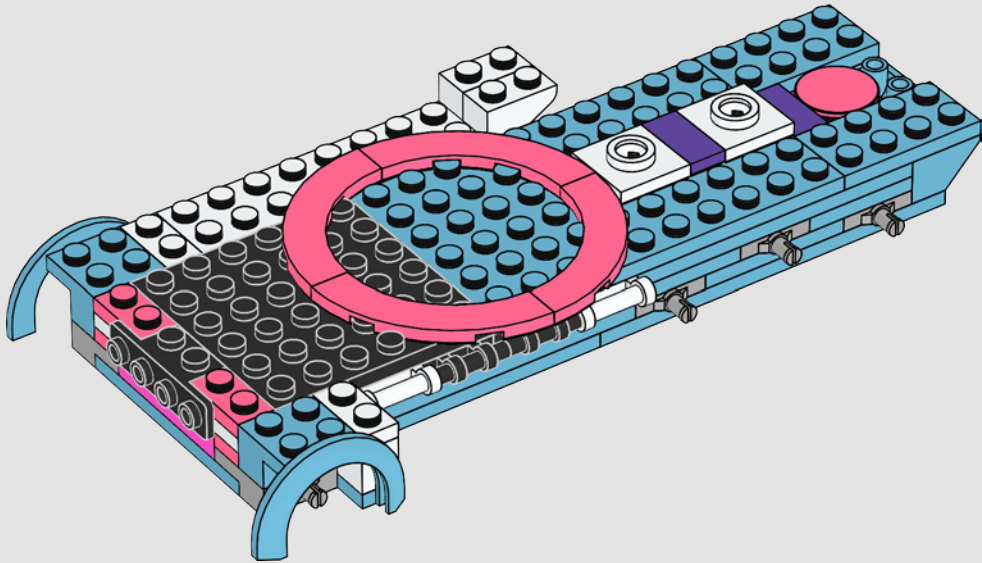

18

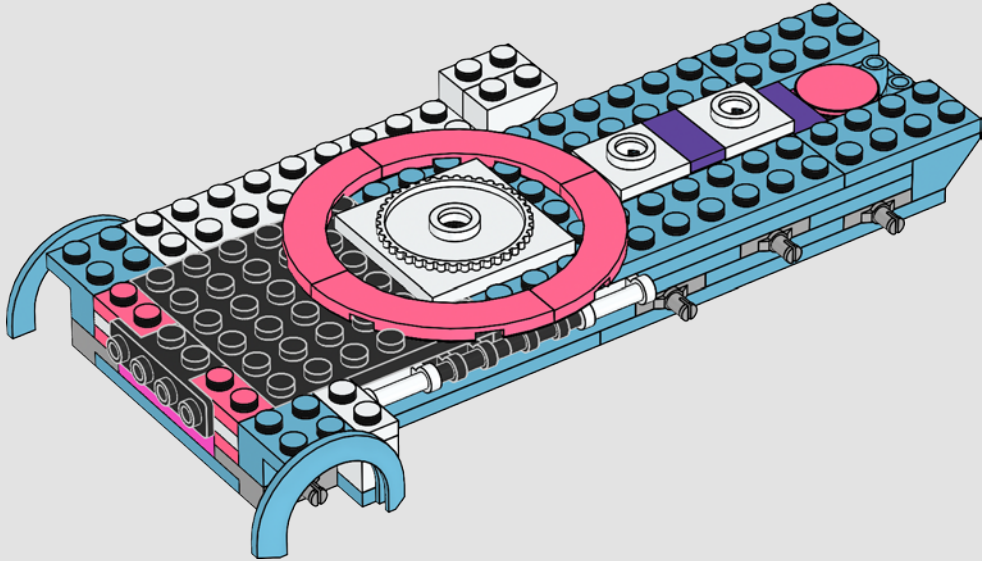

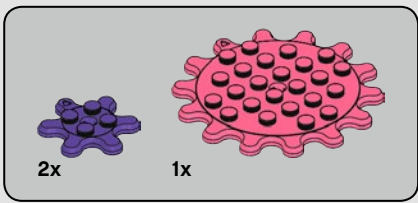

19

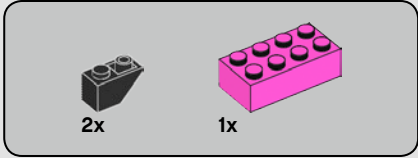
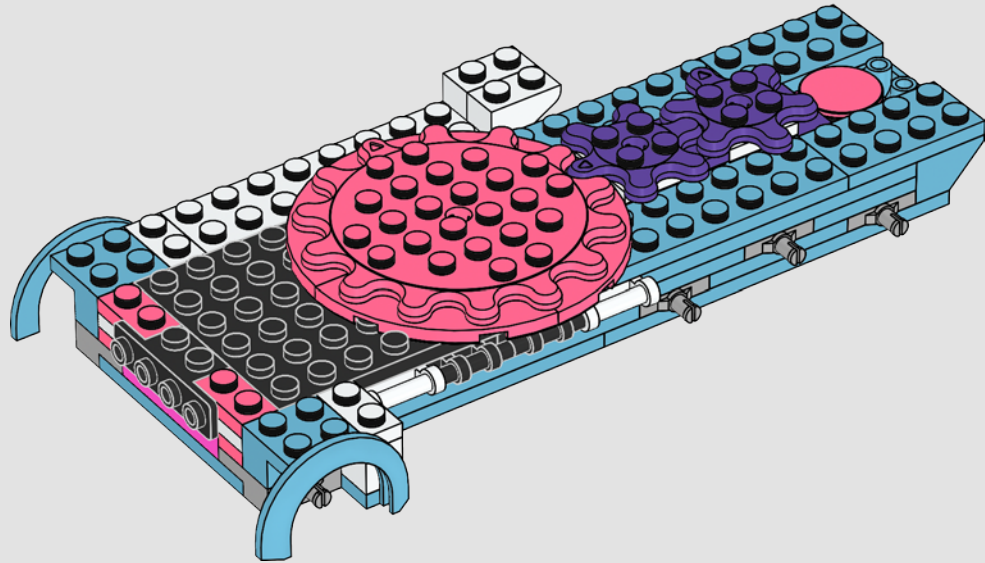

20

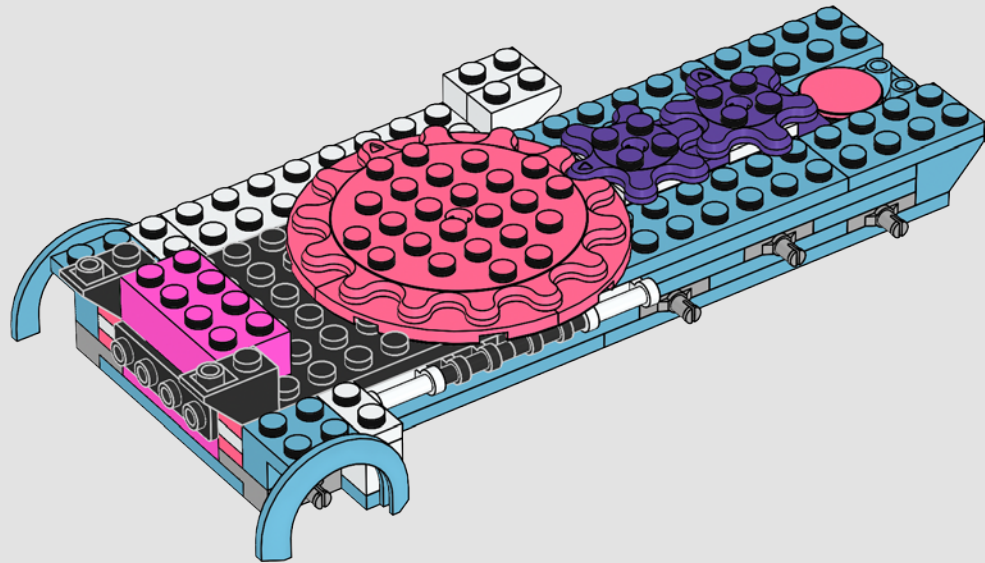

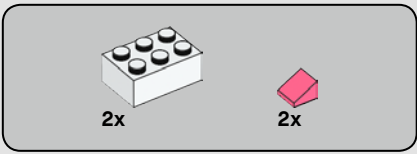

21

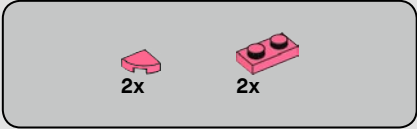
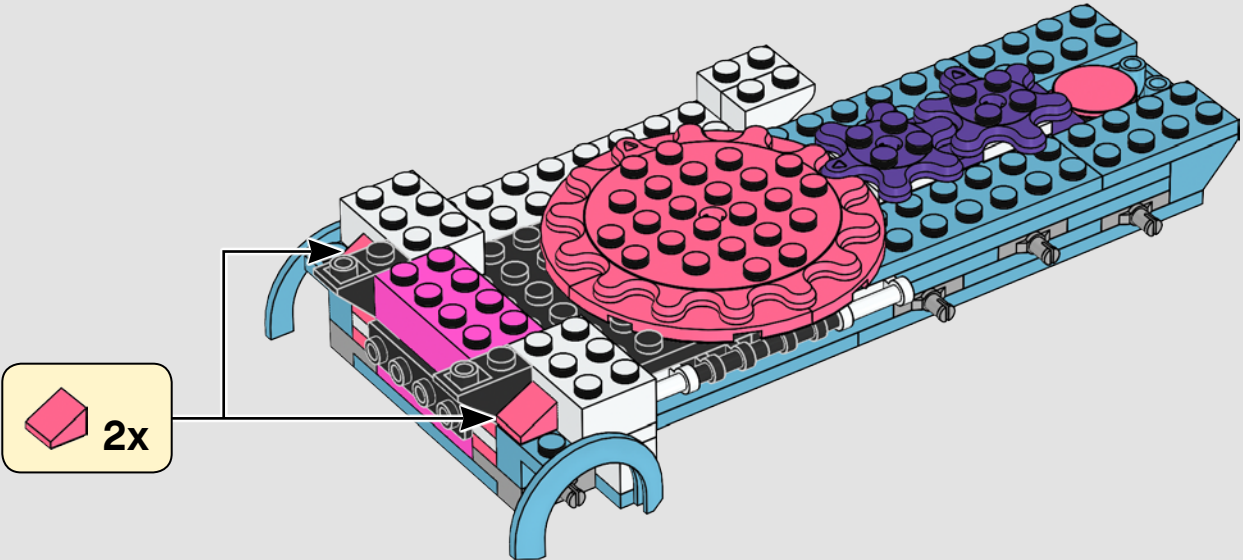

22

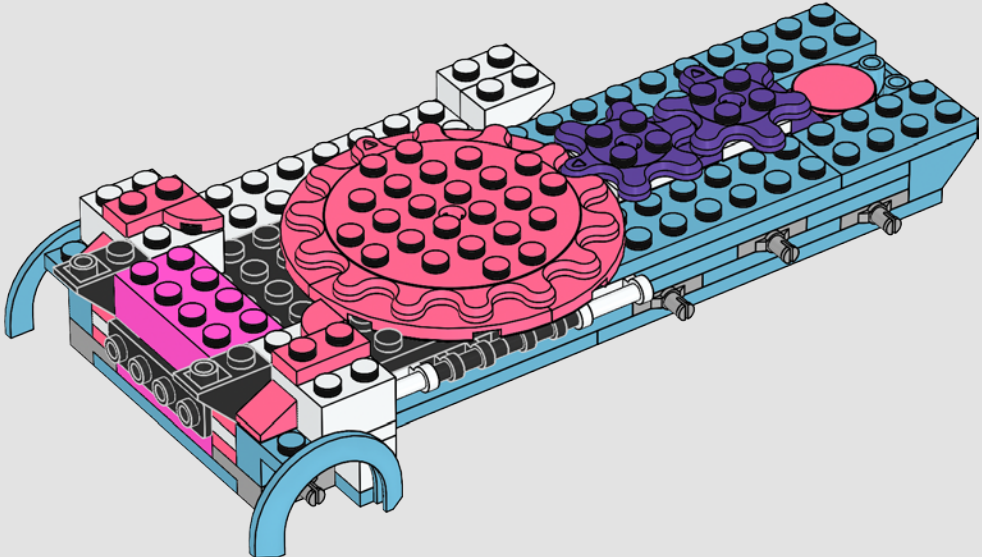

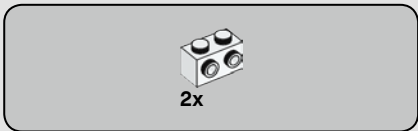

23

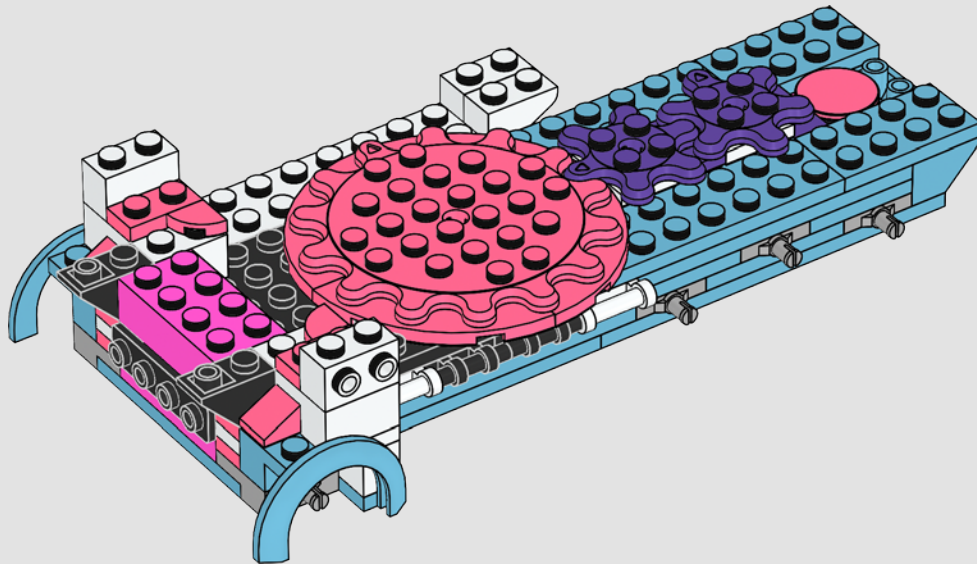

24

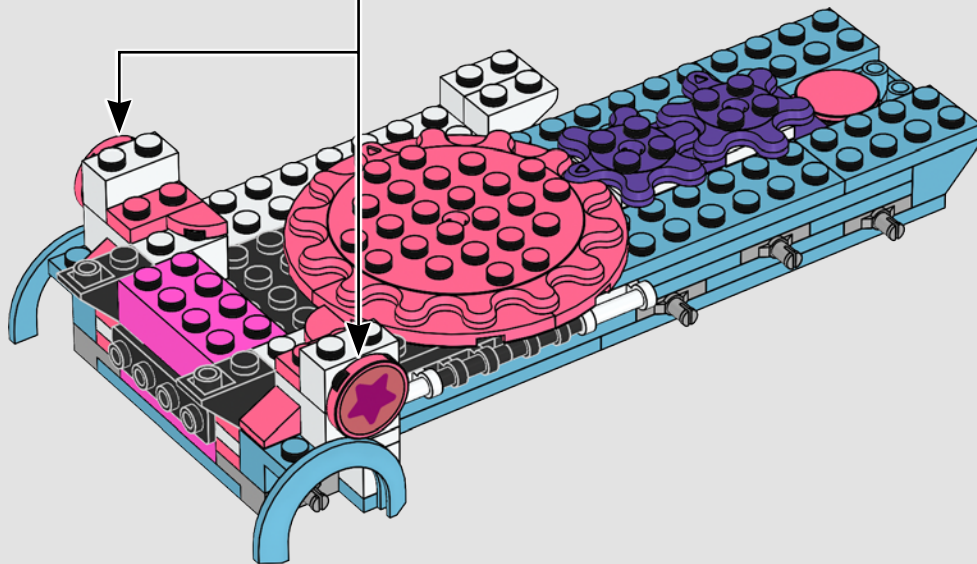
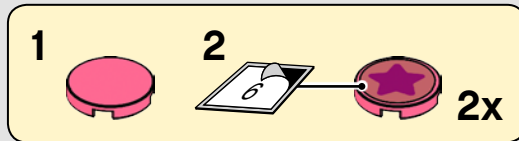

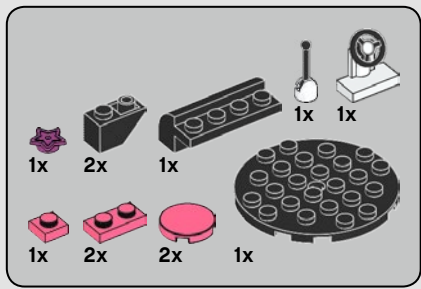

25

1

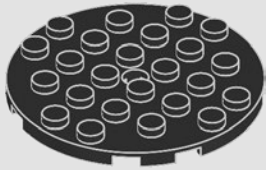

2

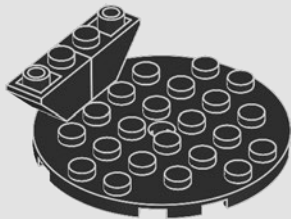

3

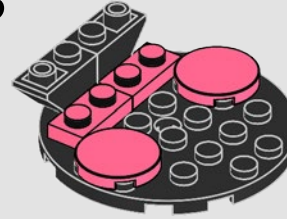

4



5



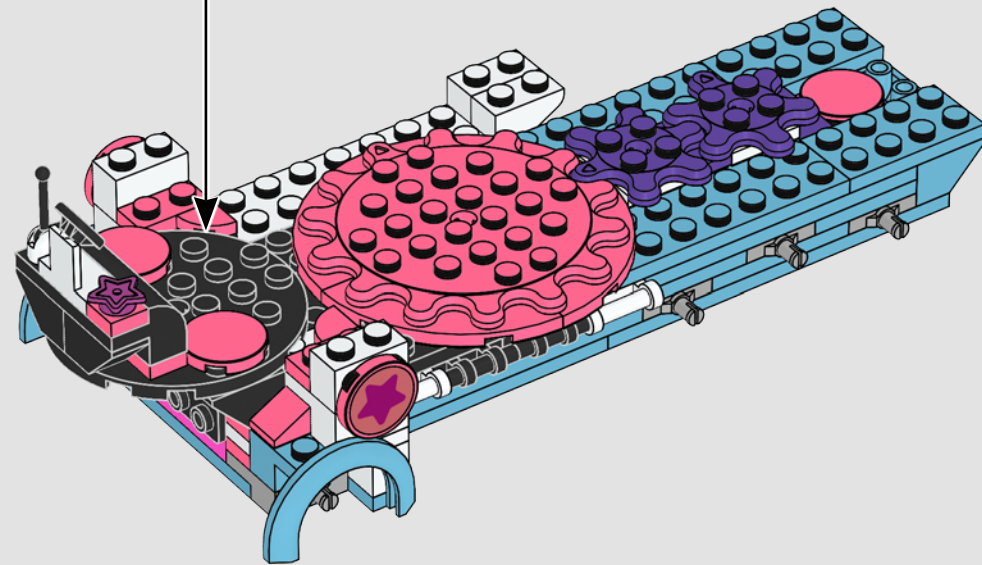
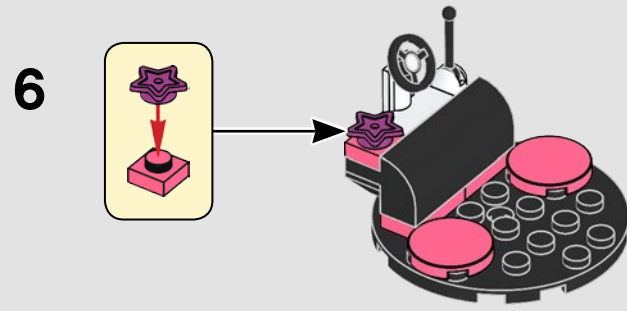

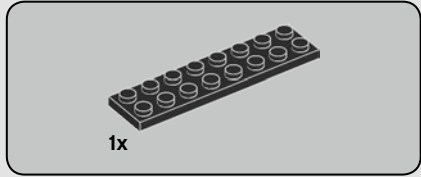
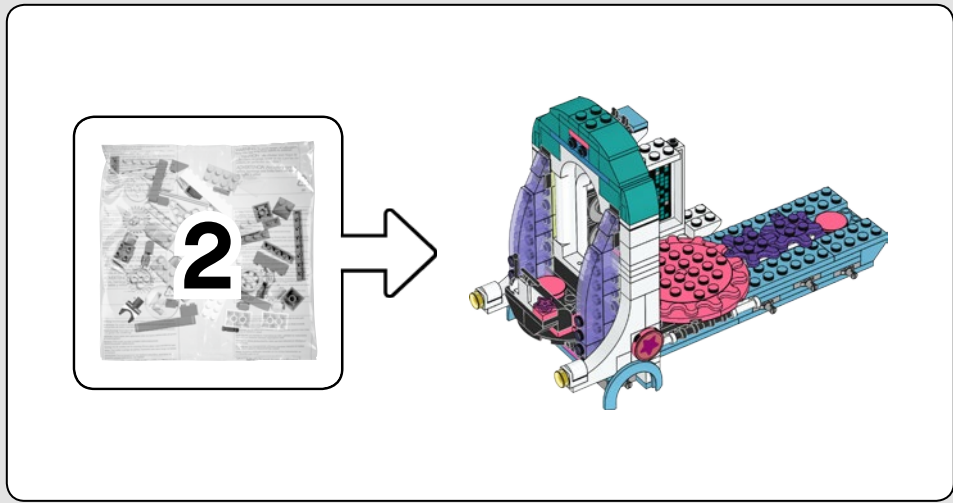

26

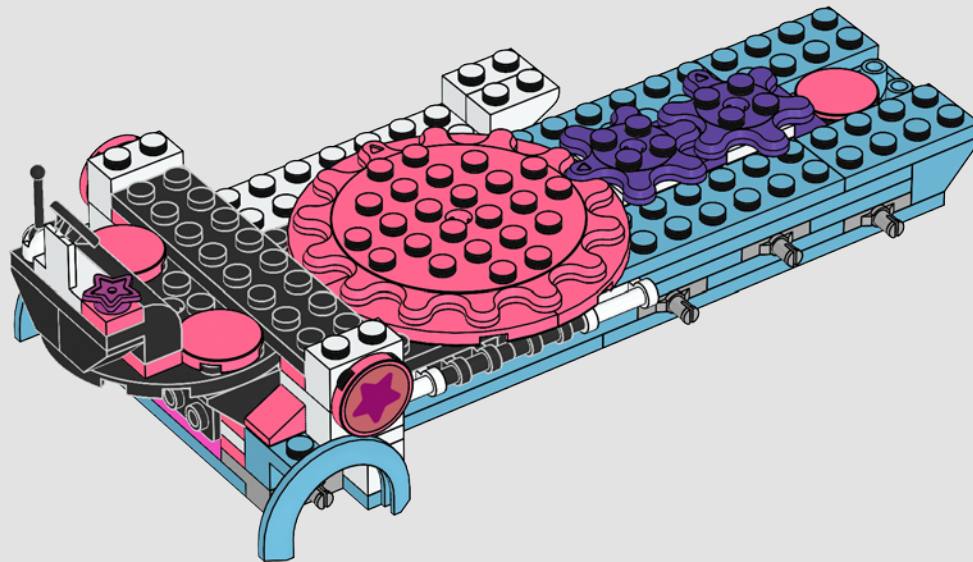



2x

27

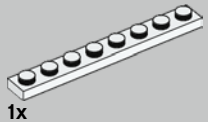
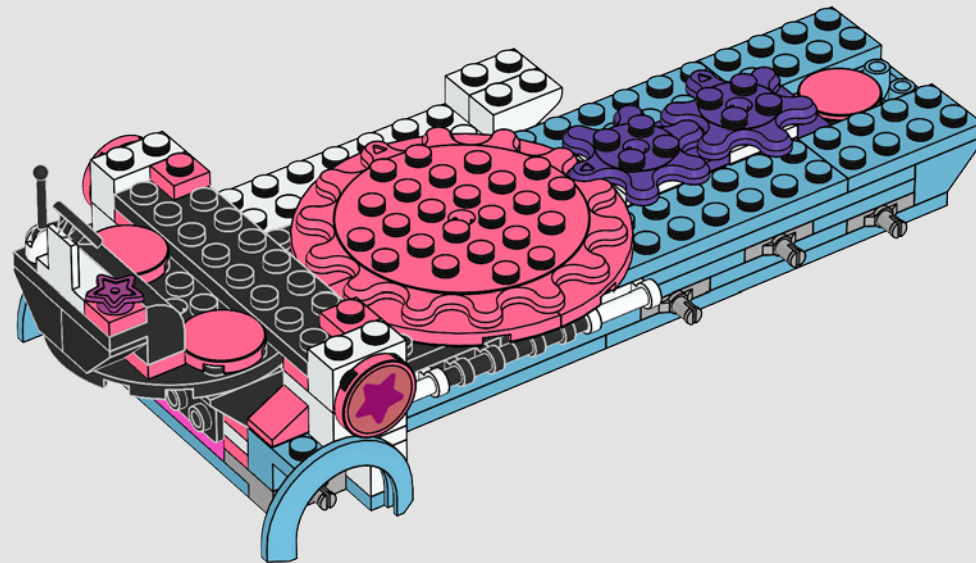

1x

28

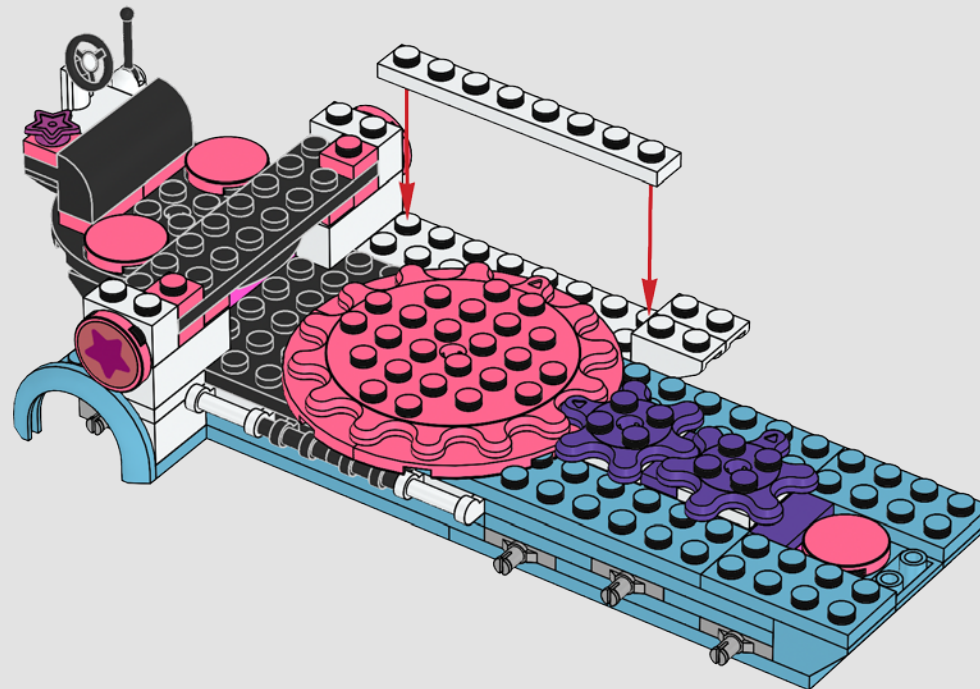

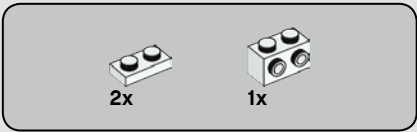

29

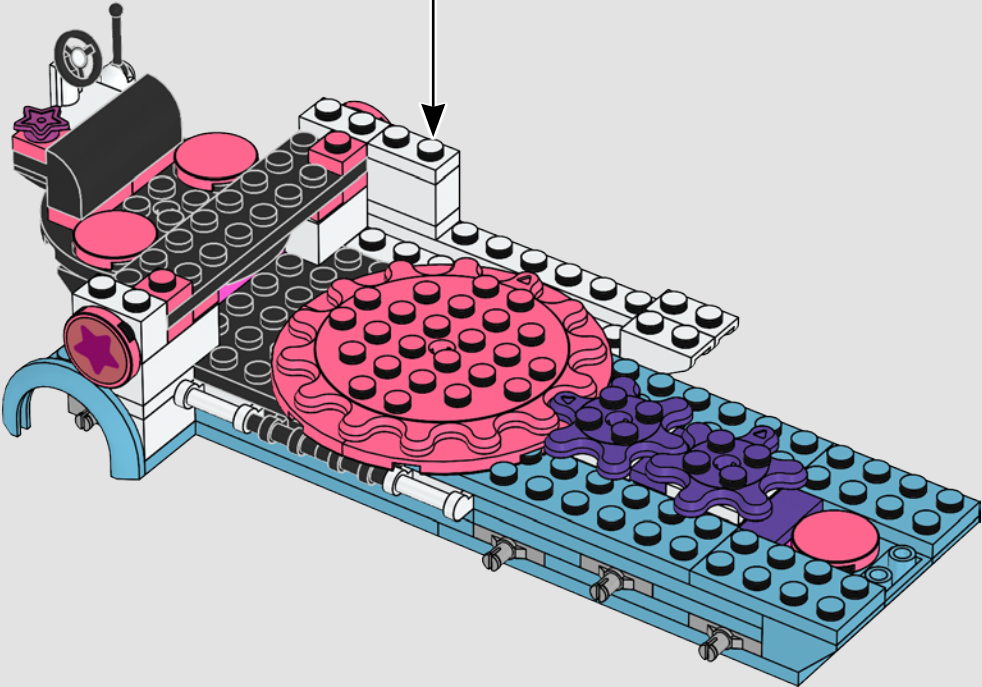
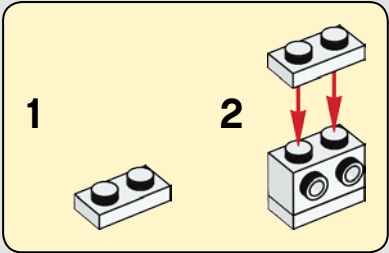

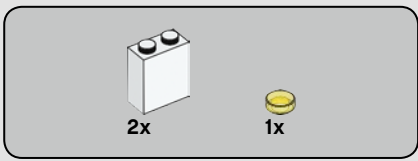

30

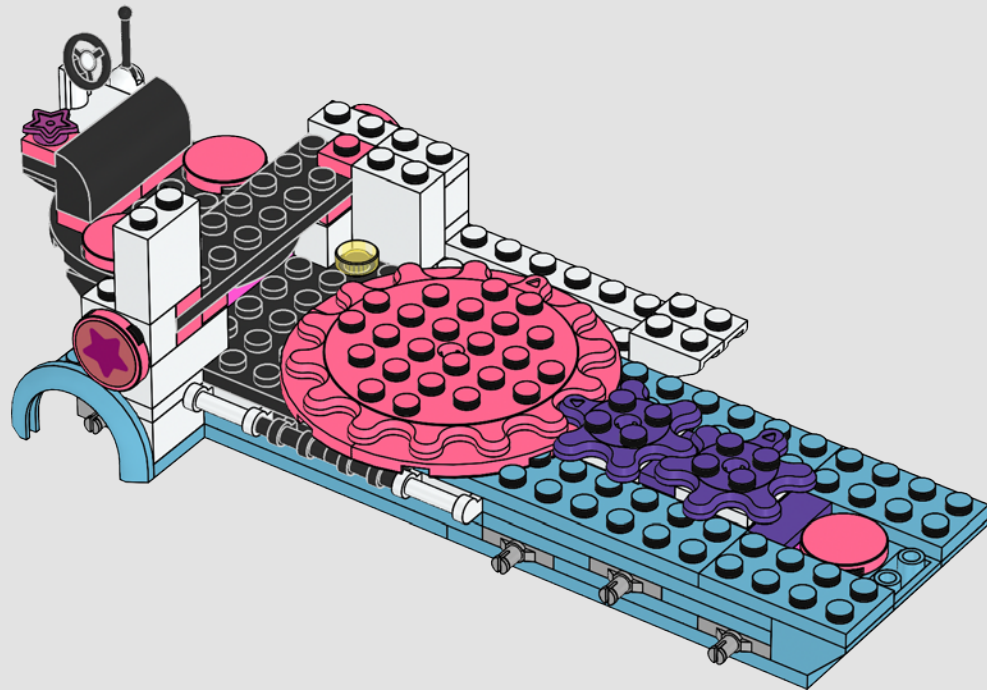

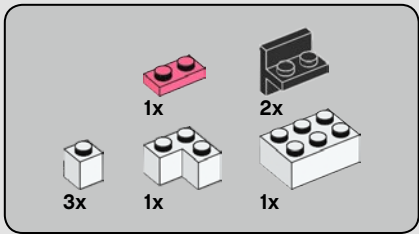

31

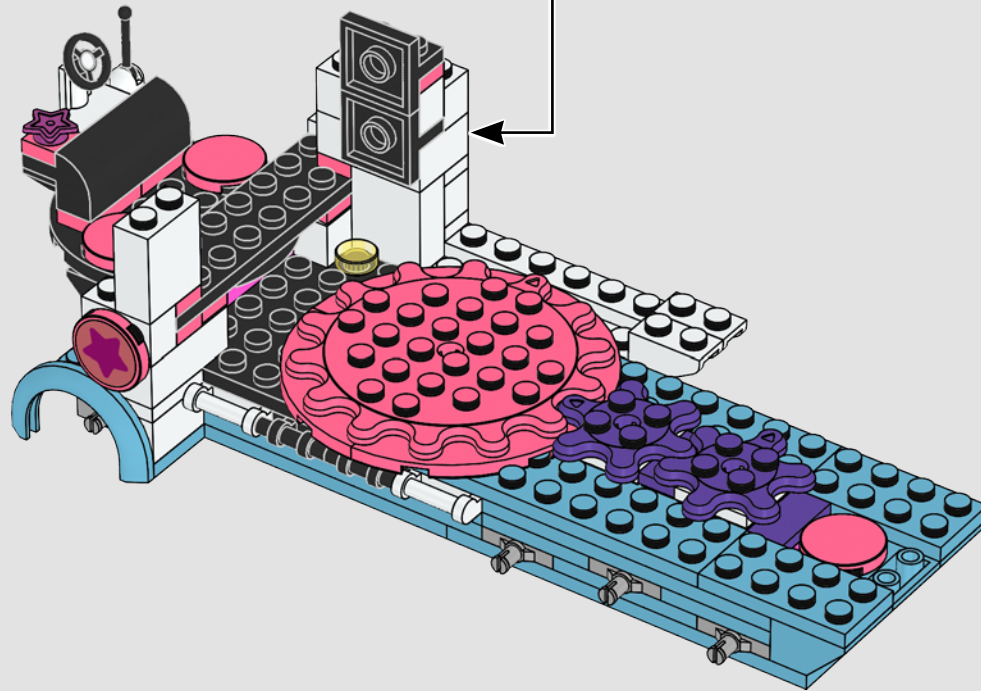
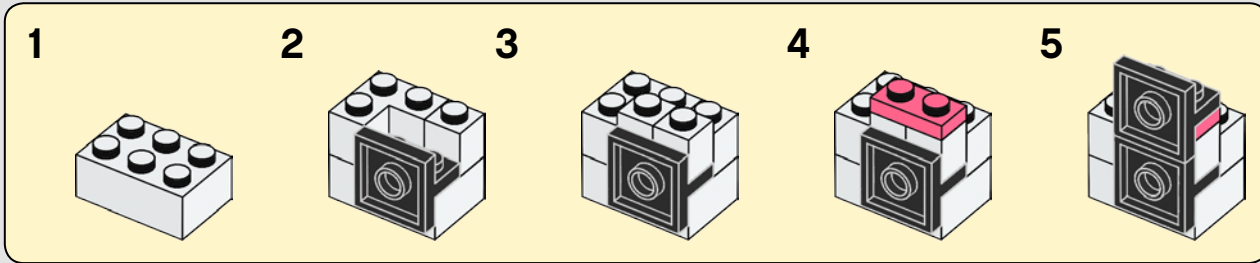

32

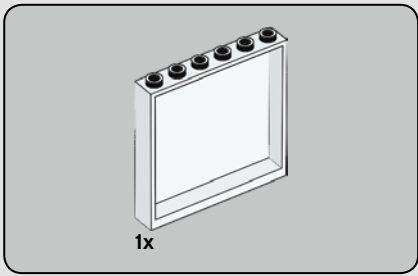

32

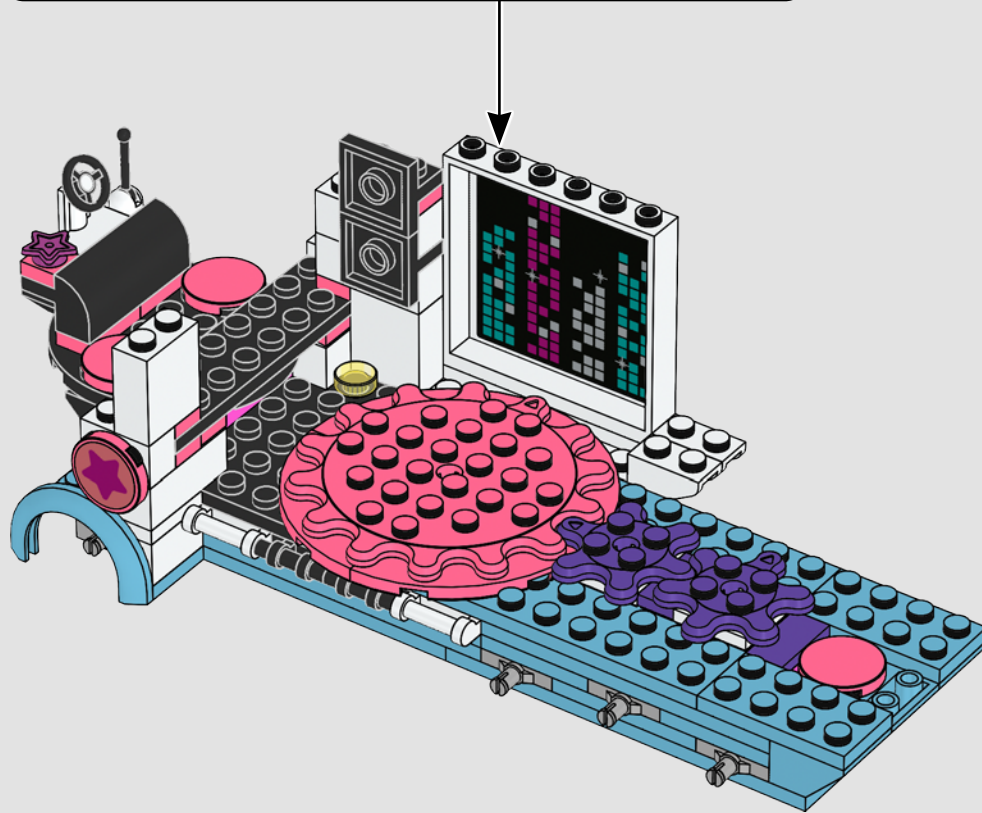
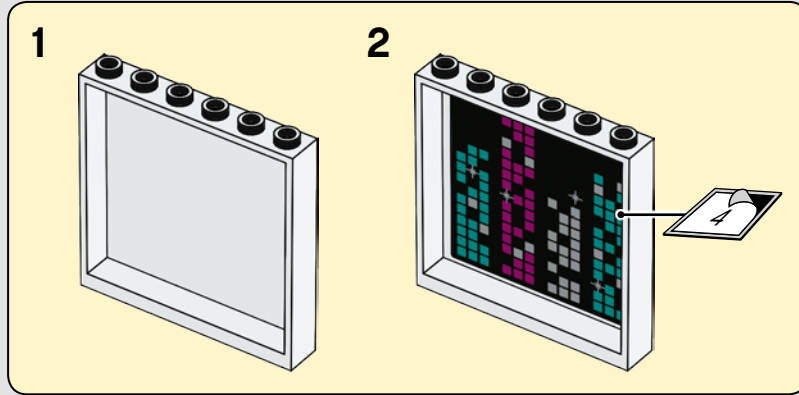

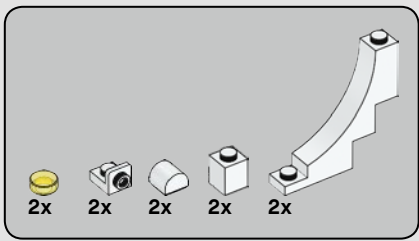

33

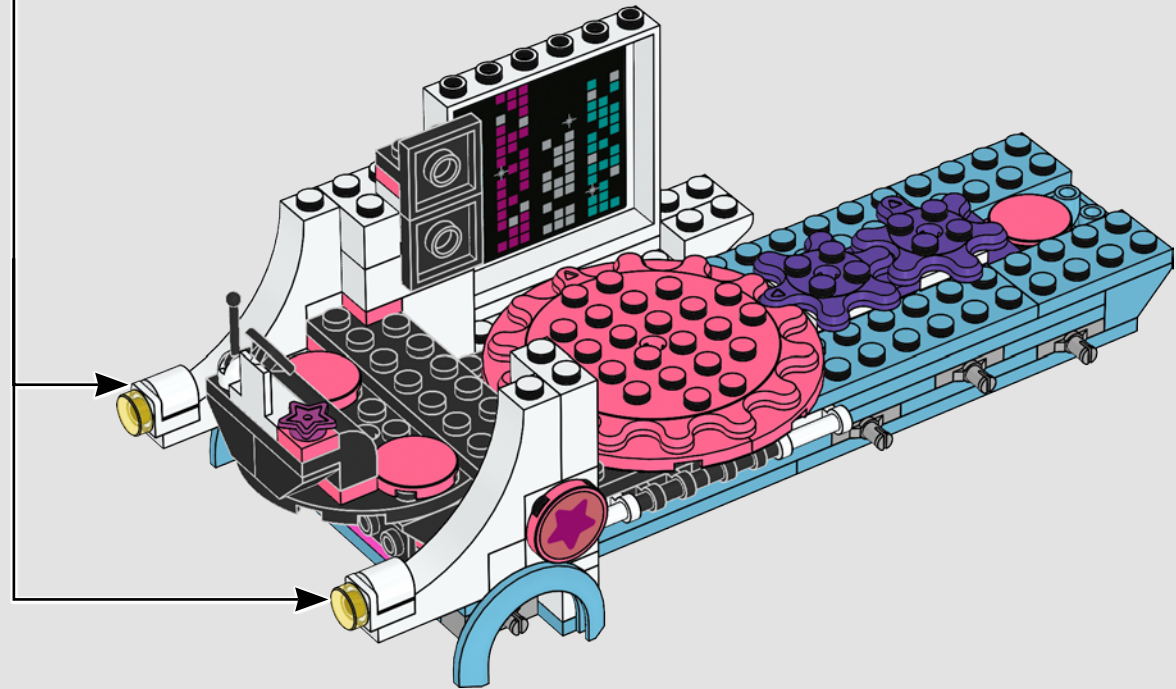
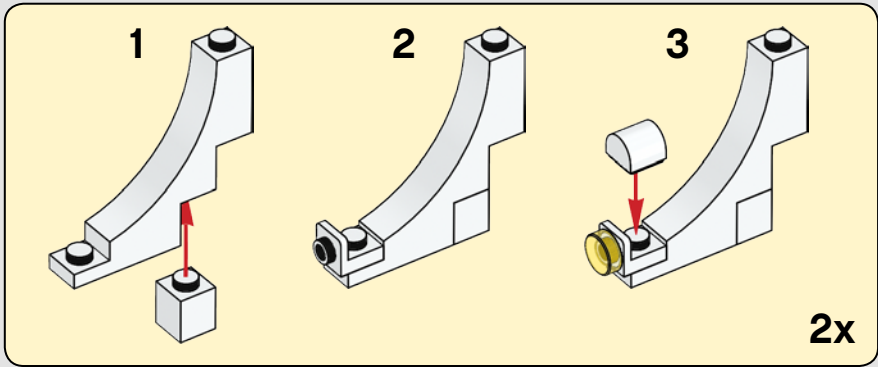

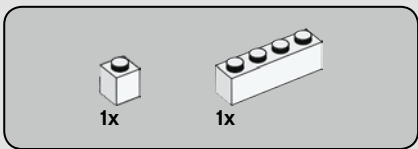

34

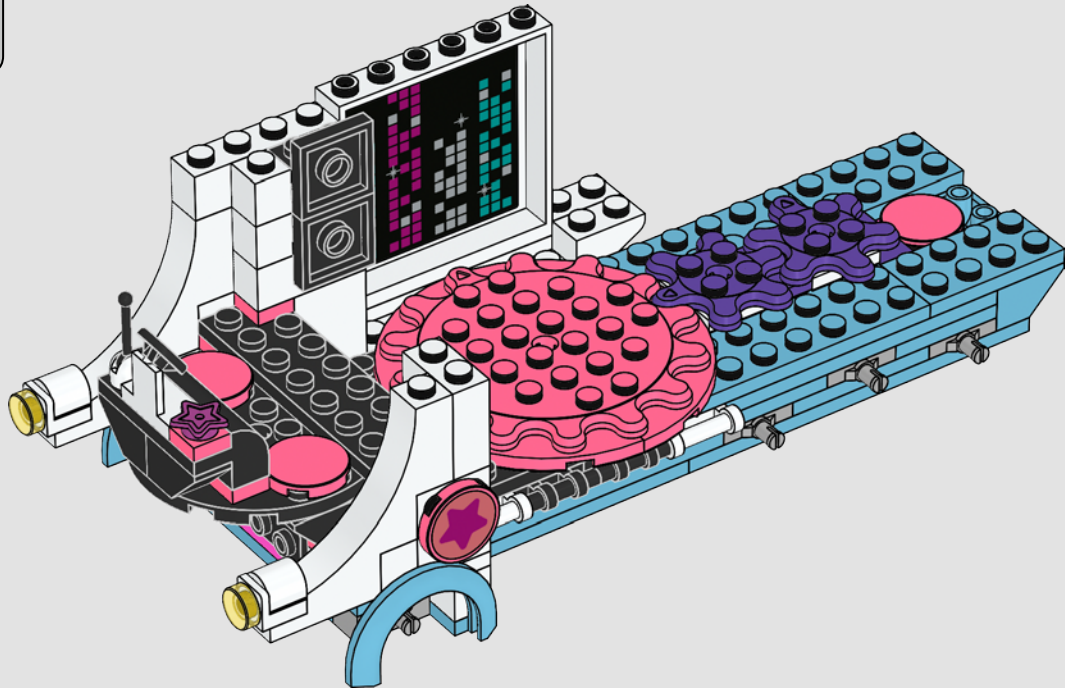

35

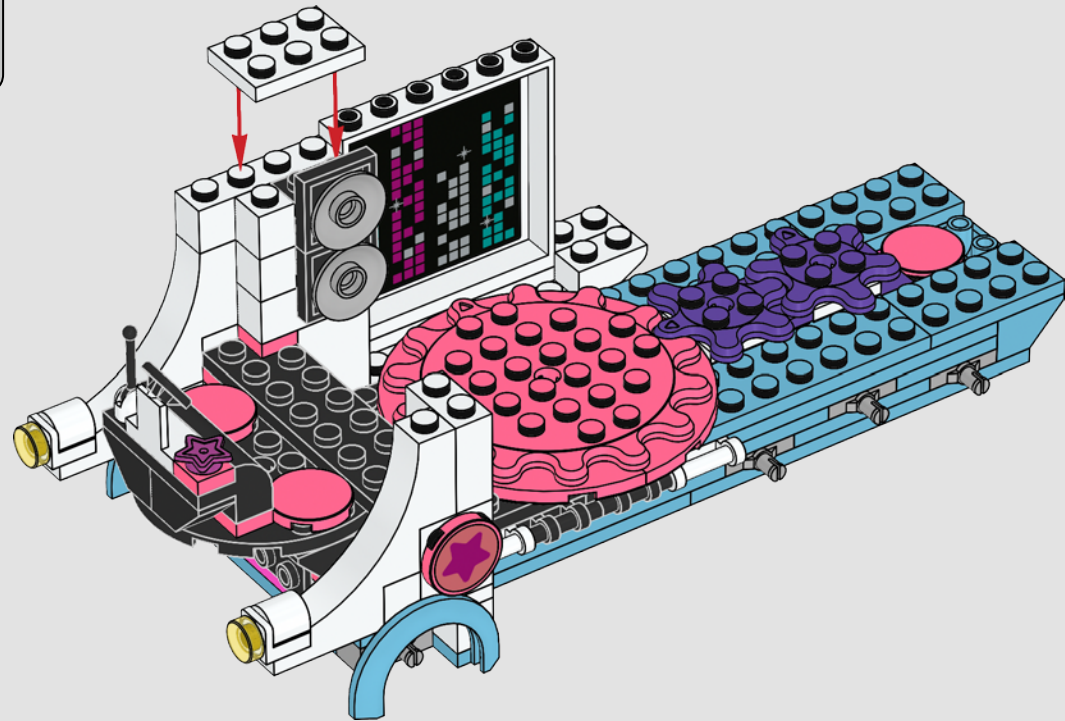

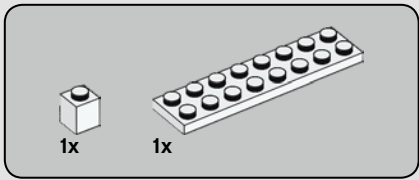

36

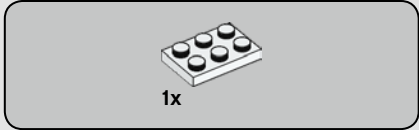
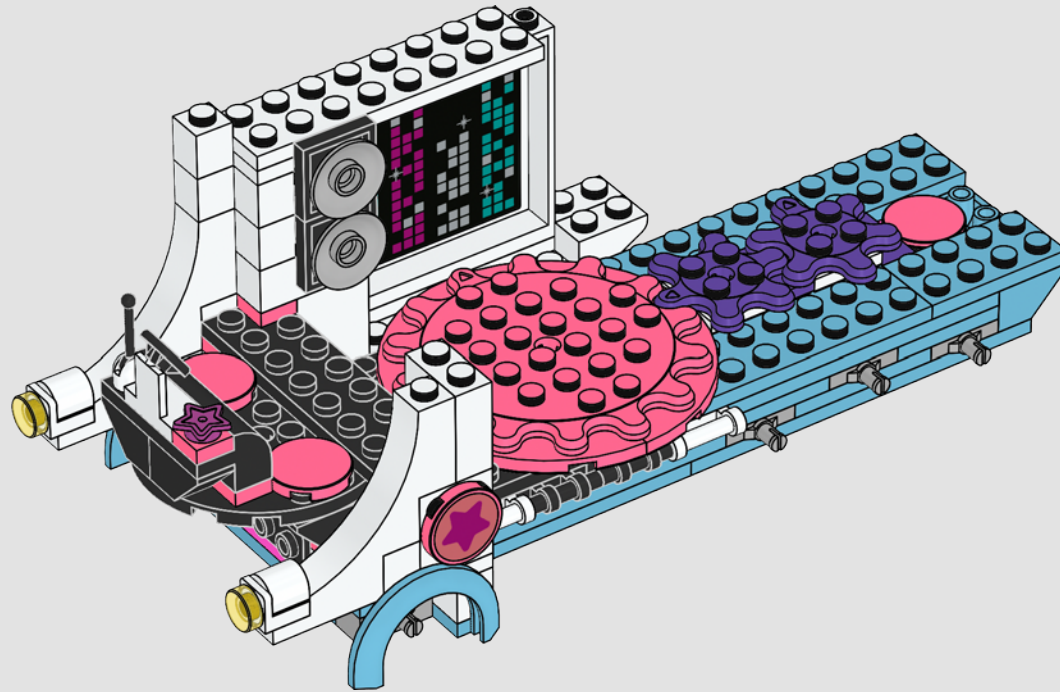

37

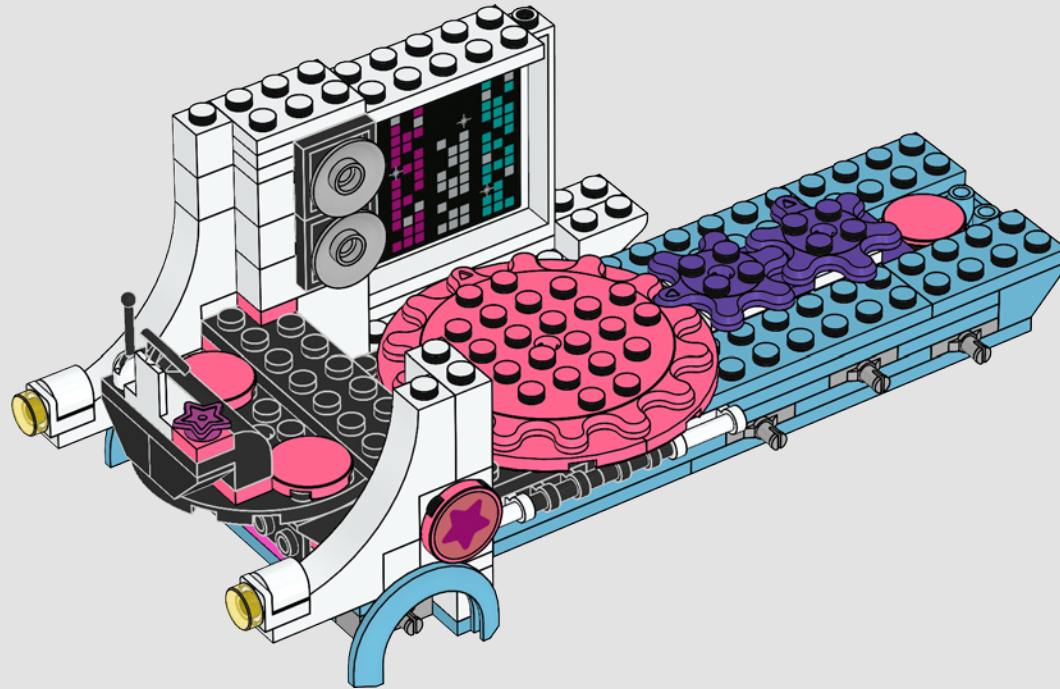

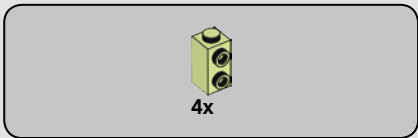

38

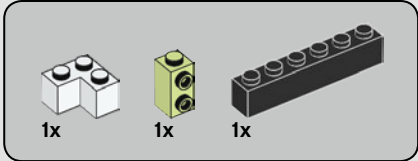
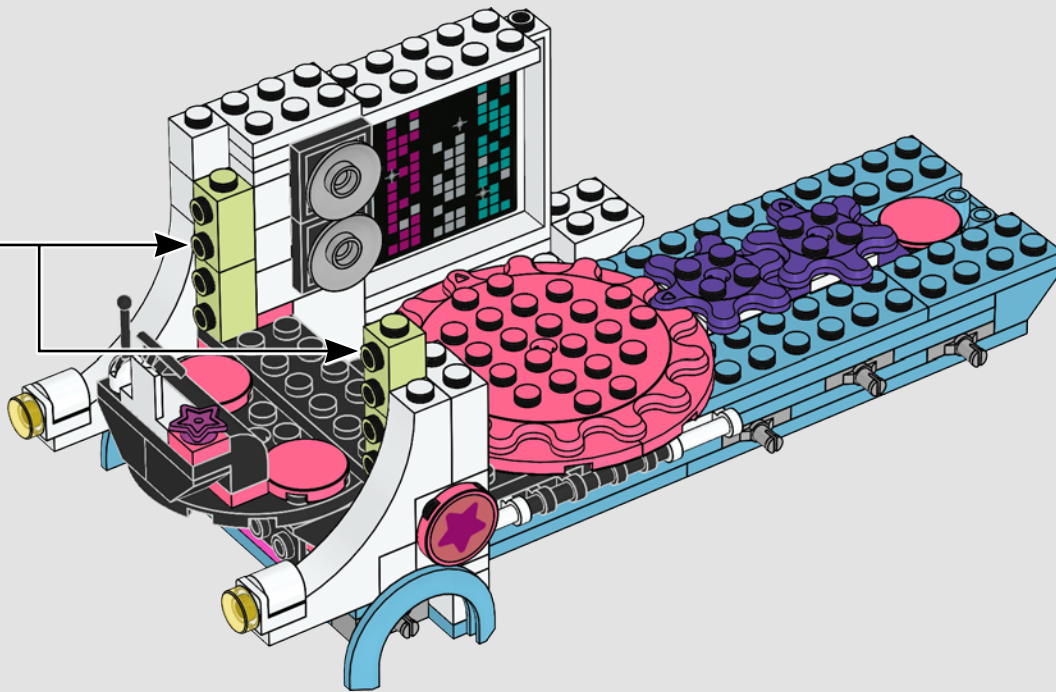
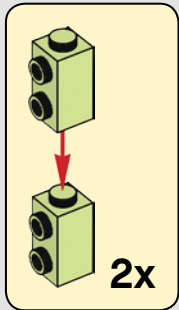

39

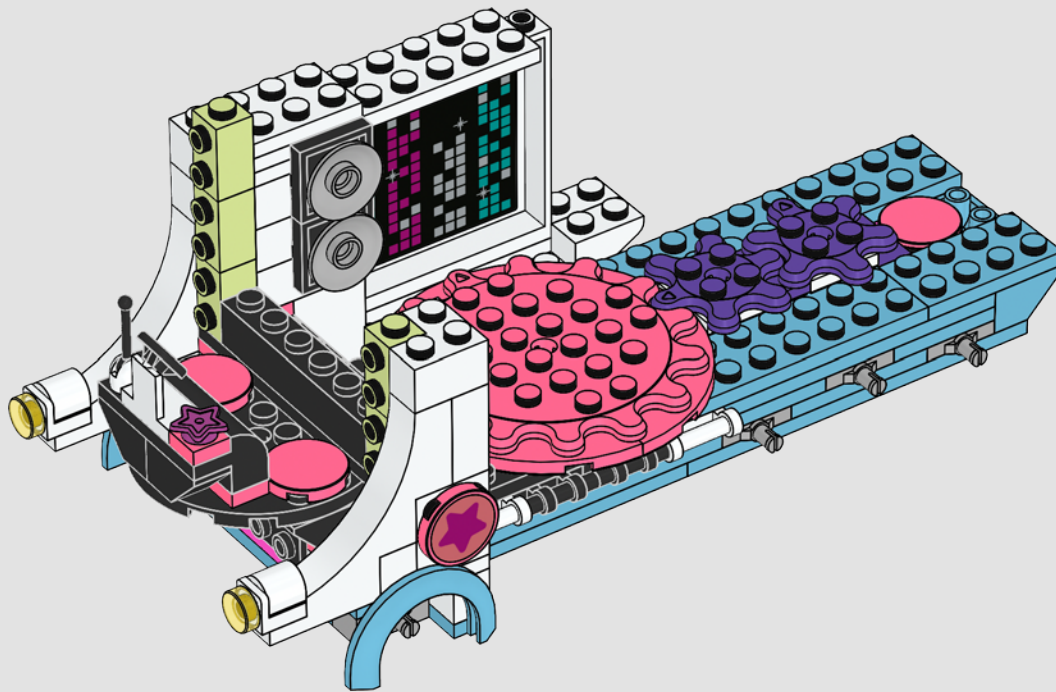

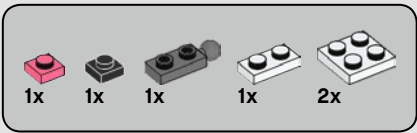

40

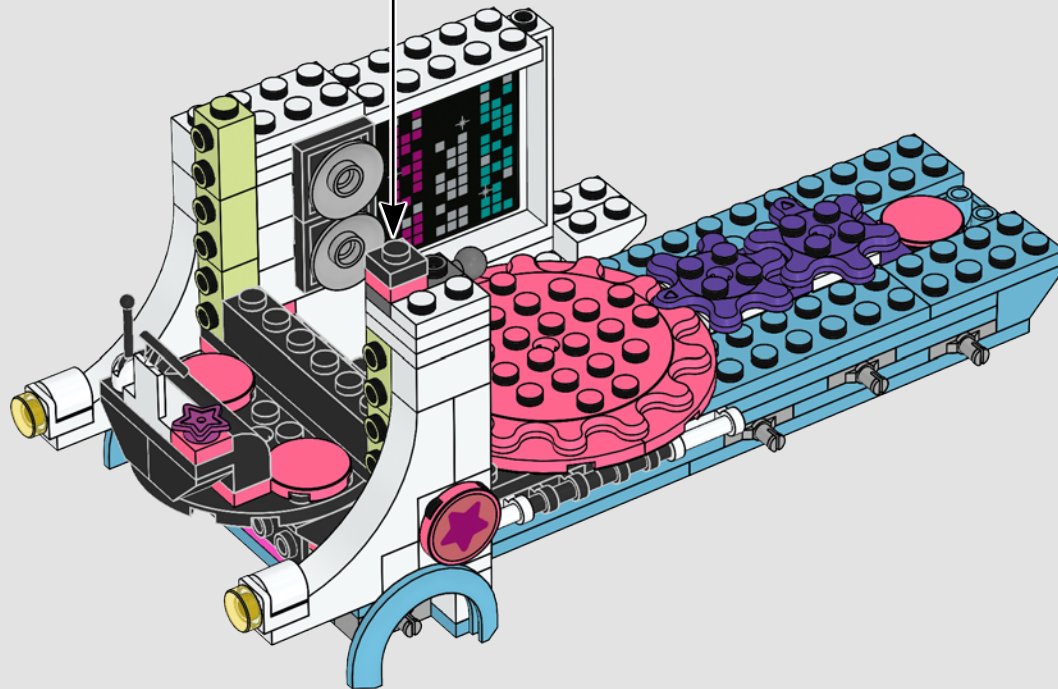
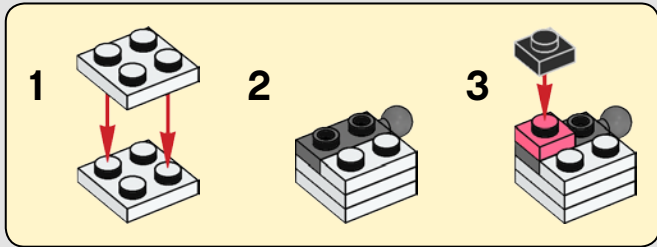



4x

41

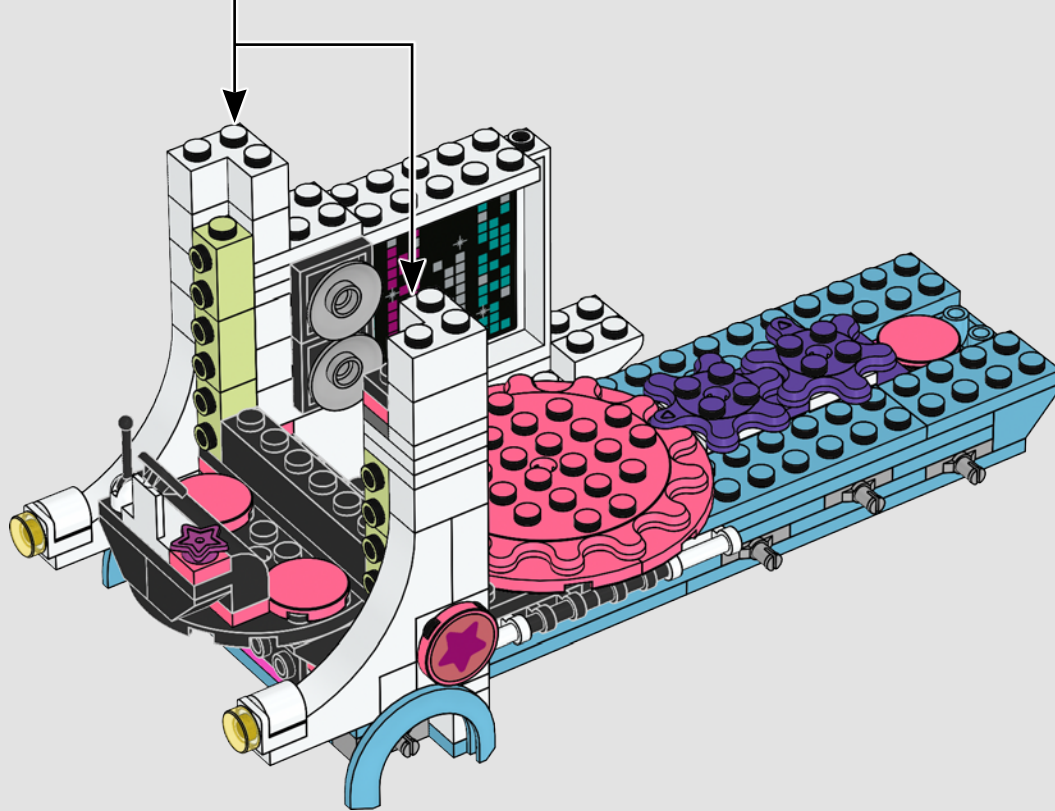
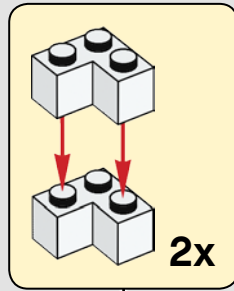

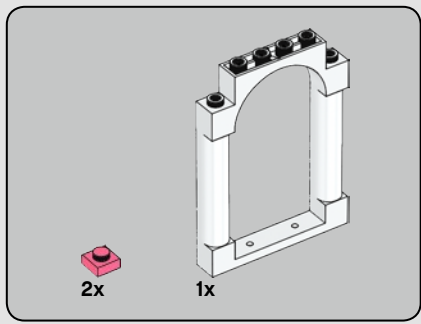

42

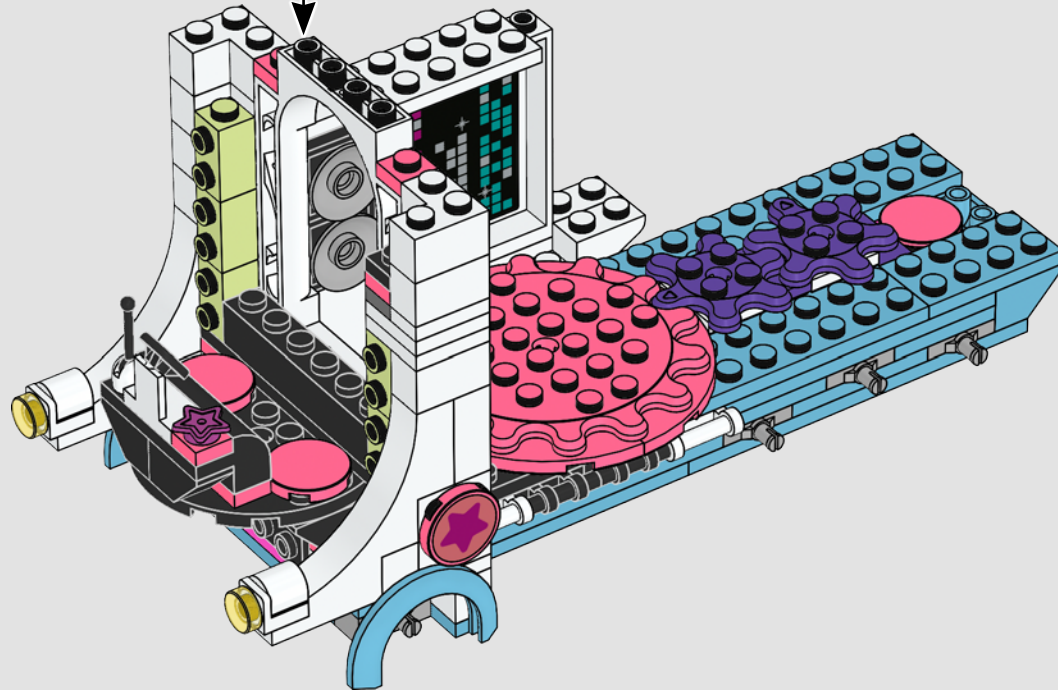
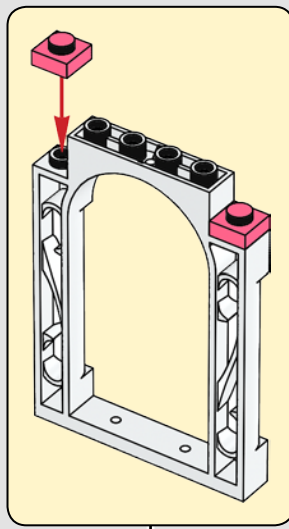

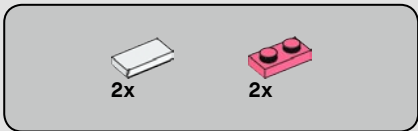

43

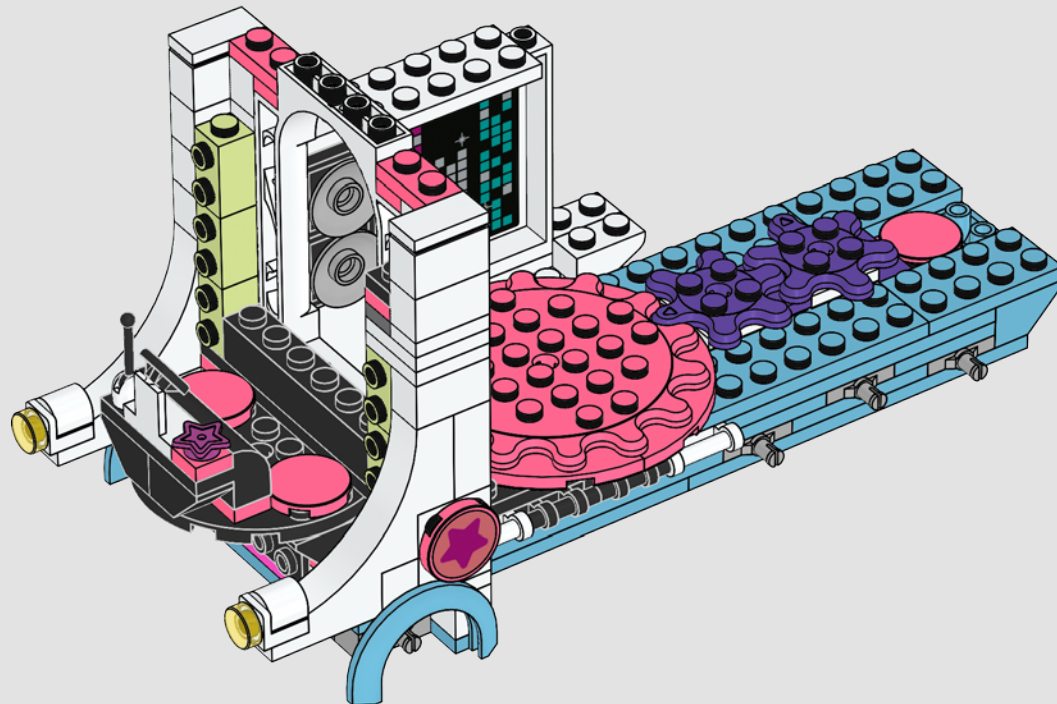

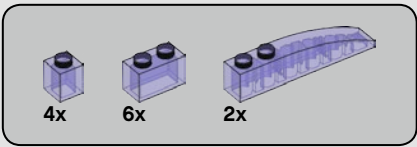

44

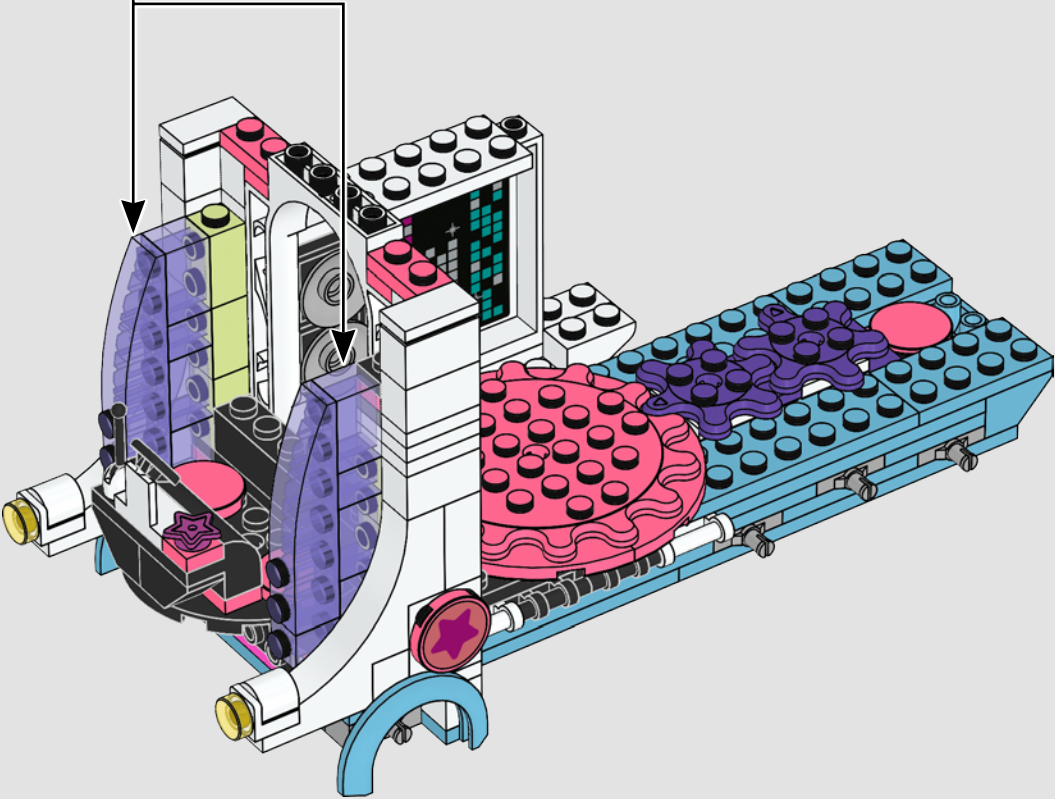
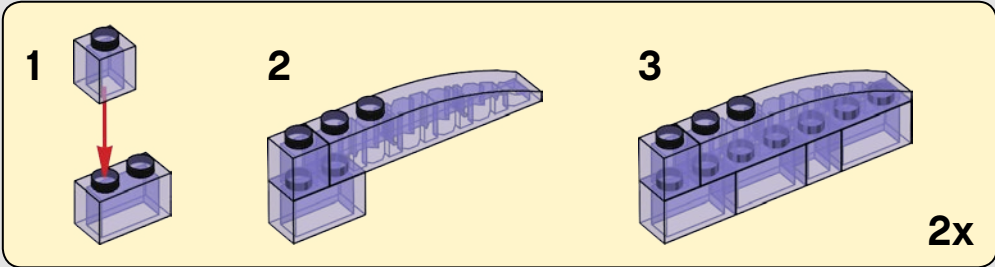



45

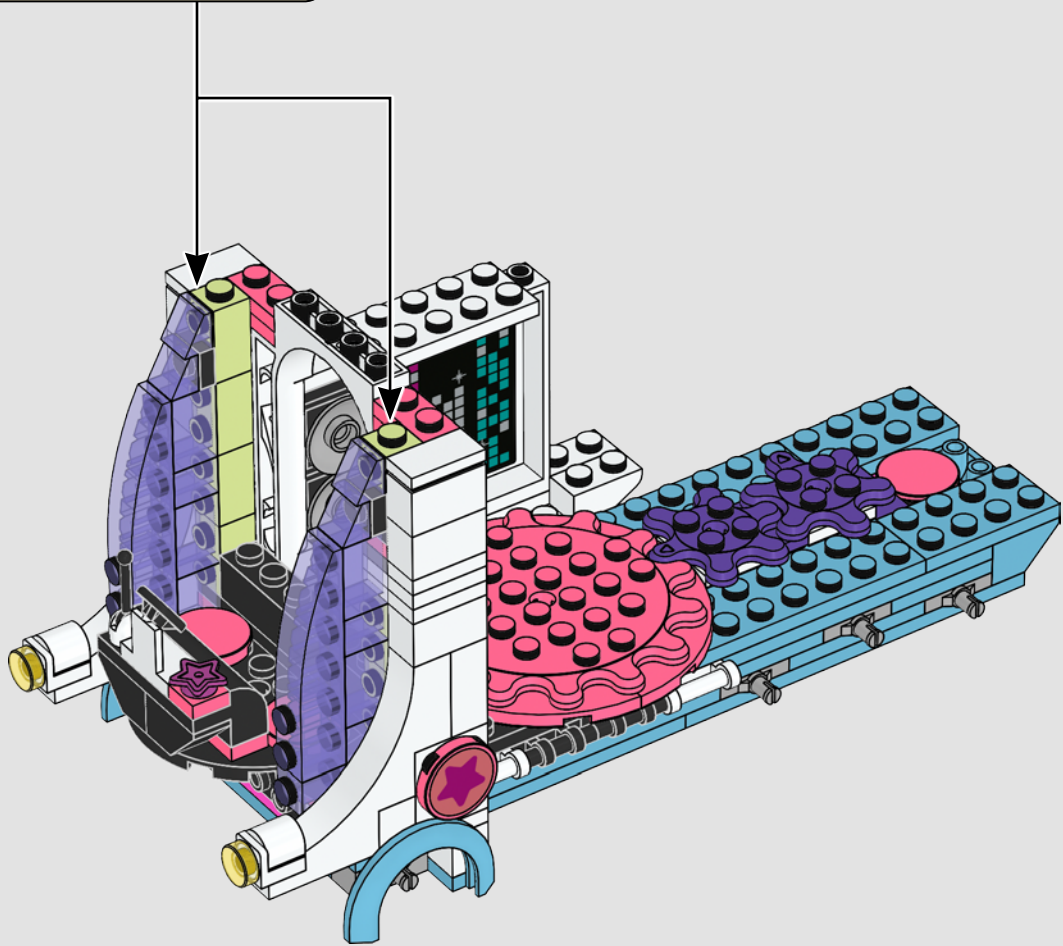
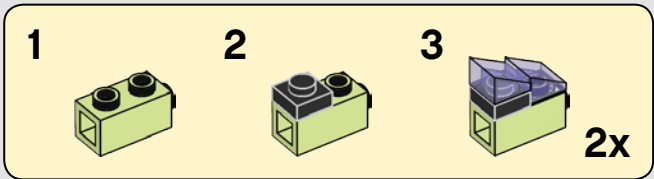



2x

46

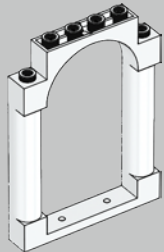
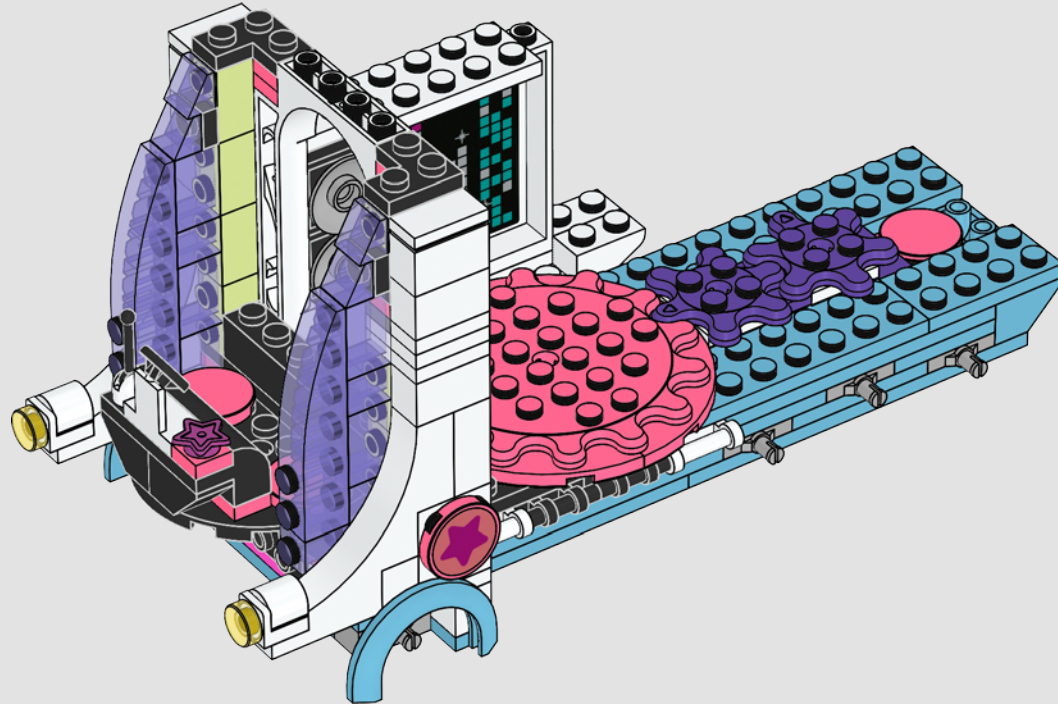

1x

47

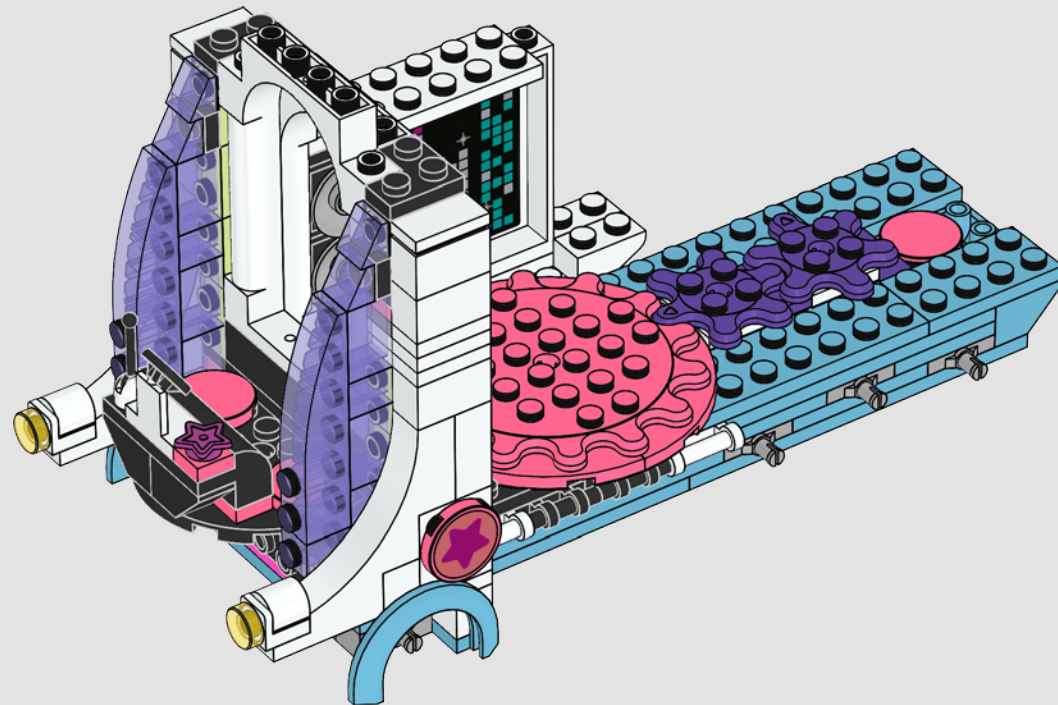

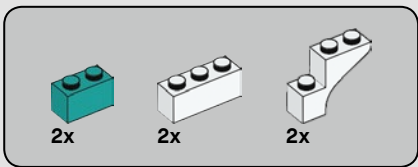

48

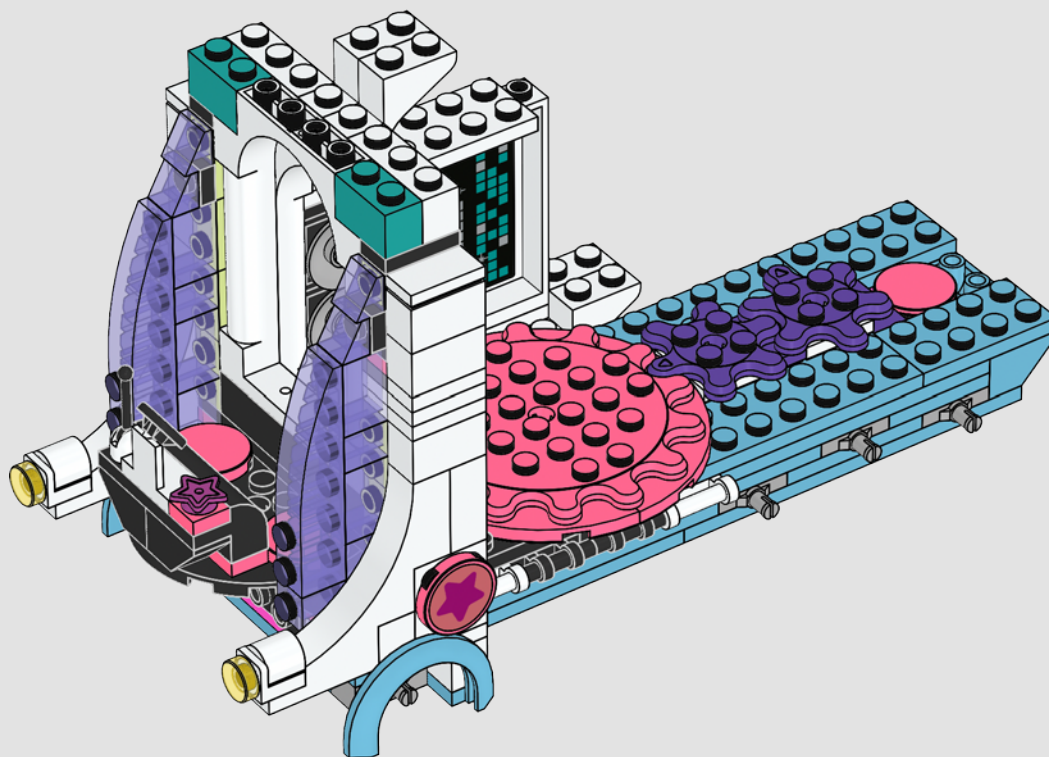

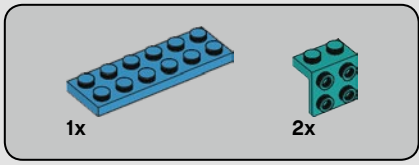

49

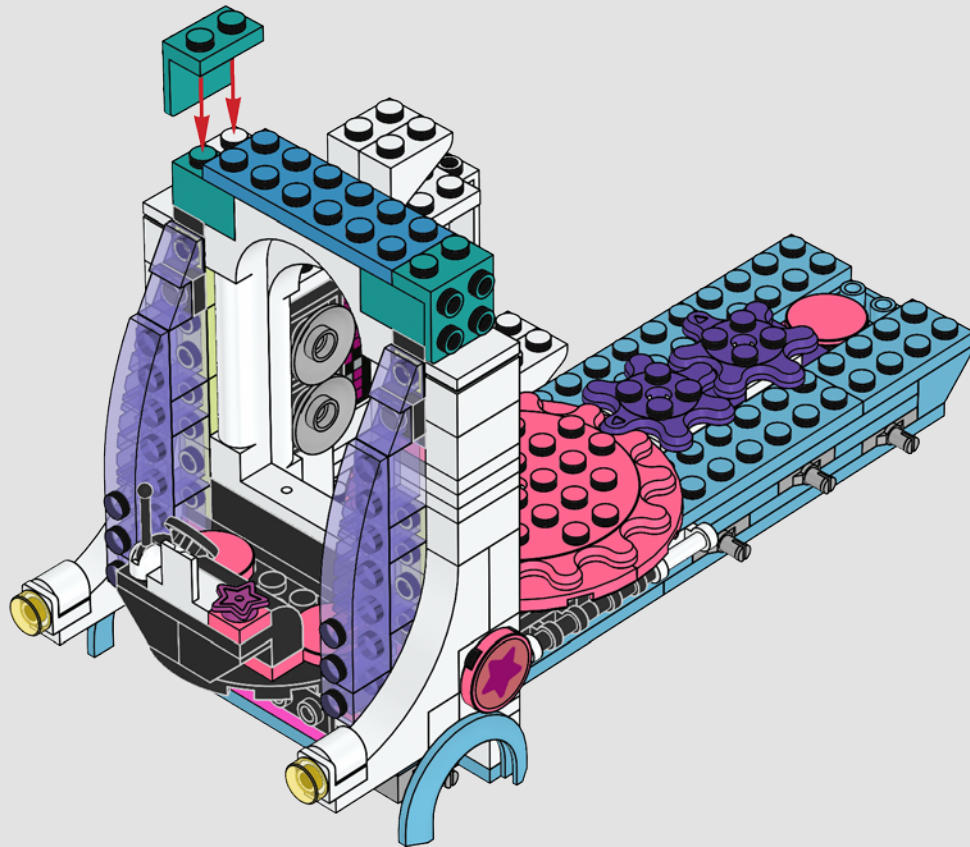

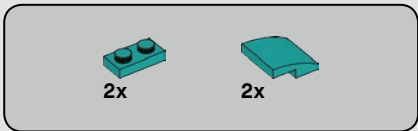

50

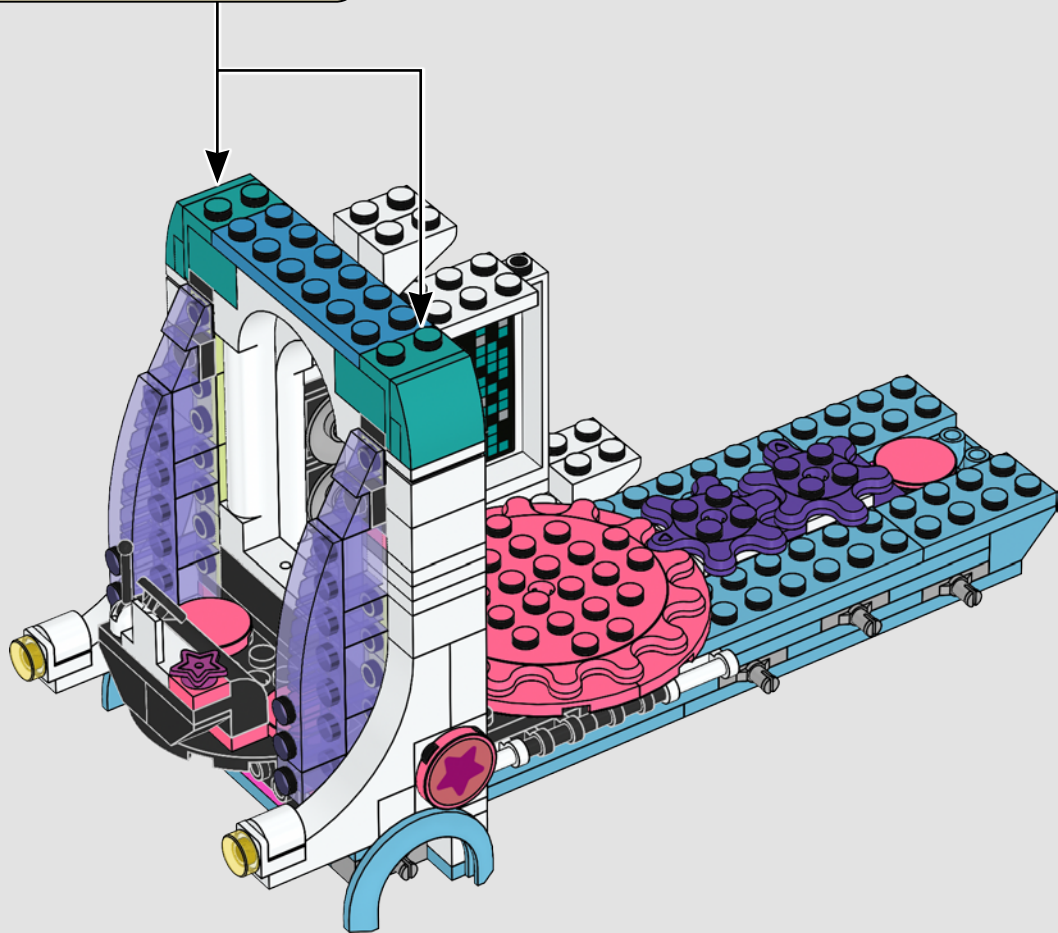
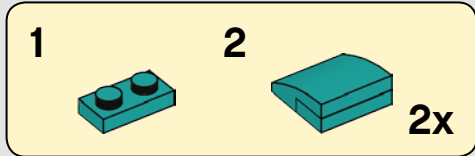



1x



1x

51

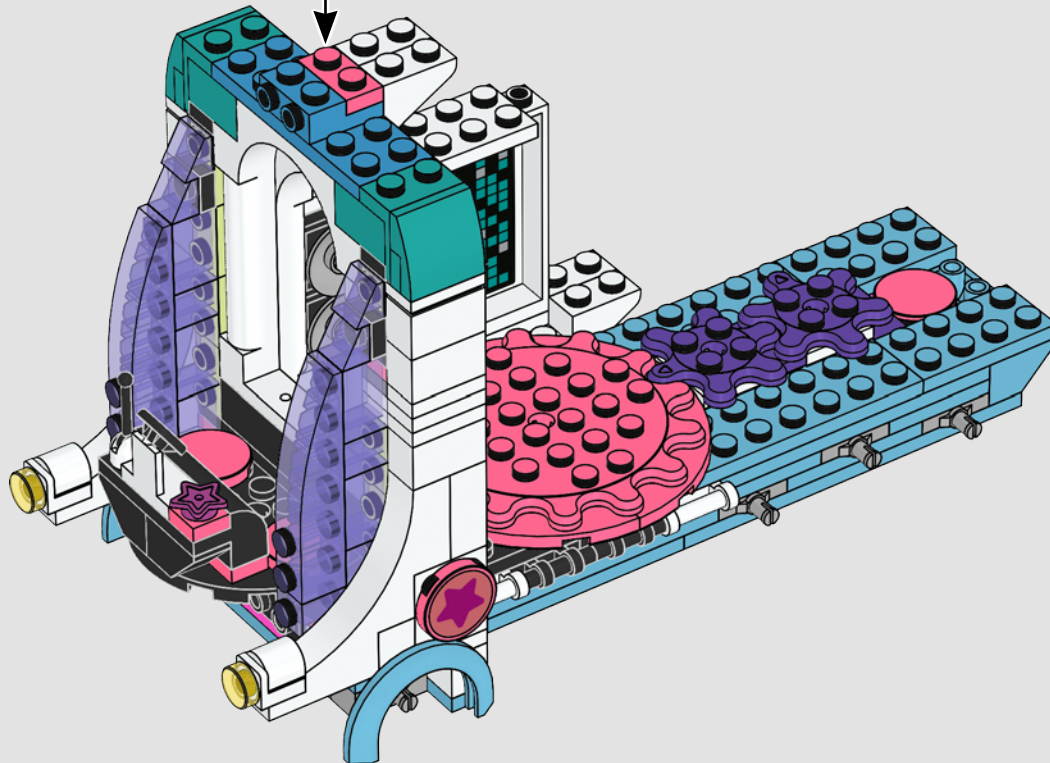
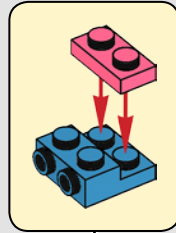

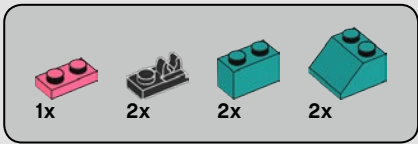

52

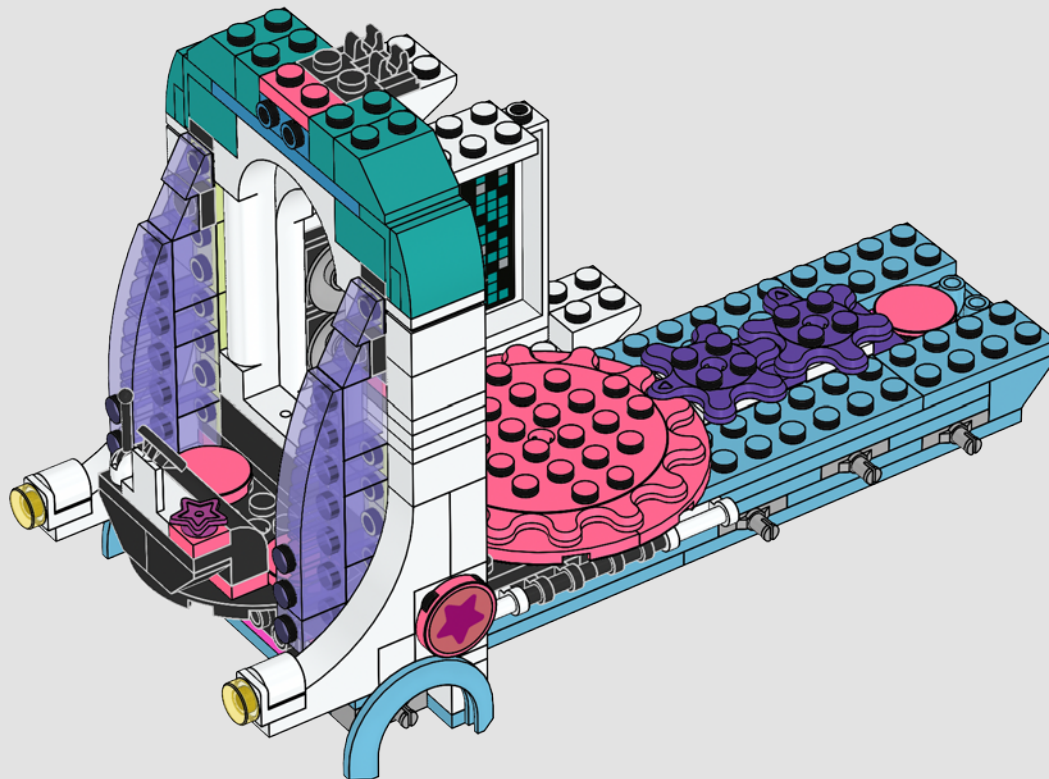

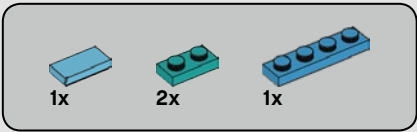

53

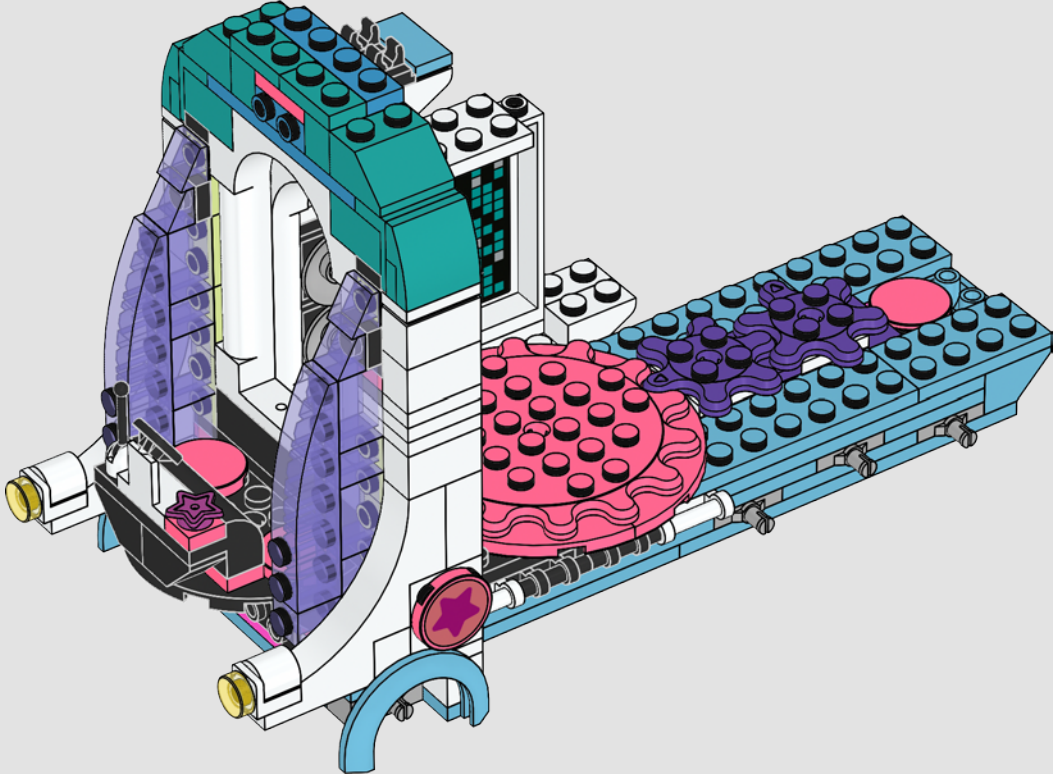

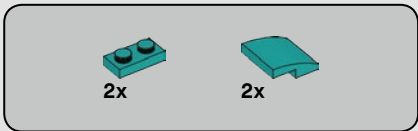

54

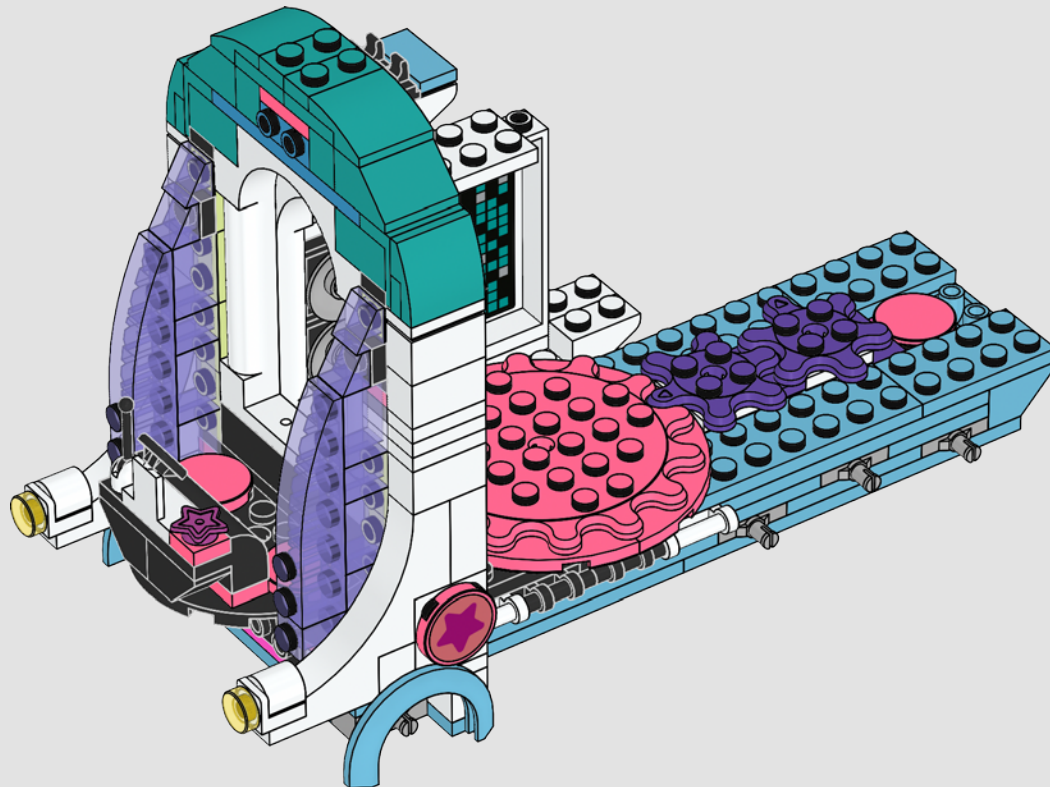

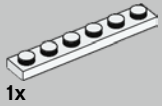
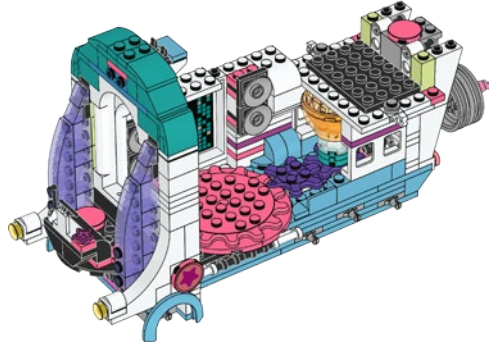
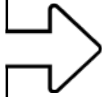
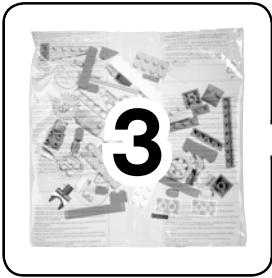

1x



2x

55

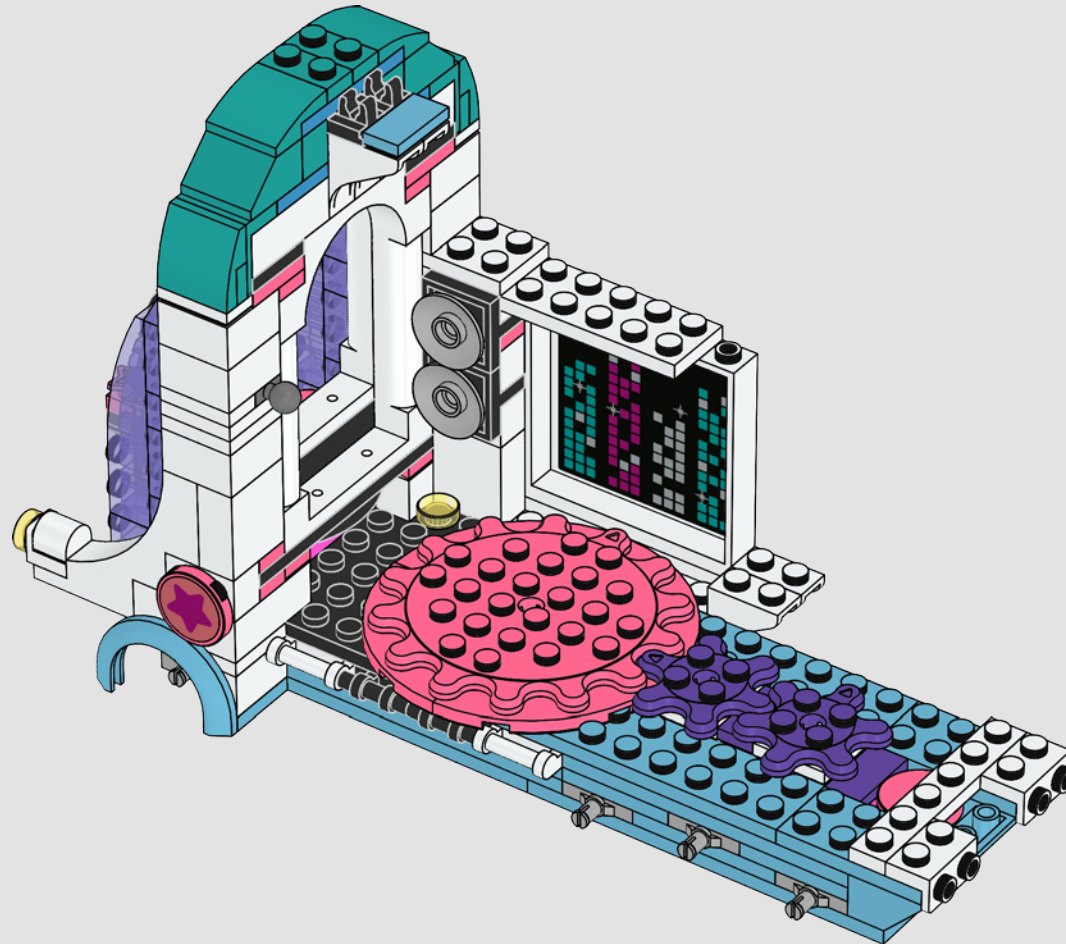

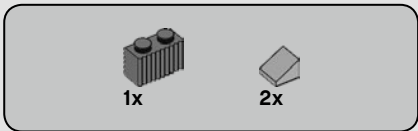

56

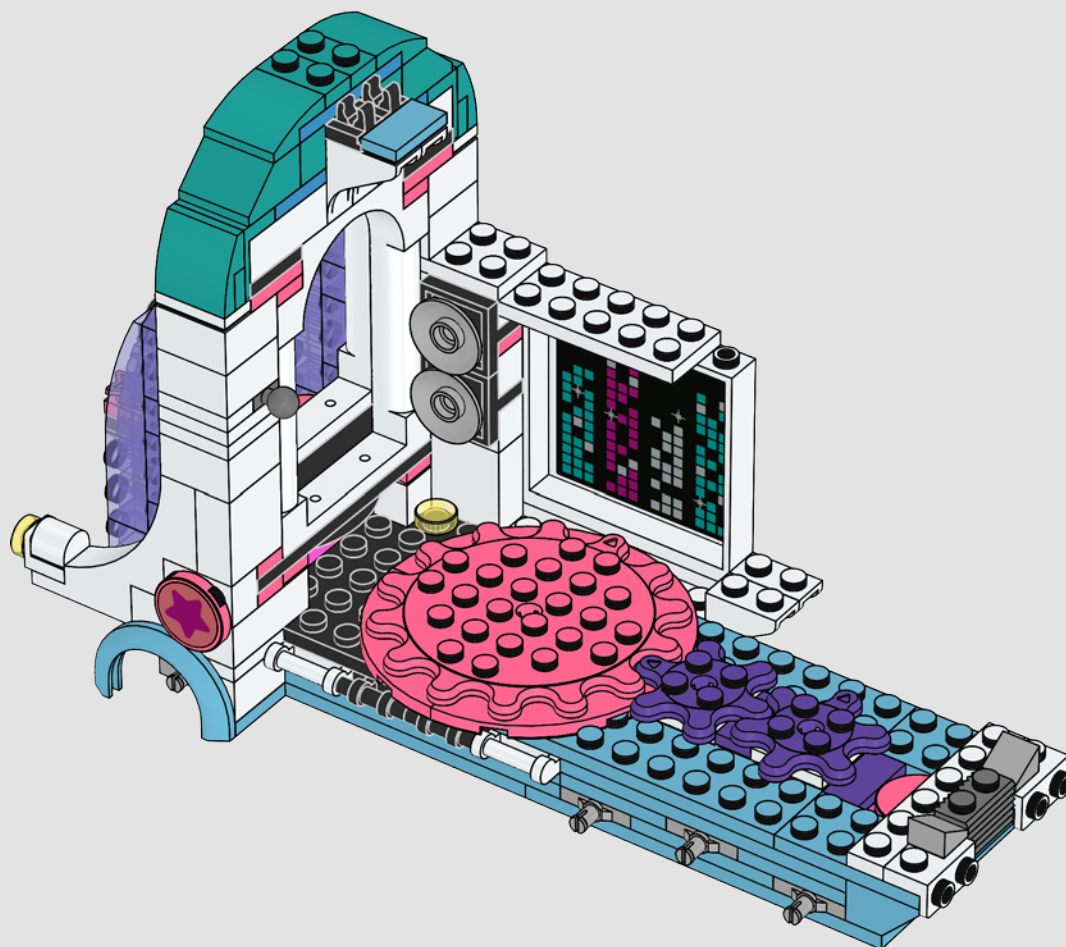

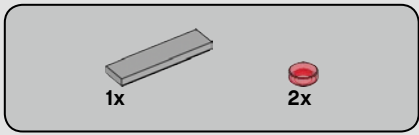

57

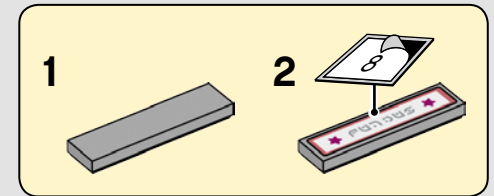
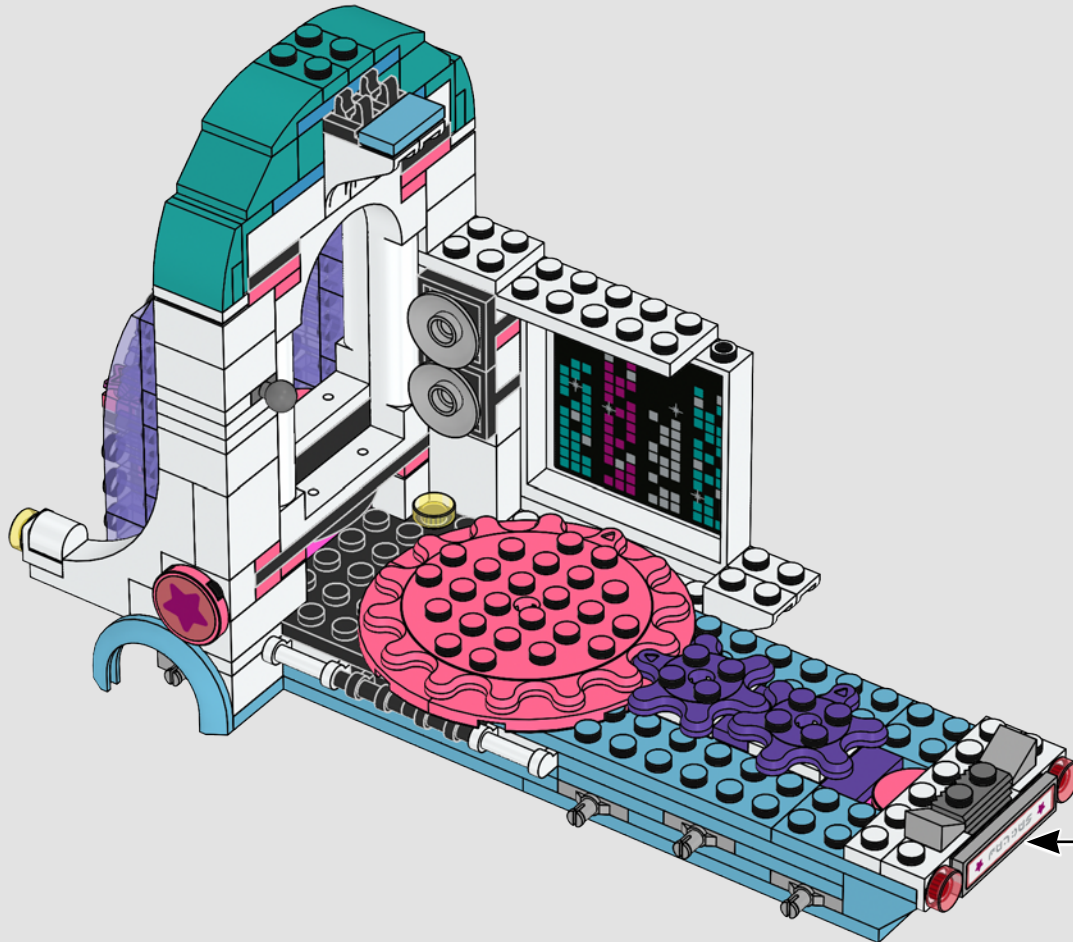

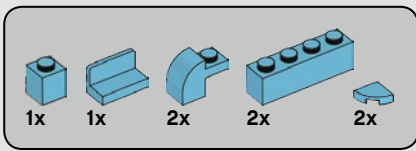

58

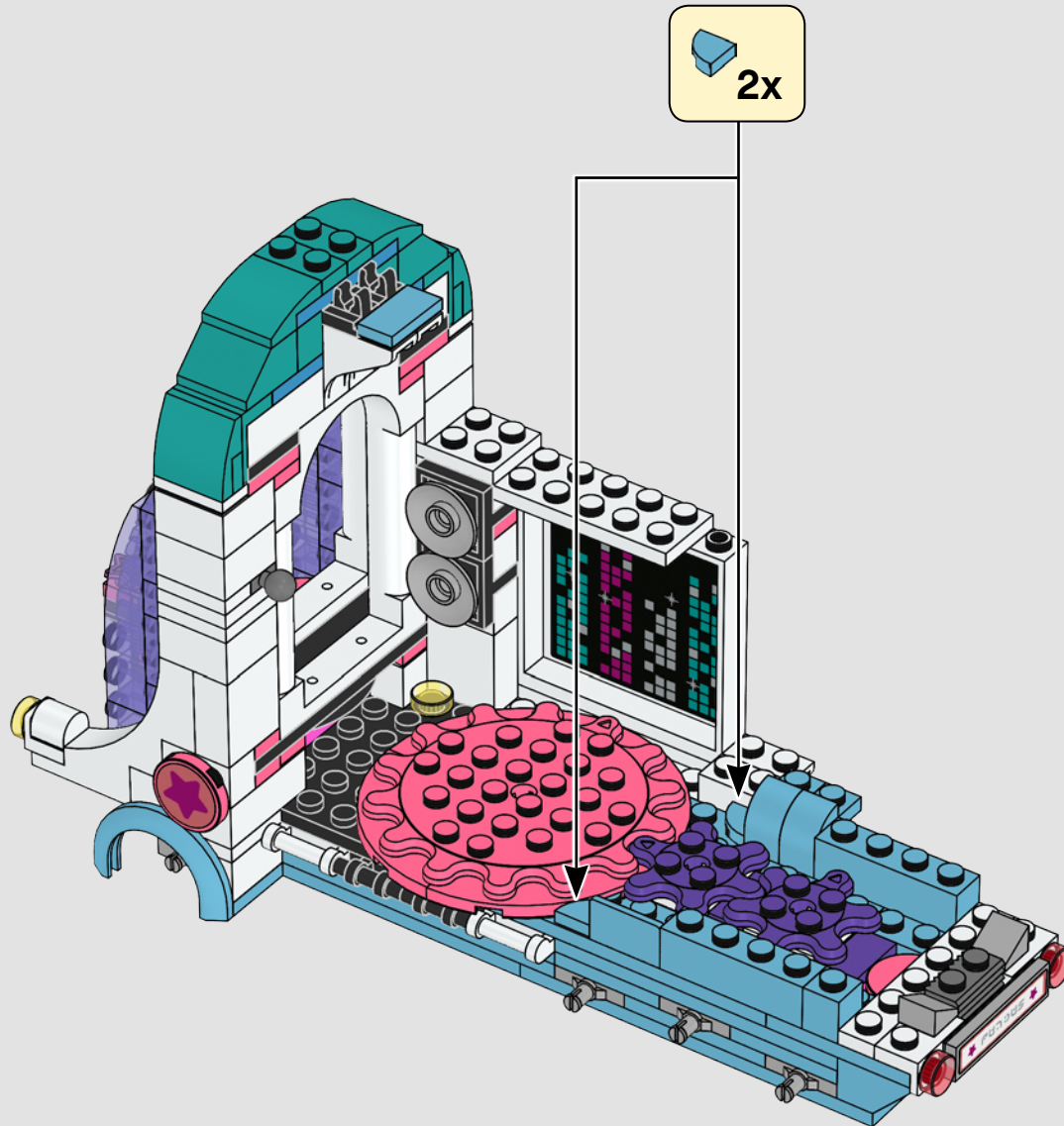

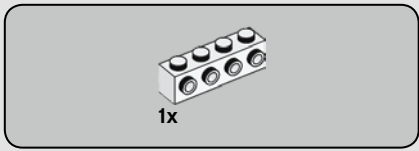

59

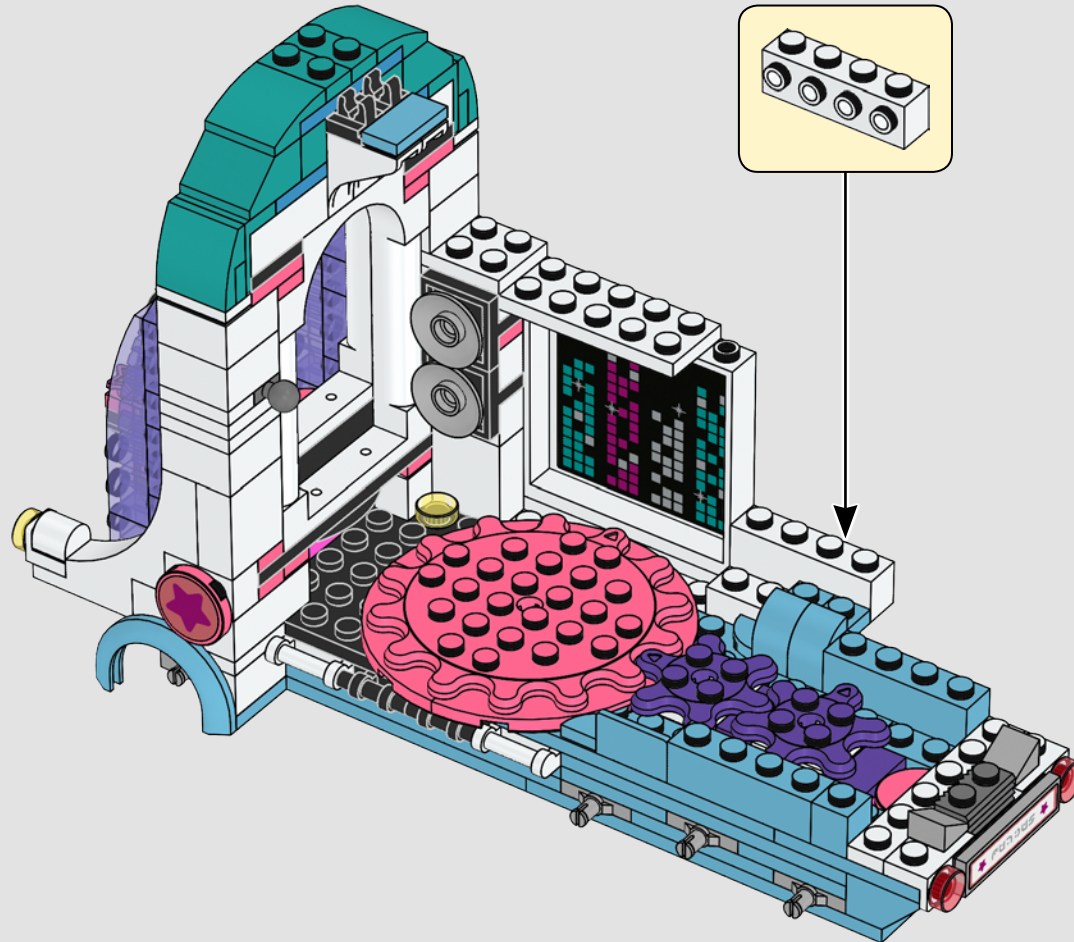

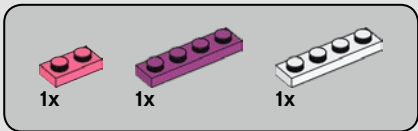

60

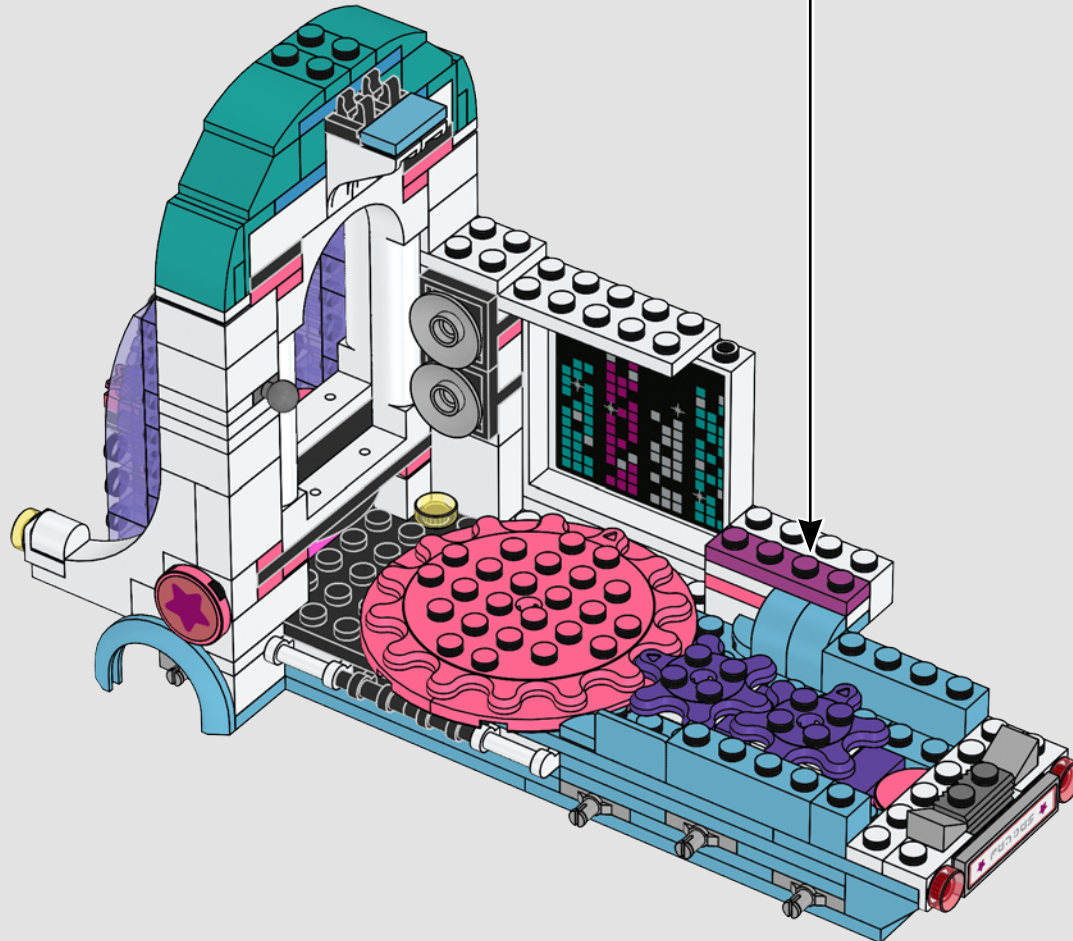
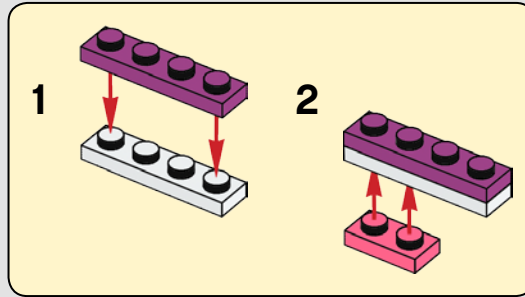

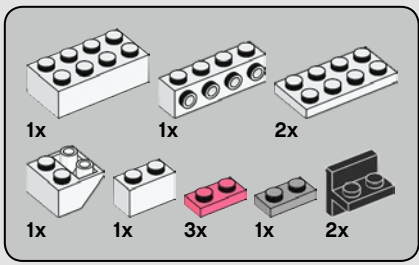

61

1

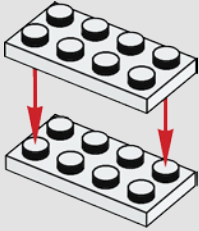

2

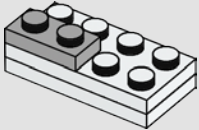

3

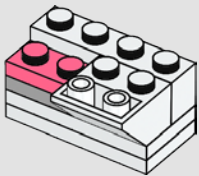

4

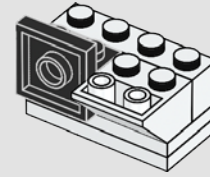

5

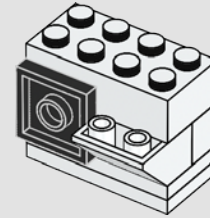

6

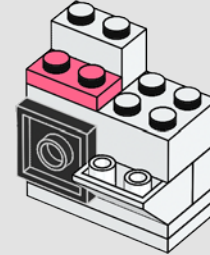

7

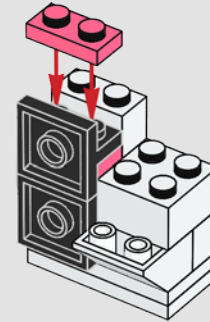

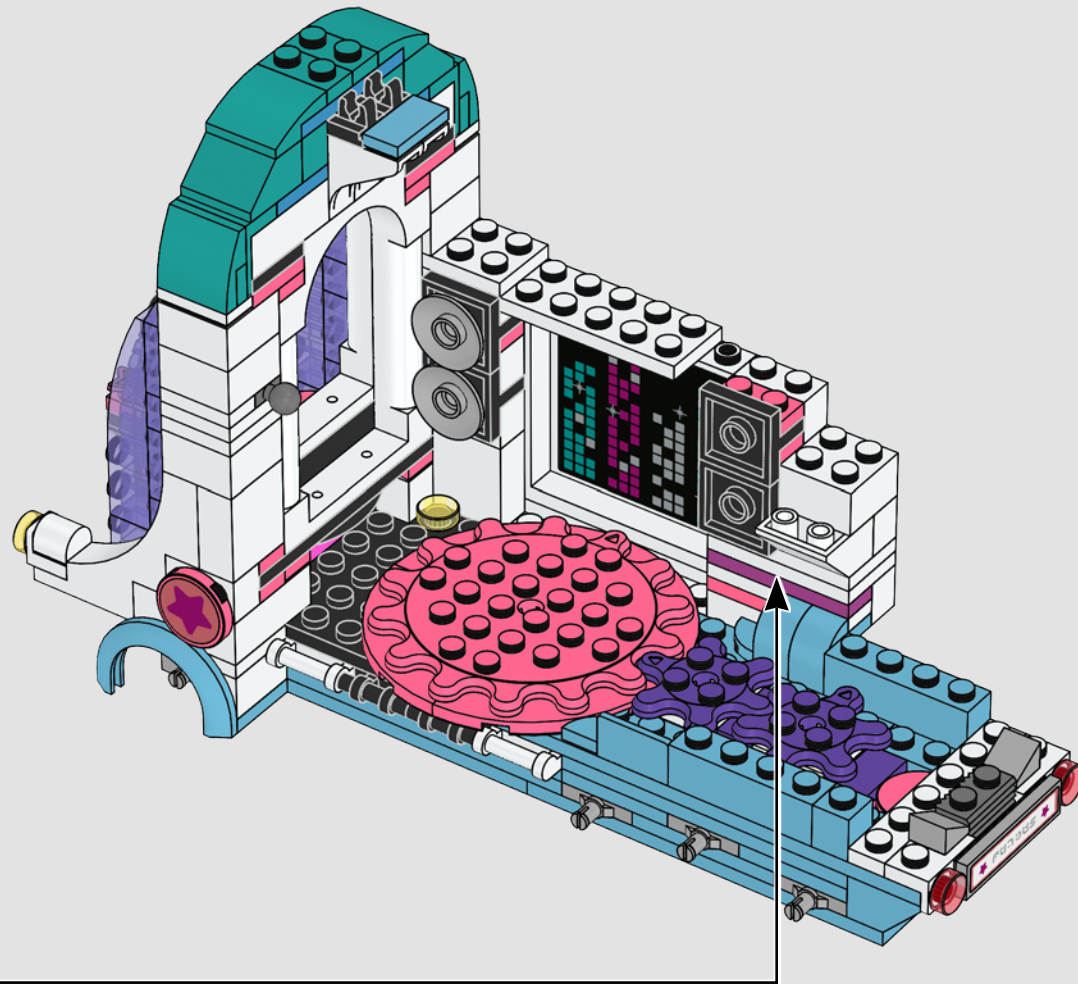

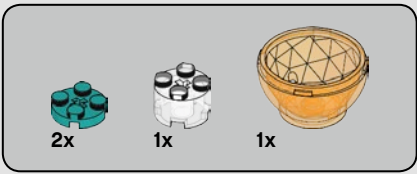

62

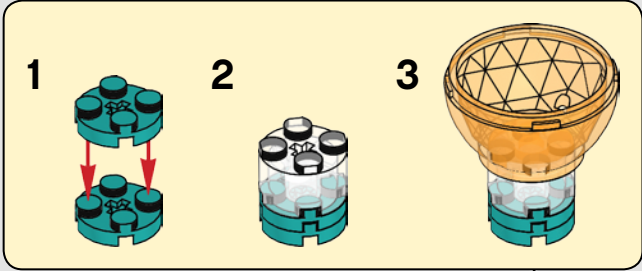
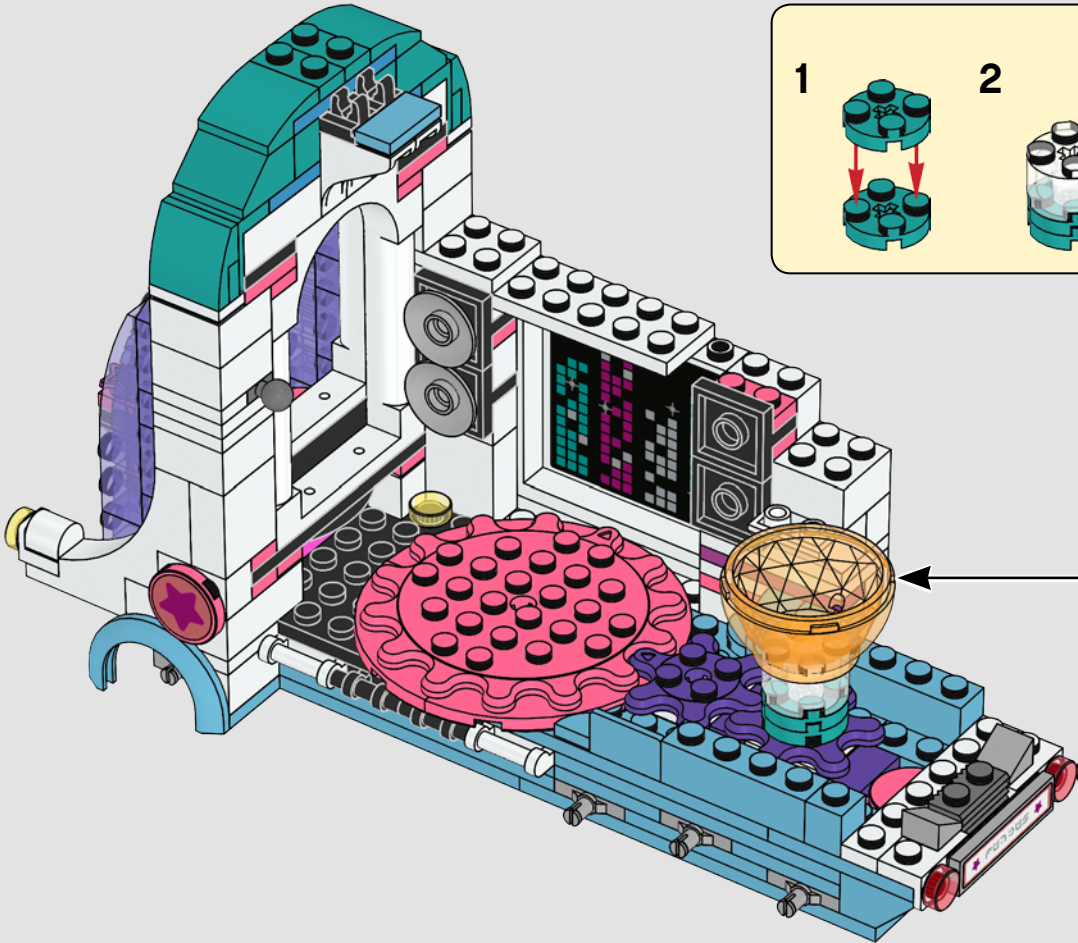

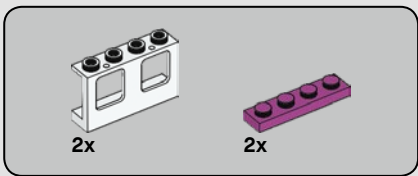

63

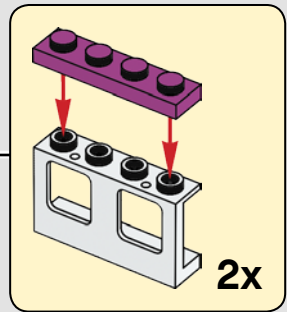
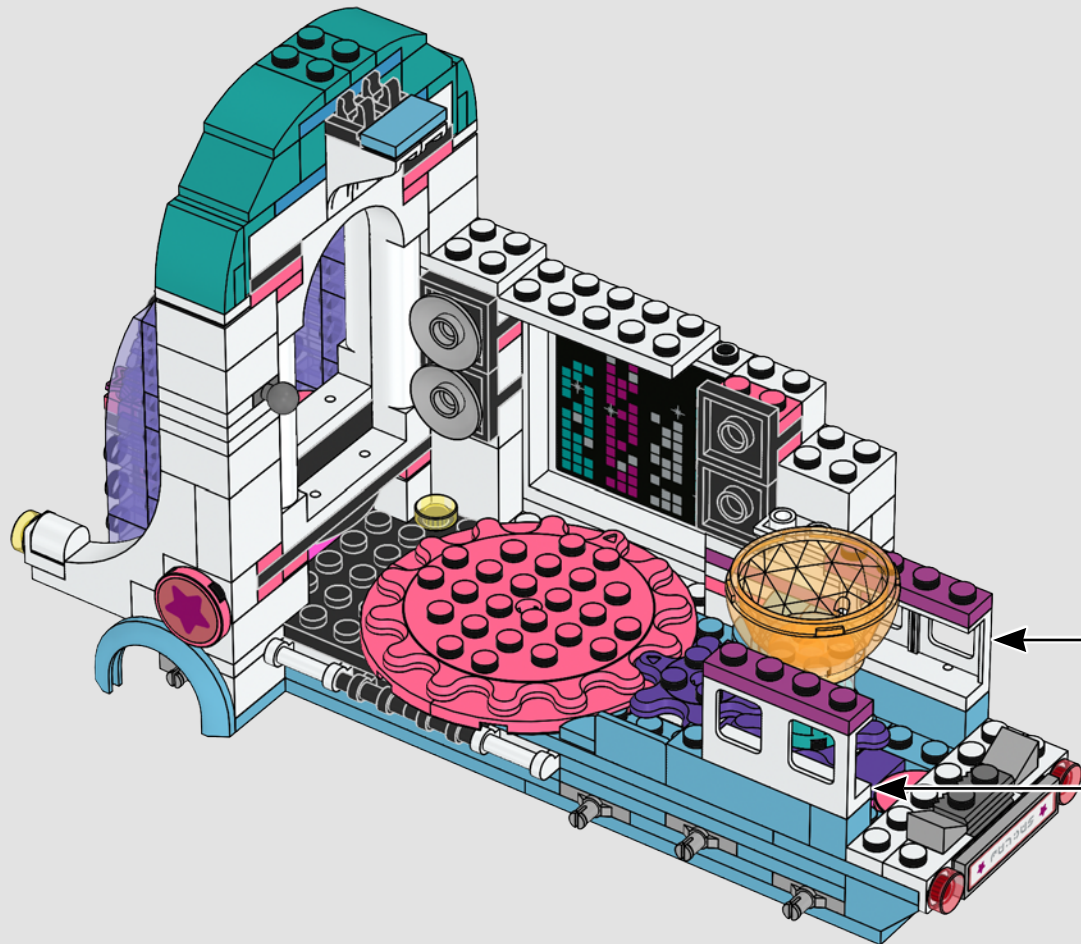

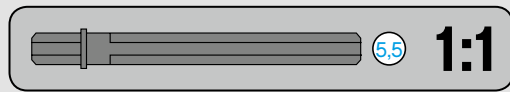
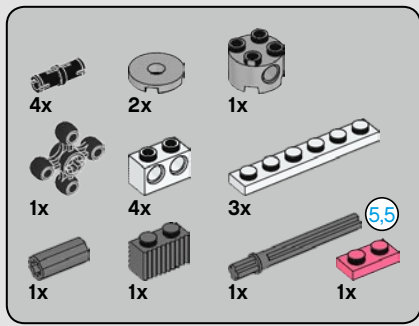

64

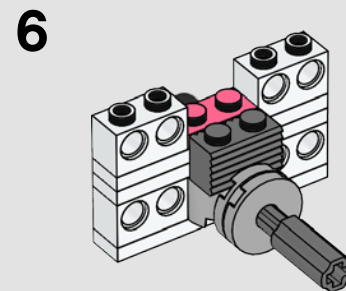
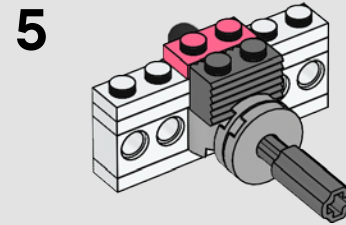
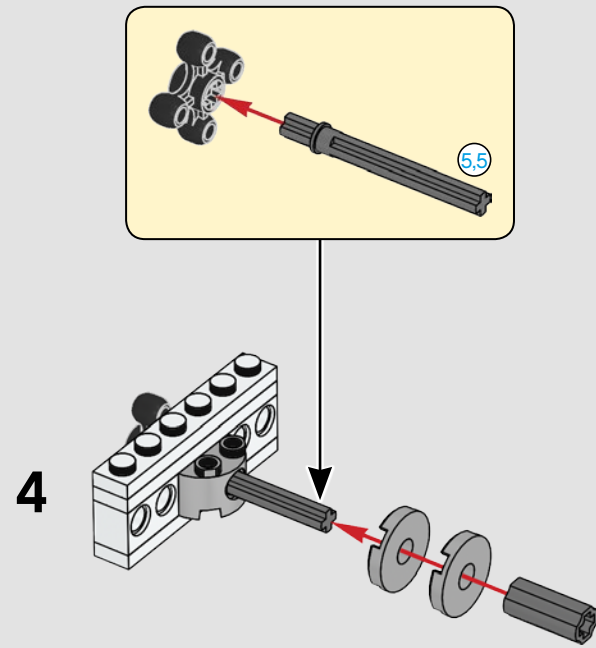
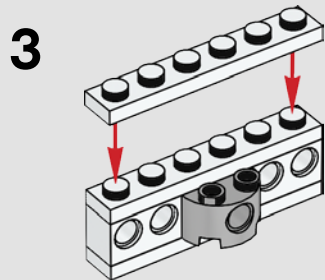
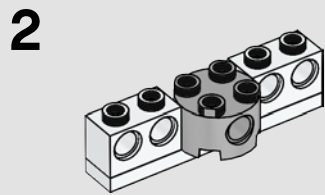
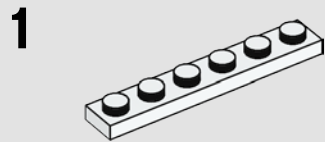

7

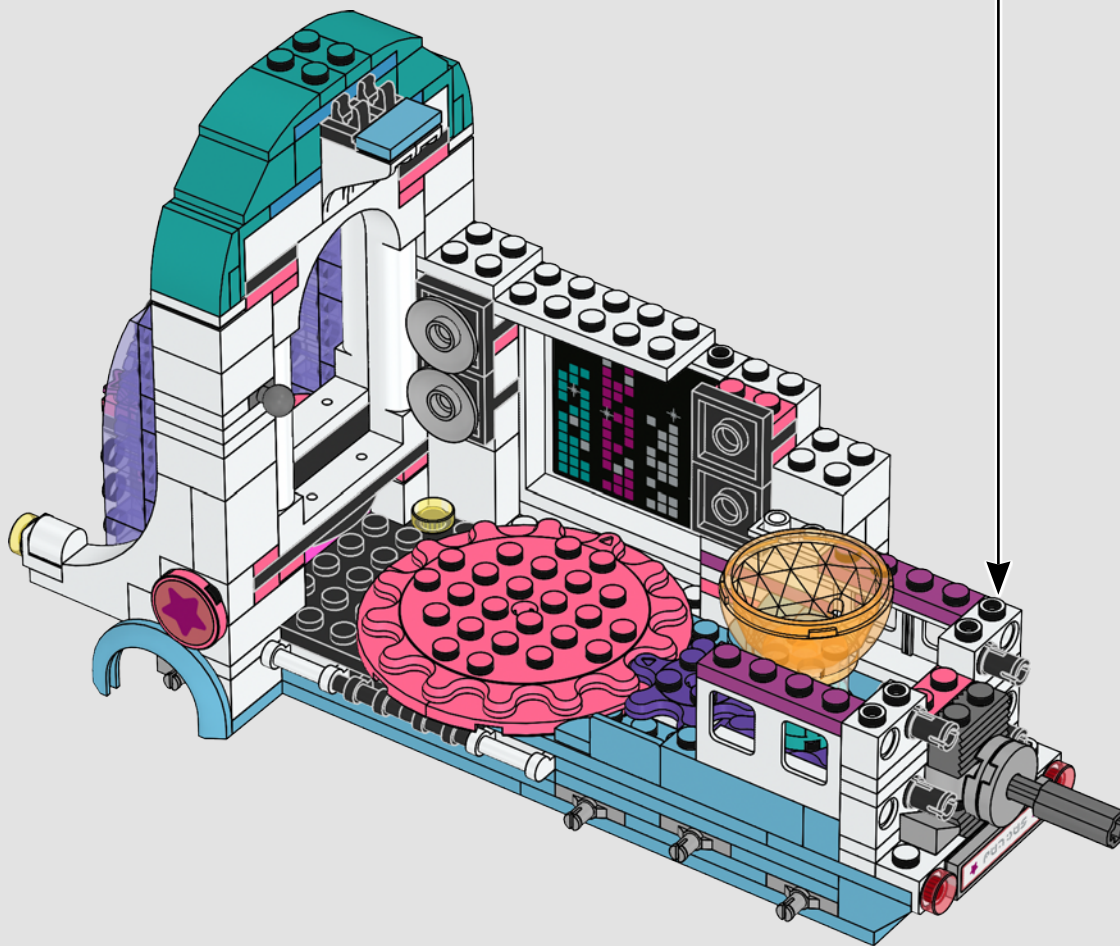
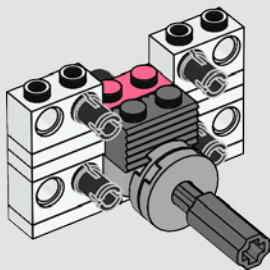



2x

65

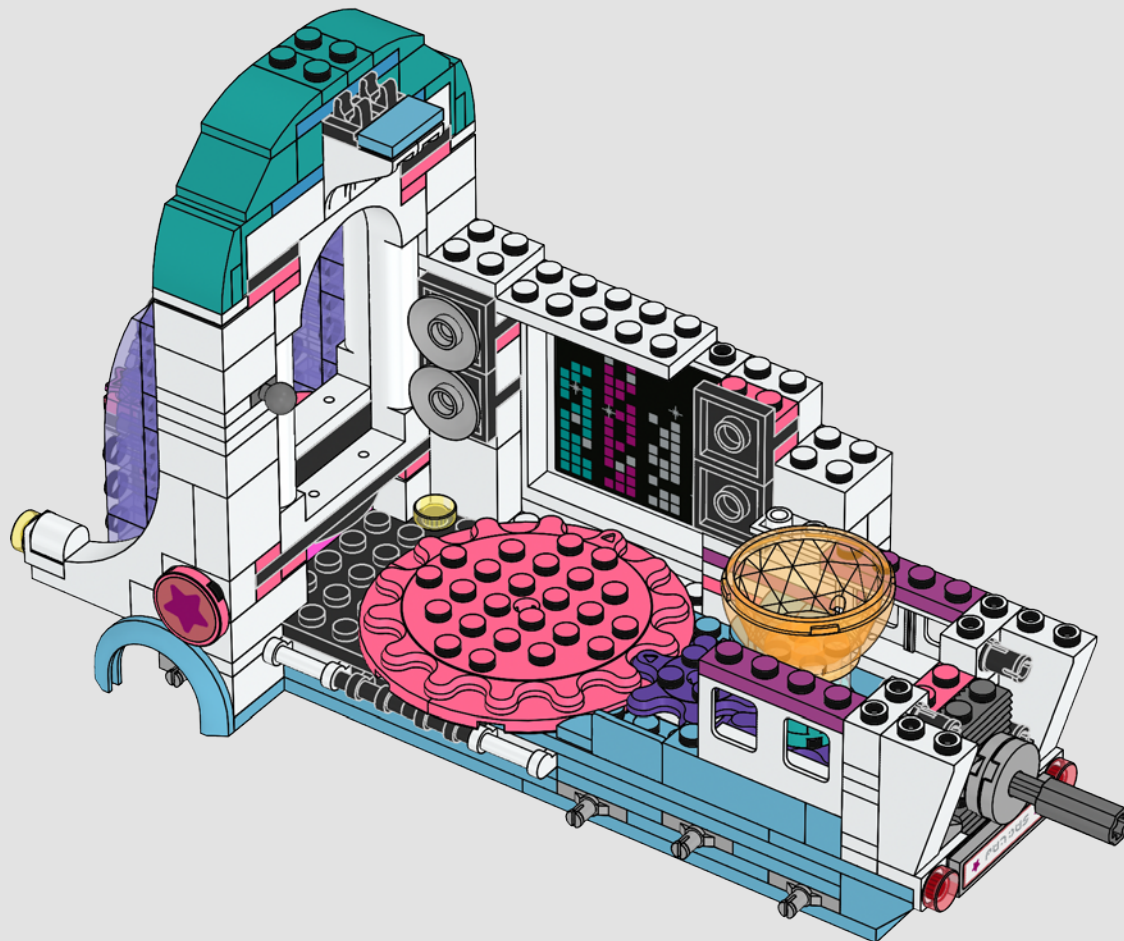

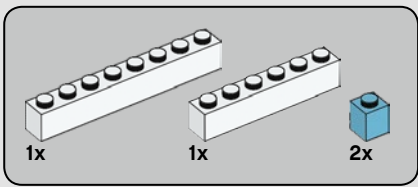

66

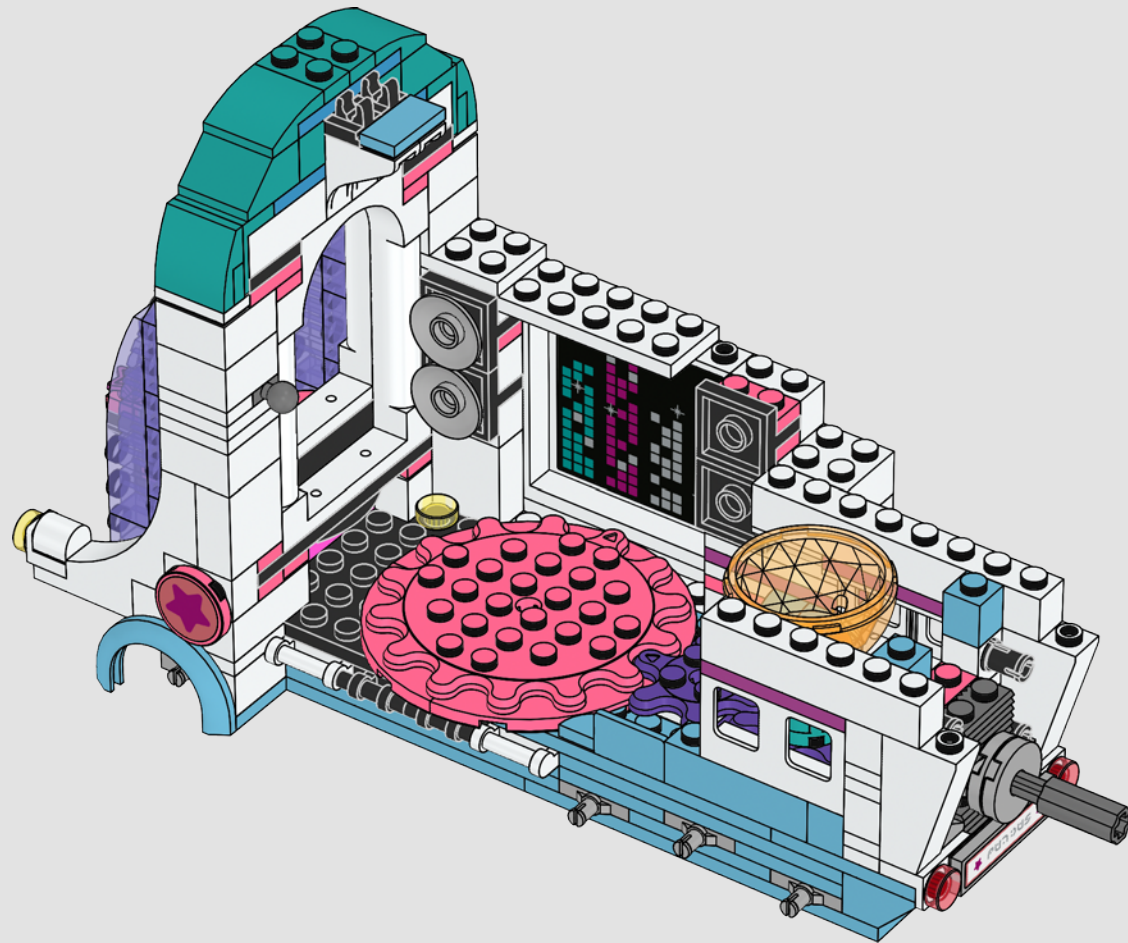

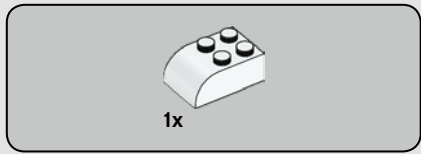

67

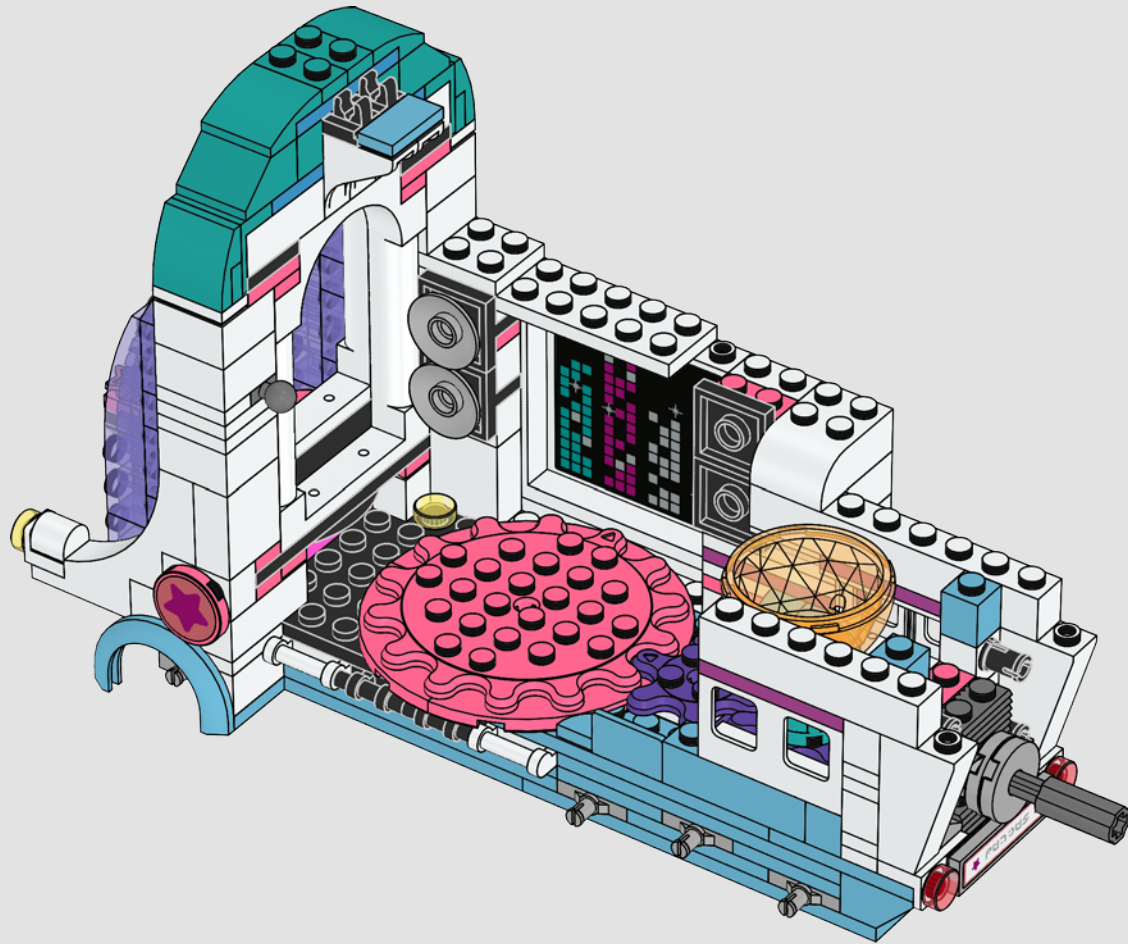

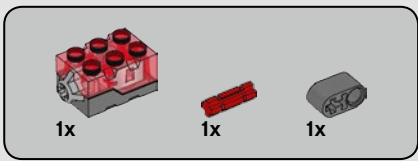

68

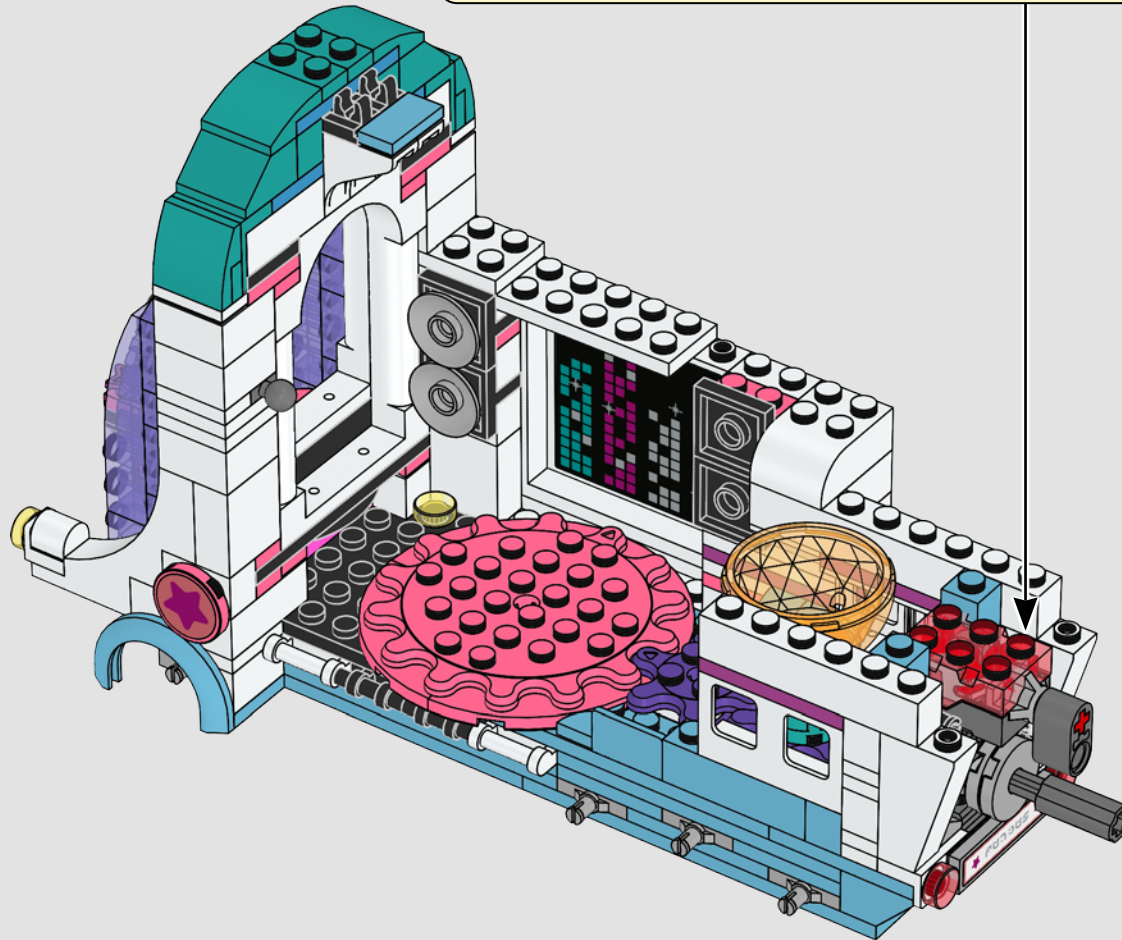
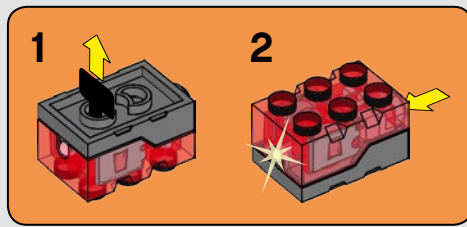

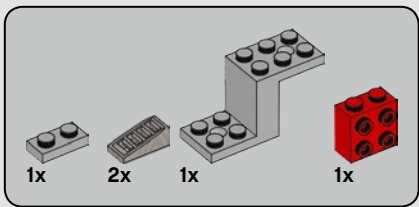

69

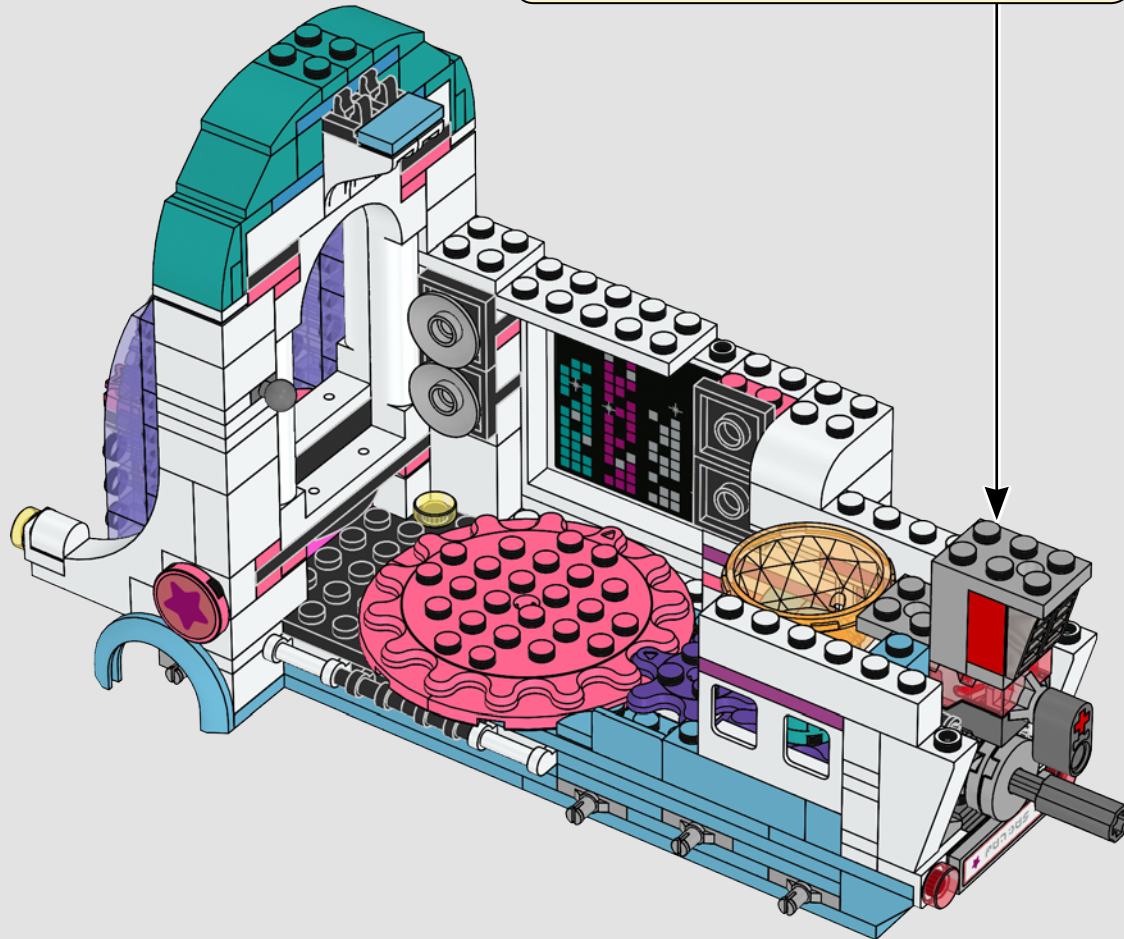
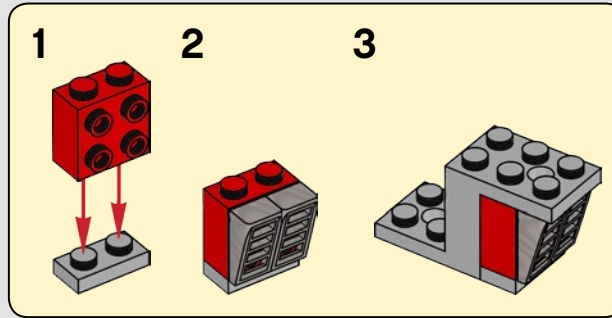

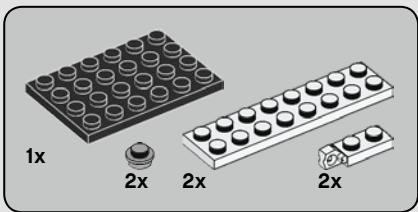

70

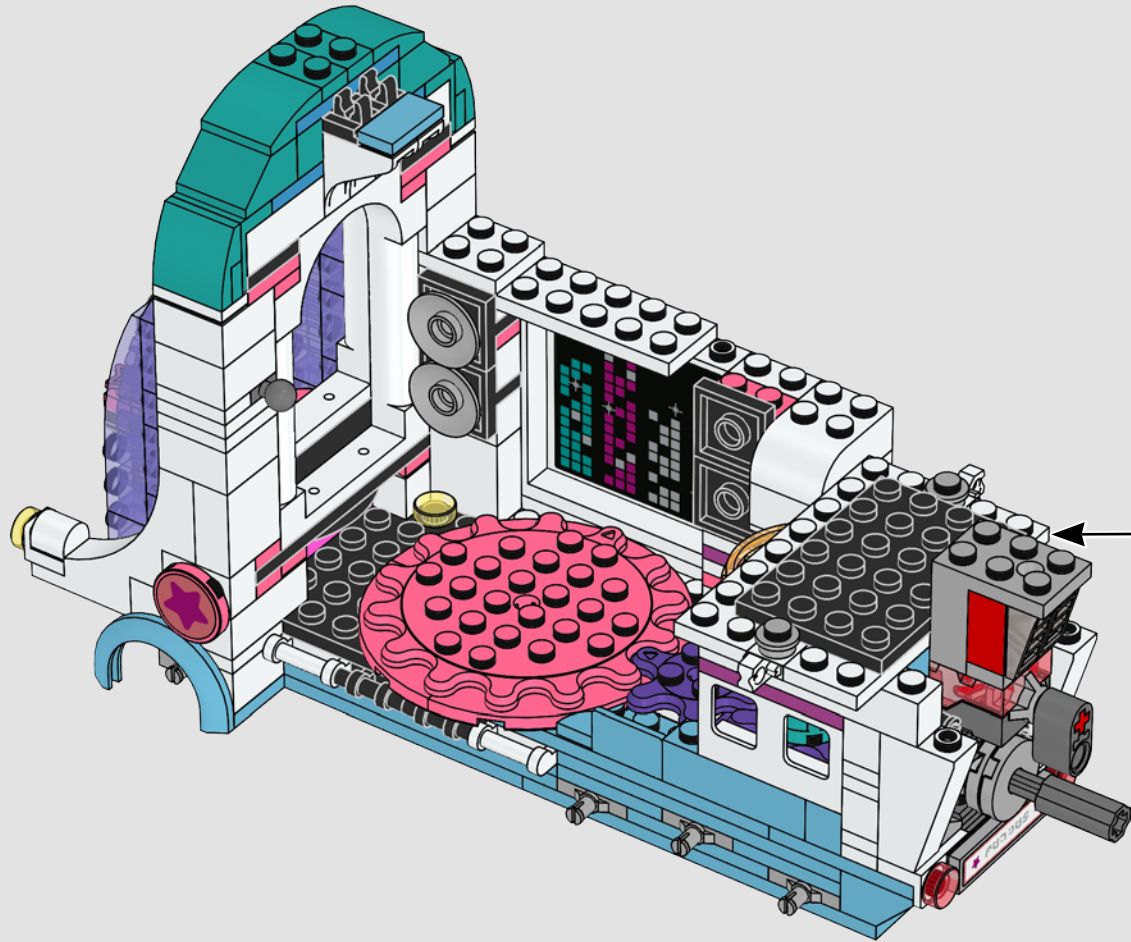
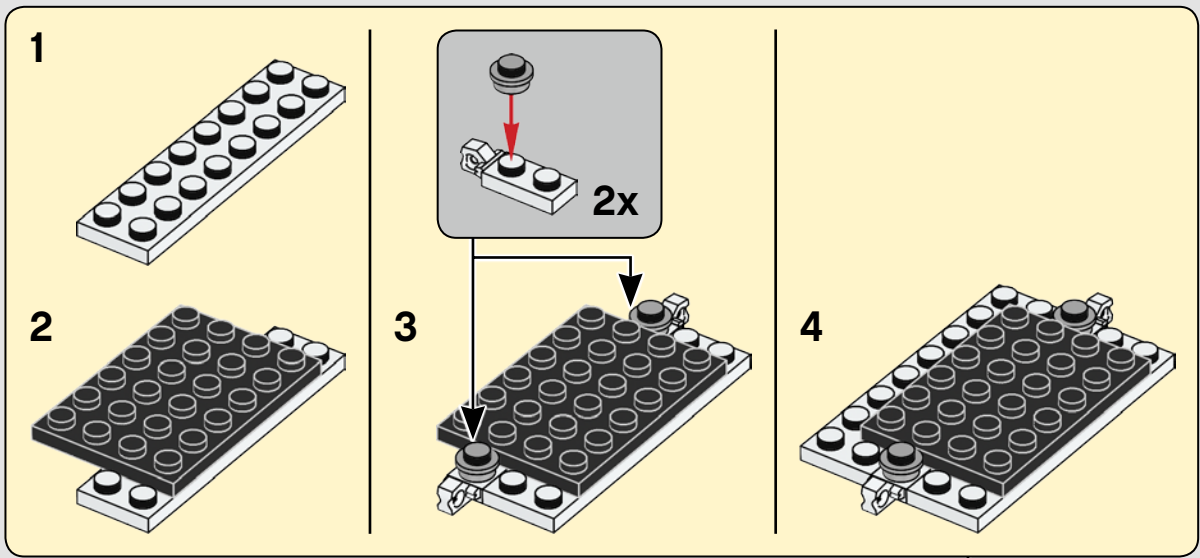

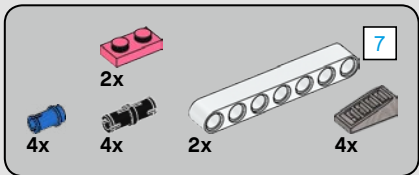
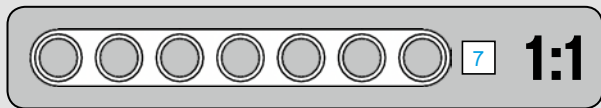

71

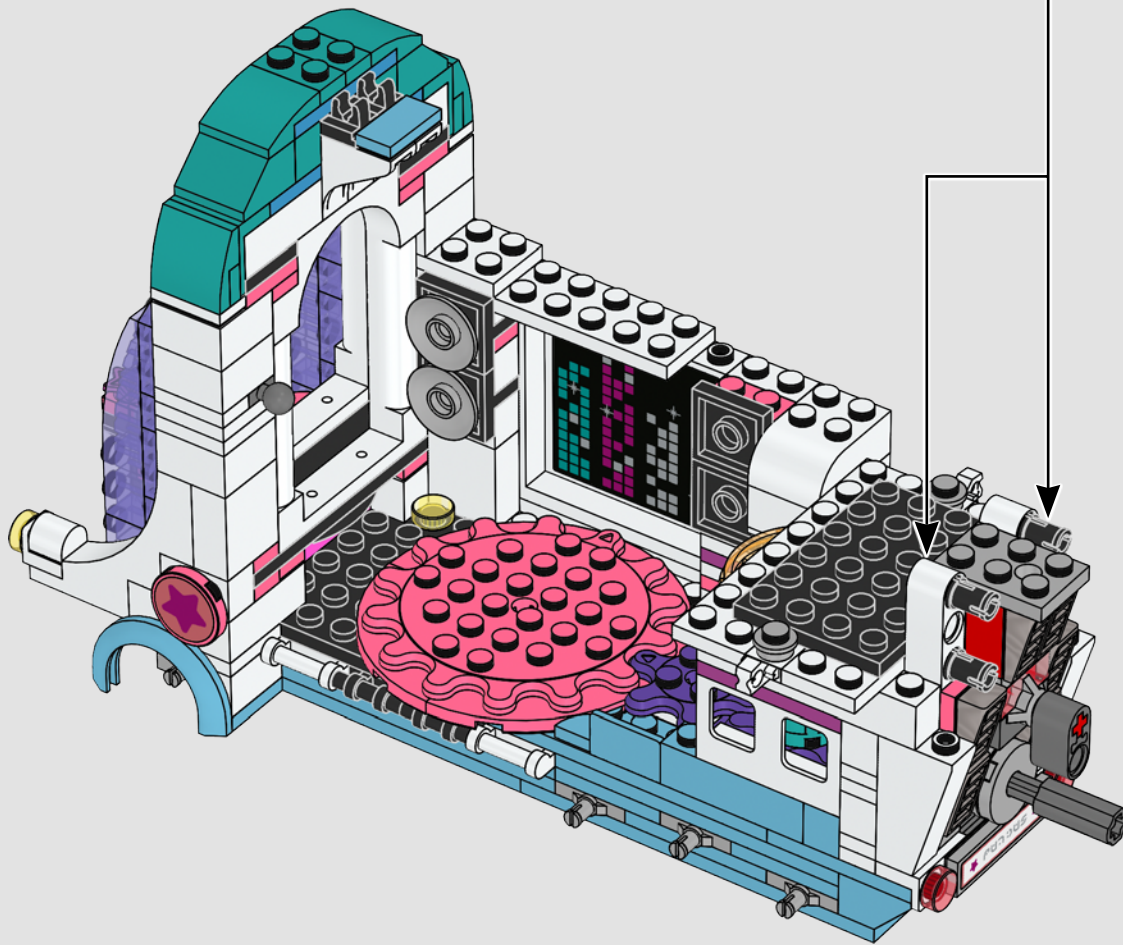
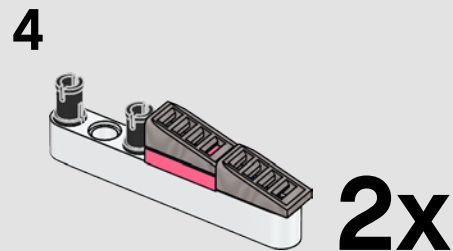
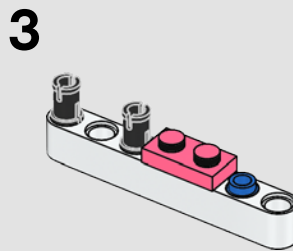
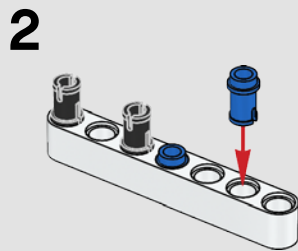
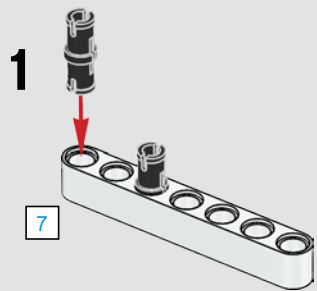

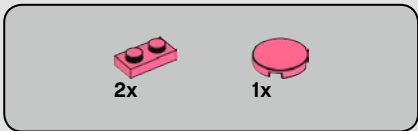

72

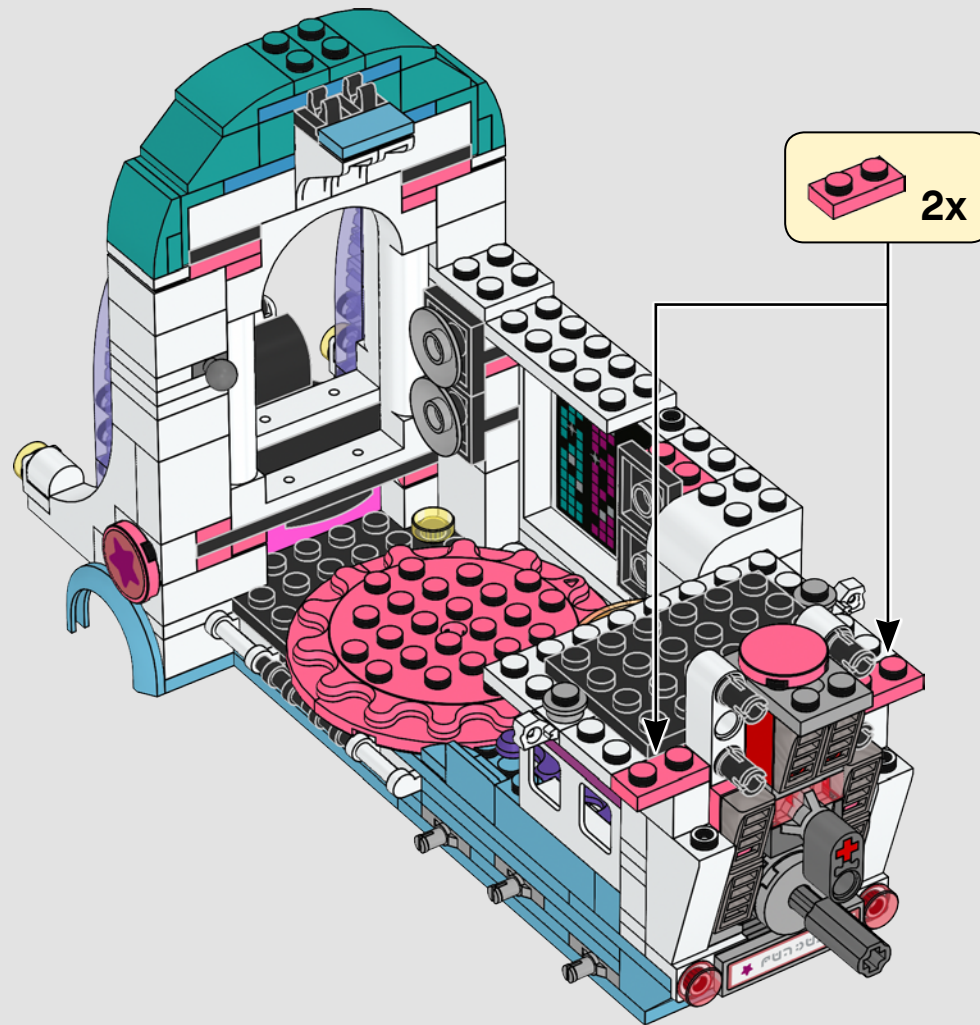

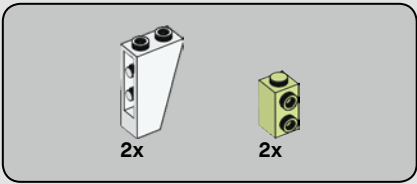

73

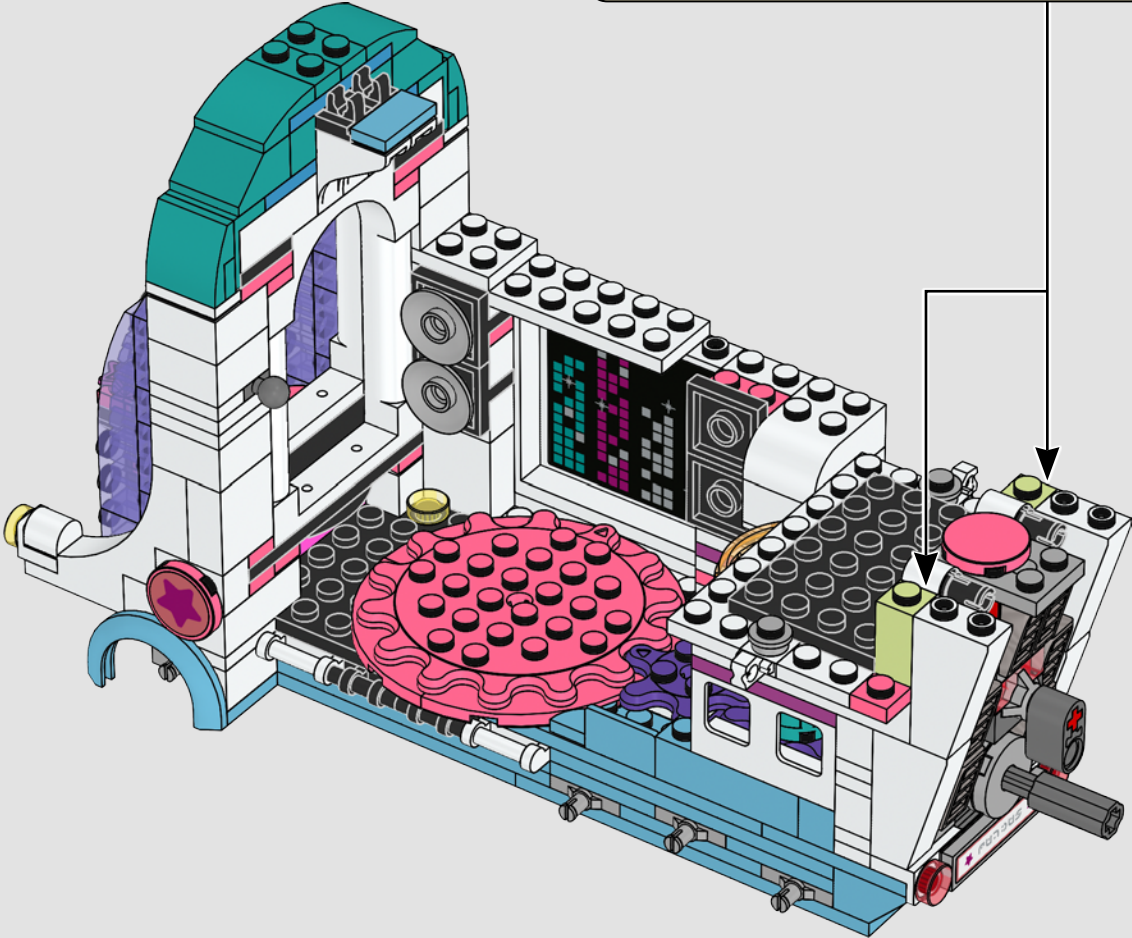
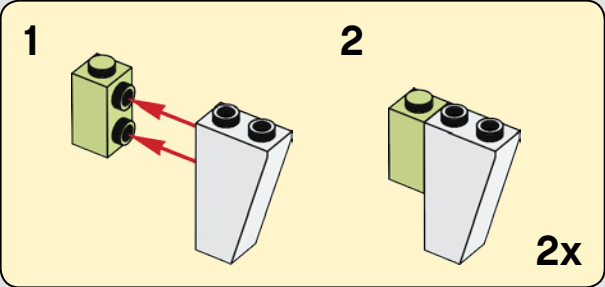

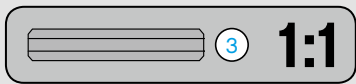

74

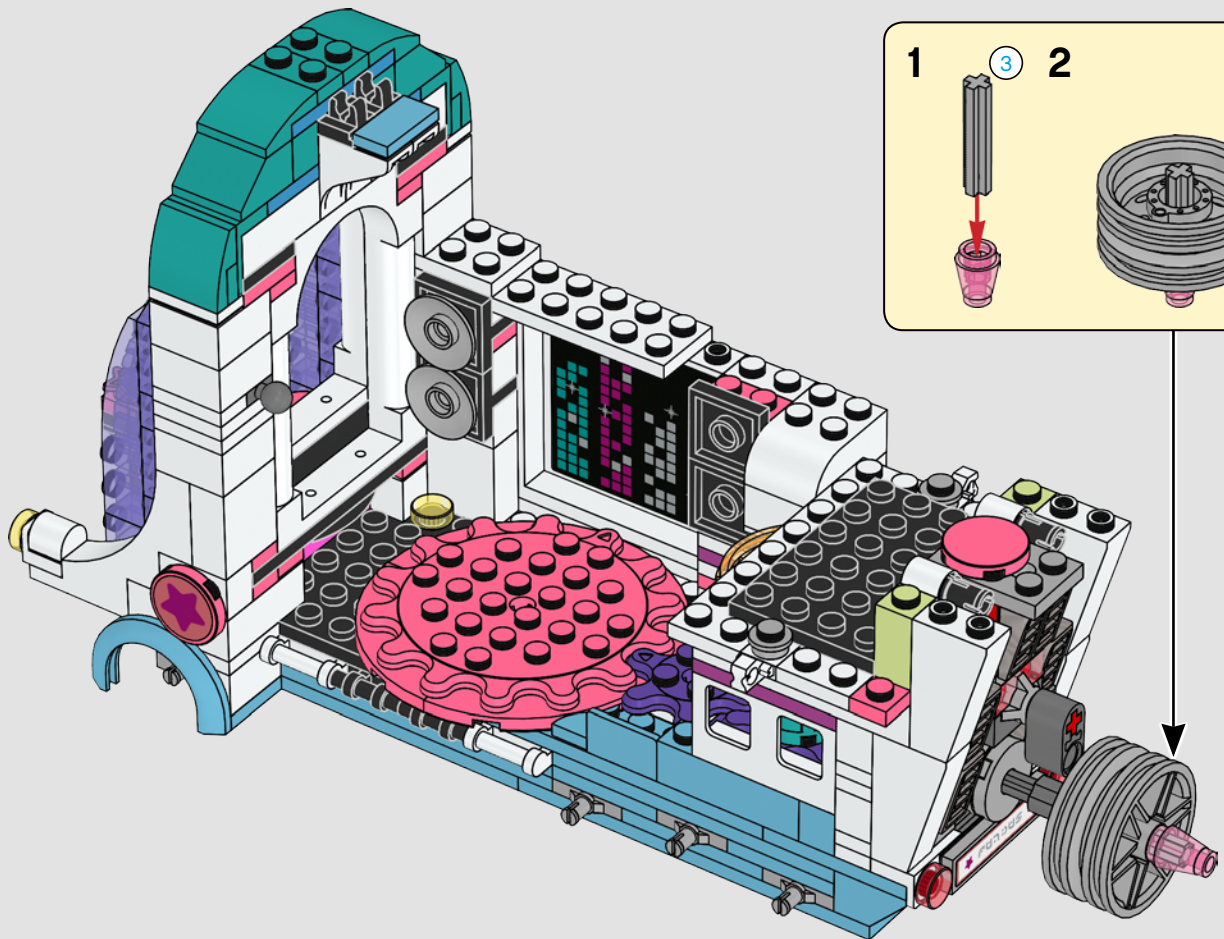

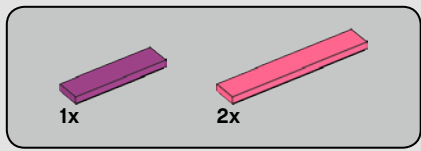

75

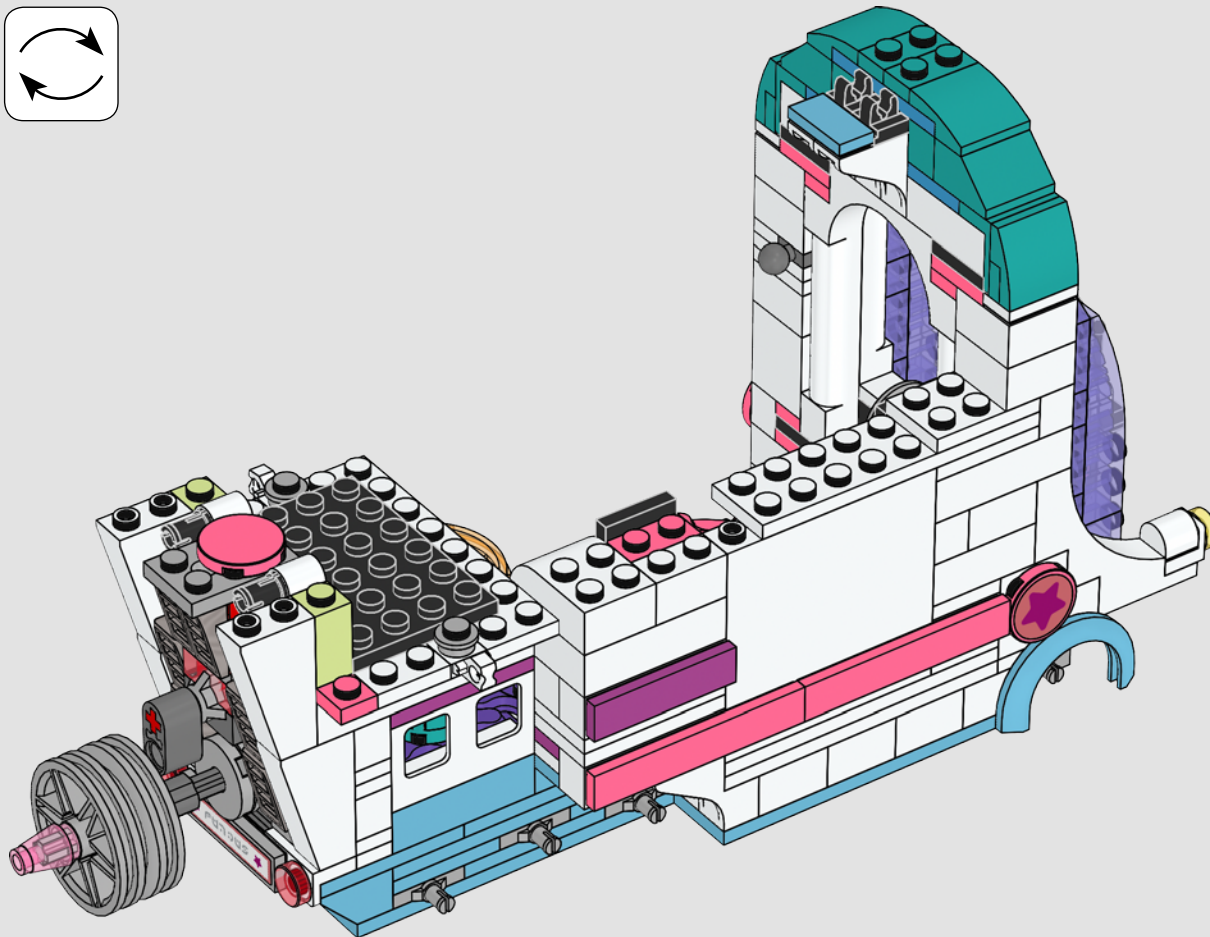
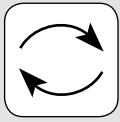

76

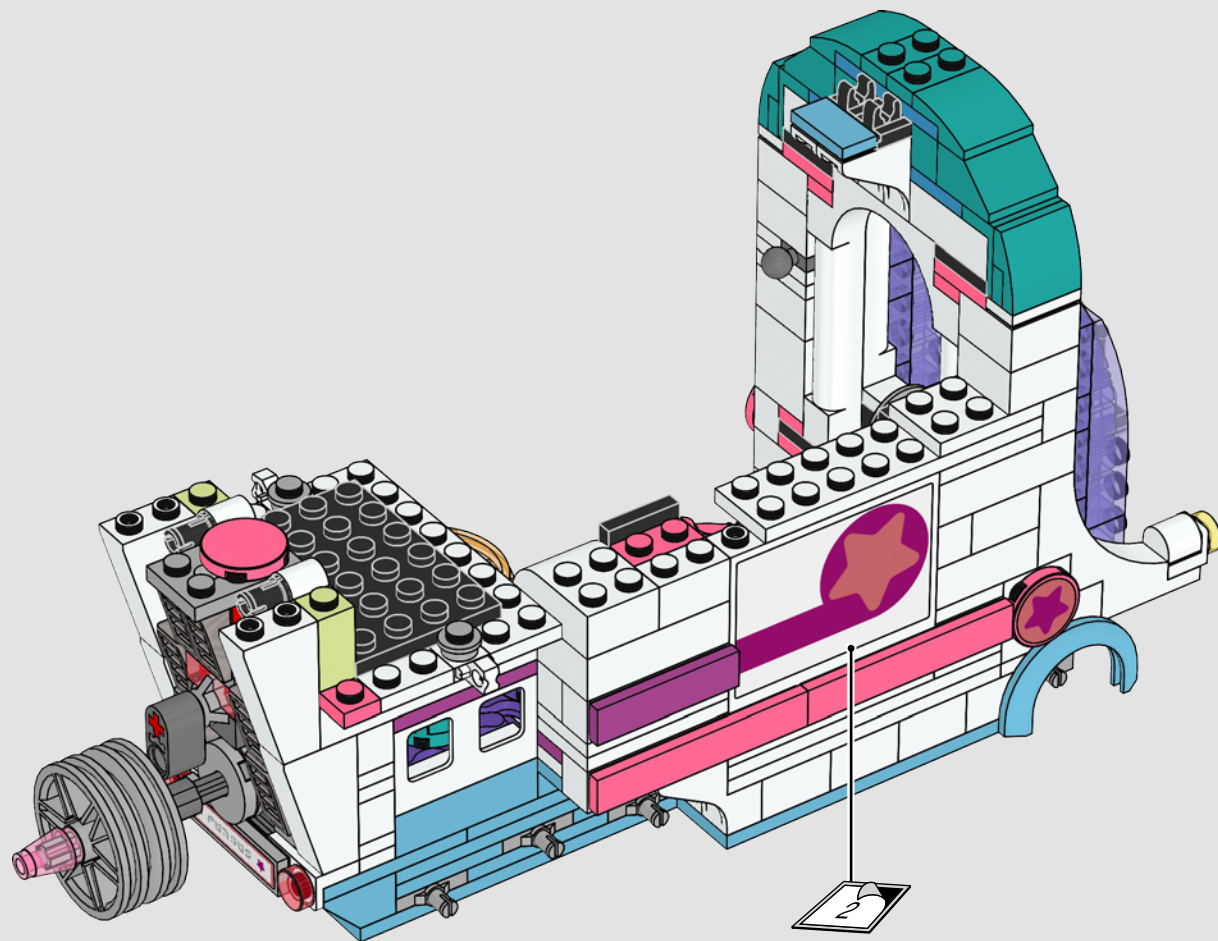



2x

77

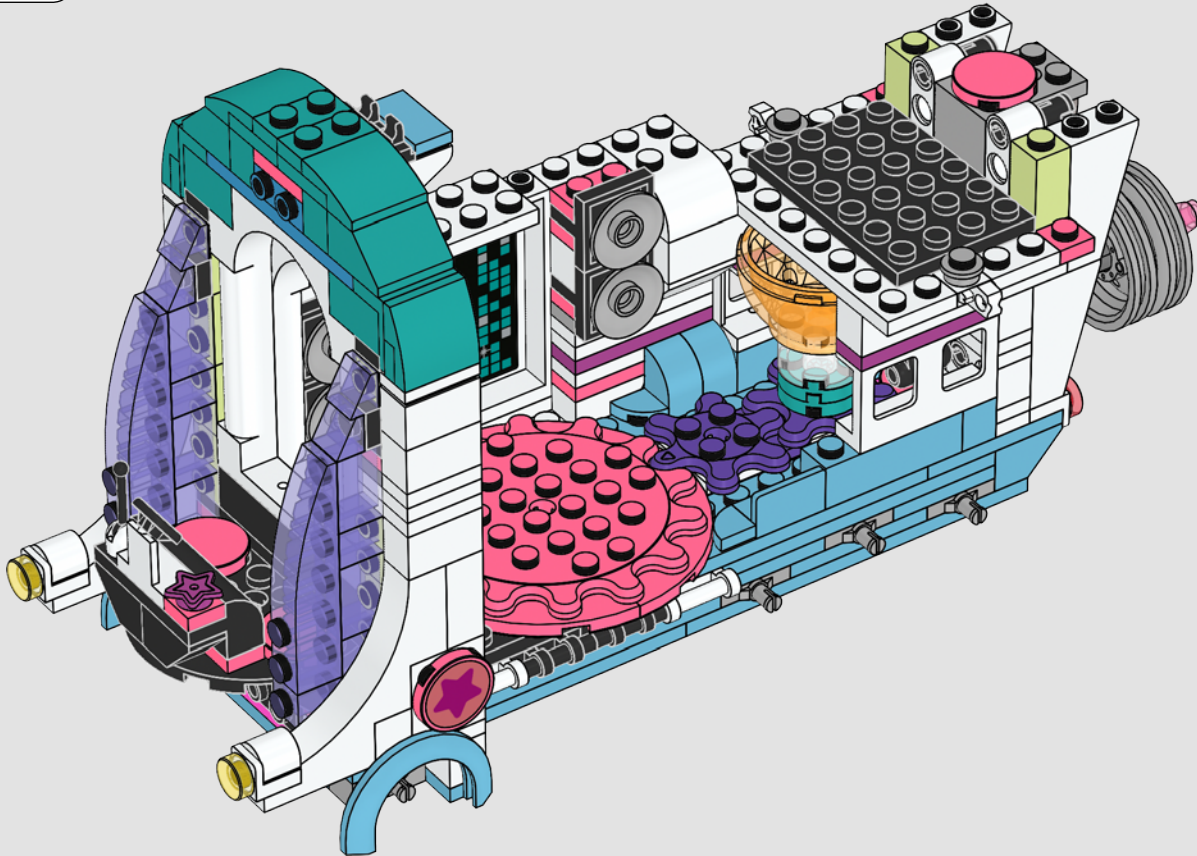
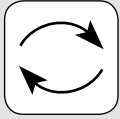

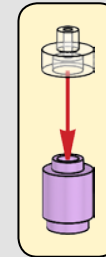
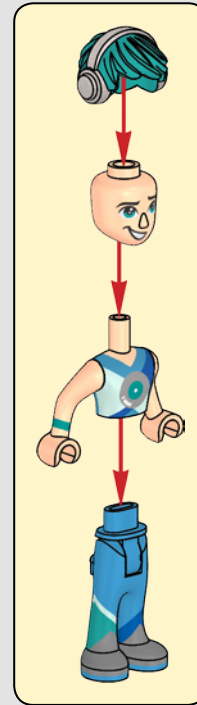
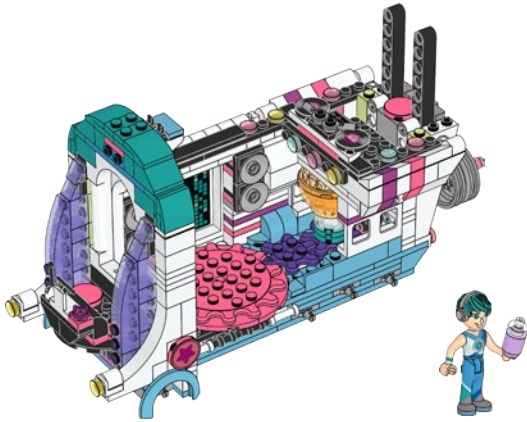
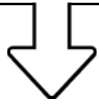

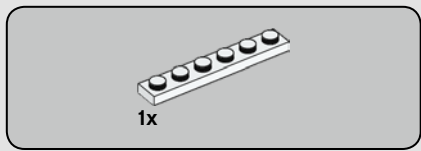

78

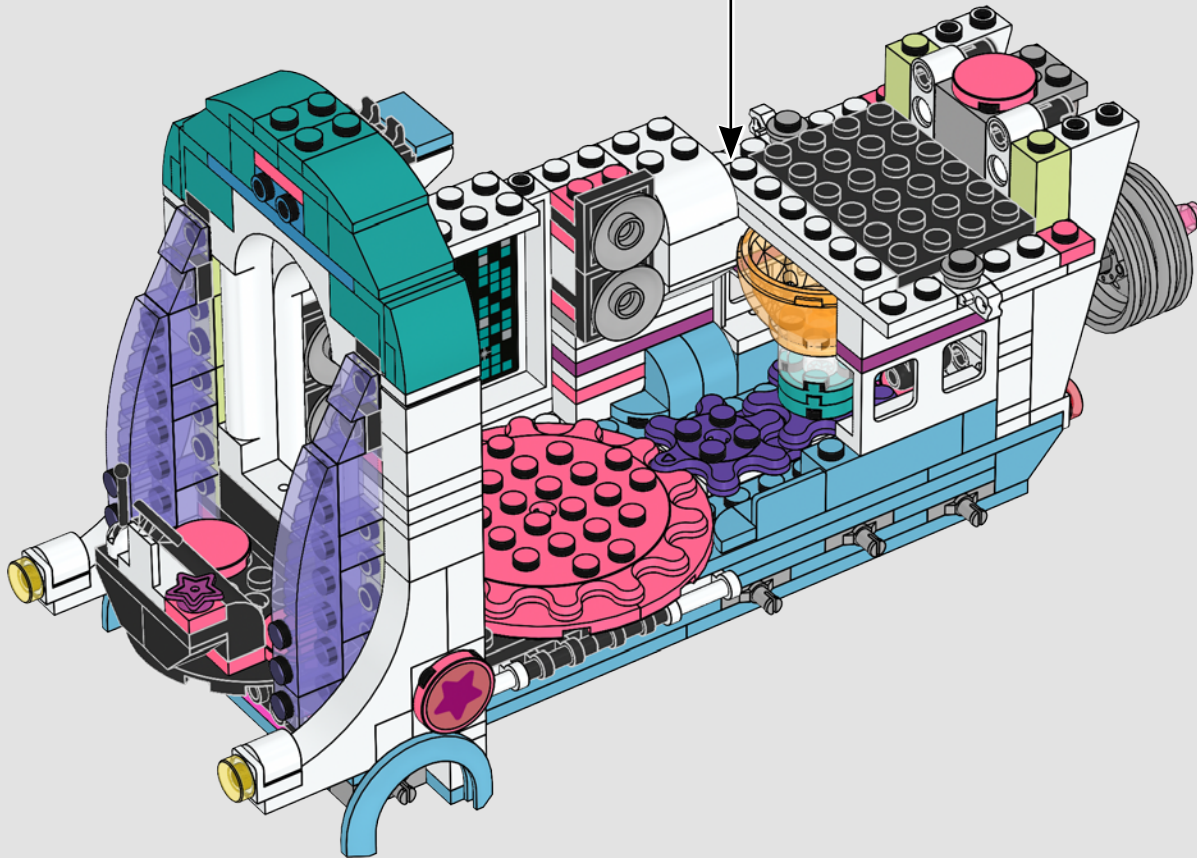
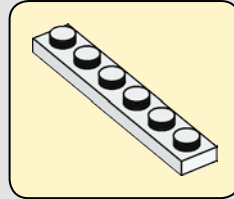

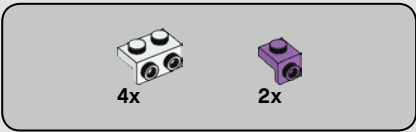

79

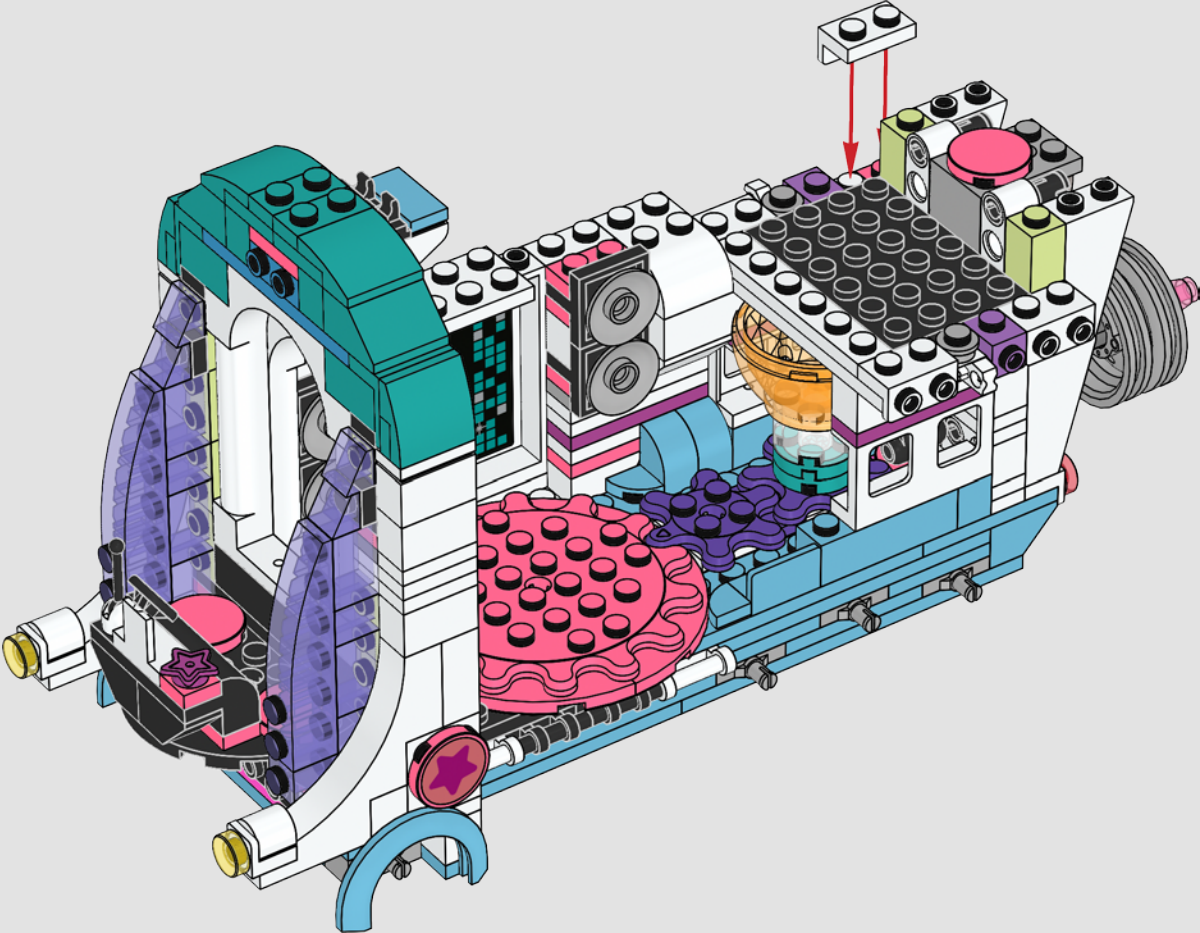

2x 2x 2x 2x

80

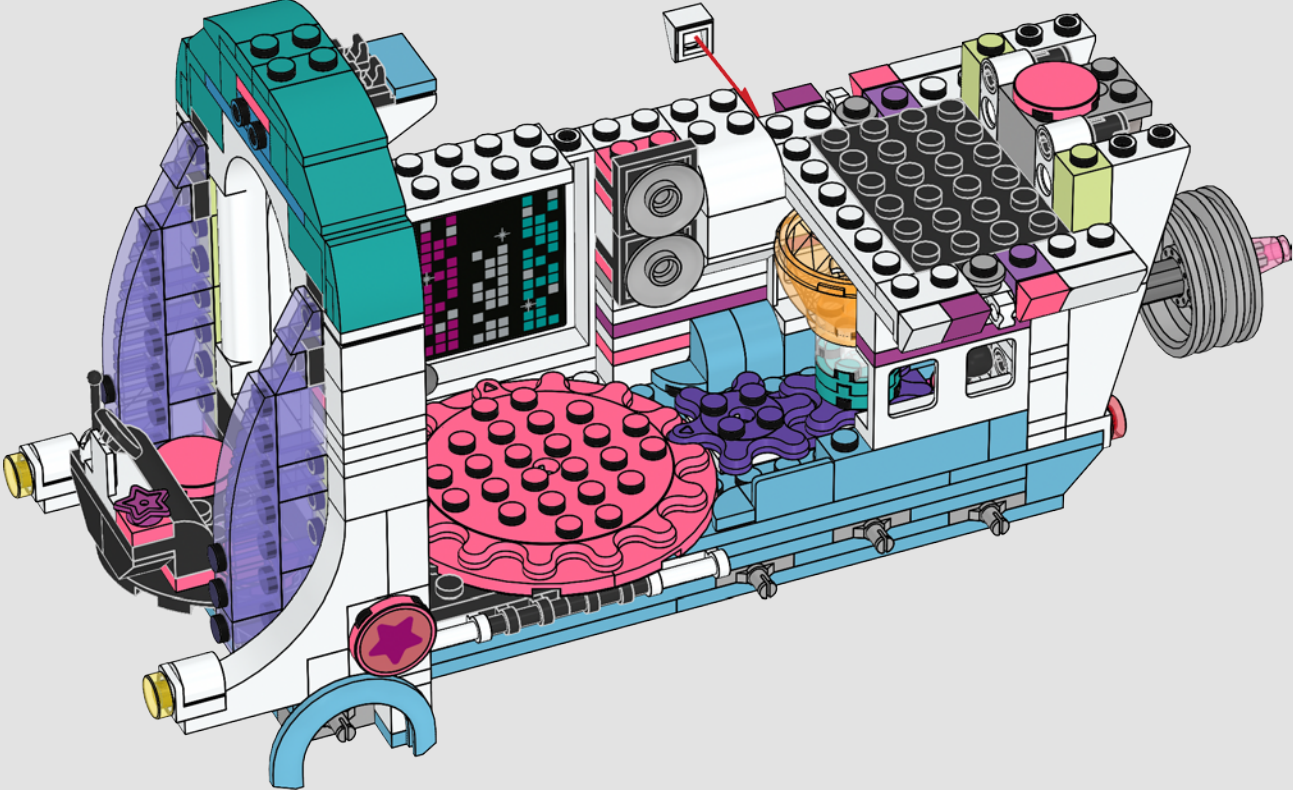

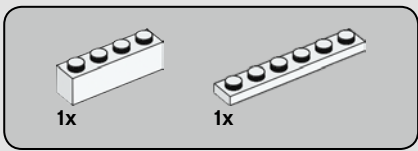

81

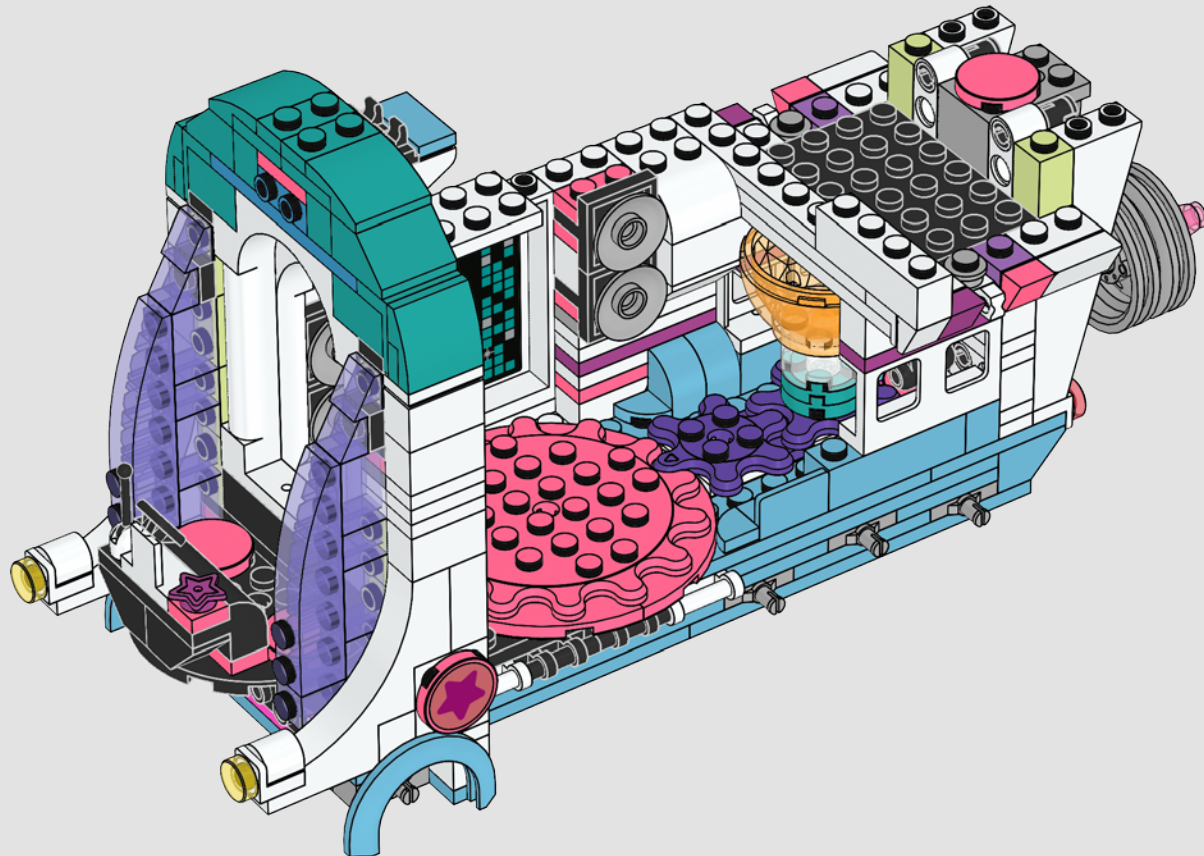

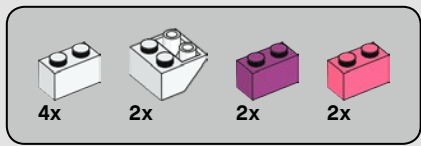

82

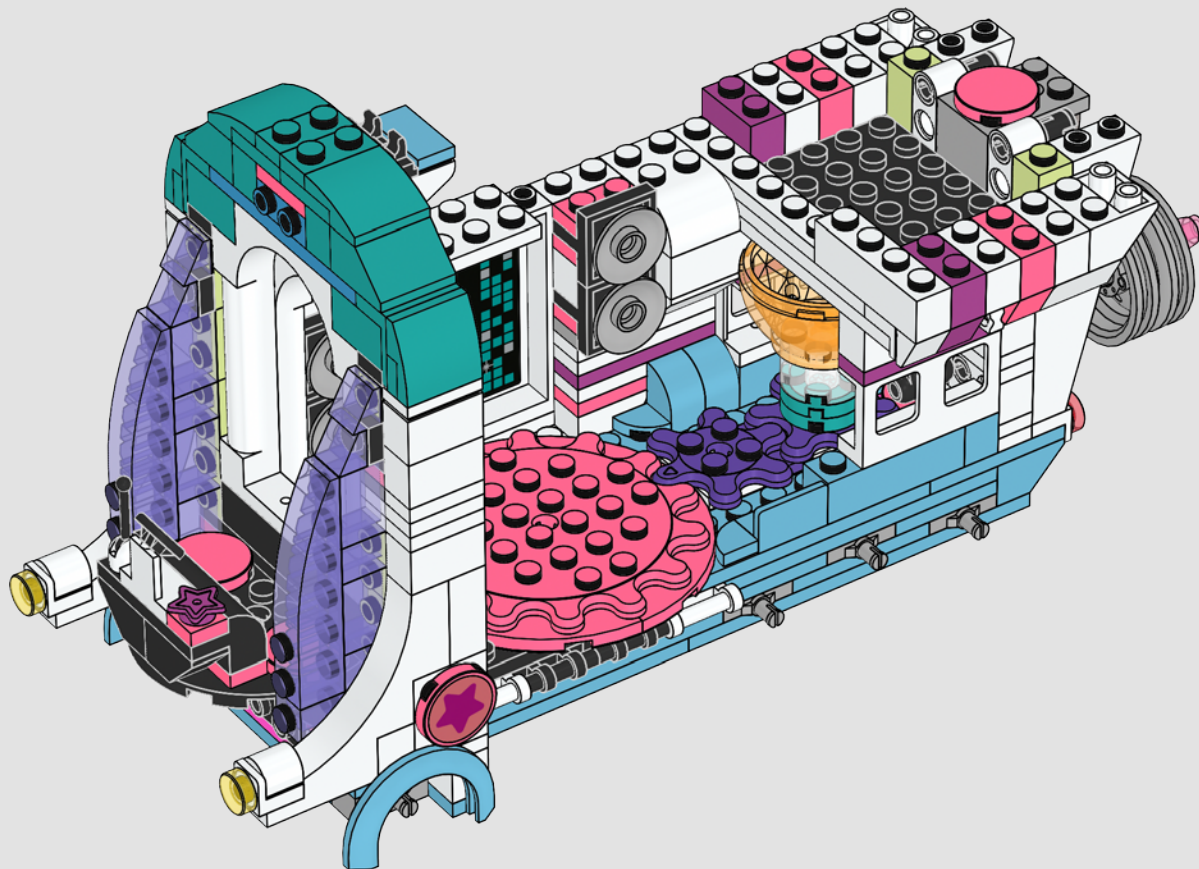

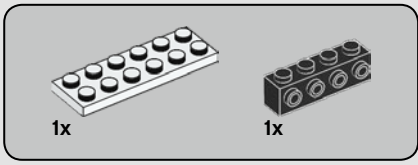

83

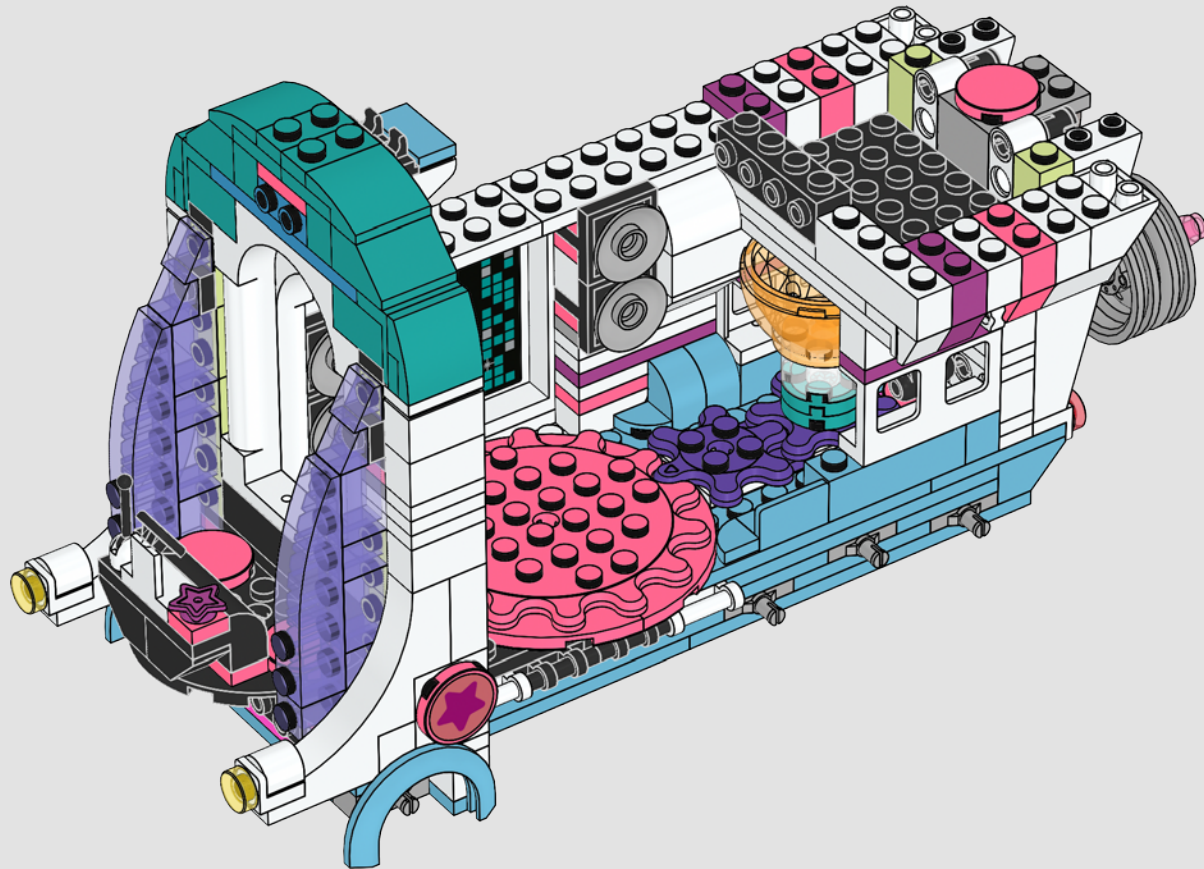

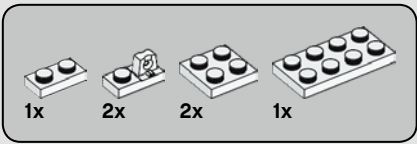

84

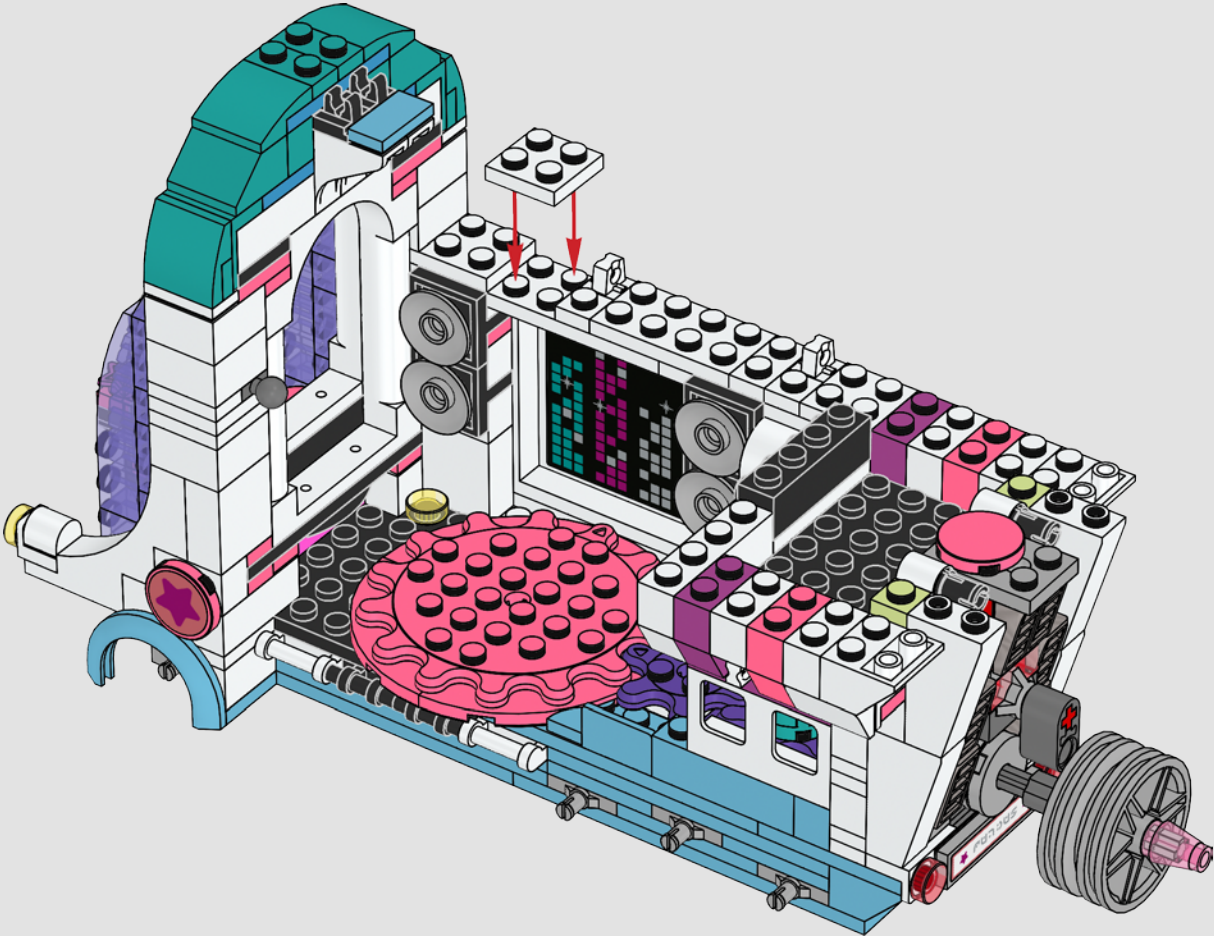



10x

85

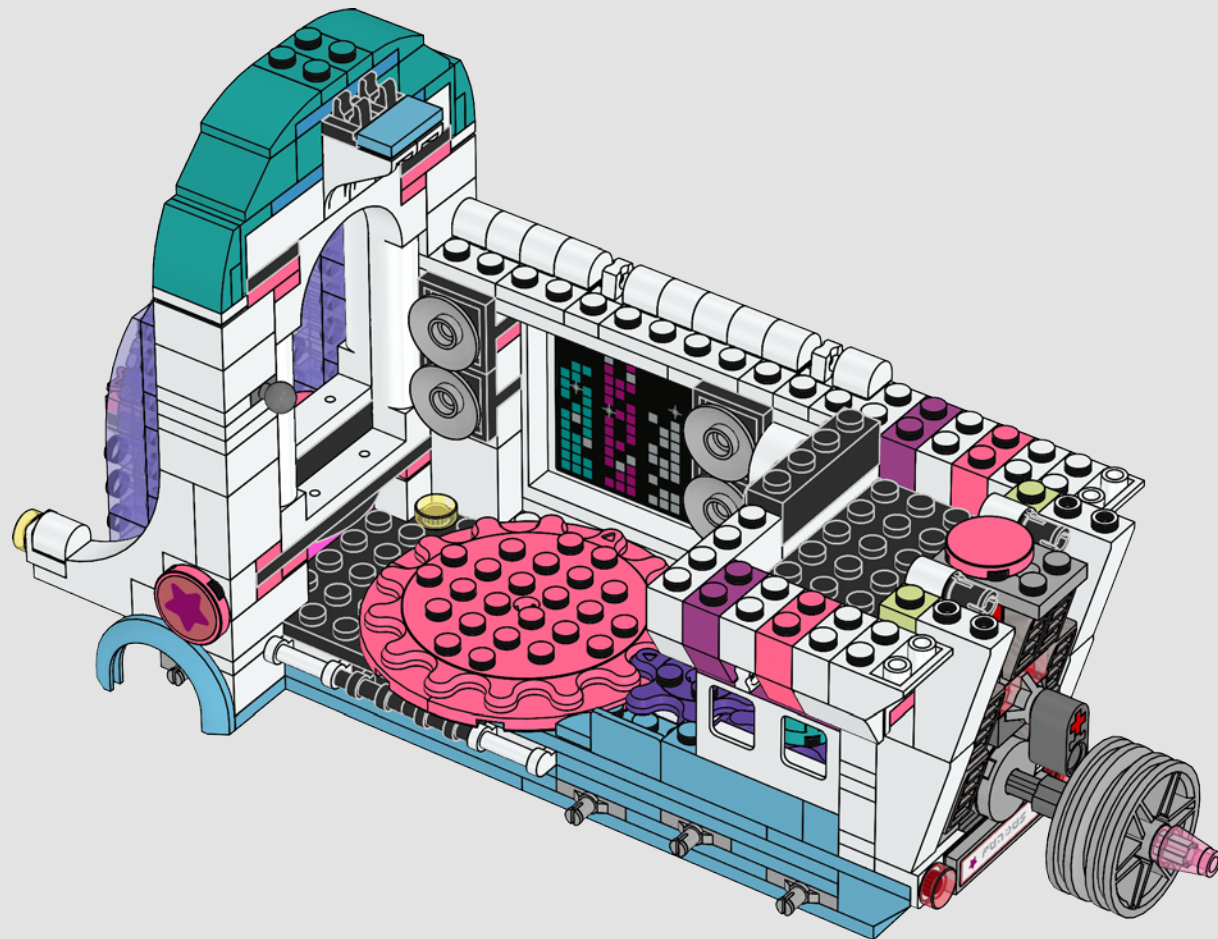

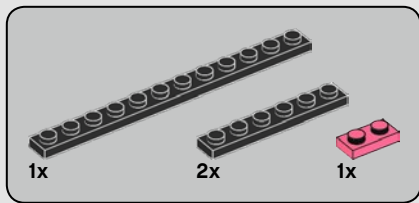

86

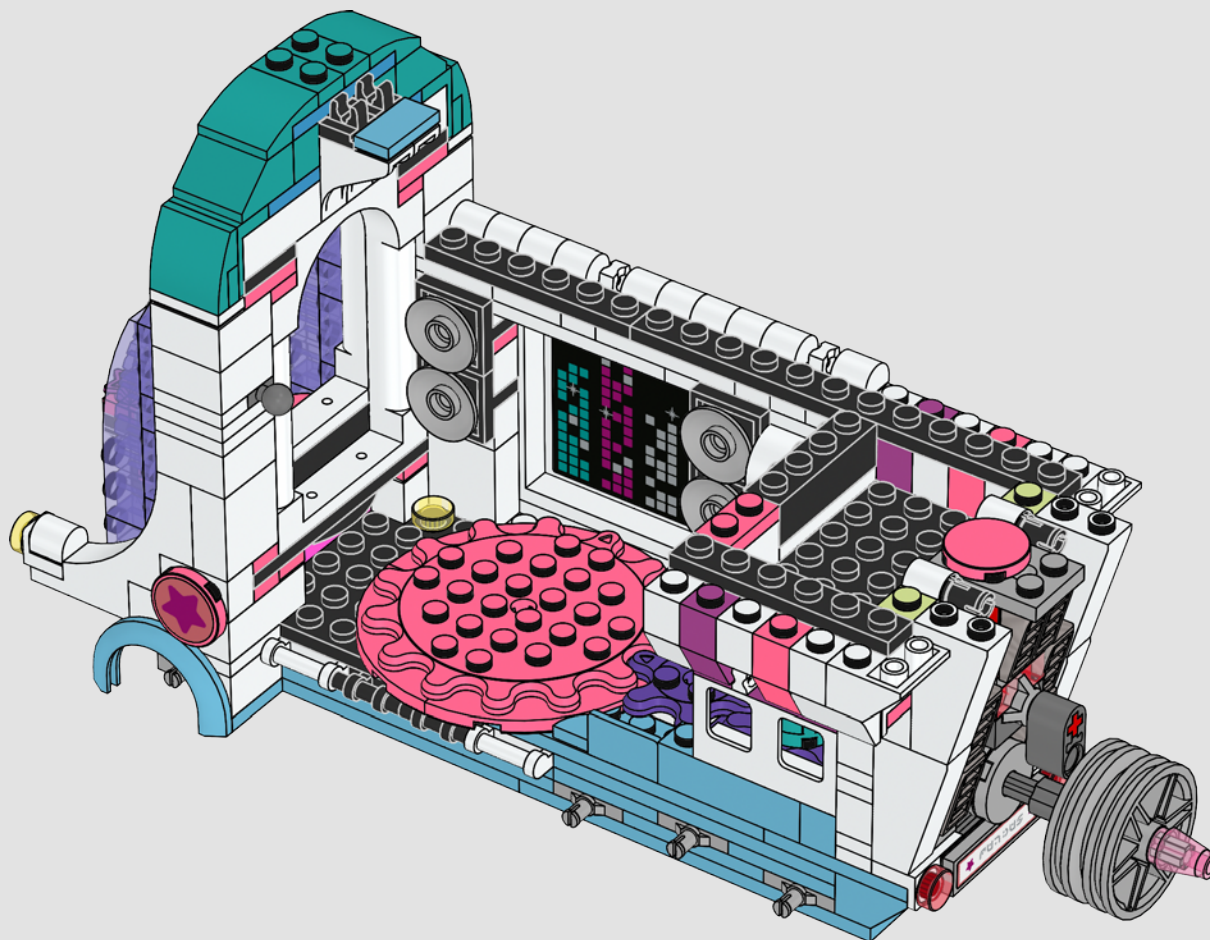

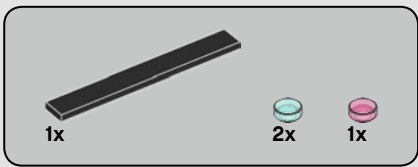

87

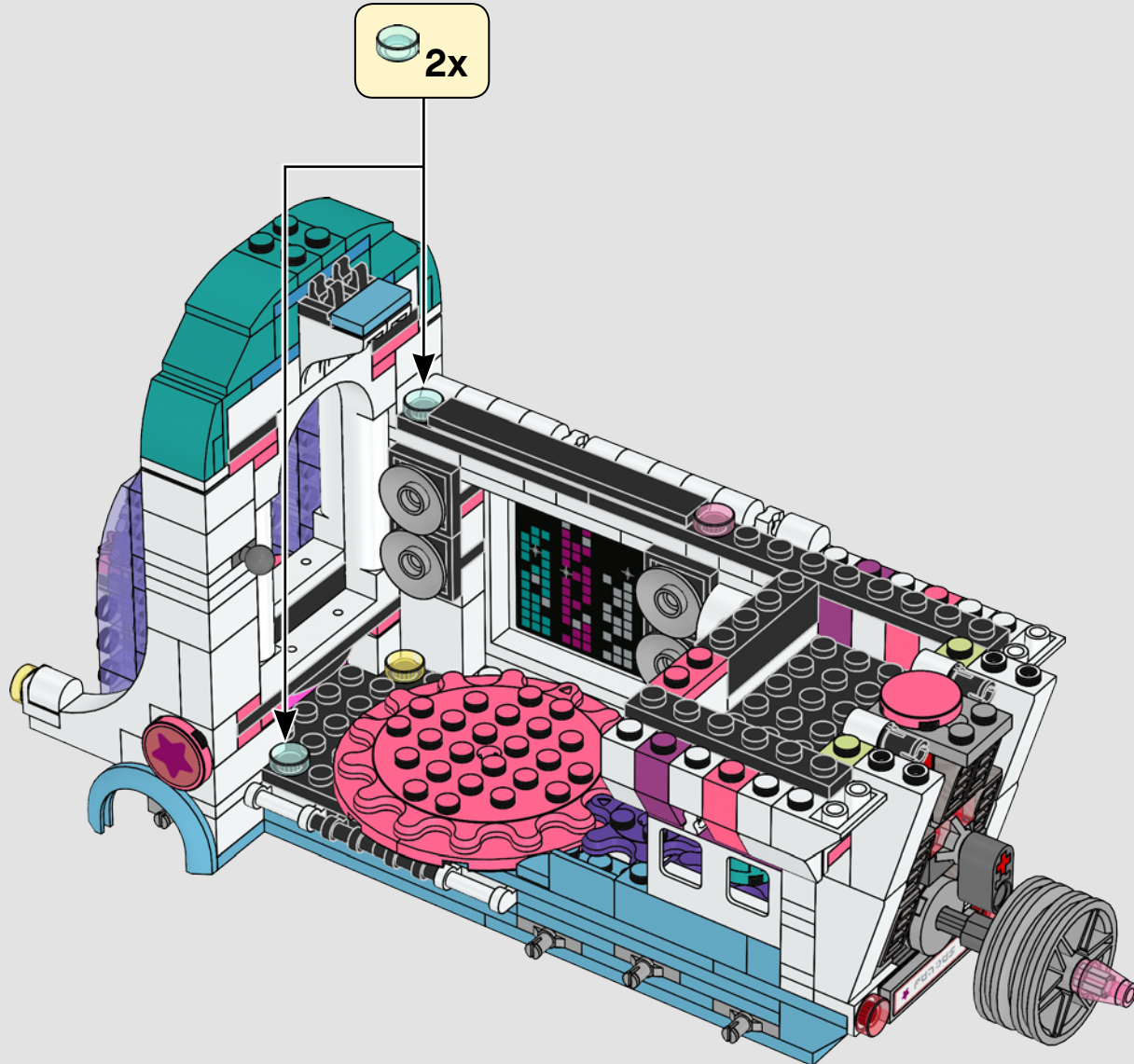





2x

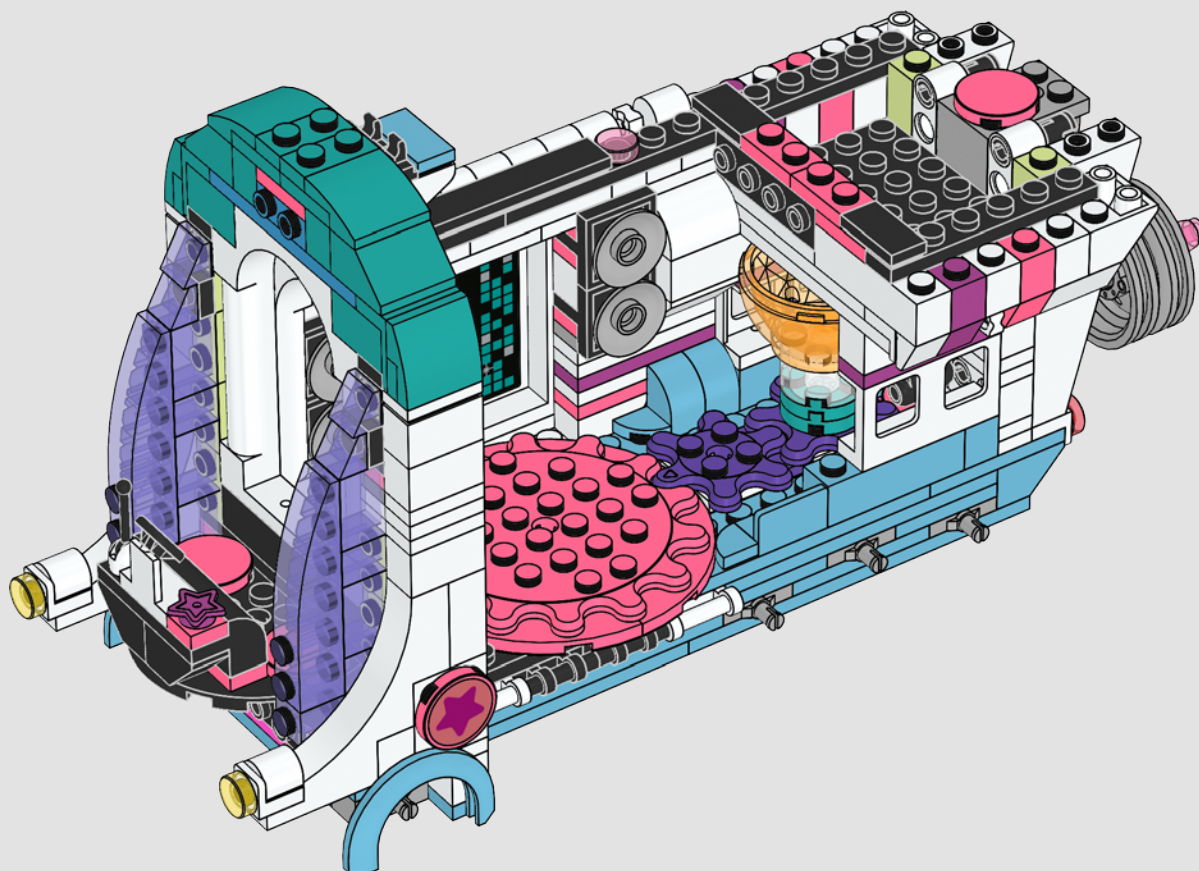

2x

88



1x  2x 

89

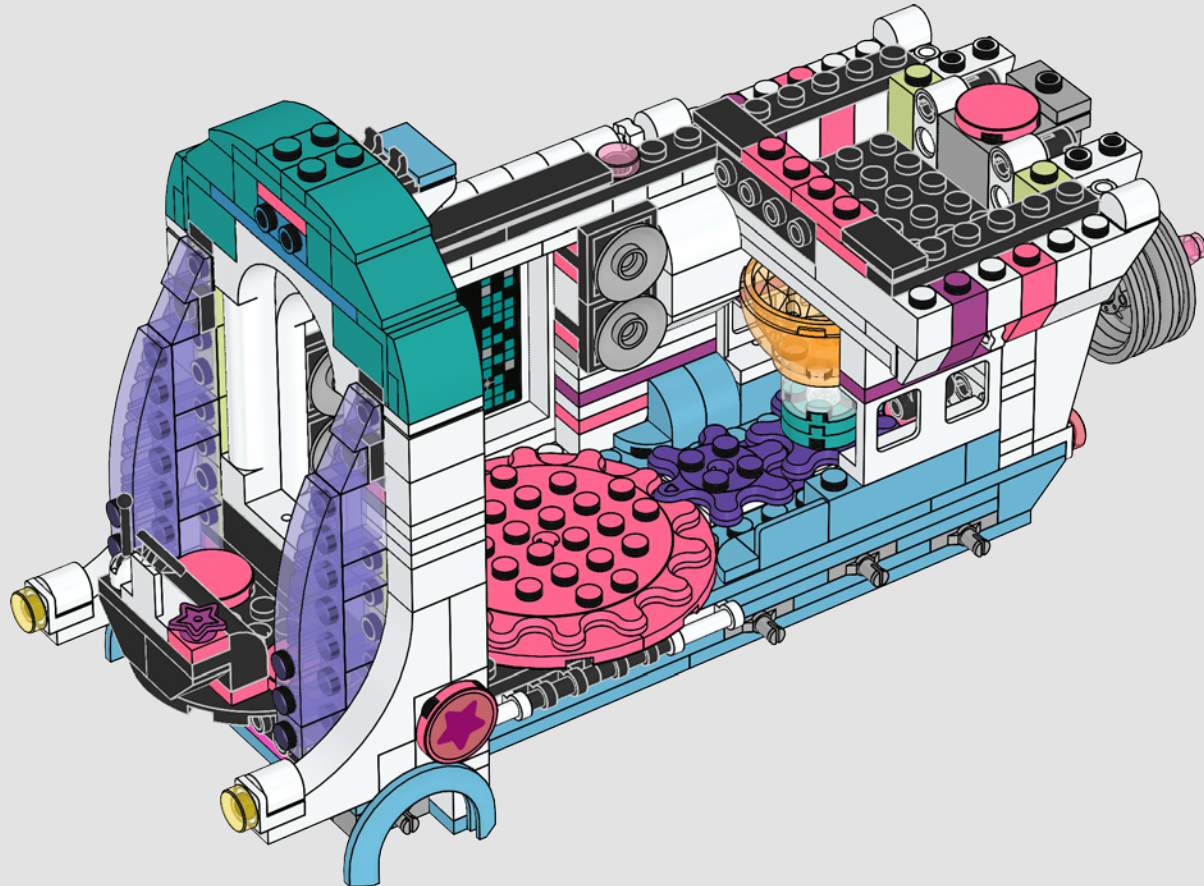

4x 2x 2x 2x

90

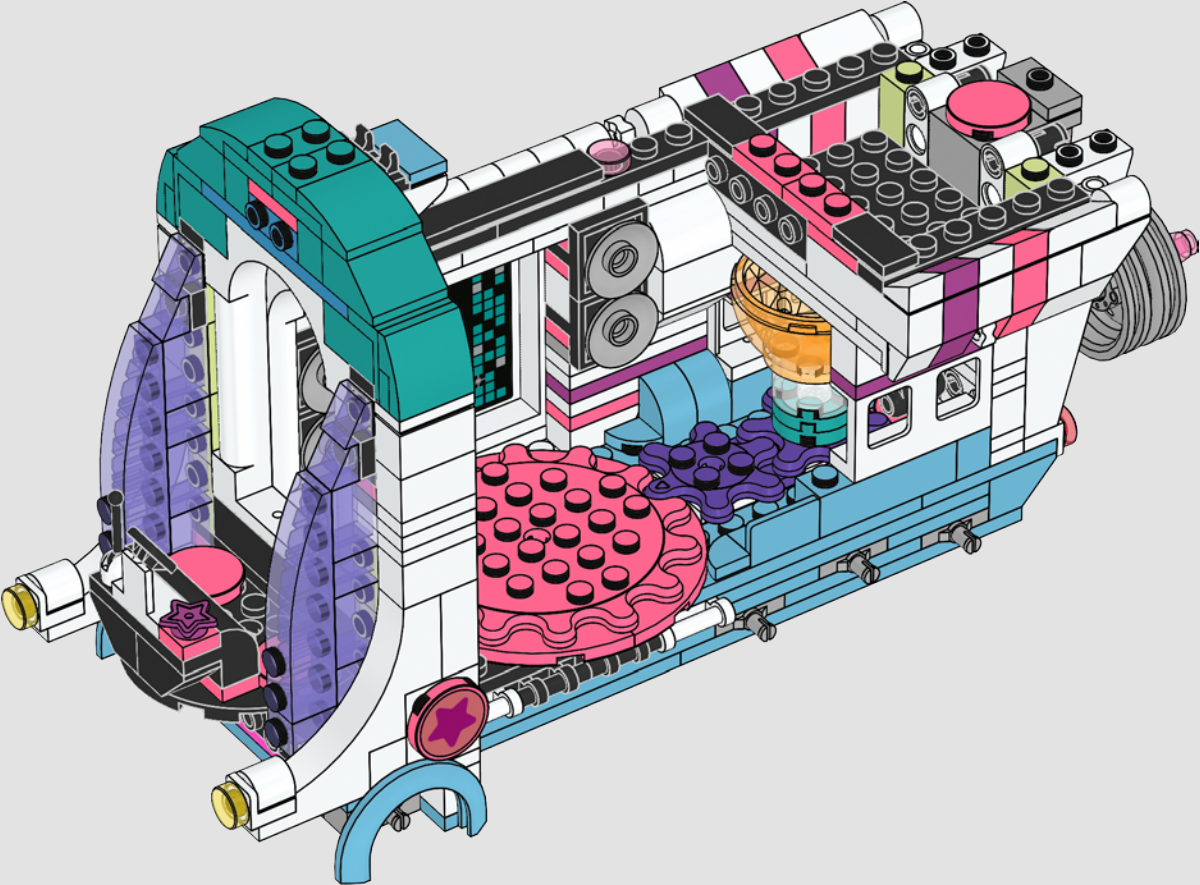

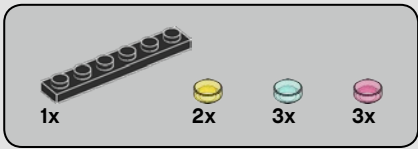

91

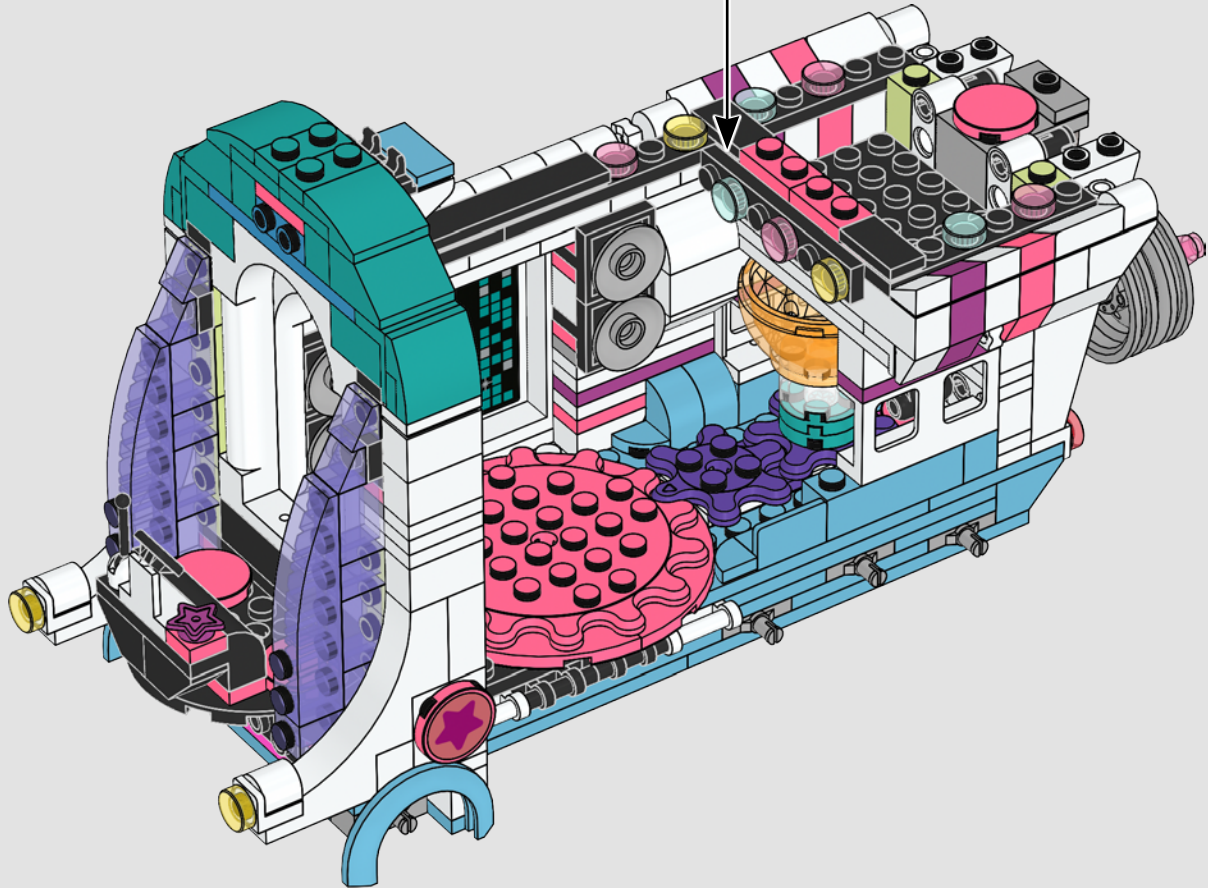
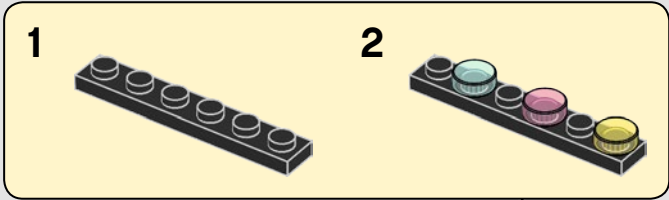

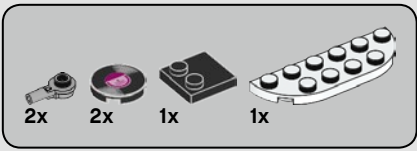

92

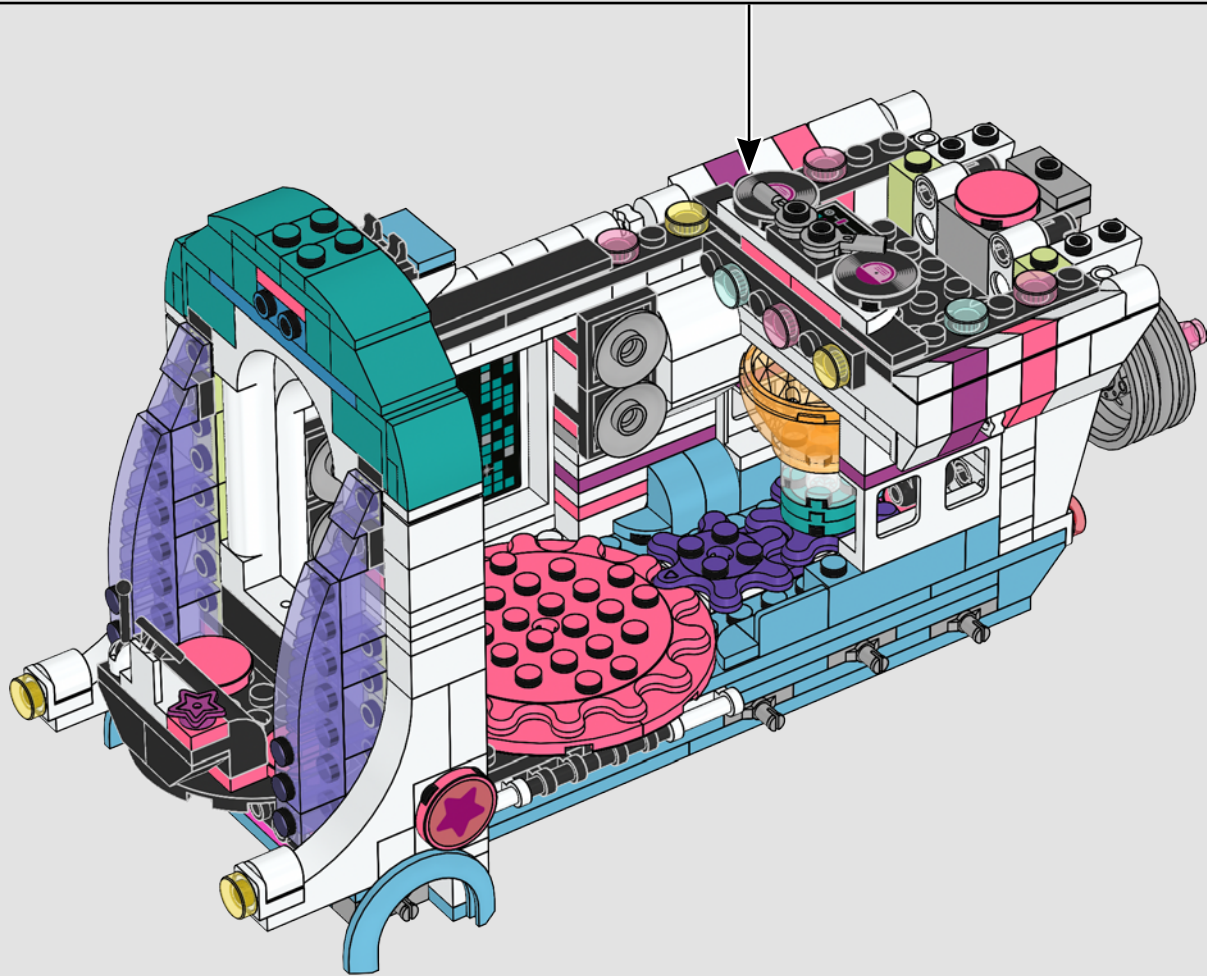
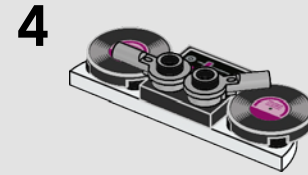
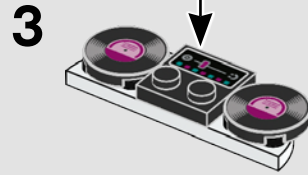
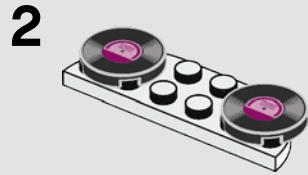
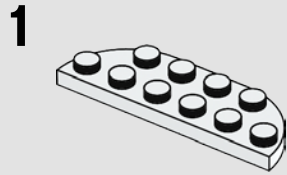
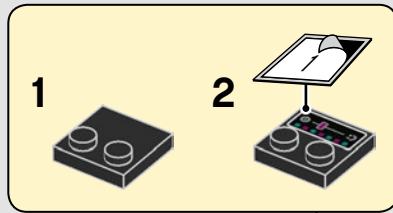

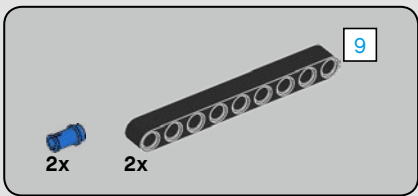

93

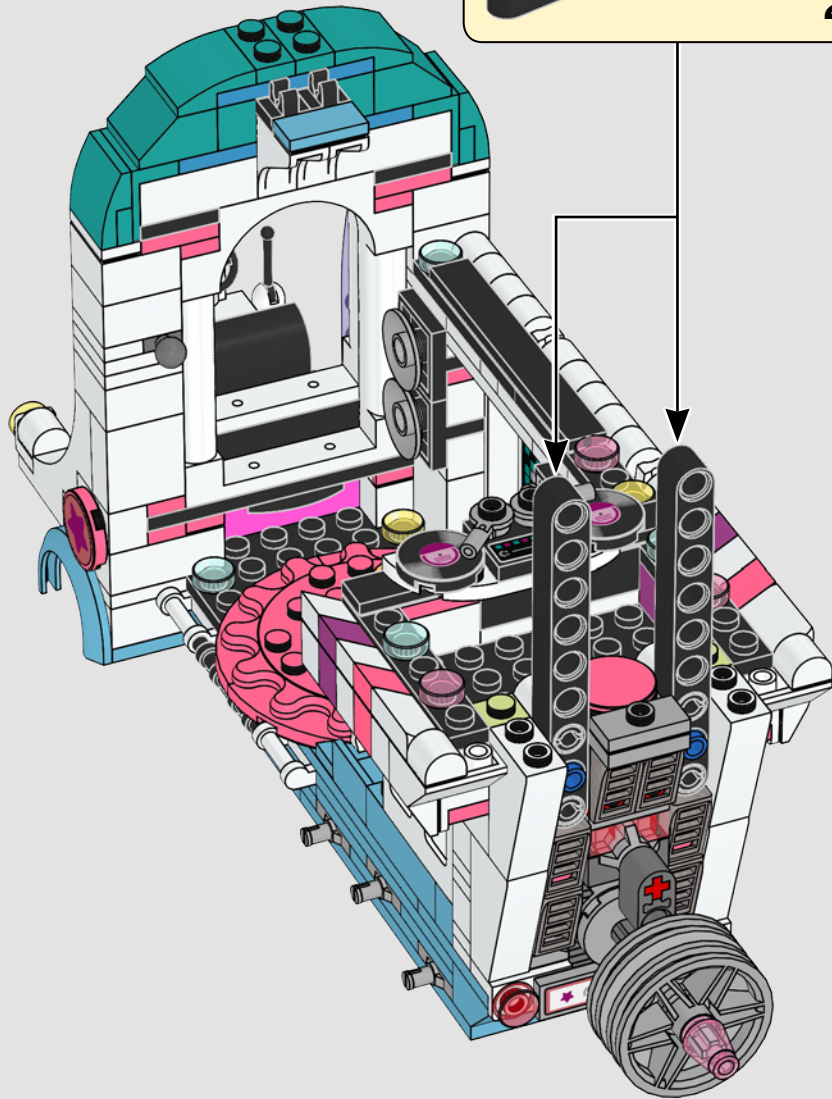
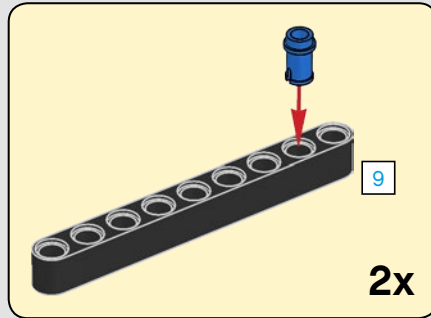

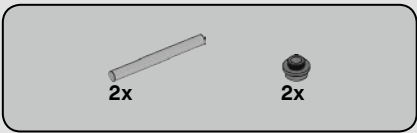

94

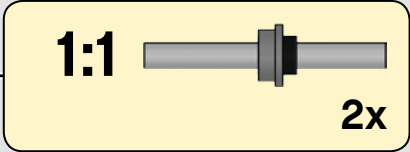
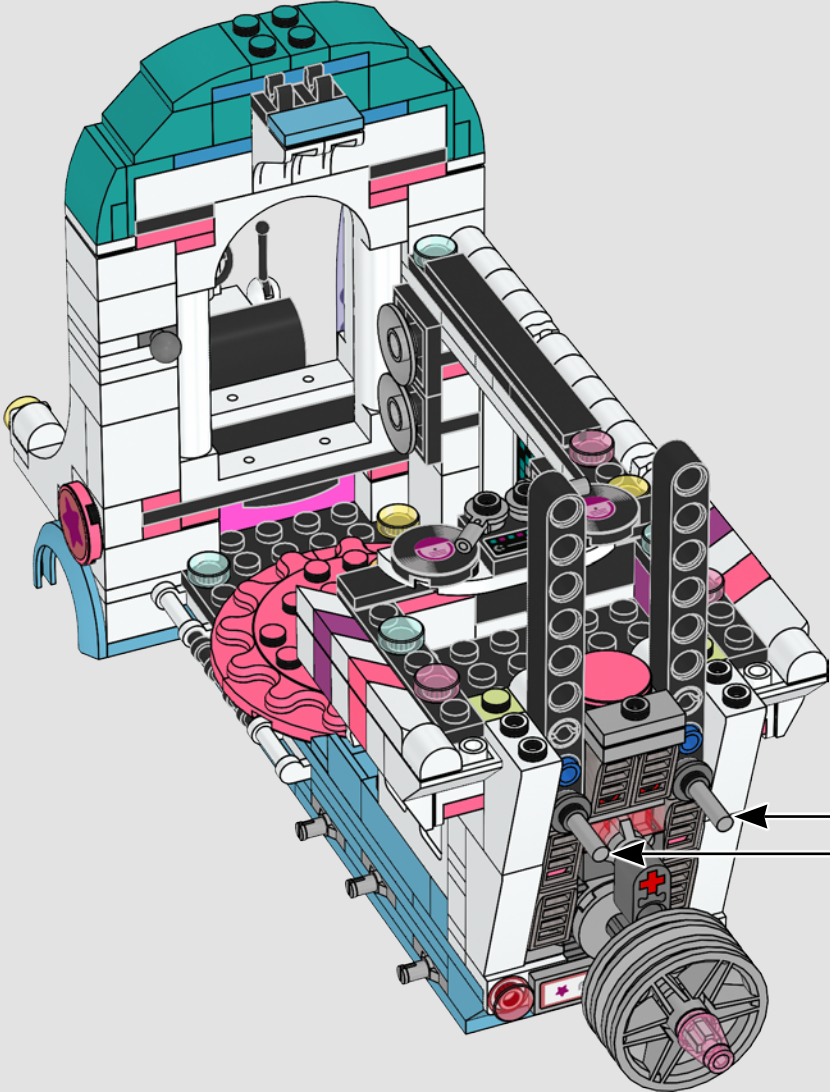

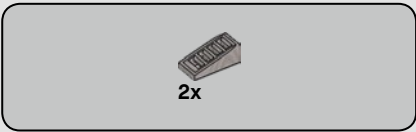

95

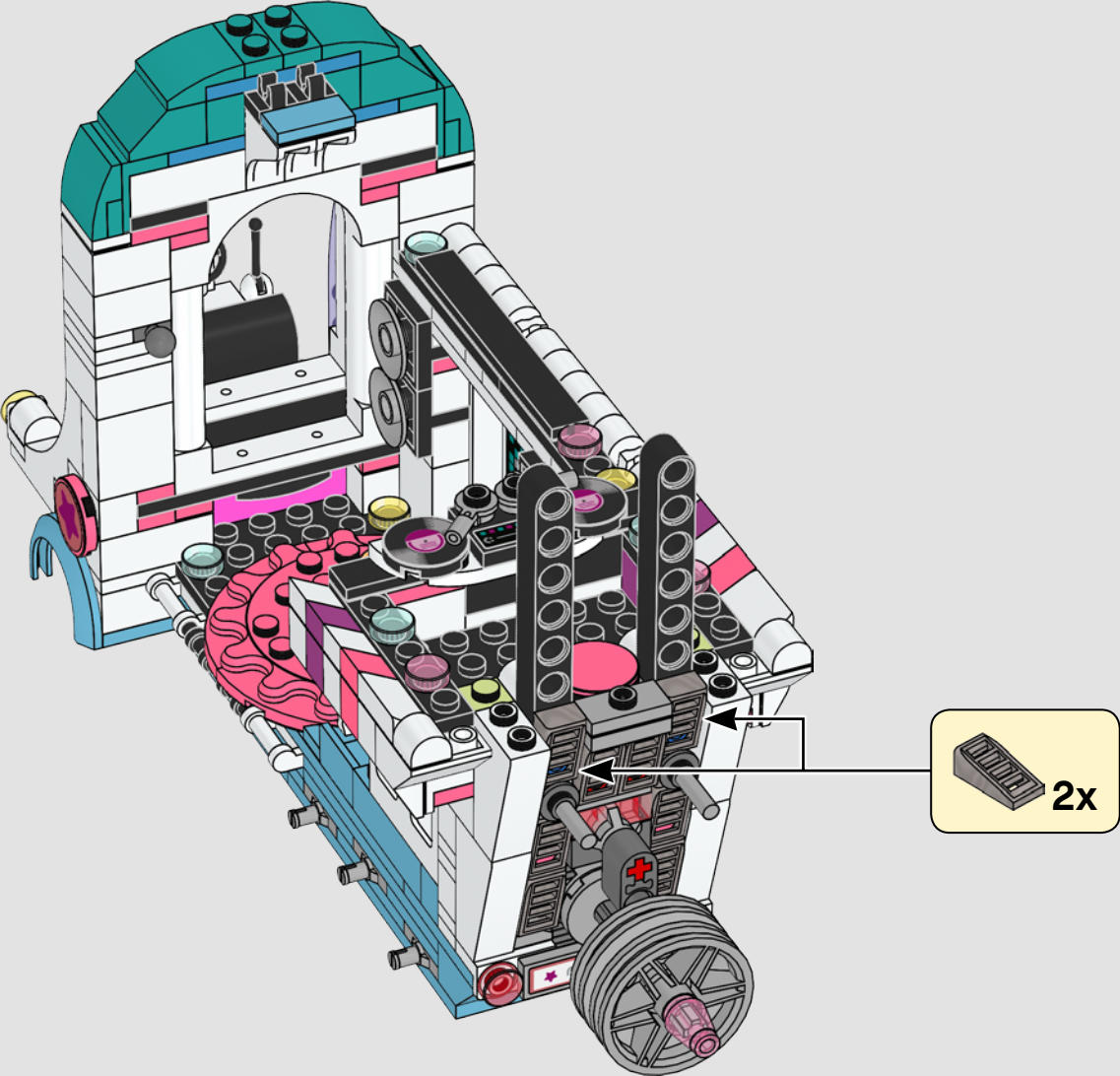

5

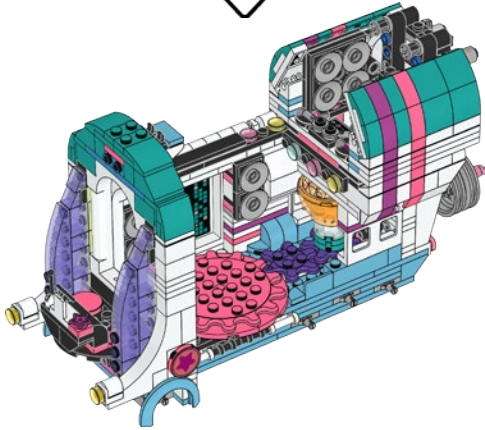
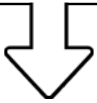
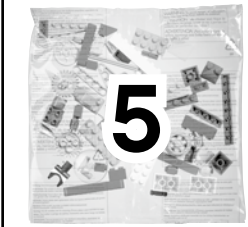

4x

96

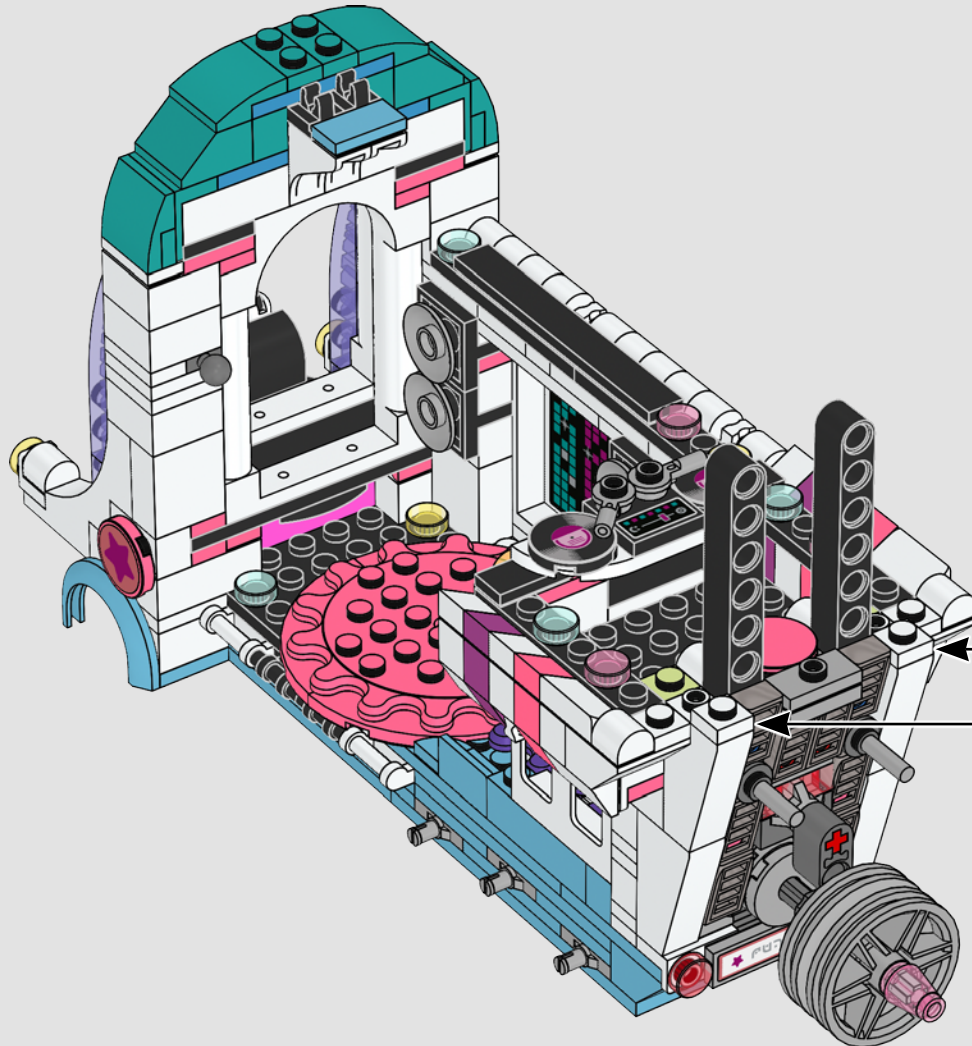

4x

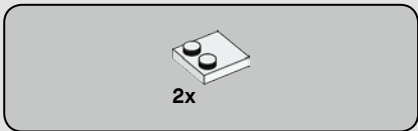

97

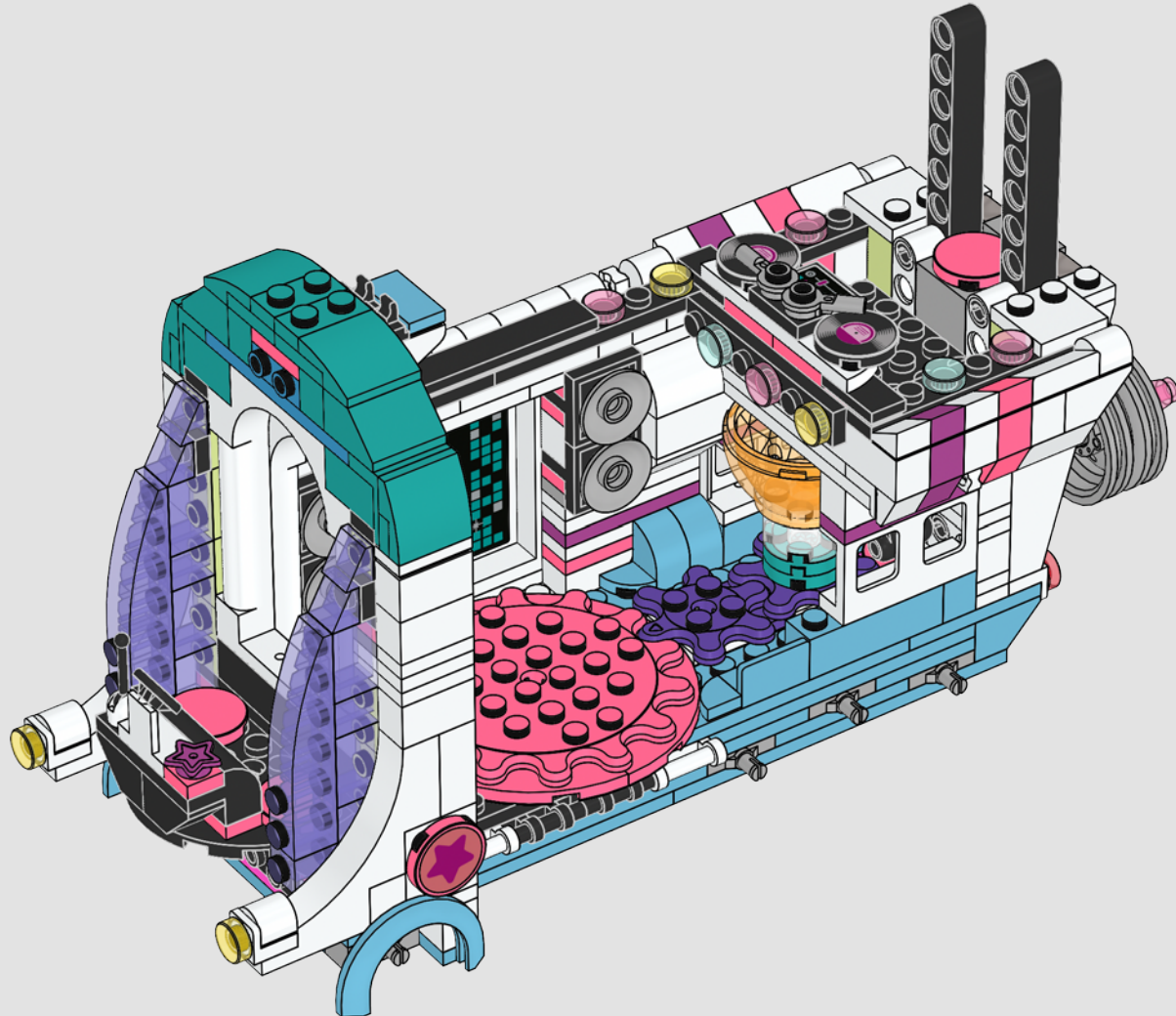



2x

98

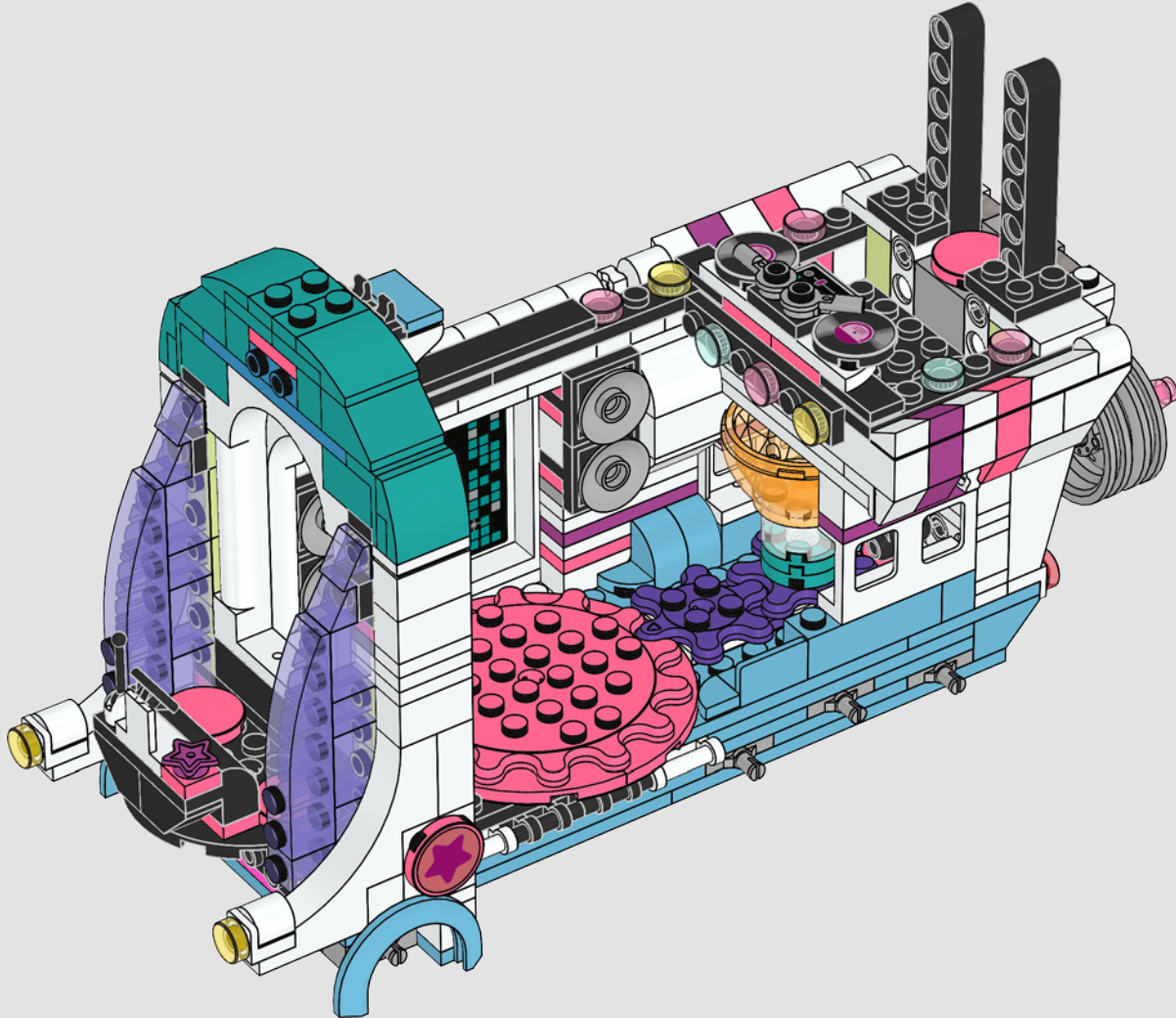

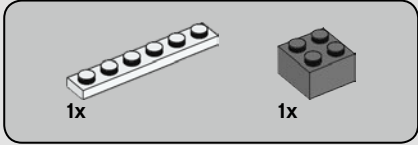
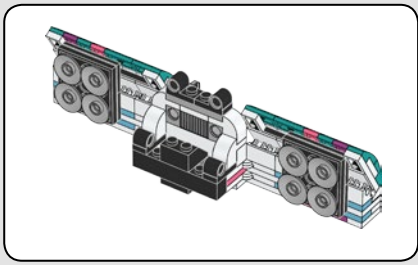

99

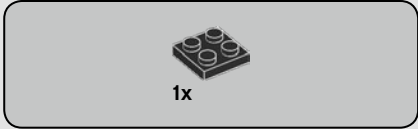
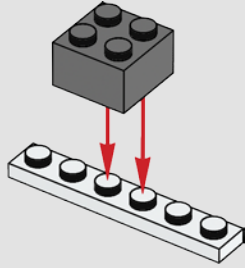

100

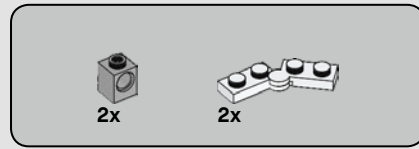
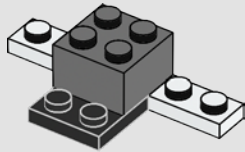

101

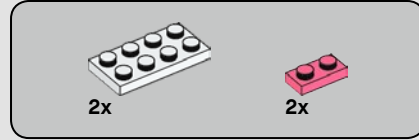
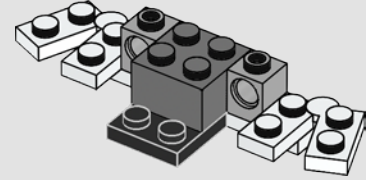

102

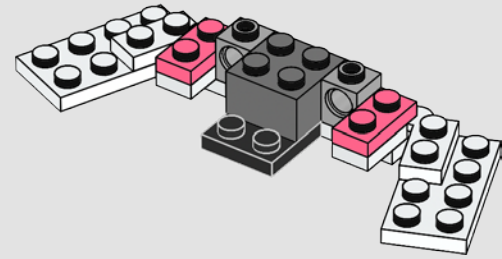

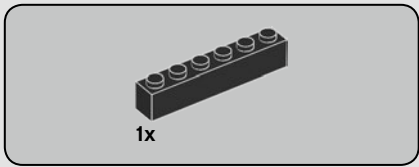

103

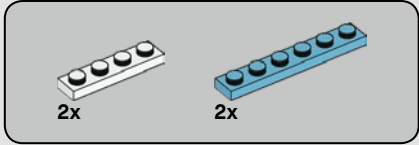
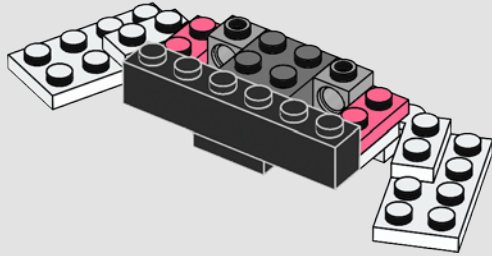

104

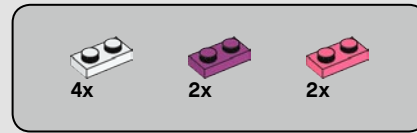
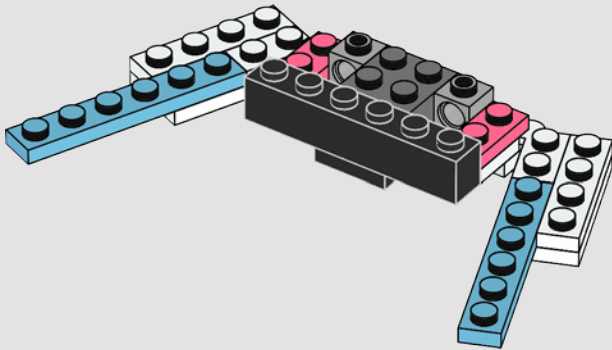

105

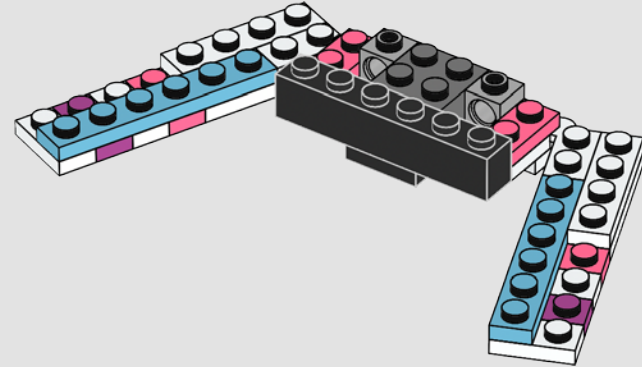

106

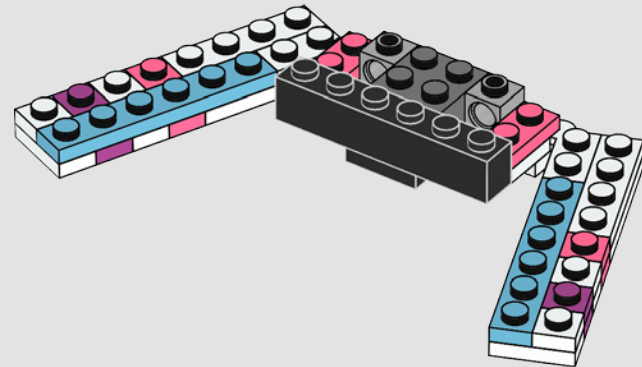

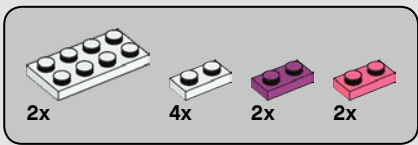

107

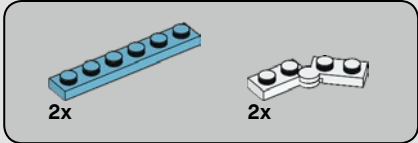
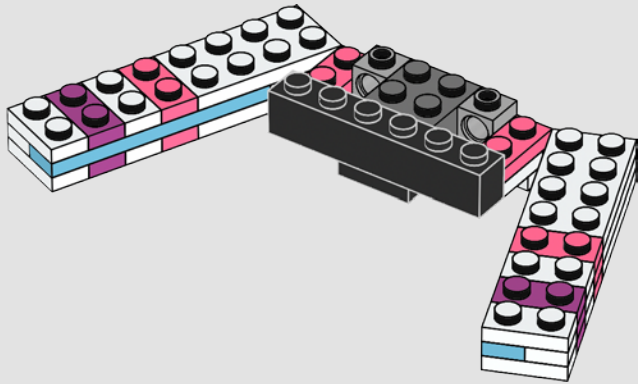

108

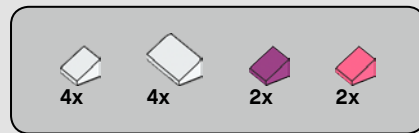
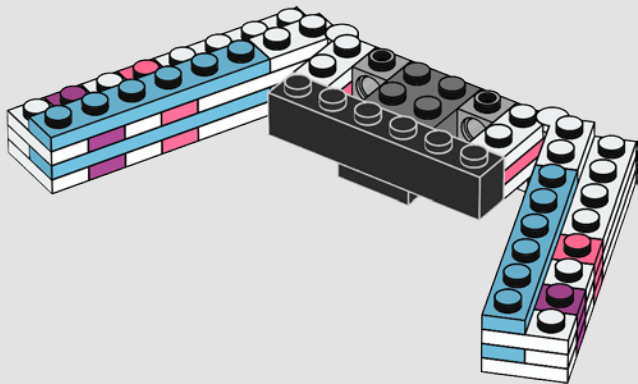

109

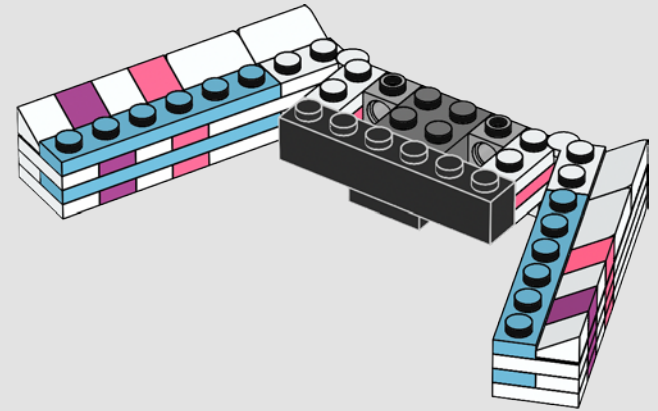

110

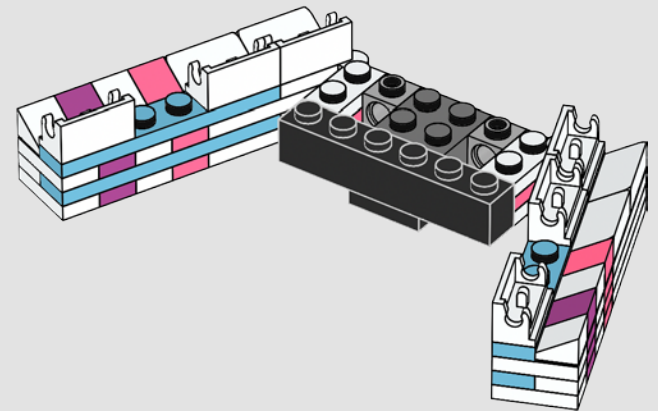

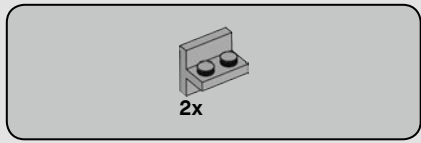

111

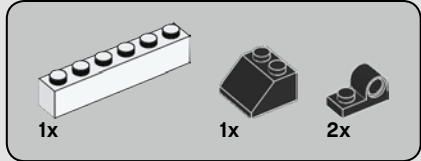
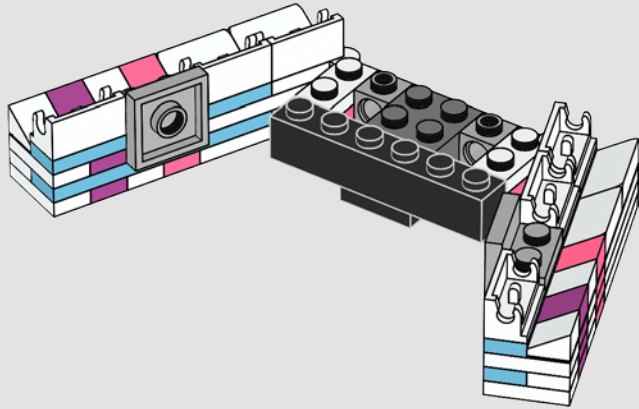

112

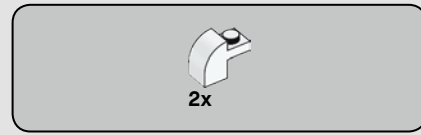
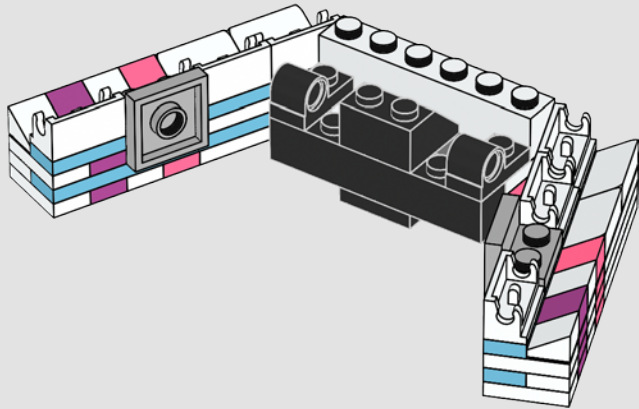

113

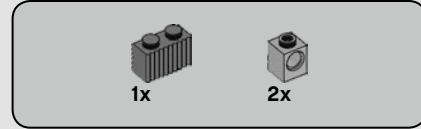
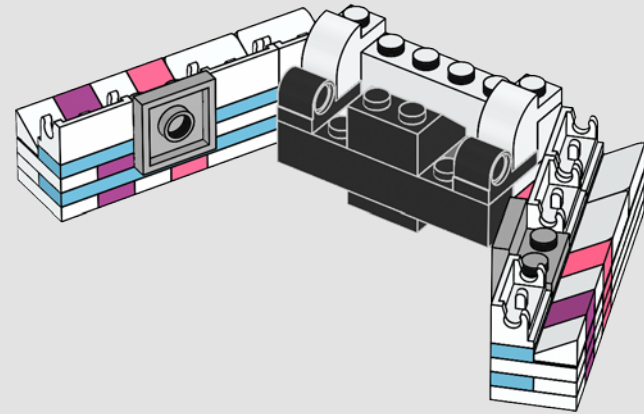

114

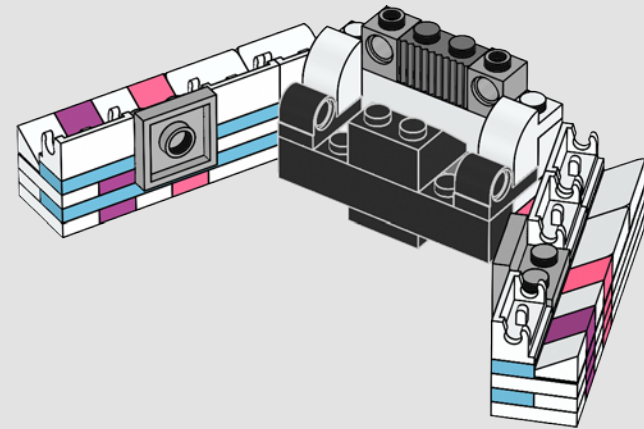

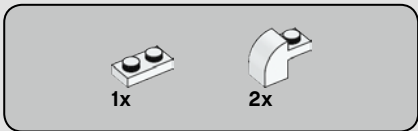

115

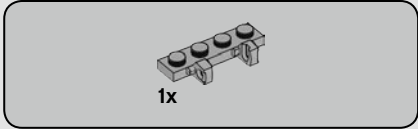
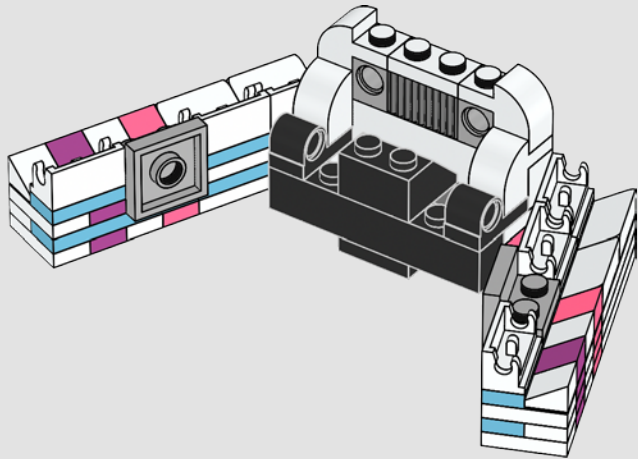

116

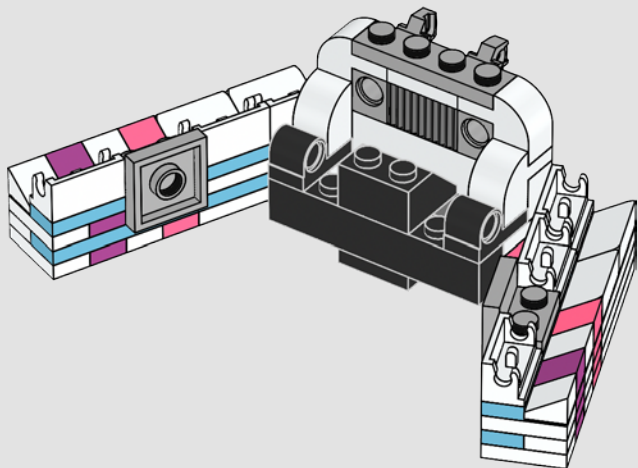

117

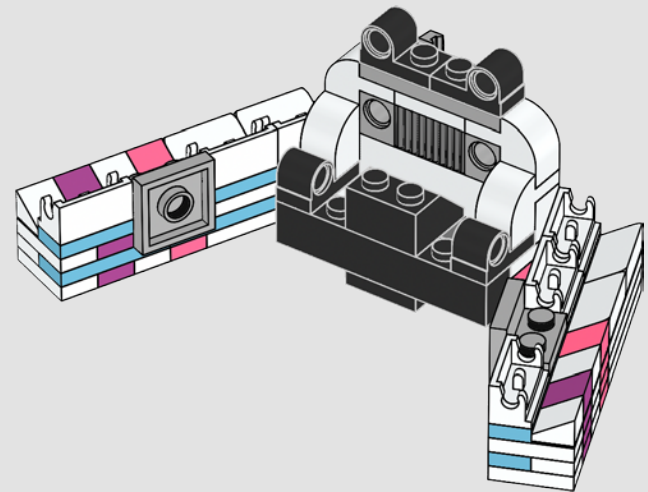

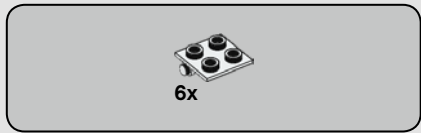

118

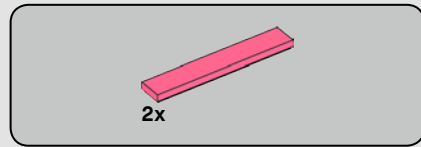
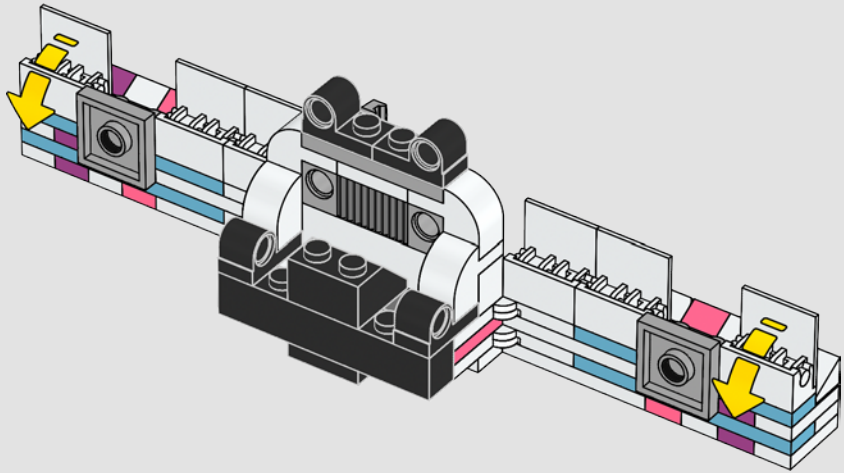

119

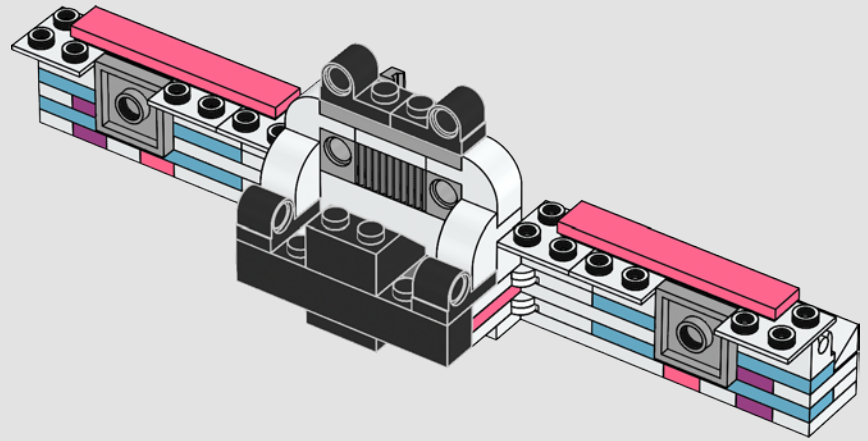

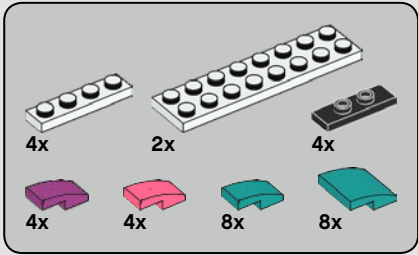
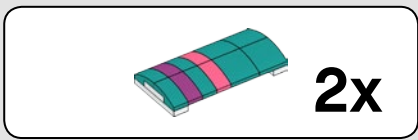

120

1

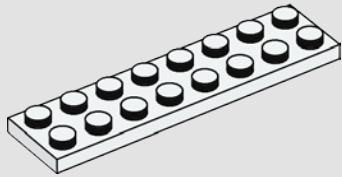

2

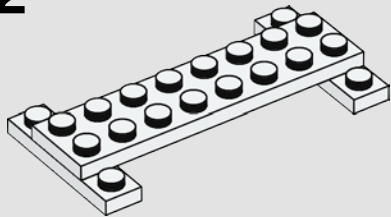

3

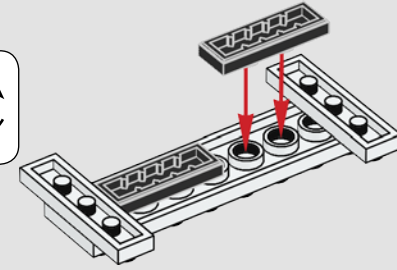
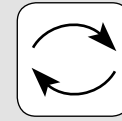

4

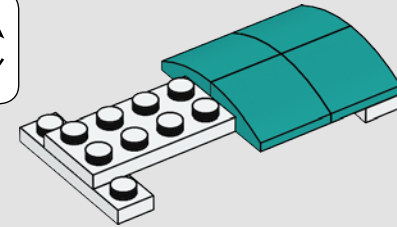
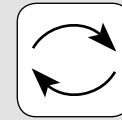

5

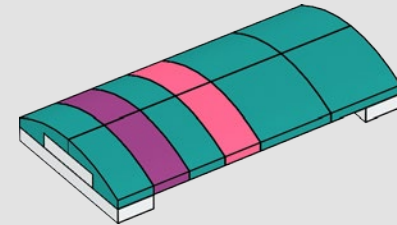

2x

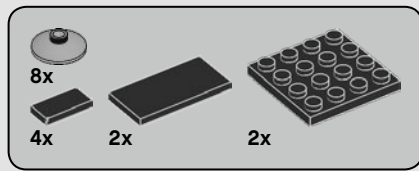

121

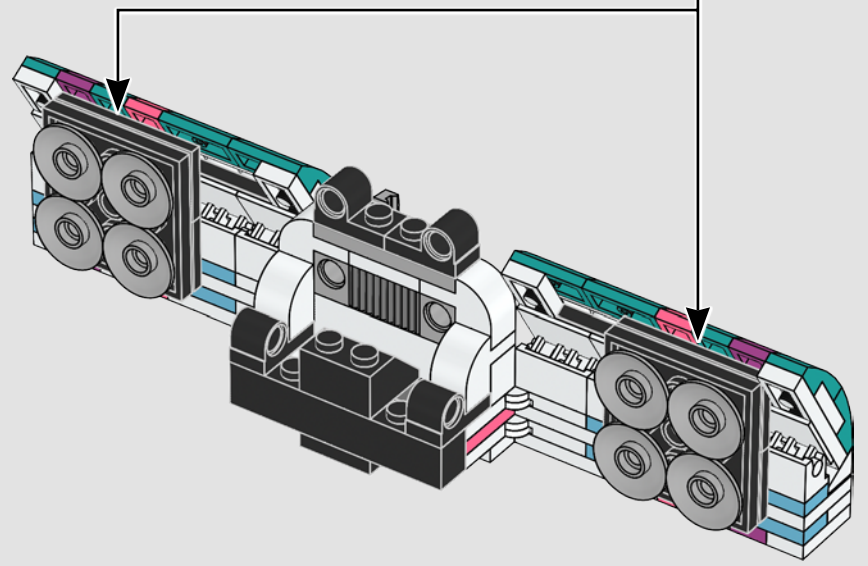
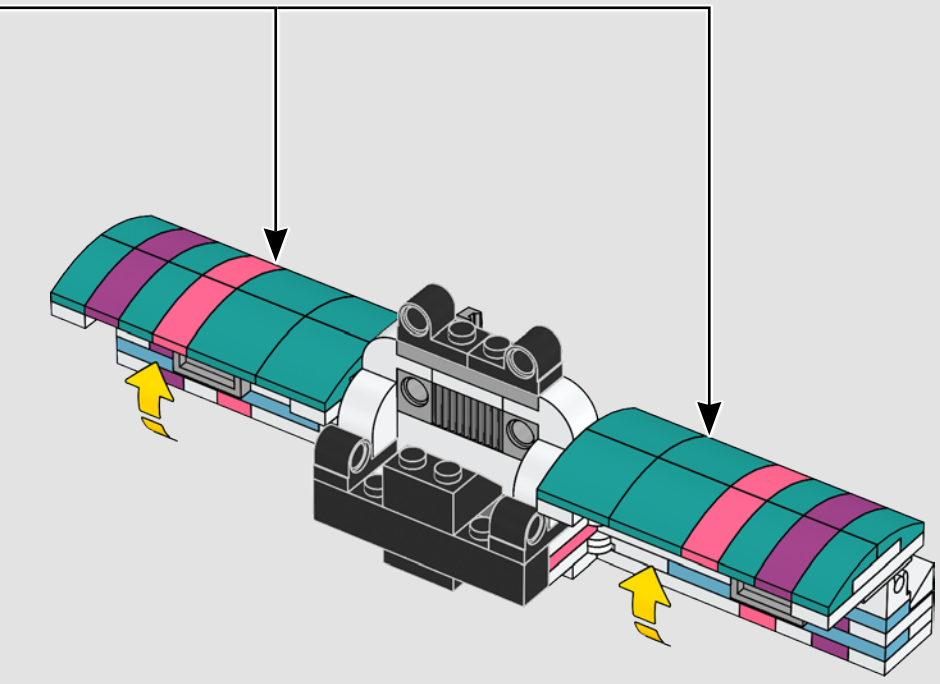
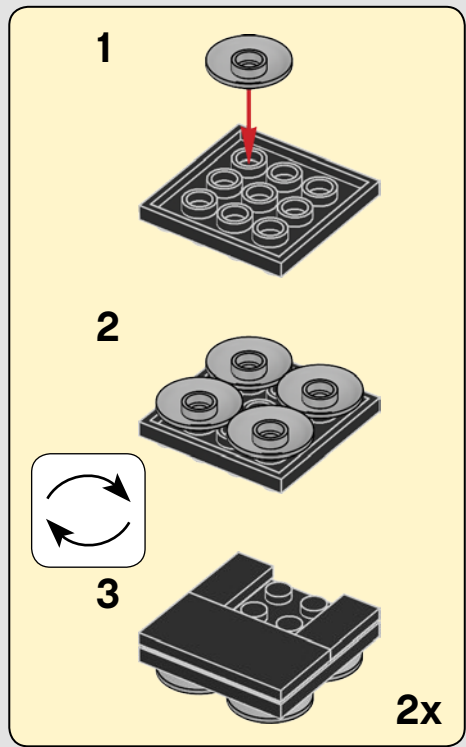

122

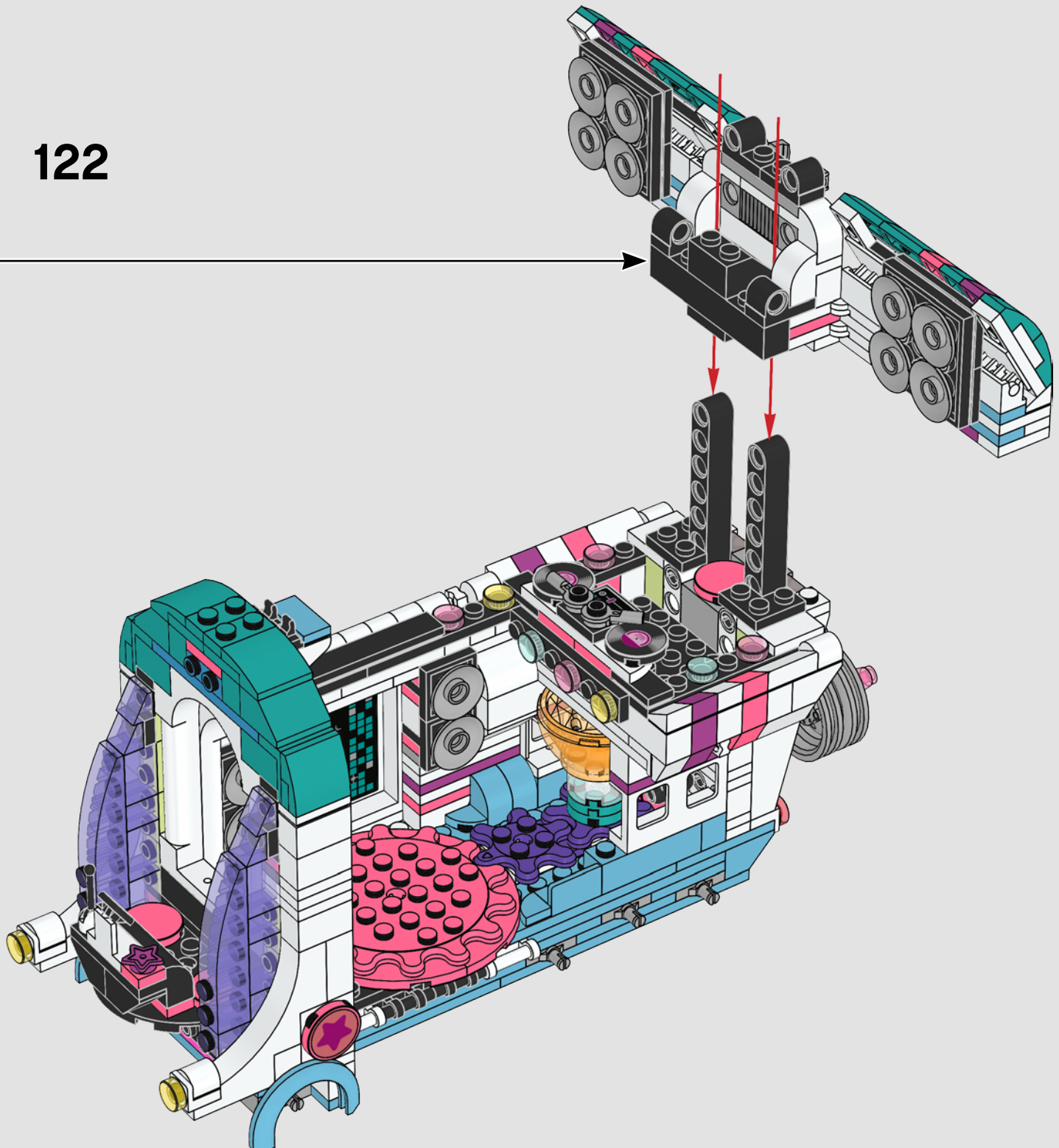



2x

123

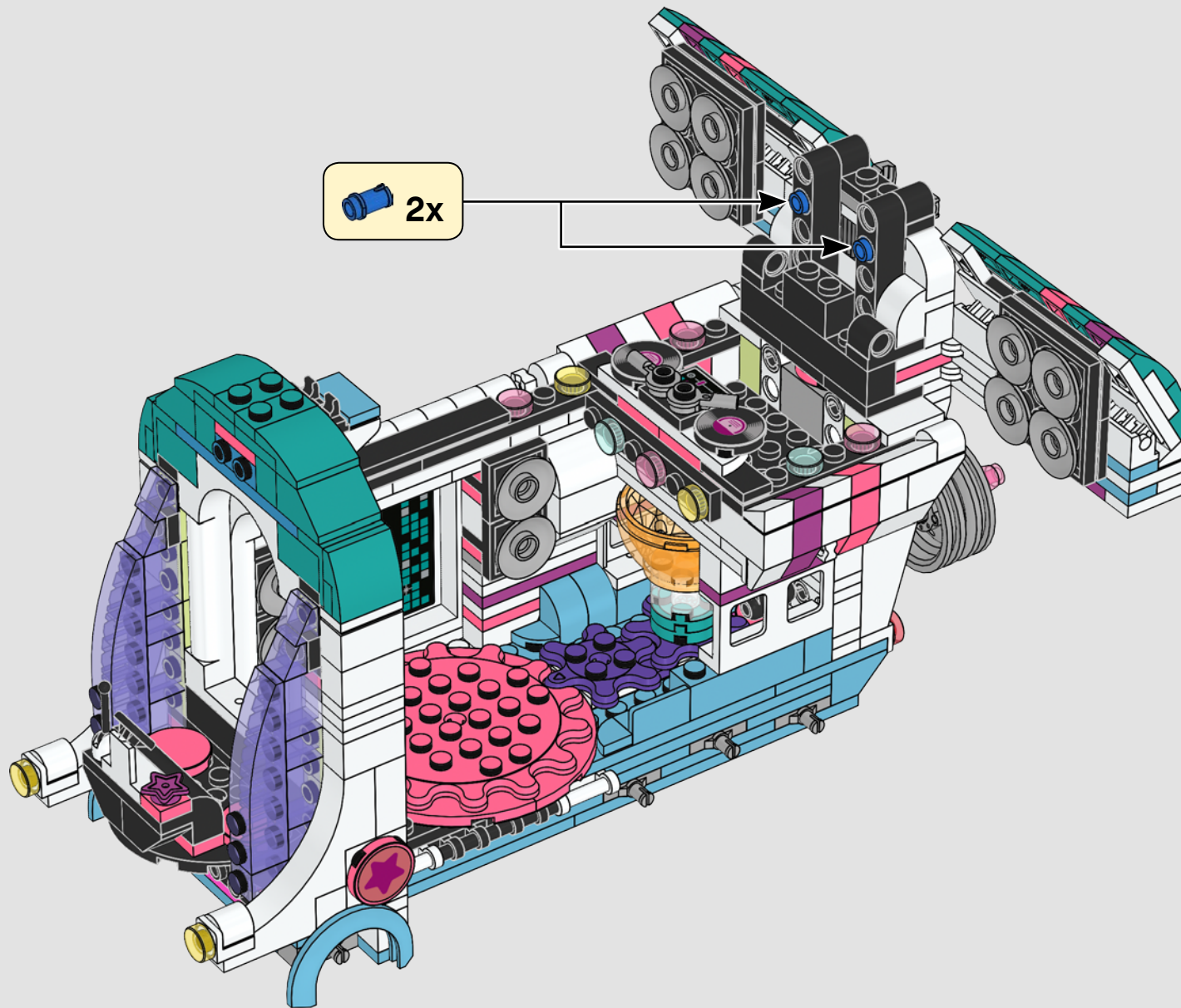



124

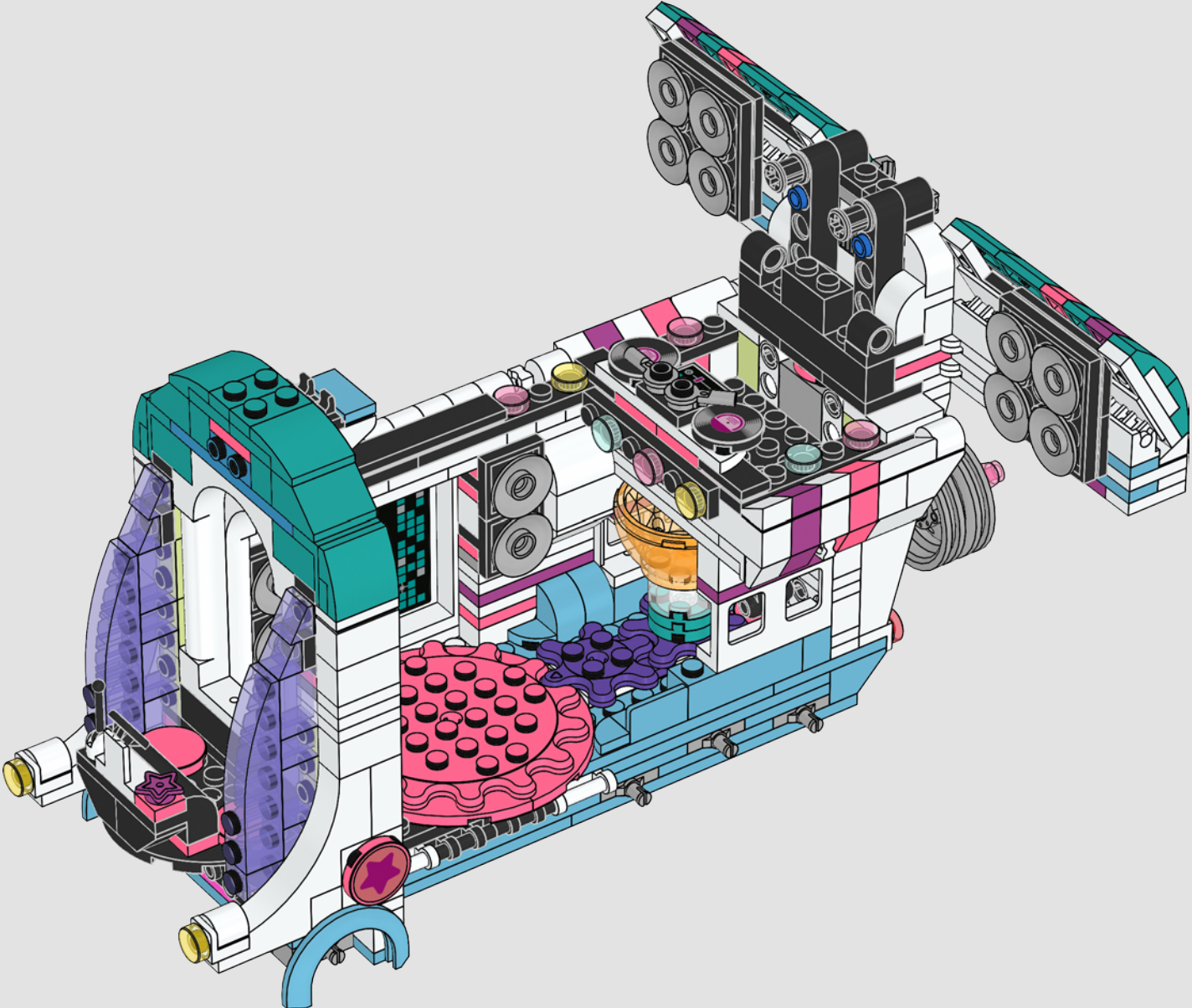

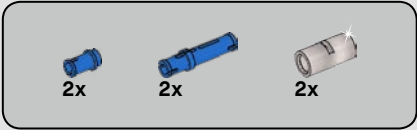

125

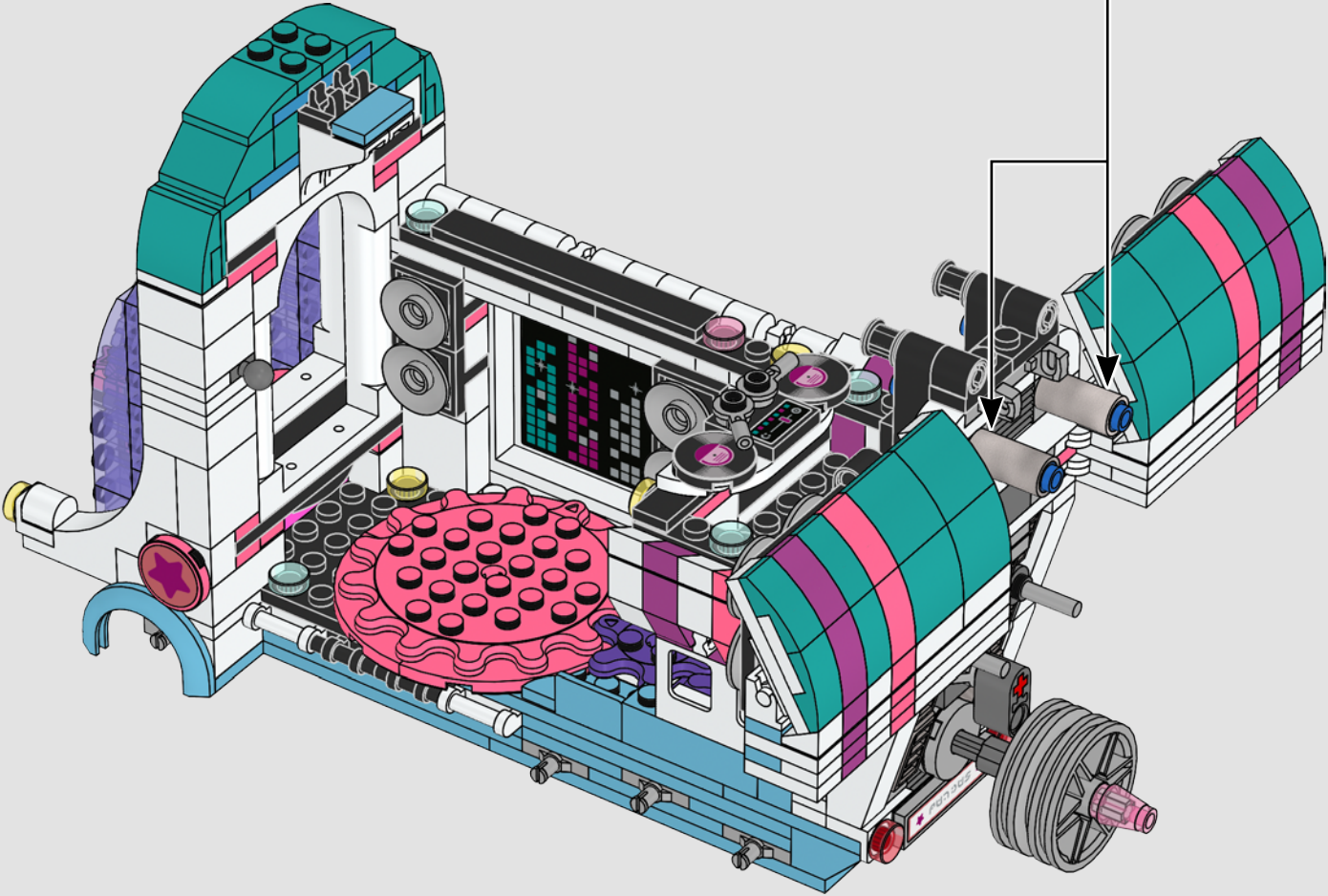
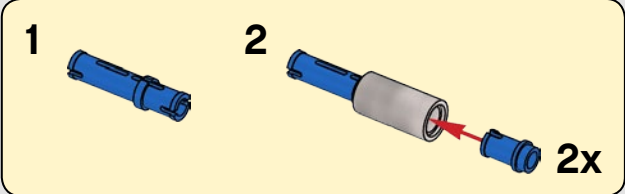

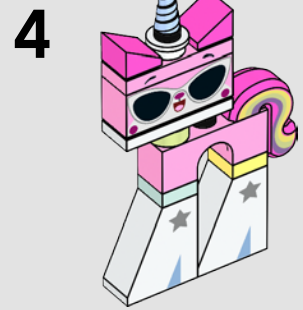
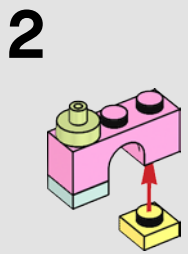
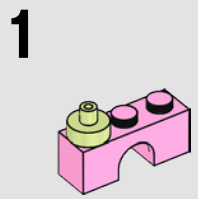
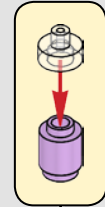
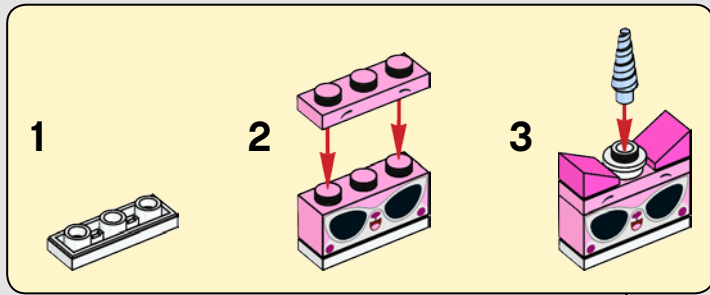
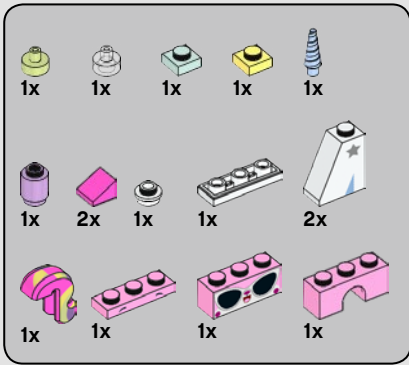
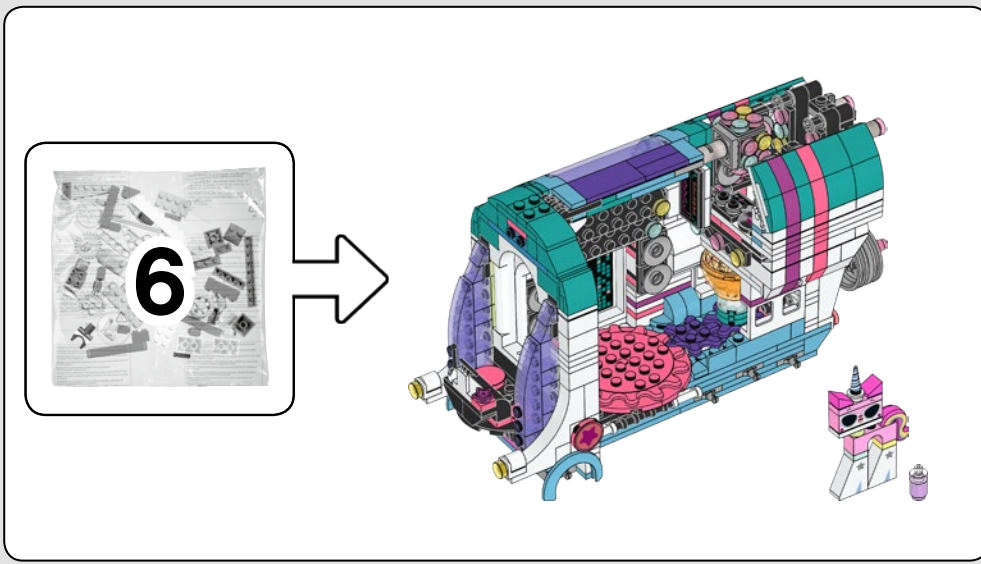



2x

126

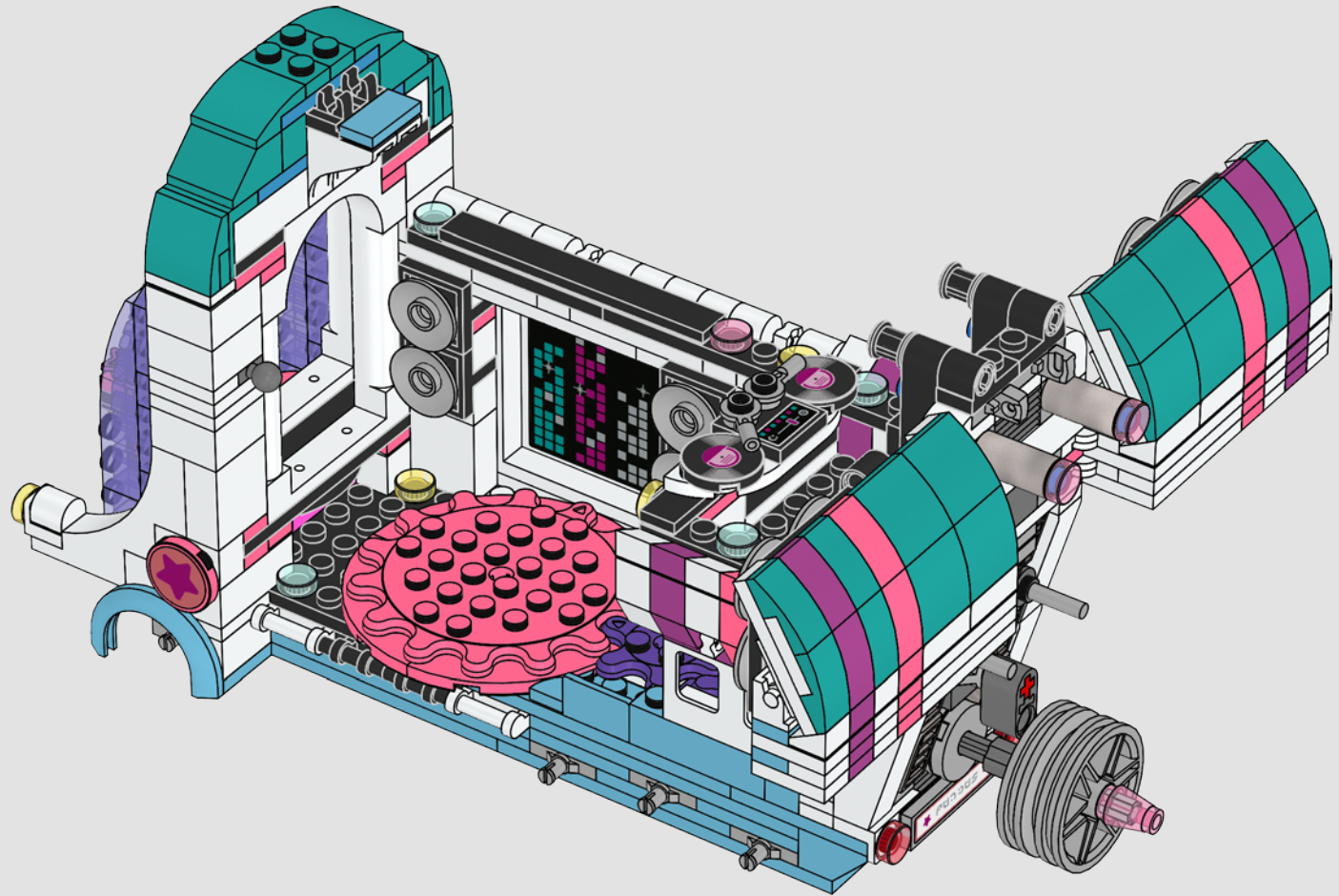



127

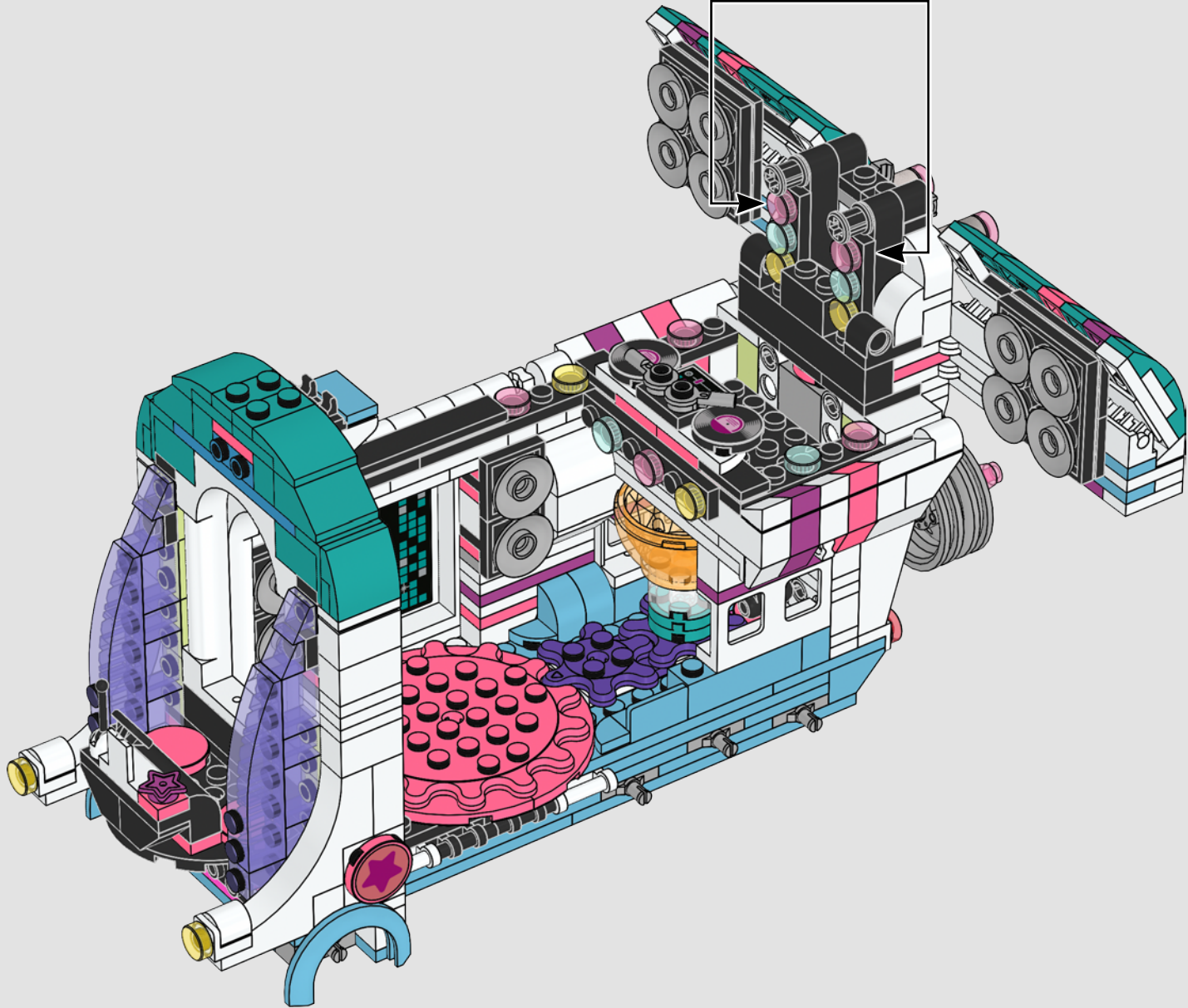
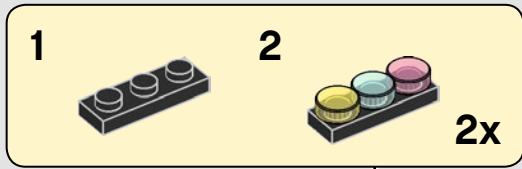

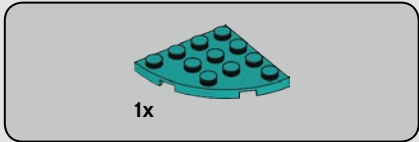
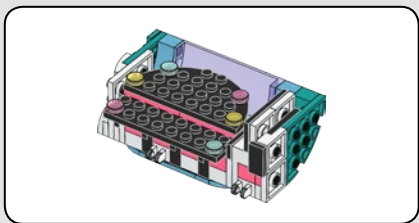

128

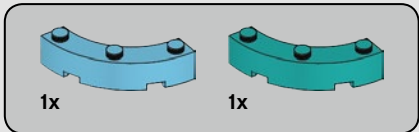
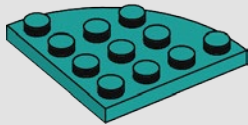

129

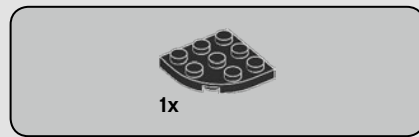
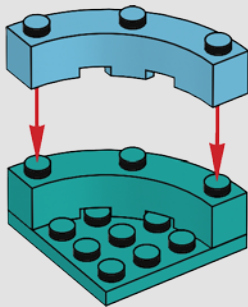

130

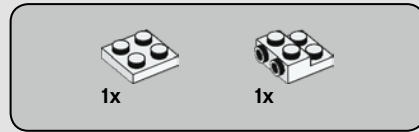
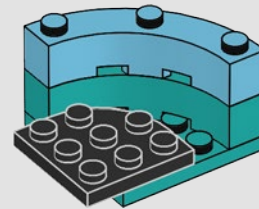

131

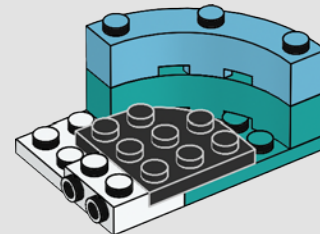

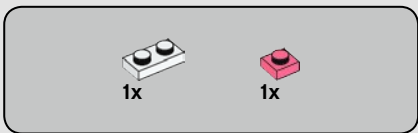

132

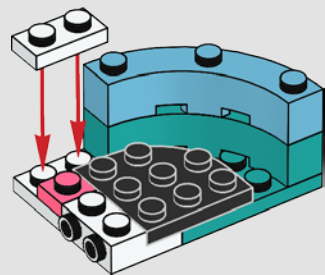

133

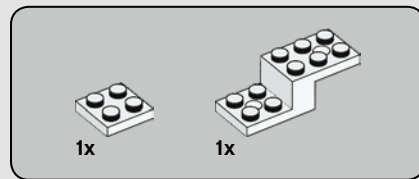
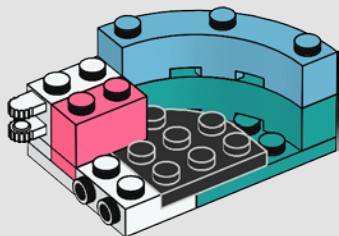

134

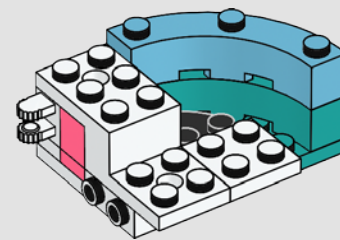

135

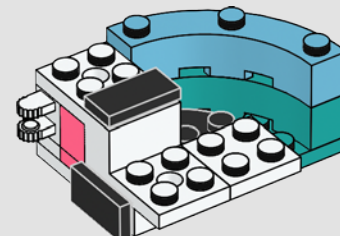

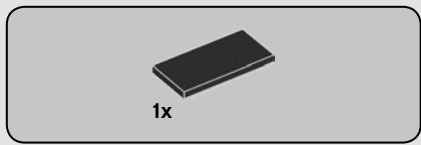

136

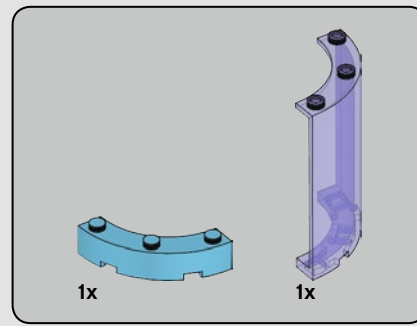
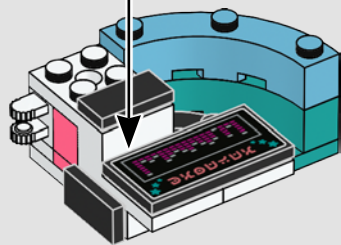
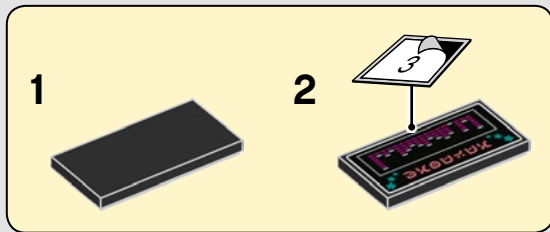

137

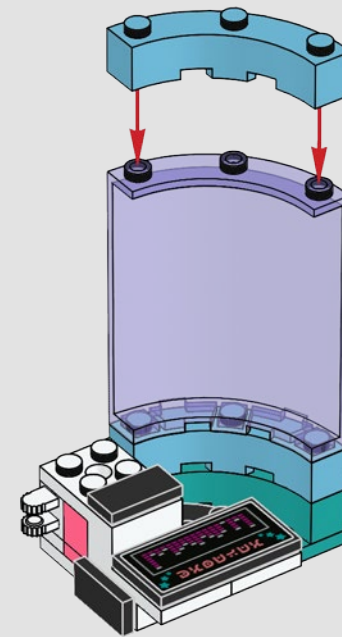

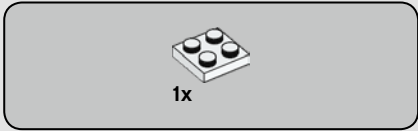
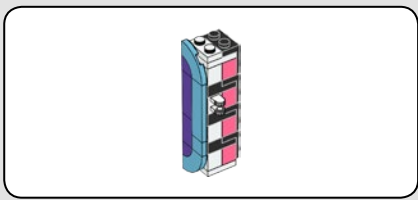

138

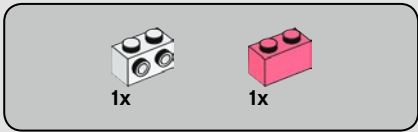
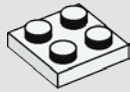

139

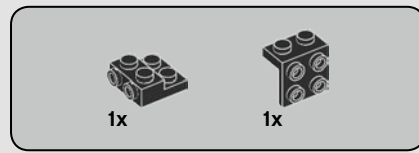
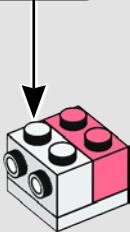
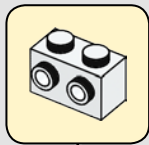

140

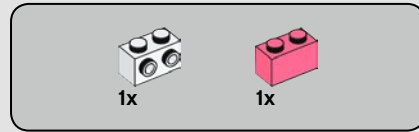
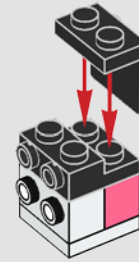

141

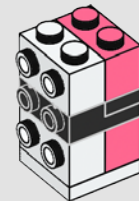

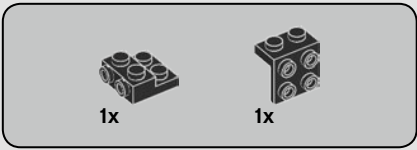

142

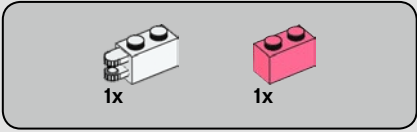
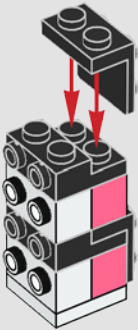

143

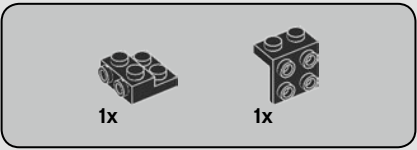
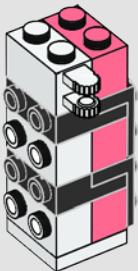

144

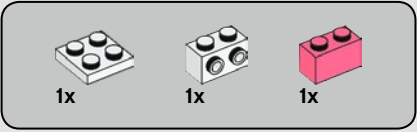
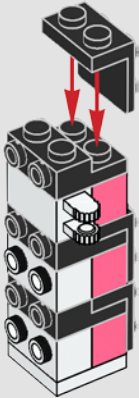

145

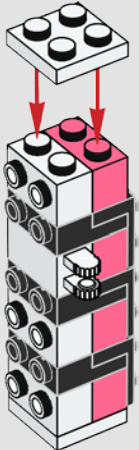

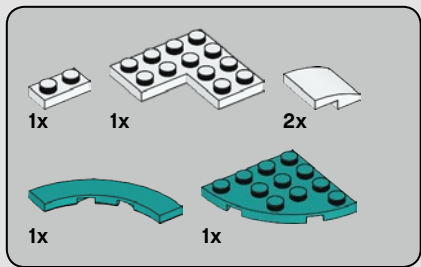

150

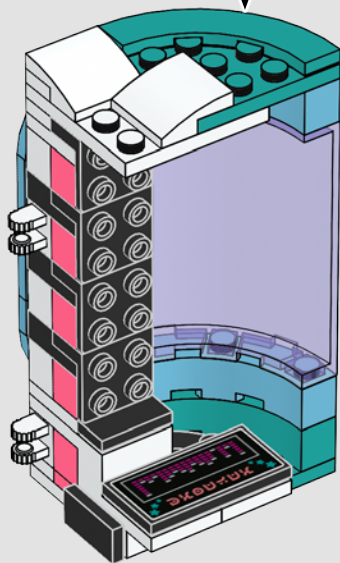
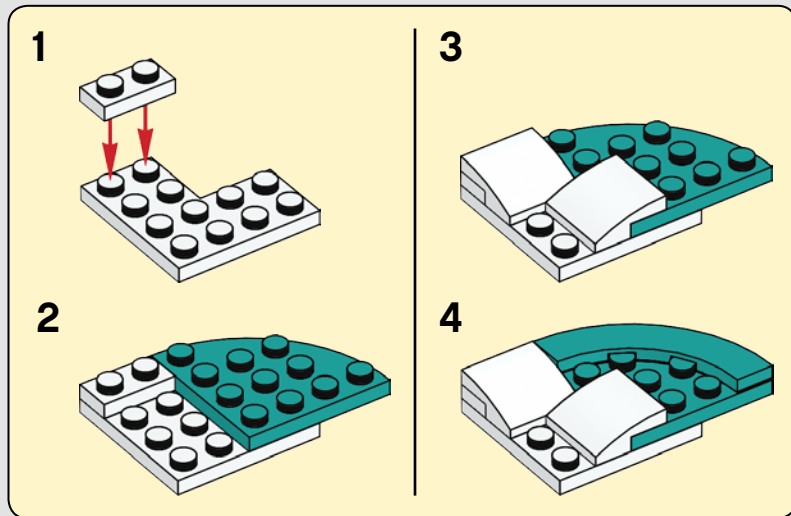

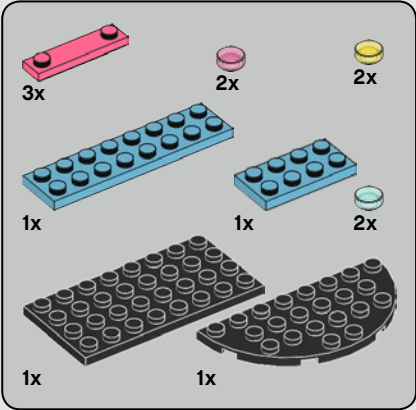
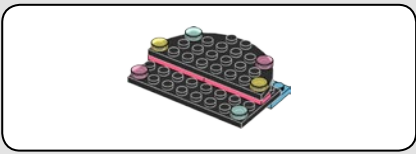

151

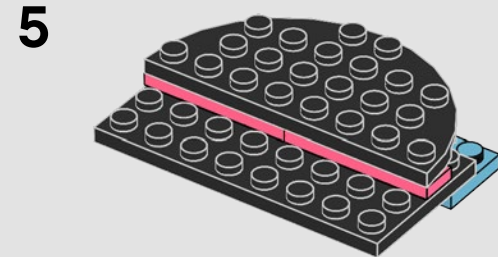
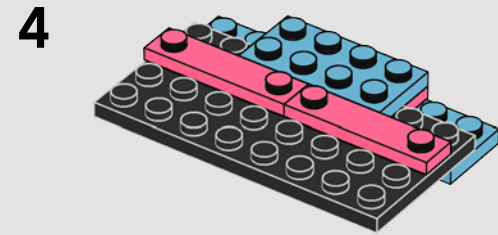
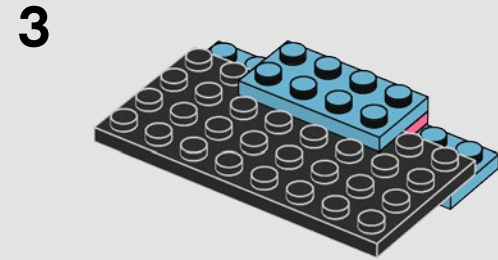
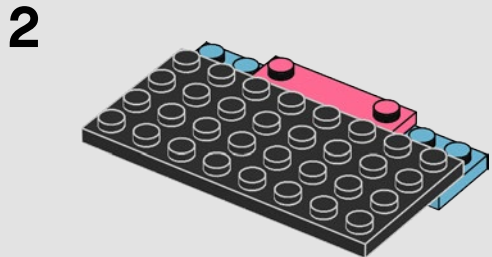
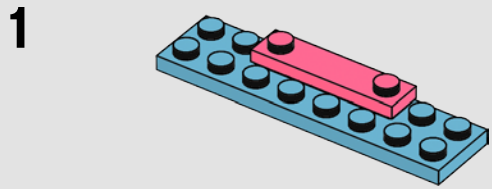

6

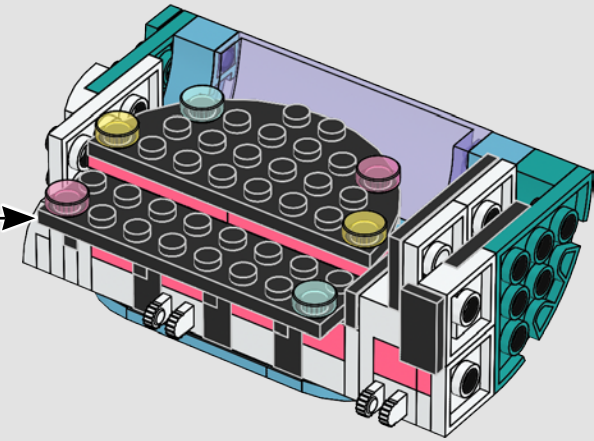
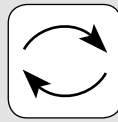
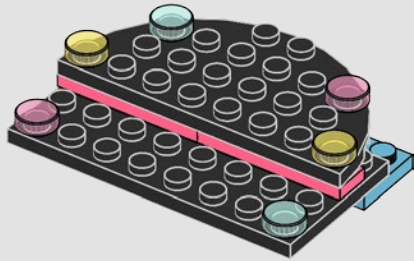

152

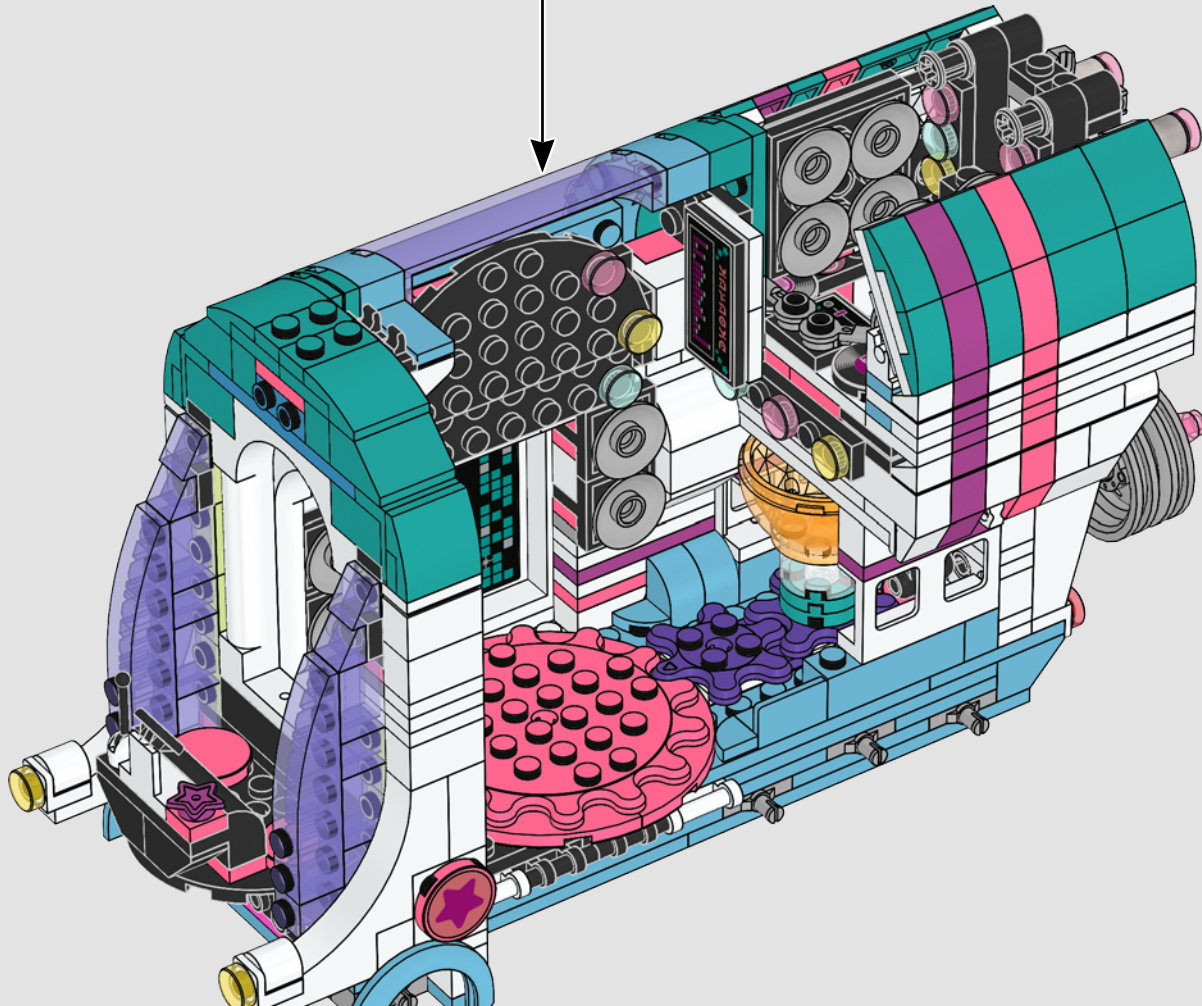

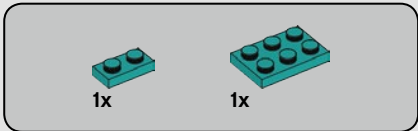

153

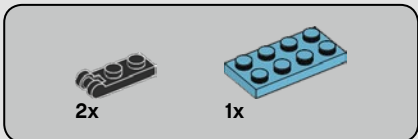
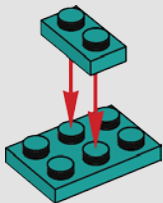

154

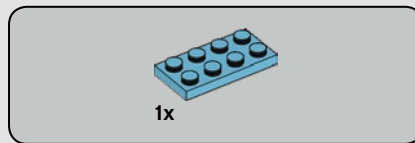
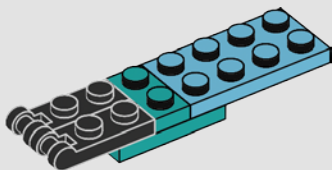

155

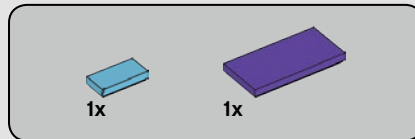
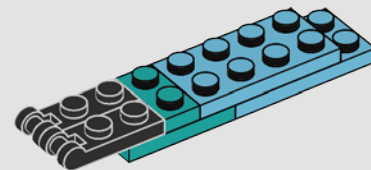

156

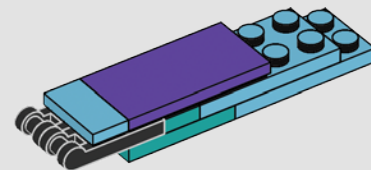

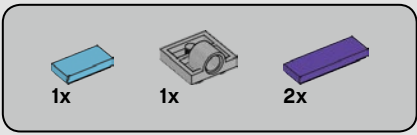

157

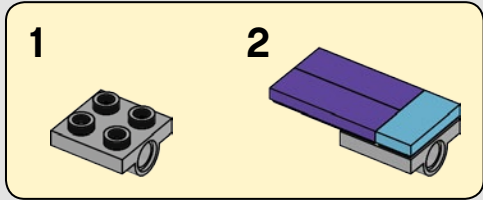
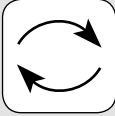

158

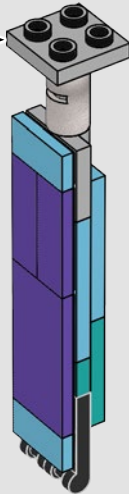
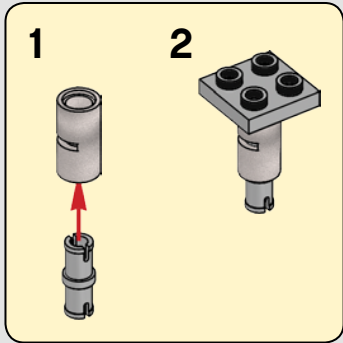

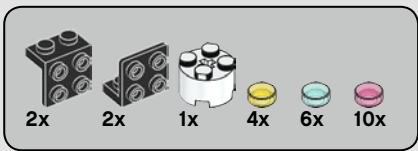

159

1

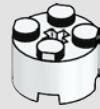

2



3



4



5

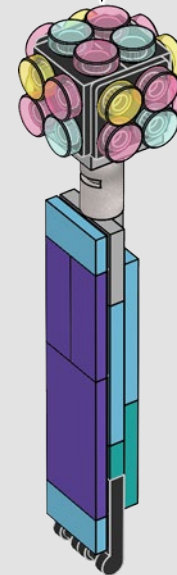

160

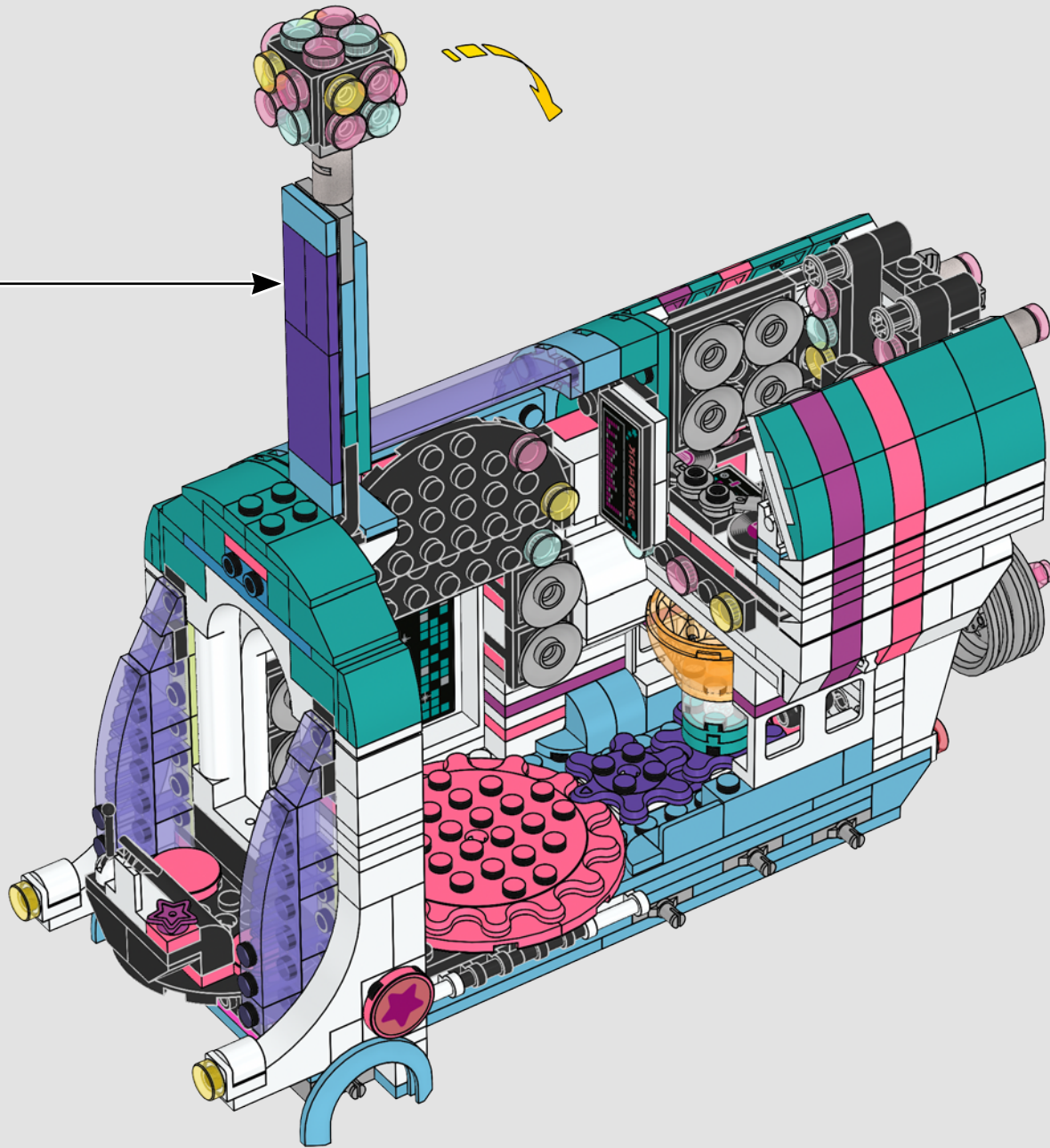

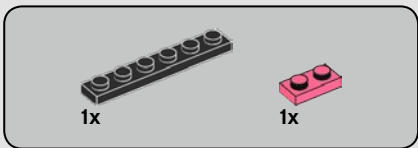
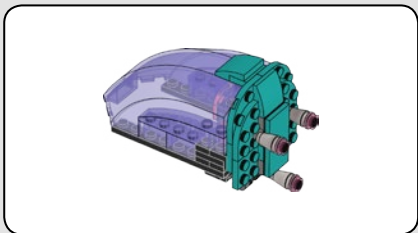
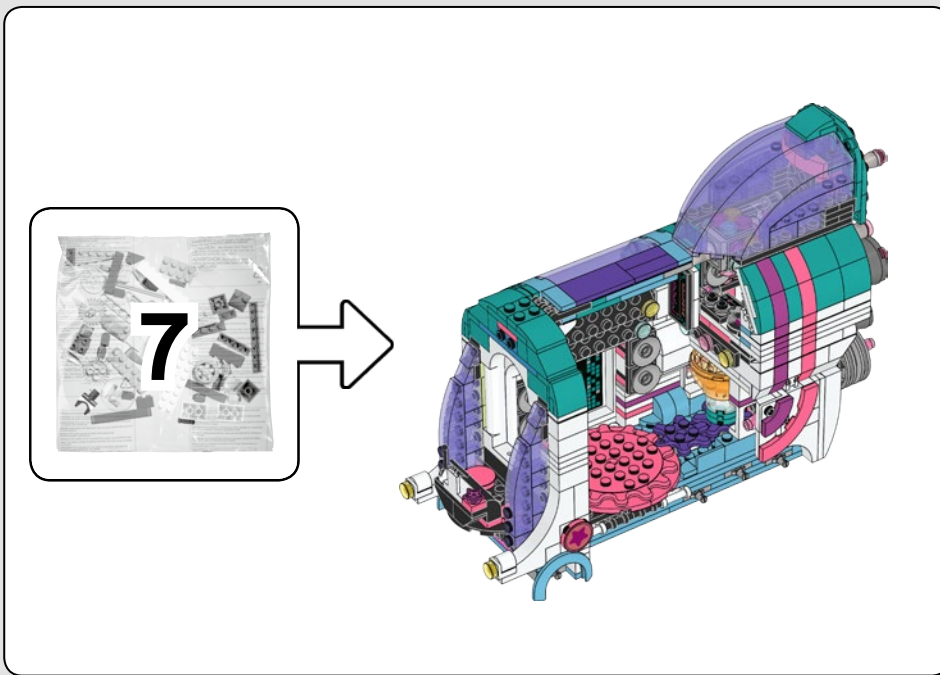

161

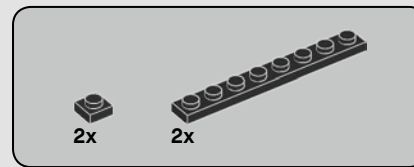
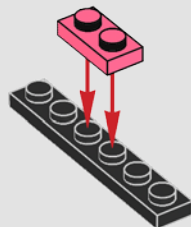

162

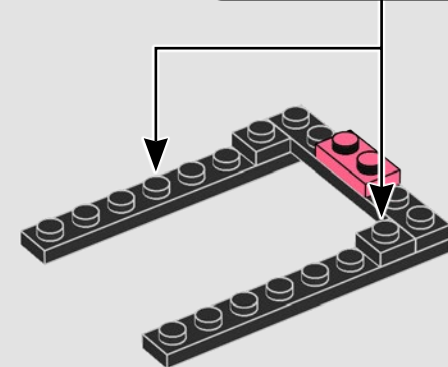
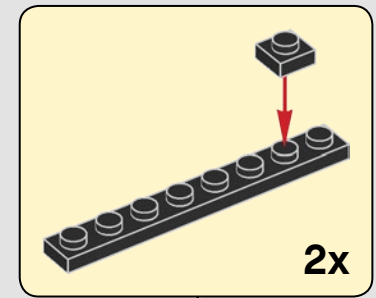

163

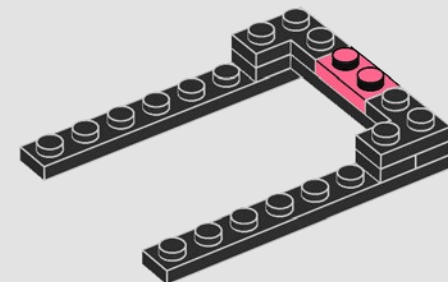

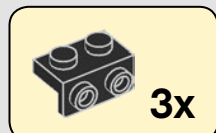

164

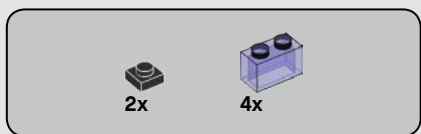
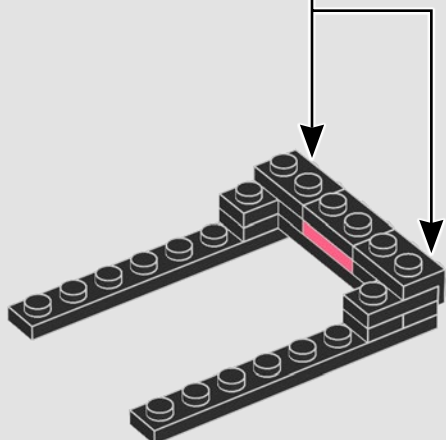

165

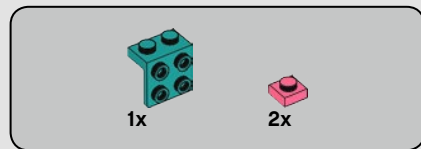
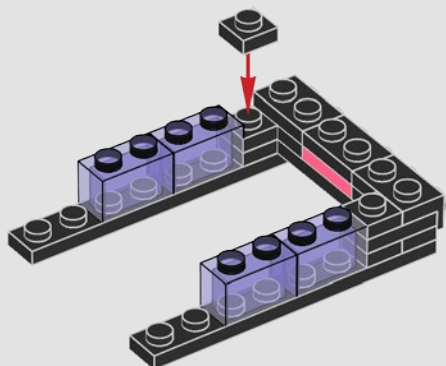

166

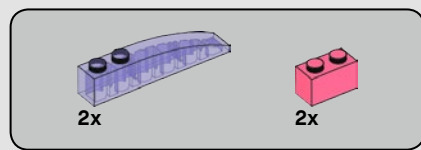
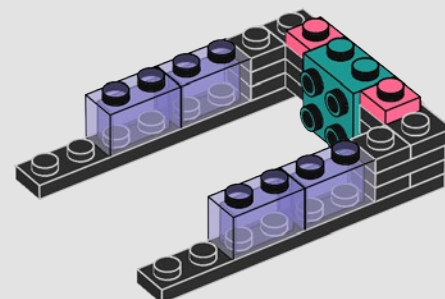

167

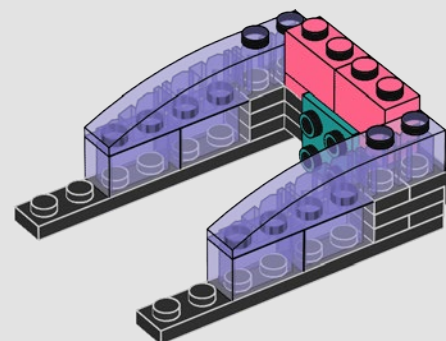

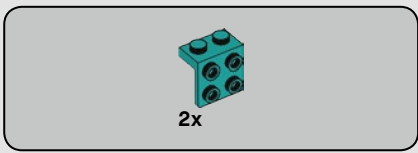

168

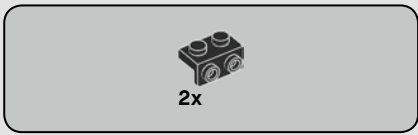
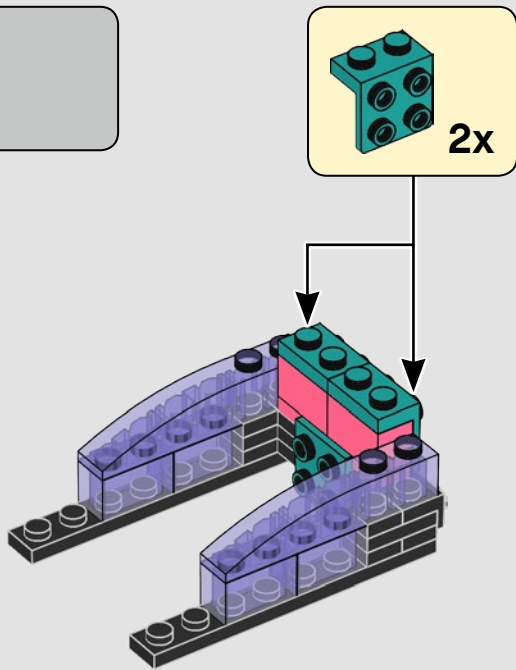

169

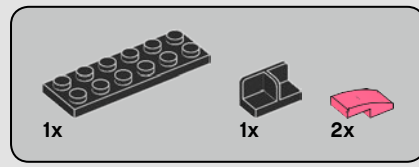
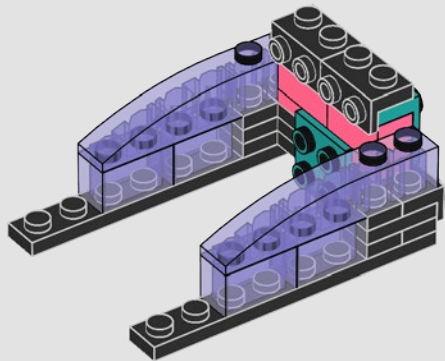

170

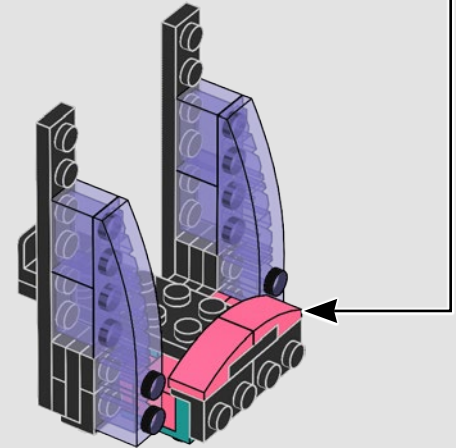
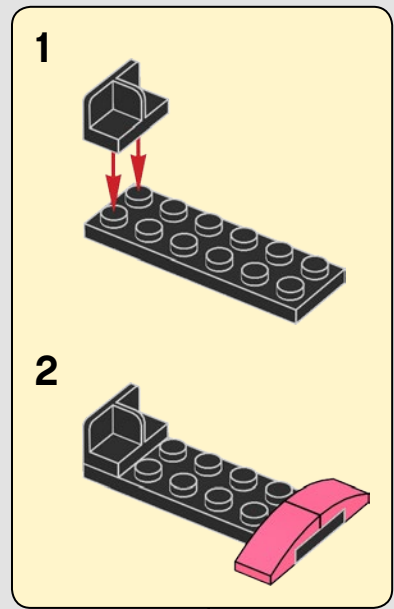
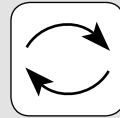

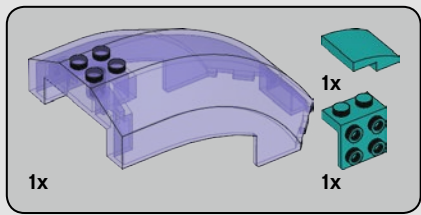

171

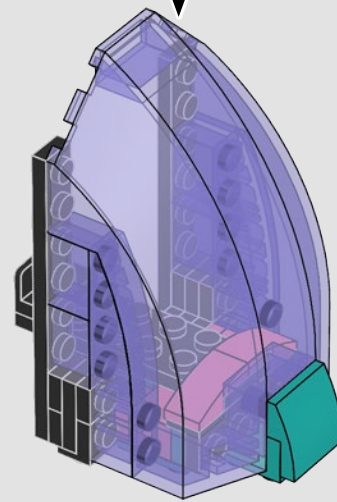
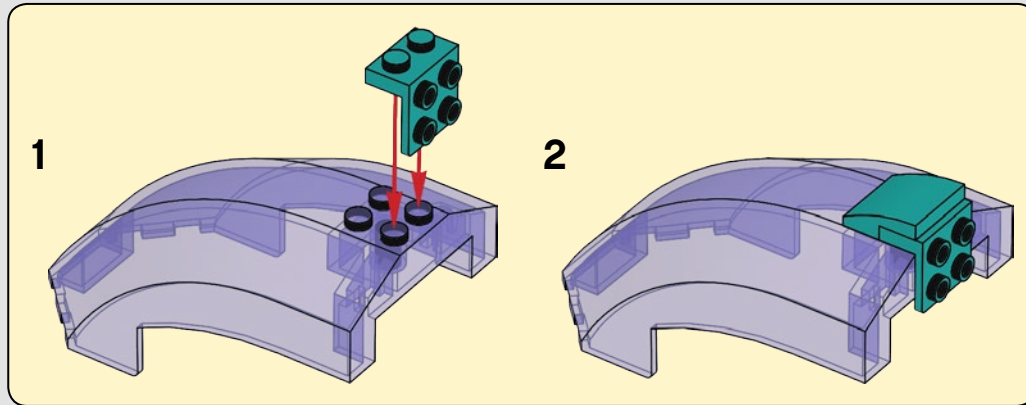

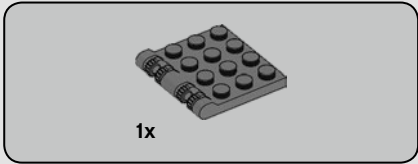

172

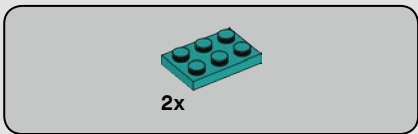
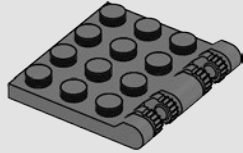

173

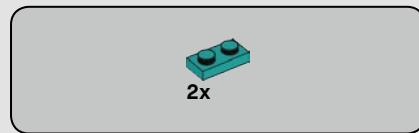
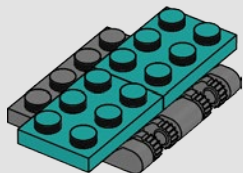

174

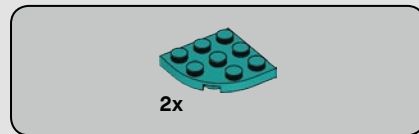
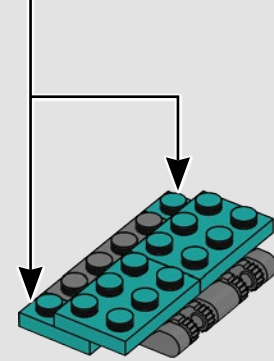
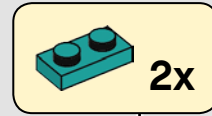

175

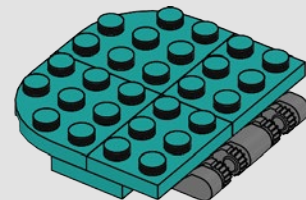

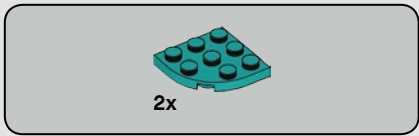

176

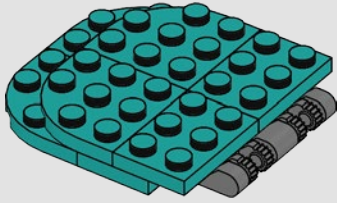

177

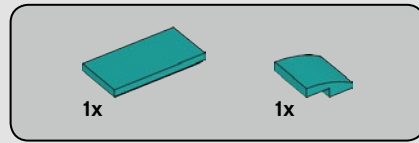
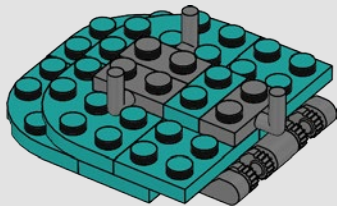

178

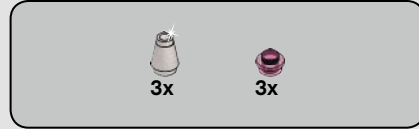
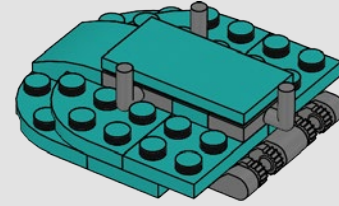

179

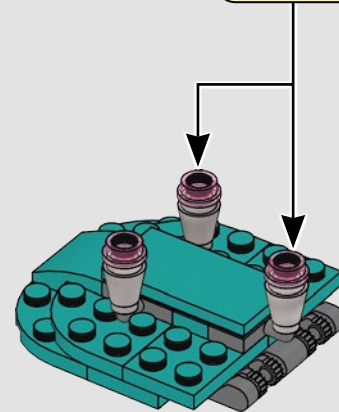
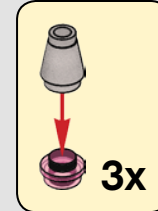

180

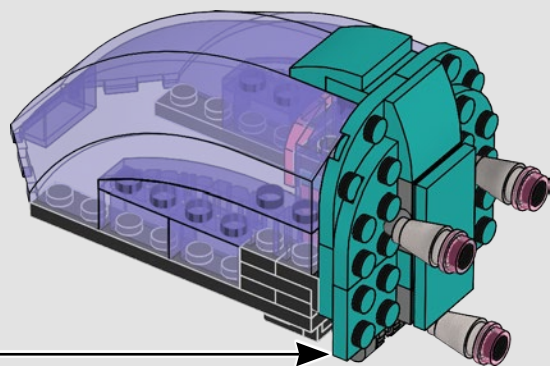
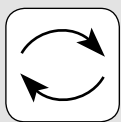

181

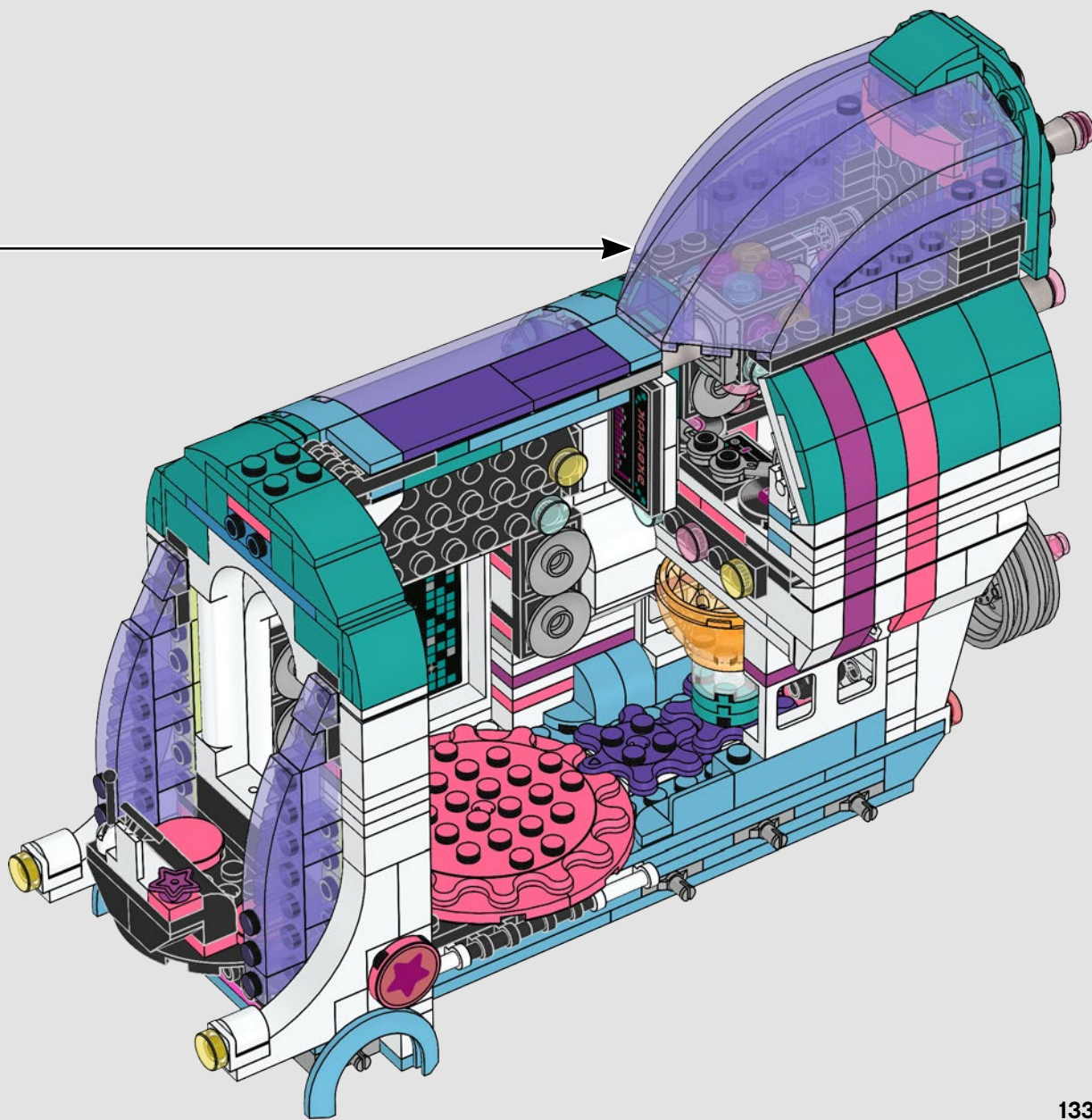

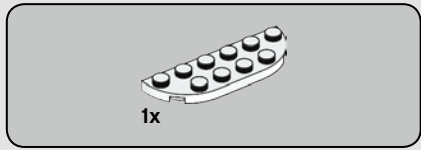
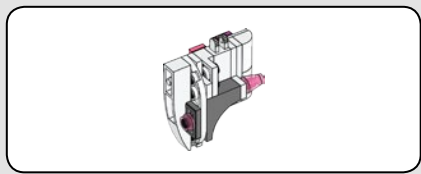

182

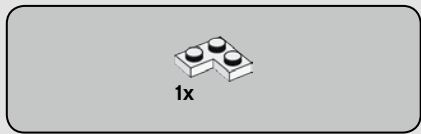

183

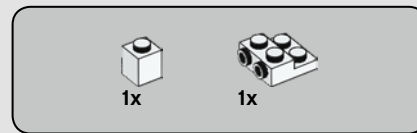
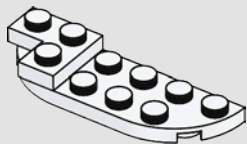

184

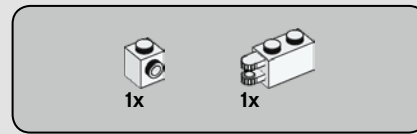
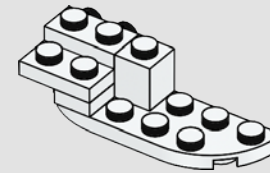

185

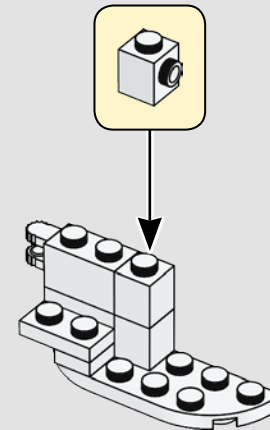

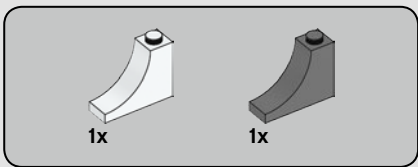

186

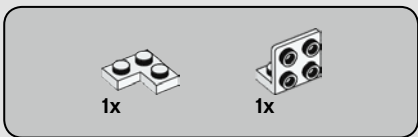
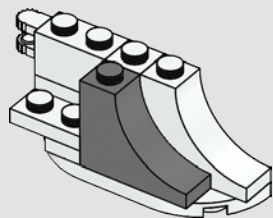

187

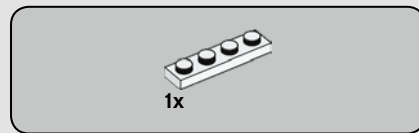
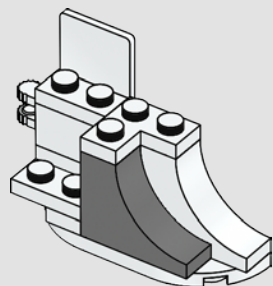

188

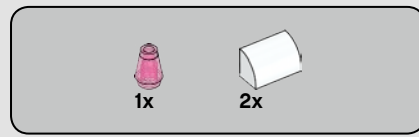
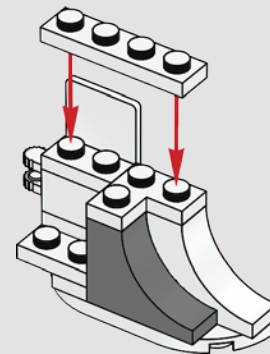

189

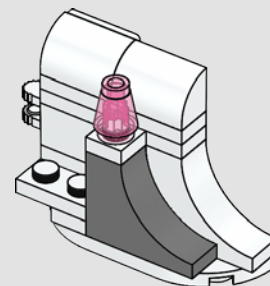

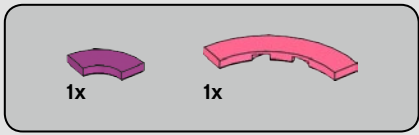

190

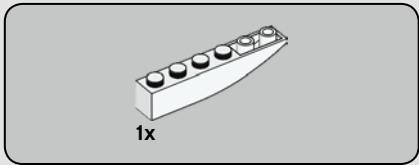
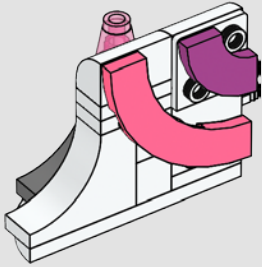
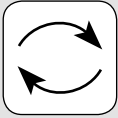

191

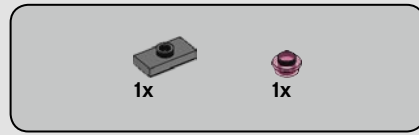
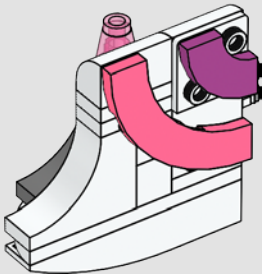

192

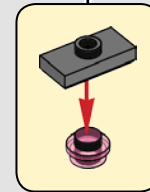
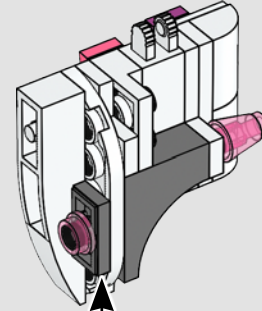
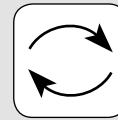

193

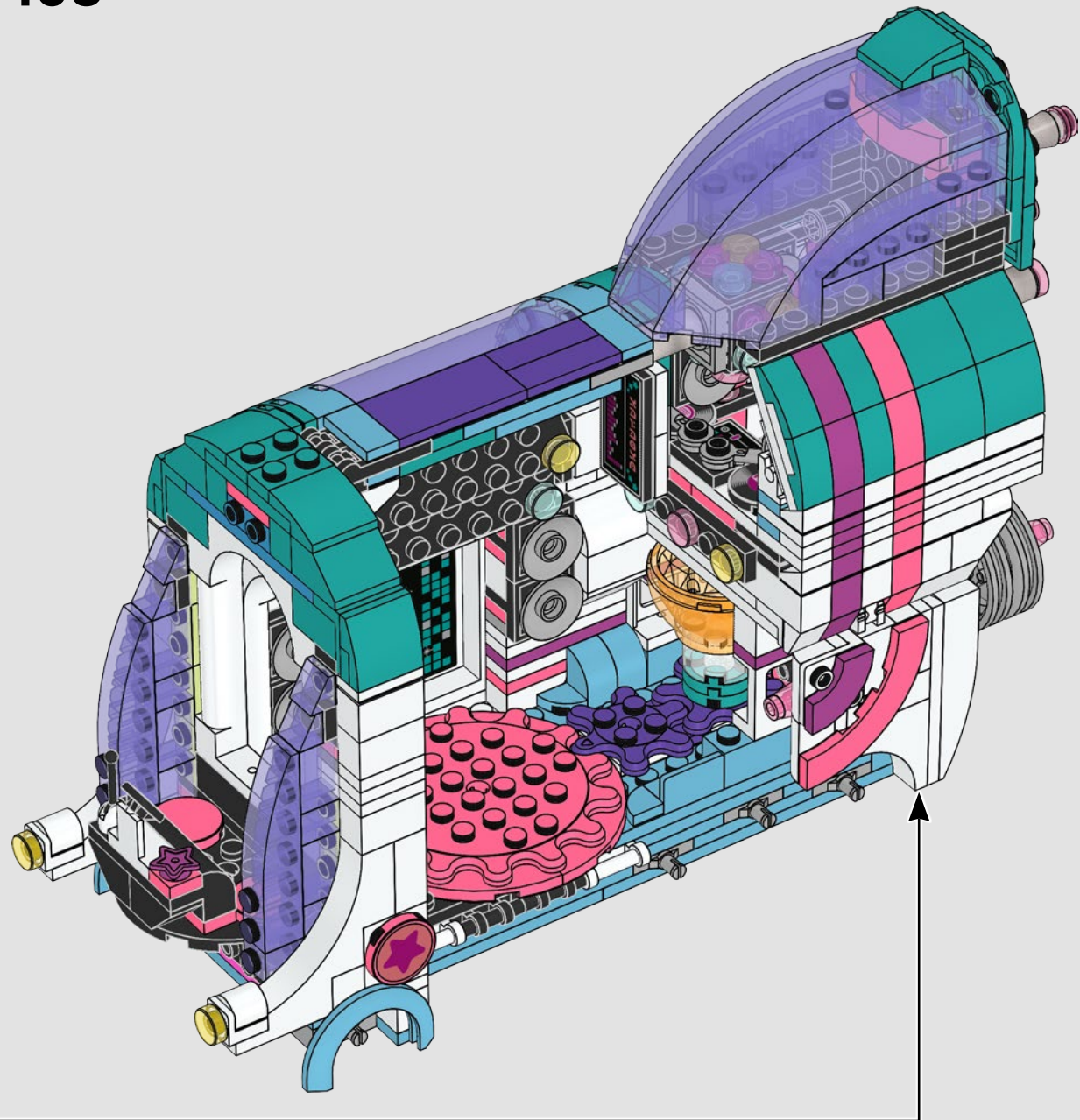

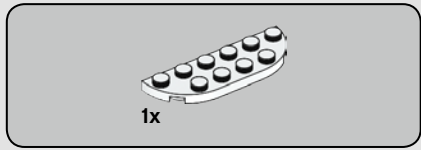
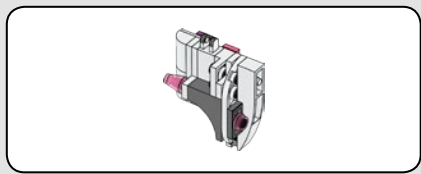

194

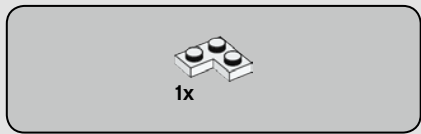

195

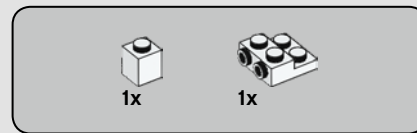
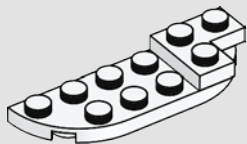

196

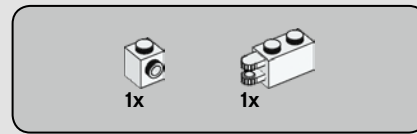
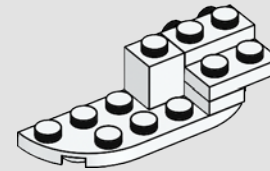

197

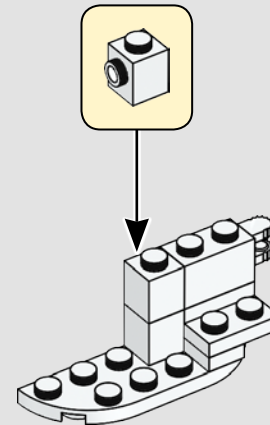

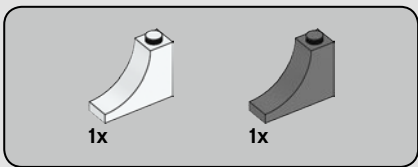

198

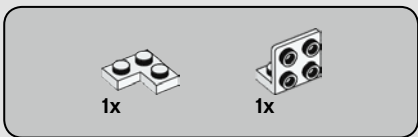
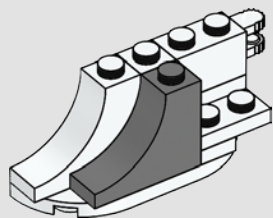

199

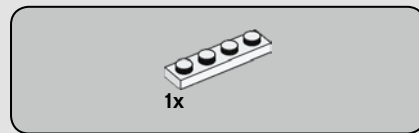
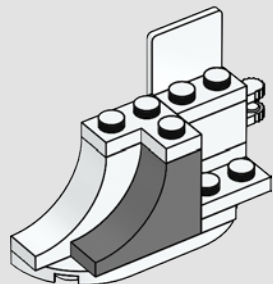

200

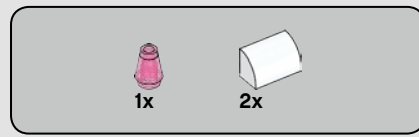
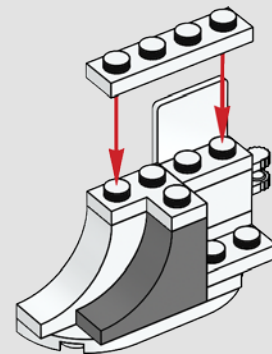

201

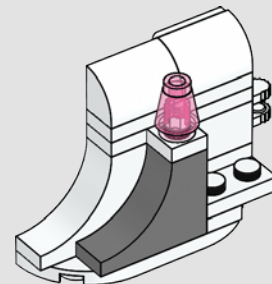

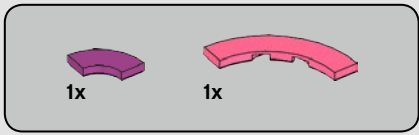

202

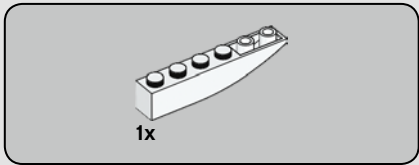
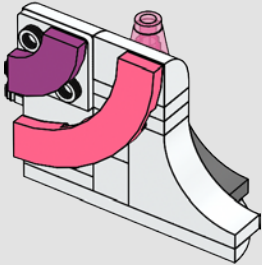

203

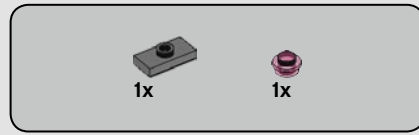
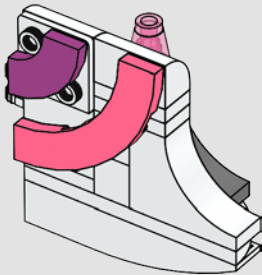

204

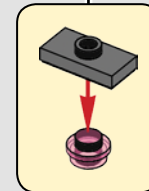
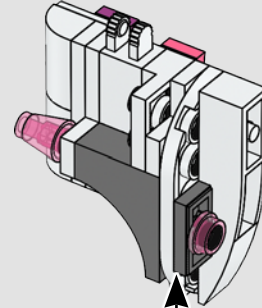
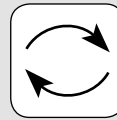

205

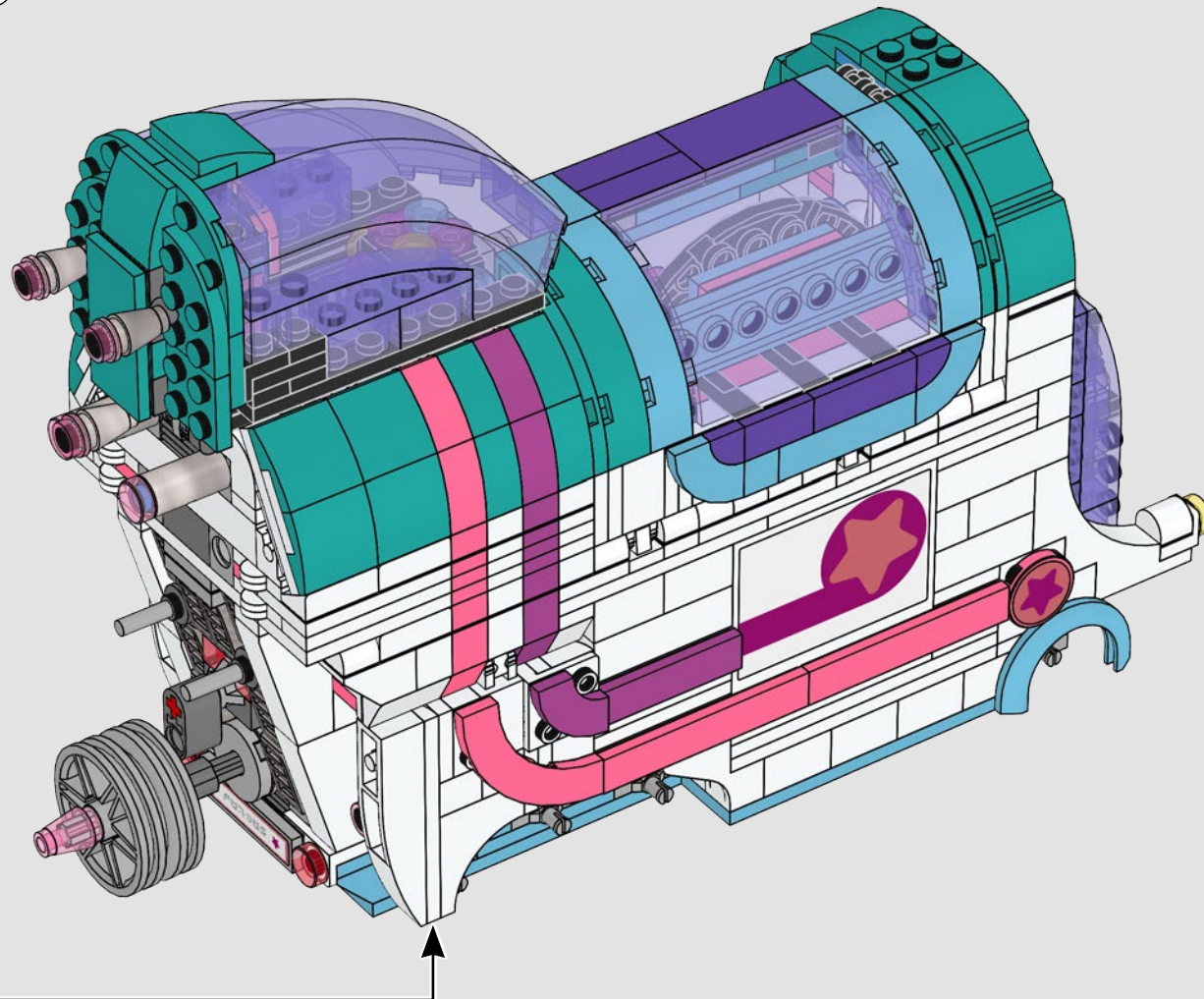
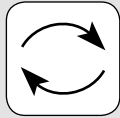

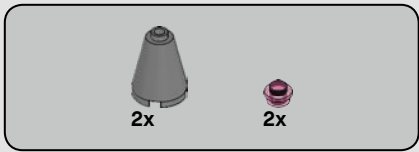

206

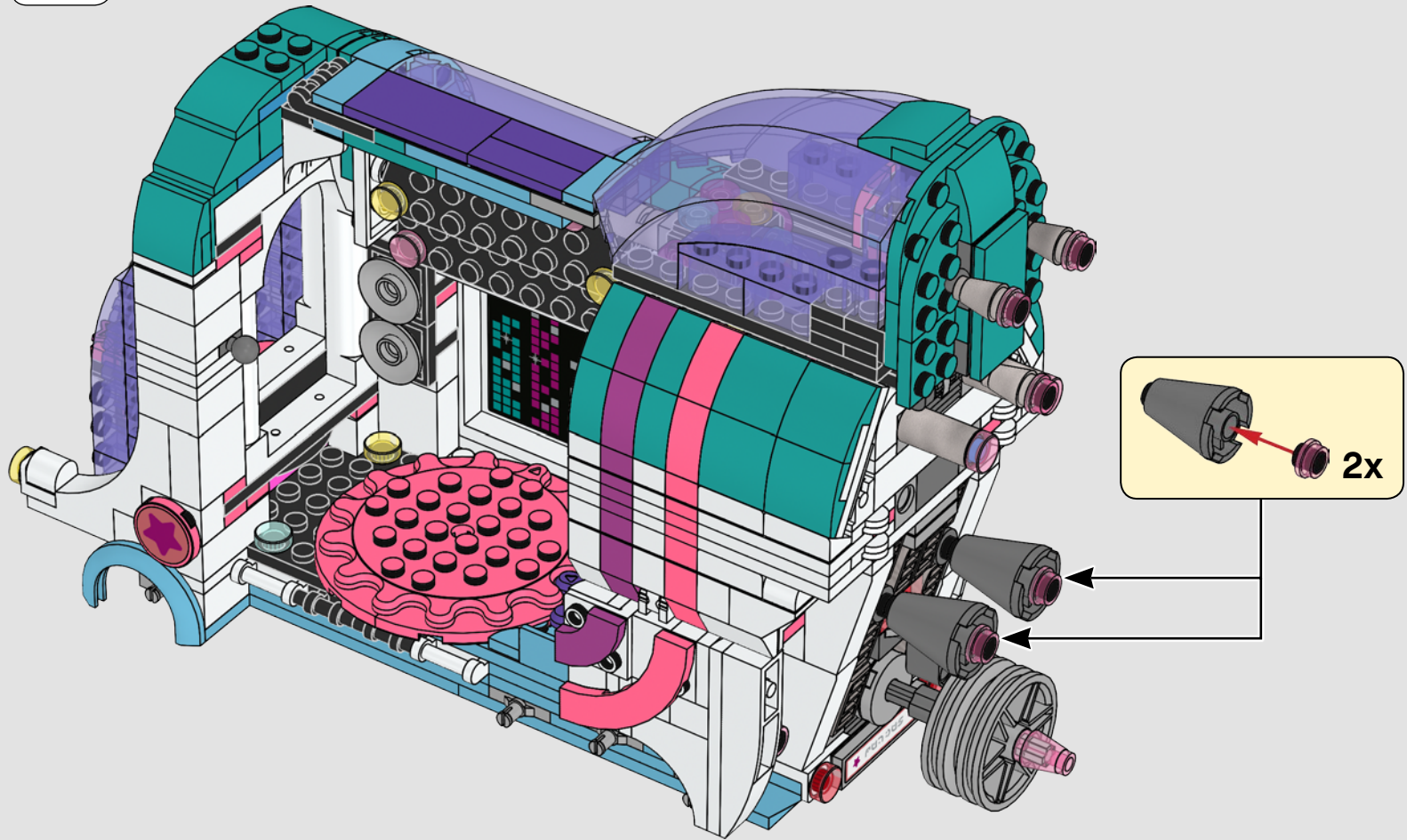
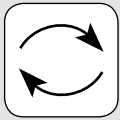

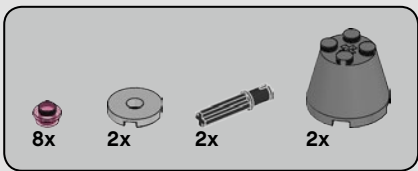

207

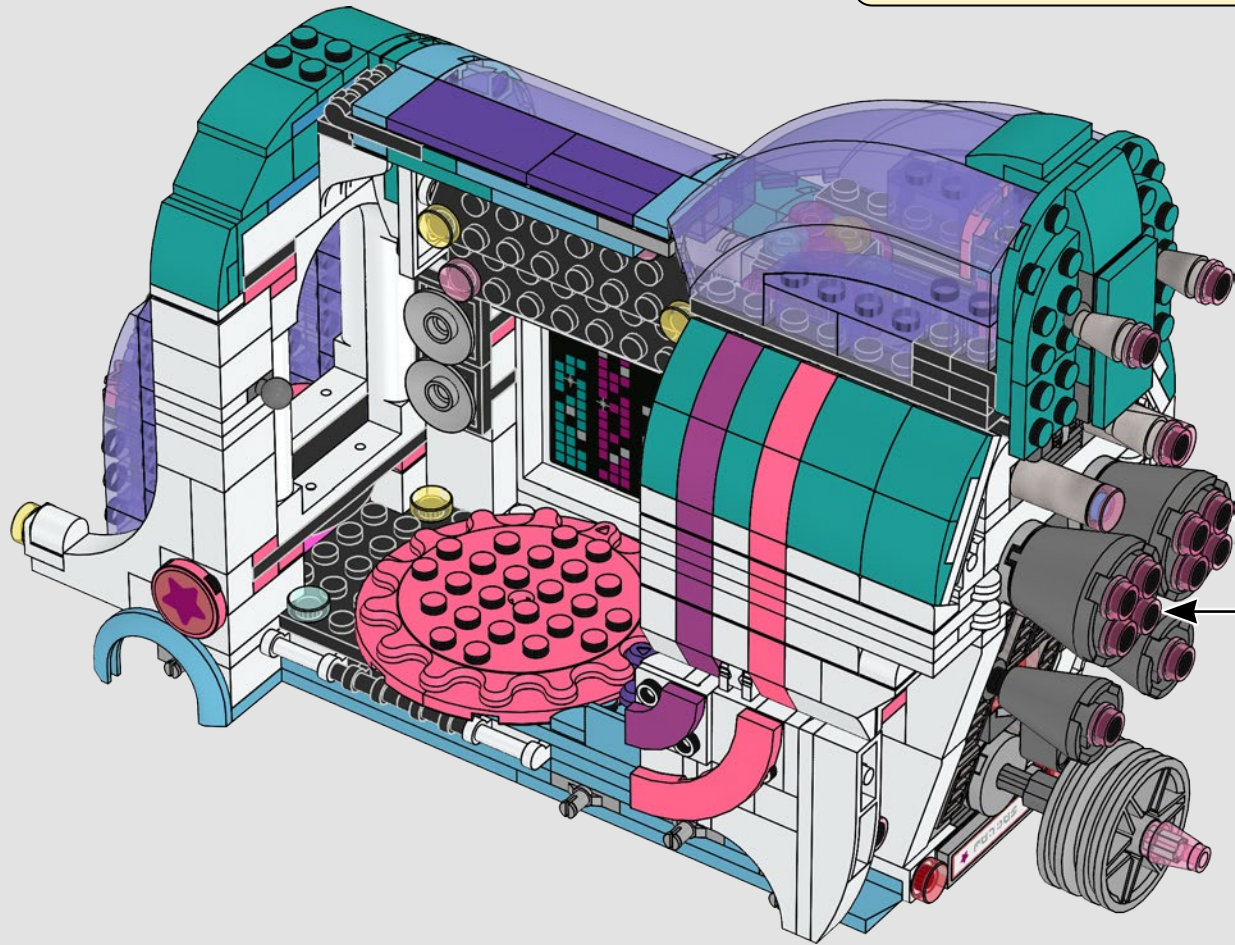
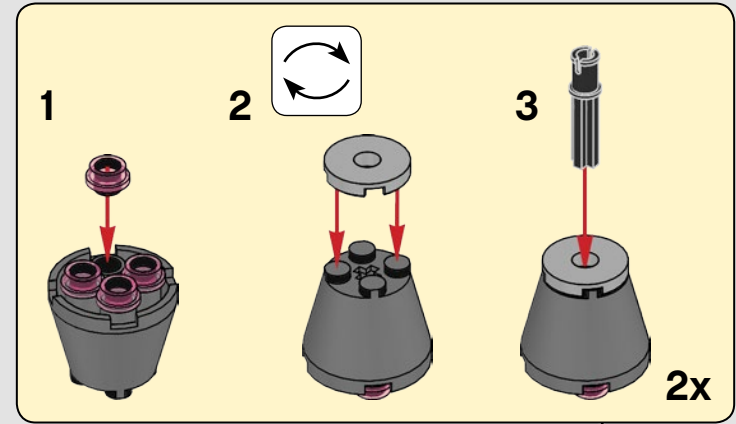

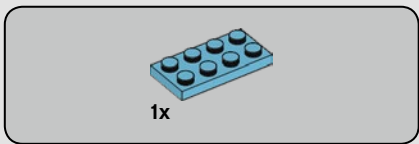
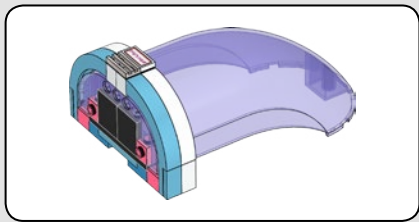
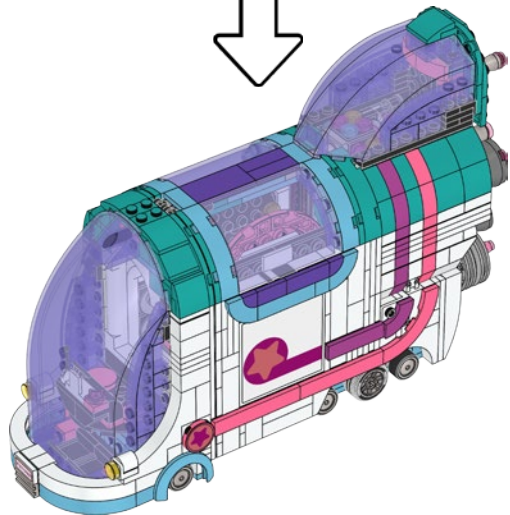
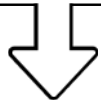
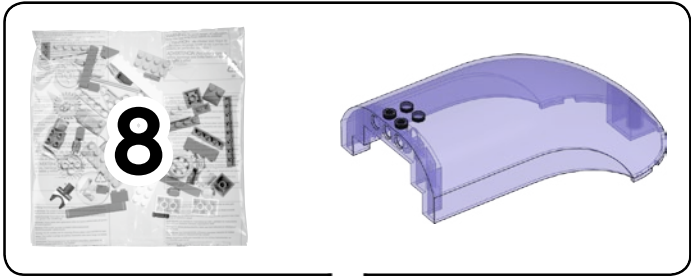

208

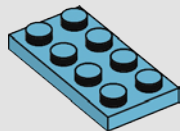

2x

209

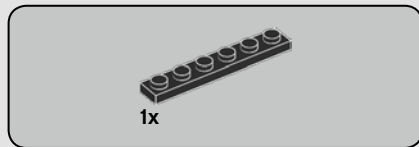
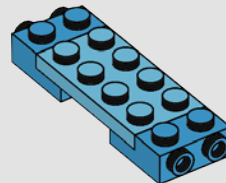

1x

210

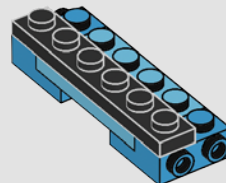

2x

2x

211

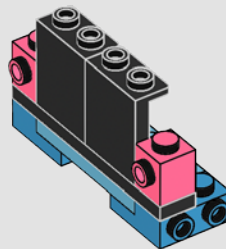

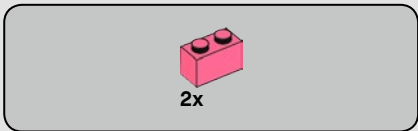

212

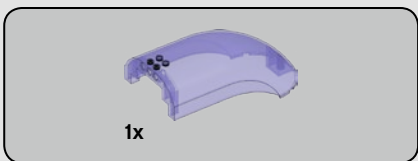
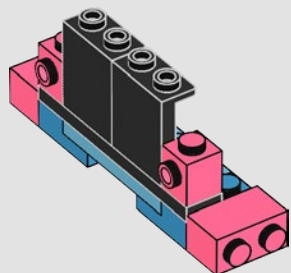

213

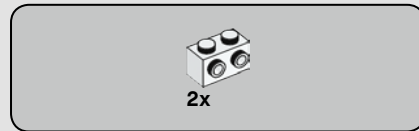
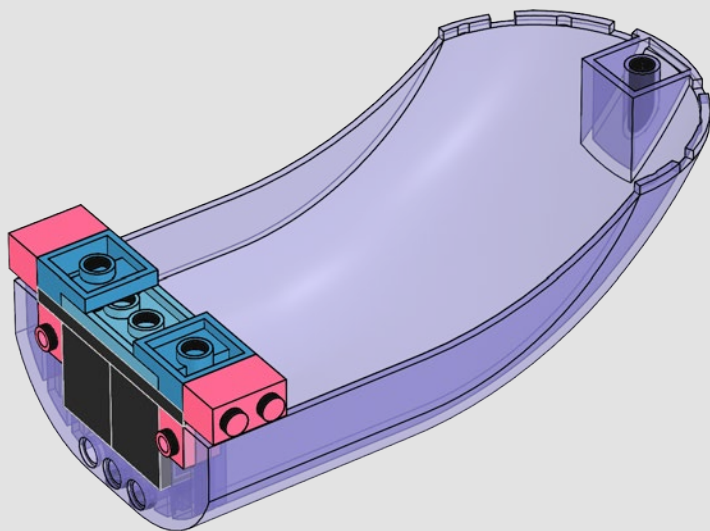
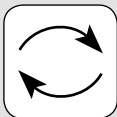

214

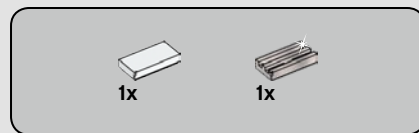
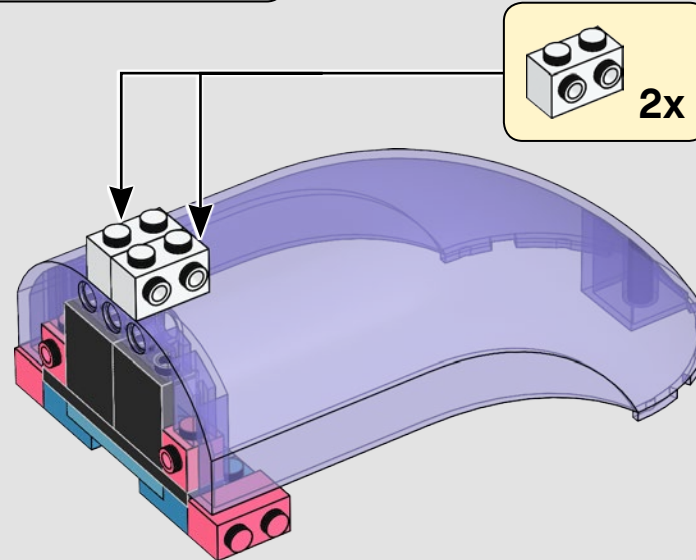
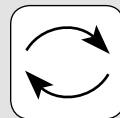

215

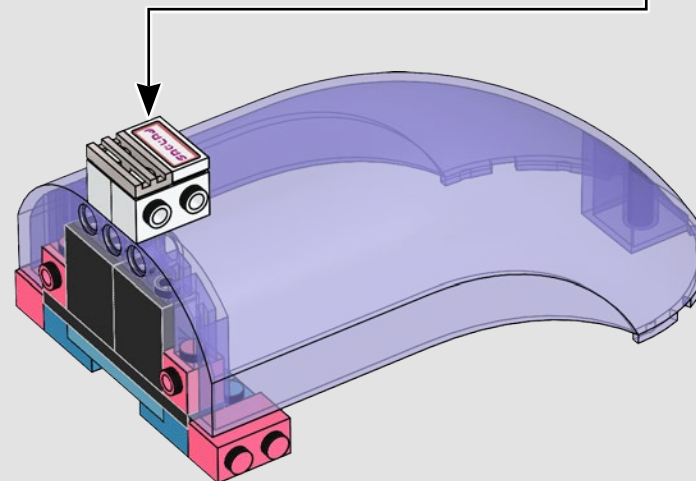
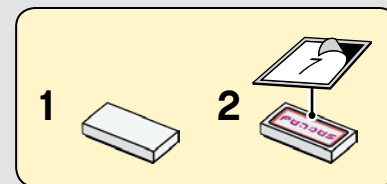

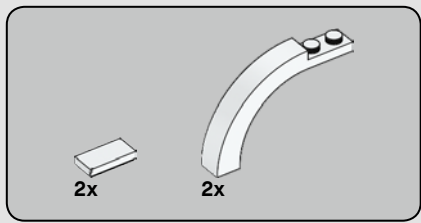

216

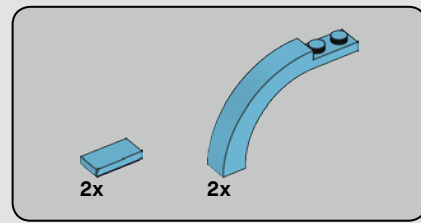
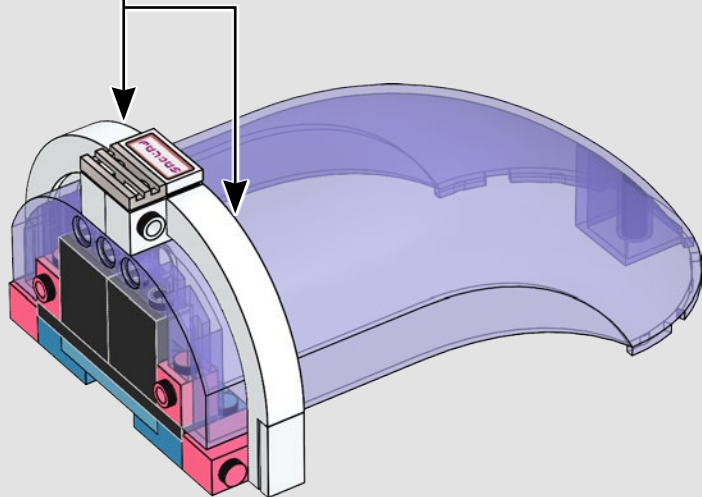
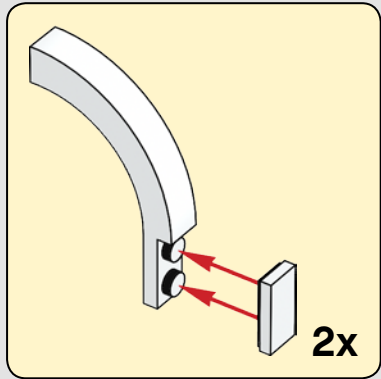

217

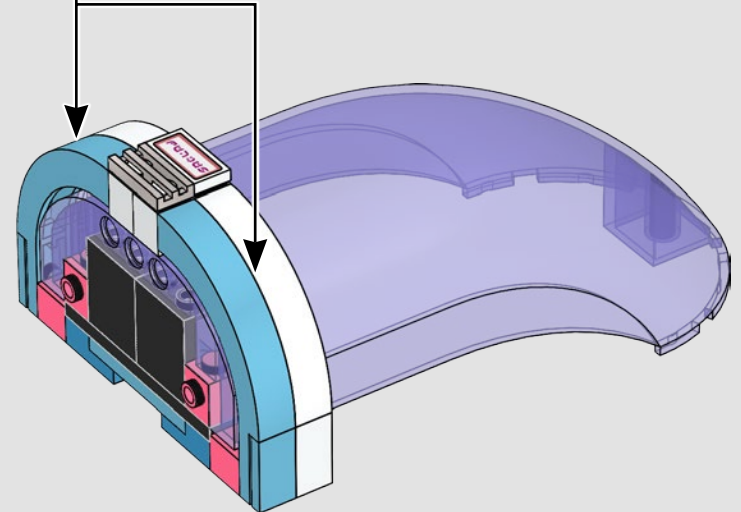
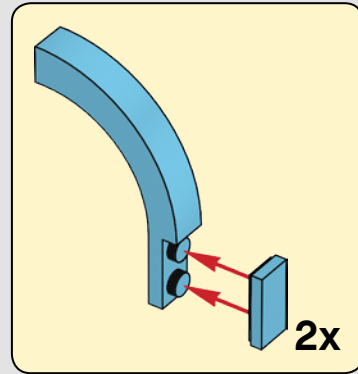

218

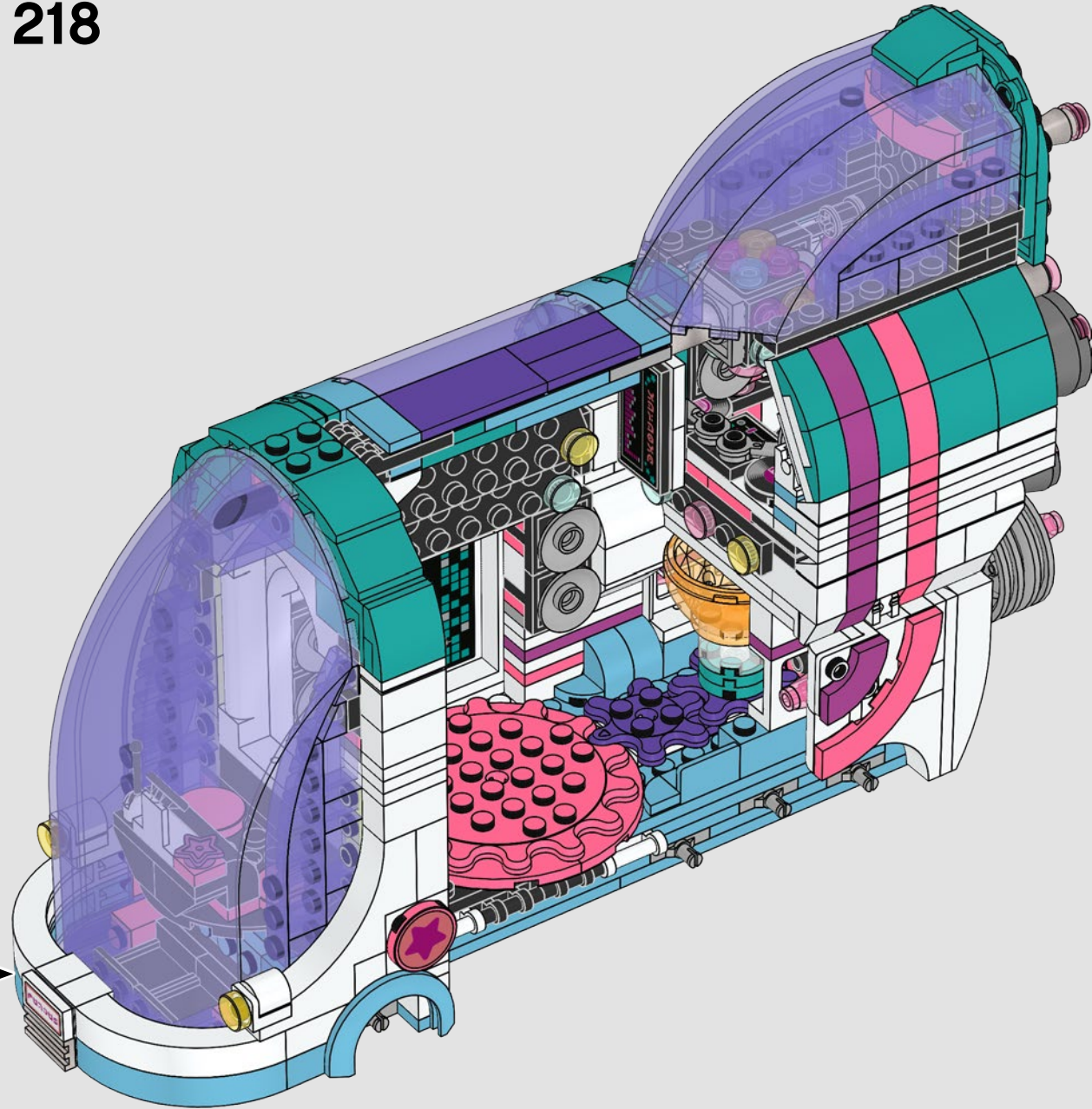

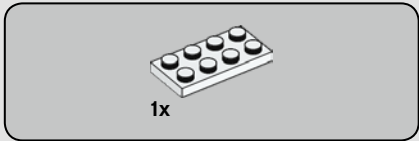
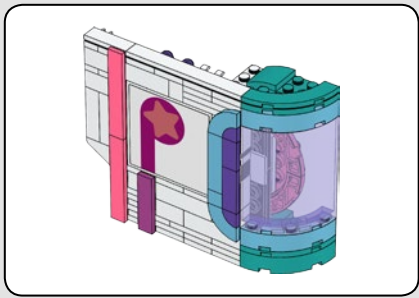

219

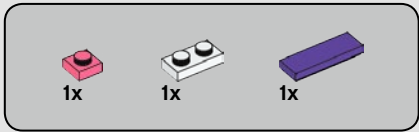
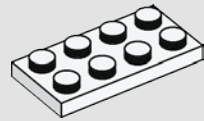

220

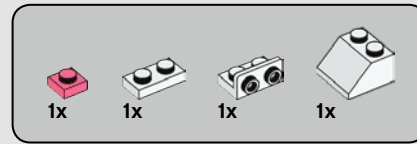
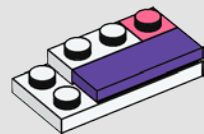

221

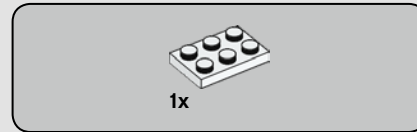
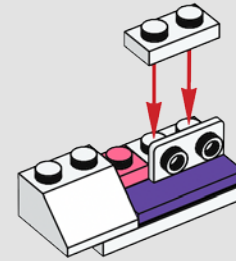

222

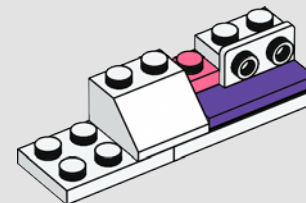

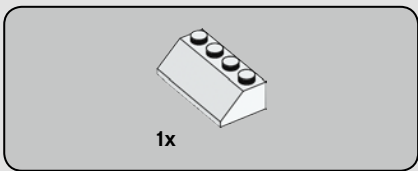

223

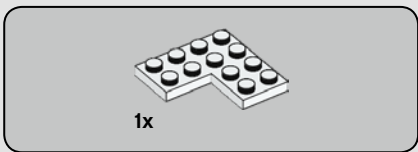
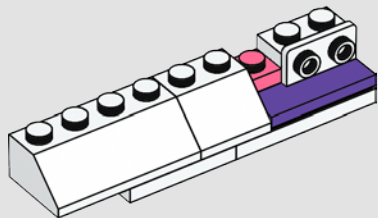

224

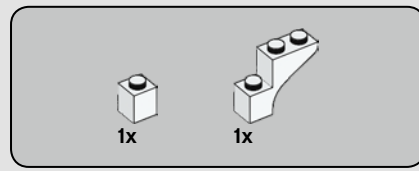
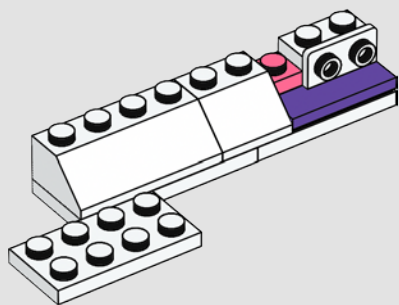

225

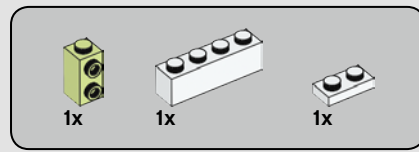
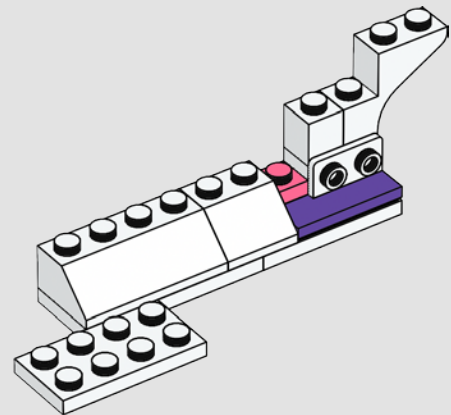

226

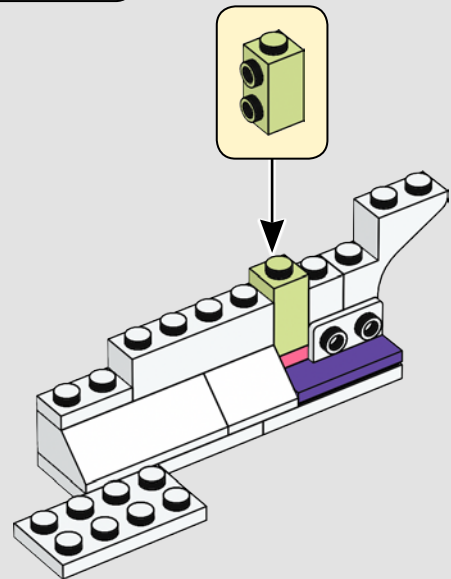



3x

227

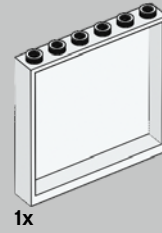
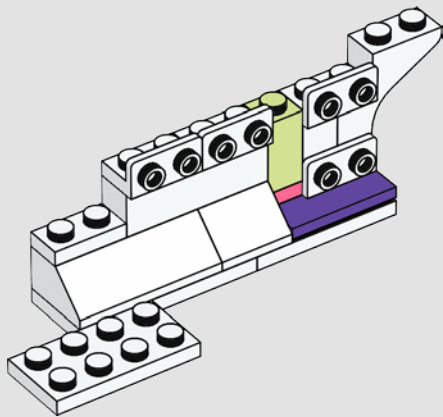

1x

228

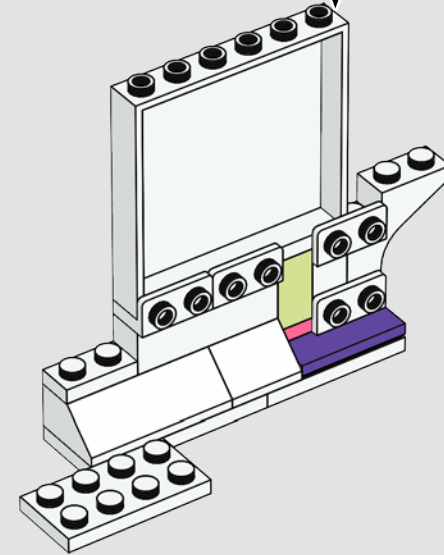
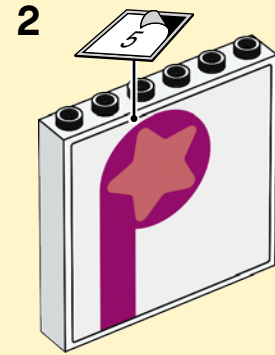
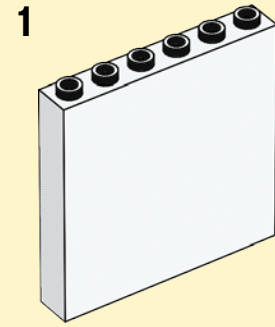

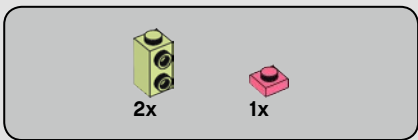

229

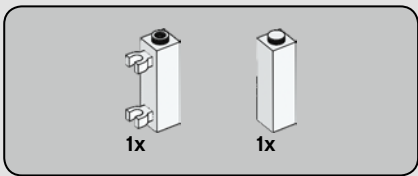
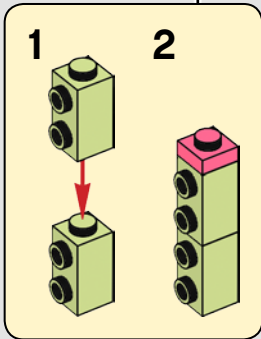
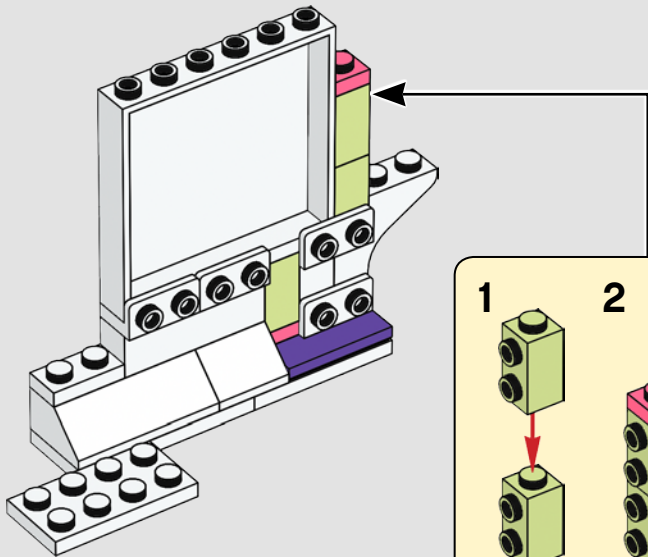

230

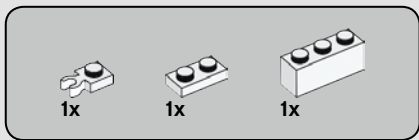
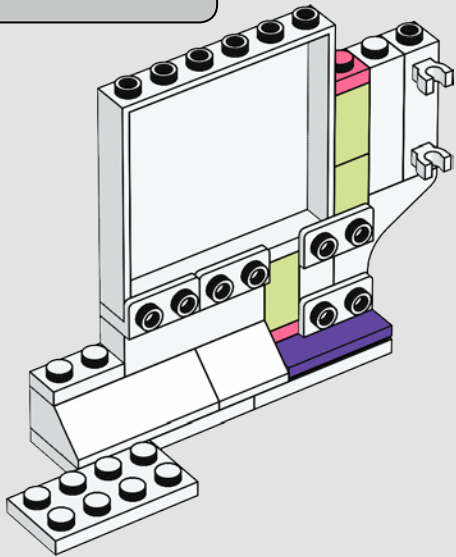

231

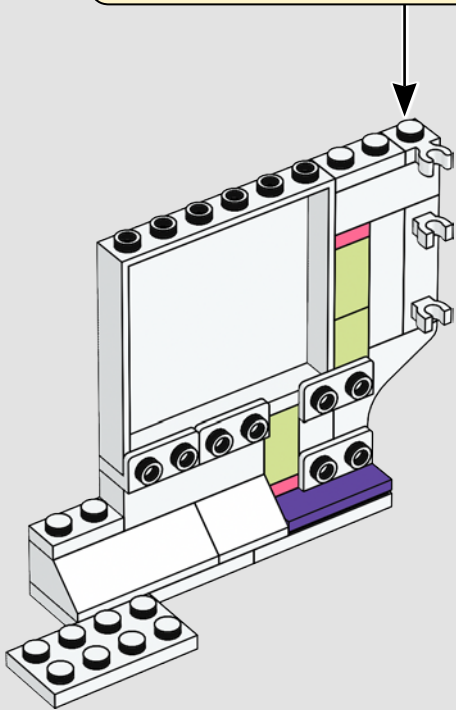
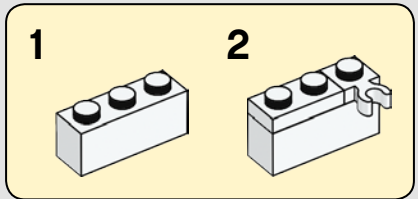

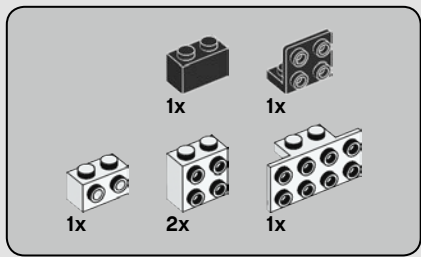

232

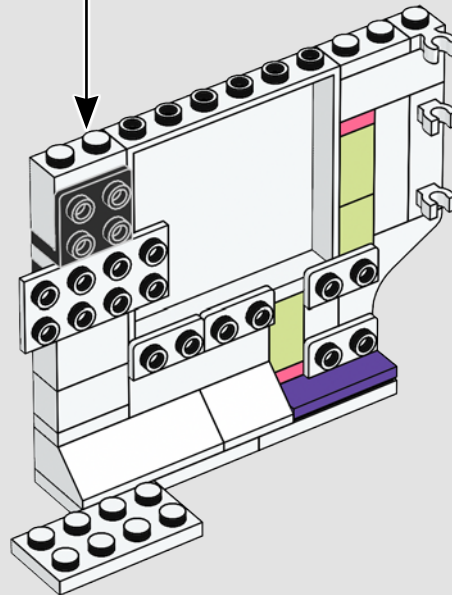
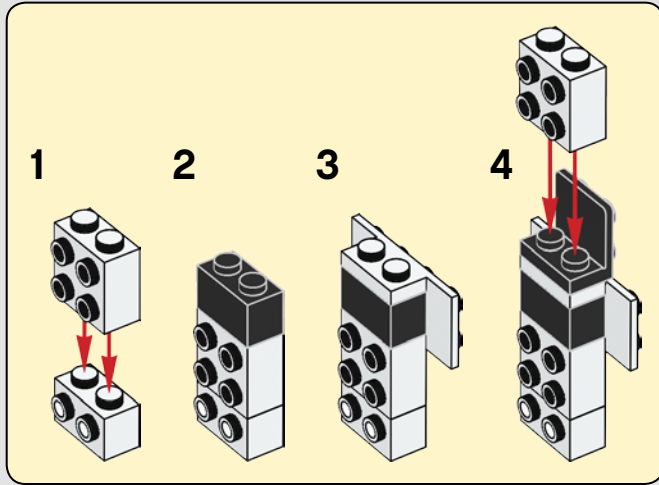

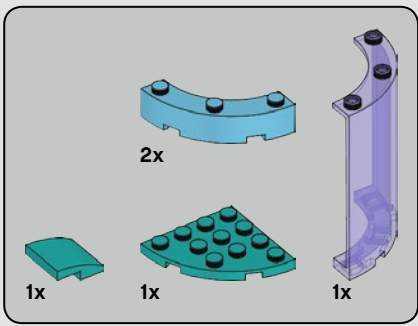

233

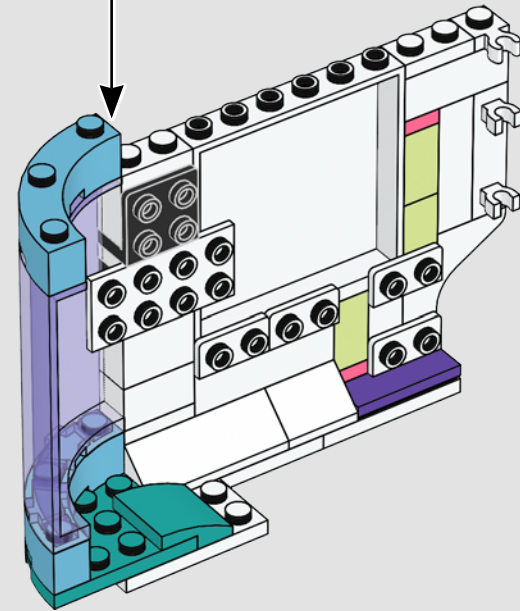
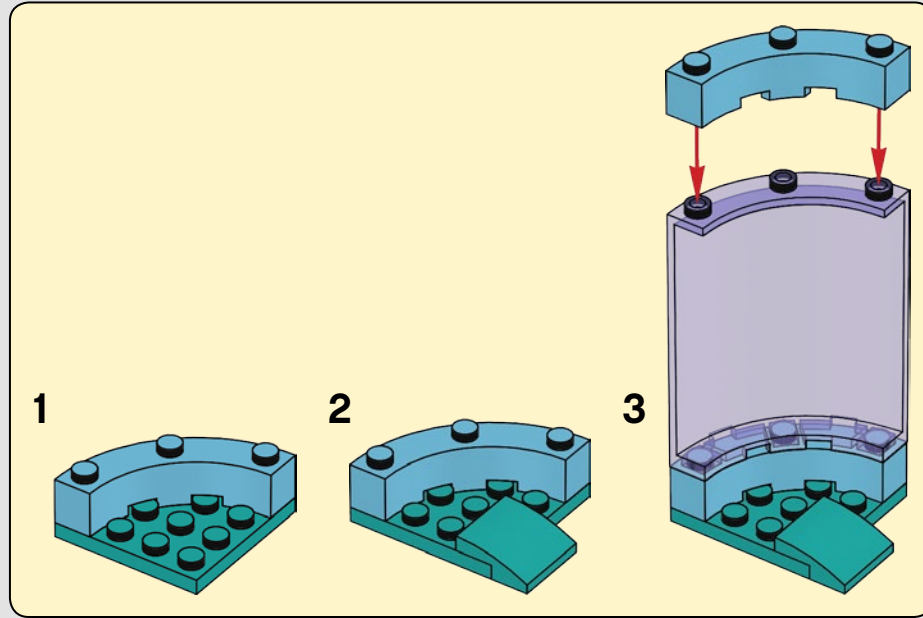

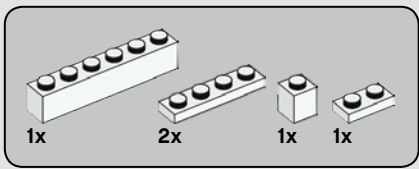

234

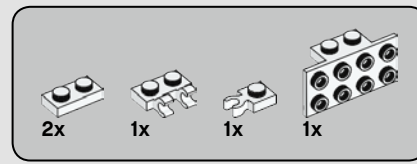
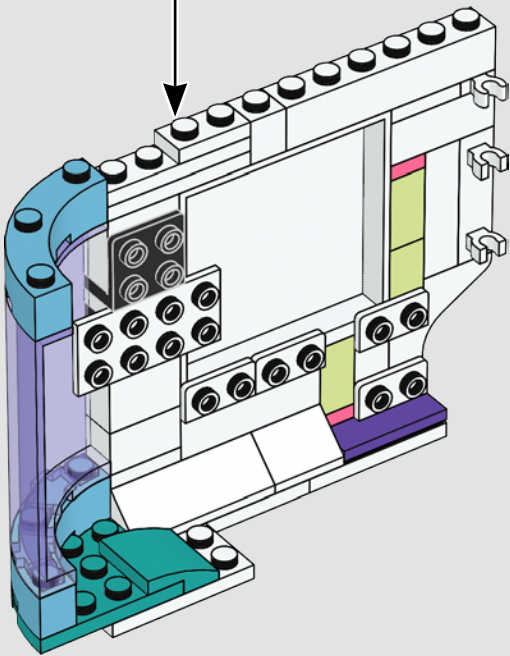
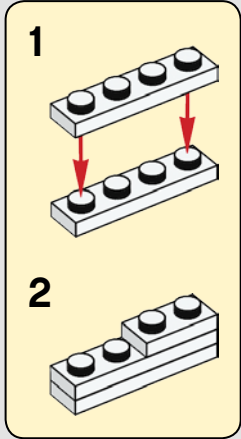

235

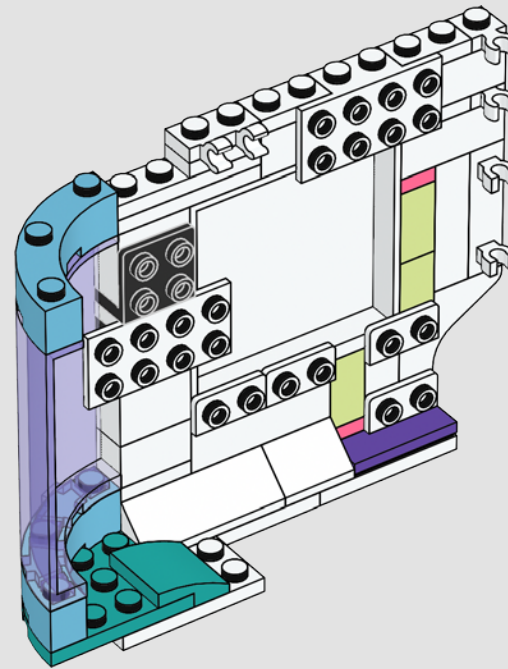

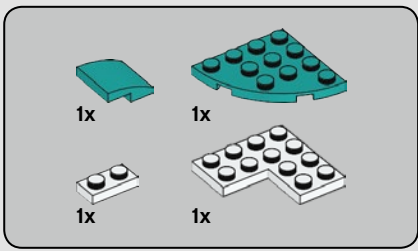

236

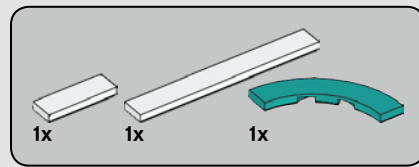
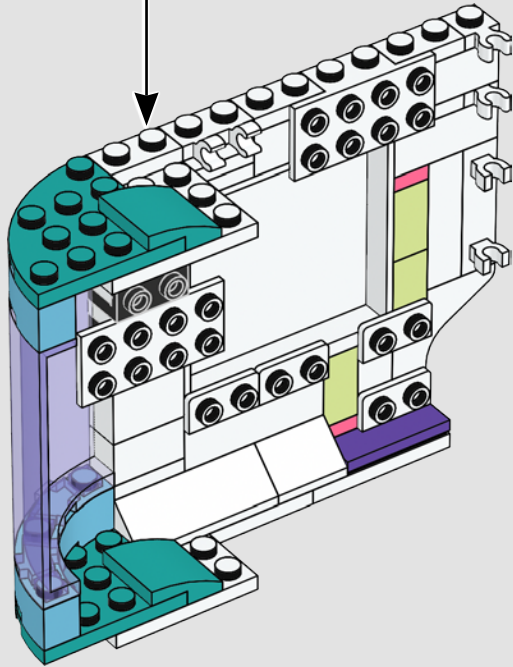
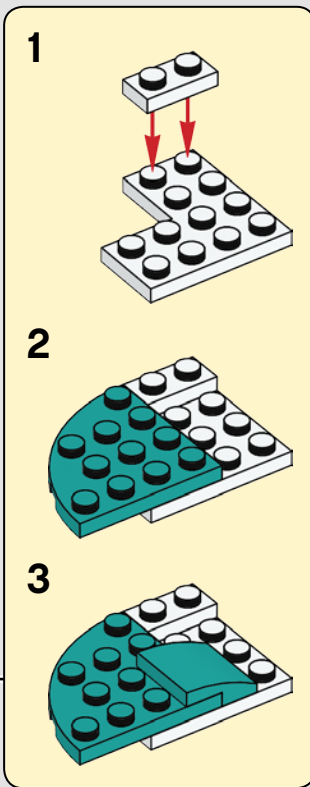

237

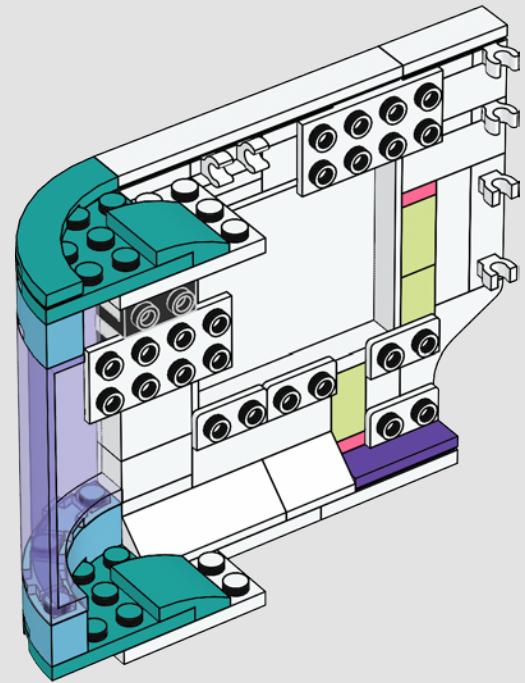

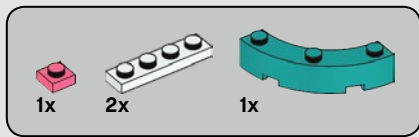

238

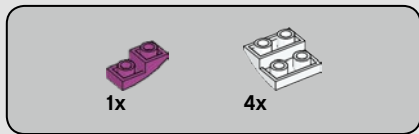
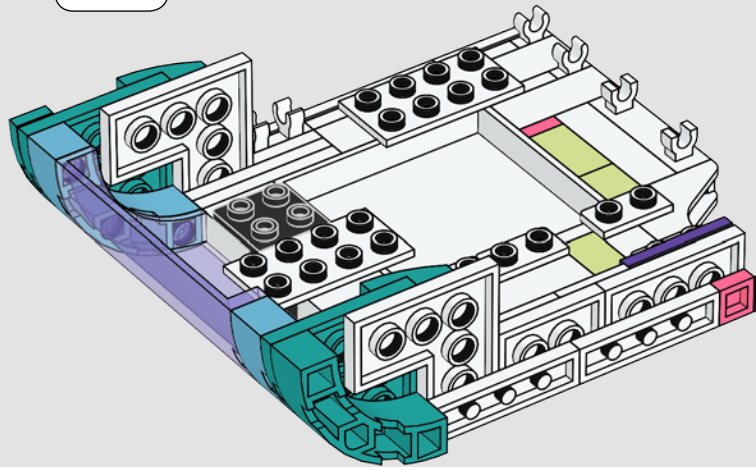
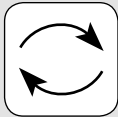

239

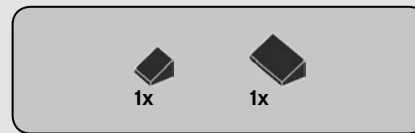
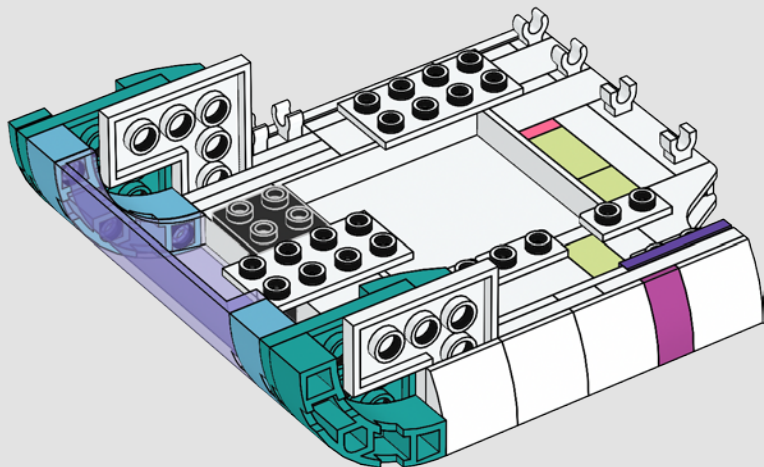

240

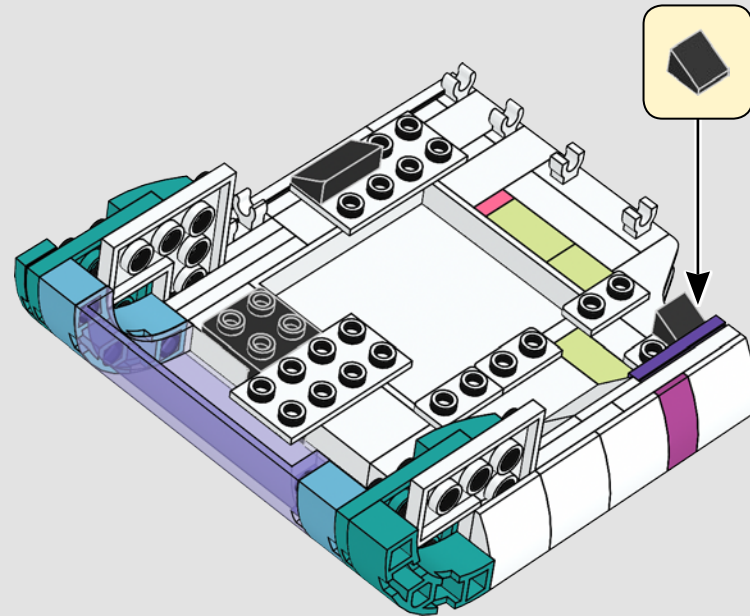

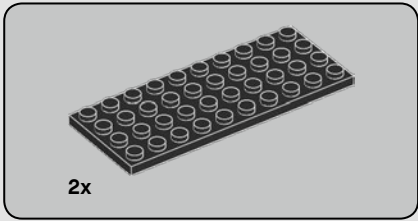
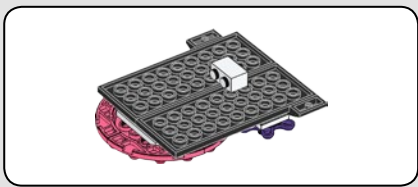

241

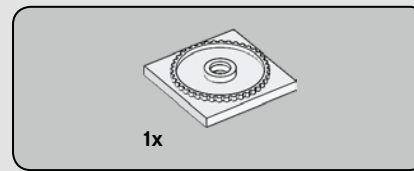
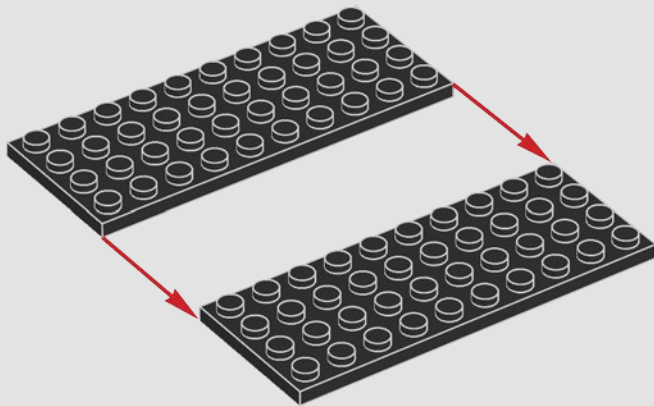

242

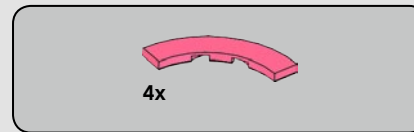
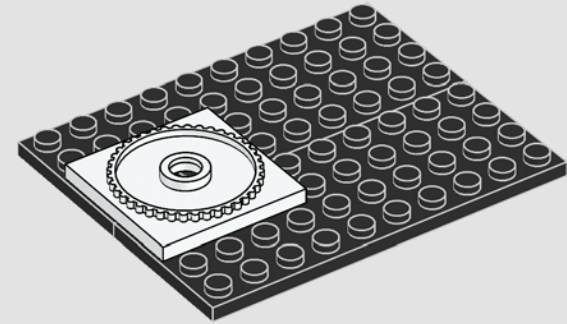

243

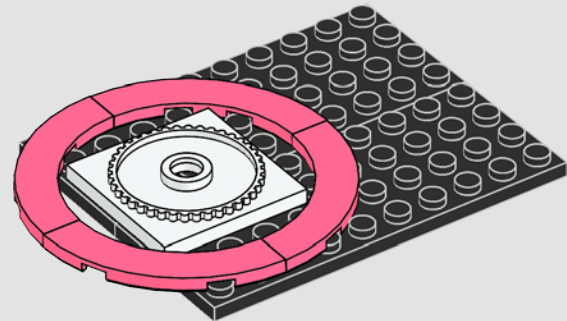

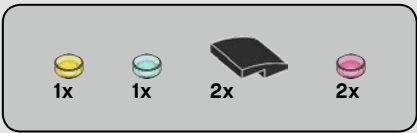

244

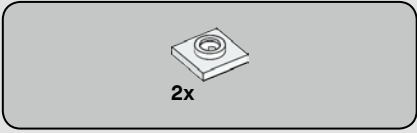
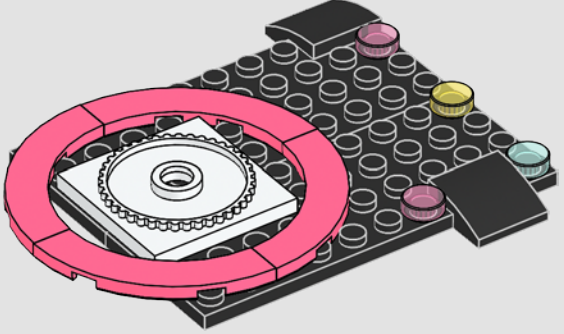

245

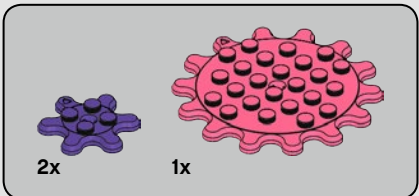
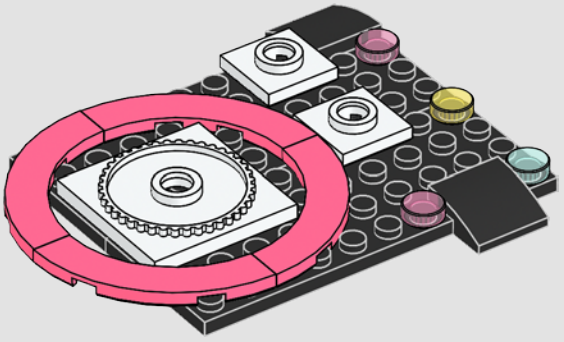

246

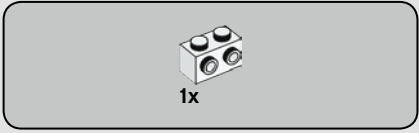
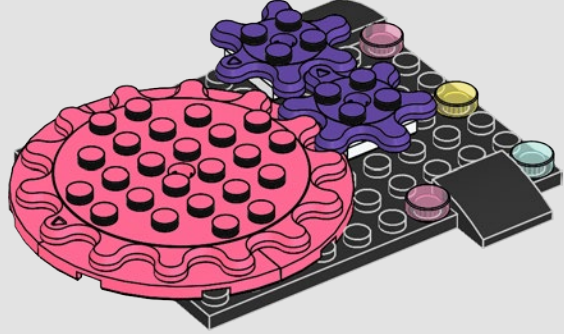

247

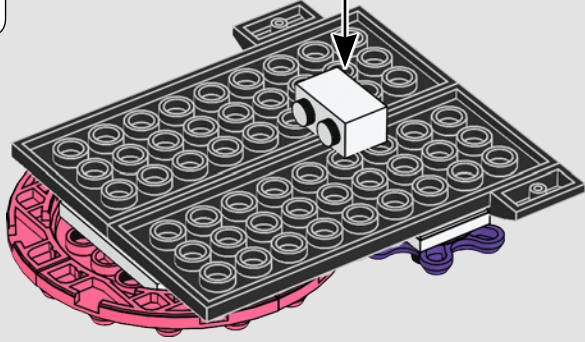
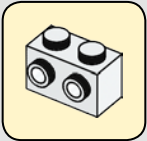
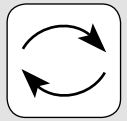

248

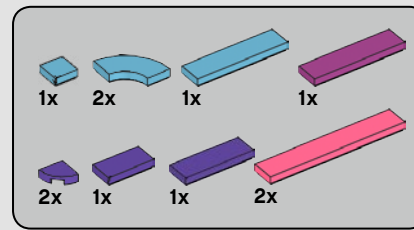
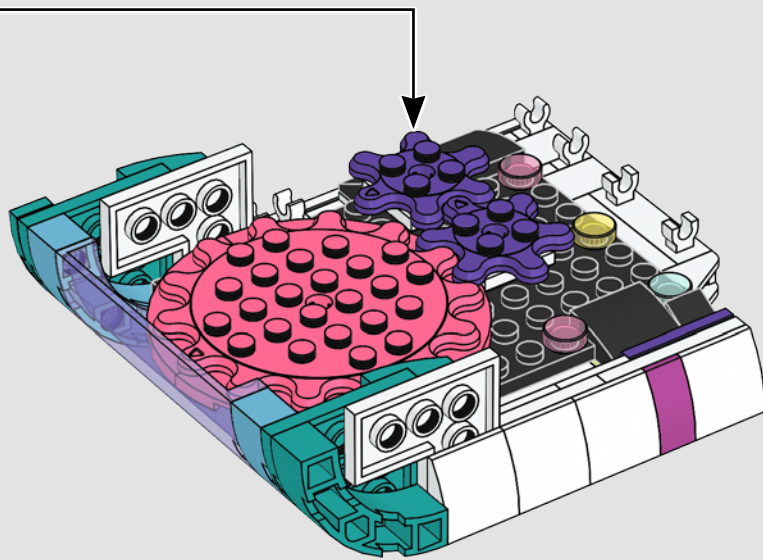

249

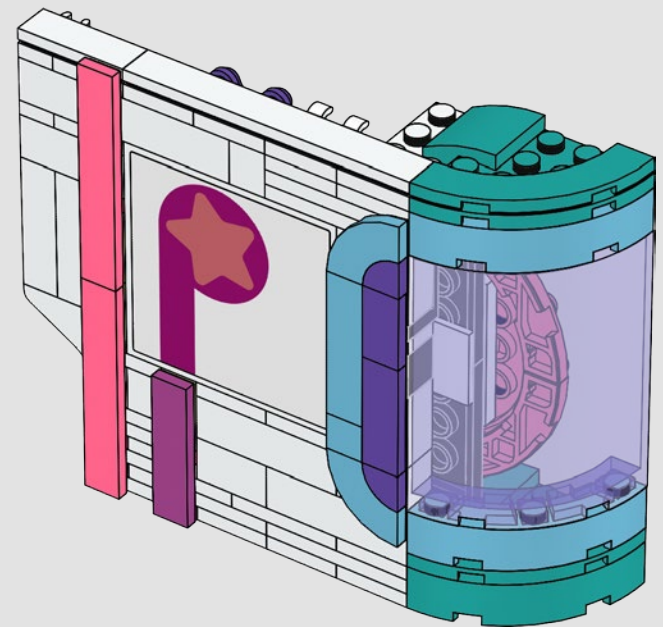
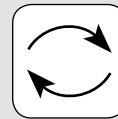

250

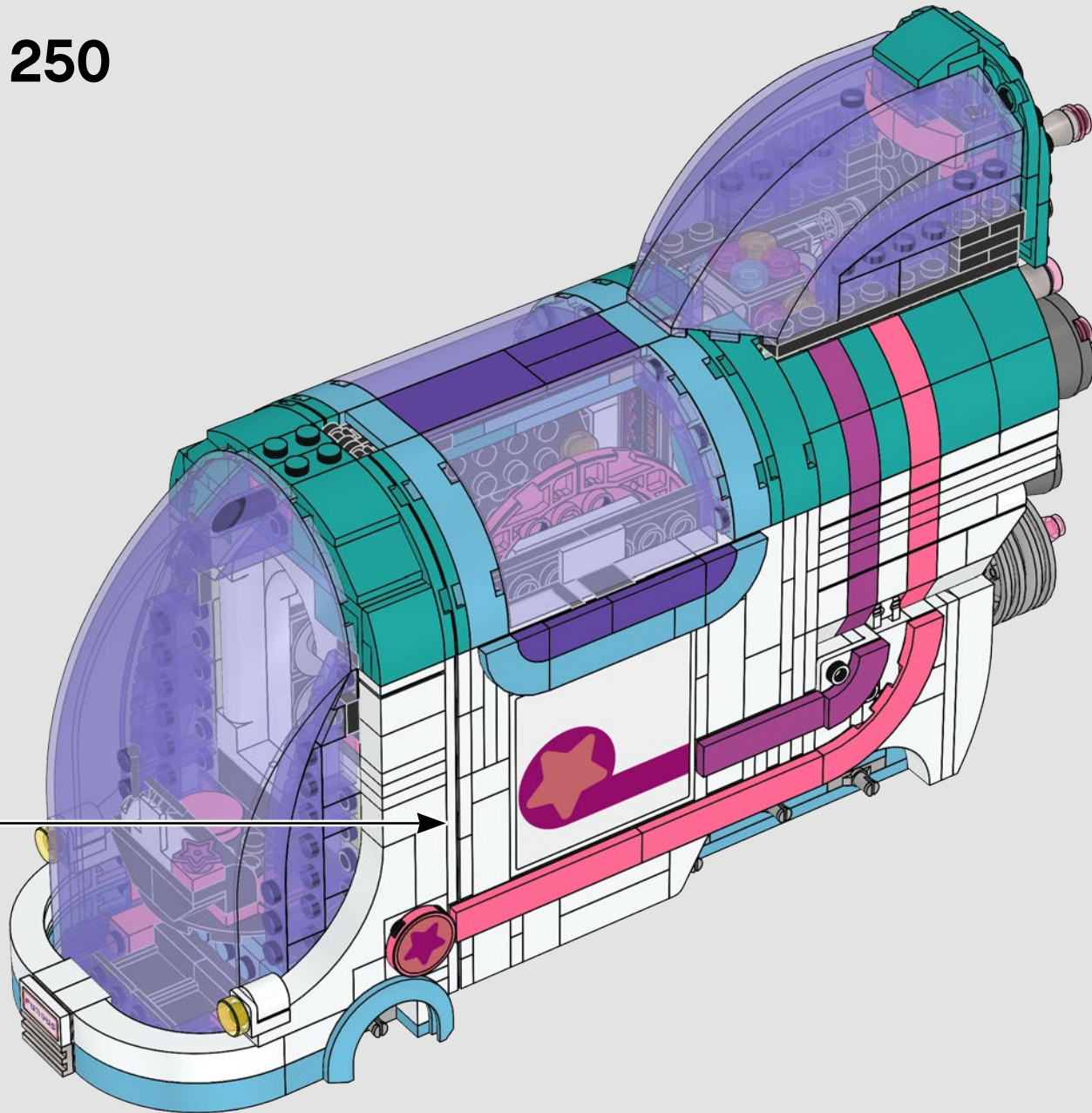



251

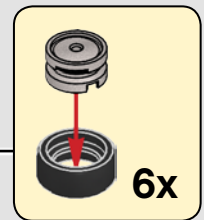
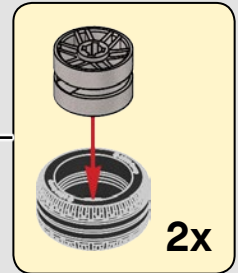
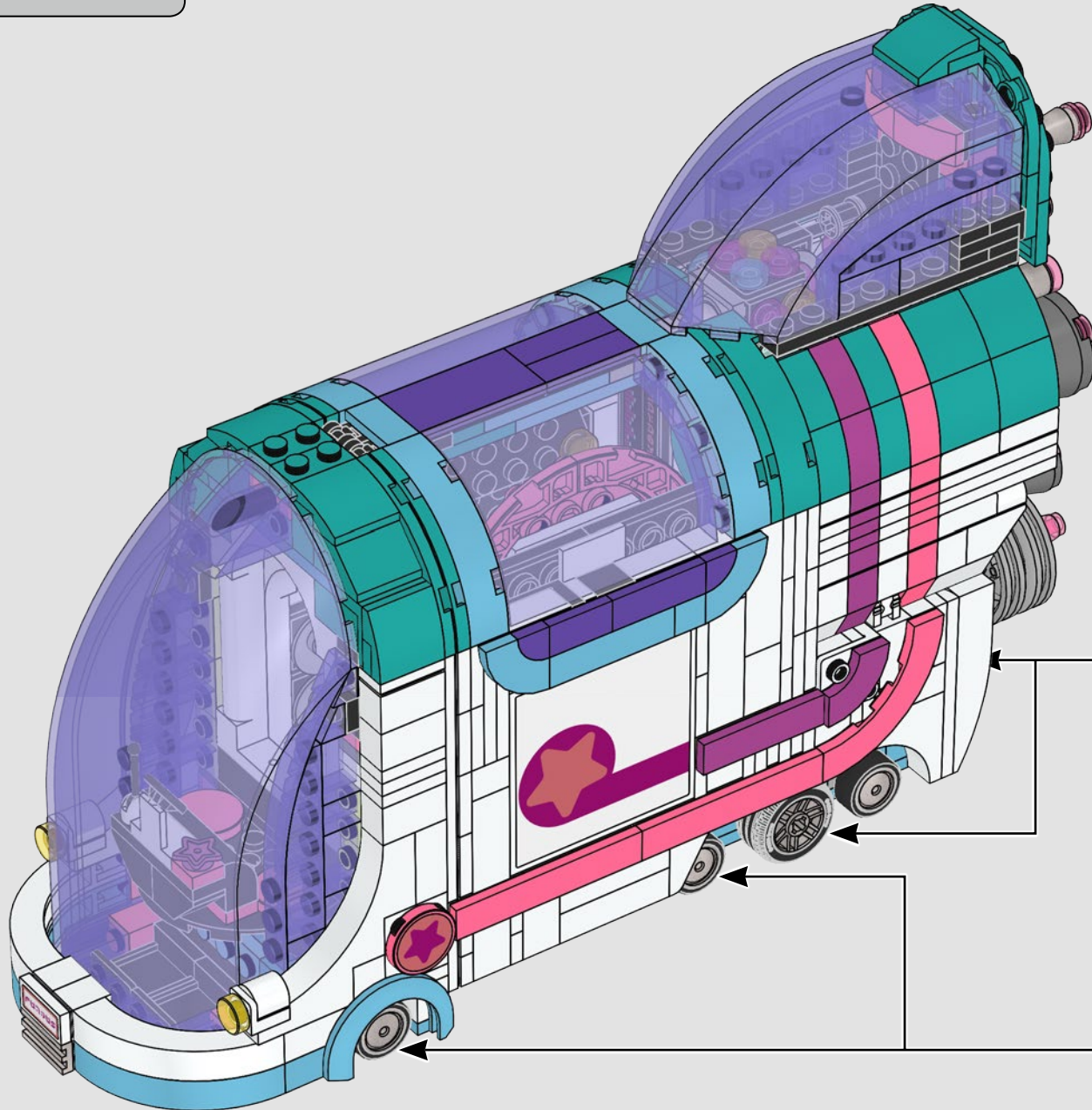

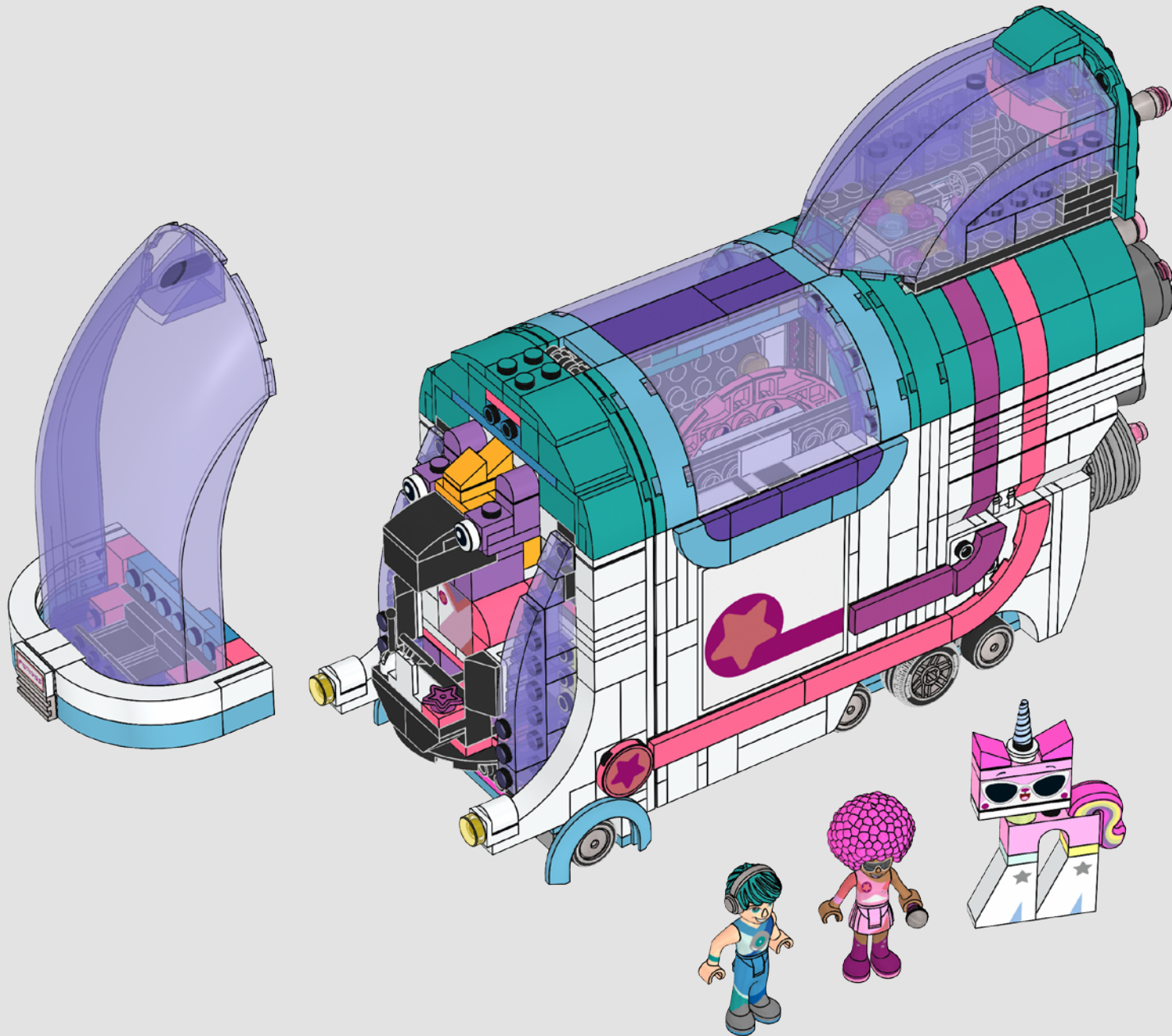

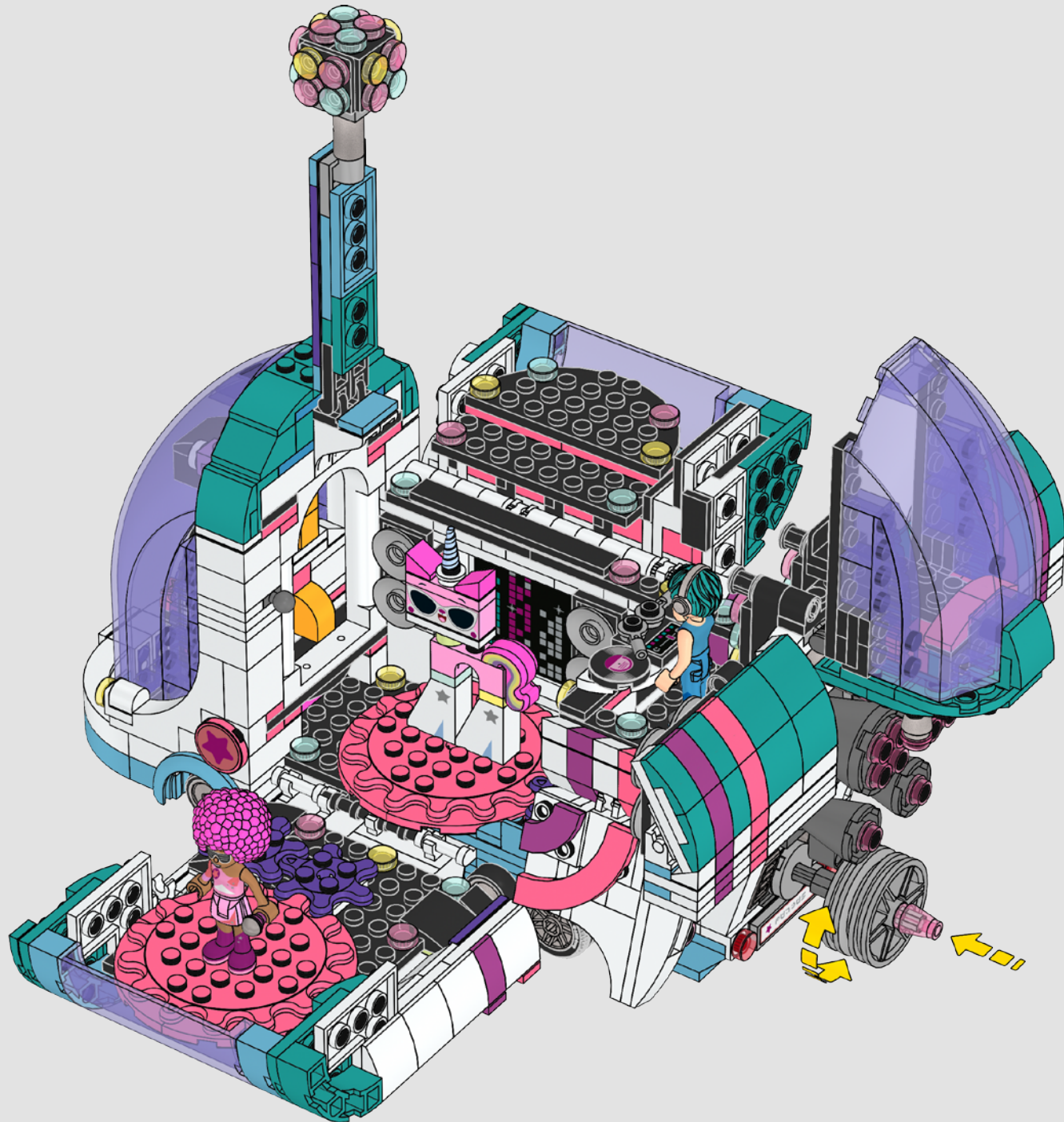



1



2



3

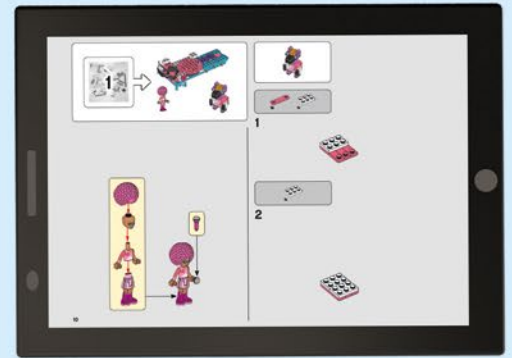



70823



70831

2 IN 1



70830



70829



70823

70829

70830

70831



7 LEGO.com/movie2

THE LEGO® MOVIE 2™ © & ™, Warner Bros. Entertainment Inc. & The LEGO Group. LEGO, the LEGO logo, DUPLO, the Minifigure and the Brick and Knob configurations are trademarks and/or copyrights of the LEGO Group. ©2019 The LEGO Group. All rights reserved. WB SHIELD: TM & © WBEI. (s19)





THE LEGO MOVIE VIDEOGAME

CK3GR7

Unlock Model In Game

Separate purchase required

Modell im Spiel freischalten

Separater Kauf erforderlich

Débloquez le modèle en jeu

Achat séparé requis

Sblocca modello nel gioco

Acquistabile separatamente

**Desbloquear Modelo
En El Juego**

A la venta por separado

Desbloqueavr modelo no jogo

É necessária compra em separado

Modell kioldása a játékban

Külön vásárlás szükséges

在游戏里解锁模型

需分开购买



PC



LEGO.com/games

THE LEGO MOVIE 2 © & ™ The LEGO Group, DC Comics, WBEL. (s19)

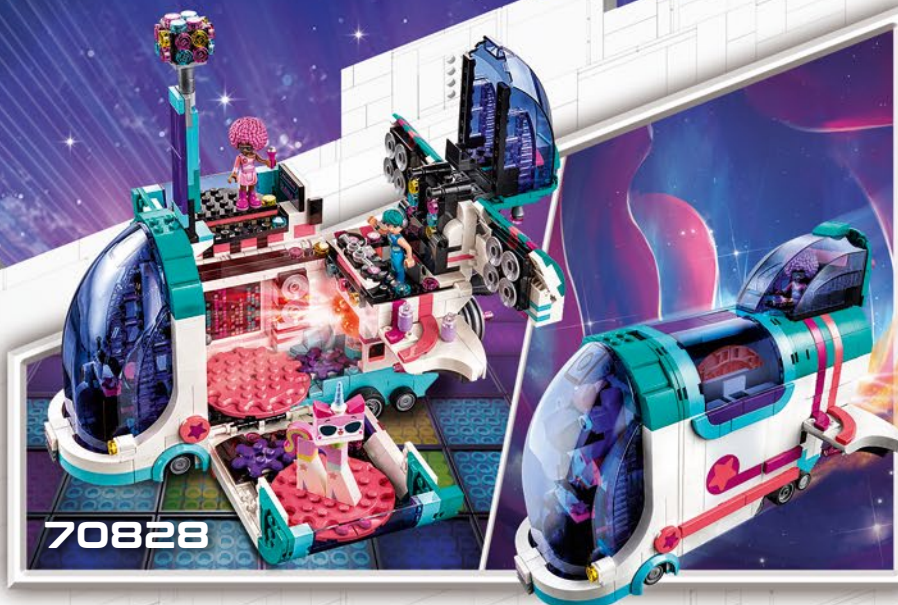

70828



70831



70830



70826



70826

70830

70831

70828



 LEGO.com/movie2

THE LEGO® MOVIE 2™ © & ™, Warner Bros. Entertainment Inc. & The LEGO Group. LEGO, the LEGO logo, DUPLO, the Minifigure and the Brick and Knob configurations are trademarks and/or copyrights of the LEGO Group. ©2019 The LEGO Group. All rights reserved. WB SHIELD: TM & © WBEI. (s19)





Friends™



41354



41355



41356



41357



41358



70823



70826



70827



70829



70823

70826

70827

70829



 [LEGO.com/movie2](https://www.lego.com/movie2)

THE LEGO® MOVIE 2™ © & ™, Warner Bros. Entertainment Inc. & The LEGO Group.
 LEGO, the LEGO logo, DUPLO, the Minifigure and the Brick and Knob configurations
 are trademarks and/or copyrights of the LEGO Group.
 ©2019 The LEGO Group. All rights reserved. WB SHIELD: TM & © WBEI. (s19)



- 1x 6168642
- 2x 4262011
- 1x 6223491
- 8x 302401
- 11x 4504369
- 14x 6258135
- 2x 4558952
- 11x 300501
- 1x 6055541
- 2x 6242241
- 2x 4613256
- 1x 4563684
- 8x 4547489
- 1x 614301
- 4x 3200001
- 2x 4113261
- 1x 6261286
- 1x 4556152
- 2x 6051511
- 4x 609101
- 1x 9551
- 30x 302301
- 5x 306901
- 6x 393701
- 6x 6248827
- 11x 6058177
- 6x 300401
- 2x 6218823
- 4x 4532972
- 6x 6018774
- 6x 6070698
- 2x 6097637
- 1x 4556152
- 2x 4222017
- 4x 6058180
- 2x 4183035
- 2x 6218822
- 4x 6210385
- 4x 6047220
- 8x 302201
- 4x 6238334
- 4x 366001
- 1x 303901
- 6x 235701
- 4x 242001
- 6x 4612342
- 3x 6046979
- 3x 362201
- 2x 6110019
- 1x 4558956
- 2x 6273213
- 2x 6029156
- 5x 302101
- 1x 621501
- 6x 300201
- 2x 4143254
- 13x 371001
- 4x 301001
- 2x 4521846
- 1x 303701
- 4x 6102776
- 8x 302001
- 1x 4558168
- 5x 4568956
- 2x 6273213
- 2x 6029156
- 5x 302101
- 1x 621501
- 6x 300201
- 2x 4143254
- 13x 371001
- 4x 301001
- 2x 4521846
- 1x 303701
- 4x 6102776
- 8x 302001
- 1x 300101
- 2x 6210689
- 1x 6053026
- 3x 6147792
- 7x 366601
- 2x 4160403
- 3x 300901
- 1x 300801
- 1x 416201
- 6x 303401
- 2x 4504228
- 2x 4611927
- 2x 6249033
- 2x 6158058
- 3x 4508662
- 1x 379501
- 2x 4495927
- 1x 346001
- 1x 300801
- 1x 416201
- 6x 303401
- 2x 4504228
- 2x 6186867
- 1x 6273152
- 1x 73737
- 1x 4504382
- 7x 302426
- 6x 4246901
- 3x 4548180
- 2x 6257775
- 8x 4121715
- 2x 4598528
- 4x 366526
- 2x 4593678
- 1x 6115086
- 4x 6114987
- 1x 300426
- 8x 306926
- 3x 302326
- 5x 6016172
- 6x 6117973
- 3x 6000650
- 4x 6250020
- 2x 4140588
- 2x 6029208
- 1x 4248204
- 1x 302226
- 1x 6192346
- 3x 6053077
- 1x 303926
- 6x 242026
- 2x 6089119
- 3x 6052126
- 2x 4140801
- 2x 4515368
- 2x 362326
- 4x 6199908
- 1x 6168620
- 1x 300226
- 1x 4162443
- 1x 4227392
- 3x 4560182
- 1x 6174252
- 2x 4160393
- 5x 366626
- 2x 300926
- 2x 4243819
- 1x 6187587
- 1x 379526
- 2x 346026
- 1x 416226
- 1x 303226
- 1x 6133200
- 1x 303426
- 2x 4645732
- 1x 395826
- 1x 303526
- 1x 4514845
- 2x 303026
- 14x 4650500
- 16x 6022171
- 1x 6259807
- 2x 6210400
- 10x 6213777
- 8x 6249427
- 4x 6217659
- 6x 6249425
- 16x 6223665
- 2x 6249419
- 3x 6249417
- 4x 6251838
- 1x 6223065
- 2x 6213795
- 4x 6254334
- 2x 6213786

3x
6125698

15x
6240230

22x
6053876

1x
6257778

1x
6210741

6x
6177349

2x
6096942

1x
6142402

4x
6070763

4x
6103415

2x
4519195

2x
6177824

2x
6078305

3x
6037652

1x
4142865

1x
6135130

10x
4143005

2x
4514553

4x
6199891

4x
4613192

5x
6167471

4x
6238330

1x
6167472

2x
6023173

2x
6061685

2x
6122504

2x
6023185

1x
6028736

1x
6249128

1x
6240515

2x
4211525

2x
4521921

4x
4211535

2x
6227897

4x
6179186

1x
6078985

12x
4211512

1x
4211807

6x
6125569

2x
4211398

1x
6066097

2x
6258820

2x
6018081

1x
6045988

1x
4237084

1x
4211815

2x
6116608

1x
4211840

1x
4211356

1x
4541318

1x
6171067

2x
6231765

2x
6092666

1x
6006141

1x
4516546

3x
4210636

3x
6261355

2x
6092572

1x
6123814

1x
4211060

2x
6201630

2x
6172811

1x
4508553

1x
4552248

2x
6127601

1x
6259668

3x
6248847

1x
6259636

1x
6273209

1x
6261968

1x
6273207

1x
6054930

1x
6259809

1x
6259865

1x
6259622

1x
6259628

3x
6121350

6x
4624473

2x
6218226

3x
6245499

1x
4619636

8x
6092115

1x
6259868

3x
6218014

1x
6133728

1x
4640891

2x
6150307

2x
4655243

3x
4619652

1x
6097419

5x
4649741

2x
4655246

1x
6146228

3x
6070756

4x
6258069

4x
6119107

2x
6177664

2x
4624705

2x
6261546

3x
4651903

4x
6261294

5x
4623598

1x
4619524

1x
4619516

2x
6036238

8x
4655256

4x
4625036

2x
6258072

4x
6097046

4x
6074793

2x
6253666

3x
6133692

12x
6216967

1x
6223506

1x
6058016

2x
6250022

18x
6258091

9x
6258098

4x
6261292

6x
6258405

14x
6258572

1x
6261293

32x
6258094

6x
6258075

6x
6259780

6x
6258096

10x
6258097

2x
6258385

1x
6058014

1x
6223426

2x
6209673

4x
6245282

4x
6240552

10x
6244912

2x
6256804

4x
6258123

1x
6265007

1x
6253665

1x
6225808

2x
6258607

Customer Service
Kundenservice
Service Consommateurs
Servicio Al Consumidor
LEGO.com/service or dial

🇩🇪 🇩🇰 🇪🇸 🇫🇷 🇮🇹 🇯🇵 🇰🇷 🇸🇪 🇸🇯 🇺🇰
🇨🇦 🇫🇮 🇸🇪 🇩🇪 🇬🇧 : 00800 5346 5555
🇺🇸 🇨🇦 : 1-800-422-5346

WIN

GO TO WWW.LEGO.COM/PRODUCTFEEDBACK AND
GIVE US YOUR SHORT **FEEDBACK** ABOUT THIS
LEGO® SET FOR A CHANCE TO WIN
A COOL LEGO PRIZE.

Terms & Conditions apply

LEGO.com/productfeedback



GEWINNE

Erzähle uns auf
www.LEGO.com/productfeedback

etwas über die Erfahrungen, die du
mit diesem LEGO® Set gemacht hast,
und sichere dir die Chance auf einen
coolen LEGO Preis!

Es gelten die Teilnahmebedingungen

GAGNE

Rends-toi sur
www.LEGO.com/productfeedback

et donne-nous quelques commen-
taires sur ce produit LEGO® pour
avoir une chance de gagner un prix
LEGO !

Voir Conditions Générales

GANAN

Visita
www.LEGO.com/productfeedback

y envíanos tu opinión acerca de este
set LEGO®. ¡Participarás en el sorteo
de un premio LEGO!

Términos y Condiciones aplicables

获取奖品

登录
www.LEGO.com/productfeedback

给出关于此乐高®套装的简短反馈，
就有机会获得炫酷乐高奖品

《条款及条件》适用

THE LEGO® MOVIE 2™ © & ™, Warner Bros. Entertainment Inc. & The LEGO Group. LEGO, the LEGO logo, DUPLO, the Minifigure and the Brick and Knob configurations are trademarks and/or copyrights of the LEGO Group.
©2019 The LEGO Group. All rights reserved. WB SHIELD: TM & © WBEI. (s19)

