



THE LEGO MOVIE

70815





1x



3x



2x

65

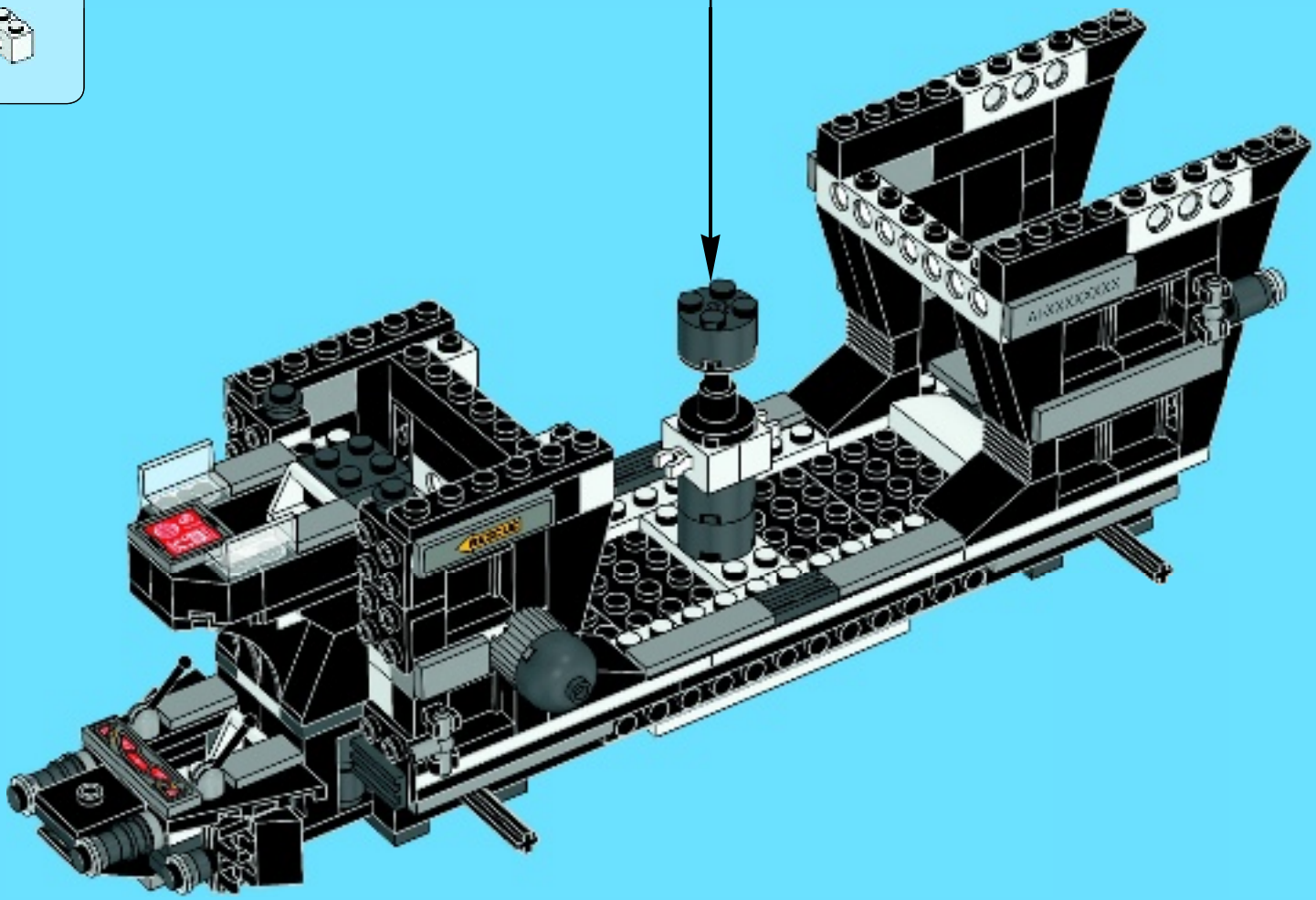
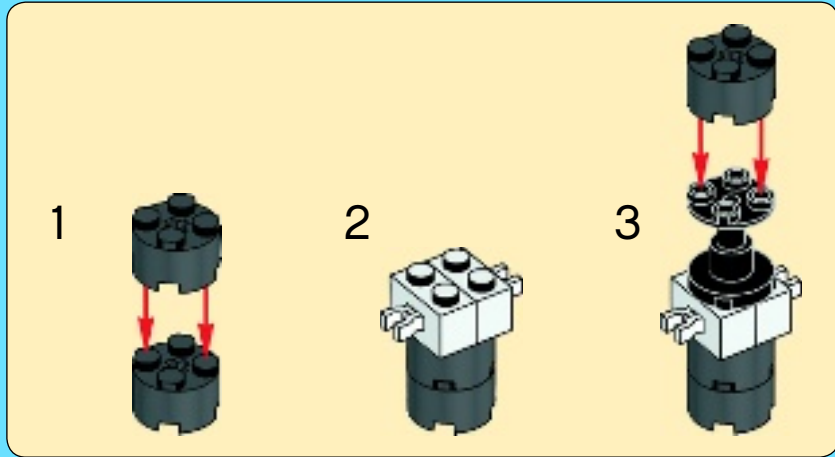

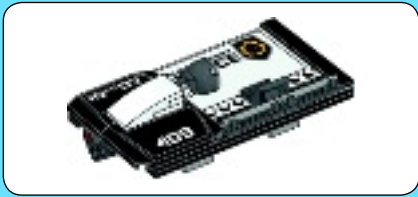

1

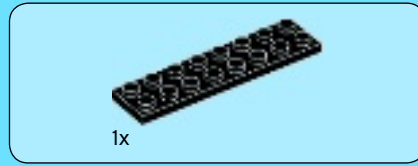
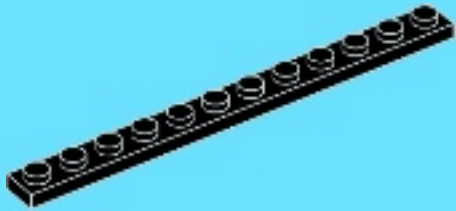

2

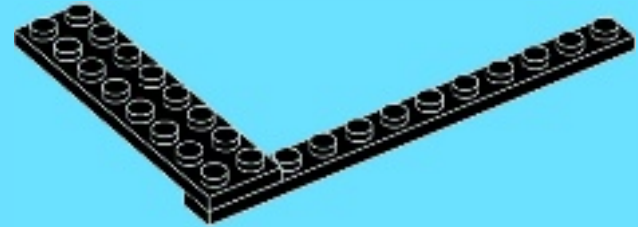

3

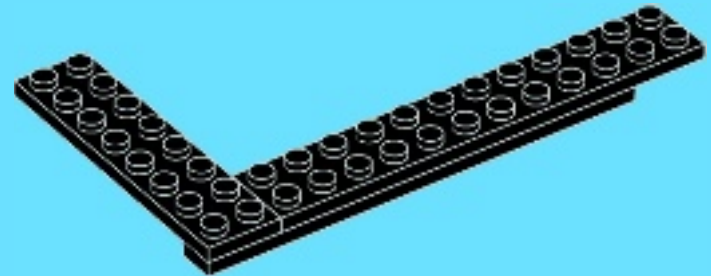

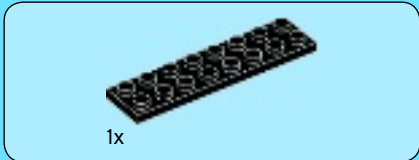

4

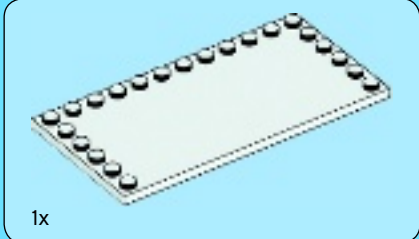
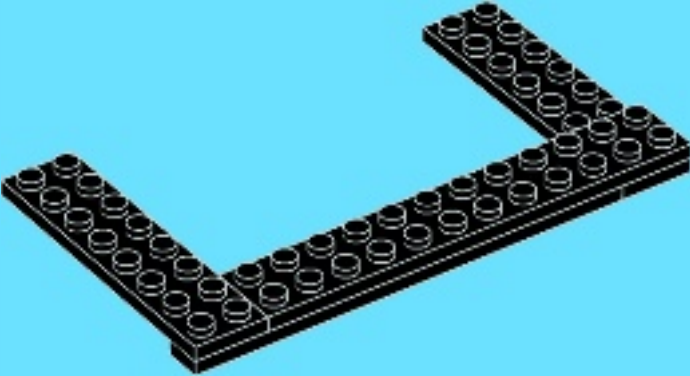

5

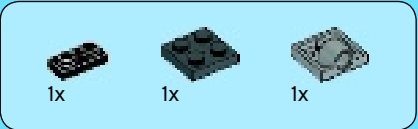
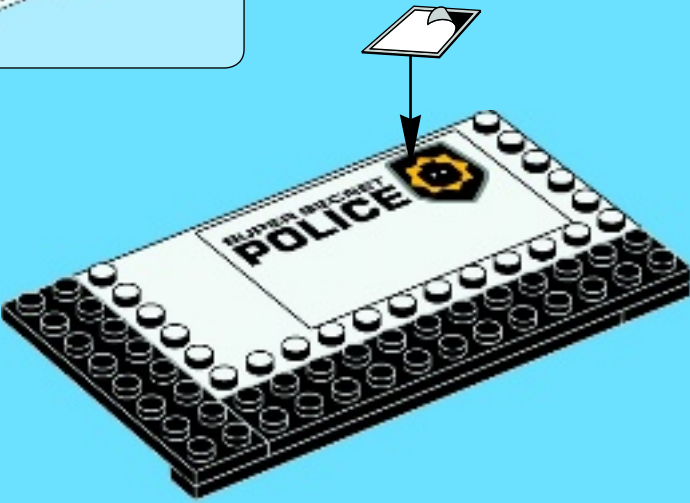

6

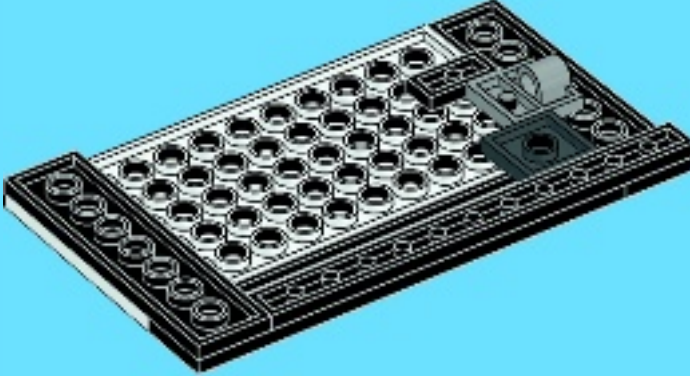
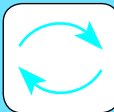

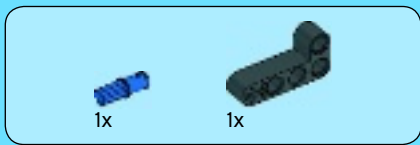

7

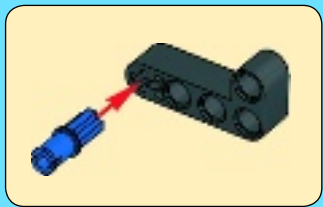
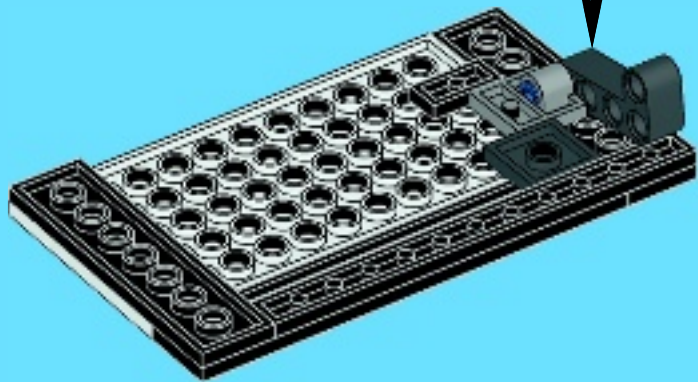

8

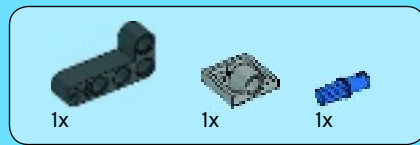
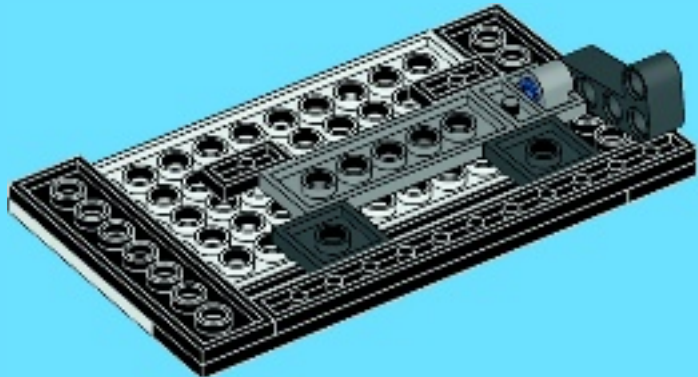

9

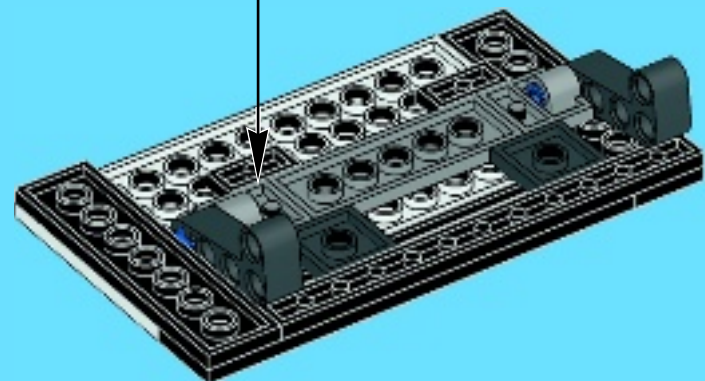
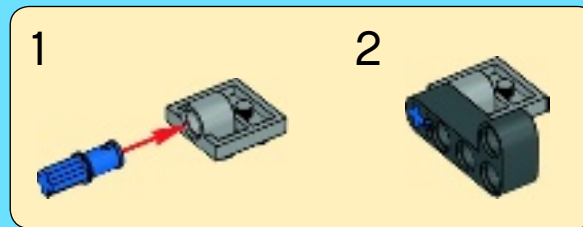



2x

10

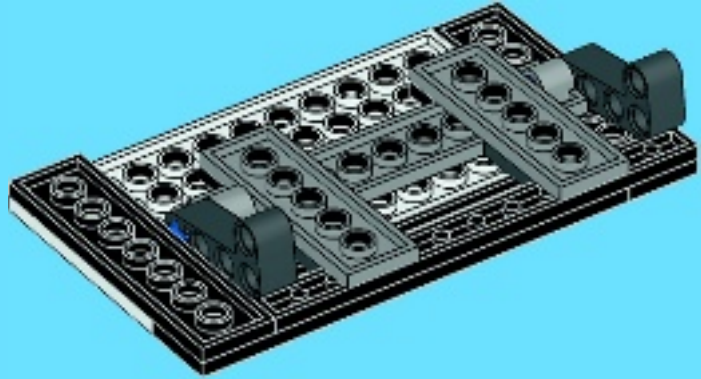

2x

11

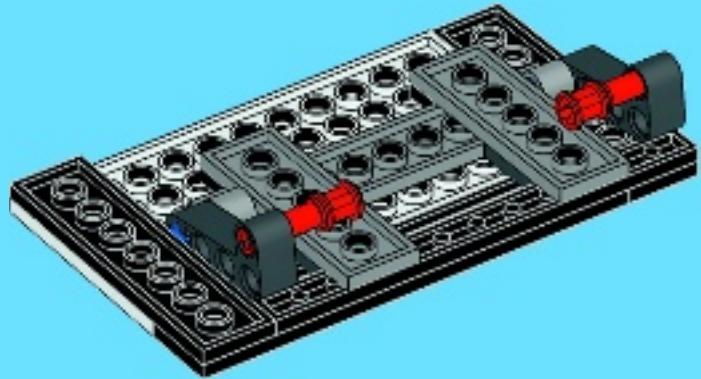

1x



2x



4x

12

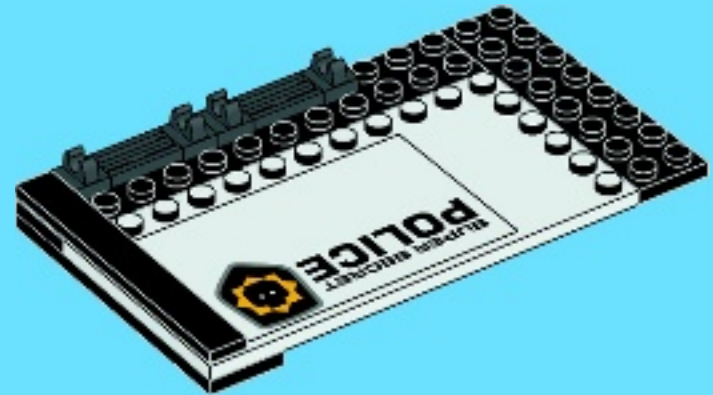
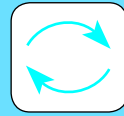

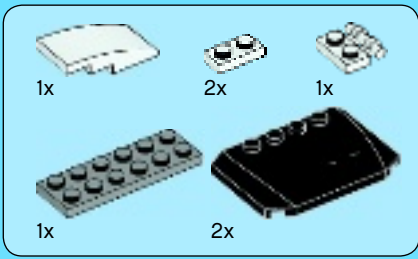

13

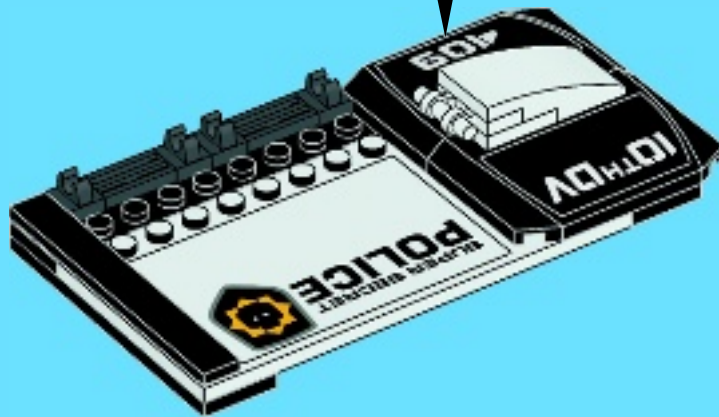
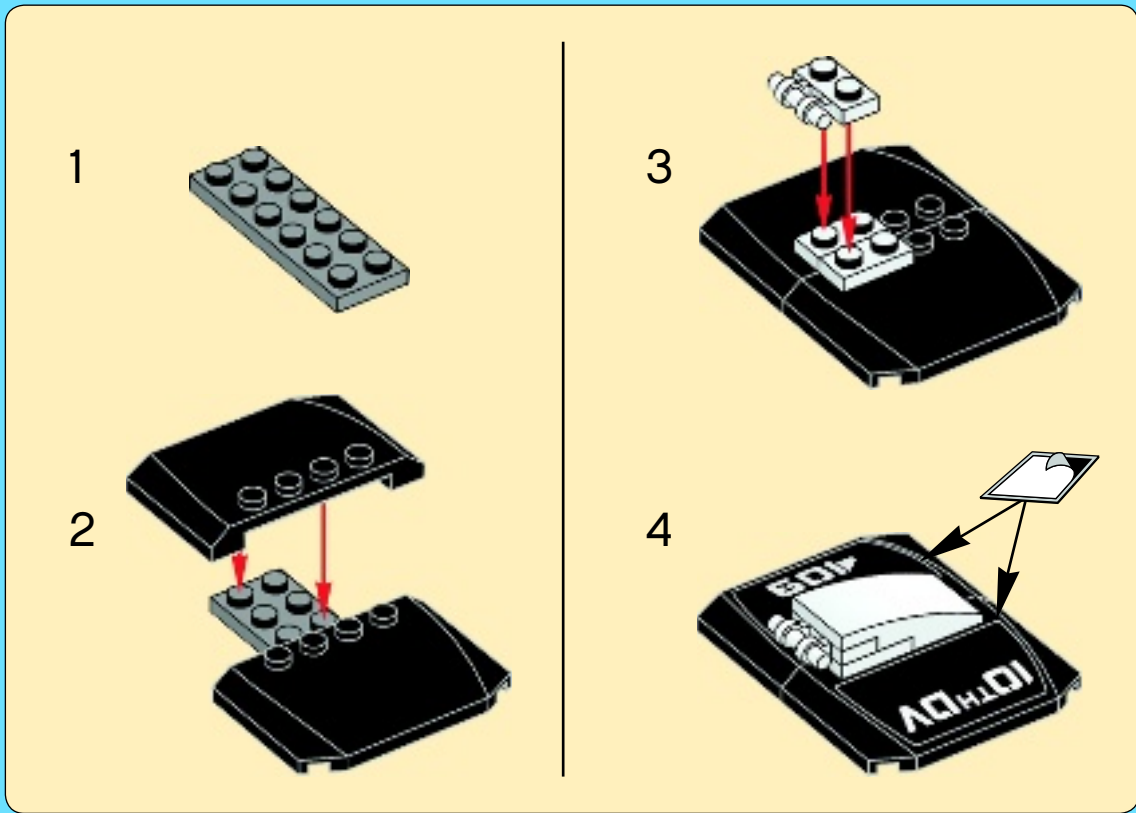

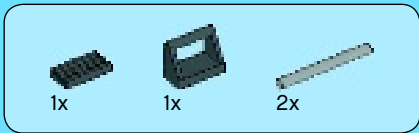

14

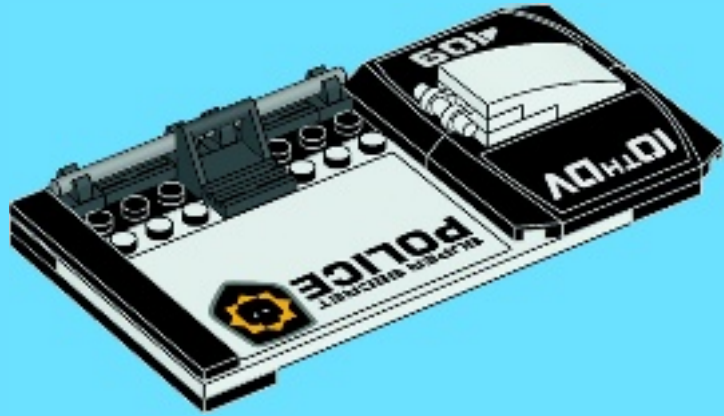

15

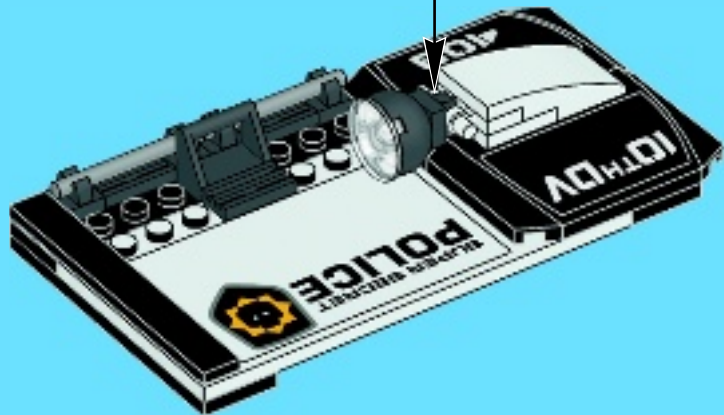
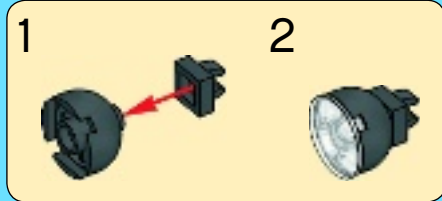

16

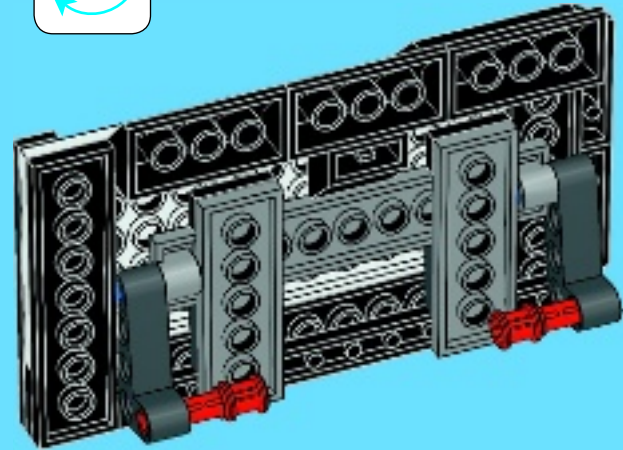
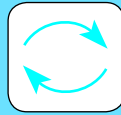



17

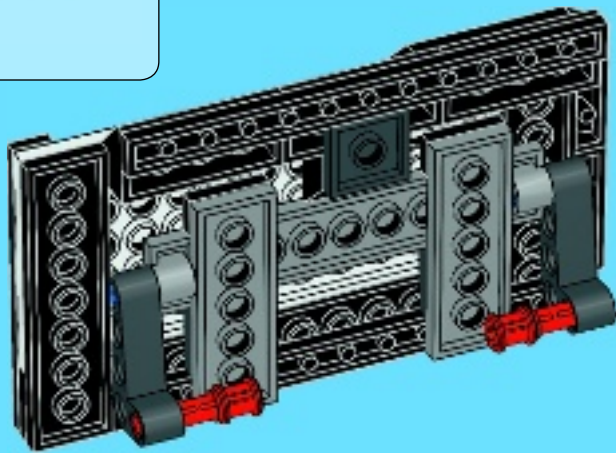

18

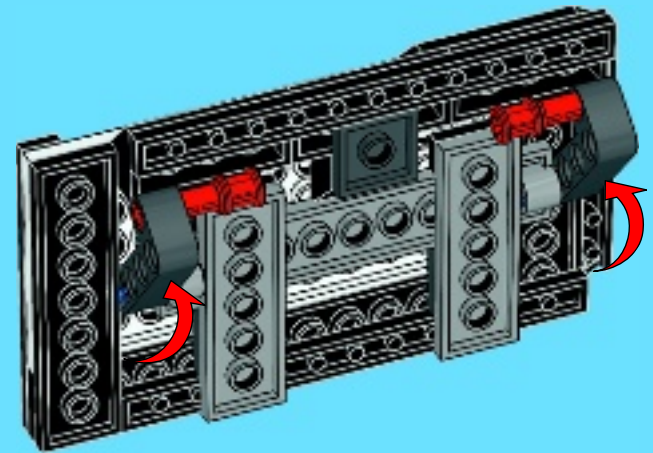

66

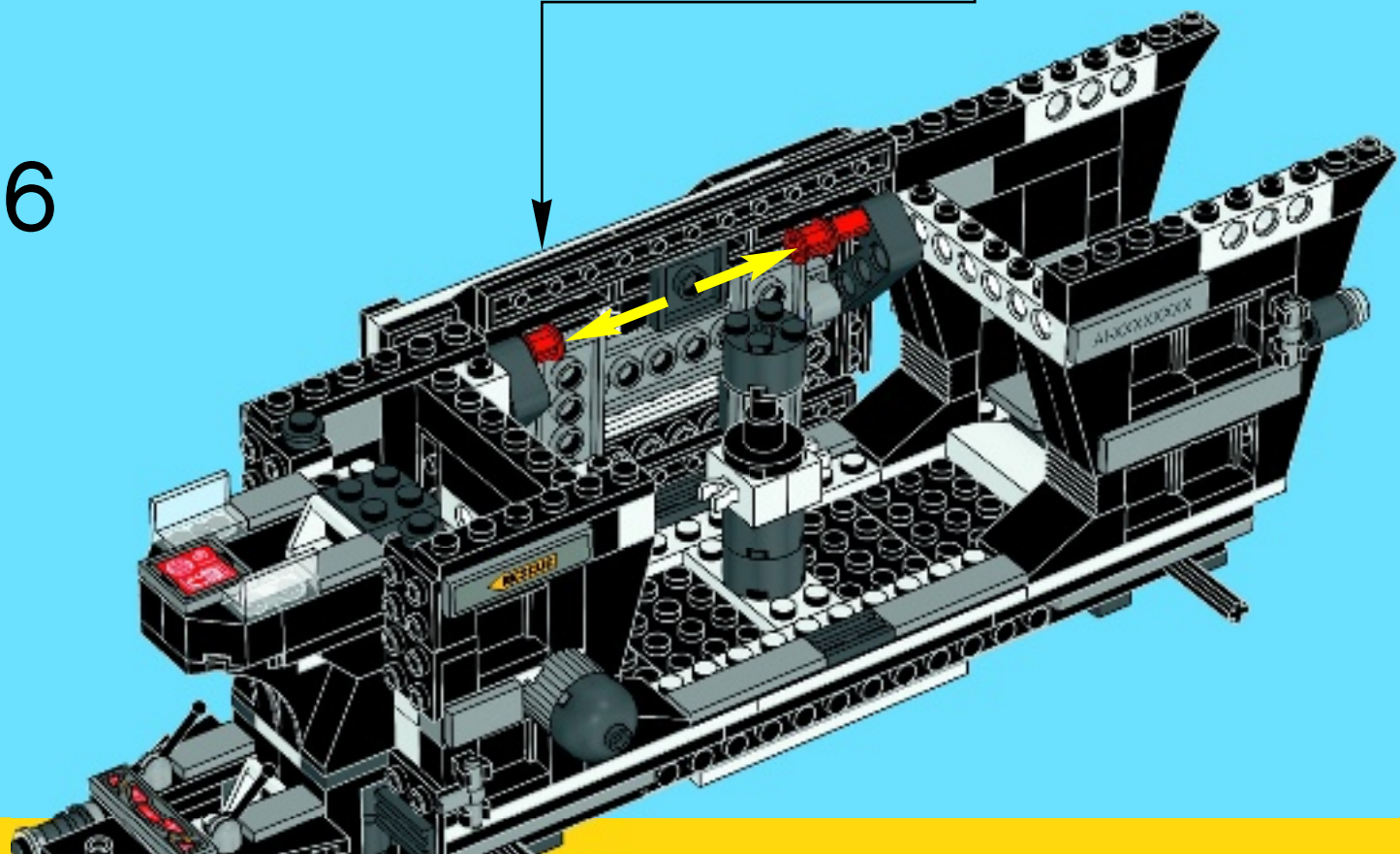

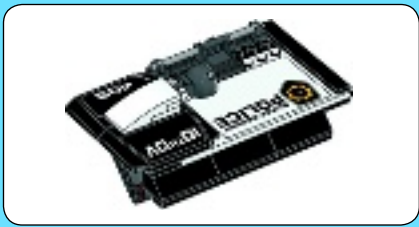

1

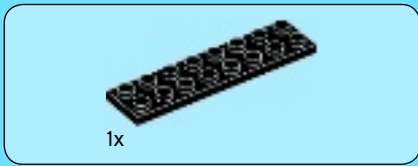

2

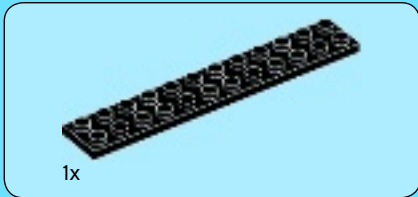
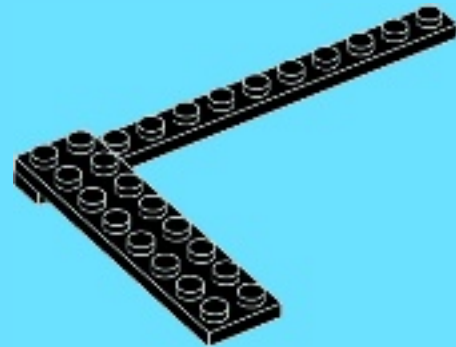

3

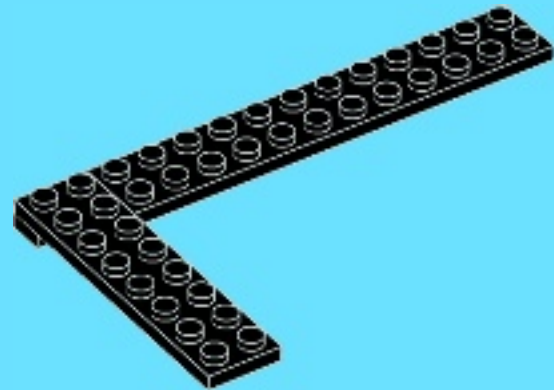

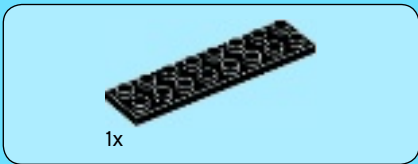

4

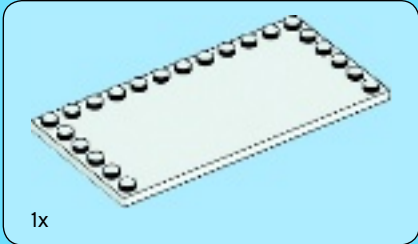
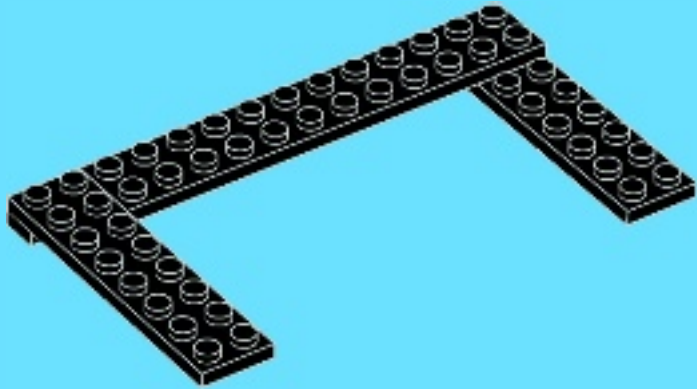

5

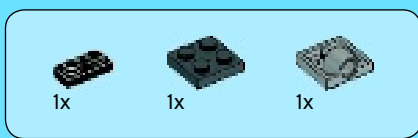
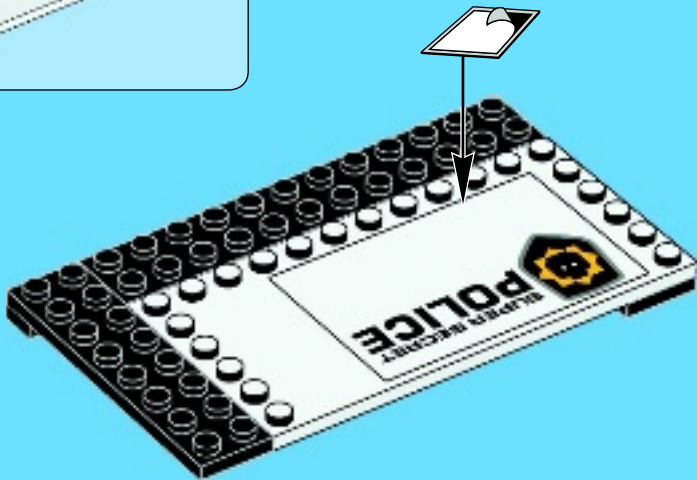

6

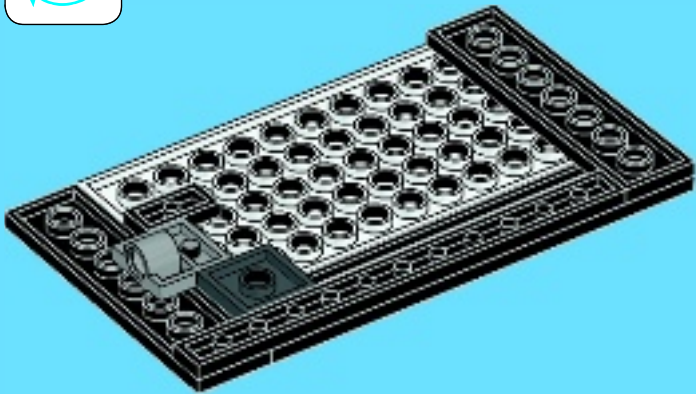
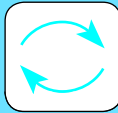



7

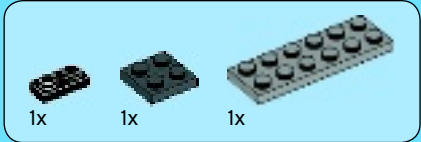
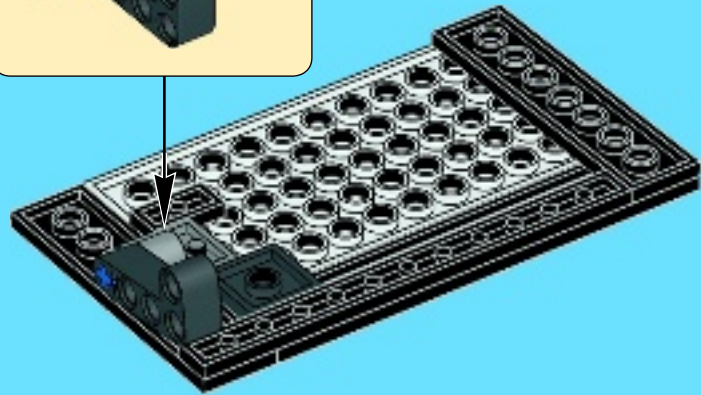
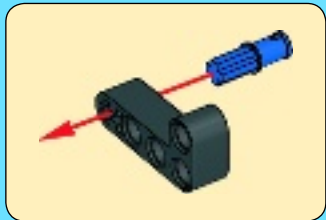

8

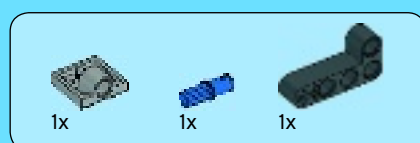
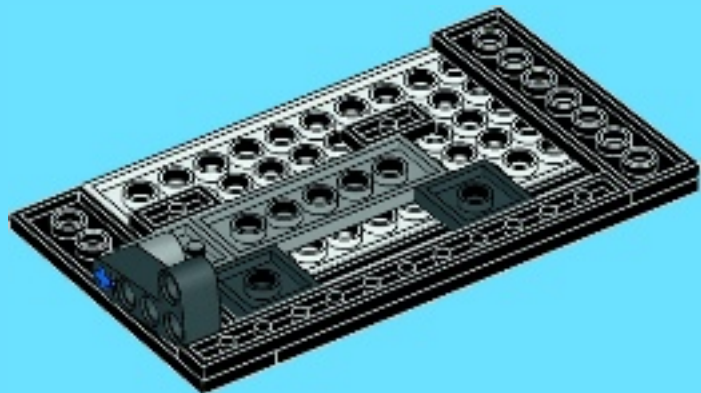

9

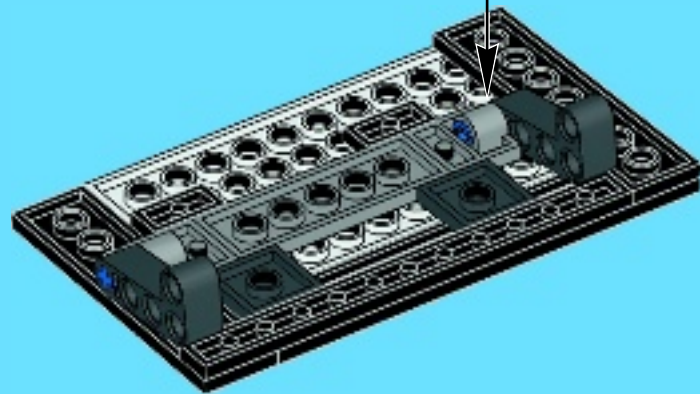
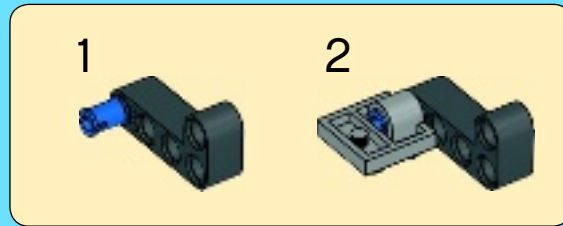



2x

10

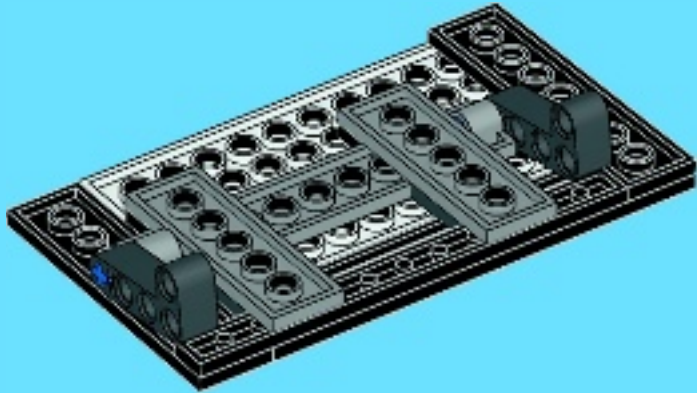

2x

11

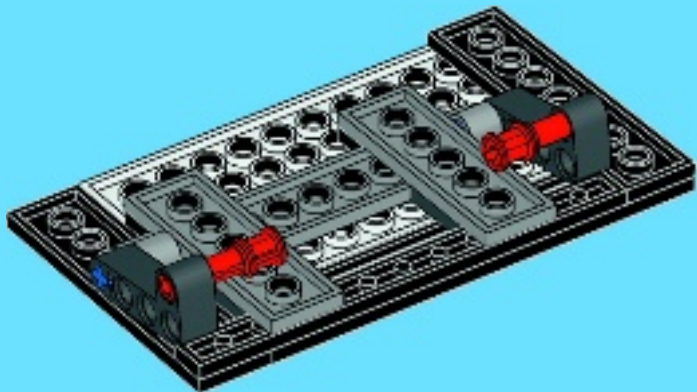

1x



2x



4x

12

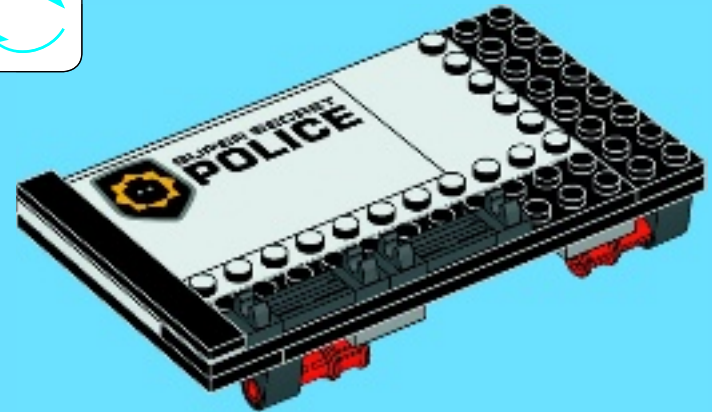
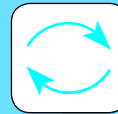

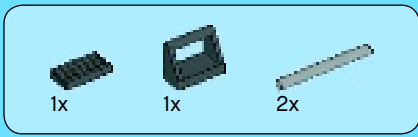

14

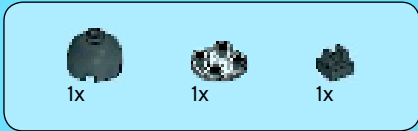

15

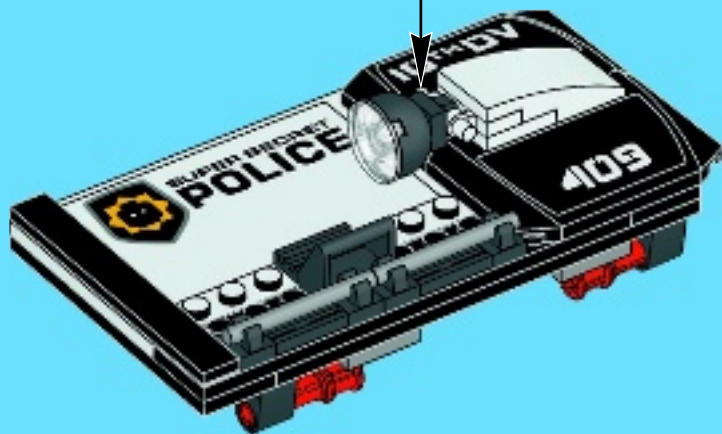
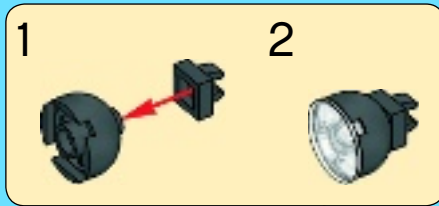

16

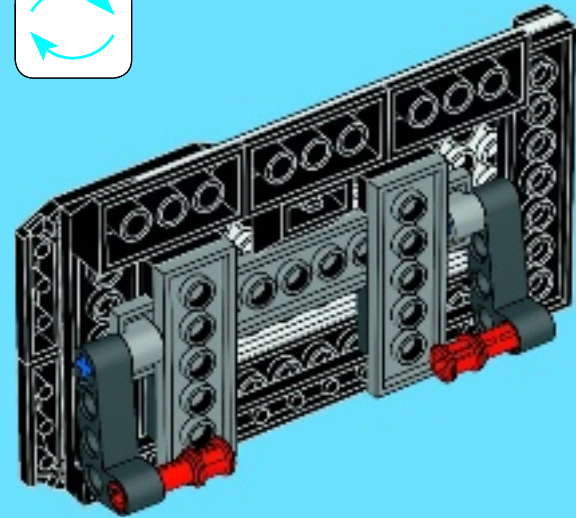
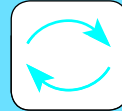



17

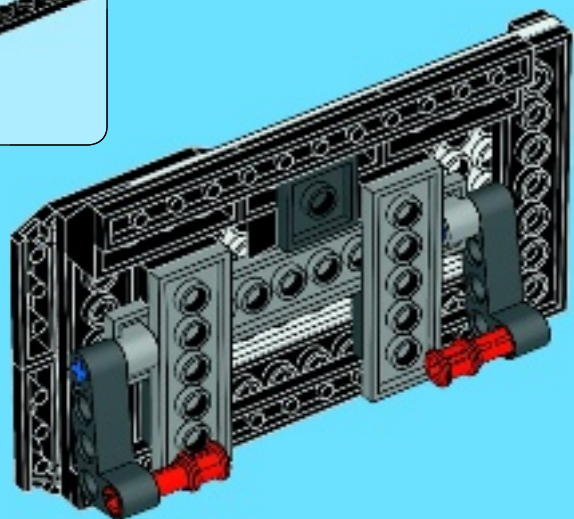

18

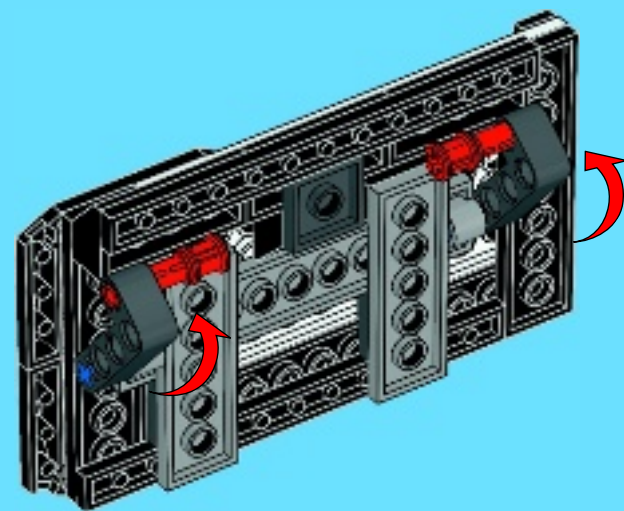

67

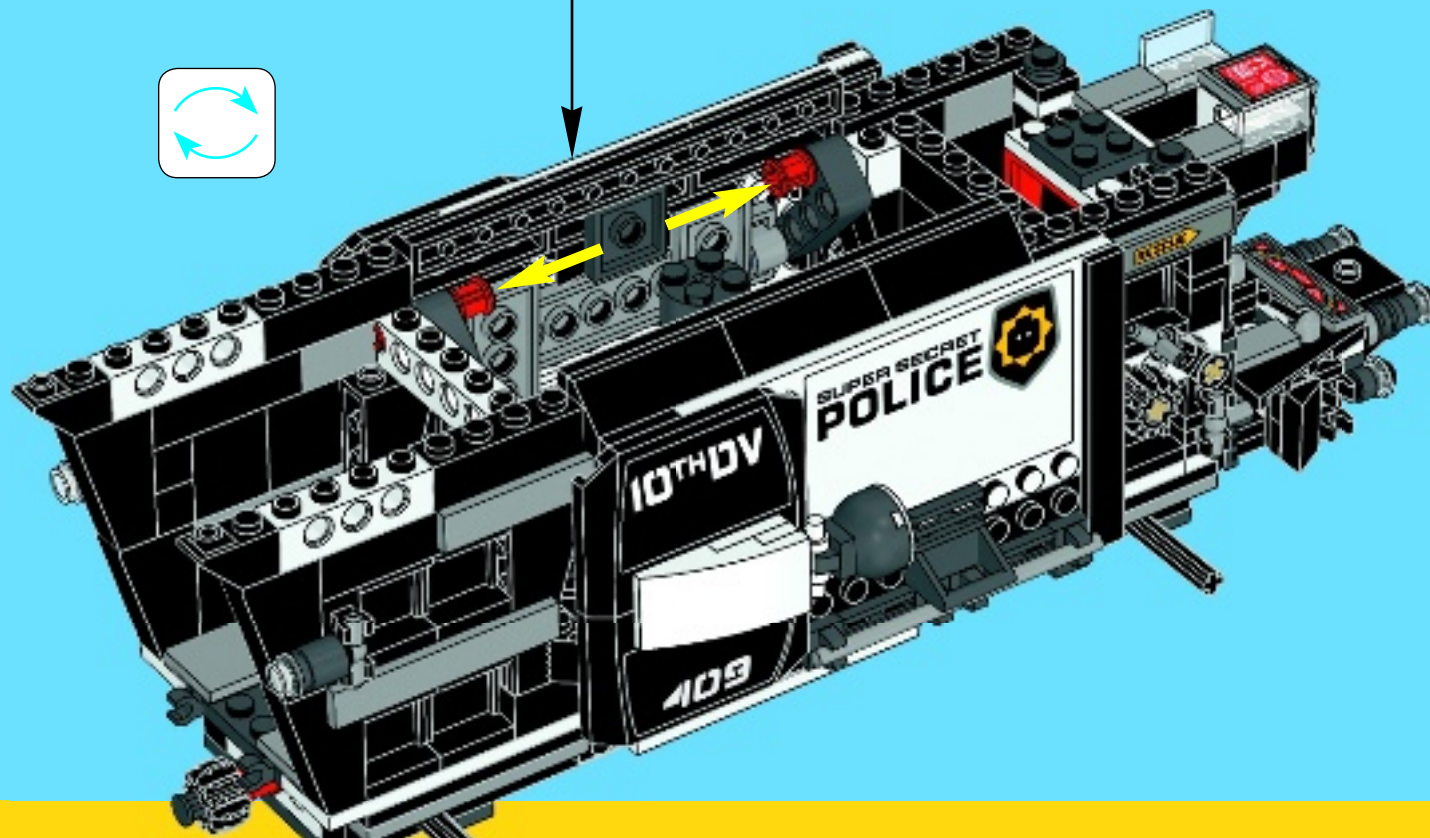
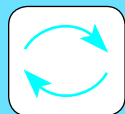

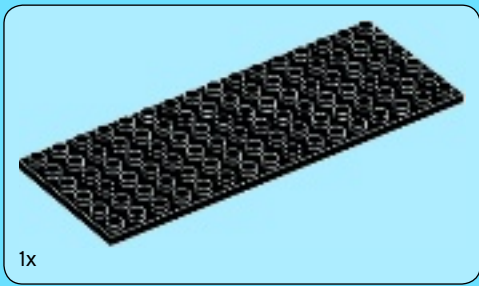

68

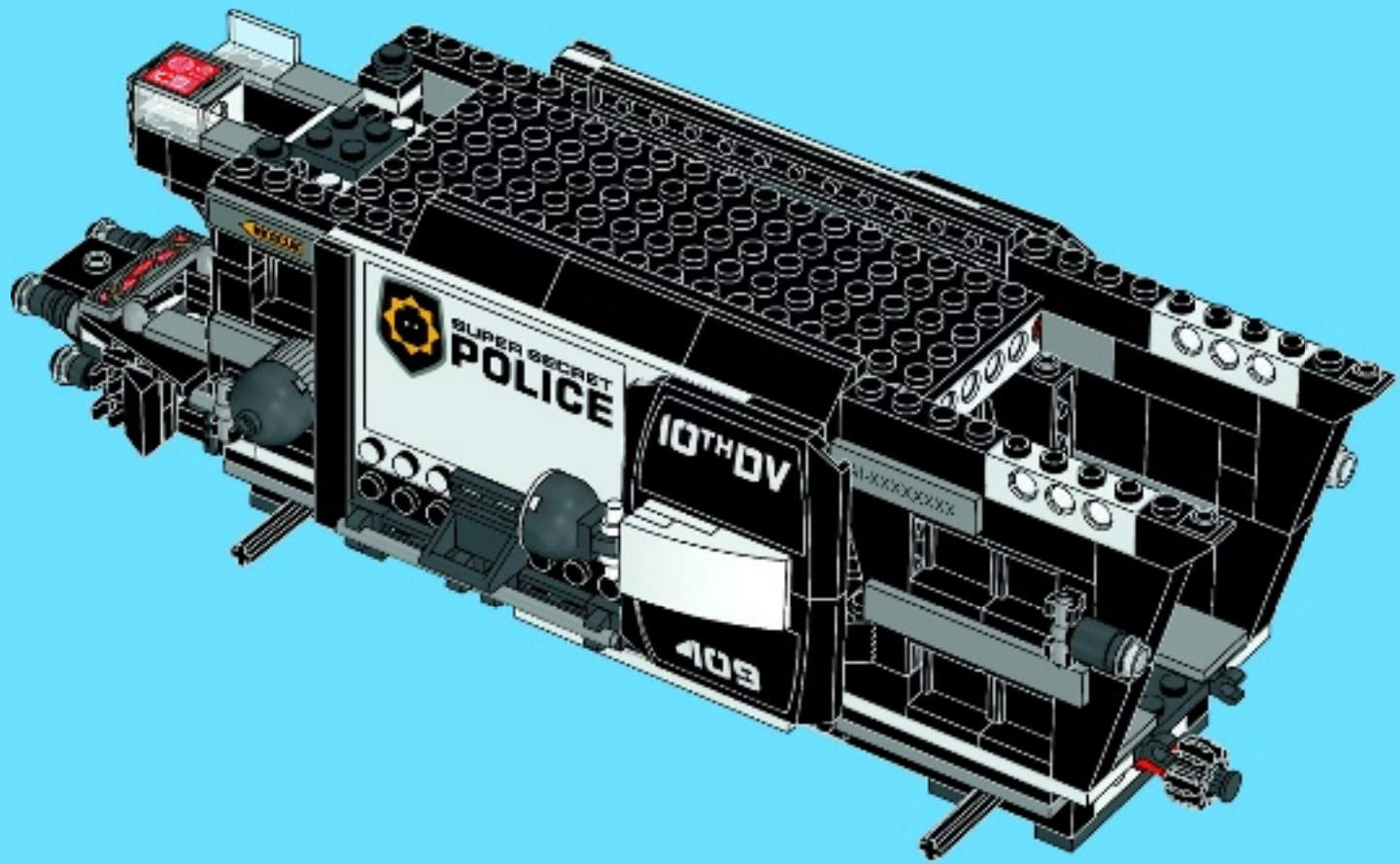
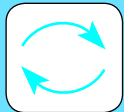



1

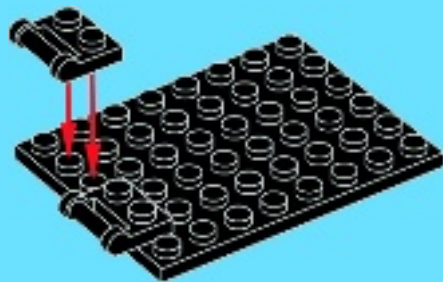

2

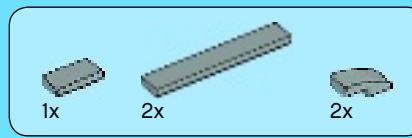

3

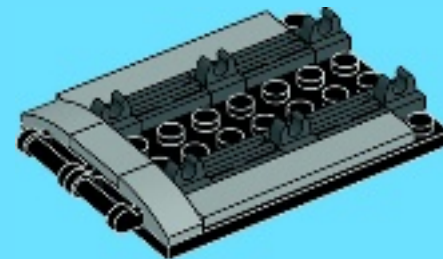



3x

4

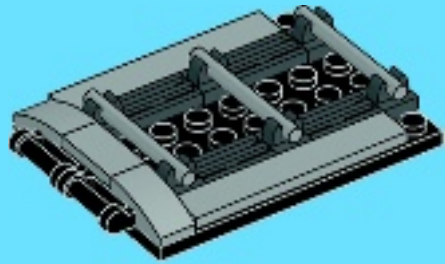

4x

5

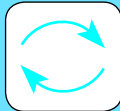

2x

6



69

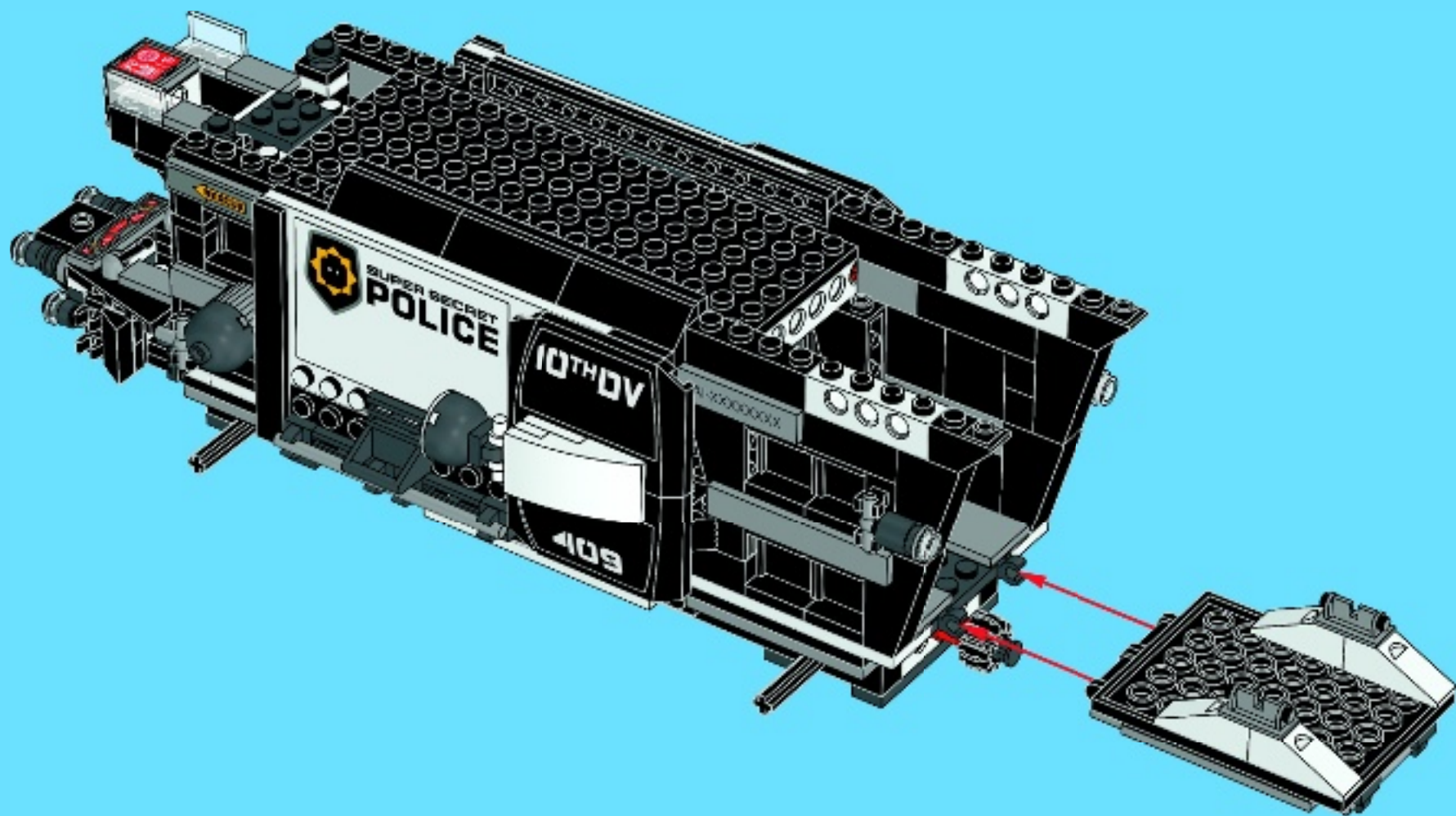



4

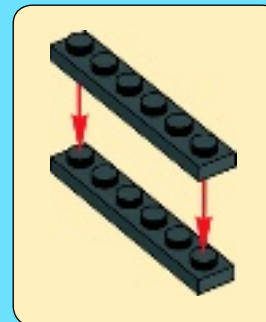
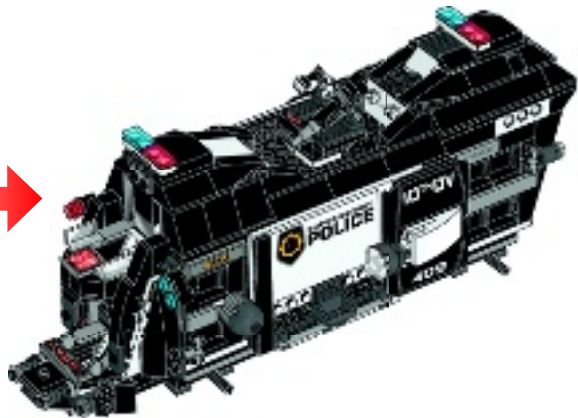

2x

70

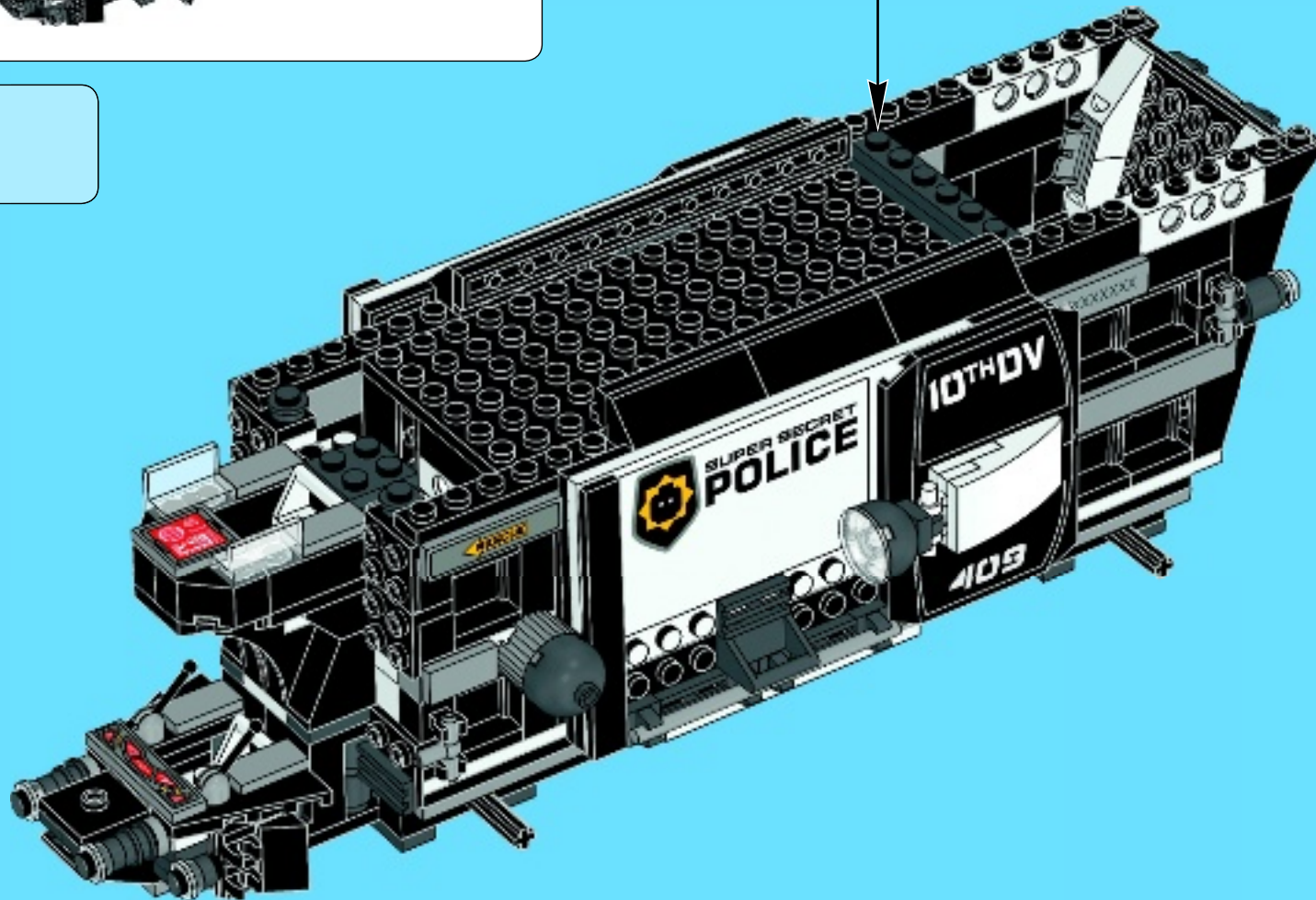



2x



1x

71

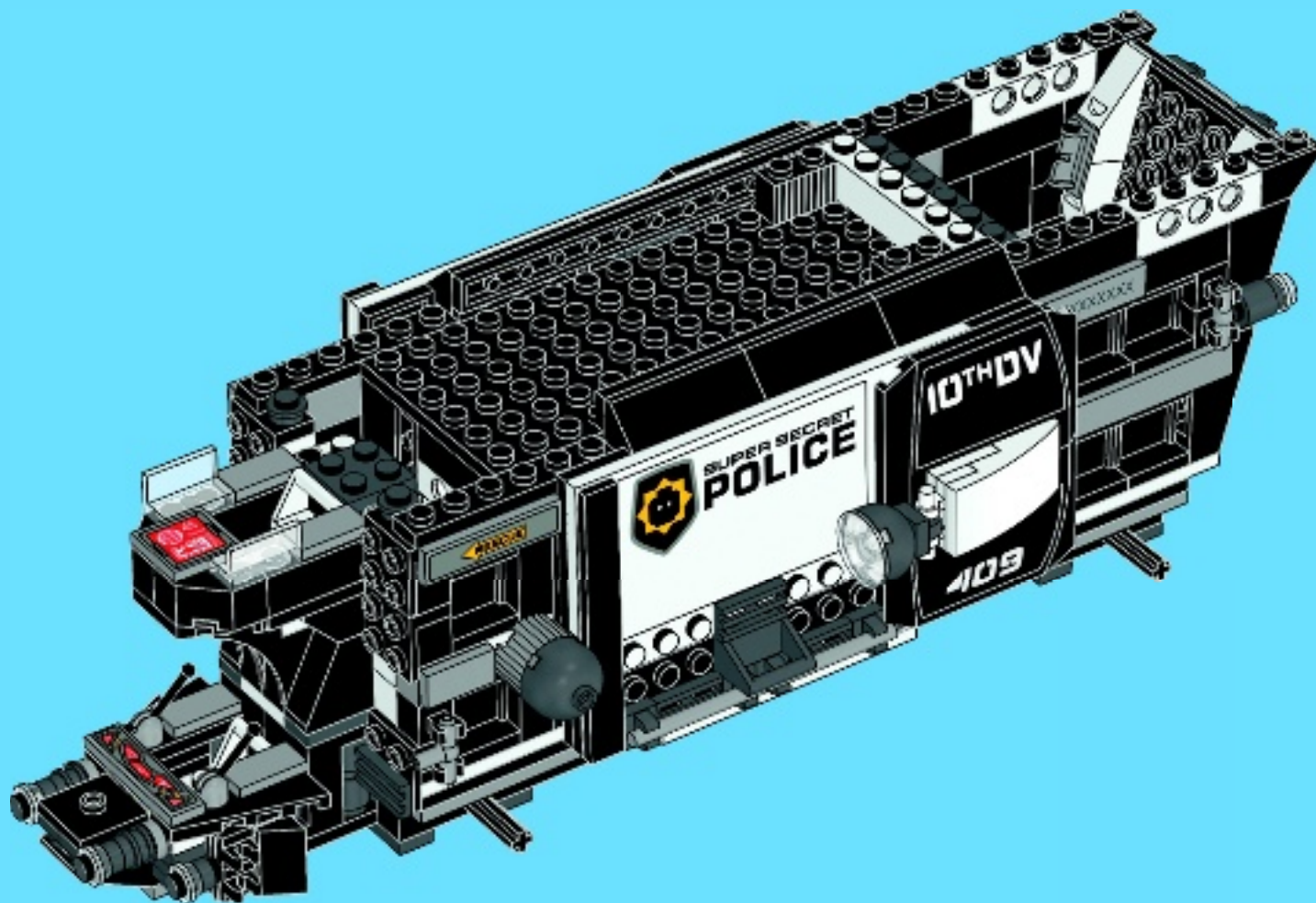



2x



2x

72

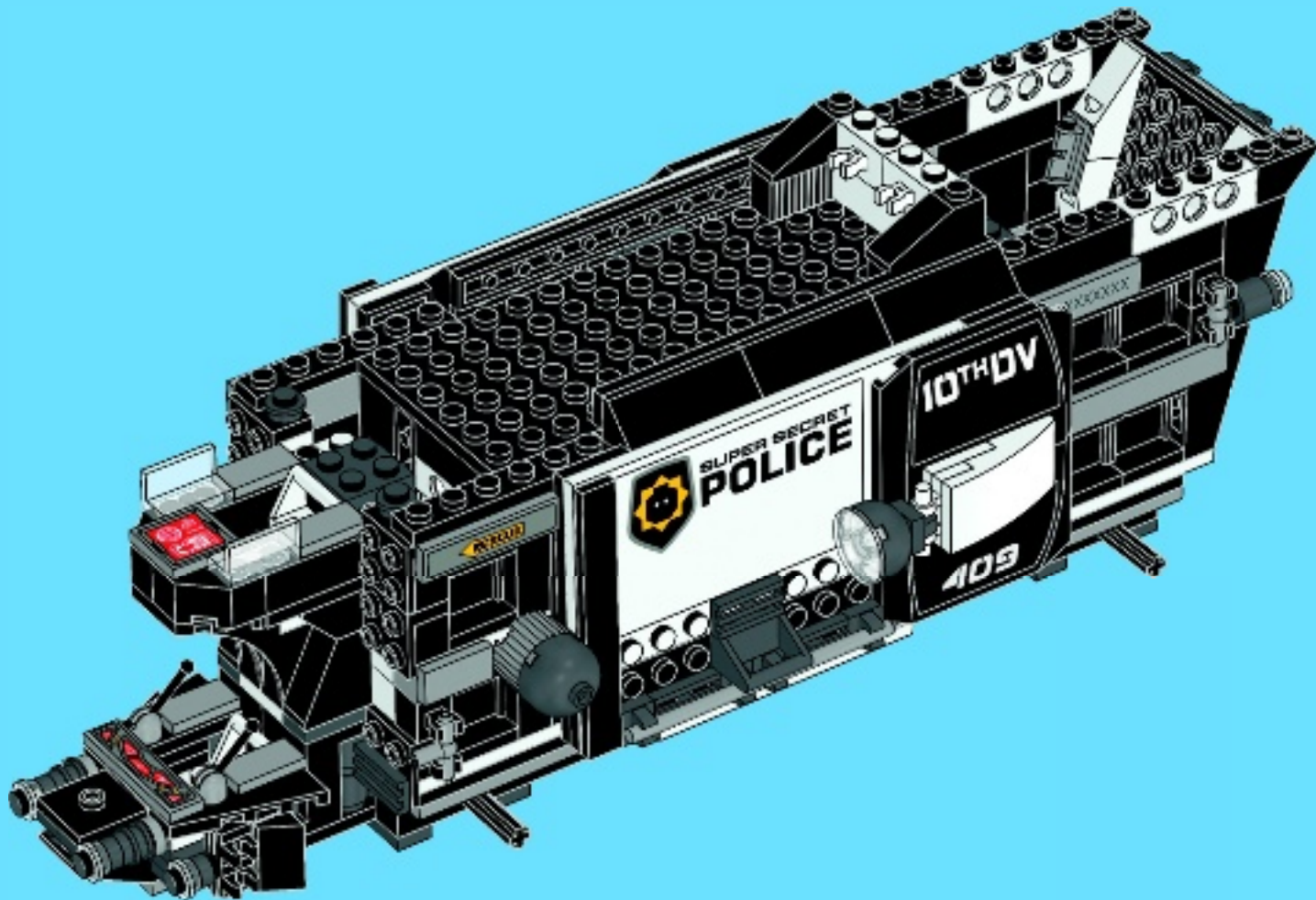

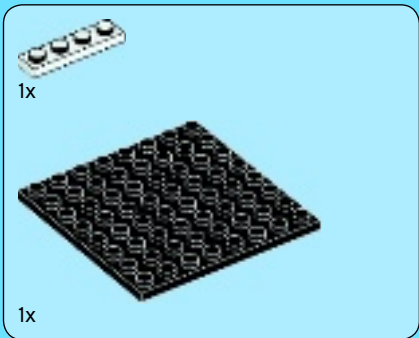

1

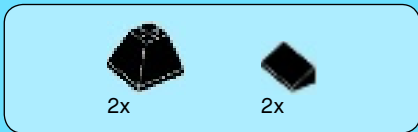

2



3

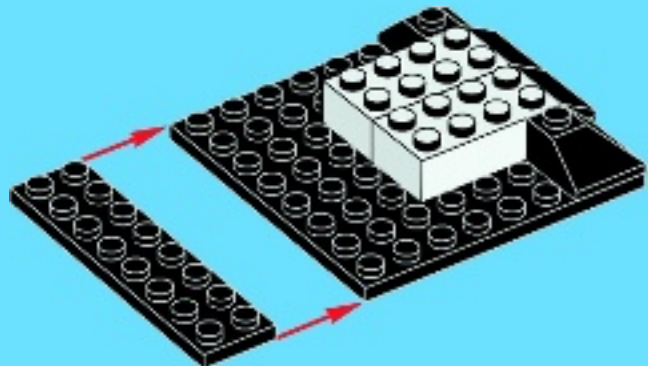

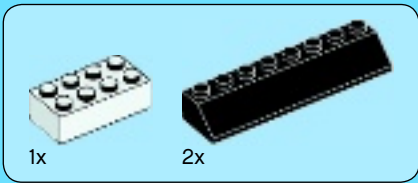

4

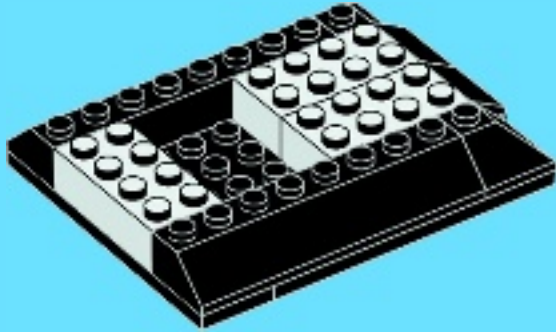

5

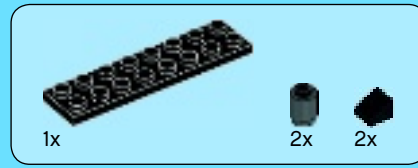
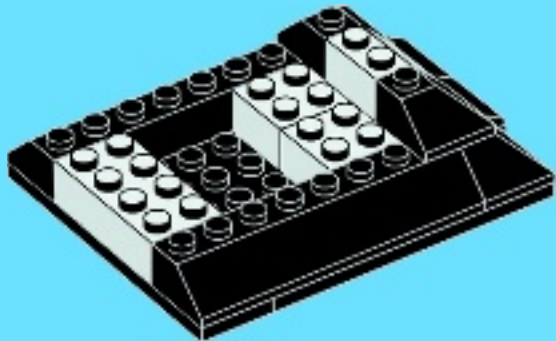

6

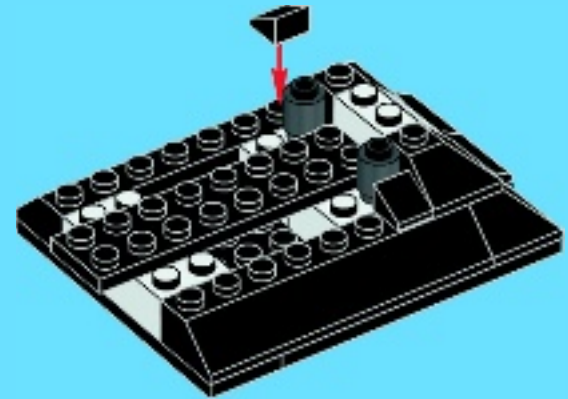

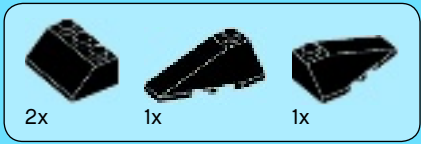

7

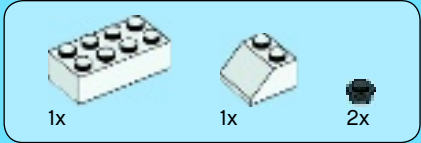
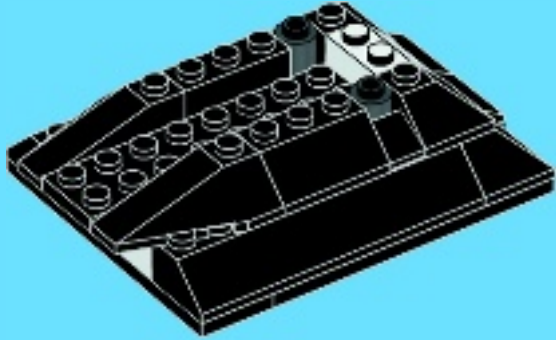

8

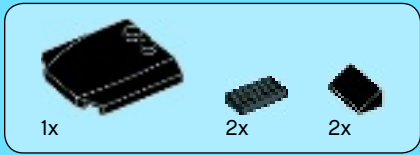

9



73

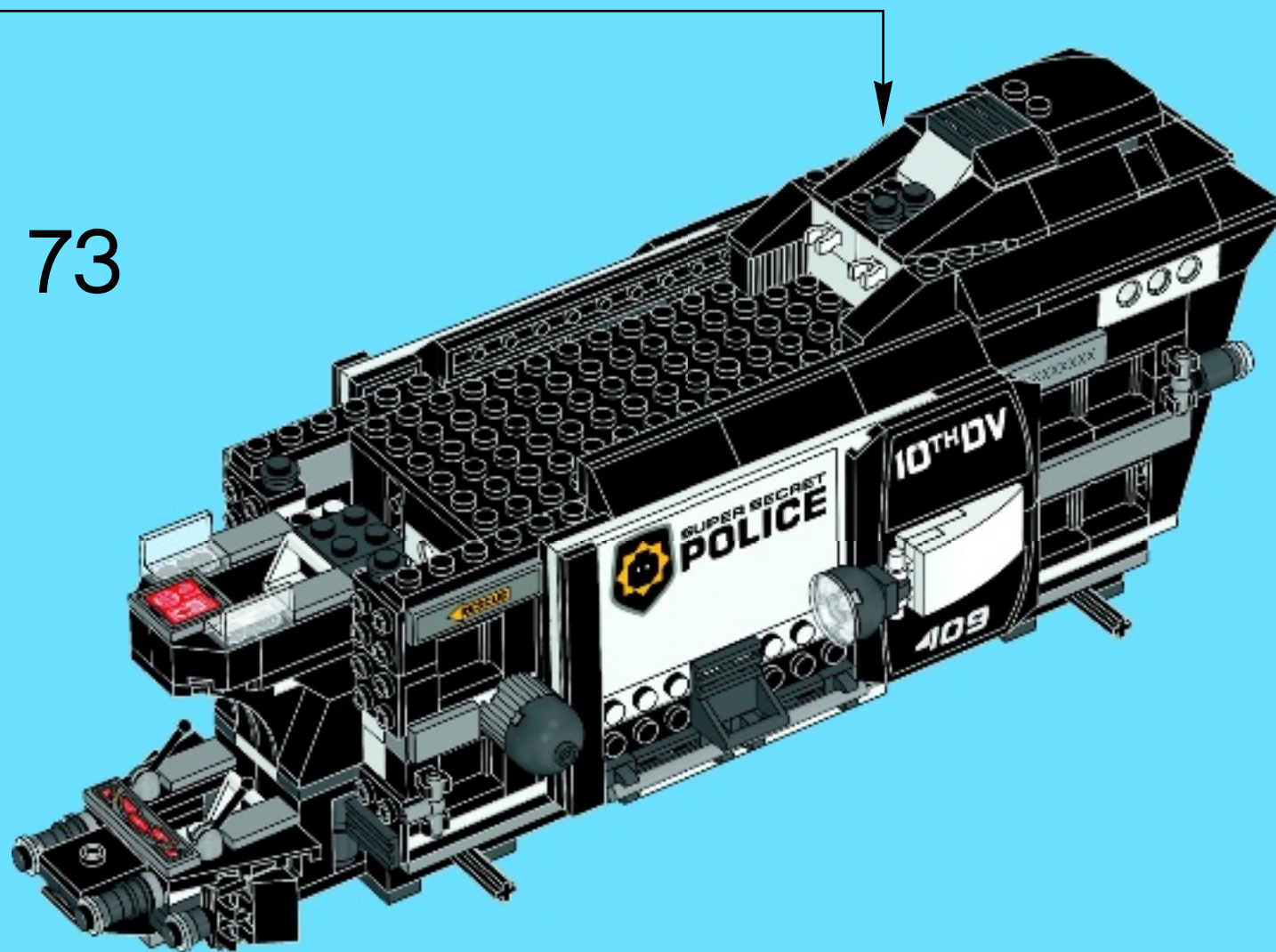

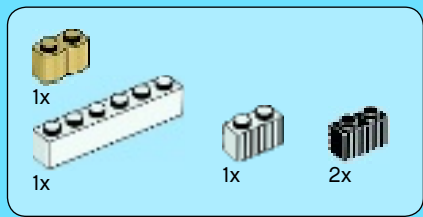

74

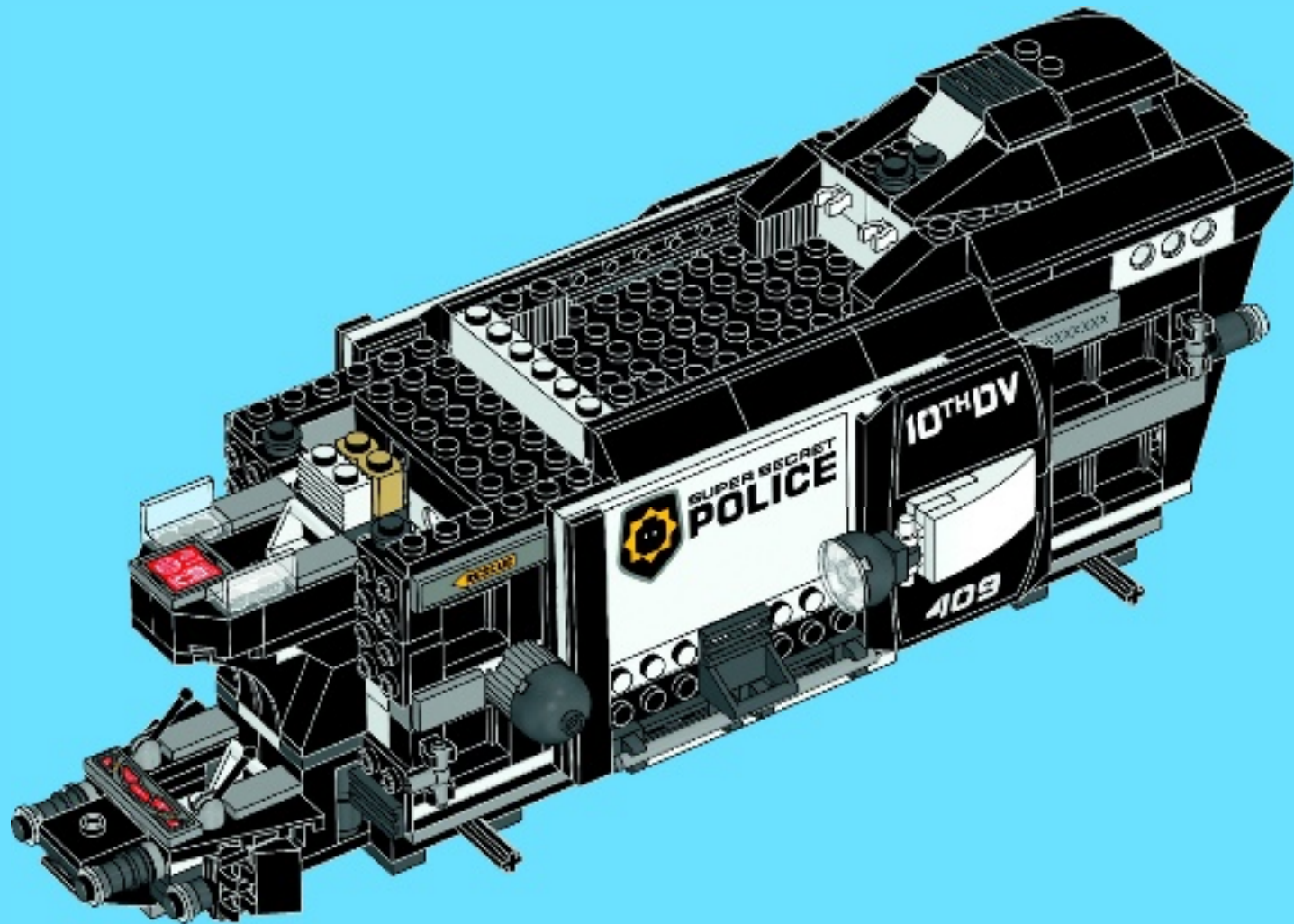

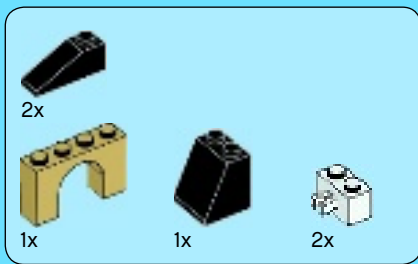

75

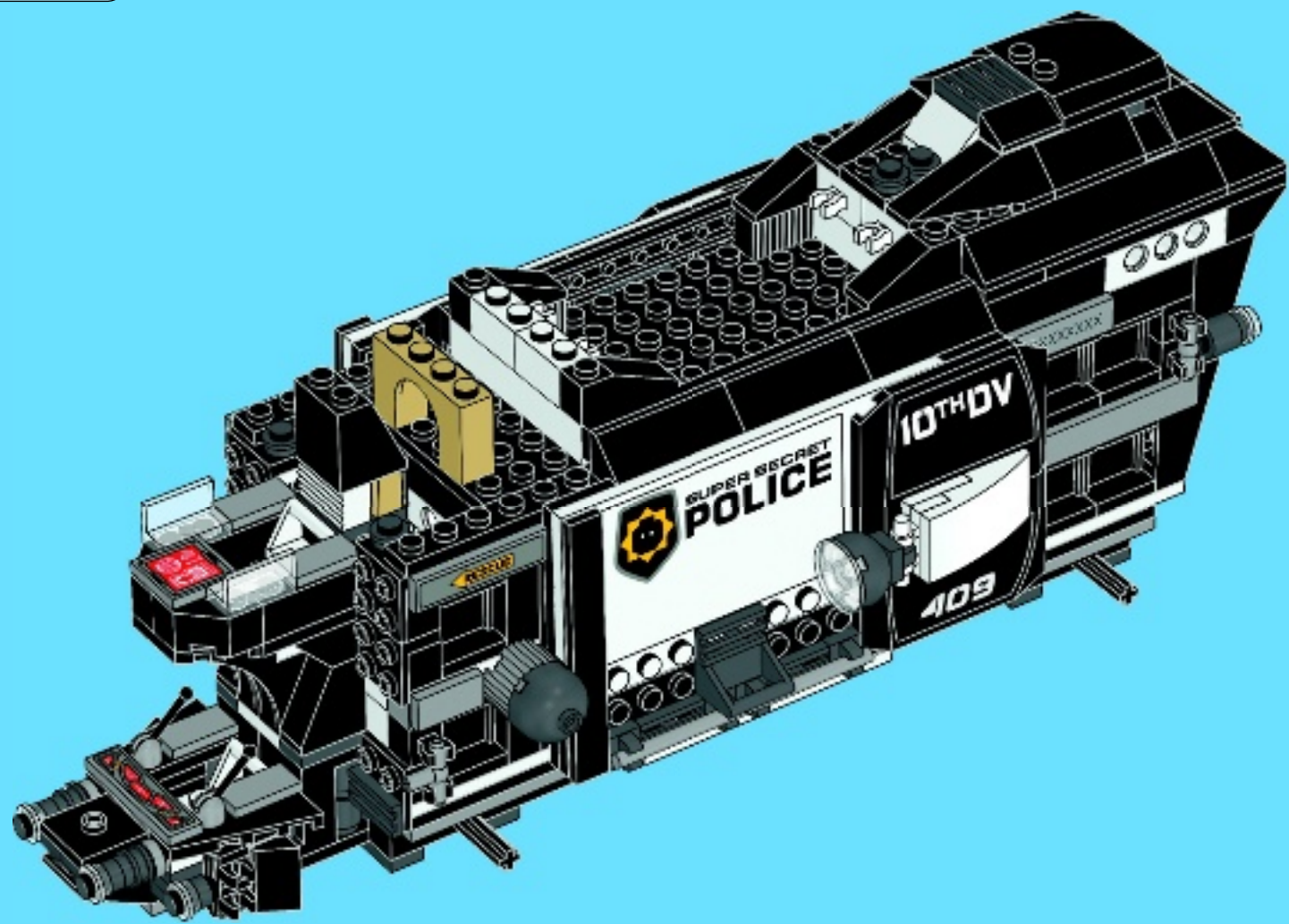



2x

76

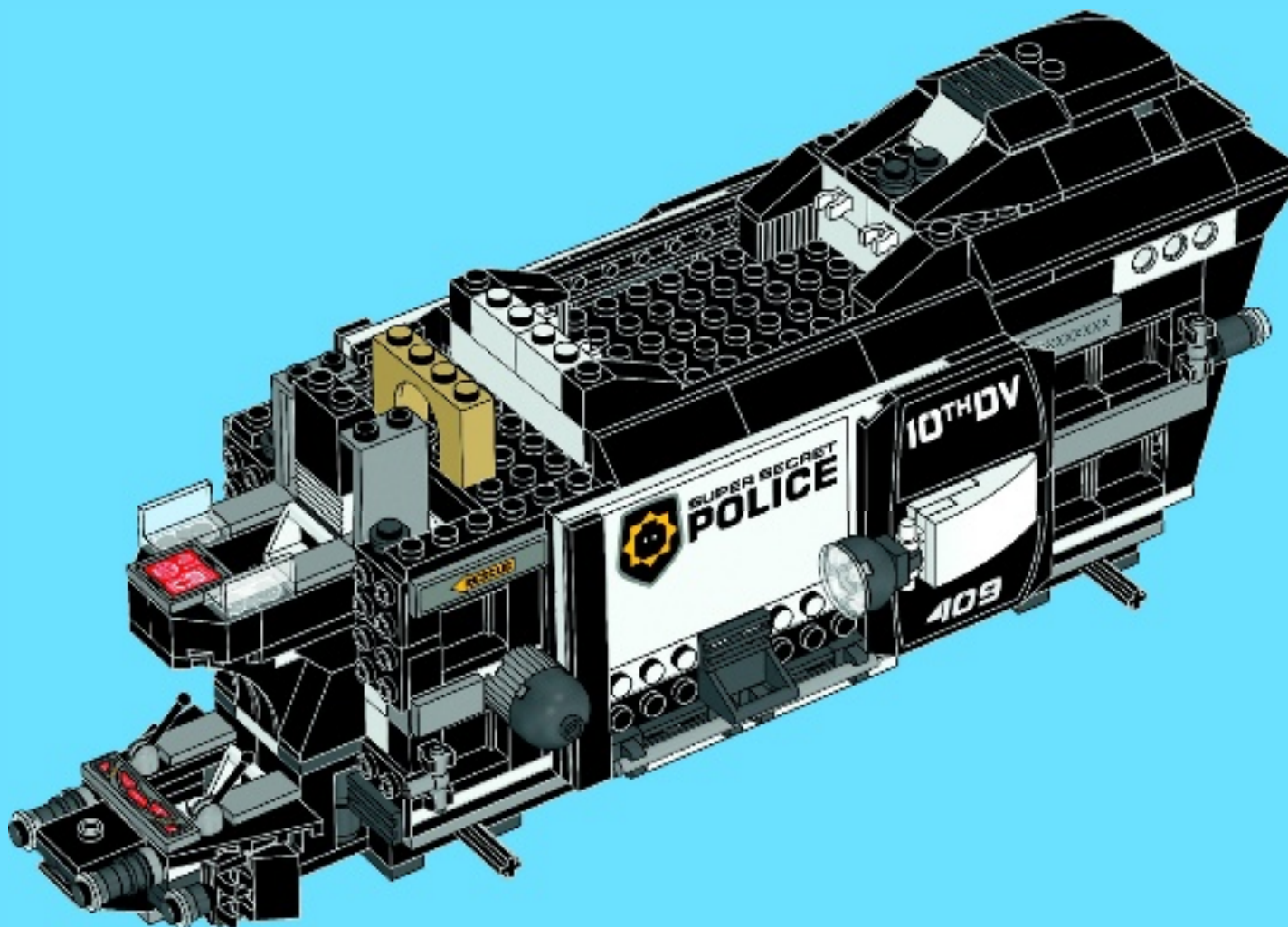



6x

77

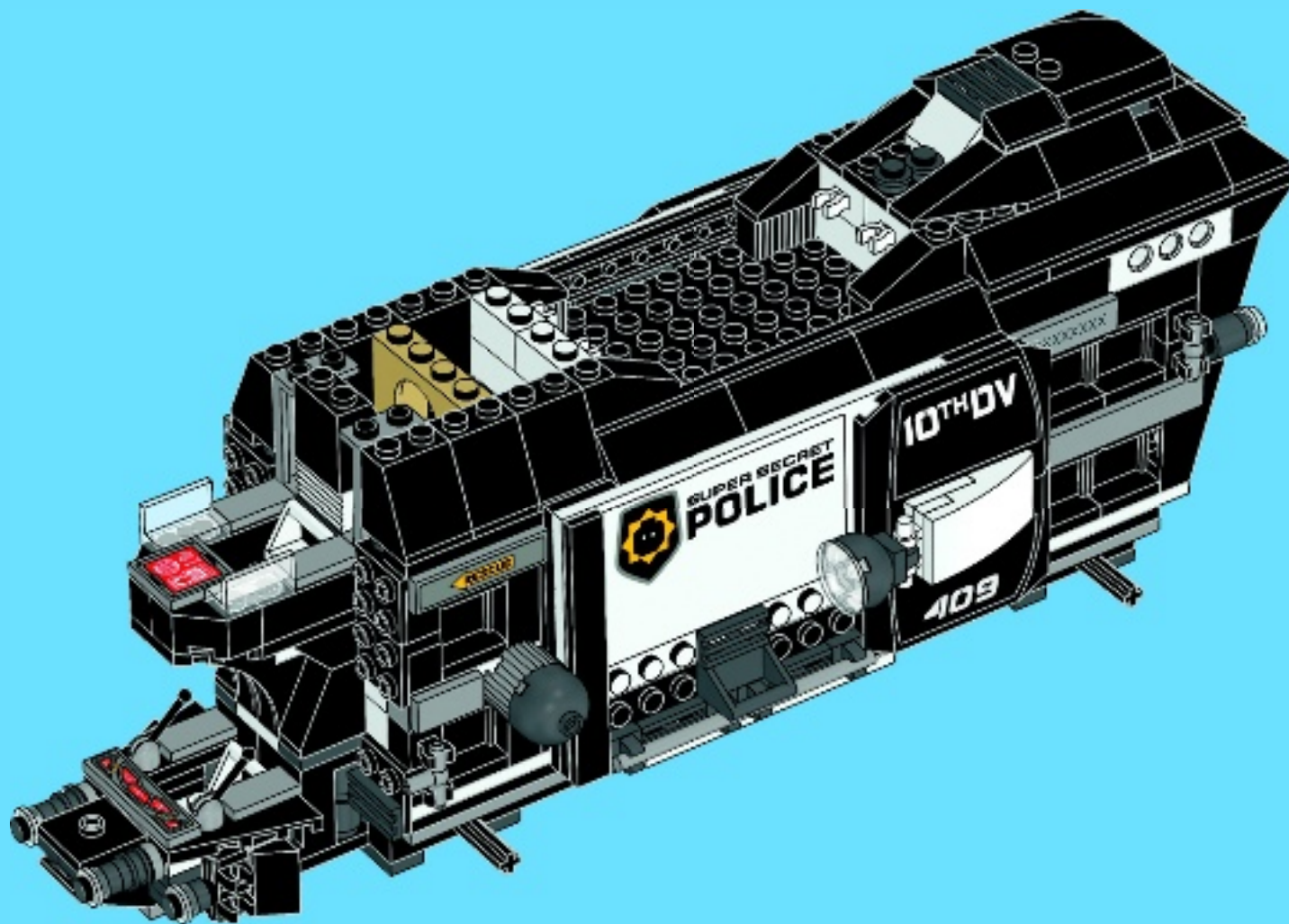

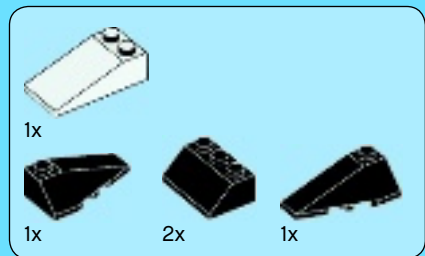

78

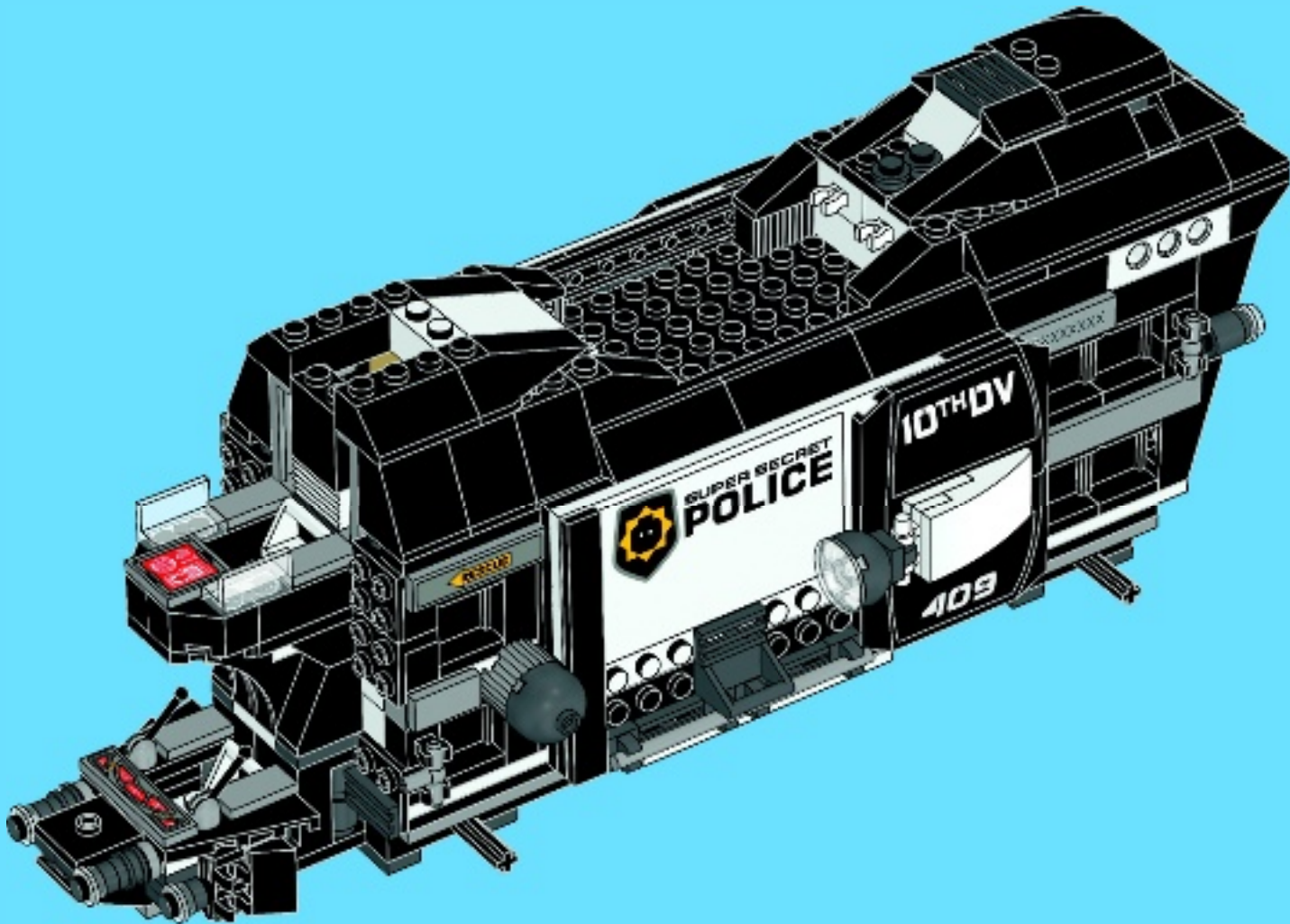



1x



1x



1x

79

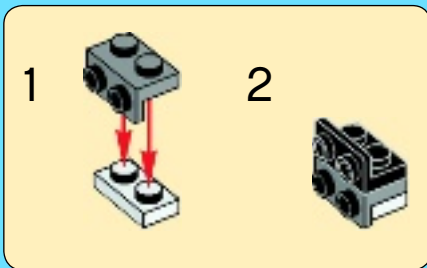

2

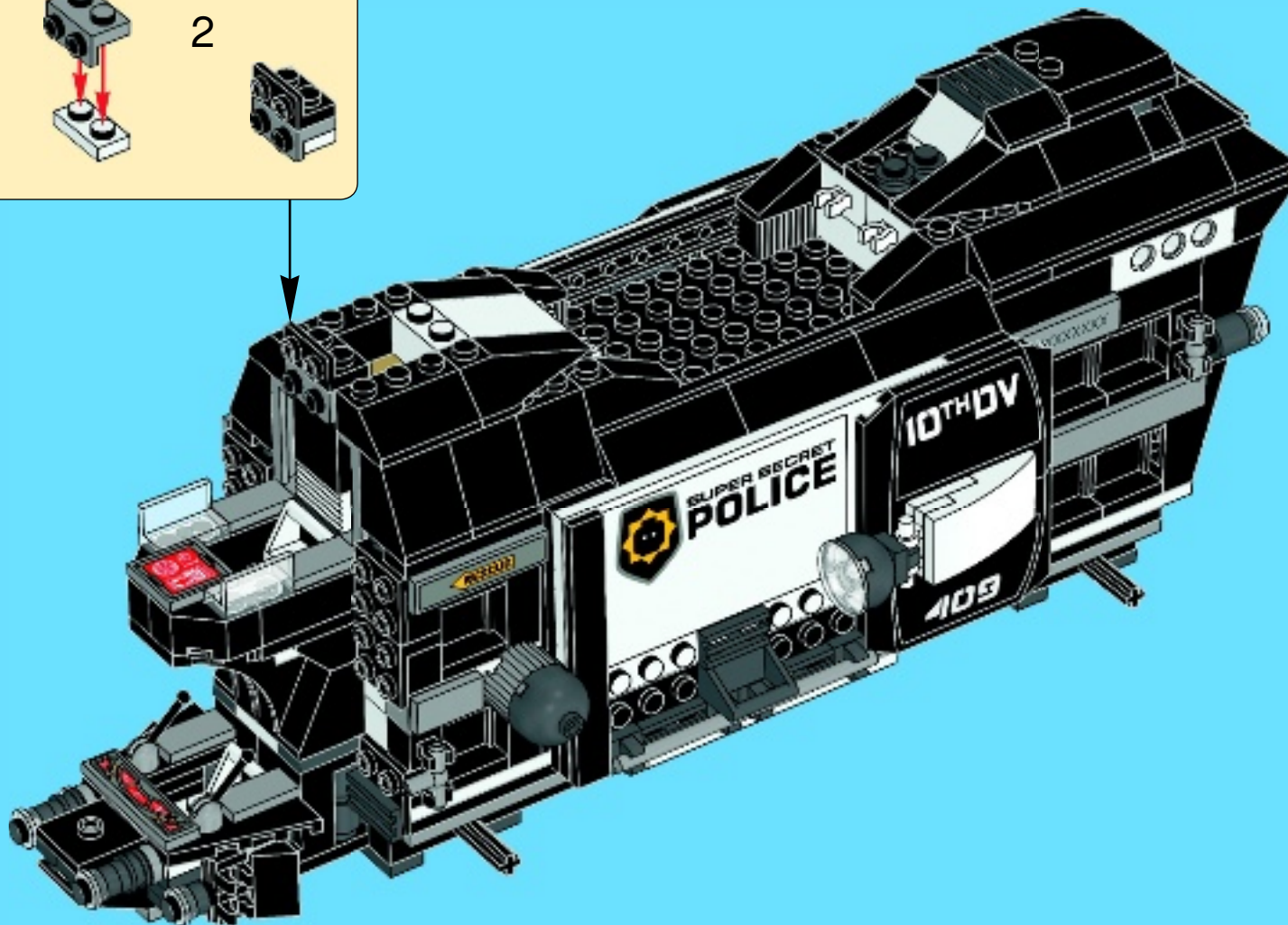



1x



1x



1x

80

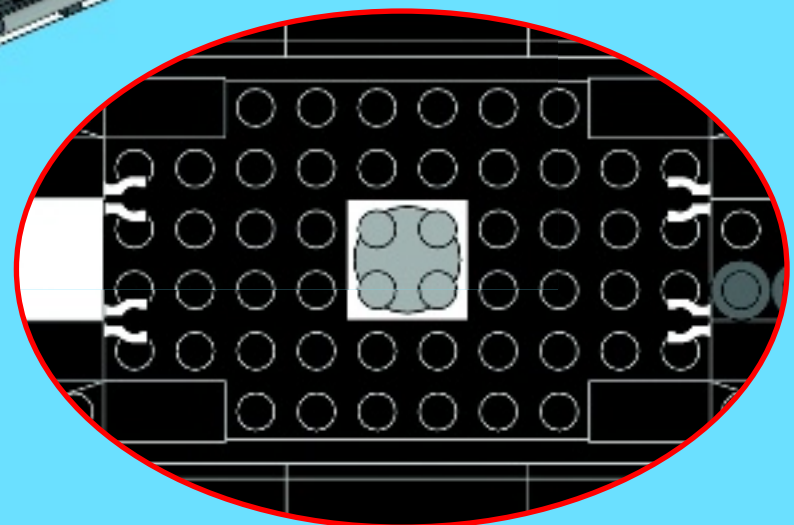
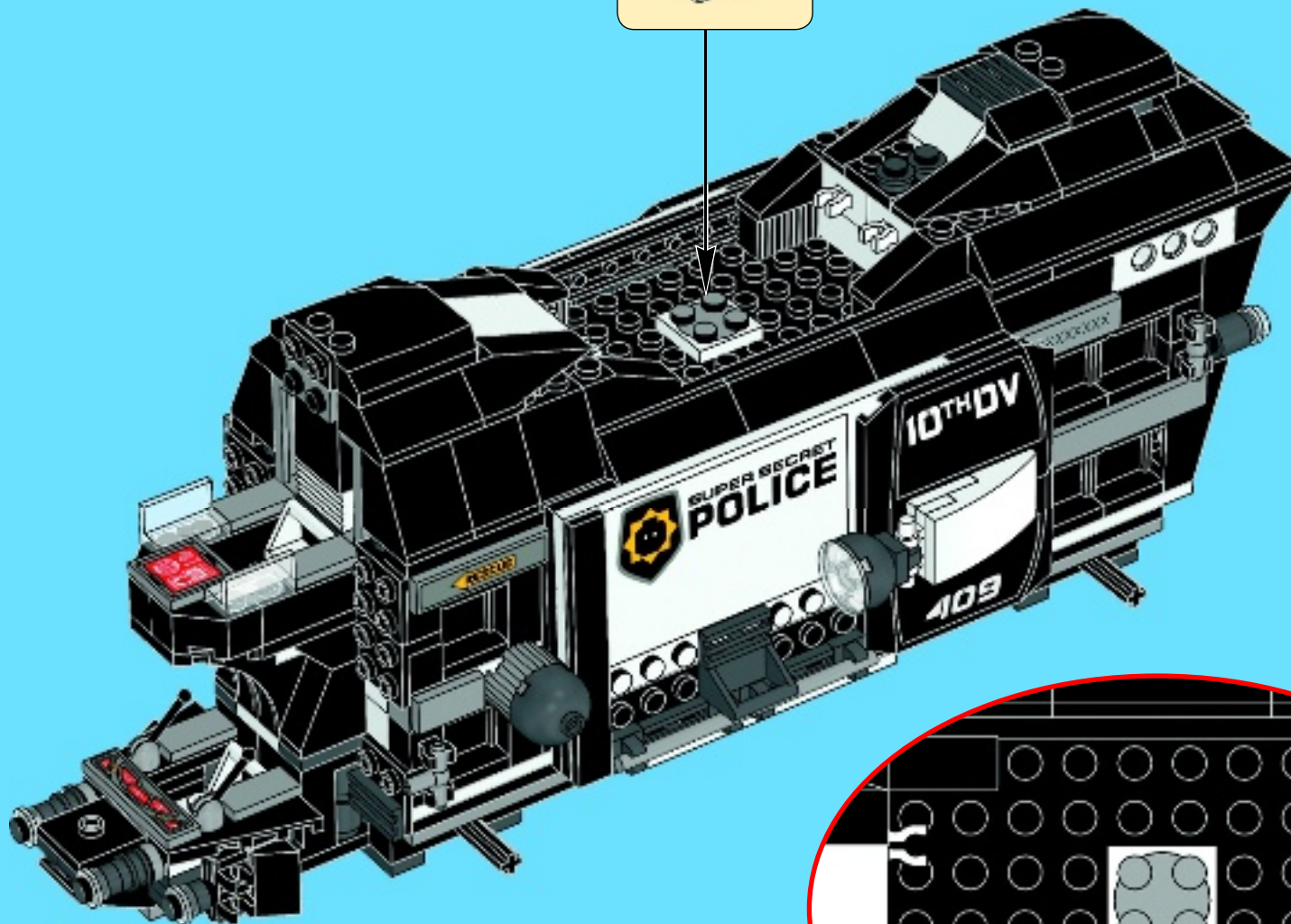
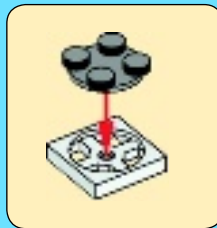



2x

1

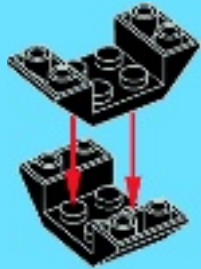

2x

2

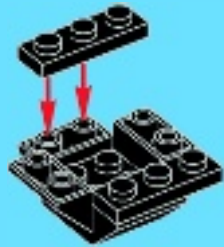

2x



2x



1x

3



1x



2x

4

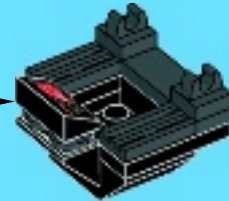
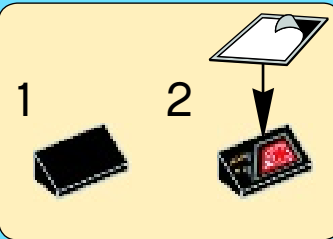



1x

5



2x

6



1x



1x

7

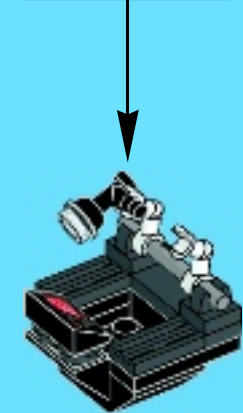
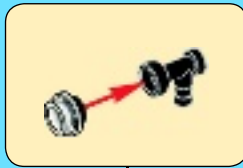

1x



1x



1x

8

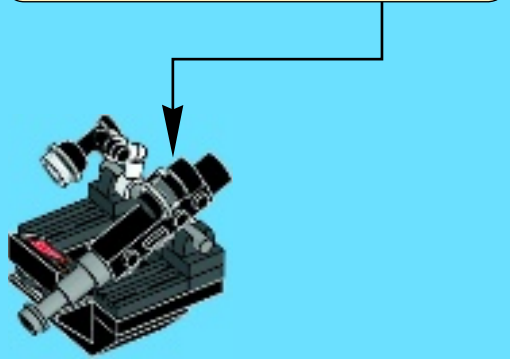
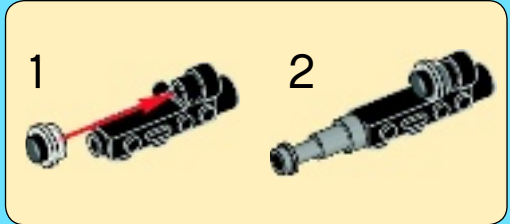

81

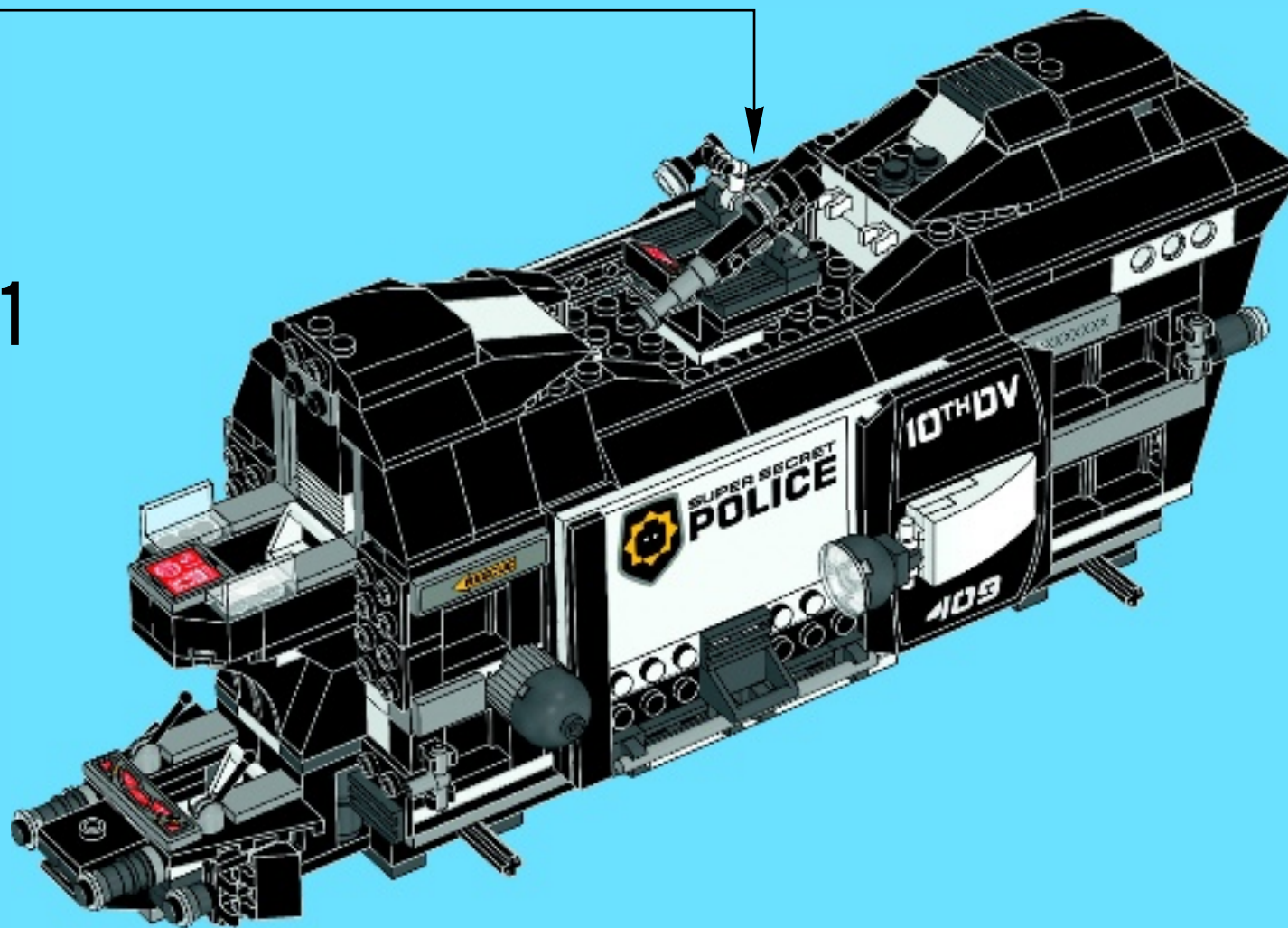



2x



2x



2x

82

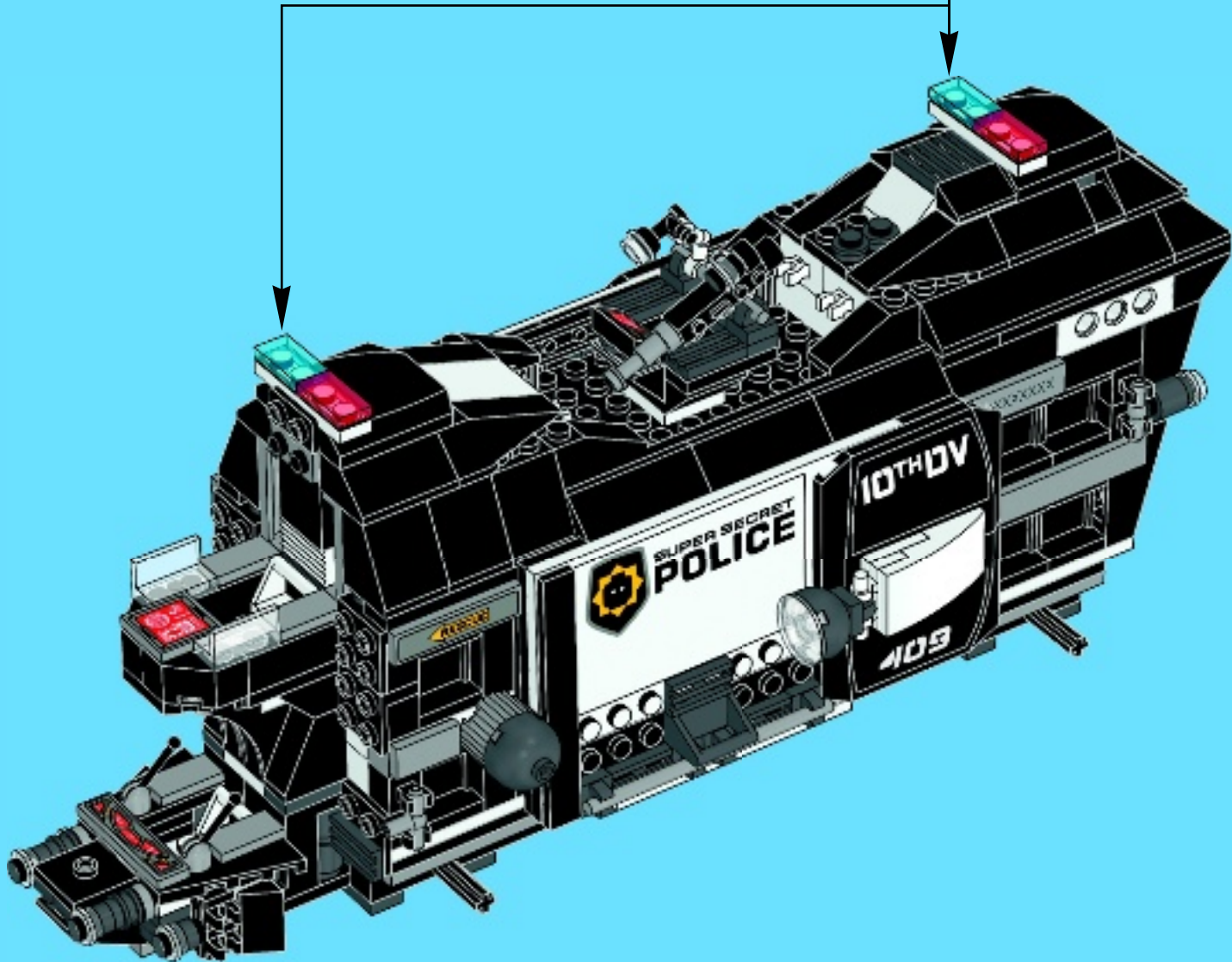
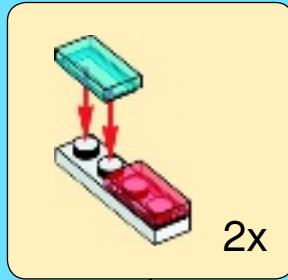



1

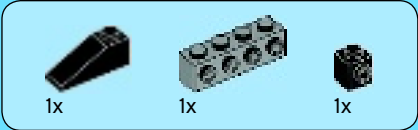

2

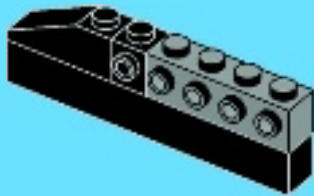

3

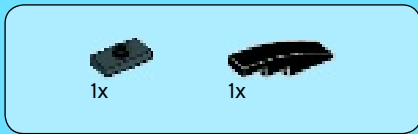
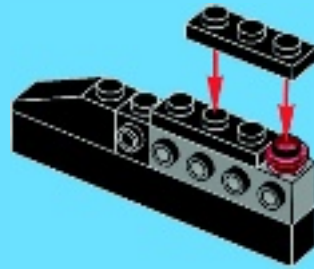

4



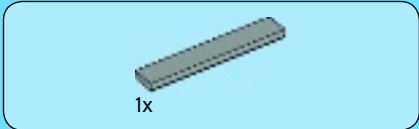

83

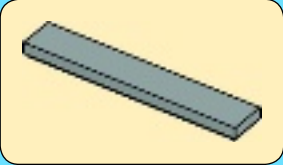
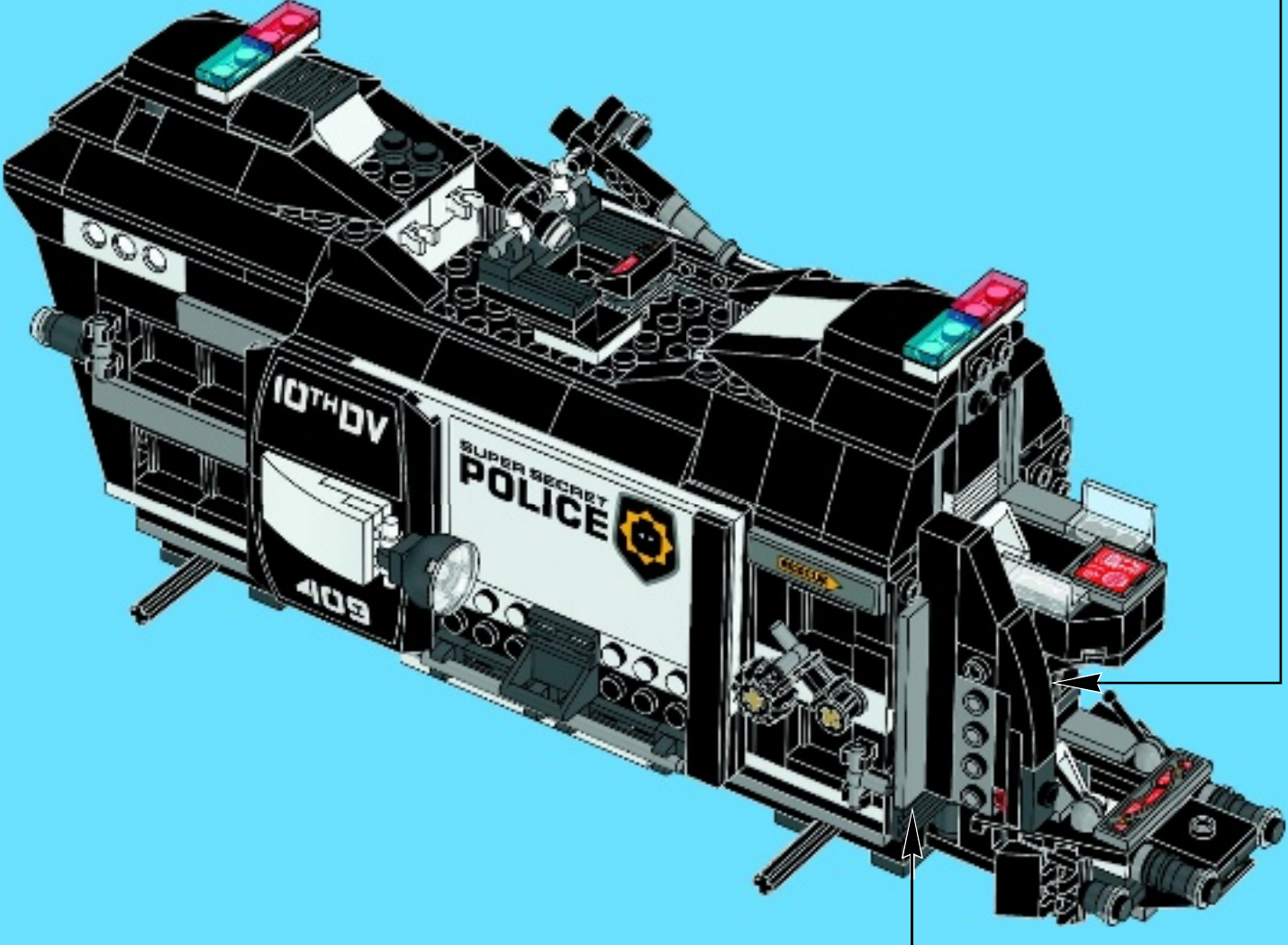
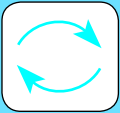

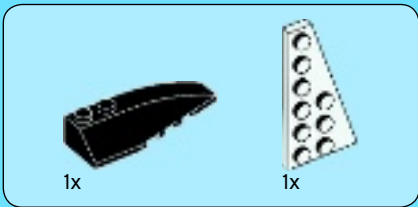

84

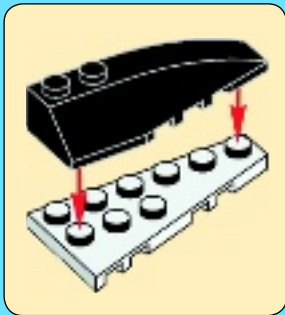
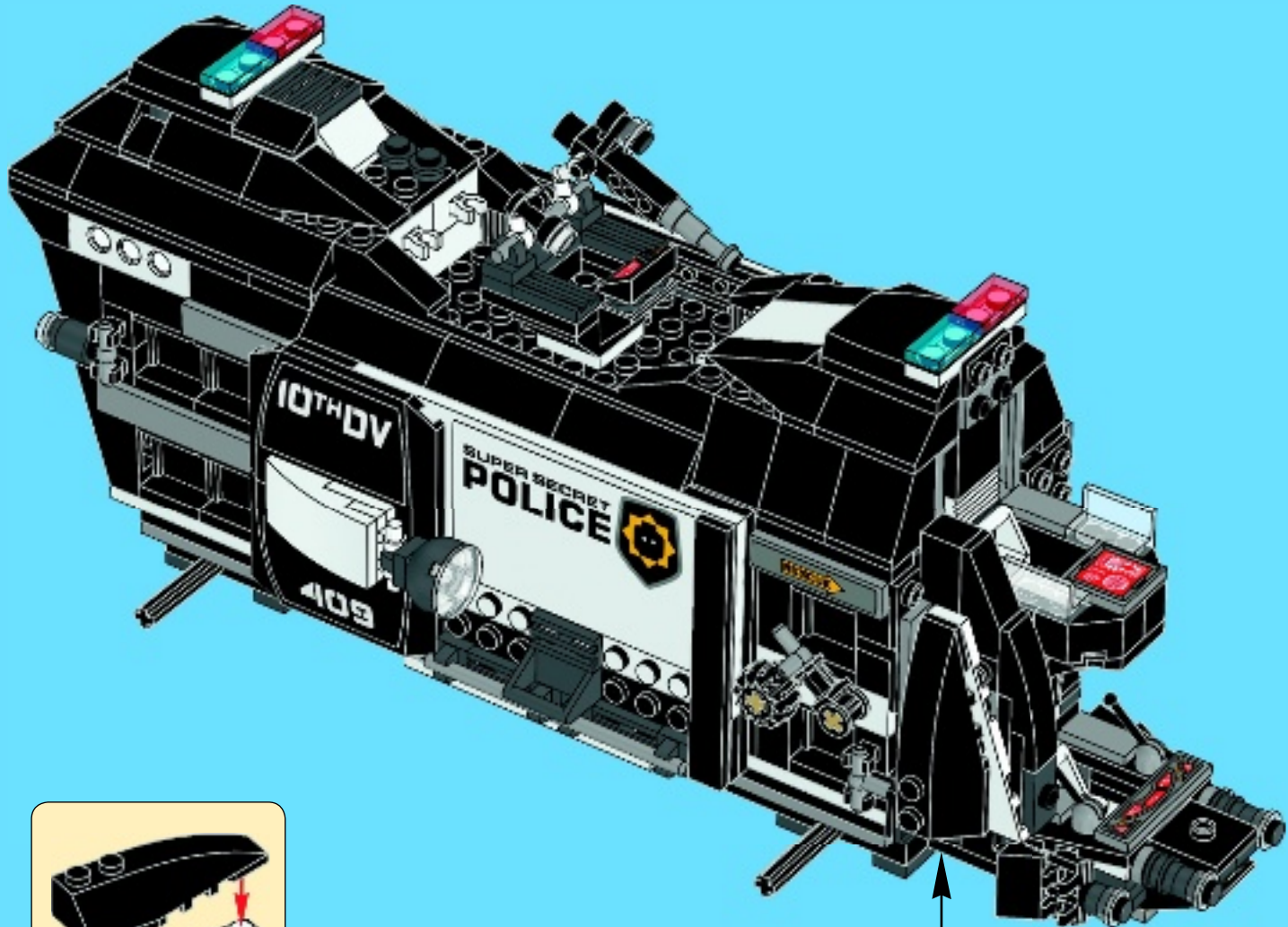



1

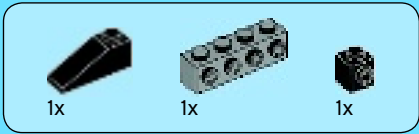

2



3

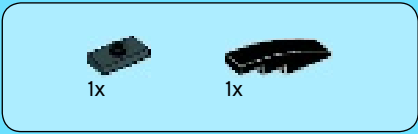
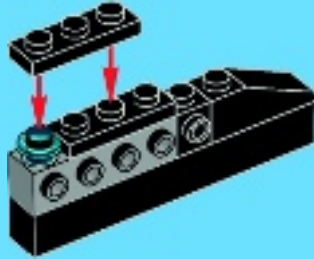

4





1x

85

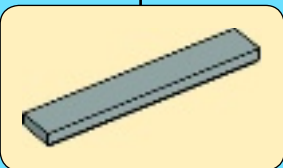
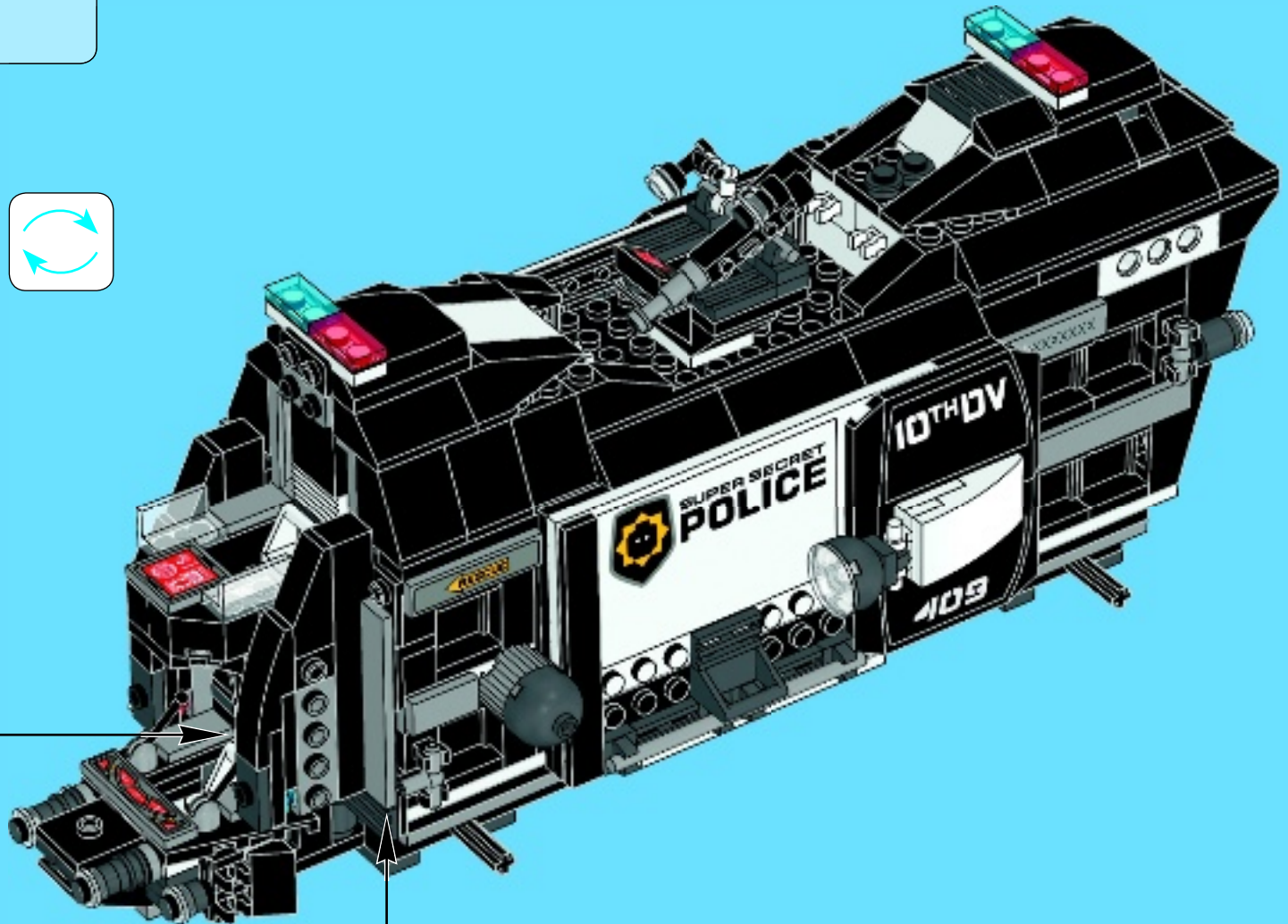
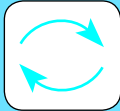

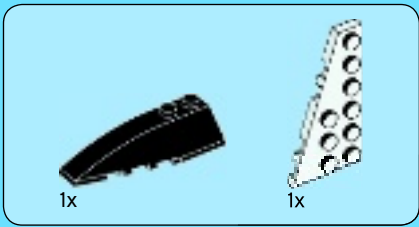

86

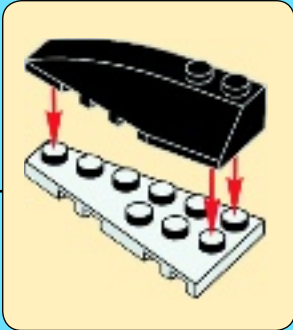

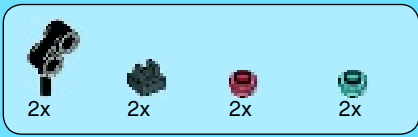

87

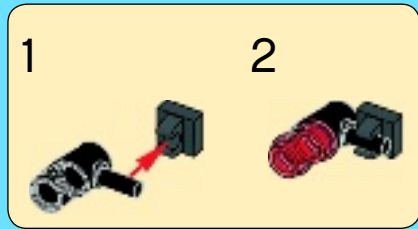

2

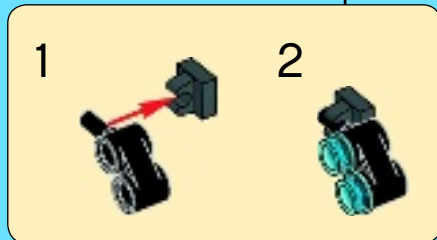
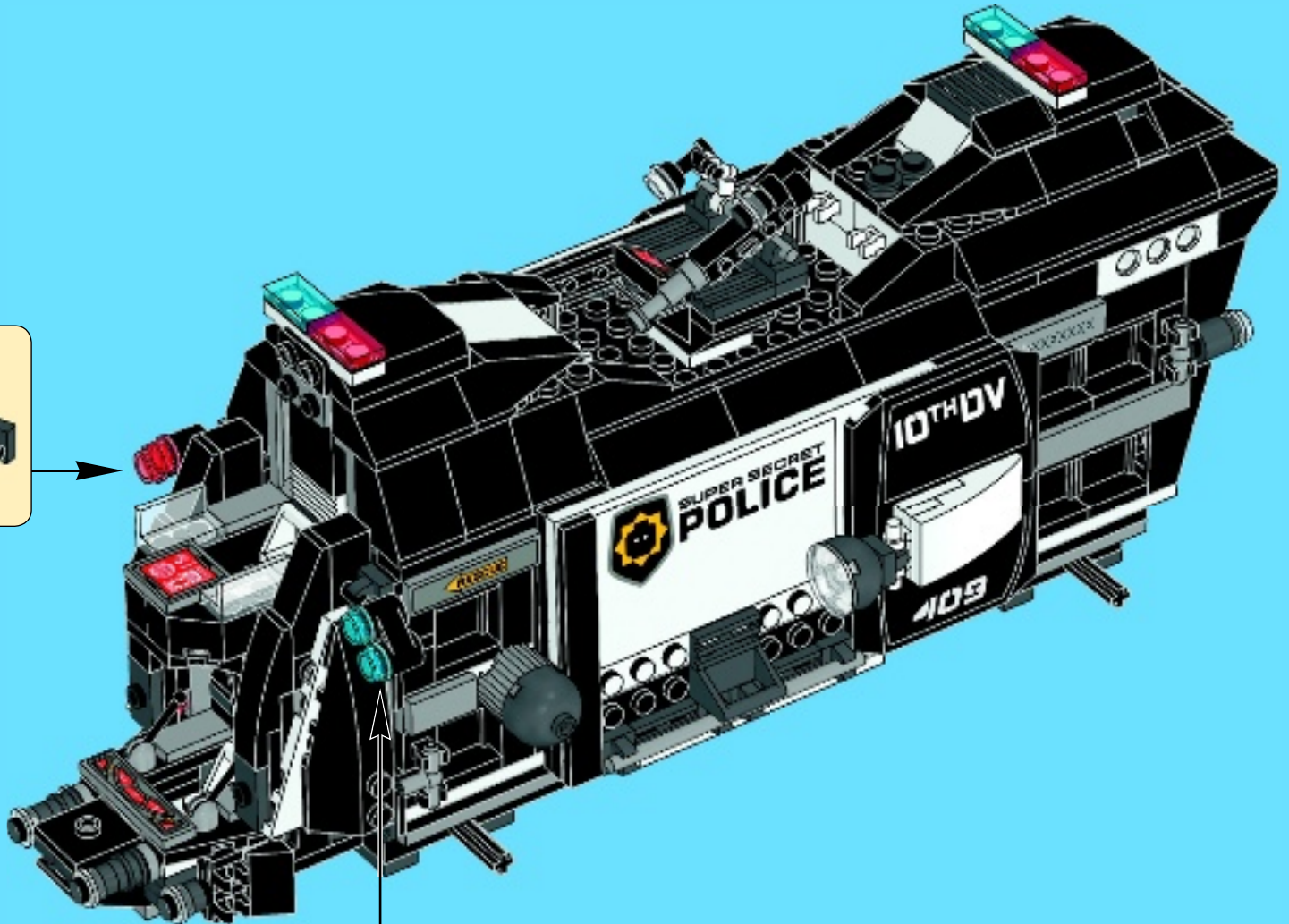



5



+

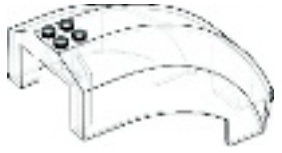



2x



2x

1

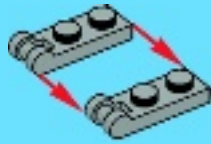

1x

2



2x

3

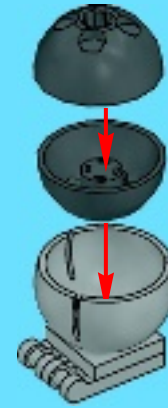

1x

4



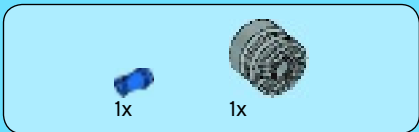

5

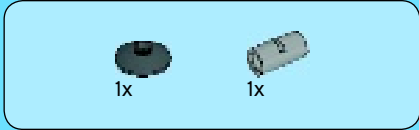

6



2x

88

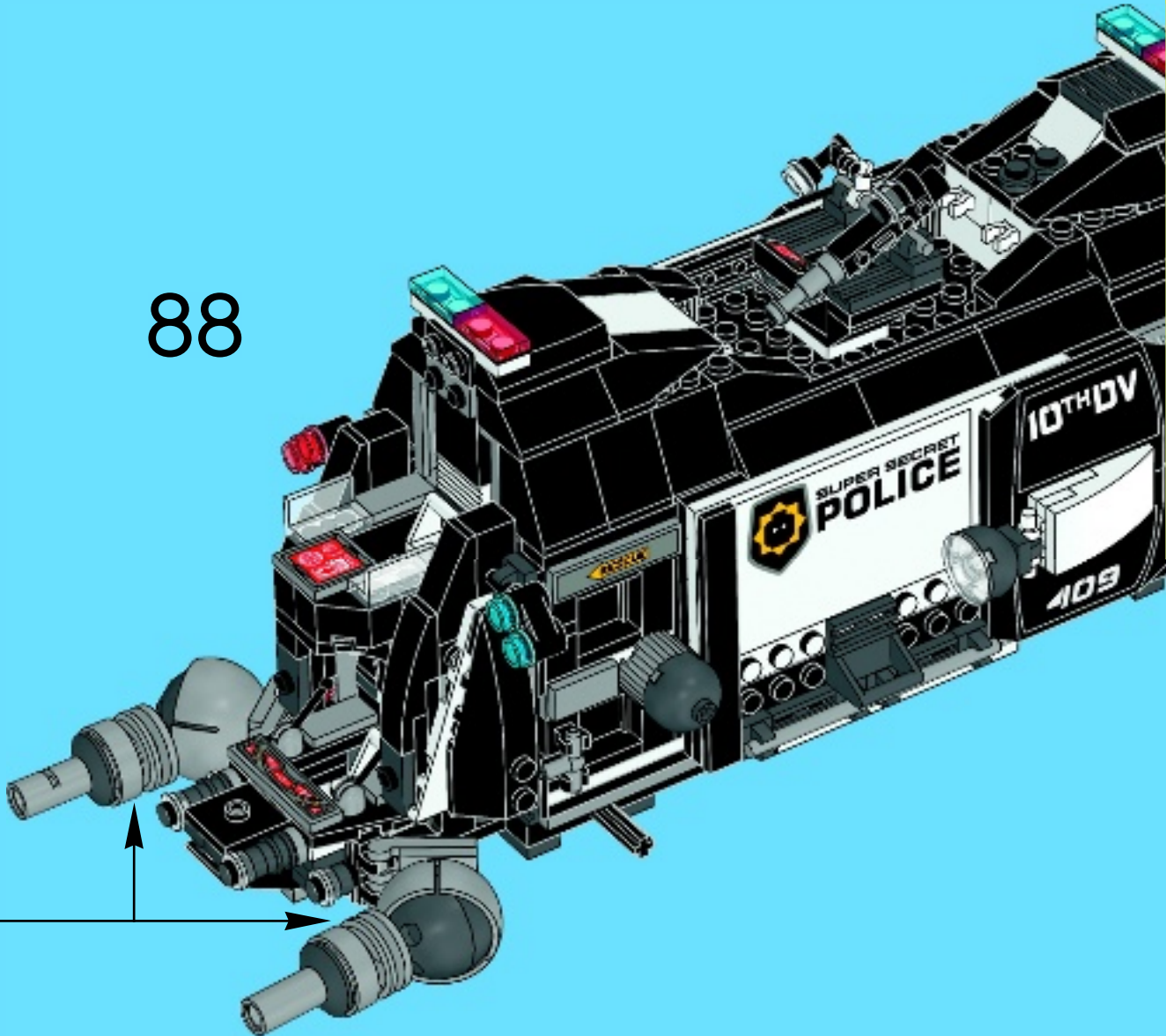

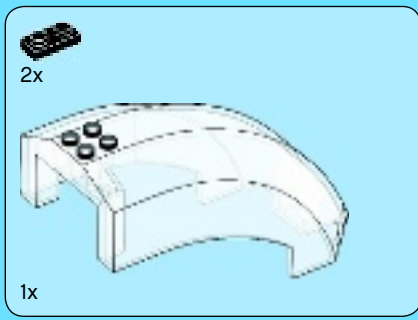

89

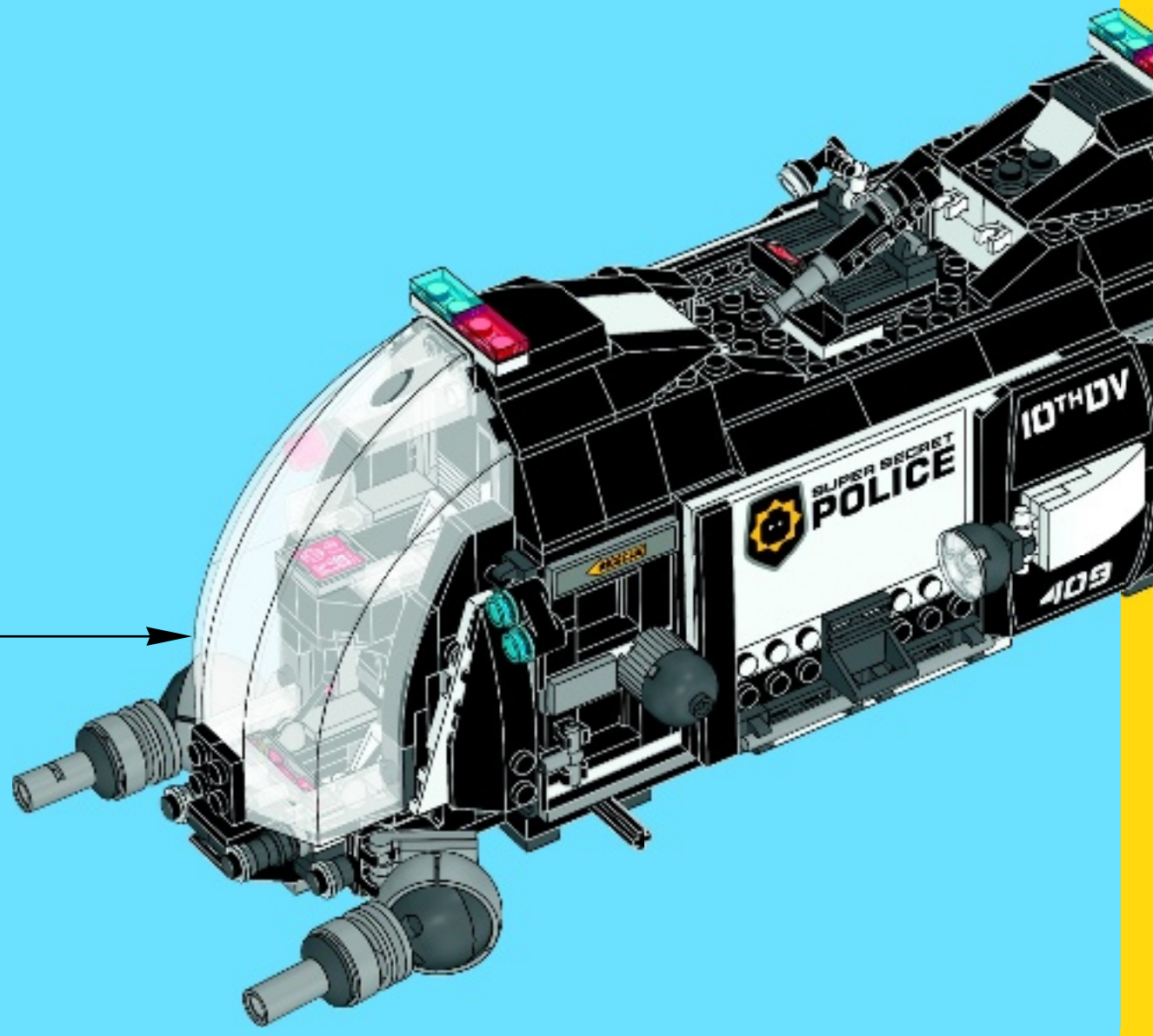
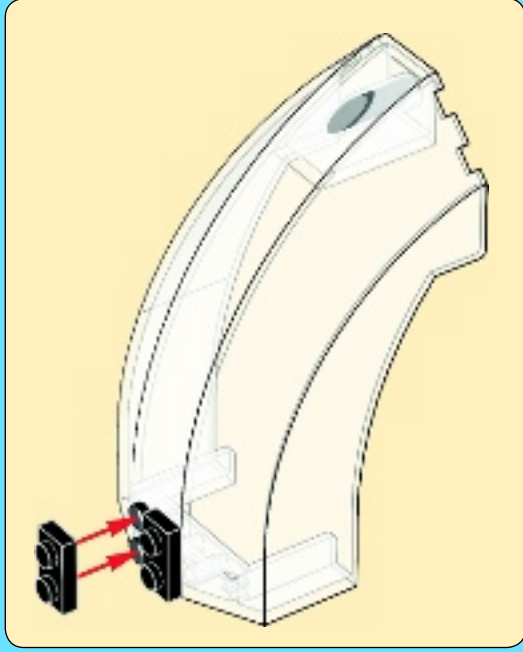

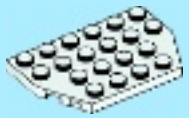

1x

1



1x



1x



1x

2



2x



2x

3



2x



1x

4

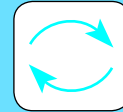

2x

5



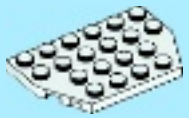

1x

1



1x



1x



1x

2



2x



2x

3



2x



1x

4

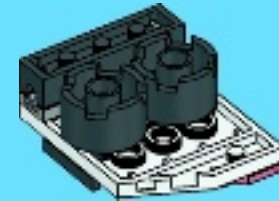
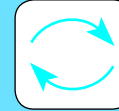

2x

5



91

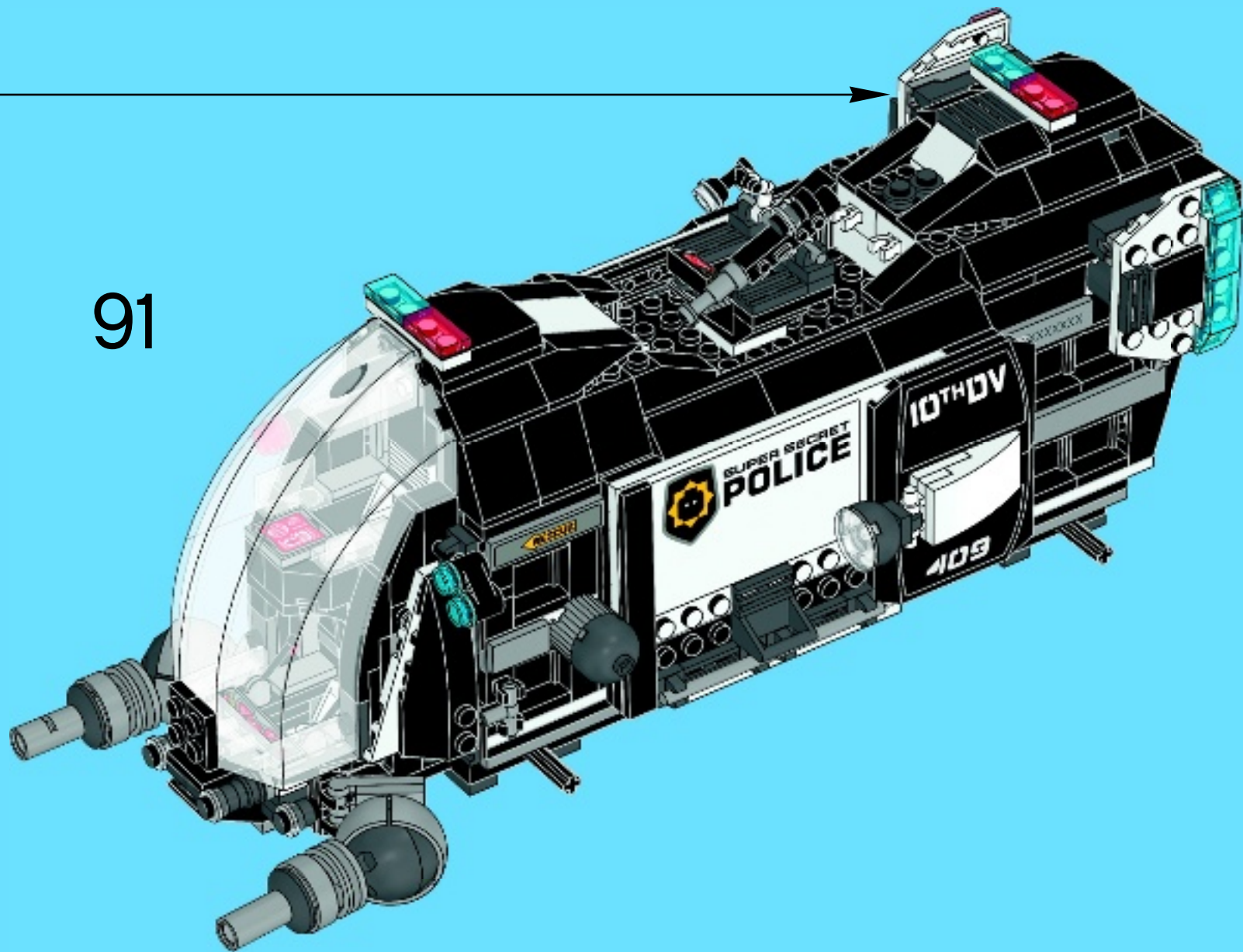



92

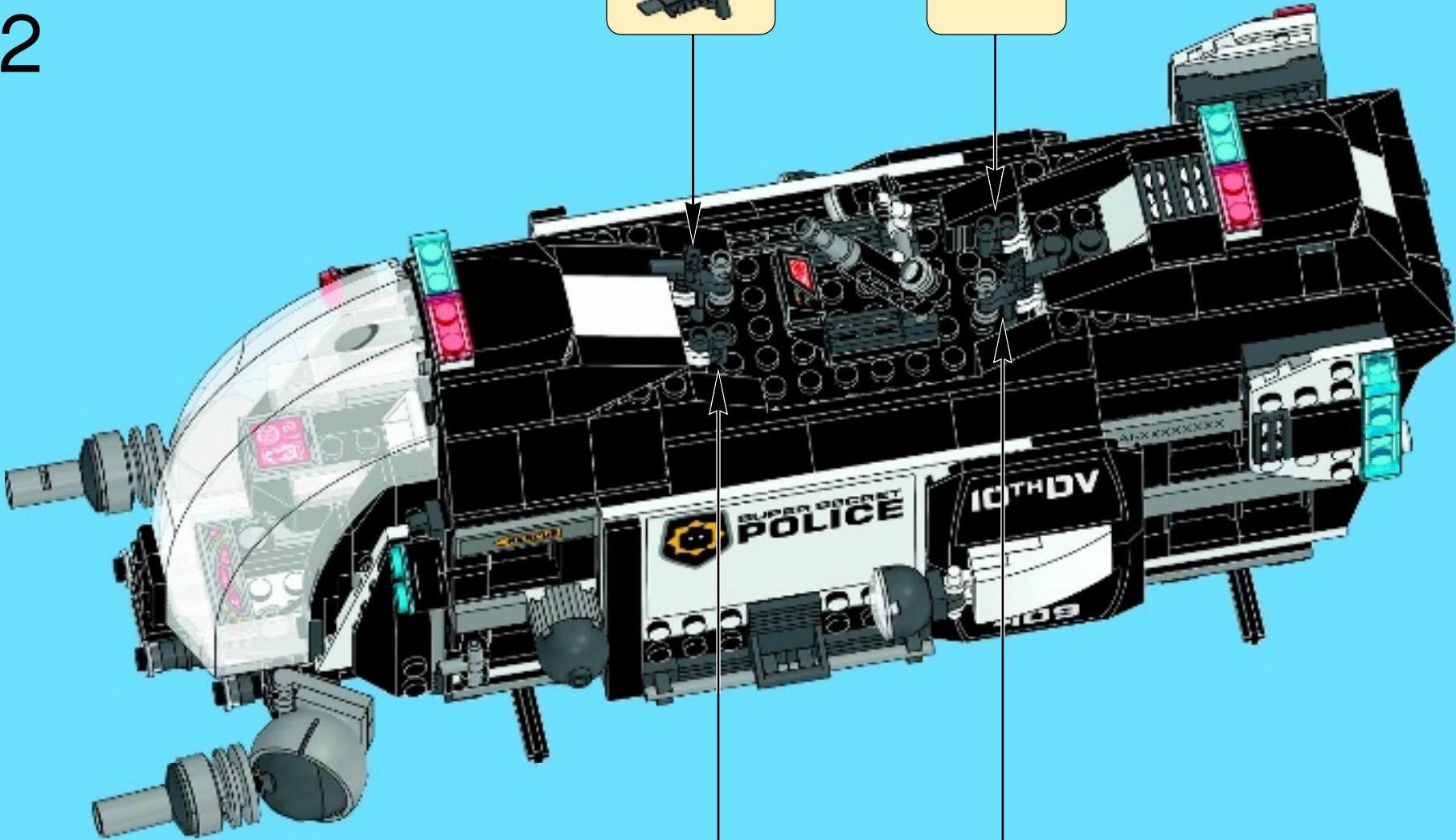



93

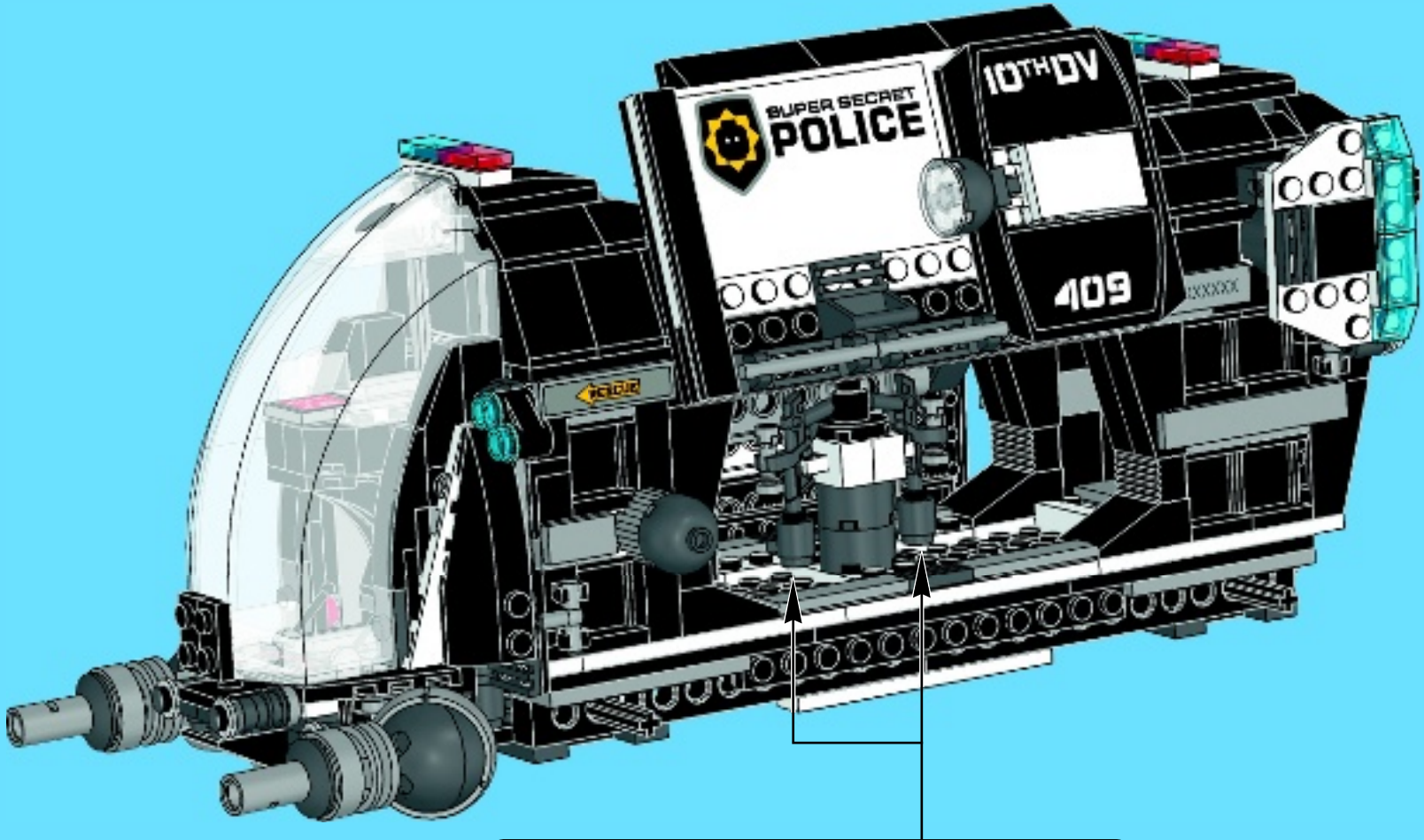



2x

1

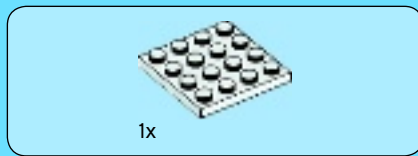
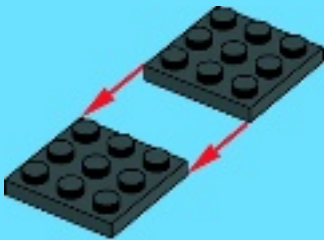

1x

2



2x

1x

3

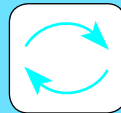

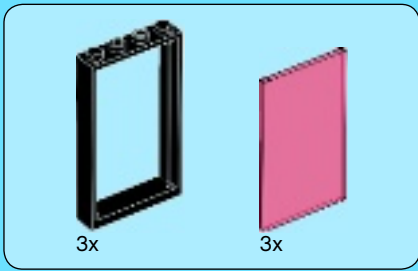

4

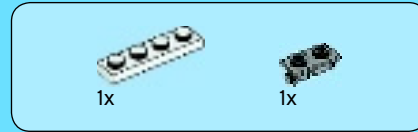
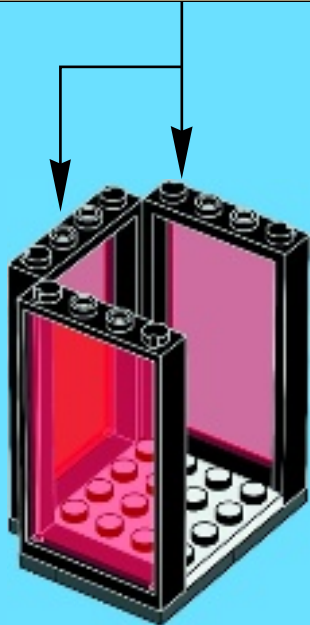
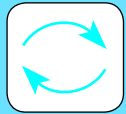
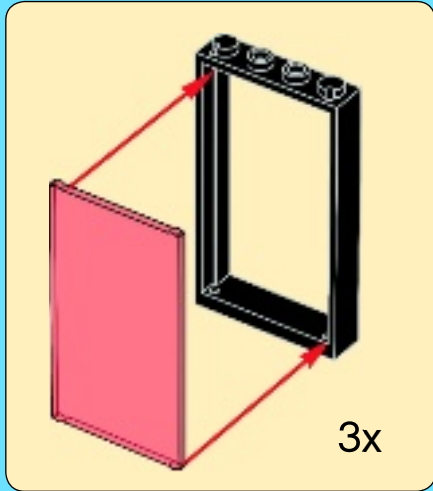

1

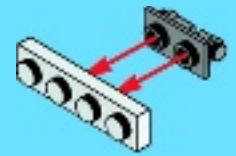

2

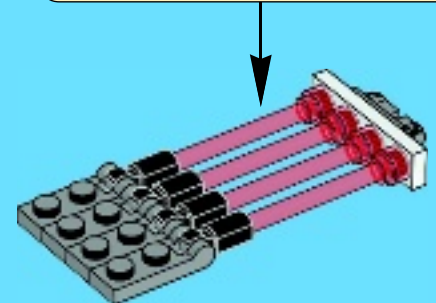
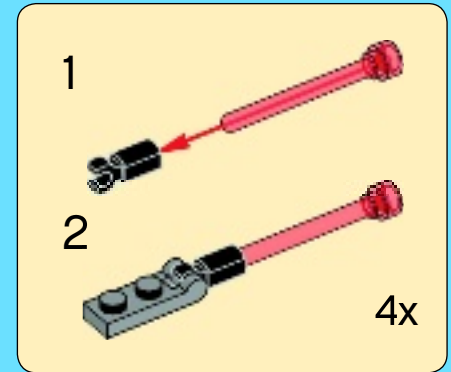



3

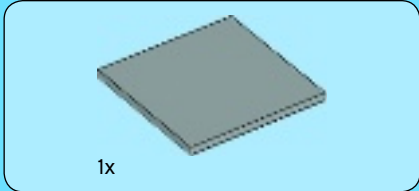
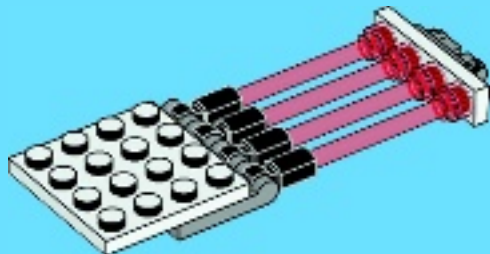

4

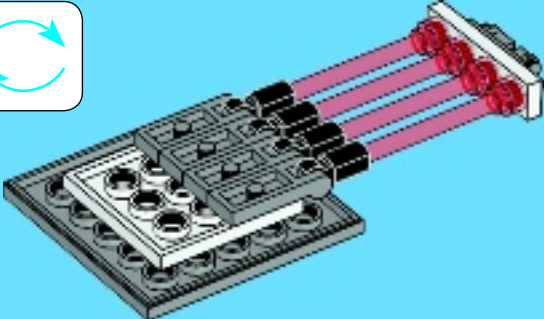
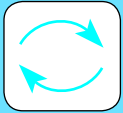

5

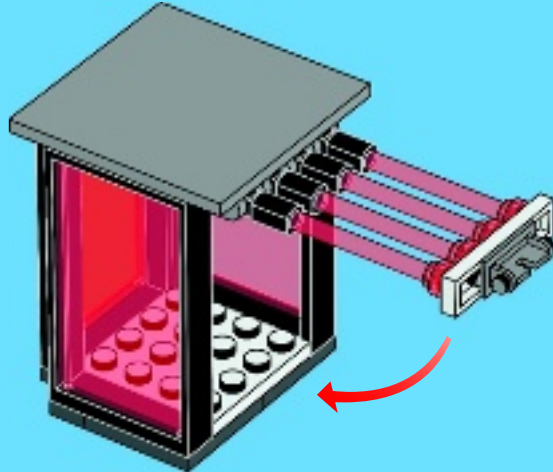

94

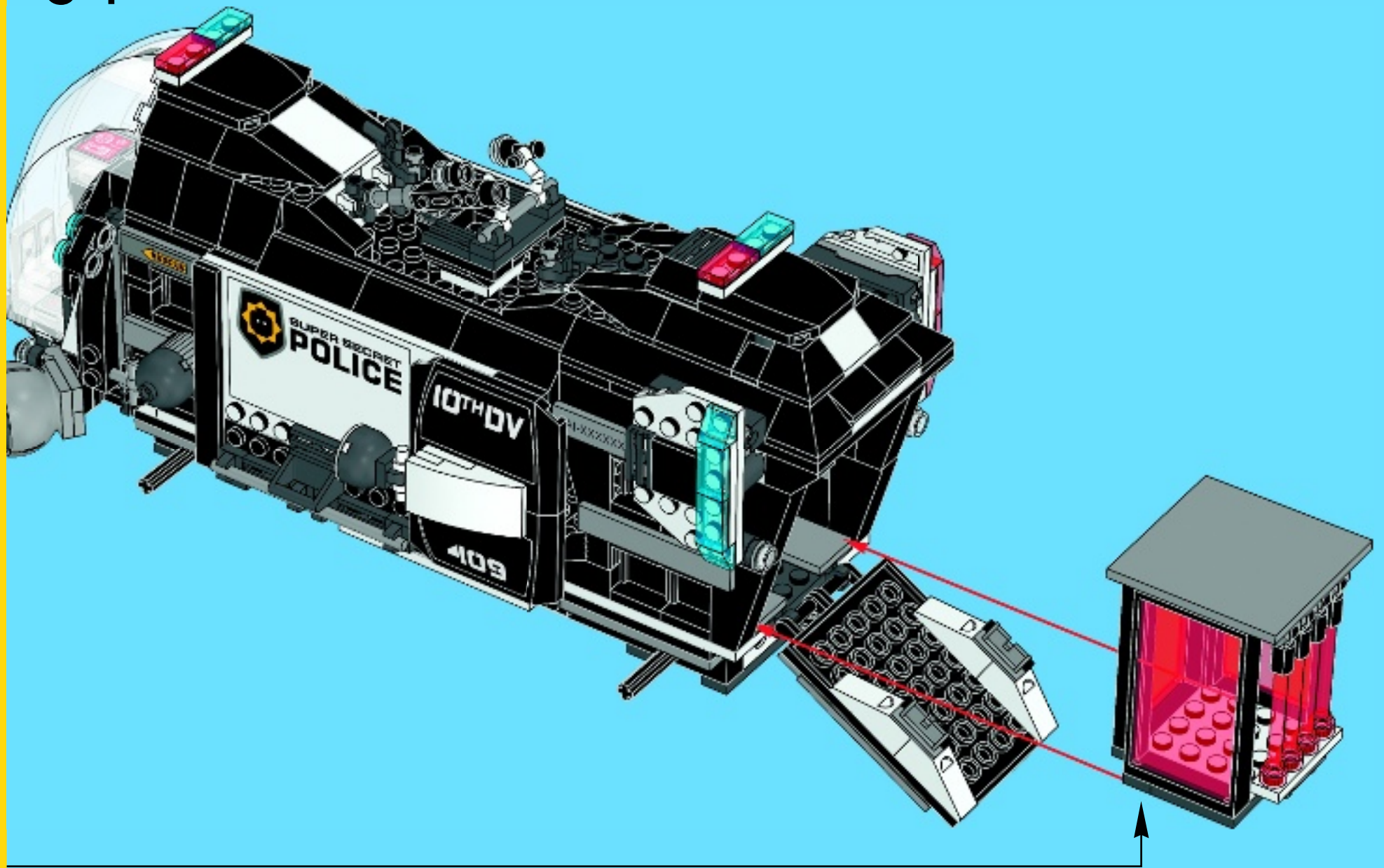



6

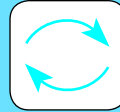
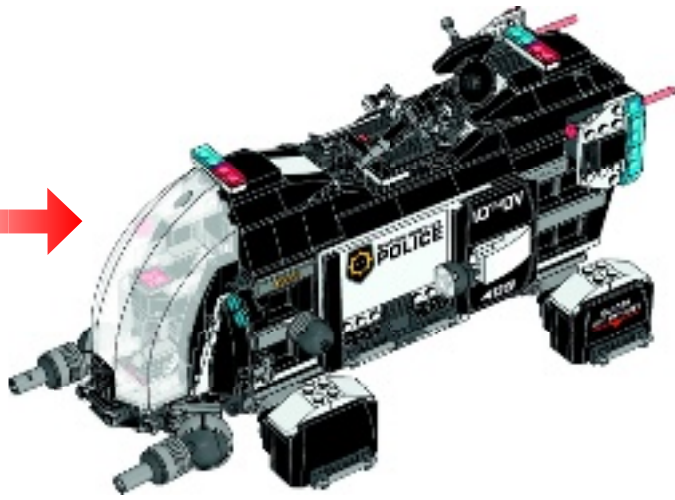

4x

95

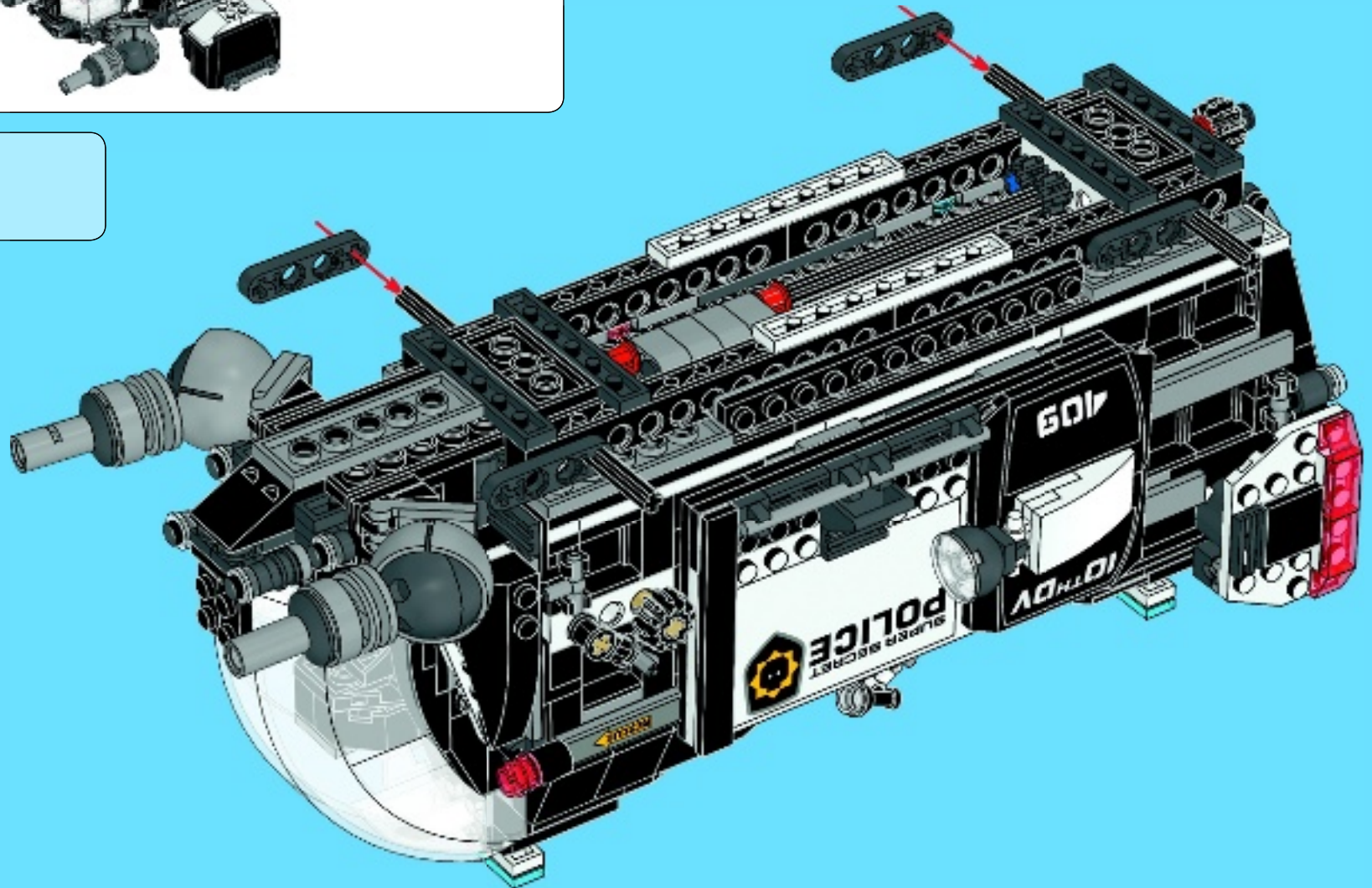



4x

96

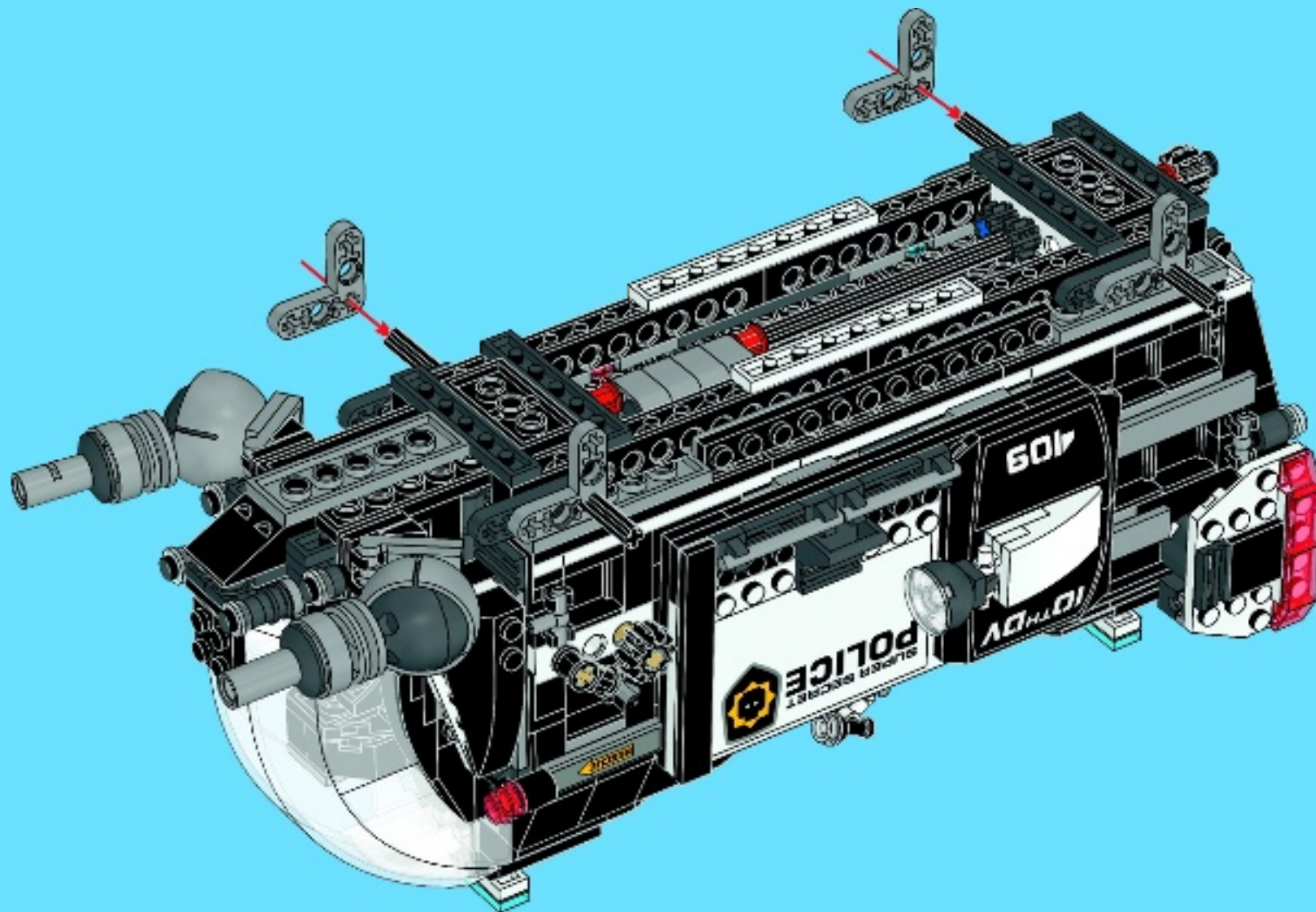

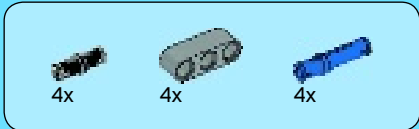

97

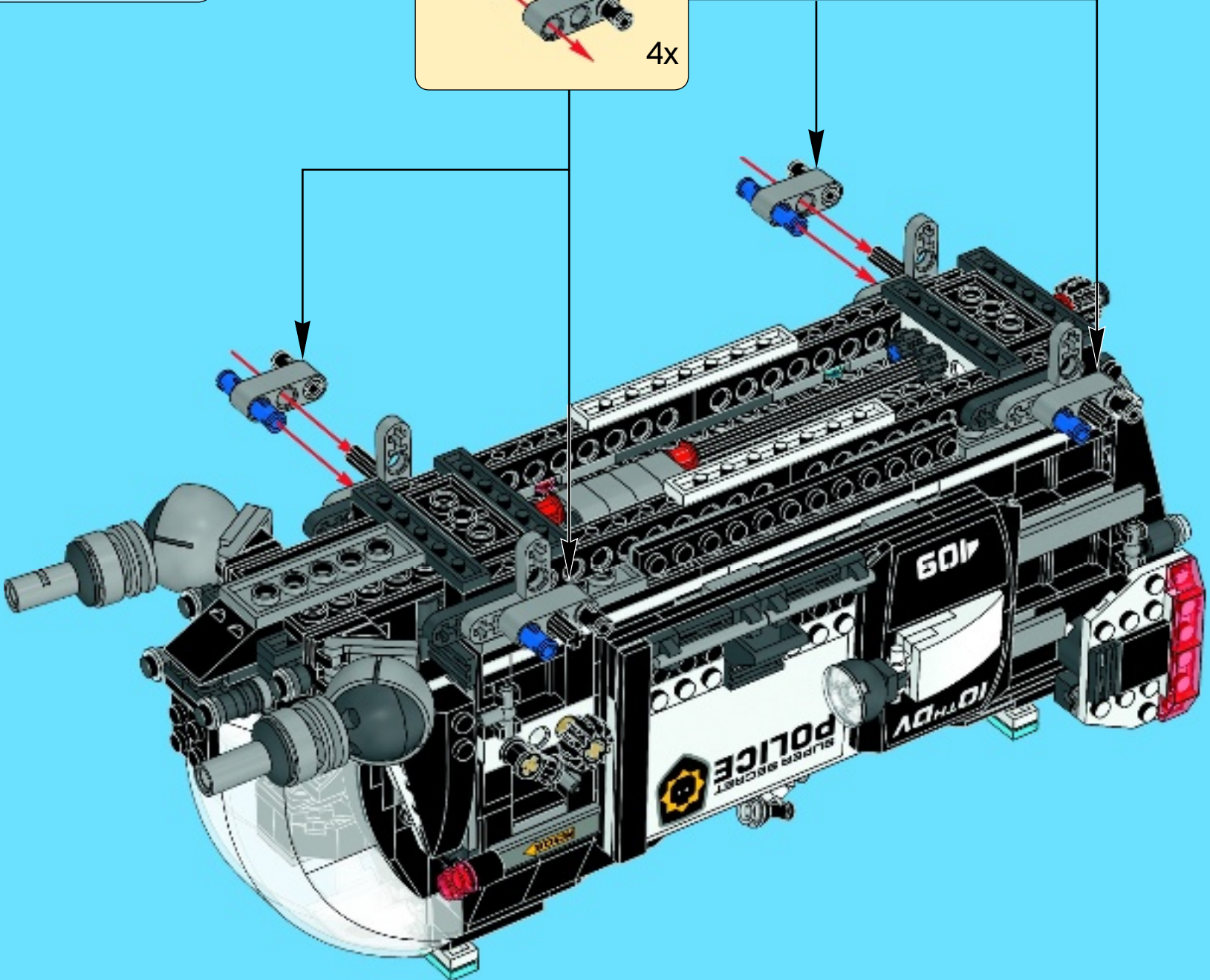
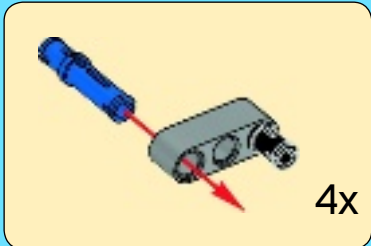



4x



2x

1



2x



1x

2

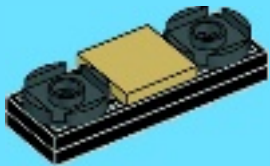

2x



1x

3

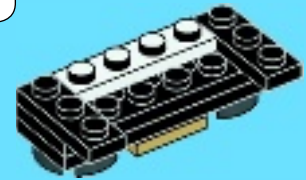
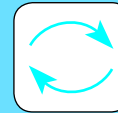

1x

4



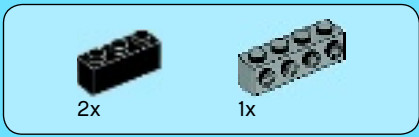

5

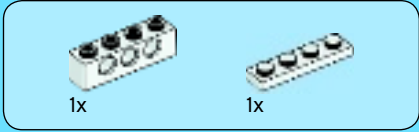
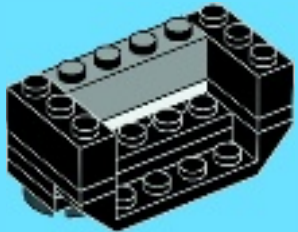

6

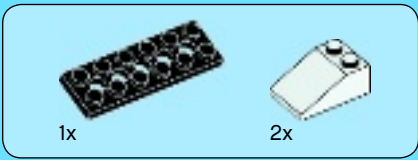

7

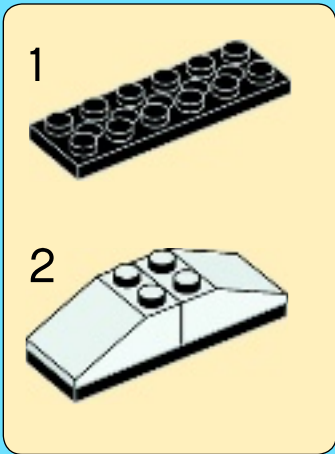

8





4x



2x

9

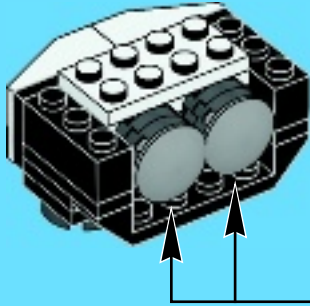

1x

10

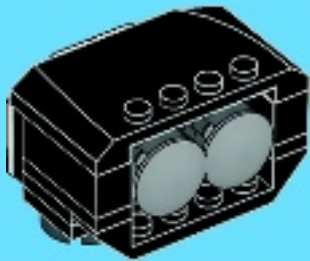

1x



1x



2x



11

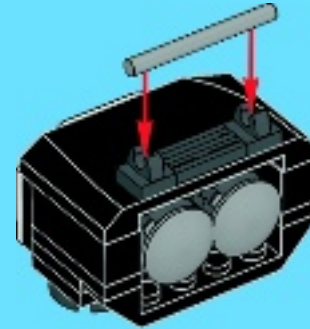

1x

5



2x

12

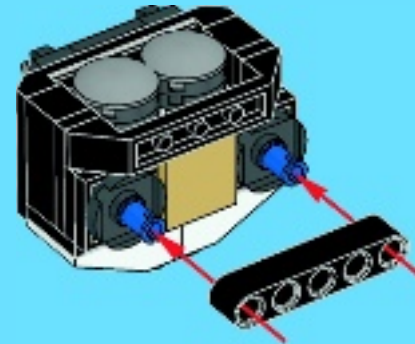
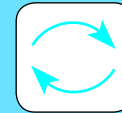

4x

98

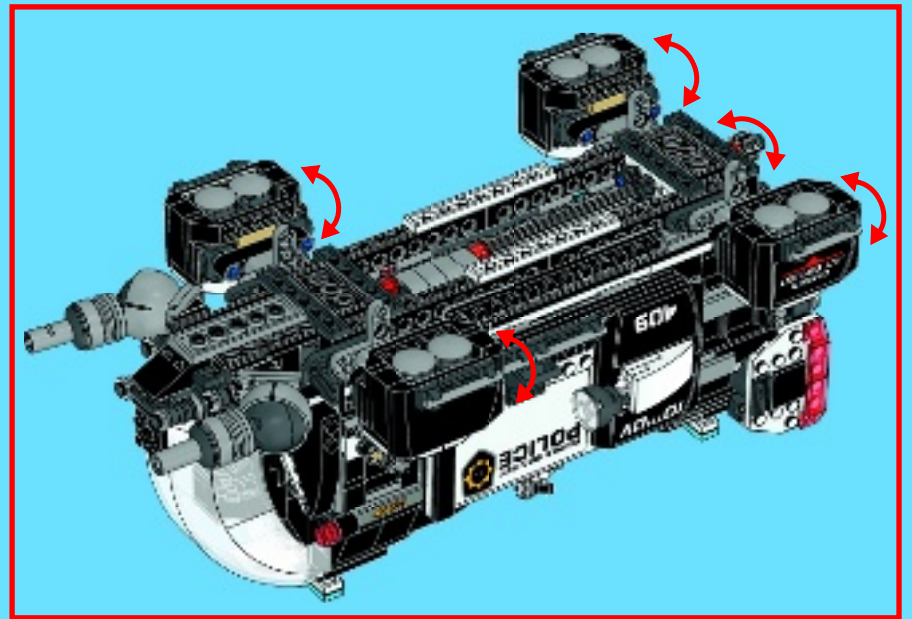
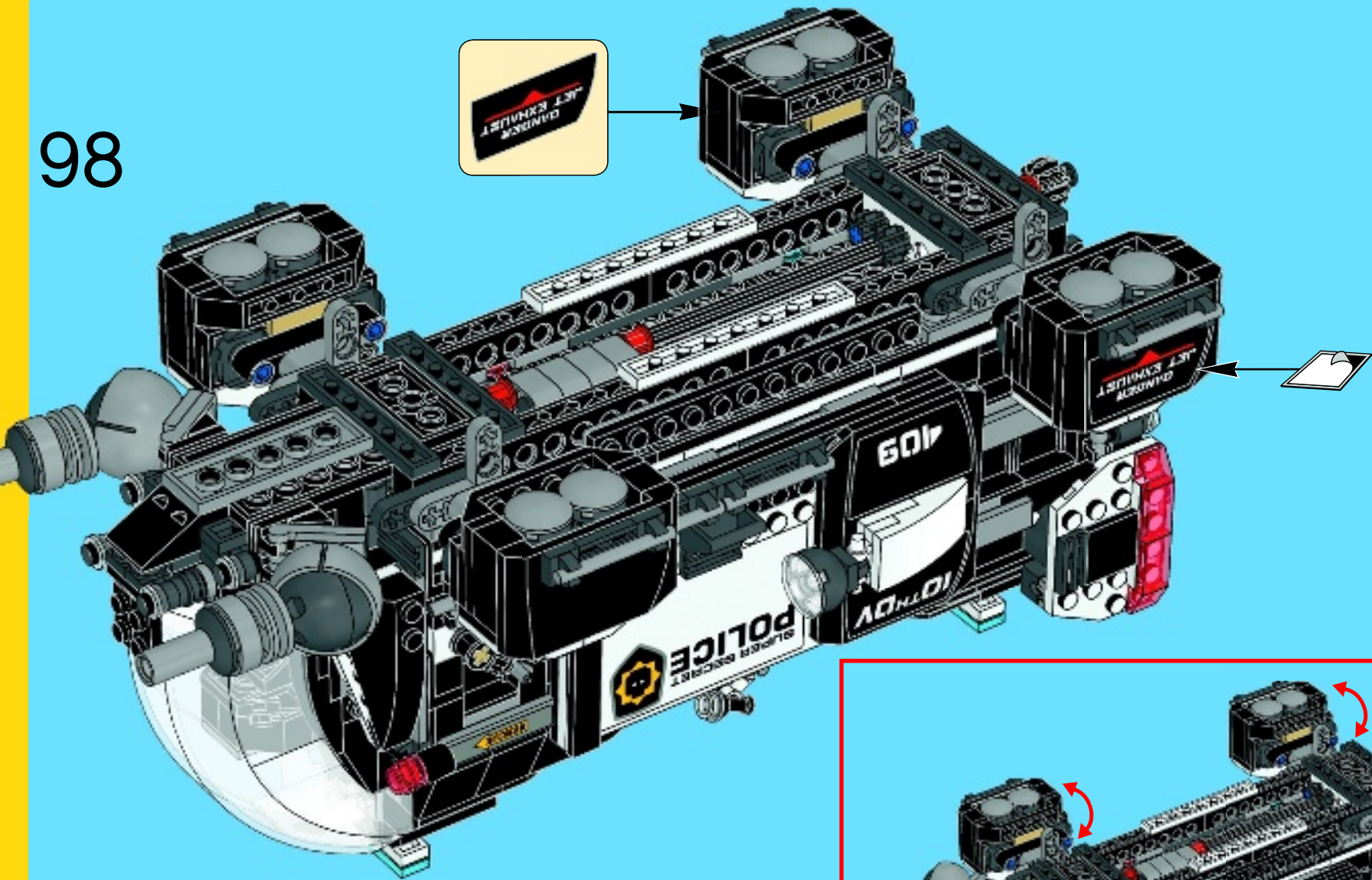

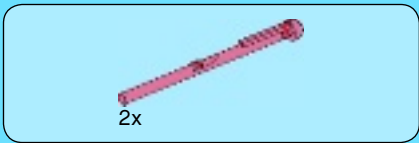

100

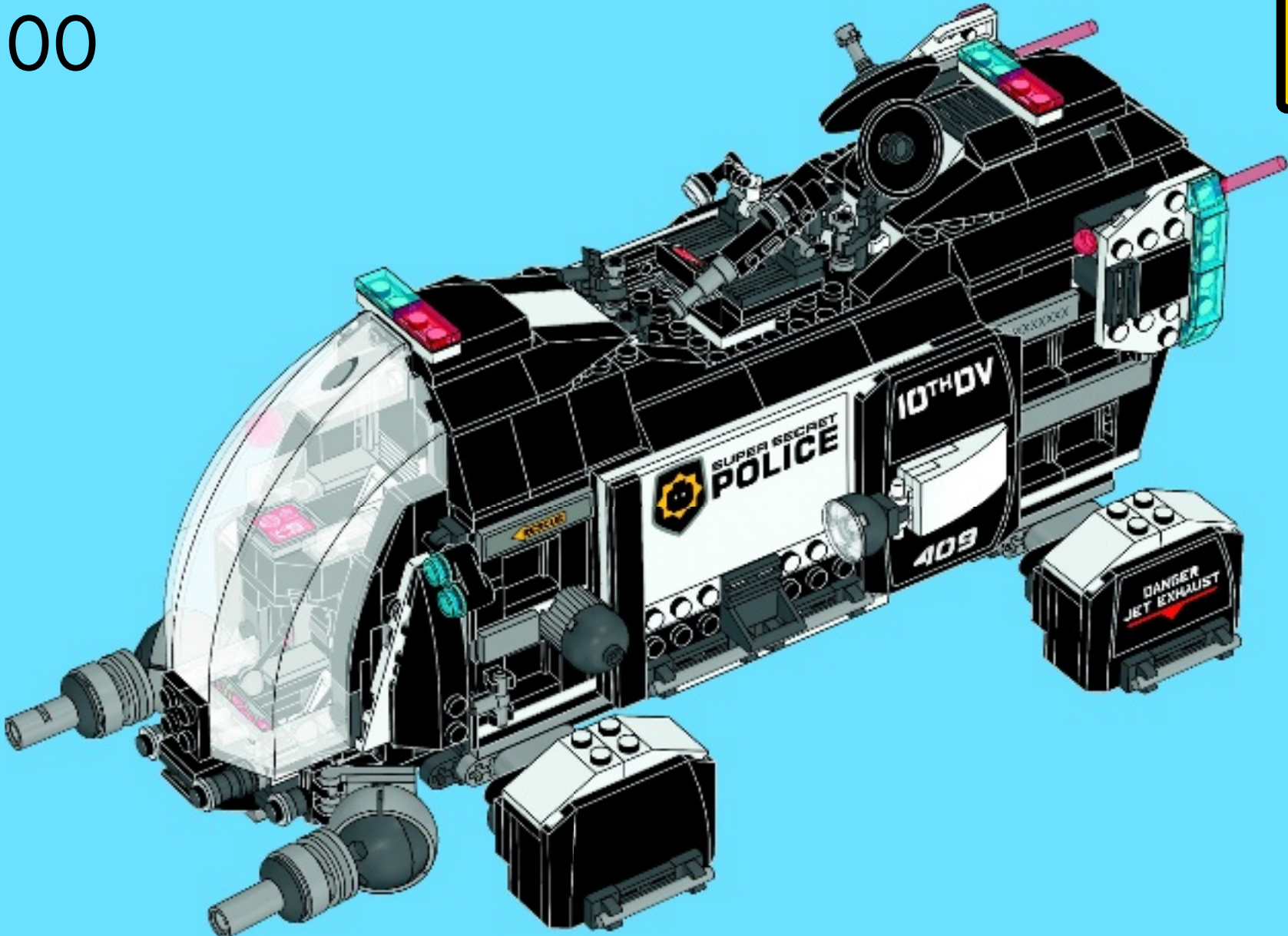

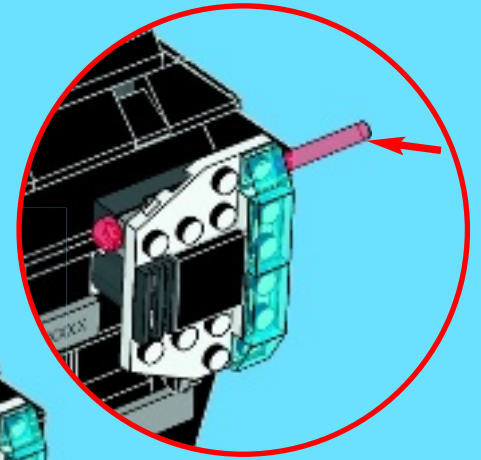
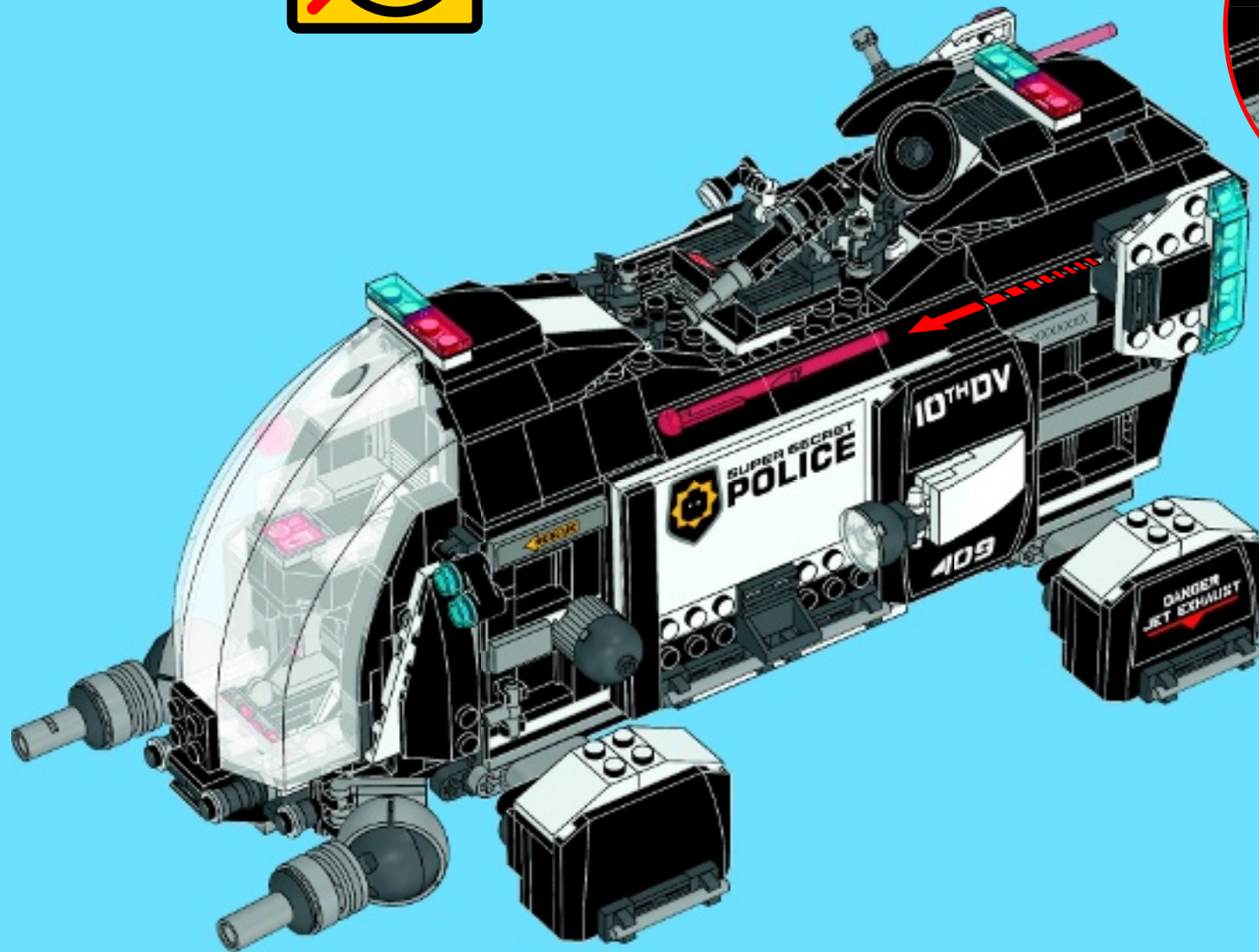



THE LEGO MOVIE VIDEOGAME



For consoles only
Pour consoles uniquement
Sólo para consolas

PS3 PS4 PSVITA XBOX ONE XBOX 360 PC WiiU NINTENDO 3DS NINTENDO DS Nintendo eShop

The LEGO Movie Videogame software © 2014 TT Games Publishing Ltd. Produced by TT Games under license from the LEGO Group. LEGO, the LEGO logo, the Brick and the Knob configurations and the Minifigure are trademarks of the LEGO Group. © 2014 The LEGO Group. THE LEGO MOVIE © The LEGO Group and Warner Bros Entertainment Inc. The "PS" Family logo and "PS3" are registered trademarks of Sony Computer Entertainment Inc. The "PS4" and "PSVITA" logos are trademarks of the same company. Wii U and Nintendo 3DS are trademarks of Nintendo. © 2012 Nintendo. All other trademarks and copyrights are the property of their respective owners. All rights reserved./Logiciel de jeu vidéo LE FILM LEGO © 2014 TT Games Publishing Ltd. Produit par TT Games sous licence du LEGO Group. LEGO, le logo LEGO, les configurations de briques et de tenons et la figurine sont des marques de commerce du LEGO Group. ©2014 The LEGO Group. LE FILM LEGO © The LEGO Group & Warner Bros. Entertainment Inc. Le logo de la gamme « PS » et le logo « PS3 » sont des marques déposées de Sony Computer Entertainment Inc. Les logos « PS4 » et « PSVITA » sont des marques de commerce de la même entreprise. Wii U et Nintendo 3DS sont des marques de commerce de Nintendo. © 2012 Nintendo. Les autres marques de commerce et copyrights appartiennent à leurs propriétaires respectifs. Tous droits réservés./Software del videojuego LA GRAN AVENTURA LEGO © 2014 TT Games Publishing Ltd. Editado por TT Games con licencia de The LEGO Group. LEGO, el logotipo de LEGO, el brick y la configuración de las espigas, así como la minifigura, son marcas comerciales de The LEGO Group. ©2014 The LEGO Group. LA GRAN AVENTURA LEGO © The LEGO Group y Warner Bros. Entertainment Inc. El logotipo de la familia "PS" y "PS3" son marcas comerciales registradas de Sony Computer Entertainment Inc. Los logotipos de "PS4" y "PSVITA" son marcas comerciales de la misma compañía. Wii U y Nintendo 3DS son marcas comerciales de Nintendo. © 2012 Nintendo. El resto de marcas comerciales y derechos de autor pertenecen a sus respectivos propietarios. Todos los derechos reservados.

RATING PENDING
COTE EN ATTENTE
RP
CONTENT RATED BY
CONTENU ÉVALUÉ PAR
ESRB
Visit www.esrb.org
for rating information
Visiter www.esrb.org
pour les classifications

WB GAMES LOGO, WB SHIELD: TM & © Warner Bros. Entertainment Inc. (s14)





2 IN 1



70804



70805



70806



LEGO PARKS

CALIFORNIA • FLORIDA



LEGO DISCOVERY CENTER

ATLANTA • CHICAGO • DALLAS/FORT WORTH
KANSAS CITY • TORONTO • WESTCHESTER



Indoor Attraction • LEGO Rides
LEGO MINILAND And Much More!

Attraction De L'interieur • Les Manèges LEGO
LEGO MINILAND Et Beaucoup Plus

Atracción De Interior • Paseos De La
Diversión De LEGO • LEGO MINILAND Y Mucho Más

KIDS GO FREE

with full paid adult ticket

Purchase at LEGOLAND.com/TLMNA2014

Now through 12/31/17.

See website for terms and offer details.

LES ENFANTS ENTRENT GRATUITEMENT

à l'achat d'un billet pour adulte

Achat sur LEGOLAND.com/TLMNA2014

Dès maintenant et jusqu'au 31/12/17

Consultez le site Web pour obtenir les conditions et les détails de l'offre

NIÑOS ENTRAN GRATIS

en la compra de una entrada de adulto los

Compra en LEGOLAND.com/TLMNA2014

Ahora hasta el 31/12/17

Condiciones y detalles de la oferta en el sitio web



club™

Free*! Gratuit!

* Paid subscription in Australia and New Zealand.
Abonnement payant en Australie et Nouvelle-Zélande.



LEGO.com/club

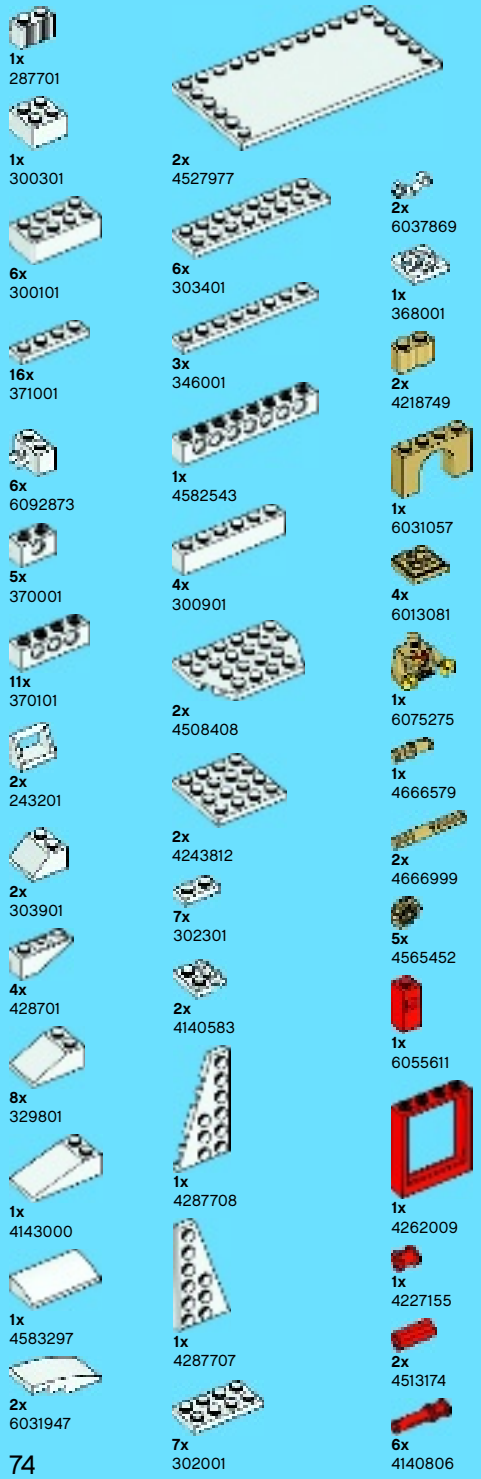

1x 287701
1x 300301
6x 300101
16x 371001
6x 6092873
5x 370001
11x 370101
2x 243201
2x 303901
4x 428701
8x 329801
1x 4143000
1x 4583297
2x 6031947
2x 4527977
1x 6037869
6x 303401
3x 346001
1x 4582543
4x 300901
2x 4508408
2x 4243812
7x 302301
2x 4140583
1x 4287708
1x 4287707
7x 302001
2x 6037869
1x 368001
2x 4218749
1x 6031057
4x 6013081
1x 6075275
1x 4666579
2x 4666999
5x 4565452
1x 6055611
1x 4262009
1x 4227155
2x 4513174
6x 4140806



4x 4514553
2x 4143005
25x 4206482
1x 6057810
1x 6075251
1x 6057958
2x 4239601
4x 6065496
6x 287726
10x 362226
6x 301026
2x 4558954
6x 4533771
2x 4584274
2x 4504382
4x 329826
7x 4548180
4x 4515373
4x 366526
12x 4636202
2x 366026
4x 4189064
1x 4551168
7x 4273703
1x 4295400
6x 428626
10x 302326
4x 303826



6x 303726
2x 4188534
4x 6064228
2x 4550017
4x 4598528
1x 243226
8x 6048855
2x 6040298
2x 6040297
2x 6038531
2x 6037746
1x 4160108
1x 4160130
1x 4180087



2x 306826
1x 4565323
14x 362326
1x 374726
1x 6020193
2x 4225201
1x 4161332
1x 4160869
12x 3200126
1x 303226
1x 4243819
2x 366626
6x 300826

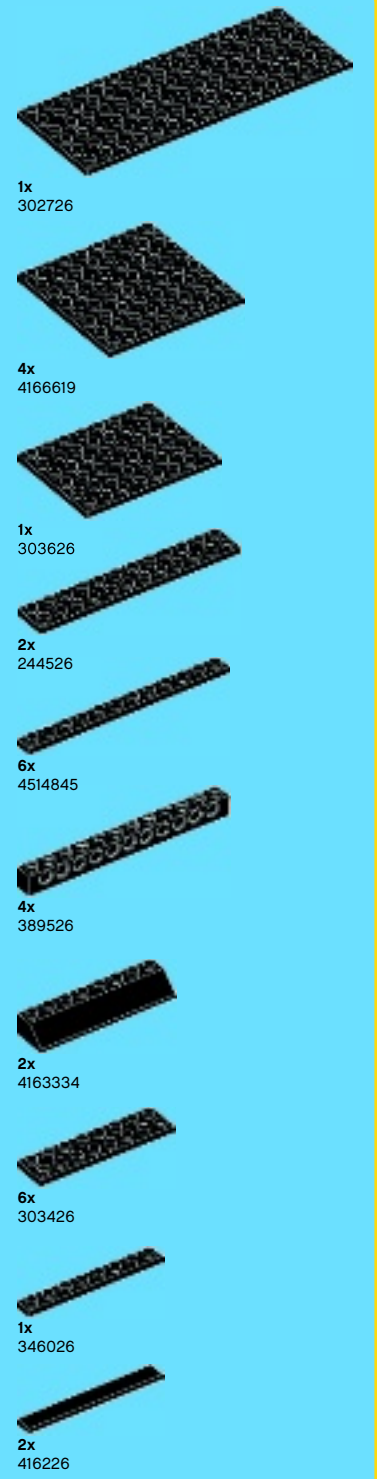

1x 302726
4x 4166619
1x 303626
2x 244526
6x 4514845
4x 389526
2x 4163334
6x 303426
1x 346026
2x 416226



Customer Service
Kundenservice
Service Consommateurs
Servicio Al Consumidor
LEGO.com/service or dial



: 00800 5346 5555
: 1-800-422-5346



DC COMICS SUPERHEROES



LEGO.com

LEGO.COM/SUPERHEROES

LEGO and the LEGO logo are trademarks of the/son des marques registradas de LEGO Group. ©2014 The LEGO Group. 6092416

THE LEGO MOVIE © The LEGO Group & Warner Bros. Entertainment Inc. LE FILM LEGO © Le Groupe LEGO et Warner Bros. Entertainment Inc. LA GRAN AVENTURA LEGO © The LEGO Group y Warner Bros. Entertainment Inc. (s14)

BATMAN: TM & © DC Comics. © Warner Bros. Entertainment Inc. (s14)



76010



76011



76013



76012



TM

TM & © DC Comics. WB SHIELD: TM & © Warner Bros. Entertainment Inc. (s14)