

The LEGO logo is displayed in its characteristic white font on a red rectangular background.

BIONICLE®

70793



LEGO.com/bionicle





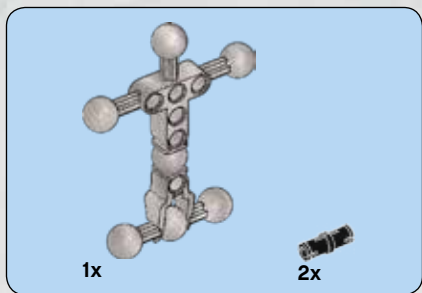

1

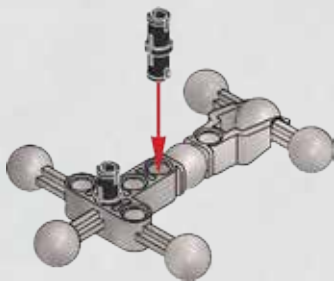

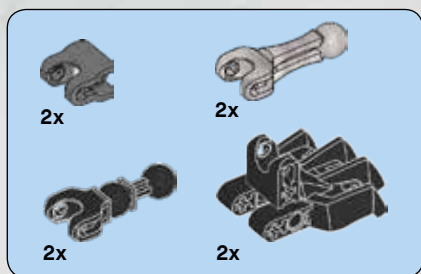

2

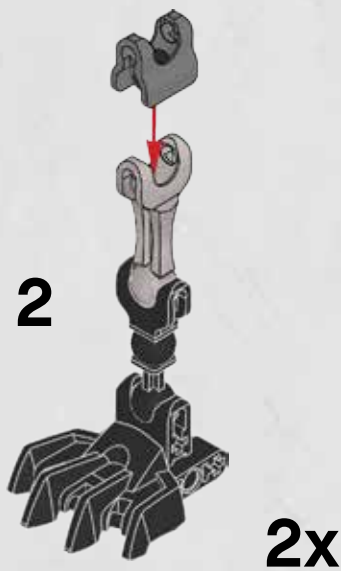
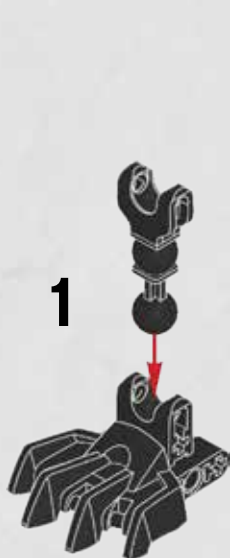

3

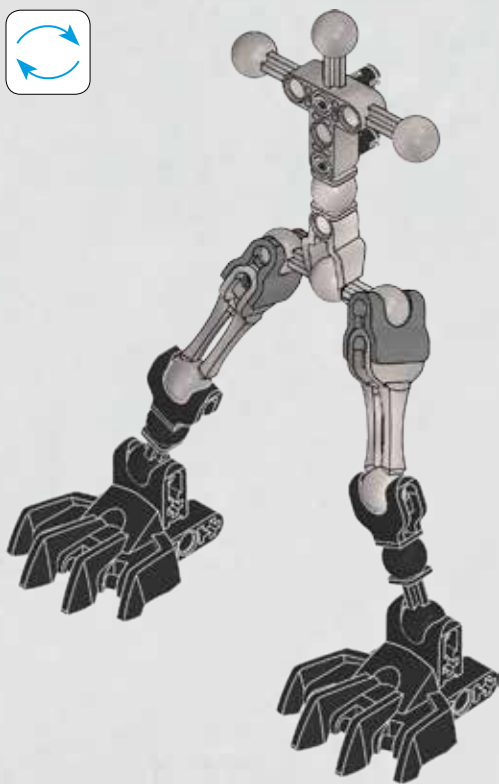

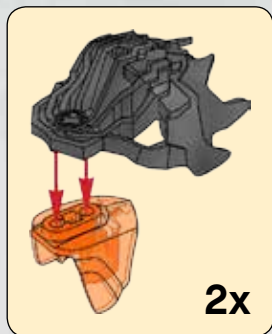
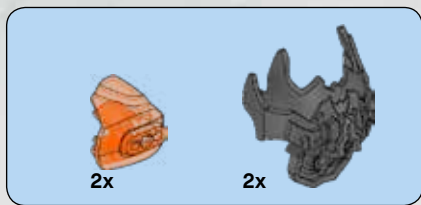

4

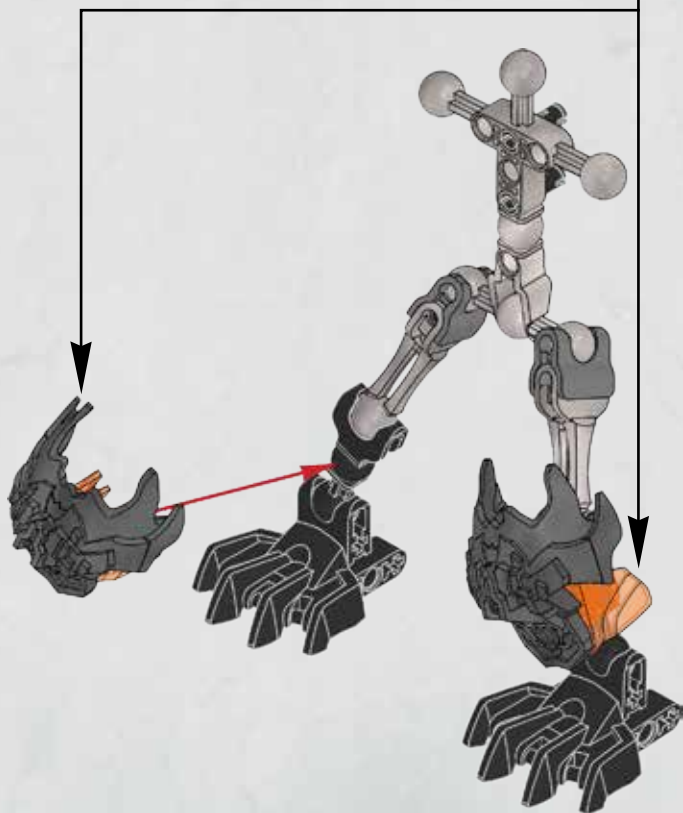

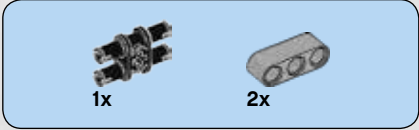

5

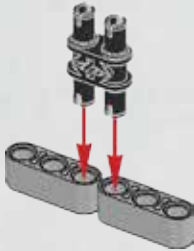

6

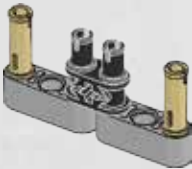

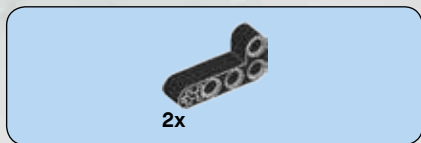

7

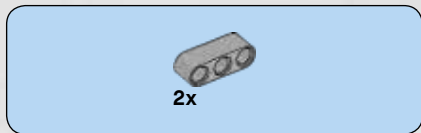

8

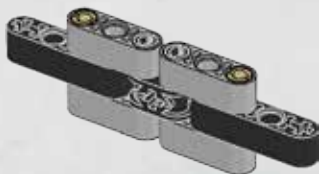

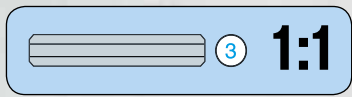
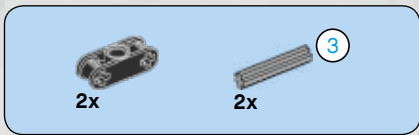

9

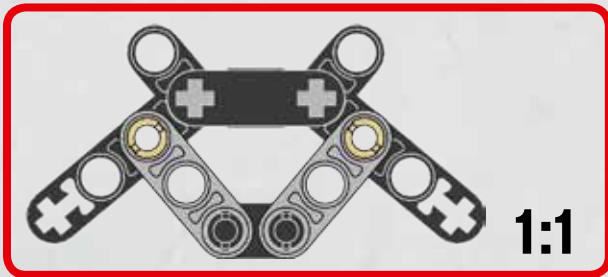
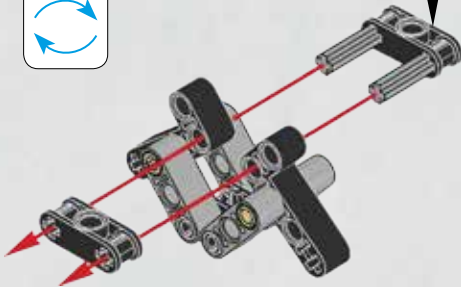
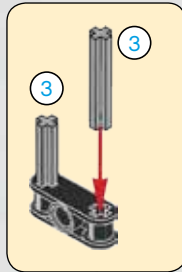



10

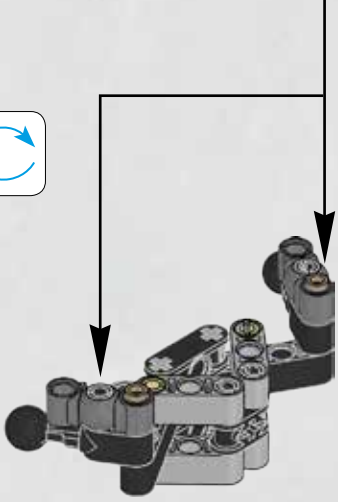
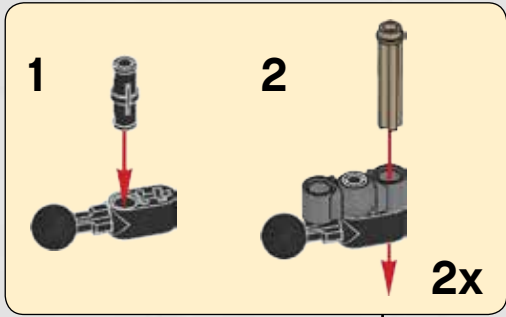

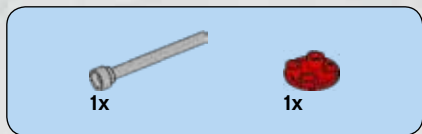

11

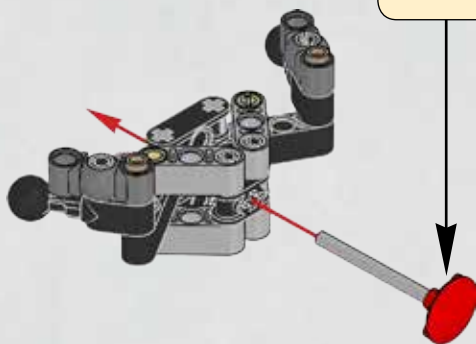
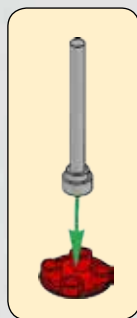

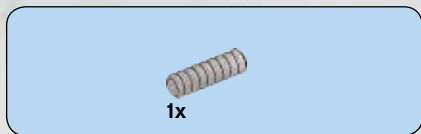

12

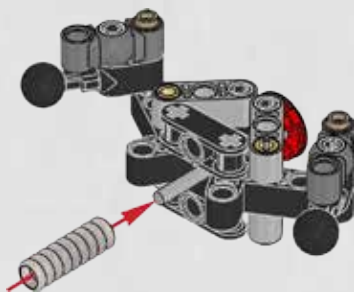

13



14

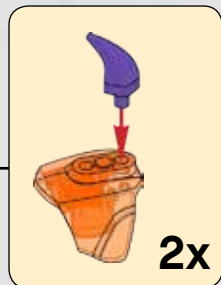

14

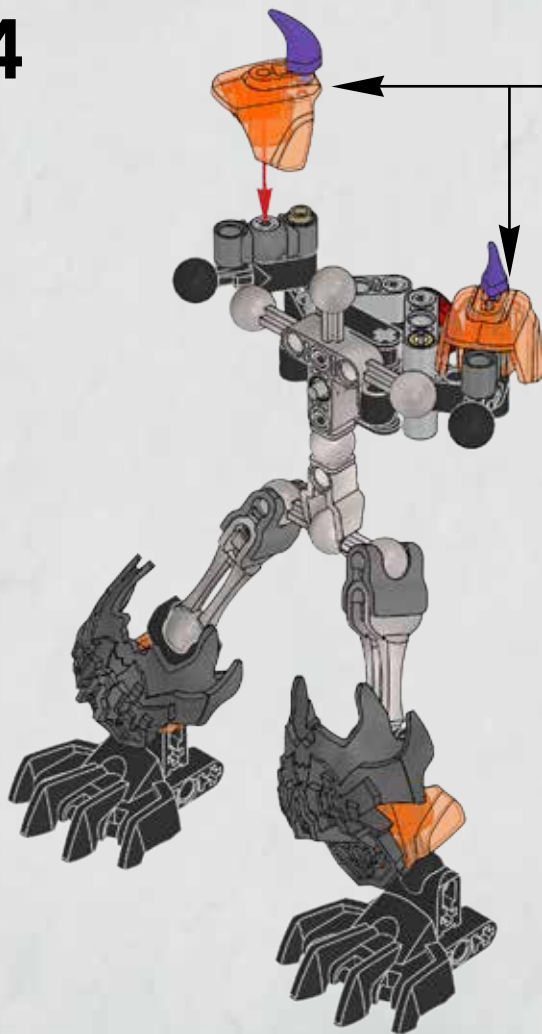



15

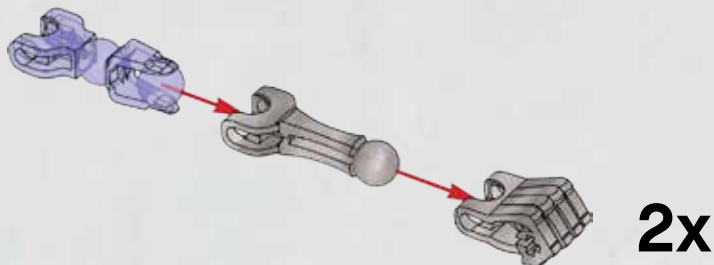

16



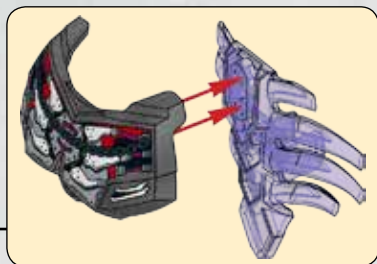

17



18

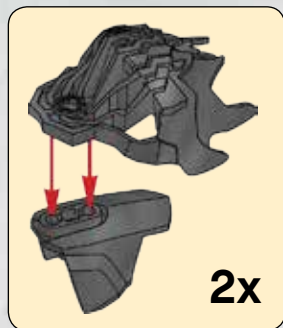
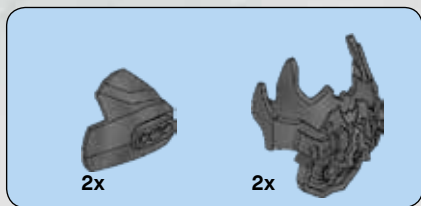

18

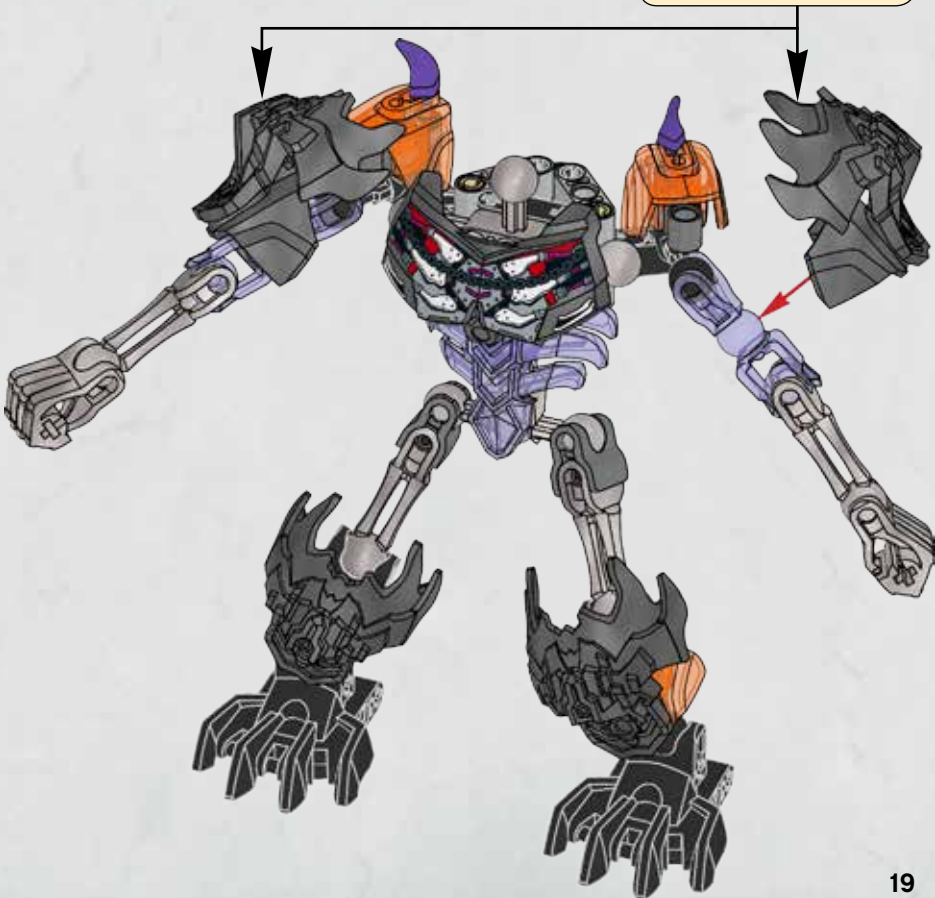



19



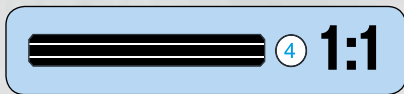
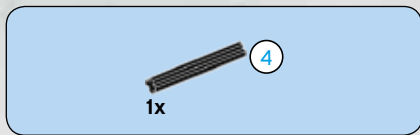

20

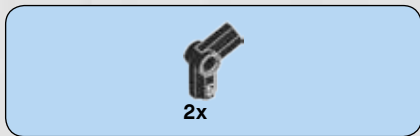
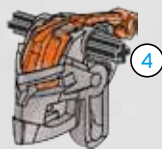

21

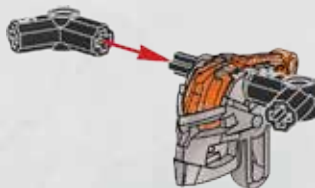



2x

22

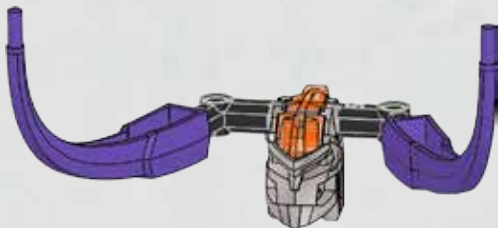

23



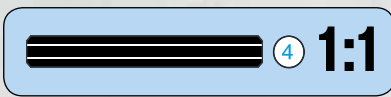
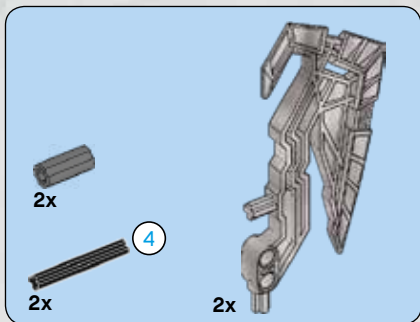

24

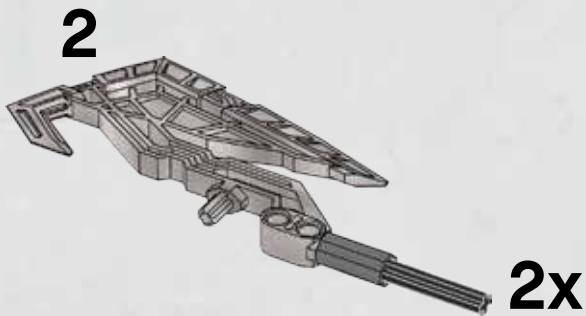
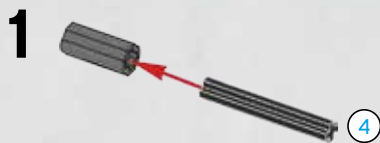

25



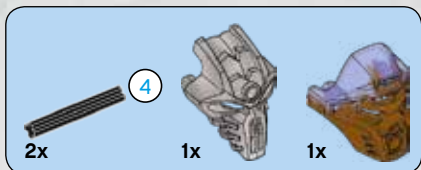

26

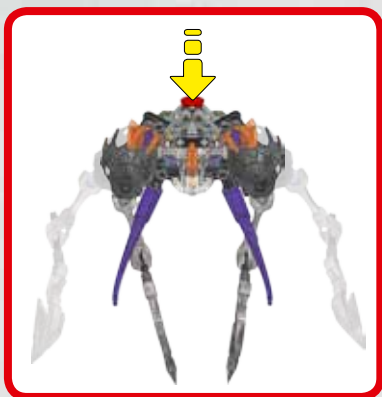

2x
4514554

1x
6116017

2x
6106472

1x
6102606

1x
4278275

1x
6102640

2x
6001085



2x
4120017

4x
6045953

2x
4516546

2x
6114372

2x
4121667

2x
6102836



2x
6061054

2x
4560108

1x
6114323

2x
6096663



2x
4593555

1x
6114323

1x
6114369

1x
6115529

2x
6056379

2x
6031821

4x
6114326



4x
4121715

1x
4211473



4x
6114328

2x
4107084

4x
4211655

1x
6115891



1x
4119589

2x
4211815

2x
4619077

2x
6114461

5x
370526



Customer Service

Kundenservice

Service Consommateurs

Servicio Al Consumidor

LEGO.com/service or dial



: 00800 5346 5555

: 1-800-422-5346



70791



70792



70793



 LEGO.com/bionicle/bi

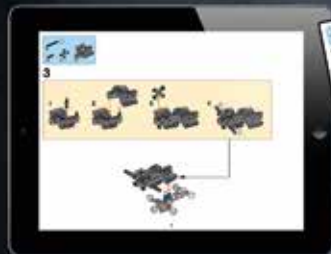

 LEGO.com/bionicle



Download App
Télécharger l'application
Descarga la App



Available on the
 **App Store**

Apple, the Apple logo, iPad, iPhone and iPod touch are trademarks of Apple Inc.
Apple, le logo Apple, iPad, iPhone et iPod touch sont des marques de commerce d'Apple Inc.
Apple, el logotipo de Apple, iPad, iPhone e iPod touch son marcas comerciales de Apple Inc.

GET IT ON

Google Play is a trademark of Google Inc.
Google Play est une marque de commerce de Google Inc.
Google Play es una marca comercial de Google Inc.





70791

70794



70795



70792



70793