

The LEGO logo is displayed in its characteristic white font with a black outline, set against a red square background.

# BIONICLE®

70791



**WARNING: CHOKING HAZARD.**  
Toy contains small parts and a small ball.  
Not for children under 3 years.



[LEGO.com/bionicle](http://LEGO.com/bionicle)





**AVERTISSEMENT :**

**RISQUE D'ÉTOUFFEMENT.** Le jouet contient des petites pièces ainsi qu'une petite boule. Il ne convient pas aux enfants de moins de 3 ans.



**ADVERTENCIA:**

**PELIGRO DE ASFIXIA.** Juguete que contiene partes pequeñas y una pelota pequeña. No recomendado para niños menores de 3 años.

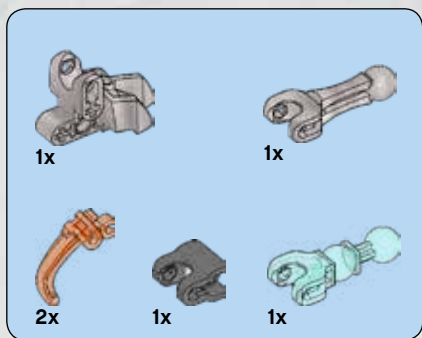

1

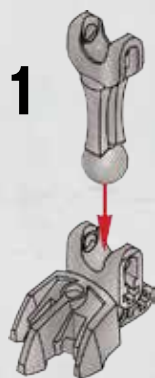

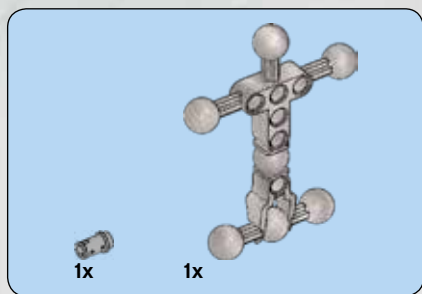

**2**

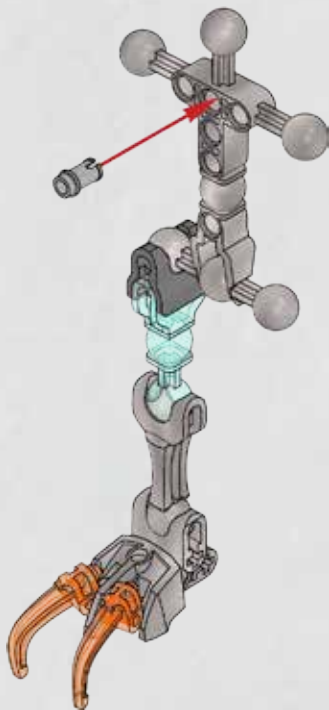

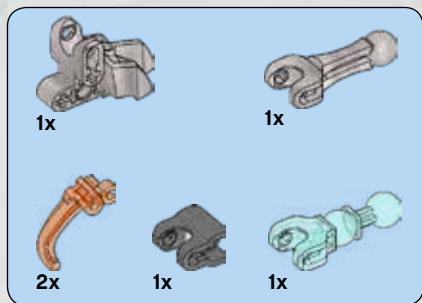

# 3

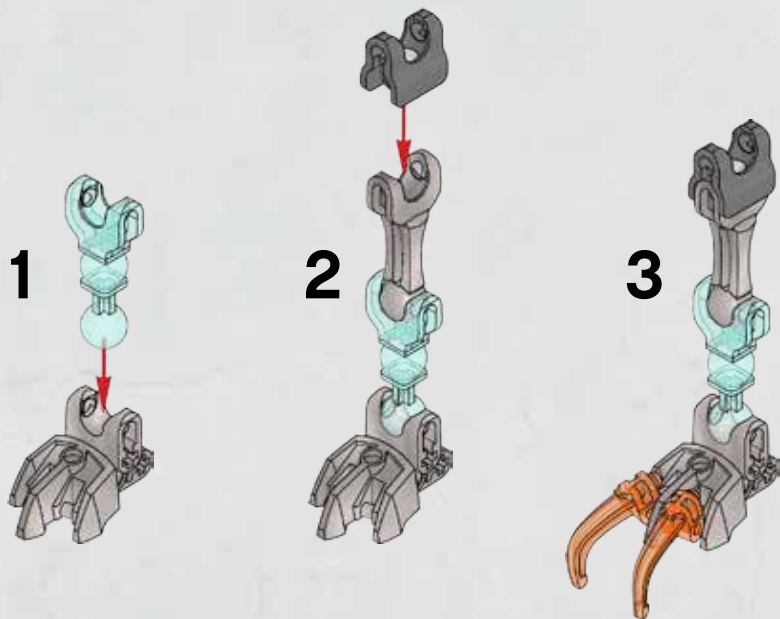



4

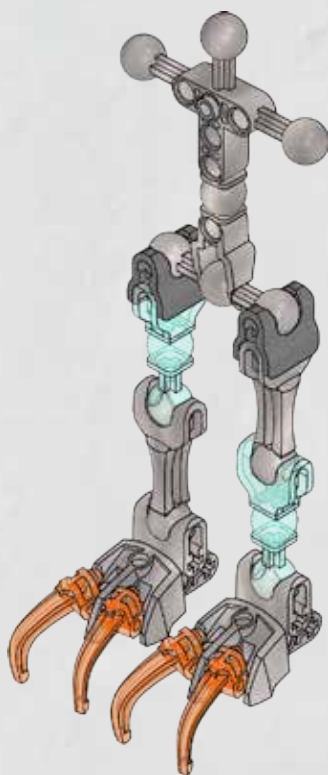

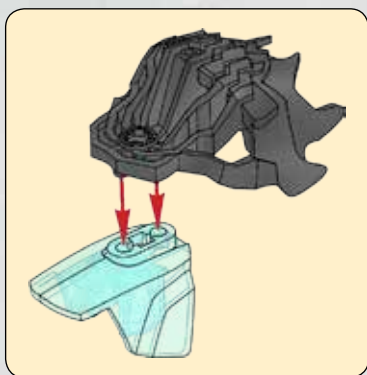
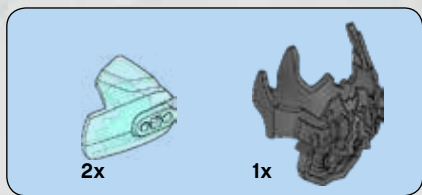

5

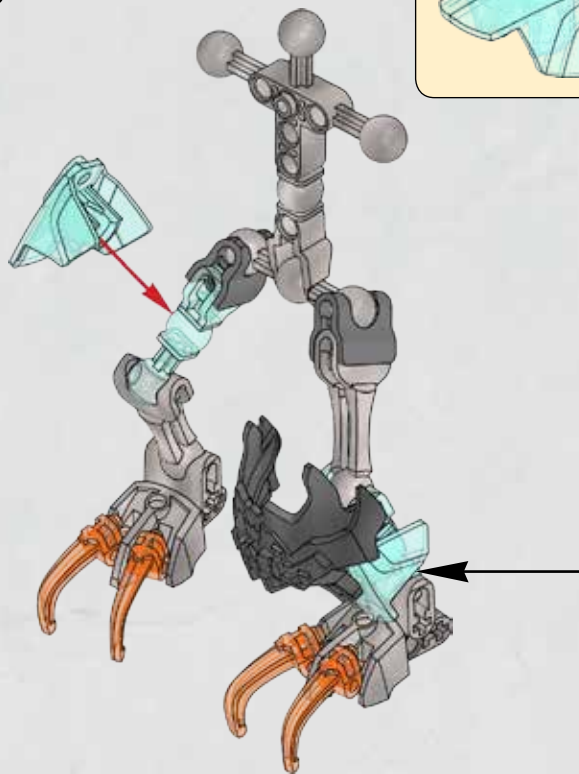



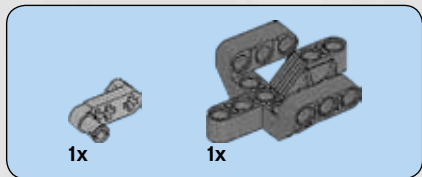

6

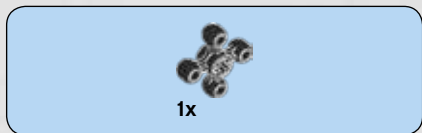
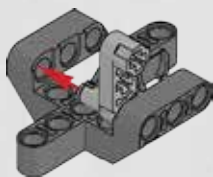

7

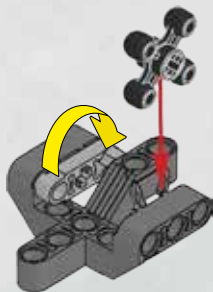

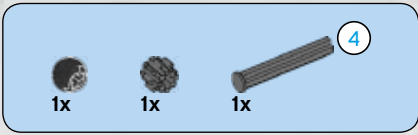

8

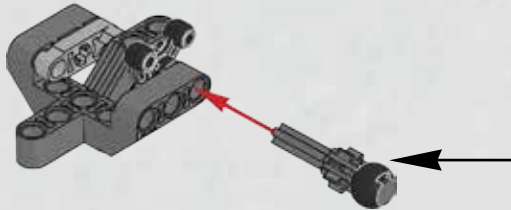
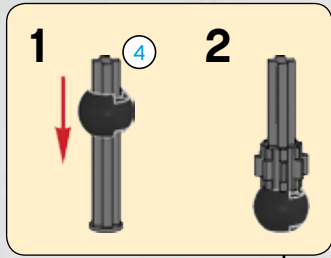

9

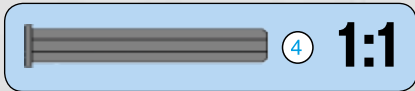
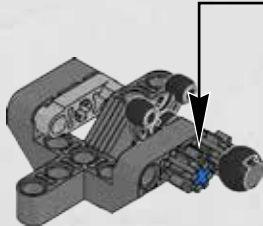
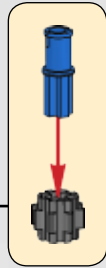

10

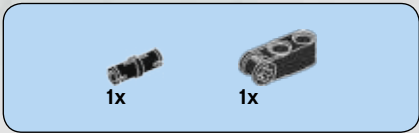

10

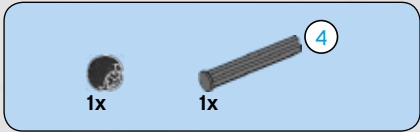
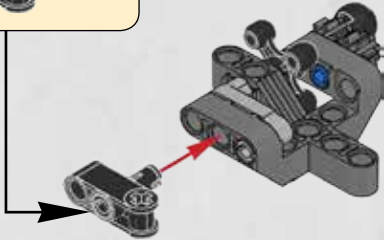
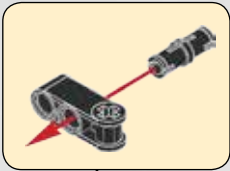

11

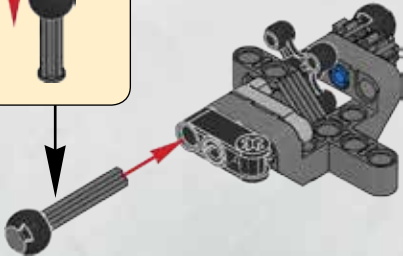
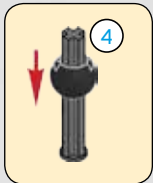



1x

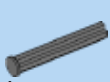

1x

4

# 12

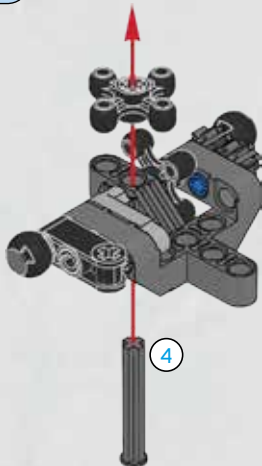

1x



1x

# 13

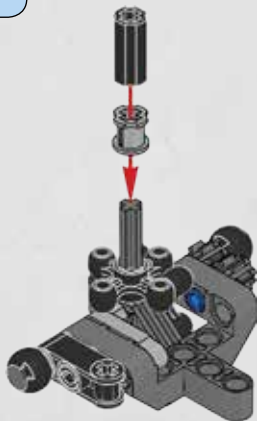



1x



1x

# 14

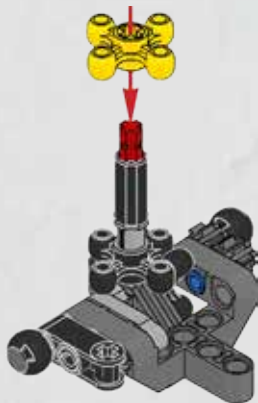

2x

# 15

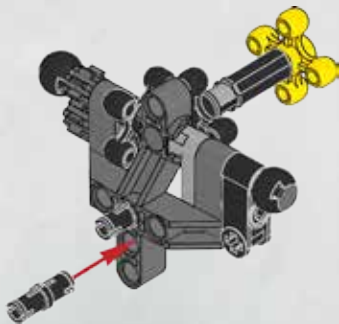

# 16

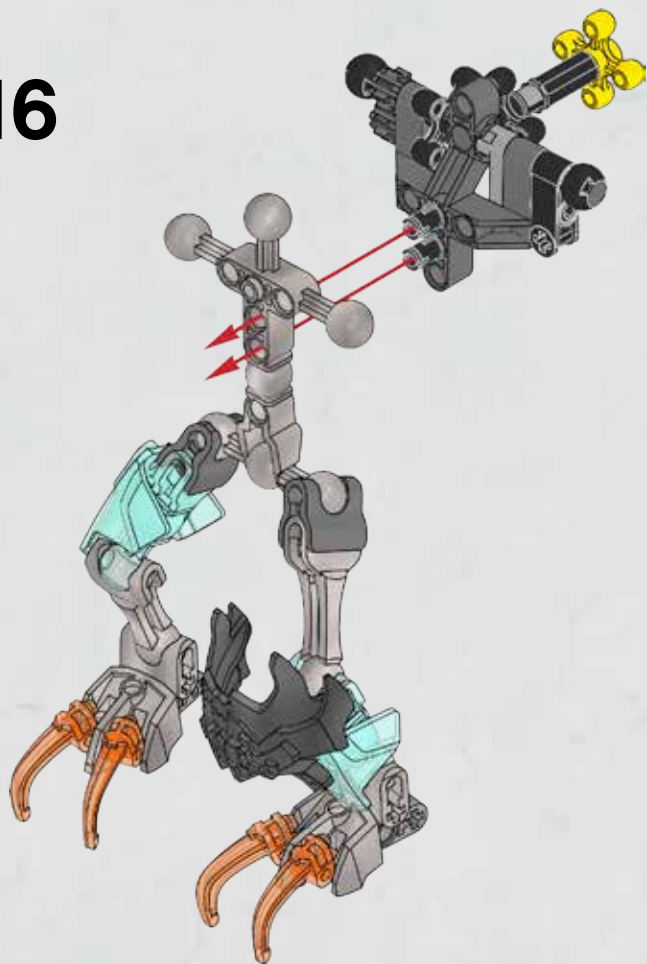



17

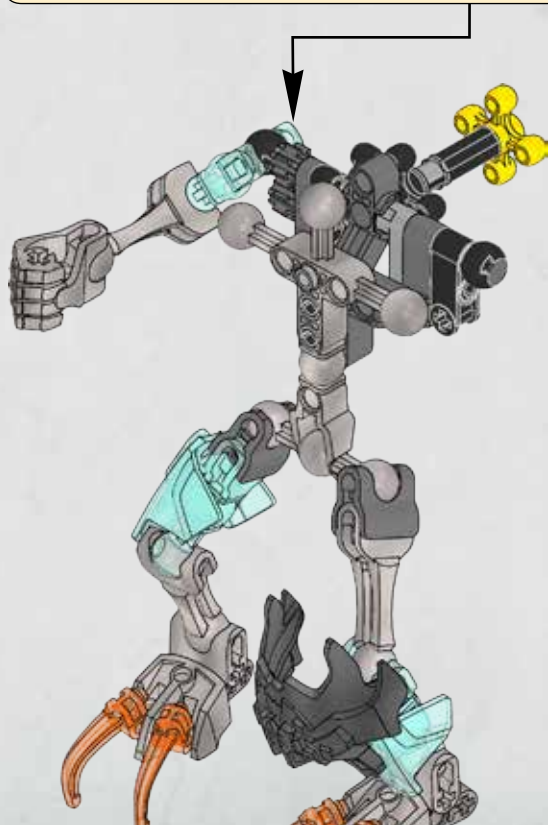
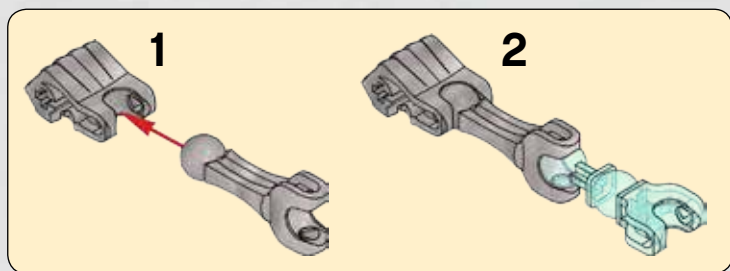





1x

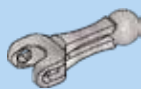

2x

# 18

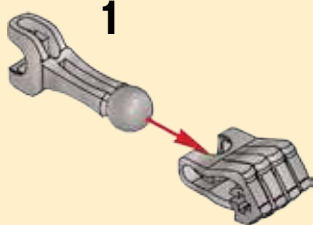

1

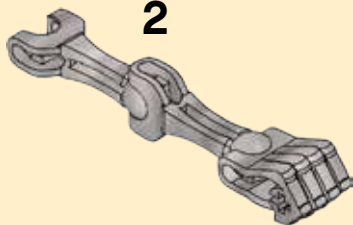

2

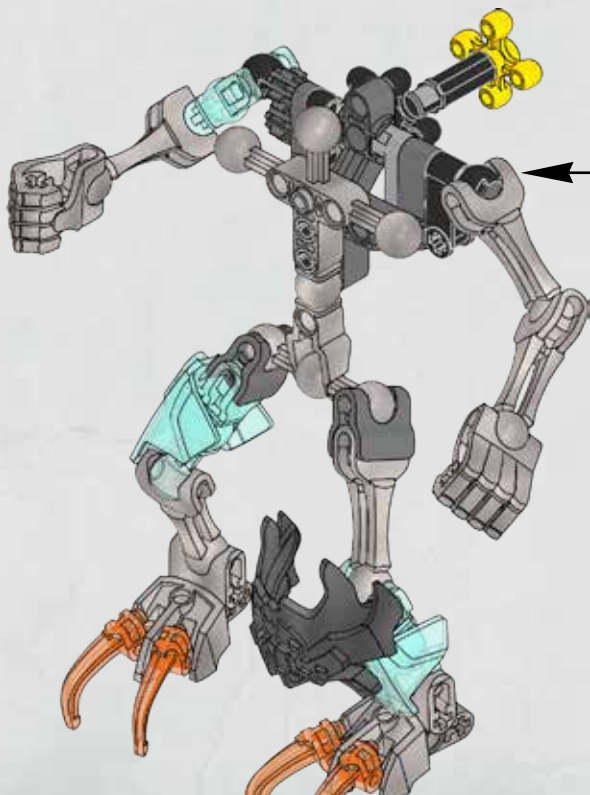

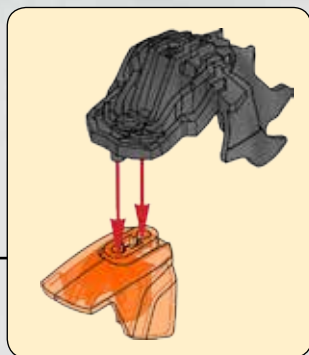
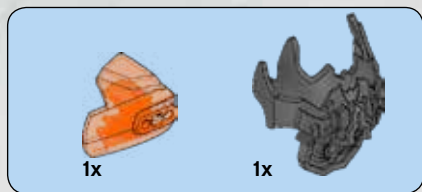

**19**

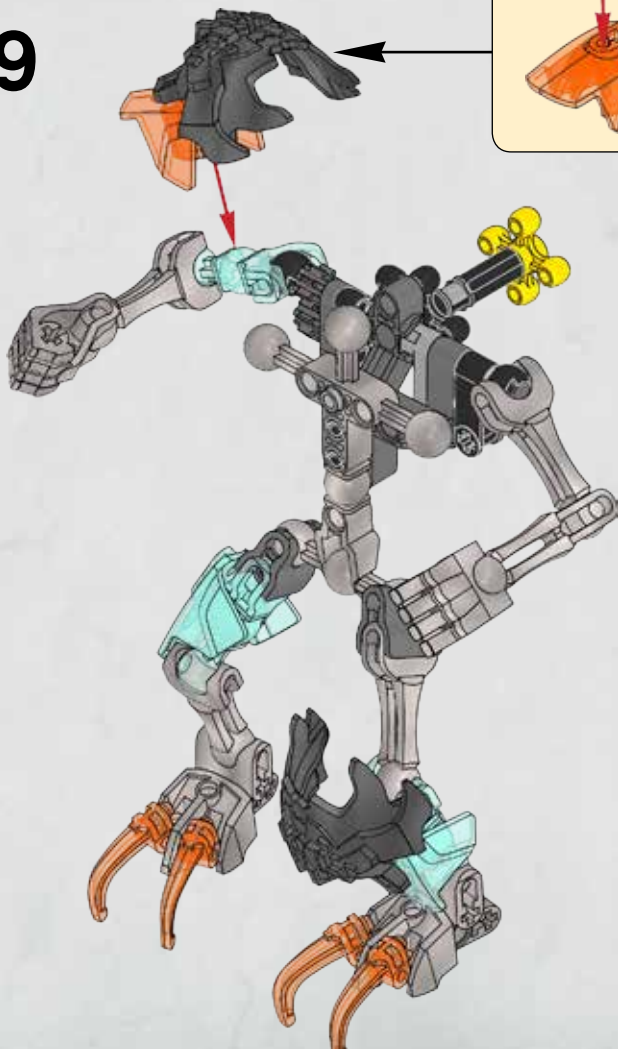

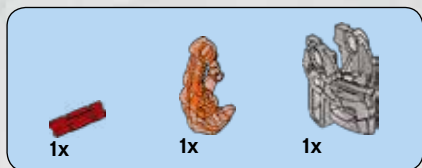

# 20

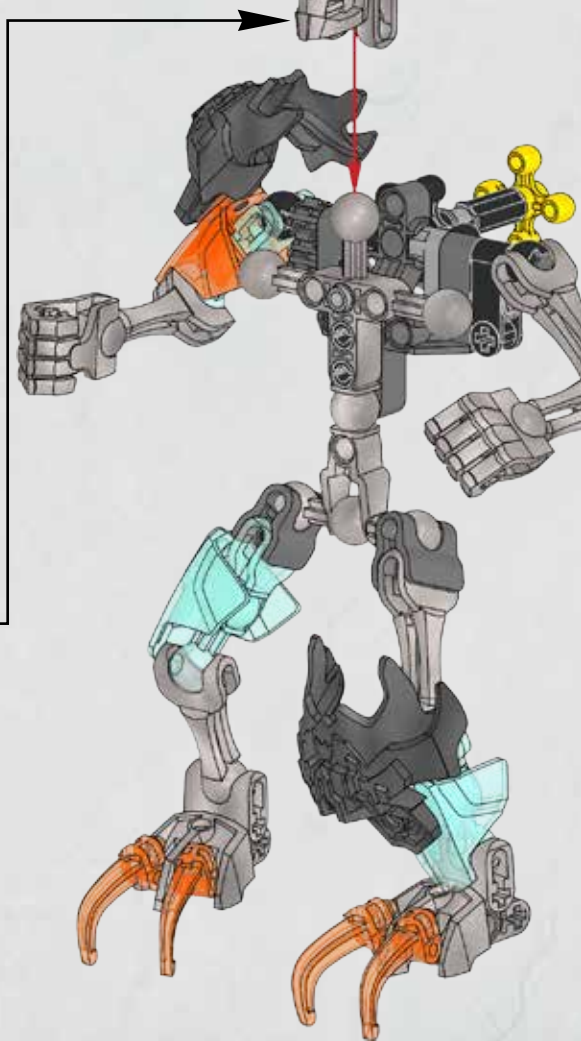
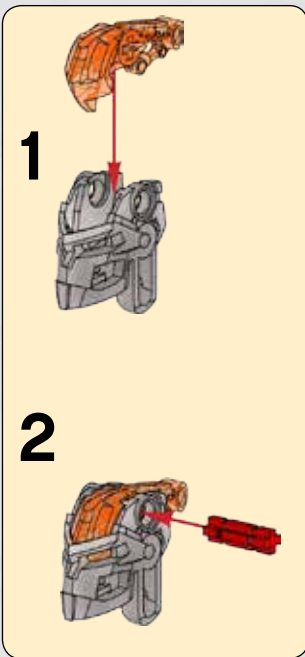

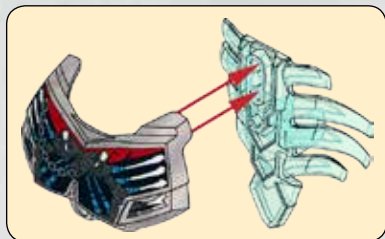

21

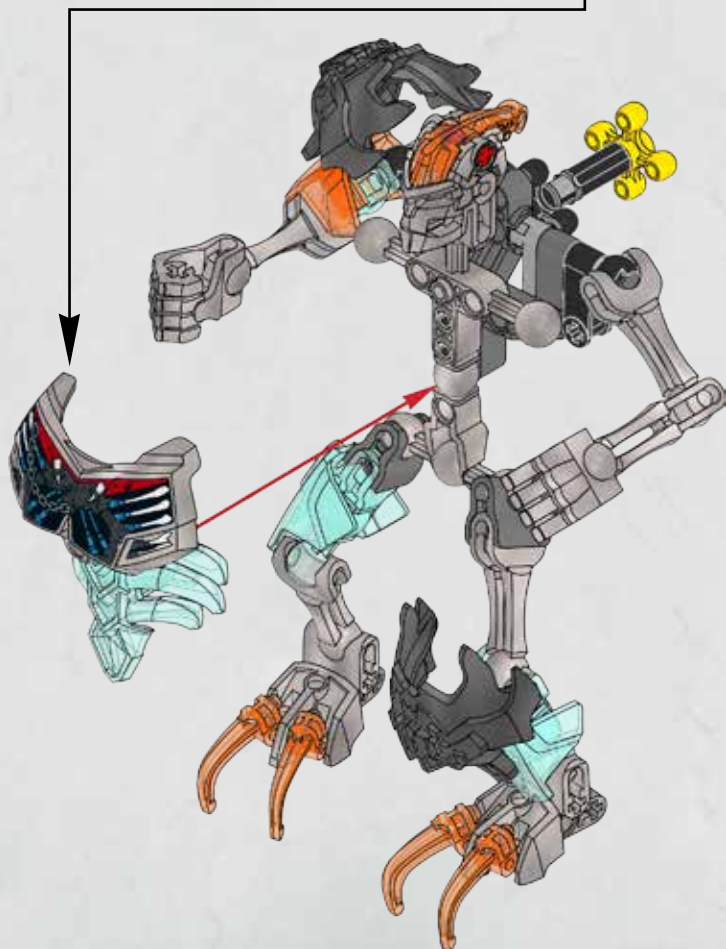

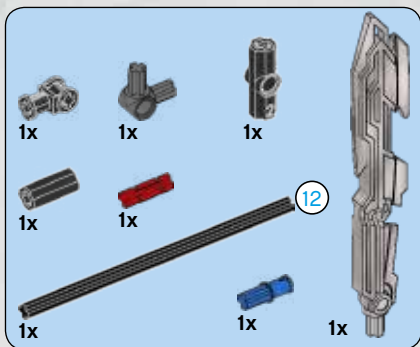

# 22

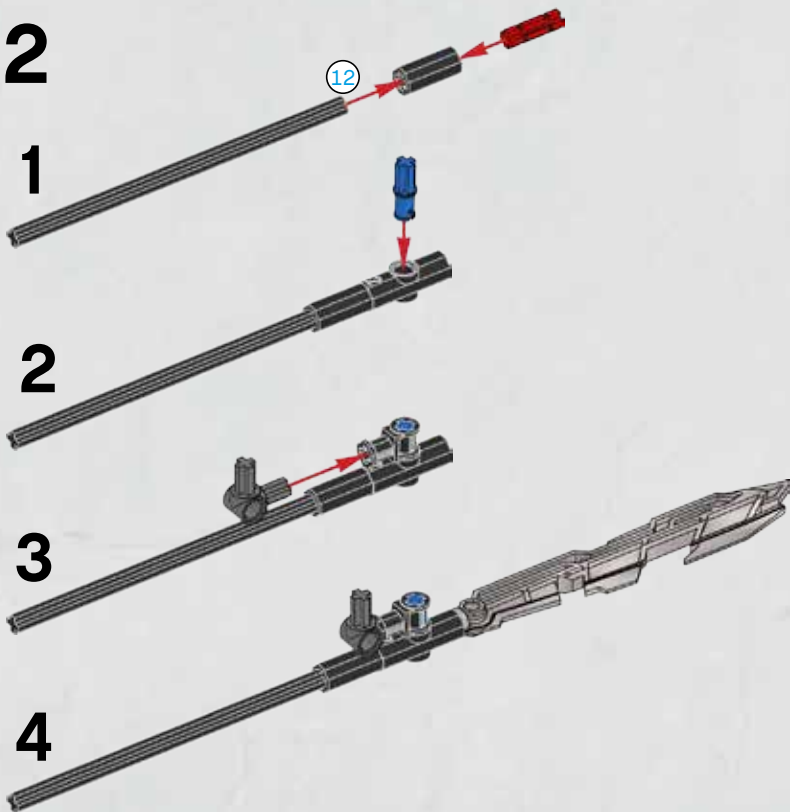

23



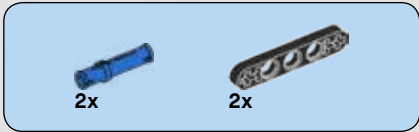
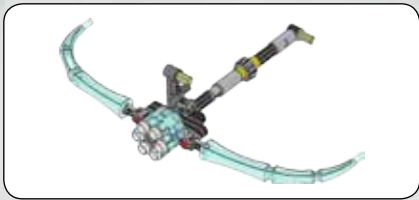

**24**

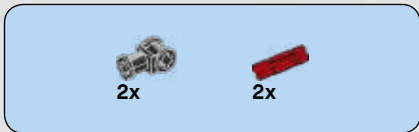
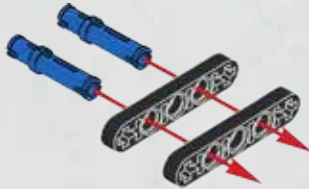

**25**

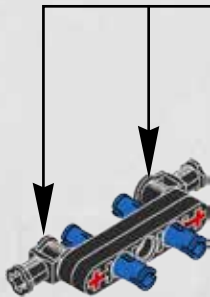
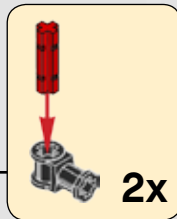



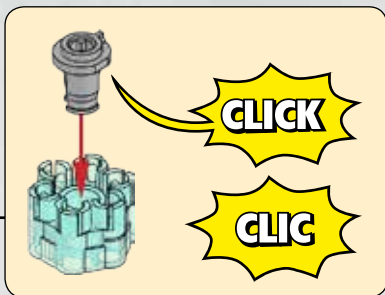

26

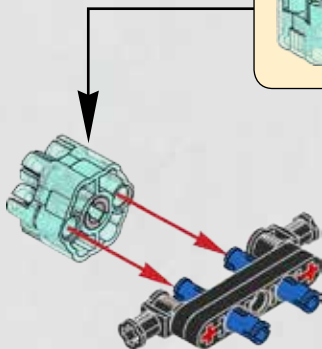

27





1x



1x

# 28

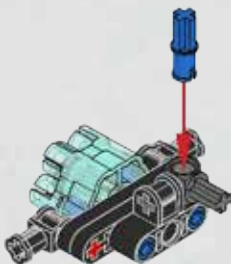

1x



1x

# 29

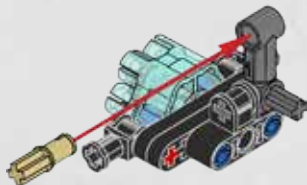

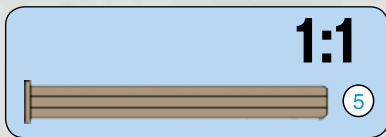
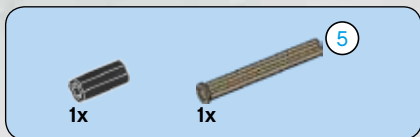

# 30

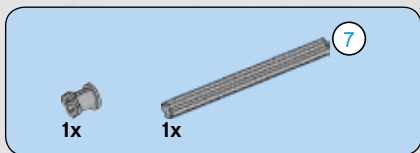
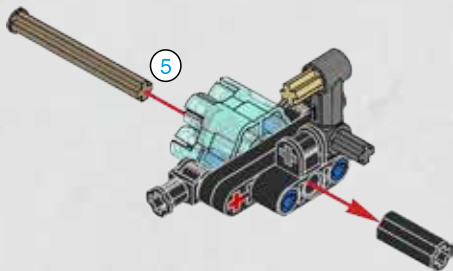

# 31

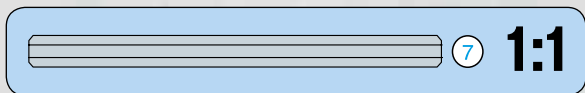
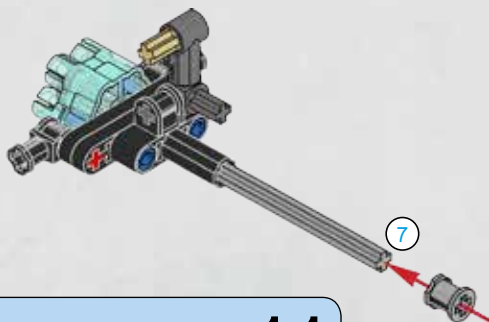



1x



1x

# 32

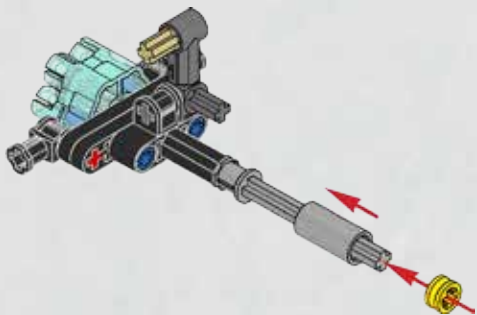

1x



1x



1x

# 33

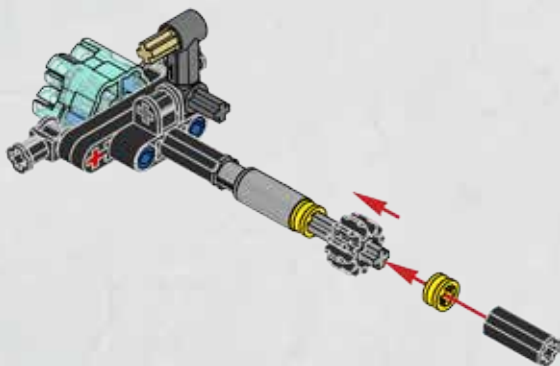



1x



1x

# 34

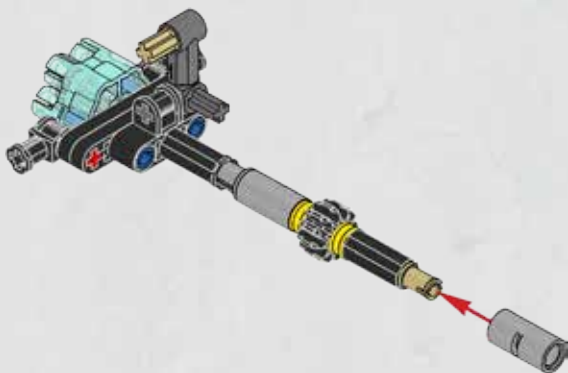

1x



1x

# 35

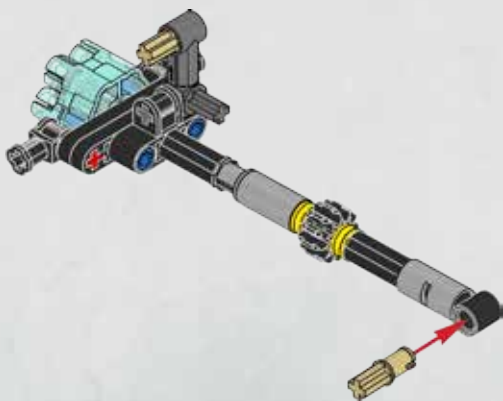

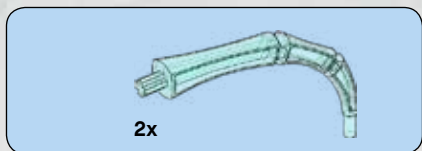

36

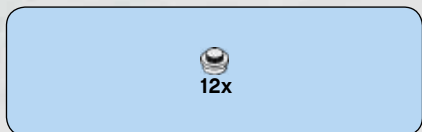
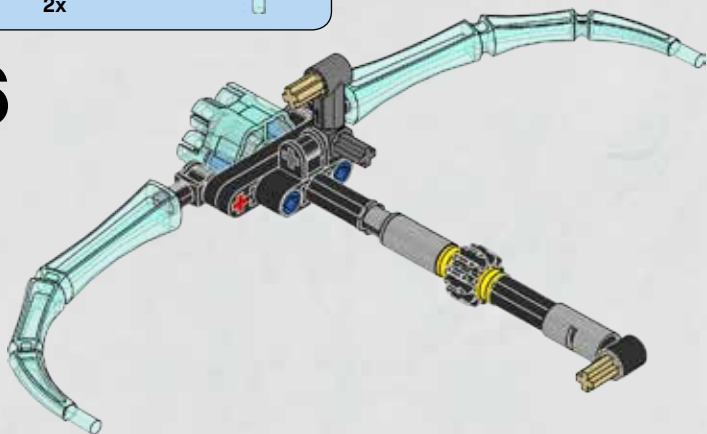

37

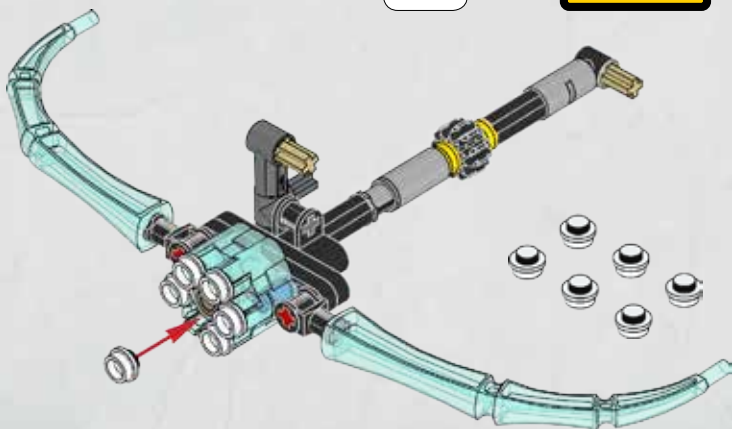

38

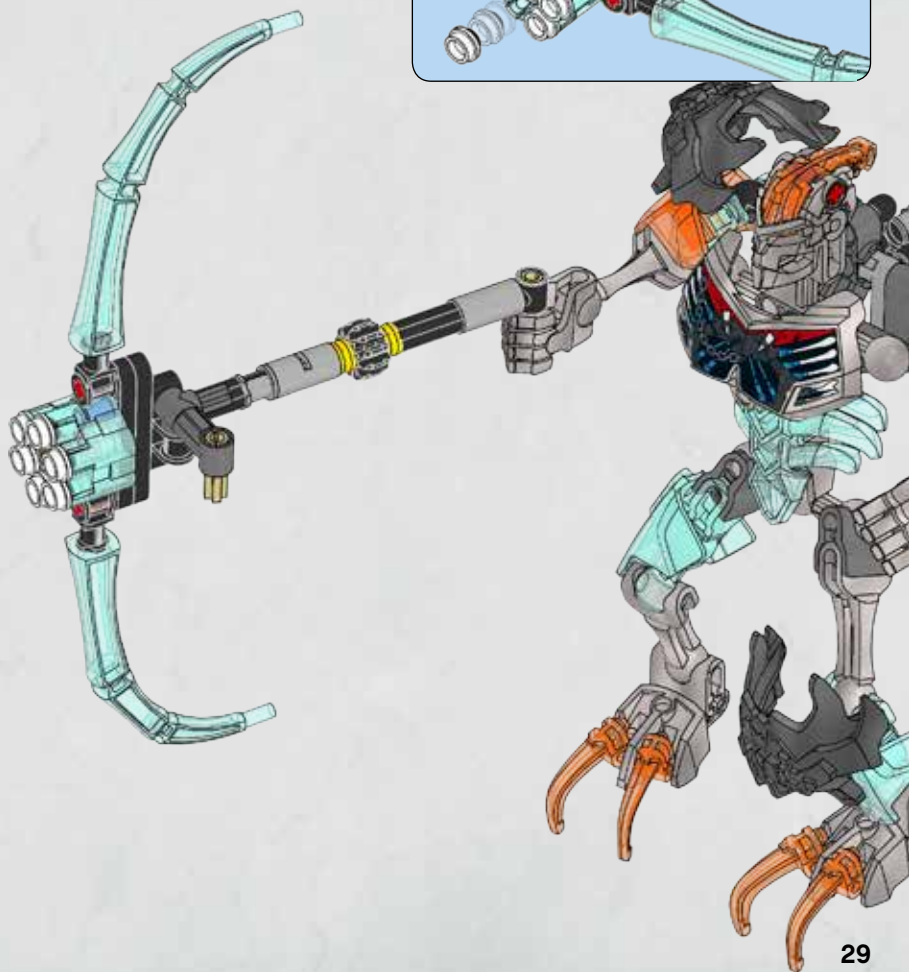
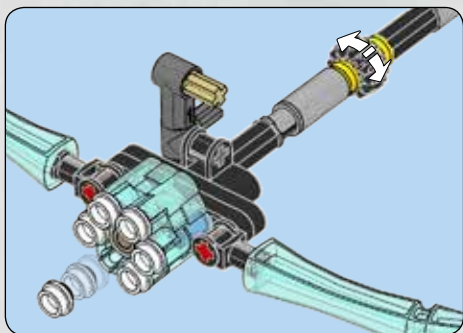





# 39

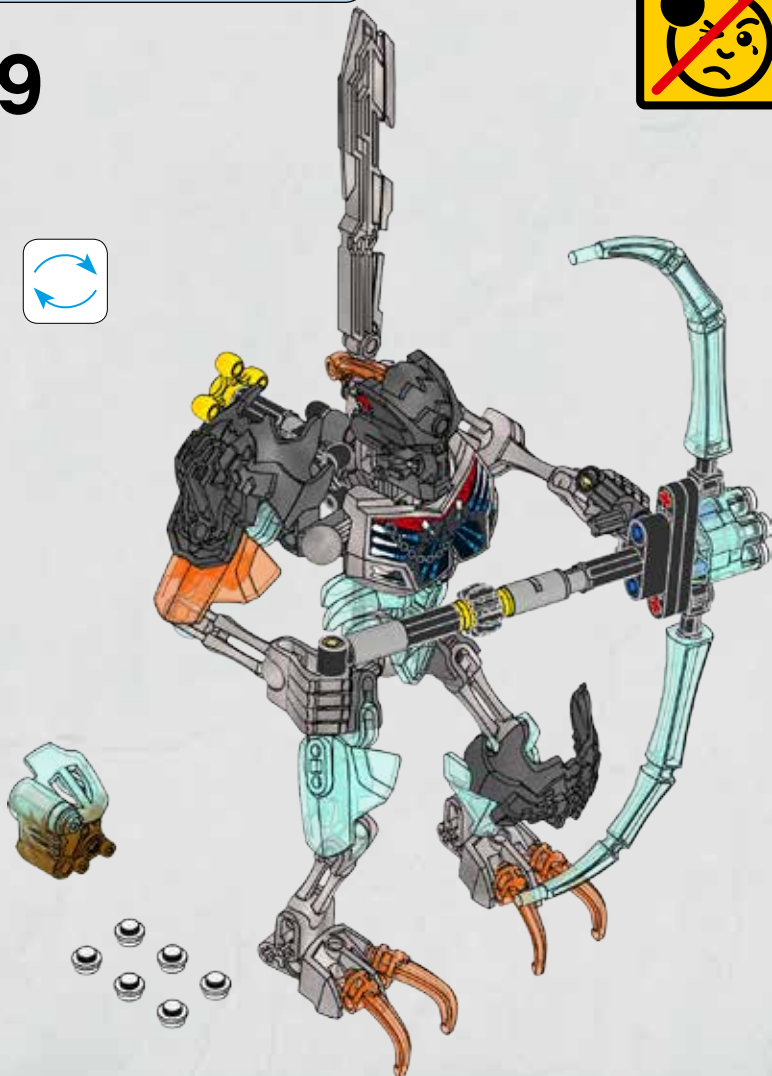

12x  
614101  
3x  
4666579  
5x  
4142865  
3x  
4206482  
2x  
4514553  
2x  
4239601  
1x  
4203493  
1x  
6073231  
1x  
4173970  
1x  
6007966  
2x  
4286267  
2x  
6030286  
1x  
4107783  
3x  
4107081  
3x  
4121715

4x  
4512363  
1x  
370826  
1x  
4177431  
2x  
4248204  
3x  
6043679  
2x  
6064988  
2x  
6029235  
1x  
6114320  
1x  
6100096  
4x  
6021344  
1x  
6102640

12

1x  
6076486  
1x  
6055631  
1x  
4563045  
1x  
4211483  
2x  
4211622  
2x  
4526985  
1x  
4211805  
1x  
6097090  
1x  
6102645  
2x  
6106472

5

7

1x  
4210658  
2x  
6005331  
3x  
6083620  
2x  
6012451  
5x  
6114326  
1x  
6115891  
2x  
4619077  
2x  
6100892

4

1x  
6114412  
1x  
6102606  
1x  
6114379  
1x  
6114577  
2x  
6114328  
1x  
6115785



Customer Service

Kundenservice

Service Consommateurs

Servicio Al Consumidor

LEGO.com/service or dial



: 00800 5346 5555

: 1-800-422-5346



70791



70792



70793



 [LEGO.com/bionicle/bi](http://LEGO.com/bionicle/bi)

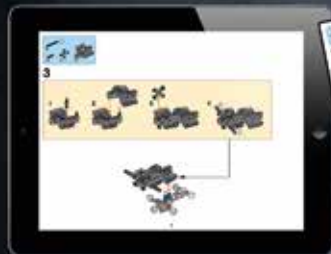

 [LEGO.com/bionicle](http://LEGO.com/bionicle)



Download App  
Télécharger l'application  
Descarga la App



Available on the  
 **App Store**

Apple, the Apple logo, iPad, iPhone and iPod touch are trademarks of Apple Inc.  
Apple, le logo Apple, iPad, iPhone et iPod touch sont des marques de commerce d'Apple Inc.  
Apple, el logotipo de Apple, iPad, iPhone e iPod touch son marcas comerciales de Apple Inc.

GET IT ON  

Google Play is a trademark of Google Inc.  
Google Play est une marque de commerce de Google Inc.  
Google Play es una marca comercial de Google Inc.







70791

70794



70795



70792



70793